



LIBRARY OF

Dr. Z. P. Metcalf

1885-1956



TRANSACTIONS

PROCEEDINGS OF  
Z. P. METCALF AND  
PROC.

OF THE

NEW ZEALAND INSTITUTE

1897

VOL. XXX.

(THIRTEENTH OF NEW SERIES)

EDITED AND PUBLISHED UNDER THE AUTHORITY OF THE BOARD OF  
GOVERNORS OF THE INSTITUTE

BY

SIR JAMES HECTOR, K.C.M.G., M.D., F.R.S.

DIRECTOR

WELLINGTON

JOHN MACKAY, GOVERNMENT PRINTING OFFICE

KEGAN, PAUL, TRENCH, TRÜBNER, & CO., PATERNOSTER HOUSE,  
CHARING CROSS ROAD, LONDON



TRANSACTIONS

OF THE

NEW ZEALAND INSTITUTE



TRANSACTIONS  
AND  
PROCEEDINGS  
OF THE  
NEW ZEALAND INSTITUTE

1897

VOL. XXX.

(THIRTEENTH OF NEW SERIES)

EDITED AND PUBLISHED UNDER THE AUTHORITY OF THE BOARD OF  
GOVERNORS OF THE INSTITUTE

BY

SIR JAMES HECTOR, K.C.M.G., M.D., F.R.S.

DIRECTOR

ISSUED JUNE, 1898

WELLINGTON  
JOHN MACKAY, GOVERNMENT PRINTING OFFICE  
KEGAN, PAUL, TRENCH, TRÜBNER, & CO., PATERNOSTER HOUSE,  
CHARING CROSS ROAD, LONDON

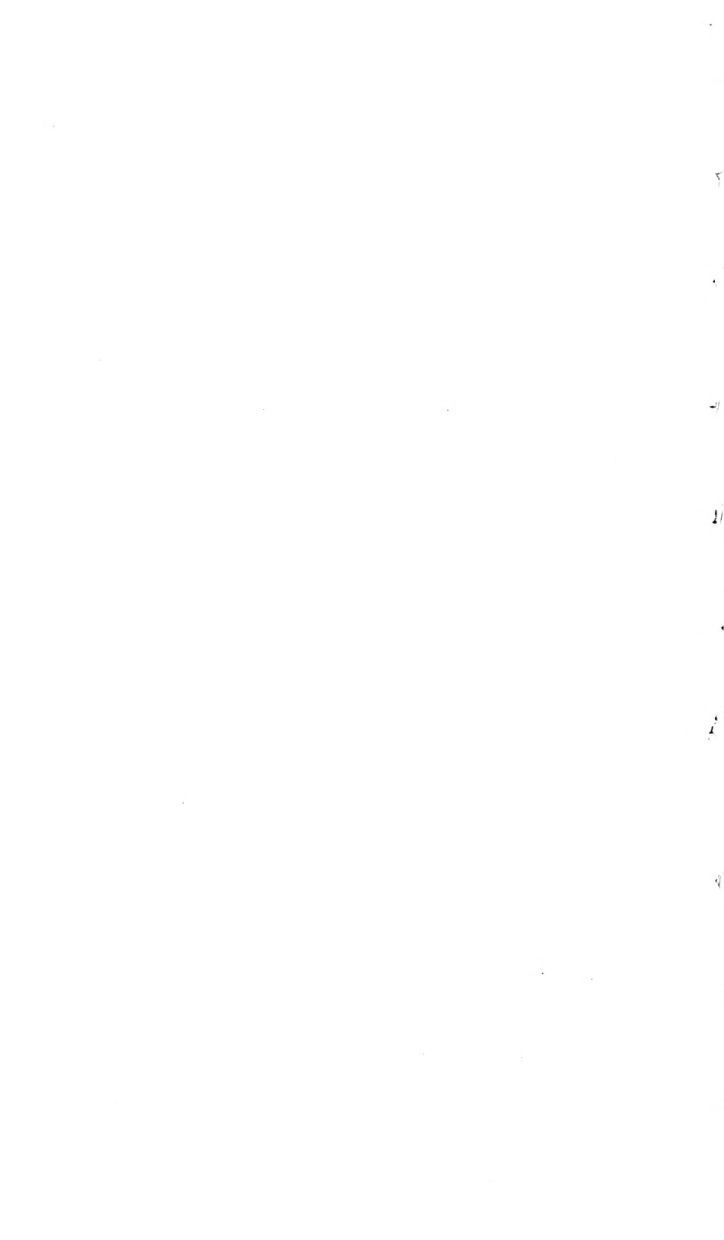

# CONTENTS.

## TRANSACTIONS.

### J.—MISCELLANEOUS.

ART.		PAGES
I.	On Material and Scientific Progress in New Zealand during the Victorian Era. By W. T. L. Travers, F.L.S. . . . .	1- 23
II.	On Rock Pictographs in South Canterbury. By A. Hamilton . . . . .	24- 29
III.	Did the Maori discover the Greenstone? By Joshua Rutland . . . . .	29- 32
IV.	Tuhoe Land: Notes on the Origin, History, Customs, and Traditions of the Tuhoe or Urewera Tribe. By Elsdon Best . . . . .	33- 41
V.	The Building of Hotunui, Whare Whakairo, W. H. Taipari's Carved House at Thames, 1878. Told by Mereana Mekomoko, Widow of the late Chief W. H. Taipari, to Gilbert Mair, 12th July, 1897	41- 44
VI.	The Insulation of Cold Stores. By Professor F. D. Brown . . . . .	44- 49
VII.	Thoughts on Comparative Mythology. By Edward Tregear . . . . .	50- 65
VIII.	The State Prevention of Consumption. By E. Robertson, M.D. . . . .	66- 79
IX.	The Tides, Currents, and the Moon. By W. Buchanan	79- 87
X.	Marsh-lights. By R. Coupland Harding . . . . .	87- 93
XI.	Under the Southern Cross; or, Life in the South Seas: Fairy Tales and Folk-lore.* By F. W. Christian, B.A. . . . .	93-109
XII.	On the Influence of the Ideal. By E. A. Mackechnie	109-118
XIII.	On an Objection to Le Sage's Theory of Gravitation. By C. Coleridge Farr, B.Sc. . . . .	118-120
XIV.	On the Magnetic Force parallel to the Axis in the Interior of Solenoids. [Abstract.] By C. Coleridge Farr . . . . .	121
XV.	Upon a Common Vital Force. By Coleman Phillips	122-130
XVI.	On Maori Stone Implements. By Captain Hutton, F.R.S. . . . .	130-134

---

\* The title printed at head of the article is "On the Outlying Islands."

## II.—ZOOLOGY.

ART. XVII.	The Grasshoppers and Locusts of New Zealand and the Kermadec Islands. By Captain F. W. Hutton, F.R.S., Curator of the Canterbury Museum, Christchurch	PAGES
	.. .. .	135-150
XVIII.	Note on the Ancient Maori Dog. By Captain F. W. Hutton	151-155
XIX.	On a Collection of Insects from the Chatham Islands, with Descriptions of Three New Species. By Captain F. W. Hutton	155-160
XX.	On the <i>Phasmidae</i> of New Zealand. By Captain F. W. Hutton	160-166
XXI.	Synopsis of the <i>Hemiptera</i> of New Zealand which have been described previous to 1896. By Captain F. W. Hutton	167-187
XXII.	Notes on New Zealand Starfishes. By H. Farquhar. Communicated by E. Lukins	187-191
XXIII.	A List of Recent and Fossil <i>Bryozoa</i> collected in Various Parts of New Zealand. By A. Hamilton	192-199
XXIV.	On the Hydroids of the Neighbourhood of Dunedin. By F. W. Hilgendorf, M.A.	200-218
XXV.	On the Occurrence of <i>Pedicellina</i> in New Zealand. By F. W. Hilgendorf	218
XXVI.	Further Coccid Notes: with Description of New Species, and Discussion of Points of Interest. By W. M. Maskell, Registrar of the University of New Zealand, Corr. Mem. Roy. Soc. of South Australia	219-252
XXVII.	Notes on <i>Regalecus</i> Sp. By S. H. Drew, F.L.S.	253-254
XXVIII.	Notes on Occurrence of <i>Regalecus argenteus</i> on the Taranaki Coast. By F. E. Clarke	254-266
XXIX.	Notes on Acclimatisation in New Zealand. By A. Bathgate	266-279
XXX.	Notes on Bird-life in the West Coast Sounds. By Richard Henry. Communicated by Sir J. Hector	279-293
XXXI.	A Romance of Samoan Natural History; or, Records relating to the Manu Mea, or Red Bird of Samoa, now nearly, if not quite, extinct. By the Rev. John B. Stair, late Vicar of St. Arnaud, Victoria, formerly of Samoa. Communicated by E. Tregear, F.R.G.S.	293-303
XXXII.	On Rats, and their Nesting in Small Branches of Trees. By Taylor White	303-309
XXXIII.	Notes on <i>Patellidae</i> , with reference to Species found on the Rocks at Island and Lyall's Bays. By W. T. L. Travers, F.L.S.	309-312
XXXIV.	Notes on New Zealand Sponges: Fourth Paper. By H. B. Kirk, M.A.	313-316
XXXV.	On the Sponges described in Dieffenbach's "New Zealand." By Arthur Dendy, D.Sc., Professor of Biology in the Canterbury College, University of New Zealand	316-320
XXXVI.	Notes on a Remarkable Collection of Marine Animals lately found on the New Brighton Beach, near Christchurch, New Zealand. By Arthur Dendy	320-326
XXXVII.	A Synonymic List of the <i>Lepidoptera</i> of New Zealand. By Richard W. Fereday, F.E.S.	326-377



ART.	III.—BOTANY.	PAGES
XXXVIII.	Description of a New Species of <i>Drimys</i> . By T. Kirk, F.L.S. . . . . .	379-380
XXXIX.	Remarks on <i>Gummera</i> "ovata," Petrie, and <i>G. flavida</i> , Colenso, in Reply to Mr. Petrie. By T. Kirk . . . . .	380-381
XL.	On New Australian and New Zealand Lichens. By James Stirton, M.D., F.L.S. Communicated by T. W. Naylor Beckett, F.L.S. . . . .	382-393
XLI.	A New Classification of the Genus <i>Pyxine</i> . By Dr. James Stirton. Communicated by T. W. Naylor Beckett, F.L.S. . . . .	393-398
XLII.	New Zealand <i>Musci</i> : Notes on a New Species of Moss belonging to the Genus <i>Seligera</i> . By R. Brown . . . . .	398-399
XLIII.	New Zealand <i>Musci</i> : Notes on the Genus <i>Tortula</i> , with Descriptions of New Species. By R. Brown . . . . .	399-409
XLIV.	New Zealand <i>Musci</i> : Notes on the Genus <i>Streptopogon</i> , Wills, with Description of a New Species. By R. Brown . . . . .	409-410
XLV.	New Zealand <i>Musci</i> : Notes on New Genus <i>Dendia</i> . By R. Brown . . . . .	411-412
XLVI.	Notes on New Zealand <i>Musci</i> , and Descriptions of Two New Species. By R. Brown . . . . .	412-414
XLVII.	On the Botany of Hikurangi Mountain. By James Adams, B.A. . . . .	414-433
XLVIII.	Description of a New Native Species of <i>Coprosma</i> . By D. Petrie, M.A., F.L.S. . . . .	433-434
XLIX.	On Curious Forms of New Zealand Fern. By H. C. Field . . . . .	434-435
L.	On the Freezing of New Zealand Alpine Plants: Notes of an Experiment conducted in the Freezing-chamber, Lyttelton. By L. Cockayne . . . . .	435-442
LI.	Notes on the Wangapeka Valley, Nelson. By R. I. Kingsley . . . . .	442-444
IV.—GEOLOGY.		
LII.	Notes on a Specimen of <i>Euryapteryx</i> from Southland. By A. Hamilton . . . . .	445-446
LIII.	Notes on the Recent Earthquake. By H. C. Field . . . . .	447-457
V.—PHYSICS.		
LIV.	On the Screening of Electro-motive Force in the Fields produced by Leyden-jar Discharges. By J. A. Erskine . . . . .	459-462
LV.	On the Relative Commercial Values of Pumice and Charcoal for Purposes of Insulation. By W. T. Firth . . . . .	463-465
LVI.	Notes on the Vertical Component of the Motions of the Earth's Atmosphere. By Major-General Schaw, C.B. (late R.E.) . . . . .	465-476
LVII.	The Histories of the Storms of the 30th January and the 16th April, 1897. By Major-General Schaw . . . . .	477-486

ART.	VI.—CHEMISTRY.	PAGES
LVIII.	On the Distillation Products of the Blackball Coal. By Dr. W. P. Evans .. .. .	487-494
LIX.	On a Convenient Form of Oil-bath for studying the Influence of Definite Temperatures on Solids. By Dr. W. P. Evans .. .. .	495-496
LX.	On the Error introduced by using a Coal-gas Flame while determining the Percentage of Sulphur in Coals, with Especial Reference to the Methods "Eschka" and "Nakamura." By Dr. W. P. Evans .. .. .	496-497
LXI.	On an Improved Adjustable Drip-proof Bunsen Burner. By Dr. W. P. Evans .. .. .	497-498
LXII.	On the Electro-deposition of Gold upon the Gold of our Drifts. By William Skey, Analyst to the Department of Mines .. .. .	498-509
LXIII.	On the Decomposition of Water by Tannic Acid in Conjunction with an Alkali. By William Skey..	509-510
LXIV.	On the Liberation of Hydrogen in a certain Vari- ation of the Apparatus used for cyaniding Gold. By William Skey .. .. .	510-512
LXV.	On the Rapid Action of Strong Cyanide Solutions on Gold superficially. By William Skey..	512-513

## VII.—ADDENDA.

LXVI.	On the Hawke's Bay Plain: Past and Present. By H. Hill, B.A., F.G.S... .. .	515-531
LXVII.	On Swallows and Martins at Hicks Bay. By H. Hill .. .. .	532
LXVIII.	On Maori Middens at Wainui, Poverty Bay. By F. Hutchinson, jun. .. .. .	533-536

## NEW ZEALAND INSTITUTE.

Twenty-ninth Annual Report .. .. .	539-541
Accounts for 1896-97 .. .. .	542

## PROCEEDINGS.

## WELLINGTON PHILOSOPHICAL SOCIETY.

	PAGES
Exhibit of <i>Histiogaster labiosus</i> ; New Zealand Pigeon; &c. ..	546
Remarks on the Manu Mea (Red Bird of Samoa). By F. W. Christian .. .. .	548
Demonstration of Pathological Specimens, illustrating Diseases of Domesticated Animals. By G. H. Barker .. .. .	550-551
On a Specimen of <i>Xiphias gladius</i> , the Northern Swordfish. By Sir J. Hector .. .. .	551-552
Description of Recent Earthquakes, especially that of 21st September. By Sir J. Hector .. .. .	552
Exhibit of New Zealand Quail .. .. .	552
Remark on Earthquake of 21st September. By W. T. L. Travers	552
Nomination of Elector of Governors of the Institute .. .. .	553
Remarks on Mr. Harding's Paper on Will-o'-the-wisps. By W. T. L. Travers .. .. .	553
On the Industries of Animals. By G. Heriot Barker .. .. .	553-554
Remarks on a Skeleton of a Sea-leopardess. By Sir J. Hector	555
Remarks on <i>Scorpio afer</i> . By Sir J. Hector .. .. .	556
Remarks on <i>Parnophorus unguis</i> . By Sir J. Hector .. .. .	556
Remarks on a Tooth of <i>Pseudoscarus</i> sp. By Sir J. Hector .. .. .	556
Remarks on Formol. By Mr. Mestayer .. .. .	556
Election of a Governor of the Institute .. .. .	557
Remarks on a Skeleton of a Sea-lioness. By Sir J. Hector .. .. .	557
Abstract of Annual Report .. .. .	558-559
Election of Officers for 1898. .. .. .	559
Criticism of Mr. P. Marshall's Paper on <i>Dodonidia helmsi</i> , in Vol. xxviii. By E. F. Hawthorne .. .. .	559-560
On <i>Solanum hamiltonii</i> . By T. Kirk, F.L.S. .. .. .	561
Exhibit of Chitons collected by Miss Mestayer .. .. .	561

## AUCKLAND INSTITUTE.

Remarks on the Museum. Inaugural Address by E. Robertson, M.D., President .. .. .	562
"A," a Passage in Archaeology. By Professor Talbot-Tubbs .. .. .	562
On Ore-deposits. By A. Montgomery .. .. .	563
On Insect Life in Gardens. By P. Marshall, F.E.S. .. .. .	563
On "The Ether." By Professor F. D. Brown .. .. .	564
On Corals and Coral Reefs. By Professor A. P. Thomas .. .. .	564
Abstract of Annual Report .. .. .	564-567
Election of Officers for 1898 .. .. .	567

## PHILOSOPHICAL INSTITUTE OF CANTERBURY.

On the Science of History. By Professor E. J. Mathew, M.A., LL.B. .. .. .	568
On Some New Zealand Seaweeds. By R. M. Laing, M.A. .. .. .	568
Exhibit of Winter-flowering Iris and Hybrid Hellebore by L. Cockayne .. .. .	569
On the Evolution of Art. By S. Hurst Seagar, A.R.I.B.A. .. .. .	570
Remarks on the Marsupial Mole ( <i>Notoryctes typhlops</i> ). By Professor Dendy .. .. .	570

	PAGES
Remarks on Palæolithic Implements from Africa. By Captain Hutton .. .. .	571
Remarks on <i>Limulus polyphemus</i> . By Professor Dendy .. .. .	571
Resolution regarding the late Mr. Thomas Kirk, F.L.S. .. .. .	571
Description of Minerals from West Australia. By C. J. Wentworth Cookson .. .. .	571
Resolution regarding the late Professor T. Jeffery Parker, F.R.S. (in Report) .. .. .	572
Abstract of Annual Report .. .. .	572-573
Election of Officers for 1898 .. .. .	573
Hypnotism: Presidential Address. By Dr. Thomas .. .. .	573

## OTAGO INSTITUTE.

Resignation of the President .. .. .	574
By-election of Officers .. .. .	574
Remarks on a Skeleton of <i>Harpagornis</i> . By Professor Parker .. .. .	574
Some Chapters in the History of Zoology. By Professor Parker .. .. .	574
Remarks on <i>Regalecus argenteus</i> . By Professor Parker .. .. .	574-575
Remarks on <i>Haplodactylus meandratius</i> . By Professor Parker .. .. .	575
On the Armour of the Kingsmill Islanders. By Professor Parker .. .. .	575
On a Mask from New Britain. By Professor Parker .. .. .	575
Notes on a Specimen of the Scaled Tunny ( <i>Lepidothynnus huttoni</i> ). By Professor Parker .. .. .	575
Description of Ancient and Modern Gems and Medals, including the Gemma Augusta. By A. Hamilton .. .. .	575-576
Notes on New Zealand Fisheries. By G. M. Thomson, F.L.S. .. .. .	576
Recent Researches on <i>Anaspides</i> . By G. M. Thomson .. .. .	580
Exhibit and Description of <i>Munida subrugosa</i> .. .. .	580
On <i>Cnemionis calcitrans</i> and <i>C. minor</i> . By A. Hamilton .. .. .	581
On Some New Zealand Fresh-water Algae. By J. S. Tennant, B.A., B.S. .. .. .	581
On Some Seaweeds from Dunedin. By J. Crosbie Smith .. .. .	581
Resolution regarding the late Professor T. Jeffery Parker, F.R.S. .. .. .	581-582
Notes on the New Zealand <i>Brachyura</i> . By G. M. Thomson .. .. .	582
A Revision of the New Zealand <i>Anomoura</i> . By G. M. Thomson .. .. .	582
On a New Marine Alga ( <i>Nitophyllum microphylla</i> ). By J. Crosbie Smith .. .. .	582
Abstract of Annual Report .. .. .	582-583
Report of the Committee on the Proposed Marine Fish-hatchery .. .. .	583-584
Election of Officers for 1898 .. .. .	584
On the Undulations of the Ether. Presidential Address by Professor Shand .. .. .	584

## HAWKE'S BAY PHILOSOPHICAL INSTITUTE.

Inaugural Address: On the Civilisation of the Saracens, and what we owe to them. By T. C. Moore, M.D., President .. .. .	585
On the Sun as a Star, and its Place in the Heavens. By T. Tanner .. .. .	585
On Germs and their Relation to Disease. By Dr. J. H. E. Jarvis .. .. .	585
On the Illustration of Books. By W. Dinwiddie .. .. .	586
The Fleeting Maru-iwi walk over Glenshea Cliff at night. By Taylor White .. .. .	586
Have we Remains of a Swimming Swan-like Moa? By Taylor White .. .. .	586
The Ceremony of Rahui. By Taylor White .. .. .	586
Moa—the Bird and the Tree. By Taylor White .. .. .	586
The Customs of the Australian Aborigines. By Dr. Leahy .. .. .	586

A Comparison of New Zealand and Australian Mortality. By C. E. Adams, B.Sc., A.I.A.	By	PAGES
.. .. .	..	586
A Comparison of the Mortality in New Zealand from 1850-70, and from 1870-90. By C. E. Adams	.. .. .	586
The Röntgen Rays. By A. Milne-Thompson, M.B., C.M.	.. .. .	586
Abstract of Annual Report	.. .. .	587
Election of Officers for 1898	.. .. .	587

WESTLAND INSTITUTE.

Abstract of Annual Report	.. .. .	588
Election of Officers for 1898	.. .. .	588

NELSON PHILOSOPHICAL SOCIETY.

List of Donations	.. .. .	589
Abstract of Annual Report	.. .. .	589-590
Election of Officers for 1898	.. .. .	590
Proposal to amalgamate with Nelson Institute	.. .. .	590

---

APPENDIX.

---

Meteorological Statistics for 1897	.. .. .	593
Remarks on the Weather for 1897	.. .. .	594
Earthquakes reported in New Zealand during 1897	.. .. .	595
Honorary Members of the New Zealand Institute	.. .. .	596
Ordinary Members of the New Zealand Institute	.. .. .	597-605
Institutions and Persons to whom this Volume is presented	.. .. .	606-610
Index	.. .. .	611-615

---

Contents	.. .. .	v.-xi.
List of Plates	.. .. .	xiii.
Board of Governors of the New Zealand Institute	.. .. .	xv.
Abstracts of Rules and Statutes of the New Zealand Institute	.. .. .	xv.-xvii.
Roll of Incorporated Societies	.. .. .	xviii.
Officers of Incorporated Societies, and Extracts from the Rules	.. .. .	xviii.-xxi.

---









# NEW ZEALAND INSTITUTE.

---

ESTABLISHED UNDER AN ACT OF THE GENERAL ASSEMBLY OF NEW  
ZEALAND INTITLED "THE NEW ZEALAND INSTITUTE ACT, 1867."

---

## BOARD OF GOVERNORS.

(EX OFFICIO.)

His Excellency the Governor.  
The Hon. the Colonial Secretary.

(NOMINATED.)

W. T. L. Travers, F.L.S.; Sir James Hector, K.C.M.G., M.D.,  
F.R.S.; W. M. Maskell; Thomas Mason; E. Tregear,  
F.R.G.S.; John Young.

(ELECTED.)

1897.—James McKerrow, F.R.A.S.; S. Percy Smith, F.R.G.S.;  
Major-General Schaw, C.B., R.E.

MANAGER: Sir James Hector.

HONORARY TREASURER: W. T. L. Travers, F.L.S.

SECRETARY: R. B. Gore.

---

## ABSTRACTS OF RULES AND STATUTES.

GAZETTED IN THE "NEW ZEALAND GAZETTE," 9TH MARCH, 1868.

### SECTION I.

#### *Incorporation of Societies.*

1. No society shall be incorporated with the Institute under the provisions of "The New Zealand Institute Act, 1867," unless such society shall consist of not less than twenty-five members, subscribing in the aggregate a sum of not less than fifty pounds sterling annually for the promotion of art, science, or such other branch of knowledge for

which it is associated, to be from time to time certified to the satisfaction of the Board of Governors of the Institute by the Chairman for the time being of the society.

2. Any society incorporated as aforesaid shall cease to be incorporated with the Institute in case the number of the members of the said society shall at any time become less than twenty-five, or the amount of money annually subscribed by such members shall at any time be less than £50.

3. The by-laws of every society to be incorporated as aforesaid shall provide for the expenditure of not less than one-third of the annual revenue in or towards the formation or support of some local public museum or library, or otherwise shall provide for the contribution of not less than one-sixth of its said revenue towards the extension and maintenance of the Museum and library of the New Zealand Institute.

4. Any society incorporated as aforesaid, which shall in any one year fail to expend the proportion of revenue affixed in manner provided by Rule 3 aforesaid, shall from thenceforth cease to be incorporated with the Institute.

5. All papers read before any society for the time being incorporated with the Institute shall be deemed to be communications to the Institute, and may then be published as Proceedings or Transactions of the Institute, subject to the following regulations of the Board of the Institute regarding publications:—

*Regulations regarding Publications.*

- (a.) The publications of the Institute shall consist of a current abstract of the proceedings of the societies for the time being incorporated with the Institute, to be intitled "Proceedings of the New Zealand Institute," and of transactions, comprising papers read before the incorporated societies (subject, however, to selection as hereinafter mentioned), to be intitled "Transactions of the New Zealand Institute."
- (b.) The Institute shall have power to reject any papers read before any of the incorporated societies.
- (c.) Papers so rejected will be returned to the society in which they were read.
- (d.) A proportional contribution may be required from each society towards the cost of publishing the Proceedings and Transactions of the Institute.
- (e.) Each incorporated society will be entitled to receive a *proportional* number of copies of the Proceedings and Transactions of the Institute, to be from time to time fixed by the Board of Governors.
- (f.) Extra copies will be issued to any of the members of incorporated societies at the cost-price of publication.

6. All property accumulated by or with funds derived from incorporated societies, and placed in charge of the Institute, shall be vested in the Institute, and be used and applied at the discretion of the Board of Governors for public advantage, in like manner with any other of the property of the Institute.

7. Subject to "The New Zealand Institute Act, 1867," and to the foregoing rules, all societies incorporated with the Institute shall be entitled to retain or alter their own form of constitution and the by-laws for their own management, and shall conduct their own affairs.

8. Upon application signed by the Chairman and countersigned by the Secretary of any society, accompanied by the certificate required under Rule No. 1, a certificate of incorporation will be granted under the seal of the Institute, and will remain in force as long as the foregoing rules of the Institute are complied with by the society.

SECTION II.

*For the Management of the Property of the Institute.*

9. All donations by societies, public departments, or private individuals to the Museum of the Institute shall be acknowledged by a printed form of receipt, and shall be duly entered in the books of the Institute provided for that purpose, and shall then be dealt with as the Board of Governors may direct.

10. Deposits of articles for the Museum may be accepted by the Institute, subject to a fortnight's notice of removal, to be given either by the owner of the articles or by the Manager of the Institute, and such deposits shall be duly entered in a separate catalogue.

11. Books relating to natural science may be deposited in the library of the Institute, subject to the following conditions:—

(a.) Such books are not to be withdrawn by the owner under six months' notice, if such notice shall be required by the Board of Governors.

(b.) Any funds especially expended on binding and preserving such deposited books at the request of the depositor shall be charged against the books, and must be refunded to the Institute before their withdrawal, always subject to special arrangements made with the Board of Governors at the time of deposit.

(c.) No books deposited in the library of the Institute shall be removed for temporary use except on the written authority or receipt of the owner, and then only for a period not exceeding seven days at any one time.

12. All books in the library of the Institute shall be duly entered in a catalogue, which shall be accessible to the public.

13. The public shall be admitted to the use of the Museum and library, subject to by-laws to be framed by the Board.

SECTION III.

The laboratory shall for the time being be and remain under the exclusive management of the Manager of the Institute.

SECTION IV.

(OF DATE 23RD SEPTEMBER, 1870.)

*Honorary Members.*

Whereas the rules of the societies incorporated under the New Zealand Institute Act provide for the election of honorary members of such societies, but inasmuch as such honorary members would not thereby become members of the New Zealand Institute, and whereas it is expedient to make provision for the election of honorary members of the New Zealand Institute, it is hereby declared,—

1. Each incorporated society may, in the month of November next, nominate for election, as honorary members of the New Zealand Institute, three persons, and in the month of November in each succeeding year one person, not residing in the colony.

2. The names, descriptions, and addresses of persons so nominated, together with the grounds on which their election as honorary members is recommended, shall be forthwith forwarded to the Manager of the New Zealand Institute, and shall by him be submitted to the Governors at the next-succeeding meeting.

3. From the persons so nominated the Governors may select in the first year not more than nine, and in each succeeding year not more than three, who shall from thenceforth be honorary members of the New Zealand Institute, provided that the total number of honorary members shall not exceed thirty.

## LIST OF INCORPORATED SOCIETIES.

---

NAME OF SOCIETY.	DATE OF INCORPORATION.
WELLINGTON PHILOSOPHICAL SOCIETY	- 10th June, 1868.
AUCKLAND INSTITUTE	- - - - 10th June, 1868.
PHILOSOPHICAL INSTITUTE OF CANTERBURY	22nd Oct., 1868.
OTAGO INSTITUTE	- - - - 18th Oct., 1869.
WESTLAND INSTITUTE	- - - - 21st Dec., 1874.
HAWKE'S BAY PHILOSOPHICAL INSTITUTE	- 31st Mar., 1875.
SOUTHLAND INSTITUTE	- - - - 21st July., 1880.
NELSON PHILOSOPHICAL SOCIETY	- - - - 20th Dec., 1883.

---

OFFICERS OF INCORPORATED SOCIETIES, AND  
EXTRACTS FROM THE RULES.

## WELLINGTON PHILOSOPHICAL SOCIETY.

OFFICE-BEARERS FOR 1898.—*President*—E. Tregear, F.R.G.S.; *Vice-presidents*—Sir W. L. Buller, F.R.S., G. V. Hudson, F.E.S.; *Council*—T. Kirk, F.L.S.; Major-General Schaw, C.B., R.E.; Sir J. Hector, F.R.S.; R. L. Mestayer, M. Inst. C.E.; H. B. Kirk, M.A.; G. Denton; W. M. Maskell; *Secretary and Treasurer*—R. B. Gore; *Auditor*—T. King.

---

*Extracts from the Rules of the Wellington Philosophical Society.*

5. Every member shall contribute annually to the funds of the Society the sum of one guinea.

6. The annual contribution shall be due on the first day of January in each year.

7. The sum of ten pounds may be paid at any time as a composition for life of the ordinary annual payment.

14. The time and place of the general meetings of members of the Society shall be fixed by the Council, and duly announced by the Secretary.

---

## AUCKLAND INSTITUTE.

OFFICE-BEARERS FOR 1898.—*President*—Professor H. A. Talbot Tubbs; *Vice-presidents*—E. Robertson, M.D., D. Petrie, F.L.S.; *Council*—G. Aickin, J. Batger, W. Berry, Professor F. D. Brown, C. Cooper, E. A. Mackechnie, T. L. Murray, T. Peacock, J. Stewart, C.E., Professor A. P. Thomas, F.L.S., J. H. Upton; *Trustees*—E. A. Mackechnie, S. P. Smith, F.R.G.S., T. Peacock; *Secretary and Curator*—T. F. Cheeseman, F.L.S., F.Z.S.; *Auditor*—W. Gorrie.

*Extracts from the Rules of the Auckland Institute.*

1. Any person desiring to become a member of the Institute shall be proposed in writing by two members, and shall be balloted for at the next meeting of the Council.

4. New members on election to pay one guinea entrance-fee, in addition to the annual subscription of one guinea, the annual subscription being payable in advance on the first day of April for the then current year.

5. Members may at any time become life-members by one payment of ten pounds ten shillings in lieu of future annual subscriptions.

10. Annual general meeting of the society on the third Monday of February in each year. Ordinary business meetings are called by the Council from time to time.

PHILOSOPHICAL INSTITUTE OF CANTERBURY.

OFFICE-BEARERS FOR 1898.—*President*—Dr. W. P. Evans; *Vice-presidents*—Mr. R. Speight and Mr. L. Cockayne; *Hon. Secretary*—Professor Dendy; *Hon. Treasurer*—Captain Hutton; *Council*—Dr. Thomas, Messrs. H. R. Webb, R. M. Laing, T. W. Naylor Beckett, J. B. Mayne, and Dr. Symes.

*Extracts from the Rules of the Philosophical Institute of Canterbury.*

8. Members of the Institute shall pay one guinea annually as a subscription to the funds of the Institute. The subscription shall be due on the 1st November in each year.

The Institute may also admit associates, who shall contribute five shillings annually to the funds of the Institute, and shall have all the privileges of members, except that they shall not have the power to vote, or be entitled to the annual volume of the Transactions.

9. Members may compound for all annual subscriptions of the current and future years by paying ten guineas.

15. The ordinary meetings of the Institute shall be held on the first Wednesday in each month during the months of May to October, both inclusive.

OTAGO INSTITUTE.

OFFICE-BEARERS FOR 1898.—*President*—F. R. Chapman; *Vice-presidents*—Professor J. Shand and A. Bathgate; *Hon. Secretary*—A. Hamilton; *Hon. Treasurer*—J. S. Tennant; *Council*—Professor J. H. Scott, A. Wilson, E. Melland, Dr. T. M. Hocken, G. M. Thomson, J. Crosbie Smith, B. C. Aston; *Auditor*—D. Brent.

*Extracts from the Constitution and Rules of the Otago Institute.*

2. Any person desiring to join the society may be elected by ballot, on being proposed in writing at any meeting of the Council or society by two members, and on the payment of the annual subscription of one guinea for the year then current.

5. Members may at any time become life-members by one payment of ten pounds and ten shillings in lieu of future annual subscriptions.

8. An annual general meeting of the members of the society shall be held in January in each year, at which meeting not less than ten members must be present, otherwise the meeting shall be adjourned by the members present from time to time until the requisite number of members is present.

(5.) The session of the Otago Institute shall be during the winter months, from May to October, both inclusive.

---

#### WESTLAND INSTITUTE.

OFFICE-BEARERS FOR 1898.—*President*—Mr. D. Macfarlane; *Vice-president*—Mr. T. H. Gill; *Hon. Treasurer*—Mr. G. Sinclair; *Trustees*—Messrs. A. H. King, W. Heinz, A. Mahan, J. Chesney, J. J. Clarke, T. W. Beare, H. L. Michel, A. J. Morton, J. S. Dawes, H. R. Lawry, Dr. Macandrew, and Rev. S. Hamilton.

---

#### *Extracts from the Rules of the Westland Institute.*

3. The Institute shall consist (1) of life-members—*i.e.*, persons who have at any one time made a donation to the Institute of ten pounds ten shillings or upwards, or persons who, in reward of special services rendered to the Institute, have been unanimously elected as such by the Committee or at the general half-yearly meeting; (2) of members who pay two pounds two shillings each year; (3) of members paying smaller sums, not less than ten shillings.

5. The Institute shall hold a half-yearly meeting on the third Monday in the months of December and June.

---

#### HAWKE'S BAY PHILOSOPHICAL INSTITUTE.

OFFICE-BEARERS FOR 1898.—*President*—A. Milne-Thomson, M.B., C.M.; *Vice-president*—T. Tanner; *Council*—W. Dinwiddie, H. Hill, B.A., F.G.S., J. Hislop, J. E. H. Jarvis, M.R.C.S., T. C. Moore, M.D., G. White; *Hon. Secretary*—C. E. Adams, B.Sc., A.I.A.; *Hon. Treasurer*—J. W. Craig; *Hon. Auditor*—J. R. Crerar.

---

#### *Extracts from the Rules of the Hawke's Bay Philosophical Institute.*

3. The annual subscription for each member shall be one guinea, payable in advance on the first day of January in every year.

4. Members may at any time become life-members by one payment of ten pounds ten shillings in lieu of future annual subscriptions.

(4.) The session of the Hawke's Bay Philosophical Institute shall be during the winter months from May to October, both inclusive; and general meetings shall be held on the second Monday in each of those six months, at 8 p.m.

SOUTHLAND INSTITUTE.

OFFICE-BEARERS. — *Trustees* — Ven. Archdeacon Stocker, Rev. John Ferguson, Dr. James Galbraith.

---

NELSON PHILOSOPHICAL SOCIETY.

OFFICE-BEARERS FOR 1898.—*President*—The Bishop of Nelson; *Vice-presidents*—Mr. A. S. Atkinson and Dr. Mackie; *Council*—Dr. Boor, Rev. F. W. Chatterton, Messrs. Gibbs, Lukins, and Bartell; *Hon. Secretary*—R. I. Kingsley; *Hon. Treasurer*—Dr. Hudson; *Hon. Curator*—R. I. Kingsley; *Assistant Curator*—E. Lukins.

---

*Extracts from the Rules of the Nelson Philosophical Society.*

4. Members shall be elected by ballot
6. The annual subscription shall be one guinea.
7. The sum of ten guineas may be paid in composition of the annual subscription.
16. Meetings shall be held on the second Monday in every month.
23. The papers read before the Society shall be immediately delivered to the Secretary.





# TRANSACTIONS



TRANSACTIONS  
OF THE  
NEW ZEALAND INSTITUTE,  
1897.

---

I.—MISCELLANEOUS.

---

ART. I.—*On Material and Scientific Progress in New Zealand during the Victorian Era.*

By W. T. L. TRAVERS, F.L.S.

[*Read before the Wellington Philosophical Society, 30th June, 1897.*]

PRESIDENTIAL ADDRESS.

IT is a matter of history that the systematic colonisation of these islands was first proposed by a private association, formed in 1826, under the title of "The New Zealand Company," and that it proceeded so far in the practical initiation of its project as to purchase lands for settlement at Hokianga and the Thames. But notwithstanding the influential position of a large number of its members it was prevented by adverse circumstances, easily understood at the time by those who were acquainted with the then condition of the native population and with the history of the missionary settlements established in the north, from carrying its objects into effect, and it was consequently dissolved. Its project was afterwards taken up by a body of persons of high position in the social and political world, under the title of "The New Zealand Association," which, before attempting any active colonising operations, applied itself diligently in directing the public mind in England to an appreciation of the advantages offered by these islands as a field for emigration, its aim being to induce the Legislature to apply to them a system of colonisa-

tion similar to that which had recently been successfully applied to South Australia under the auspices of "The South Australian Colonisation Society," in the formation and active labours of which Mr. Edward Gibbon Wakefield had taken a prominent part, as, indeed, he was then doing in connection with the New Zealand Association. It was not, however, until the first year of Her Majesty's reign that the British Government were approached upon the subject by the promoters of the movement; but ultimately, in 1837, after protracted negotiations, it was induced to offer to incorporate the association by royal charter, authorising it to carry out the colonisation of the islands upon the indicated lines, but it insisted, as a condition precedent, that the members of the association should be converted into an ordinary joint-stock company with capital sufficient to insure the success of its project. In which case the Government expressed its willingness to confide to it the settlement and government of the projected colony for a short term of years. This offer, however, was clogged with conditions so completely at variance with the main objects of the association that it was compelled to refuse it, and, no hope being held out of any modification of the obnoxious conditions, the negotiations came to an end.

Under these circumstances, Lord Durham, who was one of the most influential members of the association, was induced to bring the colonisation of the islands under the consideration of a Select Committee of the House of Lords, which, after collecting a large mass of useful information relating to them, and proving the necessity of their being systematically colonised, declined to make any recommendation on the subject, being of opinion that "the extension of the British colonies was a question belonging exclusively to the Crown."

Not discouraged by this, the association caused a Bill to be introduced by its chairman, the Hon. Mr. Baring, into the House of Commons, making provision for the objects in view; but the Bill was rejected on the second reading, to the great disappointment of its promoters, as well as of a large number of influential and enlightened persons who were interested in the matter on public grounds. Still, nothing daunted by the apparently insuperable difficulties in the way, some of the leading members of the association, bearing in mind the suggestion made when a charter was offered by the Government, formed themselves into a joint-stock company, under the title of "The New Zealand Company," which, on the 2nd May, 1839, issued a prospectus in which the main objects were declared to be the acquisition of territory in New Zealand and its sale to settlers at a uniform and sufficient price, whilst, as an inducement to purchasers, it was proposed to set apart a large proportion of the purchase-

money as a fund for promoting further emigration. It also set forth, as a salient point, that the interests of the native people from whom the required territories were to be bought, should be safeguarded. In order to carry these objects into practical effect the company at once proceeded to despatch ships and people to the islands, and between the date of the prospectus and the 24th February, 1840, no less than twelve shups were sent out, carrying 1,125 emigrants, of whom 158 were first-class passengers, 58 second-class, and 909 steerage, of the total of whom 658 were males and 467 were females.

Negotiations were then again opened with the Government for a charter, but it was not until the 12th February, 1841, after long and tedious correspondence and discussion, that the company succeeded in obtaining from the Crown this necessary sanction to its operations; and it is matter of history that, even after that concession had been made, its operations were systematically thwarted by the Colonial Office, instigated thereto by the missionaries and settlers in the north, and by the undisguisedly hostile reports of Governor Hobson and his immediate successors. In the long run, however, the indomitable pluck of the company's settlers prevailed, and it is certain that the Crown of England is indebted to their energy and perseverance for its possession of a colony of which any Empire might be proud.

You are no doubt aware that in the year 1788 a penal settlement was formed by the British Government at Port Jackson (now called Sydney), in New South Wales. The first batch of convicts, numbering 705, was sent out under the charge of Captain Phillip—who, on his arrival, became first Governor of the settlement—and that these were partly preceded and partly accompanied by voluntary emigrants, bringing up the number of its first inhabitants to 1,030. The settlement thus founded rapidly increased in population, and in the course of a few years after its foundation the vast number of whales which were found to haunt the waters between Australia and New Zealand attracted many ships engaged in the whale-fishery, and the pursuit of this industry, which was highly productive, gave an additional impetus to the progress of the settlement. This also naturally led to intercourse between Sydney and New Zealand, which became largely extended between the years 1815 and 1825, when considerable numbers of whaling and other vessels visited the harbours on the eastern coast of this Island, from the Waitemata northward, partly for the purposes of the trade in timber, flax, and human heads, and partly in order to obtain supplies of pork, potatoes, fish, and other fresh provisions, which were then produced in considerable

quantities by the natives. The result of this intercourse was that many Europeans settled in the districts north of the Thames, and particularly on the banks of the Hokianga, at the Bay of Islands, and at the Waitemata, introducing at the same time horses, cattle, and poultry, and fruits and vegetables of all kinds, which thrived wonderfully. These settlers were the agents through whom the trade with the natives was carried on, and there can be no doubt that they also thrived wonderfully. At first all transactions were carried on by barter; but this gradually gave way to the introduction of British coin and dollars, the natives having speedily become aware that they could procure anything they wanted in exchange for money, whilst the system of barter had subjected them, at the hands of the Europeans, to practices of the most rascally kind, which, however, were after a time met with corresponding knavery on the part of the natives, each party at last striving which should most completely overreach the other in its dealings. But even this change of system did not altogether save the natives from imposture, and spurious silver coin and gilded farthings still helped the European rogue, until at last the natives became so alive to the risks they ran in their dealings that they declined to trade with persons of whose honesty they had not ample proof, or unless a third person were present to vouch for the genuineness of the coin offered to them.

But whilst this was the condition of things to the north of the Thames, little had been done to mitigate the barbarous condition of the natives to the south, for until the arrival of the first colonists sent out by the New Zealand Company there were in the south no settlements of the class established at Hokianga and the Bay of Islands. Here and there along the coast between Wellington and Taranaki, and in Queen Charlotte Sound and Cloudy Bay, a few whalers were to be found, who had left their ships and contracted irregular marriages with native women; and some trade in flax had been established, for which muskets and powder were chiefly given in exchange. In all other respects, however, the condition of things was entirely different from that which existed in the northern settlements, where the influence of trade and missionary teaching had, especially between the years 1835 and 1839, greatly modified the habits, customs, prejudices, and superstitions of the native people. Indeed, in the southern parts of this Island and in the South Island the natives were practically in the same condition of barbarism as when they were seen by Cook, in proof of which I may cite a letter to the Company, written on the 13th October, 1839, by Colonel Wakefield, in which he mentioned that "only a week before that date Rauparaha had killed and cooked a man (probably a

slave) to afford a treat to some chiefs of the Ngatiraukawa who had assembled at Mana upon the occasion of a *tangi* for his sister's death;”\* whilst he also mentions that shortly before that occurrence “the Ngatiraukawa had killed six native missionaries who had wandered amongst them, and eaten their bodies, and then offered their heads for sale to his informant.” He also mentions that on the 15th October, 1839, the day before his first interview with Rauparaha, a great battle had taken place near Otaki between the Ngatiraukawa and Ngatiawa, in which nearly sixty men had been killed, and a very much larger number seriously wounded. I must not omit, however, to state that about this time the Rev. Octavius Hadfield, late Bishop of Wellington, had been stationed at Waikanae, and that his presence there soon afterwards brought about a great and beneficial change in the feelings and habits of the native people. In a letter written by Colonel Wakefield to the secretary of the New Zealand Company in February, 1842, he thus points to the results of Mr. Hadfield's labours: “Mr. Hadfield, who is a single-minded and a sincere minister of the Gospel, well deserves the estimate in which he is held by all parties in Cook Strait. Instead of jealously asserting the rights of the Church mission to land, or intermeddling respecting purchases from the natives, he has confined himself strictly to the duties of his calling as a missionary. He has brought about a permanent peace between the Ngatiawa Tribe and the fierce Ngatiraukawas, whom he has Christianized, and has devoted himself to the spiritual and medical charge of the native and white population, who occupy a coast-line of fifty miles, besides making occasional and harassing visits across the strait to the Southern Island. His health has suffered much from this service. He has always refrained from, and, it is understood, has declined, any interference in the secular affairs of the natives otherwise than by recommending a peaceful intercourse with their white neighbours upon all occasions.” From this it will be seen that the labours of Mr. Hadfield must undoubtedly have had a most beneficial effect upon the progress of the company's settlers during the first three years after their establishment in this district.

This short account of the first systematic effort at colonisation in the southern districts of this Island will no doubt convey to you some idea of the difficulties which the settlers had to overcome; but those difficulties were rendered all the

---

\* I have reasons for believing that the story as told to Colonel Wakefield was not strictly correct, and that it was Rangihaeata who had committed the deeds referred to, and that it was a young woman, and not a man, who had been the victim.

more serious by the physical character of the country and by the attitude which the first and some of the succeeding Governors of the colony adopted towards them.

In an address delivered in this building nearly thirty years ago I pointed out that before the settlement of these islands by the Europeans the native inhabitants were barbarous beyond conception, and practised rites of so foul a kind that the very existence of such rites was often doubted by modern writers. And yet these people possessed characteristics which were calculated to redeem them to a considerable extent, even in the eyes of civilised man. Brave to a fault, having a clear perception of the distinctions of rank, and therefore proud, they also possessed a large amount of intellectual capacity and even of latent moral character. Acute in their understanding and comprehension, they rapidly fell in with many of the arts and habits of the colonists, but, unaccustomed to the restraints of civilised life, and in the habit of indulging with little check their natural impulses, they found it difficult to adopt, as fully as their own appreciation of them would otherwise lead them to do, the social habits of the Europeans. Unfortunately, also, too little regard was shown to their feelings of pride and nationality, and, by the ridicule with which their habits and manners were treated, they had been driven to adopt, as individuals as well as collectively, a position of isolation, if not of hostile feeling towards the Europeans. Without having introduced amongst them any form of government more suited to promote and foster our intercourse with them, we broke down the power and influence of the greater chiefs, and induced a consequent disorganization of their own social condition. It is not, however, my purpose any further to pursue this inquiry, which belongs rather to the political economist and the legislator than to the student of geography and natural history, and I will proceed at once to call your attention to the general physical appearance presented by these islands prior to their colonisation, to the character of their fauna and flora, and to the changes which have since been effected and are now in progress.

Stretching from the 34th to the 47th degree of south latitude, in a general north-and-south direction, with an average breadth in the South Island not exceeding 120 miles, and in the North Island (except above Auckland) of about 150 miles, the whole extent may be treated as a great mountain-chain divided into two portions by Cook Strait. In the North Island there are, in the west and north-western sides of this chain, several large volcanic cones, some of the mountains of which rise to altitudes varying from 4,000 ft. to 9,000 ft. above sea-level, and of which Tongariro, nearly in the centre of the greater mass of the Island, is still active.



In the South Island the chain extends from the north (in the form of spurs radiating from the Spencer Mountains on the west side and from the Kaikoura Mountains on the east) to the extreme south, attaining its greatest elevation in Mount Cook, whilst in many places it reaches an altitude of 10,000 ft., and has a general elevation of from 6,000 ft. to 8,000 ft. In the South Island, with the exception of the Canterbury Plains and the undulating country to the north and south of them, stretching on the one side to the Waiau River and on the other to the extreme south of the Island, there was little in the general appearance of the country to induce any high idea of its capacity for sustaining a large agricultural population; nor did the North Island present, at first sight, any better field for agricultural occupation, although on the eastern side it also possesses plains—in the Hawke's Bay and Wairarapa districts—and the country, on the west coast, from Otaki to the Manukau, probably contains some of the most fertile land in the world. The eastern sides of both islands, including the slopes of the mountain-chains, contained large tracts of grassy country available for pastoral purposes, but, as a rule, the whole of the western sides were clothed with dense forest. It has been found, however, that the slopes of the mountain-chains contain excellent soil, and that when cleared of the forest growth they are capable, under proper cultivation, of being converted into valuable pasture land. The whole country may be said to be well, and in many places profusely, watered, and the native growth usually luxuriant to a degree.

It must be manifest that, in islands having so large a range of latitude as these, there must be a corresponding range in climate, and accordingly we find that, whilst in the extreme north the climate is sufficiently warm to ripen freely many of the fruits of the tropics, and that even in the neighbourhood of Auckland the citron, the orange, and the guava mature their fruit, so as we pass to the south we find it eminently suited to the production of all the varied fruits and vegetables which make the luxury of temperate climates.

It would lead me too far (nor, indeed, is it necessary in addressing a New Zealand audience) were I to attempt any detailed description of the physical aspects of the country or its climate, and the general outline I have given will be sufficient for my purpose. To the first colonists it undoubtedly presented the appearance of a country in a practically untouched condition, covered, in its forest-lands, with the growth of untold centuries, and in its open lands with grasses, ferns, and swamp-loving plants to which their eyes were totally unused, and which differed in all important respects from the wild growth of Europe.

I had intended to describe in some detail the organic natural productions of the country, but this address would then stretch to an inconvenient length, and I must leave it to your local knowledge on these points to fill up the void. This is, perhaps, the less important, for with the exception of grasses made available in their uncultivated state for depasturing purposes, and of timber used for building and other purposes, it may be said that little had been done towards utilising them, and still less towards ascertaining their properties and value. It is true that the fibre of the *Phormium tenax* had been prepared as, and still continues to be, an article of export, and if properly managed would no doubt still yield an excellent return, but I know of no other natural vegetable production of the country (unless we can give that name to kauri-gum) which had before the colonisation been turned to account.

You are all aware that the mineral resources of these islands are very large and very varied, but it is clear that the natives had no knowledge which would enable them to utilise them, for we found them still using stone and wooden weapons similar to those which in Europe characterized the middle epoch of the Neolithic age.

Such, in brief, was the condition of the country when the first settlers, acting under the impulses which ordinarily inspire modern colonists, were thrown upon it. And now how changed has it all become! Instead of the miserable pas and kaingas of an utterly barbarous race, we have a number of flourishing cities and towns inhabited by thousands of Europeans, and many of them possessing buildings which present all the characteristics of wealth and durability. Instead of the solitary canoe of the native fisherman, or the fleet of a war-party intent upon murder and rapine, our waters teem with ships busily engaged in the peaceful work of commerce, whilst large and valuable works in our various ports give facilities for the carrying-on and development of that commerce. Instead of our great tracts of native pasture lying idle, and yielding no useful living thing, they are now roamed over by and maintain large herds of cattle and flocks of sheep. Instead of the desolate but luxuriant vegetation of the swampy ground along many parts of our seaboard, and the impenetrable forests of many of our valleys, we have rich fields, producing the grain and other crops of temperate Europe. Instead of the narrow bush-track along which the savage travelled on his mission of revenge, we have railways and ordinary roads penetrating the country in all directions, and facilitating the maintenance of that intercourse which is essential to the progress of the community in wealth and civilisation. Instead of the mineral resources of the country

lying idle, we have thousands of men busily engaged in extracting them from the soil, and thus, whilst maintaining themselves, contributing to the general public wealth. We have, indeed, on all sides of us abundant evidence that the energies of our race are rapidly converting a country which in its natural state scarcely afforded means for the sustenance of man into one capable not only of maintaining a contented population, but of affording the materials for keeping alive and extending an already great foreign commerce.

The rapidity of such changes, too, strikes the onlooker with astonishment, and is inconceivable to those who have not witnessed it for themselves. In 1839 the "Tory" first visited Cook Strait on its colonising mission, and then found the natives engaged in a bloody feud, and exhibiting the most forbidding habits of savage life. All was strange and wild. Barely sixty years have elapsed since then, and already large cities have arisen in many parts of the islands. Everywhere the broad sheets of the Press are engaged in diffusing information, and in discussing the politics and wants of a civilised people. The clearing, the farm, the industrial settlement have displaced the scanty cultivation of the Maori and his ephemeral hut. The progress of a single year outspeeds the work of past centuries, and amid the charred stumps of our hill-side forests and the rough clearings of our farms we already see handsome villas surrounded with luxurious plantations and the comfortable homesteads of a contented and thriving agricultural population, whilst on every side we find the mechanical appliances of a civilised people doing their work and promoting the wealth and comfort of the settlers. The extent of these changes is emphasized when we contrast the early and present conditions of our trade and commerce, of which the following extracts from the statistics of the colony will afford some idea.

In 1854, when the General Assembly first sat, the population of the colony (exclusive of Maoris) was 32,554, and its revenue £30,000 a year at most. In April, 1896, the population (exclusive of Maoris) was 703,360, showing an increase in forty-two years of 670,806 persons; whilst for 1895 its revenue was £4,610,402, and its public debt (exclusive of the amounts owing by local bodies) reached the modest sum of £43,050,780. In 1854 the number of letters received and despatched was 138,482. In 1894 the number was 52,168,336. In 1866 the number of telegrams despatched was 48,231; in 1896 the number was 2,124,211. In 1854 the number of ships inwards was 293, with a tonnage of 74,831, and outwards 293, with a tonnage of 76,718. In 1895 the number inwards was 611, with a tonnage of 672,951, and outwards 597, with a tonnage of 648,946. In 1854 the export of wool

was 1,071,340 lb., of the value of £70,103; in 1895 it was 116,015,170 lb., of the value of £3,662,131; whilst the total value exported up to 1895 amounts to £101,325,079. In 1854 the export of grain was 93,700 bushels, of the value of £41,019 (a creamy time for the agriculturist); and in 1895 it was 2,381,837 bushels, of the value, unfortunately, of only £215,783. In 1882 the export of frozen sheep was 15,244 cwt., of the value of £19,339 (a creamy time for the sheep-farmer); and in 1895 1,134,097 cwt., of the value of £1,262,711. In 1854 we exported 1,660 tons of kauri-gum, of the value of £28,864; and in 1895 7,425 tons, of the value of £418,760. In 1857 we exported gold to the value of £40,440, and in 1895 to the value of £1,162,181, whilst the total value exported during the whole period reached £51,127,171. In 1854 we exported provisions, tallow, timber, &c., to the value of £179,341, and in 1895 to the value of £1,162,181. In 1854 our total exports reached £891,201, and in 1895 they reached £8,390,153; whilst our total exports from 1854 to 1895, both years inclusive—and chiefly to England—reached the sum of £215,000,000—the produce of the colony.

When to this we add the consumption of its products by the people of the colony, the total value of its production must have been enormous, and apparently disproportionate to the number of its population.

In 1858 the total number of horses, cattle, sheep, and pigs was as follows: Horses, 14,912; cattle, 137,204; sheep, 1,523,324; and pigs, 40,734. In 1895 the numbers were: Horses, 237,413; cattle, 1,047,901; sheep, 19,826,604; and pigs, 239,778. In 1857 the area of land in cultivation was 121,648 acres, and in 1895 it reached 10,698,809 acres. The deposits in ordinary banks were as follows: in 1857, £343,316, and in 1895, £13,544,415; and in savings-banks—1858, £7,862, and in 1895, £4,620,696. The number of miles of railway open in 1895, exclusive of 167 miles of private railway (of which eighty-four belong to the Wellington and Manawatu Railway Company), was 2,014, yielding a revenue of £1,183,041.

In view of these facts, and of others of like import which might be quoted, the newly-aroused enthusiasm in England in relation to the colonies is not much to be wondered at.

Having thus dealt with the material progress of the colony during the past sixty years, I now propose to point out, in a necessarily general way, its progress in science since its foundation. At the first meeting of the Royal Geographical Society which took place after the commencement of Her Majesty's reign the president, in addressing the Queen, who was present, mentioned that England had achieved some of her greatest triumphs in geographical discovery under the sove-

reignty of a Queen, instancing the exploits of Drake and Raleigh during the reign of Queen Elizabeth, and confidently predicted that Her Majesty's reign would be equally famed for the promotion of geographical knowledge. We all know how fully this prediction has been fulfilled, and how, during the last sixty years, English explorers have given Her Majesty's name to dominant features in every part of the globe. I am pleased at being able to state that we have amongst us one of those who, during that period, took part in a very important work of this class. I allude to the expedition sent out by the British Government in 1857 to explore and report upon the British possessions in North America which lie to the west of Lake Superior, in which expedition Sir James Hector was a prominent actor. It is probably within the knowledge of some of you that to his exploration of that part of the Rocky Mountains range which lies within British Columbia the promoters of the Canadian-Pacific line of railway owe their knowledge of the pass through which it traverses this stupendous chain, this pass having, in fact, received its name—"The Kicking-horse Pass"—from an adventure which proved nearly fatal to the explorer. The mere fact of Sir James Hector having traversed this pass might not have given it any special importance, but the circumstance that he then pointed out its suitability over all other known passes through the British portion of the chain for railway purposes gives special value and importance to his labours, and marks him as one of those whose capacity and judgment justified his selection for the work. Those who have had the pleasure of reading his admirable reports of these explorations, published as a parliamentary blue-book, and of examining the accompanying maps and sections, cannot fail to recognise in Sir James one justly entitled to distinction amongst the band of explorers and men of science whose sheaves of discovery have contributed so much, during the last sixty years, to our knowledge of the physical features of the globe. The following extract from a short account of Sir James's work by Mr. Edward Cox will give you some idea of its arduous nature on that occasion:—

"Besides the regular summer work, Sir James Hector made arduous winter journeys on foot with snow-shoes and dogs, so as to thoroughly master the features of the country at all seasons of the year. On these journeys he was accompanied by two of the men, and for months they slept every night in the snow, with the temperature sometimes at 50° Fahr. below zero. Each winter season during the expedition Sir James walked over twelve hundred miles in this fashion, living on pemmican and any chance game that might be caught or shot. During the early summer months the expedition traversed the open prairies, and autumn was devoted to

the exploration of the Rocky Mountains. Sir James discovered five different passes, ascertaining their altitudes, and surveying their features. One of these passes, named after an accident that nearly cost him his life, is that which he recommended, and has been chosen, for the great trans-continental Canadian railway, now almost completed. The extent of country traversed by the expedition was mapped by Sir James, both topographically and geologically, and described in the parliamentary blue-book. A great part of that region was then untrudden, except by Indians, but is now partially settled and traversed by roads and railways. The difficulties which beset its exploration have all disappeared, and elaborate surveys, since made in comparative ease and comfort, testify to the accuracy of the work done by Sir James, and to the justness of his deductions respecting the structure of the country and its availability for settlement. At the close of the expedition, before returning to England, he examined and reported upon the coal-mines of Vancouver Island, and made extensive journeys in order to acquaint himself with the goldfields of British Columbia and California and with some of the mines of Northern Mexico. He returned by Panama and the West Indies; and, on reaching England, besides giving official reports, he laid the result of his work in the various branches of research before the different scientific societies, to which they were of high interest. For the geographical discoveries effected by the expedition the gold medal of the Royal Geographical Society was awarded in 1861."

After Sir James's return to England he received two offers of engagement from Sir Roderick Murchison, then Director-General of the Geological Survey of Great Britain—one to undertake a mission as Political Agent and Geologist to Cashmere, with large emoluments in prospect, and the other as Geologist to the Provincial Government of Otago. More fortunately for the colony than for Sir James he chose the latter, and those who know the extent of his labours for the last thirty-three years in all branches of science, and the indomitable energy with which he has explored a large part of the most rugged and difficult regions of the colony, can have no hesitation in classing him as a good and faithful servant, fully entitled to all the honours which have been conferred upon him by the great scientific bodies of Europe and America.

Many minor explorations were made during the years preceding and following those made by Sir James, some of them under extraordinary difficulties, of which the chief was that of obtaining food. Of this class were the journeys undertaken by the late Major Heaphy and Sir Julius von Haast from Nelson to the Grey, through the vast mountain-

ranges, densely covered with forest, which lie between the valley of the Buller and the mouth of the Grey; the explorations of the great tract of mountain country which forms the western part of the Provincial Districts of Otago and Southland; the explorations of the various passes between the Nelson District and the Canterbury Plains by the late Sir Frederick Weld and myself; the exploration by myself of the country on the eastern side of the Spencer Mountains, during which I examined the Cannibal's Gorge, famous in the history of the South Island natives; and explorations undertaken for the discovery of practicable routes through the central portion of the Southern Alps, between Canterbury and Westland. Many of these various explorations were carried out by surveyors engaged in laying off and mapping the districts required for settlement, and the reports of all these explorations have, in effect, given us a very detailed knowledge of the geography of the colony.

In dealing with the progress of geographical discovery in the east, Mr. Hugh Robert Mill pointed out that the operations of the State Survey Department in India constituted a most remarkable portion of the geographical advance in Asia during the last sixty years. I wish I could say that the work of the Survey Department in this colony deserved to be characterized in the same manner, but my experience during the last twenty years has in no degree tended to modify the opinions which I expressed in reference to the surveys of New Zealand when I wrote and read a paper on that subject before this society in February, 1877. I then called attention to a report made by Major Palmer, a surveyor of great eminence, who happened to be in New Zealand in 1874 in connection with the observation of the transit of Venus. He had been requested by the General Government to examine and report upon the existing surveys of the colony, and as to the best means of getting rid of serious difficulties then known to exist in connection with them. Having undertaken the duty, he sent in his report in April, 1875. In this report he pointed out, in full detail, the causes and extent of the errors which had been committed, and which had necessarily involved, as he showed, an enormous waste of money, and recommended a course for the future which would, had it been adopted, not only have remedied the errors already committed, but would also have provided, at a moderate cost, for the completion of such trigonometrical surveys as would have insured the requisite degree of accuracy in the ordinary sectional surveys. Unfortunately for the interests of the colony, however, the general direction of the surveys shortly afterwards fell into the hands of a gentleman who was disposed to pay less regard to the necessary and proper require-

ments of the colony than to a "fad" of his own, and for the several years during which he held control a system was adopted which only increased the confusion and inaccuracies pointed out by Major Palmer, and for remedying which I regret to say that no sufficient effort has yet been made. The Land Transfer system adopted by this colony necessitates the utmost accuracy in the definition of the boundaries and relative positions of all parcels of land dealt with under it, but I have no hesitation in saying that now, as in 1877, but for forbearance on the part of neighbouring proprietors and the natural unwillingness which exists to embark in litigation, the Courts of the colony might be much employed in dealing with cases of disputed boundaries. I can only hope, in the public interest, that the enlightened views propounded by Major Palmer will one day prevail, and that the surveys of the colony will once for all be placed upon an effectual and scientific basis. I may add that the use of the system referred to is the more to be regretted, inasmuch as it still necessitates far greater outlay than would be incurred if that which was recommended by Major Palmer, and is practised in Europe and Asia, had been adopted.

It is satisfactory to turn from this to the geological surveys of these islands. These have been conducted upon the principles laid down by Murchison, Lyell, De la Beche, Ramsay, Geikie, and the host of other great men whose names have been associated with the geological survey of Great Britain. We owe this to Sir James Hector, who, as I have already mentioned, accepted the position of Geologist to the Provincial Government of Otago in the year 1861, and commenced his duties in that year. As you are aware, the chief business of the geologist is to place in clear chronological order the complicated history of the successive changes which have taken place in the organic and inorganic kingdoms in any given area of the globe, the result being to present, in respect of each geological epoch, a nearly perfect description of its physical geography at that time. It is one of the glories of the Victorian era (a term applied in 1887 by Mr. "Punch" to the then fifty years of Her Majesty's reign, but which is now extended to the present time) that geological investigations have been placed upon a sound basis, and that geologists have learnt that it is necessary to study the changes for the time being in progress as a clue to those which have taken place in the past. It has also long been plain to observation that past changes in the physical geography of our globe have been accompanied by corresponding changes in the organic kingdom, and, therefore, that any classification of the stratified rocks must necessarily be unsatisfactory which does not depend upon the observed changes and successions



of life during their deposition. As Mr. Page has put it, the palæontological and lithological aspects of a geological system are two different things, and are the same as if we spoke of the stratigraphical order of its rocks on the one hand and the zoological or botanical characters of its fossils on the other; and that to fully describe any system or suite of strata two things are necessary,—first, to ascertain their mineral composition and physical relations, so as to determine the conditions under which they were deposited and the changes they may have subsequently undergone; and, second, to examine the character of their fossils, so as to arrive at some knowledge of the biological conditions of the region at the time of their formation.

Fully appreciating the necessity of observing these canons, and with the varied experience he had gained amongst the mountain-chains of North America and in Mexico, Sir James Hector brought his great energies to bear upon the work in this colony, and succeeded in obtaining a mass of knowledge and material which has enabled him not only to formulate a general view of the geological structure of both islands, but also to lay down, in considerable detail, many of the most important formations. It has, of course, been impossible, in more than a general way, to ascertain the proportions which the existing fauna and flora bear to the extinct forms in the various strata examined, and it must be left to future palæontologists to determine this point after classifying the immense number of fossils obtained in the prosecution of the survey. But there can be little doubt that the main lines have been satisfactorily determined, and that the more detailed local surveys to be made in the future will be comparatively simple when the requisite classification of the fossils has been made. Whilst actively engaged in the direction of the survey Sir James had many able assistants in the field, amongst whom I may mention Captain Hutton, late professor of biology in the University College of Canterbury, and now curator of the Canterbury Museum; and Messrs. Cox, Park, Binns, and McKay, whose reports have been of the highest value; whilst he owed much also to the skill as a draughtsman of the late Mr. John Buchanan, whose beautiful and faithful drawings were so largely used in illustrating these reports. In connection with his main duties Sir James also gave full attention to mining, especially in the branches relating to gold and coal. The enormous value of these mines will appear when I repeat what I have already mentioned, that the former had produced upwards of fifty-one million pounds' worth of gold since 1857, when the first mining for that metal was undertaken in this colony; and that the latter, though even yet in its infancy, has produced several millions of tons of coal, of a

minimum value of 17s. 6d. per ton. Both these industries are still in full swing, and there is every reason for believing that, with simplified means of separating the gold from its matrix, not only will occupation be found for the employment of a considerable addition to the number of miners, but that the yield of the precious metal will be largely increased.

It must not be supposed that I have overlooked the valuable geological work done by Professor Von Hochstetter, who accompanied the Austrian Scientific Expedition in the "Novara," in 1860; or by Sir Julius von Haast, who for several years occupied the position of Provincial Geologist in Canterbury; or by Professors Hutton and Ulrich in Otago, in the years from 1873 to 1875, the first of whom then occupied the position of Provincial Geologist and the latter that of a consulting Mining Engineer and Geologist, and the result of whose labours is recorded in a report to the then Superintendent of Otago, made in June, 1875. Von Hochstetter's work in the field was, however, practically confined to the volcanic area in the North Island, although he also paid a short visit to Nelson and Massacre Bay; and those who have had the pleasure of perusing his published record of his travels and investigations in these islands cannot but have been struck by the extent and variety of the knowledge he obtained whilst pursuing those travels. I think it unnecessary, however, to dwell upon these practically local investigations, because Sir James himself personally examined the whole of the districts referred to in them, and has embodied those portions of the work done by these several gentlemen which fitted in with his own researches and observations, as recorded in the general reports of the Geological Survey.

Now, when we reflect how vast and valuable are the substances derived from the crust of the earth, and how varied are their applications in the industry of civilised nations, we must be satisfied of the expediency that every educated mind should possess some knowledge of the leading facts of geological science, for, whether it be for the purpose of engineering, architectural, or agricultural work, there can be no question as to the necessity of knowing all that relates to the application of its industrial and commercial details.

Geological work in the field has practically ceased since 1893, since which date Sir James Hector has not been provided with the necessary staff for pursuing it. For what reason this has been done I am not aware, but this interruption in the work of one of the most important scientific departments in the colony is much to be regretted.

The progress of chemistry in England during the reign of Her Majesty has been extraordinarily rapid, the foundation for its advance not only there, but in Europe generally, having

undoubtedly been first laid by Dalton, who propounded the atomic theory. Later on precision was given to his views by Davy, who was also the pioneer in the field of electro-chemistry. But to Faraday has been long and generally awarded the full glory of solving those important problems in electro-chemical science which have led the way to the present application of electrical energy to electrolytic decomposition, the production of light, and as a source of mechanical power. It was almost impossible for the ordinary mind to have conceived that out of the simple experiments made by Faraday, with apparatus constructed by himself—small copper discs, bits of soft iron wound round with calico and twine—would have arisen the mighty machines which are now converting the previously-wasted energies of Niagara, and will soon be converting the mighty powers of the Nile, into chemical action, supplying power to whole nations. It has been well observed that the development of chemistry during the last sixty years has changed the social and economic condition of every country which has had the intelligence to participate in it, or the sagacity to avail itself of its fruits, and there is indeed nothing more remarkable than the fact that, until very recently, the great manufacturing people of England should have ignored that science in connection with public education. This, however, is now being rapidly changed. It has been doubted whether in 1837 there were more than a couple of dozen persons altogether in the British Isles receiving systematic instruction in practical chemistry. Liebig visited England in that year, and in a letter to Berzelius, dated the 26th November, he tells the great Swedish chemist that he had been for some months in England, had seen a great deal, and learnt little. "England," he said, "is not the land of science; her chemists are ashamed to call themselves chemists, because the apothecaries have appropriated the title." He was greatly pleased with the English as a people, and delighted with the hospitality and welcome he met with; but as regards the chemists—well, Graham was the only exception, and he was precious. He evidently thought that Faraday had ceased to be reckoned among the chemists.

Liebig's example in establishing schools of chemistry in Germany soon led, however, to a great change in England, for in 1841 the Chemical Society was established, and now numbers upwards of two thousand members. In 1845 the Royal College of Chemistry was founded, and the spirit of its founders has since been carried into a large number of places in which chemical instruction and research are carried on. As regards chemical education, the change has been enormous, and Faraday's reproach to the Public School Commissioners "that the natural knowledge which had been given to the

world in such abundance remained untouched, and that no sufficient attempt was being made to convey it to the young mind, growing up and obtaining its first views of these things," is being wiped away, and chemistry is being taught in nearly all the great public schools, including the universities, whilst well-equipped chemical laboratories are to be found in almost every town in Great Britain, and those who will take the trouble to consult the pages of the "Philosophical Transactions" and of the "Journal of the Chemical Society" will be able to appreciate the enormous advance in chemical inquiry and discovery during the last fifty years.

It is to be regretted that little is being done in this connection by those who have the control of the general public education of this colony, the great majority of the people of which appear to attach more importance to strumming on a piano or daubing a canvas than they do to instruction in sciences whose applications concern them at every turn, and have important relations, either proximate or remote, with every individual pursuit in which they are engaged. Let us hope for better things.

In connection with the geological survey and with mining in this colony, the laboratory established in 1862, under the management of Mr. Skey, has done an enormous amount of accurate work; and, although no very recondite problems have been solved or startling discoveries made, the economic value of that gentleman's labours during the past thirty-five years has been very great. This will fully appear to those who take the trouble to examine the series of Laboratory Reports issued under the direction of the Geological Survey Department, which unquestionably present a record of patient and diligent research, reflecting the greatest credit upon Mr. Skey. Hundreds of careful analyses have been made of rocks, ores, and soils from all parts of the colony, which, I am afraid, have not produced due fruit, for it appears to me, generally speaking, that the records of the scientific departments of the colony excite far less interest than the contests between teams of cricketers and footballers, with which a very large portion of the columns of the daily Press are filled.

In meteorology, too, a vast amount of useful information has been collected under the general direction of Sir James Hector. From 1868 to 1895 reports were issued on this subject by the Geological Department, but since the latter date these reports have been transmitted to the Registrar-General and published in the Official Year-book of the colony. Our secretary, Mr. Gore, has throughout been connected with the practical work of this department, and the necessary observations are still collected through him from 144 stations distributed throughout the colony. Weather fore-

casting has long been under the direction of Captain Edwin, R.N., whose work has proved of great value to those "who go down to the sea in ships."

But, however great the strides made in Europe and in this colony in other branches of science during the last sixty years, there can be no question that biology has fully kept pace with them. You will remember that in 1859 Darwin propounded the hypothesis involved in the title of his work "*The Origin of Species*," a work which speedily revolutionised the views previously held as to the origin and succession of life on the globe. It has lately been contended that he was anticipated in the principal lines of that hypothesis by Herbert Spencer, and that he could not have been ignorant of this fact when he published his work, assuming, of course, that the statements contained in Mr. Clodd's recent publication—in which the accusation has been made—are true. It must, however, be remembered that Darwin had practically arrived at his main conclusions nearly thirty years before the publication of his work, and that it was from a careful consideration of the observations he had made (during his voyage in the "*Beagle*") on the distribution of the inhabitants of South America, and the relations between its then present and past inhabitants, that he was induced to review the generally-accepted doctrines as to the origin and progress of life. His own account of the matter is, that after he returned home from his voyage it occurred to him, in 1837, that something might perhaps be made out of this question by patiently accumulating and reflecting on all sorts of facts which could possibly have any bearing upon it, that after five years' work of this nature he allowed himself to speculate on the subject, and drew up some short notes, which he enlarged in 1844 into a sketch of the conclusions which seemed to him to be probable, from which period until the publication of his work he steadily pursued the same object. This sketch he submitted to Sir James Hooker, who, as well as Sir Charles Lyell (to whom Hooker had communicated the main lines of the sketch), thought it advisable that Darwin should publish some extracts from his manuscripts, to be submitted to the Royal Society, in company with a memoir in relation to the inhabitants of the Malay Archipelago, which had been sent him by Mr. Wallace, who had, independently, from the investigations detailed in his memoir, arrived at much the same general conclusions as Darwin himself, and this he accordingly did. Whatever may be the result of the statements published by Mr. Clodd, to which particular attention has lately been drawn by a recent article in one of the scientific serials, there can be no doubt that the enormous mass of facts illustrative of his hypothesis,

which are contained in his work, entitle Darwin to the honour of having first put forward the points involved in a manner which forced conviction upon his readers. At the end of his book he thus summarised the laws which he believed to have governed the production of the varied forms of life on the globe. "These laws," he says, "taken in their larger sense, are growth with reproduction; inheritance, which is almost implied by reproduction; variability from the direct and indirect action of the external conditions of life and from use and disuse; a ratio of increase so high as to lead to a struggle for existence, and, as a consequence, to natural selection, entailing divergence of character and the extinction of less-improved forms." "Thus," he adds, "from the war of nature, from famine and death, the most exalted object we are capable of conceiving—namely, the production of the higher animals—directly follows. There is a grandeur in this view of life with its several powers having been originally breathed by the Creator into a few forms or into one, and that, whilst this planet has gone cycling on according to the fixed law of gravity, from so simple a beginning endless forms most beautiful have been and are being evolved."

But, whilst Darwin's name is undoubtedly more intimately connected with the doctrine of evolution than that of any other man, he himself, with the simple honesty which characterized his whole life, readily admitted that Wallace had independently arrived at much the same general conclusions from his study of the natural history of the Malay Archipelago, and that most careful observer and naturalist has never changed his views on the subject. From the new starting-point thus given to biological science all recent investigations have proceeded, and, when we compare the present literature in every branch of natural science with the limited number of books that existed up to the date of the publication of Darwin's work, we are able to estimate the extent of interest excited by the new doctrines, and the influence they have exercised in its development.

It is from this standpoint that the greater number of those who have engaged in biological researches in New Zealand have proceeded, and I think that the people of this colony may well be proud of the results achieved. Some years ago I pointed out to this society that the islands of New Zealand occupy a unique position in connection with natural history, there being not less than twelve hundred miles of ocean intervening between them and the nearest continental land. This physical position, coupled with the peculiar forms of its fauna and flora, and the large proportion of endemic species belonging to each, has entitled it to be treated by writers on the distribution of animals and plants as constituting a

separate zoological sub-province, a circumstance which has created great interest in the investigation of its natural history, more especially as both islands are characterized by the almost total absence of land animals, except birds and the comparatively lower forms of animal life. It was natural that the birds, as being the most conspicuous objects, should have received the greatest attention, and I am inclined to believe that, except one form, of which only two specimens, a male and a female, were ever obtained, we are now well acquainted with the avifauna, both fossil and living, of these islands. The greater part of the results obtained by the large number of naturalists who have collected and recorded their observations upon the birds of New Zealand have been embodied in a fine work published by Sir Walter Buller, whose labours have received well-merited recognition at the hands of naturalists in all parts of the world, and I may add that it is matter of gratification to those who have contributed to our present knowledge on this subject that their contributions have been fairly recognised in Sir Walter's book. Amongst the more remarkable forms of our existing birds are the several known species of *Apteryx*, which were dealt with in an elaborate memoir by the late Sir Richard Owen, who pointed out their affinities with the huge extinct struthious birds known under the general name of *moa*, specimens of which are to be found in the larger museums of the colony. We owe these to the researches of Sir James Hector, of the late Sir Julius von Haast, and of Professor Hutton specially; whilst many others not claiming to rank so high in the domain of natural history have also contributed largely to them.

As you are aware, steps have lately been taken, under the auspices of the Government, to preserve the remnant of our birds from the extinction to which they have been exposed, and which is, indeed, imminent, owing to the introduction into these islands, under a total mistake as to their utility, of several of the greatest known enemies of bird-life, and we may hope that the effort will be successful.

The reptilian life found in these islands is very limited in extent, but contains two forms of the most remarkable character—namely, the *tuatara* lizard and a frog known as *Leiopelma hochstetteri*, found chiefly in the Coromandel district. The lizard is only now found in some of the outlying islands, where its continued existence is threatened by the introduction of the pig and the cat. The affinities and structure of this reptile have been the subject of many memoirs, both by New Zealand and foreign naturalists, who have shown that it is evidently connected with some of the most ancient fossil forms. The frog is remarkable chiefly as occurring in an oceanic island.

In the other families of our fauna we have had, and still have, a host of collectors and investigators, the results of whose work have been embodied either in separate volumes or manuals published by the Government under the editorship of Sir James Hector, or in the shape of memoirs in the "Transactions of the New Zealand Institute," and in various English and foreign scientific serials. Amongst these the researches and works of Sir James Hector, Professor Parker, of Dunedin, and Professor Hutton in relation to the marine and fresh-water fishes of the colony; of Professor Hutton, now supplemented by the labours of Mr. Suter, into its land and marine *Mollusca*; of Mr. Dendy, into what he has termed its "Cryptozoic fauna"; of Powell and Urquhart, into the forms and life-history of its *Arachnida*; of Captain Broun, whose fine work, in two volumes, on the *Coleoptera* deserves particular mention; and of Mr. Fereday, Mr. Hudson, and Mr. Percy Buller, in relation to its *Lepidoptera*, are highly valuable and interesting. I am tempted here to mention one insect which, though not peculiar to New Zealand, is of singular interest to naturalists, and has accordingly been the subject of many special memoirs. I allude to the *Peripatus*. This insect presents itself to us in the form of an oviparous larva, never passing beyond that stage, a circumstance which characterizes it as perhaps the most peculiar form of insect now extant. I was the first person to observe this insect in New Zealand, and, being much struck by its remarkable external characters and habits, I referred it to Captain Hutton, who at once recognised it as a *Peripatus*. I afterwards gave specimens of it to Professor Moseley, one of the naturalists of the "Challenger," who had obtained specimens of the same insect at the Cape of Good Hope, in Australia, and in Chili, and was greatly interested in the fact of its occurrence also in New Zealand, its existence here being one of the circumstances which lend a peculiar character to our fauna. The presence of this insect in these localities also lends countenance to the hypothesis that a land connection formerly existed between them, a circumstance now much discussed by physical geographers, geologists, botanists, &c.

Amongst the biological work done by our local naturalists, however, there is none which deserves more recognition than the patient, laborious, and valuable investigations made by Mr. Maskell into the life-history, habits, and natural characters of the *Coccida*. Indeed, none but those who have followed the progress of his work, and studied the beautiful microscopic drawings which form such conspicuous portions of his publications in the Transactions for several years past, can form any conception of the time and trouble given to these investigations, and it is no small tribute to their value



and accuracy that Mr. Maskell is now recognised as the leading authority on the subject of these insects, and is consulted in reference to them by naturalists in all parts of the world.

With regard to botanical research much also has been done, the great workers having been Sir Joseph Hooker, the Rev. Mr. Colenso, Sir James Hector, Mr. T. Kirk, Mr. John Buchanan, Mr. Cheeseman, of Auckland, and many others. I also took a leading part in this work as a collector, especially of alpine and sub-alpine forms, some years ago, and made large collections from the mountain districts of Nelson and Marlborough, which I sent to the museum at Kew. Mr. Kirk is now engaged in preparing a new edition of the "Handbook of the New Zealand Flora," in substitution for that issued by Sir Joseph Hooker in 1864, in order to bring our knowledge of the botany of the colony up to date; and we may rest assured, from our experience of Mr. Kirk's capacity and diligence, that the work he has undertaken will be done in a manner which will reflect credit upon himself and the colony.

This general sketch of the progress of the colony in physical and natural science would not be complete without mention of the fact that fine collections, illustrative of every branch, are contained in each of the museums in its principal cities.

In conclusion, I refer those who desire to obtain a completer knowledge of the nature and extent of the scientific work which has been done in New Zealand than could possibly be given in such an address as this to the works published under the direction of the Geological Department, and I have no hesitation in saying that until these have been examined no proper estimate can be made of the extent and value of that work; whilst the statistics of the colony, now so admirably formulated under the care of Mr. Von Dadelszen, and to which I am indebted for the evidence brought before you to-night in relation to the economic condition of the colony, afford the most convincing proofs of its progress in wealth, and of the certainty of its future prosperity, under wise administration.

I trust you will pardon me if I have failed to carry out as successfully as could be wished the somewhat ambitious design involved in the title of this address, and many of you will, I hope, be willing to admit that my self-imposed task was by no means an easy one.

---

ART. II.—*On Rock Pictographs\* in South Canterbury.*

By A. HAMILTON.

[Read before the Otago Institute, 12th October, 1897.]

## Plates I.-X.

KNOWING that a number of painted rocks existed in the limestone district about Albury and the Opihi River, I was very pleased to accept the invitation of Mr. W. W. Smith; who knows the whole district thoroughly, and who offered to point out to me the chief localities in which the pictographs are found. Leaving Albury early in the morning, we drove about four miles to the homestead of the Albury Estate, over fine rolling downs, which have recently been acquired by the Government and cut up for the benefit of small farmers and settlers. Round the homestead are some well-grown plantations of Conifers and deciduous trees, which much improve the somewhat bleak look of the downs. At the homestead we enter the valley of the Tengawai, and pass under a bold limestone scarp, which gradually narrows in the valley until it enters the hills at the Tengawai Gorge, a piece of wild and picturesque scenery, with a little native bush still remaining in the gorge. The first cave we visited was about 100 ft. up the limestone face of the cliff, and was entirely concealed by the native shrubs growing on the table slope below and in front of it. The cave was very small, not the size of an ordinary room, but it faced the sun, and no doubt was a favourite resting-place. Mr. Smith had seen the cave about ten years ago, and was, in fact, its discoverer, as, although so close to the homestead, it was not known to any one there. He says that at that time the figures covered the walls, and were particularly brilliant, mostly in red, some in black. At the present time the figures are not distinct, the walls having an appearance as if they had been smoked or blackened, possibly from the growth of fungus from the bushes in front, or from an *Alga*.

I copied three of the figures still to be made out. The floor of this cave did not seem to promise any result, so we went on up the valley. The huge masses of limestone which have become detached from the cliffs by denudation have rolled to the base of the cliff, and assume all sorts of fantastic shapes. About a quarter of a mile from the first cave is a very large shelter-cave capable of holding sixty or seventy people. The floor and the roof have a downward

---

\* Probably "petroglyphs" would be a better word.

slope, but the situation is warm and dry. The roof of this cave is covered with a number of pictographs, some of which were copied. The cave is close to a hut, and has been used by station hands for many purposes. The floor consisted of a very fine reddish clay in a state of fine dust. On putting a section trench through it a layer of cut tussock-grass largely intermixed with birds' feathers (as at the Takiroa Cave, on the Waitaki) was exposed. The birds represented were New Zealand quail (for many years quite extinct), weka (*Ocydromus*), parakeet, and pigeon. No quail-bones were obtained, but several fragments of moa-bone, and a great quantity of moa-egg shell. The layer was about 8 in. thick, and about 3 in. or 4 in. from the surface; underneath was limestone-sand, in the upper part of which was a quantity of moa-egg shell. Owing to the difficulty of working the very dusty material, and the disturbed state of the rest of the floor, we did not finish the whole area. The talus slope in front of the cave was also very stony, and we did not examine it.

At the head of the valley, about half a mile further, just at the entrance to the gorge, is a huge mass of limestone which has rolled some little distance on to the flat. A small portion of this, on the sunny side, forms an overhanging shelter, which, with a few manuka screens, might be made habitable. There was evidence that this had been the case, as when the loose sand and stones had been removed from the floor a thin layer of black burnt earth was seen. A trench 1 ft. wide was cut from the rock outwards for about 20 ft., and then all traces of the burnt earth were lost. The depth of the black layer was only a few inches; close to the rock, and scarcely traceable for any distance beneath, was the untouched limestone. Many places in the shelter itself were painted, and one group in particular was very vivid. At the ground-level there was a long red snake-like figure, resembling one at the Waitaki, apparently entering into or issuing from the furthest angle of the cave. Many of the smaller cavities weathered out in the limestone had small paintings in them, and numbers were almost entirely perished. I photographed and sketched all that were visible. Just at the entrance to the gorge, a few hundred yards beyond the rock, ploughing operations disclosed the sites of several cooking-places. From the trench across the floor of the shelter were taken two bird-bones sharpened to a fine point, a flake of quartzite, several pieces of moa-bone (*Pachyornis* ?), shells of the river-mussel, fragments of *Haliotis* shell, some small smooth beach-pebbles, part of the jaw of a dog cut into a hooked shape, and several stones burnt with fire.

Returning to Albury, we left early the next morning for the Opihi River, crossing the range of hills known as "The

Brothers." On reaching the watershed we followed down the Totara Creek until we again struck the limestone near its junction with the Opili. The first place examined was by the side of the road, and was a good specimen of a long shelter-cave, the limestone projecting forward several feet, giving ample room to walk under it. For about 40 ft. or 50 ft. the wall and roof showed traces of ancient paintings, but were nearly obliterated and much disfigured by passers-by. A number of these were sketched. Prominent amongst them is a huge *taniwha* with open mouth, in front of which is a three-armed scroll of apparently meaningless design. I have, however, since seen the pictographs figured by Dr. Von Haast,\* and recognise my figure as part of his No. 29, which is plainly a human figure escaping from a *taniwha*. There are several interesting figures in this shelter, and many of them are carefully drawn with three pointed extremities. A similar shelter a little further down the valley has been destroyed recently in getting limestone. It is said to have contained similar designs. The floors of both of these shelters were tried, but nothing beyond a shallow layer of black burnt earth and a number of the shells of the river-mussel were found.

Proceeding to the north and east, we soon reached the wide bed of the Opili, which here flows between high limestone cliffs about a mile apart. Following down the right-hand bank, or south side, we carefully examined all the likely-looking places for caves and pictographs. In a very small cave there was a well-painted figure of a shark with open mouth; in another was the name "Kotaraki," printed in the form of Roman capitals, adopted by the early scholars of the Maori race, and which is quite distinct from any European's writing or printing. We afterwards saw Maori names written in hundreds in the caves and shelters, and found no difficulty in distinguishing them from the modern European names and writings found on the walls of the shelter.

The particular cave we were looking for we passed by, but, being directed by a local resident, we turned up a small creek for a short distance amongst the hills, and found a whole series of pictographs of great interest, and in very good preservation, owing probably to their remoteness from the general track up the river-bed. The largest cave was of considerable size, some of the designs on the roof being 6 ft. long. It is used at present by cattle as a shelter. It lies on the sunny side of the creek, some distance above the water. In order to see the designs painted on the roof it was necessary to lie on the sloping floor, and then the patterns became plainly visible.

---

\* Journ. Anthrop. Inst., Aug., 1878.

In all cases we found that after being in the cave some few minutes the eye became accustomed to the light, and figures could be discerned which were not to be recognised at first. It was not possible to photograph the elaborate designs found here, so I made as careful a drawing as I could under the circumstances. In addition to the two colours—red and black—some of the figures were scratched round with white lines, probably done with a soft piece of the limestone-rock. A number of Maori names, such as “Riwa,” were painted on suitable places on the rocks in this gully. There was a figure of an ordinary *mere* on one of the rocks. This group of pictographs is probably the one which Canon Stack tried to see in 1875.\*

We crossed over the river by direction of our new guide, and visited the large rock-shelter on the north bank of the river, known locally as “Noah’s Ark.” It is about 200 yards long, and partly protected by a dense growth of the small shrub common on river-beds. As Canon Stack says, the entire surface of the rock is covered with pictographs, unfortunately much perished and defaced. Much of the damage to those within reach has been done by picnic parties, and the modern parties of Maoris when camped there eeling; but far above, out of reach, there still remain several fine specimens. One very characteristic figure is about 2 ft. long, and drawn on the white face of the cliff at least 20 ft. above the ground. There are a number of almost obliterated figures of great interest which can yet be made out by careful study when the sun is in the proper position. The figure mentioned by Canon Stack still exists in the condition he described twenty years ago. Its height above the ground, 14 ft., has probably preserved it from the assaults of parasols and penknives. The floor of the Noah’s Ark shelter seems to have been swept out by the river since the paintings were made, and we could find no remains of any kind near the rock.

Proceeding down the river, we crossed to the other side, and found a curious rock-shelter near the top of a huge limestone bluff. The roof or upper portion of the cliff projected over perhaps 20 ft., and was perhaps 80 ft. or 100 ft. from the present bed of the river. The roof could be easily seen from below, and was painted with several figures, about a dozen of one kind (see Plate X.). At the time the cave was inhabited a long talus slope probably sloped down to the river-bed. This has all been removed by the river, together with the floor of the cave, so that it is now inaccessible from the river-bed, and had a deep water-hole at the foot. This appeared to be the last outcrop of the limestone as far as we

---

\* See App. No. 2 to Dr. Von Haast’s paper, *l.c.*

could see to the east, and so we turned back, examining several small shelters up a tributary creek, on the north bank of the river. Under one rock we found the outline of a stone axe, very well drawn in red paint, about 16 in. long, and a few other solitary marks.

On my return the next day I wanted to examine a cave near the Cave Station, close to Timaru, but was unable to do so. I believe there are some pictographs in it. The execution of the paintings, on the whole, is not so careful or so striking as those at Takiroa, but those in the Opihi have been much defaced, especially those in the more exposed rock-shelters. I see no reason to doubt that the majority of the red and many of the black pictographs are genuine works of the natives inhabiting this part prior to the arrival of Europeans. The character of the designs is thoroughly consistent throughout the whole area. I have no doubt that a careful and special search would bring to light many more shelters and caves, and that it will be found that the same figures will occur in different localities. Any one familiar with the pictographs in other parts of the world will have little difficulty in deciding on the genuine character of the great bulk of the designs.

Fig. 1, Plate VII., and fig. 6, Plate IV., are almost *fac-similes* of a figure published in the "Journal of the Anthropological Institute" amongst the marks made on a document by chiefs of Easter Island in 1770. This is the only mark like a totem or symbol, the other marks on the document being more like alphabetic characters.\*

Again, in Flinders Island,† a remote islet off the coast of Australia, there are numerous pictographs of animal forms, and one, a large lizard-like monster with open jaws, resembles some of our figures in having a great expansion in the body with a figure of a man in it, probably representing a person swallowed by the monster, as in fig. 11, Plate VIII., and as seen in some unpublished figures at the Takiroa Cave.‡

\* Journ. Anthrop. Inst., vol. iii., pl. xxvii., p. 528.

† Discovered in 1821 by Mr. Cunningham, of the "Beagle" (see King's "Australia," vol. ii., p. 25, and "The Cruise of the 'Alert,'" p. 192).

‡ The same subject is represented in a Haida pictograph, published in Report of Nat. Museum, Washington, 1888, Niblack (pl. iv., and page 323), representing Skana the Orka, or whale-killer. The Chilkat and other tribes of Alaska carve figures of salmon, inside of which is the full length figure of an Indian. The allegory is of undoubtedly ancient origin and not a version of Jonah. The numerous parallels between the ethnology of the Haidas and the Maoris require careful examination.

Fig. 6, Plate I., seems to be a fair representation of a king penguin. We know that king penguins occasionally come as far north as Timaru, or, at any rate, Dunedin, as their bones are found in the camps and middens.

Fig. 2, Plate II., is, I think, meant for a seal. Fig. 6, Plate III., is, I believe, meant to represent a man dancing, but to many it appears to be a frog. The only frog found in New Zealand as endemic is a small species (*Leiopelma*) in the Coromandel district. The Tuhoe people, in the North Island, have on their carvings a *ngarara*, known as "*moko-tapiri*" or "*moko-papa*"; it is just like a frog. They say, however, it is found in holes in trees.

Several greenstone ornaments for the neck or ear have been found in Otago, shaped like the anthropomorphs in Plate VIII., figs. 8 and 9; Plate IX., fig. 2; and Plate X., fig. 3. The lines in Plate VII., fig. 4, are probably part of the ornamentation of a large fish like fig. 5, Plate IX. The curious figures in black on Plate V., fig. 3, and Plate VI., fig. 6, are on the smoky roof of a cave, and it is very difficult to draw them properly. A large looking-glass placed on the floor of the cave would probably enable them to be copied with more ease and accuracy. The details are minutely drawn in the original, especially the curious curves representing the thumbs. The enlargement of the backbone on the centre is probably similar in motive to the instances previously noted of the included man.

### ART. III.—*Did the Maori discover the Greenstone?*

By JOSHUA RUTLAND.

[*Read before the Wellington Philosophical Society, 24th November, 1897.*]

FROM the geographical position, the extent, and the varied geological character of the New Zealand Archipelago we might naturally expect that the natives, who had occupied the country for about four centuries according to their own tradition, would have made some discoveries, or evolved some art, unknown to their relatives imprisoned in the little Polynesian islands; but when Captain Cook came amongst them the Maoris were dependent on wood and stone for their weapons and implements, though the islands abound in metals; they boiled water with heated stones, though clays of the very best description were procurable; and they had not made the slightest advance in the direction of spinning and weaving,

though the climatic conditions of their new home compelled them to discard bark-cloth, and to clothe themselves with the warmer hand-made garments of *Phormium* and *Cordyline* fibre.

A close comparison of ancient New Zealand and eastern Polynesian art shows that the manufacture of greenstone articles is all that the Maori can exclusively claim. But did the modern Maori discover the greenstone and how to work it; or did they—as the Pelorus and D'Urville Island natives assert—obtain the knowledge from a people whom they found in occupation when they discovered the archipelago?

Though greenstone is not found in any of the eastern Polynesian islands or in Micronesia the inhabitants possessed a few articles made of it when Europeans first went amongst them. If the Maori came here from the Cook Islands, or the Society Group, they may have brought with them some of these articles, or a knowledge of them; but it is impossible that they could have been acquainted with the mode of working the material when they quitted Polynesia. In the manufacture of stone implements and ornaments the natives of eastern Polynesia did not excel, shell being much in use as a substitute. In Micronesia shell was exclusively used, though obsidian and other volcanic rocks were abundant. Unless Polynesian art had greatly changed between the advent of the canoe-men and the time when our knowledge of the region commences, the Maoris must have acquired their skill in working stone after they made these islands their home.

We have positive evidence of two very distinct periods in the history of New Zealand—the period of the pit-dwellers, and the modern Maori period, which virtually closed when Cook rediscovered the group. That the greenstone, and how to work it, was known to the ancient as well as the recent inhabitants is proved beyond question by numerous articles found in the Pelorus district, contiguous to pit-dwellings, and beneath the roots of large forest-trees. If the pit-dwellers, who occupied the country from the Bay of Islands to Otago, and from whose remains Judge Maning years ago concluded\* that the islands had at some remote period a much larger population than Europeans found in them—if these ancient inhabitants were a distinct people, and not merely the Maori in an early stage of their history, we must accept the tradition of the Pelorus natives with regard to the greenstone.

When Cortez landed in Mexico the envoys of Montezuma, after presenting a quantity of gold and other valuables as a particular mark of their sovereign's friendship, gave him for

---

\* "Old New Zealand," by a Pakeha-Maori (Maning).



the King of Spain four greenstones, which they informed him were worth more than as many loads of gold. These were the Chalchuites,\* that could only be worn by nobles of the very highest rank. Being merely jade, they were regarded by the Spaniards as valueless.

In China jade is regarded with superstitious veneration, and commands a high price, though it is too plentiful to be considered a precious stone. Amongst the articles presented by the Emperor of China to Queen Victoria on the occasion of her jubilee was a jade *ru-i*,† or sceptre, used by old ladies when receiving guests of ceremony. These sceptres are generally made of polished wood, inlaid with pieces of jade. In various parts of Europe jade implements have been discovered in burial-places of the Stone age. Central Asia being the only portion of the Old World where jade is known to occur, from the widely-scattered implements some archæologists have concluded it must have been an article of commerce, but to this others have objected that the transport of the stone to Europe necessitated long voyages which could not have been made by people in the rude condition the implements in question indicated. The history of the Pacific removes this difficulty. There we know that peoples unacquainted with the use of metal regularly made voyages which the Phœnicians, Greeks, and Romans would not have undertaken. How did the ancient inhabitants of New Zealand discover the jade or greenstone in the wild forest country of the South Island? Why, from amongst the countless varieties of rock the land affords, did they select it, make it a mark of rank, surround it with superstition, and take to burying it with their dead? There is but one possible explanation. A knowledge of the greenstone, the superstitions connected with it, the mode of working, and an idea of its value that made them seek it as we now seek gold, were imported from their former home.

Looking for this home, we naturally turn to the nearest place where jade is found—New Caledonia; here, as in New Zealand, when Europeans discovered the islands, the rude natives were manufacturing ornaments and implements of the venerated material. Here since have been discovered traces of a higher civilisation than existed at the time in any part of Polynesia. Evidently, then, there may have been a period in the history of the Pacific when even from Melanesia men went forth on voyages of discovery or to establish colonies.

In a note appended to my article "On the Pit-dwellings of

\* Prescott's "Conquest of Mexico."

† "The Long White Mountain," H. E. M. James.

the Pelorus District," published in the "Polynesian Journal,"\* the editors have pointed out that I laid too much stress on the Melanesian affinities of the Morioris. In an article on "Cremation among the Maoris," published in the same journal,† the writer, Mr. R. E. M. Campbell, makes the following remarks: "How much of the blood of the present native inhabitants of New Zealand is derived from the people who lived here before the arrival of the historical canoes, and how much from the conquering canoe-men? At present almost every Maori in New Zealand, except the Urewera Tribe, claim to have nothing but the bluest of blue blood, and quite deny any 'tangata whenua' admixture; but then we know that all England, so to speak, is descended from William the Conqueror—at least, so they claim. I think that probably most of the Maoris have more or less of the blood of those who came in the canoes, but that by far the greater portion is derived from those who preceded the canoes by many generations."

If this view is correct, assuming that the ancient inhabitants of New Zealand and the Chatham Islands belonged to the same stock, between the Maoris and the Morioris there will not be a very marked difference. A comparison of the Maoris and the natives of the Cook and Society Islands would be useful. Were the Papuan characteristics more pronounced in the former? If they were there must have been a cause. Since the remote period when New Zealand was first peopled the distribution of races in the Pacific may have changed, but the physical conditions of the region are unaltered. What there is reason to believe took place here may also have taken place in New Caledonia, an art commenced by one people being continued by another.

Much is being done to determine the exact island from which the historic canoe-men set forth for New Zealand, but the more important questions—Did they on their arrival find the country already peopled? and, if so, whence came the earlier inhabitants?—have received very little consideration. It is with the hope of directing attention to this subject I have raised the question, Did the Maori discover the greenstone?

---

\* "Journal of the Polynesian Society," vol. 6, p. 53.

† "Journal of the Polynesian Society," vol. 3, p. 53.

ART. IV.—*Tuhoe Land: Notes on the Origin, History, Customs, and Traditions of the Tuhoe or Urewera Tribe.*

By ELSDON BEST.

[*Read before the Auckland Institute, 4th October, 1897.*]

THE district generally known as the Urewera country, but officially as Tuhoe Land, extends north and south from Ruatoki, on the Lower Whakatane, to Lake Waikaremoana, and east and west from the head of the Waioeka River to the Whirinaki River and a line running a few miles from the right bank of the Rangitaiki River. It includes the watershed of the Upper Whakatane, with a portion of those of the Upper Waimana, Ruakituri, and Waiiau Rivers, as also the right-bank watershed of Whirinaki. The district is rugged and mountainous, the valleys being narrow, and containing little flat land, while the quality of the soil is but second rate. Nearly the whole of this area is covered with forest, which is generally of a light nature, but mixed with rimu, kahikatea, and matai. The higher ranges are covered with forests of tawai, tawari, and tawhero, the tawai predominating; while on the left bank of the Whirinaki, and tributaries thereof, are fine patches of totara.

This district is inhabited by the Tuhoe or Urewera Tribe of Maoris, who are descendants of Ngapotiki, the ancient tribe which occupied this region for centuries before the arrival of the later migration of Maoris from Hawaiki by the historic fleet some eighteen or twenty generations ago. These ancient people of New Zealand were undoubtedly Polynesians—in fact, Maori—being but a prior migration from northern isles; and, without doubt, voyages were made to New Zealand from the Pacific isles between the time of the arrival of the “Aratauhaiti” canoe, bringing over the ancestor of the Tini-o-toi, and the coming of “Mataatua,” from the crew of which vessel the Tuhoe obtained their strain of modern Hawaikian blood. Among such voyagers were Maku, Kupe, Ngahue, Paoa of Horouta, Taukata of Nga Tai-a-kupe, and Hape of Te Hapuoneone.

An ancient tradition states that the ancestors of the original people came to New Zealand in the “Aratauhaiti” canoe, about thirty-five generations ago, from a land called Mataora. The principal man of this vessel was Tiwakawaka (see below, Gen. No. 1). His father, Papa-titi-rau-maewa, was another of the crew. After the ancient war between the offspring of Rangi and Papa the kumara was brought into the world by Pani-tinaku; she was the mother of the kumara. Pani married a brother of Whanui, who procured from Rehua

a piece of kumara, or seed thereof, and caused Pani to give birth to the kumara. As the valuable possession came forth to the world she repeated the *karakia*, commencing "*Pani, Pani heke*," &c. Her children ate a portion of the kumara, and when they learnt the origin of it they were much dismayed, and said, "We have eaten the *parapara* of our mother." So alarmed were they that they left their home and scattered to all parts of the world, some of them coming to New Zealand, where they settled in a lone land, and became the origin of many ancient tribes, such as Te Tini-o-toi, Te Kawerau, Tuoi, Te Marangaranga, Tini-o-awa, Te Makahua, Tini-o-taunga, Kotore-o-hua, and others. These were some of the tribes found here by the crews of the historic fleet "*Mataatua*," "*Te Arawa*," &c. (The origin of the kumara, as above described, was preserved by tradition, though the tuber itself appears to have been unknown in New Zealand before the time of Toi-kai-rakau. When Whanui is seen flashing above the sea-horizon in the direction of the fatherland, then the *tohunga* pronounces the kumara as ready to be dug. So was this land settled by the children of Pani.)

The Tini-o-awa were a division of the ancient people. A section of this tribe, known as Ngapotiki, held Tuhoe Land, or the greater part thereof. Ngapotiki were divided into hapus, as follows: Te Kotore held the Pukareao Valley; their lands are now owned by Ngai-tawhaki. Te Hokowhitu-pakira-a-romairira occupied Ruatoki; the famous ancestor, Rangi-monoa, was of this hapu. Ngati-ha held the valley of the Upper Whakatane and the head of the Waiau River. Ngati-rakei dwelt in Te Wai-iti Valley; Ngapotiki proper at Maungapohatu; Tuahau at Manana-a-tiuhi; and Tu-mata-rakau on the Lower Waikare. The Valley of Whirinaki was held by Te Marangaranga, and that of Waimana by the ancient tribes of Maruiwi, Maru, and Tama. The first and last of these three were branches of Te Hapu-oneone, who would appear to have sprung from a different migration to that of the tribes which claim descent from and relationship with Toi, the wood-eater. The Hapu-oneone are the descendants of Hape, who flourished about twenty-five generations ago; but if he came from Hawaiki, as some claim, the name of his vessel has been lost. The Tribe of Maru held lands on the northern side of Maungapohatu, and that of Potiki occupied those to the south.

Ngapotiki are descended from Te Maunga and Hine-pukohu-rangi, from whose son, Potiki, the tribal name comes. He lived about sixteen or seventeen generations back (see below, Gen. No. 2). The Tuhoe people are also descended from the "*Mataatua*" migration—that is, from Toroa. The tribal name of Tuhoe comes from Tuhoe-potiki, third in descent from

Toroa; and that of Te Urewera from Mura-kareke, son of Tuhoe (see Gen. No. 3). The descendants of Toroa first left the coast lands and settled among Ngapotiki in the time of Karetehe, four generations from Toroa. Karetehe settled at Ruatoki with Rangi-monoa, who gave land to the newcomers. The mixed descendants of Toroa gained certain victories over Ngapotiki, but it is not the case that the inhabitants of Tuhoe Land were ever conquered by the Mataatua migrants or their descendants. The concrete truth is that Tuhoe are Ngapotiki, and should be called by that name. It is, of course, a fact that the Mataatua tribes intermarried with Ngapotiki to a considerable extent, but for all that Tuhoe are mainly aboriginal in blood to this day, and speak far more of their aboriginal ancestors than of those of Mataatua, though alive to the fact of the superior mana of the later Maori.

## TABLE OF GENERATIONS.

Tiwakawaka—Ro-tua	No. 1.
Tara-nui	
Tara-roa	
Ngai-nui	
Ngai-roa	
Ngai-whare-kiki	
Ngai-whare-kaka	
Ngai-roki	
Ngai-roka	
Ngai-peha	
Ngai-taketake	
Ngai-te-huru-manu=Te Waero	
	Toi=Te Kura-nui-a-monoa
	Rauru
	Hatonga
	Tahatiti
	Ruatapu
	Rakei-ora
	Tama-ki-te-ra
	Tama-ki-Hikurangi
	Rakei-ora II.
	Whata-kiore
	Te Puka
	Tete
	Tera
	Tama-rakei-ora
	Ira-tu-moana
	Rangi-tuhi
	Tama-poho
	Te Rewa-o-te-rangi
	Tahia-i-te-rangi
	Patu-pakeke
	Tapuika-nui
	H. T. Pio
	Te Rere-kino
	Renata Katu

## No. 2.

Tahunui-o-rangi  
Tukutuku  
Hekeheke  
Uaua

Te Maunga = Hine-pukohu-rangi

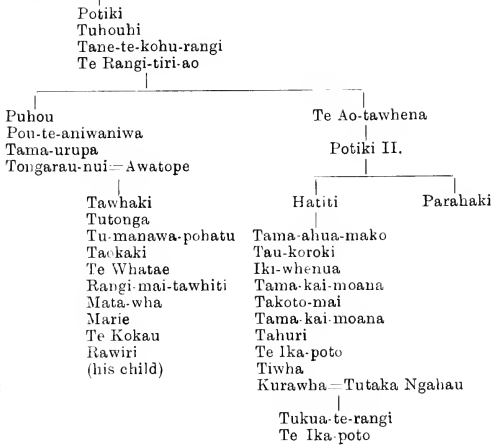

## No. 3.

Toroa

Wairaka = Paewhiti (of the aborigines)

Tamatea-ki-te-huatahi

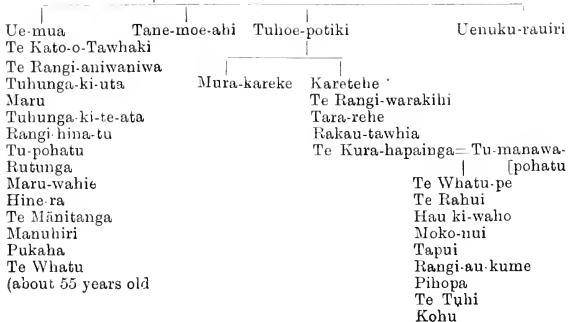

Among the Tuhoe mountaineers are conserved a large number of archaic and sacerdotal words which do not appear to be known in other parts; also, the traces of many singular ancient customs are noticeable among them, together with traditions which differ materially from those of the modern Maori. The old men of the tribe are well versed in such legends, &c., but appear to be behind other tribes in their knowledge of the Hāwaikian fatherland and traditions pertaining thereto. They still preserve the knowledge of many old-time customs and ceremonies, together with the all-necessary *karakia*. Any person having a good knowledge of the Maori tongue might here collect much new matter anent the customs of the ancient Maori.

The subject of human sacrifice alone might occupy a volume if thoroughly looked into by a competent inquirer, and also lead to many interesting comparisons with similar customs of other lands. The sacrifice for lifting the *tapu* from the *whare potae*, or house of mourning, and that on the occasion of the *taanga ngutu* (tattooing of the lips) of a woman of rank, are probably new to those interested in such matters. The sacrifice of men at the building of a new house, and the launching of a war-canoe, have been placed on record, but are interesting. Probably more so, however, is that made when the *tauirā*, or scholar, leaves his tutor and the *whare maire*, where all sacred lore was taught (Tuhoe do not use the term *whare kura*), and comes forth as a *tohunga*. In order to give *mana* to his *karakia*, and also as an equivalent for knowledge imparted to him, he slays by a spell or incantation some person selected by his tutor, and which victim was often a parent or some relative of the scholar. The *tohunga* retains the privilege of naming the *tauirā patu*, or person to be sacrificed; he selects a relative of the scholar, who, by the sacrifice of such relative, obtains the peculiar *mana* necessary to make his incantations effective. The sacrifice is led before the scholar, who slays him by means of a *karakia makutu*, or incantation to bewitch. Should he sacrifice any other than the person selected by his tutor his *karakia* will never be effective. On being *makututia* in this manner the victim is dead in a few minutes. It was not permissible for the scholar to pay the *tohunga* for teaching him in goods of any kind. The body of the victim was buried, for, being a relative, of course it was not eaten. When a man killed a relative or member of his own tribe, either in anger or such ceremonies as the above, he would take out the heart and place it to his mouth, but would not eat it. He would then repeat the *mākākā karakia* over the heart, by which the body of the slain is made *tapu*, so that no one can eat it.

When the daughter of an important chief had her lips and chin tattooed a day was set apart on which the tribe would assemble to view the work of the artist. A party would be sent forth some time before to secure a member of another tribe, for the purpose of sacrificing such person in honour of the *taanga ngutu* of the young woman, and also to give strength to the tribe. The body of such sacrifice was eaten by the people. Te Whatu said to me, "It was well to take the victim from another tribe, for it gave us the pleasure of jeering at that tribe for all time by saying, 'You are my slaves; you were slain for the *taanga ngutu* of my ancestress.' Pare-karamu, daughter of Koroki, was the last person I knew of who had a human sacrifice for her *taanga ngutu*."

*Whare Potae*.—This was a mourning-house, and took its name from that of the ancient mourning head-dress. It was sometimes called the *whare taua*. When a chief of distinction died his widow and children would remain for some time within the *whare potae*, eating food during the night time only, never during the day. When the period of mourning was over a human sacrifice was made, to take the *tapu* off the *whare potae* and its occupants—*hai heuenga mo te whare potae*, or dispersal of the mourners. The mourners are accompanied to a stream-side by the *tohunga*, or priest, where the *tapu* is taken off their heads or mourning head-dresses (*ka purea tona mahunga*). When Taupoki, of Ngati-Marakoko, died, at Waikotikoti, Tapuku, a slave, was killed for above ceremony, the body being cut up and cooked in a *hapi*, or oven, on the river-bank, just in front of my tent where I am now writing this article. The cooked flesh was eaten by the people, a portion being sent to those living at the lower Whirinaki.

*Whare Kohanga*.—This is a house to which a mother and newly-born child are removed from the *whare kahu*, or fœtus-house, the next day after birth of the child. Such a ceremony was, of course, only kept up by chiefs. The mother remained in the *whare kahu* during birth of the child. The child was taken by the priest to a stream-side, where he performed the ceremony of *tu-ora* over the infant, with appropriate *karakia*. The mother and child were then taken to the *whare kohanga*, a small house specially constructed for the purpose. The child was *tapu*, and remained for some days in this "nest-house." When the end of the *iho*, or umbilical cord, was severed it was carried to the *urupa* and there left. In some cases the *iho* was deposited in a tree or under a rock at some noted *taumata*, or resting-place, by the side of a track; such a place would ever after be known as "The *iho* of So-and-so." Also, it was sometimes deposited at the bounds of tribal lands, to preserve the tribal right and influence over



such lands. Such places are Te Rahui and Ngaheni, at Wai-karemoana. The *pure*, or *whakanoa*, ceremony was performed over the child when it was taken from the *whare kohanga*. Two *hapi* (ovens) of food were cooked, one for the priest and one for the people. With certain *karakia*, the priest then took the *tapu* off the child, who now became *noa*, and might be carried about by the women.

One of the most interesting subjects in this district is that of the various duties pertaining to the position of the *tohunga*, or priest, of the ancient Maori. Their duties appear to have been almost innumerable, for the *tohunga*, in one capacity or another, was in constant requisition. The ancient *karakia* are without number, and many of them are most interesting, containing, as they do, many words of an archaic type. A close study of the *karakia* of the Tuhoe priests, if made by a competent person, would throw much light on the beliefs and rites of the ancient Maori.

The word "*umu*" is prefixed in a strange way to many of the old *karakia*, such as *umu hiki*, an incantation to cause a hostile tribe to leave their homes and migrate; *umu tamoe*, a *karakia* to render a defeated enemy powerless to obtain revenge; *umu waharoa*, a *karakia* and ceremony performed over the dead; *umu pongipongi*, a ceremony and *karakia* to bewitch. In this case it is by no means clear that *umu* = *hangi* (an oven). It is probably an ancient word, signifying a *karakia*, or ceremony. In many sacred rites fire was used by the priest, such as the *ahi taumata* and *ahi taitai*. Also, sacred ovens were used to cook food, to be used in such ceremonies as the freeing from *tapu* of a returned war-party, and in this manner the word "*umu*" may have come to be used as a synonym for *karakia*.

As stated, the *karakia* of the Maori were innumerable, and were used for almost every act and occurrence. *Karakia* were repeated by children at their games, and they had special ones for spinning *potaka* (tops), kite-flying, and for the *karetao*, *porotiti*, *topa*, *pakuru*, and other toys, as well as for games played with the hands, such as the *hapi taua*, *upoko titi*, and *kura-winiwini*, as also for the *wi*, *tatau manawa*, *tatau tangata*, and *tatai whetu*. Though styled *karakia*, these are in many cases a mere jingle, equivalent to our nursery rhymes, and sometimes are in the form of a dialogue.

The more serious form of *karakia* cover a great scope. The ancient *tohunga* had *karakia* in his budget for causing a flooded river to subside, to blast trees and shatter rock, to harden himself for the fire ceremony, and to cause crops to grow. In commencing a journey he would *karakia* to cause the land to contract, so as to shorten his journey, and would request that the land might not be drawn out lengthways. If

doubtful of reaching his destination before nightfall he would repeat a *karakia* to hold the sun in its course, so as to give him a start, a most useful thing. When pursued by an enemy he would repeat the *hoa tapuwae* over himself to render him fleet of foot, while at the same time he would repeat the *punga* to make his pursuer slow to follow. If overtaken, he recited the *tu-mata-pongia*, which rendered him invisible. In wrestling he used the *tuaumu* incantation, and when going to battle repeated the *hoa rakau* over his weapon. The *moremore-puwaha* was to force the knowledge of the art of weaving into his womankind, and the *rotu* to calm the waves of the ocean. When reciting a *karakia* to subdue an unruly *taniwha* or the ocean he would pluck a hair from his head (*ka unuhia te tai-o-makawe*) and cast it into the waters. The *toko* was a *karakia* used to separate a wife from her husband; it was made use of by a second wife at times, to cause a favourite wife to be parted from a common husband. The *kai-ure* and others were *karakia* of the class known as *matapuru*, which were used to ward off witchcraft. If a man came to know that he had been bewitched, or that some evilly-disposed person was trying to take his *hau*, he would immediately procure some strips of *harakeke*, or flax, and tie them carefully around his body and limbs. He would then recite the *matapuru* to render harmless the spells of his enemy.

*Rua torino* (Ngatiawa).—This is a ceremony by which persons are slain by witchcraft (*karakia makutu*). The *tohunga* forms a mound of earth in the shape of a man's body. He then makes a hole in the supposed body with a stick. He then recites an incantation to draw the *wairua*, or spirit of the man he wishes to slay, into the hole. The *wairua* may be an invisible essence or it may be in the form of a fly. The *kopani karakia* is then used to close the *rua torino*, and confine the *wairua* therein, where it is destroyed, and with it, of course, the earthly body, wherever it may be.

*Rua-iti*.—This appears to be the Tuhoe term for the *rua torino*. When a *tohunga* wishes to kill a person by means of the *rua-iti* he procures from the home of the doomed person a piece of cord or string, which he takes to the *rua-iti*, and there places one end of the cord in the hole; the other end he holds in his hand. This cord serves as a *takutaku*, down which the priest causes the *wairua* (soul) of the victim to pass into the *rua*, where it is destroyed by the *karakia* known as *whakaumu*.

The counter ceremony for the above was described to me by Te Whatu, of Tuhoe, as follows: "Should I become aware that a *tohunga* is bewitching me so as to cause my body to waste away—and I should know at once if he were—I send some one to his place to bring me a piece of cord, of any kind.

I take the cord and smear it with blood procured from an incision in the left side of my body. I then kindle a fire and burn the cord; also, I cook a single *kumara* or *taewa* at that fire. The cooked *kumara* I give to the *ruwahine* (a childless woman employed in various sacred rites), who eats it. Friend! That man is dead!

“Another method of averting the effects of witchcraft is to place the *kumara* beneath the *paepae-poto* (door-sill) of my house and get the *ruwahine* to step over it.”

The *paepae-poto* is one of the most sacred parts of a house. The saying is, “*Kia wehi ki te paepae-poto a Hou.*”

To describe the various rites, customs, and ceremonies of the natives of Tuhoe Land as they obtained in pre-pakeha days would require a volume, and also much care and patience on the part of the compiler, combined with a thorough knowledge of the Maori tongue, or, at least, the vernacular thereof, a qualification which I myself, unfortunately, do not possess. It is greatly to be desired that these matters should be placed on record during the next few years, for the present generation is the last which will retain such knowledge, and, indeed, only a few old men of this time can tell of the countless ceremonies of the ancient Maori. Much has been lost beyond recall, but much may yet be saved if a few capable persons will but take the matter up.

---

ART. V.—*The Building of Hotunui, Whare Whakairo, W. H. Taipari's Carved House at Thames, 1878.*

Told by MEREANA MOKOMOKO, widow of the late chief, W. H. Taipari, to Gilbert Mair, 12th July, 1897.

[Read before the Auckland Institute, 6th September, 1897.]

My father, Apanui Hamaiwaho, chief of Ngatiawa at Whakatane, built the house Mataatua. Taipari, his father, Hotereni, and myself were invited to go to Whakatane to take away that house, but before we could go Sir Donald McLean visited Whakatane, and Ngatiawa, to show their *aroha*, gave him the house.

My father then said Ngatiawa would carve a house for me. This was in 1875. Accordingly the work was commenced forthwith, and in May, 1878, the posts were all finished, and about seventy Ngatiawa, under the chiefs Wepiha Apanui (my brother), Rangitukehu te Wharewera,

Tiopira Hukiki, Te Putere, and Te Pirini, came to Hauraki, bringing all material. The freight and passages cost £170. The first post erected was named after Pereki Awhiowhio, chief of Ngatiwhanaunga. When an attempt was made to lift the ridge-pole it failed: then we sent for Paroto Manutawhiorangi, who uttered an incantation, or *karakia*, called "*Tehuti o Tainui*" (the raising of Tainui), and lo! the great tree was lifted up quickly and easily. Such was the power of magic as exercised by Maori priests of old. During the building a number of the Ngatiawa workmen were smitten with sudden illness, which was attributed to their having burned in a cooking-fire some chips from Apanui's chisel (*whao*). It was the women who inadvertently committed sacrilege, and the sickness which fell upon our people was termed a *mate-ruahine*. When several persons had died, my brother Wepiha came to me at dawn of day saying, "*Kua ngaro a Ngatiawa* (Ngatiawa will be annihilated). Hasten you quickly to remove the spell caused by the desecration of the work of our father's chisel." I hurried to the spot, and in the midst of the assembly a small fire was made of chips from the carvings, and two kumara roasted therein, which were offered to me to eat. I trembled with fear, lest death should come to me also; but the old men said, "Fear not, you are equal in mana to Apanui, your father, and you alone can remove this spell which is destroying Ngatiawa." I then ate the roasted food, and the epidemic ceased. Soon the house was completed, and Wepiha summoned a *tohunga* called Mohi Taikororeka from Ōpotiki to perform the ceremonies called "*whai kawa*"—i.e., making the house "*noa*," removing the *tapu*, &c. After this was done, and the men had entered and eaten food in the house, three women (myself, Kitemate Kiritahanga, and Mere Taipari) were sent for to *takahi te paepae* (to tread on or cross over the threshold, and thus remove the enchantment which debarb women from entering a sacred house until this ceremony is ended), for, as you know, the ridge-pole would sag down in the middle and destroy the appearance of the house were this ceremony disregarded. As the morning star (*Kopu*) rose, we, the three women, crossed over the threshold which Te Raihi, of Ngatihaua, had *tapa'd* (called) Hape Koroki, and then the *mana o te whakairo* (the sacredness of the carving) was subjugated, overcome, and women generally were free to enter and eat within the house.

The several tribes of Ngatiawa who took part in the building were as follows: Ngatihokopu, Te Pahipoto, Te Patuwai, Te Patutatahi, &c.

The ridge-pole was a kahikatea (white-pine), procured at Turua. It was carved by Hotereni Taipari himself, and

named after his great ancestor Hotunui. These are the generations from that ancestor:—

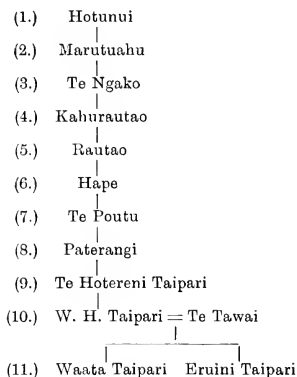

The length of the house is 80 ft.; width, 33 ft.; height, 24 ft.; length of porch, 12 ft.

The figures on the right-hand side of the porch are—(1) Kopuani, (2) Takuao, (3) Te Tai te Hura, (4) Takoto Titaha; inside on the right hand the large figures are as follows: (5) Te Motuituiti, (6) Te Iwi Tuha, (7) Te Putara, (8) Ngahaupaha, (9) (not named), (10) Te Apurangi, (11) Kahurautao, (12) Hape, (13) Matatahi, (14) Ngangaia, (15) Taitoi, (16) Pereki Awhiowhio, (17) Te Whero, (18) Te Umu, (19) Matau, (20) Kiwi.

On the left-hand side of the porch there are—(1) Kauahi, (2) Te Tuki, (3) Horowhenua, (4) Tauaiwi; on the left hand inside the figures are—(5) Paharua, (6) (not named), (7) Ramuri, (8) Parera, (9) Ureia, (10) Rautao Pouwharekura, (11) Uetawhiti, (12) Tapane, (13) Toitoi, (14) Puhoi, (15) Putoa, (16) Kawhero, (17) Pahae, (18) Pakira, (19) Tarakai Kahia, (20) Riki.

The *paepaewaho* (threshold of porch) is called “Ruamano.”

When the builders were returning to their own place they would not accept payment beyond the food and presents we had given them from time to time, but my father-in-law (Te Hotereni Taipari) felt ill at ease, saying the Ngatimaru had not sustained their ancient name for generosity; so he said to me, “My daughter, do you take this letter quickly to the Bank of New Zealand at Tauranga, and when our friends the

Ngatiawa [who were returning by sea] reach that place give them the money the bank-manager will pay you." I travelled day and night overland, and overtook the steamer at Tauranga, and I got the bag of money from the bank, and took it to the people, saying, "Behold! I have brought you a *koha* (gift) from your grandparent, Hotereni Taipari." £1,000 in single bank notes did I give them, and Ngatiawa went on their way rejoicing.

---

ART. VI.—*The Insulation of Cold-stores.*

By Professor F. D. BROWN.

[Read before the Auckland Institute, 12th July, 1897.]

Plates XI. and XII.

WHEN a low temperature is artificially maintained in any space, such as a portion of the hold of a steamer, a room in a freezing-works or butter-factory, or in a railway-truck, it is necessary to prevent, as far as possible, the access of heat from the outside. This is done by providing an internal lining to the walls and roof, distant from them some 12 in. to 18 in., and packing the intervening space with some material which does not readily allow heat to pass through it. Charcoal has hitherto been generally employed for this purpose, but it is claimed that pumice-stone is more suitable; while it is conceivable that other substances known to be good insulators might be employed with advantage.

It seemed desirable to institute an exact comparison of the insulating powers of these substances, and the following is a description of some experiments made with this object in view:—

The apparatus employed is shown in Plate XI.; it consisted of a small cylinder A of thin brass, 2 in. in diameter and 7 in. high, surrounded by a double cylinder or jacket BB made of copper. The internal diameter of this second cylinder was  $5\frac{3}{8}$  in. and its height  $10\frac{5}{8}$  in.; so that A, when placed centrally, was separated from BB by a space  $1\frac{1}{16}$  in. wide. This space CC was loosely packed with the charcoal or other substance to be experimented upon. The cylinder A was provided with a thermometer T, divided into tenths of a degree centigrade, and of such an open scale that hundredths of a degree could be easily distinguished by means of a suitable reading-telescope, which instrument was employed through-

out the experiments. The cylinder A was further furnished with a metal stirrer, driven at a constant speed by a small electromotor. The mechanical arrangement of the stirrer is shown in the drawing.

When making a series of observations the insulating substance was first packed in CC, care being taken that the cylinder A was exactly at the centre of BB. A measured quantity (300 cc.) of ice-cold water was then introduced into A, and steam was blown into BB through an orifice D, escaping at the bottom by the tube E. BB was thus kept throughout the experiment at a temperature of  $100^{\circ}$  C. The stirrer having been set in motion, the thermometer in A was observed at intervals of five minutes. The rise in the temperature of the water in A is evidently a measure of the amount of heat passing through the insulating substance from the steam-jacket in the given interval of time. At first the temperature of A rose slowly, owing to the flow of heat from the steam-jacket being largely employed in heating the insulating substance; but the rate of rise in temperature gradually increased, until after a period varying from forty to sixty minutes it attained a maximum, and then began slowly to diminish. The numbers given in the subsequent tables were, with one or two exceptions, all observed during this latter period, when it was assumed that the temperature gradient was uniform throughout the insulating material. It is, of course, important in making experiments of this kind to allow sufficient time to elapse for this uniform gradient to establish itself. That during the latter part of the experiment there should be a gradual diminution of the flow of heat into A is to be expected, inasmuch as the difference of temperature between the outside steam and the inside water becomes less as the experiment progresses.

The first series of observations were made with pumice, such as is used for insulation on steamers, which was kindly provided by the New Zealand Shipping Company. As it was probable that the insulating-power of any material would be influenced by the size of the grains employed, the pumice was first sifted so as to divide it into the following three grades: Coarse, passed through seven meshes to the linear inch, but not through twenty meshes; medium, passed through twenty meshes, but not through fifty-six meshes; fine, passed through fifty-six meshes. The pumice was not dried, but used as it came from the warehouse.

The following Table I. gives the readings of the thermometer at intervals of five minutes, starting from the moment when the water in the internal cylinder was at  $20^{\circ}$  C. precisely. The three columns of the table refer to three experiments, one made with each of the three grades of pumice:—

TABLE I.—PUMICE-STONE.

Coarse.		Medium.		Fine.	
Temperature.	Rise in Five Minutes.	Temperature.	Rise in Five Minutes.	Temperature.	Rise in Five Minutes.
20·00	2·02	20·00	2·10	20·00	2·04
22·02	1·89	22·10	1·96	22·04	2·18
23·91	1·80	24·06	1·87	24·22	2·18
25·71	1·79	25·93	1·70	26·40	2·20
27·50	1·71	27·63	1·59	28·60	1·90
29·21	1·67	29·22	1·51	30·50	1·82
30·88	1·60	30·73	1·46	32·32	1·73
32·48	1·54	32·19	1·40	34·05	1·59
34·02	1·50	33·59	1·31	35·64	1·48
35·52	..	34·90	1·28	37·12	..
..	..	36·18	..	..	..

An exactly similar set of observations was then made with charcoal, also supplied by the New Zealand Shipping Company, and of the kind used for insulation. The charcoal was in its ordinary state, and undried; it was roughly crushed in a mortar, and divided into the same three grades, with the sieves used for the pumice. Table II. gives the results:—

TABLE II.—CHARCOAL.

Coarse.		Medium.		Fine.	
Temperature.	Rise in Five Minutes.	Temperature.	Rise in Five Minutes.	Temperature.	Rise in Five Minutes.
20·00	2·69	20·00	2·82	20·00	2·91
22·69	2·57	22·82	2·72	22·91	2·80
25·26	2·44	25·54	2·55	25·71	2·67
27·70	2·32	28·09	2·39	28·38	2·58
30·02	2·17	30·48	2·23	30·96	2·41
32·19	2·03	32·71	2·09	33·37	2·27
34·22	1·91	34·80	..	35·64	..
36·13	..	..	..	..	..



From the above tables of figures we learn that when pumice and charcoal are in the form of powder they are not such good insulators as when in larger grains. Thus, in the case of the pumice the temperature of the water in the internal cylinder arose 10·88 deg. in half an hour when surrounded by the coarse material, and 12·32 deg. when surrounded by the powder. In the same way the temperature rose 14·22 deg. in half an hour with the coarsely-divided charcoal and 15·64 deg. with the powder. The difference between the coarse and medium materials is much less marked, but it would appear that the coarse is slightly the best insulator.

The figures in the tables also show that of the two substances used, pumice and charcoal, the pumice was much the better insulator. Thus, while on the coarse charcoal the temperature rose 10 deg. in twenty minutes, it only rose  $7\frac{1}{2}$  deg. with the coarse pumice.

It has already been mentioned that the rate at which the temperature increases gradually diminishes throughout each series. This is noticeable in every case. Thus, in the case of the coarse pumice the rise in temperature during the first five minutes was 2·02 deg., and during the last 1·50 deg. It has been explained that this is due to the difference in temperature between the outside steam and the inside water being less at the end than at the beginning, or, in other words, the temperature gradient across the insulator becomes less as the experiment goes on. For example, with the coarse pumice the difference between outside and inside was 80 deg. at the beginning and 64·5 deg. at the end. The heat-flows should then be in this proportion, which is very nearly 4 : 3, which is seen to be the case. The fact that the diminution is slightly greater than that which should take place theoretically is probably due to the increased evaporation of the water at the higher temperatures, by which, of course, its temperature is rendered slightly lower than it would be if no evaporation took place. This evaporation it is difficult to avoid.

After each of the experiments with charcoal had been completed, the internal cylinder, on being removed, was found to be wet on the outside, and the charcoal in the neighbourhood of the surface was found to be in a like condition. This was obviously due to the moisture in the charcoal having been distilled, as it were, from the hotter portions to the cooler. This distillation was necessarily accompanied by a transfer of heat; so that it was clear that the flow of heat across the charcoal was partly due to the moisture, and the same may have been the case with the pumice, although, with the latter substance, there was no appreciable moisture on the cylinder.

In order to avoid the errors introduced by the presence of

moisture, the pumice and charcoal were both carefully dried by heating on a metal plate for several hours, and then allowed to cool in closed vessels, so that they could not absorb water from the air. Series of observations were then made with the dry substances, exactly as before. The coarse material only was employed in each case, as it had been found that when finely divided it was less efficient. The results are given in Table III. Experiments were also made with dried slag-wool, a material largely used for covering boilers and steam-pipes, and which was furnished to me by the Railway Department through the kind intervention of Mr. Macdonald. The results with slag-wool are included in Table III. :—

TABLE III.

Charcoal.		Pumice.		Slag-wool.	
Temperature.	Rise in Five Minutes.	Temperature.	Rise in Five Minutes.	Temperature.	Rise in Five Minutes.
20·00	1·59	20·00	1·94	20·00	1·45
21·59	1·56	21·94	1·86	21·45	1·40
23·15	1·53	23·80	1·83	22·85	1·36
24·68	1·51	25·63	1·73	24·21	1·30
26·19	1·44	27·36	1·65	25·51	1·30
27·63	1·41	29·01	1·58	26·81	1·26
29·04	1·36	30·59	1·50	28·07	1·22
30·40	1·30	32·09	1·40	29·29	1·17
31·70	1·27	33·49	1·31	30·46	1·15
32·97	1·23	34·80	1·24	31·61	1·12
34·20	1·14	36·04	..	32·73	1·10
35·36	1·12	..	..	33·83	1·08
36·48	..	..	..	34·91	1·04
..	..	..	..	35·95	

The numbers in this table show that, when carefully dried, charcoal is a better insulator than pumice, and that slag-wool is better than either. Thus, at the end of half an hour, or six periods of five minutes, the rise in the temperature of the water was—With charcoal, 9·04 deg. ; with pumice, 10·59 deg. ;

with slag-wool, 8.07 deg. These numbers are proportional to 100, 117, and 89; so that if we take the heat flowing through dry charcoal under the given conditions as 100, that which flows through dry pumice under like conditions is 117, and that through slag-wool 89. Referring to Tables I. and II., we find that the rises of temperature of the water in half an hour with the coarse undried charcoal and pumice were respectively 14.22 deg. and 10.88 deg., or, taking dry charcoal as 100, they would be 157 and 120. We thus have the following comparable numbers for the flow of heat through the different substances: Dry charcoal, 100; dry pumice, 117; dry slag-wool, 89; ordinary charcoal, 157; ordinary pumice, 120. It will be noticed that, while there is a great difference between the conducting-power of dry and that of ordinary charcoal, there is but little such difference in the case of pumice. This is due to the fact that charcoal absorbs from the air a considerable amount of moisture, while pumice absorbs very little. Ordinary pumice and dry pumice are therefore almost identical, while ordinary and dry charcoal differ much.

In order to compare the absorptive power for moisture of the two substances, two wooden boxes with loosely-fitting lids were filled, one with the dry pumice the other with the dry charcoal which had been used in the experiments above described, and placed side by side in the laboratory. After the lapse of more than six months the amount of moisture which had been absorbed was estimated, and it was found that 100 parts of the charcoal had absorbed 7.22 parts of moisture, while 100 parts of the pumice had only absorbed 0.32 parts. This absorption of moisture by charcoal is greatly detrimental to the use of the substance as a thermal insulator. Its effects can only be avoided by drying the charcoal immediately before packing it in the walls of the chamber, and lining these walls with sheets of metal, soldered or riveted together so as to be perfectly airtight. With pumice these precautions are unnecessary.

The numbers recorded in Tables I., II., and III. were plotted out in the usual way, and the resulting curves are given in Plate XII. From these curves the comparative insulating powers of the several substances might be determined more exactly than has been done in the above paper. Little would be gained, however, by so doing.

ART. VII.—*Thoughts on Comparative Mythology.*

By EDWARD TREGEAR.

[*Read before the Wellington Philosophical Society, 22nd December, 1897.*]

IN venturing to write on so vast a subject as comparative mythology, I can only hope to offer a very small contribution towards the knowledge of the subject. It appears presumptuous for a pigmy to venture among the giants engaged in conflict, but my excuse is that the weapons employed grow blunted in the long-protracted fight, and the contestants are sometimes grateful for a fresh supply, even if of rough and homely manufacture. "Many men, many minds," and it may be that something of use may be added to the controversy. If not, the earnest desire may be "counted for righteousness."

The field of comparative mythology is at present occupied by two parties. It is difficult in a few words to explain the position, but, roughly, the opinions of the opposing forces are as follows: One party considers that mythology has arisen from a desire to represent the forces of nature (perhaps the phenomena of nature) symbolically, and that by a "disease of language" these symbols have grown to be considered as personal beings, and have become deities, &c. These thinkers hold that the student of mythology must search in the literature of the ancient people to which any particular myth belongs if it is wished to understand what the myth once meant. It is a necessary adjunct to such study that a most careful and accurate scholarship in classical and Oriental languages be attained before any explanation of the meaning of myths handed down to us by peoples speaking those languages be attempted.

The other party contends that mythology has had little to do with language; that the same idea or similar ideas spring up almost spontaneously among all races when on a certain level of barbarism or civilisation. It is asserted that if we wish to understand the meaning of a myth invented by barbarians we must go among modern savages and find out from them what they understand on the subject, if any similar belief to that under consideration is to be found among them.

There is, of course, much to be said on both sides; the literature published on the subject is already enormous; the side-issues are endless; and the whole question, except to master-minds strong enough to hold firmly to main principles of their argument, appears confused and intricate, almost beyond comprehension. It can only, then, be the hope of illustrating some particular incident, or supplying some lost

link in the chain of evidence, that can make an outsider's thoughts on the subject worth taking into consideration.

I am led into doing my little part by the issue of a new book by the Right Hon. Professor Max Müller. It is called "Contributions to the Science of Mythology" (Longmans, Green, and Co., 1897). I propose to make a series of running comments on those parts of the book which offer points that have struck me as capable of further illustration. I have not the presumption either to criticize the main argument or spoil the reader's enjoyment of the work by making long extracts.

Vol. I., page 6: The professor alludes to the legend of Tuna, and notes that the white kernel of the coco-nut was in Mangaia called "the brains of Tuna." He says,—

Considering that "coco-nut" was used in Mangaia in the sense of head (*testa*), the kernel or flesh of it might well be called the brain.

This is certainly true, and the remark may be further strengthened by considering the native words actually used in the legend. "The brains of Tuna" is rendered in Mangaia as *te roro o Tuna*. Now, *roro* is a widely-known Polynesian word, and the complexity with which the two ideas "flesh of the coco-nut" and "brain" are interwoven renders confusion between the two almost a certainty; or, rather, makes the identity of each almost inseparable from the other. Thus, while in Maori *roro* means "the brain," in Samoa *lolo* is used for "the coco-nut prepared for making scented oil." In Hawaiian *lolo* means "the brain"; in Mangareva *roro* is "the skull," and also "milk from coco-nuts"; in Mangaian *roro* is "brains"; in Fiji *lolo* is "the milk of the coco-nut squeezed from the kernel when scraped." This proves that in ancient Polynesian the one word probably covered both meanings—"brains" and "the soft part of coco-nut."

Page 75. The gods being once given, we can account for goddesses, for heroes and heroines. It is the gods who require explanation, and we know now with perfect certainty that in their first apparition they were simply the agents postulated as behind the most striking phenomena of nature.

This is a broad and far-reaching statement of position. It insists on the absolute necessity of drawing a mental line between mythology and folk-lore—that is, as I understand it, between the almost abstract conception of personified forces of nature and the elevation of heroic personages by means of miraculous machinery to the ranks of gods and demi-gods. It is difficult to give instances from New Zealand mythology, because it is only now beginning to emerge from obscurity; but we may consider Ao, the representative of Day or the Upper World (as opposed to Po, Night, the Lower World), as being one of the great forces, the scarcely-personified deities;

while Maui, as a hero, belongs more to the domain of folklore.\*

It is said by the priests of Tahiti that it was impossible that the Maori of New Zealand could inherit the highest forms of the old Polynesian religion, because Ngatoro-a-rangi, who arrived here in the "Arawa" canoe, was the only great priest accompanying the expedition from Hawaiki—that he was only a priest of the third rank, and, as such, was not initiated in the higher mysteries. Be that as it may, there is to be found in old Maori songs and incantations vestiges of an infinitely higher conception of a divine being than any that for a long time we were taught were to be found within the Maori Pantheon. If we look over the sea to the men of the same race as the Maori we shall find that they based their beliefs on nature-forces, and had embodied these mentally in conceptions of such forces existing in awful majesty as uncreated deities governing the universe. Consider the solemn litanies with which the natives of Hawaii worshipped their Trinity—Light, Sound, and Stability (Kane, Ku, and Lono), or, as the Maori called them, Tane, Tu, and Rongo. Here is a fragment of this litany :—

*The Priest* : O Tane and Tu, the builder, is it true ?

*The Congregation* : It is true, it is so.

*The Priest* : O great Rongo, dwelling on the water, is it true ?

*The Congregation* : It is true, it is so.

*The Priest* : Quickened, increasing, moving. Raised up is the continent (island, division). Is it true ?

*The Congregation* : It is true, it is so ; it is true, it is so. The true god.

*All together* : Tane-po-rangi, O heavenly father, with Tu, the builder, in the blazing heaven, with great Rongo of the flashing eyes, a god, the god of lightning, the fixed light of heaven, standing on the earth, on the earth of Tane-tumu-whenua ; he is god. It is true, it is so ; it is so, it is true ; he is the true god.

So, too, in Tahiti, Taaroa (Maori, Tangaroa)—who is in many places in Polynesia regarded as the god of ocean—appears in the mythology of the eastern groups as an abstract and apparently omnipresent deity. The Tahitian chant says,—

He abides—Taaroa by name—

In the immensity of space.

There was no earth, there was no heaven,

There was no sea, there was no mankind ;

Taaroa is the root,

Taaroa is the rock (or foundation),

Taaroa is the light,

Taaroa is within.

---

\* This remark is subject to the fuller consideration given to the true position of Maui in mythology in a subsequent part of this paper.

Tangaroa was also regarded as a primal deity in the Marquesas, where he is called "Tanaoa":—

In the beginning, Space and companions ;  
 Space was the high heaven,  
 Tanaoa filled and dwelt in the whole heavens.  
 And Mutuhei was entwined above.  
 There was no voice, there was no sound,  
 No living things were moving,  
 There was no day, there was no light.

It is through the mythology of these Marquesans that we are able to recognise these primal gods as nature-forces. Everything is vast, immense, mysterious ; no place for mere human heroes here. In the boundless Night resided Tanaoa, whose name here means Darkness. With him reigned Silence (Mutuhei) ; but in this realm of Darkness and Silence lay the unawakened germ of all that was hereafter to come. Evolved from himself, Light (Atea) made war on Darkness, drove him away, and confined him within limits. Proceeding from Light came Sound (Ono, or Rongo), who destroyed and broke up for ever the rule of Silence over the universe. In the struggle between Light and Darkness, Sound and Silence, the Dawn (Atanua) arose. Light took the Dawn for wife, and from their union sprang the lesser gods. As we read this cosmogony we almost seem to be listening to some old Aryan hymn setting forth the marriage of the Sun and the Dawn. Atea and Tangaroa may change their attributes, and we shall find them do so if we wander from island to island, and allow the lapse of time to weave ridiculous stories round the deities of a decaying faith, but the fact will remain, never to be explained away, that Light and Darkness, Sound and Dawn were primal gods of the Polynesian, anterior to all hero-worship, and more ancient than all folk-tales. If any one should say that such broad and abstract conceptions were impossible to these simple islanders, I would quote their lofty and magnificent hymn, where among many other fine expressions they say,—

O thrones placed in the middle of the upper heavens !  
 O thrones whereon to seat the Lord of love !  
 The great Lord Atea established in love.  
 Born is his first son, his princely son.  
 O the great prince ! O the sacred superior !  
 O the princely son ! first born of divine power.  
 O the Lord of everything ! here, there, and always.  
 O the Lord of the heavens and the entire sky !  
 O Atea ! their life, body, and spirit.

Here there is no lack of the higher religious feeling, and it is a long leap downwards before we come to the deified human hero. Even when, however, the myth has become a folk-tale it is often certain that if we could trace the folk-tale

to its fountain-head we should arrive at a myth-source—that is, at the observation of natural phenomena. I class the Maui legends rather as folk-tales than as myths only, because they are related as if they belonged to a lower stratum of thought than that we have been considering. They are told with a familiarity, with an absence of reverence, that to me seems to mark a distinction. The name of Maui is not regarded like that of Io, the Supreme Being, a name to be uttered with whispered breath, and never under a roof, only out under the great vault of heaven. Yet the deeds ascribed to Maui are of supernatural interest. He was the Sun-catcher, the Fire-bringer, the fisherman who drew the world of Day up from the abyss of Night, the hero who died in the attempt to win immortality for men. Nevertheless his story is told in colloquial language, with laughter for Maui the crafty, Maui the deceiver of gods and men. The deeds related of him shrink, on account of the strong human personality so forcibly presented in the legends, until we forget how impossible it is that the actions he is said to have performed could have been executed by any creature in human likeness or akin to our race. We seem to see him, and know him well as a brother; he sleeps on his mother's arm; he plaits his ropes, prepares his bait, chooses his weapon, performs his devotions, and, at last, dies as a mortal dies. But when we meditate on the story, stripping away the conversational freedoms and familiarities that loving sympathy with the hero has caused the narrator to add to his narrative, we find that Maui, though he is the sun-catcher, is himself the sun; though he brings fire from the under-world for mortals, he is himself the solar fire. It can be proved in many ways. How else can we explain such a verse as that in the ancient Hawaiian song:—

A-Taranga the husband, Hina-ka-te abi the wife;  
 Born was Maui the foremost; born was Maui the middle one;  
 Born was Maui Tikitiki; born was Maui from the apron (*maro*).  
 From the girdle that A-Taranga had fastened,  
 Pregnant was Hina, and a fowl (*mōa*) was born,  
 A hen's egg was the offspring that Hina conceived.

If this is related of human beings it is not to be explained. However, we know from other sources that Hina was the Moon-goddess, and that when she bore Maui (himself an immature birth\*) and the egg she was bringing forth Light and Darkness, the holy twins, as Leda brought forth the swan's egg that produced Castor and Pollux, and as in the

\* The Maori regarded premature births with superstitious awe, and looked with dread upon an abortion or miscarriage. Such abortive births were supposed to be endowed with supernatural powers, generally of a malignant character.



Veda we are told that Saranyu bore the twins of Day and Night, the Asvins.\* It is riddling talk, but there is an answer to the riddle.

I may say here, while speaking of Maui as a purely mythical personage, that consideration of the legends regarding him helps to make me a sceptic and a heretic on the subject of Maori genealogy. Some genealogies are very interesting, and when compared with others are full of points of study, especially if viewed with the eyes of the psychologist or anthropologist. But, historically, beyond a few generations back from living natives, they are, in my opinion, totally unreliable. For instance, in the pedigree of Major Ropata, Maui is shown as his direct ancestor twenty-eight generations ago.† Allowing twenty-five years to a generation, this gives seven hundred years. So that, according to this account, it is only seven centuries ago (say, in the year that Richard Cœur-de-lion died) since Maui pulled up the North Island of New Zealand from the sea. Similarly, if we consider the genealogies of Mangaia Island as given us by the late Dr. W. Wyatt Gill,‡ we find that between the high priest of Matoro, living in A.D. 1830, and his first ancestor, Papaanuku (*i.e.*, in Maori, Papa-tu-a-nuku = Mother Earth, the wife of Rangi, Heaven), there were only nine generations. This would be startling if we could not compare it with three genealogies given by Grimm in his "Teutonic Mythology,"§ in which he shows that the Princes of Kent, Bernicia, and Essex all traced their descent directly to the god Woden in nine generations also.¶

Page 78: It is said with a certain amount of plausibility that these ancient races must have remembered also something else—some real heroes, some real battles—and that they would have talked and sung of

\* Hina, the sister of Maui (the Light-god), is known to the Maori as Hina-uri—*i.e.*, Hina the dark one.

† For pedigree, see Tregear's "Maori-Polynesian Comparative Dictionary," p. 668. There can be no doubt that this is the legendary Maui, because he is given as the son of Taranga, daughter of Muriranga-whenua.

‡ "Savage Life in Polynesia," p. 227.

§ Vol. i., 165.

Kent— Woden. Wecta. Wittā. Wihgils. Hengist. Eoric. Octa. Eormenic. Æthelbeorht.	Bernicia— Woden. Bældeg. Brand. Beonoc. Aloc. Angenweit. Ingwi. Esa. Eoppa. Ida.	Essex— Woden. Saxneat. Gesecg. Andsecg. Sweppa. Sigefugel. Bedecca. Offa. Æscwine.
---	--	---

them rather than of the battle between Light and Darkness, between Day and Night, between Sunshine and Rain, between Spring and Winter. So it seems, but it has been shown that even in our own time nothing is so striking as the forgetfulness of the people where there is no printed literature to keep up the memory of great events. Experiments have been made, and it was found that peasants living near Leipzig know nothing of the great battle, except what they may have learnt at school. I myself heard an old woman assuring her friends that after Waterloo Napoleon had been hiding in England for many years, and had at last come back to Paris to fight the Germans. To test the retentiveness of the memory of peasants similar experiments have been made in the neighbourhood of the great battlefields of Frederick the Great. The people all knew some anecdote, more or less mythical, of the Olle Fritze, but of the battles near their own villages—of the position of the armies, of the flight of the enemy, of acts of valour and all the rest—they knew nothing at all. Places are shown where the king is supposed to have jumped on horseback over a river which no one but an old heathen god or a hero could ever have jumped—that is to say, popular legends were beginning to absorb historical reality.

The above remarks as to the forgetfulness of a people without printed literature need qualification. The modern instances adduced illustrate the weakness of memory among people accustomed to rely upon literature to preserve their history. They have therefore allowed their legendary memory to become almost rudimentary from disuse. Among races totally unacquainted with literature the converse of the statement takes place. With the Polynesians, for instance, the most laborious efforts were used to insure strictness in handing down their ancient legends, just as in those instances of the oral transmission of the Vedas in India, so well described by Professor Max Müller himself. Printed books are the enemies of memory.

The last sentence in the above quotation—that relating to the leap of the king across a river—may perhaps bear an illustration from my own experience. Many years ago I was walking with a Maori on the bank of the Waikato River, near the village of Te Whetu. The native chief said to me, "I will show you something that no white man has ever yet seen. I will show you our ancestor, Raukawa." This Maori belonged to the Tribe of Ngati-raukawa. We left the river-side and proceeded up a narrow valley. Turning a sharp angle in it, we came upon a huge conical stone. It was about 30 ft. in height, if my memory serves me. About 20 ft. up was a bright patch of red ochre. The Maori said, "Do you see the *kura* (red mark)?" I answered, "Yes, what is it?" He replied, "That is the blood that flowed from the wound when he was killed. That is my ancestor, Raukawa. He was a giant; he leapt across the Waikato River at the place where Cambridge now stands." I said, "I should like to understand exactly what you mean. Do you want me to know that this stone was set up in memory of your ancestor, and

made sacred for him?" He answered, "No, this is my ancestor himself." I then said, "You must know that you are talking nonsense. A stone cannot give life to a race of men, nor could it leap across the Waikato. You mean that the stone has been named for Raukawa, or else, perhaps, that your giant forefather was turned into stone by the gods and the petrified hero stands in this spot." "No," he replied doggedly, "that is Raukawa, and the red mark is the place where he was mortally wounded." I shook my head in despair. I could not follow his thought, but I feel sure that he believed in some queer idea of personality in the stone.

Page 80. Some of these riddles seem to arise quite spontaneously. Nothing was more natural for the ancient Aryas than to speak of the rising sun as the "child of the morning," and of the setting sun as the "child of the evening." Nor did it require any poetical effort to speak of the two as "twins," and as the "children of day and night." But, from another point of view, the day might be called the offspring, which would mean no more than the product, of the rising sun, and the night the offspring of the setting sun. Thus the riddle was ready at hand. Even a savage might be tempted to ask, How can the sun beget his parents? And this question is actually asked in one of the hymns of the Rig-Veda (I., 95, 4): "Who can comprehend that hidden god (Agni)? The young child has given birth to his mother."

In this quotation we see, as I think, the very heart of all mythology, and an explanation why this puzzling mythology is a "disease of language." No other mode is there of explaining the monstrous and inexplicably disgusting tales told concerning the lives and actions of the deities, unless we refer them to riddling descriptions of personified natural phenomena. As to classical and Oriental mythology, the ground is already occupied by great scholars; but I may perhaps be allowed to call the attention of Polynesian students to this mode of interpretation of our own myths. What else can explain the legend of the god Tane and his daughter Hine-a-taurira? I need not repeat the tradition; I give the references. The story, if told of one of the rulers of the universe, is horrible; but when we know that Tane, the great Heaven-father, is the Lord of Light, then we understand the imagery of the tradition, and recognise its veiled truth. It is idle to suppose that even savages would ascribe to the higher Powers faults and moral defects which they would look upon with loathing in one of themselves. Many of us have in our youth sat open-mouthed and wondering to find that cultured people like the Greeks and Romans could relate with sobriety the accounts they have given us of their great deities. The actions of Jupiter and Juno, of Apollo and Venus, were

---

\* Shortland's "Maori Religion," p. 22; White's "Ancient History of the Maori," i., 145.

actions that would have been held infamous among human citizens. We cannot conceive such citizens building temples, and offering incense to such atrocious conceptions—nay, that even while regulating their daily lives in modes conformable to exalted ideas of morality they could worship beings whose conduct, as related by priest and poet, was tainted with diabolical crime. Comparative mythology has come to explain this mystification, this benumbing ignorance of ours in regard to the thoughts and devotions of the men of an elder day; and it shows us that the action of natural phenomena has been riddled about till Light and Darkness, Dawn and Sunset, Storm and Calm, Fire and Water—aye, even Beauty and Ugliness—have been hidden under names that when misunderstood (“diseased”) have brought about as a result unbelievable life-histories of divine personages. As an example, take the Samoan tradition of Space. It says,—

Space had a long-legged seat. At another birth Cloudy Heavens brought forth a head. This was the head that was said to have fallen from the heavens. Space set it upon his high stool, and said to it, “O beloved! be a son; be a second with me on the earth.” Space started back, for all of a sudden the body of a man child was added to the head. The child was sensible, and inquired who his father was. Space replied, “Your father is yonder in the east, yonder in the west, yonder towards the sea, and yonder inland, yonder above and yonder below.” Then the boy said, “I have found my name, call me ‘All-the-sides-of-heaven.’” And from him sprang the four divisions, East, West, North, and South.

Who would be surprised if he were to find in some other place the above legend humanised?—that is, that there was a chief once who was named “The Sides of Heaven”; that he had fathers named East and West, who were also his sons, East and West. It is enigmatic, riddling, but not inexplicable. Riddles such as these are still asked as an amusement in Samoa. There, for instance, the natives find recreation in making puzzling inquiries about natural objects. They will say, “There is a man who calls out continually, day and night.” The explanation is, “The surf on the reef.” Again, they say, “A man who has a white head stands above the fence, and reaches to the heavens.” Explanation: “The smoke rising from the oven.” And so on. There is no difference between such riddles and that quoted by Mannhardt from the Russian, “What is the red gown before the forest and before the grove?” and answered by the Lett legend that tells how the Sun-daughter (the Dawn) hangs her red gown on the great oak-tree.\*

Whether we speak of sun, or surf, or smoke in this manner the observed action of the natural object has, as soon as

---

\* Max Müller, *Cont. Sci. Myth.* i., 83.

it is clothed with language, the disease-germ which will one day cause its real origin to be forgotten in the supernatural, and legends will be told about divine beings named Sun, or Surf, or Smoke. This is the genesis of all primal myths, whether related by Greek, Brahmin, or Polynesian.

Page 174. Some of these thoughts evoked in man by the aspect of nature can be discovered even among the so-called savage races of the world. But we must not imagine that because they go naked they are the same as the ancient Aryas. What there now is left of savages consists to a great extent of decadent races defeated in the universal struggle for life, driven back by more vigorous conquerors to the very edge of the habitable world, or taking refuge in deserts where there was no competition, no rivalry, no war or discord. They have become stunted intellectually, and often physically also. . . . One thing they may possess that is really genuine and old—their language—but that is the very thing which we are told we need not study in order to understand the modern savage.

It is this idea, so forcibly put in the above quotation, that is confirmed by the study of Polynesian myths and folk-lore, and still more in the study of the language. It is true, of course, that inquiry into a language is beset with many snares and pitfalls, but no one who really loves it can investigate the language of Polynesia without being impressed with the belief that herein lies embalmed the memories of other and far different epochs of enlightenment and culture than the present social and religious condition of the people would have led us to believe. Here we have barbaric or semi-barbaric tribes, in many of their customs and usages little above the veriest savage, but they possess (to use metaphor) rudimentary muscles and bones of social polity which show to the eye of the inquirer a former stage of existence, just as surely as the whale or the python exhibits an undeveloped or atrophied primal structure to the investigations of the comparative anatomist. These island peoples were probably not always island peoples; their pedigree is as ancient, if it could be traced, as that of the most civilised nation, even up to the first few human creatures that lived upon earth. Who shall say that, being barbarians, they always have been barbarians? It would, indeed, be impossible to prove, and my own belief is exactly opposed to such a notion. To what does this view of the subject lead us? To the position that if we rely too much upon modern custom or modern ignorance among savages to explain the birth of myth among primitive men we may be led entirely astray, since our modern savages may not be primitive men at all, if by primitive we understand "original," "untouched," "near the fountain-head of innocence." They may be, and probably are, the degraded descendants and broken remnants of mighty peoples, and their simplicity is not the result of innocence, but of ignorance and decay. For

instance, the infinitely intricate marriage systems of Australia and Fiji do not appear to have the merit of simplicity, while the *tapu* systems and the esoteric forms of Polynesian religion, of which we get occasional glimpses, are much more like broken-up relicts of antiquated and cumbrous ceremonials derived from ancient beliefs than the product of the mind of an untaught barbarian prostrate before the bunch of blood-stained feathers or other fetish upon which he relies for success in war or the chase, whatever may be the abstract idea that first made his fetish sacred. It is true that without modern cannibalism it would hardly have been possible for us to conceive a social condition in which cannibalism was common, and so the habits and customs of our own ancestors could not have been comprehended with the force and vividness impressed upon our minds by comparative anthropology.

Now we are able to realise the horror of man-eating; the coarseness and indelicacy therein associated with the profaned human body; the shocking cruelty and loss of such fine feeling that the existence of this one evil practice entails. It is only when we find the Fijians tying the babies of the foe by the feet to the mastheads of the canoes, so that the tender little heads might batter against the mast as the victors sailed into port among welcoming friends, that we learn its horror. Only when, as in Manguaia, we hear of the party sent to find a victim for Rongo entering a house and informing one of the girls that she is "the fish of the god"; her aunt dressing the weeping maiden in her best attire, that she might go decently outside to receive the fatal blow; then the naked body, impaled on a long spear, is carried off to the altar—when we read such tales we realise the infamous cruelty of such a custom. But we must not allow our detestation to overcome other knowledge that we gain at the same time, for we find that these same men, though cannibals by custom, were brave, were hospitable, were clever and adroit, were generally peaceable, kind in their homes, and certainly religious, even ready to die a painful death rather than do anything they thought impious or displeasing to the gods. Such knowledge it is well to gain; but there is danger to correct thinking if we project from this information inferences based thereon, and certainly not applicable to other nations or peoples under different influences, or at another stage of development. The ideas of the Fijian or the Manguaian may not explain the ideas of the Brahmin or the Greek, although their customs may illustrate forcibly to us similar customs once, perhaps, common to all. When their religious ideas are proved to have affinity, such as their myths having sprung from observation of nature-forces, then this shows that at one time or other they reached the

same intellectual level, just as the worship of a painted stone in America would show that the worshipper was on the religious level of the worshipper of a painted stone in Africa. Neither of these stages, however, may be the stage of primitive man. Modern cannibalism does not explain the story of Chronos (Saturn) devouring his children as soon as they were born, because the word "Chronos" is still transparent as "Time," and we understand how Time devours his own children; but if we considered the legend as relating to some old Greek cannibal of the name of Chronos we might (had the name become "diseased" out of recognition) have said, "Oh, yes, eating one's children is a well-known custom among savages; this is certainly an historical legend."

Page 508. It may be that the language of the Veda and Avesta can help us to explain the name of one who, according to Eustathius, was the father of Ouranos—nay, who was also called the father of Kronos. This is Akmon, which in Greek means "meteoric stone, thunderbolt, and anvil." But how could Akmon in any of these senses be called the father of Ouranos? The riddle, like many other mythological riddles, has been solved by etymology. Akmon is clearly the Vedic *asman*, which means "stone," and afterwards "thunderbolt," but also "heaven"; so that its dual is actually used in the sense of heaven and earth. It is clear, therefore, that the sky had once been conceived as a stone vault, and this is confirmed by the fact that in the Avesta also *asman* means "sky," and has remained the name for "sky" to the present day in the modern Persian word for "sky," which is *âsmân*. . . . In Sanscrit the sun also is conceived as a stone—for instance, in the Sat.-br., ix., 2, 3, 14; *asau vâ âdityo-smâ prisnih* (That sun is a dazzling stone).

Here we open up a most interesting train of thought, with unending collaterals; it is as to the connection between stone and god. It might have had its lowest expression in the worship of a simple stone as a "fetish," but even in this it appears doubtful whether the worship of the stone was not preceded by some more abstract idea. What savage, of however low a grade, could conceive that a stone could help him—that it was a superior being, that it was, as he says, "his father and mother"? Of the two considerations—viz., the transference of the idea of deity from a simple unshaped stone up to the unseen mighty beings inhabiting the heavens, or the attribution of certain powers of great gods to material objects such as stones—I prefer the latter. The transfer of supernatural powers from a deity to its symbol seems easy enough when one notes the constant craving in superstitious people for some image or material object on which to look as well as meditate. Sacredness grows round such symbols until it is hard to distinguish between reverence for the object itself or for the unseen being it represents.

In the early days of even the most cultured nations there was a time when stones of the rudest character were worshipped. The Greeks and Romans had beautiful statues of

their gods, but in their primitive days unhewn stones found plenty of worshippers. In England so late as the eleventh century King Canute had to forbid the worship of stones in England; while in Brittany it is doubtful whether at the present moment the reverence paid to sacred stones is not deeply ingrained in the hearts of the people. In Ireland not only are there traces of stone-worship everywhere, but so late as the last century there was, on the Island of Inniskea, a rude stone named Neevougi, worshipped as an idol, and kept rolled round in yards of flannel, just as the Pacific-islanders swathe their images of gods. This idol was brought out and served with incantations to calm the sea for fishing expeditions, but also to wreck the ships of strangers. Neevougi was also a potent god in times of sickness. Mahomet found the Arabians worshipping a black stone that had fallen from heaven, and that stone—the Kaaba at Mecca—has been kissed by thousands of adoring lips even in the present year. The worship of stones prevailed among the Jews until the second century of our era, as we find from the Mishna.\* They laid offerings before the Markulim, or Mercury, a kind of menhir. Their margamah was a “heap” of stones generally piled under a sacred tree, and each passer-by added a stone to the heap. A similar custom is known among the Melanesians. At Valuva, in Saddle Island, every travelling stranger throws his stone on the heap as he goes along. It is not necessary to make further reference to the innumerable examples of stone-worship that have been collected in Europe, Asia, Africa, and America, but we may notice a few instances nearer home. The Motumotu Tribe, of New Guinea, worship certain sacred stones in rivers, and many rocks and mountains are sacred. At Anicityum, in the New Hebrides, one stone, resembling a fish, is set up as a fisherman god, another resembling a bread-fruit is the bread-fruit god. The Solomon-islanders are greatly addicted to stone-worship, not only of large stones associated with powerful ghosts, but also of small sacred stones that can be carried about by sorcerers. In Samoa the gods Fonge, Toafa, Nave, and others are of stone; in Fiji offerings are made to stones of phallic shape near Vuna. In New Zealand no Maori of old times ever passed the sacred stone at the head of the Hokianga (brought by Nukutawhiti) without breaking off a *raureka* branch, laying it on the stone, and reciting a particular charm. There is a similar custom in the Banks and Solomon Islands, in which groups the natives place sticks, leaves, &c., at a place of steep descent, or where a difficult path begins.† At Nikunau they show a

\* “Mishna,” *Aboda Zarah*, iv., 1.

† Codrington, “The Melanesians,” 186.



certain chivalry in their religious matters, for among the different slabs or pillars of sandstone set up here and there among the houses the slab representing a goddess is laid flat and that symbolizing a god is placed upright. This is done lest the slab representing a lady should grow tired of standing for a long time.

These examples, interesting from an anthropological point of view, do not affect the mythological side of stone-worship, nor do they explain it. We must turn to the "word-disease" theory again before we unravel allusions to stones in the Polynesian hymns. The Maori words for stone are "*kowhatu*" and "*powhatu*." These appear to be compounds of *whatu*, and *whatu* is sometimes found in old legends and chants with the meaning of stone, but generally a stone of a peculiar kind. At present *whatu* means the "stone of a fruit, a kernel, a hailstone, the pupil of the eye"; and, in Hawaii, "the eyeball." Everywhere in Polynesia forms of this word are in use as stone—viz., *fatu*, *haku*, *atu*, &c., and it is found through all languages of the Pacific—Melanesian, Micronesian, Malay, and others—as *vatu*, *batu*, *watu*, *patu*, &c. When we find that this word has in some places acquired a secondary meaning—that of Lord or God—we must try to ascertain how it arose. That *whatu*, or *fatu*, is so applied is certain. The Marquesan hymn above quoted calls "the great Lord Atea" "*Te Fatu nui Atea*"; "the exalted Lord" is "*Te Fatu tikitiki*"; "the Lord of Ocean" is "*Te Fatu moana*." In the Chatham Islands the name of Tangaroa, the Lord of Ocean, is *Tangaroa-whatu-moana*. In Tahiti the translation of "Master and Lord" is "*O te Orometua e te Fatu*." In Hawaii Keawe is alluded to as *Haku o Hawaii*, "Lord of Hawaii." We thus see that the word was applied as a title to their highest gods. But there are most interesting examples of its use in sacrifice and incantation that might perhaps show whether the idea of sanctity grew upward or downward. Old priestly teachings reveal that when the Maori people left their ancient country (wherever that was) they brought away with them certain small precious stones of a reddish colour—very hard stones, made sacred with incantations, and dedicated to the gods. These were the *whatu-kura*, the sacred stones;\* and through all their wanderings these were religiously guarded as a means of communicating with their deities, as a kind of Urim and Thummim. When they arrived at a new island or country one of these stones was always set into another of a larger size (a hole being bored in the larger stone for the reception of the other) so soon as they could procure a suitable local stone for the purpose. This symbolized the union

---

\* Or "red stones."

between the old condition and the new. The two stones, one within the other, were then enclosed in a great wooden or stone pillar set up in the most sacred place, and never approached afterwards save by the high priest; for others to draw near it would be desecration. If the wanderings again began the stone was removed from its hiding-place, and carried off to make sacred some other shore. Can we hope to know why the red stone was sacred? Probably it arises as follows: We have all read how in the ancient world the gates of a city or the foundation of a tower were "set up" on a murdered human being. "In thy eldest son thou shalt set up the gates thereof." In Fiji it was the custom till very lately to plant each of the main posts of a chief's new house on the body of a victim: and in New Zealand the larger posts of a *pa* fence sometimes had each the body of a man buried under it. So, also, here, on the construction of a large guest-house, or a meeting-house of the tribe, a victim was sacrificed and buried at the base of the main pillar. But first the heart was cut out and was named *whatu* (stone, kernel, core—*i.e.*, cor, heart). This was cooked and eaten by the priest as the god's portion.\* In Samoa *fatu* was a name of the heart. Is it not possible that this *whatu* (the heart) was the original symbolized by the red stone carried as *whatu-kura* to be a medium of the gods, and enclosed in another stone (that acted as a sort of body to the life-giving *whatu*) on arriving in a new country? That the person killed was not always a slave, but sometimes a very precious offering indeed, may be gathered from the chant beginning *Manamana hau*,† where it says,—

Then Taraia built his house,  
Placing his youngest child  
As a *whatu* for the rearmost pillar  
Of his house, of Te Raro-akiaki.

The confusion of words noticed by Professor Max Müller as existing between *akmen* and *asman*, between "stone" and "sun," is shown to exist also in Polynesia between "stone" and "star." *Fetu* or *whetu* (a star) is probably a divergent from *whatu* (a stone). In Melanesian Futuna the word for "star" is *fatu*. This appears still more likely when we consider that in Maori *whatu* means "the pupil of the eye," and in Hawaiian "the eye-ball." We know that in Polynesia some stars were considered to be eyes, especially eyes of chiefs and heroes, just as in the ancient German mythology it is said that "Odin took Thiassi's eyes and threw them against

\* Sometimes the victim himself was called *whatu*.

† "The Polynesian Journal," v., 153.

the sky, where they formed two stars.”\* If, then, *whatu* (the eye-ball) could become *whetu*—that is, “stone” could become “star”—it is easy to see how confusion could arise as to a division in the adoration paid to the god dwelling in the star and that paid to his earthly representative, the stone named after him. That the sun was actually worshipped under the symbol of a stone is certain. The Rev. Mr. McQueen, of Skye, says that in almost every village the sun, called “Grugach, or the Fair-haired,” is represented by a rude stone, and he further adds that libations of milk were poured on the gruaich-stones.† In the Banks Islands (Melanesia) the sun is often represented by a stone in some of their magical ceremonies. “The stone to represent the sun might also be laid upon the ground, with a circle of white rods radiating from it for its beams.”‡ So that we find in localities so widely separated as Scotland, India, and Melanesia sun and stone worshipped as one, and probably called by the same word in priestly mysteries. The genesis of the idea becomes apparent. It arises from the immobility of the stone. Mountains and rocks endure, man passes by them like a fitting cloud, and so the great stones gather about them thoughts of eternity, of endless existence, of enduring peace. The sun, the lord of light, is called a rock or stone because he is the type of enduring majesty—of the unchanging duration of the times and seasons of the world. He is the foundation. As Taaroa said, “I am the rock.” Then the idea of sacredness is transferred from the enduring eternal rock in the heavens, seen only by the spiritual eye, to the lesser rock, the stone set up in honour of the ideal; so that the eye of the prosaic and unimaginative may rest thereon in comfort.

As to the sacred stone, *okaka*, put as a heart into the effigy of *raupo* (bulrush) when the priest is removing the curse called “*apiti*”; and also as to the stones named for enemies and buried when the curse called “*kanga*” is being removed, all these are of interest; but my paper has already grown to inordinate length, and many of the ideas suggested by Professor Müller’s book must be left for some other occasion.

---

\* Grimm’s “Teutonic Mythology,” vol. ii., 723.

† Tylor, “The Origin of Civilisation,” p. 226.

‡ Codrington, “The Melanesians,” p. 184.

ART. VIII.—*The State Prevention of Consumption.*

By E. ROBERTON, M.D.

[*Inaugural Address delivered before the Auckland Institute, 7th June, 1897.*]

IT has been almost a rule with recent Presidents to found the inaugural address on some matter of general interest, and yet in some way connected with their own special work. This precedent I shall follow to-night. For the remainder of the evening I wish to draw your attention to a question of public health which has during the last few years received much notice in all parts of the civilised world. I refer to the question of the State prevention of tuberculosis—in other words, what steps should the Government take in order to diminish the frequency of consumption? The subject has of late excited considerable interest in Australasia, and in most of the colonies attempts are being made to settle the question of how best to combat the spread of the disease, and to what extent it is desirable to interfere by legislative enactment.

The tendency of the discussion raised varies in different colonies. Here in New Zealand the question has been considered almost entirely from the point of view which regards the colony as incurring danger from the unrestricted immigration of those affected by the disease. In Australia it has been discussed rather from a feeling that the health of the community is already affected, and that measures are necessary chiefly to prevent the spread of tuberculosis from centres of infection already existing within the colony.

What is the reason of the present special interest in the subject? The disease is as old as civilisation itself, or older; it has for ages been responsible for a large proportion of the world's death-rate. The answer to this question is found in the fact that only in recent years has the contagious nature of tuberculosis, or consumption as it used to be called, been settled on a scientific basis, and, in consequence, the direction has been pointed out in which a hope lies of successfully combating its extension, and even of finally erasing it from the list of common diseases. Such has been the lot of other diseases, like small-pox and typhus fever, which little more than a hundred years ago held almost as prominent a place in the death-roll as tuberculosis does at present.

An opinion has been expressed by more than one observer that the sufferers from tuberculosis have of late years actually increased in proportion to the increase of the population of

the Australasian Colonies. Such increase, if actual, is not surprising, considering the great growth of some colonial cities, and the consequent crowding of the population in these centres. It might also be looked for in a population among which are descendants of so many who have sought the climates of Australia or New Zealand on account of threatened or early consumption. In the younger colonies it is just of late years that the second generation of these colonists has been reaching the early adult life at which tubercular tendencies are liable to manifest themselves in those who come of a stock predisposed to it.

The boon which any means of decreasing the number of sufferers from this disease would prove may perhaps be better understood by my naming the approximate number of deaths from it in those countries in which we are most nearly interested. In England and Wales some forty-five thousand succumb to it yearly; in Australia, about four thousand; in New Zealand, about seven hundred. Add to this tribute to death the suffering of the afflicted, the burden laid on their relatives, the loss of labour the community suffers—not only in those laid aside by the disease, but in those whose time is absorbed in nursing and caring for them—and we can realise that the benefit derived from the practical extinction of even such a fell disease as small-pox would not exceed the gain made through the extinction of tuberculosis, were that possible.

Thirty years ago, or even less, the general idea of consumption, as it was and is popularly called, was that it was a disease liable to occur, especially in certain families and constitutions, and any assertions as to its more exact cause were of a very ill-defined nature. Climate, dampness of atmosphere, impure air, and many other circumstances were recognised as predisposing causes, but the ultimate exciting cause was but matter of speculation. Here and there in medical literature are found suggestions that it was communicable from one individual to another, and cases were often adduced to support this view. But the evidence was insufficient for the infectious nature to become a generally-accepted fact; and the theory of infection was so general that it pointed out no special means of limiting the spread of the disease.

It must not, however, be assumed that this uncertainty prevented any attempts to control the disease, and that no successful means were adopted to restrict its ravages. A reference to the statistics of mortality for England and Wales during the first five years of Her Majesty's reign show that about sixty thousand died annually from this cause, being some 3,880 out of each million of the population living. In the five years ending 1891 there died annually from the same

cause only some forty-five thousand, notwithstanding the great increase of population. Reckoned per million of population, this represents only 1,635, instead of the 3,880 of fifty years previous. The decrease, moreover, had been progressive during all that time through each quinquennium, and was no doubt due to general sanitary improvements, but not to measures directed especially against tubercular disease. The ventilation of work-rooms, restriction of hours of labour and of the ages at which children were allowed to work, and other kindred measures have acted beneficially against all diseases which like tubercle best take root in those already weakened in constitution. The war waged was with disease in general, or perhaps it may be better expressed as an attempt to lessen the predisposing causes of disease, while the knowledge of the exciting cause was, in the case of tuberculosis, absent.

Tuberculosis, as its name indicates, is characterized, as regards its pathology, by the formation in the affected organs of the body of small masses of abnormal material called tubercles. These tubercles vary in size. In following the process of the disease one may note that, at first hardly perceptible, these little masses increase in size, and there gradually appears in the centre of each a yellowish colour, due to the death of the tissues in this part, and the formation from them of a cheesy substance. These masses continuing to grow coalesce with each other. After a certain stage is reached the centre of the cheesy mass begins to soften, and an abscess is formed, which finds an outlet—frequently through the normal passage of the affected organ; in the case of the lung, through the air-passages. In this way the process of excavation goes on, and a progressive case leads to the gradual destruction of large areas of the affected organ.

I go into these details to explain that until recent times a satisfactory explanation was wanting as to what caused these tubercles, which are essentially the disease. Now we know that they are due to the presence of a special germ, which finds a suitable soil for developing in those whom we in consequence call *predisposed* to consumption. No case arises of itself without the entrance of the tubercle germ into the body, and without its finding there a suitable resting-place.

The knowledge that tubercles depended on a special disease germ was arrived at only after innumerable researches, and for many years the results of these researches provided only material for dispute among those making them. One of the first steps towards the proof of the communicability of tuberculosis was the production of it by the injection of cheesy material from the tubercles into the bodies of such animals as guinea-pigs and rabbits. Later it was shown

further that after feeding these animals on food with which tubercular material had been mixed typical tubercle developed in them. This is an experiment which has been frequently made accidentally; one reported instance happened in the south of France, where a consumptive went to live at a poultry-farm. The expectoration was disposed of in such a way that the fowls' food was contaminated. The investigation of an epidemic which destroyed the fowls proved that they had contracted tuberculosis. Another example, of which several instances have been recorded, is the infection of pigs fed on the milk or flesh of tubercular cattle. The last doubt as to the infectious nature of tubercle was removed when Koch showed that a germ was present in tuberculous tissues, could be isolated, could be grown on suitable media apart from the body of any animal for several generations, and could then, when injected as a pure cultivation into other animals, produce the same typical disease.

There is little difficulty in demonstrating this germ in the expectoration of the consumptive; indeed, the abundance in the discharge from many cases presents a ready object-lesson of the danger a consumptive individual may be to those who come into contact with him or his surroundings.

After this scientific proof of the relation of cause and effect between the germ and the disease, the natural corollary was that, given a means of killing the germs, the transference of the disease was avoidable. The germs themselves are comparatively readily killed, but, owing to what is known as spore formation, the difficulty of exterminating them is much increased. Spores occupy in relation to germs a similar position to that of seed in regard to plants. A field of thistles, we know, may to all appearance be quite cleared by the simple process of killing the plants, but if they have seeded the recurrence of conditions favourable to the development of the seed—proper heat, moisture, and suitable soil—is followed by the appearance of fresh thistles.

Similarly, the spores of the tubercle bacillus may escape, and often do escape, destruction when the bacilli themselves are destroyed, and remain dormant until they find themselves in circumstances favourable to their development. They then soon become active agents, capable each one, in suitable soil, of producing myriads of its own kind. This suitable soil is found in the bodies not only of man, but of many animals with which he is brought into closest contact—the cow, the pig, the fowl, and many others. Where man or domestic animals are, the presence of the tubercle germ or its spores affords a constant opportunity for the development of fresh centres for its propagation. The infected organs of an animal may be regarded as the manufactories of the poison; the

whole animal as the distributing agent. Take, for instance, a case of advanced consumption of the lungs in the human subject, expectorating daily large quantities of broken-down tissues in which are contained innumerable germs. Unless proper care is taken—which hitherto has rarely been done—the whole surroundings are contaminated, the carpets and furniture are almost necessarily soiled, and the handkerchiefs are often, if not usually, sent to be washed along with those of other people. Experiments show that the very air is infected. At the Brompton Hospital for consumptives, near London, glass plates smeared with glycerine were placed for five days in one of the ventilating-shafts of the hospital. From what was deposited on these plates were demonstrated bacilli of tubercle in fair numbers. In a thoroughly purified ward in which a number of patients not consumptive were placed no bacilli were found in the air carried off by the extraction-shaft.

In the rooms occupied by consumptives not only are bacilli probably in the air in small numbers, but dust is formed of dried expectoration, and in this a still greater danger of dissemination lies. The spores of the germs survive in such dust, being much less susceptible to destructive influences than the germs themselves. They are unaffected by dryness, by a high degree of heat, and a strength of antiseptic solution much stronger than that which will kill the germs. Buried in the ground, they are found months later to retain their vitality. In the form of dust they are especially liable to reach the air-passages of man—his most vulnerable point in early adult life. Hence the danger of permitting consumptive patients to share bedrooms with others, or on board ship to share a cabin with fellow-passengers, and the danger of permitting consumptive tourists to occupy rooms in public houses of accommodation, hotels, or boarding-houses.

In adult life, as I have just said, tubercle most frequently affects the lungs. In childhood, however, the digestive system is most frequently attacked, and that in the form of consumption of the bowels. There is strong presumptive evidence that in these cases the virus has entered the body in the food. It has been shown by experiment that animals with whose food tuberculosis matter has been mixed show signs of the disease first in the alimentary tract. The greatest source of danger to children is milk from tuberculous cows, and there is, unfortunately, little doubt but that in times past, and, indeed, even at present, the contamination of milk with tubercle germs is by no means a rare occurrence, and what in a pure state ought to be the most suitable food for the young is converted into a means of giving what is practically poison. Tubercle in the cow shows itself with comparative frequency



in the udder, and an animal may often be in apparent good health at a time when there is discharged with the milk the broken-down material of advanced tubercle.

Another source of danger to man is the use of the flesh of tuberculous cattle as food. It is by some held that there is little danger in this unless the disease is in an advanced stage; but as a result of further recent investigation there would appear to be a grave risk incurred if there has been any tubercle whatever in the carcase. Probably at times the process of breaking down of tissues accompanying the growth of tubercles leads to the penetration of the walls of a blood-vessel and the introduction of the germs in this way into the blood. Once introduced into the blood they are distributed to all parts of the body. In this way the meat of the tuberculous animals may contain germs, although the "naked-eye" appearance is healthy.

I have dwelt thus long on the pathology and distribution of tubercles, and on the means by which infection is carried, because on these depend the precautions which must be taken to prevent it, and, of course, any legislation to this end. We have seen that the disease may be conveyed to man either from man or from some animal, and it will be convenient to discuss the subject of State prevention in connection with each of these sources separately.

While restriction is perhaps as necessary in one direction as in the other, the difficulties and the opposition to proposed reforms are not the same. As regards prevention of contagion from animals the difficulty is chiefly a financial one. In the case of preventing the spread of tubercle from man to man there is not only the financial difficulty, but also the opposition which always arises when reform is proposed in the habits of a community in any direction, especially where individual liberty or family life are likely to be affected by the change.

It is also convenient to consider these sources of infection separately because at the present time restrictions are in force to prevent the spread of tubercle from animals. There is as yet no restriction placed on any human being who, being, through tuberculosis, a source of danger to his fellows, is yet unwilling or incapable of adopting necessary precautions for their safety.

Turning first to the question of infection from animals, we have to regard especially those whose flesh is used for food, or which are producers of food in the form of milk. Practically we have to deal with cattle. Infection from other animals is comparatively rare. In the Australasian Colonies the prevalence of tuberculosis among cattle is not so great as in the northern countries of Europe, where the animals live less natural lives, where pedigree stock are more pampered, and

where in large towns, and even in the country in winter time, a large proportion of the milk-supply is drawn from stabled cows. Still, tuberculosis does exist to some extent in New Zealand, and the more our herds are subjected to proper examination the more clear it is that the disease exists to a serious degree.

Provision has been made by Government for the inspection of stock by Government officials—mostly capable veterinary surgeons—and for the destruction of tuberculous animals. To secure proper inspection of abattoirs and dairies it only requires that the local authorities should set in motion the machinery provided for the purpose. Hitherto such inspection as there has been by the local authorities has been intrusted to those who, as a general rule, do not profess to have received any expert training such as would fit them to detect any but the grosser cases of disease. There is a necessity for properly-trained officials, since the detection of disease in either living or dead animals is not always an easy matter. Often, for instance, tubercle appears first in the udder of a cow when it may be apparently in good health. It is also not at all an infrequent occurrence for decided signs of the disease to be found in the internal organs of animals slaughtered for food which during life were apparently sound. In each of these instances inspection by expert officials would be necessary. To provide this an expenditure is needed which the local authorities as yet will not face. Each borough or highway district forms a local sanitary authority by itself, and, in consequence, cannot really afford the expense which a proper carrying-out of the Public Health Act would entail. A combination of forces so as to place a large district under the control of a competent sanitary officer would render a solution of this difficulty more easy.

In many European towns where there is a properly-organized department to supervise municipal sanitation, not only is an exact naked-eye examination made of all meat for human consumption, but there is a proper staff, whose duty it is to make a microscopic examination of any suspicious material. In Denmark, a country which depends much on its dairy produce, the maintenance of efficient dairy inspection has become a matter of the gravest importance now that the question of the dissemination of tuberculosis through milk has arisen. One large private dairy association employs no less than six special veterinary surgeons, as well as the local veterinary practitioners, to keep constant watch over the herds that supply its milk. One of these veterinary surgeons examines about eight hundred cows each fortnight, making a careful note of the condition of each animal. Much remains to be done before our colony can compete with dairy arrange-

ments such as these—at any rate, in matter of exported produce guaranteed free from the poison of tuberculosis.

Farmers and dairymen are not unfavourable to proper inspection and control. Hitherto they have seconded well such attempts as have been made in the direction of reform. The practical difficulty so far has been the early diagnosis of the disease. It is difficult often to state with certainty whether an animal is tuberculous or not. Latterly there has been used for this purpose a substance called “tuberculin,” prepared from the germs of tubercle themselves by the German scientist Koch. On its first discovery it was hoped tuberculin would prove a cure for tuberculosis. This expectation has not been fulfilled; but it has been turned to good account by its use for diagnostic purposes. Its value in this direction is owing to the fact that its injection into the bodies of tuberculous animals is followed by symptoms not observed in those free from the disease. A tuberculous animal can thus be readily and early detected. A trial of this agent is now being made in New Zealand, and, if the daily Press is to be believed, with startling results. It is hoped that by this means the introduction of pedigree cattle actually affected by tubercle may be avoided, and thus the introduction into our herds of fresh strains predisposed to the disease may be in part prevented; also, that its use in herds where there is reason for suspecting tubercle may enable an early detection and removal of the affected animals.

Turning now to consider the prevention of the spread of tuberculosis from man to man, we find the matter one of much greater difficulty. In the case of infected animals, once the diagnosis is made the proper course is clear. The animals should be slaughtered, and the danger from that source so ended. The affected animal is sacrificed for the good of his fellows and of man. When, however, one of our fellow-beings is the unfortunate sufferer, the common instincts of humanity, and the sacredness of human life, demand that we should not only attempt to effect a cure, but, failing that, should prolong his life so long as possible, and in such comfort as can be afforded him, notwithstanding that he is a source of danger to those who must come in contact with him, unless careful precautions are adopted.

The cure and care of consumptives is a duty just as binding as the prevention of its spread to others. It is with this in mind that from various quarters in these colonies demands are being made that tuberculosis should be placed in the same position as other infectious diseases. There are those who are themselves unable to provide proper treatment and care, or from ignorance, incapacity, or want of will to do otherwise are liable to expose others to the risk of incurring the disease.

By regarding tuberculosis as other infectious diseases are regarded these individuals would be considered the care of the State, and be placed under suitable treatment and supervision. The rest, more fortunately situated, can make provision for themselves. As in the case of other infectious diseases, it is the poor for whom such provision is especially needed; but it would be a boon to many who would under ordinary circumstance be quite independent of State aid, and who would be in a position to recoup the State any expenditure on their behalf, but could not individually afford the expenditure necessary to provide separately adequate treatment or isolation.

It is no uncommon occurrence for a member of a family to be unfitted, by consumption, for any employment, and to be thrown a burden on his friends. From the first his case has been hopeless, because his means do not enable him to obtain the fresh air or more suitable climate which may be essential to strengthen his tissues sufficiently to resist the attacks of the tubercle poison. Going from bad to worse, he lives on, in a small house, with his wife and children, or brothers and sisters, who are obliged to occupy the same rooms, and who must be thus exposed to the risk of infection. What wonder that under such circumstances, which are by no means imaginary, one member of a family after another succumbs to the same disease, the whole family becoming impoverished by the struggle to provide the nursing and other attention required.

One of the first principles in the treatment of infectious diseases is that the patient should be isolated to such an extent that the risk of infection being carried to others is minimised, and it will be necessary to apply this principle to consumption, modifying the means adopted in consequence of the chronicity of the disease, and in accordance with the special ways in which the danger of infection presents itself.

For the State to exercise control it would be necessary for cases of tuberculosis to be notified to proper authorities, and that an efficient inspector should see that all due precautions were taken in each case, where desirable instructing the patient and his friends as to what was necessary. In cases where the proper conditions could not be fulfilled he should have authority to remove the patient into proper surroundings—*i.e.*, some institution provided by the State—a special hospital for consumptives. It is only in certain stages of the disease that such compulsory removal would be necessary.

At the present time notification is, unfortunately, the full extent to which the machinery provided by law against an infectious disease is made use of. The local health authorities have appointed no capable inspector, and, practically, any attempts at limiting the spread of an infectious disease are

due to such care as the patient, his friends, or the medical adviser may suggest. It is so customary for consumptive patients to neglect *all* precautions against infection that proper control by competent inspection would be absolutely necessary.

A special hospital for consumptives, into which, when necessary, patients should be compulsorily removed, should, however, not be instituted merely for this purpose. It should be such an institution as would induce patients to voluntarily seek admission. It should be the receptacle of all cases unable to obtain proper care at home. It would relieve the general hospital of many chronic cases, which occupy beds to the exclusion of those needing more urgent treatment—cases which are a constant cause of disturbance to the other patients, and a source of danger to others in the same ward whose powers of resistance have been weakened by illness. Such a special hospital would, however, not be sufficient in itself. Institutions should be established where consumptives in the early curable stages of the disease might be received with a view to cure. While the special hospital would be the centre of any such organization, and afford a home to those in the more advanced and therefore more infectious stages of the disease, and to those whose recovery could not be expected, for those in the early stages a special sanatorium should be built, in localities specially chosen on account of the suitability of climate. It should be possible to manage these so as to defray at least a part of the cost of their maintenance by affording to those able to work suitable outdoor employment. A special department for those able to pay should defray its own expenses. It would be an advantage, in that hotels and boarding-houses should not, in the interests of the public, be frequented by consumptives unless properly arranged and supervised for that purpose. And, on the other hand, ordinary places of accommodation in the country are, as a rule, unsuited to the needs of the consumptive, who, instead of the comforts and attention of home, finds too often, amid strangers and strange surroundings, unsuitable accommodation and a want of small attentions which but hastens the development of the disease.

The general principles on which these suggestions for State interference and supervision are based are not new. The State has, for instance, already provided proper institutions for the cure and care of mental cases, not only because an insane person may be a danger to his fellows, but because special treatment is required, and because in many cases the cost of maintaining a patient in an asylum is readily borne by those who would be unable to provide separate attendance and treatment in their own homes. So, too, with the provi-

sion already made by the State for the care and treatment of acute infectious diseases. The novelty is the application of the principle to tuberculosis. It was this same novelty which attracted so much attention to a recent legislative proposal of our Government to exclude tuberculous individuals from the colony.

A simple affirmation that it is desirable to exclude from any community those who are liable to introduce disease would hardly meet with contradiction. Thus postulated, and from the point of view of the community in which such undesirable immigrants might wish to settle, there would seem to be little ground to question the propriety of exclusion. That from the point of view of others doubts as to the right or propriety of exclusion may arise we had evidence only a few months since, when a proposal was made to enforce it by Act of Parliament. The derision with which the proposal was met in other countries, and, indeed, among many of ourselves, showed that other considerations had to be taken into account besides the mere good or ill from a health point of view of the present inhabitants of New Zealand.

I will take it as an axiom that any individual is justified in refusing to render himself liable to disease through contact with an infected stranger, and to repulse his intrusion into his house. It would be but an amplification of this axiom to apply it to nations instead of individuals. It is the widened application which is called in question: hardly, however, in its general sense; rather in its application to special diseases. The right of a man suffering from small-pox to carry with him into any country the possibility of infection is universally denied; yet the claiming of a right to exclude a man suffering from consumption—in other words, afflicted with tubercle—is regarded, altogether apart from the supposed harshness of the measure, as absurd. The difference here is, of course, between a disease like small-pox—now fortunately comparatively rare, but when it does appear presenting its horrors by direct and almost immediately visible sequence—and a disease which, like tuberculosis, is the commonest scourge of almost all lands, and which, though decidedly infectious, spreads almost imperceptibly and insidiously. Familiarity with it prevents its horrors from being regarded with the same feeling of repulsion.

There is, however, another disease—leprosy—with the closest relation to tubercle, to which great abhorrence is felt and shown in almost all civilised countries, probably more from a sentimental reason or a preconceived idea than from any actual repulsiveness which is presented. In its last stages, and in certain forms, it is no doubt often most loathsome, but in an ordinary case there is nothing of this kind.

Leprosy is not a readily communicable disease ; in fact, until quite recently doubts were entertained that it is communicable direct from one individual to another. Much of the evidence that it is infectious is derived from the similarity of its cause to that of tubercle. In spite of this, leprosy in the Australian Colonies is most strictly dealt with. The affected are isolated in proper homes. There are, it is true, few cases in comparison with the number of cases of tubercle, and the prospect of complete control and extinction is greater ; but the greater the evil the greater the necessity of the remedy, and it is certainly anomalous that so much should be done in the case of a disease relatively less infectious and less widespread while no restrictive measures at all are taken against tubercle in man.

The exclusion of consumptive individuals from our shores is not only justifiable on sanitary grounds, but in accordance with the first principles of self-preservation. The difficulties that present themselves are in the practical carrying-out of enactments against such immigration. In advanced cases of disease there would be little difficulty, since the symptoms are well marked ; but the ordinary case of tuberculosis emigrates at an early stage, when the symptoms are discoverable only by a detailed expert examination, and when to all outward appearance the person may be in tolerably good health, showing better condition than many suffering merely from some trivial transient ailment. I think I am warranted in saying that most of those in the early stages of consumption who enter this colony would, apart from an expert examination, be detected only through their own statement, if given. Evasion of the law would be comparatively easy, unless intolerable and expensive arrangements were made to subject the whole of our incoming passenger trade to detailed examination—an examination much more rigorous than that insisted on under any quarantine law. It is unlikely that any legal enactment would be properly enforced which would so disproportionately interfere with the commercial relations of the colony. The tendency of legislation in Europe at the present time is such that in England the last vestige of quarantine was abolished less than a year ago. The organization of the sanitary authorities there is such that it is felt that while the health of the community itself is properly cared for little is to be feared from without. Ships arriving in any port are under the local sanitary authorities for the time being, and are treated as any house in the district might be treated.

What is needed in the way of restriction of immigration of consumptives is that advanced cases, already a danger to those about them, should, if possible, be prevented from travelling to the colony. If carried on any ship means should

be provided on board that they may be berthed apart from other passengers, in quarters which could afterwards be thoroughly disinfected. When landed they should not be permitted to reside in any public lodging-house—they should, in fact, be subject forthwith to such regulations as might be in force in regard to our own consumptives. Unless friends were able to provide accommodation for them, approved by the sanitary authorities, they should be transferred to the Government institutions at their own cost, or at that of those introducing them. In the majority of such cases there would be no hardship. Instances are not rare where the change from a regular life on board ship to unsuitable lodgings in a strange land, and among strangers unable or incapable of rendering even necessary services to an invalid, is followed by a rapid loss of what little strength is left. The pitifulness of the case is intensified by the misery of loneliness and want of care. Such cases as these would, at any rate, be humanely cared for. Few would ever be sent to our shores were the shipping companies held liable to a penalty for knowingly carrying such passengers, and if better information were circulated in Europe regarding the hopelessness of expecting benefit to be derived by such through emigration to these colonies. Too often such cases are sent away from home either that their relations may be rid of a troublesome care or in a wild hope of improvement, which only ignorance could encourage. The notice which has been taken in the European Press of the Undesirable Immigrants Bill may be of service by limiting such immigration. The proposed legislation is a welcome sign in that the Government has recognised by it that tuberculosis is an infectious disease, and has shown itself sensible of its responsibility in regard to preventive measures. Such good, however, as it would have effected could be obtained by the adoption of measures directed against the disease already existing in the colony and the extension of the scope of these measures to vessels arriving in our harbours.

I have placed before you a short account of what at the present time seems desirable for the State to do in the way of preventing consumption. I have endeavoured to find reasons for such proposals as have been made. That they would do good if carried out there can be no doubt. The exact extent to which they would diminish the prevalence of tuberculosis it is impossible to predict. Their aim should be the *extinction* of the disease—a result obtainable only gradually and after a long period of time.

In these days of easy communication between different countries, to obtain such a result similar measures must be adopted by those communities with which there is inter-



course; and it would be necessary above all to obtain the co-operation of the mass of the people themselves. This can be obtained only by educating them to abandon their present attitude of indifference and to believe that consumption is preventible.

---

ART. IX.—*The Tides, Currents, and the Moon.*

By W. BUCHANAN.

[*Read before the Auckland Institute, 2nd August, 1897.*]

SOME three years ago I read a modern book, the subject of which was the moon, the tides, and ocean currents. I came to the conclusion that the reasons given for the various phenomena were in some cases obscure, and in others doubtful affirmatives were made. However, I let the subject drop, until not long ago I took it up again, and perused some other books on the subject, in which I found the same reasons were given, but on this occasion I made notes, which gradually extended into the material which makes up this paper.

I will begin my remarks by taking the following as a sound basis to start from—that is, that the globe revolves on its axis, and that its path is round the sun. I will also suppose that we begin our inquiry without any water on the globe or any moon in the heavens. Under those conditions it would revolve on its axis, the axis would be through its centre of gravity, and there would be five forces exerted in the combined process of revolution—namely, (1) The force which is required to keep it revolving upon its axis; (2) the centrifugal force which is generated by this the rotary motion; (3) the force which carries it on its path round the sun; (4) the force of gravity which is exerted by the sun to hold the globe in its path; (5) the centrifugal force which is generated by the force which causes the globe to go round its orbit and the gravity force which holds it in its circular path round the sun. The two first-named forces are so active on our globe that the fifth is almost latent, and each of those five forces has some influence in governing its motion round the sun.

Under the conditions from which we have started everything on the globe would be solid and rigid. There would be no life, no moonlight, no tides, and no atmosphere such as we have. Everything would be perfectly still, so beautifully poised; without any disturbing influence it would perform its annual, aimless, and silent journey round the sun.

I will now suppose that we had the water in such a position that it could be launched on to the globe, and that we did do so. Well, it would not remain at the place on which it was put. We would find that the rotary and centrifugal forces would take control of the fluid and distribute it over the earth's surface. Then gradually evaporation would take place. The rains would fall, and the hollows would be filled up. The same oceans would be formed. The same rivers would flow. So that in a short time the whole would be in equilibrium, just as it is at present. All this would take place without disturbing in the slightest degree the globe's centre of gravity.

Suppose, again, that we had put a mass of rock on to one side of the globe instead of the water, but equal in weight to it. The effect would be entirely different. We would find under those conditions the globe would have to shift its axis so as to run on its centre of gravity. In this supposition, of course, I am assuming the globe to be dense enough to resist any yielding of its mass.

From this I wish to establish the principle that the globe's centre of gravity is through its solid parts, and that the water has no influence whatever in fixing it.

#### OCEAN CURRENTS.

We will now take into consideration the ocean currents, and in doing this we are still supposed to be without the moon; but, as she has very little to do with those currents, we will proceed without her.

The instability of water is so apparent that some philosopher converted this peculiarity into a proverb: "Unstable as water." This instability and want of cohesion is nowhere more apparent than it is on the huge volume of water on the surface of the globe. As the globe revolves the water is too unstable to be able to resist the centrifugal force generated by the revolving mass, so that at the speed at which it now revolves some of the water is turned away from the direction of the poles to the equator, causing it to bulge out there. This action must cause some amount of current to flow from the direction of the poles to the equator, where it is heaped up or bulged out; the water there being furthest away from the influence of gravity, and the revolving speed being greatest at that place, the water is unable to travel quite so fast as the solid parts of the earth. If the globe revolved once in twenty-three hours, then there would be a greater flow from the poles to the equator, and the water there would bulge out further, and would also be left further behind. A still greater speed would cause a greater flow from the direction of the poles to the equator, a greater bulging-out would take place,

and it would be left still further behind. Now, this would continue until at a certain speed the water would fly off in the opposite direction to that in which the globe revolves. At this speed no water would remain on it, and all this would occur while the solid portions of the earth would have sufficient cohesion to hold together. From this it is reasonable to suppose that there is a slight centrifugal current to the equator, and that from the time the revolving speed of the globe causes the water to bulge out at the equator gravity begins to lose control, so that at the same time that the water on the equator begins to bulge out it also begins to lag behind, which is equivalent to a current in the opposite direction to that in which the globe is travelling. The centrifugal current and the water which lags behind on the equator join, and this is the cause of the Gulf Stream, the source of which would be somewhere in the vicinity of the north-west of the South American Continent, on the equator; thence to the Galapagos Islands the bulged-out water on the equator is gradually left behind, and as it goes west it increases in volume and speed all through the Pacific Ocean until it is broken up by the islands between the Malay Peninsula and the Continent of Australia. However, a large body of this current must pass through into the Indian Ocean, and goes on increasing and accumulating all through the Indian Ocean, until it is met by the advancing Continent of Africa, which meets the current like a float of a huge paddle-wheel, and the only way in which it can escape is down the coast of Africa, through the Mozambique Channel, thence down to the Cape of Good Hope. Here it would be impossible to follow it; there will be too many eddies, surface- and under-currents, which must take place with such a large body of water working its way round the Cape. Much of it, no doubt, will be deflected in directions different from what we might expect. However, some of it no doubt does get round the Cape into the Atlantic Ocean. Its course would be chiefly to the north, to replace the water flowing down the South American east coast, subsequently joining the heaped-up water at the equator, which is also getting left behind in the Atlantic Ocean, and which is forming another westerly current. Those two currents combine, and are afterwards met by the advancing South American Continent. The stream then runs down the slanting northern part of South America from Pernambuco into the Mexican Gulf, and from the gulf onward to the north. This stream is so vast, and its temperature so high, that as it travels north it changes the climate from the north-west of Europe to Iceland. It is over fifty miles in width, and different in colour to the Atlantic Ocean. Its channel through this ocean is almost as clearly defined as

the channel of a river flowing over a continent, and in some places it attains a speed of four knots per hour. As it flows north towards Newfoundland it is divided—one branch crosses the Atlantic towards the British Islands, and this current flows into the seas, channels, and inlets surrounding those islands, complicating the high- and low-water gravity tides.

From this it will be seen that the whole of the Gulf Stream is collected on and near to the equator, and this accounts for its very high temperature. In the same way a large portion of the water which is left behind on the equator is met by the South American Continent, and the only way for it to escape is by flowing down the coast from Pernambuco to Cape Horn, and, after getting round the cape, it travels north to the place from where we started; so that there must be a continuous circulating current, and also equilibrium circulation.

When a mass of water is set in motion any attempt to follow its course must be very problematical. Even in rivers, where the mass of water is descending, there are also currents ascending; but in the oceans there are other influences, causing circulation which would lead to greater complication. However, my object is to determine the cause which sets the Gulf Stream in motion; its course in any case would be the same.

I am informed that the equatorial wind theory has been demonstrated by actual experiment. The model is described as follows: A glass trough is filled with water, then wind is blown along the surface of the water, and the result is a current similar to the Gulf Stream. But the same current would take place if the trough is moved forward at a uniform speed. Both these experiments would be futile, because in each case both the gravity and centrifugal forces are ignored. To make the gravity effect clear I will give the following illustration: Water will fly off a grindstone when driven at a moderate speed, but if a power existed in the centre of the grindstone which held the water to it, then it would require to be driven at a greater speed to cause it to fly off. So it is with the trough experiment: gravity exerts its power over both the trough and the water, but the trough has no gravity power over the water. Just imagine the effect of moving the troughful of water at a speed of fifty miles an hour, and consider that on the equator the speed is a thousand miles an hour. Then the centrifugal force acts on the particles of water furthest away from the centre, where the speed is greatest, so that the tendency would be to skim the tropical surface-water on to the equator. This centrifugal force also counteracts gravity, especially on the equator, where the

speed is greatest. This would also assist in causing the surface-water on the equator to lag behind. No doubt the moderate equatorial winds may have some influence; but it is inconceivable that those moderate winds could be the cause of setting in motion such a mighty mass of water as the Gulf Stream.

#### THE MOON.

We will now suppose the moon to be in her place, where she will effect some changes upon the water which is on the surface of our globe, but before we proceed with this we will take a short time with the moon herself. It is supposed that at one time the moon revolved on her axis, and had oceans and tides on her surface. At that time she would be governed by the same five forces previously mentioned as governing the motion of our planet; but now we find the rotary motion has ceased, and with it the centrifugal force generated by the rotary; so that now there are only three of the five forces controlling the moon's motion—viz., gravity, holding her in her place; the force which carries her round her orbit; and the centrifugal force generated by the other two. This centrifugal force has come into great prominence since the rotary ceased, and it now controls the water on the moon. If any water now exists on the moon it must be on the hemisphere furthest away from the earth, because, it being a fluid, the centrifugal force would cause it to get as far away from the axis as possible, and the axis of the moon moving round her orbit is the earth. In the same way, if the globe ceased to revolve, then the same forces would cause the waters upon it to recede to the hemisphere furthest away from the sun, and the other one would always be presented to it, precisely the same as what takes place with the earth and the moon.

I think it is the opinion of scientific men that there is water on the moon, and when we take into consideration the fact that the rotary motion has ceased this helps to confirm this opinion, for without water upon it there would be nothing to retard its rotary motion, so that it would have continued to revolve; but with water on its surface the tides would be excessive, because the attraction of the moon's mass would have little control of the fluid, while the globe's attraction holding the moon in her place would have a great disturbing-power over the water, and consequently would have an effective retarding influence. The water, which we will suppose to be on the moon, and which is forced furthest away from the axis by the centrifugal force, would act (in keeping the moon's face to the earth) much the same as the piece of lead on the bottom of the ship's compass, which keeps its face

always upwards; and, for the same reason, if one hemisphere is denser than the other, it also would get furthest away from the axis.

#### TIDES.

The moon's influence in causing high- and low-water gravity tides preponderates over all other causes, so that it will be better to comment only on the moon's tides. When referring to the tides it is generally considered that it is the attraction of the moon which causes them. This is not quite correct, as it is the attraction of the earth which does so; it attracts the moon, and compels her to keep in her present path. From this we find that the moon is held in her orbit by the earth's attraction, and the strain of holding is always exerted on every square inch of land and water on the hemisphere which is under her. This strain of holding is just as real as if we could see attachments to the moon from every square inch of surface on this hemisphere. Now, the solid earth holds without yielding to the strain; but when the strain comes on the surface which is covered with water, then the water yields, and is gathered up under the moon, forming a tide; but a second tide occurs at the same time on the opposite side of the globe, and the water which forms that tide is furthest away from the moon, therefore least under her influence. This is an equilibrium tide. The truth of the above rests on the affirmation that the globe's centre of gravity is through its solid mass, and that it revolves on its axis independent of the unstable fluid on its surface. A solid body of whatever shape or size revolving in space must revolve on its centre of gravity; and if by any chance such a revolving body met with sufficient obstruction to disturb its centre of gravity, then, so soon as the disturbing influence became expended, it would have the power to immediately adjust itself so as to again revolve on its centre of gravity, demonstrating the fact that matter has an inherent power to revolve on its centre of gravity.

Now, suppose the globe to be travelling exactly the same as it is doing at present, but without water upon it, and that it rained all over the Northern Hemisphere, until there was as much water on its surface as there is on the globe at present. This water would not remain on the North Hemisphere, or, if it did, the globe would have to shift its centre of gravity, as the whole mass must revolve in poise. The shifting of the globe's centre of gravity is inconceivable, therefore the water would be distributed over the globe by the spinning motion it is subject to, causing it also to have the power of independent adjustment. From this reasoning it appears clear that the proportion of the slippery and unstable fluid on the surface

of the globe is too insufficient in proportion to the enormous weight and mass of the solid globe; and when we consider the speed at which it revolves, combined with the momentum it has acquired, the unstable fluid on its surface could not be a factor in determining its centre of gravity.

In order to get a better idea of the relative proportion which the globe and the oceans have to each other, I will suppose we have a globe 14 in. in diameter, which in round numbers would be 3 ft. 6 in. in circumference. The specific gravity of this globe is more than twice that of granite and five times greater than water. On such a globe the depth of the oceans would be represented by a thick sheet of paper. How could a globe of this density, while spinning round, have its centre of gravity influenced by such an insignificant amount of light fluid which is free to move in any direction? I am desirous of making this as clear as possible, as several statements herein may depend upon this fact.

In conclusion, we have the fact that the globe does revolve on its axis, and its axis is through its centre of gravity, so that when a tide occurs under the moon a derangement of the centre of gravity takes place, which must be adjusted in some way, and the mode of adjustment is very simple. It is accomplished by the tide which occurs at the same time on the opposite hemisphere.

From what has been said it is apparent that the tide opposite to the one raised by the moon is what I call an equilibrium tide to counterbalance the tide produced by the moon, and is governed by the same law or power which makes it compulsory for all revolving bodies to revolve on their centre of gravity, and which has also the power to adjust the equilibrium of the water when it is disturbed. This disturbance and adjustment being independent of the solid mass, consequently, for an absolute certainty, there is an equal quantity of water on the Northern and Southern Hemispheres, and, as there is a greater area of water on the southern oceans, the northern oceans must be deeper.

It is generally supposed mathematically correct that the moon has greater power to draw the water away from the earth immediately under her, but this is not correct, for it is just the opposite which takes place. To illustrate: Let us suppose the water under the moon to be on the surface of a level plain instead of being on a globe; then in that case there would be no tide of any kind, because the water would hold without yielding to the strain of holding the moon, just the same as the land holds. Under those conditions a tide would mean that the water would have to be drawn away from the earth, which is impossible; but on a globe it is quite different, as the moon does not draw the water up im-

mediately under her. The tide on the equator is only an accumulation, which cannot be very high, as the moon's influence passes too rapidly for any great rise and fall to take place immediately under her; so that it will be seen the greatest rise and fall of the tide must be on the horizon of the globe as seen from the moon.

From this reasoning I would expect—first, that the British Isles, being near to where the rise and fall of the tide is greatest, combined with the formation of the bays, seas, and inlets, together with the Gulf Stream flowing into them, would cause the water surrounding those islands to have the most complicated tides of any in the world; second, that the tides in the Hauraki Gulf would have the greatest rise and fall of any place on the Southern Hemisphere within the 40th degree of latitude, because the formation of the land in the gulf gives easy facility for the water to be drawn away by the strain of holding the moon, and the water so drawn away is not so readily replaced, and the angle is greater than it would be nearer the equator. As the distance extends the leverage increases so as to draw the water down the semi-circle, and just in the same ratio the speed on the surface of the globe decreases, so that there is a longer time of exposure to the strain of holding from the minimum to the maximum. This is not quite correct, but the effect is just the same, because the speed of the globe at the equator spreads the strain of holding over a greater surface, which is equivalent to a longer exposure to the strain of holding, so that those two factors act on the water so as to produce a greater and gradually increasing rise and fall of the tide. From this reasoning we may discard Australia and all the Pacific islands as not likely to have anything like the same rise and fall that there is in the Hauraki Gulf. Then, on the Continent of South America there is no formation of the land which suggests facility of withdrawal and obstruction to immediate partial replacement; therefore I think it is reasonable to expect the greatest rise and fall of the tide within the prescribed latitude to be in the Hauraki Gulf. On the same line of reasoning I would expect that the greatest rise and fall of the tides on the Southern Hemisphere would be in some of the estuaries near Magellan Straits, because those estuaries are at the maximum land-angle, and the speed on the surface of the globe is slowest; consequently the leverage would be greatest, and the strain of holding would be longer on one place.

In the beginning of this paper I say there are five forces which govern the motion of the earth round the sun, but it should have been six. This sixth force is that which causes all revolving bodies to revolve on their centre of gravity; but



under ordinary circumstances it is apt to be overlooked as a force, because all revolving planets revolve on their centre of gravity; but in the earth and moon system we have this sixth force illustrated by the equilibrium tide. This daily tide requires an enormous force to produce it, and the force so expended must be for adjusting the equilibrium of the whole mass at the least expenditure of energy. Without this tide the globe would revolve as an excentric, and the law of motion abhors such a form of rotation; therefore the very existence of this tide proves all I have said in regard to the purpose it serves.

I will remark, in conclusion, that when we consider the enormous amount of water on the surface of the globe, and the number of influences which affect this unstable fluid, such as tides, currents, gravity, storms, the configuration of the land on the surface and under water, &c., deflecting it into unknown channels—these causes will always render it impossible to tell by any method of calculation the time and height of high water at any given place on the globe.

---

ART. X.—*Marsh-lights.*

By R. COUPLAND HARDING.

[Read before the Wellington Philosophical Society, 4th August, 1897.]

THE phenomenon of the *ignis fatuus*, will-of-the-wisp, or fool's candle, seems to have excited interest in all ages. Literature, ancient and modern, abounds with references to the subject, and poets and moralists alike have found it an obvious image of those false lights in philosophy and religion which beguile the inquirer from the narrow paths of truth into the pitfalls of error and the gulfs of despair. Superstition has been busy with the meteor that, haunting graveyards and dangerous marshes, acts almost as if possessing life and volition. Those who have seen, and especially those who have attempted to follow, this "faithless phantom" can well understand that in a pre-scientific age an imp of darkness was supposed to guide the erratic light, in following which so many have perished.

Having recently had, for the first time, an opportunity of observing this phenomenon, I looked up such authorities as I

could discover, and have been surprised to find that marsh-candles, so long known and observed, are still the property of poetry and superstition. No accurate observations seem to be on record, and science as yet appears to have nothing to say on the subject. For instance, the "Encyclopædia Britannica" dismisses it in a few lines. It "has given rise to much difference of opinion; Kirby and Spence suggest that it may be due to luminous insects; but this explanation will certainly not apply in all cases, and it is perhaps on the whole more reasonable to believe that the phenomenon is caused by the slow combustion of marsh-gas (methyl hydride)." That is all from this high authority. Turning to "Chambers's Encyclopædia," I find a much longer, but still very vague, account, wherein I read, "The common hypothesis that the *ignis fatuus* is the flame of burning marsh-gas is untenable, for, although this gas is produced abundantly in many marshy places, it cannot ignite spontaneously." Thus do authorities differ. In Chambers I read of a German who held the end of his cane in a will-of-the-wisp for a quarter of an hour and found that it was not perceptibly heated. From this crude experiment the writer infers that "the more plausible suggestion of phosphuretted hydrogen does not account for the fact observed by the German physicist, since no gas can burn without heat, and this gas has a very pungent and characteristic smell." I can offer no opinion as to what the gas may be, but I think that these arguments have no force. It is impossible that a globule of gas which will burn for a quarter of an hour—perhaps for four times as long—before it is consumed could emit sufficient heat to perceptibly raise the temperature of a metal-shod walking-stick. The observer may not even have touched the bubble of gas—probably he did not—and even if the experiment was fairly tried it would have been as reasonable to expect the walking-stick to be warmed by contact with a glow-worm. As for the smell, the peculiar condition of the gas which renders it luminous appears to prevent its free diffusion in the atmosphere—if sensible to smell the gas cannot be seen. I read further in the same paper of an experimenter lighting a piece of paper at a will-of-the-wisp. On what authority this amazing statement rests does not appear. It seems probable that there is more than one variety of *ignis fatuus*—some observers describe "bounding" ones, leaping 60 ft. or more at a time—but that any bubble of luminous gas floating in the atmosphere is of so high a temperature as this I do not believe. If it were, the farmer whose haystack is mysteriously burned need not suspect incendiarism if there is a swamp near at hand. In the case of a steady stream of natural gas issuing under pressure from a small orifice in the earth, and artificially ignited,

it would be easy enough to light a piece of paper ; but a burning jet of this kind is not the *ignis fatuus*.

On the morning of the 14th February last, between 3 and 4 o'clock, I found myself on the Ruataniwha Plains, several miles from Takapau. I had been walking for some hours, during one of the darkest nights I have ever known, and in steady rain. I had come through the Seventy-mile Bush from Dannevirke on one of the finest highways in New Zealand, but found quite a different state of things on the plain. The road was badly cut up by recent rains, great stones were strewn about, and it was more like a ravine than a roadway. In daylight there would have been no difficulty ; in the dense darkness I found it unsafe to proceed. In fact, beginning to doubt whether I was on the right track, and fearing to go astray in the labyrinth of roads on the wide plain, I retraced my steps nearly a mile, remembering that I had not long before passed a gate, beyond which I had seen dimly a house, with lights twinkling from the windows. There, at any rate, when daylight came, I might make inquiry. By keeping near to the fence I found a foot-track in the grass, on which I could safely walk. I saw nothing either of gate or house, but soon became aware of two lights, apparently about a hundred yards away, beyond the fence. They did not seem quite steady, or I would have taken them for the lights I had previously seen. They were at about the level of my eyes, and remained steady when I stood still. Thinking there might be some illusion, I raised my glasses, which had become blurred with raindrops, but the lights remained. As I moved on they kept pace with me, and I realised what they were. I can scarcely account for the feeling of aversion with which they inspired me—insignificant gas-bubbles as they were. I found myself watching them instead of looking to my feet, and at length, being tired, I stood still. Attracted by a light on the ground, I looked down, and saw one of these horrible little bubbles disengaging itself from the sodden grass close to my feet, probably forced out of the soil by my weight. I had thus the opportunity of closely examining it. It was of a well-defined form, apparently cylindrical, rounded at the ends, just like the bubble in the glass tube of a spirit-level, only somewhat curved in shape, and about the size of a small bean. It shone with a lambent yellowish flame, brighter and more concentrated than the two floating beside me. It appeared to cling to the grass, but worked its way out slowly and steadily, with a wriggle almost like that of a living creature. I suppose I watched it for ten or fifteen seconds before it became free, when it rose so suddenly that the sight could not follow it. Looking up, I now saw three of my unwelcome companions

instead of two—just like three candles or dim lamps in the distance. This effect of distance must surely have been an illusion; really I think they could not have been many inches away; but the bubble was now undefined in form, and proportionately fainter than when it escaped from the earth. I suspect that there must have been something in the condition of these gas-bubbles—perhaps their electrical state—that kept them self-contained, and prevented their mingling with the air. I went on, still accompanied by my familiars, till I came to a gate, but not the one I was seeking. I paused—so did they. I went through—they went before instead of keeping at my side. Soon I found myself on slippery clay, with a suspicious gleam of water ahead, the three lights still moving forward. I turned my back on them, returned to the road, and went on, when I found them at my side as before; but thereafter I paid little attention to them. Coming to the end of the fence, I knew I must have passed the house. I decided to wait, and did wait, for dawn—for a long hour. When I stopped I looked for my attendants, and they were not to be seen. They must have been visible quite a quarter of an hour, and have accompanied me nearly a mile. Their behaviour was exactly such as is described by poets and story-tellers in literature familiar to us all. What was new to me, and unlike anything I have read or heard of, was the newborn will-of-the-wisp emerging from the ground. I should add that this did not occur in swamp- or bog-land, but on the margin of an ordinary grass paddock, on a plain consisting of shingle covered with no great depth of earth, and that the moisture of the soil was exceptional, owing to recent heavy rains. Kirby and Spence's theory of luminous insects would not apply here. What I saw were luminous gas-bubbles, presumably from decaying organic matter; the light, I infer, resulted from slow combustion, necessarily at a low temperature, as the gas, which would not have filled a thimble, burned steadily for at least a quarter of an hour. According to Chambers, the impure hydrogen gas of marshes is not known to ignite spontaneously, and all attempts to imitate the phenomenon of the *ignis fatuus* have been unsuccessful. This seems to me to suggest some peculiar electrical condition of the gas as being the cause of the appearance.

The most puzzling feature of the will-of-the-wisp, so general as to have become typical, and which I had full opportunity of verifying, is its habit of closely accompanying or preceding a traveller while maintaining the illusion of being at a considerable distance. On this occasion, though the air was not calm, there was very little wind. I confess that I cannot account for the apparent attraction that caused these uncanny meteors to accompany me a mile in the darkness,

and to go before me when I altered my course. I can well imagine how fatal this habit has proved in the case of many an unsuspecting wayfarer who has lost his way among marshes and old quarries. Fearful of losing sight of the "hospitable ray," he has not looked to his feet, and has miserably perished in some deep pool or quaking bog, or has been dashed to death at the foot of a precipice.

Chambers says that the phenomenon was much more common and familiar in Europe a century ago than now—that as the country is drained and cultivated the marsh-lights disappear. If so, there is the more reason to carefully study this curious phenomenon when opportunity arises; and it is with the view of adding to the slender stock of information on the subject that I place these observations on record.

And incidentally I would remark on the curious Celtic superstition of "corpse-candles," which are described as exactly such appearances as I saw last February. A large and yellow one is supposed to indicate the approaching death of an adult; a small bluish one that of a child; and both are sometimes seen together. They are supposed to leave the house of the person about to die, to follow the line taken by the body in the funeral procession, indicating every stoppage on the way, and disappearing at the site of the grave. As in all matters of common popular belief, there is a mass of testimony on the subject, not only of natives, but of tourists and others. Cases are known of visitors to Wales, sturdy sceptics on arrival, who have returned convinced of the truth of the omen. That these "candles" are other than the ordinary *ignis fatuus* I do not suppose, and all allowance must be made for embellishments to establish coincidences. The "corpse-candle" seems to invert the ordinary phenomenon. It is easy to imagine the luminous globule rising from a charnel-vault or recently-opened grave and slowly drifting along the village street to scare the belated wanderer or horrify the old lady who watches it from her casement, but that it should rise from some quiet home, travel at funeral pace to the graveyard, and there disappear is peculiar, to say the least, and if true is an instance of the characteristic perversity of the meteor.

That superstition has laid hold upon it I do not wonder. Its simulation of the friendly light so longed for by the wayfarer, its mocking dance before his eyes, its habit of leading him to danger and even death, its weird and unaccountable vagaries, might well lead the simple-minded to regard it, as they always seem to have done, as the visible manifestation of some malignant and infernal demon.

---

## SUPPLEMENT TO MR. HARDING'S PAPER.

[*Extract from Memoirs of General Marbot, read before the Wellington Philosophical Society, 3rd November, 1897, by Mr. W. T. L. Travers.*]

THE 23rd Chasseurs, posted at Zapole, were covering one flank of the united corps when Marshal Victor, hearing that a large force of the enemy was at Vonisokoi-Ghorodie, ordered General Castex to reconnoitre this point with one of his regiments. It was the turn for mine to march. We started at nightfall, and reached Ghorodie without hindrance. The village stood in a bottom, on a large drained marsh. Everything was quiet, and the peasants, whom I questioned through Lorenz, had not seen a Russian soldier for a month. I therefore prepared to go back to Zapole; but our return was not as calm as our outward march had been. There was no fog, but the night was very dark, and I was afraid that the regiment was going astray among the numerous dykes in the marsh. I therefore took for guide one of the inhabitants of Ghorodie who appeared less stupid than the others. My column had proceeded in good order for half an hour when I suddenly perceived bivouac fires upon the hills surrounding the marsh. I halted my men, and sent out two intelligent sergeants to reconnoitre, bidding them try and avoid being seen. They soon came back saying that a strong body was blocking our way, while another was in position in our rear. I turned round, and when I saw thousands of fires between me and Ghorodie it seemed clear that I had inadvertently got into the middle of an army corps, which was preparing to bivouac on the spot. The fires kept increasing in number; the plain and hills were soon covered with them, and presented the appearance of a camp of fifty thousand men, in the midst of which was I with less than seven hundred troopers. The odds were great, but how were we to avoid the danger which threatened? The only way was to gallop forward in silence along the main dyke upon which we were, to surprise the enemy by a sudden charge, and cut our way through, sword in hand. Once out of the light of the camp-fires the darkness would save us from pursuit. Having decided on this course, I sent officers all along the column to let the troops know, being certain that all would approve my plan and follow me resolutely. I must admit that I was not without anxiety, for the enemy's infantry might stand to their arms at the first challenge of a sentry, and kill many of my people while my regiment was passing in front of it. In the middle of my anxiety the peasant who was guiding us burst into shouts of laughter, and Lorenz did the same. In vain did I question the latter. He could not stop laughing; and, not knowing enough French to explain the unusual circum-

stances, he showed me his cloak, on which had just settled one of the will-o'-the-wisps which we had taken for bivouac fires. The phenomenon was produced by the marsh emanations, which a slight frost following on a day of hot autumn sunshine had condensed. In a little time the whole regiment was covered with these fires, as large as eggs, at which the soldiers were much diverted. Thus relieved from one of the greatest frights that I had ever had, I returned to Zapole.

---

ART. XI.—*On the Outlying Islands.*

By F. W. CHRISTIAN, B.A.

[*Read before the Wellington Philosophical Society, 25th August, 1897.*]

FIG. 1. An ancient Yap grave, Ramung Island, North Yap: A fine specimen of its kind. The Island of Yap is full of these quaint relics of the past, most of them of considerable antiquity. This was discerned upon a promontory of the island facing down upon the straits separating Ramung from the sister-island of Map. On this headland is a larger cemetery, the older graves wreathed in a dense tangle of climbing fern. The construction recalls the *langi*, or burial-places, of the old princes of Tongatabu, the upright tapering slabs of basalt excepted, which seem to suggest a Japanese influence. At a village near Tokio, in Japan, there is a celebrated shrine, where the forty-seven Ronins—certain mighty heroes of old—are buried, where the same weird ornamentation is observed of upright stone slabs tapering to a point. This Yap grave belongs to a famous warrior of olden times. It measures 12 yards square at the lowest tier; height, about 6 ft.

Fig. 2. A less pretentious structure, sketched near the village of Fal, on the other side of the island.

Fig. 3(a). One of the Yap lodges, or club-houses, with wide paved terrace in front, and specimens of *fe*, or native stone-money, leaning against the lower tier, forming the foundation of the house. It may be observed that the burial-places of Yap, the elaborately-paved roads and causeways which traverse the island, and the long series of embankments, thickly planted with dwarf bamboos which shut in the paths on either side, all very much suggest a Japanese influence. It seems quite reasonable to suppose that Japanese junks, proas from the piratical Sulu Archipelago, and from the coasts of sea-roving Dyaks, as well as southern Chinese trading-

vessels, have visited these seas for centuries past, whether on adventurous or piratical forays, or upon distant trading expeditions in search of the sponges, the turtle-shell, the tre-pang or *bêche-de-mer*, and the pearl-shell, in which all these islands abound.

Fig. 3(b). An ancient sacred place or fortification upon the Islet of Lele, off the coast of Kusaie, the south-easternmost of the Caroline Group. The king, or *tokusa*, is standing below. The walls are from 25 ft. to 35 ft. high, and some 12 ft. or 13 ft. thick. This Island of Lele is seamed with the vestiges of old canals and waterways, and traversed in many places by massive lines of wall built upon Cyclopean principles, all in a more or less ruinous condition, probably the remains of an elaborate system of fortification, the work of a vanished people of superior civilisation, upon whose past history the natives can throw but little light. Probably, however, they are the remnants of the work of a band of Japanese, either traders or pirates, carried down into these seas in a typhoon, mingling themselves with the natives, and gaining in time an ascendancy over the folk on the mainland across the bay

The name of the larger island—Kusaie, known in the neighbouring islands as Koto, Kotiu, and Kiuthiu—recalls strongly the name of Kiu-Siu, the large southerly island of the Japan group.

The name of the smaller island—Lele, upon which these ruins occur, which means “permission”—lends a colour to the theory of its occupation by a body of strangers taking up their abode by convention or agreement, possibly from a wrecked junk or from one of the early Nagasaki trading-vessels, which, according to a Japanese merchant, used in ancient times to make long voyages to the south and east, before the Emperor To-Kogunsama interdicted distant trading expeditions, about the year 1640. The natives themselves attribute the building of the great Cyclopean wall, enclosures, and canals that thickly stud the Island of Lele to a dominant foreign race who arrived in foreign vessels (Uak-palang) from the north-west, and who raised these forts as defences against their neighbours on the mainland, whom they put to tribute, imposing upon them, when visiting Lele as vassals of the Tokusa, the humiliation of doing obeisance by crouching down low, and of never raising their voices above a whisper in addressing him. The stones, massive blocks and shafts of prismatic basalt, were brought, the natives say, from South Harbour on rafts and floats. The ruins on Lele are not so elaborately constructed as those in Metalanim, but they have a rude and massive grandeur of their own. Like the Pona-peans, they used extensively axes and adzes (*tola*) of excellent workmanship, laboriously ground and polished down



from the great central piece of the *Tridacna gigas*, or popo-shell. The specimens received from Li-kiak-sa, an aged native teacher of Lele, are excellently white, and smooth as polished marble, with fine cutting edges. In length they measure from 6 in. to 9 in. or 10 in., by 2 in. or  $2\frac{1}{2}$  in. in breadth.

They appear to have known the use of iron, at least by tradition, as their word *masa* is correlative with the Malayan forms *mesi*, *bassi*, and *besi*, and perhaps even with the Hindustani *mus* or *mis*. Many of the words in their language resemble Malayo-Polynesian words to the far south-west, and there is also a slight Melanesian admixture. They use long delicate tapering paddles, like the Sonsorol-islanders. They make fairly good sailors, and appear to be of a peaceful, obedient, and easy-going nature. Their chief manufactures are pandanus-leaf hats (*suraf*), which they plait with as much skill as the Pingelap natives. From the same invaluable fabric they make ornamental baskets of pretty design, and light, delicate sleeping-mats of fine texture. But the most interesting industry of all is their weaving of fine belts and ribbons from the soft and delicate textile—the banana fibre—using a loom or primitive weaving-machine called *puas* (in Ponapu, *katuntar*; Hindustani, *tant*) very similar in model to that seen in some of the less advanced villages in the interior of Japan, where the restive demon of machinery has not yet wholly ousted hand-manufacture. The patterns are quaint and graceful, and the grouping of the tints carefully considered and worked out to the avoidance of harsh, crude, conflicting colours. A rich blue tint is obtained from the juice of the trunks of young banana-suckers, the wild turmeric root and that of the *Morinda (I.) citrifolia* supplies the shades of yellow, black tints are obtained from burnt nuts of the *Aleurites*, and a bright reddish-brown is prepared from the scraped and pounded bark of the mangrove-roots. Other gradations of hue they get by carefully boiling in small quantities of water pieces of gaudy cotton fabrics, which their innate good taste rejects as an eyesore. No doubt this is due to the old hereditary æsthetic tastes due to the influence of their early Japanese ancestry or admixture of race.

Fig. 4. We see a group of Yap natives, who, together with their near neighbours of Ngoli and the Pelews, represent the primitive Dravidian type of Barata or South India, thinly overlaid by more recent Malayo-Polynesian waves of population breaking into their area, or grazing past them on their great ceaseless surge and flow eastward, and still further eastward, past the north coast of New Guinea, thence spreading themselves out over Pacific lands; the ancestors of the Hawaiian, the Samoan, the Marquesan, and the Maori. Thus, the Malayo-Polynesian infusion being somewhat slight, we

need not greatly wonder at the difference in customs and the darkness of colour, and the appearance of quaint and exotic tree-names unknown to Polynesian ears, and of words of fearful and wonderful harshness of sound, in place of the sweet-vowelled undersong of their more favoured Polynesian brethren. The island is full of different dialects, and the good folk have about twenty different ways of expressing the negative—a great gift for diplomats, who frequently may be supposed to deal with such.

The Yap people have a plentiful stock of folk-lore, and a very elaborate astronomical system. In old days they seem to have been great conquerors and navigators, sending trading and fighting expeditions up to Pulawat or Enderby Island, and as far even as Ruk and the East Mortlocks, in search of the *taik*, a noted cosmetic in Micronesia, made up of finely-scraped and powdered turmeric root done up in neat little cones. This word is found in Maori *takou* (red ochre), in the Peruvian *takeu* (red clay), and in the North Marquesan *taiki*, and in New Hebrides *tei*, *teik*, id. (a red, vermilion, or crimson colour). The Yap people also occasionally visited Ponape, in the extreme east of the group, where several traditions of their visits are retained in local names. Thus, the landing-place at the mouth of the Ronkiti River, on the south-west coast, is called Chakar-en-Yap—*i.e.*, “the strip of beach belonging to Yap”; and a pink-fleshed banana is also called *ut-in-Yap*, or the Yap banana.

One of the most remarkable Yap traditions deals with a great canoe let down out of the sky by ropes, filled with ladies—fairy folk—who came down to see the dances and feasting of the young people of the island. Some one cut the ropes, and, though most of them climbed up in time, two were left behind—mother and daughter. The disconsolate couple hid for a long while in a dark cavern in the rocks near Tomil Bay; but the daughter was snared by nets at last whilst bathing one day, and the mother, who seems to have been a sort of ogress, came after her daughter, who became the wife of the chief of Tomil. The fairy stepmother, by her insatiable appetite, nearly caused a famine in the land. Twice a day she would devour a monstrous pile of cocoanuts, husks and all. At last the King of Tomil, in despair, cut off the supplies, and bade this wonderful old witch use her magic powers, and forage for herself. Promptly the fairy turned herself into an enormous rat, “much bigger than a cat,” says the narrator, and went upon the hill-terraces and plantations by night, and made a clean sweep of all the sweet-potatoes and yams of the settlement. At last, however, a certain skilled setter of traps placed an elaborately-devised machine in her path, which dropped a huge mass of rock on the intruder, and finished the

witch and her tricks together. Whilst all men wondered at the size of this mighty rat, word was brought that a typhoon was coming out of the north. All was confusion and dismay. The rain poured down in torrents, amidst a strong hurricane; lightning flashed, thunder roared, the earth shook, and little by little the waters of the ocean began to cover the doomed island. The king and his fairy wife slipped away, and climbed up to the table-land overlooking Tomil Bay, taking with them abundance of magic herbs with which to perform the *machamach* (cf. Japanese *maji*, magic: Araucanian (S. Chili) *machi*, magic, sorcery, medicine-man), or incantations, to stay the progress of the coming flood, which reached their feet and there subsided. All the lowlands of Yap were covered, and the folk perished, all save one man, a slave of Unean, and the prudent couple. When the waters went down the Unean slave saw the lowlands of Nimiguil emerging, so he went down to the newly-risen coast-line, inserted a bamboo rod in the reef in token of possession, and went his way. By-and-by the chief and his fairy wife met the slave, and were much surprised, supposing him to have perished with the rest. Said the slave, "I'm nobody's slave now. All these new-risen flats belong to me. See the pole I have fixed in the reef to show myself the rightful owner." So they went their way, and let him be. Wherefore the descendants of that man of Unean live in Nimiguil unto this day. "But how did he find a wife if all the others were drowned in the flood?" I asked. "By *machamach*, of course," replied the old man with some asperity. "Everything was possible to the gods in those times. And there are people in Nimiguil to this day, and Nimiguil belongs to Unean. When Unean man want *kaikai* he send Nimiguil; Nimiguil man he bring it quick."

The above is a fair specimen of the average irrational Yap myth, considerably condensed, for the native orator is nothing if not diffuse, and is continually branching off upon irrelevant topics, apart from the main track of the narrative. Like all primitive folk the Yap natives believe in all manner of spirits and unseen agencies potent for harm. The Creator, they say, is *Yalafath*, a mighty and benevolent deity, who sits in the sky and views placidly the work of his hands and the operations of the multitudes of *kan* (also called *yan*), or genii, mostly evil and malevolent, each busy in his own sphere of activity. This *yalafath* is possibly the Japanese word *arakashi*, "to create." The Yap conception appears at least somewhat Buddhistic in character. Amongst savage races, however, we frequently see the notion of a placid, mighty, and good-natured and indolent Supreme Power, with a host of minor powers busy and energetic working for evil and mischief, unchecked in their lawless labours, and therefore to be conciliated at all

hazards. It may easily be understood that the Yap Pantheon is an extensive one. Fire, earthquake, sea, rain, wind, plague, famine, cultivation, thieving, fishing, feasting, dancing, canoe- and house-building, all have their supernatural dominant power, genius, or patron spirit.

From Yap in the west to Ponape in the east is a far cry, the Caroline chain extending over quite sixteen hundred miles of sea. Numerous little coral islands lie scattered over the intervening space, whose names appear to have been the despair of early navigators. These little spots have evidently received a very large infusion of Polynesian blood, lying as they do right in the track of the early *prahus* coming out of the Sunda and Gilolo passages, pressing on ever further and further eastward.

The languages of Uleai, Ifalik, Satawal, Uluthi, of Lamotrek, Pulawat, and the Hall group, as well as the dialects spoken in the great lagoon of Hogolen and the East and West Mortlocks, are full of interest to the philologist, containing, in addition to numerous intrusive Japanese words, a great number of Polynesian root-words, hacked and chipped, mutilated, abraded, shorn of terminal vowel-sounds, but still unmistakably Polynesian. Furthermore, there is one little island midway between Ruk and the New Guinea coast named Monte Verde, or "Green Mountain," by early Spanish navigators. The natives call it Nuku-Oro. (There is another Nuku-n-or or Luku-n-or in the S.E. Mortlocks a little further to the north.) The language is a very pure ancient Polynesian one, combining the phonesis of the Maori, the Samoan, the Tahitian, and the Futunan, with a few picturesque irregularities and differentiations of its own in vocabulary. The vocabulary of the Mortlock-islanders has considerable Polynesian affinities, as J. S. Kubary some fifteen years ago pointed out clearly enough in his work for the *Godeffroy* Brothers firm, of Hamburg.

An interesting fact about the Ruk and Mortlock islanders is that of their distortion of the lower lobe of their ears to an enormous size, reminding one of the practice in ancient Peru, and that current amongst the early image-building inhabitants of Rapa-nui, or Easter Island, whom the people of Rapa-iti, who exterminated them, called the Taringa Roroa, or Great Ears.

So we pass on to the Island of Ponape (*Pan-u-Pei*, "the land of the holy places"—cf. Mortlocks *fanu*, land, and Polynesian forms *fanua*, *whenua*, *enua*, *fenua*), otherwise called Seniavina by Russian navigators, who many years ago did good exploration- and chart-work in these little-known waters. Ponape herself is a fertile little island lying 6 deg. 48 min. north by 158 deg. 14 min. east, some seventy miles in circumference,

surrounded by a dense belt of mangroves for the most part, the exhalations of which, from the month of April onwards up to September on the cessation of the trade wind blowing bright and clear out of the north-east, produce many catarrhal and febrile affections amongst the natives. The population of the island is some five thousand, of which the larger portion reside in the Kiti and Metalanim districts. The language is a northern form of Malayo-Polynesian, with a strong Melanesian and a fairly strong Japanese tinge; it has many affinities to the Tagala, the Bisayan, the Ilocan, and the Formosan. All the old traditions, and, indeed, the architecture and disposition of the ruins themselves, point distinctly to a Malayo-Japanese civilisation overthrown by a great barbarian invasion from the south. The great ruins in the Metalanim district have keenly attracted the attention of the curious. They are built upon a number of small coral islets, intersected by numerous waterways more or less shallow, every year more and more overgrown and choked up with the encroaching mangrove-belt. The largest enclosure is upon the Island of Nantauach. The great outer wall measures about 215 ft. by 185 ft. in area, and about 30 ft. in height at highest point, enclosing an inner wall about 80 ft. by 60 ft., which encloses a great vault or tomb, where excavations yielded rich results in shell ornaments, ancient adzes and war-axes, spear-heads, and countless fragments of broken relics and bones. Of vaults in Nantauach I counted four in all, every one of them yielding a more or less plenteous harvest, of which I shall write later on.

To continue, Ponape is a rich and fertile island, producing abundance of copra, ivory-nut, and ais-nut (cf. Mortlocks *aset*, id.; Yap *alhidh*), the last-named a large brownish-red nut with rough outer rind which produces a valuable varnish, hardly known as yet in European markets. The island's resources have hardly been developed at all. A clearing has been made round the little settlement of Santiago, Not district, and Henry Nanapei, Chief of Ronkiti (a district on the south coast), a most progressive and enterprising man, far in advance of his generation in every way, has at great pains planted a great valley with cocoanuts and otherwise improved the land; but these are two solitary exhibitions of energy and industry, and quite out of keeping with the general rule of listlessness, laziness, and *laissez faire*. Brooks and rivulets of sweet water everywhere abound, and the island scenery presents a rich panorama of forest and waterfalls, a glorious scene of rich, varied, luxuriant tropical vegetation. Birds abound, several species being peculiar to the island, amongst others the paluch (cf. German New Guinea *balos*, *balus*, a pigeon), a brown-and-white pigeon, and a reddish-and-brown

parroquet (*Eos rubiginosa*), called *cherret* or *terrep* (cf. Maori *torete*, a parrakeet). A peculiar black-and-brown lizard (*kie*) is found, resembling a miniature alligator. Huge eels abound in the swamps, and, strange to say, are greatly dreaded by the natives, probably owing to some lingering notion of Asiatic serpent-worship. The Ponapeans call the eel *kamichik* (ancient name *it*). The palm family are represented by several varieties of the ever-present cocconut-palm, or *ni*, by two areca-palms, the *katai* and the *kotop*, by the *param* or swamp-palm (the *nipa* of the Philippines), and last, but not least, by the *och*, or vegetable-ivory palm, called by the Spanish "Palma de Marfil," the round hard nuts of which find a ready sale in the European markets.

The island is divided up into three large provinces—*Kiti*, *U*, and *Metalanim*—and into two small ones—*Not* and *Chokach* (called erroneously "Jakoits" by American missionaries), each under its own chief or king, and subdivided into numerous small districts, each under its own petty chief or *au* (cf. Polynesian *sau* and *hau*, id.).

Ponape, though she possesses, as far as we know, no mineral wealth, contains rich resources in her forests. Amongst her most remarkable forest-trees are the *ichau*, the *luach* (two *Calophyllum*), the *koret*, a tall timber tree with red wood valuable for cabinet-making; the *tong*, a fine reddish-brown wood; the *pulok* and *uaingal*, species of giant mangrove; the *pona*, or rosewood (*Thesperia popularia*), and the *ikoik*, a tree with very hard reddish wood with a beautiful grain. The *marap* (*Incarpus edulis*) and the *chatak*, a tall buttressed tree bearing clusters of bright blue oval berries—the food of the fruit-pigeons—also produce a good hard wood valuable for housebuilding and the construction of boats. Other two remarkable trees are the *nin* (cf. sundry Indonesian dialects where the banyan is called *nin*) and the *aio*, or banyan-tree, both belonging to the *Ficoid* order. The almost untrodden wilderness of the interior grows many other forest-trees and plants, many merely ornamental, some reputed to possess valuable medicinal qualities. Weeds and creeping plants abound everywhere, to the great annoyance and impediment of the booted and clothed foreigner who rashly ventures into the woody labyrinths.

The highest peak in the island is that of *Tolocom* (2,861 ft.), in *Kiti* district; *Mount Whana*, in the same district, and *Mount Kupuricha*, in *U*, are nearly as high. Close to the *Kiti* and *Metalanim* border is a curious-looking basalt shaft, called by the Natives "Chila-U," or the "adze-head," known to Captain "Bully" Hayes, of buccaneering fame, by the equally picturesque title of "the Sentry-box." It overlooks the pretty and picturesque *Island of Motok*, whose people

dwell in security; like the good folk of Laish of old, "They dwelt afar off in peace, for no enemy was nigh." A little way further up, past Nantamarni (the abode of Joe Kehoe, a good old American settler) and Nantiati, the Metalanim coast is indented by two deep harbours—Middle Harbour (Ponatik) and Weather Harbour (at the head of the latter is Chapalap River, where in the late war the Spanish lost heavily in storming a native fort)—formerly frequented by whaling-vessels, but now deserted and abandoned by sailing-masters and whaling captains alike, who were thoroughly disgusted at the double-dealing and incredible avarice of the natives of this part, who with justice may be termed the meanest islanders of the Pacific. Nowadays nearly all ships trading touch at Mutok Harbour, or Ronkiti, where the anchorage is good, and wood and water, provisions and produce, cheaper and easier to be procured. The King of Metalanim and his favourite courtier and factotum, David Lumpoi, are two curious personages. The latter picked up his English and his manners together from a whaling-vessel. *Verb. sap.* The former is a gloomy, morose old man, who turned religious in his old age in order to dodge the sins and crimes of his youth. He has a great hatred and contempt of the *macha potopot*, or white faces, which is as cordially reciprocated by all of them who have met him. He draws the princely salary of 20 dollars a month from the Spanish to keep him in good humour; and so the farce goes on. Whether the comedy will or will not result one day in a tragedy remains to be seen.

Fig. 5 represents the great entrance to Nantauach, which comes all of a sudden into view as the canoeist shoots round the angle to the right of Uchentau. The terrace here is nearly 7 ft. above the canal, and hereabouts the immense solidity of the masonry once more strikes us. The left side of gateway is about 25 ft. in height, and the right about 30 ft., overshadowed with a gigantic ikoik tree, a species of rosewood with long, scarlet, trumpet-shaped flowers—with a profusion of deep-green leaves which the explorer had not the heart to destroy for its beauty. Formerly hereabouts the walls were much higher, but much of the masonry has fallen into ruin from earthquakes. Passing on through the great gateway we come into a spacious courtyard, with a second enclosure surrounded with a wide terrace, some 4 ft. high, facing us, which stretches away to the right into a sort of wing or supplementary structure with a low wall running completely across the centre dividing the front from the back court.

Fig. 6 gives a view of the second enclosure, which has quite a Japanese appearance, and which has suffered much less from wear-and-tear and accidents than the great outer

wall. Here our labouring party had great trouble in removing a dense forest of hibiscus and a large number of forest saplings, which, crowding around in dense masses, the result of many and many a year's unrestrained growth, completely hid the whole structure from view, as seen in figs. 7 and 8. Immediately within this second enclosure is the great treasure-chamber and vault of King Chau-te-Leur (who answers to old King Cole, the jolly old soul, of ancient British tradition, famous for his love for strong pipes, pots of ale, and his three merry fiddlers); or, rather, one of the Chau-te-Leur dynasty of ancient Ponape, when kings were kings indeed, and the whole island was united under one head. (*Chau* = Polynesian *Sau*, *Hau*, or *Au*; which last Rarotongan form also appears as the Ponapean *Au*, a small district chief. *Leur* perhaps = the Timor *Lior*, and the Malayan *Lior*, in the sense of foreign, external. Possibly here a foreign or intrusive Malayan dynasty is indicated.) The last of the dynasty suffered a hapless fate. Under a fierce and terrible warrior named Ichō-Kalakal a great fleet of war-canoes came up from the Pali Air, the barren lands of the south, probably from the New Hebrides or New Guinea coast. Swarms of savage invaders poured in upon the peaceful settlers, and almost completely obliterated the ancient civilisation, after a most obstinate resistance, in which many thousands perished, the king himself, like the pious Æneas of classic fame, perishing in the waters of the great river close at hand, and being converted into a large blue river-fish, which to this day the people of Metalanim will not eat. The conquerors used their victory with the usual barbarous license. The old men and priests (the holders of the old traditions) were put to death everywhere without mercy, even as Edward of England put to death as many of the Welsh bards as fell into his pitiless hands during his bloody and devastating invasion of the land of the Cymry, for fear that they at some future time might arouse anew the spirit of the conquered folk by reciting the old ballads and tales of heroic days long past. Thus perished the ancient civilisation of the Chau-te-Leur kings, under whose rule the walls of Nantauach were built by the two noble architects, Olosipa and Olosopa, the Dioscuri or Great Twin Brethren of ancient Ponape, who arrived many hundred years ago in a great ship from the north-west, landing first in Chokach, and thence coming down to the Metalanim coast, where these two mighty heroes and their following settled down, instructing the people in architecture and the peaceful arts.

Judging from the great number of Japanese words occurring in Caroline Island languages in general, and in the islands of Ponape and Kusaie in particular, it seems highly probable



that the district of Metalanim was the seat of an ancient Japanese civilisation, mingled with that of Malayan settlers, themselves a series of tribes of mixed blood, who, coming wave upon wave, swept the Chokalai, or aboriginal Negritos, further and further up into the valleys, killing the men and taking the women and children for slaves. The nascent civilisation formed by the uniting of these three elements appears to have been finally overcome by a great invasion of barbarians from the south, the holy places being turned for the time into a series of fortifications, the reduction of which must have been effected very slowly, and at a frightful cost of life on both sides.

The principal treasure-chamber, shown in figs. 7 and 8, was carefully excavated by our party. Great numbers of delicate, white, circular, flat shell beads were first unearthed. Next a number of handsome shell axes and adzes, varying from 2 ft. to 8 in. in length, white and polished as fine marble, with keen cutting edges formed by long and laborious rubbing-down from the centre-shaft of the *Tridacna gigas*, or giant clam; an immense number of rose-coloured shell beads, discs of 1 in. to  $\frac{3}{4}$  in. across, perforated with great exactitude in the very centre; also a quantity of flesh-coloured shell pendants, like carnelian, used in ornamenting the fringes of the belts of elaborately-woven banana fibre, the insignia of great chiefs and the *chaumaro*, or wise men, of ancient times. Many ancient pearl-shell fishhooks were also found; also one spear-head of a smoke-coloured flake of crystal, which Kubary, an old German resident, declared to be obsidian, the *itzli*, or volcanic glass, used by the ancient Mexicans for their *macca-uill*, or tooth-bladed swords. The native in No. 7 was one of our workmen from Ponatik, who joined the exploring party under an idea that much *moni uaitata*, or good red gold money, was buried here. After grubbing away in the dirt for many days, he finally gave up in disgust at unearthing a huge skull, remarking, "Old stone axe no good; skull belong dead man me no like; hard work, he no good; red money, he very good."

Fig. 9 represents the irregular wing stretching out to the right of the inner enclosure, also containing a smaller vault, from which we also dug up a few handfuls of beads and shell ornaments. The two figures in the centre are two of our workmen from over the Kiti border, who came fearlessly and cheerfully over amongst their old hereditary foes of Metalanim to help us in the work. In the end our five Kiti workmen did the work of more than a dozen of the sulky and surly subjects of King Paul. So true is the saying, "One volunteer is worth a dozen pressed men."

Fig. 10 represents a portion of the great inner courtyard

towards the west, thickly strewn with fragments of broken basalt columns, doubtless shaken down from the great walls above by the shock of some earthquake long past. Some of these shafts are of enormous size and weight, many running up to 28 ft. in length by 3 ft. across and  $3\frac{1}{2}$  ft. in depth. What engineering methods the builders could possibly have used in putting these enormous masses so carefully and exactly into the position, as seen elsewhere in the other views of the masonry standing as yet intact, must for ever remain a matter of conjecture to us. A possible solution is the theory of the employment of great numbers of men, acting under skilled guidance and strict discipline, parbuckling with thick coils of cinet-ropes and tough hibiscus bark one by one these enormous masses up a sloping platform of felled tree-trunks profusely lubricated with cocoanut-oil so as to substantially reduce the friction.

Any of our audience to-night who has visited China and Japan no doubt is familiar with many Titanic engineering feats, gigantic victories of mind over inanimate matter, there and elsewhere in the marvellous East, the great mother hive of the swarming nations.

Fig. 11 represents the east inner angle of the great outer wall of Nantauach, here 15 ft. thick and 42 ft. in height, the clearing of which occupied our party of seven nearly a whole day, under a terrific tropical downpour of rain. Observe the peculiarly solid disposition of the blocks in straight tiers or lines, alternately lengthwise and crosswise, an excellent combination of elegance and stability out of very rude and rough materials by a folk seemingly unprovided with iron tools and chisels. For these same huge basalt columns were never cut or chiselled out by the hand of man; for it is precisely into these five- and six- and seven-sided prisms that the basalt cools down and solidifies under the operation of titanic or vulcanian laws and issues from the great melting-pots, crucibles, and workshops of nature in the fire kingdoms underground. It may be remarked that the cliffs of Chokach and the U provinces have the same remarkable organ-pipe formation as those fringing the Tasmanian coast. Therefore when we admire these massive structures we should justly wonder at the mechanical and constructive skill of these early peoples in moving and setting into their places the rude and rough material with which the past and present forces of nature have strewn their rocky glens and the desolate mountain-valleys far inland; giant columns—which awaited, as the native traditions say, but the magic bidding of the Master Builders, the Great Twin Brethren—were seen to fly through the air swift as birds on the wing and settle down into their appointed places.

Fig. 12 represents the south-west angle of the outer wall of Nantauach facing towards the great sea-wall of Nanmoluchai, the island of the camp-fire embers, which shuts out the heavy rollers of the open harbour from the Polynesian Venice, embowered in its maze of placid canals, mirroring in their depths the old terraces of black rock with their fringes and streamers of alga and water-weed—each a veritable Lethæan wharf—half visible amongst the ever-encroaching mangrove clumps—children of the tropical ooze and slime. A great banyan, or Indian fig-tree, has solidly established itself 30 ft. up, searching out with its long root-sprays, with their clinging tresses of fibre, every crack and cranny in the slowly-yielding masonry, threatening at no distant date to throw the whole gigantic mass out of just balance and poise. The central figures are those of the explorer and of the first and second lieutenants of the Spanish cruiser “Quiros,” which at that time happened to be lying in the great harbour close by, much to the indignation of King Paul, who, in a spirit of dastardly treachery, sent on board a present of poisonous fish, which very nearly ended in the death of one or two of the crew.

It should be here observed that the explorer received very many kindnesses from the captain of the same vessel, Don Miguel Velasco, and the officers. Don Miguel has been recently appointed Governor of the Eastern Carolines, where his frank and straightforward way of dealing with the natives is certain to bear good results, and perhaps in the end disarm the animosity and ill-will of the ever-grumbling and ever-discontented tribesmen of that somewhat crusty native convert, King Paul, of Metalanim.

Fig. 13 represents the same group a little further along the side of the wall looking down on terrace and canal, copiously strewn with boughs and branches, trunks and saplings, hewn away from the immense mass of tropical vegetation which, when we first arrived, hid nearly all the masonry from view. The seated figure is a worthy old American settler, Joe Kehoe, who, with his two stalwart half-caste sons, joined our small party down the coast at Ponatik Harbour before we set out, and who rendered us most invaluable services under very trying and discouraging conditions.

Fig. 14 represents the angle of the outer wall of the same island, facing north-west; height, 28 ft.; thickness of wall, 15 ft. This wall also required laborious clearing, it being necessary to fell three or four large forest-trees which had grown up from the terrace below, greatly to the discomfort of the poor Manilla photographer, who was quite unused to the fatigues of axè-work, and who kept from time to time

nervously glancing behind his back, fearing a rifle-shot from any one of the thickets in the dense jungle stretching round us on every side. King Paul, a few weeks later, they say, whilst viewing the destruction wrought in the jungles around these sacred walls, flew into a violent passion, declaring that the small party of explorers had done more hard work and chopped down more trees in a week than he and his whole tribe could get through in six months. "How is it?" quoth the wrathful monarch, "Is not the white stranger afraid to disturb the rest of the seven great and twelve lesser gods—the Lords of War, of Disease, and Death." Whilst this most unjust and rascally monarch was meditating mischief, and dreaming of revenge, he was struck down, and many of his people also, with a most violent fever and influenza. Says one rival tribesman of Kiti, a writer of songs, or *melakaka*, "In the Isle of Tomun, the king's land, was groaning, murmuring, and tribulation. The strong man went not forth to the fishing nor the mighty man to his daily toil; and the sneezing of the sick folk was heard even unto the border of Kiti. And King Paul Ichipau lay sick in the lodge, taken with pains and burnings and shiverings, and his wrath blazed hotly the while against the stranger from over seas who had bearded the ancient spirits in their high places, disturbing them in their long rest and tempting them to break out in anger on the folk within all the Metalanim coasts, and he gave orders to seize the strangers and plunder their goods. But the strangers, being aware of his evil mind, had privily stolen away by night; nor were they found again within the land for many, many days."

Fig. 15 is the *wei*, or turtle-stone, of Ichu-Kalakal the Terrible, upon which the turtles, or some say the human victims, were slain on great feast-days. In justice to Ichu-Kalakal, the leader of the great barbarian invasion from the south—a most cruel and relentless conqueror—the traditions do not all agree on this point, some attributing the practice of cannibalism solely to the Li-ot, or eaters of raw flesh, an early legendary people of the island. Hereabouts in the waterway is a great roundish black rock, rudely carved into the shape of a huge human head. This is called the head of Laponga the wizard, a sort of Ponapean Mopsus, who knew the language of the birds and the utterances of the winds, the trees, and the flowers, about whose miracles and practical jokes and humorous revenges numerous songs are sung around the camp-fires and in the great lodges on days of high festival.

Fig. 16 represents a distant view of the islands of Na-Pali and Na-Kap, lying off the entrance to the great harbour of Metalanim, with a half-submerged pile of enormous stones in

the foreground—portions of the ancient sea-wall of Nanmoluchai, probably thrown down by an earthquake. In rough weather the break of the great rollers against, around, and over this huge barrier is terrifically grand, the whole atmosphere filled with a thick haze of motes and flakes of sea-spray, and great foam-sponges flying thickly through the sounding air. Near this weird spot an eccentric old Frenchman made his abode in a little nook amongst the rocks, where he ended his days in most approved hermit fashion. The landing here, even in the calmest weather, is most dangerous, many lives having been lost. Fishing parties now give the spot a very wide berth, saying that dangerous currents circulate amongst the great stones sunk deep down, and regard the place as a haunted and ill-omened spot.

Fig. 17 represents the eastern angle of the holy island of Pan Katara, a little further down south from Nantauach, with the solitary inhabitant a small white goat belonging to King Paul, which came down to nibble and browse upon the fresh green shoots and leaves of the boughs and branches and creepers, the *débris* of our clearing, which occupied a whole sultry summer's day. This island in olden times was a solemn council-ground or husting, where the chiefs and elders and heads of the districts and magicians conferred together at regular intervals, and held solemn feasts. This island is also supposed to be haunted, all who rashly violate the sacred precincts being liable to be smitten with leprosy. The Ponapeans call these *Lil-charaui*. A similar idea also obtains in the cemeteries of Fiji and the *maraes* (the *balai* of Java), or holy places, of Tahiti, so heavily lies the awe of the Dead Hand upon the hearts of the South-Sea-islanders, otherwise so lively and gay. This reaches its climax in the gloomy and tremendous imagery of the nature worship and spirit-lore of the islanders of the Marquesas and distant Rapa-nui (Easter Island), the land of stone statues, the work of Hoto-matua and Hina-ahu-one—the last link in the long long chain of evidences which connect the races of the great Continents of Asia and America on the Pacific side, mainly through the long and adventurous voyages of those Phœnicians of central and south-west Pacific, the early Japanese and the Malayans.

Fig. 18. Boy and pig on Nalap Island.

Fig. 19. Nanapei as a youth.

Fig. 20. Nanapei, of Ronkiti, at present age.

Fig. 21. Scenery at mouth of Ronkiti River.

Fig. 22. A witch-doctress, or medicine-woman.

Fig. 23. The sanctuary of the Pako, or shark god, in the Ant atoll, twelve miles south from Ponape; an appanage of the King of Kiti.

Fig. 24. Nan Aua, nephew of the King of Kiti (south coast), admiral of the fishing fleet.

Fig. 25. Padre Augustino, chaplain of the forces in the operations of 1889-91; present head of the Capuchin mission.

Fig. 26. Scenery on the Kiti River, near the Catholic school, bordered by hibiscus trees, gorgeous most of the year with huge yellow blossoms, with velvety black centres.

Fig. 27. Brother of King Paul, of Metalanim, with carved paddle in hand and circlet of white shell on head, a native belt of pink, grey, and white shells threaded upon a framework of banana fibre; dressed in *kol*, or native kilt, made of the split filaments of the young cocoanut-leaf.

Fig. 28. Obadiah of Aru, with Mortlock school-book in hand—the *kapas fel puk eu*, which, being interpreted, means “No. 1: good book.” Owing to fondness for money, and a somewhat catholic and indiscriminate taste for strong and fiery liquors, he fell from the ministry, and retired into private life on the Metalanim border.

Fig. 29. View of David Lumpoi’s house at Ponatik, on the Metalanim coast, where we stayed a month amongst some very mercenary folk.

Fig. 30. Picture of Luis, a Tahitian settler, in the characteristic pose of the average island trader about ten times a day, surrounded with bunches of native bananas, with the beach and fringing palm groves of Ponatik in the background.

Fig. 31. A Metalanim youth, who spoke a little Spanish, and improved the occasion by suggesting to the Manilla man to rob his employer. A little knowledge seems to have a dangerous effect sometimes upon the native imagination.

Fig. 32. A view of King Paul’s great canoe in the boatshed on the Island of Napali, off the mouth of the great harbour. On hearing that his canoe had been photographed King Paul flew into a passion, and sent to ask for extra pay, which was promptly and indignantly refused.

Fig. 33. A native of Ponatik, a noted desperado and marked man, grievously suspected of having hacked to pieces wounded men after the repulse of a Spanish detachment at Ketam. Such men work great harm and cause great disaffection amongst the tribesmen; and it is certain that should Japan ever annex these islands Japanese justice would not suffer these and others like them to live.

Fig. 34 represents the Islet of Uch-en-tau, a perfect type of one of the smaller islets. There, by the grudging assent of King Paul, during our explorations our party camped and kept our tools and provisions, returning every evening, muddy and weary and famished, but laden with curiosities, the results of our excavations in the vaults.

Fig. 35 represents the angle of the great outer wall facing towards the entrance to the bay, known to the American whalers as "Middle Harbour." The wall is encircled by a spacious terrace raised some 6 ft. above the canal, and occupied thickly by cocoanut-palms and dracænas, the deep-red leaves of which contrast prettily with the sombre hues of the lichen-encrusted masonry and the fresh green of the tender palm-fronds just turning from their early delicate red-brown.

---

ART. XII.—*On the Influence of the Ideal.*

By E. A. MACKECHNIE.

[*Read before the Auckland Institute, 4th October, 1897.*]

What is it that keeps men in continual discontent and agitation? It is, that they cannot make realities correspond with their conceptions.

WILHELM MEISTER.

IN every stage of man's history there has been a dream of a millennium on earth. Something is to happen—some change to take place in ourselves or in our social order—by which the animalism of our nature is to be subdued, and somehow transformed. Whether we have sprung from the lower animals or not is immaterial to our present purpose, for by a little self-analysis we recognise, sadly enough at times, that the basic organization of our nature is purely animal. The laws affecting animal life affect us; and we are governed for the most part by animal appetites, passions, and desires. Our affections, emotions, and intellectual processes even differ from theirs not in kind, but in degree only. The evidence in support of this view is indeed overwhelming; but under the influence of the ideal it is frequently ignored, and human nature regarded as something entirely different from what it is in reality—something far beyond the everyday average of our race. It is endowed with a higher intelligence, more developed moral sense, and a far greater control over self than it possesses. This is clearly illusory. We cannot incorporate ideal life with the life of the real. There are no true relations between the two, and the difference becomes painfully apparent whenever we attempt to realise our ideal conceptions. If we could trace a thought to its beginning—as we do disease to its microbe—and say with precision in what faculty of the mind or by what neural process in the brain it originated, we might check the illusive play of the imagination, and so establish a balance between that faculty

and reason. At present we are incapable of so adjusting mind and action.

The limits and aim of this paper render it unnecessary to enter more fully into the nature of the several kinds or degrees of illusion, the theory of cognition, or the problems respecting the nature of the real. Suffice it to say that the ideal influences, consciously or unconsciously, the most educated and intellectual, as well as the least intelligent; that the convictions associated with the ideal are strong and permanent; and that it frequently produces, when attempts are made to reduce it into practice, consequences of the most disastrous kind. A few illustrative instances may serve, possibly, to impress more fully upon your minds the essential differences between the actual and imaginary—the practical and speculative—and these we will now proceed to consider.

The French Revolution aimed at establishing a social republic on the principle of pure equality. "The goal of the Revolution," it was said at the time, "is to destroy inequality and to establish the happiness of all." That was the dream of Rousseau, Morelly, and kindred spirits, and it was shared in by Robespierre and other leaders of the revolutionary movement. They were honestly sincere in their belief. That seems to be established. They sought in all singleness of purpose, with great ability, great energy, and stirring eloquence, to redress the wrongs of the suffering masses, and to regenerate the human race. The old structure of society was to be thrown down, and a new order of equality and brotherhood to take its place. The people had risen, and were to bring about, like a mighty magician, a wonderful transformation. Every grievance was to be righted, the downtrodden raised, and prosperity and contentment spread broadcast throughout the land. The "sovereign people" (as their flatterers love to term them) had seized upon power with no gentle hand, and proceeded to show how fitted they were to rule. The unlettered, the inexperienced, the thoughtless, the thriftless were to exercise their skill in the science of government. Nothing appeared easier to accomplish than to destroy the existing complex organization of society, and to substitute for it a social fabric on a simpler and happier plan. The people felt their power, and determined to oppose and overthrow constitutional authority. Who could resist them in their numbers and their might? An ideal vision of liberty, equality, fraternity appeared to them in all the vividness of reality, and lured them onward from one rash act to another. Intoxicated with the prospect, and their own enthusiasm on behalf of humanity, they never paused to reflect or to inquire. And the end? History, the saddest in the world, makes us familiar with the result. In the hands of the



people liberty degenerated into license and excess; equality proved that men would not submit to be governed by equals, and that there could be no equal division of either possessions or gifts of nature; and brotherly love, overcome by unreasoning hate, fled from the scene appalled. It would be well for the people of all countries if they could discern, amid the lurid glare of that tragedy, the important lesson which it teaches with such profound pathos.

Not only did the prominent actors in the great drama of the Revolution fall under the influence of the ideal, but many thoughtful men, with minds of an imaginative order, regarded it as the dawn of better things, and watched its unfolding with intense interest. Poets are said to be the interpreters of their age, and it may be of service to consider for a moment the impression made upon them by the tragedy enacted in France. The leading poets of the day expected a golden age to arise from the social upheaval, and expressed the hopes of humanity with great poetic fervour, in glowing and picturesque language. Wordsworth, with many others, looked forward with hope and joy, expecting great things from the revolt against the existing and settled order of society. In his estimation it would clear away all that stayed, so disastrously, the progress of mankind, and diffuse happiness throughout the world. He exclaims,—

What temper at the prospect did not wake  
To happiness unthought of? The inert  
Were roused, and lively natures rapt away.

The change, he thought, would not be confined to France, but would extend and become universal, and all the nations of the earth be enfranchised:—

Not favoured spots alone, but the whole earth  
The beauty wore of promise.

Then came the reaction, and the horror caused by the exercise of the popular will was too appalling, too degrading, too humiliating to man as a reasoning being not to convey a personal shock of the greatest intensity. Wordsworth became dejected, and for a time his mental and bodily health suffered.

The influence of the ideal is, in this instance, clearly marked. It must have been great indeed, and most strongly felt, to lead a mind like Wordsworth's to believe that out of a nation's madness and unreason a reign of reason would arise. But minds of his order, dominated over by the imagination, love to depict the ideal as the actual, and to paint in glowing and attractive colours the peace and contentment that follows upon an ideal primitive state of life. Their raptures evoke enthusiasm in other minds, but for all practical purposes their

poetic views, whether expressed in prose or verse, are misleading and useless.

A poetess of considerable power, Mrs. Browning, has added many exquisitely-expressed fancies to the wealth of our literature. In many of her poems she enters the realms of the ideal and seeks to make her visions of love and sacrifice for others accomplished facts in this prosaic world. But the desire to realise in actual practice the ideal is more clearly seen in her preface to the poem entitled "Napoleon the Third in Italy." The following extract well illustrates our subject: "I confess that I dream of the day when an English statesman shall arise with a heart too large for England—having the courage in the face of his countrymen to assert of some suggested policy, 'This is good for your trade; this is necessary for your domination; but it will vex the people hard by; it will hurt a people further off; it will profit nothing to the general humanity; therefore away with it, it is not for you or for me.' When a British Minister dares speak so, and when a British public applauds him speaking, then shall the nation be glorious." Do we not recognise the improbability of all this? If any Minister could be so unwise as to act in the manner indicated, or any people foolish enough to support him in his un wisdom, what would be the result? Our worldly experience tells us that a people so acting would soon cease to be a nation. We find all European Powers armed to the teeth, for offensive and defensive purposes, and ready to take advantage of any weakness in a neighbouring State which would warrant aggression. Viewing human nature in the light and spirit of these national acts, we cannot but marvel at the subtle influence of the ideal which leads to its being represented and coloured so differently. Mrs. Browning says truly, "She dreamed."

Another instance may be mentioned illustrative of our subject. That dreamer of beautiful dreams, John Ruskin, prides himself upon being a communist of the most pronounced type. During his term of office as Slade Professor of Art at the University of Oxford he led his students, by way of recreation, to manly and useful toil. "Will none of you," he said, "of your own strength and your leisure, do anything for the poor—drain a single cottage, repair a single village by-way; and you yourselves will be more strong, and your hearts more light, than had your leisure been spent in costly games or more hurtful amusements?" To this noble appeal there was a generous response, and for some time the work was continued with a fair share of success; but eventually, owing to the laughter of the onlookers and the jeers of the peasantry, the scheme was abandoned. It is singular, but we are not surprised to find that those for whose benefit the exertions were

made were the first to deem them extravagant, and in the highest degree absurd. Ruskin's communistic principles and views are based on his interpretation of the Scriptures. The majority of men, we well know, do not share or agree with those views, and never dream of attempting to put them into practice. He has been severely censured for employing his great talents in opposition to the existing state of things, and much acrimonious writing has been indulged in between himself and his opponents. It is a contest between communism and individualism which cannot now be determined. But from a contemplation of his life and teachings we are led to believe—(1) That his fine imaginative mind is governed in great measure, if not exclusively, by the ideal; (2) that the purely ideal cannot be made practical, for the ideal makes no allowance, or no sufficient allowance, for the imperfections of human nature; (3) that human nature is, as at present constituted, unfitted to carry out those social reforms which Ruskin advocates with such persuasive eloquence. Undoubtedly the dream which haunts most frequently the human imagination is the dream of communism, or its kindred schemes of socialism. Visions arise of great social reforms, and when powerfully and eloquently advocated appeal with irresistible force to the unreasoning. There is something very attractive, even fascinating, in the idea of universal happiness. It clings to humanity, and has thrown a spell over many minds and many generations. Under its influence it is sought to give a new and binding constitution to the world, based on the unity of society—a community of ideas, a community of labour, a community of interest, a community of self-sacrifice. Governed by those illusive optimistic views, the conflicting interests and motives that sway mankind are lost sight of, and these bring failure to all such schemes.

In the early days of the Christian era the experiment was tried. On the death of the Great Teacher the little band of his disciples and adherents formed themselves into such a community. But very shortly the claims upon the common fund became greater than the common fund could bear, and an appeal had to be made to the brethren at Antioch for aid. Had such a community of interest been the natural order of society we may hold, with reasonable certainty, that it would have shared the success of the religion of which it seemed to form part. But a community of interest does not appear to be the natural order of society. "It is natural," says a great writer, "that institutions founded on communism should enjoy at the beginning a period of brilliancy, for communism involves always high mental exaltation; but it is equally natural that such institutions should very quickly degenerate, because communism is contrary to the instincts of human

nature. In his virtuous fits man readily believes that he can entirely sacrifice his selfish instincts and his peculiar interests; but egotism has its revenge by proving that absolute disinterestedness engenders evils more serious than those it is hoped to avoid by the renunciation of personal rights to property." (Renan.)

How fruitful a source of error the ideal is to the inexperienced may be shown by a recent instance within our own knowledge. The scheme of the New Australia allured many from their homes to find an earthly paradise in a far-away land. No one who has read, and derived benefit from reading, Hepworth Dixon's "New America," and similar works, would have thought for a moment of joining such an expedition, or the party of socialists who settled somewhere in Africa. They would have known beforehand that all such efforts to alter human nature must fail.

The fundamental error of communists is patent to all except themselves. Humanity's aim, from the very nature of man, is not repose, but strife and struggle. He feels the need of these, and engages in them to rise in the scale of being. We dream of calm contentment, but when put into practice life becomes to most men utterly unendurable. The sea is held in a state of healthful unrest by the winds sweeping over its surface and by other influences affecting it. So with the unrest of life. It is not to be denied that in too many instances we have to deplore the monopolizing greed of individualism and all its attendant evils. But, better so; individualism can be endured with far greater contentment than the stagnation of communism—that sea whose tideless waters destroy all the energies of life.

The career of men who have unselfishly striven, however mistaken their efforts may have been, to remodel society, and place it on a happier basis, claims our best attention at the present day. It is full of interest to the thoughtful. They were men of ability, of singular energy, self-sacrificing to the last degree, and guided by an intense love for their kind. Their singleness of purpose commands our respect, the object they had in view our best sympathies. Let us trace, then, though by the veriest imperfect outline imaginable, the philanthropic life-work of one of these enthusiasts.

During a period of great commercial depression and of starvation wages Robert Owen came boldly forward to the rescue of the working-classes. He was no dreamer, but a shrewd business-man of strong common-sense, of methodical habits, of practical knowledge, of philanthropic disposition. He earned his own living from the age of nine, entering upon the battle of life with no more equipment of knowledge than he could obtain in those years. He passed rapidly from one business

experience and success to another, educating himself as he went on. At the age of nineteen he was manager of a cotton-mill. It was in bad order at that time, but he reorganized it after his own experience and on his own responsibility. His administrative ability, intelligence, industry, and steadiness became generally known, and he was regarded as the foremost cotton-spinner of his day. He became manager, and afterwards the owner, of the cotton-mills at New Lanark, which employed some two thousand operatives. They were much given to thieving, drunkenness, and other vices of a more or less serious nature. The education of the young was neglected, their houses were filthy and unhealthy, and a general air of discomfort pervaded the whole. The workmen, amid these dismal surroundings, suffered and toiled. Owen, from his own comfortable home and happy family circle, looked out upon the misery, ignorance, and crime around him, and he was greatly moved. With characteristic energy he set to work to remedy it all, and in a short time he brought about a wonderful transformation. He improved the houses of his workpeople, trained them to habits of order, cleanliness, and thrift, built stores from which they were supplied at wholesale rates, erected a common dining-hall to avoid the work of separate cooking, opened houses for the reception of infants (the kindergarten of the present day), formed schools for the young (established afterwards on his model throughout Great Britain), excluded children from the workshops, and led those he employed gradually to a higher life of thought and action. In the midst of all these labours trade suddenly collapsed; other masters closed their mills, and discharged their hands, but Owen kept his open all the time, at a cost to himself of £7,000. His workpeople became warmly attached to him, worked steadily and well, and made the mill a great financial success. Owen, so far successful, sought to expand his benevolent schemes. He gained the ear of the country by addresses and publications of all kinds, and was regarded as a great social reformer. Communistic views eventually dominated his mind, and he sought to enforce them. They failed in England, and he sought to establish them in America. There he was also disappointed, and after two years' experiences of his New Harmony had to return to London. But he was nothing daunted. Scheme followed scheme, all alike in the object to be obtained, and all alike doomed to failure. But to the end of his long life of eighty-seven years he laboured unceasingly, bent on alleviating the miseries and hardships of the masses, and raising them to a higher level in life. We cannot contemplate this man's earthly career without feelings of profound sympathy and admiration. If any one could have succeeded in his self-imposed

task Owen ought to have done so. The business habits of a lifetime, his organizing capacity, the fortune acquired by his own industry, the generous instincts of his being, were all devoted to carry out his schemes for the amelioration of the condition of the world's toilers. With these qualifications, why did complete failure attend his self-sacrificing efforts? The answer is plain: he attempted the impossible. Under the influence of the ideal he fell into the fatal error of believing that an economical revolution could succeed—that the social structure could be destroyed, and communism take the place of individualism, before a moral regeneration is brought about. To believe the reverse, and that such an absolute change in the structure of the social scale can be effected first, and then that a moral regeneration will follow, is to believe in a miracle greater than creation. It would be a creation over again on a new basis—a creation reversing and destroying the first.

As another illustrative instance, it will be instructive to notice the influence of the ideal in those schemes of government which, providing for the representation in the governing body of every adult male and female of the population, are held by their propounders to be absolutely perfect. We need not go back to the times of Plato or Sir Thomas More to prove that "plans of Governments that propose great reformation in the manners of mankind are purely imaginary"; but we may take the writings of a man who not only claimed to be a reliable political teacher and guide, but who has impressed his opinions and views upon mankind in a remarkable manner. They are of great weight with the people of many countries, and are acted upon by some democratic Legislatures as if they were inspired. They are, however, deemed unsound by more profound thinkers.

Mr. James Mill, father of Mr. John Stuart Mill, puts forward his "Essay on Government" as a perfect solution of the great political problem, and the most perfect system of government conceivable. In that essay occurs what has been called the greatest-happiness principle, or, as stated by Mr. Mill, "the greatest happiness of the greatest number." The phrase is often repeated as the very quintessence of wisdom by Mr. Mill's admirers, who quote it in and out of season in a parrot-like fashion, without the remotest idea of the absurdity they are uttering. This sophistical phrase, so indefinite, yet so taking with men who have acquired little knowledge from books or by experience, has passed into a kind of proverb, and has done much mischief. Lord Macaulay criticizes that essay, and shows conclusively that Mr. Mill's proposal to give the poor majority power over the rich minority would, on his own principles, be disastrous to the well-being of society, and

that the entire essay is a series of sophisms and blunders deserving not of respect, but of the derision of mankind. This vehement attack Lord Macaulay was not inclined either to soften or withdraw. He remained firm to his own convictions, and would not retract a single doctrine which he had advanced. "To the end of his life he never saw any grounds for believing that in this he had gone too far." Having stated that the civilised world has now nothing to fear from barbarism, he adds, "But is it possible that in the bosom of civilisation itself may be engendered the malady which shall destroy it? Is it possible that institutions may be established which, without the help of earthquake, of famine, of pestilence, or of the foreign sword, may undo the work of so many ages of wisdom and glory, and gradually sweep away taste, literature, science, commerce, manufactures, everything but the rude acts necessary to support of animal life? If the principles of Mr. Mill be sound, we say without hesitation that the form of government which he recommends will assuredly produce all this." Truly a sad forecast.

Another instance, found recorded in the histories of the New Testament, is so aptly illustrative of the difference between the purely ideal and what is practical that we venture, with due reverence, briefly to refer to it. You doubtless all remember the imagined incident that befel a man as he journeyed from Jerusalem to Jericho, as narrated in the gospels. At the conclusion of the little narrative the inquirer as to who was his neighbour was, in his turn, asked a question. His inner conscience compelled him to answer truthfully, and if the question were put to any one of ourselves at the present day we should probably answer with equal truthfulness. Now, suppose an attempt were made to reduce the admitted duty to our neighbour into active practice, and to enforce performance by an Act of Parliament: it would then become necessary to define by an interpretation clause what was included in the word "neighbour." If the interpretation was as wide as the nature of the case requires, and included the whole race of human beings, it would be held by our Courts of law void for uncertainty. A definition of the word "duty" presents equal difficulties, and would be as fully open to objection. But in the court of conscience they are both readily recognised and acted upon, though not enforceable by any earthly tribunal. In the gospel narrative neither word is defined, and the duty is, it will be observed, enforced less by a command than by an earnest exhortation. We have here before us the ideally perfect, and at the same time have to acknowledge that we are incapable of enforcing it in practice. But the narrative of the gospel history enables us to discern the true value and importance of the ideal. We

place before our mental vision some high excellence—the higher and nobler the more difficult of attainment—and are inspired to frame or model our lives upon it. We frequently fail—fall short of what we intended; but the ideal remains before us; and if we are true to our better selves we as repeatedly strive again. These attempts to rise in the scale of being—the very discipline of life—have an educational and elevating force. They are not opposed to, but sanctioned by, reason, and tend to raise us to a higher level than that of mere animal life. We reach this end not through communism, an idle dream of the impossible, but by individualism, ever developing higher resolves and a nobler personality. By this means we attain, if we ever can attain, the highest expression of humanity—its ideal perfection.

---

ART. XIII. — *On an Objection to Le Sage's Theory of Gravitation.*

By C. COLERIDGE FARR, B.Sc.

*Read before the Philosophical Institute of Canterbury, 5th May, 1897.]*

THE only theory to account for gravitation which has received any serious support is that due to Le Sage, who published his hypothesis in the "Transactions of the Royal Berlin Academy" in 1784. He supposed gravity to be caused by streams of exceedingly minute bodies, which he calls ultra-mundane corpuscles, colliding with grosser matter, and the screening effect of one body on another gave rise to a tendency of the two bodies to come together. It can be shown that this force would fall off as the square of the distance increases, and that if we assume a sufficient openness in the structure of matter, the force will be proportioned to the product of the two masses involved. Though it might perhaps be too much to say that Le Sage's theory has been looked upon as being the final solution of the cause of gravity, yet it has had serious and careful consideration from such men as Kelvin, Isenkrahe, &c. There is one difficulty in it which Lord Kelvin has completely got over, and that is the objection that had been raised that if these ultra-mundane corpuscles did not rebound with less velocity when they approached gross matter there could be no gravitation, and that if they did lose velocity at impact sufficient heat would be generated to raise all gravitating bodies to a white heat.



It is not my object at present to show how this difficulty may be overcome (as it has been naturally and without any fanciful assumptions); I merely quote it to show that scientific men of the highest standing have thought the theory sufficiently probable to spend time in its improvement, and as recently as 1895 Preston wrote a thesis on it, for which he was awarded the degree of Ph.D. at the University of Munich.

Now, there is an objection to this theory of Le Sage out of which I see no escape, and which lies at the root of the whole hypothesis. It will easily account for the force of gravity falling off as the square of the distance increases, and provided we assume a sufficient openness in the structure of matter it will account for proportionality to mass. But it is just that sufficient openness that we cannot grant, and, curiously enough, the evidence comes from a very unexpected quarter. It is, of course, well known that the gaseous laws, symbolically expressed as  $pv = RT$ , are merely approximations to the truth, and that they become less accurate approximations the more nearly a gas approaches its point of liquefaction. In order to obtain a more exact expression of the behaviour of gases Van der Waals,\* in a paper "On the Continuity of the Gaseous and Liquid State of Matter" (a paper which has been translated by Threlfall and Adams, and published in English as one of the Memoirs of the Physical Society of London), improved this expression by the introduction of two small constants, and wrote the gaseous laws as

$$\left(p + \frac{a}{v^2}\right)(v - b) = RT.$$

As showing the degree of approximation reached by this formula, the following table of values observed for  $pv$  by Amagat, and of those calculated for  $pv$  by Baynes, from the above formula may be of interest. The gas under experiment was ethylene:—

$p$ .	1,000 $pv$ .		$p$ .	1,000 $pv$ .	
	Obs.	Calc.		Obs.	Calc.
31.58	914	895	133.26	520	520
45.80	781	782	176.01	643	642
59.38	522	624	233.58	817	805
72.86	416	387	282.21	941	940
84.16	399	392	329.14	1,067	1,067
94.53	413	413	398.71	1,248	1,254
110.47	454	456	..	..	..

\* *Kontinuität der gas förmigen und flüssigen Zustände*, Leipzig, 1881.

The pressures are given in atmospheres, and the temperature was 20° C.

This table shows two things: It shows in the first place how hopelessly untrue the older formula  $pv = RT$  is when the pressure becomes large, for that formula at constant temperature gives

$$pv = \text{a constant};$$

and it also shows how very near an approximation to the truth Van der Waal's expression is, especially at abnormally high pressures.

It is, perhaps, unnecessary to lay further stress on the truth of Van der Waal's formula. It has played a most important part in physical research, and there is the strongest evidence in its favour.

Now, Nernst has shown\* that it follows from this equation, combined with the critical pressure, volume, and temperature, "that at their respective boiling-points and at atmospheric pressure the molecules of the most various liquids, such as water, ether, carbon-disulphide, benzene chlorethane, ethyl-acetate, sulphur-dioxide, &c., occupy a space very nearly 0.3 of the total apparent volume." In other words, the intermolecular spaces are about double the volume of the molecules on their superficial areas  $2\frac{2}{3} : 1$ —*i.e.*, the holes in the network have an area of about 1.58 times that of the threads.

Applying this to Le Sage's theory of gravity, it will be evident that if we consider the action of the ultra-mundane corpuscles in layers of matter situated at any considerable depth in a liquid at its boiling-point we must arrive at the conclusion that it will be nil, for the molecules near the surface must screen those more deeply situated, and there can be no bombardment. But unless these corpuscles reach every single molecule in a body, of whatever size, without any alteration in the direction of their motion in order to reach that molecule, the theory fails to account for the proportionality of gravity to mass. Gravity ought, were Le Sage's hypothesis true, to be a function of the temperature, and to depend on whether the gravitating body were in the gaseous, liquid, or solid state.

---

\* Nernst, "Theoretical Chemistry," translated by Palmer, p. 196.

## ART. XIV.—On the Magnetic Force parallel to the Axis in the Interior of Solenoids.

By C. COLERIDGE FARR, B.Sc.

[Read before the Philosophical Institute of Canterbury, 1st September, 1897.]

## [ABSTRACT.]

In this paper, which is essentially mathematical, the author takes the expressions for the potential in the interior of solenoids as given by Maxwell and Thomson and Tait in terms of zonal spherical harmonics, and differentiates them with respect to "z," the axial direction of the coil. As a result of this differentiation it is shown that this component of the magnetic force can be simply expressed in terms of zonal harmonics, and as far as  $n = 6$  the relations

$$\frac{d}{dz} \left( \frac{P_n(\theta)}{r^{n+1}} \right) = (n+1) \frac{P_{n+1}(\theta)}{r^{n+2}}$$

$$\frac{d}{dz} (r^n P_n(\theta)) = -nr^{n-1} P_{n-1}(\theta)$$

are proved. The general proofs of these identities with those of two more of a similar nature form the subject of another paper.

The solution of the main problem is divided into six cases, and general expressions given in four of these, from which the component parallel to the axis at any point can be obtained with the help of Perry's tables of zonal harmonics. The expressions for the magnetic force in the two remaining cases can be easily written down from the previous discussion.

From the general formulæ the following special cases are derived:—

(1.) The magnetic force parallel to the axis at the centre of an infinitely long solenoid is  $4\pi Nj$  (the usual expression).

(2.) The magnetic force parallel to the axis is constant over the plane end of an infinitely long solenoid, and equal to  $2\pi Nj$ .

(3.) The magnetic force parallel to the axis at the centre of a very short shallow-wound solenoid is equal to  $\frac{2\pi j K}{T}$  (the expression adopted in the case of simple galvanometers).

Where  $N$  = number of turns per unit of length.

$j$  = current in C.G.S. units.

$K$  = total number of turns on the coil  
=  $2 l N$  where  $2l$  is the length.

$T$  = radius of the coil.

ART. XV.—*Upon a Common Vital Force.*

By COLEMAN PHILLIPS.

## SECTION IV.—OF THE HIGHER PHYSICAL AND SOCIAL LAWS.

[*Read before the Wellington Philosophical Society, 14th July, 1897.*]

OF the higher vital laws which govern humanity as well as this earth's fauna and flora, proving the existence of some guiding force common to all living things, I wish to refer to the following. These laws, upon investigation, will be found widely ruling, permanent, almost absolute, and far beyond any law we may place upon any of our statute-books. Indeed, I know of no human law so certain as any one of them. We all admit their essentiality, so that we rarely enact anything concerning them. They are, as it were, the common law of nature. Supposing we lost all our human laws, society would still be admirably held together under these higher vital laws. I supply members with those I have already searched into, but I propose to add others from time to time. My object in submitting these papers is simply to place the facts I have collected before members, and I trust, as a searcher after truth, independent of all previous authority, that I shall be allowed to submit these facts for subsequent deduction or induction and analysis.

*A.—Physical Laws.*

(1) The pairing of animals and birds, including matrimony; (2) the existence of measurement; (3) the law of heredity, modified by (4), that no two living things are exactly alike; (5) the law of beauty; (6) evening sunsets, furnishing daily models of art; (7) the law of harmony; (8) the warning signals of pain; (9) the law of natural selection; (10) the various powers of light (photography, &c.); (11) the prolific reproduction of species; (12) the law that females slightly exceed males in number; (13) progressive development and adaptation of species one to the other and to the condition of the planet; (14) the law of vibration; (15) the law of internal change and variation; (16) chemical action in all its wondrous phases.

*B.—Mental or Social Laws.*

(1) The reality of virtue; (2) the certainty of morality; (3) the necessity for worship of some kind; (4) the law of temperance—whether mental or physical (the passionate man and the drunkard being inferior); (5) the utility of misfortune as a

teacher of wisdom to the individual and the nation; (6) the beauty of moderation; (7) the great utility of experience; (8) the law of memory; (9) the absolute reality of goodness; (10) the absolute reality of love; (11) the blind affection of the mother for her young; (12) the absolute reality of courage, truth, friendship, pleasure, ambition, industry, honour, fame, reverence, sympathy, unselfishness, justice, mercy, and abstemiousness, &c., together with the existence of envy, sorrow, hate, revenge, superstition, cunning, bigotry, anger, cowardice, selfishness, despotism, injustice, &c.; (13) the innate knowledge that a luxurious life is harmful; (14) the repugnance to an idle life; (15) the great laws of independence and dependence; (16) the utility of mirth, fun, and laughter; (17) the doctrine of sudden inspiration; (18) the utility of contentment and discontent; (19) the mental birth of moral consciousness and responsibility; (20) the law that poverty is oftentimes a blessing; (21) the pleasure we feel in bestowing happiness upon others; (22) the sorrow we feel in having done wrong; (23) the law that surfeit always attends upon excess; (24) the great doctrine of our free will and free agency absolutely negating the human law of fate; (25) the law that the arrogance of the rich or powerful is always checked by the revolution or insolence of the poor; (26) the law of modesty—that a truly great man is usually governed by this law; (27) the law of genius.

Little need be said by me in explanation of this section of my subject. I shall be told that many of these laws are mere instincts and emotions. I have purposely written this section in order to give them a far higher place in nature's working. I have referred to law No. 2A in Art. lxxii., vol. xxvi., of our Transactions, p. 604, "Accuracy of Measurement in Spiders' Webs"); also in Art. xlv., vol. xxviii., of our Transactions, "On the Accuracy of Measurement in the Comb of the Hive Bee." I might now draw attention to the wonderful accuracy of measurement in crystallization; also in the seed-capsules of plants, notably that of the common sunflower; and the gradation of measurement in the seeds themselves contained in a capsule, say, 1 ft. in diameter.

As to law 5A: The sea-vapour ascending from the Caribbean Sea falls upon Mont Blanc in the most beautiful form of snow. There is apparently but little necessity for so much beauty of form in such a high region, but the great law rules inexorably; there cannot be order without beauty. So with the beauty of trees, plants, flowers, men, women, children, animals, birds, and insects. We all admit its rule wherever we see it. The beauty, too, of the young is often their greatest protection. Thus, the beauty and playfulness of the young lamb, kitten, or puppy appeals at once for protection from the

fiercer animals, even from the vilest specimen of the human race.

As to law 8A: We often have to thank the rule of pain for its danger-signals, in order to preserve our physical well-doing.

With regard to law 9A: I consider that far too much has been made of the law of natural selection, and I regard it only as one of the minor laws governing vital action.

As to law 17B: In section II. of this paper (Art. lxxii. of vol. xxvi., p. 609, "Discovery *v.* Invention,") I have given some instances of the dominance of this law. Science always names its discoveries as such, and not by the word "invention." Thus, the Davy lamp has always been called a discovery, as Sir H. Davy knew nothing whatever about mining. Pliny attributes the discovery of glass to a mere accident. The precision of modern astronomy dates from Galileo and the lamp; the law of gravitation from Newton and the accidental fall of the apple. The discovery of the royal purple dye had its origin in a shepherd's dog eating a snail. The reflecting apparatus used in our lighthouses, printers' rollers, chloroform, Gillott's steel pens, Professor Röntgen's *x*-rays, quicksilver, vulcanised indiarubber, Montgolfier's balloon, Kuffelar's scarlet colour, durable Staffordshire pottery-glaze, were each and all wholly or partly accidental discoveries. I think it only right to collect and record these instances, to show how much we discover, and what humble instruments nature uses to reveal to us the secrets she imparts for our good. M. Noebel has just left by his will a very large sum of money to reward what he specially names as the most important "discoveries" in certain branches of physical science. So, too, M. Hilaire de Chardennet ascribes his late most important discovery of the process of making silk from wood as a "sudden inspiration," and his glass worms are only imitations of the living silk-worms. The webs of spiders must be from cellulose too. In the South Sea Islands I have noticed the natives whipping the huge webs, stretching from tree to tree, on to a small triangle of wood, the addition of web upon web eventually making a cap of wonderful strength and lightness. All these accidental discoveries and "sudden inspirations" point unerringly to the existence of a sea of laws, which we name "natural laws," and to which it would be folly to close our eyes in blind devotion to any one of the laws that I have named.

With regard to law 10A, the properties of light: I would ask permission to submit to members, in order to place the matter on record, the natural picture-markings of a rabbit chased by a small dog, found upon the inside of an ordinary black wild rabbit's pelt, lent me for submission by Mr. W. H.

Frauks, of Carterton, Wairarapa. It is evidently a "mother marking"—a natural photograph, yet being a part process, as it were, of Professor Röntgen's *x*-rays. The same thing appears, I think, in the colour-markings of all young animals. Thus young calves are marked in numerous instances with their mothers' marks, owing to the rays of light being microscopically conveyed and imprinted upon the embryo or fœtus. I submit this matter as another simple explanation of the existence of a common vital force, seeing that there is hardly any difference in this picture and that of any ordinary camera-work. No doubt the doe rabbit, the mother of this little one, must have received a sudden fright, and, by an instantaneous photograph (the eyes acting as the lens of a camera), imprinted the scene upon the tender young skin. Can any person doubt that some vibratory path must exist within the animal's body by means of which such an admirable picture could be reduced and printed. The rays of light must travel by this path as through the lens of the camera. The force must be common to the rabbit and the camera. An inspection of the fur side of the pelt will show exactly the same picture on the fur, but of a slightly darker colour to the rest of the pelt. It is remarkable how true the picture has kept pace with the growth of the skin. The picture represents life and movement. This skin is to be deposited in the local museum at Carterton. I think a photograph might be taken of this natural photograph or a sketch made for our next volume.

In the case of young calves the markings are made more by the rays of light penetrating the whole body of the cow by means of the vibratory path I have mentioned, and then being reduced and conveyed upon the young calf. I own a Dutch-Friesian black-and-white cow, one of the breed I had the honour of introducing into the North Island of this colony about the year 1888. Her calves generally bear her own markings, so closely in one instance that it is difficult for a passer-by to distinguish the mother from the heifer. The white markings being under the mother's belly and on the hips, her own eyes could not possibly have acted as the lens of a camera; so that the markings must be carried *through* the body almost line for line, by means of what we now call the *x*-rays of light. The same colours are also used in the markings—namely, white and black. Another instance of this is a flash of lightning, or, rather, the electric fluid, killing a person, and imprinting upon the body a picture of the tree under which the victim took shelter, or a portion of, say, a steel chain which the victim wore.

To return to my rabbit-skin picture, I need hardly remind members of the first-recorded instance we possess of these

natural markings—namely, the early biblical one of the peeled hazel and poplar rods placed in the watering-troughs, to produce ring-straked, speckled, and spotted lambs. But I must say that in the scores of thousands of rabbit-skins which have passed through my hands I have never seen anything like the present skin.

In poultry so wonderfully are the parent-bird markings carried on through any particular species that the mind marvels at their being included feather by feather on the embryo within the egg. All the markings are there, too, before the chick is hatched out of the shell; at any rate, the greater portion of them. Some path must surely exist through which the rays of light act, the vital force preserving and conveying them microscopically upon the germ. It is, of course, not really beyond the grasp of our intellect when we consider that we have instruments now to investigate down to twenty-six thousand diameters. I think I am justified in saying that there are two distinct forces at work herein—namely, (1) the vibratory path carrying the picture-rays, which we may admit to be the subtle ether; and (2) the force to converge, reduce, and preserve the rays.

In trees, plants, fishes, and insects the same law rules, although I do not for one moment mean to say that sunlight is absolutely required to continue parent markings; but for brilliant or pronounced markings of any kind certainly sunlight or light of some kind is required. The young leaves in a rosebud are pink before the bud opens. That colour comes from, as it were, stored-up spectroscopic lines of a thousand generations of ancestors, and the colour consequently “runs with the plant” until artificially grafted or altered.

Shape, size, form, and measurement follow a somewhat similar law, except where absolutely broken by the use of a different host, or an absolute departure in form. But the return is then to the original parent markings. This subject, however, requires a special section to itself.

The mere reduplication of the parent form and markings, as in the case of the hundreds of acorns from the oak, or the thousands of seeds in the capsule of the poppy or sunflower, or the myriads of ova in the herring, is not one whit more remarkable than the multitude of cells and fibres in the human brain. The power of the vital force to subdivide and yet to vary is best shown by law 4A—that “no two things in nature are alike,” not even two herrings. So that although any two herrings carry on the colour-markings and form of their common parent, yet they are no more exactly like each other or their common parent than are any two human beings alike to each other or to their parent. There is no limit to subdivision, nor do I see any more difficulty in subdivision than



our being able to take a hundred photographs in a second with our revolving cameras. We can also reduce a large-sized animal to a photograph not larger in size than a pin's head. What we can do with our rough instruments surely nature can do a million times better.

As to sex-markings, in the herring-ova there is not much difference in colour-markings for sex; but in game and poultry there is a vast difference, the male bird being generally far more handsome than the female. Law No. 9A, as explained to us, absolutely fails to account for the female wild-duck retaining for thousands of generations its dun colour, as opposed to the more brilliant male markings. I might point out the solution of this matter partly from my rabbit-skin and the existence of the force I have mentioned. The eye of the female is quite capable of acting as a lens, and storing up the male markings on the embryo, nature always continuing the female marking by the action of light itself printing those colours *through* the body of the female, law No. 1A keeping the colours true. For this reason fowl-fanciers should never allow their prize fowls to see other breeds than themselves, and, if possible, the male and female birds should be closely paired off. In a barn-yard the great diversity in colour arises from the law I am pointing out acting blindly and mixing up the parent markings. Such is a simple explanation of the difference in sex-markings. But if any person will read Alfred R. Wallace's "*Tropical Nature*," and his chapter upon "*The Colours of Animals and Sexual Selection*," he will be surprised at the weakness of the arguments that writer adduces in order to bring this most difficult subject under law No. 9A—to be solely and entirely governed by that law (natural selection). He points out, too, that Darwin, in his "*Descent of Man*," arrived at the conclusion "that diversity of colour in the sexes is due primarily to the transmission of colour variations either to one sex only or to both sexes, the difference depending on some unknown law, and not being due to natural selection." I have always said that a different conclusion from their theory of natural selection might be drawn from every page of Darwin's writings; but that great writer is usually modest, and readily admits the failure of his theory when it does not fit in. Wallace, on the contrary, utterly condemns Darwin's modest remark on this point, and proceeds to write page after page of the most inconclusive argument and illustration in order to show that the law of natural selection must apply in the transmission of sexual colour. I do not think the law has anything to do with it. It may indeed be that the male ovum has within it a stored-up picture of the male, with every colour complete. Darwin himself admits that it does not apply, but says that it is

ruled rather by some unknown law. I hope that the facts I am laying before members point to that unknown law—viz., the lately-discovered penetrating properties of light, acting in conjunction with the common vital force.

We cannot say anything for certain upon the point whether the male ovum has within itself a stored-up picture of the male. Our microscopes tell us there is little appreciable difference between the ovum that fertilises female birds to those which fertilise the females in the other natural kingdoms. Yet, from the same-looking seed is produced a bird or an animal true to parent markings; the male after his kind, the female after hers. Law No. 9A cannot possibly have anything whatever to do with this one stupendous unity of organization—namely, that the fertilisation of bird, reptile, fish, animal, and human being all take their origin from a similar-looking seed egg; so that it follows that natural selection cannot be the *origin* of species. Everything comes *ab ovo*. So too in skulls: all skulls are much alike, from the skull of a man to the skull of a pike. Between these two far-reaching unities in organization alone (from spermatozoa to the skull) law No. 9A plays but a minor part.

Laws 11A and 12A amongst humanity appear to be limited to a birth-rate for the whole planet of seventy a minute, and a death-rate of sixty-six, giving a nett increase of 2,200,000 souls each year, the females, to preserve the species, being slightly in excess of the males. In sheep the ewe hoggets are always more hardy than the male hoggets, it being easy to rear three ewes in the open all the winter where two males would only just get along. And to assure the minds of sheep-farmers in lambing and docking time, and their having to count a great number of tails, I might mention that the number of female lambs in a large flock is usually 5 per cent. greater than the number of male lambs during, say, a period of five seasons or more.

I should like now, before concluding this section, to add a few words to the work of the beaver in dam-building (see Art. lxxii., vol. xxvi., p. 607, of our Transactions), and to ask the assistance of any Canadian observer in explaining the matter. A beaver's hut consists of two rooms, one almost above and one quite beneath the water. The upper room has a shelf just above the water-line running round the inside, sufficiently large to contain three or four beds. As these huts are built before the dam is closed, it is clear that the animal, when building the shelf, forms a previous estimate of the height the water will rise on the dam-wall. I doubt, too, whether we have paid sufficient attention to the manner in which these animals fell and cut up trees, and how exactly equal and common is this knowledge to our bushmen and to

the beaver. With its long front chisel teeth the beaver puts in an all-round scarf in the trunk of the tree, just as any bushman with his axe would do. "Then the beaver stops a little and looks at the tree, to find out in which direction it is going to fall. After making up its mind, it goes to the opposite side of the tree, so as to be out of the way, puts in two or three deep bites, and down comes the tree." Now, as the bushman and the beaver act almost similarly in this matter, I think I am justified in pointing to the common nature of the ruling law.

Generally the laws I have set out in this section have a far wider ruling than in human emotions or human action. Some of them will be found to hold almost exactly equal sway in the hives of bees, colonies of ants, among spiders, wasps, and other insects and animals.

As to law 27B (genius), there is a case in Wellington at the present moment of a child born so weak that it had to be reared on a pillow, and to receive its nourishment partly through its body. It was too feeble to suckle. But at eight years of age that child is one of those marvellous musical geniuses we sometimes hear of, and can play exceedingly difficult music long before its little hands can span the octave. Again, in the Wairarapa I know of babies born with such weak digestions that it is exceedingly difficult to get them to take any food without the use of lime-water and pepsine. And yet the vital laws pull those babies through their infancy, and turn them out strong men and women. In this these laws are far superior to the one law of which so much has been, in my opinion, quite mistakenly made, "let the strongest live and the weakest die," commonly known as "the survival of the fittest." Here we see the very weakest infant a marvel of genius. Its weak body is endowed with a brain so closely in touch with the laws of harmony and vibration that unknowingly to itself it produces musical chords and arrangements that surprise us. There is also the case of the young Handel, at the age of four, surprising his parents and friends. And so with the many calculating boys we read of. We call such things mere eccentricities; but to my mind these eccentricities reveal very clearly the existence of the great governing laws I have mentioned. There is the case of one calculating boy who did the most astonishing sums in arithmetic, but who could never explain how he did them; and as he grew older he lost the power of doing them. We ourselves know little yet of the power of the numerals. We can but gaze in wonder, and marvel at the power, say, of the figures 9, 10, or 12. "The survival of the fittest," from what I have said, is therefore anything but a general governing law. I have not, as yet, included it in my list of laws, as I am doubtful whether it

rules at all in nature's working so widely as is claimed for it, the other laws above mentioned really doing its work. I think, therefore, members will forgive me for trying in this section of my subject to raise scientific research into the domain of the above laws as a whole, and not to fit nature's working into any one minor law. In chemistry we experiment and discover most curious and startling combinations. Surely we ought to admit the rule of pre-existing laws governing those combinations. And if we admit this in chemistry, surely we ought also to admit the ever-present attendance of the other equally important laws above-named governing vital action. Those laws are always with us, governing us, in every direction; and in so far as they show themselves equally in entirely different genera and species, so ought we to consider them common vital laws.

---

ART. XVI.—*On Maori Stone Implements.*

By Captain HUTTON, F.R.S.

[*Substance of an Address to the Philosophical Institute of Canterbury on the 4th August, 1897.*]

Plate XIII.

I do not wish you to think for a moment that I am an adept in Maori lore. To be a Maori expert it is necessary to have lived among the Maoris in the North Island, where alone a knowledge of their manners and customs can be obtained. There is, however, one small portion of Maori art which can be better studied in the South than in the North Island, and that is the manufacture of stone implements. Stone implements are far more abundant here than in the North; and while many stone-implement manufactories have been discovered in Nelson, Canterbury, and Otago, I have never heard of any in the North Island. This is no doubt due to the greater variety of suitable stones found in our mountains, especially in the District of Nelson, where also they occur near the sea.

I am also favoured by the fact that our Museum contains an admirable collection from the kitchen-middens and caves of the South Island illustrative of all the processes of manufacture, as well as samples of the finished implements from Mongonui, in the north, to Stewart Island, in the south; and it is from this collection that I have selected a few specimens to illustrate this address.

## THE STONES USED.

Knives and scrapers were made from hard fine-grained stones, such as chert, quartzite, chalcedony, and obsidian. Flint was occasionally used, but they are rare in New Zealand. Net-sinkers and pestles were made out of soft volcanic rocks, such as andesite and trachyte; while for adzes and *meres* any compact, hard, and tough rock was used. The commonest were igneous rocks, such as basalt, dolerite, and aphanite; but many of the rocks are metamorphic, such as hornstone and cherty-slate. Greenstone also comes under this head. Of it there are two varieties—(1) Nephrite, or pounamu, which is a silicate of magnesia and lime; and (2) bowenite, or tangiwai, which is a silicate of magnesia only, but contains a small quantity of water. Bowenite is softer than nephrite, and can be scratched with the point of a knife.

## HOW STONE IMPLEMENTS WERE MADE.

Our knowledge of how the Maoris made their stone implements rests partly on eye-witnesses—for up to quite a late date greenstone was worked by the natives—partly on information derived from old Maoris, who recognised the tools when shown them and described how they were used, and partly on inferences drawn from an examination of the implements themselves. It appears that four different processes—flaking, battering, grinding, and cutting—were employed, either singly or in combination, in making stone implements, all of which were also used in Europe during the Neolithic age.

*Flaking*, or chipping, means the knocking-off of thin flakes of considerable size. There were two objects in flaking—one when the flakes were intended for use, while the core or nucleus from which the flakes had been chipped was generally thrown away; and the other when the core itself had to be chipped into an axe or adze, and the flakes were not intended to be used. Flakes were knocked off with hammerstones, which were not large, but of such a size as could be easily held in the hand. A tough stone was selected, the green gabbro, found near Nelson, being, as Mr. Lukins informs me, one that was much prized by the Maoris for this purpose. Cores also were often used for hammers. The large flakes often show the mark of the blow which separated them from the core, but the smaller ones rarely do so; indeed, it would be impossible with a stone-hammer to trim up the axes in the way that many of them have been done. This trimming process was accomplished by means of flaking-tools or fabricators, long, narrow, and blunt at each end, which were used as punches, probably being held in the hand and struck with a piece of wood.

*Battering*, or picking, is breaking down or pulverising the stone by means of numerous slight blows of a hammer. The hammers used seem to have been elongated rounded pebbles, with rather a pointed end. This process was chiefly used on the coarser-grained rocks, such as diorite and quartzite, which did not flake well; but we often see marks of both flaking and battering on the same implement. Sometimes large blocks of greenstone, after they had been split, were divided by battering, as in the exhibited specimen which was found on the beach at Wainui, in Golden Bay. It shows two adzes roughly marked out by a groove on each side of the slab, and these grooves have evidently been formed by battering with small hammers.

*Grinding*.—The implements, after having been flaked or bruised, were ground smooth on pieces of sandstone or quartzite called "ho-anga." These rubbing-stones were generally large, 12 in. or more across; but disc-shaped stones, hollowed in the centre, are commonly found in old encampments. They are about 4 in. in diameter, and have evidently been used as rubbers, probably for making net-sinkers. Sharpening-stones are long, narrow, and either rectangular or oval in section. They were no doubt used for sharpening axes and chisels.

*Cutting*, or sawing, was done by a blunt stone instrument called "mania," either fastened into a piece of stick or held in the hand, and used either with or without fine wet sand. The stone to be cut was first ground down to its proper thickness, a deep cut was made on each side, and the implement was then broken out along the thin place. This method was usually employed for nephrite implements only, but the Museum possesses two pieces of basalt in the process of being cut. There are in the collection cutting-implements made of obsidian, nephrite, and sandstone, all of which have been worn, as well as a chert-cutter, mounted in a wooden handle, which was made by a Maori for Sir Julius von Haast.

#### WHAT STONE IMPLEMENTS WERE USED FOR.

The principal use of stone implements was working wood. Flakes were used for making holes, for sharpening the points of fish-spears, and as saws in wood-carving. The perforators or drills were sometimes simple flakes that happened to have a sharp point, but most of them have been subsequently trimmed. These have been mistaken for spear-heads\*, or arrow-heads.† For sharpening spears a hollow was knocked out on one side, making what are called "notched" or "hol-

\* Trans. N.Z. Inst., vol. xii., p. 152.

† Trans. N.Z. Inst., vol. xiii., p. 436.

lowed" flakes. The saws are serrated by blows generally delivered on one side only, and the Maori never attained to such a high state of art as the neolithic European. These saws were probably used for cutting bone as well as wood. Rubbers of sandstone and pumice were used for smoothing down the marks of the adze. Polishers of fine-grained hard stone were used for burnishing spears and other wooden weapons. They are long in shape, and either circular or semi-circular in section. Wood-carvers are flakes ground to a sharp edge. Chisels were also used for carving; they are long in shape, and with a sharp-ground edge. The small nephrite chisels were mounted in a straight handle, and used with a wooden mallet.

The most important implements are those called axes or adzes, but all of them were hafted as adzes. Most of the so-called axes are elliptical, with flat sides, in section, but some are simply elliptical, and a good many are rectangular in transverse section; none are meniscoid or lens-shaped in cross-section, such as commonly occurs in Melanesian stone adzes. The smaller axes are called *panahe*, the moderate-sized ones *toki*, and the larger ones *kapu*. It is these that the Europeans generally call adzes. They are straight or curved longitudinally, and often have a kind of handle worked on them by battering, for the lashing. Three different kinds may be distinguished: (1) Broad adzes, which are rectangular in cross-section, broader than thick, and the cutting-edge long and straight; (2) narrow adzes, which are triangular in section, thicker than broad, and the cutting-edge less than the thickness; (3) curved adzes, which are generally round in cross-section, or round with flat sides, and the cutting-edge is curved like a gouge. The second kind of adze is an essentially Maori production, but the third somewhat resembles adzes from the Solomon Islands. Wedges were used for splitting wood. No doubt the *tokis* were often so used, but some of them, with flat butts and the edge equally ground on both sides, may be safely distinguished as wedges.

*Hammers*.—Probably pieces of wood were generally used, but there is in the Museum an implement on which a handle for lashing has been worked, but the opposite end has been ground flat. It was found with a Maori skeleton in the sand-hills on the Sumner Road.

The stone implements used in warfare were the *mere* and the *patu*, both of which are well known. They are distinguished by having a small hole through the handle end. This hole was formed by a drill armed with a quartz crystal, and the process has been described by Mr. F. Chapman.\* The

\* Trans. N.Z. Inst., vol. xxiv., p. 497, &c.

flax which was intended to form the mats called *kotowai* was prepared by pounding with short thick stone pestles, while a long narrow stone pestle was used for pounding hinau-berries in a wooden mortar. Scrapers for cleaning kumaras and knives for cutting flax, large fish, &c., were simple flakes, not trimmed in any way. Obsidian flakes were used for cutting their own flesh when mourning, and also for cutting the hair. For the latter process another stone was necessary to cut against; these are either cylindrical or flat. Stone sinkers were used for nets, and occasionally pumice was employed for floats. Canoe-anchors were large stones, with a groove round them for the rope.

---

## EXPLANATION OF PLATE XIII.

1. Hammer-stone, from Nelson.
  2. Flaking-tool, from Purakanui, Otago.
  3. Hollow scraper for sharpening eel-spears, Nelson.
  4. Borer for wood, from the mouth of the Rakaia, Canterbury.
  5. Saw for cutting bone and wood, from the mouth of the Rakaia, Canterbury.
  6. Sharpening-stone for axes, from Nelson.
- All the figures are reduced about one-half.



## II.—ZOOLOGY.

---

ART. XVII.—*The Grasshoppers and Locusts of New Zealand and the Kermadec Islands.*

By Captain F. W. HUTTON, F.R.S., Curator of the  
Canterbury Museum, Christchurch.

[Read before the Philosophical Institute of Canterbury, 1st September,  
1897.]

Plate XIV.

No part of the insect fauna of New Zealand has been more neglected than the grasshoppers. Up to 1881 only four species had been described, and two of these are, I believe, identical. In 1884 H. de Saussure added another to the list, and there it has remained up to the present time.

Thirty years ago, when I came to New Zealand, the *Acrididæ* were in myriads all over the open country, but now they require looking for in almost all the cultivated districts where introduced birds are common, while in the neighbourhood of the large towns they are practically extinct; and, if any record is to be made of them before they vanish, it is quite time that some one should take it in hand. For our grasshoppers do not take to the introduced plants, and they avoid cultivated fields, but keep almost entirely to the native vegetation, on land that has not been disturbed by the plough. During the last seven years I have obtained as many specimens as I could from all parts of New Zealand. My own opportunities for collecting are now very few, and I have had to trust largely to others; especially I have to thank Mr. G. V. Hudson for sending me several very interesting insects from the Districts of Nelson, Marlborough, and Wellington, and Mr. Herbert Clarke for presenting his collection of *Orthoptera* to the Museum.

In the present paper twelve species are added to the list, thus bringing the total number up to sixteen; and I have also included the single species which has been described from the Kermadec Islands, for these now form part of New Zealand.

It is a remarkable fact that there are no grasshoppers in the Chatham Islands. Mr. Fougère informs me that about twelve years ago he saw one of a smoky-brown colour and

able to fly: probably it was a specimen of *Pachytylus migratoroides*.

I do not feel certain that I have correctly determined Brunner's genera *Phaulacridium* and *Trigoniza*, for not only has he neither described nor indicated any species belonging to them, but he has never even given full generic descriptions. However, I think it better to use these names provisionally than to make new ones.

### Group LOCUSTODEA.

Tarsi four-jointed; antennæ long and setaceous; ovipositor of the female generally elongated.

### Family LOCUSTIDÆ.

Tarsi depressed; anterior tibiæ with auditory pits.

#### KEY TO THE NEW ZEALAND GENERA.

Fastigium narrow, low, divided by a transverse groove ..	<i>Cædicia</i> .
Fastigium broad, rounded, ascending .. ..	<i>Xiphidium</i> .
Fastigium forming a spine between the antennæ ..	<i>Agræcia</i> .

### Sub-family PHANEROPTERINÆ.

First and second joints of the tarsi rounded on the sides.

#### Genus CÆDICIA, Stål. (1874.)

Fastigium of the vertex more or less separated from the frontal costa. Pronotum flat above. Fore coxæ spined; knee-lobes of the femora bidentate; anterior tibiæ with both auditory pits open. Subgenital plate of the male large, bilobed, the cerci long and incurved. Ovipositor of the female short, compressed, curved upwards.

*Distribution*.—Australia, Amboina, Tongatabu, and West Africa.

#### *Cædicia olivacea*.

*Cædicia olivacea*, Brunner, Mon. der Phaneropteriden, p. 193 (1878). *Xiphidium maoricum*, Hudson, Man. Entomology of N.Z., p. 114, pl. xvii., fig. 1 (1892), not of Walker.

Green when alive, generally turning brown when dry. Disc of the pronotum with parallel sides, its side lobes rounded, deepest in the middle. Anterior radial vein of the elytra branched a little before the middle. Lobes of the meso- and meta-sterna triangular. Hind femora armed below with six small spines on the inner margin and seven or eight on the outer. Fore tibiæ sulcate above, armed below with five spines on the outer (anterior) margin and three on the inner (posterior) margin, in addition to the apical spines; unarmed above. Middle tibiæ armed below with eight or nine spines on the outer (anterior) and six on the inner (posterior) margin; above with one spine behind the middle. Subgenital plate in the female rounded, emarginate.

Length of the body, 19–20 mm.; of the pronotum, 5–6 mm.; of the elytra, ♂ 33 mm., ♀ 26 mm.; of the hind femora, 18–19 mm.; of the ovipositor, 3 mm. Greatest breadth of the elytron, 7·5 mm.

*Localities.*—Auckland and Nelson. Found also in New South Wales and Queensland.

In our insects the elytra are narrow, as in *C. porrecta*, while the lobes of the pronotum and the ovipositor resemble those of *C. olivacea*; nevertheless, I think it has been introduced into New Zealand, for, although it is a very conspicuous species, none of the earlier collectors sent specimens to the British Museum. Probably it was introduced into Nelson in the early days of the gold-diggings, and taken from there to Auckland.

#### Sub-family CONOCEPHALINÆ.

Fastigium free, prominent; fore tibiæ not grooved on the sides; first and second joints of the tarsi grooved on the sides.

Genus XIPHIDIUM, Serville. (1839.)

Head rather large, the fastigium forming a rounded elevation between the antennæ. Pronotum short. Fore and middle tibiæ very finely spinulose, the hind tibiæ with two rows of fine spines above; auditory pits rimate. Elytra narrow, rounded at the tip, sometimes rudimentary. Sub-anal plate in the male large and forked, in the female convex and pointed. Ovipositor long, nearly straight.

*Distribution.*—Widely spread in both hemispheres.

#### *Xiphidium semivittatum.*

*Decticus semivittatus*, Walker, Cat. Dermap. Salt. in Brit. Mus., ii., p. 263 (1869). *Xiphidium maoricum*, Walker, l.c., p. 276 (1869); not Hudson, Man. Ent. of N.Z. *Xiphidium antipodum*, Scudder, Pro. Bost. Soc. of Nat. Hist., xvii., p. 460 (1875). (?) *Xiphidium vittatum*, Redtenbacher (part), Verh. zool.-bot. Gesell., Wien., 1891, p. 513. *Xiphidium geniculare*, Redtenbacher, l.c., p. 527.

Green when alive, brown when dry; a broad reddish-brown median stripe, bordered with pale-yellow, on the vertex. This stripe is sometimes continued on to the pronotum, but more often it divides into two, which pass along each side of the pronotum, and are generally continued as interrupted bands on the sides of the abdomen. Fastigium broad, the lateral margins distinctly diverging. Pronotum with a faint medio-dorsal impressed line. Prosternum with two spines. Elytra and wings generally developed in the male, rudimentary in the female, the elytra with a dark-brown costal stripe. Hind femur fuscous at the apex; the

knee-lobes, on both sides, bidentate; armed below on the outer margin with four or five minute and distant spines. Fore and middle tibiæ with five spines below, on each side, in addition to the apical spines. Subgenital lamina of the male truncated, that of the female emarginate. Ovipositor slender, as long as the abdomen.

Length of the body, ♂ 14–17 mm., ♀ 15–19 mm.; of the pronotum, ♂ 3–3.5 mm., ♀ 3.5–4 mm.; of the elytra, ♂ 21 mm., ♀ 4 mm.; of the hind femur, ♂ 17 mm., ♀ 14–17 mm.; of the ovipositor, 11–12 mm.

*Localities*.—Auckland, Lower Waikato, and Taranaki districts. Perhaps identical with *X. bilineatum*, Erichson (1842), from Tasmania.

The elytra of the male reach far beyond the end of the abdomen, and the wings are still longer. I have seen no female with well-developed wings, but Walker describes one under the name of *X. maoricum*. The first joint of the hind tarsi have no lateral appendages, and Walker was therefore wrong in putting this species into *Decticus*. Redtenbacher gives Aru Island and New Zealand as the localities for his *X. vittatum*, and Moluccas and New Zealand as the localities for his *X. geniculare*, which, except in colour and length of elytra, seems to be identical with *vittatum*. I think that there is only one species in New Zealand, and suspect that there are some errors in his localities.

#### Genus AGRÆCIA, Serville. (1839.)

Head large, face oblique; fastigium forming a spine between the antennæ. Disc of the pronotum flat, feebly keeled laterally. Prosternum with two spines. Elytra linear, rather longer than the wings; first radial vein forked beyond the middle, its two branches also forked; second radial with one fork. All the femora and tibiæ with many small spines; the posterior tibiæ keeled above and with strong spines. Auditory pits oval. Ovipositor shorter than the abdomen, compressed, strongly curved upwards.

*Distribution*.—Widely spread in both hemispheres.

**Agræcia solida**, Walker, Cat. Derm. Salt. in Brit. Mus., part ii., p. 295 (1869).

*Male*: Testaceous, stout, nearly cylindrical. Head and prothorax thinly punctured. Head hardly broader than the prothorax; an acute spine between the eyes; front scabrous, piceous; face and labrum black; face pale, testaceous towards the tip. Eyes very prominent. Palpi pale, testaceous; fourth joint of the maxillary palpi much shorter than the third; fifth subclavate, truncate, much longer than the third. Antennæ about twice the length of the body. Prothorax

with two slight curved transverse furrows; hind border slightly elongated, much rounded. Prosternum, mesosternum, and metasternum with a black curved band on each. Prosternum with two spines. Apical appendages of the abdomen consisting of two short obtuse teeth above, of two slender obtuse slightly-curved spines beneath, and with two intermediate thick obtuse slightly-curved spines. Legs stout; fore coxæ with one spine; femora and tibiæ with small black-tipped spines; fore femora with five spines on the outer side and with six on the inner side; middle femora with six spines on the outer side and with two on the inner side; hind femora with a single row of ten spines; fore tibiæ with six spines on each side; middle tibiæ with ten spines on the outer side and with fewer on the inner side; hind tibiæ with four rows of spines, two with twelve or thirteen spines each and two with six or seven. Wings not extending beyond the abdomen. Fore-wings irregularly and very thickly reticulated, unspotted; costa much rounded, except towards the tip. Hind-wings pellucid; veins pale testaceous. *Female*: Ovipositor piceous, curved, much shorter than the abdomen. Length of the body, 57–63 mm.; of the wings, 88–105 mm. (Walker).

Sunday Island, Kermadec.

I have seen no specimen of this species.

#### Group ACRIDIODEA.

Tarsi three-jointed, those of the hind legs like the others. Antennæ shorter than the length of the body. Auditory organs (tympana) situated on the sides of the first abdominal segment. Female without an elongated ovipositor.

#### Family ACRIDIDÆ.

Prosternum armed with a strong blunt spine. Pronotum generally punctate or rugose, the three transverse sulci usually continuous over the dorsum, the lateral lobes longer than deep, the posterior lateral angles obtuse.

The Maori name for these insects is "mawitiwiti."

#### KEY TO THE NEW ZEALAND GENERA.

- |    |                           |  |                           |
|----|---------------------------|--|---------------------------|
| a. | Pronotum rounded above    | .. .. .  | <i>Pezotettix</i> .       |
| b. | Pronotum flattened above. |  |                           |
|    | a <sup>1</sup> .          | External margin of hind tibia with nine or ten spines.         |                           |
|    | a <sup>2</sup> .          | Hind femora without an apical tooth                            | .. <i>Sigaus</i> .        |
|    | b <sup>2</sup> .          | Hind femora with a small apical tooth above                    | .. <i>Phaulacridium</i> . |
|    | b <sup>1</sup> .          | External margins of hind tibia with eight spines.              |                           |
|    | c <sup>2</sup> .          | Vertex deflexed, fastigium passing into the frontal costa      | .. <i>Paprides</i> .      |
|    | d <sup>2</sup> .          | Vertex not deflexed, fastigium distinct from the frontal costa | .. <i>Trigoniza</i> .     |

## Genus SIGAUS, genus novum.

Head with the fastigium very slightly deflexed, the margins raised and confluent at the apex; face oblique; frontal costa rather narrow, slightly grooved, with parallel sides, indistinct on the lower part of the face; cheek carinæ slightly developed, straight. Antennæ longer than the head and pronotum, flattened, slightly clavate; composed of 24 joints, of which the second is much shorter than the first, the fourth joint the shortest; from the 11th to the 17th they are rather longer than broad, the rest are broader than long. Antennal fossæ very deep. Pronotum flat above, expanding posteriorly, the two anterior transverse sulci obliterated on the back; the posterior sulcus slightly sinuated, bending backward from the median carina, and then forward to the lateral carinæ. Prosternal spine rounded, blunt at the point. Lobes of the metasternum in the female nearly as wide apart as those of the mesosternum, the space between the last broader than long, its sides rather diverging and rounded. Elytra and wings rudimentary, widely separated. Posterior femora passing slightly the end of the abdomen, unarmed at the apex; knee-lobes rather pointed, but not acute. Posterior tibiæ above with nine spines in each row, in addition to the two apical pairs; the apical spines rather short, those of each pair equal. Second joint of the hind tarsi short. Subgenital plate in the female not keeled, obscurely toothed at the end. Male unknown.

*Distribution*.—New Zealand only, so far as is at present known.

**Sigaüs piliferus.** Plate XIV, figs. 1a–1d.

Ochraceous, the hind legs yellowish; a narrow dark band from the eye along the pronotum, just under the lateral carina; inner surfaces of the hind femora marked with black. Vertex rugose, with a distinct median carina. Pronotum rugose, the posterior margin truncated and sinuated, the median carina very slight. Elytra reaching the middle of the second abdominal segment. Hind tibiæ very hairy.

Length of body, 33 mm.; of pronotum, 8 mm.; of hind femur, 20 mm.

*Locality*.—Auckland.

A single female specimen, sent me by Captain Broun.

## Genus PHAULACRIDUM, Brunner. (1891.)

*Praxilla*, Stål. (1878); not of Reichenbach (1853), nor of Malgrem (1865).

Head with the fastigium flattish, slightly deflexed, the margins raised and confluent at the apex; face slightly oblique in the female, more so in the male; the cheek carinæ distinct; frontal costa grooved, continued almost to the

clypeal suture. Antennæ slender, not much flattened, 22-jointed, the third joint longer than the second, the fourth the shortest; from the sixth to the end they are longer than broad. Pronotum nearly smooth, expanding posteriorly, median and lateral carinæ distinct but not strong, all three transverse grooves continuous over the back, the anterior margin straight, the posterior margin rounded. Prosternal tubercle transverse, rapidly tapering to a blunt point, rather short. Lobes of the metasternum closer together than those of the mesosternum (especially in the male), the space between the latter broader than long, and with its sides nearly parallel. Elytra and wings usually rudimentary (in the New Zealand species), but the inner edges of the elytra always touch near their apices; wings (when present) with the areole quadrate, or longer than broad. Hind femora passing the end of the abdomen, their apices armed above with a small tooth; the knee-lobes blunt. Posterior tibiæ with two pairs of apical spurs, of which the inner pair is longer than the outer pair, their external margin with nine or ten (rarely eight) spines in addition to those of the apex. Second joint of the posterior tarsi short. Subgenital plate of the male swollen, rather broader than the abdomen; the supra-anal plate triangular and acute. Subgenital plate of the female keeled, its posterior margin with three teeth, the keel not reaching the median tooth; supra-anal plate triangular, the apex forming a right angle.

*Distribution*.—Australia, New Zealand, and Lord Howe's Island. Of 218 specimens captured in South Canterbury last April only two had the elytra and wings developed, but I do not know whether this proportion always holds good; it may vary with hot and cold seasons.

#### KEY TO THE SPECIES.

A broad pale band on each side of the pronotum	..	<i>P. marginale</i> .
No broad pale band on each side of the pronotum	..	<i>P. luteum</i> .

**Phaulacridium marginale.** Plate XIV., figs. 2a-2d.

*Caloptenus marginalis*, Walker, Cat. Dermap. Salt. in Brit. Mus., part iv., p. 710 (1870); Hutton, Cat. Orthoptera of N.Z., p. 92, Wellington, 1881.

Varying from fuscous to yellowish-brown or greenish, paler below. A broad pale-yellow band passes along each of the lateral keels of the pronotum backwards on to the elytra and forwards on to the head as far as the eyes, by which they are interrupted, but appear again on each side of the vertex and unite at its apex; occasionally they may be traced on the upper part of the eyes. On the pronotum these yellow streaks are bordered on both sides with velvety black (except in var.  $\beta$ ). Abdomen usually with a broad dark-brown band on each side. Hind femora rather longer than the abdomen in

the female, considerably longer in the male; generally with two angular transverse black spots above, one near the base the other before the middle, sometimes with a yellow longitudinal band along the upper outer keel. Hind tibiae usually bright-red, sometimes fulvous or olivaceous. Pronotum with the prescutum about as long as broad, the post-scutellum about equal to the three anterior parts, its length generally equal to its greatest breadth. Elytra almost always rudimentary, reaching to the fifth abdominal segment; the wings not reaching the third segment.

Length of body, ♂ 12–13 mm., ♀ 14–16 mm.; of pronotum, ♂ 3 mm., ♀ 4 mm.; of hind femur, ♂ 8 mm., ♀ 10 mm.; elytron, when fully developed, 16 mm.

Var. *β*. The inner black bands on the pronotum absent.

*Localities*. — Throughout New Zealand; abundant in places.

The females are about twice as numerous as the males. I have a single winged female from Otago. The discoidal area of the elytron is pale-brown with a few short darker transverse streaks; the marginal and axillary areas are transparent. The humeral vein divides into two equally strong branches, of which the upper is simple and the lower is once forked.

***Phaulacridium luteum*.** Plate XIV., fig. 3.

*Caloptenus marginalis*, Hudson, Man. Entomol. of N.Z., p. 116, pl. xvii., fig. 4, not of Walker.

Reddish or yellowish brown, occasionally olivaceous green, obscurely marbled with fuscous; usually without any longitudinal bands on the pronotum. Hind femora rather longer than the abdomen in the female, considerably longer in the male, sometimes with two black angular spots above, as in the last species. Hind tibiae usually bright-red, sometimes olivaceous. Pronotum with the prescutum generally broader than long in the female; length of the post-scutellum less than its greatest breadth. Elytra and wings usually rudimentary, reaching to the fourth abdominal segment.

Length of body, ♂ 13–15 mm., ♀ 15–17 mm.; of pronotum, ♂ 3 mm., ♀ 4 mm.; of hind femur, ♂ 8–10 mm., ♀ 10–11 mm.; elytron, when fully developed, 10 mm.

Var. *β*. Pronotum with a black velvety band on each side of the anterior lobe, just below the lateral keels; lateral keels occasionally pale.

*Localities*. — Throughout New Zealand; abundant in places.

I have not seen any specimens of the var. *β* from north of Lake Taupo. The females are about twice as numerous as the males. I have a typical winged female from South Canterbury, and three winged females belonging to var. *β*, two of which are from Wellington and one from South Canterbury.



In all the whole of the elytron is dark-brown. In the type the humeral vein splits into three equally strong branches, of which the anterior is simple, the intermediate singly forked, and the posterior is simple on the left side and doubly forked on the right side. In var.  $\beta$  the specimens from Wellington also have the humeral vein divided into three equally strong branches, of which the anterior is simple, the intermediate is doubly forked, and the posterior is singly forked on the left side and simple or once forked on the right side. In the specimen from South Canterbury the humeral vein divides into only two equally strong branches, of which the anterior is simple and the posterior (=intermediate) is once forked. The venation, therefore, is variable.

It is only after some hesitation that I have determined to make this form into a distinct species. My reason for doing so is that the connecting-links between the two forms are comparatively few in number. Of 190 individuals now before me, sixty belong to the typical *marginale*, and thirteen to *marginale*, var.  $\beta$ . No less than eighty-six belong to the typical *luteum*, and twenty-eight to *luteum*, var.  $\beta$ , leaving only three individuals which might be considered as intermediate, and all these three approach more nearly to *luteum*, var.  $\beta$ , than to *marginale*, var.  $\beta$ . It seemed to me, therefore, that to make the form *luteum* into a variety of *marginale* would either obscure the relations between them by omitting to indicate the intermediate forms or else I should have to make the intermediate forms into sub-varieties, which would have been a cumbrous and inconvenient device.

Genus PEZOTETTIX, Burmeister. (1840.)

Head with the fastigium deflexed, its margins slightly raised, and passing into those of the frontal costa, which is more or less grooved. Face slightly oblique in both sexes. Antennæ thick and rather flattened, 23-jointed, the joints at the distal end indistinct, the fourth shortest, the third as short or shorter than the second; from the fourth to the seventh broader than long. Pronotum rather short and scarcely expanding posteriorly, rounded on the dorsum, the lateral keels absent and the median one but slightly developed; all three transverse; sulci continuous over the dorsum; front margin truncated, the posterior margin slightly produced and emarginate. Prosternal tubercle large, transverse at the base, rounded at the tip. Metasternal lobes nearly as far apart as those of the mesosternum in the female, but nearer together in the male; space between the mesosternal lobes slightly transverse, and with its sides nearly parallel. Elytra rudimentary, widely separated on the back; wings absent. Hind femora barely passing the tip of the abdomen, their apices armed above with a small tooth; the knee-lobes short and

rounded. Posterior tibiæ with two pairs of apical spines, of which the inner pair are considerably longer than the outer pair; their external margins with seven or eight spines in addition to the apical pair. Second joint of the hind tarsi short. Subgenital plate of the male not swollen, narrower than the abdomen; that of the female not keeled.

*Distribution*.—Widely distributed in both hemispheres.

The foregoing generic characters are drawn up from New Zealand specimens, for I am by no means sure that they really belong to *Pezotettix*. On the other hand, in the absence of northern specimens for comparison, I do not feel justified in making a new genus for their reception, as they closely resemble *Pezotettix*, both in form and in habits.

#### KEY TO THE SPECIES.

Large; sternal shield not broader than long.

Subgenital plate in the female not toothed at the end .. *P. nivalis*.

Subgenital plate in the female toothed at the end .. *P. collina*.

Small; sternal shield broader than long.

Subgenital plate in the female concave at the end .. *P. petricola*.

Subgenital plate in the female rounded at the end .. *P. terrestris*.

#### *Pezotettix nivalis*.

Fuscous brown; the hind tibiæ and lower surfaces of the hind femora bright-red, apical halves of the spines on the hind tibiæ black. Head nearly smooth, no median keel on vertex; cheek carinæ distinct, undulating, reaching the clypeal suture. Pronotum slightly rugulose, the median keel indistinct. Sternal shield as long as broad. Elytra just reaching the third abdominal segment. Segments of the abdomen smooth, or nearly so. Hind tibiæ with seven spines on the outer margin in addition to the apical pair. Supra-anal plate in the male not notched on the sides, that of the female triangular with the apex rounded. Subgenital plate of the female not toothed at the end. The male is much more hairy than the female.

Length of the body, ♂ 18–19 mm., ♀ 27–28 mm.; of the pronotum, ♂ 5 mm., ♀ 6 mm.; of the hind femur, ♂ 10 mm., ♀ 15–16 mm.

*Localities*.—Mount Cook, at high altitudes (G. E. Mannering); Mueller Glacier (H. Suter).

#### *Pezotettix collina*. Plate XIV., figs. 4a–4c.

Colours as in the last species. Head slightly roughened, the median keel of the vertex slightly indicated; cheek carinæ distinct, undulating, reaching to the clypeal suture. Pronotum very rugulose, the median keel indistinct. Sternal shield as long as broad. Elytra reaching rather beyond the end of the second segment. First three abdominal segments roughened on the back. Hind tibiæ with eight spines on the outer margin in addition to the apical pair. Supra-anal plate

of the male with a slight notch on each side, that of the female lanceolate. Subgenital plate of the female with three strong teeth on the posterior margin.

Length of the body, ♂ 23–24 mm., ♀ 30–31 mm.; of the pronotum, ♂ 5.5 mm., ♀ 7 mm.; of the hind femur, ♂ 15 mm., ♀ 18 mm.

*Locality*.—Mount Arthur, near Nelson, at elevations above 4,500 ft. (G. V. Hudson).

The male is not so hairy as in *P. nivalis*.

#### ***Pezotettix petricola.***

Dark fuscous, slightly speckled with yellowish-brown; hind femora reddish below, hind tibiae and spines dark fuscous. Head rugulose, without median keel on the vertex, the cheek carinae indistinct. Pronotum rugulose, the median keel very slightly developed, not reaching the anterior border, posterior margin emarginate, the postero-lateral margins slightly concave, the two anterior transverse; sulci obscure. Sternal shield much broader than long. Abdomen rugulose. Elytra reaching the second abdominal segment. Hind femora barely reaching the end of the abdomen; the superior carina but slightly developed. Subgenital plate of the female concave at the tip.

Length, ♀ 16 mm.; of pronotum, 3 mm.; of hind femur, 9 mm. Male unknown.

*Locality*.—Marlborough, among stones in the river-beds (G. V. Hudson).

#### ***Pezotettix terrestris.***

Reddish-brown, paler below; hind femora lighter on the proximal half, outside greenish, below bright-red; upper surfaces of the hind tibiae and the bases of the spines on them pale. Head smooth, without any median keel on the vertex; lateral carinae indistinct. Pronotum nearly smooth, the median keel very slightly developed, not reaching the anterior border, posterior margin emarginate, postero-lateral margins slightly concave, the two anterior transverse sulci obscure. Sternal shield much broader than long. Abdomen smooth. Elytra reaching the second abdominal segment. Hind femora barely reaching the tip of the abdomen, the superior carina slightly developed. Subgenital plate of the female rounded at the tip.

Length of the body, ♀ 17 mm.; of the pronotum, 3 mm.; of the hind femur, 9 mm. Male unknown.

*Locality*.—Wellington (G. V. Hudson).

#### **Genus PAPRIDES, genus novum.**

Head with the fastigium deflexed or subhorizontal, slightly margined; frontal costa continuing almost to the clypeal suture, slightly expanding downwards, distinctly grooved;

cheek carinæ well marked, slightly sinuated at the antennæ. Antennæ rather thick and slightly flattened, 23- or 24-jointed, third joint as long as or longer than the second, the fourth the shortest; from the ninth to the sixteenth longer than broad, the rest broader than long. Pronotum slightly expanding posteriorly, the posterior margin emarginate, flat on the dorsum, the median and lateral keels distinct, the three transverse sulci continuous over the dorsum; scutum and scutellum about equal in length. Prosternal spine transverse at the base; lobes of the metasternum in the female considerably closer than those of the mesosternum; the space between the last broader than long, and with parallel sides. Elytra rudimentary, widely separated; wings rudimentary or absent. Hind femora in the female barely passing the tip of the abdomen, their apices armed above with a small tooth; the knee-lobes rounded and blunt. Hind tibiæ terete, with two pairs of apical spines, of which the inner pair are rather longer than the outer pair, their external margins armed with eight spines, regularly placed, in addition to the apical pair. Second joint of the hind tarsi short. Subgenital plate of the female variable, usually with two or three sharp teeth. Supra-anal plate rounded at the apex.

*Distribution*.—New Zealand only, so far as at present known.

KEY TO THE SPECIES.

Prosternal tubercle truncate at the end	..	..	<i>P. nitidus</i> .
Prosternal tubercle rounded at the end	..	..	<i>P. australis</i> .

**Paprides nitidus.** Plate XIV., figs. 5a-5d.

Bright-green when alive, brownish when dry, the hind tibiæ bright-red. On each side a pale-yellow band, bordered externally with fuscous, runs from the eye along the lateral carinæ of the pronotum, and are continued along the inner side of the elytra. The abdomen with a broad fuscous band on each side and a more obscure one along the keel of the dorsum. Hind femora obliquely banded with fuscous and with fuscous spots. Head with the vertex rugulose and without any median keel, the fastigium much deflexed, the genæ smooth. Pronotum sometimes with one or both of the anterior sulci obliterated; the posterior sulcus straight. Prosternal tubercle truncated at the end. Elytra reaching to the centre of the second abdominal segment; wings rudimentary. Subgenital plate of the female variable.

Length of the body, ♀ 22-23 mm.; of pronotum, 5 mm.; of hind femur, 13-14 mm. Male unknown.

*Localities*.—North Canterbury, on the hills; Mount Cook district (H. Suter); Mount Arthur and Mount Peel, in the Collingwood district (G. V. Hudson).

After death this species loses all trace of its green colour.

**Paprides australis.**

The colours, after being in alcohol, are ochraceous, with a more or less interrupted dark band on each side. The fastigium is less deflexed than in the last species, and there is a slight median keel on the vertex. The three transverse sulci of the pronotum are continuous over the dorsum, and the posterior one is distinctly sinuated. The prosternal tubercle is tapering and rounded at the tip. The elytra reach to the middle of the second abdominal segment; the wings are absent. The subgenital plate of the female is 3-toothed at the apex.

Length of the body, ♀ 23 mm.; of pronotum, 5 mm.; of hind femur, 15 mm. Male unknown.

*Locality.*—Glenorchy, at the head of Lake Wakatipu (C. Chilton).

Genus TRIGONIZA, Brunner de Wattenwyl. (1891.)

Head with the fastigium triangular, not deflexed, the margins raised and confluent at the apex; face oblique in the female, very oblique in the male; cheek carinæ distinct, extending to the clypeal suture, slightly undulated; frontal costa constricted above the antennæ, below which it expands and is grooved; lateral ocelli overhung by the vertex. Antennæ short, much flattened, 20-jointed, the third joint about as long as the second, the fourth the shortest, all but the last broader than long. Pronotum flattened dorsally, expanding posteriorly, median and lateral keels distinct, the three transverse sulci usually obsolete on the dorsum, sometimes absent; the posterior margin slightly produced and undulated. Prosternal tubercle large, transverse, slightly rounded at the apex; lobes of the metasternum closer together than those of the mesosternum (especially in the male), the space between the latter broader than long and with its sides nearly parallel. Elytra rudimentary, widely separated; the wings rudimentary or absent. Hind femora unarmed. Hind tibiæ terete, with two pairs of apical spines, of which the inner pair is longer than the outer pair; their exterior margins with eight, or occasionally nine, spines placed regularly. Second joint of the hind tarsi short. The anterior abdominal terga with three keels. Subgenital plate of the male rather swollen, slightly broader than the abdomen; that of the female not keeled, the apex with an acute tooth. Supra-anal plate of the male short, acute, the sides slightly concave; that of the female triangular, blunt at the apex.

*Distribution.*—New Zealand only, so far as is at present known.

## KEY TO THE SPECIES.

Dorsum of the pronotum not constricted.	
Green, without any yellow on the sides of the thorax	<i>T. campestris</i> .
Brownish-green, usually with a yellow patch on each side of the thorax .. .. .	<i>T. directa</i> .
Dorsum of the pronotum constricted behind the prescutum.	
Fuscous brown .. .. .	<i>T. rugosa</i> .

**Trigoniza campestris.** Plate XIV., figs. 6a–6c.

Bright-green; the lateral keels of the pronotum, the greater part of the dorsal surface of the abdomen, the elytra, and the inferior keel of the hind femora yellow; lower surface of the hind femora and distal ends of the hind tibiæ red. Vertex with a distinct median keel, the fastigium slightly deflexed. Pronotum rugulose, the lateral keels at first nearly parallel, diverging on the post-scutellum. Elytra reaching a little beyond the second abdominal segment; wings absent. Hind femora passing the end of the abdomen.

Length of the body, ♀ 20–33 mm.; of pronotum, 4–5 mm.; of hind femur, 13–15 mm. I have seen no fully-developed male.

*Locality*.—North Canterbury; on the plains.

Occasionally the whole dorsal surface from the vertex to the end of the abdomen is brown, and so makes an approach to the next species.

**Trigoniza directa.** Plate XIV., figs. 7a, 7b.

Bright-green or reddish-green on the sides and upper surfaces of the hind femora; dorsum, elytra, and lower half of the hind femora reddish-brown; generally a large yellow patch on each side of the pronotum; under-surface of the hind femora and distal ends of the hind tibiæ bright-red. Fastigium not deflexed, otherwise the form and sculpture as in *T. campestris*.

Length of body, ♂ 14–15 mm.; ♀ 21–25 mm.; of the pronotum, ♂ 3 mm., ♀ 5 mm.; of the hind femur, ♂ 9 mm., ♀ 13 mm.

*Localities*.—South Canterbury and Otago; on the low lands.

I have only two specimens from South Canterbury; all the others are from near Fortrose, in South Otago. Sometimes the whole insect is brown when dry.

**Trigoniza rugosa.** Plate XIV., fig. 8.

Fuscous brown, variegated with lighter and darker, the lower surfaces of the hind femora bright-red. Head, pronotum, and the two first abdominal segments rugose. Median keel on the vertex indistinct or absent. Lateral keels of the pronotum slightly converging on the prescutum, rapidly expanding posteriorly, the posterior lateral margins slightly

crenulated. Prosternal tubercle almost truncated. Elytra reaching a little beyond the second abdominal segment; wings rudimentary. Hind femora in the female not passing the tip of the abdomen. Supra-anal plate of the female very short.

Length of the body, ♀ 25 mm.; of the pronotum, 5 mm.; of the hind femur, 13 mm. Male unknown.

*Locality*.—North Canterbury; on the lower hills.

#### Family CEDIPODIDÆ.

Prosternum unarmed. Pronotum more or less cristate down the middle, some or all of the transverse sulci obliterated on the dorsum; the scutum nearly smooth; the lateral lobes deeper than long, and with their anterior and posterior margins nearly parallel.

#### Genus PACHYTYLUS, Fieber. (1853.)

Head without lateral furrows. Pronotum slightly cristate, the crest notched by the posterior sulcus. Elytra shining, sprinkled with grey, the stigmata placed before the middle. Wings hyaline with black veins and densely reticulated with fuscous.

*Distribution*.—Widely spread over the old hemisphere.

#### KEY TO THE SPECIES.

Pronotum slightly constricted, forming an obtuse angle at the median crest .. .. .	<i>P. cinerascens</i> .
Pronotum strongly constricted, forming an acute angle at the median crest .. .. .	<i>P. migratoroides</i> .

#### *Pachytylus cinerascens*.

*Gryllus cinerascens*, Fabricius, Ent. Syst., ii., 59 (1775).

*Pachytylus cinerascens*, Fischer, Orthop. Europ., p. 395, pl. 18, fig. 13 (1853); Saussure, "Prodromus *Cedipodiorum*," p. 120 (1884). *Edipoda cinerascens*, Hutton, Cat. Orthop. N.Z., p. 93 (1881); Hudson, Man. N.Z. Entomology, p. 115, pl. 17, fig. 3 (1892).

Colours varied, green and brown. Behind each eye a black longitudinal mark, which is continued on the pronotum; on the head it has an orange central stripe. Hind tibiæ reddish. Elytra transparent, some of the transverse veins brown, others pale, forming brown and pale spots; the base yellowish-green, usually unspotted. Pronotum but slightly compressed, the crest nearly straight along its upper margin.

Length of the body, ♂ 33–39 mm., ♀ 34–44 mm.; of elytra, ♂ 34–37 mm., ♀ 42–48 mm.; of hind femur, ♂ 21–23 mm., ♀ 23–27 mm.

*Localities*.—This species ranges over the warmer parts of Europe and Asia, as well as Africa and Australia, and pene-

trates into Polynesia. In New Zealand it is abundant in the Auckland and Nelson Districts. Formerly it was also found in the north-eastern portion of the South Island as far south as Banks Peninsula, but I have seen no specimens from there for several years.

It varies much in colour and in size, as well as in the shape of the anterior and posterior margins of the pronotum. Specimens from New Zealand and Polynesia are rather smaller than those from Europe, and differ slightly in other respects.

#### *Pachytylus migratoroides*.

*Edipoda migratoroides*, Reich., in Lefebvre et Galinier Voyage en Abyssinia, iii., p. 430, pl. 18, fig. 12. *Pachytylus migratoroides*, Saussure, "Prodomus *Edipodiorum*," p. 120 (1884).

The pronotum much constricted and rugulose over the entire surface; the central crest slightly arched.

*Localities*.—This species is found in Abyssinia, India, Philippine Islands, and Australia. In New Zealand it is only known from Auckland, where it appears to be rare.

I have only one New Zealand specimen, a female with the wings not fully developed, and probably immature, although the ocelli are present. In colour it is much darker than *P. cinerascens*, being of a yellowish-brown, largely covered with dark-brown; the elytra and wings, which only reach half-way down the abdomen, are uniformly brown. The length of its body is 34 mm., and hind femur 18 mm.

The measurements given by De Saussure are: Length of the body, ♂ 42 mm., ♀ 46 mm.; of the elytra, ♂ 46 mm., ♀ 60 mm.

In my specimen the sides of the frontal costa are nearly parallel, and do not widen out below the ocelli, as in the variety *capito*, from Madagascar.

#### EXPLANATION OF PLATE XIV.

- Fig. 1. *Sigaüs piliferus*: 1a, head and thorax from above; 1b, distal end of hind femur; 1c, hind tarsus; 1d, sternal shield of female.
- Fig. 2. *Phaulacridium marginale*: 2a, head and thorax from above; 2b, hind tarsus; 2c, sternal shield of female; 2d, elytron.
- Fig. 3. *Phaulacridium luteum*: elytron.
- Fig. 4. *Pezotettix collina*: 4a, head and thorax from above; 4b, sternal shield of female; 4c, hind tarsus.
- Fig. 5. *Paprides nitidus*: 5a, head and thorax from above; 5b, head and thorax from the side; 5c, head from the front; 5d, distal end of hind femur.
- Fig. 6. *Trigoniza campestris*: 6a, head and thorax from above; 6b, sternal shield of female; 6c, hind tarsus.
- Fig. 7. *Trigoniza directa*: 7a, head and thorax from the side; 7b, head from the front.
- Fig. 8. *Trigoniza rugosa*: head and thorax from above.



## ART. XVIII.—Note on the Ancient Maori Dog.

By Captain F. W. HUTTON, Curator of the Canterbury Museum.

[Read before the Philosophical Institute of Canterbury, 5th May, 1897.]

## Plate XV.

ALTHOUGH several papers have appeared in the "Transactions of the New Zealand Institute" on the ancient dog of the Maoris,\* no one as yet has given measurements of specimens the age of which is undoubted, so that they can be compared with the measurements of other dogs. Messrs. Windle and Humphreys give the comparative measurements, taking the basicranial axis at 100, of a dog's skull from New Zealand, now in the Oxford Museum, which they presume to have belonged to the dog of the Maoris, and they also quote Fitzinger as saying that the similarity of characteristics between the Maori dog and the Great Pariah is so marked as to leave no doubt that the former is a climatic modification of the latter;† but no actual measurements are given. I have therefore thought that it would be useful to place on record the measurements of some bones of dogs in the Canterbury Museum from the old Maori kitchen-middens, the great age of which cannot be doubted, all those from the South Island having been found associated with moa-bones.

The measurements given are in millimetres, and have been made according to the plan of Professor Huxley in his paper "On the Cranial and Dental Characters of the *Canidae*."‡ As mandibles are more common than crania, they naturally show a wider variation in size, and I estimate that the largest mandible in the collection belonged to a skull with a total length of about 190 mm., while the smallest indicates a skull of about 130 mm. in length. In the lower jaw, numbered C, the third molar is suppressed, but in all the others it is, or has been, present. For the sake of comparison I have also given the measurements of the skull of a dingo which is in the Museum:—

---

\* Sir James Hector, in vol. ix., p. 243; the Rev. W. Colenso, in vols. x., p. 135, and xxv., p. 495; Mr. Taylor White, in vols. xxii., p. 327, xxiv., p. 540, and xxvi. p. 585.

† Pro. Zool. Society of London, 1890, p. 22.

‡ Pro. Zool. Society of London, 1880, p. 243.

CRANIAL AND DENTAL MEASUREMENTS OF THE ANCIENT MAORI DOG AND DINGO.

	A.	B.	C.	D.	E.	F.	G.	H.	I.	J.	K.	L.	M.	N.	O.	P.	Q.
Total length ..	..	179	..	..	..	170	162	..	..	..	..	..	157	..	145	..	176
Zygomatic width ..	..	112	..	..	..	..	..	..	..	..	..	91	87	..	..	..	100
Length of palate ..	..	91	..	85	83	86	78	..	..	..	..	79	79	..	70	..	85
Width of palate ..	..	65	..	60	58	59	55	..	..	..	..	53	57	..	53	..	59
Basiscranial axis ..	..	55	..	..	..	45	46	..	..	..	..	..	49	..	44	..	57
Length of ramus ..	143	139	135	..	..	..	129	122	133	132	112	..	119	121	117	103	130
Length <u>pm. and m.</u>	..	53	..	52	50	53	55	..	..	..	..	49	53	..	51	..	63
Length <u>pm. and m.</u>	..	71	66	61	..	..	64	61	68	66	60	..	65	61	64	59	71
Length <u>pm. 4</u>	..	16	..	16	14	15	16	..	..	..	..	13	15	..	14	..	19
Length <u>m. 1</u>	..	10	..	10	9	10	9	..	..	..	..	9	10	..	10	..	12
Length <u>m. 1</u>	..	20	18	18	..	..	17	18	18	18	17	..	19	18	19	17	20
Length <u>m. 2</u>	..	8	7	..	..	..	8	8	8	8	7	..	8	..	8	6	9

A to H are from the sandhills at the mouth of the Shag River, Otago.

I to K are from the Moa-bone Point Cave, on the Sumner Road.

L is from Monk's Cave, on the Sumner Road.

M to P are from the sandhills near the Waimarama River, in Hawke's Bay, and were collected by Mr. F. H. Meinertzhagen.

Q is a dingo from Australia.

Of six skulls which show the postorbital process of the frontal bone four have it convex, as in most wild dogs; but in D and E it is slightly concave, with the outer margin raised, and is similar to that of the dingo and of a domestic dog in the Museum collection. The temporal ridges rarely meet and the sagittal crest is generally small. The skulls are remarkable for the shortness of the basicranial axis and the smallness of the teeth. The total length of the skull is less than three times the width of the palate, consequently it is relatively shorter and broader than the skull of the dingo, or of the Indian Pariah dog; but the premaxilla is not so deep as in the dingo, making the upper profile of the head more concave, so that the muzzle, although short, is pointed. The orbits are larger than in the dingo, notwithstanding that the eye has been described as small.

In the following table I have shown the comparative measurements, taking the basicranial axis as 100; but as I am not quite certain that the mandibles belong to the skulls with which they are associated some doubt attaches to those numbers. These mandibles, however, seem to fit the skulls. Several of the measurements from Messrs. Windle and Humphreys's paper are added for comparison:—

COMPARATIVE MEASUREMENTS: the Basicranial Axis taken at 100.

	N.Z. Dog (5 Skulls).			N.Z. Oxford Skull.	Dingo.		Pariah. Messrs. W. & H.	Sheep-dog. Messrs. W. & H.	Skye Terrier. Messrs. W. & H.
	Max.	Min.	Av.		Museum.	Messrs. W. & H.			
Total length ..	354	320	339	323	308	303	302	288	304
Zygomatic width ..	203	178	190	173	175	173	166	157	194
Length of palate ..	179	160	167	163	149	149	147	141	153
Width of palate ..	123	116	119	111	103	104	100	100	119
Length $\overline{pm. \text{ and } m.}$ ..	120	96	107	110	110	108	108	113	108
Length $\overline{pm. \text{ and } m.}$ ..	145	120	134	131	124	126	123	117	125
Length $\overline{pm. 1}$ ..	34	29	31	31	33	31	31	29	36
Length $\overline{m. 1}$ ..	22	18	20	22	21	20	20	21	23
Length $\overline{m. 1}$ ..	43	32	37	38	35	34	34	34	39
Length $\overline{m. 2}$ ..	18	14	16	..	15	13	13	14	15

These comparative measurements, although not of much use in bringing out the special characteristics of the Maori dog,\*

\* Professor Karl Pearson has lately shown that this method of taking ratios may lead to very erroneous conclusions: *Pro. Royal Soc.*, vol. 60, p. 489.

show that the Oxford skull has been rightly named, but they by no means bear out Fitzinger's statement that the ancient Maori dog closely resembled the Pariah, of India.

There are not many leg-bones of the Maori dog in the Museum. Of two femora, one, from Shag Point, is 142 mm., and the other, from the Maori encampment at the mouth of the Rakaiia, is 136 mm. in length. A tibia from the Moa-bone Point Cave is 114 mm. in length. A humerus from Shag Point has a length of 125 mm.; and another, from the Moa-bone Point Cave, of 119 mm. A radius from Shag Point is 120 mm., and an ulna from the Moa-bone Point Cave is 122 mm. in length.

I have no skeletons of domesticated dogs to compare these measurements with, but I have compared them with the skeletons of a wolf and a fox in the Museum, with the following results, the length of the head being taken as 100 in each case:—

COMPARATIVE MEASUREMENTS OF WOLF, FOX, AND MAORI DOG.

—	Humerus.	Radius.	Femur.	Tibia.
Wolf .. ..	80	78	86	83
Fox .. ..	84	81	86	95
Maori dog ..	74	73	85	70

These comparative measurements show that the ancient Maori dog had short legs, the femur being the only bone which shows no reduction in length. The bones are stout, quite as stout in proportion as those of the wolf, and much stouter than those of the fox.

There are also in the Museum three mats made of strips of dog's skin fastened on to flax. They were, I believe, purchased by Sir J. von Haast, and appear to be very old, but I can find no history of them. The mats are about 43 in. in length, but I think that none of the strips of skin go the whole length: the longest I could find was 27 in. Their width is  $\frac{1}{4}$  in. or less. There are two colours only, white and dark-brown. The brown is so dark that it might casually be called black, but it is really brown. Possibly the colour may have faded. Both in colour and in length of hair these mats closely resemble the skin of the stuffed dog from Waikawa, in the Wellington Museum; and in its short legs and pointed nose this specimen must closely resemble the ancient Maori dog as described by Crozet and others. It would be interesting to have measurements of the skull of this specimen, which could be compared with those here given of the skulls from the Maori kitchen-middens.

EXPLANATION OF PLATE XV.

SKULLS OF ANCIENT MAORI DOGS.

The upper and middle figures are crania from the sandhills at the mouth of the Shag River, Otago. They were found associated with moa-bones.

The lower figure is a cranium from the sandhills north of Waimarama, Hawke's Bay.

The figures are reduced about one-half.

ART. XIX.—*On a Collection of Insects from the Chatham Islands, with Descriptions of Three New Species.*

By Captain F. W. HUTTON, Curator of the Canterbury Museum, Christchurch.

[Read before the Philosophical Institute of Canterbury, 1st September, 1897.]

So little is known about the insect fauna of the Chatham Islands that a list of a small collection made by Mr. J. J. Fougère on the main island will not be unacceptable. This collection was contained in a bottle of methylated spirits, and, in consequence, many of the specimens were in bad condition, especially the *Diptera*; but in most cases they were sufficiently well preserved for identification. The bottle contained no *Lepidoptera*.

COLEOPTERA.

*Anchomenus submetallicus*, White, Voy. "Erebus" and "Terror," Insects, p. 2 (*Colpodes*); Broun, Man. Coleopt. N.Z., p. 24.

*Colymbetes rufimanus*, White, Voy. "Erebus" and "Terror," Insects, p. 6; Broun, Man. Coleopt. N.Z., p. 74.

*Staphylinus oculatus*, Fabricius, Ent. Syst., ii., p. 521; Broun, Man. Coleopt. N.Z., p. 107.

*Sternaulax zealandicus*, Marseul; Broun, Man. Coleopt. N.Z., p. 162.

This insect seems to agree with New Zealand specimens, but as the fore tibiae are broken off I cannot make a complete comparison. It is, however, much smaller, being only 5 mm. in length.

*Leperina wakefieldi*, Sharp, Ent. Mon. Mag., Jan., 1877; Broun, Man. Coleopt. N.Z., p. 179.

The length varies from 14–9 mm.

*Rhytinotus squamulosus*, Broun, Man. Coleopt. N.Z., p. 204.

A curious species, easily recognised. The genus must not be confounded with *Rhytinota*, of Eschsch (1831).

*Diagrypnodes wakefieldi*, Waterhouse, Trans. Ent. Soc. London, 1876; Broun, Man. Coleopt. N.Z., p. 217.

*Ceratognathus helotoides*, Thomson, Ann. Soc. Ent. France, ser. 4, vol. 2; Broun, Man. Coleopt. N.Z., p. 254.

The length of this species is from 11–9½ mm.

*Aphodius granarius*, Linnæus.

A European species, which has also been introduced into Canterbury.

*Lacon murinus*, Linnæus.

Another European species, but one which I have never seen in New Zealand.

*Thoramus obscurus*, Sharp, Ann. Mag. Nat. Hist., 1877; Broun, Man. Coleopt. N.Z., p. 281.

*Thoramus lævithorax*, White, Voy. "Erebus" and "Terror," Insects, p. 7 (*Elater*), pl. 1, fig. 10; Broun, Man. Coleopt. N.Z., p. 282.

*Mecastrus convexus*, Sharp, Ann. Mag. Nat. Hist., 1877; Broun, Man. Coleopt. N.Z., p. 293.

*Monocrepidius subrufus*, Broun, Man. Coleopt. N.Z., p. 294.

I am not sure about the identification of this species, as the body is not nude, but clothed with scattered pale hairs, and the depression on the thorax is not divided by a line. There are eight impressed lines on each elytron, and the colour varies from dark castaneous to reddish-brown. Length, 8 mm.

*Phymatophaea electa*, Pascoe, Ann. Mag. Nat. Hist., 1876; Broun, Man. Coleopt. N.Z., p. 334.

*Cilibe pascoei*, Bates, Ann. Mag. Nat. Hist., 1873; Broun, Man. Coleopt. N.Z., p. 372.

Several specimens. Length, 14–11 mm.; width, 8–5½ mm.

*Sessinia strigipennis*, White, Voy. "Erebus" and "Terror," Insects, p. 12 (*Dryops*); Broun, Man. Coleopt. N.Z., p. 420.

*Thelyphassa diaphana*, Pascoe, Ann. Mag. Nat. Hist., 1876; Broun, Man. Coleopt. N.Z., p. 422.

One example, which is smaller than the type, being only 10 mm. in length.

*Otiorhynchus sulcatus*, Fabricius.

A European species, which has also been introduced into Canterbury. It is often injurious to vines, strawberries, &c.

*Psepholax sulcatus*, White, Voy. "Erebus" and "Terror,"  
Insects, p. 15, pl. 3, fig. 1; Broun, Man. Coleopt. N.Z.,  
p. 479.

*Psepholax femoratus*, Broun, Man. Coleopt. N.Z., p. 481.

*Aldonus hylobioides*, White, Voy. "Erebus" and "Terror,"  
Insects, p. 16, pl. 3, fig. 9; Broun, Man. Coleopt. N.Z.,  
p. 483.

White mentions that in Captain Parry's collection there is a small specimen not half the size of the type, and differing somewhat from it in marking, having a waved black line on the side of each elytron. In this collection from Chatham Islands there is also a great difference in the size of the specimens. In three the length is 12 mm., in another it is 10 mm., in another 9 mm., and in another only 7 mm. I can see no difference in colour, and there are no black marks on the elytra.

*Acalles fougeri*, species nova.

Subovate, black, covered with scales, except a median band on the thorax and elytra. The scales on each border of the nude band are black, those on the sides of the thorax and elytra and on the legs pale-yellowish white, variegated with black.

Length (without rostrum), 8–10 mm. Apparently allied to *A. pascoei*, but easily recognised by its colours.

The *antennæ* are piceous, inserted at about one-fourth from the apex of the rostrum; the scape is slightly curved and clavate, it reaches nearly to the eyes; the first two joints of the funiculus are about as long as the other five together, the club ovate. Rostrum black, moderately curved, the front strongly punctate. Eyes moderate, ovate. *Head* covered with black scales except a spot over each eye and a mark on the forehead, which are pale dirty yellow. *Thorax* longer than broad, the front constricted, the non-constricted portion slightly transverse; the base not much sinuated; the nude middle portion smooth; the sides covered with pale-yellowish scales, among which are some dark ones forming three indeterminate longitudinal lines. *Scutellum* invisible. *Elytra* ovate, without any shoulders, broader than the thorax, their apices much bent down; very coarsely pitted in longitudinal rows, the interstices finely granulated; two rows of pits on the nude portion of each elytron and about five more rows which are covered with scales. The scales on the sides of the elytra are pale-yellowish, with dark scales in the pits. *Abdomen* with the first two abdominal sterna very broad, the next two very narrow; all clothed with pale scales. *Legs* robust, covered with pale scales and transverse bands of fuscous scales on the femora and tibiæ; tarsi black.

The type is in the Canterbury Museum, Christchurch.

*Platypus apicalis*, White, Voy. "Erebus" and "Terror,"  
Insects, p. 18; Broun, Man. Coleopt. N.Z., p. 541.

*Xuthodes punctipennis*, Pascoe, Ann. Mag. Nat. Hist., 1875;  
Broun, Man. Coleopt. N.Z., p. 580.

*Xuthodes divergens*, Broun, Man. Coleopt. N.Z., p. 581.

I have not been able to compare this insect with a specimen from New Zealand. The punctuation of the elytra resembles that of *X. punctipennis*.

*Zorion minutum*, Fabricius, Syst. Ent., p. 192; Broun, Man. Coleopt. N.Z., p. 584.

*Xylotoles costatus*, Pascoe, Ann. Mag. Nat. Hist., 1875;  
Broun, Man. Coleopt. N.Z., p. 599.

*Tetrorca cilipes*, White, Voy. "Erebus" and "Terror,"  
Insects, p. 21, pl. 4, fig. 9; Broun, Man. Coleopt. N.Z.,  
p. 609.

*Hybolasius trigonellaris*, species nova.

Dark testaceous, clothed with yellowish hairs, each elytron having, near the centre, a triangular piceous mark, the apices of which nearly meet on the suture. Length,  $5\frac{1}{2}$ –6 mm.

The first joint of the *antennæ* is thick and rather shorter than either the third or the fourth, which are nearly equal; the other seven are much shorter and gradually decreasing in length, their apices are fuscous. *Head* with the antennal elevations large, the vertex punctate and with a narrow impressed line down the centre. *Thorax* finely punctate, the lateral and dorsal tubercles low and rounded. *Elytra* coarsely punctate on the basal half, a few scattered white setæ near the costal margin; an acute compressed basal tubercle on each. *Legs* long, fuscous, except the outsides of the femora, which are testaceous.

This species differs from *H. wakefieldi* in its colours and in the thoracic dorsal tubercles not being transverse. The type is in the Canterbury Museum, Christchurch.

*Coccinella 11-punctata*, Linnæus.

A European species, which has also been introduced into New Zealand, and is now very abundant.

#### HYMENOPTERA.

*Pison morosus*, Smith, Cat. Hymenoptera in Brit. Mus., part 4,  
p. 317; Hutton, Cat. Hymenoptera of N.Z., p. 103.

*Ichneumon insidiator*, Smith, Trans. Entomological Soc. of  
London, 1876, p. 476; Hutton, Cat. Hymenoptera of N.Z.,  
p. 119.

*Ichneumon sollicitorius*, Fabricius, Syst. Ent., 1774, p. 332;  
Hutton, Cat. Hymenoptera of N.Z., p. 120.



*Paniscus ephippiatus*, Smith, Trans. Entomological Soc. of London, 1876, p. 478; Hutton, Cat. Hymenoptera of N.Z., p. 126.

DIPTERA.

*Dilophus nigrostigma*, Walker, Cat. Diptera in British Museum, p. 121 (*Bibio*); Hutton, Cat. Diptera of N.Z., p. 18.

*Saropogon discus*, Walker, Cat. Diptera in British Museum, p. 353 (*Dasyogon*); Hutton, Cat. Diptera of N.Z., p. 26.

*Odontomyia australiensis*, Schiner, Reise der "Novara," Diptera, p. 59; Hutton, Cat. Diptera of N.Z., p. 38.

*Clitellaria amyris*, Walker (?), Cat. Diptera in British Museum, p. 535 (*Odontomyia*); Hutton, Cat. Diptera of N.Z., p. 39.

The scutellum is black bordered with yellow, and not yellow, as in Walker's description, but New Zealand specimens are the same.

*Helophilus trilineatus*, Fabricius (?), White, Voy. "Erebus" and "Terror," Insects, pl. 7, fig. 19; Hutton, Cat. Diptera of N.Z., p. 41.

The small variety, which is also found in New Zealand. The Chatham Islands specimens have the hairs on the abdomen bright golden-yellow, and may be distinct.

*Mallota ineptus*, Walker, Cat. Diptera in Brit. Mus., p. 608 (*Helophilus*); Hutton, Cat. Diptera of N.Z., p. 41.

*Syrphus novæ-zealandiæ*, Macquart, Dip. Exotiques, supp. v., p. 115; Hutton, Cat. Diptera of N.Z., p. 44.

*Calliphora aureopunctata*, Macquart, Dip. Exotiques, supp. v., p. 130; Hutton, Cat. Diptera of N.Z., p. 59.

*Sarcophoga læmica*, White, Voy. "Erebus" and "Terror," Insects, pl. 7, fig. 18; Hutton, Cat. Diptera of N.Z., p. 62.

HEMIPTERA.

*Rhopalimorpha ignota*, species nova.

Like *R. obscura*, but without any smooth band on the head and pronotum. Length, 9 mm.; breadth,  $4\frac{1}{2}$  mm. Oval; ochraceous; shining; sparsely but deeply punctured with black on the head, pronotum, scutellum, and basal portion of the elytra. A narrow smooth line on the scutellum, but none on the pronotum or head. Antennæ ochraceous, darker towards the tips; the second joint rather shorter than the third. Nervures of the membranous portion of the elytra brown. Legs ochraceous. Abdomen margined below with red. The type is in the Canterbury Museum, Christchurch.

*Melampsalta cruentata*, Fabricius, Syst. Ent., 680 (*Tetti-  
gonia*).

○ *Philænus trimaculatus*, White, Voy. "Erebus" and "Terror,"  
Insects, pl. 7, fig. 10.

ORTHOPTERA.

*Periplaneta undulivitta*, Walker, Cat. Blattidæ in British  
Museum, p. 144.

*Anisolabis littorea*, White, Voy. "Erebus" and "Terror,"  
Insects, pl. 6, figs. 4, 5 (*Forficula*).

ODONATA.

*Somatochlora smithii*, White, Voy. "Erebus" and "Terror,"  
Insects, pl. 6, fig. 2 (*Cordulia*).

*Lestes colensonis*, White, Voy. "Erebus" and "Terror,"  
Insects, pl. 6, fig. 3 (*Agrion*).

*Xanthagrion sobrinum*, McLachlan, Ann. Mag. Nat. Hist.,  
1873 (*Telebasis*); Trans. N.Z., Inst., vol. vi., Appendix,  
p. xciii.

---

ART. XX.—*The Phasmidæ of New Zealand.*

By Captain HUTTON, F.R.S., Curator of the Canterbury  
Museum.

[Read before the Philosophical Institute of Canterbury, 3rd November,  
1897.]

THE *Phasmidæ*, known also as "stick-insects" and "leaf-insects," have their head-quarters in the Malay Archipelago, but are spread over all the warm parts of the earth, including Polynesia, as far as Hawaii, Samoa, and Tonga. They are not favourites with collectors, because they take up a large amount of space in the cabinet, and consequently large collections for comparison are not available. Also, they are apt to lose one or more of their legs, which are redeveloped, but of a smaller size, and generally destitute of spines. There are other difficulties connected with their study. None of the New Zealand species have either wings or ocelli, and immature forms can only be distinguished by the imperfect development of their sexual appendages and by their softer integument; while the immature form is known, in some cases, to differ in colour from the adult. Also, the males are comparatively rare, and differ from the females in being more slender and often less spiny than the females. Indeed, the spines on the body and legs are generally variable in both sexes, and the

best distinguishing characters are the relative lengths of the different parts of the body. It is therefore evident that a considerable amount of observation in the field is necessary before we can decide how many species there are in New Zealand. And this work should be undertaken without delay, for our stick-insects seem to be unable to protect themselves from the introduced birds, and are rapidly becoming scarce in the neighbourhood of the towns.

In this family the first abdominal segment is consolidated with the metanotum, and is called the "median segment." It forms part of the metathorax, and the first abdominal segment is really the second.

The habitats given to each species are only those known to me. They are merely intended as the commencement of a work which can only be carried out by the united efforts of several observers; but it is hoped that this paper will help to fix the nomenclature, which is the first step in any investigation.

#### KEY TO THE GENERA.

Antennæ shorter than the anterior femora, which are not longer than the posterior femora .. ..	<i>Pachymorpha</i> .
Antennæ as long as the anterior femora, which are longer than the posterior femora—	
Metathorax longer than the middle femora..	<i>Clitarchus</i> .
Metathorax shorter than the middle femora	<i>Argosarchus</i> .

#### Genus *Pachymorpha*, Gray (1835).

Body scabrous. Antennæ short, considerably shorter than the anterior femora (in the New Zealand species composed of 16–18 joints); first joint large; the second nearly as broad as the first, slightly longer than broad; the third narrower, longer than the second but shorter than the first. Head with two tubercles between the eyes, their bases approximated or continuous. Mesothorax about the length of the middle femora; metathorax shorter. Legs moderate or short, the posterior femora as long as the anterior, the middle and posterior legs with denticulations on the upper edges; tibiæ and first joint of the tarsi simple; tarsi short. Anal styles short, hardly projecting.

♂. Fourth segment of the abdomen longer than broad, not lobate.

♀. Fourth segment of the abdomen longer than broad, with a prominent depressed lobe on each side. Ovipositor not reaching the end of the abdomen.

*Distribution*.—New Zealand; Australia; Burma; and Africa.

The New Zealand species differ from the others in the body not being tectiform above.

**Pachymorpha hystriculea.**

*Pachymorpha hystriculea*, Westwood, Cat. Orthopterous Insects in the Brit. Mus., part i., p. 16, pl. 1, fig. 4 (1859). *Bacillus hystriculea*, Hutton, Cat. Orthoptera of New Zealand, p. 75 (1881).

The spines on the body are short and very variable, and the species is best distinguished by the dorsal foliaceous appendage on the third and fourth abdominal segments. It is small on the third but largely developed on the fourth segment. The following are the dimensions of a female specimen in the Canterbury Museum: Length of the body, 53 mm.; of mesothorax, 10 mm.; of metathorax, 9 mm.; of abdomen, 27 mm.; of antennæ, 9 mm.; of anterior femur,  $12\frac{1}{2}$  mm.; of middle femur, 11 mm.; of posterior femur, 13 mm.

*Hab.* Dunedin.

**Pachymorpha annulata**, sp. nov.

♀. Dark yellowish-brown, with indications of paler transverse bands on the femora. Body rugose with short blunt points, the dorsal surface rounded. Tubercles of the head broadly connected at their bases. Pro- and meso-notum with a pair of short spines near the posterior margin; metanotum with two pairs. The first seven abdominal segments with elevated posterior margins, each armed with a pair of spines, which are largest on the fourth segment. All the femora and tibiæ with blunt denticulations above; the middle and hind femora with three larger denticulations below, a pair near the distal end and a single one near the middle. Supra-anal plate slightly emarginate at the apex. Ovipositor keeled, rounded at the apex. Length of the body, 49 mm.; of mesothorax,  $9\frac{1}{2}$  mm.; of metathorax, 8 mm.; of abdomen, 26 mm.; of antennæ, 10 mm.; of anterior femur,  $12\frac{1}{2}$  mm.; of middle femur, 11 mm.; of posterior femur, 13 mm.

*Hab.* Dunedin.

This species is not so spiny as *P. hystriculea*, and the denticulations on the legs are blunter. But its distinguishing characters are the elevated posterior margins of the abdominal segments.

Genus **Clitarchus**, Stål. (1875).

Antennæ slender, about as long as the anterior femora, 20–22-jointed; first joint large, contracted towards the base; second joint narrower, subquadrate; third joint longer than the second but shorter than the first. Head with a keel on each side between the eyes and the bases of the antennæ. Pronotum with a transverse impression near the middle. Metathorax nearly as long as the mesothorax. First segment of the abdomen longer than broad. Legs medium, the middle

femora not longer than the metathorax; margins of the femora generally dentate throughout most of their length, the posterior armed with a tooth near the apex. First joint of the tarsi rather long, tectiform above. Anal styles foliaceous, elongated.

♂. Abdominal segments dilated at the ends; the last compressed, its sides deflexed and expanding posteriorly.

♀. Ovipositor reaching the apex of the abdomen; subcymbiform, gradually narrowed posteriorly.

*Distribution.*—New Zealand only.

#### SECTION A.

Body smooth. First joint of the anterior tarsi longer than the others together. First segment of the abdomen much longer than broad. No spine on the ovipositor. Anal styles narrow.

#### *Clitarchus hookeri.*

*Bacillus hookeri*: White, Zool. Voy. "Erebus" and "Terror," Insects, p. 24, pl. 6, fig. 6 (1846). Westwood, Cat. Orthopterous Insects in Brit. Mus., part i., p. 14 (1859). Hutton, Cat. Orthoptera of New Zealand, p. 74 (1881). *Clitarchus hookeri*, Stål., Recensio Orthopterorum, part iii., p. 83 (1875). *Phasma hookeri*, Butler, in Zool. Voy. "Erebus" and "Terror," Insects, p. 24 (1874).

*Hab.* North Island and Canterbury.

In this species all the femora are serrated, more strongly in the female than in the male.

#### *Clitarchus coloreus.*

*Bacillus coloreus*, Colenso, Trans. N.Z. Inst., vol. xvii., p. 151 (1885).

This species is closely allied to *C. hookeri*, but Mr. Colenso says it is very distinct, owing to its many and bright colours, as well as the configuration of the head and anterior femora.

*Hab.* Hawke's Bay.

#### *Clitarchus læviusculus.*

*Clitarchus læviusculus*, Stål., Recensio Orthopterorum, part iii., p. 82 (1875).

♀. "Pale-greenish, ornamented with a black dorsal line (in the example described it can be distinguished on the pronotum, on the bases of the other thoracic segments, and on the apices of the abdominal segments). Antennæ toward their apices and the bases of the anterior femora lightly tinged with rose-pink. Femora slender, the posterior pair below armed with an acute tooth near the apex on the mar-

gin. Length of the body, 83 mm.; of thorax, 36 mm.; of mesothorax, 16½ mm.; of metathorax, 16 mm.; of abdomen, 42 mm.; of anterior femur, 20 mm.; of middle femur, 13 mm.; of posterior femur, 18 mm. Width of the mesothorax, 3 mm." (Stål.)

*Hab.* Canterbury.

This species differs from *C. hookeri* in having the legs more slender and quite unarmed, except the subapical teeth of the posterior femora. The head has two slight tubercles at its base in the middle.

#### SECTION B.

Thorax spined. First joint of the anterior tarsi not longer than the others together. First segment of the abdomen subquadrate. A spine near the base of the ovipositor. Anal styles broad.

##### 1. *A protuberance between the eyes.*

#### **Clitarchus spiniger.**

*Acanthoderus spiniger*: White, Zool. Voy. "Erebus" and "Terror," Insects, p. 24 (1846). Westwood, Cat.

Orthopterous Insects in Brit. Mus., p. 48 (1859).

Hutton, Cat. Orthoptera of New Zealand, p. 76 (1881).

Described from a single male specimen collected by Dr. Sinclair.

*Hab.* Auckland(?).

#### **Clitarchus atro-articulus.**

*Bacillus atro-articulus*, Colenso, Trans. N.Z. Inst., vol. xvii., p. 154 (1885).

*Hab.* Hawke's Bay.

Described from a single female specimen. Perhaps it is the female of the last species.

##### 2. *No protuberance between the eyes.*

#### **Clitarchus prasinus.**

*Acanthoderus prasinus*: Westwood, Cat. Orthopterous Insects in the Brit. Mus., part i., p. 49, pl. iii., fig. 2 (1859). Hutton, Cat. Orthoptera of New Zealand, p. 77 (1881).

Described from a female collected by Sir G. Grey.

*Hab.* Auckland and Canterbury.

#### **Clitarchus filiformis.**

*Bacillus filiformis*, Colenso, Trans. N.Z. Inst., vol. xvii., p. 153 (1885).

*Hab.* Hawke's Bay.

Probably the male of the last species.

**Clitarchus geisovii.**

*Bacillus geisovii* : Kaup., Pro. Zool. Soc. of London, 1866, p. 578. Hutton, Cat. Orthoptera of New Zealand, p. 75 (1881).

This species is easily distinguished from *C. prasinus* by having the abdominal segments strongly spined above. The type, which is in the Berlin Museum, is a male. The following is a description of two females in the Canterbury Museum, which I believe to belong to the same species :—

Pale-green (turning brown when dry), with strong black spines. Head with about eight spines, of which two pairs are on the vertex. Prothorax with one to three pairs of spines above and two spines on each side, smooth below. Mesothorax and metathorax with numerous strong spines above and on the sides, and a few below. The first four or five abdominal segments with strong spines above, nearly smooth below, the posterior segments with only a pair of spines. The fourth, fifth, and sixth segments have lateral lobes, those of the sixth segment being the largest. Anterior coxæ with strong spines; anterior femora with one row of spines below and slightly serrated above; middle and posterior femora with two rows of spines below and two above. Anterior tibiæ unarmed; middle and posterior tibiæ with a single proximal denticulation above. Supra-anal plate squarely truncated at the apex. Length of the body, 78 mm.; of the mesothorax, 15 mm.; of metathorax, 14 mm.; of abdomen, 42 mm.; of antennæ, 19 mm.; of anterior femur, 19 mm.; of middle femur, 12½ mm.; of posterior femur, 15 mm.

*Hab.* Marton, near Wanganui.

**Genus Argosarchus, gen. nov.**

Allied to *Clitarchus*, but differing in the following characters: The spines on the body are more slender, and sharper. Antennæ 23-jointed; first joint with parallel sides; the second longer than broad; the third elongated, longer than the first. Metathorax considerably shorter than the mesothorax; not longer than the middle femora. Basal joints of the middle and posterior tarsi crested. Anal styles much shorter than in *Clitarchus*. Median segment shorter than the metanotum. Tibiæ below carinate to the apex. Anal styles flattened.

*Distribution.*—New Zealand only.

**Argosarchus horridus.**

*Acanthoderus horridus* : White, Zool. Voy. "Erebus" and "Terror," Insects, p. 24, pl. 5, fig. 4 (1846). Westwood, Cat. Orthopterous Insects in Brit. Mus., p. 49

(1859). Hutton, Cat. Orthoptera of New Zealand, p. 76 (1881).

*Hab.* Auckland (?); Canterbury.

**Argosarchus gerhardii.**

*Bacillus gerhardii*: Kaup., Pro. Zool. Soc. of London, 1866, p. 577. Hutton, Cat. Orthoptera of New Zealand, p. 75 (1881).

This species is distinguished from the last by its smooth head and pronotum, but I believe it to be only a variety, as I have several intermediate forms. The following are the dimensions of the largest female in the Museum collection: Length of the body, 152 mm.; of the mesothorax, 32 mm.; of the metathorax, 24 mm.; of the abdomen, 80 mm.; of the antennæ, 38 mm.; of the anterior femur, 37 mm.; of the middle femur, 28½ mm.; of the posterior femur, 31 mm. The colour is generally brown or grey, and in the female lateral lobes are sometimes present on the fourth and sixth abdominal segments, but more often they are absent.

*Hab.* Southland; Canterbury.

**Argosarchus sylvaticus.**

*Bacillus sylvaticus*, Colenso, Trans. N.Z. Inst., vol. xiv., p. 278 (1882).

*Hab.* Hawke's Bay.

This species has no spines on the head; but the pronotum is said to have three longitudinal rows of large distant spines, 3-4 in each row, and the prosternum is said to be very spiny, with long sharp spines. Perhaps there is some error in the description; and, if so, it will have to be united with the last species.

*Incertæ sedis.*

**Bacillus minimus**, Colenso, Trans. N.Z. Inst., vol. xvii., p. 153 (1885).

*Hab.* Hawke's Bay.

The description is not sufficient to enable me to make out the genus to which this belongs. Mr. Colenso says that it is adult, but the reasons he gives for so thinking—viz., "its fully-developed antennæ," &c.—are not very convincing.

---



ART. XXI.—*Synopsis of the Hemiptera of New Zealand which have been described previous to 1896.*

By Captain F. W. HUTTON, F.R.S., Curator of the Canterbury Museum, Christchurch.

[Read before the Philosophical Institute of Canterbury, 7th July, 1897.]

THE *Hemiptera*, or *Rhynchota*, are easily distinguished from other insects by having the mouth produced into a long, straight sucking-tube, or rostrum, bent under the body. Usually they have four wings, but some are apterous. There is no true pupa stage, the young, or larva, passing into the adult or imago, which, however, can almost always be recognised by possessing wings and ocelli, while the larva never has either.

They are divided into three sub-orders, as follows: *Heteroptera*—Tarsi three-jointed; wings horizontal, the anterior pair overlapping each other; rostrum springing from the front. *Homoptera*—Tarsi three-jointed; wings inclined, the anterior pair not overlapping each other; rostrum springing from the chin. *Phytophthiria*—Tarsi one- or two-jointed. The last sub-order contains a number of small insects of which the New Zealand species have been described by Mr. W. M. Maskell. They are therefore omitted in this synopsis, which includes the *Heteroptera* and *Homoptera* only.

In the "Transactions of the New Zealand Institute," vol. vi., p. 169, I published a list of the New Zealand *Hemiptera* which had been described previously to 1870. In 1871-73 Mr. Walker's "Catalogue of the *Hemiptera-Heteroptera* in the British Museum" appeared, which contained a few more. In 1874 Mr. A. G. Butler gave a new list in the "Zoology of the Voyage of the 'Erebus' and 'Terror'"; but the most important addition to our knowledge of the order was made by Mr. F. Buchanan White, who published a list, with descriptions of many new species, in the "Entomologists' Monthly Magazine," vols. xiv. to xvi. (1878-79). Since then very little has been done except the rectification of the nomenclature of the *Cicadidæ*, by Mr. W. F. Kirby, in the "Transactions of the New Zealand Institute," vol. xxviii., p. 454.

In the present synopsis the keys are adapted to the New Zealand genera only, and are merely intended to help the collector in naming his captures. It will generally be necessary to refer to the original descriptions before deciding that he has got something new.

## Sub-order HETEROPTERA.

These insects include what are known as the bugs. The fore-wings are called elytra, or hemelytra, and are generally coriaceous and opaque at the base, membranous and transparent at the apex. The basal portion consists of two pieces—the *corium* on the outside and the *clavus* on the inside, the line between them being called the *claval suture*. In the *Capsidæ* and the *Anthocoridæ* the corium is produced into a triangular piece called the *cuneus*, which is joined to the corium by a flexible suture. The apical portion of the elytron is called the *membrane*: sometimes it is not developed. The posterior wings are entirely membranous when present, but often they are wanting.

## KEY TO THE FAMILIES.

- A. *Antennæ prominent; the posterior legs like the others, for walking.*
1. Scutellum covering the whole inner margin of the elytra .. .. . *Scutelleridæ.*
  2. Scutellum not reaching much beyond the base of the membrane of the elytra; body broadly oval.
    - a. Tibiæ unarmed.
      - a<sup>1</sup>. Abdomen with a spine projecting forwards .. .. . *Acanthosomatidæ.*
      - b<sup>1</sup>. Abdomen without any spine.
        - a<sup>2</sup>. Basal joint of rostrum not in a groove .. .. . *Asopidæ.*
        - b<sup>2</sup>. Basal joint of rostrum in a groove.
          - a<sup>3</sup>. Abdomen with a longitudinal furrow .. .. . *Halysidæ.*
          - b<sup>3</sup>. Abdomen without a longitudinal furrow.
            - a<sup>4</sup>. Head flat, slightly foliaceous .. .. . *Sciocoridæ.*
            - b<sup>4</sup>. Head not foliaceous .. .. . *Pentatomidæ.*
        - b. Tibiæ armed with spines .. .. . *Cydnidæ.*
      3. Scutellum not reaching the membrane of the elytra; body narrowly oval or elongate (except *Saldidæ*).
        - c. Elytra without a cuneus.
          - c<sup>1</sup>. Rostrum not entirely free; antennæ shorter than the body.
            - c<sup>2</sup>. Rostrum not in a groove.
              - c<sup>3</sup>. Antennæ inserted on upper side of the head .. .. . *Berytidæ.*
              - d<sup>3</sup>. Antennæ inserted on lower side of the head.
                - c<sup>4</sup>. Membrane of elytra with a cross-vein .. .. . *Lygæidæ.*
                - d<sup>4</sup>. Membrane with longitudinal veins only .. .. . *Pachymeridæ.*
            - d<sup>2</sup>. Rostrum in a groove.
              - e<sup>4</sup>. Fore-legs raptorial .. .. . *Phymatidæ.*
              - f<sup>4</sup>. Fore-legs like the others .. .. . *Aradidæ.*
          - d<sup>1</sup>. Rostrum entirely free; antennæ longer than the body.

- e*<sup>2</sup>. Head with a neck behind the eyes.  
*e*<sup>3</sup>. Fore coxæ short .. .. *Reduviidæ*.  
*f*<sup>3</sup>. Fore coxæ very long .. .. *Emesidæ*.  
*f*<sup>2</sup>. Head without a distinct neck behind the eyes .. .. *Saldidæ*.  
*d*. Elytra with a cuneus.  
*g*<sup>1</sup>. Cuneus on the outer margin of the corium *Anthocoridæ*.  
*h*<sup>1</sup>. Cuneus at the apex of the corium .. *Capsidæ*.  
*B*. Antennæ hidden; the posterior legs elevated and ciliated for swimming.  
*e*. Rostrum exposed; anterior tarsi two-jointed *Notonectidæ*.  
*f*. Rostrum hidden; anterior tarsi one-jointed .. *Corixidæ*.

Family SCUTELLERIDÆ.

KEY TO THE GENERA.

- Second joint of the antennæ much shorter than third .. *Calliphara*.  
 Second joint of the antennæ much longer than third .. *Peltophora*.

**Calliphara imperialis**, Fab., E.S., iv., 81, 6 (*Cimex*). *Callidea imperialis*, Dallas, B.M. Cat. Hemiptera, p. 24.

Pronotum and scutellum red; abdomen blue, margined with crimson.

*Hab.* An Australian species, a specimen of which in the British Museum is said to have come from New Zealand.

**Peltophora pedicellata**, Kirby, Introduction, iii., p. 517. *Scutiphora picta*, Guér., Voy. "Coquille," Zool., ii., p. 165, pl. xi., fig. 7.

Greenish-blue, with the margins of the pronotum and two spots on the scutellum ochraceous. Length, 15 mm.

*Hab.* An Australian species, said to have been captured in Auckland by the "Novara" Expedition.

Family ASOPIDÆ.

KEY TO THE GENERA.

- Lateral angles of the thorax with sharp spines .. .. *Æchalia*.  
 Lateral angles of the thorax with blunt spines .. .. *Cermatulus*.

**Æchalia schellebergii**, Guér., Voy. "Coquille," Zool., ii., p. 168, pl. xi., fig. 9. *Pentatoma consocialis*, Boisd., Voy. de l'Astrol., ii., p. 630; Butler, Voy. "Erebus" and "Terror," Insects, pl. 7, fig. 2. *Rhaphigaster perfectus*, Walker, Cat. Hem.-Het. B.M., 8vo, part 2, p. 371.

Brownish-yellow, with black punctures; scutellum with a dark band beyond the middle and a pale-yellow apex. Length, 11 mm.

*Hab.* An Australian species, found also at Auckland, and in the Philippine Islands.

Walker described his *R. perfectus* as having the third joint of the antennæ longer than the second or the fourth; in other

respects his description agrees with that of *P. consocialis*, Boisduval.

**Cermatulus nasalis**, Hope, Cat., p. 32; Dallas, B.M. Cat., p. 106, pl. 2, fig. 3; Butler, Voy. "Erebus" and "Terror," pl. 7, fig. 4; Hudson, Man. N.Z. Entomology, pl. 20, fig. 3. *Asopus nummularis*, Erichson, Arch. für Naturg., viii., p. 276. *Rhaphigaster pentatomoides*, Walker, Cat. Hem.-Het. B.M., p. 370.

Dull-red, with brown punctures. Pronotum with a slight transverse impression which is irregularly bordered with black. Scutellum with a pale tip. Elytra with a black spot beyond the middle. Length, 10 mm.

*Hab.* Throughout New Zealand, from Auckland to Otago. Found also in Australia and Tasmania; generally on trees.

#### FAMILY SCIOCORIDÆ.

##### KEY TO THE GENERA.

Membrane of elytra with reticulated veins	..	..	<i>Dictyotus</i> .
Membrane of elytra with longitudinal veins	..	..	<i>Sciocoris</i> .

**Dictyotus polysticticus** (White), Butler, Voy. "Erebus" and "Terror," Insects, p. 26, pl. 7, fig. 5. *Pentatoma vilis*, Walker, Cat. Hem.-Het. B.M., p. 309.

Brownish-red, with brown punctures. Scutellum with a small black spot on each angle. Margins of the abdomen spotted. Length, 8-9 mm.

*Hab.* Auckland to Otago. Found also in Tasmania.

If White's figure without description does not count, then Walker's name will have to be taken.

**Sciocoris helferi**, Fieb. Rhynchotogr., p. 449.

Greyish-yellow, punctured with brown; pronotum with yellowish sides. Corium longer than the scutellum; the membrane with brownish spots. Abdomen with a row of black spots. Length, 6 mm.

*Hab.* A South European species, said to have been collected in Auckland by the "Novara" Expedition.

#### Family PENTATOMIDÆ.

In this family the middle lobe of the head is sometimes the longest in the larva, but in the imago the side-lobes project beyond it.

**Nezara amoyti** (White), Dallas, B.M. Cat., p. 278 (*Rhaphigaster*).

Abdomen not keeled. Green or greenish-brown, densely punctured. Pronotum, elytra, and abdomen margined with paler. Length, 15-17 mm.

*Hab.* Auckland and Canterbury. Found also in Australia.

**Nezara prasina**, Linn., S.N., i. (*Cimex*). Walker, Cat. Hemip. Het. B.M., p. 354.

Abdomen keeled. Yellow, with green spots on the pronotum and scutellum, and a large subapical green spot on each of the elytra. Length, 13–16 mm.

*Hab.* Specimens are in the British Museum from New Zealand. The species is widely distributed over the greater part of the world.

#### Family HALYDIDÆ.

Body broad, flat above, membrane generally rudimentary .. *Platycoris*.

**Platycoris immarginatus**, Dallas, Cat. Hemip. B.M., p. 154.

Black, sprinkled with small whitish warts. Anterior angles of prothorax and outer margin at the base of elytra yellowish. Legs yellowish - orange and black. Length, 8–9 mm.

*Hab.* There is in the British Museum one specimen from New Zealand and another from Australia.

#### Family ACANTHOSOMATIDÆ.

##### KEY TO THE GENERA.

Abdominal spine small	..	..	..	..	<i>Rhopalimorpha</i> .
Abdominal spine large	..	..	..	..	<i>Anubis</i> .

**Rhopalimorpha obscura** (White), Dallas, Cat. Hem. B.M., p. 293; Voy. "Erebus" and "Terror," pl. 7, fig. 8.

*Rhopalimorpha similis*, Mayr, Reise "Novara," Hemiptera, taf. 2, fig. 14.

Ochraceous, with brown punctures. A narrow smooth pale line down the middle of the pronotum and scutellum. Abdomen black above, margined with yellow. Length, 8–9 mm.

*Hab.* Auckland to Otago.

*R. similis* has the second joint of the antennæ longer than the third, and may be distinct.

**Anubis vittatus**, Fabr., E.S., iv., 96, and S.R., 165, 52 (*Cimex*). *Acanthosoma vittatum*, Butler, Voy. "Erebus" and "Terror," Insects, pl. 7, fig. 1.

Greenish-brown, the anterior portion of the pronotum and the margins of the elytra yellowish. Pronotum subspinose on each side. Length, 10 mm.

*Hab.* Auckland to Otago, common; on bushes, &c.

## Family CYDNIDÆ.

## KEY TO THE GENERA.

With ocelli	..	..	..	..	<i>Geotomus</i> .
No ocelli	..	..	..	..	<i>Chærocydnus</i> and <i>Pangœus</i> .

**Geotomus leptospermi** (White), Butler, Voy. "Erebus" and "Terror," Insects, p. 25 (*Ethusa*), pl. 7, fig. 3.

Black, with reddish-brown elytra and legs. Length, 5-6 mm.

*Hab.* Auckland to Canterbury.

**Pangœus scotti**, Signoret, Ann. Soc. Ent. de France, 1882, p. 259, pl. 9, fig. 117.

Oval; maroon-brown, the rostrum and antennæ lighter; the tarsi yellow. Head with three and pronotum with seven or eight bristles on each side; front margin of the elytra with five hairy spots. Length,  $6\frac{3}{4}$  mm.; breadth,  $3\frac{1}{2}$  mm.

*Hab.* New Zealand.

**Chærocydnus nigrosignatus**, Buchanan White, Ent. Mo. Mag., vol. 14 (1878), p. 275.

Brownish-yellow, remotely punctured with brown; an irregular transverse dark-brown band near the anterior border of the pronotum. Sides of the head, pronotum, and basal half of the front margin of the corium with long reddish-brown bristles. Length, 4-5 mm.; breadth,  $3-3\frac{1}{2}$  mm.

*Hab.* Canterbury and Otago.

## Family BERYTIDÆ.

Apical lamina of the head reaching beyond the apex .. .. *Neides*.

**Neides wakefieldi**, Buchanan White, Ent. Mo. Mag., vol. 15, p. 31.

Pale-red; sides of the head and prostethium with a longitudinal brown line. Elytra only one-fifth of the length of the abdomen. Length, 7-8 mm.; breadth, 1 mm.

*Hab.* Wellington.

Perhaps an apterous form of a dimorphic species (*Buch. White*).

## Family LYGÆIDÆ.

## KEY TO THE GENERA.

a. First joint of the rostrum longer than the head ..	..	<i>Lygæus</i> .
b. First joint of the rostrum not longer than the head.		
a <sup>1</sup> . Fore femora unarmed.		
a <sup>2</sup> . Third and fourth veins united near the base ..	..	<i>Arocatus</i> .
b <sup>2</sup> . Third and fourth veins parallel ..	..	<i>Nysius</i> .
b <sup>1</sup> . Fore femora with a spine before the apex ..	..	<i>Paresuris</i>

**Lygæus pacificus**, Boisduval, Voy. "Astrolabe," ii., p. 639, pl. 11, fig. 20.

Black; the head, three stripes on the pronotum, and a spot on the elytra reddish.

*Hab.* Found in Australia, Tasmania, and India. A specimen in the British Museum is said to have come from New Zealand.

**Arocatus ruficollis**, Walker, Cat. Hem.—Het. B.M., part 5, p. 64 (*Lygæus*).

Black; pronotum with an anterior red band; beneath red. Length, 7 mm.

*Hab.* Auckland to Otago.

Allied to *A. rusticus*, Stål, an Australian species.

**Nysius zealandicus**, Dallas, Cat. Hemip. B.M., p. 552; Butler, Voy. "Erebus" and "Terror," pl. 7, fig. 6.

Greyish-brown; below, brown spotted with white. Antennæ black, apex of the third joint yellowish-brown. Length, 6–7 mm.

*Hab.* Auckland to Otago; common in Auckland, in gardens.

The teeth on the hind margin of the pronotum are often nearly or quite obsolete.

**Nysius anceps**, Buchanan White, Ent. Mo. Mag., vol. 15, p. 33.

Brownish-red, variegated with black; a yellowish band through the basal half of the head to the apex of the scutellum. Elytra short, the membrane rudimentary. Length, 5–6 mm.; breadth, 2 mm.

*Hab.* Canterbury.

**Nysius huttoni**, Buchanan White, Ent. Mo. Mag., vol. 15, p. 32.

Greyish-red, variegated with black; membrane of elytra spotted with brown near the base; below black, marked with yellow. Length, 3–4 mm.; breadth,  $1\frac{3}{4}$  mm.

*Hab.* Canterbury and Otago; common, running on the ground in gardens, &c.

Variable in the intensity of the dark markings.

**Paresuris helmsi**, Reuter, Rev. Ent. de France, 1890, p. 192.

Reddish-brown, with ochraceous spots. Elytra short, variegated ochraceous and red, with three opaque spots nearly in a line. Length,  $3\frac{3}{4}$  mm.

*Hab.* Greymouth.

The body is obovate; the head transverse; the second joint of the rostrum reaching the fore coxæ. Antennæ inserted near the eyes. Elytra strongly punctate.

## Family PACHYMERIDÆ.

## KEY TO THE GENERA.

- a.* Pronotum contracted in the middle .. .. *Plociomerus*.  
*b.* Pronotum not contracted, the sides keeled.  
*a*<sup>1</sup>. Anterior border of pronotum margined .. .. *Scolopostethus*.  
*b*<sup>1</sup>. Anterior border of pronotum not margined.  
*a*<sup>2</sup>. Pronotum as long as broad .. .. *Margareta*.  
*b*<sup>2</sup>. Pronotum broader than long.  
*a*<sup>3</sup>. Rostrum passing the middle coxæ .. .. *Targarema*.  
*b*<sup>3</sup>. Rostrum not passing the middle coxæ .. .. *Metagera*.

**Plociomerus inornatus**, Walker, Cat. Hem.-Het. B.M., part 5, p. 112. *P. nigriceps*, Mayr, Reise "Novara," Zool. band ii., abthl. i., p. 128 (not of Dallas). *P. douglasi*, Buchanan White, Ent. Mo. Mag., vol 13., p. 105.

Reddish; black beneath; hairy. Legs yellow, the femora with more or less black. Length, 5 mm.

*Hab.* Auckland.

**Metagera obscura**, Buchanan White, Ent. Mo. Mag., vol. 15., p. 34.

Dull chestnut-brown; pronotum and scutellum with whitish-brown marks. A central band on the posterior half of the scutellum, and a streak in the middle of the apical margin of the corium, blackish. Length, 3-4 mm.; breadth, 1½ mm.

*Hab.* Canterbury.

**Targarema electa**, Buchanan White, Ent. Mo. Mag., vol. 15, p. 74.

Dull chestnut-brown, variegated with paler. Corium with a dark streak from the base to near the middle of the claval suture, and another from beyond the middle to the inner apical margin. Also a dark patch near the outer apical angle. Length, 6 mm.; breadth, 2½ mm.

*Hab.* Auckland.

**Targarema stali**, Buchanan White, Ent. Mo. Mag., vol. 15, p. 73.

Dull chestnut-brown, variegated with paler. Corium with a black streak from the inner apical angle to the middle of the claval suture. Length, 3-4 mm.; breadth, 1¼-1¾ mm.

*Hab.* Auckland.

**Margareta dominica**, Buchanan White, Ent. Mo. Mag., vol 15, p. 75.

Above dull-brown, variegated with darker; below dark-brown. Posterior half of the pronotum rather coarsely punctured. Length, 6 mm.; breadth, 2 mm.

*Hab.* Auckland.



**Scolopostethus putoni**, Buchanan White, Ent. Mo. Mag., vol. 15, p. 75.

Dull reddish-brown, variegated with darker. A black spot in the middle of the scutellum, and one on each of the hind angles of the pronotum. Head and front lobe of pronotum black. Length, 3 mm.

*Hab.* Auckland.

#### Family PHYMATIDÆ.

Head thick, quadrangular on the sides; the lateral margins of the pronotum produced and serrated .. .. *Phymata*.

**Phymata feredayi**, Scott, Stett. Ent. Zeit., vol. 31, p. 102 (1876).

Light ochraceous with dark-brown markings; head and pronotum covered with small, white, crowded granulations. Head prolonged anteriorly into two pointed protuberances with a slight bend backwards. Length, 6-7 mm.

*Hab.* Christchurch.

**Phymata conspicua**, Scott, Stett. Ent. Zeit., vol. 31, p. 103 (1876).

Like the last, but the head not prolonged anteriorly. Length, 5-6 lines.

*Hab.* Christchurch.

#### Family ARADIDÆ.

##### KEY TO THE GENERA.

- a. Body granulated; rostrum longer than the head.
  - a<sup>1</sup>. Body oval .. .. *Aradus*.
  - b<sup>1</sup>. Body elongated .. .. *Neuroctenus*.
- b. Body not granulated; rostrum shorter than the head.
  - c<sup>1</sup>. Membrane of elytra with veins; body linear.
    - a<sup>2</sup>. Second joint of antennæ not longer than the first .. .. *Crimia*.
    - b<sup>2</sup>. Second joint of antennæ longer than the first .. .. *Meziva*.
  - d<sup>1</sup>. Membrane of elytra without veins; body long-oval .. .. *Aneurys*.

The insects belonging to this family are usually found under loose bark, or in moss.

**Aradus australis**, Erichson, Wiegmann's Archiv. f. Nat., viii., band i., p. 281.

Black; thorax with six keels; membrane of the hemelytra hyaline, spotted with fuscous. Length, 5 mm.

*Hab.* Tasmania. This, or an allied species, is found in Otago and Canterbury.

**Neuroctenus hochstetteri**, Mayr, Reise "Novara," Zool., ii., Hem., p. 166, pl. 4, fig. 47.

Black, the tarsi brown. Length, 7-8 mm.

*Hab.* Auckland.

**Crimia attenuata**, Walker, Cat. Hem.-Het. in B.M., part vii., p. 22.

Black, the hind borders of the ventral segments red. First three joints of the antennæ about equal. Length, 9 mm.

*Hab.* There are specimens from New Zealand in the British Museum.

**Mezira maorica**, Walker, Cat. Hem.-Het. in B.M., part vii., p. 29.

Black. First joint of the antennæ much shorter than the second or third, which are equal. Length, 8 mm.

*Hab.* There are specimens from New Zealand in the British Museum.

Mr. Butler thinks that this species is the same as the last.

**Aneuris browni**, Buchanan White, Ent. Mo. Mag., vol. 13, p. 106.

Reddish-brown. First joint of the antennæ pyriform and truncate at the apex; about the same length as the second. Length, 3-4 mm.

*Hab.* Auckland.

#### Family CAPSIDÆ.

##### KEY TO THE GENERA.

- a. First joint of hind tarsi longer than the second.
- a<sup>1</sup>. Body linear; first joint of rostrum longer than the head .. .. . *Megaloceræa*.
  - b<sup>1</sup>. Body oblong; first joint of rostrum as long as the head.
    - a<sup>2</sup>. First joint of antennæ reaching beyond the head .. .. . *Morna*.
    - b<sup>2</sup>. First joint of antennæ not reaching apex of head .. .. . *Reuda*.
- b. First joint of hind tarsi not longer than the second.
- c<sup>1</sup>. Pronotum with a collar on the fore border .. *Capsus*.
  - a<sup>1</sup>. Pronotum without an anterior collar .. *Leptomerochoris*.

These insects run quickly and fly easily; they are fond of fruit.

**Megaloceræa reuteriana**, Buchanan White, Ent. Mo. Mag., vol. 15, p. 130.

Pale dull-red, variegated with brown. Middle and hind femora with indistinct pale-brown spots. Length, 5-7 mm.; breadth,  $1\frac{3}{4}$  mm.

*Hab.* Canterbury.

**Morna capsoides**, Buchanan White, Ent. Mo. Mag., vol. 15, p. 131.

Dull reddish-brown, variegated with red; a central band

through the head, pronotum, and scutellum, generally yellowish-red. Length, 7–8 mm.; breadth, 3–3½ mm.

*Hab.* Auckland.

**Morna scotti**, Buchanan White, Ent. Mo. Mag., vol. 15, p. 131.

Shining reddish-brown, variegated with blackish and whitish; legs black. Indications of a pale longitudinal line through the head, pronotum, and scutellum. Length, 5 mm.; breadth, 2 mm.

*Hab.* Canterbury and Otago.

**Reuda mayri**, Buchanan White, Ent. Mo. Mag., vol. 15, p. 132.

Brownish-red, with irregular brown spots; legs yellowish, with dark-brown rings; tarsi dark-brown. Length, 5 mm.

*Hab.* Auckland.

**Capsus laticinctus**, Walker, Cat. Hem.-Het. in B.M., part vi., p. 127.

Yellowish-brown, with dark longitudinal streaks. First joint of the antennæ half the length of the second. Length, 5 mm.

*Hab.* There is a specimen from New Zealand in the British Museum.

**Capsus ustulatus**, Walker, Cat. Hem.-Het. in B.M., part vi., p. 128.

Yellowish-brown, with darker longitudinal streaks. First joint of the antennæ twice as long as the second. Length, 5–6 mm.

*Hab.* There is a specimen from New Zealand in the British Museum.

Probably it is identical with the last species.

**Leptomerocoris maoricus**, Walker, Cat. Hem.-Het. in B.M., part vi., p. 146.

Dull-red or brown, paler beneath. Corium with a red mark on the middle of the exterior border. Length, 3 mm.

*Hab.* There are specimens from New Zealand in the British Museum.

#### Family ANTHOCORIDÆ.

Head elongate; pronotum with a broad transverse ridge *Cardiastethus*.

##### KEY TO THE SPECIES.

- a.* Third and fourth veins of the membrane coalesce and form a small cell .. .. *C. brownianus*.  
*b.* All the veins of the membrane free.  
*a*<sup>1</sup>. Sides of the pronotum straight .. .. *C. consors*.  
*b*<sup>1</sup>. Sides of the pronotum rounded .. .. *C. poweri*.

**Cardiastethus brounianus**, Buchanan White, Ent. Mo. Mag., vol. 15, p. 159.

Dark-brown, with long pale hairs; second joint of antennæ and legs brownish-yellow. Transverse depression of the pronotum nearly obsolete. Length, 2–3 mm.

*Hab.* Auckland.

**Cardiastethus consors**, Buchanan White, Ent. Mo. Mag., vol. 16, p. 143.

Brownish-yellow, with long pale hairs, marked with reddish-brown; external part of the cuneus rosy. Only the outer vein of the membrane is distinct. Length, 3 mm.

*Hab.* Auckland.

**Cardiastethus poweri**, Buchanan White, Ent. Mo. Mag., vol. 16, p. 143.

Dark reddish-brown, with long grey hairs; marked with paler. All the veins of the membrane are very indistinct. Length, 1–2 mm.

*Hab.* Auckland.

#### Family REDUVIDÆ.

##### KEY TO THE GENERA.

Rostrum three-jointed, not extending beyond the fore coxæ .. *Pirates*.  
Rostrum four-jointed, extending beyond the fore coxæ .. *Nabis*.

These insects generally feed on other insects.

**Pirates ephippigera**, White, in Dieffenbach's "New Zealand," vol. 2, p. 283; Butler, in Voy. "Erebus" and "Terror," pl. 7, fig. 7.

Black, with reddish-yellow legs and antennæ and an ochraceous patch on the inner edge of each elytron near the base. Length, 19 mm.

*Hab.* Specimens from Australia and New Zealand are in the British Museum.

This species belongs to the sub-genus *Brachysandalus*.

**Nabis maoricus**, Walker, Cat. Hem.-Het. in B.M., part vii., p. 145.

Pale dull-red, with four black spots on the elytra; legs pale-yellow; scutellum wholly pale. Length, 6 mm.

*Hab.* There are specimens from New Zealand in the British Museum.

**Nabis saundersi**, Buchanan White, Ent. Mo. Mag., vol. 15, p. 159.

Yellowish-red, with a black central longitudinal band. Length, 8–9 mm.; breadth, 2 mm.

*Hab.* Auckland to Otago.

Family EMESIDÆ.

Wingless; fore femora with a tooth at the base .. .. *Emesodema*.

**Emesodema huttoni**, Scott, Ent. Mo. Mag., vol. 11 (May, 1874).

Dull-brown. Anterior margin of pronotum slightly wider than the head, and with a narrow collar. Fore femora with two dense rows of short spines on the under-side, among which, at irregular intervals, are about five long ones. Length, 6 mm.

*Hab.* Auckland and Wellington.

Family SALDIDÆ.

Body oval; pronotum with an anterior callosity .. .. *Salda*.

The animals belonging to *Salda* are found running over the stones and sand on the shores of the ocean and inland waters.

**Salda australis**, Buchanan White, Ent. Mo. Mag., vol. 13, p. 106.

Black, with obscure yellowish-brown spots on the elytra; with dark-greyish pubescence and a few golden hairs. Femora with the base and a broad ring near the apex brownish-yellow. Membrane with four cells, fuscous, a blackish spot near the anterior margin. Length, 4–5 mm.

*Hab.* Auckland.

**Salda butleri**, Buchanan White, Ent. Mo. Mag., vol. 15, p. 160.

Black, marked with brownish-yellow on the pronotum and elytra; with black and golden hairs. Membrane large, with four cells, fuscous, spotted with paler in the cells. Length, 5 mm.

*Hab.* Otago: shores of Lake Wakatipu.

**Salda lælaps**, Buchanan White, Ent. Mo. Mag., vol. 15, p. 160.

Black, marked with brownish-yellow on the head, pronotum, and elytra; with black and golden hairs. Legs yellowish, a broad band at the middle of the femora and the apices of the tibiæ and tarsi blackish. Membrane small, with four cells, the innermost of which is very short. Length, 4–5 mm.; breadth, 2½–3 mm.

*Hab.* Canterbury.

Family NOTONECTIDÆ.

Antennæ four-jointed, the fourth longer than the third .. .. *Anisops*.

**Anisops wakefieldi**, Buchanan White, Ent. Mo. Mag., vol. 15, p. 161.

Shining yellowish-white; scutellum generally black, mar-

gined with yellowish-white; abdomen blackish, spotted above with yellow. Fore tarsi twice the length of the claws. Length, 9 mm.; breadth,  $2\frac{3}{4}$  mm.

*Hab.* Canterbury and Otago; in ponds.

The scutellum is sometimes entirely pale. The male and female are of the same size.

**Anisops assimilis**, Buchanan White, Ent. Mo. Mag., vol. 15, p. 161.

Shining yellowish-white; the scutellum slightly marked with black; abdomen yellow, marked with black. Fore tarsi four times the length of the claws. Length, ♂ 6–7½ mm., ♀ 7½–8 mm.; breadth, ♂  $1\frac{3}{4}$ –2 mm., ♀ 2 mm.

*Hab.* Otago.

Female specimens are scarcely distinguishable from those of the last species, except by their smaller size and paler scutellum. The labrum, however, seems to be longer in *assimilis*, reaching nearly to the middle of the third joint of the rostrum, while in *wakefieldi* it scarcely extends beyond the base.

#### Family CORIXIDÆ.

Antennæ four-jointed; scutellum covered .. .. *Corixa*.

**Corixa arguta**, Buchanan White, Ent. Mo. Mag., vol. 15, p. 161. *C. zealandicus*, Hudson, Man. N.Z. Entomology, pl. 20, fig. 5.

Pronotum with about ten yellow-and-black transverse lines; elytra with undulating yellow-and-black lines. Length, 7–8 mm.

*Hab.* Auckland to Otago; abundant in stagnant water.

Rather variable in size, but constant in the markings.

In the female the palæ are narrowly cultrate. In the male they are cultrate, rounded on the back, a little produced at the base below; frontal fovea oval, passing a little beyond the lower angle of the eyes; venter fuscous in the middle; strigil circular, furnished with eight more or less shortened rows of teeth.

#### Sub-order HOMOPTERA.

In this sub-order the anterior wings are called the *tegmina*. They are either altogether membranous, as in the *Cicadas* (*Cicadidæ*), or altogether coriaceous, as in the leaf-hoppers (*Cercopidæ*). They have a small *basal area*, followed by a long *radial area*. These are followed by a transverse row of six *ulnar areas*, and these by a row of eight *apical areas*, the area next the outer margin being, in each case,

considered as the first of each row. The posterior wings are smaller.

The Maori name for *Cicada* is *tatarakihi*.

KEY TO THE FAMILIES.

- a. Antennae six-jointed; ocelli three .. .. . *Cicadidae*.
- b. Antennae three- or two-jointed; ocelli two or none.
  - a<sup>1</sup>. Ocelli placed on the crown .. .. . *Cercopidae*.
  - b<sup>1</sup>. Ocelli placed between the eyes .. .. . *Tassidae*.
  - c<sup>1</sup>. Ocelli placed below the eyes .. .. . *Fulgoridae*.

Family CICADIDÆ.

- Tympana uncovered; ulnar veins of tegmina united at their origin .. .. . *Melampsalta*.

KEY TO THE SPECIES.

- a<sup>1</sup>. Apex of fifth ulnar area acute .. .. . *M. scutellaris*.
- b<sup>1</sup>. Apex of fifth ulnar area obtuse.
  - a<sup>2</sup>. General colour reddish, greenish, or yellowish.
    - a<sup>3</sup>. Abdominal segments not black on the sides.
      - a<sup>4</sup>. Tegmina greenish near the base .. .. . *M. muta*.
      - b<sup>4</sup>. Tegmina colourless .. .. . *M. cutora*.
    - b<sup>3</sup>. Abdominal segments black on the sides.
      - c<sup>4</sup>. Black marks on the lower surface of abdomen.
        - a<sup>5</sup>. Base of the wings red .. .. . *M. cincta*.
        - b<sup>5</sup>. Base of the wings colourless.
          - a<sup>6</sup>. Three or four black stripes on the mesonotum .. .. . *M. cruentata*.
          - b<sup>6</sup>. Two black stripes on the mesonotum .. .. . *M. angusta*.
      - d<sup>4</sup>. No black marks on the lower surface of abdomen .. .. . *M. iolanthe*.
  - b<sup>2</sup>. General colour blackish.
    - c<sup>3</sup>. Tegmina with fuscous marks near the apex .. .. . *M. cingulata*.
    - d<sup>3</sup>. Tegmina without any fuscous marks.
      - e<sup>4</sup>. Larger, very hairy.
        - With reddish markings .. .. . *M. mangu*.
        - Without red markings .. .. . *M. cassiope*.
      - f<sup>4</sup>. Smaller, less hairy, with reddish markings .. .. . *M. nervosa*.

*Melampsalta scutellaris*, Walker, Cat. Homop. in B.M., p. 150  
*(Cicada)*. *Cicada arche*, Walker, l.c., p. 195. *Cicada tristis*, Hudson, Trans. N.Z. Inst., vol. xxiii., p. 52.

Dull bronzy-greenish, with silvery pubescence; mesonotum with four obconical black marks, more or less vermiculated with reddish; abdomen with a broad central longitudinal dark band below. Tegmina rather narrow, tinged with brown or greenish, the costa tawny and the post-costal area fuscous; wings with the anal vein infuscated; fourth apical area does not project between the second and third ulnar areas. Length, 15–20 mm.; expanse, 45–63 mm.

*Hab.* Wellington. *np* *(2)*

- **Melampsalta cingulata**, Fabricius, Syst. Ent., 680, 9 (*Tettigonia*); Hudson, Man. N.Z. Entomology, pl. 20, fig. 1; Trans. N.Z. Inst., xxiii., p. 50. ○ *Cicada zealandica*, Boisdual, Voy. "Astrolabe," Ent., pl. 10, fig. 6. ○ *Cicada indivulsa*, Walker, Cat. Homop. in B.M., suppl., p. 33.

Head and thorax ochraceous or greenish, with black markings. A large black spot on the mesonotum just in front of the cruciform elevation, and a smaller black spot on each side of it. Abdomen dull-black, with reddish marks on the last segment. Tegmina with fuscous marks on the transverse veins at the bases of the second and third apical areas. Wings with a dark spot on the margin, at the anal angle, and another near the base. Length, 20–22 mm.; expanse, 67 mm.

*Hab.* Auckland to Southland.

- Var. **obscura**, Hudson, Trans. N.Z. Inst., xxiii., p. 51.

Smaller and duller in colour.

*Hab.* Kaikoura Mountains, in river-beds.

- **Melampsalta muta**, Fabricius, Syst. Ent., 681, 17 (*Tettigonia*).  
○ *Cicada muta*, Hudson, Man. N.Z. Ent., pl. xx., fig. 2.  
○ *Cicada muta*, var. *sub-alpina*, Hudson, Trans. N.Z. Inst., xxiii., p. 52.

Green or ochraceous. Mesonotum with two black spots on the disc in front of the cruciform elevation, and a black mark on each side. Abdomen with a silvery band, which is usually margined with black; no dark markings below. Tegmina and wings tinged with green near the base. Tarsi black. Length, 20 mm.; expanse, 53 mm.

*Hab.* Nelson, in sub-alpine localities, and Southland.

- **Melampsalta cutora**, Walker, Cat. Homop. B.M., p. 172  
○ (*Cicada*). *Cicada ochrina*, Walker, *l.c.*, suppl., p. 34.  
○ *Cicada aprilina*, Hudson, Trans. N.Z. Inst., xxiii., p. 53.

Like the last, but the tegmina and wings are colourless, and the legs rarely have dark markings. Length, 15–21 mm.; expanse, 42–58 mm.

Probably a variety of *M. muta*.

*Hab.* Auckland, Lake Taupo, and Canterbury.

- **Melampsalta cruentata**, Fabricius, Syst. Ent., 680, 10 (*Tettigonia*). ○ *Cicada rosea*, Walker, Cat. Homop. B.M., p. 220.  
○ *Cicada bilinea*, Walker, Cat. Homop. B.M., suppl., p. 34.  
○ *Cicada muta*, var. *rufescens*, Hudson, Trans. N.Z. Inst., xxiii., p. 52.

Reddish, ochraceous, or greenish, with black markings. Head thickly covered with hairs. Posterior margin of pronotum rosy red. Abdominal segments black above, with



posterior red borders; below they are reddish, with a black spot in the middle of each. Costa rosy or brown. Length, 20 mm.; expanse, 49 mm.

*Hab.* Nelson to Southland, and the Chatham Islands.

Var. *sericea*, Walker, *l.c.*, p. 172.

Costa green, black towards the tip.

*Hab.* Auckland.

○ Var. *flavescens*, Hudson, *l.c.*, p. 52.

Bright-yellow.

*Hab.* Mountains of Nelson.

○ *Melampsalta angusta*, Walker, Cat. Homop. B.M., p. 174

○ (*Cicada*). *Cicada muta*, var. *cinerascens*, Hudson, Trans. N.Z. Inst., xxiii., p. 52.

Yellowish-brown, with black markings. Mesonotum with only two broad obconical dark streaks. Abdomen as in *M. cruentata*, but the dark spots down the centre of the lower surface are broader and often confluent into a band. Length, 17 mm.; expanse, 47 mm.

*Hab.* Wellington and Canterbury.

○ *Melampsalta cincta*, Walker, Cat. Homop. in B.M., p. 204

○ (*Cicada*). *Cicada muta*, var. *minor*, Hudson, Trans. N.Z. Inst., xxiii., p. 52.

Tawny or reddish, with black markings; abdominal segments black, margined posteriorly with red above, and red with a black spot in the middle of each below. Tegmina rather broad, the basal area red; wings with the anal veins broadly margined with red. Length, 16–17 mm.; expanse, 35–37 mm.

*Hab.* Lake Taupo to Wellington.

○ *Melampsalta iolanthe*, Hudson, Trans. N.Z. Inst., xxiii., p. 53

○ (*Cicada*). *Cicada iolanthe*, Man. of N.Z. Entomology, pl. 20, fig. 3.

Greenish or ochraceous, with black markings; the abdominal segments black, bordered posteriorly with red; below they are red. Tegmina rather broad, the costa green or brown. Length, 14 mm.; expanse, 34 mm.

*Hab.* Lake Taupo, Nelson, and Canterbury.

○ *Melampsalta nervosa*, Walker, Cat. Homop. in B.M., p. 213

○ (*Cicada*).

Black, with reddish stripes on the thorax; hind margins of the abdominal segments green. Legs yellow, marked with black. Length, 15 mm.; expanse, 36 mm.

*Hab.* Auckland.

**Melampsalta mangu**, Buchanan White, Ent. Mo. Mag., vol. 15, p. 214.

Black, with obsolete reddish markings on the thorax; long black-and-grey hairs and pale pubescence. Hind borders of the abdominal segments sometimes reddish or yellowish; lower surface pale-rosy. Legs pale-rosy, with black marks. Length, 17–20 mm.; expanse, 32–40 mm.

*Hab.* Mountains of Canterbury.

**Melampsalta cassiope**, Hudson, Trans. N.Z. Inst., xxiii., p. 54 (*Cicada*).

Black; the female with whitish hairs. Length, 19–21 mm.; expanse, 41–47 mm.

*Hab.* Mountains of Nelson and Marlborough.

Perhaps a variety of the last, but with longer wings.

#### Family CERCOPIDÆ.

##### KEY TO THE GENERA.

Ocelli approximated .. .. .	.. .. .	.. .. .	.. .. .	.. .. .	.. .. .	♂ <i>Aphrophora</i> .
Ocelli wide apart .. .. .	.. .. .	.. .. .	.. .. .	.. .. .	.. .. .	♂ <i>Philænus</i> .

These insects are known as leaf-hoppers.

♂ **Aphrophora jactator**, Buchanan White, Ent. Mo. Mag., vol. 15, p. 214.

Fuscous brown, with a greyish-green tinge. Tegmina with two pale blotches on the front margin, and a brown triangular blotch between them. Length, 10–12 mm.

*Hab.* Auckland.

♂ **Philænus fingens**, Walker, Cat. Homop. in B.M., p. 718 (*Ptyelus*).

Yellow. Pronotum with a dark stripe on each side. Tegmina whitish, with an undulating ferruginous stripe through the disc. Length, 5 mm.

*Hab.* Auckland.

♂ **Philænus subvirescens** (White), Butler, Voy. "Erebus" and "Terror," pl. 7, fig. 9.

Ochraceous; elytra pale greenish-red. Length, 7 mm.

*Hab.* Auckland.

♂ **Philænus trimaculatus** (White), Butler, Voy. "Erebus" and "Terror," pl. 7, fig. 10.

Dull-red or greenish, with a black spot on each side of the pronotum. Tegmina darker in the centre, with a large pale patch on the margin near the apex, and a curved pale sub-basal streak. Length, 7 mm.

*Hab.* Auckland to Otago, and the Chatham Islands. Common.

Family JASSIDÆ.

KEY TO THE GENERA.

- Head produced .. .. . *Dorydium.* )  
 Head not produced; elytra not bordered.. .. . *Athysanus.* )

*Dorydium westwoodi*, Buchanan White, Ent. Mo. Mag., vol. 15, p. 215.

Pale ochraceous. Head and thorax finely punctate. Tegmina coarsely punctate. Length, 14 mm.; length of the head, 4 mm.

*Hab.* Christchurch.

*Athysanus negatus*, Buchanan White, Ent. Mo. Mag., vol. 15, p. 215.

Pale rufous-brown, with some indistinct darker spots on the pronotum. Back of the abdomen black in the male and pale-brown in the female. Length, 5 mm.

*Hab.* Otago.

Family FULGORIDÆ.

KEY TO THE GENERA.

- a. Wings broad, horizontal in repose .. .. . *Ricania.* )  
 b. Wings inclined in repose.  
   a<sup>1</sup>. Antennæ rather long; second joint longer than the first .. .. . *Cona.* )  
   b<sup>1</sup>. Antennæ short; second joint globular.  
     a<sup>2</sup>. Hind tibiæ unarmed; head narrower than the pronotum.  
       a<sup>3</sup>. Veins of the tegmina without dark marks .. *Cixius.* -  
       b<sup>3</sup>. Veins of the tegmina with dark spots or dots .. .. . *Oliarus.* )  
       c<sup>3</sup>. Veins of the tegmina with dark rings .. .. . *Aka.* )  
   b<sup>2</sup>. Hind tibiæ spined or toothed.  
     a<sup>3</sup>. Head narrower than the pronotum .. .. . *Agandecca.* )  
     b<sup>3</sup>. Head rather broader than the pronotum .. .. . *Semo.* )

KEY TO THE SPECIES OF CIXIUS.

- a. Tegmina with a transverse mark on the disc .. .. . *C. interior.* )  
 b. Tegmina without any discal mark; veins black at the tips.  
   a<sup>1</sup>. Veins yellow .. .. . *C. punctimargo.* )  
   b<sup>1</sup>. Veins reddish.  
     a<sup>2</sup>. Stigma with a black dot .. .. . *C. rufifrons.*  
     b<sup>2</sup>. Stigma whitish at the base .. .. . *C. aspilus.* )

*Cixius interior*, Walker, Cat. Homop. in B.M., supplement, p. 82.

Dull-red; abdomen pale-brown; posterior margins of the segments whitish. Veins pale-red, black towards the tips; stigma whitish. Length, 4 mm.

*Hab.* Specimens from New Zealand are in the British Museum.

**Cixius punctimargo**, Walker, Cat. Homop. in B.M., supplement, p. 81.

Pale-yellow. Tegmina with black transverse veins and a black mark at the tip of each apical vein. Length, 3 mm.

*Hab.* Specimens from New Zealand are in the British Museum.

**Cixius rufifrons**, Walker, Cat. Homop. in B.M., supplement, p. 83.

Pale-brown, the face red. Veins dull-red, with black points towards their tips. Length, 4 mm.

*Hab.* Specimens from New Zealand are in the British Museum.

**Cixius aspilus**, Walker, Cat. Homop. in B.M., supplement, p. 83.

Pale-reddish. Veins pale-reddish, black towards the tips. Length, 4 mm.

*Hab.* Specimens from New Zealand are in the British Museum.

**Oliarus oppositus**, Walker, Cat. Homop. in B.M., p. 345  
*O*(*Cixius*).

Black; crown of the head with a tawny ridge; pronotum margined with tawny. Mesonotum red, with fine bands. Hind borders of the abdominal segments yellow. Tegmina rather tawny, the stigma yellow and brown. Veins yellow, with dark spots. Length, 3-4 mm.

*Hab.* Bay of Islands.

**Oliarus marginalis**, Walker, Cat. Homop. in B.M., supplement, p. 82 (*Cixius*).

Black; the head and thorax bordered with reddish; hind borders of the abdominal segments reddish on each side. Tegmina colourless; stigma black, with a white dot at its inner end. Veins reddish, with black dots. Length, 5 mm.

*Hab.* Canterbury.

**Aka finitima**, Walker, Cat. Homop. in B.M., supplement, p. 81 (*Cixius*).

Pale-yellowish or reddish, the face brown; thorax sometimes black; abdomen blackish above; legs with black bands. Tegmina greyish; the veins pale-reddish, with black rings. Length, 4 mm.

*Hab.* Canterbury.

**Semo clypeatus**, Buchanan White, Ent. Mo. Mag., vol. 15, p. 217.

Pale ochreous-brown, marked with darker on the head, scutellum, and abdomen. Length, 4–5 mm.

*Hab.* Otago.

**Agandecca annectens**, Buchanan White, Ent. Mo. Mag., vol. 15, p. 218.

Reddish. Tegmina yellowish, the veins marked with whitish; commissure of clavus, from the middle to the apex, piceous. Length, 5 mm.

*Hab.* Otago.

**Ricania australis**, Walker, Cat. Homop. in B.M., p. 430  
(*Pochazia*).

Ferruginous. Tegmina slightly tawny, the fore border near the base testaceous, margin and two imperfect bands brown; wings margined with brown. Length, 5 mm.

*Hab.* Auckland, probably introduced from Australia.

**Cona cælata**, Buchanan White, Ent. Mo. Mag., vol. 15, p. 218.

Pale-brown, variegated with darker; keels of the head, pronotum, and scutellum generally red. Tegmina hyaline, more or less clouded with brown. Length, 4–6 mm.

*Hab.* Auckland.

---

ART. XXII.—*Notes on New Zealand Starfishes.*

By H. FARQUHAR.

Communicated by E. Lukins.

[*Read before the Nelson Philosophical Society, 30th August, 1897.*]

**Asterias calamaria**, Gray.

This is a very variable species, and reminds one of the variations of *A. rubens*, as described by Professor Bell, Ann. and Mag. Nat. Hist. (6), vii., p. 469 (1891). There are at least two well-marked forms—a large, coarse variety with stout rays, covered with thick skin, having short, stout, truncated, irregular spines on the abactinal surface, often in groups of three or four closely packed together, each group surrounded by a wreath of pedicellariæ at the base, the rows of spines often interrupted; and a more delicate variety, with long, thin, tapering, flexible rays covered with thin skin, the

abactinal spines comparatively long, fine, pointed, single, and arranged in regular longitudinal rows on the rays, with a few smaller spines here and there between the rows, each spine with a narrow wreath of pedicellariæ at the base. The infra-marginal plates, which are adjacent to the adambulacral plates, bear a double row of spines, which becomes triple towards the base of the arms, while the supramarginal plates only have a single spine on every other plate. Specimens of this variety when taken curl the rays backwards over the disc, and usually remain thus in a bunched-up basket shape. The latter seems to be the prevailing form at Nelson, while the coarse variety is abundant in Wellington Harbour. When I received a few young examples only of the finer variety from Mr. Lukins, of Nelson, I supposed that they belonged to a distinct species, but the receipt of a larger series, some of them full grown, proved their identity. Intermediate forms connecting the two varieties are not rare. Young individuals of this species always have a number of small arms budding out between the larger ones, or a group of small ones on one side of the disc, like that figured by M. De Lorient, *Mém. Soc. Phys. Genève*, xxix. (1885), pl. vii., fig. 2. They appear to have only a small number of arms at first (4 to 7), and the others are added afterwards. The coarse variety, with which I am familiar in life at Wellington, is never found here under stones (except very young individuals), but always on stones or rocks, while Mr. Lukins reports that he finds the finer variety at Nelson plentiful under stones at low water. This explains a statement made by Mr. Etheridge which puzzled me for some time, that at Lord Howe Island "scarcely a stone of any size can be overturned but what examples of this species are to be seen clinging to it." ("Lord Howe Island," p. 39 (1889).)

I have received a giant specimen of this species from Mr. Lukins, collected by Mr. Donald Sutherland at Milford Sound. It has ten arms, and measures 20 in. between the extremities of the arms.

### **Stichaster insignis**, Farquhar.

When collecting this species I noticed several times that there appeared to be a difference between specimens from Point Jerningham and those taken at Highwater Islet, in Evans's Bay. I therefore collected some specimens at Point Jerningham, and placed them in a glass jar, and then I went on to Highwater Islet and collected specimens there, which I placed in another jar. The difference was now seen to be very distinct. The colour of all the specimens from Point Jerningham was clear red or pink above and white or yellowish beneath, while those from Highwater Islet were

darker and usually tinged with purple or brown on the dorsal surface and brown beneath, and the rays not so stout as those from Point Jerningham. It is remarkable and extremely interesting to find two varieties of this little species at two stations only a mile and a quarter apart. I think we may conclude from this that the young are not carried far from their place of birth by the currents, and that this form is probably capable of great variations under different conditions of life.

If one is only alert enough there is always something new to be observed on the sea-shore which will add to our stock of knowledge, and, although perhaps apparently insignificant, may presently tend to the solution of important biological problems. The study of the variations and habits of our littoral marine animals, their distribution in time and space, and their relations to one another, to the animals of other regions, and to those which inhabited the New Zealand seas in former times, is extremely interesting and important, and presents a large field for the future investigations of New Zealand naturalists; and, although the would-be generalisers of to-day (able to explain everything according to their own pet theories) despise those who occupy themselves with the minutiae of natural history, we must always remember that it is necessary to study nature in detail to get a true general view of the whole.

**Stichaster suteri**, var. *lævigatus*, Hutton.

Mr. E. Lukins, who recently visited the southern islands in the Government steamer "Hinemoa," brought three little starfishes from Carnley Harbour, Auckland Islands, which I at once pronounced to be specimens of *Stichaster suteri*, Loriol. When I examined them, however, I found that they had no spines on the abactinal surface. I have suspected for some time that the starfish from Dunedin, identified by Professor Hutton as *Asterias rupicola* (Trans. N.Z. Inst., vol. xi., p. 343), may have been a specimen of *S. suteri*, and Mr. Lukins's re-discovery of this variety at the Auckland Islands has confirmed my suspicion. I have recently been able to compare specimens of *S. suteri* with a specimen of *Asterias rupicola* from Kerguelen, and I find that they are quite distinct, the Kerguelen form being a true *Asterias*, as described by Professor Verrill (Bull. U.S. Nat. Mus., vol. i., p. 71, 1876). *A. rupicola* does not therefore belong to the New Zealand fauna.

The specimens brought from the Auckland Islands by Mr. Lukins agree in every respect with specimens of *S. suteri*, except in having no spines on the dorsal surface. Professor Hutton, however, obtained one specimen from the same locality with "a row of spines along the back and traces of a lateral

row on each side" (Trans. N.Z. Inst., vol. xi., p. 343). This variety suggests the question, Why is the armature on the abactinal plates of this species not developed, or only very feebly developed, at the Auckland Islands, in the cold water of the Antarctic drift, while it is always well developed on the shores of the main-land? A specimen found at Stewart Island by Mr. H. B. Kirk is intermediate. The specimens collected by Mr. Lukins are in the Nelson Museum.

**Cribrella lukinsii**, n. sp.

R = 23 mm.; r = 7 mm.

Rays five in number, rounded, rigid, inflated at the base and tapering rapidly to the extremity, which is rather finely pointed. Breadth of a ray near the base, 9.5 mm.; height, 9 mm. Disc small, not clearly marked off from the bases of the rays. The papular areas are small, but fairly well defined, with one to three pores in each. The abactinal and lateral plates are small and irregular in form, broader than long; they bear compact groups of very minute, uniform, delicate spinelets with denticulate tips. On the lateral surface of the rays the spinelets form somewhat irregular, double, transverse rows. The armature of the adambulacral plates consists of a single row of six to eight spinelets (sometimes rather irregularly placed, and double without) similar to those on the abactinal plates, but somewhat larger, increasing slightly in size towards the furrow, one minute smooth spinelet placed high in the furrow. The madreporite is small and indistinct, situated at the summit of one of the interbrachial arcs; it bears a few scattered extremely minute spinelets. In the only specimen examined there is a very large compact group of spinelets in the centre of the disc, apparently covering the dorso-central plate. The colour is very dark-grey, almost black, with a brownish tinge, slightly paler beneath.

I cannot give a figure at present, for the only specimen available was found by Mr. E. Lukins on a high cliff at the entrance of Carnley Harbour, Auckland Islands, where it had been thrown by the waves, and the spines are somewhat displaced. It had not been long exposed, however, for when Mr. Lukins brought it to me in spirits the tube-feet were not decayed or dried up.

Type specimen in the Nelson Museum.

**Cribrella ornata**, Perrier.

I have what I take to be a specimen of this species, which was found by Mr. A. S. Danby at the Snares. Unfortunately, it has been roughly dried, and is, in consequence, much distorted, so that I cannot figure it. The colour is deep reddish-orange above and pale-yellow beneath.



Mr. Sladen gives for the distribution of this species, "Off New Zealand and Campbell Islands, and extending to the Cape of Good Hope" ("Challenger" Report, vol. xxx., p. 541). The original type specimens were collected by Count Castelnau at the Cape of Good Hope, and the naturalists of the "Challenger" Expedition found the species in the same locality. Through the kindness of Mr. A. Reischek, Director of the Linz Museum, I am able to give here M. Perrier's description of this species, from the "Annales des Sciences Naturelles," xii., p. 251 (1869): "Cinq bas arrondis, s'amincissant graduellement du bas vers l'extrémité, obtus au sommet; quatre fois aussi longs à partir du centre que le rayon du disque, quatre fois également aussi longs que leur largeur à la base. Surface dorsale tout entière couverte de papilles granuleuses qui sont disposées en rangs serrés sur les ossicules du réseau et circonscrivent par conséquent des espaces nus, dans lesquels se trouvent plusieurs pores tentaculaires. Plaque madreporique située au bord de la partie declive de l'intervalle de deux bras, c'est-à-dire vers le milieu du rayon du disque, et dont les collines saillantes rayonnent en se dichotomisant à partir d'un point excentrique. Ses piquants des sillons ambulacraires sont cylindriques, assez gros, tronqués au sommet et disposés sur deux rangs. En dehors on voit deux rangées longitudinales des groupes de papilles. Diamètre, 75 millimètres environ."

#### **Cribrella compacta**, Sladen.

The starfish which was identified by Professor Hutton as *C. oculata* (Ech. of N.Z., p. 7) is, I believe, a specimen of Mr. Sladen's species *C. compacta*, the type of which was dredged up by the naturalists of the "Challenger" Expedition off the west coast. Professor Hutton's specimen, which is in the Colonial Museum, is unfortunately glued to a piece of board, so that I cannot examine the actinal surface, except a small portion of the extremity of a ray. I have little doubt, however, that it belongs to Mr. Sladen's species.

---

ART. XXIII.—*A List of Recent and Fossil Bryozoa collected in various Parts of New Zealand.*

By A. HAMILTON.

[Read before the Otago Institute, 12th October, 1897.]

IN 1880, when living at Petane, near Napier, I commenced a correspondence with Miss E. C. Jelly, who was then residing at Bristol, on the subject of our New Zealand *Bryozoa*, and from that time until quite recently I have been forwarding parcels of recent and fossil species from different parts of New Zealand. Miss Jelly has long been known as an enthusiastic student of the *Bryozoa*, and as one whose intimate acquaintance with the literature of the subject gives authority to the excellent synonymic catalogue of the recent marine *Bryozoa*, published by her in 1889.

Through Miss Jelly the specimens I collected have been passed on to the principal authorities on the various groups, and several of the new species have been described in English scientific publications, and others are still awaiting description. Many species still living have been obtained as fossils from the upper beds of the Wanganui series typically exposed at Petane and Napier; and many of these are also found in the Tertiary beds of Australia. Whenever deep-sea dredgings are undertaken in the deeper waters of the New Zealand coast we may expect a considerable addition to the rarer genera. The localities from which the specimens have been forwarded are:—

1. *Napier*.—The species under this heading are either from the littoral of the harbour, from the old dead shells thrown up by storm on the beach, or from adjacent parts of the Hawke's Bay coast. The fossil species are from the Napier limestone, a local formation included in the lower beds of the Wanganui series of the geological survey.

2. *Wanganui*.—Some of the species under this head are from the typical locality, Shakespeare's Cliff, Wanganui, others from the corresponding blue clays and sands on the Hawke's Bay side of the Island.

3. *Wellington*.—These are all recent species, collected at various times on the shores of Cook Strait.

4. *Dunedin*.—These are also littoral species collected at various times.

5. *Foveaux Strait*.—The oyster-beds of the strait between Stewart Island and the South Island of New Zealand afford a very large number of excellent specimens of *Bryozoa*, and by examining the oyster-shells and a little dredging many species have been obtained.

6. *Dusky Sound*.—I am indebted to Mr. R. Henry for a quantity of dead shells of *Pinna novæ-zealandiæ*, collected by him at Resolution Island, Dusky Sound, and on these and on some gigantic worm-tubes are a host of specimens in perfect condition, which makes one long for a dredging expedition in the West Coast Sounds.

The second list represents the result of Mr. Waters's examination of a collection of fossil *Bryozoa* sent Home to Miss Jelly by me from localities near Petane, together with some collected by Captain Hutton at Wanganui. The paper, with figures and full descriptive notes of the species, was published in the "Quarterly Journal of the Geological Society."\*

I take this opportunity of rectifying a slight misunderstanding about the exact localities, which is only of importance to our local geologists. The description of the localities says, "They are from Petane and Waipukurau, both representing a well-known horizon, and also some from Waikato (*sic*), and Trig's Station, Tanner's Run," &c. In a footnote Mr. Waters says, "This (Waikato) is written 'Whakati,' but I have not been able to find out that there is such a place, whereas *Bryozoa* of this age are known from Waikato Heads." I regret that the labels were thought to be in error, and that the name was changed to a place a hundred miles or so away, simply because Mr. Waters could not find out that there was such a place, as it is the proper name of the locality—a rocky headland just to the north of the Tongoio Creek and Lagoon, a few miles north of Napier. Possibly it should be Whakaati, but this is another matter.

Again, the locality given as Trig's Station, Tanner's Run, should be as it was written—trig. station (trigonometrical station or peg) on Tanner's Run at Petane, a locality from which a great number of specimens were obtained, but which were generally in very poor condition.† Mr. Waters is entitled to our hearty thanks for the attention he has given to these specimens, as the task of determining fossil *Polyzoa* is a tedious one, demanding a prolonged examination of generally very unsatisfactory specimens. I hope he will publish the list of *Cyclostomata* of the collection as he promised in the paper quoted. In order to bring this list into line with the other I have prefixed the reference numbers of Miss Jelly's catalogue to each species, and in a few cases have altered the nomenclature to correspond. Of the seventy-eight species mentioned in the second list, sixty are known to be living at the present time, and twenty-eight are also found fossil in Australia.

\* Waters, Tertiary *Bryozoa* of N.Z., in Quar. Jour. Geo. Soc., vol. 43, 1887, p. 40.

† Tommy Gully (Petane) = Tommy's Gully, is a local name for a valley opening on to the Tongoio Road.

## LIST OF SPECIES.

			Napier.	Vanganni.	Wellington.	Dunedin.	Foveaux Strait.	Dusky Sound.
<i>Cheilostomata.</i>								
272.	<i>Catenicella</i>	<i>ventricosa, Busk</i>	..	..	X	..	X	..
251.	"	<i>hastata, Busk</i>	..	..	X	..	X	..
240.	"	<i>cribraria, Busk</i>	..	..	X	..	X	..
259.	"	<i>perforata, Busk</i>	..	..	X	..	X	..
233.	"	<i>alata, Wyv. Thom.</i>	..	..	X	X	X	..
239.	"	<i>cornuta, Busk</i>	..	..	X	..	X	..
236.	"	<i>carinata, Busk</i>	..	..	X	X	..	X
267.	"	<i>scutella, Hutton</i>	..	..	..	X	..	..
241.	"	<i>crystallina, Wyv. Thom.</i>	..	..	X	..	..	..
219.	<i>Calpidium</i>	<i>ponderosum, Goldst.</i>	..	..	X	..	..	..
224.	<i>Canda</i>	<i>arachnoides, Lamx.</i>	..	..	X	..	..	..
608.	<i>Eucratea</i>	<i>chelata, Linn.</i>	..	..	X	..	..	..
32.	<i>Cetea</i>	<i>dilatata, Busk</i>	..	..	..	..	..	..
29.	"	<i>anguina, Linn.</i>	..	..	X	X	..	..
36.	"	<i>recta, Hincks</i>	..	..	X	X	..	..
437.	<i>Cellularia</i>	<i>cuspidata, Busk</i>	..	..	..	X	..	..
1099.	<i>Menipea</i>	<i>crystallina, Gray</i>	..	..	..	X	..	..
1105.	"	<i>fuegensis, Busk</i>	..	..	..	X	..	..
1111.	"	<i>patagonica, Busk</i>	..	..	X	..	..	X
1524.	<i>Scrupocellaria</i>	<i>scrupea, Busk</i>	..	..	..	X	..	X
210.	<i>Cabarea</i>	<i>lyallii, Busk</i>	..	..	..	X	..	..
215.	"	<i>rostrata, Busk</i>	..	..	X	X	..	..
202.	"	<i>boryii, Audouin</i>	..	..	X	X	X	..
101.	<i>Beania</i>	<i>bilaminata, Hincks</i>	..	..	X	X	..	..
106.	"	<i>elongata, Hincks</i>	..	..	X	..	..	..
108a.	"	<i>hirtissima, Heller, var. robusta,</i> <i>Hincks</i>	..	..	X	..	..	..
111.	"	<i>intermedia, Hincks</i>	..	..	X	..	X	..
115.	"	<i>spinigera, McGill</i>	..	..	..	..	X	..
112.	"	<i>magellanica, Busk</i>	..	..	X	..	..	..
116.	"	<i>(Amathia?) swainsoni, Hutton</i>	..	..	..	..	X	..
33.	<i>Bicellaria</i>	<i>tuba, Busk</i>	..	..	X	..	..	..
181.	<i>Bugula</i>	<i>neritina, Linn.</i>	..	..	X	..	..	..
168.	"	<i>dentata, Lamx.</i>	..	..	X	X	..	..
285.	<i>Cellaria</i>	<i>malvinensis, Busk</i>	..	..	X	X	X	..
294.	"	<i>setigera, Desm.</i>	..	..	X	X	..	..
296.	"	<i>tenuirostris, Busk</i>	..	..	..	..	X	..
1643.	<i>Tubucellaria</i>	<i>hirsuta, Lamx.</i>	..	..	X	..	..	..
1644.	"	<i>opuntioides, Pallas</i>	..	..	X	..	..	..
667.	<i>Flustra</i>	<i>episcopalis, Busk</i>	..	..	X	X	X	..
673.	"	<i>indivisa, Busk</i>	..	..	X	..	..	..
673a.	"	<i>var. cyathiformis, McGill</i>	..	..	X	..	X	..
220.	<i>Calwellia</i>	<i>bicornis, Wyv. Thom.</i>	..	..	X	..	..	..
223.	"	<i>sinclairii, Busk</i>	..	..	X	..	..	..
558.	<i>Dimetopia</i>	<i>spicata, Busk</i>	..	..	..	X	..	..
556.	"	<i>cornuta, Busk</i>	..	..	..	X	..	..
1014.	<i>Membranipora</i>	<i>membranacea, Linn.</i>	..	..	X	X	..	..
1033.	"	<i>pilosa, Linn.</i>	..	..	X	X	..	..
1033g.	"	<i>forma foliacea, Hincks</i>	..	..	X	..	..	..

## LIST OF SPECIES—continued.

		Napier.	Wanganui.	Wellington.	Dunedin.	Foveaux Strait.	Dusky Sound.
<i>Cheilostomata</i> —continued.							
1072.	<i>Membranipora trifolium</i> , S. Wood	..	..	..	..	x	..
1048.	" <i>roborata</i> , Hincks ..	..	..	..	..	x	..
1063.	" <i>spinosa</i> , Q. and G... ..	..	x	x	..	..	..
1081.	" <i>valdemunita</i> , Hincks ..	..	x	x	..	..	..
1060.	" <i>solidula</i> , Alder and H. ..	..	x	x	..	x	..
992.	" <i>hians</i> , Hincks ..	..	x	..	..	..	..
992a.	" " <i>var. occultata</i> , Waters	..	..	..	x	..	..
931.	" <i>acuta</i> , Hincks ..	..	x	..	..	..	..
1017.	" <i>monostachys</i> , Busk ..	..	x	..	..	..	..
1047.	" <i>reticulum</i> , Linn. ..	..	x	..	..	..	..
1051.	" <i>rubida</i> , Hincks ..	..	x	..	..	..	..
1055.	" <i>serrata</i> , McGill ..	..	..	x	..	x	..
937.	" <i>annulus</i> , Manzoni..	..	x	..	..	..	..
1183.	<i>Monoporella crassatina</i> , Waters ..	..	..	x	x	x	..
1182.	" <i>capensis</i> , Busk ..	..	x	..	..	..	..
1585.	<i>Steganoporella neo-zealandica</i> , Busk	..	x	x	..	x	..
1584.	" <i>magnilabris</i> , Busk ..	..	x	x	..	..	..
1133.	<i>Micropora lepida</i> , Hincks ..	..	x	x	..	..	..
1135.	" <i>perforata</i> , McGill ..	..	x	..	..	..	..
1144.	<i>Microporella ciliata</i> , Pallas ..	..	x	x	..	..	..
1144c.	" " <i>var. vibraculifera</i> , Hincks	..	x	x	..	..	x
1147b.	" <i>decorata</i> , Reuss, <i>var. angustipora</i> , Hincks	..	x	..	..	..	..
1145.	" <i>coscinophora</i> , Reuss, <i>var. mucronata</i> , McGill	..	..	..	..	..	x
1161c.	" <i>malusii</i> , Audouin, <i>var. disjuncta</i> , Hincks	..	x	x	..	..	..
445.	<i>Chorizopora brongniartii</i> , Audouin	..	..	..	..	x	..
1217.	<i>Mucronella præstans</i> , Hincks ..	..	x	x	..	..	..
1199a.	" <i>diaphana</i> , McGill, <i>var. armata</i> , Hincks	..	x	..	..	..	..
1229.	" <i>tricuspis</i> , Hincks ..	..	x	..	..	x	..
1212.	" <i>peachii</i> , Johnston ..	..	x	x	..	..	..
1212.	" " <i>var. octodentata</i> , Hincks	..	..	..	..	x	..
1190a.	" <i>biincisa</i> , Waters, <i>var. bicuspis</i> , Hincks	..	x	..	..	..	..
	" <i>firmata</i> , Waters ..	..	x	x	..	..	..
1555.	<i>Smittia napierii</i> , Waters ..	..	x	x	..	..	..
1578.	" <i>unispinosa</i> , Waters ..	..	..	x	x	..	..
1575.	" <i>trispinosa</i> , Johnston ..	..	..	..	x	..	..
1547.	" <i>landsborovii</i> , Johnston ..	..	..	x	..	..	..
1285.	<i>Porella marsupium</i> , McGill ..	..	..	x	..	..	..
809.	<i>Lepralia cincta</i> , Hincks ..	..	..	x	..	..	..
823a.	" <i>flexuosa</i> , Hutton ..	..	..	..	..	x	..
826.	" <i>foraminigera</i> , Hutton ..	..	x	x	..	..	x
848.	" <i>poissonii</i> , Audouin ..	..	x	..	..	..	x
854.	" <i>rectilineata</i> , Hincks ..	..	..	..	..	..	..
845.	" <i>pallasiana</i> , Moll. ..	..	x	x	..	x	..

## LIST OF SPECIES—continued.

	Napier.	Wanganui.	Wellington.	Dunedin.	Foveaux Strait.	Dusky Sound.
<i>Cheilostomata</i> —continued.						
1328. <i>Retepora cellulosa</i> , Linn. . . . .	..	..	..	..	..	..
1324. " <i>avicularis</i> , McGill . . . . .	..	..	..	..	..	X
1327. " <i>fissa</i> , McGill . . . . .	..	..	..	..	X	..
1092. <i>Membraniporella nitida</i> , Johnston . . . . .	..	X	..	..	..	..
473. <i>Cribrilina figularis</i> , Johnston . . . . .	..	..	..	..	X	..
483. " <i>monoceros</i> , Busk . . . . .	..	X	X	..	X	X
715. <i>Haswellia auriculata</i> , Busk . . . . .	..	..	X	X	..	..
725. <i>Hippothoa flagellum</i> , Manzoni . . . . .	..	X	..	..	..	..
723. " <i>divaricata</i> , Lamx. . . . .	..	..	X	X	..	X
1398. <i>Schizoporella biserialis</i> , Hincks . . . . .	..	X	..	..	..	..
1405. " <i>cinctipora</i> , Hincks . . . . .	..	X	X	..	..	X
1395. " <i>auriculata</i> , Hassall. . . . .	..	..	..	..	..	X
1403. " <i>cecilii</i> , Audouin . . . . .	..	X	..	..	..	..
1406. " <i>circinata</i> , McGill . . . . .	..	X	X	..	..	X
1411. " <i>cribrilifera</i> , Hincks. . . . .	..	X	X	X	..	..
1431. " <i>hyalina</i> , Linn. . . . .	..	X	X	..	..	..
1431a. " " <i>var. cornuta</i> , Busk . . . . .	..	X	X	..	..	..
1431c. " " <i>var. tuberculata</i> , Hincks . . . . .	..	..	X	..	..	..
1469. " <i>ridleyi</i> , McGill . . . . .	..	X	X	..	..	..
" <i>scintillans</i> , Hincks . . . . .	..	..	..	..	..	X
1408. " <i>conservata</i> , Waters. . . . .	..	..	..	..	..	X
1476a. " <i>sinuosa</i> , Busk, <i>var. armata</i> , Hincks . . . . .	..	X	..	..	..	X
1378. <i>Rhynchopora bispinosa</i> , Johnston . . . . .	..	X	X	..	..	X
299. <i>Cellepora agglutinans</i> , Hutton . . . . .	..	X	..	X	X	..
355. " <i>granum</i> , Waters . . . . .	..	X	X	..	..	..
356. " <i>hastigera</i> , Busk . . . . .	..	..	X	..	..	..
417. " <i>tridenticulata</i> , Busk . . . . .	..	..	X	..	..	..
<i>Adeonellopsis parvipunctata</i> , McGill . . . . .	..	..	..	X	..	..
<i>Cyclostomata</i> .						
501. <i>Crisia edwardsiana</i> , d'Orb. . . . .	..	X	X	..	..	X
773. <i>Idmonea ramosa</i> , d'Orb. . . . .	..	..	..	..	X	X
757. " <i>contorta</i> , Busk . . . . .	..	X	X	..	..	..
757. " <i>marionensis</i> , Busk . . . . .	..	X	..	..	..	..
771. " <i>radians</i> , Lamk. . . . .	..	..	X	..	..	X
770. " <i>parasitica</i> , Busk . . . . .	..	..	X	..	..	..
775. " <i>serpens</i> , Linn. . . . .	..	..	X	..	..	X
769. " <i>milneana</i> , d'Orb. . . . .	..	X	X	X	..	X
458. ? " <i>cancellata</i> , Golistein . . . . .	..	X	..	..	..	..
585. <i>Entalophora raripora</i> , d'Orb. . . . .	..	..	..	..	..	X
582. " <i>intricaria</i> , Busk . . . . .	..	..	X	..	..	..
580. " <i>haastiana</i> , Stoliczka. . . . .	..	..	X	..	..	..
583. " <i>parasitica</i> , Busk . . . . .	..	X	..	..	..	..
" <i>proboscidea</i> , Waters . . . . .	..	..	..	..	..	X
448. <i>Cinctipora elegans</i> , Hutton . . . . .	..	..	X	X	..	X
552. <i>Diastopora sarniensis</i> , Norman . . . . .	..	X	X	..	..	X
553. " <i>suborbicularis</i> , Hincks . . . . .	..	..	X	..	..	X

LIST OF SPECIES—continued.

	Napier.	Wanganui.	Wellington.	Dunedin.	Foveaux Strait	Dusky Sound.
<i>Cyclostomata</i> —continued.						
644. <i>Filisparsa irregularis</i> , <i>Menegh.</i> ..	..	x	..	..	..	..
1604. <i>Stomatopora granulata</i> , <i>M.-Edw.</i> ..	..	x	..	..	..	..
1608. " <i>major</i> , <i>Johnston</i> ..	..	..	..	..	x	..
754. <i>Hornera foliacea</i> , <i>McGill.</i> ..	..	..	x	..	..	x
743. " <i>striata</i> , <i>Stoliczka</i> ..	..	..	..	..	x	..
735. " <i>frondiculata</i> , <i>Lamx.</i> ..	..	..	..	..	..	x
1645. <i>Tubulipora biduplicata</i> , <i>Waters</i> ..	..	..	..	..	x	x
1682. <i>Supercystis digitata</i> , <i>d'Orb.</i> ..	..	..	x	x	..	x
881. <i>Lichenopora holdsworthii</i> , <i>Busk</i> ..	..	..	..	..	x	..
887. " <i>novae-zealandiae</i> , <i>Busk</i> ..	..	x	..	..	..	..
875. " <i>clypeiformis</i> , <i>d'Orb.</i> ..	..	x	x	..	..	x
880. " <i>hispidia</i> , <i>Fleming</i> ..	..	x	x	..	..	..
889. " <i>pristis</i> , <i>McGill</i> ..	..	..	..	..	x	..
" <i>wanganuiensis</i> , <i>Waters</i> ..	..	x	x	..	..	..
719. <i>Heteropora pelliculata</i> , <i>Waters</i> ..	..	..	..	..	x	..
<i>Ctenostomata.</i>						
697. <i>Flustrella binderi</i> , <i>Harvey</i> ..	..	x	..	x	x	..
<i>Amathia swainsoni</i> , <i>Hutton</i> ..	..	..	..	x	x	..

LIST OF TERTIARY CHEILOSTOMATOUS BRYOZOA FROM NEW ZEALAND, BY ARTHUR W. WATERS.\*

NOTE.—a or z indicates that the form is known living in Australia or New Zealand; 1 = Curdie's Creek; 2 = Mount Gambier; 3 = Bairnsdale; 4 = Muddy Creek; 5 = Aldinga; 6 = Murray Cliffs.

	Living.	Napier.	Waipukurau.	Petane.	Trig. Station.	Shakespeare's Cliff.	Australian (fossil).
285. <i>Cellaria malvinensis</i> , <i>Busk</i> ..	x <sup>z</sup>	..	x	..	..	x	1, 2, 3, 4, 6
1017. <i>Membranipora monostachys</i> , <i>Busk</i> ..	x <sup>z</sup>	x	..	..	..	..	..
1002. " <i>lineata</i> , <i>Linn.</i> ..	x <sup>z</sup>	..	..	..	..	x	..
" <i>lacreixii</i> , <i>Audouin</i> , var. <i>grandis</i> , <i>Waters</i> ..	..	x	x	..	..	..	..
978. " <i>dumerilii</i> , <i>Audouin</i> ..	x	..	x	..	..	..	..
" <i>nobilis</i> , <i>Reuss</i> ..	..	x	..	x	..	..	..
1060. " <i>solidula</i> , <i>Alder and H.</i> ..	x <sup>z</sup>	..	x	..	..	x	..
937. " <i>annulus</i> , <i>Manzoni</i> ..	x	x	x	x	..	..	2
956. " <i>cervicornis</i> , <i>Busk</i> ..	x <sup>a</sup>	x	..	..	..	..	2
1063. " <i>spinosa</i> , <i>Q. and G.</i> ..	x <sup>az</sup>	x	..	..	..	..	..
985. " <i>flemingii</i> , <i>Busk</i> ..	x	x	..	..	..	..	5
1072. " <i>trifolium</i> , <i>S. Wood</i> ..	x	x	..	..	..	..	..

\* Quar. Jour. Geol. Soc., vol. 43, 1887, p. 40, pl. vi.-viii.

## LIST OF TERTIARY CHEILOSTOMATOUS BRYOZOA, ETC.—continued.

	Living.	Napier.	Waipukurau	Petane.	Trig. Station	Shakespeare's Cliff.	Australian (fossil).
992a. <i>Membranipora hians</i> , <i>Hincks</i> , var. <i>occultata</i> , <i>Waters</i>	x <sup>z</sup>	x	..	..	..	..	..
1182. <i>Monoporella capensis</i> , <i>Busk</i>	..	x	x	x	..	..	x
"    "    var. <i>dentata</i> , <i>W.</i>	..	x	..	..	..	..	..
1183.    " <i>crassatina</i> , <i>Waters</i>	..	x <sup>z</sup>	x	x	..	..	2, 5, 6
1184.    " <i>disjuncta</i> , <i>Manzoni</i>	..	x <sup>z</sup>	x	..	..	..	..
"    " <i>waipukurensis</i> , <i>Waters</i>	..	..	x	x	..	x	..
1585. <i>Steganoporella neo-zelanica</i> , <i>Busk</i>	..	x <sup>z</sup>	x	x	x	..	..
1133. <i>Micropora lepida</i> , <i>Hincks</i>	..	x <sup>z</sup>	x	..	..	..	..
1128.    "    " <i>elongata</i> , <i>Hincks</i>	..	x <sup>z</sup>	x	..	..	x	..
1092. <i>Membraniporella nitida</i> , <i>Johnston</i> , var.	..	x <sup>z</sup>	x	x	..	..	..
483. <i>Cribrilina monoceros</i> , <i>Busk</i>	..	x <sup>a</sup>	x	x	..	..	3
473.    "    " <i>figularis</i> , <i>Johnston</i>	..	x	..	x	..	..	6
485.    "    " <i>radiata</i> , <i>Moll.</i> , var. <i>endlicheri</i> , <i>Reuss</i>	..	x <sup>z</sup>	..	..	..	..	..
1144. <i>Microporella ciliata</i> , <i>Pallas</i>	..	x <sup>az</sup>	x	x	..	x	..
1161.    "    " <i>malusii</i> , <i>Audouin</i>	..	x <sup>az</sup>	x	..	x	..	..
1160.    "    " <i>macropora</i> , <i>Stoliczka</i>	..	x <sup>a</sup>	..	x	..	..	..
1147b.    "    " <i>decorata</i> , var. <i>angustipora</i> , <i>Hincks</i>	..	x <sup>z</sup>	x	x	x	x	..
1217. <i>Mucronella præstans</i> , <i>Hincks</i>	..	x <sup>z</sup>	..	x	..	..	..
1212.    "    " <i>peachii</i> , <i>Johnston</i>	..	x <sup>z</sup>	x	..	..	..	1, 2
1212b.    "    "    var. <i>octodentata</i> , <i>Hincks</i>	..	x <sup>z</sup>	x	x	..	x	..
1187.    "    " <i>alvareziana</i> , <i>d'Orb.</i>	..	x	..	x	..	x	..
1229.    "    " <i>tricuspis</i> , <i>Hincks</i>	..	x <sup>az</sup>	..	..	x	..	..
"    "    var. <i>waipukurensis</i> , <i>W.</i>	..	..	..	x	..	..	..
1214.    "    " <i>porosa</i> , <i>Hincks</i> , var. <i>minima</i> , <i>W.</i>	..	..	..	..	x	..	..
"    " <i>liversidgei</i> , <i>Ten.-Woods</i>	..	..	..	x	..	..	2
"    " <i>firmata</i> , <i>Waters</i>	..	..	x	x	..	..	..
1190.    "    " <i>biincisa</i> , <i>Waters</i>	..	x <sup>z</sup>	..	x	..	..	..
1562. <i>Smittia reticulata</i> , <i>J. McGill</i>	..	x <sup>az</sup>	..	..	..	..	2, 3, 6
1547.    "    " <i>landsborovii</i> , <i>Johnston</i>	..	x <sup>a</sup>	..	..	x	..	6
1556.    "    " <i>nitida</i> , <i>Verrill</i>	..	x <sup>a</sup>	x	x	..	..	3, 6
1555.    "    " <i>napierii</i> , <i>Waters</i>	..	x <sup>a</sup>	x	x	..	x	..
1298. <i>Porina magnirostris</i> , <i>McGill</i>	..	x <sup>a</sup>	..	x	..	..	2, 6
715. <i>Haswellia auriculata</i> , <i>Busk</i>	..	..	x	..	..	..	..
842. <i>Lepralia mucronata</i> , <i>Smith</i>	..	x <sup>a</sup>	x	..	..	..	1, 2, 3, 4, 6
848.    "    " <i>poissonii</i> , <i>Audouin</i>	..	x <sup>z</sup>	x	x	x	..	x
854.    "    " <i>rectilineata</i> , <i>Hincks</i>	..	x <sup>z</sup>	x	x	..	..	x
829a.    "    " <i>imbellis</i> , <i>Busk</i>	..	..	x	x	x	..	..
846.    "    " <i>pertusa</i> , <i>Esper.</i>	..	x	x	..	..	..	4
817.    "    " <i>depressa</i> , <i>Busk</i>	..	x	x	..	..	..	6
"    "    var. <i>semiluna</i> , <i>Reuss</i> , var. <i>simplex</i> , <i>W.</i>	..	..	x	..	..	..	..
826.    "    " <i>foraminigera</i> , <i>Hincks</i>	..	x <sup>z</sup>	..	x	..	..	..
"    " <i>bistata</i> , <i>Waters</i>	..	..	..	x	..	..	..
530. <i>Cyclicopora longipora</i> , <i>McGill</i>	..	x <sup>a</sup>	..	x	..	x	..



LIST OF TERTIARY CHEILOSTOMATOUS BRYOZOA, ETC.—continued.

	Living.	Napier.	Waipukurau.	Petane.	Trig. Station.	Shakespeare's Cliff.	Australian (fossil).
1285. <i>Porella marsupium</i> , McGill ..	x	..	x	..	..	..	..
1285a. " " var. <i>porifera</i> , <i>Hincks</i>	x	x	x	..	..	..	..
1277. " <i>concinna</i> , Busk ..	x	..	..	..	x	..	2
725. <i>Hippothoa flagellum</i> , Manzoni ..	x <sup>z</sup>	x	..	..	..	..	..
1406. <i>Schizoporella circinata</i> , McGill ..	x <sup>z</sup>	..	x	..	..	..	..
1395. " <i>auriculata</i> , Hassall ..	x <sup>a</sup>	x	..	..	..	..	2, 3
1469. " <i>ridleyi</i> , McGill ..	x <sup>a</sup>	x	x	..	..	..	..
1453. " <i>marsupifera</i> , Busk ..	x <sup>z</sup>	..	x	..	..	..	..
1397. " <i>biaperta</i> , Mich. ..	x <sup>z</sup>	..	x	..	..	..	..
1411. " <i>cribrilifera</i> , Hincks ..	x <sup>z</sup>	..	..	x	..	x	..
" <i>clavula</i> , Manzoni ..	..	..	x	..	..	..	..
1408. " <i>conservata</i> , Waters ..	x <sup>a</sup>	x	..	..	..	..	1, 2
" <i>obliqua</i> (?), McGill ..	x <sup>a</sup>	..	x	..	..	..	..
1405a. " <i>cinctipora</i> , Hincks, var. <i>personata</i> , W.	x <sup>z</sup>	..	x	x	..	..	..
1487. " <i>tuberosa</i> , Reuss, var. <i>angustata</i> , W.	..	..	x	..	..	..	..
1431. " <i>hyalina</i> , Linn. ..	x <sup>a</sup>	..	x	..	x	x	..
300. <i>Cellepora albirostris</i> , Smitt. ..	x <sup>a</sup>	x	..	..	..	x	6
417. " <i>tridenticulata</i> , Busk ..	x <sup>a</sup>	..	x	..	..	..	5, 6
328. " <i>coronopus</i> , S. Wood ..	x	x	..	..	..	..	2, 5
331. " <i>costata</i> , McGill ..	x <sup>a</sup>	x	..	..	..	..	..
" <i>decepta</i> , Waters ..	..	x	..	..	..	..	..
1380. <i>Rhyncopora longirostris</i> , Hincks ..	x <sup>a</sup>	x	..	..	..	..	..
<i>Lunulites petaloides</i> , d'Orb. ..	x	x	..	..	..	x	2, 4
<i>Cyclostomata.*</i>							
553. <i>Diastopora suborbicularis</i> , Hincks ..	x	x	x	x	..	..	..
585. <i>Entalophora raripora</i> , d'Orb. ..	x	x	x	x	..	..	..
735. <i>Hornera frondiculata</i> , Lamx. ..	..	..	x	..	x	..	..
880. <i>Lichenopora hispida</i> , Fleming ..	..	..	..	x	x	..	..

\* I find a few of our New Zealand fossil Cyclostomata mentioned in a paper by Mr. Waters "On North Italian Bryozoa," part ii., in the Quar. Jour. Geol. Soc. for 1892 (vol. 48, p. 133).

ART. XXIV.—*On the Hydroids of the Neighbourhood of Dunedin.*

By F. W. HILGENDORF, M.A.

(From the Biological Laboratory of the University of Otago.)

[Read before the Otago Institute, 13th July, 1897.]

Plates XVI.—XXI.

I SHALL divide this paper into three parts—First, an account of the methods employed in collecting and preserving the specimens, the books of reference at my disposal, the classification followed, &c. ; second, a detailed account of the species obtained ; and, third, a summary of results, both as regards my own knowledge and facts hitherto unrecorded.

INTRODUCTION.

My chief collecting-ground has been Otago Harbour, especially on the stones and piles under the wharves. Two species were found in rock-pools on Tomahawk Beach, where the open ocean breaks, and the skeletons of a few dead specimens were found on Kuri Beach, a few miles further south. I collected intermittently during the six months between April and October, our winter season in this hemisphere, and therefore an unfavourable time as regards weather, while only in the last one or two months is there any chance of seeing anything of the reproduction. This accounts for the frequency of those unsatisfactory words "Gonosome not present." I have preserved specimens of all the species and varieties obtained, as a rule staining them with borax carmine and mounting them in Canada balsam. Living specimens were always killed by osmic acid, since this is by far the quickest killing method known to me, often fixing the zooids before they have time to retract their tentacles. For examination of fresh specimens methyl green was usually employed as a stain, and treatment with 1 per cent. acetic acid was found to be a very satisfactory clearing agent. Sections were cut in a few cases where mere microscopic examination failed to reveal all the details of structure. Specimens to be cut in section were fixed by Flemming's strong chromo-aceto-osmic acid solution (*vide* Lee's "Microtomists' Vade-mecum," sec. 36), hardened by increasing strengths of alcohol, imbedded in paraffin, and cut in sections  $\frac{1}{100}$  mm. thick. They were then stained with hæmatoxylin, and mounted in Canada balsam in the usual way.

I have had at my disposal a fair number of books and papers on the hydroids. The following are those that I have actually consulted:—Allman: *Gymnoblástico Hydroids*; Trans. Royal Society, vol. clxviii.; “Challenger” Reports in vols. vii. and xxiii.; “*Linneæan Society Journal*,” vol. xii.; “*Gulf Stream Hydroids*.” Hincks: *Ann. and Mag. of Natural History*, ser. 3, vol. viii.; *ibid.*, ser. 2, vol. x. Thompson: *Ann. and Mag. Nat. Hist.*, 10, iv. Grey: Dieffenbach’s “*New Zealand*.” Johnstone: “*British Zoophytes*.” Hutton: *Trans. N.Z. Inst.*, v., p. 256. Coughtrey: *Trans. N.Z. Inst.*, vii., p. 283; *ibid.*, viii.; and *Ann. Mag. Nat. Hist.* (4), xvii. Von Lendenfeld: *Linn. Soc. N.S.W.*, ix.; *Zeitschrift für wiss. Zool.*, Band. xxxviii. Bale: *Linn. Soc. N.S.W.*, 2, iii.; *Catalogue of Aust. Hyd.* Clarke: “*Bulletin of Comparative Zoology of Harvard College*,” vol. xxv., No. 6. Farquhar: *Catalogue of N.Z. Hydroids*, in *Trans. N.Z. Inst.*, vol. xxviii., p. 459. In all, nineteen books and papers. Other works are referred to in the descriptions of the species, but these are all I have had the opportunity of consulting for myself. Mr. Farquhar’s paper has been of the greatest service to me, as it contains an exhaustive and absolutely correct catalogue of our hydroids, with references to all the works in which they have been mentioned. Hydroids described under many names have been identified by careful comparison, and the study of the group greatly facilitated thereby.

I have followed the classification given by Allman in his report on the hydroids collected by the “Challenger” Expedition, vol. xxiii., p. lii.

<i>Sub-order.</i>	<i>Legion.</i>	<i>Family.</i>
Gymnoblæstea	Tubularinæ ..	Clavidiæ, Bongainvillidiæ, Eudendridæ.
	Hydractininiæ ..	Hydractinidiæ, &c.
	Corymorphinæ ..	Monocaulidiæ, &c.
	Hydrolarinæ ..	Monobranchildæ, &c.
Calypthoblæstea	Campanularinæ ..	Campanularidiæ, &c.
	Sertularinæ ..	Sertularidiæ, Syntheceidiæ, &c.
	Plumularinæ ..	Plumularidiæ, Aglaophenidiæ, &c.
	Thalamomorpha ..	Idiidiæ.

## GYMNOBLÆSTEÆ.

## CLAVIDÆ.

**Tubiclava fruticosa.** Plate XVI., figs. 1, 1a.

*Tubiclava fruticosa*, Allman, 1871, *Gymno.-Hyd.*, 257.

Trophosome: Hydrocaulus attaining a height of 1 in., more or less branched; perisarc smooth. Hydranths claviform, tentacles occupying the distal two-thirds of the zooid. They are about fourteen in number.

Gonosome: Unknown.

*Hab.* Europe; Dunedin.

The specimens found by Allman were of a bright-vermilion colour and  $\frac{1}{3}$  in. in height. Mine, as I say, are a full inch in height, and of only a very dusky-red colour. They were, however, found under a wharf at Dunedin, and quite covered with slime and dirt. After preservation in spirit they have become quite black. My specimens grow in little tufts, just as Allman describes his as doing.

## BOUGAINVILLIDÆ.

### HEMITHECA, nov. gen.

**Hemitheca intermedia**, nov. sp. Plate XVI., figs. 2, 2a.

Trophosome: Hydrocaulus branching and well developed, divided into internodes by distinct constrictions in a conspicuous perisarc. A branch springs from the distal part of each internode of the main stem, and a hydrotheca from the same part of each internode on the branches. The hydrotheca does not deserve this name, for though it covers the peduncle of the hydranth, swells into a cup shape, and has a small intrathecal ridge, yet the zooid is quite incapable of being retracted into it. Hydranth has a conical hypostome, surrounded by eighteen tentacles, disposed in a single row.

Gonosome: Not present.

*Hab.* Submerged piles, Dunedin Wharf.

This genus possesses all the interest common to transition forms, for it markedly partakes of the characters of both gymnoblasts and calyptoblasts. The method of growth and branching, the division into internodes, the pseudo-hydrothecæ with their intrathecal ridges, all belong to the sertularian type of hydroids, and if I had found this as a dry dead specimen I should have referred it to the genus *Campanularia*; but the irretractability of the zooids (which is quite diagnostic of gymnoblasts), the conical hypostome, with its single row of tentacles surrounding it, is quite a characteristic of the *Bougainvillidæ*. The colony in my specimens reached the height of 2 in. The time of the year perhaps accounted for the entire absence of gonophores. Both specific and generic names denote the place of this hydroid between the two sub-classes.

## TUBULARIADÆ.

**Tubularia attenoides**. Plate XVI., figs. 3, 3a.

*Tubularia attenoides*, Coughtrey, 1875, Trans. N.Z. Inst., viii., 302.

Trophosome: The hydrocaulus consists of a cluster of simple semi-tortuous stems springing from a branched creep-

ing hydrorhiza. The hydrophyton is from 1 in. to 2 in. in height. Perisarc is annulated for the proximal third of its length, where it is tough in texture and horny in colour; higher up it is only irregularly wrinkled and transparent, while near its distal end it is again delicately annulated. Hydranth consisting of two parts, each bearing its row of tentacles, proximal row about 24, distal about 16. General colour of the zooid, orange-vermilion.

Gonosome: Not present.

*Hab.* Dunedin Harbour and Tomahawk Beach, in rock-pools.

As this hydroid grows in patches about the size of a five-shilling-piece attached to the side of a rock-pool, with its bright colours and waving tentacles quite visible to the naked eye, it forms one of the prettiest objects to be met with in the rock-pools of our coast. When on a slide or in a watch-glass of salt-water it has a curious habit of curling up its tentacles into more or less of a spiral. The colouring is deepest within the distal or inner circuit of tentacles, and extends in a dusky vermilion into the distal end of the cœnosarc. Sections  $\frac{1}{2500}$  in. in thickness failed to show any trace of nerve cells, but showed that the endoderm cells almost close up the cavity of the enteron, leaving only a narrow tube.

***Obelia nigrocaulus*, nov. sp.** Plate XVII., figs. 1, 1a.

Trophosome: Hydrocaulus irregularly branched, the branches bearing hydrothecæ on alternate sides. Branches annulated (6 or 7 rings) above the origin of each hydrotheca. Hydrothecæ supported on pedicels almost as long as the theca and marked with 6-8 annulations; conical rather narrow, graceful, and with entire thecostome. Basal part of hydrocaulus deep-black, further up dark-brown, next light-brown, and distal branchlets quite transparent. Hydrothecæ borne only on distal ends of branches.

Gonosome: Not present.

*Hab.* On stones; very plentiful at low-water mark, Dunedin Harbour.

On several occasions I picked up stones covered with a black bristly growth while looking for hydroids under the Dunedin wharves. My pocket-lens showed nothing of the structure of this growth, and I frequently threw it away as a decayed seaweed; but one day, my curiosity having been piqued, I took a piece home and examined it in sea-water under the microscope. Then I found that, though the greater part of the growth was enclosed in a dense black cuticular substance, the distal parts of it bore very graceful campanulate hydrothecæ, from which equally graceful and slender polyps were protruded and actively waving their tentacles.

The black pigment lies in the perisarc, and seems to be deposited periodically, since it is deepest in the oldest parts of the hydrocaulus. The specific name is descriptive.

**Obelia geniculata.** Plate XVII., figs. 2, 2a.

*Obelia geniculata*: Linnæus, 1767, Syst. Nat., i., 1312. Allman, 1864, Ann. Nat. Hist. (3), xiii., 372, 1888; Rep. Hydroida, Chall. Exp., vol. 23, pt. 70, p. 23. Coughtrey, 1875, Trans. N.Z. Inst., viii., 299; Ann. Nat. Hist. (4), xvii., 24. Hincks, 1868, Hist. Brit. Hyd. Zooph., 149. Bale, 1884, Cat. Aus. Hyd., 59, 1894; Proc. Roy. Soc. Vic. (new series), vi., 99. Marktanner-Turneretscher, 1890, Annal. des k. k. Natur. Hofm., v., 208.

*Laomedra geniculata*: Lamouroux, Cor. Flex., 205. Johnstone, Brit. Zoo., 103. Coughtrey, 1874, Trans. N.Z. Inst., vii., 290.

*Sertularia geniculata*, Linnæus, Syst. Nat., i., 1312.

*Eucope diaphana*, Agassiz, Nat. Hist. U.S., iv., 322.

Trophosome: Hydrocaulus consisting of simple stems, which arise from an open network hydrorhiza, and attain a height of  $\frac{3}{4}$  in. Hydrothecæ conical, slender, with entire margin, alternate, supported each on a strongly annulated peduncle. Below the peduncle in every case is a bracket or knee-like swelling of the chitinous perisarc, which gives the species its name.

Gonosome: Gonangia borne on short annulated peduncles which spring from the angles between the hydrothecæ and the stem, urn-shaped, gradually widening from below upwards, and terminating distally in a short band-like neck which carries the orifice on its summit.

*Hab.* Australia; Wellington Harbour; Cook Strait; south and east coast of South Island; Europe; east coast of North America.

Coughtrey remarks that this species presents some variation between its New Zealand and European forms, the chief being the greater strength and stoutness of the New Zealand variety. A specimen that I secured at Port Chalmers seemed to have gone into a purely reproductive phase; all the nutritive polyps were dead, and even the hydrothecæ, with part of their peduncles, were broken off; but the whole hydrocaulus was covered with gonangia, from which the medusa buds, although it was mid-winter, were in the act of escaping. Another specimen from Tomahawk Rocks showed the same peculiarity. This is one of the commonest hydroids in our harbour, often spreading over whole masses of seaweed. Its milk-white appearance as it floats in the water, and its

bracket-like swellings of perisarc as it lies on the microscope slide, always make it easy to recognise.

\**Calycella parkeri*, nov. sp. Plate XVII., figs. 3, 3a, 3b, 3c, 3d, and Plate XVIII.

Trophosome: A creeping filamentous hydrorhiza gives off shoots which are delicate, transparent, profusely branched, and rise to the height of 1 in. Hydrocaulus strongly ringed above the origin of each branch; branches annulated above their origin and distal to the origin of each hydrotheca; pedicels of hydrothecæ annulated. Hydrothecæ alternate, campanulate, with thecostome entire, wavy or regularly serrated, with small even teeth. Interior of central cavity of cœnosarc pigmented. Hypostomes very large.

Gonosome: Reproduction by means of sporosacs or degenerate medusæ affixed to the blastostyle. The gonatheca is large and campanulate, with a broad open mouth. Three sporosacs, as a rule; one blastostyle, which elongates as the distal sporosacs are extruded. They remain connected with, are receiving nourishment through, the blastostyle till the ova are matured, and the planulæ or ciliated larvæ formed.

*Hab.* On piles, Dunedin Harbour.

The most remarkable feature about the trophosome of this hydroid occurs in connection with the zooid. The hypostome is extremely distensible, and often expands into a great trumpet-like body considerably larger than the zooid itself. While in a state of retraction it projects above the retracted tentacles. A brown pigment is lodged in the endoderm cells. The nematocysts of the tentacles are very large, and are placed in bands round the tentacles at regular intervals, giving them a segmented appearance. The method of reproduction seems comparatively rare among Calyptoblasts, occurring only in three *Sertularia* and in *Calycella*. All the sporosacs that I observed were females, containing ova, but probably the sperms are liberated earlier, and I was too late to see them. One point in the reproduction seems unlike anything that I have read about—that is, that the planula, even after it has burst the acrocyst, seemed to be attached to the spadix by a stalk. For this to be the case all the ova must remain attached to the spadix when they are budded off from it, and this is proof of the endodermal origin of the reproductive elements in this case. There are two well-defined varieties of gonosome, and I think the one with the long gonatheca and numerous sporosacs may be named variety "*Macrogonangiata*." This hydroid grows very abundantly on the piles up to 2½ ft. above the low-water mark. Thus it was for at least four hours per tide out of water. This is the only

hydroid that I have observed living above low-tide mark. The specific name is in honour of Professor T. J. Parker, D.Sc., F.R.S.

**Sertularia bispinosa.** Plate XIX., figs. 1, 1a.

*Dynamene bispinosa*, Gray, 1843, Dieffenbach's "New Zealand," ii., 294.

*Sertularia bispinosa*: Hutton, 1872, Trans. N.Z. Inst., v., 257. Coughtrey, 1874, *ib.*, vii., 284; 1875, *ib.*, viii., 300; 1876, *ib.*, Ann. Nat. Hist. (4), xvii., 27. Bale, 1884, Cat. Aus. Hyd., 68; 1887, Trans. Roy. Soc. Vic., xxiii., 92; 1888, Proc. Linn. Soc. N.S.W., 2, iii., 745. Marktanner-Turneretscher, 1890, Annal. des k. k. Natur. Hofm., v., 229.

*Sertularia operculata* (?), Thompson, 1879, Ann. Nat. Hist. (5), iii., 106.

*Diphasia symmetrica*, v. Lendenfeld, 1884, Proc. Linn. Soc. N.S.W., ix., 414.

Trophosome: The hydrophyton is long, lax, and strong. Hydrocaulus sparingly dichotomously branched. Hydrothecæ opposite, tubular; aperture obliquely truncated, and with two strong teeth on the outside.

Gonosome: Gonangia large and pyriform, smooth, with a strong tooth on each side at the top, rising above the gonostome.

*Hab.* Indian Ocean; Australia; Auckland; Lyall Bay; Dunedin.

This is by far the commonest hydroid of the neighbourhood. It grows very plentifully on the shells of sea-mussels, having there the appearance of a strong beard. In the specimens that reach a greater size the hydrocaulus is much more tender and thin. One specimen of mine is 18 in. high, while others of the strong variety do not attain a height of above 2 in.

Since writing the above I have found many specimens with a form of gonophore different from that figured in Plate XX., fig. 1. These specimens are so numerous that I cannot doubt that the variety of gonosome reproduced in Plate XX., fig. 7a, is the commoner one, and this opinion is strengthened by the fact that this is the form given by Coughtrey as the only one observed by him. Instead of the gonophore being pyriform it is almost triangular, and the lateral teeth, instead of being comparatively small, are immense projections rising far above the orifice of the gonophore. I have found this big-toothed variety in *S. bispinosa*, *trispinosa*, and *elongata*, and in *S. trispinosa* I have also found gradations between the two varieties figured.



**Sertularia trispinosa.** Plate XX., figs. 7, 7a, 7b.

*Sertularia trispinosa*: Coughtrey, 1874, Trans. N.Z. Inst., vii., 284; 1875, *ib.*, viii., 300; 1876, Ann. Nat. Hist. (4), xvii., 28; Bale, 1884, Cat. Aus. Hyd., 69; 1883, Proc. Roy. Soc. Vict., xxiii., 92.

Trophosome: Hydrophyton lax, bushy. Hydrocaulus delicate, silvery-yellow, branched. Hydrothecæ opposite, tubular. Thecostome with three very distinct long sharp teeth.

Gonosome: Sessile, large, triangular. Gonophores with two large teeth rising on each side of the orifice, or the teeth may be of an uneven size and the orifice on an elevation, as in fig. 7a.

*Hab.* New Zealand; Australia; Taieri Beach.

I found my specimens of this species in the same habitat as those mentioned by Coughtrey—namely, on the stems of *Boltenia*. The two varieties of gonophore are interesting, for through the uneven-toothed one we easily arrive at that figured on Plate XIX., 3b, as the ordinary one for *S. trispinosa* and *elongata*.

**Sertularia johnstoni.** Plate XIX., figs. 2, 2a.

*Sertularia johnstoni*: Gray, 1843, Dieffenbach's "New Zealand," ii., 294. Hutton, 1872, Trans. N.Z. Inst., v., 256. Coughtrey, 1874, *ib.*, vii., 281.

*Sertularia subpinnata*, Hutton, 1872, Trans. N.Z. Inst., v., 256.

*Sertularia delicatula*, Hutton, 1872, Trans. N.Z. Inst., v., 256.

*Sertularella johnstoni*: Coughtrey, 1875, Trans. N.Z. Inst., viii., 299; 1876, Ann. Nat. Hist. (4), xvii., 26. Thoupson, 1879, Ann. Nat. Hist. (5), iii., 101. Allman, 1876, Jnl. Linn. Soc. (Zoo.), xii., 261. Bale, 1884, Cat. Aus. Hyd., 109; 1887, Proc. Roy. Soc. Vict., xxiii., 93; 1894, *ib.*, vi. (new ser.), 102.

*Sertularella purpurea*, Kirchenpauer, 1884, Abh. des Natur., viii.

Trophosome: Hydrophyton is lax and delicate. The hydrocaulus spreads dichotomously, and is subpinnately branched. The branching is profuse, so that the whole hydrophyton forms a tangled mass. The hydrothecæ are far apart, alternate, and exserted. Thecostome tridentate, two strong blunt cusps on the apocauline and one on the epicauline side.

Gonosome: Gonangia subpedicellate, large, transversely ridged; from six to ten ridges, the distal ones usually best marked. In some the gonostome is situated in a saucer-like depression in the truncated end of the gonangium; in others there is an infundibuliform tube; and in others again a simple tube.

*Hab.* Australia; Tasmania; Chatham Islands; Lyall Bay (Wellington); and east and south coasts of the South Island: in rock-pools and on seaweeds.

This hydroid is very common on the coast near Dunedin; it is found attached to fronds of a Laminarian and to pebbles. Tangled masses of dead specimens as large as one's fist are often picked up on the beach. Farquhar, in his catalogue of New Zealand hydroids, mentions this one as *Sertularella johnstoni*; but Samuel F. Clarke, writing in "The Bulletin of the Museum of Comparative Zoology at Harvard College" (vol. 25, No. 6, xi., p. 76), says that Allman is of opinion that the later knowledge gained of the genera *Sertularia* and *Sertularella* makes it necessary to unite them, retaining the name *Sertularia*; and, although I have not been able to find Allman's remarks to this effect, I have described this species under the name given it by Gray in 1843—*Sertularia johnstoni*.

***Sertularia elongata.*** Plate XIX., figs. 3, 3a, 3b.

*Sertularia elongata*: Lamouroux, 1816, Hist. Polyp. Flex., 189. Thompson, 1879, Ann. Nat. Hist. (5), iii., 107. Bale, 1884, Cat. Aus. Hyd. Zooph., 75; 1888, Proc. Linn. Soc. N.S.W., ii., 3, 770. Allman, 1885, Jnl. Linn. Soc. (Zoo.), xix., 140. Marktanner-Turneretscher, 1890, Ann. des k. k. Natur. Hofm., v., 230.

*Dyamene abietinoides*, Gray, 1843, Dieffenbach's "New Zealand," ii., 294.

*Sertularia abietinoides*: Hutton, 1872, Trans. N.Z. Inst., v., 257. Coughtrey, 1874, *ib.*, vii., 285; 1875, *ib.*, viii., 300; 1876, Ann. Nat. Hist. (4), xvii., 28.

Trophosome: The hydrorhiza forms a close strong fibrous network, spreading over and clinging to the object to which it is attached; it occurs in clumps or patches, not being very extensive. Hydrophyton erect. Hydrocaulus gives off alternate pinnæ at very short intervals; the more distant of the pinnæ may be themselves branched. The hydrothecæ occur in pairs, subopposite, tubular, slightly sigmoid, incurved, and free for about a third of their length. Thecostome furnished with five or six fairly long acute teeth. The hydrothecæ occur on the main stem, as well as on the pinnæ.

Gonosome: The gonangia spring from a point just below the origin of the hydrothecæ; they are pyriform and large, being about three times as long as a hydrotheca, truncated at the orifice, and having long spines springing from the sides of the gonangia, and rising considerably above the gonostome.

*Hab.* Australia; Tasmania; Lyall Bay (Wellington); Kuri Beach and Taieri Beach (Otago): on fronds of seaweeds.

This species seems to vary considerably in size. Thompson

mentions that the hydrocaulus may attain the height of 5 in. My largest specimen is 3 in. long, while Coughtrey's Lyall Bay specimen barely measured  $1\frac{1}{2}$  in. It is, according to Bale, by far the commonest species on the south coast of Australia, but does not seem so common in New Zealand, since Coughtrey found none in Otago, and all my specimens were collected on the Kuri Beach, where, however, they are fairly abundant. It is a very beautiful feathery hydroid, and its beauty is often increased by the secondary branching of its pinnæ. Thompson describes the Australian varieties as jointed, but my specimens do not show any sign of nodes. The colour varies from a light to a rather dark horn. The specimen found at Taieri Beach was well marked by having immensely long teeth round the thecostome. In some cases these teeth are as long as the rest of the hydrotheca. In this specimen, too, the gonophore was triangular, and had immense lateral teeth like that of *S. bispinosa*.

**Sertularia minima.** Plate XX., figs. 1, 1a.

*Synthecium gracilis*, Coughtrey, 1874, Trans. N.Z. Inst., vii., 286.

*Sertularia pumila*, Coughtrey, 1875, Trans. N.Z. Inst., viii., 301; 1876, Ann. Nat. Hist. (4), xvii., 29.

*Sertularia minima*: Thompson, 1879, Ann. Nat. Hist. (10), iii., 104. Bale, 1884, Cat. Aus. Hyd., 89; 1887, Proc. Roy. Soc. Vic., xxiii., 109. Marktanner-Turneretscher, 1890, Annal. des k. k. Natur. Hofm., v., 231. Allman, 1885, Jnl. Linn. Soc. (Zool.), xix., 138.

*Sertularia plumiloides*, Bale, 1882, Jnl. Mic. Soc. Vic., ii., 21, 45.

Hydrorhiza delicate, creeping over the fronds of seaweeds. It is marked by little pit-like indentations.

Trophosome: Hydrocaulus erect, attaining a height of no more than  $\frac{1}{4}$  in., and bearing six to ten pairs of opposite synthealous, adnate, tubular hydrothecæ. Thecostome bidentate and oblique.

Gonosome: One gonangium to each hydrocaulus, arising from a point just below the lowest pair of hydrothecæ. Each is a large pyriform body, with an entire gonostome.

*Hab.* Australia; Cape of Good Hope; Timaru; Dunedin: on small seaweeds.

The only particular of structure that I have noted in addition to those observed by others who have described this species is the presence of pit-like indentations into the hydrorhiza, and even this seems to have been noticed by Coughtrey, for he gives a drawing of the hydrorhiza, but as it is not helped by any description I cannot quite understand it. The

hydrocauli spring only from the point of intersection of two filaments of the hydrorhiza, a peculiarity which I have not noticed anywhere else where the hydrorhiza was a creeping filamentous network as here. My specimens were found completely covering the fronds of a delicate ribbon-like seaweed.

**Sertularia polyzonias.** Plate XX., figs. 2, 2a.

*Sertularia polyzonias*, Linnæus, 1767, Syst. Nat., i., 1312.

*Sertularella polyzonias*: Hincks, 1868, Hist. Brit. Hyd., 235. Bale, 1884, Cat. Aus. Hyd., 104. Johnstone, Brit. Zooph., 61. Marktanner-Turneretscher, 1890, Annal. des k. k. Natur. Hofm., v., 224. Allman, 1879, Trans. Roy. Soc., clxviii., 282.

*Sertularia simplex*, Hutton, 1872, Trans. N.Z. Inst., v., 257. Coughtrey, 1874, *ib.*, vii., 283; 1875, *ib.*, viii., 300.

*Sertularella simplex*, Coughtrey, 1876, Ann. and Mag. Nat. Hist. (4), xvii., 27.

*Sertularella kerguelensis*, Allman, 1876, Ann. Nat. Hist. (4), xvii., 113.

Trophosome: Hydrocaulus simple, divided by twisted joints into internodes, each bearing a hydrotheca on its upper end. Hydrothecæ adnate for about one-third of their length, large, divergent, swollen below, but narrow above. The edges of the thecostome are slightly everted, and bear four teeth.

Gonosome: Gonathecæ large, subpedicellate, with a few transverse wrinkles, very indistinct, and a short neck.

*Hab.* Europe; North America; Falkland Islands; South Africa; Kerguelen; Australia; Lyall Bay; Timaru; Dunedin.

This hydroid occurs in immense numbers on seaweeds and stones washed up on the beaches round Dunedin. The hydrocaulus does not attain a height of more than  $\frac{3}{4}$  in., and only two of all the specimens collected showed branching. A good deal of variation is observable in all points of the structure. The teeth of the thecostome may be acute or obtuse, or even almost absent, leaving only a sinuous margin to the orifice. The character of the joint between the internodes varies in its obliqueness and distinctness. The swelling at the base of the hydrothecæ varies in size, and the distinctness of the wrinkles around the gonangium varies so as to make these either almost invisible or well-developed annulations.

**Thuiaria subarticulata.** Plate XX., figs. 6, 6a.

*Thuiaria articulata*, Hutton, 1872, Trans. N.Z. Inst., v., 258.

*Thuiaria subarticulata*: Coughtrey, 1874, *ib.*, vii., 287; 1875, *ib.*, viii., 301; 1876, Ann. Nat. Hist. (4), xvii., 30. Thompson, 1879, Ann. Nat. Hist. (5), iii., 110. Bale, 1888, Proc. Linn. Soc. N.S.W. (ser. 2), iii., 746.

*Thuiaria bidens*, Allman, 1876, Jnl. Linn. Soc. (Zool.), xii., 269.

*Sertularia fertilis*, Lendenfeld, 1884, Proc. Linn. Soc. N.S.W., ix., 406.

Trophosome: Hydrophyton erect. Hydrocaulus gives off alternate pinnæ at very short intervals; the more distant pinnæ are themselves branched. Hydrothecæ occur in pairs, subopposite, tubular, slightly sigmoid, and free for about one-third of their length. In all this like *Sertularia elongata*, but the absence of nodes on the hydrocaulus between every pair of hydrothecæ makes this distinctly a Thuiarian. The hydrothecæ have two small sharp teeth on the inner side of the thecostome, and two obscure blunt ones on the outer side.

Gonosome: Gonophore a short clear stalk surmounted by a barrel-shaped expansion, round which run six or eight ribs, exactly as in *S. johnstoni*, though here the ribs are much fewer in number.

*Hab.* Lyall Bay; Oamaru; Timaru; Taieri Beach.

#### SYNTHECIIDÆ.

##### **Syntheticium elegans.** Plate XX., figs. 3, 3a.

*Syntheticium elegans*: Allman, 1870, Gymno. Hyd., 229; 1876, Jnl. Linn. Soc. (Zool.), xii., 266. Coughtrey, 1874, Trans. N.Z. Inst., vii., 285.

*Sertularia elegans*, Coughtrey, 1875, *ib.*, viii., 301; 1876, Ann. Nat. Hist. (4), xvii., 29.

Trophosome: Hydrocaulus attains a height of about  $\frac{1}{2}$  in. or less, springing from a creeping filament, and very sparingly branched, or not branched at all. Internodes separated from each other by a deep constriction. Hydrothecæ borne along both the main stem and its branches, deep, tubular, cylindrical, perfectly even thecostome, adnate to the internode for about half their height, then becoming free and curving outwards.

Gonosome: Not present.

*Hab.* New Zealand (Allman); Stewart Island (Coughtrey). My own specimens came from Dunedin, Upper Harbour, on shells.

The gonosome of this species is so remarkable as to have necessitated the placing of the almost typical Sertularian into a distinct family. Although there were none present in my specimens, I shall here give Allman's description, from Jnl. Linn. Soc. (Zool.), xii., 266: "Gonangia large, elliptical, opening on the summit by a tubular orifice, strongly annulated,

with the annular ridges discontinuous where they meet in a mesal zig-zag line on the front and back of the gonangium. Peduncle of the gonangium entirely concealed within the hydrotheca, which encloses it." Allman's specimen, obtained from Mr. Busk's collection, had at least a dozen gonangia on it; but of all the specimens examined by Coughtrey only the lower three-quarters of one was found, and my specimens have none at all. The close approximation of the opposite hydrothecæ, which gave the genus its name, is, however, quite sufficient for purposes of identification. Allman's must have been a very favourable specimen, for he draws it at least 2 in. in height, while Coughtrey speaks of his numerous specimens as "pigmy in size," and mine never exceed a bare  $\frac{1}{2}$  in. The polyps themselves are very active, protrude a great distance from the hydrotheca, and actively wave their particularly long tentacles in search of prey.

#### CAMPANULARIDÆ.

\* *Hypanthea asymmetrica*, nov. sp. Plate XX., figs. 4, 4a, 4b.

Trophosome: Hydrocaulus a creeping, branched, reticulated stolon, which gives off peduncles at intervals along its length. Peduncles  $\frac{1}{2}$  in. in height, having three or four very definite constrictions, between which the perisarc takes on a dice-box shape. Perisarc immensely thickened, and very asymmetrically in the hydrotheca. Zooid with a great lobe filling up part of the irregular cavity of the hydrotheca.

Gonosome: Not present.

*Hab.* Rock-pools at Kuri Beach; rather rare, creeping over seaweeds.

The one-sided thickening of the perisarc of the hydrotheca noticed in *H. aggregata* and *H. bilabiata* is here carried to an enormous degree. The cavity of the hydrotheca is hardly saucer-shaped, but almost quite flat. The canal through which the cœnosarc runs is not in the centre of the hydrotheca, but quite to one side, and the mouth and centre of the tentacular circuit are in the same straight line with this. Then, projecting from the side of the hydranth is an oval lobe, nearly as big as the zooid itself, and almost constricted off from it. In this is lodged a red pigment, sometimes dull, but sometimes bright-vermilion. I should have been tempted to call this the gonophore if it had not been so unique a thing among Calyptoblasts, although common among Gymnoblasts, and if I had not caught on one occasion, in conjunction with a specimen of this species, a broken part of what may have been a gonangium. I have given a sketch of the supposed shape of this gonangium. The excessive thickening of the perisarc observed in the hydrotheca is carried into the

peduncle, where the wall is at least one and a half times as thick as the cavity is wide, and into the hydrorhiza, where it is reticulated. The specific name is given because of the marked departure from the radial symmetry usually found in hydroids.

**Hypanthea bilabiata.** Plate XX., figs. 5, 5a.

*Campanularia bilabiata*, Coughtrey, 1874, Trans. N.Z. Inst., vii., 291; 1875, *ib.*, viii., 299; 1876, Ann. Nat. Hist. (4), xvii., 25.

*Eucopella campanularia*, Von Lendenfeld, 1883, Zeit. weiss. Zoo., 38, 497; 1884, Proc. Linn. Soc. N.S.W., ix., 608. Bale, 1888, Proc. Linn. Soc. N.S.W. (2), iii., 751; 1888, Cat. Aus. Hyd., 60.

Trophosome: "Hydrocaulus a creeping and reticulated stolon, from which are emitted scattered simple pedicels. The pedicels are about  $\frac{1}{4}$  in. in height, and with a swollen summit, which, through the intervention of a single globular segment, supports the hydrotheca." The pedicel is smooth and cylindrical. Hydrothecæ bilaterally symmetrical, with an oblique bilabiate entire margin. The walls of the hydrothecæ, peduncles, and hydrorhiza are greatly thickened, the perisarc thinning away only where the peduncle springs from the hydrorhiza.

Gonosome: Gonangia more numerous than nutritive zooids, springing, like the peduncles of the hydrothecæ, from the creeping stolon. Two forms, one as long as the peduncle with its hydrotheca, and another barely half as long as this. Both are urceolate, raised on very short but definite pedicels, and have greatly thickened perisarc.

*Hab.* Australia; Timaru; Tomahawk (Dunedin): on seaweeds, in rock-pools.

This species combines some of the characters of both *H. hemispherica* and *H. aggregata*, as described by Allman in the "Challenger" Reports." It agrees with *H. aggregata* in its size (about  $\frac{1}{2}$  in.), in the conical shape of its hydrotheca, and the thinness of its perisarc (relative to that of *H. hemispherica*). It agrees with *H. hemispherica* in the shape of its large gonangia, in their size, and in their distribution, being not densely aggregated, but occurring about alternately with the hydrothecæ. The perisarc of the peduncle as it nears the point of junction with the hydrorhiza thins away till it is no thicker than that of an ordinary Campanularian. The compression of the hydrotheca causing a bilateral symmetry is very peculiar: it causes the perisarc to be thicker on one side than on the other, and an oblique orifice to the hydrotheca. The hydrotheca is set on the peduncle at an angle of about 45 degrees.

## PLUMULARIIDÆ.

**Plumularia setacea.** Plate XXI., figs. 1, 1a, 1b, 1c, 1d.

*Corallina setacea*, Ellis, Corall., 38 (an. 1755).

*Sertularia pinnata*, Lin. Syst., 1312.

*Sertularia setacea*: Ellis and Soland., Zooph., 47. Lister, Phil. Trans., 1534, 371.

*Aglaophenia setacea*, Lainour., Cor. Flex., 272.

*Plumularia setacea*: Lam., Anim. s. Vert., ii., 129. Hassall, Ann. Nat. Hist., vii., 285. Couch, Zooph. Cornw., 16; Corn. Faun., iii., 33. Johnston, 1867, Brit. Zooph., 97. Hincks, 1868, Hist. Brit. Hyd., 296. Bale, 1888, Proc. Linn. Soc. N.S.W. (ser. 2), iii., 778.

*Plumularia tripartita*, v. Lendenfeld, 1884, Proc. Linn. Soc. N.S.W., ix., 477.

Trophosome: Hydrocaulus attaining a height of 4 in., sometimes branched, pinnæ alternate, situated one at the top of each of the long internodes. The pinnæ are divided into alternate long and short internodes, of which only the long ones bear hydrothecæ. Hydrothecæ small, adnate almost to the thecostome, so that the aperture has its plane almost at right angles to the axis of the pinna. The character of the nematophores places *P. setacea* in the section *Eleutheroplea*, for they are narrow at the base and movable. One springs from below each hydrotheca, and a pair just above it, one from each short internode of the pinna, and one from the base of each internode on the stem.

Gonosome: The character of the gonangia places *P. setacea* in the still further division of the Eleutheroplean Plumularians—the *Phyloctocarpa*. The gonothecæ spring upward from the axils of the pinnæ, and, each being longer than the interval between two pinnæ, are densely crowded. They are slender, fusiform, with a rather long tubular neck.

*Hab.* Europe; Australia; Timaru; Dunedin.

This is the only Plumularian I have found, but it is extremely abundant, and gives excellent opportunities for the study of the *Plumulariida* as a whole. The nematophores are abundant, and the thread cells of large size. In the theca of the nematophore there is an intrathecal ridge, by which the cavity of the cup is divided into proximal and distal parts: this ridge does not occur in the hydrothecæ. The body of the hydranth is divided by a constriction into two parts, in both of which the enteric cavity is of considerable size. The ectoderm is composed of small cells, but those of the endoderm are of great relative size, and have scattered through them granular gland cells. Great masses of pigment are lodged in both proximal and distal divisions of the enteric cavity; they



are of many colours, varying through yellow, brown, and green. From their constancy these seem to be lodged in the endoderm cells, and have nothing to do with the presence of food. A strong core of endoderm cells runs through the axis of each tentacle, the ectoderm of which is loaded with irregularly distributed nematocysts. The mouth is placed on a conical hypostome, and the mosaic arrangement of the ectoderm cells is very apparent on the expanded parts of the zooid. Two varieties of this species have come under my own notice. In one the hydrocaulus attains the height of  $\frac{1}{2}$  in. or even  $\frac{5}{8}$  in., the oldest parts having taken on a light-horn colour. The other variety seems never to attain a height of more than  $\frac{3}{4}$  in. or  $\frac{1}{2}$  in., has a milk-white appearance in the water, is really colourless, and occurs densely investing the seaweeds in rock-pools. The third variety is that described by von Lendenfeld under the name of *Plumularia tripartita*. This differs from *P. setacea* in the trilobation of the hydranth, and in a very different arrangement of the nematophores, the pairs of these structures occurring below instead of above the hydrothecæ. My variety, with its single constriction of the hydranth, is evidently intermediate between the European variety with no constriction and v. Lendenfeld's with two.

Sub-family STATOPLEA—AGLAOPHENIDÆ.

Section PHYLACTOCARPA.

**Aglaophenia filicula.** Plate XXI., figs. 2, 2a, 2b.

*Aglaophenia filicula*, 1873, Allman, Chall. Rep., part xx., p. 36.

Trophosome: Colony attaining a height of 3 in., rooted by a creeping tubular fibre. Hydrocladia about  $\frac{1}{4}$  in., alternate. Hydrothecæ deep, thimble-shaped, serrated margin, with the median tooth larger than the lateral ones. Intrathecal ridge near the base of the hydrotheca, springing only from the inner side. Mesial nematophores adnate to walls of hydrothecæ for about three-fourths of their height, and then becoming free as a beak-like process which scarcely overtops the margin. Lateral nematophores tubular, overtopping the margin of the hydrothecæ.

Gonosome: Not present.

*Hab.* Taieri Beach and Martin's Bay, New Zealand; Azores.

The appearance of this hydroid is deceptively like that of *Sertularia elongata*; it is not very common, although not distinctly rare here. The only difference I have observed between my specimens and those described by Allman is that I have not found "an imperfect septum near the distal extremity

of the mesial nematophore." Allman found his specimen off the Azores in 2,700 ft. of water, while mine was cast up on a beach in New Zealand. The fact of it being found on this beach, however, says very little concerning its habitat, for the water off that part of the coast is very deep, very rapidly going to the 1,000-fathom line. Again, Antipatharians 5 ft. in height and 20 in. round the stem have been found on the same beach, so probably my specimen may be a deep-sea form, since Antipatharians of this size certainly are. Yet the fact that this species has been found only at the Azores and at New Zealand is interesting.

Since writing the above I have found a specimen at Taieri Beach, but there is not the slightest evidence as to whether it is a deep-sea form or not. This specimen differed in the following points from that found at Martin's Bay: (1) The colour is a light-horn, instead of a dark reddish-brown; (2) in the hydrocaulus two septa occur to one hydrotheca—one is just below the lateral nematotheca, the other just opposite the intrathecal ridge; (3) the intrathecal ridge is very distinct, and springs from all round the hydrotheca.

The following may be taken as a summary of the new facts set forth above:—

(1.) Three matters connected with geographical distribution: (a.) Concerning *Aglaophenia filicula*, which was hitherto found only in the Azores, I am inclined to think that this is a case of independent convergent modifications. Since we have so many nearly allied species of *Aglaophenia* here, it is not at all improbable that one should vary in the same way as those in the Azores. (b.) Concerning *Pedicellina gracilis*, this is distinctly a case for the distributionist; as also is (c.) *Tubiclava fruticosa*.

(2.) The discovery of a new genus so clearly intermediate between the two sub-orders of hydroids.

(3.) The discovery of the genus *Calycella* here; also another account of its reproduction, such accounts being rather scanty.

(4.) The ascertaining of the identity of Allman's genus *Hypanthea* with *Euplectella* and *Campanularia*.

(5.) A new species of *Obelia*, with a distinctively adaptive modification. The cuticular thickening is, I think, to be regarded as a protection against winter frosts.

(6.) A new species of *Hypanthea*.

## EXPLANATION OF PLATES XVI.—XXI.

## PLATE XVI.

- Fig. 1. *Tubiclava fruticosa*.  
 Fig. 1a. " (natural size).  
 Fig. 2. *Hemitheca intermedia*.  
 Fig. 2a. " (natural size).  
 Fig. 3. *Tubularia attenoides*.  
 Fig. 3a. " (natural size).  
 Fig. 3b. Tr. section of polyp.

## PLATE XVII.

- Fig. 1. *Obelia nigrocaulus*.  
 Fig. 1a. " (natural size).  
 Fig. 2. *Obelia geniculata*.  
 Fig. 2a. " (natural size).  
 Fig. 3. *Calycella parkeri*.  
 Fig. 3a. Portion of tentacle, highly magnified.  
 Fig. 3b. Part of specimen (natural size).  
 Fig. 3c. Part of stem, highly magnified to show pigment in endoderm.  
 Fig. 3d. Variations of theca.

## PLATE XVIII.

- Fig. 1. Four stages in the reproduction of *Calycella*.  
 Fig. 1a. A variety of gonosome.

## PLATE XIX.

- Fig. 1. *Sertularia bispinosa*.  
 Fig. 1a. " (part), (natural size).  
 Fig. 2. *Sertularia johnstoni*.  
 Fig. 2a. " (natural size).  
 Fig. 3. *Sertularia elongata*.  
 Fig. 3b. " (showing gonangium).  
 Fig. 3a. Natural size of colony.

## PLATE XX.

- Fig. 1. *Sertularia minima*.  
 Fig. 1a. Habitat of same (natural size).  
 Fig. 2. *Sertularia polyzonias*.  
 Fig. 2a. " (natural size).  
 Fig. 3. *Syntheicum elegans*.  
 Fig. 3a. " (natural size).  
 Fig. 4. *Hypanthea asymmetrica*.  
 Fig. 4a. " (natural size).  
 Fig. 4b. Supposed form of gonotheca.  
 Fig. 5. *Hypanthea bilabiata*.  
 Fig. 5a. Gonosome.  
 Fig. 6. *Thuiaria subarticulata*.  
 Fig. 6a. Gonophore.  
 Fig. 7. *Sertularia trispinosa*.  
 Fig. 7a., 7b. Two varieties of gonangium.

## PLATE XXI.

- Fig. 1. *Plumularia setacea*.  
 Fig. 1a. " (natural size).  
 Fig. 1b. Variety showing constrictions in cœnosarc.  
 Fig. 1c. Gonangia.

## PLATE XXI.—continued.

- Fig. 1*d*. A gonangium with blastostyle and medusa buds.  
 Fig. 2. *Aglaophenia filicula*, from the side.  
 Fig. 2*a*. " " from in front.  
 Fig. 2*b*. " " (natural size).

---

ART. XXV.—On the Occurrence of *Pedicellina* in New Zealand.

By F. W. HILGENDORF, M.A.

(From the Biological Laboratory of the University of Otago.)

[Read before the Otago Institute, 13th July, 1897.]

Plate XXII.

AMONG hydroids I found, growing on the stems of *Obelia nigrocaulus*, the only representative of the *Polyzoa endoprocta* yet recorded from New Zealand. It is *Pedicellina gracilis*, Sars, Plate XXII., figs. 1, 1*a*, 1*b*; Johnstone, Brit. Zoo., 385; Goodsir, Ann. Nat. Hist., xv., 380; Hincks, Ann. Nat. Hist. (2), viii., 360, and Brit. Zooph., 570.

This Endoproctan is quite microscopic, and may be recognised by the enlarged base of the peduncle, in which the muscular power is placed, and to which the remarkably energetic movements of *Pedicellina gracilis* are due, the part above being a rigid rod supporting the almost globular body. The variety mentioned by Hincks with the muscular swelling elongated and divided into two or three parts was also present.

The finding of this specimen has extended the geographical distribution of the *Endoprocta* in a rather remarkable manner. Formerly members of this order had been found only in Norway, Spitzbergen, White Sea, and Roscoff. Now it is found in New Zealand, quite the antipodes of all the localities in which it was formerly found. The fact, too, of this being precisely the same species, and even presenting the two same varieties, is noteworthy.

---

EXPLANATION OF PLATE XXII.

1. *Pedicellina gracilis*, closed.  
 1*a*. " " with tentacles expanded.  
 1*b*. A variety of the same.

ART. XXVI.—*Further Coccid Notes: with Description of New Species, and Discussion of Points of Interest.*

By W. M. MASKELL, Registrar of the University of New Zealand, Corr. Mem. Roy. Soc. of South Australia.

[Read before the Wellington Philosophical Society, 16th February, 1898.]

## Plates XXIII.—XXVII.

THE majority of the new species recorded in this paper form part of a collection of *Coccidæ* made by Mr. A. Koebele, in China and Japan, in 1896 and 1897. In my paper of last year I was able to include about thirteen species from this collection, but the rest did not reach me until too late for publication then. I sent to the Entomologists' Monthly Magazine in October, 1897, an advance list of all of these, and the new species described in this paper were briefly mentioned in it. As regards species already known, also included in the Koebele collection, I must refer students to the numbers for October and November, 1897, of the Ent. Mo. Mag.

An excellent work has been published during 1897 by Mr. Cockerell on the "Food Plants of *Coccidæ*," in which he brings together in a compact and convenient form all the knowledge we have up to the present as to the plants attacked by all the species of Coccids. The work is a very welcome and very useful one, and must have required much industry and research. It is inevitable that in such a publication there should be a few points requiring rectification, but these seem to be not of much importance. I may mention two or three. On page 728, near the bottom, it is stated that "*Aspid. camellie* is *A. rapax*"; but *A. rapax* is frequently mentioned in the book, which must be an error, as the name *camellie* has priority. On page 733 it is stated that I once identified my own *Dactylopius vastator* as my own *D. albizzia*. This would have been indeed a peculiar mistake, the two being absolutely dissimilar; but I cannot account for the statement. On page 755 it is suggested that my *Poliaspis media* and *Planchonia epacridis* may be Australian, being found in New Zealand on *Leucopogon fraseri*, which is an Australian plant. In the first place I must respectfully decline the accusation that I ever called *Planchonia* by the name *Asterolecanium*. However, *Leucopogon fraseri*, whether Australian or not, is a native of New Zealand.

But there is an error in the work of more importance than these small points, and it is one for which Mr. Cockerell is not

in the least responsible, for it has been made by every writer on Coccids down to the year 1897. It is that, as stated on his page 782, *Icerya seychellarum* attacks the sugar-cane. According to Mons. d'Emmerez de Charmoy ("Revue Agricole de l'Île Maurice," April, 1897) this insect never touches sugar-cane. "During many years," he says, "that I have given close attention to the parasitic insects of sugar-cane I have never known one single instance where this insect was found on cane, or even on any gramineous plant, in spite of its almost omnivorous character, . . . not even accidentally, when other plants in the immediate neighbourhood of a cane-field were infested with it." M. de Charmoy repeats the same thing in a letter to me. I may observe that in 1896, reporting this species from China, on *Rosa* and *Podocarpus* (Trans. N.Z. Inst., vol. xxix., p. 330), I remarked that it evidently was not confined to the sugar-cane.

It is easy to understand how this curious—and in a way, possibly, mischievous—error came about. It arose from the far-too-common practice of speaking of injurious insects by the vulgar names used by farmers and gardeners. It appears that every scale in Mauritius which produces white cotton is called "le pou blanc," or "le pou à poche blanche"; and when the insect in question was first described from that island it was assumed that it was identical with the *Coccus sacchari* of Guérin Menneville, 1867, which Signoret, in 1875, placed in his new genus *Icerya*, stating that "it does great damage to sugar plantations." Afterwards it was found to be identical with an insect from the Seychelles Islands, which Westwood, in 1855, had described as *Dorthezia seychellarum*, on palm-trees; but the sugar-eating propensity was still attributed to it. Every writer on Coccids, from Signoret and Riley to Cockerell and myself, fell into this mistake. Now, it appears that "le pou blanc," or "le pou à poche blanche," really means three (quite possibly more) different things—*Icerya seychellarum*, *Dactylopius sacchari*, and *Pulvinaria gasteralpha*, of which the second is certainly a sugar-pest; and also (as M. de Charmoy informs me) even *Diaspis amygdali*, because it is white; and that *I. seychellarum* infests nearly everything except gramineous plants.

M. de Charmoy tells me that he proposes to apply the name "le pou blanc" to *I. seychellarum*, "le pou à poche blanche" to *Pulvinaria gasteralpha*, and "le pou de la canne" to *Dactylopius sacchari*. This will, of course, be some improvement; but, personally, I would deprecate the use of trivial names. Some day we shall be falling into extreme confusion in consequence of them. Our friends in America are the chief sinners in this respect. Such names as "the white scale," "the black scale," "the round scale,"

“the long scale,” “the San José scale” may be good enough for newspapers or for farmers’ meetings, where every Coccid is a “scale” and every other insect a “worm” or a “bug,” but they are out of place in a publication emanating from a scientific society or a scientific department, and the case of *Icerya seychellarum* is a proof of it.

In one of his letters to me M. de Charмой enclosed a photograph showing that part of a *Ceroplastes* (species not indicated) which contains the dorsal abdominal lobes. These lobes are slightly expanded, and from between them there extrudes a cylindrical tube, slightly dilated at the tip, which M. de Charмой rightly recognises as the honeydew organ. I am much pleased to get this photograph, which demonstrates the correctness of my observation in 1886 of a similar organ in *Ctenochiton*, a genus nearly allied to *Ceroplastes*. I think that no other writer has mentioned this organ, although the great prevalence of fungoid growth (black blight, smut, &c.) on plants infested by Coccids shows what a quantity of honeydew they must excrete.

#### NOTES ON THE GENUS *Aspidiotus*.

Two publications have appeared during the year which deal with *Aspidiotus*, and both propose to divide it into a number of sub-genera. One is merely a preliminary synoptical key, without detailed description, by Dr. G. Leonardi, of the Laboratory of Economic Entomology at Portici, Italy. This suggests nine sub-genera, all founded upon the anatomical features of the female insect, without taking any notice of the puparium. This, if subdivision is required, seems to be quite the correct principle to proceed upon, though I confess that the nomenclature of details (in Latin) is to me not clear; for example, I scarcely know what is meant by “trulla,” though probably it signifies “lobe”; and “paraphyses” I do not understand. But, unless Dr. Leonardi proposes to give much fuller details when defining completely his sub-genera, I think that some of his characters are scarcely valid. Thus, he separates *Odonaspis* from *Chentraspis* merely by the presence or absence of spinneret groups. I believe that this may be a valid character for distinction of species; but, seeing the very great variation in the groups even of any given species, even sometimes amongst several insects on the same leaf or twig, it can scarcely be sufficient for genera. For example, in *Aspidiotus* (*Chentraspis*, Leon.) *unilobis* I have, since my original description, seen a specimen with two orifices on one side and one on the other. I did not think the matter important enough to mention it at the time; but clearly these three orifices represented “groups”; consequently the absence of

groups is not constant. On this view three of Dr. Leonardi's genera would disappear—*Chrysomphalus*, *Aonidiella*, *Aspidites*.

The other publication is by Mr. T. D. A. Cockerell, and is entitled "The San José Scale and its Nearest Allies," but it is really a revision of the whole genus *Aspidiotus*. In this work Mr. Cockerell partly agrees with Dr. Leonardi, but he goes much farther, and on the whole proposes thirteen subgenera. For these, as far as I can make out, he employs both the puparium and the insect; but his definitions are vague and difficult to understand. For example, he includes in one group *Chrysomphalus*, *Melanaspis*, *Mycetaspis*, and *Aonidiella*; but all that he gives for comparison is "*Melanaspis*, a modified *Chrysomphalus*"; "*Mycetaspis*, a greatly modified *Chrysomphalus*," &c. Again, "*Pseudaonidia*, type *A. duplex*, a remarkable Asiatic type"; *Xerophilaspis*, an extraordinary little form," &c. As for the main genus *Aspidiotus*, he attaches to it the letters "s. str.," of which I cannot as yet conjecture the meaning. It will be seen that some of Mr. Cockerell's names are the same as those of Dr. Leonardi, and I gather that on the whole the two writers agree.

There are a few points in Mr. Cockerell's paper as to which I shall have something to say presently; meanwhile, on the general question of generic subdivision, I must observe that it seems to me entirely premature. In my opinion it will be none too late twenty years hence to begin this work. The systematic study of *Coccidæ*, in the proper sense, does not date back beyond 1860, and even now there are scarcely twenty names known of men who devote themselves to it thoroughly (I exclude those who merely take it up in a fragmentary way, or in the intervals of economic or other work). Moreover, very few countries have yet been explored to any extent. The greater part of Asia, of North and South America, of the Pacific Islands, and even of Europe, is unworked; and whereas the total number of species of all the genera of *Coccidæ* which are now known to science does not exceed, if even it reaches, one thousand, it is absurd to imagine that we have discovered more than a fraction of those existing in the world. It results, as a matter of course, that any scheme of subdivision of so small a genus of insects as *Aspidiotus* must be continually subject to revision, to rerevision, to revision a fourth or a tenth time as new forms are found to obliterate the boundaries laid down by this or by that author. There is not the least cause for hurry. If all the species now known are left in *Aspidiotus* no harm can be done; whereas if all the suggested subgenera have to be again divided, split into minuter fragments, shifted about



to suit the needs of the day, the future student must be subjected to confusion and trouble quite annoying and wearisome. I have already remarked that *Odonaspis* and *Chentraspis*, as they now stand, require alteration: such names as *Pseudodiaspis*, *Morganella*, *Xerophilaspis*, &c., invented to suit single species differing from others only in trivial details, will surely have to be abandoned. I observe also in Mr. Cockerell's list not less than twenty-two species which he is unable to attach to any one even of the long series of sub-genera proposed by him. This can only indicate that the series will have to be extended by perhaps half a dozen more very shortly; and there will be no end to it.

I willingly acknowledge the great industry and acumen manifested in Mr. Cockerell's work, and have no doubt that when Dr. Leonardi publishes the full details of his scheme the same qualities will be abundantly manifested. Yet the thing is premature, and it would probably be better to leave *Aspidiotus* alone for at least several years to come, as also *Lecanium* and other sub-families of *Coccidæ*.

As to a few matters of detail to which I remarked just now that exception must be taken, I find Mr. Cockerell stating (page 15) that he is convinced that my variety of *A. perniciosus*, found on *Eucalyptus* in Australia, does not belong to that species. I can only say that I am just as convinced that it does, and this after repeated examination and comparison of my specimens.

I cannot accept the proposed *Morganella maskelli*, Cockll., not only as to the new sub-genus, but as to the species. As for the genus, the insect is made to differ from *Aspidiotus longispina* (to which I had attached it in 1894) by having its lobes contiguous and the scaly hairs of the margin serrated. Surely neither of these can possibly be considered generic, or even sub-generic, characters. As for the species, I have compared it with type of *longispina* sent to me by Mr. Morgan, and I do not see the least difference in the lobes. The serrated hairs are different, certainly, and probably the insect may be a variety of *longispina*, as I put it in this paper, but I am quite unable to consider it as anything more, for it agrees absolutely with that species in every particular except these serrations.

I do not see in Mr. Cockerell's list any mention of *Aspidiotus camellie*, Boisduval, but *Aspidiotus rapax*, Comst., is included. But these two are identical, and Boisduval's name dates from 1867, Comstock's from 1880. The omission of one of these indicates that Mr. Cockerell acknowledges the identity; but, if priority is to be of any value, he should have inserted *camellie* and left out *rapax*.

## Section DIASPIDINÆ.

## Genus ASPIDIOTUS.

**Aspidiotus secretus**, Cockerell, var. **lobulatus**, var. nov.

The type of this species was partly described by Mr. Cockerell in the Supplement to "Psyche," March, 1890. A fuller description, with figures, is given by Mr. Green in "Coccidæ of Ceylon," part i., p. 64, 1896. The insect lives "between the layers of the dry sheathing petioles of bamboo."

The present variety differs from the type in having a clear and distinct small lobe at each side of the single large median terminal lobe; in the type these lateral lobes do not exist. The two large groups of spinnerets are joined at the top by a single line of orifices. Mr. Green says that in the Cingalese form this line is wanting.

*Hab.* In Japan, on *Bambusa*, sp. My specimens were sent by Mr. Koebele from Miyanoshta; he attached them to the genus *Diaspis*, judging probably from the appearance of the male puparium, but I agree with Mr. Green that, as this is not carinated, the species belongs to *Aspidiotus*.

This is No. 1513 of the Koebele collection.

**Aspidiotus dictyospermi**, Morgan, var.

This variety differs from the type only in having a rather lighter-coloured puparium and in the spinneret groups. I examined five specimens; three of them had no spinnerets at all, the two others had six orifices in each upper group (the type has three or four) and four in each lower group (the type has two). These differences are indeed scarcely sufficient to constitute even a valid variety.

*Hab.* In China, on *Erythrina indica*. Specimens from Hongkong, sent by Mr. Koebele (his No. 1528).

**Aspidiotus rossi**, Maskell.

Mr. J. G. O. Tepper, of Adelaide, sends me the following note as to this species: "*A. rossi* breeds specially well on *Coccoloba*, apparently without injuring it, even in large numbers, likewise on *Hyssop* and *Artemisia*; but even a few injure, and a moderate number kill, *Abutilons*, notably the smaller kinds, as if they were poisoned." Seeing that *A. rossi* is spreading to several countries outside Australia, these remarks will be interesting.

**Aspidiotus cydoniæ**, Comstock, var. **tecta**, var. nov.

The insect agrees entirely with the type in the lobes, hairs, and spinnerets, but the puparium differs, being flatter and also subcortical, with a thin covering of bark-cells.

*Hab.* In the Sandwich Islands (where also the type exists),

on "ohia" tree. Specimens from Mr. Koebele (his No. 1561).

Writing in 1894 on *Chionaspis biclavis*, Comst. (Trans. N.Z. Inst., vol. xxvii., p. 49), I established a new variety of the species, characterized by lying exposed outside the bark instead of mining beneath it. In the "Report of the Californian State Board of Horticulture for 1895-96," p. 37, Mr. A. Craw expresses the opinion that "this is very poor ground upon which to erect even a variety." I venture to differ from him, considering that the habit of burrowing or not burrowing is quite important enough to warrant the placing of such emphasis upon it as is implied by the word "variety."

**Aspidiotus bilobis**, sp. nov. Plate XXIII., fig. 1.

Female puparium greyish or yellowish-grey, convex, rather solid; pellicles not quite central. Diameter about  $\frac{1}{25}$  in.; outline subcircular.

Male puparium similar in colour and texture to that of the female, but smaller and more elliptical.

Adult female yellow. Abdomen terminating in two median lobes, which are cylindrical with rounded ends; the sides are straight and parallel, the ends minutely serrated. Separated from these lobes by a small interval in which there are one or two fine hairs is a small denticulate projection on each side, which is scarcely distinct enough to be considered a lobe; and there are also a few triangular scaly hairs. No groups of spinnerets, but at the extremity of the abdomen there are a number of very small dorsal circular pores.

*Hab.* In China, on grass. The insects appear to affect the roots, or the lower parts of the stem just above the ground. My specimens are from Hongkong, sent by Mr. Koebele (his No. 1518).

This species seems to be allied to *A. camelliæ*, in which also there are only two terminal lobes and no groups of spinnerets. But the lobes in the present case are quite cylindrical and *direct*, whereas in *A. camelliæ* they are broadly and roundly triangular and *oblique*, sloping inwards.

**Aspidiotus longispina**, Morgan, var. *ornata*, var. nov.

This species was first described by Mr. A. Morgan in the Ent. Mo. Mag., August, 1889, on *Cupania*, from Demerara. In 1894 (Trans. N.Z. Inst., vol. xxvii., p. 38) I reported it on various trees in the Sandwich Islands. I have it again in Mr. Koebele's collection (no number attached) from the same locality; and I have lately received it on an unnamed plant from Mauritius, sent by M. d'Emmerez de Charmoy. It is clearly a tropical form—at least, no report of it has come from a temperate region.

The variation here noted consists in the fact that the long scaly hairs on the abdominal margin are conspicuously serrated and even branched, whereas in the type they are simple. Writing of the species in 1894, I noted the point, but did not think it necessary to even found a variety upon it. However, now that it appears from two such widely-separated localities as Honolulu and Mauritius it may fairly be considered a variety from the serrations. In 1894, also, I mentioned that the marginal long setæ seemed to be six on each side, instead of four, as in the type. I do not find this to be a constant character; some specimens exhibit four, some six; this must therefore be discarded.

I have already mentioned (*ante*, p. 223) that Mr. Cockerell's proposed new sub-genus for this form, and his name, *Morganella maskelli*, cannot be accepted. Every single character, with the exception of the serrated hairs, agrees with the type of *longispina*, and the difference is too trivial to even make a new species. As regards a point mentioned by Mr. Cockerell, "closely adjacent or contiguous median lobes," that is not valid. Taking two specimens, one of the type the other of the variety, it requires very close examination indeed to see which has the closer lobes; and even then I think any difference may be accounted for by more or less pressure of a cover-glass.

I therefore maintain my specific determination, but am willing to consider the form as a variety.

#### **Aspidiotus implicatus, sp. nov.**

Female puparium subcircular, white, slightly convex, thin and papery; pellicles pale-yellow, very indistinct. The puparia are entangled amongst the close thick hairs of the plant, and are very inconspicuous. Diameter about  $\frac{1}{40}$  in.

Male puparium whitish, elliptical, flat, non-carinated; length about  $\frac{1}{65}$  in.

Adult female yellow. Abdomen exhibiting two median terminal lobes, sloping inwards, the outer margin of each with a conspicuous notch, and a smaller notch on the rounded extremity. Beyond the lobes are on each side two deepish indentations of the margin, and several scaly hairs, of which some are simple, others broad and conspicuously forked. The spinnerets vary: in some specimens none at all are visible; in others there is a single superior orifice, and either one or two on each side.

*Hab.* In China, on *Campanula*, sp. (? the name of the plant was indistinct on the parcel). Specimens sent from Tamsui, Formosa, by Mr. Koebele (his No. 1498).

This species appears to be intermediate between *A. camellia* and *A. cydonia*, but is much smaller than either. The deep

notches in the lobes separate it from *camellia*, and the absence, or almost absence, of spinnerets from *cydonia*.

#### Genus AONIDIA.

**Aonidia elæagnûs**, sp. nov. Plate XXIII., figs. 2, 3.

Female puparium circular, rather solid, yellowish-brown or reddish-yellow in colour; diameter about  $\frac{1}{30}$  in.; almost entirely occupied by the second pellicle; the first pellicle is small, yellow, and usually placed in a circular depression.

Male puparium elliptical, rather lighter-coloured than that of the female, the pellicle yellow, terminal; length about  $\frac{1}{25}$  in.

The larval pellicle is oval, and exhibits at the posterior extremity indications of terminal lobes.

The second female pellicle, which occupies almost the whole puparium, is elliptical, tapering posteriorly, and ends in six slender cylindrical emarginate lobes, all sloping inwards.

Adult female yellow, or brownish; length about  $\frac{1}{50}$  in. The cephalic and thoracic regions largely overlap the abdominal. Abdomen triangular, with nearly straight emarginate sides, terminating in a single median lobe; this lobe is slightly notched on each side, and has a deep indentation on the terminal edge, so that it looks as if it were double. Separated from it by a short interval along the margin is another very small lobe, and still further along another still smaller (or, indeed, rather an indication of a lobe). There are no hairs or spines except one or two, very short and fine, on the anterior abdomen. No groups of spinnerets, but there are a few minute circular pores near the posterior margin.

Male unknown.

*Hab.* In Japan, on *Elæagnus macrophylla*. My specimens were sent by Mr. Koebele (no number attached to them).

This form is clearly distinct from any of the species of this genus described by Mr. Green from Ceylon, and from all others known to me. The abdominal characters in many species of this genus are most peculiar.

In the *Agricultural Gazette* of New South Wales, August, 1897, Mr. C. Fuller describes a Diaspid insect forming galls on *Eucalyptus* in Australia, to which he gives the name *Maskellia globosa*. In its gall-making habit this insect is quite distinct from *Aonidia elæagnus*; but the figure of the abdominal region given by Mr. Fuller bears a remarkable resemblance to that of the Japanese form, with the exception of the projection on the anterior margin, which, however, is not important. In the six minute widely-separated lobes (assuming that in *M. globosa* there is really a median pair, and not one double), in the

absence of spinneret groups, and in the position of the scattered single orifices the two are precisely similar. I suppose, however, that the gall must be taken as a sufficient character for distinction.

#### Genus DIASPIS.

**Diaspis rosæ**, Sandberg, var. **spinosa**, var. nov.

Puparia of both female and male resembling those of the type, but the colour of the adult female is brown instead of red, and the spines on the abdominal margin are much more numerous. In the type there are only seven or eight on each side, but in the present variety there are from fourteen to eighteen. The spinneret groups and lobes are as in the type, and the male puparium is distinctly carinated.

*Hab.* In Japan, on *Smilax*, sp. Specimens sent by Mr. Koebele from Atami (his No. 1545).

In "Coccidæ of Ceylon," part i., page 91, Mr. Green describes *D. fagraæ*, a species very close to *D. rosæ*; but he states that the male puparium is not carinated (which would seem to remove it from *Diaspis*). This character at once separates it from our variety; moreover, its pellicles are dark-red. *Aspidiotus smilacis*, Comstock, is quite different.

**Diaspis amygdali**, Tryon, var. **rubra**, var. nov.

The differences from the type are, first, the deeper red colour of the pellicles, which is quite conspicuous; and, secondly, the comparative smallness of the terminal lobes, which are not more than half, or two-thirds, of those in the type. Other characters identical.

*Hab.* In Japan, on *Oriza japonica*; specimens sent by Mr. Koebele (his No 1220); and in Ceylon, on *Loranthus*, sp., also from Mr. Koebele (his No. 1410).

The specimens from both localities are identical, and I think that they approach nearest to a form mentioned by Mr. Green ("Coccidæ of Ceylon," part i., p. 89) on *Geranium*. Originally Mr. Green proposed to name this *D. geranii*, but he afterwards attached it to *D. amygdali*. In two prepared slides which I possess of this form on *Geranium* I find that the dimensions of the terminal lobes vary considerably.

#### Genus PARLATORIA.

**Parlatoria sinensis**, sp. nov. Plate XXIII., fig. 4.

Female puparium really whitish or yellowish, but covered usually with such a coating of fungus as to seem quite black. The puparia are massed together, encrusting the twig, so that the form of each is not easily made out; but it appears to be subcircular, somewhat convex, with a diameter of about  $\frac{1}{10}$  in.

Male puparium flatter and more elliptical than that of the female; not carinated.

Adult female brownish-yellow; form normal. Abdomen terminating in the usual fringe of emarginate lobes, with serrated scaly hairs between them; but these scaly hairs seem to be less numerous than usual, and do not extend along the whole margin.

*Hab.* In China, on *Citrus aurantium*. My specimens are from Hongkong, sent by Mr. Koebele (I think, his No. 1571, but the number was indistinct).

There is little whereby to distinguish the species of this genus, but I think this is new, from the paucity of the scaly serrated hairs. An insect named by Mr. Cockerell *Aspidiotus biformis* (Canad. Entom., 1894, p. 131) has a margin rather remotely resembling this, but its lobes have smooth sides.

#### **Parlatoria proteus, Curtis, var. palmæ, var. nov.**

Puparia, both female and male, resembling generally those of the type, but with a darker appearance to the naked eye or under a weak lens, on account of the darker pellicles.

Adult female also resembling generally the type, but in all the specimens examined I find the scaly hairs on the abdominal margin narrower, and some of them, instead of being laterally serrated, are terminally forked; possibly in living specimens the typical hairs would be seen. There are four groups of spinnerets, anterior pair with eight orifices, posterior pair with six. The marginal lobes are normal.

*Hab.* In Australia, on date-palms in the northern district of South Australia. These palms were imported, as I understand, from Algeria about three years ago, and were planted near Lake Harry. My specimens were sent by Mr. A. Molineux, of Adelaide, and I also received some from Mr. French, of Melbourne.

Mr. Cockerell ("Entomologist," 1895, p. 52) describes, under the name *Parlatoria victrix*, an insect on date-palms in Arizona, imported from Egypt. Two of the characters which he gives are, "No grouped glands; plates scale-like." The latter character I am not able to interpret, but the figure which he gives of the abdominal margin does not agree with my Australian form. If he is right in stating that *P. victrix* has no spinneret groups it must be a different species, for in my specimens the groups are quite clear, and exactly as in *P. proteus*.

I have seen somewhere (but cannot verify the reference) that date-palms in Algeria are attacked by *P. zizyphi*, Lucas, and the dark colour, superficially, of the puparia of this Australian form might easily cause them to be mistaken for that. Mr. Cockerell also states that his *P. victrix* was

formerly supposed to be *zizyphi*. I suppose there is no doubt that the palms brought their parasite with them from Algeria. I reported in 1892 the type of *P. proteus* in Queensland, but it is not likely that it spread from there to South Australia.

GENUS MYTILASPIS.

**Mytilaspis flava**, Targioni, var. **hawaiiensis**, Maskell, 1894.

This insect occurs in China, on *Pyrus sinensis*. Specimens sent from Amoy by Mr. Koebele (his No. 1133).

In 1894 I established this variety on the absence of spines from the anterior abdominal segment. My Chinese specimens clearly exhibit these spines, and therefore the variety should probably be abandoned. But it may be convenient to retain the name for the present to indicate that the form is indigenous in the Far East and in the Pacific, as well as in Europe.

**Mytilaspis spinifera**, Maskell, *forma major*.

This form is identical with the type in everything but size, being quite twice as large, and averaging  $\frac{1}{8}$  in. in length and nearly the same in breadth of puparium.

*Hab.* In Australia, on *Acacia pendula* (same as the type). Specimens from Hay, Riverina, New South Wales, sent by Mr. Musson.

**Mytilaspis machili**, sp. nov. Plate XXIII., fig. 5.

Female puparium dark-brown, elongated, pyriform; length about  $\frac{1}{12}$  in.

Male puparium more cylindrical than that of the female; colour darkish-yellow; length about  $\frac{1}{10}$  in. Some specimens are white.

Adult female brown; form normal. Abdomen ending in two moderate lobes with a small median depression in which are two small spiny pairs; these lobes are rounded with very inconspicuous lateral emarginations; beyond them on each side are two much smaller subconical lobes. The margin bears a few spines in pairs. Five groups of spinnerets; upper group with 4 to 6 orifices; upper laterals 6 to 8; lower laterals 8 to 10. Several dorsal tubular spinnerets.

Adult male unknown.

*Hab.* In Japan, on *Machilus thunbergii*. Specimens from Yokohama, sent by Mr. Koebele (his No. 1514).

In my list of the Koebele collection, published in the Ent. Mo. Mag. (October and November, 1897), I did not attach any name to this form, thinking that perhaps it might after all turn out to be a variety of *M. crawii*, Cockerell; but I now consider it as distinct. On the leaves sent to me there were



many more male puparia than females, mingled with *Aspidiotus ficus* and a species of *Parlatoria*.

Genus POLIASPIS.

*Poliaspis pini*, sp. nov. Plate XXIII., fig. 6.

Female puparium elongated, mussel-shaped; colour brown, with the pellicles orange and the abdominal end white. Length about  $\frac{1}{10}$  in.

Male puparium similar in form and colour to that of the female; length about  $\frac{1}{15}$  in.

Adult female brown, of the normal elongated form. Abdomen ending in an emarginate curve, minutely serrated, and with several elongated oval pores near the margin; in the middle four small lobes of equal size and two smaller ones. Between the lobes, and along the margin, are a few short spiny hairs. The anterior abdominal and the posterior thoracic segments bear some short marginal spines. Eight groups of spinnerets; the anterior row of three groups, of which the two lateral ones have about 4 orifices; the median one about 10; of the rest, the median group has 4 to 6; the upper laterals 10 to 12; the lower laterals about 12. There are several dorsal tubular spinnerets.

Male unknown.

*Hab.* In Japan, on *Pinus densiflora*. Specimens from Miyanoshta, sent by Mr. Koebele (his No. 1494).

The dark-coloured puparium is unusual in this genus; indeed, I originally established the name from the Greek *πολλός* (white, shining), and the other known species have this character.

Genus CHIONASPIS.

*Chionaspis chinensis*, Cockerell, Rep. State Board of Hort., California, 1895, p. 37.

Specimens of this insect were sent to me from Atami, Japan, on *Quercus acuta*, by Mr. Koebele (his Nos. 1496 and 1549). The form was originally described as on *Quercus* trees imported into California from China. Mr. Cockerell considers it as intermediate between *C. nyssæ*, Comstock, and *C. eugeniae*, Mask., and I think he is right. Indeed, in my list in the Ent. Mo. Mag. (November, 1897) I set it down as probably *C. eugeniae*, var.

Genus FIORINIA.

*Fiorinia signata*, sp. nov. Plate XXIII., figs. 7-9.

Female puparium greyish-white, rather widely pyriform; the single terminal pellicle is yellow; the surface of the

secreted portion is marked by rather strong transverse striæ, forming shallow corrugations. The second pellicle, which is yellow, occupies almost the whole puparium. Length about  $\frac{1}{25}$  in.

Male puparium snowy-white, rather loose in texture, semi-cylindrical; length about  $\frac{1}{10}$  in.; terminal pellicle yellow.

The second female pellicle is broadly elliptical, with both ends tapering rapidly. The cephalic end is truncate and smooth; the posterior end is broken by many small irregular denticulate lobules, between which are six or eight spines, the anterior spine on each side being rather strong.

Adult female yellowish-brown. Length about  $\frac{1}{50}$  in. Abdomen terminating in a semicircular curve, broken by many irregularities, but there are no regular or conspicuous lobes. On the margin there are from fourteen to eighteen spines on each side, of which about half are short and fine, the rest long and strong. Four groups of spinnerets: upper groups with 14 to 18 orifices; lower groups, 12 to 16; in some specimens a small upper median group of 2 or 3 may be made out.

*Hab.* In Japan, on *Bambusa tessellata*. Specimens from Miyanoshita, sent by Mr. Koebele (his No. 1495).

The pyriform striated female puparium at once distinguishes this species.

**Fiorinia camelliæ**, Comstock. *Fiorinia pinicola*, Mask., Ent. Mo. Mag., Oct., 1897.

My identification of this in the Ent. Mo. Mag. was a gross error. Subsequent examination shows that there is no difference from *F. camelliæ*. The specimens were on *Pinus sinensis*, Hongkong, and on *Cupressus juniperinus*, Formosa, from Mr. Koebele (his Nos. 1529, 1130).

**Fiorinia tenuis**, sp. nov. Plate XXIII., fig. 10.

Female puparium pale-yellow, irregularly elliptical, very thin and transparent; length about  $\frac{1}{40}$  in. The second pellicle is also extremely thin and brittle, and occupies almost all the puparium; its posterior extremity exhibits some irregular indentations, amongst which are some short and rather strong spines.

Male puparium white, but the specimens seen were not in good order.

Adult female greyish-yellow. Length about  $\frac{1}{50}$  in. Abdomen exhibiting an irregularly serrated margin, the serrations bearing numerous rather strong and thick spines, but there are no regular lobes. Five groups of spinnerets, each consisting of from 5 to 8 orifices. The groups are so nearly contiguous as to form almost an arch. There are also several dorsal tubular spinnerets.

*Hab.* In Japan, on *Bambusa*, sp. Specimens from Miyashita, sent by Mr. Koebele (his No. 1510). This particular species of bamboo has, at the junction of the leaf-stalk with the leaf, a coating of short hairs on the underside, and the insects are found amongst these hairs, but are very inconspicuous.

The very thin puparium and pellicles and the spines on the abdominal extremity will distinguish this form. It differs from *F. saprosma*, Green, in the absence of a terminal abdominal depression, in having no marginal "jointed tubercles," and in the spinneret groups. The extremity of the second pellicle is not unlike that of *F. syncarpia*, Mask., an Australian form, but the adult differs.

***Fiorinia bambusæ***, sp. nov. Plate XXIV., figs. 1-5.

Female puparium very long and excessively slender; the length reaches  $\frac{1}{3}$  in., the width only about  $\frac{1}{150}$  in. The colour is white, but appears yellow, from the second pellicle showing through it. The texture is very thin and transparent. Sides straight and parallel.

Male puparium white, similar in form to that of the female; length about  $\frac{1}{25}$  in.; width about  $\frac{1}{150}$  in. The pellicle is yellow.

The first female pellicle is very pale-yellow, almost white, very elongate-elliptical, with parallel sides and smoothly rounded ends. The antennæ present no special features. I have not been able to make out the feet. The dorsum is covered with many transverse rows of minute specks, which, under a high magnification, appear multilocular, but they vanish in the medium employed for microscopic preparation.

The second pellicle is yellow, occupying almost all the puparium. The margin all along the sides is broken by minute irregular corrugations. Near the posterior end the pellicle is transversely segmented, and ends in a broad and shallow depression, and on each side a few rather strong spiny hairs.

The adult female is cylindrical and very slender. Length about  $\frac{1}{40}$  in. Abdomen ending in a curve broken by very minute serrations, and in the middle two very small trifoliate lobes, each with an interior thickening of the epidermis; between and alongside these lobes are a few spiny hairs. But many specimens show no indications of lobes at all, the margin of the abdomen in them, all round, being almost entirely smooth. This form is very noticeable in one of my prepared specimens, which shows the adult still in the puparium, covered by the second pellicle, and I imagine that it results from a bending under of the extremity whereby the ultimate edge is hidden. I have seen the same smooth

curves in females extracted from the puparium. I can see only two groups of spinnerets, each with three orifices.

Adult male unknown.

*Hab.* In China, on *Bambusa fortunei*. Specimens from Hongkong, sent by Mr. Koebele (his No. 1534).

An extremely elegant and distinct species, remarkable for its length and slenderness. Mr. Green has a form, *Chionaspis* (originally *Mytilaspis*) *elongata*, on *Arundinaria*, which is a kind of bamboo, in Ceylon; but it is quite different in the puparium and in other characters.

**Fiorinia nephelii**, sp. nov. Plate XXIV., figs. 6–10.

Insects inhabiting small pits on the under-surface of a leaf. There is a corresponding elevation on the upper surface. Usually each pit contains three or four insects of different stages.

Female puparium yellow, but the median region appears dark-brown, from the second pellicle showing through it. The form is irregularly elliptical. Length about  $\frac{3}{8}$  in.

Male puparium white, semicylindrical, not carinated; pellicle yellowish-brown; length about  $\frac{1}{4}$  in. This puparium lies on the surface of the leaf, and not in a pit. When several are collected together the cottony secretion forms a mass of white fluff, the form of each being indistinguishable.

Larva in its early stage yellow, darkening with age, so that when its exuviae form the first pellicle they are brown. Form regularly elliptical; length varying with age from about  $\frac{1}{10}$  in. to  $\frac{1}{8}$  in. The antennae, feet, and terminal setae are normal, but the margin, both in the male and the female, bears a number of rather long slender spiny hairs.

The second pellicle is dark-brown, elliptical, with a somewhat irregular edge. The posterior extremity has a conspicuous depression, the sides of which form minutely serratulate lobes; and on the abdominal margin there are a few short and thick spines.

Adult female entirely enclosed within the second pellicle, so that it is extremely difficult to extract. The form is normal. Colour brown; length about  $\frac{1}{5}$  in. The abdomen ends in a depression with serratulate sides, as in the second pellicle, and there are a few short marginal spines. I have not been able to satisfy myself as to the spinnerets, but there are probably the usual five groups.

Adult male unknown.

*Hab.* In China, on *Nephelium longana*, and in Queensland, on the same plant. Specimens sent from Hongkong, Tamsui, and Brisbane, by Mr. Koebele (his No. 1417).

It was only after very considerable trouble that I was able to extract sufficient of the adult females from the

second pellicle to make out the abdominal characters, but I did not succeed in getting a single uninjured specimen.

The terminal depression and spines of the female, both second stage and adult, in this species approach those of *F. camelliae*; but its habit of forming pits in the leaf, and also the long marginal spines of the larva, clearly distinguish it. Mr. Koebele sent me the specimens under the name *F. secreta*, Green, but they do not agree with that. I have specimens of *F. secreta* from Mr. Green himself, and I find them quite distinct. They form little rounded galls on the upper surface of the leaf, and there is either no visible orifice in the under-surface, or else a very minute one; whereas *F. nephelii* forms a pit in the under-surface, and merely presses out the upper surface in a small elevation. Moreover, the long marginal spines are very clear and conspicuous on both male and female larva of *F. nephelii*, whilst Mr. Green makes no mention of them in *F. secreta*, and I can see none in my specimens.

#### Section LECANINÆ.

##### Genus CEROPLASTES.

*Ceroplastes vinsonii*, Signoret. Plate XXV., figs. 1, 2.

I have received from Dr. Anderson, of Calcutta, three specimens which I shall attach to this species; also a small coloured drawing of the insect as it appears when alive. These specimens agree altogether with Signoret's description, having the eight lateral waxy tuberosities and the central boss; moreover, in the specimen which I have prepared for microscopic examination I find the peculiar "arrow-headed" spines situated near the spiracular depressions, with spiny hairs posterior to them. These "arrow-heads" are made by Signoret a distinctive character of the species, and he separates *C. fairmairii* from *C. vinsonii* by the absence of spiny hairs from the former. Comstock (Rep. of Entom., 1880, p. 331) expresses a doubt whether these processes have sufficient specific value, for he says he finds them also in his species, *C. floridensis*; but it is quite possible that this may be identical with *C. vinsonii*. In any case, only three species of the genus are said to exhibit them.

*Hab.* In India, on *Thea*, at Darjeeling.

##### Genus CERONEMA.

*Ceronema japonicum*, sp. nov. Plate XXV., figs. 3-9.

Female insects partially or wholly covered by closely-woven white semi-cottony threads; sometimes these are absent, except on the median dorsal region, the rest of the body being naked. On this median region the threads are very long, curl-

ing outwards in long elevated curves, and frequently extending beyond the margin.

Male pupa covered by a test of white secretion, which is rather more solid than that of the female, approaching to glassy plates. Some male tests exhibit median curling threads, but others do not. Length of male test about  $\frac{1}{20}$  in.

Adult female yellowish, of normal Lecanid form, rather flat, with a slightly-raised median longitudinal ridge of rather darker colour; length about  $\frac{1}{13}$  in. The outline is elliptical, rather narrowed anteriorly. Antennæ of seven joints, of which the fourth is the longest, then the third, and the rest are sub-equal; in the fourth there is a "false joint," so that it might be sometimes taken for two; there is one hair on the first, two on the fourth, and four to six on the last. Feet moderately thick; the tibia is only slightly longer than the tarsus; upper digitules slender, knobbed hairs, lower pair dilated. The abdominal cleft is normal, but in all the specimens examined I find two anogenital rings, one anterior to the other, both "compound," and both bearing several hairs; and there are two pairs of lobes, one to each ring. The margin of the body bears a double row of spines, one set being twice as large as the other. At each of the four spiracular depressions there is a group of about six much larger and longer spines. All over the body there are numerous scattered spinneret orifices of two sizes, the smaller ones being the most frequent. On the median dorsal region, where the raised ridge exists, there are two longitudinal series of short thick conical spines, extending from the rostrum nearly to the abdominal cleft.

Second stage unknown.

Larva yellow, active, flat, of normal Lecanid elliptical form; length about  $\frac{1}{80}$  in. Antennæ of six rather thick joints. Feet and abdominal lobes normal. I cannot detect any median spines or orifices. The margin bears a series of fine hairs, not set closely together.

Adult male unknown.

*Hab.* In Japan, on *Ilex crenata*, and in India, on tea. My Japanese specimens are from Miyanoshita, sent by Mr. Koebele (his Nos. 1476 and 1478); the Indian ones were sent by Dr. Anderson, of the Indian Museum, Calcutta, who gives no particular locality.

I think that this form is clearly allied to the Australian *Ceronema banksiæ*, Mask., 1894, the principal difference being that the organs which produce the long curling threads are here on the median dorsum, whereas in *C. banksiæ* they are nearer to the margin. The result is that in the Japanese species the threads curl outwards, while in the Australian they curl inwards. Other differences, of course, are in the marginal spines, the antennæ, &c. I am not able to explain the

appearance of two anal rings, but these were constant in all my specimens, both from India and Japan.

I shall presently describe another Japanese insect—*Lecanium notatum*—also partly on tea, in which there are markings on the median dorsal carina; but that is different in other respects, as will be seen.

#### Genus LECANIUM.

**Lecanium ficus**, sp. nov. Plate XXV., figs. 10, 11.

Adult female elongated, narrow, convex, smooth, without dorsal carina; colour darkish-brown; length about  $\frac{1}{4}$  in. Antennæ of eight joints, the third, fourth, and fifth the longest, and subequal, the sixth and seventh the shortest. Feet moderate; tibia not quite twice the length of the tarsus; upper digitules fine hairs, lower pair only slightly dilated. Margin bearing only a very few short hairs. Epidermis marked by numbers of oval spots, rather large, and on the abdominal region with some fine hairs.

Female of the second stage yellow, flat, elliptical; length about  $\frac{1}{25}$  in. Antennæ of six joints. Margin bearing only a very few fine hairs.

Larva yellow, flat, elliptical; length about  $\frac{1}{35}$  in. The antennæ and feet present no special features. The margin is very minutely crenulated, but bears no hairs. Terminal setæ moderate.

*Hab.* In China, on *Ficus*, sp. Specimens from Swatow (on the sea-shore), sent by Mr. Koebele (his No. 1349).

This form is allied to *L. longulum*, Douglas, and it also seems to be near to *L. anthurii*, Signoret, and to *L. terminaliæ*, Cockerell, but it appears to differ from all. *L. longulum* may perhaps (*apud* Douglas) have eight-jointed antennæ, *anthurii* has seven, and in *terminaliæ* the antennæ are not described. I shall leave the species separate for the present.

**Lecanium ribis**, Fitch.

I have received from Mr. T. W. Kirk specimens of this species on grape-vine from the Wairarapa district, New Zealand. They are identical with those mentioned in my paper of 1891 (Trans. N.Z. Inst., vol. xxiv., p. 22) as occurring on the same plant at Ashburton.

**Lecanium berberidis**, Schrank.

I reported this species from Australia in 1896 (Trans. N.Z. Inst., vol. xxix., p. 311), but with a note of interrogation, because I was not certain as to one character given by Signoret—viz., the swollen anterior tarsi and median tibiæ. Since then I have received, by the kindness of Dr. Berlese,

Part II. of his "*Cheremotheca italica*," containing the European type of the species. On examination I find that these specimens also do not show any abnormal form of the feet, and that the only thing in which the Australian form differs is size, which may be accounted for by climate, food-plant, &c. If any note, therefore, is required, it need only be to add the words "forma major."

***Lecanium notatum***, sp. nov. Plate XXV., fig. 12-15.

Adult female yellow, flattish, with a slightly-raised longitudinal dorsal ridge; form elliptical; length about  $\frac{1}{11}$  in. Antennæ of eight joints, of which the third is much the longest; next the fourth and second, which are equal; next the fifth; the rest short and subequal. Feet rather long; the tibia is twice as long as the tarsus; upper digitules long fine knobbed hairs, lower pair long and rather widely dilated. Margin bearing a single series of fine hairs. The dorsal ridge is marked by an irregular longitudinal series of polygonal cells; these cells disappear in a prepared and mounted specimen. Mentum monomerous.

Male pupa covered by a white glassy test of the usual angular-elliptical form, composed of flat polygonal plates.

Adult male yellow. Length about  $\frac{1}{8\frac{1}{2}}$  in. The spike is rather long, but there are no special characters.

*Hab.* In Japan, on *Pittosporum*, sp., and on tea. The male tests are most numerous on *Pittosporum*. Specimens from Atami, sent by Mr. Koebele (his No. 1475).

This species appears to be allied to *L. minimum*, Newstead, but differs in the antenna, in the proportions of the tibia and tarsus, and in the median dorsal cells.

***Lecanium globulosum***, sp. nov. Plate XXVI., figs. 1, 2.

Adult female semiglobular, the border somewhat flattened; colour clear yellow; diameter about  $\frac{1}{8}$  in. Epidermis covered with many minute yellow spots, but no definite tessellation is apparent either in the natural state or after preparation for the microscope. Antennæ of six joints, of which the third is much the longest, the rest subequal. Feet moderate; upper digitules long fine hairs, lower pair long and very slightly dilated. Abdominal cleft, lobes, and anal ring normal. Margin without hairs.

Female of the second stage clear yellow, elliptical, flattish, with a median longitudinal dorsal carina; length about  $\frac{1}{13}$  in. Antennæ of six joints.

Larva yellow, flat, elliptical; length about  $\frac{1}{50}$  in. Antennæ of six joints. The margin is minutely crenulated; the spiracular spines are rather long, and there are some shortish fine hairs, set rather far apart.



Male unknown.

*Hab.* In China, on *Stillingia sebifera* (the "tallow-tree"). Specimens sent from Hongkong by Mr. Koebele (his No. 1541).

This insect belongs to Signoret's third series, and seems to be allied to *L. genevense*, *L. prunastri*, &c., species in which the dermal tessellation is extremely indistinct.

On the packet containing the specimens sent Mr. Koebele writes, "Covered over by ants." I found no ants in the parcel, and Mr. Koebele does not state that the species is subterranean, whilst the piece of the plant sent is clearly not part of a root. All ants, however, are not subterranean, as I understand.

**Lecanium melaleucæ**, sp. nov. Plate XXVI., figs. 3-8.

Adult female reddish-brown, elliptical, tapering anteriorly, very slightly convex, the median dorsal region darker coloured than the margins, but there is no conspicuous dorsal carina. Length averaging about  $\frac{1}{9}$  in., but may reach  $\frac{1}{7}$  in. Epidermis slightly rough with minute pustules, which, in a prepared specimen, appear as subcircular cells. In some specimens, on the median dorsal region, there is a longitudinal series of white waxy tufts, but these are by no means constant. Antennæ of (probably) six joints; the last three are confused, and may be four; the basal joint is very thick, the rest tapering, the third being much the longest; on the last are some short hairs, and there is a long hair on the second. Feet moderate; in the early adult the tibia is shorter than the tarsus, but when fully grown it is longer; the upper digitules are long fine hairs, the lower pair long and widely dilated. The margin bears no hairs, but there is a group of blunt spines in each of the four spiracular depressions. The rostrum is normal, the mentum globular, monomerous; in the early adult the rostral setæ, before passing through the mentum, are often encased in a sort of cylindrical sac, or agglomerated together; but I have failed to find this feature in a fully-grown specimen, and in the early state it seems to be not constant. The abdominal cleft, lobes, and anal ring are normal.

Female of the second stage lighter coloured than the adult, elliptical; length about  $\frac{1}{10}$  in.; on the dorsum there is a slightly-raised longitudinal ridge, with two other transverse ones less conspicuous. Antennæ of six rather confused joints. The rostral setæ are usually encased as in the early adult.

Larva yellow, elliptical, flat; length varying from about  $\frac{1}{6.5}$  in. in the earliest to  $\frac{1}{4.0}$  in. in the latest stage. Antennæ of six rather thick joints. Feet moderate, digitules rather thick. Abdominal setæ moderate. Rostral setæ encased as in the second stage, the loop being usually very long, and reaching

almost to the abdominal extremity. Margin bearing a few scattered short fine hairs; spiracular spines rather long.

Male pupa covered by a glassy thin test of the normal Lecanid form, composed of polygonal plates. Length of the test about  $\frac{1}{11}$  in.; but the central portion of this test is again covered by a snow-white mass of thicker and more waxy material, and this is, as a rule, divided on the median dorsal region by a shallow longitudinal groove, which becomes much deeper at the cephalic extremity, where the mass is separated into two parallel portions; at the abdominal extremity the two divisions converge; the lateral regions of the test bear narrow ridges of white wax covering the divisions of the plates; so that, on the whole, the upper covering of a test presents somewhat the appearance of the egg-case of a dog-fish, only snowy white.

Adult male dark-red; length about  $\frac{1}{17}$  in., inclusive of the head and the spike. Wings iridescent, with red nervures. Haltere fusiform, with a single terminal seta bent into a hook. Antennæ of probably nine joints, but the divisions are not clear, and there may be ten; all have numerous hairs, four on the last joint being knobbed. Feet rather long, with numerous hairs on every joint. Anal spike moderate, slightly curved.

*Hab.* In Australia, on *Melaleuca*, sp. Specimens from Palmer Island, Clarence River, New South Wales, sent by Mr. Froggatt.

I am not able to attach this to any known species, on account principally of the curious rostral setæ of the female and the test of the male pupa. Externally, and to the naked eye, or under a weak lens, the female is not unlike *L. tessellatum*, but there is no dermal tessellation. I think it may fairly be considered as new.

***Lecanium casuarinæ*, sp. nov.** Plate XXVI., figs. 9-14.

Adult female dull dark-red in colour, semiglobular; diameter averaging  $\frac{3}{8}$  in.; dorsum sometimes smooth, sometimes with one longitudinal and two transverse ridges, not very conspicuous; scattered over the body are a number of minute specks of white wax, which, however, are scarcely visible to the naked eye or under a weak lens. The ventral surface is concave, with a thick margin, and covers a number of larvæ. Antennæ and feet entirely wanting, the only organs visible, even after preparation, being the rostrum, the spiracles, and the abdominal lobes. The rostrum is moderate, the mentum monomerous, the setæ remarkably long. The spiracles are very large, bivalvular, situated in deep depressions, with enormous tracheæ. Abdominal cleft normal, the lobes very small, triangular. The dorsal skin bears some

rather large scattered circular orifices which appear to be at the apices of small pustules; also a number of minute simple circular orifices. The margin bears only very few or no spines.

Female of the second stage elliptical, slightly convex. The true colour is red, but the dorsum is covered with a coating, not very thick, of white wax, not homogeneous, but composed of small polygonal segments as in the adult, only much more closely set, and almost wholly concealing the insect. The ventral surface is slightly concave, and varies in colour from dull-yellow to dull-red. Dorsally there is a longitudinal raised ridge and also two transverse ones, all rather inconspicuous as a rule. The length of the insect at this stage is about  $\frac{1}{2}$  in. Antennæ and feet entirely absent. Rostral setæ extraordinarily long, coiled in a large circle before passing through the mentum. Abdominal lobes small and black. The spiracles, as in the adult, and the tracheæ, are enormously developed, and the spiracular depressions very deep. The margin of the body, all round, bears a row of moderately long blunt spines set closely together. Dorsally there are the same large spots and small orifices as in the adult, but these, especially the small ones, are very much more numerous.

Larva flat, regularly elliptical, active; colour dull-red; form normally Lecanid; length about  $\frac{1}{2}$  in. Antennæ rather long, with six joints, of which the third is twice as long as any other; all the joints bear many hairs. Feet also rather long; the tibia is twice as long as the tarsus; tarsal digitules fine hairs, lower pair very slightly dilated. Abdominal cleft, lobes, and setæ normal. Margin bearing some spines, but not set so closely as in the second stage. The spiracular depressions are very deep, and bear club-like spines. The rostral setæ are enormously long.

Male unknown.

*Hab.* In Australia, on *Casuarina*, sp. Specimens from Myrniong, Victoria, sent by Mr. Lidgett, who says in his letter, "They were found in the centre of the branch, having evidently followed the hole left by the larva of the moth *Marogia gigantella*, Walk., and had taken up their abode about 18 in. from the point of entrance, quite safe from the attacks of birds, &c. Half a dozen ants seemed to be busy attending to them."

The burrow of the moth larva is rather less than  $\frac{1}{2}$  in. in diameter, so that there is just room for these large Coccids to occupy it without too much crowding. It may be presumed that they do not begin to make use of this tunnel until after the moth has emerged, unless it does so from some other orifice than that where the larva enters; otherwise it is not easy to see how it could make its way out, as the Lecanids practically fill up most of the space.

This species is second in size only to *L. mirificum*, Mask., 1896, and in many respects is curious and interesting. The spiracles, which are only noticeable in the adult and the second stage, being absent from the larva, differ from those of any other Coccid with which I am acquainted; and, as my figures show, the irregular and pubescent joints of the larval antenna and foot are abnormal amongst the *Lecaninæ*. It is curious that the marginal spines, so numerous in the second stage, should disappear in the adult. The very extraordinary length of the rostral setæ in all stages is also a curious character, although it would not at all serve for specific distinction, seeing that scarcely any two species of Coccids have setæ of the same length, some being just as exceptionally short as those of *L. casuarinæ* are long.

#### Genus PULVINARIA.

##### *Pulvinaria psidii*, Maskell.

This species is evidently widely distributed in tropical and subtropical regions, and has been found in Ceylon, in China, and in Japan since I first described it from Hawaii in 1892.

Amongst the Koebele collection (his Nos. 1277, 1507) were many males. The male test is of the normal glassy angular form. The adult male is brown, about  $\frac{1}{3}\frac{1}{2}$  in. long; the feet rather long, the tibia three times as long as the tarsus; antennæ of nine joints; abdominal spike rather long and thick.

This insect appears to attack a good many various plants in hot countries.

##### *Pulvinaria maskelli*, Olliff, var. *spiniosior*, Maskell.

Specimens of this species were sent to me by Mr. Musson, on *Pittosporum phillyræoide*, Richmond, New South Wales (collected by Mr. G. Valder); amongst them were a number of male tests, hitherto undescribed.

These tests present no special features, but are rather more waxy than usual, and also less angular, the corners of the plates being rounded off, so that the outline is almost or quite elliptical. I could not find a male insect.

#### Section HEMICOCCINÆ.

##### Subsection CRYPTOKERMITIDÆ.

##### Genus MALLOCOCCUS, gen. nov.

##### *Mallophora*, Maskell, 1896.

I am informed that my name *Mallophora*, for the Chinese species *M. sinensis* (Trans. N.Z. Inst., vol. xxix., p. 314), was employed by Macquart, in 1834, for a genus of flies. I must

therefore make a correction as above; probably the name now proposed will be free from any such objection.

Section COCCINÆ.

Genus ERIOCOCCUS.

**Eriococcus graminis**, sp. nov. Plate XXVII., figs. 1-3.

Adult females enclosed in sacs of white cotton, which are massed together, and appear as if encrusting the plant. These sacs are rather closely felted, elliptical. Length about  $\frac{1}{10}$  in., but, being crowded together, it is not easy to make this out clearly. Sacs from which the female has fallen out are usually filled with empty white egg shells.

Male pupa-sacs similar to those of the females, but smaller; usually mixed up with them on the plant.

Adult female elliptical, but shrivelling as usual at gestation; colour dull dark greenish-brown; length before gestation about  $\frac{1}{15}$  in. Antennæ of seven joints, rather thick; the third is the longest. Feet rather long; tibia shorter than the tarsus, as usual in the genus. Anal tubercles and ring normal. Epidermis covered with very numerous fine rather short hairs interspersed with blunt spines, and on the margin the spines are arranged in a row, and are longer and thicker.

Larva yellow; form normal; length about  $\frac{1}{80}$  in. Antenna of six rather thick joints. Foot bearing several hairs on the tibia and tarsus.

Second stage and male unknown.

*Hab.* In China, on grass. Specimens from Hongkong, sent by Mr. Koebele (his Nos. 1523 and 1546).

This form is not far removed from the New Zealand *E. pallidus*. It differs in the marginal spines, and also in the massing of many sacs together (but this last character may be due to the food-plant).

**Eriococcus exiguus**, sp. nov. Plate XXVII., figs. 4-6.

Sac of adult female yellow, elliptical, rather loosely felted; length about  $\frac{1}{40}$  in. The sacs are entangled amongst the numerous hairs of the leaf.

Sac of male white, loosely felted, cylindrical; length about  $\frac{1}{60}$  in.

Adult female brownish-yellow, of normal form, shrivelling at gestation. Length before gestation about  $\frac{1}{70}$  in. Antennæ thick, with six subequal joints. Feet showing no peculiar characters. Anal tubercles rather long. Margin bearing a row of short, thick, sharply conical spines.

Larva brownish-yellow, of the normal elliptical form; length about  $\frac{1}{110}$  in. The margin bears short, thick, conical spines, as in the adult.

Male unknown.

*Hab.* In China, on a plant the name of which was not sent to me. The leaves are light-green, rather like those of a rose, but covered on the underside with a dense pubescence. Some very small Diaspid male puparia are on the same leaves. Specimens from Hongkong and Tamsui, sent by Mr. Koebele (his No. 1525).

The extreme smallness, the yellow sac, and the marginal conical spines will distinguish this species.

### **Eriococcus eucalypti**, Maskell.

Mr. Tepper informs me that this species, in South Australia, is usually accompanied by *Dactylopius eucalypti*, and that both are especially injurious to *Eucalyptus rostrata* (red-gum, river-gum), which is "simply ruined by it since the brush-tongued parrots and other sweets-loving birds have been exterminated in the locality." I do not remember noticing any previous observations as to the action of birds upon Coccids, excepting a remark of my own several years ago that the white-eye, or blight-bird (*Zosterops lateralis*), pecked at *Lecanium hesperidum*; and a paper by Mr. Newstead in the Ent. Mo. Mag., April, 1895, in which he states that four species of Coccids were found by him in the stomachs of birds in England. Mr. Tepper's remark is therefore of great interest, and will, I hope, induce some naturalist to investigate this subject, which is important in many respects.

### **Eriococcus paradoxus**, Mask., var. *simplex*, var. nov.

Sac of female similar to that of the type, so closely felted as to seem waxy, but not (in the specimens seen) aggregated in such solid masses.

Adult female of a deep-red colour, similar to the type in the peg-top form, the terminal lobes, the anal ring, and the size, in the atrophied antennæ, and in the absence of feet, which are replaced by spines; but instead of large numbers of figure-of-eight spinnerets there are only moderate numbers of simple circular orifices, most of which are small, a few near the abdominal extremity being larger.

*Hab.* In Australia, on *Eucalyptus*, sp. Specimens from Albury, sent by Mr. Froggatt.

### Genus RIPERSIA.

Mr. R. H. Pettitt, of Lansing, Michigan, U.S.A., was kind enough to send me specimens of an insect of this genus found in ants' nests in that region. He did not ask me to describe it, but I have suggested to him the name *R. myrmecophila*.

It appears to be distinguished from other species by its great pubescence, not only on the body, but also on the antennæ and feet.

I should attach this form to *Ripersia* on account of the six-jointed antenna. Mr. Newstead has included in this genus a number of species—*e.g.*, *R. pulveraria*, *R. tomlinii*, *R. tumida*—where the antennæ have seven joints. I am obliged, although with diffidence, to differ from him on this point, for I imagine that what has led him to such a conclusion is the absence of tarsal digitules, and this seems to be a character usually difficult to make sure of. I often find that the digitules in a dead specimen are broken off, and they are often frequently destroyed in the process of preparation. The digitules of the claw are more permanent. Moreover, in such species as *R. fraxini*, Newst., or *R. fagi*, Mask., the tarsal digitules are present, as also in this Michigan species. It would follow, therefore, that by-and-by we should have to further subdivide *Ripersia*, making a separate division of those with six-jointed antennæ and tarsal digitules, which would be a great pity. I prefer very much to put all the six-jointed forms (with otherwise Dactylopid characters) into *Ripersia*, leaving those with seven or eight joints (whatever their digitules) in *Dactylopius*, as being the plan least likely to lead to confusion.

#### Genus DACTYLOPIUS.

##### *Dactylopius graminis*, Maskell, var. *orientalis*, var. nov.

Insects enclosed in sacs of white felted cotton, which are massed together on the plant, the proper form of each being irregularly elliptical. Insect dark-purple or dark-brown, subglobular or slightly elliptical; length about  $\frac{1}{15}$  in. Antennæ of seven joints, the first six subequal, the last as long as any two others. Feet moderate; digitules all fine hairs. Anal tubercles very inconspicuous, almost obsolete, with shortish setæ and fine hairs; anal ring with six hairs. Epidermis covered with numerous simple circular spinneret-orifices of two sizes.

Larva and male not observed.

*Hab.* In China, on stems of grass. Specimens from Hongkong, sent by Mr. Koebele (his No. 1501).

This is so near to *D. graminis*, described by me in the Trans. N.Z. Inst., vol. xxiv., 1891, p. 36, that I have decided to attach it to that species as a variety, on account of the seven-jointed antenna, the only conspicuously differentiating character. It differs from *D. herbicola*, Mask., 1891, in the form of the feet and in the entire sac, and it may be distinguished from *Ripersia tomlinii*, Newstead, 1892, by its aerial habitat, and by the smooth hairless feet (*R. tomlinii* has a

good deal of pubescence). The type of *D. graminis* came from the Cape of Good Hope.

**Dactylopius syringæ**, sp. nov. (?) Plate XXVII., figs 7, 8.

Adult females enclosed in very loosely woven snow-white elliptical sacs aggregated in a mass on the plant.

Male pupæ in similar but smaller sacs.

Adult female yellow; length about  $\frac{1}{16}$  in. Antennæ of eight joints, the eighth being the longest and fusiform; the antennal formula is 8213 (45) (67); there are two or three hairs on each joint. Feet moderate; the trochanter bears a long seta; the tibia and tarsus have a few hairs on the inner margins; the tarsal digitules are fine hairs, digitules of the claw very slightly dilated. Anal tubercles rather broad, but not very prominent; each bears a seta and several short conical spines; anal ring with six hairs. Epidermis covered with numerous small simple circular spinnerets, and with a rather dense pubescence, many of the hairs, especially on the cephalic region, being rather strong and long. In two specimens examined there were three transverse elongated irregular spots on the dorsum, one on each of the anterior abdominal segments.

Larva not observed.

Adult male brown; wings grey; length about  $\frac{1}{20}$  in. Antennæ and feet presenting no special characters. Abdominal spike short and conical; setæ and cottony "tails" rather long.

*Hab.* In Japan, on *Syringa amurensis*. Specimens sent from Atami by Mr. Koebele (his No. 1550).

I advance this species with some diffidence, because on the pieces of bark sent to me almost all the specimens were males, and I could only extract three females in a condition for observation. The antennal formula is not far removed from that of *D. cocotis*, Mask., 1889, or perhaps of *D. solani*, Cockerell, 1894. The latter, however, differs in other particulars. The cottony secretion of *D. cocotis* is much less distinctly separable into elliptical sacs (although even in *D. syringæ* the sacs are not very clearly defined). The male of *D. cocotis* is not known. Probably *D. syringæ* may be best separated from that species by the more conspicuous anal tubercles, the fewer hairs on the tibia and tarsus, and the longer dorsal hairs, which do not form tufts at the margin. For the present I shall leave it as a distinct species.

#### Section IDIOCOCCINÆ.

I established this section in 1892 (Trans. N.Z. Inst., vol. xxv., p. 236) for the express purpose of including a number of species which are of so peculiar a character that



they could not be made to enter into any known group or section. But even amongst themselves these forms present such divergences that it really might be quite possible to erect a new genus to suit each one. Such a proceeding, however, would be to me so distasteful that I prefer almost any plan to it. In consequence, when laying down the characters of the section I made them purposely extremely general, and as wide as possible. Unfortunately, in one instance I departed from this rule: I definitely stated that the anogenital ring was hairless. The departure was unfortunate, as it obliges me now to modify the sectional characters a little, a thing which it would have been better to avoid. Up to the present date I possess twenty-two species and varieties included in this section, and Mr. Cockerell has another—*Sphærococcus tokionis*.

But there are two of these species which depart from the general rule in having anal rings with hairs. For these, therefore, it seems necessary to erect a new genus; but, as in all other respects they enter into the section *Idiococcineæ*, and certainly cannot be satisfactorily placed in any other section, I shall simply enlarge a little the sectional characters, and lay them down now as follows:—

IDIOCOCCINÆ.

Adult females active or stationary; gall-making, or naked, or producing cotton or wax. Anal tubercles absent or rudimentary. Anal ring with or without hairs. Antennæ with usually less than seven joints, frequently atrophied. Body not prolonged posteriorly in a "tail."

The genera included in this section up to the present time will be—

Insects gall-making; form much elongated; anal ring hairless	.. .. .	<i>Cylindrococcus.</i>
Insects naked, or covered, or gall-making; form various; anal ring hairless	.. .. .	<i>Sphærococcus.</i>
Insects naked, or covered, or gall-making; form various; anal ring with hairs	.. .. .	<i>Chatococcus.</i>

At present the last of these three will include the insect described by me in 1892 as *Sphærococcus bambusæ*, and a new species lately discovered in China—*C. graminis*. The form reported by Cockerell as *S. tokionis* appears to be not unlike *bambusæ*, but I have not been able to make out the anal ring.

Genus SPHÆROCOCCUS.

*Sphærococcus parvus*, sp. nov. Plate XXVII., figs. 9-11.

Insects dwelling in the rugosities of the bark of the plant, where their presence is primarily indicated by small tufts of

white cotton, in the midst of which are the yellowish-brown, hard, semiglobular tests covering the insects. The test averages about  $\frac{1}{40}$  in. in diameter.

Adult female reddish-brown, globular, filling the test. The antennæ are almost completely obsolete, being represented by very minute tubercles bearing a few hairs. Feet absent. Anal ring simple, hairless; anal tubercles absent. Indeed, with the exception of some small circular multilocular spinnerets scattered on the dorsum the only visible organs are the rostrum and the spiracles. The rostrum is moderately large, with a monomerous mentum and shortish setæ; the spiracles are tubular.

Larva red; length about  $\frac{1}{100}$  in. Form normal; antennæ of six confused short joints, on the last of which are two long hairs. Feet rather thick; digitules fine hairs. Anal tubercles prominent, but small; setæ moderate.

*Hab.* In Japan, on cherry. Specimens sent by Mr. Koebele (his No. 1521); locality not mentioned.

In the absence of organs there is only the test to fall back upon for distinction, and the size. I think that in both respects this species is new.

Amongst Mr. Koebele's parcels was one (No. 1515) labelled "Japan, on *Quercus*." I was unable to observe definitely any insects. There were some small brown tests on the bark, and one mutilated female extracted was reddish-brown, seemingly about  $\frac{1}{40}$  in. in diameter, and without any organs visible. It is possible that this also was *S. parvus*.

### **Sphærococcus populi**, sp. nov. Plate XXVII., figs. 12-16.

Adult female covered by a very hard and solid waxy test of a dull dense-black colour, considerably convex, circular in outline; diameter about  $\frac{1}{3}$  in.; this test is roughened by numbers of minute polygonal pustules, which, after prolonged boiling in potash, and viewed sideways, form conspicuous elevations; on the median dorsal region there may be faintly discerned six small depressions, or pits, in two rows.

On turning over the test the flat ventral surface of the insect is seen surrounded by a ring of black wax, within which is visible some of the thin white powdery meal scattered over the interior of the test. This ventral surface is just as black as the test. It is very difficult to separate the insect from its covering, and the best plan for examination is to boil the whole together, when the dorsal part of the test, and the enclosed insect, become more or less transparent, though the marginal ring defies the action of the potash. When so treated it is found that the insect possesses six feet, although nothing can be seen of them by external observation.

It is probable that atrophied antennæ and an anogenital ring also exist, but both of these must be situated under, or close to, the marginal ring, and as this will not dissolve they cannot be made out. The feet are peculiar: the two anterior pairs are short, thick, and deformed, the joints much swollen, and the tibia and tarsus fused into one; the posterior pair are longer and more slender, and the joints can be separated. The rostrum is normal, the mentum probably dimerous. On the dorsum six round spots are visible in two rows, answering to the six depressions in the test. Epidermis much wrinkled. There are no clear spinneret-orifices, but towards the margin the skin is covered with great numbers of very minute puncta, which may be spinnerets, and also with rather large clear oval cells. If antennæ exist they must be extremely small.

Larva and male unknown.

*Hab.* In Japan, on *Populus tremula*, var. *villosa*. Specimens from Nikko, sent by Mr. Koebele (his No. 1492).

When publishing in the Ent. Mo. Mag. my list of Mr. Koebele's collection I had not made up my mind as to this species, but I think it is undoubtedly a *Sphaerococcus*. In its hardness and resistance to potash it approaches *Chætococcus bambusæ*, and in the unequal and deformed feet *Sphaerococcus inflatipes*.

#### Genus CHÆTOCOCCUS, gen. nov.

General characters of *Idiococcine*; anal ring bearing some hairs.

**Chætococcus bambusæ.** *Sphaerococcus bambusæ*, Maskell, Trans. N.Z. Inst., 1892, vol. xxv., p. 237.

Mr. E. E. Green drew my attention some months ago to the fact that this species has hairs on the anal ring. When originally describing it I had great difficulty in finding the ring at all, on account of the excessive hardness of the epidermis, which refused to become transparent even after very long boiling; but I find one of my prepared specimens, after five years' immersion in dammar solution, sufficiently lucid to show some long hairs, which, as far as I can make out, are six in number, though there may be eight.

This species, originally from the Sandwich Islands, has since been found in Ceylon, and I hear lately from M. d'Emmerez de Charmoy that it is plentiful in Mauritius.

But Mr. Green, in the same letter to me, made the somewhat startling statement that he was convinced that specimens in Ceylon "identical with *Sphaerococcus bambusæ*" were also identical with the genus *Antonina*, Signoret, a statement founded upon actual comparison with specimens of *A. purpurea*

sent to him by Herr K. Sulc. I confess that this, coming from so thorough a student of Coccids as Mr. Green, not only astonished, but rather disturbed me. *A. purpurea* is placed by Signoret (although not very definitely) amongst the *Acanthococcidæ*. I possessed in my cabinet a specimen sent to me by Signoret himself in or about 1881, but as it was a single one I did not like to remove it for examination, and I therefore wrote to Mr. Green and also to Mr. Newstead in the hope of procuring others. But later, in looking through some boxes of duplicates, I found that Dr. Signoret had sent me four specimens, three of which were in the box. Being thus enabled to examine the species microscopically, I can state definitely that there is no resemblance between *A. purpurea* and *C. bambusæ* except externally and superficially. I had already some suspicion of this, because Signoret's figure (in his pl. xv., 3A) bears no likeness at all to *C. bambusæ*; and his descriptions of both the adult and the larva, although by no means satisfactory, will also not agree with that species. But on examination I find that *A. purpurea* produces a good deal of dark-red or purple matter; that it easily yields to the action of potash; that the spinneret-orifices, the marginal hairs, the segments of the abdominal region, and the posterior extremity correspond with Signoret's figure, and are quite different from *C. bambusæ*. As for the larva, there is nothing in that of *C. bambusæ* resembling what Signoret calls the "striking and extraordinary" development of the rostral setæ in *A. purpurea*. Whatever, therefore, may be the superficial resemblances, the anatomical characters forbid me to place *bambusæ* in the genus *Antonina*.

It remains to note that this further inquiry of mine seems to indicate to me that *Antonina* was erroneously placed by Signoret amongst the *Acanthococcidæ*. The anal tubercles of *A. purpurea* resemble those of *Dactylopius* or *Ripersia* much more nearly than those of *Eriococcus* or *Planchonia*. However, I cannot positively decide this point without an examination of the larva and the second stage, which is not in my power at present. I am not aware of any account of the species since that of Signoret in 1874.

**Chætococcus graminis**, sp. nov. Plate XXVII., figs. 17–19.

Adult female partially (often almost wholly) covered by a coating of white cotton, which is closely felted, and looks sometimes quite solid. Insect dark-brown, semiglobular, becoming concave beneath at gestation; diameter about  $\frac{1}{13}$  in. As usual in this section the principal organs have disappeared; the antennæ are reduced to mere tubercles, and the feet are entirely absent. The rostrum and spiracles are normal. Epidermis covered with great numbers of circular

spinnerets, which are most numerous at the abdominal extremity, where they are frequently tubular, and are mingled with many short fine hairs. The extreme abdominal margin also bears some hairs longer than the others. The anal ring is large, compound, and bears eight rather strong hairs. In the margin beneath it there is a shallow depression, and from this to the anal ring there is a band of much darker brown colour.

Larva and male unknown.

*Hab.* In China, on grass. Specimens from Hongkong, sent by Mr. Koebele (his No. 1520). The parcels were labelled "*Eriococcus*"; but, although the cottony sacs at first suggest that genus, the insect clearly does not belong to it. The specimens of the plant have been cut just at the surface of the ground, but I am not able to say whether the species should be called subterranean or aerial.

In the close assemblage of spinnerets on the abdominal region, in the much darker colour of that part, and in the terminal marginal depression, *C. graminis* resembles the Australian species *Sphærococcus casuarinæ*, Mask., 1891, but that species produces (as far as is known) no cotton, and its anal ring is quite clearly hairless.

---

EXPLANATION OF PLATES XXIII.—XXVII.

PLATE XXIII.

- Fig. 1. *Aspidiotus bilobis*, abdominal margin.  
 Fig. 2. *Aonidia eleagnis*, abdominal margin of second pellicle.  
 Fig. 3. " pygidium of adult female.  
 Fig. 4. *Parlatoria sinensis*, lobes and scaly hairs.  
 Fig. 5. *Mytilaspis machili*, lobes.  
 Fig. 6. *Poliaspis pini*, pygidium of female.  
 Fig. 7. *Fiorinia signata*, puparia, female and male.  
 Fig. 8. " second pellicle.  
 Fig. 9. " abdominal margin.  
 Fig. 10. *Fiorinia tenuis*, pygidium of female.

PLATE XXIV.

- Fig. 1. *Fiorinia bambusæ*, female and pellicles.  
 Fig. 2. " spots on first pellicle.  
 Fig. 3. " termination of second pellicle.  
 Fig. 4. " adult female, diagram.  
 Fig. 5. " pygidium of female.  
 Fig. 6. *Fiorinia nephelii*, insects on underside of leaf, male and female.  
 Fig. 7. " elevations on upper side of leaf.  
 Fig. 8. " larva, early.  
 Fig. 9. " first pellicle.  
 Fig. 10. " abdominal margin of female.

## PLATE XXV.

- Fig. 1. *Ceroplastes vinsonii*, adult female, dorsal view.  
 Fig. 2. " " marginal spines.  
 Fig. 3. *Ceronema japonicum*, adult female, dorsal view.  
 Fig. 4. " " diagram.  
 Fig. 5. " " antenna.  
 Fig. 6. " " abdominal extremity.  
 Fig. 7. " " marginal spines.  
 Fig. 8. " " spines of spiracular depressions.  
 Fig. 9. " " conical spines of dorsum.  
 Fig. 10. *Lecanium ficis*, adult female, dorsal view.  
 Fig. 11. " " antenna.  
 Fig. 12. *Lecanium notatum*, adult female, dorsal view.  
 Fig. 13. " " antenna.  
 Fig. 14. " " foot.  
 Fig. 15. " " dorsal spots.

## PLATE XXVI.

- Fig. 1. *Lecanium globulosum*, insects on twig.  
 Fig. 2. " " antenna of adult female.  
 Fig. 3. *Lecanium melaleuca*, insects on leaf.  
 Fig. 4. " " adult female, dorsal view.  
 Fig. 5. " " dorsal cells.  
 Fig. 6. " " antenna.  
 Fig. 7. " " rostral setæ.  
 Fig. 8. " " test of male.  
 Fig. 9. *Lecanium casuarinæ*, adult female, side view.  
 Fig. 10. " " female, second stage, dorsal view.  
 Fig. 11. " " female, second stage, spiracle, trachea, dorsal orifices, and spines.  
 Fig. 12. " " larva.  
 Fig. 13. " " antenna of larva.  
 Fig. 14. " " foot of larva.

## PLATE XXVII.

- Fig. 1. *Eriococcus graminis*, insects in sacs on leaf.  
 Fig. 2. " " antenna of adult.  
 Fig. 3. " " marginal spines of adult.  
 Fig. 4. *Eriococcus exiguus*, sacs on leaf.  
 Fig. 5. " " antenna of adult.  
 Fig. 6. " " marginal spines of adult.  
 Fig. 7. *Dactylopius syringæ*, insects on twig.  
 Fig. 8. " " antenna of adult.  
 Fig. 9. *Sphærococcus parvus*, insects on bark.  
 Fig. 10. " " adult female, dorsal view.  
 Fig. 11. " " adult female, side view, with cotton.  
 Fig. 12. *Sphærococcus populi*, insects on twig.  
 Fig. 13. " " pustules of test, side view.  
 Fig. 14. " " adult female, ventral view.  
 Fig. 15. " " anterior of foot.  
 Fig. 16. " " posterior of foot.  
 Fig. 17. *Chætococcus graminis*, insects in sacs on grass.  
 Fig. 18. " " adult female, dorsal view.  
 Fig. 19. " " adult female, abdominal extremity.

ART. XXVII.—*Notes on Regalecus Sp.*

By S. H. DREW, F.L.S., Wanganui Museum.

[*Read before the Wellington Philosophical Society, 4th August, 1897.*]

EASTER gales seem now to have become established facts, and those of last Easter in our Island were quite up to the record. Many sea-birds were blown far inland. The petrels seem to suffer the most, and still more so if hailstones are driven by the fiercer squalls of the south-east gales. Some of the Prions were found alive thirty-six miles from the sea. I saw several albatros, and secured one in immature plumage of the shy albatros (*Diomedea salvini*, Roths.), which had been blown in at Waitotara.

The only fish that has come to hand here from the effects of the gale is a young *Regalecus* sp. This uncommon fish was cast ashore at Waikanae, and kindly forwarded to me by Mr. John Field. It was in fairly good order for a *Regalecus*, though almost broken in two about 18 in. from the tail, the dorsal fin being also very much destroyed. The total length was 7 ft. 4 $\frac{1}{4}$  in. The fish tapered very gradually, but the greatest depth seemed to be about 2 ft. from the gill-openings, and was 8 $\frac{1}{2}$  in., the dorsal fin here being 2 in. in addition. The head measured 8 $\frac{1}{2}$  in. with the mouth open, which is protractile; the eye 1 $\frac{5}{8}$  in. in diameter. The length of ventral or oar fins I found to be 3 ft. 1 in. The one bony ray forming the fin was very much the same in thickness and appearance as the quill of a peacock's tail-feather would be if the feather part had been stripped away. The blade parts of these oar-fins were oval in shape, measuring 12 in. by 1 in., the colour being bright rosy-crimson shaded by deep-blue markings. There were films or finlets along the spine of this fin of the same colours, but no doubt the colours of these tender parts were much altered by the knocking about they received on the beach. The other fins were of a rosy-red colour. The dorsal fin contained 168 rays; pectoral fin, 14. The body of the fish was like bright frosted silver, reminding me much of the satin silver we see so much of now in electro-plate—not shining like a mackerel, but with the surface grained, and much brighter than a frost-fish. The irregular perpendicular markings of deep blue were much wider than in other two much larger specimens I have seen, these being over  $\frac{1}{2}$  in. wide. There was no caudal fin; the fish ended abruptly with thick rounded end, and there were no spines at caudal end, as mentioned by Couch: no filament or membrane. The crest

plumes consisted of six; four were broken away, but the two left measured 16 in. and  $16\frac{3}{4}$  in. The liver was bright scarlet. The stomach was quite empty, except some coarse sand, small pieces of shell, and pumice-stone that had been swallowed in the creature's death agony.

---

ART. XXVIII.—*Notes on Occurrence of Regalecus argenteus on the Taranaki Coast.*

By F. E. CLARKE.

[*Read before the Wellington Philosophical Society, 13th October, 1897.*]

Plates XXVIII.—XXX.

THE specimen came ashore at Moturoa Bay, at the first reef to the east of the life-boat shed, on the 28th November, 1895, and, so far as I can learn, is the first recorded occurrence of the fish on the coasts of the North Island, all those hitherto obtained having been incidental to the South Island.

It may not be out of place to state that for a couple of days previous to the stranding of our visitant, and also on the morning the event happened, the neighbouring sea had been frequented by several small whales—evidently of the goose-beak variety, and which were both fighting amongst themselves and were attacked by one or more threshers. In their rampaging below they may have disturbed the ribband fish, and so have been the primary cause of its deviation into shallow water, and so on to the beach.

The finder, Mr. McKay, stated he was sitting quietly amongst the rocks near the margin of the sea (it being dead low-water at the time) when, hearing a gentle splashing, he proceeded to the spot, and discovered the fish, which was not quite dead, but giving the little tremor now and then which led to its detection. He informed me it was perfectly undamaged, except that the two ventral rays were broken off; but I imagine this was done in hauling the fish out of the water, and placing it in the cart on a board, in which fashion it was brought up to town, a distance of about two miles. However, by the time I saw it but one of the rays was left, and it was only on my drawing attention to it, under the fish, that the existence of such appendages appeared to be in his cognisance.

The fish then was not long dead, as a few slight movements or quivering of the muscles occurred. It presented a



most beautiful and at the same time fragile appearance, looking as if it were made out of brilliant polished silver, the jet-black markings on the shoulders being very much enhanced thereby, as were also the varied scarlet and bright-red tints of the elevated anterior portions of the dorsal fin or crest, whilst the oval and rounded markings on the sides seemed to alternately intensify or diminish in tone. The first and second elevated portions of the dorsal were exactly as described by Professor Parker (Trans. N.Z. Inst., vol. xx., p. 25), the formulæ agreeing, but the rays of the third extended, or lower, portion of the dorsal, as may be seen by my enumeration, are much more numerous. In all other particulars but those hereafter described there was perfect agreement also. The fractured pelvic or ventral ray had the shaft partly split and then broken diagonally, making a perfect joint with the stump left on the fish, verifying that there had been no curtailment in its total length, and I have much delight in fully describing and illustrating its peculiar and so far hitherto undetected development. The bony part of the shaft reminded me very much of such portion of the plume of a peacock, but in consistence was much harder. The total length of the filament when fitted in its position was 3 ft.  $1\frac{3}{4}$  in., and it was supplied, as has been before described, along its rearmost or axillary edge with a membrane. This membrane commenced at the axillæ with a width of about  $\frac{3}{10}$  in., which width was kept for a little distance, but slightly decreasing, then gradually increasing until, at a point about 2 in. from commencement, it had widened to a rounded shape, with a width about equal to twice the height of the lower central portion of the emargination; thus the membrane continued in emarginations or waves of like spacing and proportions until a point 7.5 in. from the commencement of the spatulate expansion of the extremity was reached; here the membrane terminated, not abruptly, but with a flowing curve from the previous expansion, leaving the now extremely delicate shaft perfectly bare. The regularity of the distances between the summits of the waved outline of the membrane kept pretty constant at the distance (2 in.) noted, but the heights gradually and slightly declined from those near the origin of the shaft of 0.2 in. for the lower and 0.4 in. for the higher portions to near and at the extreme end of the membrane, where the heights were respectively  $\frac{3}{20}$  in. for the lower and  $\frac{3}{10}$  in. for the higher emargination. The shaft was quite white at the thicker or basal end, darkening at the thinner or terminal. The colour of the membrane between the more elevated portions was a transparent ruby tint, and at the more elevated portions a bright and opaque scarlet, capped on each summit with an ellipsoidal patch of opaque milk-white. My drawings (Plates XXVIII.—XXX.)

will delineate more fully the size and shape of the membrane, the ray or filament, and its extraordinary spatulate termination, which, as far as I can discover, are now exactly illustrated for the first time.

The appendage at the extremity reminded me more of a petal from an orchidaceous flower than as forming part of the fin of a fish—bizarre enough as fish-fins are in shape and colour. In fact, the view of this beautiful fish in its pristine glory and brilliancy created in me quite an awesome effect, its aspect was so expressive of probable future enlightenments of nature's wonderful and perfect constructions from the deep.

The total length of the spatulate process was 3.45 in. From the point of its origination on the lower edge of the shaft a fine membrane gradually arises, of a semi-transparent light-red colour. This borders the lower edge of the shaft, rising gradually in height, but with a slightly waved outline, until it reaches the extreme width of 0.3 in.; it then decreases gradually in width, following the shaft, which takes a bold sweep round the lower and posterior margin of the principal fleshy and opaque central portion of the appendage (which is thus strengthened and stiffened), running out to nothing at the termination of the shaft. On the upper edge of the shaft, 0.8 in. posterior to the point of commencement of the lower part, originates another fine membrane, also of a semi-transparent light-red colour, which runs along the upper edge in gradually-widening outline for 0.55 in., where it meets the angle of origination of the principal fleshy central and opaque portion before alluded to, along the margin of which it then runs in rapidly-decreasing width until, at a point about 0.8 in. from such angle of origin, it terminates. The central portion of the appendage is of general pyriform shape, 2.1 in. in extreme length, with a width of 1.15 in.; it is quite thick and fleshy; on the outward surface coloured light purple-grey, flecked towards the upper margin with small blood-coloured goutts or splashes. It reminds me much in its tints and roughly in shape of a highly-coloured bird's egg. The lower surface of the fleshy portion is of a uniform darker purplish-grey.

The drawings show this appendage spread out flat to its fullest extent, the membranes all lying smooth and even. It also had this shape when immersed in water, but in life it is also probably capable of being turned to the shape as shown on the alternate little drawing which shows the whole length of the ray or filament.

From the half-dried or mutilated conditions of the few portions of these pelvic rays which have been previously observed it is easily conjectured that unless the individuals describing had been fully prepared by former acquaintance

with these fish, either by actual contact or careful bibliographical study, minutiae now ventilated may have escaped notice hitherto, or have been undistinguishable. Mr. Kingsley's article on the specimen taken in Nelson Harbour (published in *Trans. N.Z. Inst.*, vol. xxii., 1889, p. 333) shows two lobes or widened portions of the membrane; probably the rest were destroyed, but, more likely (and as it would have been difficult to notice without soaking and floating out in water), a large portion of the membrane had been partially broken away from the shaft, and thus, coalescing, gave the two-lobed appearance. Another item which may have been existent in other specimens, though it so far remains undescribed, but which existed in this one, was a double row of minute re- and slightly out-curved spines which ran along the summit of the back of the fish on each side of and immediately at the base of the third or low portion of the dorsal fin, each pair being slightly in advance of the origin of each fin-ray. They were more developed towards the caudal extremity. The tubercles along the lower surface of the fish, near the caudal extremity, were very much harder and stronger than in any other part of the body, slightly resembling in that respect the larger size and more indurated condition of the dermal processes along the upper limb of the caudal extremity of *Notidanus*.

With this paper I forward an exact reproduction of the caudal extremity (Plate XXX.) This I traced from the original. As it shows, the fin-rays of the dorsal were getting very short, so that it was evidently very near the "perfect" end of such fin. The lower margin of the fish, up to within  $\frac{1}{2}$  in. of its termination, exhibited its original configuration, and was not scarred or defaced in any manner, the tubercles, as before noted, near termination becoming quite ossified. The upper margin, on the contrary, had a freshly-healed cicatrix, 3.3 in. in length, the healed dermis being of quite a different and distinct nature from the silvery covered epidermis adjoining. It had the aspect of having been cut or bitten off diagonally, and then healed, one and a half of the delicate vertebræ showing at the extreme end of the scar (for a full  $\frac{1}{2}$  in.), reminding one of a badly-amputated finger, or of the early stage after the fracture of a lizard's or snake's tail. The sketch delineates what I describe. This part of the caudal extremity was exceedingly delicate, the cross-section thickness being not more than  $\frac{1}{4}$  in. at the thickest part. Like most of the Tæniiform fishes I have had the opportunity of examining, the forehead was not covered with the same kind of tuberculated skin common to the rest of the body. It is there perfectly smooth, and almost agrees in coloration with the rich purple skin on the soft and protractile portions of the mouth.

			Ft.	In.
Total length of fish with mouth closed	..	..	11	1½
" " " protruded	..	..	11	4½
Length from chin (mouth protruded) to anal orifice	..	..	4	2
Greatest depth of fish (with dorsal erect included)	..	..	0	11
" " of body of fish (at vertical between second and third feet of length)	..	..	0	9½
Depth of body under vertical of fourth foot of length	..	..	0	9¼
" " fifth "	..	..	0	8·8
" " sixth "	..	..	0	7·8
" " seventh "	..	..	0	7·2
" " eighth "	..	..	0	6·5
" " ninth "	..	..	0	5·5
" " tenth "	..	..	0	4·5
" " eleventh "	..	..	0	3

The above depths are all at the distances noted from the extremity of jaws with mouth protruded. The fish died with the mouth protruded. If the points had been fixed with mouth closed in, variations would have arisen, on account of the considerable "spring" the mouth then had.

Extreme length of head (with mouth protruded),  $8\frac{3}{4}$  in.; length of head (with mouth closed), about  $6\frac{1}{4}$  in.; diameter of orbit of eye, 1·42 in. Altitude of head through vertical of centre of eye is almost equal to four diameters of orbit. Diameter of eye (from margin to margin of iris, including same, and across pupil) = width of base of pectoral fin. Pupil of eye is small and horizontally oval: horizontal diameter, 0·45 in.; vertical diameter, 0·33 in.

The forehead is decidedly concave. The eye is much larger in proportion than as shown by Professor Parker's drawing (vol. xvi., plate xxiii.); also, the free limbs of the opercula differ in contour from such drawing; and in the specimen I am describing the front part of the erect pectorals slightly overlaps the posterior margins of gill-covers. The pelvic or ventral rays commence immediately in the vertical with the posterior termination of bases of pectorals. The nostrils are not as large also as shown in Plate XXVIII. The eyes are much closer to the top of head. The drawing referred to shows a space of almost two diameters of the orbit between the top of same and dorsal outline, whilst in my specimen it is a little more than one only. The space between the origin of lateral line also and dorsal outline is in mine but half in proportion as therein shown, being one diameter of the orbit below such outline only, whilst from such more elevated position it falls still more rapidly. The angle at summit of forehead in profile is not as acute as that shown in drawing of Moeraki specimen quoted. From the angle at commencement of opening of gill-covers the outline of margin of same is curved concavely for a distance of 1·55 in.; it then falls obliquely at a generally obtuse angle, but as both intersection marginal boundaries are convex the resultant angle appears more acute than it is

actually. The distance to the next angle is 0·8 in. Here the margin falls downwards, at nearly a right angle to its former course, for a distance of 1·85 in., whence it turns in an oblique and rounded sweep, running thence under the throat to the commissure.

The pectoral fin of the *Moturoa* specimen differs from that shown in Professor Parker's drawing. In the first place, it is set further forwards (nearer to the gill-covers), leading to the overlap before mentioned; in the second, the first rays are much shorter in proportion, and the last rays much longer, resulting in a much squarer total outline for fin.

The basal portions of membrane of elevated anterior of dorsal were continuous, and ran in due ratio into that of the low portion, when I first examined the specimen; but from its excessive fragility—being much more so than is due to its comparison with the size of the fish—very little handling soon broke it; and the owners, not appreciating the necessity for keeping the delicate rays of the high division of the fin intact, did not take sufficient care of them in the many changes of location the specimen was subjected to in its exhibition, &c., and so they were soon most woefully injured. I luckily spread these and the ventral ray and their delicate membranes fully out at the earliest opportunity, and took tracings from their outlines.

Classifying the dorsal fin as in three sections of which the bases were continuous, the first had one comparatively stout ray (almost  $\frac{1}{10}$  in. in diameter at the base) and four very delicate ones, scarcely thicker at bases than fine darning-needles. The second section started with six stoutish rays, the first four having about equal thickness at their bases (not quite  $\frac{1}{10}$  in., and being less in thickness than the first ray of all), and being very close together at bases. The next two were less stout, and, with the next four (also decreasing in stoutness), were placed further apart from each other. Thus the total of rays in the first two divisions equalled those described by Professor Parker—fourteen. The quality of these, however, is of a much firmer nature than any of those forming the low extended portion of the dorsal. They are decidedly osseous (though so fine), the thicker ones more so; elongated spines may better express their substance. Those supporting the membrane of the low portion of the dorsal may be described as "simple, soft, inarticulated rays." The membrane of the first division was continuous up to such a height as left a proportion of about a fifth of the total altitude with the rays partially free, or only fringed more correctly with membrane; whilst the first ray, at its extreme tip, had the peculiar anterior fringe about  $1\frac{1}{2}$  in. in length. The coloration of the membrane was a semi-transparent ruby-red, dotted in more or less even

transverse rows with dark-scarlet. These dots were more numerous than as described by Professor Parker, but still in single series between each ray. The second division had the membrane continuous at the base only, extending thus continuously for a height ranging from nearly 3 in. at its anterior to a little less than 1 in. at its posterior portion. The remainder of the rays were merely fringed along their posterior surfaces, with membrane scolloped in same fashion and degree almost as that already described as belonging to the ventral (pelvic) ray, except that as they decreased in height and position posteriorly the said scolloping decreased also until it ran out into the continuous basal portion of the membrane before referred to. The extreme tips of each of the rays belonging to this division had what also forms another distinctive feature—viz., the peculiar membranous “tag,” resembling somewhat in shape the head of an assegai. What formed the first ray of the low and extended portion of the dorsal (and is the fifteenth consecutive ray of the total extent of such fin) is slightly higher than the sixteenth consecutive ray, but, as before mentioned, is quite different in quality. The seventeenth ray, again, showed an increase in height, equalling almost half that of the extreme height of the low portion of dorsal. The third or low division of the dorsal contained, up to the point of fracture of what was left of the caudal extremity, 245 rays: making the total for the whole of the dorsal existing 259 rays. This considerably exceeds those of Professor Parker’s Moeraki and Otago Harbour specimens (of 1883 and 1887), and of the New Brighton *Regalecus* (of 1876), which were respectively 205, 189, and 232.

The condition of the Moturoa specimen with regard to the proportions of the dorsal rays as compared with Professor Parker’s specimens hardens our facts as to the permanence of his species *argenteus*, but to me it is obvious that comparisons of head-lengths and body-depths with total existing lengths of, in all cases so far exactly described, mutilated specimens cannot be of any value yet for specific distinctions, any more than can the total number of dorsal rays existing in any of the incomplete specimens; also, the proportion of the fishes *ante* and *post* the anal orifice. Granting this, in spite of the considerations of Collett and Lütken (*vide* Professor Parker’s article, Trans. N.Z. Inst., vol. xx., page 23), we have available the ratios of the head-length and body-depth as compared with the distances between tip of snout and anal orifice, and the number of dorsal fin-rays to the vertical from same. The comparison of the body-depth with such space is not, however, infallible, I own, on account of the variations arising therein from sex and condition; but it is better than a comparison with the total length of any fish exhibiting mutila-

tion at the caudal extremity. Personally, I think when we do obtain a *Regalecus* with a perfect caudal extremity we will find that the caudal-fin is partly placed at a considerable angle with the longitudinal axis of the body, closely resembling that of *Trachypterus*. Unfortunately, so many of the old illustrations extant of these fish evidence, with what we now know, great artistic license with regard to their extremities.

Proportion of head with protruded jaws to distance from snout to anal orifice .. .. .	1 : 5.7
Proportion of head with mouth closed to distance from snout to anal orifice .. .. .	1 : 7.6
Greatest depth of body is to same distance .. .. .	1 : 5.2
Total number of dorsal fin-rays to vertical with anal orifice ..	107th
(i.e., 93rd ray of low portion of dorsal.)	

For purposes of comparison, however, as such proportions of other New Zealand specimens have been tabulated, I give those of head and depth to total of existing length, &c. :—

Head with jaws protruded :: total length : 1 :: 15.5.

Head with jaws closed :: total length : 1 :: 21.

Greatest depth (with jaws protruded) :: total length : 1 :: 14.3.

Greatest depth :: total length with jaws retracted : 1 :: 14.

Proportion of pre-anal region to trunk—

Head (with mouth protruded) + trunk is to total length (with mouth protruded) : 1 :: 2.7.

Head (with mouth retracted) + trunk is to total length (with mouth retracted) : 1 :: 2.8.

The greatest thickness of the body was barely over 2 in.

The depth of body at vertical through posterior angle of oper- culum .. .. .	Ft.	in.
Height of pectoral fin .. .. .	0	1.85
Width of base of pectoral fin .. .. .	0	1.1
Depth of body at vertical through first foot of length ..	0	8
"                    "                    second                    "                    "	0	9.5
"                    "                    third                    "                    "	0	9.3
Extreme height of first ray of dorsal .. .. .	1	9
"                    second                    "                    "	1	7
"                    third                    "                    "	1	4
"                    fourth                    "                    "	1	1
"                    fifth                    "                    "	1	0
"                    sixth                    "                    "	2	4
"                    seventh                    "                    "	2	0
"                    eighth                    "                    "	1	7
"                    ninth                    "                    "	1	3
"                    tenth                    "                    "	0	11
"                    eleventh                    "                    "	0	8
"                    twelfth                    "                    "	0	6
"                    thirteenth                    "                    "	0	3
"                    fourteenth                    "                    "	0	1½
"                    dorsal rays over first foot line ..	0	1½
"                    "                    third                    "                    "	0	2¼
"                    "                    fifth                    "                    "	0	2.1
"                    "                    seventh                    "                    "	0	1¾
"                    "                    ninth                    "                    "	0	1½
"                    "                    eleventh                    "                    "	0	0.6

The longitudinal ridges were not so pronounced as I expected to find them when the fish was perfectly fresh, perhaps because of its good condition; but they became more prominent when the fish became partly dry. Nor did they all lose themselves in the lateral line, as has so frequently been described; the two lowest certainly did, but the others approached it and each other at their termination on top of head without merging. There was no appearance of teeth, and the internal economy of the fish I was unable to examine, from a cause referred to later on.

The intense black markings stopped short of the 3ft. vertical line; they were confined wholly to the upper part of the fish in such limit with the exception of two, one of which was situated about intermediate in such length, and was of considerable length, almost touching the lateral line; the other, a short one, almost at the limit, and lower down on the side, about midway between the top of back and the lateral line. As the fish gradually dried, in two or three days' time, numerous transverse markings developed themselves, more especially along the whole of the post-anal division, and the round and oval greyish markings became more apparent.

The membrane of the long low portion of dorsal was from the first, and continued, immaculate. The rays thereof also had no colour.

The lateral line ran generally along the sides at a distance of about one-third the depth from and parallel with the lower margin until the third foot vertical line from the snout was reached, when its contour gradually rose. On reaching near the first foot vertical it inclined upwards more rapidly still, just clearing the upper angle of gill-opening, from whence it continued, ending over and close to the top of eye.

I endeavoured to obtain the specimen for the Wellington Museum and afterwards for New Plymouth, but the price required was much too high. When decomposition had far advanced, and the specimen had been much injured, from the rough handling before referred to, the owners desired to sell, but it was useless for scientific purposes then. Unfortunately for science, the "shillings" came in too rapidly on its exhibition, though I am afraid, from the good advertising I gave it, I was much to blame. I happily took copious notes, measurements, and sketches when I first examined the fish, and, when I discovered satisfactory negotiations would fail in obtaining it for dissection and preservation in part, Mr. Gordon, of our department, very kindly took a couple of photographs of it with a half-plate camera. This was on the second day, when the fragile dorsal had so severely suffered. The intended full-length "shot" failed, as it cut off the fore part of the head, but the second exposure was taken close to the fish, taking



in the head and about a foot of the trunk only. Mr. McKay thereafter would not allow us, either for love or money, to take any more photographs, drawings, or measurements, or do anything further with the fish until it was practically rotten and worthless, which was a pity. The remaining pelvic ray was soon lost; for this latter I was very sorry, as I should have taken steps to obtain it at the first, it being a perfect specimen, as before mentioned.

My drawings comprise an outline tracing from my large drawing of the whole fish (Plate XXVIII.); drawing to scale of part of the scalloped margin of the pelvic (ventral) ray; of the spatulate tip; and of the whole length of the ray (Plate XXIX.); enlarged sketch of the little outcurved spines at the bases of the low dorsal rays; and drawing to scale of the caudal termination of the fish (Plate XXX.).

In terminating my notes I cannot fail to observe how favoured we have been on the coasts of our adopted country in the comparatively numerous occurrences of these fishes. Writing in 1880, Professor Günther, in his "Study of Fishes," notes the scarcity of the capture of very closely resembling species on the British coasts, not more than sixteen being recorded between the years 1759 and 1878; whilst in New Zealand, since record of the first occurrence of a *Regalecus* in 1860 to the present date, ten have been publicly recorded to my knowledge, a recapitulation of which may not be amiss:—

No. 1. At Nelson, in October, 1860. Described by Mr. W. T. L. Travers in *Trans. N.Z. Inst.*, vol. iii., p. 307.

No. 2. Found on beach at Hominy Cove, near Jackson's Bay, Westland South, by Mr. James Teer, in February, 1874 (as noted by me in the *Trans. N.Z. Inst.*, vol. xiii., p. 196). Length, 14 ft. Part of the vertebræ and cranial cartilage deposited by me, on behalf of Mr. Teer, in Hokitika Museum.

No. 3. At New Brighton, Canterbury, 7th May, 1876. Described by the late Sir Julius von Haast and Dr. Powell (*Trans. N.Z. Inst.*, vol. x., p. 246, and vol. xi., p. 269). 12 ft. 5 in. in length. Preserved in Canterbury Museum.

No. 4. At Little Waimangaroa Beach, Karamea, Nelson District, in July, 1877. Picked up by Mr. Alexander McDonald (noted in *Westport Times*, July, 1877, and referred to in preceding article in *Trans. N.Z. Inst.*, vol. x., p. 250). Length, 14 ft. 4 in.

No. 5. At Cape Farewell Sandspit, Nelson District, *circa* November, 1877. Noted by Sir James Hector to the Wellington Philosophical Institute, 1st December, 1877 (*vide Trans. N.Z. Inst.*, vol. x., p. 533). 13 ft. in length. Ventral ray in Wellington Museum.

No. 6. Near Moeraki, Otago District, 1881. Noted by Professor Parker (Trans. N.Z. Inst., vol. xvi., p. 285).

No. 7. At Moeraki, Otago District, 14th June, 1883. Fully described by Professor Parker (Trans. N.Z. Inst., vol. xvi., p. 284). Length,  $12\frac{1}{2}$  ft. Skeleton in British Museum.

No. 8. At Portobello, Otago District, 3rd June, 1887. Found by Mr. Harwood, and presented by him to the Otago Museum. Described by Professor Parker (Trans. N.Z. Inst., vol. xx., p. 20). Length, 11 ft. Skeleton and skin now in Otago Museum.

No. 9. At Nelson Harbour, 23rd September, 1889; by Mr. Aske, fisherman. Described by Mr. R. J. Kingsley (Trans. N.Z. Inst., vol. xxii., p. 333). Length, about 13 ft.

No. 10. At Moturoa Bay, near New Plymouth, Taranaki District, on 28th November, 1895. Noted by me in *Taranaki Daily News*, 30th November, 1895. The subject of the present notes.

Since writing the above I saw by telegram that another specimen of *Regalecus* had been obtained near Dunedin, which appears also to have fallen into the hands of Professor Parker, by whom (so it stated) it was credited with being the most perfect specimen so far obtained.

---

#### FURTHER NOTES ON THE OCCURRENCE OF REGALECUS ON THE TARANAKI COAST.

I find that an amendment must be made to my former notes on the occurrence of *Regalecus* on the New Zealand coasts, inasmuch as I omitted mention of the specimen described by H. O. Forbes, Esq., F.Z.S. (vol. xxiv. of the Transactions, p. 192), which was caught at Okain's Bay, Banks Peninsula, Canterbury, on the 26th May, 1891. This should stand as tenth on the list, making the Moturoa specimen the eleventh. The Okain's Bay fish, from its expressedly dried condition as defined by the description thereof, must have lost much of the prominence of the smaller tubercles covering the spaces between the ridges of the larger sized. All are purely epidermal, and decrease much in size and height on the sides of the fish the nearer they approach the caudal extremity, almost disappearing as the skin dries. The blackness of the so-called longitudinal bars and the dark colour along the post-anal ventral edge was also, I think, due to such condition.

The five specimens of *Regalecus* now more carefully described and measured allows contrast of the ratios as between head-length and body-depth with that of the pre-anal division as proposed by me. Following the example set by Professor Parker and Mr. Forbes for further ready re-

ference in connection with any future specimens, I repeat their tabulations of measurements, adding thereto the proportion for the above bases—from their data—for their fish, placing my equivalents for comparison in a further column. As you will note, the results are remarkably close in some of them, identical in others.

	New Brighton (South Island).	Moeraki (South Island).	Otago Harbour (South Island).	Okain's Bay (South Island).	Moturoa (North Island).
	Ft. in.	Ft. in.	Ft. in.	Ft. in.	Ft. in.
Total length	12 5	12 6	(17 0) (11 0)	18 10	11 1.5
Greatest height of body	0 13.5	0 15.25	0 12.1	0 14.5	0 9.5
Length of head (jaws retracted)	0 7.75	0 9.0	0 9.5	0 8.125	0 6.25
Distance between snout and anus	4 11	5 6	4 9.5	5 4.125	3 11.5
Proportion of height to length	1 : 11	1 : 10	1 : 11	1 : 15.6	1 : 14
Proportion of length of head to total length	1 : 19	1 : 17	1 : 14	1 : 27.35	1 : 21
Proportion of pre-anal region to total length	1 : 2.5	1 : 2.27	1 : 2.29	1 : 3.36	1 : 2.8
Proportion of head to pre-anal region	1 : 7.6	1 : 7.3	1 : 6	1 : 7.9	1 : 7.6
Proportion of greatest height to pre-anal region	1 : 4.37	1 : 4.32	1 : 4.75	1 : 4.42	1 : 5.2
Total number of dorsal fin-rays (to mutilated termination of tail)	232	205	189(?)	422(?)	259
	(9 (?) + 223)	(14 + 191)	(14 + 175)	(221) 14(?)	(14 + 245)
				(170)	

It is a pity no drawing or copy of Mr. Forbes's photograph was given showing the caudal extremity of the Okain's Bay specimen.

Since the occurrence of *Regalecus* in Victoria, referred to in Mr. Forbes's article on the Okain's Bay fish (and which Victorian specimen was described by Professor McCoy, "Prodrômus of the Zoology of Victoria," decade xv.), another is reported as having been found by the Cape Everard lighthouse-keeper, for which *vide* issue of the Melbourne *Leader* of the 1st August, 1896, page 7, in which paper is also reproduced the illustration—a very rough one—and which, if correct in its details as far as they go, differs considerably from what we recognise as *argenteus*—for instance, the longitudinal lateral bands or ridges, counting the thin one shown nearest the dorsal margin, number seven; the transverse irregular bands extend over more than half the total length, and in some case right across the body; whilst the higher portion of the dorsal rays are shown as all connected with a common membrane, with the anterior rays the highest, gradually decreasing rearwards without any division.

---

ART. XXIX.—*Notes on Acclimatisation in New Zealand.*

By A. BATHGATE.

[*Read before the Otago Institute, 13th July, 1897.*]

IT was only natural in a country like New Zealand, with such a limited indigenous fauna, that the settlers should establish acclimatisation societies, and endeavour to introduce the familiar forms of wild life from their native lands; but it is a matter for regret that the zeal of the earlier acclimatisers was greater than their knowledge, and that mistakes were made by them fraught with evil results of a far-reaching and permanent nature. Due care and consideration would have prevented the introduction of several undesirable immigrants, which now, like the poor, are always with us. For example, I remember talking to a gentleman who was then a member of the council of our local society when the first shipment of birds was brought here, and in telling me what they were getting he mentioned the green linnet amongst others that was being imported. Knowing that the greenfinch was often called by that name, I ventured to suggest that it was anything but a suitable bird; but he replied that I was mistaken, and that the bird they were getting was harmless, and a beautiful song-bird. It, alas! proved to be no linnet, but that pest of the farmer, the harsh-voiced greenfinch. Now, though probably the man employed to bring out the birds gave the

gentleman referred to the erroneous information regarding the bird's vocal powers and harmlessness, a little inquiry as to its habits and repute in the Old Country would have made the society hesitate before turning loose such a well-known enemy of the seed-grower.

One result of such mistakes has been to render the acclimatisation societies timid of introducing anything that could be called a "small bird," as the rabbit has made them afraid of importing anything that will eat grass. These societies have now pretty well become mere piscicultural societies, which make occasional spasmodic efforts to introduce "something to shoot" in the way of game birds. I do not desire to underrate the valuable work they have done in stocking our rivers with splendid fish, and thus adding an additional attraction to life in this colony; but while they did these things they ought not to have left other work undone which would have been more within the scope of their functions than keeping up a supply of fish for the anglers' hooks. Their work should have ended when the trout were successfully established, and had they left the restocking of the rivers to anglers' associations they might have had leisure to devote more of their energies to acclimatisation proper. Of course, the answer is that their main source of revenue is from the fishing licenses, and that without this income they would hardly be able to exist, so I suppose we must accept the situation and be thankful for the good work that they have done. I cannot but think, however, that if the societies were to extend the scope of their operations somewhat they would be more popular, and might increase their roll of members. One duty in which the societies have been lacking is that no attempt has been made, so far as I know, to keep any record of the results of their experiments, which, on the whole, have been conducted in a very haphazard and unsystematic manner.

It would have been impossible to have obtained full or continuous observations of the divers birds and animals that have from time to time been introduced, recording what changes of habit, if any, were induced by their new environment, and also what changes, if any, their introduction brought about in our native flora or fauna; but something might have been done in this direction. Imperfect as such records would have been, I have no doubt but that, had the societies endeavoured to compile them, much interesting information would have been collected and preserved. For example, I remember hearing that many years ago it was almost impossible to grow barley in the Oamaru district, owing to the depredations of a black hairy caterpillar, which attacked the grain when it was swelling by gnawing the juicy stem just under the ear, which was thus caused to fall and

wither. The caterpillar then dropped to the ground, and, climbing up the next stem, repeated his operations. So numerous were they that a field, if attacked, would hardly be worth harvesting. After the starlings became numerous these caterpillars disappeared, and it is not unreasonable to suppose that the Oamaru farmers owe a debt of gratitude to the Acclimatisation Society for their freedom from this scourge—indeed, probably the whole colony owes its continued ability to grow barley to the introduction of the starling, for, though I never heard of the caterpillar referred to behaving in the same manner in any other district, yet if it were the larva of an accidentally introduced insect it would surely have spread; while if it were indigenous it probably would have discovered the new food-supply in other districts also, and, if naturally local, have spread from the same reason.

Now, had our societies authenticated and recorded facts like these they would have preserved evidence of their own usefulness. The errors that have been made remain patent, the good they have done is mostly hidden from sight, and, as my criticism of their doings may have seemed somewhat adverse, I may say that I firmly believe the good done far outweighs the evil. Had they done nothing but introduce the starling they would have done well. I shall give you another instance of the benefits conferred by that bird. Before the starlings became numerous it was no uncommon thing to see English grass wither up in large patches, as though scorched by fire. This was due to the work of two different insects—a crane-fly and an *Elatér*, or click beetle, the larvæ of both of which were addicted to the habit of eating the roots of the grass just under the surface. They were both, I believe, native insects, though there are similar insects with similar habits in Britain; but, as both are still to be found in the colony, their identity or difference could easily be established. English grass was then comparatively limited, and was often greatly damaged by these depredators. I remember, in 1867, visiting a runholder who had a small lawn of English grass laid down in front of his house, which, to my surprise, was covered with toumatukuru bushes, which had been collected from the run. On my asking the reason for this new departure in lawn decoration, he replied, "Oh! it's to keep the hens off. I don't know what has taken them, but I could not keep them off any other way. They were scratching the grass out by the roots even." Suspecting the cause, I made an examination, and found the grass so full of the beetle grubs that in places one could almost roll it up like a carpet and disclose the larvæ beneath. I showed them to my host, saying, "These are what the hens are after: it is the grubs, not the hens, that are destroying your lawn, and if you keep the

fowls off the grubs are so thick there will be no grass left soon." Seeing is believing. He was easily convinced, and called a man to remove the scrub he had been at such trouble to gather to keep his best friend at bay. Since the starlings became established I have never observed the grass injured to the extent I have described. To the agency of the starling I attribute the almost total disappearance of the grasshopper and the *Cicada* in this neighbourhood. When I came here the Town Belt was alive with the former, while the latter were very much more numerous than they are now. I do not know that either of these insects did much harm, though the grasshoppers were sometimes injurious to young turnip-crops. Their disappearance, as well as what I have related about other insects, proves that the introduced birds keep insects in check.

It is impossible in the time at my disposal to deal exhaustively with the subject of acclimatisation, even were I competent to do so, and I shall therefore merely glance at what has been done locally in the past, and throw out a few suggestions as to what might be done in the future. I shall omit all reference to fish-culture, as I have already referred to the success which has crowned the work of the societies in the introduction of trout; and, as the subject of the introduction of sea-fish has been enthusiastically taken up by Mr. G. M. Thomson, I shall not touch on that branch of the subject further than to say that I hope when the marine hatchery is established the experiment of introducing lobsters will be renewed, and that a trial will also be made to acclimatise the edible crab. It may also be well to introduce the good edible variety of the mussel, which is largely cultivated for the market in the south of France, and is not to be despised as an addition to our coastal harvest. It should not be very difficult to transport them.

Oysters were successfully brought out by the Provincial Government in the old days of sailing-ships, so with our present more rapid communication mussels might be carried in safety. The mention of these oysters reminds me of their fate. A small number were landed alive, and as the extensive beds at Foveaux Strait was then unknown the juicy natives were looked upon with peculiar interest. They were put in a small enclosure in the harbour near Portobello, under the care of a local member of the Provincial Council, who, observing one day a stranger in a boat in the vicinity of the oyster-bed, hurried to the spot, and when he got to the shore plainly saw the stranger swallowing an oyster. He called out to him, went for a boat, and when he reached the bed found that the stranger had disappeared and the oysters with him, for there was nothing left but the empty shells. The perpetrator of the

outrage was never discovered. And so ended the only attempt at acclimatisation made by the Otago Provincial Government. Would that the efforts of the Provincial Government of Southland had terminated in a similar manner. It is to them that we are indebted for the presence of the rabbit, which we could well have done without, though bunny is not the unmitigated evil some would have us think. It is true he ruined a number of our runholders, and greatly lessened the stock-carrying capacity of extensive areas of country, but he has afforded employment to large numbers of our population, and now figures as a not unimportant item in our export lists, to say nothing of his supplying healthy sport to thousands annually. His presence is, however, responsible for the introduction of the stoats and weasels by the General Government, which must be classed as one of the grave errors in acclimatisation; and also to the introduction of the microbe of chicken cholera, which I, like the Gore farmers, fear will be attended with more evil than good, for it stands to reason that, if it takes root so as to be of service in perceptibly reducing the rabbits, it must also decimate our feathered fauna, and may lead to our old enemies the hairy caterpillar and the *Elater* grub getting the upper hand again, to say nothing of its perhaps killing off some of the less robust species of our indigenous avifauna.

I have referred to the timidity of our societies regarding the introduction of "small birds," and some may think that if their numbers be reduced by the chicken cholera good will result; but, unfortunately, it will not discriminate between the green linnet or finch, in whose favour nothing can be said, and our benefactor the starling. In importing further birds more care should be taken to select the subjects, and there are many small birds which could be acclimatised with advantage. The stupid idea that because some small birds are nocuous all small birds are, instead of being encouraged by our acclimatisation societies, should be combated, and our country population taught better. At present some of our County Councils give rewards for the eggs and heads of small birds, and pay for sparrows, green linnets, goldfinches, and hedge-sparrows indiscriminately. The two former are destructive, and should be kept in check; the goldfinch does little or no harm, though a seed-eating bird, and must do good in checking the spread of the Californian thistle and other weeds with winged seeds; while the latter is one of our best friends, lives on insects, and should be protected rather than destroyed. Perhaps, being misnamed a sparrow, he shares in the curses hurled at the head of his namesake the impudent sparrow of our streets. I regret to observe that this pretty little sombre-coated bird, which is our earliest songster—his sweet warble being heard before



even the earliest thrush—is not nearly so common as he once was. As to the sparrow proper, it is a matter for regret that he was not left at Home; and there was the experience of other lands as a warning, for he was introduced into New York to keep down some insect-pest, but the inhabitants were not long in regretting that they had made his acquaintance. I believe our society turned out one or two, but the sparrows came to us from Christchurch. When I first visited that city they were then already numerous, and I had not seen any since I left the Home-country. A year or two afterwards I saw them in considerable numbers at Oamaru; shortly afterwards I observed their advanced guard at Palmerston; and the year after that I saw the first sparrow I had noticed in Dunedin, where they bred and mustered with great rapidity.

No doubt the sparrow does a great deal of good, for he feeds his numerous broods of young almost, if not entirely, on insects; but I think it might have been possible to get a bird or birds that would have done the same amount of good without any attendant harm. I have been told that the sparrow was not voluntarily introduced by the Christchurch society, but that a few pairs were brought out by a ship captain as a speculation about the time the society was importing birds. He was, however, disappointed in realising his shipment at a good price, for the society would have none of them, so he liberated the lot. If the tale be true, how often must the members of the society who declined the purchase have regretted that they did not buy the sparrows and wring their necks.

A similar ignorance to that of the farmer in putting all small birds in the same category has been displayed by our legislators. For example, "The Animals Protection Act, 1880," absolutely prohibits the importation of hawks and birds of prey. One would almost think that the Parliament had been composed of English gamekeepers, who are the uncompromising foes of any bird or animal that they even imagine might kill a young pheasant or partridge. Yet the kestrel, a well-known British hawk, feeds chiefly on field-mice and the larger insects, such as fat-bodied moths and beetles. Our own sparrow-hawk is rather a rare bird, and the large swamp-hawk is of little or no use in keeping the small-birds in check; so I think it would be a good thing to introduce some birds of prey from other lands—for there is no reason why we should not look to America, as well as Europe, for subjects for acclimatisation. The British owls are useful birds, and would, I think, help to keep down the sparrows. Some of the shrikes or butcher-birds, of which there are two species which visit Britain, might also be introduced with advantage; they prey upon insects and young birds. Even the carrion-crow would,

I think, do more good than harm. It would destroy a good many young rabbits, and if it did kill a weakling lamb or two it would merely take the place of the seagulls, which are addicted to that pernicious custom, whose numbers it would reduce, as from its partiality for eggs it would find a rich harvest in the nests of the gulls, which breed in the shingly riverbeds.

None of these birds could be imported as the law now stands, but the present prohibition might be repealed, as the Act of 1895 prohibits the importation of any animals, birds, insects, or reptiles without the consent of the Minister for Agriculture. This provision was introduced because of the Christchurch society contemplating the introduction of wood-pigeons. Their intention was announced in the Press, and, knowing that wood-pigeons were anything but farmers' friends, I wrote to the *Otago Daily Times* protesting against their introduction, and suggesting that the farmers' clubs should petition the Government to interfere. Several clubs did so, with the result that the project was abandoned, and the legislative enactment referred to passed. It is a wise provision, if the Minister be well advised, as it will prevent ill-considered experiments; and it is better that good things should not be imported rather than any bad ones should be introduced.

Of the other birds introduced by our society, the blackbird and thrush are amongst the most prominent. The former, notwithstanding his mellow song, would have been better omitted from their list, owing to its partiality for fruit. The thrush is also given to the same bad habit, but in a lesser degree, and he is a shyer bird and more easily kept under. He is also very fond of snails, which have, unfortunately, been introduced, and are very numerous in different localities in the North, and have also, I am told, made their appearance at Gore. For my part, I would willingly allow the tuneful mavis his modicum of fruit in return for his pleasant song; but those who do not take the same view may find consolation in his snail-destroying habits. If the sparrow, the greenfinch, and the blackbird could be eliminated, I do not think we should have much to complain of in the work done by the societies. The chaffinch, a seed-eating bird, thrived splendidly at first, but, so far as the neighbourhood of Dunedin is concerned, has almost died out. For some years the bush at the Glen used to be full of them, and their sharp, bright little song was pleasant to the ear; but they are now all gone—why or wherefore I cannot tell. I saw a few at Moeraki some years ago, and also more recently at Banks Peninsula, but in neither locality were they at all numerous. The cirl-bunting, a bird which lives on insects in summer and seeds in winter, thrived and increased in this neighbourhood for some

years, and, like the chaffinch, disappeared. It is still to be met with, I am told, in the Tokomairiro district. It was often mistaken for the yellow-hammer by those not familiar with both birds. The latter was amongst the number let loose, and, though they increased somewhat, they never became numerous, but were to be seen about where St. Clair now is, and amongst the gorse above Caversham for a few years. They never took a firm hold, however, and have, I think, all died off. Red-poles, twites, and reed-sparrows were turned loose and never heard of again, while the English robin failed to find a congenial habitat in our land. The skylark, on the other hand, has spread all over the country, and, though it is granivorous, does no great amount of harm.

These are all the small birds that have been introduced into Otago so far as I have been able to ascertain, though the society have no easily accessible records earlier than 1876. Some nightingales were, if I recollect aright, let loose by the Hon. Mr. Larnach on the Peninsula; but, seeing we have few ants here, they could hardly be expected to thrive, as ants' eggs, as they are popularly called, being really the pupæ, form an important item of their food; besides, being birds of passage, they might have sought other localities, though I have never heard of their turning up in the North Island or Australia. The latest introduction by our society is the lap-wing, which should, if it thrives, prove a desirable acquisition; but it is too soon yet to judge of the result of the experiment. Most of the birds mentioned are seed-eating. Such birds are most easily introduced, and, as a rule, are the least to be desired; but in these days of direct steamers it would be easier to bring out insectivorous birds than it was in the old sailing-ship days, when most of the birds were imported, and I think the attempt should be made. I fear such useful birds as the goat-sucker, or any of the titmice, would not stand the long voyage; but some of the warblers might do so, as I think would that delightful little songster the wren, which is a very hardy little bird.

It may be urged that most of the British insectivorous birds are birds of passage, and that our position is so isolated that such birds would have nowhere to go. If they were compelled to migrate in search of food it is possible that in the milder climates of the North Island and the west coast of this Island they might find a sufficient food-supply without going farther afield. Our pretty little native fantailed fly-catcher could not survive a British winter, yet here a descent to the coastal districts from the colder inland regions is for them a sufficient migration. They frequently visit my garden and verandahs in the winter in search of food, but are rarely

to be met with so near Dunedin in the summer. If our fantail can survive our winter with such a slight migration I think many British birds could also do so, whilst such birds as the wren and titmouse would in winter search every crack and cranny for the hidden eggs and pupæ of insects which from their habits escape the starling and other insectivorous birds we already possess.

But, as I have said before, I think a mistake is made in looking chiefly to Britain for objects for introduction. The conditions in California and Oregon must in some respects be more allied to those in New Zealand than are those of Britain, and it is probable that some useful birds might be procured thence. The larger birds which it has been attempted to acclimatise have been chiefly introduced with a view to sport—such as pheasants, partridges, Californian quail, black grouse, English wild-duck, and Australian swans. The latter have spread all over the country, but, with the exception of the Californian quail, none of the others have been successfully established. Both pheasants and partridges gave good hopes of becoming well acclimatised, especially the former, but they were destroyed when rabbit-poisoning became prevalent. No doubt that had a great deal to do with their extinction; but it was not the only factor, for the pheasants, after increasing rapidly, died off in localities where no rabbit-poisoning was resorted to, such as Banks Peninsula. A gentleman resident there for many years informed me that the same thing happened with the domestic turkey, which he let run wild when he first settled there. The turkeys increased not merely in number, but also in size, for several years, but after a time they began to dwindle in number and decrease in weight till none were left in a wild state.

Our society also turned out some Indian minahs and Australian magpies, but, so far as I know, neither succeeded. A few of the former took up their abode in First Church spire, and lived there for two or three years, but eventually died out. Minahs are, however, numerous in some parts of the North Island. Near Wanganui I saw many of them. And the Australian magpie is, I believe, quite established in some localities in Canterbury. If our climate be too rigorous for them their place might be supplied in Otago by the English magpie, which is a most useful bird, though an enemy to the gamekeeper. I need only mention that there were also introduced hares (which in this province shared the fate of the pheasants), axis, fallow, and red-deer—of which the two last, at least, have done well; but it has always seemed to me a pity that nothing has been done in the way of stocking our high mountains with chamois, ibex, big horns, or some such mountain sport-affording denizen.

What an immense attraction sport of that nature would be in the eyes of many, and though these animals eat grass they would interfere but little, if at all, with the seemingly more useful sheep. I say "seemingly more useful," for I believe that were some such sport-affording animal established in our mountains it would be more profitable than the slightly increased number of sheep which the country might carry would be.

There might also possibly be animals which could be introduced with advantage viewed from another standpoint than that of sport. When I was a boy I remember reading a great deal about the bovine-like antelope, the eland, which it was suggested might be domesticated in England, be the means of affording a new source of food-supply, and a change from the continual beef and mutton. I was reminded of this lately by seeing it mentioned that an English nobleman owned a small herd in his park. Probably the experiment of domestication was never tried, but it would, I think, have much more chance of success in our more genial clime than in England, and might be worth trying if the animals could now be got, for they are almost, if not altogether, extinct in their native land—South Africa. The fact that ostriches have been successfully reared in this colony would augur well for success, and at the present price of frozen mutton it might pay us to tickle the British palate with a new sensation, and ship frozen eland instead.

The only other animal besides those that I have mentioned that has been introduced in this part of the colony is the opossum, which is increasing, and, I am told, here yields a better fur than in its native home. Our society once got some hedgehogs, but landed only one, I think. They ought to repeat the experiment, for it is a most useful animal, living on insects, slugs, and snails, as does the shrew (or shrew-mouse as it is often called, though its diet no more resembles that of the mouse proper than does that of the hedge-sparrow resemble the diet of the house-sparrow). Either or both of these animals should be introduced, and would keep in check some of our insect foes.

While some native insects have already disappeared or been reduced in number, others have increased. As an instance of the former I may mention a small bright metallic-green beetle that used to be very common thirty years ago. Its favourite food was the manuka scrub, but it by no means confined its attention to that, and used to attack introduced plants as well. It has disappeared in this neighbourhood, and probably the much-abused sparrow may claim credit for its extinction.

An instance of the increase of an indigenous insect is that

of a brown beetle, which is very destructive both in the larval and imago stages. Those of you who are gardeners must be familiar with the larvæ, especially if your gardens are on a dry and sunny slope. They are white grubs with the hinder part doubled up under them, and look very much like the grub of the cockchafer. These beetles have increased greatly of late years, no doubt owing to the loosening of the soil by cultivation permitting more of the larvæ to attain maturity, and probably also owing to the introduction of additional food-supplies, though they do not seem to be very particular as to what they eat. They are partial to the roots of young *Cupressus macrocarpa*, strawberries, and other plants. I know one man who had to abandon a small piece of ground he had leased for nursery purposes because of the ravages of this pest. The beetles live on the foliage of many plants, and are so numerous as to sometimes quite disfigure them, and the larvæ, as I said, live on the roots; so that in both stages this insect is a pest. The beetle is nocturnal, or at least crepuscular in its habits, and so escapes our birds. In the day-time it hides about the roots of bushes and under clods of earth, and places of that sort, where it would be found by the hedgehog or shrew.

The toad, too, is a reptile which would assist in thinning their numbers, and would, I should think, be very easily introduced. It might not be in favour with bee-keepers, as toads have been known to take up a position near a hive and pick off the bees from the landing-stage, but this drawback could be easily combated, and would be more than compensated by the services it would render in destroying the woodlice or slaters, which are a great pest to gardeners, to say nothing of other insects which it would keep down. English entomological collectors sometimes obtain specimens of rare beetles by catching toads in the early morning and cutting them open on the chance of finding some of these rare *Coleoptera* undigested. The British frog, too, would be useful, but not so much so as the toad, as it does not travel so far from water as does the latter.

An attempt might be made to introduce some useful insects, though extreme care would have to be exercised in any experiments in this direction. So far as I am aware, the only attempt to do so was the introduction of the bumble-bee by the Canterbury society, their object being the fertilisation of the red-clover, a result which has been successfully attained, while several garden plants, such as the foxglove and primrose, seed much more profusely now than they did before the bumble-bee was numerous; indeed, so far as primroses are concerned, I never noticed my plants spreading at all by seedlings before the advent of the bumble-bee, but now they

do so freely. One at times hears complaints of the depredations of these bees amongst the flowers from gardeners, but on the whole I think their introduction is not a matter for regret. Probably if some of the insect-eating creatures I have mentioned were introduced they would aid in keeping the numbers of these bees within proper bounds. There are also carnivorous insects which might be introduced with advantage. For instance, there is the golden ground-beetle (*Carabus auratus*), which is a very useful predacious beetle, and the *Calosoma sycophanta* is of such a voracious nature that it is a true cannibal, eating anything in the shape of an insect, including even its own kind. Then, the European glow-worm, which is the female of a beetle (*Lampyris splendidula*), lives on snails and slugs, as also does one species of *Silpha* (*S. lavigata*), while another species (*S. quadripunctata*) lives on caterpillars. But one species of this genus (*S. opaca*) lives on vegetable food, and is fond of young beet-root; so that care would have to be taken that the desired kind was obtained. I have mentioned two or three insects, but the list could be increased. Some of these could, I should think, be easily imported by bringing out the pupæ in the cool-chamber of a direct steamer.

There is one other aspect of acclimatisation which must be touched upon before I close. I refer to what may be called accidental acclimatisation, and, as a rule, the immigrants we receive in this manner are decidedly undesirable. In this category must be placed rats, mice, the house-fly, the bot-fly, snails, fruit-tree blights, Hessian fly, and other noxious insects, some species of earthworms, &c. I suppose the slater or woodlouse is also an introduction, but I am not certain; at any rate, this destructive crustacean is quite at home here now. The earthworm is perhaps the only unobjectionable name in that list, and it has thriven and multiplied exceedingly, so that now the majority of our garden earthworms belong to introduced species. Possibly the house-fly should also be excepted, which, though somewhat of a nuisance, is perhaps the lesser of two evils, for it is said to have driven away to a large extent the native blow-fly, which was so numerous and objectionable in the early days. The house-fly was supposed to have been introduced by the Australian cattle-ships, and I remember hearing of country people taking them from town to their homes in match-boxes after it had been ascertained that they supplanted the blow-flies. Some may think that the diminution of the numbers of the native blow-fly is due to the imported birds, but it began some years before any such birds had been liberated. The latest accidental introduction that has come under my notice is the earwig, of which we also have an indigenous

species, which I saw a few months ago at Nelson. This addition to our population will be much deplored by our gardeners, especially by dahlia-growers. These accidental introductions are a strong reason why our acclimatisation societies should not relax their efforts if any argument be necessary in favour of continuing acclimatisation, which, rightly directed, might still be of great service to our agriculturists and the community generally.

Time will not permit my referring to the acclimatisation of plants, which is a department in which much more can be and has been done by individual effort than is possible in the others which I have glanced at.

In conclusion, I would again reiterate that it is desirable that the societies should in the future endeavour to keep more perfect records regarding their work than they have done in the past. Another desideratum, in my opinion, is the publication of a cheap handbook, giving in popular form some information regarding not only our introduced but our native fauna, so that our rural population might be enabled to discriminate between the noxious and beneficial, or, at least, harmless, species of birds and insects. The lack of knowledge is prevalent in the Old World as well as here. I have already referred to the mania of gamekeepers for indiscriminate slaughter, while such useful creatures as the shrew and the toad are often treated as evil things, and ruthlessly killed whenever seen. Dr. Duncan, in his "Transformation of Insects," in writing of the golden ground-beetle, which I have mentioned, says, "It destroys a great number of insects which do much mischief to agriculture; but, of course, country people crush them whenever they have an opportunity, instead of preserving them." The information contained in such a book would be a most important part of the technical education of our farmers, and it is to be hoped that some day such a book may be written. The Government have done a little in the way of printing leaflets regarding different pests, but what is wanted is something more comprehensive and in a more permanent form, and I trust that my suggestion may some day bear fruit.

I observe it is arranged that a conference of the acclimatisation societies of the colony is to be held, and I venture to suggest that they might consider the advisability of coming to some arrangement whereby the waste of energy that has occurred in the past might be obviated in the future, which arises from their independent action. An example of this is to be found in the fact that more than one society imported the same kind of birds and fish, while with a little patience they might have drawn their supplies from another portion of the colony at considerably less expense. No doubt such points as



this will receive due consideration at the hands of the conference, and they might possibly agree to take united action in some of the more expensive experiments. The proposal to hold the conference is a good sign, and one which augurs well for the future of acclimatisation in New Zealand, which is a field in which much yet remains to be done.

---

ART. XXX.—*Notes on Bird-life in the West Coast Sounds.*

By RICHARD HENRY.

Communicated by Sir J. Hector.

[*Read before the Wellington Philosophical Society, 13th October, 1897.*]

**Woodhens (*Ocydromus*).**

We have cleared most of the little peninsula on which our house stands, and now it is a favourite place for the woodhens, but they do not like each other's company, and there are seldom more than two to be seen at once, though there are half a dozen occasional visitors. They often treat us to some spirited races across the open, and are no mean runners when assisted by their wings, but all seem to be so well matched that they generally run dead heats. If there happens to be one a little slow it is sure to be *minus* its tail, which is not of much account anyway; yet they seem to think a great deal of it, for the pulling of a feather is sure to bring on a fight, very fierce at first, but quickly dying away into threatening attitudes and various grunts which may represent bad language. The championship appears to be awarded more for courage than muscle, because the smallest hen, when she was thinking of nesting, would hunt away all the others, both males and females, except her mate, with whom she was generally friendly, but not always so. Those were the only pair here mated throughout the winter, and the only pair that would sing in concert. The male is our pet, and we call him "Chicken."

Out of all the others we hardly heard a chirrup until about the 16th July, when several of the old widows became quite musical all at once, and vied with each other in calling the loudest and the fastest. Then, to our surprise, we heard by the lower note and slower tune of one that it was a male. This one came to our place in a most disreputable rig-out of half-moulted feathers, so I called it "Scrag." It was a weakly, poor thing, and one of the hens used to thrash it and

hunt it away. That is why I thought it a widow, though it had the stronger beak and legs of a male. However, I gave it a few good dinners of boiled fish, and it soon plucked up courage and learned to know the rattle of the lid on the dog's pot, and would come up carefully for a share. The dog seemed to notice that they only took little bits, and he soon disregarded them; so that now when I spread out fish on a stone it is common to see a weka on one side and a dog on the other, and both quite contented.

With better times and a grand new coat Scrag actually captivated the hen that used to hunt him about so contemptuously—the old story, “The course of true love,” &c. Then he started a series of fights with Chicken, and kept them up for several days, until both had lost nearly all the pretty feathers on their heads; and Chicken was obliged to give up part of his domain, retaining the house and Sandy Bay, while Scrag has Boatshed Beach. The boundary is a bunch of fallen timber, and they keep it fairly well, only Scrag is tempted up to the house sometimes for scraps, when he knows he is poaching, and will run with whatever he gets and eat it on his own ground. Chicken often hunts him to the boundary, but Scrag will not run a yard past it, so that they often have a fight down there, but nothing very serious. They jump up and kick like common fowl, but their claws are very weak, and can have no effect on such tough hides as theirs; and their wings are soft and fluffy, and only useful to hide their heads when down at the end of a round. The beak is the weapon, and the head the only place they aim at, so that there is a lot of shaping and fencing for very little bloodshed; in fact, their whole aim appears to be to disfigure each other by plucking the feathers that contribute most to personal appearances. At all events, that is the result of their battles. If Chicken was fighting for a mate now he would have no chance at all, for he looks so scrubby about the head that no self-respecting Maori-hen would look at him. The hens seem to have the same object in view when they fight, and it is equally effective. There was a pretty little hen here until she got her head plucked and lost all her good looks, and now she is always calling for a mate, but apparently cannot find one. This is surely an advance on the old method of deciding between rivals, for science has a better show, and there is less cruelty, yet the desired effect is attained.

Chicken can dance beautifully when he likes, which is very seldom, and very little of it at that. He waves his wings, dives his head, swings it to and fro, and then with a flap, a jump, and another wave of the wings, he blinks his eyes as if he forgot the rest. Yet he has the right idea, and knows perfectly well what is graceful in motion. He has also some idea

of "showing off," his beauty-spots being the bared primaries, which he shows to the best advantage by stretching his wings forward towards the ground, at the same time making himself tall and full breasted; but the humour takes him just as seldom as the dancing.

I found their nest about 200 yards away, in the sunniest place they could find, on a little hill. It is sheltered from the rain by the drooping flax-leaves, is deep and warm, and lined with frayed and dead flax. Every evening she used to go up there and call for him, and if down at the house he would answer and go away at once. They were always clucking and croaking about there, but I could never find any eggs in it.

On the 24th August, in the early morning, Chicken marched into the house and craned his neck at my hands with unusual eagerness. I thought he must be very hungry, and I gave him some food, which, contrary to his usual custom, he took up and carried away, trotting along the beach with his neck stretched out as if he was in a great hurry. After breakfast, when working at our big boatshed, we noticed him passing several times with some tiny grub or worm in his bill. I thought he must be feeding his mate while hatching, and went away to see the nest, but it was empty and cold. Yet all that day he was running back and forward until evening, when his gait gave the idea that he was tired out with so many journeys. Late in the evening he stayed away, and his mate came up to the house for food. Next morning when he came I went away along his track, and Burt gave him something, which he promptly brought along, but instead of going to the nest he turned away in the bush, and I had to follow his beaten track until I heard him clucking, and soon saw him under the bushes breaking up the food and calling his mate to the feast. I saw her on a new nest, but fearing she might forsake that also I came away and left them.

A day or two later, when both were at the house, I went away to see the eggs; but the nest was empty—no eggs and no young ones. "All a hoax," said I, "or else the rats have eaten them." But next day, when coming home, we met them near the beach, and they scolded and threatened the dogs, so that I knew they had chickens; but I had to wait a long time before the old ones got confidence enough to call out of their hiding three tiny little black chickens, which were just able to stagger about, yet with sense enough to scramble under cover when the old ones told them to do so. They gradually brought them nearer the house until they occupied a sheltered corner, where the little ones remained while the parents went away for food. They are the very best of nurses. The male in particular is never tired of running here and there and bringing home something. They seldom succeed in getting

more than enough, because when we give them too much they cram the little ones until they cannot eat another scrap, and then the old ones become solicitous, and hold up food to them with a crooning, pitiful note, as if they feared the little gluttons were going to die because they could not eat.

On a wet day the parents look miserable running about in the wet, but the little ones will be stowed away in some cosy nook, and never think of following the old ones without a great deal of calling and coaxing. In this matter they appear quite intellectual compared with other fowl; but they may have learned the idea before the advent of rats, and retained part of it for more than a hundred generations after its utility had become doubtful. That is in theory. In practice there are as many wekas as can get a decent living, many of them being poor and insufficiently fed, for which they can thank the rats. Recently I left a penguin's egg near a rat-hole, and when I returned ten minutes later the egg was gone. The rats are numerous and fierce, and why they have not eaten the little chickens when both parents are away I cannot understand, especially when they are so often in holes that would just suit the rats.

The staple food of the wekas appears to be sand-fleas, which are here in plenty, not only on the beaches, but all through the bush, under the dead leaves and rubbish; and they are never tired raking over this and pulling about the seaweed in search of them. They also pull about the dead grass and turn over every chip in search of other things, but it is all done with the beak—they are not such fools as to go kicking things all over the place like common fowls. The sand-fleas are lively, and can make long jumps, so that whilst a rooster would be turning round to look for them they would have all jumped away. Of course, there are hosts of other insects, including cockroaches in plenty and monster earthworms, which they may catch at night, for they are often out on mild nights, and always active late in the evening. Yet they seem to prefer the scraps from our table to anything they have on their own, and soon learn to eat everything we have. They may have acquired their taste for fish by finding some stranded on the beach, but where they learned to eat bread and butter is a mystery, for they take to it like a robin. There is a little plant with a white bulb like a marble which they know well, and like to eat, but it is watery and quite tasteless.

I threw my hat at one of them one day for being in some mischief, and it is quite comical how long and how well he remembers it, for whenever I take my hat off now he is under cover like a flash. And, again, a young one came to us at the clearing, and after dinner we brought it some food; and in that one lesson it learned the motion of the hand in throwing

the food, so that some days after when I pretended to throw it something it ran towards me and looked for it on the ground. Thus they appear to be strikingly sensible, because they learn at once by experience; and if every living thing did that there would be hardly any fools after a few years' experience. Though their brain may be very small, it is probably of fine quality, or perhaps a host of fancies are absent in their case, and only the useful faculties are developed.

I found Scrag's nest on the 7th September, with two eggs in it, but they laid another after that, and brought out the chickens on the 8th October, so that the period of incubation was about twenty-seven days. They took turns at hatching, for when I saw the hen on the beach I found the male on the nest, and *vice versa*; and in this they show their sense also, for it is easy for two compared with one doing it all, as in the case of the kiwi and kakapo.

In July, when out at the clearing, I heard a woodhen screaming in distress down in a gully, and as it continued I called to Burt, who was nearer the spot, to see what was the matter. Guided by the sound, he went down quickly and found a sparrow-hawk holding on to a woodhen under a log. He caught the hawk, and the hen ran away. When I went over I saw that the hawk's beak was full of the inner down of the hen, so that she had a narrow escape that time, and by calling for help exchanged places with her enemy. They have a special note to indicate the presence of a sparrow-hawk, and generally let us know when there is one about. The tuis, mokos, and robins can also sing out "Sparrow-hawk!" in their own language, and all the others understand; so that he is proclaimed everywhere he goes, which is just what he does not want, and he must have a very vexatious time of it trying to get a living. On another occasion I hung a fishing-net on the clothes-lines to dry, and when we came home a little male sparrow-hawk was caught in the net about 1 ft. from the ground. Our tame weka was in a great state of agitation, yet bold enough to come up and peck at the hawk in defence of her chickens, who was probably stooping for one of them when the net caught him.

In seven weeks the three chickens grew up nearly as big as their parents, but very soft, of course. And then one of them disappeared, with a hawk, I suppose, though we had killed six, and thought we were doing a good turn, because we saw one hunting a pigeon.

When the tide is low and the wekas are tempted away out on the beaches I think the hawks take 90 per cent. of the young ones, which may be quite desirable, because from recent developments the wekas appear to be the worst enemies of the ducks.

Our goose made her nest right before the window, and only 10 yards from the house. In gathering material she took a little straw, but preferred more substantial stuff. When leaving the nest she carefully covered up the egg, so that I was surprised to find it so deep among the sprigs and chips. I covered it up again as I got it, but next morning the nest was opened, and only a few scraps of eggshell remained. I was not sure whether it was the dog or the weka, but intended to find out. The weka was evidently interested in the nest, for we saw him walking round while the goose was on it. We knew, also, that he would break an egg at sight, for we tried him with a penguin's egg; he had also stolen a roa's egg-shell and destroyed it. This was a strong shell, and I saved part of it to show how he could punch holes in it. He could pick up a penguin's egg and run away with it so quickly that I could hardly get it from him. We got several goose-eggs by going at once and taking them away, until one morning I was busy with log-fires and did not go at once. I heard when the goose came off, because her mate gave her a noisy greeting, and a few minutes afterwards I found the nest torn about and the weka and his family around the broken egg some yards away. Next time the goose was on the nest the weka waited about there all the time, though the gander tried to drive him away, and I went out and threw soft things at him, yet he flipped about and defied me, so that I took a dislike to him for his outrageous cunning. When the goose came away Burt went at once and found the weka digging up the nest in search of the egg; and when she started to hatch, though there were no eggs, she regularly covered up the nest when leaving it, and the weka never failed to rake it out when he found her absent, and, of course, a goose could never hatch an egg where there was such an artful and patient thief as that.

Long ago I knew they were egg-eaters, but I never dreamed that they were half so bad as this shows them to be. We have had this weka since it was a chicken, and he has only a small domain where there are no penguins. Probably he never saw a duck's nest in his life, and certainly not a goose's, for this was the first in the sound, yet he seemed to know all about it, and that the eggs would be covered up. The ducks cover theirs until they start to hatch, and then also when they leave the nest of their own accord; and that is evidently where this weka's forefathers learned the habit, and faithfully handed it down to this promising youngster. To this small matter hangs a very long, old story, which we will never hear in full, about the ducks watching and fighting for their eggs, and the wekas successfully robbing them year after year until it became a fixed habit for transmission, the result of which we saw plainer and truer than by writing.

No doubt the weka is a finished thief; but he is not a fighter, because his wings are useless, and his courage is very little better for that purpose. The little teal are terrors to fight with each other, and then they make their wings crack like whips, so that they could easily drive off a weka; and as for a "paradise," she could kill one if she caught hold of it—but that would be the trouble.

There are wekas on Resolution Island, and when I saw this one's talent I feared for the mother kakapo, who has to do all the nesting herself, until I remembered that she stays at home during the day and only goes to feed at night, when the wekas are mostly tired. This habit she can thank for the very existence of her race.

We have spent a great deal of time clearing for grass, in the hope of fostering paradise ducks. We were inclined to foster wekas also, and were fortunate in having the experience with the goose's nest, otherwise we might have worked for a certain failure. Now, if I get the ducks the Maori-hen will have to leave Pigeon Island. With all their intellect they have weak points, of course, for the strangers will walk up and put their heads in a snare when you hold them out a bait on the point of a stick; and all those who are near at hand will come out and show themselves, while those that are far away are often calling out to tell where they are. I was always friendly to the poor old wekas, and thought them well worth developing, and I am very sorry to have to write them down so mischievous among their fellows. For all that they may turn out to be the most valuable pets in New Zealand.

We saw them skipping about at dusk catching moths and beetles on the wing; and with their very great cleverness and their tireless activity I think they would be a cure for the codlin-moths in orchards. There was some talk of importing bats from England for that purpose, but a bat is a mammal that might catch flies near an anthrax carcass and then fly away over fences and rivers to drop the germs of disease or die among healthy stock; and if we only knew enough about their migrations in the Old World the flight of disease might not appear so mysterious. In Victoria I knew where many hundreds of bats, perhaps thousands, used to sleep in a great old hollow tree, and often saw them streaming out of there in the evening like a swarm of bees. They were easily caught in dozens with a piece of netting, and I found that every one carried a variety of very visible parasites, and perhaps invisible ones, because they had an offensive smell. They often hawk for flies about dwellings and animal camping-grounds, so that they appear to be ideal mediums for collecting, exchanging, and distributing germs.

A new race of bats invigorated by transportation might turn

out the very worst importation for New Zealand. On the other hand, a weka is the easiest of all birds to inclose where it is wanted, also the easiest to catch, to keep, and to carry, and would be likely to thrive well in its native land. If they only lived in England our fruitgrowers would be longing for them; but because they are at hand they are not much thought of in their own country. No doubt they will be eagerly inquired for in far-off countries if ever it is known that they have all the qualifications required.

Since writing the above I find that they will kill each other's young, and this, with the curious habit of leaving them behind, makes it necessary that each pair, when breeding, should have a run of their own, and be able to make it warm for all intruders. When the little ones are alarmed they pipe out a penetrating call for assistance, and then the old ones appear as if by magic. Perhaps that is why the cunning rat did not eat them—he feared that shrill call and its consequences. When our chickens were about seven weeks old the mother handed them over to the father and took no more care of them, but went up on the hill behind the house, built another nest, and had three eggs in it partly hatched on the 28th October. I took one of them to get the embryo for Dr. Parker, intending to take the others at different stages if I am at home. At this rate every gardener could breed as many as he wanted.

They can swim and dive well to escape, but I never saw them in the water except on business. It is wonderful how they can dispose of food, for they seem to be never beaten either by quality or quantity. A few minutes after a feast they are as hungry as ever, and they get rolling fat very quickly.

Our weka looks after his two big chickens during the day, bags food for them or hunts it up on the beach, and apparently gives them everything he gets. Sometimes he gives them a wiggling and chases them away—for schooling, I suppose—yet he fights for them and has many a lively run hunting away intruders, who sometimes chase them and make them scream for assistance. Then he snorts and coughs, and his eyes glare with indignation as he rushes about looking for the offender, who is often sly enough to flip round a corner and make a bee-line out of dangerous ground.

At the end of October this is his usual day's work until some time in the afternoon, when he goes up the hill to the nest where his mate is hatching, takes her place, and lets her come out for food. If we see her we give her plenty, but she is in no hurry returning, evidently confident that the eggs are safe in his keeping until she has had her outing at leisure.

I wonder greatly they are such good managers if they



cannot talk. Fancy him going up to the nest, if you can, and putting her off it without exchanging ideas about his object or intention, and without promising to remain until she returns. It is far easier for me to imagine him saying, "Come out now and get something to eat; I will take care of the eggs until you return, and do not be in any hurry, because I am tired and will be glad of a rest here."

17th November.—This evening I was looking at the antics of the woodhens when Scrag made a rush at something, and then I heard a rat screaming in a big hole under a stump. The dogs also heard it, and I had just time to see the weka drag out a rat when the dogs rushed in and killed the rodent, and I lost the chance of as great a treat as a bull-fight. I know it would require the keenest activity for a weka to kill a rat single-handed, and am not sure that it could do so; but the rat's screams would be sure to attract another weka, and then I think the pair could manage it quite easily, for one could hold while the other stabbed, or both could tug and pull, in which they seem to take a delight, and are very tenacious, so that the rat would be worried to death. This tenacity of hold is quite unexpected from the shape of the weka's beak, but I have played with them by trailing a little fish on the rod, and was surprised how they could hold on until I lifted them off the ground.

22nd November.—We went to Breaksea Sound, and camped in a beautiful place called Beach Harbour, two miles east of Acheron Passage. We soon had the Maori-hens for company, of course, and there were two grown-up chickens. They were all rather shy at first, but food soon opened the way to their friendship or gratitude. I threw an old fellow some crabs, which he evidently took note of at once, for he followed me along the beach, and, after a few lessons, when I turned over a stone and he saw the crabs running he would come up and catch them himself, and his example soon made the others tame. Then I opened cockles for him with my knife, and he would stand at my knee and eat them with more confidence than the Maori-hen I had reared. But the reason I mention him at all is because he gave us an exhibition of his skill as a fisherman. Often I saw them wading in shallow water, but thought the fish too lively for them to catch. However, this one brought up several little fish as long as my finger, and paraded them about, calling his chickens to come for them. His neck and legs appeared to be rather long, as if to suit that sort of work, and I saw him peeping cautiously round corners as if expecting shy game, so that he must have been an old hand at it; and probably his forefathers were fishermen, because the circumstances were suitable.

With the isolation which these birds seem to crave, and indefinite time, it would not be hard to imagine the origin of a race of waders. In fact, the weka appears to be just the sort of bird to start with, because it will eat anything, and the little chickens are very hardy, with apparently a surplus of digestive power, which latter may be nearer the spirit of life than the old people used to think.

If a tribe of wekas had abundance of any one sort of food, either fish or fruit, I think they would be content with that, and become adapted for obtaining it; and with such material the simple laws we recently heard of could develop a variety of forms in accordance with the great variety of conditions, and the wonder is there are so few to fill them.

In Australia I knew the rails that came there in the spring, when the corn was knee-high. They made their nests in clover bottoms, and I often found their eggs, which were just like the weka's, but much smaller of course. The chickens were also quite black like the weka's, and the parents made the same sort of croaking noise when I went near their nest, but I do not remember their ordinary cry. They could fly well, but did so unwillingly when alarmed, as if they preferred the long grass for refuge; but a dog would make them fly, and then their style was like that of the swamp-hen. They were distinctly migratory, but I never heard where they came from, nor could I imagine any suitable place for them in Australia during the dry season, because they seemed to like damp places. Then, if ever they came to New Zealand, it is no wonder they thought it a paradise, and, deciding to remain for ever, gave up flying. And the wekas have still a trace of their old migratory habits, because they will risk their lives like the rats, and swim for miles to get away out on some lonely island, far from their old homes and their persecuting neighbours. And perhaps these two, with their colonising impulse and great digestive power, may represent advanced germs of the fauna of many lands.

#### **The Roa (*Apteryx australis*).**

In coming home on the 10th December we brought two roas, and I have been feeding them since, and watching their manners in their little paddock in the evenings. Two things are notable—the large paddock they eat, and their unexpected activity. The ones I used to keep for a little while at Te Anau gave me the idea that they were slow creatures, but one of these can skip about like a rabbit, and I suspected it of eating all the food, so kept on putting in more and more, till now they get about  $1\frac{1}{2}$  lb. of fish and a few extras.

They do not take kindly to fish or meat at first; they often

refused it when we had them in cages for removal to the islands. So now I do not trouble them the first night, but the second evening I catch them and make them eat a few pieces, and the night after they will eat it readily themselves. I knew they ate a few berries in their own homes, and, fearing fish might be too monotonous, I rolled it in oatmeal, until now they will eat porridge by itself. In the day time they sleep huddled up together, though at first they would fight, not being mates, but now they seem to be the best of friends. I made a dark den for them, but they would not go into it, preferring to sleep behind it, under the log, where I can see them shivering with the cold, and annoyed by the sandflies.

The male is always much smaller than the female, and this one is moulting, which makes him look smaller still; so he gets in a nook inside, and the female sits close to him and almost over him, as if to keep him warm. There is only a round ball of their brown drooping feathers to be seen, and perhaps the point of the long beak clear of the feathers in some unexpected place.

When disturbed they lift their sleepy-looking heads from under the mantle of long feathers on the shoulders, where one would think them safe from sandflies, but I often see dots of blood around the eyes and mouth, for the flies are very insidious, and may bite severely without leaving a trace. Where there were no sandflies they might thrive much better than they do here; and, as they are so easily enclosed, it is a wonder every extensive garden has not a pair, for there is no doubt about their value, because they are specially fitted for finding the garden-pests that can so easily hide from jabbering sparrows and other musical humbugs that came here under false pretences.

The song of the roa is not very musical, but might become sweeter by association than our blackbirds and thrushes that pay us in whistles for stealing our fruit; while roas are humble, and so harmless that they will not even scratch the ground, but probe it with their slender beaks, guided by scent and hearing in the night time, and then go to their holes at daylight, only to come out again when the other workers are going to bed.

There can be no harm in speculating about how these curious birds came to New Zealand, for there are no degrees in ignorance when nobody knows. Men may have done the mysterious distribution as part of their business here. The fact of finding no geological proof only amounts to the silly man's evidence when he offered to bring a dozen men to swear that they did not see him steal a spade. We know that men are eminently fitted for such work, and that they

have been at it as long as we know anything about them; then, why not previously? They brought lions and tigers to Rome about two thousand years ago. There are as wonderful ruins in Java as there are in Egypt, and some of the Rajah's keep pet tigers there to-day. Then, why not formerly, when perhaps they brought them as far as the Romans did, and even across "Wallace's line"? Even the sea-shells benefit more than half the living things by extracting the surplus lime that might poison the fish. Then, why should not the ablest have useful work to do for the community?

Recent research suggests the probability of roas originating from birds that could fly. That is a very good story, but there is not nearly enough of it, because they must have had many adventures since they first flew up for a skite round some Old-World mountain-tops and got blown away to New Zealand. In the first place they found no enemies in the New Zealand scrub, or they would not have lost their wings; and possibly there were swift hawks about that made them afraid to show themselves until they quite forgot about their wings.

There might have been a long period of cold, when roas were the fittest to survive as long as any forest remained. There may have been a sinking of the land, when such mountaineers as roas would be the most likely to survive with their varied food; and when the land rose again some of them may have gone down relieved of enemies, and developed into moas in the fruitful valleys; for nature takes no heed of time in fitting her people for their surroundings. And even now no more perfect fit exists than that of the roas for their dominions. Their feathers are hairy at the tips and hard to wet or disarrange, yet soft and downy at the roots, amply warm and waterproof; and their skins are thick and oily, as if to defy the everlasting damp of the shady forest, where they never feel a gleam of sunshine.

As their food is in the ground, on the steep hill-sides, they have powerful legs for climbing, with strong spurs on their heels to let them go down steep and slippery places with ease and safety. The wing is no bigger than one of their toes, and naked with the exception of a row of little penfeathers, in memory of the old quills of long ago; while the tiny shoulder is useful as a rest for the beak when asleep.

The wonderful beak is long, slender, and slightly curved, but, unlike all others, with the nostrils at the very tip, which fit it for finding its food deep in the moss and roots, where it had no competitors. It has also cutting-edges, which I was not aware of until I saw them rasping a lath of the cage. It is white when alive and partly transparent when recently dead, showing a network of blood-vessels, as if highly sensi-

tive for feeling its food at the bottom of the holes. Those holes are the size of a pencil when in earth, and 4 in. or 5 in. deep, but when in moss are cone-shaped, as if made with the head, and perhaps 10 in. deep, thus showing how acute their scent and hearing must be to locate some silent grub or worm down there. Only in a garden in the evening or bright moonlight can one be seen at work. Then it lifts its foot and puts it down so gently, with its neck outstretched and ear forward, in a listening attitude, that I am almost sure it depends greatly on its hearing for finding its food; and it must be sharp to detect the small noises of white grubs and wire-worms 1 in. or 2 in. underground, yet near grass-land at Te Anau I have found their stomachs half-filled with them in the spring, and with beetles and other things I never noticed elsewhere.

It often rests the point of its beak on the ground, apparently for support, but it may be to scent the worm-holes that come to the surface. Though their sight seems to be of little use to them, there is no doubt about their keen scent, because when a worm or piece of meat is thrown near them they are aware of its presence at once, and touch the ground here and there, coming nearer and nearer until it is felt and taken up. I have often seen their tracks on the sandy beaches at Te Anau, and was puzzled to know why there were only a few regular steps and then a deep footprint and a long stride to the right or left; but now I think they get part of their food in the spring by catching insects that fly close to the ground, especially in those seasons when green beetles and the like are a nuisance; so their eyesight is of some use to them, notwithstanding their blind manner. I find that they can change their food, like the woodhen, for I put in a big moki's head, boiled, a few nights ago, and they picked it clean: and now I only put in a dish of promiscuous scraps, and they clean it up like little pigs, so that they are very satisfactory to feed.

Mr. Ness, of Port Chalmers, has kept a splendid one in perfect health for years, and I promised to send him a mate for it; so that is what my captives are for. Three-foot netting is quite sufficient to enclose them, and, as there are hundreds of places already enclosed, it is a pity no one tries this way of dealing with pests in gardens, of which we hear so much now and then, with the value of sparrows, &c. It is not at all hopeless to domesticate them. Though they only lay their one great egg, yet they may breed twice as fast as sheep or cattle, because I have found eggs in July and November; so that many of them may lay twice in the year under favourable circumstances. I am confident that if they were better known they would be highly valued by gardeners, and become quite common, which would be the best of all ways of saving them

permanently. At all events, some one should try the experiment, and if authorised to do so I would send a pair to any one having a suitable place, and willing to give them a little food in winter, for of course they could do nothing in frost unless there were plantations.

Though they could make holes for themselves in the soft banks, yet I think they very seldom do so, for there are always plenty to choose from under the roots of trees where they can sleep during the day. For the nest they like rather a small hole with only one entrance, and in the driest place they can find. There they gather a few handfuls of dry fern-leaves and scrub and lay their one great egg; and I think the male takes entire charge of it, and never leaves it until it is hatched, but I am not quite sure of this, for the female may sit a while at night and let him come out for food, but I never found one on an egg, though I have seen dozens of nests in the last fourteen years. On a very few occasions I have found the female in the hole with him when sitting, but generally he is there alone, though at other times the adults are always in pairs. Even if I was to go up the spur in the dark to a nest I might disturb them and learn nothing; but the point of his endurance can be easily settled by those that keep them in gardens.

At the beginning of his task he is in good condition, but when the egg is nearly hatched he is poor and quite stupid, while his mate is wide awake and fightable, so that they have just exchanged places since she laid that egg. I found two chickens just hatched, one of them not quite dry; yet there was not a scrap of eggshell in the nest, and I could not account for it. The chickens were quite helpless, and unable to stand up, so they must have either absorbed food enough to last them until they could walk or the parents carried it to them. When they are able to walk some of them at least are quite careless about staying with the old ones, for I have found a tender little thing several yards away from where the parents were asleep; and I found a tiny grey kiwi in a knot-hole near the beach, and my dog could not find the mother at all. So there are many questions to be asked about them, for they have some curious ways, and as yet we may not know half their history. From the size of the egg and the shape of his body it would be impossible for him to hatch two eggs at one time, so that the big egg must be a very old legacy.

The voice of the male is a high-pitched rather musical scream, with a tremble and a sudden drop of several notes at the end of each call, which may be about two seconds duration, repeated five or six times. The female sings nearly the same tune, but in a much lower and hoarser tone, somewhat

like ro-ar, ro-ar, with both syllables accented and a slight rest between.

When disturbed in their holes they crack their beaks like a snap of the fingers, and protest in a grunt or growl, but never use the beak for defence. In fact, I often take both legs in my hand before they seem to be aware of it. But long ago I caught one by the head, and with its powerful legs and strong sharp claws it wounded my hand and wrist severely—poisonous wounds that were very slow to heal.

If cornered in their paddock here their behaviour is quite courageous, especially that of the female, for she will come towards my hand and stamp and kick with such energy that I take care to keep it out of the way. I think she could easily defend herself against a ferret out in the open, but not in a hole. So whoever essays to keep them should provide a den with a small entrance and a chamber inside without corners, so that poor roa would have room to use its legs.

On one occasion I found a little male *A. oweni* hatching an *A. australis* egg. He could not have driven away his big cousin, so there may be hybrids which would be somewhat like *A. haastii*. Every item is worth recording, because we know so little about them.

When a roa passes by our tent at night and becomes conscious of intruders it instantly alters its creeping step, and tramps along with such a heavy footfall that I could not believe it to be a roa until I proved it several times by letting loose my dog. As their hearing is the keenest perhaps that heavy tramp is "putting on style" from their point of view, where sight is not of much account.

---

ART. XXXI.—*A Romance of Samoan Natural History; or Records relating to the Manu Mea, or Red Bird of Samoa, now nearly, if not quite, extinct.*

By the Rev. JOHN B. STAIR, late Vicar of St. Arnaud, Victoria, formerly of Samoa.

Communicated by E. Tregear, F.R.G.S.

[*Read before the Wellington Philosophical Society, 4th August, 1897.*]

"WHAT shall I send you from the islands?" was the question I put to an old friend, fond of natural history pursuits, as I was leaving England for the South Seas in 1838. "Send me a dodo," was the prompt but startling reply, and one

that I thought had but little chance of being in the slightest degree realised; but, strange to say, as the years rolled on, from that most unlikely part of the world, and in a very unexpected manner, I was enabled to do a great deal towards making known to the scientific world the nearest approach now known to the long-lost and long-extinct dodo.

In 1843, or some five years after my friend's strange and jocular request, a Samoan native brought me a couple of what I at once saw were rare and extraordinary birds, male and female—the manu mea, or red bird of Samoa. I had never seen any before, and the man assured me that they were very rare birds, and most difficult to obtain. I gladly paid the required reward, and made arrangements for the safe keeping of my prizes. That they were extraordinary birds was at once seen, not simply from their rarity, but also from their singular appearance. The head and strong hooked beak resembled a parrot, but the legs were as unmistakably of the pigeon family; so that the whole appearance of the bird was a puzzle. I searched in vain through every book at my disposal for some clue as to its character, but could find nothing whatever to solve the mystery. The birds had been captured on the nest, and were thus uninjured, and likely to do well in captivity; but at that time I had no idea of the treasure thus brought to me. Still, I was greatly delighted with my prizes, and took every precaution to insure their safety. My native lads were familiar with the food required, and fed them after the manner of their pigeons, at feeding which they were adepts.

At first the birds were very timid and shy, but soon began to quiet down, and there seemed every prospect of our being able to keep them in confinement. Some time after, however, one of the birds was, unfortunately, killed, but the other continued to thrive, until late in the year 1843 a friend, Mr. Evans, who was going to Sydney, kindly offered to take the bird there, and endeavour to ascertain something about it, and thus satisfy my curiosity as to its character and class. Some native lads on board the vessel took charge of the bird, and fed it, native fashion; and, as they are clever bird-fanciers, it reached Sydney safely. Mr. Evans at once took it to a taxidermist, and endeavoured to ascertain from him something further about it, but the man was equally at a loss with myself, and could give no information whatever: the bird was a marvel he could not solve. My friend's business engagements prevented his taking further trouble in the matter, and he left the bird with that gentleman, bringing me, on his return, a lory in exchange, but not the slightest information of the kind I so much desired.

Deprived of native care and attention the bird, apparently,



soon died, and the skin, with others, was purchased by or for Lady Harvey, either in Sydney or else in Scotland; but eventually this unique and precious specimen came into the possession of Sir William Jardine, of Edinburgh, and was first described by him in 1845 ("Annals of Natural History," vol. xvi., p. 175) under the name of "*Gnathodon strigirostris*." Its true habitat, however, was unknown until it was announced later on, in Mr. Strickland's "Report on the Progress and Present State of Ornithology," read before the British Association at York, that "the recent American voyage of discovery will extend our knowledge of Polynesian zoology, and its researches will be made known by Mr. Titian Peale, who is said to have discovered, among other varieties, a new bird, allied to the dodo, which he proposes to name '*Didunculus*,' and we believe *strigirostris* has been applied specifically."

I may here mention that during the visit of the United States Exploring Expedition to Samoa, in 1838-40, before alluded to, several members of the expedition, including Mr. Peale, the naturalist, were my guests for a short time at Falelatai, on their way to the mountain at the back of the settlement, and during their visit I spoke to them of the manu mea, described its habits as well as I could, and told them how I had tried in vain to obtain it. I did not see them on their return from the mountain, but heard afterwards that they had obtained a specimen.

From the specimen in Sir William Jardine's possession the bird was figured by Mr. Gould in his magnificent work the "Birds of Australia," and its distinctive character shown. At that time there were only two specimens known to exist—viz., the one in the United States, taken there by Commodore Wilkes, and the other the one in the collection of Sir W. Jardine, in Edinburgh—the identical bird that I had sent to Sydney in 1843.

After my return to England in 1846 the late Dr. Gray, of the British Museum, showed me a drawing of this bird, which I at once recognised, as also a drawing of a new species of *Apteryx*, which had been made from a skin purchased in Sydney in the same lot with the skin of the manu mea which I had sent from the islands to Sydney, and which he explained came from some place unknown. A native chief who was with me at the time at once recognised this latter bird as the puna'e (springer-up), a bird well known in Samoa, but which, like the manu mea, was rapidly becoming extinct. Both Dr. Gray and the late Mr. Mitchell, of the Zoological Gardens, took great interest in the description I gave of the habits of these birds; and I suggested that prompt and special efforts should be made to procure further specimens of both

before it was too late, advice which after many years was acted upon.

Fourteen years pass : and I had been many years resident in Victoria, but had heard nothing further of the famous manu mea, when one day I was surprised to see a notice in the *Argus* of the 2nd or 3rd August, 1862, calling attention to the fact that at a meeting of the Royal Society, recently held in Melbourne, a letter was read from His Excellency Sir H. Barkley referring to a communication which he had received from London relative to some rare pigeons (*Didunculus strigirostris*) from the Navigator Islands, which the Zoological Society of London were most desirous of procuring. The society offered £50 per pair for living specimens, and £10 to £12 for skins. His Excellency forwarded some drawings of the pigeon, and stated that he had endeavoured to assist the effort, but asked for further information, if it could be obtained. I at once communicated with Dr. Mueller, the then vice-president of the Society, and told him that I recognised the description as that of the manu mea, or red bird of Samoa, and gave him such information as I possessed respecting it. My letter was quickly followed by a reply from Dr. Mueller, accompanied by a coloured drawing of the bird, which could not be mistaken.

Subsequently a notice of a meeting of the Royal Society was published in the *Argus* of the 14th August, 1862, in which it was stated that an interesting letter was read from the Rev. J. B. Stair, of Broadmeadows, relating to the pigeon from the Navigator Islands, upon which information had been requested by Sir H. Barkley on behalf of the Zoological Society of London. Mr. Stair had seen the tracing of the bird, and recognised it as the manu mea, or red bird of the islands. He had also kindly mentioned the names of several gentlemen in the islands who he thought would use their best influence in endeavouring to procure specimens, but in consequence of the great rarity of the bird he is very doubtful of their success.

Under date of the 15th August Mr. Sprigg, the secretary of the Acclimatisation Society of Victoria, wrote to me stating that Dr. Mueller had placed my letter respecting the *Didunculus* before the Society, and that he had been directed by them to return me their best thanks for the information I had afforded them. Mr. Sprigg stated that he had written to J. C. Williams, Esq., H.B.M. Consul at Samoa, asking his help in procuring specimens of the bird. He had also sent copies of my letter to Mr. Williams. He further said, "I have also furnished a complete copy to Sir H. Barkley," who, in reply to Mr. Sprigg, says, "With the information supplied by the Rev. Mr. Stair I trust there will be no insuperable difficulty in obtaining the bird, if still in existence ; but, should it

not be forthcoming, I will beg of Commodore Burnett to let one of the ships of war passing that way call and repeat the inquiry, as suggested by Mr. Stair."

Five months later, under date of the 10th January, 1863, Mr. Sprigg, of Melbourne, wrote to me, enclosing copy of a letter he had received from Mr. Williams, of Samoa, *re* the manu mea, in which he says, "I have been over twenty years trying to get one of the birds you write about, and have only just within the last two months been fortunate enough to secure one, which is now thriving well, and I hope that when I go to Sydney I shall be able to take it with me. Although, for myself, I should rather favour the Sydney Acclimatisation Society, yet, as you have first written to me about the bird, I should think it only just to give you the first offer. I have had great difficulty in obtaining the bird, as they are nearly extinct, having been destroyed by the wild-cats. The Rev. J. B. Stair's account is very correct. I hope to be in Sydney about May or June, when I shall be happy to hold any further communications with you.—JOHN WILLIAMS, British Consulate, Apia, Upolu, Samoa, 19th November, 1862."

From this time onward, until the end of August, 1863, with the exception of a notice concerning the habits of the bird, by Dr. G. Bennett, of Sydney, no further information appeared respecting the success or otherwise of the search for this much-coveted bird. At length, on the 30th August, 1863, the Melbourne *Argus* of that date announced the fact that a pair of *Didunculus* had reached Sydney from Samoa, and had been purchased by Dr. Bennett for the London Zoological Society, and that the birds "were doing well." Dr. Bennett bought them on his own account, for transmission to the Zoological Society of London. At a meeting of the Acclimatisation Society of New South Wales, at which he made the statement, he said, "He wished to express his thanks to that Society, as also to the Acclimatisation Society of Victoria, for the liberal resolutions passed by them to unite with him in the purchase, on account of the very high price demanded for the birds, the ultimate object, however, of which would be to send them to the same destination he intended; but, on reflection, he considered it more desirable and more satisfactory to take the sole responsibility upon himself, as well as the expense. These birds were nearly, if not quite, extinct, and were remarkable as forming a living example of the long-extinct dodo, of which nothing now remained but one head and foot, the first being placed in the Ashmolean Museum at Oxford, and the latter in the British Museum. A cast from this foot could be seen in the Museum at Sydney." Dr. Bennett further stated that the only specimen of the *Didunculus* at present in Europe was the one in

the possession of Sir William Jardine, and from it all the drawings and descriptions of the bird had been made. There were also, it is said, two specimens in America; and these three, with his two living birds, now in Sydney, were all at present known to exist. No living specimen had as yet ever been seen in Europe.

Three days later, on the 3rd September, 1863, the following paragraph appeared in the *Argus*: "With reference to the paragraph which appeared on Monday concerning the purchase of a pair of rare birds (the *Didunculus*) by Dr. George Bennett, of Sydney, we have been requested to state that, although Dr. Bennett is the actual possessor, it is solely to the exertions of the council of the Acclimatisation Society of Melbourne that the scientific world is indebted for the possession of these long-sought-for birds. It was at the request of this council, and upon the faith of their representations, that Mr. J. C. Williams, the British Consul at the Samoan Group, brought them to Sydney, and it was intended that the purchase should have been a joint one with Dr. Bennett, the council being desirous of allowing him to participate in the honour, as he had for many years been endeavouring to procure a specimen of this bird." This arrangement, however, had not been carried out, and Dr. Bennett observes that he "considered it more advisable and satisfactory to take the sole responsibility and expense. The Zoological Society of London had been informed to whom the credit is due." This explanation was most certainly due to the council of the Acclimatisation Society of Victoria, as they had been under the distinct promise of first offer of purchasing the bird by Mr. Williams in his communication of the 19th November, 1862.

Mr. Williams reached Sydney on the 13th June, 1863, and five weeks later, on the 24th July, a second *manu mea* was brought to Sydney for him, so that he could offer two birds for sale, a fact considered of much importance. The last bird that reached Sydney was from a different island—Savaii—and was considered older than the one brought by Mr. Williams. Both were, however, placed together, but the last-received bird seemed wilder and more restless than the other, a fact no doubt arising from its having been more recently captured and placed in confinement. Up to the time of purchase the birds had continued under native care and feeding, which was of great help alike to the birds themselves and to those who subsequently took charge of them, the Samoans being very successful in their treatment of the native birds.

On the 21st August, 1863, Dr. Bennett completed the purchase of the two birds, and took possession. A little over three weeks later the older and last-received bird sickened and

died, to the great disappointment of all concerned. Alluding to the time subsequent to the purchase, Dr. Bennett says, "The adult bird often runs wildly about the cage, flapping its wings, and, when the door is opened, makes every effort to escape. On the 12th September, a little over three weeks after the purchase, the older and last-received bird refused food, which continued to the morning of the 14th September, when several fits carried it off in the course of the day. I placed the body, entire, in spirits, to enable a complete anatomical description to be given of the bird by Professor Owen." Dr. Bennett further says, "I observed a quantity of white powder, such as is often seen to fall from the white cockatoos, on the bottom of the cage, and on the 4th October, the remaining bird not seeming well, a change was made in the food, loquats being given, of which the bird cracked the seeds, and seemed better for the change. On the 23rd October it again refused food, but took a large quantity of gravel, yet still eating nothing for two days. It was therefore thought that the loquat-seeds did not agree with it, and they were discontinued. On the 25th October the bird got much worse, and, fearing it might die, it was placed in a parrot-cage, so as to enable the artist summoned to finish the drawing from life, as it would be better seen in a large cage, when, to the great surprise of all, the bird jumped from the perch, and commenced eating what, on examination, was found to be hemp-seed, and from that time it was fed on that kind of food, and soon regained its usual health." This singular circumstance clearly points to the difficulty of arranging food for a bird whose habits are so little understood. I have no doubt that the death of the other bird arose from change of food, and also, perhaps, from change of attendance, the natives so much better understanding their habits than Europeans. The surviving bird throve well on this change of diet, and after a time was placed on board the ship "La Hogue," Captain Williams, and given in charge of Mr. Broughton, the chief steward, who had acquired great experience in the management of birds, and in whose skill and care every confidence was felt.

The "La Hogue" sailed from Sydney on the morning of the 12th January, 1864, and reached England safely on the 10th April following, and on the next day—11th April—the manu mea was handed over to the charge of the authorities of the Zoological Gardens, Regent's Park, thus realising the long-cherished dream of having one of these wonderful birds alive in England.

A few days later, under date of the 26th April, 1864, Dr. Selater, the secretary of the gardens, wrote to Dr. Bennett: "I am delighted to be able to tell you that the *Didunculus* is now alive, and in good health, in the gardens. The bird is not

in good feather, but feeds well, and Mr. Bartlett assures me is likely to live."

Thus ends this, to me, interesting and romantic story of this strange bird, connecting, as it does, so significantly with the past.

A few remarks on the general characteristics of the bird, as also its habits when wild in its native forest and when in captivity, may be acceptable.

#### GENERAL CHARACTERISTICS.

As to these, I cannot do better than quote from "Further Notes on the Tooth-billed Pigeon of the Navigator Islands (*Didunculus strigirostris*)," written by Dr. Bennett from data given by myself, and published in the *Sydney Morning Herald* of the 3rd September, 1862:—

"Since the publication of my observations on the tooth-billed pigeon of the Navigator Islands, in the *Sydney Morning Herald* of the 19th August, 1862, I have received a communication from the secretary of the Acclimatisation Society of Victoria, containing some valuable notes given to them respecting this rare and valuable bird by the Rev. John B. Stair, of Broadmeadows, Victoria, formerly resident for some time at the Samoan or Navigator Islands, considered the exclusive habitat of this singular bird. I have now selected those portions relating to the bird which are new to science, or will more fully add to its history, and complete, as far as possible, our knowledge of this nearly extinct bird. Mr. Stair says he has seen the *Didunculus*, and that it is named by the natives the *manu meca*, or red bird, from the most predominant colour of its plumage being chocolate-red. In 1843 Mr. Stair had two in his possession, one of which was unfortunately killed, and the other was taken to Sydney by a friend to see if it were known, but nothing could be learnt respecting it. The bird was left there, and subsequently died, the skin being afterwards purchased, with others, either by or on account of Lady Harvey, and eventually found its way into the possession of Sir William Jardine, of Edinburgh. The bird was formerly found in great numbers, and this assertion may excite some surprise that such a bird should not have been seen and procured by the early navigators. Now Mr. Stair further observes that which I have for some time suspected—viz., that the bird is nearly, if not quite, extinct. It feeds on plantains, and is partial to the fruit of the *soi*, a species of *Dioscorea*, or yam, a twining plant found in the forests of the islands, and producing a fruit resembling a small potato. The habits of this bird, Mr. Stair says, are exceedingly shy and timid, and, like the ground-pigeon, it roosts on bushes or stumps of trees, and feeds on the ground.

They also build their nests in such situations, and during the breeding season both parents aid in the duty of incubation, and relieve each other with great regularity; and so intent are they when sitting on the eggs as to be easily captured. It was in this way that the two living specimens were obtained for him. They are also captured by the natives with bird-lime, or shot with arrows, the sportsman concealing himself near an open space in which some quantity of the *soi*, their favourite food, has been placed."

"The power of wing of most of the pigeon tribe is very great, and it also obtains in this bird. It flies through the air with a loud noise, like our topknot pigeon (*Lopholimus antarcticus*), found in the Illawarra district, and many of our Australian pigeons. Mr. Stair describes it when in flight as making so great a noise with its wings that when heard at a distance it resembles the rumbling of distant thunder."

I have myself often mistaken it for this in the forest when travelling, and can quite understand the delusion. Tradition states that on one occasion a company of *atua* (warriors) were put to flight, on the march to the scene of action, through mistaking the noise of the distant rumbling caused by this bird on the wing for the rapid approach of a body of opposing troops. They broke, and fled in dismay; but their faint-heartedness was chronicled in sarcastic verse, and resounded long afterwards to their dismay and confusion, as their prowess was rehearsed. A canoe-song, which I have often heard sung, thus records it:—

Pa; lulu le manu, e,  
Sosola, Safata.

(With a thunder-crash the bird flies,  
And Safata runs away!)

Dr. Bennett alludes to the singular fact of the manu mea not having been observed by the early navigators, or, indeed, by later ones. Many causes may have contributed to this. In its wild state it was strictly a forest bird, very timid and shy, but apparently at one time very abundant, and taken for food in great numbers. From this peculiar shyness, however, the birds do not appear to have become pets with the natives, as is the case with many other pigeons and doves, both ground or otherwise. Many hundreds of these other birds were caught, and tamed and trained by the natives of Samoa, who were very fond of them, and spent much of their time with them.

Bougainville, who discovered the islands in 1768, says, "The islands where we touched were clothed to the summit with trees laden with fruit, on which wood-pigeons and green, rose, and different coloured turtle-doves reposed. The islanders amuse themselves in their

leisure hours by taming birds. Their houses were full of wood-pigeons, and they bartered them by hundreds." But it seems certain that no bird like the *manu mea* was offered for sale to any of those visitors, for we may be sure that a bird of so singular a form would not have escaped the notice of the naturalists attached to those expeditions.

I think the fact is clear that these birds were seldom tamed by the natives, from their timid and restless habits. Hunting them, however, was a very favourite sport with the natives, especially those who resided in the inland villages, and who thus had greater facilities for seeing them, and becoming familiar with their habits. Of late years, however, their numbers have decreased rapidly, since, added to human enemies, the wild-cats, which have increased rapidly, have destroyed vast numbers, and, there being no power to order the destruction of these pests, the complete extinction of the bird becomes simply a question of time.

As to its bearing in confinement, we have many interesting particulars given us by Dr. Bennett, who was an enthusiastic and careful observer. Speaking of the first bird brought by Mr. Williams to Sydney, Dr. Bennett says, "I examined the bird carefully, and found it in good health, but very timid, and a young bird, in immature plumage, with the teeth of the lower mandible not yet developed. It was the size of the Nicobar pigeon, but rounder and more plump in form. It kept steadily looking at me during the time I was examining it, uttering occasionally a plaintive 'Goo, goo, goo.'"

Referring to the same bird later on, Dr. Bennett says, "It has now attained the full plumage of the adult bird, and the teeth of the lower mandibles are fully developed. When any one approaches the cage it will sometimes retire to an obscure corner, but at other times will remain quiet on the perch, watching every movement of the spectator. It invariably feeds in the light, but will not do so if any one is present. The only opportunity we had of observing its mode of feeding was through the window, when the bird was placed in the verandah of the house. It usually kept on the low perch, but when disturbed would jump on the ground and run rapidly about, and then take refuge in the darkest part of the cage. The whole time that the bird was in my possession it never became domesticated, nor evinced the slightest attachment to the lady who daily fed it; it was the same to her as to a stranger, and I do not think the *Didunculus* a bird that will be easily domesticated, or reconciled to captivity. At that time the cleaning of the cage was attended with difficulty, from its violent fluttering on any one approaching for the purpose, in which it evinced no little power of wing."



Dr. Bennett's description of the bird last brought to Sydney, the older bird of the two, will give a good idea of its general appearance. He says, "I found it was a full-grown bird, in adult plumage, with the teeth of the lower mandibles well developed. The head, neck, and upper part of the back was of a greenish-black; the back, wings, tail, and tail-coverts of a chocolate-red. The legs and feet were of a bright scarlet. The mandibles are of a bright orange-red, shaded off near the top with very bright yellow. The cere around the eyes is also of a bright orange-red colour; the irides brownish-black."

Dr. Bennett cherished an idea which I fear is not likely to be carried out. He says, "For some length of time I have been endeavouring to procure this bird and naturalise it in New South Wales, considering that, from its inhabiting a very limited range, it might soon become extinct, similar to the dodo, *Dinornis*, and more recently the *Notornis* (*Notornis mantelli*) and Phillip Island parrot (*Nestor productus*); and unless some exertion is made to protect them the *Apteryx*, kakapo or night-parrot (*Strigops habroptilus*), and the singular *Neomorpha* ('huia' of the natives), all inhabiting New Zealand, will also perish."

This will, I fear, be very soon the case with the remarkable bird we have been considering, as also with the puna'e, or *Apteryx*, of Samoa, a smaller and apparently distinct species from that of New Zealand.

---

ART. XXXII.—On Rats, and their Nesting in Small Branches of Trees.

By TAYLOR WHITE.

[Read before the Hawke's Bay Philosophical Institute, 12th October, 1897.]

It is a singular fact that certain natural occurrences may remain unnoticed and without record for many years, and that after such lapse of time more than one person will almost simultaneously be attracted towards them by accident or otherwise, and take special notice of the self-same peculiarity. In this case, previous to my reading Mr. Kingsley's paper on the occurrence of rats nesting in low trees and bushes,\* I had also quite recently obtained evidence of the

---

\* "Note on Arboreal Nests of Bush-rat (*Mus maorium*)," by R. I. Kingsley, Trans. N.Z. Inst., xxvii., p. 238.

same habit, and this paper should have been prepared and placed before the members of our society during one of the meetings of last session, but owing to a pressure of other work the writing of this note was never accomplished, and this preliminary opening is for the purpose of enabling me to claim an original discovery, and not a following of Mr. Kingsley's original remarks on the same subject.

I have long known that rats, which I suppose are Norway rats (*Mus decumanus*), were in the habit of climbing up the many-stemmed and thickly-clustering heads of the kiekie, a many-headed plant which clings so pertinaciously to many of our forest-trees, and often ascends to a considerable height—not by turning around so much as by the hold it takes by short rootlets, which are given off at frequent intervals along its extended length, and by these root-fibres the plant firmly grasps the rough bark of its supporter. These stems make good ladders by which the rat can climb to his favourite cluster of kiekie heads, which, with their long ribbon-like leaves, form a good hiding-place and a dry thatched roof, and here our friend the rat can take his daily slumbers and become suitably refreshed and invigorated preparatory to his midnight rambles.

There is very little doubt that the forest rats occasionally make a kind of nest in the kiekie clumps, by drawing together the dry leaves of their shelter, and nests built in such a thicket of drooping leaves would be entirely concealed from the view or knowledge of any but the most persevering searchers after hidden treasures in the animal or vegetable kingdom. I only remember to have once seen a rat's nest in the kiekie stems, and in this instance the surroundings were different, for the forest had been felled, burnt, and sown in English grass, so that the clinging kiekie and the giant tree (left standing) which supported it had been long dead. The day previous to my passing that way had been a specially windy one, and the long and sinuous stems of kiekie had given way, and lay extended on the ground. I was attracted to the spot by noticing a roll of fibrous material among the stems, and, although in a great hurry at the time, I stopped to investigate it. The bunch of dry material proved to be a dome-roofed nest; but I never examined it very closely, for on my first touching it out sprang an animal of a yellow or cream colour, which had the size and appearance of a rat. This creature speedily hid itself in the long swamp-grass on the edges of a pool of water, and although I and my dogs made diligent search for it we were unsuccessful. Whether the animal was a rat or a weasel I cannot be positive, but its colour being of a much lighter shade than that of a weasel, whose colour I call a dull red, my conclusion was that it was a rat of an abnormal colour.

During the winter season previous to the present—that is, in the year 1895—when cutting down a small tree so that my Angora goats might eat the leaves, I saw among its branches a dark something, seemingly a short piece of the trunk or stem of the punga, or fern-tree. When looking more closely, it proved to be a nest of a most peculiar architecture, and a great novelty. The base or foundation was formed by a number of dry sticks, or, rather, thin twigs, having no leaves adherent to them. These were crossed, and roughly interlaced, and most probably had been placed and brought together by a bird, possibly a tui, or, as the people at the Zoological Society's gardens in London name it, the "poi bird," thereby following Captain Cook's very mistaken rendering of its Maori name. Upon this platform a rat had evidently raised a superstructure which was to serve him as a permanent home, or perhaps Mrs. Rat required a nursery for her children; but on this latter point we have no evidence. The back of the rat's nest was of moss, mixed with a few twigs, similar to those forming the platform, and no doubt were raised from the latter, and used as a stiffener, to give solidity to the back wall of the nest. The sides and front were of moss alone, and the entrance was not visible, but could be found by touch of the fingers. The covering material used for roofing-in the top gave to the structure a most singular appearance, and readily gave the idea that a parody of the human head had been manufactured. This most remarkable result was obtained by the introduction of an entirely different material for the roofing of the dome—namely, the hairy covering taken from the young fronds of the black punga. These being of a stiff hairlike texture, black and shining, made a very good but rough imitation of a crop of short-cut bristly hair. The interior of the nest was lined with the large, coarse, and serrated leaves of the so-called native currant, which would seem anything but a desirable lining. The small tree which held the nest, some 10 ft. from the ground, was growing in close proximity to a large rata-tree—the species that produces a mass of scarlet flowers at Christmas time. Into the top of this large tree extended the rope-like vines of a second species of rata, having small white flowers, which, although it reaches and competes for light and air with the tallest forest-trees, never attains to the dignity of a tree itself. This rata-vine is named in Maori "*akatea*," and is in Maori story sometimes the vehicle by whose assistance the spirits of the dead descend to the *reinga*, or place of abode after death. By the aid of this natural ladder my rat evidently climbed up to the nest, and by this road carried all the material for the building of the nest.

After finding No. 1 rat's nest I kept a sharp look-out for others, and in a few weeks' time discovered No. 2; but for the

succeeding twelve months I have been unable to find any others. This nest was in the upper branches of a young ribbon-wood tree, *alias* thousand-jacket or lace-bark, all of which names denote a remarkable characteristic of this small tree. Its inner bark is made up of a great number of separate wrappers, each of which is finer than writing-paper, and each wrapper is made up of fine fibres, held together by a glutinous tissue, and has the similitude of open lace-work. This lace-work, or easily-divided bark, is superior in design but somewhat after the same plan as that peculiar material known as bass matting, a European mercantile product exported from Russia, and greatly used by British gardeners in tying plants to a support. I think the lime- or linden-tree (*Tilia europæa*) supplies this material. This small ribbon-wood (*Hoheria betulina*) was supporting and thickly surrounded by a bush-lawyer (*Rubus australis*), and near by was growing a large toitoti (*Arundo conspicua*), having seed-stems with their straw-coloured feathery grass-heads. This nest was about 7 ft. from the ground, and the outer part was built of the flower-heads or culms of the toitoti grass (a grass almost identical with the pampas grass of South America). These yellow culms were massed together, to the size of a man's two hands when placed together, and were mainly held in place by the entangled runners of the bush-lawyer. The inside was lined with the coarse leaves of the native currant-bush, as was also No. 1 nest. The using of this coarse lining was remarkable, for the toitoti flowers would seem a warmer, softer, and more suitable substance than the thick, harsh, disconnected leaves.

These are the only two nests I have seen, and I am unable to say for certain what species of our rats is the architect, but suppose they were made by the black rat (*Mus rattus*). It still seems to be the general idea in the northern parts of New Zealand that the original native rat is the black animal resembling *Mus rattus* of Europe, whereas the true *Mus maorium* is a smaller-sized rat, very similar in colour to the Norway rat (*Mus decumanus*). I was greatly interested to notice in the publication of "New Arrivals at the Zoological Gardens, Regent's Park," mention made of the safe arrival of fifteen or more rats received from the Kermadec Islands, presented by Lady Glasgow, the wife of our present Governor. I have little doubt but that they will be found identical with our small grey-brown rat (*Mus maorium*). Sir Walter Buller informs me that he saw in the zoological department of the British Museum specimens of this New Zealand rat, which had been presented by Sir George Grey many years ago, and which up to the present have remained unnoticed.

Mention is made of the black rat by Mr. T. F. Cheeseman, of Auckland, in his interesting paper on New Zealand rats,

wherein he remarks that many persons consider the Maori rat extinct, but that "others, whose views are perhaps equally entitled to attention, believe that the small black rat still found in forest districts and on the outlying islands, and which occasionally makes incursions in considerable numbers into the settled portion of the country, is the true indigenous species."\*

In vol. xxvii., p. 238, of the Transactions Mr. R. I. Kingsley heads his paper "Arboreal Nests of Bush-rat (*Mus maorium*)," but I fail to see that he satisfactorily proves the identity of the nest-builder in his communication; in fact, from a newspaper cutting of later date it seems to me that he champions the black rat. A farmer residing in Aniseed Valley complains that a hitherto unnoticed species of rat of a black colour has commenced to climb his fruit-trees and eat the fruit suspended from the branches. The editor replies that Mr. Kingsley says this black rat is the original rat of New Zealand (*Mus maorium*). Therefore I maintain we have as yet no satisfactory proof as to whether *Mus rattus* or *Mus maorium* are the arboreal nest-builders, and I favour the idea that it will prove to be *Mus rattus*. One reason for assuming this is that the Maoris make no mention of this habit pertaining to their edible rat of long ago. Further, I am inclined to suppose that this nesting in the small branches of trees and shrubs is a newly-acquired instinct, possibly developed to aid the black rat (?) in the struggle for existence against his stronger and cannibal neighbour *Mus decumanus*. If so, it is very remarkable that instances of this new habit should appear simultaneously, and be recorded for the first time in two places so far apart, and with Cook Strait intervening.

To show how prevalent the black rat is in the North Island I will give a few extracts from letters received:—

Under date the 27th June, 1895, Captain Thomas Good, of Oeo, Taranaki, writes, "The native black, or tree-climbing, rat is not uncommon. It is different both in size and colour to the Norwegian rat, the latter being dingy-brown, and the former black, inclining to slate underneath."

Mr. H. C. Field, of Wanganui, writes on the 16th May, 1895, "As regards the rats, it is the black kind which the Maoris of this part always told me was the 'kiore Maori,' and the brown Norway one is called the 'kiore pakeha.' They eat the former greedily, because it is exclusively a vegetable feeder, while they reject the latter on the ground that it will eat excrement. I was present when Buller exhibited the small brown or fawn-coloured rat from the Pacific Islands and said it was the true 'kiore Maori,' and I was

---

\* Trans. N.Z. Inst., vol. xxvi., p. 219.

surprised at the assertion, both because I had never seen such a rat, and because our Maoris had always identified the black one as the rodent in question. I made inquiry lately at the principal grain-stores in town as regards the rats, of which they catch a good many, and find that the only animals of the *Mus* tribe which trouble them are the brown Norway rat and the common mouse, though the black fellows are far from uncommon in the gardens and orchards around the town. I often, too, see dead rats, which have been killed either in the streets or thrown there after death, but they are all brown ones. I do not at all believe that the black rat is driving out the brown one, but should say the opposite was the case, as the brown fellow is carnivorous, while the other seems exclusively a vegetable feeder. In England, too, the brown rat drives out the black one."

A further communication, dated the 26th June, 1895, says, "'Kiore' is not an unusual part of Maori names [*i.e.*, personal and local.—T. W.] I do not think the Maoris ever caught rats in pits as traps, the native *tawhiti* being arranged on the same principle as an English mole-trap, and wonderfully effective; but it is by no means unlikely that the rodents were often caught in the kumara-pits, which were beehive-shaped excavations in dry ground, usually on top of ridges, and had only a square opening at the top, just large enough to enable a person to descend into them. If a rat got into one to eat the kumaras he would find it hard to get out, particularly as the pits were usually lined with *weki*, the fibrous lower part of a fern-tree stem, which rats seem greatly to object to gnawing. It was also used to line potato-pits."

Mr. J. R. Annabell writes me as follows: "I cleared the bush off a hill near the junction of the Ketaruki and Wanganui Rivers, and found four or five pits about 4 ft. to 5 ft. deep, with overhanging sides. The natives told me they were dug many years ago to catch rats. I found the remains of several kiwi (*Apteryx*) in them, which skeletons I have since set up."

Wishing to find out if the black rat (*Mus rattus*) occasionally comes to this country in the shipping, I sent circular letters to several of our leading merchants who have their storage buildings near the shipping at Port Ahuriri. Messrs. Williams and Kettle have sent me word that a black rat, having a longer tail than usual, has been caught on their premises, and placed in spirits. It will be deposited in our Museum at Napier. Some eighteen years ago I picked up a dead specimen of *Mus rattus* at the front entrance to Messrs. Murray, Roberts, and Co.'s store at the same place. These two instances are fair evidence that this rat will be found arriving in the shipping. It is notable that *Mus rattus* is never found occupying buildings or corn stacks, but keeps to

the forest and open country. Can the small *Mus maorium* also be an emigrant at this date, or would the more powerful and savage *Mus decumanus* destroy them on the voyage?

Particulars of a rat's nest in a *C. macrocarpa* tree, which is mentioned in the *Hawke's Bay Herald*, where two black rats were killed by the employés of Mr. Goddard, of Havelock North, have not yet come to hand.

---

ART. XXXIII.—Notes on Patellidæ, with reference to Species found on the Rocks at Island and Lyall's Bays.

By W. T. L. TRAVERS, F.L.S.

[Read before the Wellington Philosophical Society, 13th October, 1897.]

I HAVE placed upon the table this evening some specimens of the *Patellidæ* obtained from the rocks and pools of Island and Lyall's Bays, several of which, as you will see, are of great beauty; and I also exhibit a couple of specimens of a species found at the Kermadecs, as an example of the remarkable increase in size which animals of this genus attain in warmer seas. It is at once apparent to observers that the shells of all the animals belonging to this family differ materially from those of any other of the shelled Mollusca, inasmuch as they are destitute of any special aperture, and show no trace of a spire. Each consists of one piece only, the ordinary form being that of a widened cone, varying in height in the several species, and having the apex more or less distant from the true centre. The animal which occupies each of these shells is large in proportion to the dimensions of its shell,—is furnished with a fleshy mantle, under the projecting edges of which the respiratory organs are placed,—and possesses tentacles carrying eyes on the undersides of their bases.

But its most remarkable organ is the tongue, which, in the great majority of the species, consists of a flattish and extremely narrow ribbon-like body varying from 3 in. to even 10 in. in length, soft and vascular and somewhat dilated at the tip, the whole length, except the tip, being armed with three practically parallel rows of spinous teeth, pointing backwards. Each of the teeth of the middle row is cut into four points, and those of the outer rows,—which are not absolutely opposite to those of the middle row,—into two points only: the width of the surface on which the three rows are placed does not exceed  $\frac{1}{12}$  in. These teeth are used for rasping down during their passage into the gullet the minute seaweeds on which the

animal feeds. Mr. Patterson, who first observed the tongue of the limpet, mistook it for some strange species of worm, but on examining several animals the supposed worm was found in all, and great was his astonishment when he discovered that what he saw was in reality the tongue of the animal, and not a mere intruder into the privacy of its conical abode. So long as the animal is not feeding the tongue is rolled into a spiral like a spring, but when used for feeding it is thrust out from side to side until it has become charged with food, and is then withdrawn into the stomach, unloaded, and again put forth. This class of tongue, however, except as regards its remarkable length, is common to all the phytophagous gasteropods, and is thus alluded to by Johnson in his "Introduction to Conchology": "When a phytophagous gasteropod is about to eat it thrusts forward a spinous tongue, protruding at the same time the lip on each side, by which the tip of the tongue is compressed and forced into the form of the bowl of a spoon. The food is then taken hold of by the lips, and, being pressed by the tongue against the upper horny jaw, a portion is bitten off, and this is passed along the tongue by a peristaltic motion of that organ, and by the retropulsive action of the adjacent muscles, until, torn and rasped by the sharp teeth, it is made to enter the gullet. At the entrance of this canal there is a uvular caruncle, which is supposed to be the seat of the animal's taste, and on its side a pair of lobulated salivary glands, or sometimes two pairs, which convey a secretion into its upper part to lubricate and soften the mass. The gullet is a muscular canal, lined interiorly with a mucous coat, presenting the same structure as the whole alimentary canal and is generally plaited in a longitudinal direction." I do not know that any of the New Zealand species have been dissected, or that any detailed observations of their habits of feeding have been made, and as I have not had time myself to make any such observations I must leave it to others to determine to what extent the foregoing general remarks apply to our indigenous species.

The family *Patellidæ* consists of three sub-families, the species of which are very numerous and widely distributed, though I believe none exist in the Arctic seas, and we may therefore assume that none will be found in the Antarctic zone. As already mentioned, the largest species are usually found in the warmer seas, the example which I show from the Kermadecs illustrating this rule. Each of the sub-families is specially liable to variation in the form, colour, and surface of the shell, and these characters therefore must not be implicitly relied upon in the determination of species. Several of these animals possess the means of wearing the surface of the rocks to which they adhere into pits coincident in form



with the edges of their shells, each of these pits constituting the permanent abode of one individual, to which it regularly returns after its excursions in search of food; but I suspect that in the case of those which possess this habit it is only acted upon when the animal has attained its full growth. The pits referred to are said by Mr. Gosse to be excavated by means of sharp crystals of silica embedded in the substance of the under-surface of the animal's foot. I am informed by my son that the Kermadec limpet usually occupies slight elevations, the surrounding rocks being worn away by the action of the waves.

In the case of the large species which I now exhibit this habit certainly cannot prevail, for, contrary to the usual rule as regards the *Patellidæ*, its shell is insufficient in size to hold the entire animal, the mantle at all times protruding beyond its edge, and remaining fully exposed, whilst it also possesses in only a feeble degree the power of adhering to the rock. It is evidently a rare species too, for I have only found four specimens during the last year and a half.

The common limpet of the English coast affords a special example of the habit of using a fixed abode, the full-grown animal at all events invariably occupying an oval pit corresponding exactly in shape and dimensions with its shell. This habit was first noticed by Mr. Jukis, a native of Guernsey, who tested it by marking individuals to avoid mistake, and then noticing their roaming from and regular return to their places of rest, where the shell in each case was found exactly to correspond with the surface of the rock to which it was attached. "There," he says, "it will rest or sleep, and only relax its strong adhesion when the muscular fibre becomes exhausted by long contraction, in which state a sudden blow given horizontally will easily displace it."

Collectors well know the force with which the limpet adheres to the rock, especially when it becomes aware of an attack, and has had time to put forth its muscular strength. Réaumur found that a weight of from 28 lb. to 30 lb. was required to overcome the force with which this adhesion took place in some cases, which he attributed wholly to the exercise of muscular energy; but Dr. Johnson, in dealing with this point in his "Introduction to Conchology," mentions that if the finger be applied to the foot of a detached animal, or to the spot on which it rested, it will be held there by a very sensible resistance although no adhesive matter is perceptible, but that if the spot be moistened with water no further adhesion will occur on the application of the finger,—the adhesive matter having as he supposed been removed, the sea-water being apparently the solvent by which the animal's connection with the rock is loosened at its own will."

Careful observations on these points in regard to our own species will be of special interest, and would not be difficult if conducted by means of a well-established aquarium, the materials for which are obtainable from the localities referred to.

In this other species which I now exhibit you will see a remarkable instance of another habit of these animals—namely, that of adapting the rim of its shell to the shape and irregularities of the substance to which it adheres. Looking at the bizarre shapes of the shells before you it is difficult to suppose that the animals had the ordinary regular form possessed by such as inhabit strictly symmetrical shells; but as a fact the inhabitant of each of those now shown was quite as regular in form as those which occupied the perfect ovals of the other specimens, as you will see on looking at the dried specimens now shown. I am inclined to doubt whether this particular species ever leaves its special site, and to think either that it depends for its food on the numerous minute vegetable organisms which are brought within its reach by the tidal water, or that it finds sufficient pasture at all times within reach of its tongue. I have found that nearly all the species I exhibit form, as it were, separate colonies, and are not generally intermixed on any particular rock; but, even if this observation should be corroborated, I am not prepared to suggest any particular reason to account for the fact.

In Europe the common limpet constitutes an article of food, especially amongst the lower classes who live in the neighbourhood of the sea-coast, many tons of them being so used daily in some localities; and, although the edible portion is coarse, hard, and unsavoury, its use has often been the means of escape from the horrors of famine.\* It is largely employed as bait for sea-fishing, but is inferior even for this purpose to many other species of the Mollusca.

To the student of natural history the varied forms of this family will be found to be full of interest, and will afford abundant scope for the exercise of intelligent observation; and I venture to express a hope that some of our young naturalists will endeavour to settle many points which are still moot in regard to their life-history and habits. They will find ample means for doing this in the localities from which I made my own collections.

---

\* It is interesting to note that the animal of the limpet was used for food by primitive man, for the shells occur in large quantities in their ancient cooking-places; whilst necklaces formed from the shells are also found in the most ancient cromlechs or subterranean burying-places.

ART. XXXIV.—*Notes on New Zealand Sponges: Fourth Paper.*

By H. B. KIRK, M.A.

[*Read before the Wellington Philosophical Society, 16th February, 1898.*]

Plates XXXI. and XXXII.

## CLASS CALCAREA.

## Order HETEROCÆLA, Poléjaeff.

Family I. LEUCASCIDÆ, Dendy. (See "Synopsis of the Australian Calcarea Heterocœla," published by Royal Society of Victoria, 1892.)

Genus *Leucascus*, Dendy.*Leucascus simplex*, Dendy, *loc. cit.*

This interesting sponge occurs between the tide-marks in Cook Strait. It is readily distinguishable from the Ascons, in company with which it is often found, by the comparatively smooth non-reticulated surface. Dr. Dendy says, "All the spicules are alike, except that some exhibit an incipient apical ray." I have found quadriradiate spicules constantly present, the apical rays being thin and thorn-like, 0·07 mm. long and about 0·003 mm. thick, curved slightly, and protruding generally into the flagellated chambers, although occasionally they protrude into the larger exhalant canals.

Family II. SYCETTIDÆ, Dendy, *loc. cit.*Genus *Sycon*.

Radial chambers not intercommunicating. Articulate tubar skeleton. The distal end of the chambers provided each with a tuft of oxete spicules.

*Sycon pedicellatum*, n. sp. Plate XXXI., figs. Ia., Ib., and Plate XXXII., fig. I.

Sponge tubular, narrowly pyriform in shape, carried on a hollow pedicel, which is connected with a branching stolon, from which three to a dozen sponges may spring. Height of sponge and pedicel from 5 cm. to 8 cm.; greatest breadth of sponge, 1 cm. to 1·5 cm. Oscule provided with an inconspicuous fringe of oxea.

*Spicules* :—

Oxea : (a.) Oxea of the peristome : These are very slender, and are slightly curved. Length, 1·7 mm.; breadth, 0·005 mm. (b.) Large oxea of the parenchyma : These resemble the oxea of the peristome, except in size. They are comparatively

large, 0.36 mm.  $\times$  0.01 mm. They enter sparingly into the wall of the radial tubes. They often reach from the gastral wall, and they project from the outer surface of the sponge, entering, in their distal portion, into the composition of the dermal cones. They taper evenly to a sharp point at either end. (c.) Oxea of the dermal cones: These are slender spicules, twisted after the fashion of many "mortar spicules." Size, 0.12 mm.  $\times$  0.003 mm. (d.) Oxea of stolon: These are straight or slightly curved, and sharp-pointed. They echinate the surface freely.

Triradiate spicules: These are all sagittal. They may or may not be slightly irregular. (a.) Subgastral: Paired rays short and slightly curved towards the basal ray, 0.03 mm.; basal ray, 0.17 mm.  $\times$  0.008 mm. The paired rays are almost at right angles to the basal ray. (b.) Parenchymal: Paired rays sometimes nearly as long as basal ray, making an angle of about 120° with it. These spicules also enter into the composition of the distal cones. (c.) Triradiates of stolon, like the gastral triradiates, but often having the tips of the paired rays strongly recurved.

Quadriradiates: These occur in the gastral cortex and in the stolon. They are all sagittal. The angle made by the paired rays with the basal ray may be from 90° to about 145°. Basal ray, 0.14 mm.; oral ray, 0.13 mm.; apical ray, 0.1 mm. Greatest breadth, 0.005 mm.

All the spicules of this sponge are very graceful and slender. The flagellated chambers are hexagonal in section, and the intercanals triangular.

In spiculation this sponge resembles *Sycon carteri*, Dendy, from which, however, it differs in the more slender character of all its spicules, in the shape and size of the oxea of the distal cones, and in the presence of the parenchymal oxea. To a less extent it resembles Haeckel's *Sycandra ampulla*, from which, however, it is quite distinct. Colour, brownish-white.

Locality: Whangaruru and adjacent coast of North Auckland, between the tide-marks.

NOTE.—Since this description was in type I have found the sponge in a much finer form at Plimmerton, in Cook Strait.

**Sycon ornatum**, n. sp. Plate XXXI., figs. IIa., IIb., and Plate XXXII., fig. II.

Sponge solitary, tubular, generally broader near the base than above; about 15 cm. in height, from a quarter to half of the height being made by a narrow spicular funnel, provided at its mouth with a delicate peristome and, occasionally, with a thin spicular veil. To the naked eye the body of the sponge is hispid in appearance, from the oxea of the distal cones. This appearance is not noticeable in the funnel, although the funnel

is provided with fine oxea. The radial tubes are hexagonal in section, the intercanals quadrangular.

*Spicules* :—

Oxea of the peristome : Long, slender, slightly curved, very finely pointed at each end ; 0·64 mm.  $\times$  0·005 mm.

Oxea of the distal cones : These are of three kinds—a long spicule, 0·72 mm.  $\times$  0·018 mm. ; a shorter one much more numerous than the first, 0·25 mm.  $\times$  0·01 mm. ; and a very slender spicule, 0·25 mm.  $\times$  0·003 mm. The spicules of all three kinds are straight, or nearly so. The oxea that are scattered over the surface of the funnel are mainly of the two latter kinds.

Triradiates of the parenchyma : These are sagittal, the oral rays making an angle of about  $110^\circ$  with the basal ray. Length of basal ray, 0·1 mm. to 0·14 mm. ; of oral rays, 0·06 mm. to 0·1 mm. Oral rays slightly curved towards each other, or straight. Thickness, 0·01 mm. Spicules of similar shape, but about twice as large, and with the oral rays straight or slightly curved towards the basal rays, are found in the funnel.

Subgastral triradiates : Sagittal, oral rays slightly curved towards the basal ray, which is about 0·16 mm. long. Occasionally a fourth ray is developed.

Gastral quadriradiates : Basal ray, 0·16 mm.  $\times$  0·015 mm. ; oral rays, 0·1 mm.  $\times$  0·01 mm. ; apical ray, 0·07 mm.  $\times$  0·015 mm. This ray is slightly blunt, furnishing the only instance of any but a sharp-pointed ray in this sponge. It is directed upwards, at an angle of about  $130^\circ$  with the basal ray, and is only very slightly curved. Similar spicules, but about twice as large, are found in the funnel.

Locality : Cook Strait, between tide-marks.

#### EXPLANATION OF PLATES XXXI. AND XXXII.

##### PLATE XXXI.

- Ia. *Sycon pedicellatum*, enlarged.  
 Ib. " section showing arrangement of skeleton.  
 IIa. *Sycon ornatum*, natural size.  
 IIb. " section showing arrangement of skeleton.

##### PLATE XXXII.

##### I. Spicules of *Sycon pedicellatum*.

- a. Oxeote of parenchyma.  
 b. " peristome.  
 c. Small oxeote of distal cones.  
 d, d, d, d. Parenchymal triradiate spicules.  
 e, e, e. Subgastral triradiate spicules.  
 f. Rare subgastral spicule with incipient fourth ray.  
 g. Triradiate spicule from stolon.  
 h, h, h. Gastral quadriradiate spicules ; a. r., apical ray.  
 i, i. Quadriradiate spicules from pedicel.

## PLATE XXXII.—continued.

II. Spicules of *Sycon ornatum*.

- a. Large oxeote of distal cones.
- b. Oxeote of peristome.
- c, c. Ordinary oxea of distal cones.
- d, d. Slender oxea of distal cones.
- e, e, e. Parenchymal triradiate spicules.
- f, f. Subgastral triradiate spicules.
- g. Subgastral spicule with incipient fourth ray.
- h. Triradiate spicule from funnel.
- i, i. Gastral quadriradiate spicules.
- k, k. Quadriradiate spicules from base of funnel.

## ART. XXXV.—On the Sponges described in Dieffenbach's "New Zealand."

By ARTHUR DENDY, D.Sc., Professor of Biology in the Canterbury College, University of New Zealand.

[Read before the Philosophical Institute of Canterbury, 3rd November, 1897.]

## Plates XXXIII. and XXXIV.

Some years ago my friend Mr. H. B. Kirk, M.A., called my attention to the fact that certain sponges had been described by Gray in Dieffenbach's "Travels in New Zealand," published in 1843. The descriptions of that period being quite insufficient for purposes of identification, and it being a matter of some interest to know what these sponges really were, I applied to my friend Mr. R. Kirkpatrick, in charge of the sponges at the British Museum, for further light on the subject. Mr. Kirkpatrick most kindly instituted a search for the original types, and fortunately succeeded in finding them. I desire to express my deep sense of gratitude to Mr. Kirkpatrick for his trouble, and also to the keeper of the Zoological Department for his kindness in permitting the specimens to be forwarded to me here in New Zealand. Thus after a lapse of more than half a century the actual specimens collected by Dr. Sinclair in the early days of the settlement of the colony have again found their way to New Zealand, and it is possible to redescribe them in the light of modern knowledge. Whether or not the specimens sent are only portions of the originals I do not know, but at any rate they are quite sufficient to make a specific description easy. They will be deposited in the Canterbury Museum, Christchurch, where

they were photographed for the purposes of this paper by Mr. W. Sparkes. All the specimens had been dried.

**Axinella sinclairi**, Gray, sp.

1843: *Spongia sinclairi*, Gray, Dieffenbach's "Travels in New Zealand," vol. ii., p. 295.

The original description runs as follows:—

SPONGIA SINCLAIRI, Gray.

Inhabits New Zealand. Dr. A. Sinclair.

Branchy; branches cylindrical, forked; apices conical, yellow; surface with branched subcylindrical grooves, in certain spots; ostioles small, numerous.

Var. 1. Branches elongate, cylindrical, free.

Var. 2. Branches short, repeatedly forked, apices often anastomosing.

I have received two specimens of this species from the British Museum, marked in Plate XXXIV. as F and G.

F is labelled "*Spongia sinclairii*, Gray, var. 1. Type. New Zealand: Dr. Sinclair," and there is no reason to doubt the correctness of this label. The specimen (*vide* Plate XXXIV.) consists of three rather slender subcylindrical branches of a pale-yellow colour, each about 65 mm. in length and 5 mm. in diameter. The branching is apparently dichotomous. The surface is minutely hispid, and is marked by irregularly stellately-arranged grooves, doubtless representing convergent exhalant canals. (These are not well shown in the figure, as they are visible chiefly on the other side of the specimen.) Texture rather hard, with friable surface and strong axial condensation. The skeleton is typically axinellid, consisting of a very dense axial portion extending over nearly one-third of the diameter of the branch, with irregular subplumose columns springing from the axial portion and curving outwards and upwards to the surface, where they terminate in irregular close-set tufts. Both in the axial and peripheral portions of the skeleton numerous spicules cross the principal lines in all directions, rendering the whole indefinite. There is no conspicuous horny matter. The spicules are of three chief forms, but, as usual in the genus, they are very variable: (1.) Smooth oxea, usually gradually sharp-pointed and more or less curved; size, say, about 0.3 mm. by 0.0125 mm., but very variable. (2.) Smooth styli, similar to the foregoing, but broadly rounded at one end and less abundant. (3.) Very long, smooth, sinuous spicules (strongyla), with both ends broadly rounded off but often unequal. Owing to their great length, it is difficult to see both ends of any given spicule *in situ*, one being generally either broken off or concealed by adjacent spicules in the sections. They occur abundantly, mixed with the other spicules and lying in various directions, in the axial portion of the sponge.

and are two or three times as long and proportionately very much more slender than the average oxea. Preparations boiled out in hydrochloric acid show these sinuous strongyla so numerous and of such length as to be extremely characteristic, measuring up to about 0·8 mm. by 0·008 mm.

G is labelled "*Spongia sinclairii*, Gray, var. 2. Type. New Zealand: Dr. Sinclair," and here again there is no reason to doubt the correctness of the label. The specimen (*vide* Plate XXXIV.) consists of short branches forking in a very regular dichotomous manner, slightly stouter than in var. 1 and occasionally anastomosing. In other respects, including the skeleton, it agrees so closely with var. 1 as to require no further description.

#### *Chalina ramosa*, Gray, sp.

1843: *Spongia ramosa*, Gray, Dieffenbach's "Travels in New Zealand," vol. ii., p. 295. 1887: *Ceraochalina levis*, Lendenfeld, "Die Chalineen des Australischen Gebietes," Zool. Jahrbuch, vol. ii., p. 782, pl. xix., fig. 19.

The original description runs as follows:—

#### SPONGIA RAMOSA, Gray.

Inhabits New Zealand. *Dr. Sinclair.*

Pale-brown, soft, spongy, branchy; branches elongate, subcylindrical, of a very fine uniform texture, with a few small scattered ostioles in a line on each side; fibres horny, very thin.

Var. 1. Branches moderately elongate, sometimes anastomosing.

Var. 2. Branches very long, free.

I have received four specimens nominally belonging to this species from the British Museum, marked in Plate XXXIII. as A, B, C, and D.

A is labelled "*Spongia ramosa*, Gray, var. 1. Type. New Zealand: Dr. Sinclair." It is evidently really var. 2. It consists of three long slender branches and one much shorter. The total length of the specimen is 265 mm., and the width of the somewhat compressed branches is about 8 mm. in the widest parts. The vents are minute but numerous, arranged in single series along the margins. The surface is smooth, but finely granular. The colour is pale-brown and the texture now decidedly hard. The main skeleton towards the surface is a pretty close subrectangularly-meshed network of stout horny fibre of a pale-yellow colour. The primary lines contain a narrow multispicular core, the secondaries a sparse single series of similar spicules. The primary and secondary fibres are both of about the same thickness, averaging about 0·075 mm. in diameter, while the meshes measure about 0·28 mm. across. Passing inwards the meshes become wider and very loose and irregular, while the fibres are many of them slenderer and with fewer spicules. The dermal skeleton



is a close polygonal-meshed network of rather slender horny fibres containing spicules for the most part scattered uniserially in the axis of the fibre, occasionally projecting in small irregular tufts; the meshes of the network are about 0.1 mm. in diameter, the fibres varying under 0.055 mm. The spicules are short but rather stout, hastately-pointed or spindle-shaped oxea, with very conspicuous axial canals—size about 0.04 mm. by 0.005 mm.—occurring sparsely in the fibres and forming a very inconspicuous part of the skeleton in comparison with the spongin.

B is labelled "*Spongia ramosa*, Gray, var. 2. Type. New Zealand: Dr. Sinclair: 42, 12, 2, 122." It is evidently really var. 1, as shown by the shorter branches anastomosing in one place. The vents are fewer, but arranged similarly, and there are no external differences worth mentioning. The skeleton also is practically identical with that of A, though better preserved, and therefore less irregular in the interior of the section examined, with the spicules a trifle smaller, and with much less conspicuous axial canals.

C is labelled "*Spongia ramosa*, Gray, var. 2. Type. New Zealand: Dr. Sinclair." It is identical in structure with the preceding, though a little softer in texture.

D is also labelled "*Spongia ramosa*, Gray, var. 2. Type. New Zealand: Dr. Sinclair," but it is doubtful whether it really belongs to the same species as the preceding. The branching is more bushy, and the branches more slender and nodose, while the oxea are fewer, slightly longer, and much slenderer, measuring about 0.05 mm. by 0.0021 mm. It is, at any rate, a closely-related *Chalina*.

### *Spongelia varia*, Gray, sp.

1843: *Spongia varia*, Gray, Dieffenbach's "Travels in New Zealand," vol. ii., p. 295.

The original description runs as follows:—

#### SPONGIA VARIA, Gray.

Inhabits New Zealand. Dr. Sinclair.

Pale-brown, soft, flexible, branchy; branches elongate, subcylindrical, soft, of a fine texture, with large scattered ostioles; tips of the branches subclavate, sometimes united to one another.

Like the former,\* but of a larger size, rather looser texture, and with larger ostioles.

I have received one specimen of this species from the British Museum, marked on Plate XXXIV. as E, and labelled "*Spongia varia*, Gray. Type. New Zealand: Dr. Sinclair," with the number "180" on a smaller label. It is an irregularly-branched sponge (*vide* Plate XXXIV.), and the

\* i.e., "*Spongia ramosa*."

branches are now much compressed; but this is evidently in part, though not entirely, due to artificial pressure. The branches are about 85 mm. long and vary much in breadth.

The vents are fairly numerous and irregularly scattered, each about 1 mm., or a little more, in diameter. The texture is tough and resilient, fibrous; the colour light-brown; the surface even but minutely conulose and reticulate from the exposed fibre, only the skeleton remaining. The skeleton is a fairly close-meshed irregular network of very pale-coloured horny fibre. The primary fibres, running more or less parallel with one another towards the surface, are about 0.1 mm. thick and, say, 0.2 mm. distant from one another; they have an uneven outline, and are filled with small particles of sand or mud. They are connected by an irregular network of much slenderer secondary fibres, free from foreign matter, and about 0.03 mm. in diameter.

---

DESCRIPTION OF PLATES XXXIII. AND XXXIV.

PLATE XXXIII.

- Fig. A. *Chalina ramosa* (*Spongia ramosa*, Gray)  $\times \frac{11}{15}$ .  
 Fig. B. *Chalina ramosa* (*Spongia ramosa*, Gray)  $\times \frac{11}{15}$ .  
 Fig. C. *Chalina ramosa* (*Spongia ramosa*, Gray)  $\times \frac{11}{15}$ .  
 Fig. D. (?) *Chalina ramosa* (*Spongia ramosa*, Gray)  $\times \frac{11}{15}$ .

PLATE XXXIV.

- Fig. E. *Spongelia varia* (*Spongia varia*, Gray)  $\times \frac{7}{8}$ .  
 Fig. F. *Azinella sinclairi* (*Spongia sinclairi*, Gray)  $\times \frac{7}{8}$ .  
 Fig. G. *Azinella sinclairi* (*Spongia sinclairi*, Gray)  $\times \frac{7}{8}$ .

---

ART. XXXVI.—Notes on a Remarkable Collection of Marine Animals lately found on the New Brighton Beach, near Christchurch, New Zealand.

By ARTHUR DENDY, D.Sc., Professor of Biology in the Canterbury College, University of New Zealand.

[Read before the Philosophical Institute of Canterbury, 1st September, 1897.]

THE New Brighton Beach does not usually afford a very rich harvest to the collector of marine animals. Formed by a gently-sloping expanse of sand, rising inland into low dunes, it is entirely devoid of those rock-pools which, on other parts of the coast, afford such a happy hunting-ground to the naturalist.

The littoral fauna of New Brighton consists of animals which for the most part live buried in the sand, such, for example, as the well-known pipi (*Mesodesma spissa*), which forms enormous beds in certain parts of the beach, recognised by the innumerable small holes in the sand, through which, when the beds are covered by the advancing tide, the bivalves protrude their long extensile siphons, in order to take the sea-water into the mantle-chamber for respiratory and nutritive purposes. Nearer the sea, just about low-water mark, lives that remarkable sea-urchin *Arachnoides placenta*, whose delicate flat shell, though common enough, is so rarely found entire among the *débris* thrown up at high-water mark; and it is to this same zone that we must probably assign the common but handsome bivalves *Dosinia australis* and *Mactra æquilatera*.

Further out again, and probably at a depth of several fathoms, there must be a great sandbank inhabited by a very rich animal population. As a rule this bank appears to be undisturbed by tides and currents, and its inhabitants are rarely seen thrown up on the shore. Occasionally, however, dead valves of *Glycymeris (Panopea)* and *Zenatia* are met with on the beach, and one or two specimens of the pink scaly Holothurian, lately described by me under the name *Colochirus ocnoides*, have also been found from time to time. In July, 1896, also, immense numbers of young specimens of the even more strange-looking Holothurian long since named by Captain Hutton *Caudina coriacea* were met with on the beach, but they were all young, and probably came from a bank in shallower water than that frequented by the adults.

A few days ago, on the 24th August, I was informed by Mr. Sinclair that a large quantity of shellfish had been thrown up on the New Brighton Beach, and my curiosity was keenly aroused by the sight of fresh specimens of *Glycymeris (Panopea)* and *Zenatia*, with the animal in a perfect state of preservation, which he kindly brought for my inspection. I immediately went down to New Brighton, and was rewarded by a sight which was truly astonishing. About half a mile south of the pier, between tide-marks, lay an immense bank of shellfish, intermingled with other animals. I believe I am not exaggerating when I say that there were many tons of animals there. So numerous were they that even the voracious gulls, which usually destroy everything almost as soon as it is thrown up on the beach, had been able to make very little impression upon the great mass of animal food thus unexpectedly provided for them. I am told that a similar bank of shellfish was lying nearer the Heathcote estuary, but I had no time to visit this. Of course, there were also quantities of the animals scattered along the shore.

The bank which I visited was made up principally of *Zenatia acinaces* (= *deshayesi*), a bivalve hitherto considered rare, at any rate on this part of the coast. It evidently lives buried in the sand, and it has a long single siphon containing the united exhalant and inhalant tubes, and a well-developed foot of a beautiful pink colour, which is doubtless used for boring its way into the sand. Much less common, but still abundant, was *Vanganella taylori*, also in a living condition, a large bivalve of a genus peculiar to New Zealand, of which the animal has been almost, if not quite, unknown. It also has a well-developed foot, but of a white colour, and a well-developed siphon containing the united exhalant and inhalant tubes. A much more remarkable bivalve is *Glycymeris* (*Panopea*) *zealandica*, with an enormous siphon, which must be fully 8 in. or 9 in. long in the extended condition, and an aborted foot, which can probably be protruded through a small aperture left between the soldered mantle-lobes in front, and may still be used as a boring-organ. It must have required a powerful disturbance of the sea to dig out and cast on shore this animal, buried probably to a depth of about 1 ft. in the sand. It was not nearly as common as *Zenatia*, but many specimens were found.

The most beautiful of the shellfish was the delicate unequal-valved form generally known under the name of *Anatina angasi*, a species which I believe has hitherto rarely been found so far south, but which was thrown up in large numbers on this occasion. These living specimens showed that the animal possesses separate inhalant and exhalant siphons, a fact which Mr. Suter tells me will probably necessitate the removal of the species from the genus *Anatina* altogether. The other bivalves met with in the fresh condition were *Tellina alba*, *Mactra discors*, *Dosinia australis*, *Venus yatei*, and *Solenomya parkinsoni*, the last named, which is extremely rare, being remarkable for its peculiar sucker-like foot. *Lucina dentata* was brought to me with the animal in a few days later, and I believe a good many specimens were found.

Mr. J. B. Mayne also obtained a fine living specimen of *Pinna zealandica* a few days afterwards from the same beach. It is probable, however, that the *Pinna*, which is not infrequently met with on the beach, came from a different locality from the majority of the Lamellibranchs mentioned; it is found incrustated with seaweed and Polyzoa, and probably comes from some muddy shore in the neighbourhood of Lyttelton Harbour.

In addition to the lamellibranchiate molluscs, which constituted by far the greater part of the spoil, I must mention the following animals found amongst them: *Pinnotheres*

*pisum*, a small crab which I have found living as a commensal in *Mytilus latus*, *Vanganelia taylori*, and *Pinna zealandica*, and which Mr. Suter tells me also occurs in *Mactra discors* and *Mactra equilatera*, was very abundant.

The remarkable Holothurian *Caudina coriacea* was found in enormous numbers, and the specimens were nearly all adult, while on a previous occasion, as already mentioned, large numbers of young specimens were thrown up, and no adults. The American *Caudina arenata* is known to bury itself in the sand with only the tip of the tail projecting, and doubtless the same is true of our species, so that only a considerable disturbance of the sea-bed could cause it to be thrown on shore in such quantities.

*Colochirus ocnoides*, a curious scaly Holothurian, resembling a pink worm, which I have lately described for the first time in the "Proceedings of the Linnean Society of London," and which has hitherto been known only from a very few specimens, was found in thousands. Probably I should be correct in saying that there were millions of this animal lying on the beach; they lay in heaps, and might have been collected with a shovel.

*Echinocardium australe*, a widely-distributed heart-urchin, rarely found at New Brighton, was represented by a few dead specimens.

I reserve for the end the most interesting find of all, a very large Gephyrean worm, a new species of *Echiurus*, which I propose to describe under the name *Echiurus nova-zealandicæ*. Of this I was fortunate enough to find three specimens in the short space of time at my disposal, and Mr. Alfred Cockayne, who afterwards kindly searched for it at my request, found four more, three of which are now in the possession of the Canterbury Museum. This animal in life resembles an elongated cylindrical bag or bolster. It may be more than 8 in. long, with a thickness in the middle of about 1 in. when extended. When contracted it looks like a short thick sausage, becoming loose and baggy when badly preserved. The colour in life is dark purplish-red, and the body cavity is filled with a rather thick dark-red liquid resembling blood and containing numerous corpuscles. The skin is smooth. Anteriorly the body is produced into a very short proboscis, resembling a stand-up collar, with a slit down the front. At the base of the collar, below the slit, are two horny hooks, and a single ring of similar hooks surrounds the body at the hinder end, a short way in front of the terminal anus. The animal resembles a Japanese species, *Echiurus uncinatus*, which is used by the Japanese fishermen for bait, but it differs in its much larger size, its smooth integument, and probably also in some details of internal anatomy. It forms an extremely in-

teresting addition to the New Zealand marine fauna. Mr. H. B. Kirk informs me that he has in former years seen this animal thrown up in large numbers on the beach at Petone, near Wellington. My own attention was first attracted to it by a specimen in the Wellington Museum, of which the history was unknown, since when I have been on the look-out for it, and it afforded me no little satisfaction to rediscover it in the living condition at New Brighton.

Pelagic animals, such as *Physalia*, *Spirula*, and *Phronima*, which are sometimes thrown up on the New Brighton Beach,\* the first named often in large numbers, were on this occasion remarkable for their absence, the only indications of pelagic animals which I noticed being a few lumps of jelly, apparently belonging to some medusa.

It was surprising to notice how quickly the vast heaps of shellfish disappeared, buried in the sand or swept out to sea again; in a fortnight from the time when they were cast on shore scarcely a trace of them was visible, and the beach had resumed its ordinary uninteresting aspect.

The cause of the unusual and, so far as I know, unprecedented phenomenon recorded in this short notice is not very easy to determine. Mr. R. M. Laing, M.A., who has had much experience in collecting on this coast, tells me—and what he says harmonizes very well with my own observations—that there are two well-marked currents in the sea off New Brighton—the one more inland coming from the mouth of the Waimakariri River, trending south along the shore, and bringing with it enormous quantities of drift-wood when the river is in flood; the other, a more important current, trending northwards for a long distance up the coast. It is probably this latter which, in heavy weather, brings to the beach, from the rocky coast of Banks Peninsula and the mouth of Lyttelton Harbour, the vast quantities of the giant seaweeds *Macrocystis* and *D'Urvillea*, amongst whose roots numerous Polyzoa, Chitons, and other small animals are to be found, and also the remarkable stalked Ascidian *Boltenia*, one of the commonest animals found on the beach, and the handsome *Pinna* already referred to. It is possible that, as Mr. Laing further suggested to me, the two currents may meet and form a vortex. I imagine that under certain conditions this vortex may become so powerful as to churn up the sand to a considerable depth, bringing to light its buried inhabitants, which are then cast on the shore by the heavy tides. Something of this kind seems to have happened lately, for the majority of the animals cast up were certainly sand-dwelling forms. They probably came from some locality directly opposite the

---

\* In the case of *Spirula* only empty shells, as usual, are found.

beach, and they reveal a hitherto unsuspected wealth of animal life which may be of great importance as a food-supply for marine fishes, which are very abundant along this coast. *Callorhynchus antarcticus* must have a breeding-ground somewhere close by, for the egg-cases of this fish are thrown up in enormous numbers on the New Brighton Beach.

Mr. C. O. Lillie, of the Canterbury Agricultural College, has kindly supplied me with the appended information as to the wind during the ten days prior to the 24th August, as recorded at Lincoln, distant about sixteen miles inland from New Brighton. The great mass of animals was certainly thrown up on the shore a few days before the 24th. I have little information as to the exact time of their appearance, but I am informed by one of my students that they had begun to appear on the 21st, though not in any quantity. It will be seen from Mr. Lillie's report that there was an unusually strong north-east wind on the 17th and 18th, and to this I am inclined to attribute the disturbance. The normal currents may have been diverted temporarily so as to cut into a sandbank usually undisturbed; or a vortex may, as already suggested, have been produced, possibly assisted by the sudden change of wind from north-east to south-west.

[Extract from Meteorological Records.]

				Number of Miles of Wind for Pre- vious Twenty- four Hours.	Direction at 9.30 a.m.
August 14	..	..	..	120	S.W.
" 15	..	..	..	128	S.W.
" 16	..	..	..	1	N.E.
" 17	..	..	..	153	N.E.
" 18	..	..	..	354	N.E.
" 19	..	..	..	104	S.W.
" 20	..	..	..	164	S.W.
" 21	..	..	..	91	S.W.
" 22	..	..	..	188	S.W.
" 23	..	..	..	260	S.W.
" 24	..	..	..	60	Calm.

Too much reliance should not be placed on these records—in fact, regard them as rather qualitative than quantitative. A high wind for twenty-four hours gives a reading between 300 and 350 miles. The reading of 354 miles on the 18th shows that there was a strong wind on the 17th–18th.

C. O. LILLIE,  
Meteorological Observer.

#### APPENDIX.

Mr. Henry Suter has kindly supplied me with the following list of Mollusca which he has found on the New Brighton Beach at various times, including those recently thrown up:—

- |   |  |
|---|--|
| 1. <i>Plaxiphora cœlata</i> , <i>Reeve</i> .        | 26. <i>Tellina alba</i> , <i>Q. and G.</i>   |
| 2. " <i>ovata</i> , <i>Hutt.</i>                    | 27. " <i>di-sculus</i> , <i>Desh.</i>  |
| 3. <i>Chiton sinclairi</i> , <i>Gray.</i>           | 28. <i>Mactra iscora</i> , <i>Gray.</i>  |
| 4. <i>Onithochiton undulatus</i> , <i>Q. and G.</i> | 29. <i>Mactra æquilatera</i> , <i>Desh.</i>  |
| 5. <i>Patella stellifera</i> , <i>Gmel.</i>         | 30. <i>Vanganelia taylori</i> , <i>Gray.</i>   |
| 6. <i>Haliotis iris</i> , <i>Martyn.</i>            | 31. <i>Zenatia acinaces</i> , <i>Q. and G.</i> (= <i>Z. deshayesi</i> , <i>Reeve</i> ).    |
| 7. " <i>virginea</i> , <i>Chemn.</i>                | 32. <i>Mesodesma novæ-zealandiæ</i> , <i>Chemn.</i>  |
| 8. <i>Emarginula striatula</i> , <i>Q. and G.</i>   | 33. <i>Mesodesma spissa</i> , <i>Reeve.</i>  |
| 9. <i>Astraliun cooki</i> , <i>Chemn.</i>           | 34. <i>Dosinia australis</i> , <i>Gray.</i>  |
| 10. <i>Calyptiæa calyptriformis</i> , <i>L.</i>     | 35. " <i>subrosea</i> , <i>Gray.</i>   |
| 11. <i>Struthiolaria papulosa</i> , <i>Mart.</i>    | 36. <i>Venus yatei</i> , <i>Gray.</i>  |
| 12. <i>Siphonalia nodosa</i> , <i>Mart.</i>         | 37. " <i>stutchburvi</i> , <i>Gray.</i>  |
| 13. <i>Trophon ambiguus</i> , <i>Phil.</i>          | 38. " <i>costata</i> , <i>Q. and G.</i>  |
| 14. <i>Scaphella pacifica</i> , <i>Lam.</i>         | 39. <i>P. tricola siliqua</i> , <i>Desh.</i>   |
| 15. <i>Ancilla australis</i> , <i>Sow.</i>          | 40. <i>Psammobia lineolata</i> , <i>Gray.</i>  |
| 16. <i>Æolis plicata</i> , <i>Hutt.</i>             | 41. <i>Solenotellina nitida</i> , <i>Gray.</i>   |
| 17. <i>Amphibola avellana</i> , <i>Chemn.</i>       | 42. " <i>spenceri</i> , <i>Hutt.</i> (M.S.).   |
| 18. <i>Siphonaria zealandica</i> , <i>Q. and G.</i> | 43. <i>Glycymeris zealandica</i> , <i>Q. and G.</i>  |
| 19. <i>Solenomya parkinsoni</i> , <i>Smith.</i>     | 44. <i>Saxicava arctica</i> , <i>Sow.</i>  |
| 20. <i>Mytilus magellanicus</i> , <i>Chemn.</i>     | 45. <i>Bontrea (?) angasi</i> , <i>C. and F.</i> ( <i>Anatina angasi</i> , <i>Auct.</i> ). |
| 21. " <i>latus</i> , <i>Chemn.</i>                  | 46. <i>Spirula peronii</i> , <i>Lam.</i>   |
| 22. <i>Pinna zealandica</i> , <i>Gray.</i>          |  |
| 23. <i>Ostrea reniformis</i> , <i>Sow.</i>          |  |
| 24. <i>Chlamys zealandica</i> , <i>Gray.</i>        |  |
| 25. <i>Lucina dentata</i> , <i>Wood.</i>            |  |

ART. XXXVII.—A *Synonymic List of the Lepidoptera of New Zealand.*

By RICHARD W. FEREDAY, F.E.S.

[*Read before the Philosophical Institute of Canterbury, 4th November, 1896.*]

THE formation of this list is due to Captain Hutton, F.R.S., who some time ago impressed upon me the desirability of collecting together and arranging the several named and described species of *Lepidoptera* of New Zealand comprised in numerous papers of Mr. Meyrick, published from time to time in the "Transactions of the New Zealand Institute" and other publications. I have to thank Captain Hutton for very valuable assistance in compiling the list and rendering my task more easy; but at the same time he is not to be considered in any way responsible for any errors that may be found therein.



Order LEPIDOPTERA.

Section RHOPALOCERA.

Family NYMPHALIDÆ.

Sub-family DANAINÆ.

**Danais**, Lat.

*Danais archippus*, *Fab.*

*Papilio archippus*, *Fab.*, *Spec. Ins.*, p. 55, n. 243 (1781). *Danais berenicæ*, *Fered.*, *Trans. N.Z. Inst.*, vol. vi., p. 183; *Colenso*, *Trans. N.Z. Inst.*, x., p. 276. *D. archippus*, *Butl.*, *Trans. N.Z. Inst.*, x., p. 265. *D. pterippus*, *Trans. N.Z. Inst.*, xxiii., p. 192.

Sub-family SATYRINÆ.

**Percnodaimon**, *Butl.*

*Percnodaimon pluto*, *Fered.*

*Erebia pluto*, *Fered.*, *Trans. N.Z. Inst.*, iv., p. 217, and xii., p. 265, pl. ix., fig. 2; and vol. xv., p. 197. *E. merula*, *Hewitson*, *Ent. Mo. Mag.*, xii., p. 10. *Oreina (?) othello*, *Fered.*, *Trans. N.Z. Inst.*, viii., pp. 302-4, pl. ix. *Percnodaimon pluto*, *Butl.*, *Ent. Mo. Mag.*, xiii., p. 153 (1876), and x., p. 268.

**Erebiola**, *Fered.*

*Erebiola butleri*, *Fered.*

*E. butleri*, *Fered.*, *Trans. N.Z. Inst.*, xii., p. 265, pl. ix., fig. 4.

**Argyropheuga**, *Doubl.*

*Argyropheuga antipodum*, *Doubl.*

*A. antipodum*, *Doubl.*, *Ann. and Mag. Nat. Hist.*, xvi., p. 307 (1845); *Gen. Diurn. Lep.*, pl. 63, fig. 6 (1851); *Butl.*, *Cat. Lep. N.Z.*, p. 2, tab. 1, figs. 4-7 (1874), and *Trans. N.Z. Inst.*, x., p. 268.

**Dodonidia**, *Butl.*

*Dodonidia helmsi*, *Fered.*

Genus (?) *helmsi*, *Fered.*, *Trans. N.Z. Inst.*, xv., p. 193 (1882). *Dodonidia helmsii*, *Butl.*, *Ann. and Mag. Nat. Hist.*, xiii. (5th series), pp. 171-3 (1884). *D. helmsi*, *Marshall*, *Trans. N.Z. Inst.*, xxviii., pp. 312-3, pl. xv.

Sub-family NYMPHALINÆ.

**Pyrameis**, *Hüb.*

*Pyrameis gonerilla*, *Fab.*

*Papilio (n.g.) gonerilla*, *Fab.*, *Syst. Ent.*, p. 498, n. 237 (1775); *Sp. Ins.*, p. 82, n. 361 (1781); *Ent. Syst.*, iii., p. 103, n. 317 (1793). *P. gonerilla*, *Fab.*, *Mant. Ins.*, p. 44, n. 437 (1787); *Donovan*, *Ins. New Holland*, pl. 25, fig. 2 (1805). *Vanessa gonerilla*, *Dieffenbaech's "New Zealand,"* ii., app., p. 284 (1843); *White*, in *Taylor's "New Zealand,"* pl. ii., fig. 1 (1855). *Pyrameis gonerilla*, *Butl.*, *Cat. Lep. N.Z.*, p. 2, tab. i., figs. 10, 11, and *Trans. N.Z. Inst.*, x., p. 270; *Colenso*, *Trans. N.Z. Inst.*, xxi., p. 196.

*Pyrameis itea*, *Fab.*

*Papilio (n.g.) itea*, *Fab.*, *Syst. Ent.*, p. 498, n. 238 (1775); *Sp. Ins.*, p. 82, n. 362 (1781); *Mant. Ins.*, p. 45, n. 438 (1787); *Ent. Syst.*, p. 103, n. 318 (1793); *Donovan, Ins. New Holland*, pl. 26, fig. 1 (1805). *Vanessa itea*, *Godart, Enc. Meth.*, ix., p. 321, n. 57 (1819); *Dieffenbach's "New Zealand,"* ii., app., p. 284 (1843); *White, in Taylor's "New Zealand,"* pl. 2, figs. 2, 2 (1855). *Bassaris itea*, *Hübner, Samml. Esot. Schmett.* (1816-24). *Pyrameis itea*, *Doubl., Gen. Diurn. Lep.*, p. 202 (1849); *Butl., Cat. Lep. N.Z.*, p. 3 (1874), and *Trans. N.Z. Inst.*, x., p. 270.

*Pyrameis kershawii*, *M'Coy.*

*Cynthia kershawii*, *M'Coy, Ann. and Mag. Nat. Hist.*, iv., vol. i., p. 76 (1868). *C. cardui*, *White, in Taylor's "New Zealand,"* pl. 2, fig. 5 (1855). *Pyrameis cardui* (var. *P. kershawii*), *Butl., Cat. Lep. N.Z.*, p. 3, and *Trans. N.Z. Inst.*, x., p. 269, pl. xii., fig. 1.

**Diadema**, *Boisd.**Diadema nerina*, *Fab.*

*Papilio nerina*, *Fab.*, *Syst. Ent.*, p. 509, n. 277 (1775); *Donovan, Ins. New Holland*, pl. 27, fig. 1 (1805). *P. iphigenia*, *Cramer, Pap. Exot.*, 1, pl. lxxvii., figs. D, E (1779). Var. *P. proserpina*, *Cramer, Pap. Exot.*, 3, pl. cexviii., figs. C, D (1782). Male (?) *P. auge*, *Cramer, Pap. Exot.*, 2, pl. exc., figs. A, B (1779). *Diadema bolina*, *Fered., Trans. N.Z. Inst.*, ix., p. 463. *D. nerina*, *Butl., Trans. N.Z. Inst.*, x., p. 271.

## Sub-family HELICONINÆ (DANAINÆ).

**Hamadryas**, *Boisd.**Hamadryas zoilus*, *Fab.*

*Papilio zoilus*, *Fab.*, *Syst. Ent.*, p. 480, n. 163 (1775); *Sp. Ins.*, p. 53, n. 229 (1781); *Mant. Ins.*, p. 25, n. 265 (1787); *Ent. Syst.*, iii., p. 42, n. 128 (1793); *Gen. Diurn. Lep.*, pl. xviii., fig. 1 (1847). *Hamadryas zoilus*, *Boisd., Voy. Astrol.*, p. 91; *Dieffenbach's "New Zealand,"* ii., app., p. 284 (1843); *Butl., Cat. Lep. N.Z.*, p. 2 (1874), and *Trans. N.Z. Inst.*, x., p. 276.

## Family LYCÆNIDÆ.

## Sub-family LYCÆNINÆ.

**Chrysophanus**, *Hübner.**Chrysophanus salustius*, *Fab.*

*Hesperia (R.) salustius*, *Fab.*, *Ent. Syst.*, iii., p. 310, n. 175 (1793). *Lycæna edna*, *Doubl., Dieffenbach's "New Zealand,"* app., p. 283 (1843). *Polyommatus edna*, *Westwood and Hewitson, Gen. Diurn. Lep.*, pl. 76, fig. 6 (1852); *White, in Taylor's "New Zealand,"* pl. 2, figs. 3, 4 (1855). *Chrysophanus salustius*, *Butl., Cat. Lep. N.Z.*, p. 3, tab. 1, figs. 1-3 (1874), and *Trans. N.Z. Inst.*, x., p. 274 (1878); *Fered., Trans. N.Z. Inst.*, ix., p. 461 (1877), and x., p. 253, pl. viii., figs. A, B, 2 (1878).

*Chrysophanus maui*, *Fered.*

*C. maui*, *Fered., Trans. N.Z. Inst.*, ix., p. 254, pl. viii., fig. C, 1 (1878).

*Chrysophanus rauparaha*, *Fered.*

*C. rauparaha*, *Fered., Trans. N.Z. Inst.*, x., p. 255, pl. viii., figs. E, 4 (1878).

*Chrysophanus enysii*, *Butl.*

*C. enysii*, *Butl.*, *Ent. Mo. Mag.*, xiii., p. 153 (1876), and *Trans. N.Z. Inst.*, x., p. 274, pl. xii., figs. 4, 5, 6 (1878).

*Chrysophanus feredayi*, *Bates.*

*C. feredayi*, *Bates*, *Ent. Mo. Mag.*, iv., p. 53 (1867); *Butl.*, *Cat. Lep. N.Z.*, p. 3 (1874); *Fered.*, *Trans. N.Z. Inst.*, ix., pp. 461-2 (1877), and x., p. 254, pl. viii., figs. D, 3 (1878); *Butl.*, *Trans. N.Z. Inst.*, x., p. 275, pl. xii., figs. 7, 8, 9 (1878).

*Chrysophanus boldenarum*, *White.*

*Lycæna boldenarum*, *White*, *Proc. Ent. Soc.*, ser. 3, i., p. 26 (1862). *Chrysophanus boldenarum*, *Butl.*, *Cat. Lep. N.Z.*, p. 3, tab. 1, figs. 8, 9 (1874), and *Trans. N.Z. Inst.*, x., p. 273 (1878); *Fered.*, *Trans. N.Z. Inst.*, ix., pp. 461-2, and *Trans. N.Z. Inst.*, x., p. 256, pl. viii., figs. I, H, 5, 6, 7, 8 (1878).

**Lycæna**, *Fab.*

*Lycæna oxleyi*, *Feld.*

*L. oxleyi*, *Feld.*, *Reise der "Novara," Lep.*, ii., p. 280, n. 354, pl. 35, fig. 6 (1865); *Bates*, *Ent. Mo. Mag.*, iv., p. 53; *Butl.*, *Cat. Lep. N.Z.*, p. 4 (1874), and *Trans. N.Z. Inst.*, x., p. 273 (1878).

*Lycæna phœbe*, *Murray.*

*L. phœbe*, *Murray*, *Ent. Mo. Mag.*, 1873, p. 107; *Butl.*, *Trans. N.Z. Inst.*, x., p. 272, pl. xii., figs. 2, 3 (1878).

Section HETEROCERA.

Group BOMBYCINA.

Family HEPIALIDÆ.

**Porina**, *Walk.*

*Porina dinodes*, *Meyr.*

*P. dinodes*, *Meyr.*, *Trans. N.Z. Inst.*, vol. xxii., p. 206.

*Porina mairi*, *Buller.*

*P. mairi*, *Buller*, *Trans. N.Z. Inst.*, vol. v., p. 279, pl. 17; *Meyr.*, *Trans. N.Z. Inst.*, vol. xxii., p. 207.

*Porina enysii*, *Butl.*

*P. enysii*, *Butl.*, *Proc. Zool. Soc. Lond.* (1877), p. 381, pl. xliii., f. 7; *Meyr.*, *Trans. N.Z. Inst.*, vol. xxii., p. 207.

*Porina characterifer*, *Walk.*

*Hepialus characterifer*, *Walk.*, *Cat. Lep. Brit. Mus.*, suppl. ii., p. 594 (1865). *Orycanus impletus*, *ib.*, p. 598. *Hepialus characterifer*, *Butl.*, *Cat. Lep. N.Z.*, p. 5. *Porina characterifera*, *Meyr.*, *Trans. N.Z. Inst.*, vol. xxii., p. 208.

*Porina cervinata*, *Walk.*

*Ethamma cervinata*, *Walk.*, *Cat. Lep. Brit. Mus.*, suppl. ii., p. 595. *Porina vexata*, *ib.*, p. 597. *P. fuliginea*, *Butl.*, "*Cistula Entomologica*," vol. ii., p. 488. *P. cervinata*, *Butl.*, *Cat. Lep. N.Z.*, p. 5; *Meyr.*, *Trans. N.Z. Inst.*, vol. xxii., p. 208.

NOTE.—*Mr. Meyrick* also includes "*Pielus variolaris*, *Guén.*, *Ent. Mo. Mag.*, vol. v., p. 1," as a synonym, but it must be a mistake, for I have a duplicate of the type de-

scribed by Guénée, and it is quite different from *cervinata*.—  
R. W. F.

*Porina despectus*, Walk.

*Hepialus despectus*, Walk., Cat. Lep. Brit. Mus., suppl. ii., p. 594.

*Porina despecta*, Meyr., Trans. N.Z. Inst., xxii., p. 209.

*Porina umbraculatus*, Guén.

*Pielus umbraculatus*, Guén., Ent. Mo. Mag., vol. v., p. 1 (1868).

*Porina umbraculata*, Butl., Cat. Lep. N.Z., p. 5; Meyr., Trans. N.Z. Inst., vol. xxii., p. 209.

*Porina variolaris*, Guén.

*Pielus variolaris*, Guén., Ent. Mo. Mag., vol. v., p. 1. *Porina*

*signata*, Butl., Cat. Lep. N.Z., p. 5. *P. umbraculata*, Meyr., Trans. N.Z. Inst., vol. xxii., p. 208.

*Porina signata*, Walk.

*Elhamma signata*, Walk., Cat. Lep. Brit. Mus., vii., p. 1563 (1856).

*Porina novæ-zelandiæ*, ib., p. 1573. *P. signata*, Butl., Cat. Lep. N.Z., p. 5, tab. 2, f. 8; Meyr., Trans. N.Z. Inst., xxii., p. 210.

### **Hepialus**, Fab., Gen. Ins., p. 162 (1776).

*Hepialus virescens*, Doubl.

*H. virescens*, Doubl., Dieffenbach's "New Zealand," vol. ii., p. 284 (1843): White, Taylor's "New Zealand," pl. i., f. 6 (1855).

*H. rubroviridans*, White, l.c., pl. 1, fig. 1. *Charagia virescens*, Walk., Cat. Lep. Brit. Mus., vii., p. 1569; Scott, Trans. Ent. Soc. N.S.W., ii., 28. *C. fischeri*, Feld., Reise der "Novara," pl. lxxx., f. 1.

*C. hectori*, Butl., Proc. Zool. Soc. Lond., 1877, p. 380. *C. virescens*, Butl., Cat. Lep. N.Z., p. 4. *Hepialus virescens*, Meyr., Trans. N.Z. Inst., xxii., p. 211.

*Hepialus ingens*, Walk.

*Charagia ingens*, Walk., Cat. Lep. Brit. Mus., xxxii., supp. ii., p. 596. *Seto ingens*, Butl., Cat. Lep. N.Z., p. 5.

Meyrick says, "I believe the record to be erroneous; it is certainly Australian, and I have never met with a really authentic New Zealand specimen" (Trans. N.Z. Inst., xxii., p. 205).

### Group SPHINGINA.

#### Family PSYCHIDÆ.

#### **Æceticus**, Guild.

*Æceticus omnivora*, Fered.

*Lothula omnivora*, Fered., Trans. N.Z. Inst., vol. x., p. 260, pl. 9.

*Æceticus omnivorus*, Meyr., Trans. N.Z. Inst., vol. xxii., p. 212.

#### **Orophora**, Fered.

*Orophora unicolor*, Butl.

*Psyche unicolor*, Butl., Proc. Zool. Soc. Lond., 1877, p. 381. *Orophora toumatou*, Fered., Trans. N.Z. Inst., vol. x., p. 260, pl. 9. *O. unicolor*, Meyr., Trans. N.Z. Inst., vol. xxii., p. 212.

Family SPHINGIDÆ.

**Sphinx**, Linn.

*Sphinx convolvuli*, Linn.

*S. convolvuli*, Linn., Syst. Nat., 1, 2, p. 789 (1766); White, Taylor's "New Zealand," pl. 1, f. 13 (1855). *S. convolvuli*, var.  $\gamma$ , Walk, Cat. Lep. N.Z., viii., p. 213 (1856). *S. convolvuli* (var. *S. distans*), Butl., Cat. Lep. N.Z., p. 4, tab. 2, fig. 11. *S. convolvuli* (*Protoparce distans*, Butl.), Meyr., Trans. N.Z. Inst., vol. xxii., p. 213.

Group HYPISINA.

Family SESIADÆ.

**Sesia**, Fabr.

*Sesia tipuliformis*, Linn.

*Sphinx tipuliformis*, Linn., Faun. Succ., p. 289, n. 1096. *Setia tipuliformis*, Fab., Ent. Syst., iii., 1, p. 385, n. 21 (1793). *Sesia tipuliformis*, Meigen, Syst. Besch., ii., p. 119, n. 25, pl. 63, f. 2. *Ægeria tipuliformis*, Stephens, Ill. Brit. Ent. Haust., 1, p. 142 (1829). *Trochilium tipuliforme*, Newman, Ent. Mag., i., p. 78. *Sphinx salmachus*, Linn., Syst. Nat., Ed. 10, p. 493, n. 30. *Ægeria tipuliformis*, Butl., Cat. Lep. N.Z., p. 4. *Sesia tipuliformis*, Cl., Meyr., Trans. N.Z. Inst., vol. xxii., p. 214.

Family ARCTIADÆ.

**Metacrias**, Meyr.

*Metacrias strategica*, Hudson.

*Arctia strategica*, Hudson, Entom., 1889, p. 53. *Metacrias strategica*, Meyr., Trans. N.Z. Inst., xxii., p. 216.

*Metacrias erichrysa*, Meyr.

*M. erichrysa*, Meyr., Proc. Linn. Soc. N.S.W., p. 749 (1886), and Trans. N.Z. Inst., xxii., p. 216.

*Metacrias huttonii*, Butl.

*Phaos huttonii*, Butl., "Cistula Entomologica," ii., p. 487. *Metacrias huttonii*, Meyr., Proc. Linn. Soc. N.S.W., p. 750 (1886), and Trans. N.Z. Inst., xxii., p. 216.

**Deiopeia**, Stephens.

*Deiopeia pulchella*, Linn.

(? genus) *pulchella*, Linn. *Deiopeia pulchella*, Meyr., Trans. N.Z. Inst., xxii., p. 217.

Family HYPISIDÆ.

**Nyctemera**, Hübn.

*Nyctemera annulatum*, Boisd.

*Leptosoma annulatum*, Boisd., Voy. de l'Astr., Ent., v., p. 197, pl. 5, fig. 9 (1853); Doubl., Dieffenbach's "New Zealand," ii., p. 284. *Nyctemera doubledayi*, Walk., Cat. Lep. Brit. Mus., ii., p. 392. *N. annulata*, Butl., Cat. Lep. N.Z., p. 4. *Leptosoma annulatum*, Bates, Ent. Mo. Mag., v., p. 2. *Nyctemera annulata*, Meyr., Proc. Linn. Soc. N.S.W., 1886, p. 760, and Trans. N.Z. Inst., xxii., p. 218.

## Group NOCTUINA.

## Family NOCTUIDÆ.

**Physetica**, Meyr.*Physetica cærulea*, Guén.

*Agrotis cærulea*, Guén., Ent. Mo. Mag., v., p. 38. *Physetica cærulea*, Meyr., Trans. N.Z. Inst., xix., p. 5.

**Leucania**, Hübn.*Leucania griseipennis*, Feld.

*Manistra griseipennis*, Feld., Reise der Nov., pl. cix., fig. 22. *Chera virescens*, Butl., Cist. Ent., ii., p. 489. *Spalotis inconstans*, *ib.*, p. 545. *Leucania moderata*, Meyr., Trans. N.Z. Inst., xix., p. 7; *ib.*, xx., p. 44.

*Leucania moderata*, Walk.

*Agrotis* (?) *moderata*, Walk., Cat. Lep. Brit. Mus., supp. ii., p. 705. *Eumichtis sistens*, Guén., Ent. Mo. Mag., v., p. 39. *Agrotis* (?) *moderata*, Butl., Cat. Lep. N.Z., p. 7. *Manistra sistens*, Meyr., Trans. N.Z. Inst., xix., p. 19. *Leucania moderata*, Meyr., *ib.*, xx., p. 45.

*Leucania temperata*, Walk.

*Bryophila temperata*, Walk., Cat. Lep. Brit. Mus., xv., p. 1648. *Xylina inceptura*, *ib.*, p. 1736. *X. deceptura*, *ib.*, p. 1737. *Bryophila temperata*, Butl., Cat. Lep. N.Z., p. 6. *Leucania temperata*, Meyr., Trans. N.Z. Inst., xx., p. 45.

*Leucania nullifera*, Walk.

*Agrotis nullifera*, Walk., Cat. Lep. Brit. Mus., xi., p. 742; Butl., Cat. Lep. N.Z., p. 7, tab. 2, fig. 5; Guén., Ent. Mo. Mag., v., p. 3. *Leucania nullifera*, Meyr., Trans. N.Z. Inst., xix., p. 7.

*Leucania purdii*, Fered.

*L. purdii*, Fered., Trans. N.Z. Inst., xv., p. 195; Meyr., Trans. N.Z. Inst., xix., p. 8.

*Leucania atristriga*, Walk.

*Xylina atristriga*, Walk., Cat. Lep. Brit. Mus., xxxiii., supp. iii., p. 756. *Manistra antipoda*, Feld., Reis. der Nov., pl. cix., n. 23. *Xylina atristriga*, Butl., Cat. Lep. N.Z., p. 9. *Leucania atristriga*, Meyr., Trans. N.Z. Inst., xix., p. 8.

*Leucania propria*, Walk.

*L. propria*, Walk., Cat. Lep. Brit. Mus., ix., p. 111; Guén., Ent. Mo. Mag., v., p. 2; Butl., Voy. Ereb., pl. ix., fig. 4; Butl., Cat. Lep. N.Z., p. 6; Meyr., Trans. N.Z. Inst., xix., p. 9.

*Leucania acantistis*, Meyr.

*L. acantistis*, Meyr., Trans. N.Z. Inst., xix., p. 9.

*Leucania phaula*, Meyr.

*L. phaula*, Meyr., Trans. N.Z. Inst., xix., p. 10.

*Leucania alopa*, Meyr.

*D. alopa*, Meyr., Trans. N.Z. Inst., xix., p. 10.

*Leucania unica*, Walk.

*L. unica*, Walk., Cat. Lep. Brit. Mus., ix., p. 112; Butl., Voy. Ereb., pl. ix., fig. 9; Butl., Cat. Lep. N.Z., p. 6, tab. 2, fig. 9. *Nonagria juncicolor*, Guén., Ent. Mo. Mag., v., p. 2. *Leucania unica*, Meyr., Trans. N.Z. Inst., xix., p. 10.

*Leucania aulacias*, *Meyr.*

*L. aulacias*, *Meyr.*, *Trans. N.Z. Inst.*, xix., p. 11.

*Leucania arotis*, *Meyr.*

*L. arotis*, *Meyr.*, *Trans. N.Z. Inst.*, xix., p. 11.

*Leucania sulcana*, *Fered.*

*L. sulcana*, *Fered.*, *Trans. N.Z. Inst.*, xii., p. 267, pl. ix.; *Meyr.*, *Trans. N.Z. Inst.*, xix., p. 11.

*Leucania semivittata*, *Walk.*

*L. semivittata*, *Walk.*, *Cat. Lep. Brit. Mus.*, xxxii., suppl. ii., p. 628; *Meyr.*, *Trans. N.Z. Inst.*, xix., p. 12.

*Leucania blenheimensis*, *Fered.*

*L. blenheimensis*, *Fered.*, *Trans. N.Z. Inst.*, xv., p. 196; *Meyr.*, *Trans. N.Z. Inst.*, xix., p. 12.

*Leucania extranea*, *Guén.*

*L. extranea*, *Noct.*, v., p. 77; *Butl.*, *Voy. Ereb.*, pl. ix., fig. 2; *Butl.*, *Cat. Lep. N.Z.*, p. 6; *Meyr.*, *Trans. N.Z. Inst.*, xix., p. 12.

**Ichneutica**, *Meyr.*

*Ichneutica ceraunias*, *Meyr.*

*I. ceraunias*, *Meyr.*, *Trans. N.Z. Inst.*, xix., p. 13.

**Mamestra**, *Treitschke.*

*Mamestra disjungens*, *Walk.*

*Heliophobus disjungens*, *Walk.*, *Cat. Lep. Brit. Mus.*, xv., p. 1681; *Butl.*, *Voy. Ereb.*, pl. ix., fig. 1; *Butl.*, *Cat. Lep. N.Z.*, p. 6. *Hadena nervata*, *Guén.*, *Ent. Mo. Mag.*, v., p. 40. *Mamestra disjungens*, *Meyr.*, *Trans. N.Z. Inst.*, xix., p. 15.

*Mamestra paracausta*, *Meyr.*

*M. paracausta*, *Meyr.*, *Trans. N.Z. Inst.*, xix., p. 15.

*Mamestra insignis*, *Walk.*

*Euplexia insignis*, *Walk.*, *Cat. Lep. Brit. Mus.*, xxxiii., suppl. iii., p. 724; *Xylina turbida*, *ib.*, p. 754; *Butl.*, *Cat. Lep. N.Z.*, p. 9. *Euplexia insignis*, *Butl.*, *ib.*, p. 8. *Hadena lignifusca*, *Butl.*, *Proc. Zool. Soc. Lond.*, 1877, p. 385. *H. insignis*, *Butl.*, *Cist. Ent.*, ii., p. 492. *Mamestra polychroa*, *Meyr.*, *Trans. N.Z. Inst.*, xix., p. 16. *M. insignis*, *Meyr.*, *Trans. N.Z. Inst.*, xx., p. 45.

*Mamestra plena*, *Walk.*

*Erana plena*, *Walk.*, *Cat. Lep. Brit. Mus.*, xxxiii., suppl. iii., p. 744. *Mamestra sphagnea*, *Feld.*, *Reise der Nov.*, pl. cix., fig. 17. *Erana plena*, *Butl.*, *Cat. Lep. N.Z.*, p. 8. *Dianthaccia viridis*, *Butl.*, *Cist. Ent.*, ii., p. 547. *Mamestra plena*, *Meyr.*, *Trans. N.Z. Inst.*, xix., p. 17.

*Mamestra lithias*, *Meyr.*

*M. lithias*, *Meyr.*, *Trans. N.Z. Inst.*, xix., p. 17.

*Mamestra mutans*, *Walk.*

*Hadena mutans*, *Walk.*, *Cat. Lep. Brit. Mus.*, xi., p. 602. *H. lignifusca*, *Walk.*, *ib.*, p. 603. *Mamestra angusta*, *Feld.*, *Reise der Nov.*, pl. cix., fig. 18. *M. acceptrix*, *ib.*, fig. 19. *Hadena mutans*, *Butl.*, *Cat. Lep. N.Z.*, p. 8. *H. debilis*, *Butl.*, *Proc. Zool. Soc. London*, 1877, p. 385, pl. xlii., fig. 6. *H. mutans*, *ib.*, and *Cist. Ent.*, ii., p. 491. *Mamestra mutans*, *Meyr.*, *Trans. N.Z. Inst.*, xix., p. 17.

**Mamestra agorastis**, *Meyr.**M. agorastis*, Meyr., Trans. N.Z. Inst., xix., p. 18.**Mamestra pictula**, *White.**Dianthocia pictula*, White, Taylor's "New Zealand," pl. i., fig. 3. *Hadena pictula*, Walk., Cat. Lep. Brit. Mus., xi., p. 602; Butl., Cat. Lep. N.Z., p. 8. *Meturana pictula*, Butl., Proc. Zool. Soc. Lond., 1887, p. 386, pl. xlii., fig. 1. *Mamestra pictula*, Meyr., Trans. N.Z. Inst., xix., p. 18.**Mamestra rhodopleura**, *Meyr.**M. rhodopleura*, Meyr., Trans. N.Z. Inst., xix., p. 19.**Mamestra pelistis**, *Meyr.**M. pelistis*, Meyr., Trans. N.Z. Inst., xix., p. 20.**Mamestra vitiosa**, *Butl.**Apamea vitiosa*, Butl., Proc. Zool. Soc. Lond., 1877, p. 384, pl. xlii., fig. 3. *Mamestra oethistis*, Meyr., Trans. N.Z. Inst., xix., p. 20. *M. vitiosa*, Meyr., Trans. N.Z. Inst., xx., p. 45.**Mamestra proteastis**, *Meyr.**M. proteastis*, Meyr., Trans. N.Z. Inst., xx., p. 45. *M. vitiosa*, Meyr., Trans. N.Z. Inst., xix., p. 20.**Mamestra tartarea**, *Butl.**Graphiphora tartarea*, Butl., Proc. Zool. Soc. Lond., 1877, p. 384, pl. xlii., fig. 2. *Mamestra tartarea*, Meyr., Trans. N.Z. Inst., xix., p. 21.**Mamestra homoscia**, *Meyr.**M. homoscia*, Meyr., Trans. N.Z. Inst., xix., p. 21.**Mamestra composita**, *Guén.**Cloantha composita*, Guén., Noct. vi., p. 114. *Auchmis composita*, Walk., Cat. Lep. Brit. Mus., xi., p. 616; Butl., Voy. Ereb., pl. ix., fig. 12; Butl., Cat. Lep. N.Z., p. 8. *Mamestra maori*, Feld., Reise der Nov., pl. cix., fig. 24. *M. composita*, Meyr., Trans. N.Z. Inst., xix., p. 22.**Mamestra steropastis**, *Meyr.**M. steropastis*, Meyr., Trans. N.Z. Inst., xix., p. 22.**Mamestra infensa**, *Walk.**Orthosia infensa*, Walk., Cat. Lep. Brit. Mus., xi., p. 748; Butl., Cat. Lep. N.Z., p. 7. *Mamestra arachnias*, Meyr., xix., p. 23. *M. infensa*, Meyr., xx., p. 45.**Mamestra omoplaca**, *Meyr.**M. omoplaca*, Meyr., Trans. N.Z. Inst., xix., p. 24.**Mamestra dotata**, *Walk.**Dasytopia dotata*, Walk., Cat. Lep. Brit. Mus., xi., p. 522; Butl., Cat. Lep. N.Z., p. 8. *Mamestra dotata*, Meyr., Trans. N.Z. Inst., xix., p. 24.**Mamestra stipata**, *Walk.**Xylina stipata*, Walk., Cat. Lep. Brit. Mus., iii., supp., p. 753; Butl., Cat. Lep. N.Z., p. 9. *Xylophasia stipata*, Butl., Cist. Ent., ii., p. 488. *Mamestra stipata*, Meyr., Trans. N.Z. Inst., xix., p. 25.**Mamestra rubescens**, *Butl.**Xylophasia rubescens*, Butl., Cist. Ent., ii., p. 489. *Mamestra rubescens*, Meyr., Trans. N.Z. Inst., xix., p. 25.



**Mamestra lignana, Walk.**

*Hadena lignana*, Walk., Cat. Lep. Brit. Mus., xi., p. 543; Butl., Cat. Lep. N.Z., p. 8; Butl., Proc. Zool. Soc., 1877, p. 385, pl. xlii., fig. 6. *Xylophasia morosa*, Butl., Cist. Ent., ii., p. 543. *Mamestra lignana*, Meyr., Trans. N.Z. Inst., xix., p. 26.

**Mamestra ustistriga, Walk.**

*Xylina ustistriga*, Walk., Cat. Lep. Brit. Mus., xi., p. 630. *X. lignisecta*, *ib.*, p. 631; Butl., Cat. Lep. N.Z., p. 8; Butl., Proc. Zool. Soc., 1877, p. 386. *Mamestra ustistriga*, Meyr., Trans. N.Z. Inst., xix., p. 26.

**Mamestra prionistis, Meyr.**

*M. prionistis*, Meyr., Trans. N.Z. Inst., xix., p. 27.

**Mamestra phricias, Meyr.**

*M. temperata*, Meyr., Trans. N.Z. Inst., xix., p. 27. *M. phricias*, Meyr., Trans. N.Z. Inst., xx., p. 46.

**Mamestra cucullina, Guén.**

*Xylocampa cucullina*, Guén., Ent. Mo. Mag., v., p. 40; Butl., Cat. Lep. N.Z., p. 8. *Agrotis mitis*, Butl., Proc. Zool. Soc., 1877, p. 383, pl. xlii., fig. 5; Butl., Cist. Ent., ii., p. 489. *Mamestra cucullina*, Meyr., Trans. N.Z. Inst., xix., p. 28.

**Erana, Walk.**

**Erana graminosa, Walk.**

*E. graminosa*, Walk., Cat. Lep. Brit. Mus., xi., p. 605. *E. vicens*, *ib.*, xxxiii., supp., p. 743. *E. graminosa*, Butl., Cat. Lep. N.Z., p. 8; Butl., Cist. Ent., ii., p. 492; Meyr., Trans. N.Z. Inst., xix., p. 28.

**Miselia, Steph.**

**Miselia pessota, Meyr.**

*M. pessota*, Meyr., Trans. N.Z. Inst., xix., p. 29.

**Orthosia, Tr.**

**Orthosia comma, Walk.**

*Mamestra comma*, Walk., Cat. Lep. Brit. Mus., ix., p. 239; Butl., Voy. Erebb., pl. ix., fig. 6; Butl., Cat. Lep. N.Z., p. 7. *Graphiphora implexa*, Walk., Cat. Lep. Brit. Mus., x., p. 405. *Hadena plusiata*, Walk., Cat. Lep. Brit. Mus., xxxiii., supp., p. 742; Butl., Cat. Lep. N.Z., p. 8. *Nitocris bicomma*, Guén., Ent. Mo. Mag., v., p. 4; Butl., Cat. Lep. N.Z., p. 7. *Orthosia comma*, Meyr., Trans. N.Z. Inst., xix., p. 30.

**Orthosia immunis, Walk.**

*Teniocampa immunis*, Walk., Cat. Lep. Brit. Mus., x., p. 430. *Cerastis innocua*, *ib.*, 1710. *Agrotis acetina*, Feld., Reis. der Nov., pl. cix., fig. 6. *Teniocampa immunis*, Butl., Cat. Lep. N.Z., p. 7. *Orthosia immunis*, Meyr., Trans. N.Z. Inst., xix., p. 30.

**Xanthia, Ochsenh.**

**Xanthia purpurea, Butl.**

*Graphiphora purpurea*, Butl., Cist. Ent., ii., p. 490. *Xanthia ceramodes*, Meyr., Trans. N.Z. Inst., xix., p. 31. *X. purpurea*, Meyr., Trans. N.Z. Inst., xx., p. 46.

**Bityla, Walk.**

**Bityla defigurata, Walk.**

*Xylina defigurata*, Walk., Cat. Lep. Brit. Mus., xxxiii., supp., 756. *Bityla thoracica*, *ib.*, p. 869; Butl., Cat. Lep. N.Z., p. 10. *B. defigurata*, Meyr., Trans. N.Z. Inst., xix., p. 31.

*Bityla sericea*, *Butl.*

*B. sericea*, Butl., Proc. Zool. Soc. Lond., 1877, p. 387, pl. xlii., fig. 12; Meyr., Trans. N.Z. Inst., xix., p. 31.

**Agrotis**, *Ochs.**Agrotis ypsilon*, *Rott.*

*Noctua ypsilon*, Rott. *Agrotis suffusa*, Hübn. *A. ypsilon*, Meyr., Trans. N.Z. Inst., xix., p. 32. (?) If same as *Agrotis suffusa*, Treitschke, and *Noctua suffusa*, Denis, see Butl., Cat. Lep. N.Z., p. 7, and Proc. Zool. Soc. London, 1877, p. 383.—R. W. F.

*Agrotis admirationis*, *Guén.*

*A. admirationis*, Guén., Ent. Mo. Mag., v., p. 38; Butl., Cat. Lep. N.Z., p. 7, and Proc. Zool. Soc. Lond., ii., p. 384. Also, Meyr., Trans. N.Z. Inst., xix., p. 33; but Mr. Meyrick has made some mistake, for I have duplicate of the type named by Guén., and Mr. Meyrick's description in a way agrees with it, and it was not found on roots of tussock-grass on sandhills.—R. W. F.

*Agrotis sericea*, *Butl.*

*Chersotis sericea*, Butl., Cist. Ent., ii., p. 490. *C. inconspicua*, *ib.*, p. 545. *Agrotis sericea*, Meyr., Trans. N.Z. Inst., xix., p. 33. *A. inconspicua*, *ib.*, p. 34. *A. sericea*, Meyr., Trans., N.Z. Inst., xx., p. 46.

*Agrotis ceropachoides*, *Guén.*

*A. ceropachoides*, Guén., Ent. Mo. Mag., v., p. 39; Butl., Cat. Lep. N.Z., p. 7; Meyr., Trans. N.Z. Inst., xix., p. 34.

**Heliothis**, *Ochs.**Heliothis armigera*, *Hüb.*

*H. armigera*, Hübn., Samml. Eur. Schmett. Noct., pl. 79, fig. 370; Butl., Cat. Lep. N.Z., p. 9. *H. conferta*, Walk., Cat. Lep. Brit. Mus., xi., p. 690; Butl., Cat. Lep. N.Z., p. 9, and Proc. Zool. Soc. Lond., 1877, p. 387. *H. armigera*, Meyr., Trans. N.Z. Inst., xix., p. 84.

**Cosmodes**, *Guén.**Cosmodes elegans*, *Donovan.*

*Phalena elegans*, Don., Ins. New Holl., pl. 36, fig. 5. *Cosmodes elegans*, Guén., Sp. Gen. Lep. Noct., vi., p. 290; Butl., Cat. Lep. N.Z., p. 9; Meyr., Trans. N.Z. Inst., xix., p. 35.

## Family PLUSIADÆ.

**Plusia**, *Ochs.**Plusia eriosoma*, *Doubl.*

*P. eriosoma*, Doubl., Dieffenbach's "New Zealand," p. 285; Butl., Voy. Erebn., pl. x., figs. 1, 2; Butl., Cat. Lep. N.Z., p. 9, tab. 3, figs. 1, 2. *P. argentifera*, Guén., Gen. Noct., vi., p. 352. *P. eriosoma*, Meyr., Trans. N.Z. Inst., xix., p. 36.

**Dasypodia**, *Guén.**Dasypodia selenophora*, *Guén.*

*D. selenophora*, Guén., Noct., vii., p. 175; Butl., Cat. Lep. N.Z., p. 10; Meyr., Trans. N.Z. Inst., xix., p. 38. (?) *erebus*, n.s., White, in Taylor's "New Zealand," pl. 1, figs. 2, 2 (1855).

CORRIGENDA.

- Page 327, lines 22 and 23. *For* *Argyrophenga* *read* *Argyrophenga*.  
Page 328, line 5 from bottom. *For* *Trans. N.Z. Inst.*, ix, *read* *Trans. N.Z. Inst.*, x.  
Page 332, line 9. *For* *Maniestra* *read* *Mamestra*.  
Page 336, line 15. *For* in a way agrees *read* in no way agrees.  
Page 337, line 18, *should read* *Orthosia, Oclis*,\* *to connect with footnote*.  
Page 337, line 22. *Dele* Family *Monocteniadæ*.  
Page 337, lines 23 to 26. *Transfer* Genus *Theoxena*, *Meyr.*, to p. 345, *after* *Dichromodes*.  
Page 338, lines 25 and 26. *For* *Pancyma* *read* *Pancyma*.  
Page 338, line 9 from bottom. *For* *megaspilata* *read* *megaspilata*.  
Page 341, line 18. *For* *subducta* *read* *subductata*.  
Page 345. *After* *Dichromodes* *insert* *Theoxena*, *from* p. 337.  
Page 345, line 17. *After* *L. alectoraria*, *Walk.*, l.c., *insert* *xx.*, p. 259.  
Page 345, line 17. *For* *Aspitates* *read* *Aspidates*.  
Page 345, bottom line. *For* 316 *read* 216.  
Page 349, line 15 from bottom. *For* *hybreadalis* *read* *hybreasalis*.  
Page 349, line 10 from bottom. *For* *Trans. N.Z. Inst.*, *xxi.*, *read* *Trans. Ent. Soc. Lond.*, 1884.  
Page 356, line 13. *For* p. 22 *read* p. 23.  
Page 356, line 15. *For* p. 22 *read* p. 24.  
Page 366, line 11. *After* *Stainton* *insert* *Man. Brit. Butt. & Moth.* ii., p. 358.  
Page 369, lines 12, 13, 15. *For* *Eutoma* *read* *Eutorna*.  
Page 372, line 6 from bottom. *For* *Stt.* *read* *Stainton*.  
Page 372, line 6 from bottom. *For* 397 *read* 399.  
Page 374, line 10. *For* *C. miniellum* *read* *S (?) mmiella*.  
Page 374, line 10. *After* pl. *cxl.* *insert* *fig. 42*.

[To be inserted opposite page 336.]



**Rhapsa**, Walk.

*Rhapsa scotosialis*, *Walk.*

*R. scotosialis*, Walk., *Cat. Lep. Brit. Mus.*, xxxiv., *supp.*, p. 1150; *Butl., Cat. Lep. N.Z.*, p. 10, *Proc. Zool. Soc. Lond.*, 1877, p. 388, and *Cist. Ent.*, ii., p. 492. *Herminia lilacina*, *Butl., Proc. Zool. Soc. Lond.*, 1877, p. 388, pl. xlii., fig. 11. *Rhapsa scotosialis*, *Meyr., Trans. N.Z. Inst.*, xix, p. 38.

**Hyphenodes**, Guén.

*Hyphenodes exsularis*, *Meyr.*

*H. exsularis*, *Meyr., Trans. N.Z. Inst.*, xx., p. 46.

**Xylina**, Treitschke.\*

*Xylina spurcata*, *Walk.*

*Cat. Lep. Brit. Mus.*, xi., p. 631; *Butl., Cat. Lep. N.Z.*, p. 8.

*Xylina provida*, *Walk.*

*l.c.*, xv., p. 1737; *Butl., l.c.*, p. 9.

*Xylina vexata*, *Walk.*

*l.c.*, xxxiii, *supp.*, p. 755; *Butl., l.c.*, p. 9.

**Orthosia**, Ochs.

*Orthosia communicata*, *Walk.*

*l.c.*, xxxiii, *supp.*, p. 716; *Butl., l.c.*, p. 7.

Group GEOMETRINA.

Family MONOCTENIADÆ.

**Theoxena**, Meyr.

*Theoxena scissaria*, *Guén.*

*Panagra scissaria*, *Guén., Ent. Mo. Mag.*, v., p. 43. *Theoxena scissaria*, *Meyr., Trans., N.Z. Inst.*, xvi., p. 56.

Family ACIDALIADÆ.

**Acidalia**, Tr.

*Acidalia rubraria*, *Doubl.*

*Ptychopoda* (?) *rubraria*, *Doubl., Dieffenbach's "New Zealand,"* ii., p. 286. *Acidalia repletaria*, *Walk., Cat. Lep. Brit. Mus.*, xxiv., p. 778. *A. attributa*, *Walk., ib.*, p. 779. *A. rubraria*, *Walk., ib.*, p. 781. *Fidonia* (?) *acidaliaria*, *Walk., ib.*, xxv., p. 1037. *Acidalia jiglinaria*, *Guén., A. rubraria*, *Butl., Cat. Lep. N.Z.*, p. 13; *ib.*, *Proc. Zool. Soc. Lond.*, 1877, p. 390; *ib.*, *Cist. Ent.*, ii., p. 498; *Meyr., Trans. N.Z. Inst.*, xvi., p. 57, and xvii., p. 63.

**Xyridacma**, Meyr.

*Xyridacma hemipteraria*, *Guén.*

*Hemerophila hemipteraria*, *Guén., Xyridacma hemipteraria*, *Meyr., Trans. N.Z. Inst.*, xx., p. 60.

\* See *Meyrick, Trans. N.Z. Inst.*, xix., p. 39, as to these.

## Family LARENTIADÆ.

**Paradetis**, Meyr.Paradetis porphyrias, *Meyr.**Parysatis porphyrias*, Mevr., Trans. N.Z. Inst., xvi., p. 59.**Epicyme**, Meyr.Epicyme rubropunctaria, *Doubl.**Ptychopoda rubropunctaria*, Doubl., Dieffenbach's "New Zealand," ii., p. 287. *Asthena risata*, Guén. *A. nullata*, Guén., Ent. Mo. Mag., v., p. 42. *Acidalia pulcherrima*, Walk., Cat. Lep. Brit. Mus., xxiv., p. 780; Butl., Cat. Lep. N.Z., p. 13, tab. 3, fig. 18. *Hippolyte rubropunctaria*, Meyr., Trans. N.Z. Inst., xvi., p. 60; *ib.*, xvii., p. 63.**Epiphryne**, Meyr.Epiphryne undosata, *Feld.**Cidaria undosata*, Feld., Reise der Nov., v., pl. cxxviii., fig. 2. *Acidalia undosata*, Butl., Proc. Zool. Soc. Lond., 1877, p. 391, and Cist. Ent., ii., p. 499. *Epiphryne undosata*, Meyr., *l.c.*, xvi., p. 60.**Aulopola**, Meyr.Aulopola xanthaspis, *Meyr.**Hermione xanthaspis*, Meyr., *l.c.*, xvi., p. 61.**Asaphodes**, Meyr.Asaphodes abrogata, *Walk.**Aspilates abrogata*, Walk., Cat. Lep. Brit. Mus., xxiv., p. 1075; Butl., Cat. Lep. N.Z., p. 14. *Fidonia (?) servularia*, Guén., Ent. Mo. Mag., v., p. 43. *Thyone abrogata*, Meyr., Trans. N.Z. Inst., xvi., p. 61.**Paneyma**, Meyr.Paneyma verriculata, *Feld.**Cidaria verriculata*, Feld., Reise der Nov., v., pl. cxxxi., fig. 20. *Phibalapteryx verriculata*, Butl., Proc. Zool. Soc. Lond., 1877, p. 396. *Panopæa verriculata*, Meyr., Trans. N.Z. Inst., xvi., p. 62.**Homodotis**, Meyr.Homodotis rufescens, *Butl.**Larentia (?) rufescens*, Butl., Cist. Ent., ii., p. 502. *Eurydice cymosema*, Meyr., Trans. N.Z. Inst., xvii., p. 63.**Probolæa**, Meyr.Probolæa megaspilata, *Walk.**Larentia megaspilata*, Walk., Cat. Lep. Brit. Mus., xxiv., p. 1198. *Cidaria assata*, Feld., Reise der Nov., Lep., v., pl. cxxxi., fig. 4. *C. nehata*, Feld., *l.c.*, fig. 6. *Larentia megaspilata*, Butl., Cat. Lep. N.Z., p. 14; *ib.*, Cist. Ent., ii., p. 502. *Larentia (?) nehata*, *ib.*, p. 503. *Harpalyce megaspilata*, Meyr., Trans. N.Z. Inst., xvi., p. 63.Probolæa parora, *Meyr.**Harpalyce parora*, Meyr., Trans. N.Z. Inst., xvii., p. 63. *H. humeraria*, *ib.*, xvi., p. 64.**Arcteuthes**, Meyr.Arcteuthes euclidiata, *Guén.**Coremia euclidiata*, Guén. *C. glypticata*, *ib.*, 420. *Fidonia catapyrrha*, Butl., Proc. Zool. Soc. Lond., 1877, p. 392, pl. xliii., fig. 2. *Stratonice catapyrrha*, Meyr., *l.c.*, xvi., p. 64; *ib.*, xvii., p. 63.

*Arcteuthes chrysopeda*, *Meyr.*

*A. chrysopeda*, *Meyr., l.c.*, xx., p. 47.

**Elvia**, *Walk.*

*Elvia glaucata*, *Walk.*

*E. glaucata*, *Walk., l.c.*, p. 1431; *Feld., l.c.*, cxxxii., fig. 25; *Butl., Cat. Lep. N.Z.*, p. 18, and *Cist. Ent.*, ii., p. 509; *Meyr., Trans. N.Z. Inst.*, xvi., p. 65.

**Pasiphila**, *Meyr.*

*Pasiphila plinthina*, *Meyr.*

*P. plinthina*, *Meyr., l.c.*, xx., p. 49.

*Pasiphila muscosata*, *Walk.*

*Eupithecia muscosata*, *Walk., l.c.*, xxiv., p. 1246. *Euthecia cidariaria*, *Guén., Ent. Mo. Mag.*, v., p. 62. *Cidaria aquosata*, *Feld., l.c.*, pl. cxxx., fig. 33. *Eupithecia cidariaria*, *Butl., Cat. Lep. N.Z.*, p. 15. *Cidaria muscosata*, *Butl., Cist. Ent.*, ii., p. 508.

*Pasiphila bilineolata*, *Walk.*

*Eupithecia bilineolata*, *Walk., l.c.*, xxiv., p. 1246. *Scotosia denotata*, *Walk., l.c.*, xxv., p. 1361; *Butl., Cat. Lep. N.Z.*, p. 16; *Meyr., l.c.*, xvii., p. 67. *S. humerata*, *ib.*, xxv., p. 1362. *Eupithecia semi-albata*, *ib.*, xxvi., p. 1708. *E. (?) bilineolata*, *Butl., Cat. Lep. N.Z.*, p. 15. *Scotosia humerata*, *ib.*, p. 16. *Eupithecia semialbata*, *ib.*, p. 15. *Helastia charybæis*, *ib.*, *Cist. Ent.*, ii., p. 503. *H. calida*, *ib.*, p. 504. *Pasiphila bilineolata*, *Meyr., l.c.*, xx., p. 50.

*Pasiphila nereis*, *Meyr.*

*P. nereis*, *Meyr., l.c.*, xx., p. 51.

*Pasiphila sphragitis*, *Meyr.*

*P. sphragitis*, *Meyr., l.c.*, xx., p. 51.

*Pasiphila lichenodes*, *Purdie.*

*P. lichenodes*, *Purd.*; *Meyr., l.c.*, xx., p. 52.

*Pasiphila indicataria*, *Walk.*

*Eupithecia indicataria*, *Walk., l.c.*, xxvi., p. 1708; *Butl., Cat. Lep. N.Z.*, p. 15. *Pasiphila indicataria*, *Meyr., l.c.*, xx., p. 52.

*Pasiphila inductata*, *Walk.*

*Coremia inductata*, *Walk., l.c.*, xxv., p. 1322; *Butl., Cat. Lep. N.Z.*, p. 15; *Scotosia subitata*, *Walk., l.c.*, xxv., p. 1362; *Butl., Cat. Lep. N.Z.*, p. 16. *Pasiphila inductata*, *Meyr., l.c.*, xx., p. 53.

*Pasiphila dryas*, *Meyr.*

*P. dryas*, *Meyr., l.c.*, xxiii., p. 97.

**Phrixogonus**, *Butl.*

*Phrixogonus denotata*, *Walk.*

*Scotosia denotata*, *Walk., l.c.*, xxv., p. 1362; *Butl., Cat. Lep. N.Z.*, p. 16. *Phibalapteryx parvulata*, *Walk., l.c.*, xxvi., p. 1721; *Butl., Cat. Lep. N.Z.*, p. 16. *Phrixogonus denotatus (sic)*, *Meyr., l.c.*, xx., p. 53.

**Tatosoma**, *Butl.*

*Tatosoma lestevata*, *Walk.*

*Cidaria lestivata*, *Walk., l.c.*, xxv., p. 1416. *Sauris ranata*, *Feld., l.c.*, pl. cxxxi., fig. 11. *Tatosoma lestevata*, *Butl., Cat. Lep. N.Z.*, p. 18; *ib.*, *Proc. Zool. Soc. Lond.*, 1877, p. 398; *Meyr., l.c.*, xvi., p. 67.

**Tatosoma agrionata**, *Walk.*

*Cidaria agrionata*, Walk., *l.c.*, xxv., p. 1417. *C. tipulata*, *ib.*, 1417. *C. inclinataria*, *ib.*, 1418. *C. transitaria*, *ib.*, 1419. *C. collectaria*, *ib.*, 1419. *Sauris mistata*, Feld., *l.c.*, pl. cxxxi., fig. 12. *Tatosoma transitaria*, Butl., *Cist. Ent.*, ii., p. 304. *T. agrionata*, Meyr., *l.c.*, xvii., p. 64.

**Tatosoma timora**, *Meyr.*

*T. timora*, Meyr., *l.c.*, xvii., p. 64. *T. agrionata*, Meyr., *l.c.*, xvi., p. 68.

**Asthena**, Hübner.**Asthena pulchraria**, *Doubl.*

*Acidalia pulchraria*, *Doubl.*, Dieffenbach's "New Zealand," app., p. 286; Butl., *Cat. Lep. N.Z.*, p. 13; *ib.*, *Proc. Zool. Soc. Lond.*, 1877, p. 390. *Chlorochroma plurilineata*, Walk., *l.c.*, xxii., pp. 563 and 676. *Asthena ondinata*, Guén., *Sp. Gen. Lep. Phal.*, i., p. 438, pl. xix., fig. 4; Butl., *Cat. Lep. N.Z.*, p. 12, tab. 3, fig. 20; *ib.*, *Cist. Ent.*, ii., p. 498. *Cidaria ondinata*, Feld., *l.c.*, pl. cxxviii., fig. 17. *Asthena pulchraria*, Meyr., *l.c.*, xvi., p. 69.

**Asthena schistaria**, *Walk.*

*Acidalia schistaria*, Walk., *l.c.*, xxiv., p. 782; Butl., *Cat. Lep. N.Z.*, p. 13; *ib.*, *Proc. Zool. Soc. Lond.*, 1877, p. 391; *ib.*, *Cist. Ent.*, ii., p. 498. *Asthena subpurpureata*, Walk., *l.c.*, xxvi., p. 1588; Butl., *Cat. Lep. N.Z.*, p. 12; *ib.*, *Proc. Zool. Soc. Lond.*, 1877, p. 390; *ib.*, *Cist. Ent.*, ii., p. 498. *A. schistaria*, Meyr., *l.c.*, xvi., p. 69.

**Scotosia**, Stephens.**Scotosia gobiata**, *Feld.*

*Cidaria gobiata*, Feld., *l.c.*, pl. cxxxi., fig. 2. *Phibalapteryx gobiata*, *P. simulans*, *P. undulifera*, Butl., *Cist. Ent.*, ii., p. 506. *P. anguligera*, *P. rivularis*, *ib.*, p. 507. *Scotosia gobiata*, Meyr., *l.c.*, xvi., p. 70.

**Cephalissa**, Meyr.**Cephalissa deltoidata**, *Walk.*

*Coremia deltoidata*, Walk., *l.c.*, xxv., p. 1321; Butl., *Cat. Lep. N.Z.*, p. 15. *Cidaria inclarata*, Walk., *l.c.*, xxv., p. 1411; Butl., *Proc. Zool. Soc. Lond.*, 1877, p. 398; *ib.*, *Cist. Ent.*, ii., p. 508. *C. perductata*, Walk., *l.c.*, xxv., p. 1412; Butl., *Cat. Lep. N.Z.*, p. 17. *C. congressata*, Walk., *l.c.*, xxv., p. 1412; Butl., *Cat. Lep. N.Z.*, p. 17. *C. conversata*, Walk., *l.c.*, xxv., p. 1413. *C. descriptata*, Walk., *l.c.*, xxv., p. 1414. *C. bisignata*, Walk., *l.c.*, p. 1415. *C. aggregata*, Walk., *l.c.*, p. 1415; Butl., *Cist. Ent.*, ii., p. 508. *C. congregata*, Walk., *l.c.*, p. 1415; Butl., *Cat. Lep. N.Z.*, p. 17; *ib.*, *Proc. Zool. Soc. Lond.*, 1877, p. 397. *C. plagifurcata*, Walk., *l.c.*, xxv., p. 1416; Butl., *Cat. Lep. N.Z.*, p. 17; *ib.*, *Proc. Zool. Soc. Lond.*, 1877, p. 398. *Coremia pastinaria*, Guén., *Ent. Mo. Mag.*, v., p. 64; Butl., *Cat. Lep. N.Z.*, p. 16. *Cidaria inopiata*, Feld., *l.c.*, pl. cxxxii., fig. 3. *C. monoliata*, *ib.*, *l.c.*, pl. cxxxii., fig. 8. *C. perversata*, *ib.*, pl. cxxxii., figs. 14, 24. *Scotosia deltoidata*, Meyr., *l.c.*, xvi., p. 70. *Cephalissa deltoidata*, Meyr., *l.c.*, xx., p. 54.

**Epyaxa**, Meyr.**Epyaxa rosearia**, *Doubl.*

*Cidaria rosearia*, *Doubl.*, Dieffenbach's "New Zealand," ii., p. 285. *Coremia rosearia*, Butl., *Cat. Lep. N.Z.*, p. 15, tab. 3., fig. 13; Butl., *Proc. Zool. Soc. Lond.*, 1877, p. 396; Butl., *Cist. Ent.*, ii., p. 505. *C. arduaria*, Guén., *Ent. Mo. Mag.*, v., p. 63; Butl., *Cat. Lep. N.Z.*,



p. 16; Butl., Proc. Zool. Soc. Lond., 1877, p. 396. *C. inamendaria*, Guén., Ent. Mo. Mag., v., p. 63; Butl., Cat. Lep. N.Z., p. 16. *Epyaxa rosearia*, Meyr., l.c., xvi., p. 71.

*Epyaxa orophyla*, Meyr.

*E. orophyla*, Meyr., l.c., xvi., p. 71.

*Epyaxa semifissata*, Walk.

*Coremia semifissata*, Walk., l.c., xxv., p. 1320; Butl., Cat. Lep. N.Z., p. 15. *C. ypsilonaria*, Guén., Ent. Mo. Mag., v., p. 94; Butl., Cat. Lep. N.Z., p. 16. *Cidaria delicatulata*, Guén., Ent. Mo. Mag., v., p. 94; Butl., Cat. Lep. N.Z., p. 17. *Epyaxa semifissata*, Meyr., l.c., xvi., p. 72.

*Epyaxa chlamydata*, Meyr.

*E. chlamydata*, Meyr., l.c., xvi., p. 72.

*Epyaxa limonodes*, Meyr.

*E. limonodes*, Meyr., l.c., xx., p. 54.

*Epyaxa subductata*, Walk.

*Larentia subductata*, Walk., l.c., xxiv., p. 1198; Butl., Cat. Lep. N.Z., p. 14. *Epyaxa subducta*, Meyr., l.c., xx., p. 55

**Anachloris**, Meyr.

*Anachloris subochraria*, Doubl.

*Aspilates* (?) *subochraria*, Doubl., Dieffenbach's "New Zealand," ii., p. 285. *A. euboliaria*, Walk., l.c., xxvi., p. 1684; Butl., Cat. Lep. N.Z., p. 14; and see Meyr., l.c., xvii., p. 66. *Camptogramma subochraria*, Butl., Cat. Lep. N.Z., p. 16, tab. 3, fig. 16; Butl., Proc. Zool. Soc. Lond., 1877, p. 396. *C. strangulata*, Guén., Gen. Lep. Phal., ii.(?), p. 423. *C. fuscinata*, Guén., Ent. Mo. Mag., v., p. 92; Butl., Cat. Lep. N.Z., p. 16. *Arsinoe subochraria*, Meyr., l.c., xvi., p. 73. *Anachloris subochraria*, Meyr., l.c., xx., p. 56.

*Anachloris prionota*, Meyr.

*Arsinoe prionota*, Meyr., l.c., xvi., p. 73.

**Cidaria**, Tr.

*Cidaria triphragma*, Meyr.

*C. triphragma*, Meyr., l.c., xvi., p. 74.

*Cidaria rixata*, Feld.

*C. rixata*, Feld., l.c., pl. cxxxii., fig. 1. *Coremia squalida*, Butl., Cist. Ent., ii., p. 505. *Cidaria rixata*, Meyr., l.c., xvi., p. 75.

*Cidaria purpurifera*, Fered.

*C. purpurifera*, Fered., N.Z. Journ. Sc., 1883, p. 531, Trans. N.Z. Inst., xvi., p. 119; Meyr., l.c., xvi., p. 75.

*Cidaria similata*, Walk.

*C. similata*, Walk., l.c., xxv., p. 1413; Butl., Cat. Lep. N.Z., p. 17; Butl., Proc. Zool. Soc. Lond., 1877, p. 397, and Cist. Ent., ii., p. 508. *C. timarata*, Feld., l.c., pl. cxxxii., fig. 19. *C. similata*, Meyr., l.c., xvi., p. 76.

*Cidaria callichlora*, Butl.

*C. callichlora*, Butl., Cist. Ent., ii., p. 509; Meyr., l.c., xvi., p. 76.

*Cidaria arida*, Butl.

*Melanthia arida*, Butl., Cist. Ent., ii., p. 505. *Cidaria chaotica*, Meyr., l.c., xvi., p. 76. *C. arida*, Meyr., l.c., xvii., p. 64.

## Larentia, Tr.

## Larentia stinata, Guén.

*Camptogramma stinata*, Guén., Ent. Mo. Mag., v., p. 92; Butl., Cat. Lep. N.Z., p. 16, and Proc. Zool. Soc. Lond., 1877, p. 396. *Larentia stinaria*, Meyr., l.c., xvi., p. 78.

## Larentia præfectata, Walk.

*Acidalia præfectata*, Walk., l.c., xxiv., p. 781; Butl., Cat. Lep. N.Z., p. 13. *A. subtentaria*, Walk., l.c., xxvi., p. 1610; Butl., Cat. Lep. N.Z., p. 13. *A. absconditaria*, Walk., l.c., xxvi., p. 1611; Butl., Cat. Lep. N.Z., p. 13, tab. 3, fig. 21. *Larentia præfectata*, Meyr., l.c., xvi., p. 78.

## Larentia nephelias, Meyr.

*L. nephelias*, Meyr., l.c., xvi., p. 78.

## Larentia cataphracta, Meyr.

*L. cataphracta*, Meyr., l.c., xvi., p. 79.

## Larentia clarata, Walk.

*L. clarata*, Walk., l.c., xxiv., p. 1197; Butl., Cat. Lep. N.Z., p. 14, tab. 3, fig. 14. *Cidaria pyramaria*, Guén., Ent. Mo. Mag., v., p. 93; Butl., Cat. Lep. N.Z., p. 17. *Larentia clarata*, Meyr., l.c., xvi., p. 79.

## Larentia beata, Butl.

*Cidaria beata*, Butl., Proc. Zool. Soc. Lond., 1877, p. 397, pl. xliii., fig. 6; *ib.*, Cist. Ent., vol. ii., p. 508. *Larentia beata*, Meyr., l.c., xvi., p. 79.

## Larentia chlorias, Meyr.

*L. chlorias*, Meyr., l.c., xvi., p. 80.

## Larentia ægrota, Butl.

*Selidosema ægrota*, Butl., Cist. Ent., ii., p. 499; Meyr., l.c., xvi., p. 80.

## Larentia lucidata, Walk.

*L. lucidata*, Walk., l.c., xxiv., p. 1200; Butl., Cat. Lep. N.Z., p. 14. *Coremia plurimata*, Walk., l.c., xxv., p. 1321; Butl., Cat. Lep. N.Z., p. 15. *Panagra veinipunctata*, Walk., l.c., xxvi., p. 1666; Butl., Cat. Lep. N.Z., p. 13. *Larentia psamathodes*, Meyr., l.c., xvi., p. 81. *L. lucidata*, *ib.*, l.c., xvii., p. 64.

## Larentia quadristrigata, Walk.

*L. quadristrigata*, Walk., l.c., xxiv., p. 1200; Butl., Cat. Lep. N.Z., p. 14. *L. interchusa*, Walk., l.c., xxiv., p. 1202; Butl., Cat. Lep. N.Z., p. 13. *L. quadristrigata*, Meyr., l.c., xvii., p. 67.

## Larentia helias, Meyr.

*L. helias*, Meyr., l.c., xvi., p. 81.

## Larentia prasinias, Meyr.

*L. prasinias*, Meyr., l.c., xvi., p. 81.

## Larentia chionogramma, Meyr.

*L. chionogramma*, Meyr., l.c., xvi., p. 82.

## Larentia obarata, Feld.

*Cidaria obarata*, Feld., l.c., pl. cxxxii., fig. 33. *Larentia obarata*, Meyr., l.c., xvi., p. 82.

## Larentia subobscurata, Walk.

*Scotosia subobscurata*, Walk., l.c., xxv., p. 1358; Butl., Cat. Lep. N.Z., p. 16. *Larentia petropola*, Meyr., l.c., xvi., p. 82. *L. obscurata*, *ib.*, l.c., xvii., p. 64.

*Larentia cinerearia*, Doubl.

*Cidaria* (?) *cinerearia*, Doubl., Dieffenbach's "New Zealand," ii., p. 286. *Larentia* (?) *inverata*, Walk., *l.c.*, xxiv., p. 1199; Butl., Cat. Lep. N.Z., p. 14; *ib.*, Cist. Ent., ii., p. 503. *L. semisignata*, Walk., *l.c.*, xxiv., p. 1200; Butl., Cat. Lep. N.Z., p. 14; *ib.*, Proc. Zool. Soc. Lond., 1877, p. 394. *L. inoperata*, Walk., *l.c.*, xxiv., p. 1201. *L. diffusaria*, Walk., *l.c.*, xxiv., p. 1201; Butl., Cat. Lep. N.Z., p. 15. *L. punctilineata*, Walk., *l.c.*, xxiv., p. 1202; Butl., Cat. Lep. N.Z., p. 15, tab. 3, fig. 12; *ib.*, Cist. Ent., ii., p. 501. *Cidaria dissociata*, Walk., *l.c.*, xxvi., p. 1734; Butl., Cat. Lep. N.Z., p. 17. *C. similisata*, Walk., *l.c.*, xxvi., p. 1735. *C. semilisata*, Butl., Cat. Lep. N.Z., p. 17. *Larentia corcularia*, Guén., Ent. Mo. Mag., v., p. 61; Butl., Cat. Lep. N.Z., p. 15. *L. infantaria*, Guén., *l.c.*, p. 62; Butl., Cat. Lep. N.Z., p. 15. *Helastia epitheciaria*, Guén., *l.c.*, p. 95; Butl., Cat. Lep. N.Z., p. 17. *Cidaria sphaeriata*, Feld., *l.c.*, pl. cxxxi., fig. 14. *Larentia cinerearia*, Butl., Cat. Lep. N.Z., p. 15; Meyr., *l.c.*, xvi., p. 83; *ib.*, xvii., p. 64.

*Larentia subductata*, Walk.

*L. subductata*, Walk., *l.c.*, xxiv., p. 1198; Butl., Cat. Lep. N.Z., p. 14; Meyr., *l.c.*, xvii., p. 66.

*Larentia anthracias*, Meyr.

*L. anthracias*, Meyr., *l.c.*, xvi., p. 84.

*Larentia bulbulata*, Guén.

*Cidaria bulbulata*, Guén., *l.c.*, p. 94; Butl., Cat. Lep. N.Z., p. 17. *Larentia bulbulata*, Meyr., *l.c.*, xvi., p. 84.

*Larentia falcata*, Butl.

*L. (?) falcata*, Butl., Cist. Ent., ii., p. 501; Meyr., *l.c.*, xvii., p. 67; *ib.*, xx., p. 58.

*Larentia mnesichola*, Meyr.

*L. mnesichola*, Meyr., *l.c.*, xx., p. 56.

*Larentia cosmadora*, Meyr.

*L. cosmadora*, Meyr., *l.c.*, xx., p. 57.

*Larentia bryopis*, Meyr.

*L. bryopis*, Meyr., *l.c.*, xx., p. 57.

*Larentia camelias*, Meyr.

*L. camelias*, Meyr., *l.c.*, xx., p. 58.

*Larentia chorica*, Meyr.

*L. chorica*, Meyr., *l.c.*, xx., p. 58.

**Notorias**, Meyr.

*Notorias insignis*, Butl.

*Aspilates insignis*, Butl., Proc. Zool. Soc. Lond., 1877, p. 393, pl. xliii., fig. 1. *Pasitheia insignis*, Meyr., *l.c.*, xvi., p. 85.

*Notorias orphnæa*, Meyr.

*Pasitheia orphnæa*, Meyr., *l.c.*, xvi., p. 85.

*Notorias mechanitis*, Meyr.

*Pasitheia mechanitis*, Meyr., *l.c.*, xvi., p. 86.

*Notorias paradelpa*, Meyr.

*Pasitheia paradelpa*, Meyr., *l.c.*, xvi., p. 86.

*Notorias strategica*, Meyr.

*Pasitheia strategica*, Meyr., *l.c.*, xvi., p. 87.

Notorias callicrena, *Meyr.*

*Pasithea callicrena*, *Meyr., l.c., xvi., p. 87.*

Notorias perornata, *Walk.*

*Fidonia perornata*, *Walk., l.c., xxvi., p. 1672; Butl., Cat. Lep. N.Z., p. 15. Pasithea perornata, Meyr., l.c., xvi., p. 87.*

Notorias niphocrena, *Meyr.*

*Pasithea niphocrena*, *Meyr., l.c., xvi., p. 88.*

Notorias ferox, *Butl.*

*Fidonia ferox*, *Butl., Proc. Zool. Soc. Lond., 1877, p. 392, pl. xlii., fig. 8. Pasithea ferox, Meyr., l.c., xvi., p. 88.*

Notorias zopyra, *Meyr.*

*Pasithea zopyra*, *Meyr., l.c., xvi., p. 89.*

Notorias vulcanica, *Meyr.*

*Pasithea vulcanica*, *Meyr., l.c., xvi., p. 89.*

Notorias brephosata, *Walk.*

*Fidonia brephosata*, *Walk., l.c., xxiv., p. 1037; Butl., Cat. Lep. N.Z., p. 14, tab. 3, fig. 3; ib., Proc. Zool. Soc. Lond., 1877, p. 391. Iarentia catocalaria, Guén., l.c., v., p. 62; Butl., Cat. Lep. N.Z., p. 15. Fidonia catocalaria, Butl., Cist. Ent., ii., p. 499. F. brephos, Feld., l.c., pl. cxxix., fig. 5. Pasithea brephos, Meyr., l.c., xvi., p. 89.*

Notorias omichlias, *Meyr.*

*Pasithea omichlias*, *Meyr., l.c., xvi., p. 90.*

### **Stathmonyma, Meyr.**

Stathmonyma enysii, *Butl.*

*Fidonia enysii*, *Butl., Proc. Zool. Soc. Lond., 1877, p. 391, pl. xlii., fig. 9. Stathmonyma homomorpha, Meyr., l.c., xvi., 9. S. enysii, Meyr., l.c., xvii., p. 65.*

Stathmonyma anceps, *Butl.*

*Fidonia anceps*, *Butl., Proc. Zool. Soc. Lond., 1877, p. 392, pl. xlii., fig. 3. Stathmonyma homomorpha, Meyr., l.c., xvi., p. 91.*

Stathmonyma hectori, *Butl.*

*Euclidia hectori*, *Butl., Proc. Zool. Soc. Lond., 1877, p. 387, pl. xlii., fig. 4. Stathmonyma hectori, Meyr., l.c., xvi., p. 91.*

### **Dasyuris, Guén.**

Dasyuris partheniata, *Guén.*

*D. partheniata*, *Guén., l.c., p. 93; Butl., Cat. Lep. N.Z., p. 16; ib., Proc. Zool. Soc. Lond., 1877, p. 393; Meyr., l.c., xvi., p. 92.*

### **Cephalissa, Meyr.**

Cephalissa siria, *Meyr.*

*C. siria*, *Meyr., l.c., xvi., p. 93.*

### **Samana, Walk.**

Samana falcatella, *Walk.*

*S. falcatella*, *Walk., l.c., xxvii., p. 197; Butl., Cat. Lep. N.Z., p. 19; Meyr., l.c., xvi., p. 93.*

Samana acutata, *Butl.*

*S. acutata*, *Butl., Proc. Zool. Soc. Lond., 1877, p. 401; Meyr., l.c., xvii., p. 67.*

Family MONOCTENIADÆ.

**Dichromodes**, Guén.

*Dichromodes nigra*, *Butl.*

*Cacopsodos nigra*, *Butl.*; *Meyr.*, *Trans. N.Z. Inst.*, xx., p. 60; *ib.*, xxiii., p. 184.

*Dichromodes gypsotis*, *Meyr.*

*D. gypsotis*, *Meyr.*, *l.c.*, xx., p. 60. *Cacopsodos niger*, *Meyr.*, *l.c.*, xvi., p. 94.

*Dichromodes petrina*, *Meyr.*

*D. petrina*, *Meyr.*, *l.c.*, xxiv., p. 216.

*Dichromodes niger*, *Butl.*

*Cacopsodos niger*, *Butl.*, *Proc. Zool. Soc. Lond.*, 1877, p. 395; *Meyr.*, *l.c.*, xvi., p. 94; and see *Meyr.*, *l.c.*, xviii., p. 184, and xx., p. 60.

Family LYRCEIDÆ.

**Lyrcea**, Walk.

*Lyrcea alectoraria*, *Walk.*

*L. alectoraria*, *Walk.*, *l.c.*; *Butl.*, *Cist. Ent.*, ii., p. 496; *Aspitates* (?) *primata*, *Walk.*, *l.c.*, xxiv., p. 1076; *Butl.*, *Cat. Lep. N.Z.*, p. 14, tab. 3, fig. 4. *Ennomos ustaria*, *Walk.*, *l.c.*, xxvi., p. 1519; *Butl.*, *Cat. Lep. N.Z.*, p. 12. *Eurotopia mixtaria*, *Walk.*, *l.c.*, xxvi., p. 1506; *Butl.*, *Cat. Lep. N.Z.*, p. 11, tab. 3, fig. 5. *Amilapsis* (?) *acroiaria*, *Feld.*, *l.c.*, pl. cxxxiii., fig. 6. *Lyrcea varians*, *Butl.*, *Cist. Ent.*, ii., p. 496; *L. alectoraria*, *Meyr.*, *l.c.*, xvi., p. 95; *Meyr.*, *l.c.*, xvii., p. 66.

Family SELIDOSEMIIDÆ.

**Hybernia**, Lat.

*Hybernia indociliaria*, *Walk.*

*Zermizinga indociliaria*, *Walk.*, *l.c.*, xxvi., p. 1530; *Butl.*, *Cat. Lep. N.Z.*, p. 12. *Hybernia boreophilaria*, *Guén.*, *Ent. Mo. Mag.*, v., p. 61. *H. indocilis*, *Meyr.*, *l.c.*, xvi., p. 97.

**Selidosema**, Hübn.

*Selidosema fenerata*, *Feld.*

*Rhyparia fenerata*, *Feld.*, *l.c.*, pl. cxxxi., fig. 7. *Zylobara fenerata*, *Butl.*, *Cist. Ent.*, ii., p. 498. *Boarmia fenerata*, *Meyr.*, *l.c.*, xx., p. 61; and see *Meyr.*, *l.c.*, xxiv., p. 216, as to *Selidosema*.

*Selidosema productata*, *Walk.*

*Larentia productata*, *Walk.*, *l.c.*, xxiv., p. 1197; *Butl.*, *Cat. Lep. N.Z.*, p. 14; *Butl.*, *Proc. Zool. Soc. Lond.*, 1877, p. 394. *Pseudocoremia indistincta*, *Butl.*, *Cist. Ent.*, ii., p. 498. *Selidosema pungata*, *Feld.*, *l.c.*, pl. cxxxii., fig. 23; *S.* (?) *fragosata*, *Feld.*, *l.c.*, pl. cxxxii., fig. 29; and see *Meyr.*, *l.c.*, xxiv., p. 216, as to *Selidosema*.

*Selidosema suavis*, *Butl.*

*Pseudocoremia suavis*, *Butl.*, *Cist. Ent.*, ii., p. 497. *Pachygnemia usitata*, *Butl.*, *Cist. Ent.*, ii., p. 501. *Pseudocoremia lupinata*, *Meyr.*, *l.c.*, xvi., p. 98. *Boarmia suavis*, *Meyr.*, *l.c.*, xxiii., p. 101; and see *Meyr.*, *l.c.*, xxiv., p. 216, as to *Selidosema*.

*Selidosema lupinata*, *Feld.*

*Cidaria lupinata*, *Feld.*, *l.c.*, pl. cxxxi., fig. 19. *Pseudocoremia lupinata*, *Butl.*, *Cist. Ent.*, ii., p. 496. *Boarmia lupinata*, *Meyr.*, *l.c.*, xxiii., p. 101; and see *Meyr.*, *l.c.*, xxiv., p. 316, as to *Selidosema*.

*Selidosema melinata*, *Feld.*

*Numeria melinata*, *Feld.*, *l.c.*, pl. cxxix., fig. 9. *Pseudocoremia indistincta*,\* *Butl.*, *Proc. Zool. Soc. Lond.*, 1877, p. 394, pl. xliiii., fig. 8, and *Cist. Ent.*, ii., p. 498. *P. confusa*, *Butl.* (see *Meyr.*, *l.c.*, xvii., p. 65). *P. melinata*, *Meyr.*, *l.c.*, xvi., p. 99. *Boarmia melinata*, *Meyr.*, *l.c.*, xx., p. 61; and see *Meyr.*, *l.c.*, xxiv., p. 216, as to *Selidosema*.

*Selidosema dejectaria*, *Walk.*

*Boarmia dejectaria*, *Walk.*, *l.c.*, xxi., p. 394; *Butl.*, *Cat. Lep. N.Z.*, p. 12, and *Proc. Zool. Soc. Lond.*, p. 390. *B. attracta*, *Walk.*, *l.c.*, xxi., p. 394; *Butl.*, *Cat. Lep. N.Z.*, p. 12. *B. exprompta*, *Walk.*, *l.c.*, xxi., p. 395. *Tephrosia patularia*, *Walk.*, *l.c.*, xxi., p. 422; *Butl.*, *Cat. Lep. N.Z.*, p. 12, tab. 3, fig. 8. *T. scriptaria*, *Walk.*, *l.c.*, xxi., p. 422; *Butl.*, *Cat. Lep. N.Z.*, p. 12. *Scotosia lignosata*, *Walk.*, *l.c.*, xxv., p. 1361. *S. erebinata*, *Walk.*, *l.c.*, xxv., p. 1358. *S. stigmaticata*, *Walk.*, *l.c.*, xxv., p. 1359; *Butl.*, *Cat. Lep. N.Z.*, p. 16. *Gnophos panularia*, *Guén.*, *l.c.*, p. 42. *Scotopteryx maoriata*, *Feld.*, *l.c.*, pl. cxxvi., fig. 4. *Hemerophila* (?) *sulpitiata*, *Feld.*, *l.c.*, cxxvi., fig. 7. *H. caprimulgata*, *Feld.*, *l.c.*, pl. cxxvi., fig. 12. *Boarmia dejectaria*, *Meyr.*, *l.c.*, xvi., p. 100; and see *Meyr.*, *l.c.*, xxiv., p. 216, as to *Selidosema*.

*Selidosema panagrata*, *Walk.*

*Scotosia panagrata*, *Walk.*, *l.c.*, xxv., p. 1360; *Butl.*, *Cat. Lep. N.Z.*, p. 16. *Angerona menanaria*, *Walk.*, *l.c.*, xxvi., p. 1500; *Butl.*, *Cat. Lep. N.Z.*, p. 11. *Epirrhantis* (?) *antipodaria*, *Feld.*, *l.c.*, pl. cxxvi., fig. 3. *Hyperythra dessicata*, *Butl.*, *Cist. Ent.*, ii., p. 495. *H. arenacea*, *Butl.*, *Cist. Ent.*, ii., p. 495. *Barsine panagrata*, *Meyr.*, *l.c.*, xvi., p. 100; and see *Meyr.*, *l.c.*, xvii., p. 65, as to *Barsine*, and xxiv., p. 216, as to *Selidosema*.

*Selidosema rudisata*, *Walk.*

*Cidaria rudisata*, *Walk.*, *l.c.*, xxv., p. 1420; *Butl.*, *Cat. Lep. N.Z.*, p. 17. *Boarmia astrapia*, *Meyr.*, *l.c.*, xxii., p. 218. *B. rudiata*, *Meyr.*, *l.c.*, xxiii., p. 101; and see *Meyr.*, *l.c.*, xxiv., p. 216, as to *Selidosema*.

*Selidosema aristarcha*, *Meyr.*

*S. aristarcha*, *Meyr.*, *l.c.*, xxiv., p. 216.

**Detunda**, *Walk.**Detunda atronivea*, *Walk.*

*D. atronivea*, *Walk.*, *l.c.*, xxxii., p. 619. *Chlenias* (?) *manxifera*, *Fered.*, *Trans. N.Z. Inst.*, xii., p. 268, pl. ix., fig. 1. *Detunda atronivea*, *Meyr.*, *l.c.*, xvi., p. 101.

*Detunda egregia*, *Feld.*

*Chlenias egregia*, *Feld.*, *l.c.*, pl. cxxxii., fig. 24; *Fered.*, *l.c.*, xii., p. 268, pl. ix., fig. 2. *Detunda egregia*, *Meyr.*, *l.c.*, xvi., p. 101.

**Declana**, *Walk.**Declana floccosa*, *Walk.*

*D. floccosa*, *Walk.*, *l.c.*, xv., p. 1649; *Butl.*, *Proc. Zool. Soc. Lond.*, 1877, p. 398. *Argua scabra*, *Walk.*, *l.c.*, xxviii., p. 448. *Declana scabra*, *Butl.*, *Cist. Ent.*, ii., p. 500. *D. feredayi*, *Butl.*, *Proc. Zool. Soc. Lond.*, 1877, p. 398, pl. xliiii., fig. 5. *D. nigrosparsa*, *Butl.*, *Cist. Ent.*, ii., p. 500. *D. floccosa*, *Meyr.*, *l.c.*, xvi., p. 102.

\* Mr. Meyrick puts this so. I think it must be a mistake; *indistincta* does not appear to me to be identical with *melinata*.—R. W. F.

*Declana junctilinea*, Walk.

*Politeia junctilinea*, Walk., *l.c.*, xxviii., p. 643. *Chlenias verrucosa*, Feld., *l.c.*, pl. cxxxi., fig. 22. *Declana crassitibia*, ♂, Meyr., *l.c.*, xvi., p. 103. *D. junctilinea*, Meyr., *l.c.*, xvii., p. 65.

**Epicasis**, Meyr.

*Epicasis niveata*, Butl.

*Declana niveata*, Butl., *Cist. Ent.*, ii., p. 500. *Atossa niveata*, Meyr., *l.c.*, xvi., p. 104; and see Meyr., *l.c.*, xviii., p. 184.

**Ipana**, Walk.

*Ipana leptomera*, Walk.

*I. leptomera*, Walk., *l.c.*, xv., p. 1662; Butl., *Cat. Lep. N.Z.*, p. 6. *Amphilape crassitibia*, Feld., *l.c.*, pl. cix., fig. 10. *Declana crassitibia*, ♀, Meyr., *Trans. N.Z. Inst.*, xvi., p. 103. *Ipana leptomera*, Meyr., *l.c.*, xvii., p. 66.

**Gonophylla**, Meyr.

*Gonophylla nelsonaria*, Feld.

*Gonodontis nelsonaria*, Feld., *l.c.*, pl. cxiii., fig. 3. *G. felix*, Butl., *Proc. Zool. Soc. Lond.*, 1877, 389, tab. xlii., fig. 10. *Phyllodoce nelsonaria*, Meyr., *l.c.*, xvi., p. 104; and see Meyr., *l.c.*, xviii., p. 184.

**Sestra**, Walk.

*Sestra humeraria*, Walk.

*Macaria humeraria*, Walk., *l.c.*, xxiii., p. 490. *Lozogramma obtusaria*, *ib.*, p. 985. *Sestra obtusaria*, Butl., *Cist. Ent.*, ii., p. 390. *Cidaria flexata*, Walk., *l.c.*, xxv., p. 1421; Butl., *Cat. Lep. N.Z.*, p. 17. *Sestra flexata*, Butl., *Cist. Ent.*, ii., p. 494. *Cidaria (?) obruncata*, Walk., *l.c.*, xxv., p. 1421; Butl., *Proc. Zool. Soc. Lond.*, 1877, p. 389. *Sestra fusiplagiata*, Walk., *l.c.*, xxvi., p. 1750; Butl., *Cat. Lep. N.Z.*, p. 12. *S. humeraria*, Butl., *Cist. Ent.*, ii., p. 494. *Amastris encausta*, Meyr., *l.c.*, xvi., p. 105. *A. humeraria*, Meyr., *l.c.*, xvii., p. 66; and see Meyr., *l.c.*, xviii., p. 184.

**Chalastra**, Walk.

*Chalastra pellurgata*, Walk.

*C. pellurgata*, Walk., *l.c.*, xxv., p. 1430; Butl., *Cat. Lep. N.Z.*, p. 18. *Itama cinerascens*, Feld., *l.c.*, pl. cxxxi., fig. 1. *Stratocleis streptophora*, Meyr., *l.c.*, xvi., p. 106. *Chalastra pellurgata*, Meyr., *l.c.*, xvii., p. 66.

**Azelina**, Guén.

*Azelina fortinata*, Guén.

*Polygonia fortinata*, Guén., *Ent. Mo. Mag.*, v., p. 41. *Caustoloma (?) ziczac*, Feld., *l.c.*, pl. cxxxii., fig. 4. *Azelina fortinata*, Meyr., *l.c.*, xvi., p. 106.

*Azelina gallaria*, Walk.

*Selenia gallaria*, Walk., *l.c.*, xx., p. 185; Butl., *Cat. Lep. N.Z.*, p. 11, tab. 3, figs. 6, 7. *Euchlana (?) palthidata*, Feld., *l.c.*, pl. cxxxii., figs. 21, 22. *Stratocleis gallaria*, Meyr., *l.c.*, xvi., p. 105. *Azelina gallaria*, Meyr., *l.c.*, xx., p. 62.

**Drepanodes**, Guén.

*Drepanodes muriferata*, Walk.

*Gargaphia muriferata*, Walk., *l.c.*, xxvi., p. 1635; Butl., *Cat. Lep. N.Z.*, p. 13. *Panagra ephyaria*, Walk., *l.c.*, xxvi., p. 1761; Butl., *Cat. Lep. N.Z.*, p. 13. (?) *Zanclognatha (?) cookaria*, Feld., *l.c.*, pl. cxxxiii., fig. 26. *Z. haastaria*, Feld., *l.c.*, fig. 32. *Drepanodes muriferata*, Meyr., *l.c.*, xvi., p. 107.

## Group PYRALIDINA.

## Family PYRALIDIDÆ.

**Asopia, Tr.***Asopia farinalis*, Linn.

*Phalæna-Pyralis farinalis*, Linn., Syst. Nat., p. 880; Butl., Cist. Ent., ii., p. 555. *Asopia farinalis*, Meyr., l.c., xvii., p. 122.

**Deana, Butl.***Deana paronalis*, Walk.

*Scopula* (?) *paronalis*, Walk., l.c., xviii., p. 797. *Daraba paronalis* Butl., Proc. Zool. Soc. Lond., 1877, p. 388. *Deana paronalis*, Butl., Cist. Ent., ii., p. 555.

**Diplopseustis, Meyr.***Diplopseustis minima*, Butl.

*Cymoriza minima*, Butl., Proc. Zool. Soc. Lond., 1880, p. 684. *Diplopseustis minima*, Meyr., Trans. Ent. Soc. Lond., 1884, p. 285; *ib.*, Trans. N.Z. Inst., xx., p. 63.

## Family SICULODIDÆ.

**Siculodes, Hs.***Siculodes subfasciata*, Walk.

*Morova subfasciata*, Walk., l.c., supp. ii., p. 523; Butl., Cat. Lep. N.Z., p. 4. *Cacæcia gallicolens*, Butl., Cat. Lep. N.Z., p. 20. *Siculodes subfasciata*, Meyr., Trans. N.Z. Inst., xvi., p. 108.

## Family MUSOTIMIDÆ.

**Musotima, Meyr.***Musotima aduncalis*, Feld.

*Diathrausta aduncalis*, Feld., l.c., cxxxv., fig. 11. *Musotima aduncalis*, Meyr., Trans. Ent. Soc. Lond., 1884, p. 289.

*Musotima nitidalis*, Walk.

*Isopteryx nitidalis*, Walk., l.c., xxv., p. 1417. *Diathrausta tima-ralis*, Feld., l.c., cxxxv., fig. 23. *Musotima nitidalis*, Meyr., Trans. Ent. Soc. Lond., 1884, p. 290.

## Family BOTYDIDÆ.

**Diasemia, Guén.***Diasemia grammalis*, Doubl.

*D. grammalis*, Doubl., Dieffenbach's "New Zealand," ii., p. 287; Butl., Cat. Lep. N.Z., p. 10; Butl., Cist. Ent., ii., p. 556; Meyr., Trans. Ent. Soc. Lond., 1884, p. 302. *D. spilonotalis*, Snell., Midd. Sum., 73.

**Sceliodes, Guén.***Sceliodes cordalis*, Doubl.

*Margaritia cordalis*, Doubl., l.c., ii., p. 288. *Sceliodes mucidalis*, Guén. *Scopula* (?) *cordalis*, Walk., l.c., xviii., p. 794. *Daraba exten-salis*, Walk., xxv., p. 1311. *D. cordalis*, Butl., Cat. Lep. N.Z., p. 10, tab. 3, fig. 22. *Eretria obsistalis*, Snell., Tijd. v. Ent., 1880, p. 206; *ib.*, 1883, pl. vi., fig. 12. *Sceliodes cordalis*, Meyr., Trans. Ent. Soc. Lond., 1884, p. 303, and Trans. N.Z. Inst., xxi., p. 187.



**Zinckenia**, Zeller.

*Zinckenia recurvalis*, F.

*Phalena recurvalis*, F., E.S., 407. *Zinckenia*, Caff., 55; Guén., 225. *Phalena angustalis*, F., Mant., 309. *P. fascialis*, Stoll., pl. xxxvi., fig. 13; Cr., 398; O. *Hydrocampa albifascialis*, Boisd., Mad., 119, pl. xvi., fig. 1. *Zinckenia recurvalis*, Meyr., Trans. Ent. Soc. Lond., 1884, p. 308.

**Proternia**, Meyr.

*Proternia philocapna*, Meyr.

*P. philocapna*, Meyr., Trans. Ent. Soc. Lond., 1884, p. 317.

**Mecyna**, Guén.

*Mecyna deprivalis*, Walk.

*M. deprivalis*, Walk., l.c., xix., p. 806; Butl., Cist. Ent., ii., p. 557. *Botys maorialis*, Feld., l.c., pl. cxxxiv., fig. 34; Meyr., Trans. Ent. Soc. Lond., 1884, p. 327, and Trans. N.Z. Inst., xxi., p. 188.

**Mnesictena**, Meyr.

*Mnesictena marmarina*, Meyr.

*M. marmarina*, Meyr., Trans. Ent. Soc. Lond., 1884, p. 329.

*Mnesictena flavidalis*, Doubl.

*Margaritia flavidalis*, Doubl., l.c., ii., p. 287. *M. quadralis*, ib., p. 288. *Scopula aipsalis*, Walk., l.c., xviii., p. 796; Butl., Cat. Lep. N.Z., p. 10. *S. flavidalis*, Butl., Proc. Zool. Soc. Lond., 1877, p. 388; ib., Cist. Ent., ii., pp. 493 and 556. *S. quadralis*, Butl., Cat. Lep. N.Z., p. 10, and Cist. Ent., ii., p. 557. *Botys otagalis*, Feld., l.c., cxxxiv., fig. 35. *Mnesictena flavidalis*, Meyr., Trans. Ent. Soc. Lond., 1884, p. 330.

*Mnesictena notata*, Butl.

*Scopula notata*, Butl., Cist. Ent., ii., p. 493; Meyr., Trans. Ent. Soc. Lond., 1884, p. 330.

*Mnesictena daiclesalis*, Walk.

*Scopula daiclesalis*, Walk., l.c., xix., p. 1017; Butl., Cat. Lep. N.Z., p. 11. *Mnesictena daiclealis*, Meyr., Trans. N.Z. Inst., xxi., p. 155.

**Nesarcha**, Meyr.

*Nesarcha hybreadalis*, Walk.

*Scopula hybreasalis*, Walk., l.c., xviii., p. 797; Butl., Cat. Lep. N.Z., p. 11. *S. paronalis*, Walk., l.c., xviii., p. 797; Butl., Cat. Lep. N.Z., p. 11. *Adena zanthialis*, Walk., l.c., xxvii., p. 198; Butl., Cat. Lep. N.Z., p. 19, and Proc. Zool. Soc. Lond., 1877, p. 402. *Nesarcha hybreadalis*, Meyr., Trans. N.Z. Inst., xxi., p. 330.

Family SCOPARIADÆ.

**Nyctarcha**, Meyr.

*Nyctarcha atra*, Butl.

*Orosana atra*, Butl., Proc. Zool. Soc. Lond., 1877, p. 404. *Nyctarcha atra*, Meyr., Trans. Ent. Soc. Lond., 1884, p. 346, and Trans. N.Z. Inst., xvii., p. 70.

**Scoparia**, Haw.

*Scoparia oreas*, Meyr.

*S. oreas*, Meyr., Trans. N.Z. Inst., xvii., p. 81.

Scoparia philerga, *Meyr.*

*S. philerga*, Meyr., Trans. N.Z. Inst., xvii., p. 81.

Scoparia chlamydota, *Meyr.*

*S. chlamydota*, Meyr., Trans. N.Z. Inst., xvii., p. 82.

Scoparia minusculalis, *Walk.*

*S. minusculalis*, Walk., *l.c.*, xxxiv., p. 1503; Butl., Cat. Lep. N.Z., p. 11, and Cist. Ent., ii, p. 557; Meyr., Trans. Ent. Soc. Lond., 1884, p. 347, and Trans. N.Z. Inst., xvii., p. 82.

Scoparia hemiplaca, *Meyr.*

*S. hemiplaca*, Meyr., Trans. N.Z. Inst., xxi., p. 155.

Scoparia linealis, *Walk.*

*S. linealis*, Walk., *l.c.*, xxxiv., p. 1503; Butl., Cat. Lep. N.Z., p. 11; and *vide* Meyr., Trans. N.Z. Inst., xvii., p. 119.

Scoparia minualis, *Walk.*

*S. minualis*, Walk., *l.c.*, xxxiv., p. 1504; Butl., Cat. Lep. N.Z., p. 11; Meyr., Trans. Ent. Soc. Lond., 1884, p. 347, and Trans. N.Z. Inst., xvii., p. 83.

Scoparia chimera, *Meyr.*

*S. chimera*, Meyr., Trans. N.Z. Inst., xvii., p. 84.

Scoparia dinodes, *Meyr.*

*S. dinodes*, Meyr., Trans. N.Z. Inst., xvii., p. 85.

Scoparia acharis, *Meyr.*

*S. acharis*, Meyr., Trans. N.Z. Inst., xvii., p. 85.

Scoparia cymatias, *Meyr.*

*S. cymatias*, Meyr., Trans. N.Z. Inst., xvii., p. 86.

Scoparia microphthalma, *Meyr.*

*S. microphthalma*, Meyr., Trans. N.Z. Inst., xvii., p. 87.

Scoparia hemicycla, *Meyr.*

*S. hemicycla*, Meyr., Trans. N.Z. Inst., xvii., p. 87.

Scoparia ergatis, *Meyr.*

*S. ergatis*, Meyr., Trans. N.Z. Inst., xvii., p. 88.

Scoparia encapna, *Meyr.*

*S. encapna*, Meyr., Trans. N.Z. Inst., xx., p. 65.

Scoparia critica, *Meyr.*

*S. critica*, Meyr., Trans. N.Z. Inst., xvii., p. 88.

Scoparia characta, *Meyr.*

*S. characta*, Meyr., Trans. N.Z. Inst., xvii., p. 90.

Scoparia ustimacula, *Feld.*

*S. ustimacula*, Feld., *l.c.*, pl. cxxxv., fig. 17; Meyr., Trans. Ent. Soc. Lond., 1884, p. 347, and Trans. N.Z. Inst., xvii., p. 91. *S. conifera*, Butl., Cist. Ent., ii, p. 493.

Scoparia pongalis, *Feld.*

*S. pongalis*, Feld., *l.c.*, pl. cxxxvii., fig. 33; Meyr., Trans. Ent. Soc. Lond., 1884, p. 347, and Trans. N.Z. Inst., xvii., p. 91.

Scoparia melanægis, *Meyr.*

*S. melanægis*, Meyr., Trans. N.Z. Inst., xvii., p. 92.

Scoparia trapezophora, *Meyr.*

*S. trapezophora*, Meyr., Trans. N.Z. Inst., xvii., p. 93.

- Scoparia philetachra, *Meyr.*  
*S. philetachra*, Meyr., Trans. N.Z. Inst., xvii., p. 93.
- Scoparia colpota, *Meyr.*  
*S. colpota*, Meyr., Trans. N.Z. Inst., xx., p. 65.
- Scoparia periphanes, *Meyr.*  
*S. periphanes*, Meyr., Trans. N.Z. Inst., xvii., p. 94.
- Scoparia diphtheralis, *Walk.*  
*S. diphtheralis*, Walk., *l.c.*, xxxiv., p. 1501; Butl., Cat. Lep. N.Z., p. 11, also Proc. Zool. Soc. Lond., 1877, p. 388, and Cist. Ent., ii., p. 557; Meyr., Trans. Ent. Soc. Lond., 1884, p. 347, and Trans. N.Z. Inst., xvii., p. 94.
- Scoparia submarginalis, *Walk.*  
*Hypochealia submarginalis*, Walk., *l.c.*, xxvii., p. 48; Butl., Cat. Lep. N.Z., p. 18. *Nephopteryx maoriella*, Walk., *l.c.*, xxxv., p. 1720; Butl., Cat. Lep. N.Z., p. 18. *Scoparia submarginalis*, Meyr., Trans. Ent. Soc. Lond., 1884, p. 347, and Trans. N.Z. Inst., xvii., p. 95.
- Scoparia cataxesta, *Meyr.*  
*S. cataxesta*, Meyr., Trans. N.Z. Inst., xvii., p. 96.
- Scoparia tetracycla, *Meyr.*  
*S. tetracycla*, Meyr., Trans. N.Z. Inst., xvii., p. 97.
- Scoparia indistinctalis, *Walk.*  
*Hypochealia indistinctalis*, Walk., *l.c.*, xxvii., p. 48; Butl., Cat. Lep. N.Z., p. 18. *Scoparia rakaiensis*, Knaggs, Ent. Mo. Mag., iv., p. 80; Butl., Cat. Lep. N.Z., p. 11, and Proc. Zool. Soc. Lond., 1877, p. 389. *S. indistinctalis*, Butl., Cist. Ent., ii., p. 557; Meyr., Trans. Ent. Soc. Lond., 1884, p. 347, and Trans. N.Z. Inst., xvii., p. 97.
- Scoparia chalicodes, *Meyr.*  
*S. chalicodes*, Meyr., Trans. N.Z. Inst., xvii., p. 98.
- Scoparia leptalea, *Meyr.*  
*S. leptalea*, Meyr., Trans. N.Z. Inst., xvii., p. 98.
- Scoparia psammitis, *Meyr.*  
*S. psammitis*, Meyr., Trans. N.Z. Inst., xvii., p. 99.
- Scoparia epicomia, *Meyr.*  
*S. epicomia*, Meyr., Trans. N.Z. Inst., xvii., p. 99.
- Scoparia feredayi, *Knaggs.*  
*S. feredayi*, Knaggs, Ent. Mo. Mag., iv., p. 80; Butl., Cat. Lep. N.Z., p. 11. *S. moanalis*, Feld., *l.c.*, pl. cxxxvii., fig. 34. *S. feredayi*, Meyr., Trans. Ent. Soc. Lond., 1884, p. 348, and Trans. N.Z. Inst., xvii., p. 100.
- Scoparia acompa, *Meyr.*  
*S. acompa*, Meyr., Trans. N.Z. Inst., xvii., p. 100.
- Scoparia manganentis, *Meyr.*  
*S. manganentis*, Meyr., Trans. N.Z. Inst., xvii., p. 102.
- Scoparia crypsinoa, *Meyr.*  
*S. crypsinoa*, Meyr., Trans. N.Z. Inst., xvii., p. 102.
- Scoparia axena, *Meyr.*  
*S. axena*, Meyr., Trans. N.Z. Inst., xvii., p. 103.

*Scoparia steropæa*, *Meyr.**S. steropæa*, Meyr., Trans. N.Z. Inst., xvii., p. 103.*Scoparia exilis*, *Knaggs.**S. exilis*, Knaggs, Ent. Mo. Mag., iv., p. 81; Butl., Cat. Lep. N.Z., p. 11; Meyr., Trans. Ent. Soc. Lond., 1884, p. 348, and Trans. N.Z. Inst., xvii., p. 104.*Scoparia elaphra*, *Meyr.**S. elaphra*, Meyr., Trans. N.Z. Inst., xvii., p. 105.*Scoparia paltomacha*, *Meyr.**S. paltomacha*, Meyr., Trans. N.Z. Inst., xvii., p. 105.*Scoparia deltophora*, *Meyr.**S. deltophora*, Meyr., Trans. N.Z. Inst., xvii., p. 106.*Scoparia sabulosellus*, *Walk.**Crambus sabulosellus*, Walk., l.c., xxvii., p. 178; Butl., Cat. Lep. N.Z., p. 19, and Cist. Ent., ii., p. 509. *Scoparia sabulosella*, Meyr., Trans. Ent. Soc. Lond., 1884, p. 348, and Trans. N.Z. Inst., xvii., p. 106.*Scoparia panopla*, *Meyr.**S. panopla*, Meyr., Trans. N.Z. Inst., xvii., p. 107.*Scoparia trivirgatus*, *Feld.**Crambus trivirgatus*, Feld., l.c., pl. cxxxvii., fig. 29; Butl., Proc. Zool. Soc., 1877, p. 400, and Cist. Ent., ii., p. 558. *Scoparia trivirgata*, Meyr., Trans. Ent. Soc. Lond., 1884, p. 348, and Trans. N.Z. Inst., xvii., p. 107.**Xeroscopia**, *Meyr.**Xeroscopia petrina*, *Meyr.**X. petrina*, Meyr., Trans. N.Z. Inst., xvii., p. 111.*Xeroscopia cyameuta*, *Meyr.**X. cyameuta*, Meyr., Trans. N.Z. Inst., xvii., p. 112.*Xeroscopia astragalota*, *Meyr.**X. astragalota*, Meyr., Trans. N.Z. Inst., xvii., p. 113.*Xeroscopia rotuellus*, *Feld.**Crambus rotuellus*, Feld., l.c., pl. cxxxvii., fig. 30. *Xeroscopia rotuella*, Meyr., Trans. Ent. Soc. Lond., 1884, p. 350, and Trans. N.Z. Inst., xvii., p. 113.*Xeroscopia harpalea*, *Meyr.**X. harpalea*, Meyr., Trans. N.Z. Inst., xvii., p. 114.*Xeroscopia ejuncida*, *Knaggs.**Scoparia ejuncida*, Knaggs, Ent. Mo. Mag., iv., p. 81; Butl., Cat. Lep. N.Z., p. 11. *Xeroscopia ejuncida*, Meyr., Trans. Ent. Soc. Lond., 1884, p. 349, and Trans. N.Z. Inst., xvii., p. 114.*Xeroscopia niphospora*, *Meyr.**X. niphospora*, Meyr., Trans. N.Z. Inst., xvii., p. 115.*Xeroscopia apheles*, *Meyr.**X. apheles*, Meyr., Trans. N.Z. Inst., xvii., p. 115.*Xeroscopia aspidota*, *Meyr.**X. aspidota*, Meyr., Trans. N.Z. Inst., xvii., p. 115.*Xeroscopia nomeutis*, *Meyr.**X. nomeutis*, Meyr., Trans. N.Z. Inst., xvii., p. 116.

*Xeroscopa epicremna*, *Meyr.*

*X. epicremna*, *Meyr.*, *Trans. N.Z. Inst.*, xvii., p. 117.

*Xeroscopa legnota*, *Meyr.*

*X. legnota*, *Meyr.*, *Trans. N.Z. Inst.*, xvii., p. 117.

*Xeroscopa octophora*, *Meyr.*

*X. octophora*, *Meyr.*, *Trans. N.Z. Inst.*, xvii., p. 118.

*Xeroscopa asterisca*, *Meyr.*

*X. asterisca*, *Meyr.*, *Trans. N.Z. Inst.*, xvii., p. 118.

*Xeroscopa leucogramma*, *Meyr.*

*X. leucogramma*, *Meyr.*, *Trans. N.Z. Inst.*, xvii., p. 119.

### Family PTEROPHORIDÆ.

#### **Aciptilia**, Hübn.

*Aciptilia furcatalis*, *Walk.*

*Aciptilus furcatalis*, *Walk.*, *l.c.*, xxx., p. 950; *Butl.*, *Cat. Lep. N.Z.*, p. 25; *Aciptilia furcatalis*, *Meyr.*, *Trans. N.Z. Inst.*, xvii., p. 123.

*Aciptilia lycosema*, *Meyr.*

*A. lycosema*, *Meyr.*, *Trans. N.Z. Inst.*, xvii., p. 124.

*Aciptilia monospilalis*, *Walk.*

*Aciptilus monospilalis*, *Walk.*, *l.c.*, xxx., p. 950; *Butl.*, *Cat. Lep. N.Z.*, p. 25. *Aciptilia monospilalis*, *Meyr.*, *Trans. N.Z. Inst.*, xvii., p. 124.

*Aciptilia innotatalis*, *Walk.*

*Pterophorus innotatalis*, *Walk.*, *l.c.*, xxx., p. 945; *Butl.*, *Cat. Lep. N.Z.*, p. 25. *Aciptilia innotatalis*, *Meyr.*, *Trans. N.Z. Inst.*, xvii., p. 124.

#### **Lioptilus**, *Wallgr.*

*Lioptilus celidotus*, *Meyr.*

*L. celidotus*, *Meyr.*, *Trans. N.Z. Inst.*, xvii., p. 125.

#### **Mimæseoptilus**, *Wallgr.*

*Mimæseoptilus orites*, *Meyr.*

*M. orites*, *Meyr.*, *Trans. N.Z. Inst.*, xvii., p. 126.

*Mimæseoptilus charadrias*, *Meyr.*

*M. charadrias*, *Meyr.*, *Trans. N.Z. Inst.*, xvii., p. 126.

*Mimæseoptilus lithoxestus*, *Meyr.*

*M. lithoxestus*, *Meyr.*, *Trans. N.Z. Inst.*, xvii., p. 127.

#### **Platyptilia**, Hübn.

*Platyptilia haasti*, *Feld.*

*P. haasti*, *Feld.*, *l.c.*, pl. cxi., fig. 58; *Meyr.*, *Trans. N.Z. Inst.*, xvii., p. 128.

*Platyptilia falcatalis*, *Walk.*

*Platyptilus falcatalis*, *Walk.*, *l.c.*, xxx., p. 931; *Butl.*, *Cat. Lep. N.Z.*, p. 25. *P. reptetalis*, *Walk.*, *l.c.*, xxx., p. 931; *Butl.*, *Cat. Lep. N.Z.*, p. 25; *Butl.*, *Proc. Zool. Soc. Lond.*, 1877, p. 407. *Platyptilia falcatalis*, *Meyr.*, *Trans. N.Z. Inst.*, xvii., p. 128.

*Platyptilia heliastis*, *Meyr.*

*P. heliastis*, *Meyr.*, *Trans. N.Z. Inst.*, xvii., p. 129.

## Family HYDROCAMPIDÆ.

**Paraponyx**, Hübn.Paraponyx nitens, *Butl.**P. nitens*, Butl., Cist. Ent., ii., p. 556. *Hygralia nitens*, Meyr., Trans. N.Z. Inst., xvii., p. 130.**Clepsicosma**, Meyr.Clepsicosma iridia, *Meyr.**C. iridia*, Meyr., Trans. N.Z. Inst., xx., p. 64.

## Family CRAMBIDÆ.

**Hednota**, Meyr.Hednota leucophthalma, *Meyr.**Thinastota leucophthalma*, Meyr., Trans. N.Z. Inst., xv., p. 7.**Cryptomima**, Meyr.Cryptomima acerella, *Walk.**Gadira acerella*, Walk., l.c., xxxv., p. 1742; Butl., Cat. Lep. N.Z., p. 18, Proc. Zool. Soc. Lond., 1877, p. 399, and Cist. Ent., ii., p. 558. *Botys mahanga*, Feld., l.c., pl. cxxxvii., fig. 27. *Cryptomima acerella*, Meyr., Trans. N.Z. Inst., xv., p. 8.**Scenoploca**, Meyr.Scenoploca petraula, *Meyr.**S. petraula*, Meyr., Trans. N.Z. Inst., xv., p. 9.**Diptychophora**, Zeller.Diptychophora pyrsophanes, *Meyr.**D. pyrsophanes*, Meyr., Trans. N.Z. Inst., xv., p. 11.Diptychophora chrysochyta, *Meyr.**D. chrysochyta*, Meyr., Trans. N.Z. Inst., xv., p. 12.Diptychophora interruptus, *Feld.**Crambus interruptus*, Feld., l.c., pl. cxxxv., fig. 15. *Diptychophora astrosema*, Meyr., Trans. N.Z. Inst., xv., p. 13. *D. interrupta*, Meyr., Trans. N.Z. Inst., xvii., p. 130.Diptychophora lepidella, *Walk.**Eromene lepidella*, Walk., xxxv., p. 1761; Butl., Cat. Lep. N.Z., p. 19, and Cist. Ent., ii., p. 558. *Crambus gracilis*, Feld., l.c., pl. cxxxvii., fig. 26. *Diptychophora lepidella*, Meyr., Trans. N.Z. Inst., xv., p. 14.Diptychophora leucoxantha, *Meyr.**D. leucoxantha*, Meyr., Trans. N.Z. Inst., xv., p. 15.Diptychophora metallifera, *Butl.**Eromene metallifera*, Butl., Proc. Zool. Soc. Lond., 1877, p. 401, pl. xliii., fig. 11. *Diptychophora metallifera*, Meyr., Trans. N.Z. Inst., xv., p. 15.Diptychophora auriscriptella, *Walk.**Eromene auriscriptella*, Walk., l.c., xxx., p. 976; Butl., Cat. Lep. N.Z., p. 19, Proc. Zool. Soc. Lond., p. 401, and Cist. Ent., ii., p. 559. *Diptychophora auriscriptella*, Meyr., Trans. N.Z. Inst., xv., p. 16.

*Diptychophora helioctypa*, *Meyr.*

*D. helioctypa*, *Meyr.*, *Trans. N.Z. Inst.*, xv., p. 17.

*Diptychophora elaina*, *Meyr.*

*D. elaina*, *Meyr.*, *Trans. N.Z. Inst.*, xv., p. 17, and *Trans. N.Z. Inst.*, xvii., p. 132.

*Diptychophora selenæa*, *Meyr.*

*D. selenæa*, *Meyr.*, *Trans. N.Z. Inst.*, xvii., p. 131.

*Diptychophora holanthes*, *Meyr.*

*D. holanthes*, *Meyr.*, *Trans. N.Z. Inst.*, xvii., p. 131.

*Diptychophora bipunctella*, *Walk.*

*Eromene bipunctella*, *Walk.*, *l.c.*, xxxv., p. 1761; *Butl.*, *Cat. Lep. N.Z.*, p. 19. *Diptychophora bipunctella*, *Meyr.*, *Trans. N.Z. Inst.*, xvii., p. 132.

*Diptychophora epiphæa*, *Meyr.*

*D. epiphæa*, *Meyr.*, *Trans. N.Z. Inst.*, xvii., p. 132.

*Diptychophora harmonica*, *Meyr.*

*D. harmonica*, *Meyr.*, *Trans. N.Z. Inst.*, xx., p. 71.

**Orocrambus**, *Meyr.*

*Orocrambus melampetrus*, *Meyr.*

*O. melampetrus*, *Meyr.*, *Trans. N.Z. Inst.*, xvii., p. 133.

*Orocrambus catacaustus*, *Meyr.*

*O. catacaustus*, *Meyr.*, *Trans. N.Z. Inst.*, xx., p. 67. *Crambus catacaustus*, *Meyr.*, *Trans. N.Z. Inst.*, xvii., p. 134.

*Orocrambus tritonellus*, *Meyr.*

*O. tritonellus*, *Meyr.*, *Trans. N.Z. Inst.*, xx., p. 67. *Crambus tritonellus*, *Meyr.*, *Trans. N.Z. Inst.*, xvii., p. 134.

*Orocrambus mylites*, *Meyr.*

*O. mylites*, *Meyr.*, *Trans. N.Z. Inst.*, xx., p. 67.

**Thinasotia**, *Hein.*

*Thinasotia claviferella*, *Walk.*

*Aquila claviferella*, *Walk.*, *l.c.*, xxxv., p. 1765. *Aphomia strigosa*, *Butl.*, *Proc. Zool. Soc. Lond.*, 1877, p. 398, pl. xliii., fig. 10. *Crambus strigosus*, *Meyr.*, *Trans. N.Z. Inst.*, xv., p. 31. *Thinasotia claviferella*, *Meyr.*, *Trans. N.Z. Inst.*, xx., p. 69.

**Tauroscopa**, *Meyr.*

*Tauroscopa gorgopis*, *Meyr.*

*T. gorgopis*, *Meyr.*, *Trans. N.Z. Inst.*, xx., p. 69.

**Crambus**, *Fab.*

*Crambus æthonellus*, *Meyr.*

*C. æthonellus*, *Meyr.*, *Trans. N.Z. Inst.*, xv., p. 19.

*Crambus corrupta*, *Butl.*

*Hypochalcia corrupta*, *Butl.*, *Proc. Zool. Soc. Lond.*, 1877, p. 399, pl. xliii., fig. 9. *Crambus corruptus*, *Meyr.*, *Trans. N.Z. Inst.*, xv., p. 20.

*Crambus ramosellus*, Doubl.

*C. ramosellus*, Doubl., Dieffenbach's "New Zealand," vol. ii., p. 288; Butl., Cat. Lep. N.Z., p. 18, and Proc. Zool. Soc. Lond., 1877, p. 400; Meyr., Trans. N.Z. Inst., xv., p. 21. *C. rangona*, Feld., l.c., pl. cxxxvii., fig. 25. *Chilo leucanialis*, Butl., Proc. Zool. Soc. Lond., 1877, p. 401.

*Crambus angustipennis*, Z.

*Chilo angustipennis*, Z., Hor. Ross., 1877, 15, pl. i., fig. 3. *Crambus angustipennis*, Meyr., Trans. N.Z. Inst., xv., p. 22.

*Crambus dicrenellus*, Meyr.

*C. dicrenellus*, Meyr., Trans. N.Z. Inst., xv., p. 22.

*Crambus haplotomus*, Meyr.

*C. haplotomus*, Meyr., Trans. N.Z. Inst., xv., p. 22.

*Crambus callirrhöus*, Meyr.

*C. callirrhöus*, Meyr., Trans. N.Z. Inst., xv., p. 22.

*Crambus simplex*, Butl.

*Chilo simplex*, Butl., Proc. Zool. Soc. Lond., 1877, p. 400, pl. xliii., fig. 12; Cist. Ent., ii., p. 558. *Crambus simplex*, Meyr., Trans. N.Z. Inst., xv., p. 24.

*Crambus siriellus*, Meyr.

*C. siriellus*, Meyr., Trans. N.Z. Inst., xv., p. 25.

*Crambus apicellus*, Z.

*C. apicellus*, Z., Mon. Cr., 31, Meyr., Trans. N.Z. Inst., xv., p. 26.

*Crambus vitellus*, Doubl.

*C. vitellus*, Doubl., l.c., p. 289; Butl., Cat. Lep. N.Z., p. 18; Meyr., Trans. N.Z. Inst., xv., p. 27. *C. nexalis*, Walk., l.c., xxvii., p. 178; Butl., Cat. Lep. N.Z., p. 18. *C. transcissalis*, Walk., l.c., xxvii., p. 178; Butl., Cat. Lep. N.Z., p. 19. *C. sublicellus*, Z., Mon. Cr., 31. *C. bisectellus*, ib., 32. *C. incrassatellus*, ib., 32. *C. vapiäus*, Butl., Proc. Zool. Soc. Lond., 1877, p. 399.

*Crambus flexuosellus*, Doubl.

*C. flexuosellus*, Doubl., l.c., p. 289; Butl., Cat. Lep. N.Z., p. 18, Proc. Zool. Soc. Lond., p. 399, and Cist. Ent., ii., pp. 358 and 509; Feld., l.c., cxxxvii., fig. 32; Meyr., Trans. N.Z. Inst., xv., p. 28.

*Crambus tuhualis*, Feld.

*C. tuhualis*, Feld., l.c., cxxxvii., fig. 18; Meyr., Trans. N.Z. Inst., xv., p. 28. *C. vulgaris*, Butl., Proc. Zool. Soc. Lond., 1877, p. 400, pl. xliii., fig. 7, and Cist. Ent., ii., p. 558.

*Crambus cyclopicus*, Meyr.

*C. cyclopicus*, Meyr., Trans. N.Z. Inst., xv., p. 29.

*Crambus harpophorus*, Meyr.

*C. harpophorus*, Meyr., Trans. N.Z. Inst., xv., p. 30.

*Crambus xanthogrammus*, Meyr.

*C. xanthogrammus*, Meyr., Trans. N.Z. Inst., xv., p. 32.

*Crambus ephorus*, Meyr.

*C. ephorus*, Meyr., Trans. N.Z. Inst., xvii., p. 135.

*Crambus crenæus*, Meyr.

*C. crenæus*, Meyr., Trans. N.Z. Inst., xvii., p. 135.



*Crambus enchophorus*, *Meyr.*

*C. enchophorus*, *Meyr.*, *Trans. N.Z. Inst.*, xvii., p. 136.

*Crambus diploorrhous*, *Meyr.*

*C. diploorrhous*, *Meyr.*, *Trans. N.Z. Inst.*, xvii., p. 136.

*Crambus pedias*, *Meyr.*

*C. pedias*, *Meyr.*, *Trans. N.Z. Inst.*, xvii., p. 137.

*Crambus paraxenus*, *Meyr.*

*C. paraxenus*, *Meyr.*, *Trans. N.Z. Inst.*, xvii., p. 137.

*Crambus sophronellus*, *Meyr.*

*C. sophronellus*, *Meyr.*, *Trans. N.Z. Inst.*, xvii., p. 138.

*Crambus oncobolus*, *Meyr.*

*C. oncobolus*, *Meyr.*, *Trans. N.Z. Inst.*, xvii., p. 138.

*Crambus heliotes*, *Meyr.*

*C. heliotes*, *Meyr.*, *Trans. N.Z. Inst.*, xx., p. 68.

*Crambus isoclytus*, *Meyr.*

*C. isoclytus*, *Meyr.*, *Trans. N.Z. Inst.*, xx., p. 68.

#### Family PHYCITIDÆ.

##### **Crocydopora**, *Meyr.*

*Crocydopora cinigerella*, *Walk.*

*Nephopteryx cinigerella*, *Walk., l.c.*, xxxv., p. 1719. *N. stenopterella*, *Meyr.*, *Proc. Linn. Soc. N.S.W.*, 1878, p. 200. *Crocydopora cinigerella*, *Meyr.*, *Trans. N.Z. Inst.*, xx., p. 72.

##### **Homœosoma**, *Curt.*

*Homœosoma vagella* (?).

See *Meyr.*, *Trans. N.Z. Inst.*, xx., p. 72.

#### Family GALLERIADÆ.

##### **Achrœa**, *Hübner.*

*Achrœa grisella*, *F.*

*A. grisella*, *F.*; *Meyr.*, *Trans. N.Z. Inst.*, xx., p. 73.

#### Group TORTRICINA.

#### Family TORTRICIDÆ.

##### **Dichelia**, *Guén.*

*Dichelia luci plagana*, *Walk.*

*Pedisca luci plagana*, *Walk., l.c.*, xxviii., p. 381; *Butl., Cat. Lep. N.Z.*, p. 22, and *Cist. Ent.*, ii., p. 510. *Dichelia luci plagana*, *Meyr.*, *Proc. Linn. Soc. N.S.W.*, 1881, p. 470, and *Trans. N.Z. Inst.*, xv., p. 36.

##### **Capua**, *Steph.*

*Capua semiferana*, *Walk.*

*Teras semiferana*, *Walk., l.c.*, xxviii., p. 306; *Butl., Cat. Lep. N.Z.*, p. 19. *Sciaphila detritana*, *Walk., l.c.*, xxviii., p. 356; *Butl., Cat. Lep. N.Z.*, p. 21. *Tinea admotella*, *Walk., l.c.*, xxviii., p. 485; *Butl., Cat. Lep. N.Z.*, p. 22. *Grapholita abnegatana*, *Walk., l.c.*, xxx., p. 991; *Butl., Cat. Lep. N.Z.*, p. 22. *Capua semiferana*, *Meyr.*, *Proc. Linn. Soc. N.S.W.*, 1881, p. 453, and *Trans. N.Z. Inst.*, xv., p. 37.

**Pyrgotis, Meyr.****Pyrgotis plagiata, Walk.**

*Conchylis plagiata*, Walk., *l.c.*, xxviii., p. 370; Butl., Cat. Lep. N.Z., p. 22. *C. recusana*, *l.c.*, xxviii., p. 371; Butl., Cat. Lep. N.Z., p. 22. *Grapholitha punana*, Feld., *l.c.*, pl. cxxxvii., fig. 43. (?) *G. zylina*, *ib.*, 44. *Pyrgotis plagiata*, Meyr., Trans. N.Z. Inst., xv., p. 38.

**Pyrgotis zygiana, Meyr.**

*P. zygiana*, Meyr., Trans. N.Z. Inst., xv., p. 39.

**Pyrgotis eudorana, Meyr.**

*P. eudorana*, Meyr., Trans. N.Z. Inst., xvii., p. 143.

**Pyrgotis plinthoglypta, Meyr.**

*P. plinthoglypta*, Meyr., Trans. N.Z. Inst., xxiv., p. 218.

**Adoxophyes, Meyr.****Adoxophyes lotinana, Meyr.**

*A. lotinana*, Meyr., Trans. N.Z. Inst., xv., p. 40.

**Adoxophyes conditana, Walk.**

*Teras conditana*, Walk., *l.c.*, xxviii., p. 306; Butl., Cat. Lep. N.Z., p. 19. *Pandemis gavisana*, Walk., *l.c.*, xxviii., p. 312; Butl., Cat. Lep. N.Z., p. 20. *Conchylis marginana*, Walk., *l.c.*, xxviii., p. 371; Butl., Cat. Lep. N.Z., p. 22. (?) *Rhacodia rureana*, Feld., *l.c.*, pl. cxxxvii., fig. 47. *Teras flavescens*, Butl., Proc. Zool. Soc. Lond., 1877, p. 402. *Pyrgotis porphyreana*, Meyr., Proc. Linn. Soc. N.S.W., 1881, p. 443. *Capua aoristana*, *ib.*, p. 446. *Adoxophyes conditana*, Meyr., Trans. N.Z. Inst., xv., p. 40.

**Adoxophyes camelina, Meyr.**

*A. camelina*, Meyr., Trans. N.Z. Inst., xxiii., p. 97.

**Proselena, Meyr.****Proselena aspistana, Meyr.**

*P. aspistana*, Meyr., Trans. N.Z. Inst., xv., p. 42.

**Proselena hemionana, Meyr.**

*P. hemionana*, Meyr., Trans. N.Z. Inst., xv., p. 43.

**Proselena siriana, Meyr.**

*P. siriana*, Meyr., Trans. N.Z. Inst., xv., p. 43.

**Proselena elephantina, Meyr.**

*P. elephantina*, Meyr., Trans. N.Z. Inst., xvii., p. 143.

**Proselena eremana, Meyr.**

*P. eremana*, Meyr., Trans. N.Z. Inst., xvii., p. 144.

**Proselena loxias, Meyr.**

*P. loxias*, Meyr., Trans. N.Z. Inst., xx., p. 74.

**Proselena eribola, Meyr.**

*P. eribola*, Meyr., Trans. N.Z. Inst., xxi., p. 156.

**Proselena zatrophana, Meyr.**

*Harmologa zatrophana*, Meyr., Trans. N.Z. Inst., xv., p. 46. *Proselena zatrophana*, Meyr., Trans. N.Z. Inst., xvii., p. 144.

**Harmologa, Meyr.****Harmologa sisyrana, Meyr.**

*H. sisyrana*, Meyr., Trans. N.Z. Inst., xv., p. 44.

*Harmologa oblongana*, Walk.

*Teras oblongana*, Walk., *l.c.*, xxviii., p. 303; Butl., Cat. Lep. N.Z., p. 19. *Cacæcia oblongana*, Meyr., Proc. Linn. Soc. N.S.W., 1881, p. 489. *Teras inaptana*, Walk., *l.c.*, xxviii., p. 304; Butl., Cat. Lep. N.Z., p. 19. *T. cuneigera*, Butl., Cist. Ent., ii., p. 559. *Harmologa oblongana*, Meyr., Trans. N.Z. Inst., xv., p. 45, and xvii., p. 144.

*Harmologa ænea*, Butl.

*Teras ænea*, Butl., Proc. Zool. Soc. Lond., 1877, p. 402. *Harmologa ænea*, Meyr., Trans. N.Z. Inst., xv., p. 46.

*Harmologa amplexana*, Z.

*Idiographis* (?) *amplexana*, Z., z. b. V., 1875, p. 222. *Cacæcia amplexana*, Meyr., Proc. Linn. Soc. N.S.W., 1881, p. 494. *C. vilis*, Butl., Proc. Zool. Soc. Lond., 1877, p. 402, pl. xliii., fig. 15; *ib.*, Cist. Ent., ii., p. 559. *Harmologa amplexana*, Meyr., Trans. N.Z. Inst., xv., p. 47.

*Harmologa latomana*, Meyr.

*H. latomana*, Meyr., Trans. N.Z. Inst., xvii., p. 145.

*Harmologa sirea*, Meyr.

*H. sirea*, Meyr., Trans. N.Z. Inst., xvii., p. 145.

**Ctenopseustris**, Meyr.

*Ctenopseustris obliquana*, Walk.

*Teras obliquana*, Walk., *l.c.*, xxviii., p. 302; Butl., Cat. Lep. N.Z., p. 19. *T. spurcatana*, Walk., *l.c.*, xxviii., p. 305; Butl., Cat. Lep. N.Z., p. 19. *Cacæcia obliquana*, Meyr., Proc. Linn. Soc. N.S.W., 1881, p. 487. *Sciaphila transtrigana*, Walk., *l.c.*, xxviii., p. 354; Butl., Cat. Lep. N.Z., p. 21. *S. turbulentana*, Walk., *l.c.*, xxviii., p. 355; Butl., Cat. Lep. N.Z., p. 21. *Teras cuneiferana*, Walk., xxxv., p. 1780; Butl., Cat. Lep. N.Z., p. 20. *Tortrix ropeana*, Feld., *l.c.*, pl. cxxxvii., fig. 45. *T. herana*, *ib.*, fig. 52; (?) *Teras congestana*, Walk., *l.c.*, xxviii., p. 308; Butl., Cat. Lep. N.Z., p. 20. *Pædisca obliquana*, Meyr., Trans. N.Z. Inst., xv., p. 60. *Ctenopseustris obliquana*, Meyr., Trans. N.Z. Inst., xvii., p. 146.

**Cacæcia**, Hübn.

*Cacæcia excessana*, Walk.

*Teras excessana*, Walk., *l.c.*, xxviii., p. 303; Butl., Cat. Lep. N.Z., p. 19. *Cacæcia excessana*, Meyr., Proc. Linn. Soc. N.S.W., 1881, p. 491. *Teras biguttana*, Walk., *l.c.*, xxviii., p. 305; Butl., Cat. Lep. N.Z., p. 19. *Tortrix taipana*, Feld., *l.c.*, pl. cxxxvii., fig. 46. *Cacæcia inana*, Butl., Proc. Zool. Soc. Lond., 1877, p. 403, pl. xliii., fig. 13. *C. excessana*, Meyr., Trans. N.Z. Inst., xv., p. 48.

*Cacæcia enoplana*, Meyr.

*C. enoplana*, Meyr., Trans. N.Z. Inst., xv., p. 49.

*Cacæcia alopecana*, Meyr.

*C. alopecana*, Meyr., Trans. N.Z. Inst., xvii., p. 147.

*Cacæcia astrologana*, Meyr.

*C. astrologana*, Meyr., Trans. N.Z. Inst., xxi., p. 156.

**Tortrix**, Tr.

*Tortrix charactana*, Meyr.

*Cacæcia charactana*, Meyr., Proc. Linn. Soc. N.S.W., 1881, p. 492. *Tortrix charactana*, Meyr., Trans. N.Z. Inst., xv., p. 50.

*Tortrix demiana*, Meyr.

*T. demiana*, Meyr., Trans. N.Z. Inst., xv., p. 51.

**Tortrix pictoriana**, *Feld.*

*Grapholitha pictoriana*, *Feld.*, *l.c.*, pl. cxxxvii., fig. 55. *Tortrix pictoriana*, *Meyr.*, *Trans. N.Z. Inst.*, xv., p. 51.

**Tortrix philopoana**, *Meyr.*

*T. philopoana*, *Meyr.*, *Proc. Linn. Soc. N.S.W.*, 1881, p. 515; *ib.*, *Trans. N.Z. Inst.*, xv., p. 52.

**Tortrix leucaniana**, *Walk.*

*Conchylis leucaniana*, *Walk.*, *l.c.*, xxviii., p. 370; *Butl. Cat. Lep. N.Z.*, p. 22. *Tortrix leucaniana*, *Meyr.*, *Proc. Linn. Soc. N.S.W.*, 1881, p. 517, and *Trans. N.Z. Inst.*, xv., p. 53. *Gelechia intactella*, *Walk.*, *l.c.*, xxix., p. 652; *Butl. Cat. Lep. N.Z.*, p. 23. *Teras paucularia*, *Walk.*, *l.c.*, xxxv., p. 1781; *Butl. Cat. Lep. N.Z.*, p. 20.

**Tortrix aërodana**, *Meyr.*

*T. aërodana*, *Meyr.*, *Trans. N.Z. Inst.*, xv., p. 22.

**Dipterina**, *Meyr.***Dipterina jactatana**, *Walk.*

*Batodes jactatana*, *Walk.*, *l.c.*, xxviii., p. 317; *Butl. Cat. Lep. N.Z.*, p. 21. *Sciaphila flexivittana*, *Walk.*, *l.c.*, xxviii., p. 353; *Butl. Cat. Lep. N.Z.*, p. 21. *Pædisca privatana*, *Walk.*, *l.c.*, xxviii., p. 382; *Butl. Cat. Lep. N.Z.*, p. 22. *Grapholitha voluta*, *Feld.*, *l.c.*, pl. cxxxvii., fig. 39. *Dipterina jactatana*, *Meyr.*, *Trans. N.Z. Inst.*, xv., p. 54.

**Dipterina incessana**, *Walk.*

*Teras incessana*, *Walk.*, *l.c.*, xxviii., p. 304; *Butl. Cat. Lep. N.Z.*, p. 19. *Arctrophora incessana*, *Meyr.*, *Proc. Linn. Soc. N.S.W.*, 1881, p. 529. *Dipterina incessana*, *Meyr.*, *Trans. N.Z. Inst.*, xv., p. 55.

**Dipterina imbriferana**, *Meyr.*

*D. imbriferana*, *Meyr.*, *Proc. Linn. Soc. N.S.W.*, 1881, p. 527, and *Trans. N.Z. Inst.*, xv., p. 55.

**Eurythecta**, *Meyr.***Eurythecta robusta**, *Butl.*

*Zelotheres* (?) *robusta*, *Butl.*, *Proc. Zool. Soc. Lond.*, 1877, p. 403, pl. xliii., fig. 17. *Steganoptycha* (?) *negligens*, *ib.*, p. 404, pl. xliii., fig. 18. *Eurythecta robusta*, *Meyr.*, *Trans. N.Z. Inst.*, xv., p. 56.

**Prothelymna**, *Meyr.***Prothelymna nephelotana**, *Meyr.*

*P. nephelotana*, *Meyr.*, *Trans. N.Z. Inst.*, xv., p. 57.

## Family GRAPHOLITHIDÆ.

**Epalxiphora**, *Meyr.***Epalxiphora axenana**, *Meyr.*

*E. axenana*, *Meyr.*, *Proc. Linn. Soc. N.S.W.*, 1881, p. 648, and *Trans. N.Z. Inst.*, xv., p. 58.

**Bactra**, *Steph.***Bactra lanceolana**, *Hb.*

*Aphelia lanceolana*, *Hb.*, *Meyr.*, *Trans. N.Z. Inst.*, xv., p. 59.

**Carpocapsa**, *Tr.***Carpocapsa pomonella**, *L.*

*C. pomonella*, *L.*; *Meyr.*, *Trans. N.Z. Inst.*, xv., p. 61.

**Protithona**, Meyr.

*Protithona fugitivana*, Meyr.

*P. fugitivana*, Meyr., Trans. N.Z. Inst., xv., p. 62.

**Noteraula**, Meyr.

*Noteraula straminea*, Meyr.

*N. straminea*, Meyr., Trans. N.Z. Inst., xxiv., p. 217. *Chiloides straminea*, Meyr., Trans. N.Z. Inst., xvii., p. 142.

**Strepsicrates**, Meyr.

*Strepsicrates ejectana*, Walk.

*Sciaphila ejectana*, Walk., l.c., xxviii., p. 350. *Strepsiceros ejectana*, Meyr., Proc. Linn. Soc. N.S.W., 1881, p. 681, and Trans. N.Z. Inst., xv., p. 63. (?) *Sciaphila absconditana*, Walk., l.c., xxviii., p. 351. *S. servilisana*, ib., p. 356; Butl., Cat. Lep. N.Z., p. 21. *S. saxana*, Walk., l.c., xxviii., p. 357; Butl., Cat. Lep. N.Z., p. 21. *Conchylis ligniferana*, Walk., l.c., xxviii., p. 363.

*Strepsicrates zopherana*, Meyr.

*Strepsiceros zopherana*, Meyr., Proc. Linn. Soc. N.S.W., 1881, p. 688, and Trans. N.Z. Inst., xv., p. 64.

*Strepsicrates charopa*, Meyr.

*S. charopa*, Meyr., Trans. N.Z. Inst., xx., p. 73.

*Strepsicrates parthenia*, Meyr.

*S. parthenia*, Meyr., Trans. N.Z. Inst., xx., p. 73.

**Hendecasticha**, Meyr.

*Hendecasticha æthaliana*, Meyr.

*H. æthaliana*, Meyr., Proc. Linn. Soc. N.S.W., 1881, p. 692, and Trans. N.Z. Inst., xv., p. 64.

**Exoria**, Meyr.

*Exoria mochlophorana*, Meyr.

*E. mochlophorana*, Meyr., Trans. N.Z. Inst., xv., p. 65.

Family CONCHYLIDÆ.

**Heterocrossa**, Meyr.

*Heterocrossa adreptella*, Walk.

*Gelechia adreptella*, Walk., l.c., xxix., p. 654; Butl., Cat. Lep. N.Z., p. 23. *Paramorpha adreptella*, Meyr., Proc. Linn. Soc. N.S.W., 1881, p. 698. *Heterocrossa adreptella*, Meyr., Trans. N.Z. Inst., xv., p. 66.

*Heterocrossa gonosemana*, Meyr.

*H. gonosemana*, Meyr., Proc. Linn. Soc. N.S.W., 1882, and Trans. N.Z. Inst., xv., p. 67.

*Heterocrossa cryodana*, Meyr.

*H. cryodana*, Meyr., Trans. N.Z. Inst., xvii., p. 148.

*Heterocrossa epomiana*, Meyr.

*H. epomiana*, Meyr., Trans. N.Z. Inst., xvii., p. 149.

*Heterocrossa exochana*, Meyr.

*H. exochana*, Meyr., Trans. N.Z. Inst., xx., p. 76.

**Heterocrossa eriphylla**, *Meyr.**H. eriphylla*, Meyr., Trans. N.Z. Inst., xx, p. 76.**Heterocrossa charaxias**, *Meyr.**H. charaxias*, Meyr., Trans. N.Z. Inst., xxiii., p. 98.**Isonomeutis**, *Meyr.***Isonomeutis amauropa**, *Meyr.**I. amauropa*, Meyr., Trans. N.Z. Inst., xx., p. 75.

## Group TINEINA.

## Family GELECHIADÆ.

**Megacraspedus**, *Z.***Megacraspedus calamogonus**, *Meyr.**M. calamogonus*, Meyr., Trans. N.Z. Inst., xviii., p. 163.**Isochasta**, *Meyr.***Isochasta paradesma**, *Meyr.**I. paradesma*, Meyr., Trans. N.Z. Inst., xviii., p. 163.**Thiotricha**, *Meyr.***Thiotricha tetraphala**, *Meyr.**T. tetraphala*, Meyr., Trans. N.Z. Inst., xviii., p. 164.**Thiotricha thorybodes**, *Meyr.**T. thorybodes*, Meyr., Trans. N.Z. Inst., xviii., p. 164.**Scieropepla**, *Meyr.***Scieropepla typhicola**, *Meyr.**S. typhicola*, Meyr., Trans. N.Z. Inst., xviii., p. 165.**Gelechia**, *Z.***Gelechia solanella**, *Boisd.**Bryotropha solanella*, Boisd., J. B. Soc. Centr. Hort., 1874; Ragonot, Bull. Soc. Ent. Fr., v., pp. xxxv., xxxvii.; Meyr., Proc. Linn. Soc. N.S.W., 1879, p. 112, and Trans. N.Z. Inst., xviii., p. 166.  
*Gelechia terrella*, Walk., l.c., xxx., p. 1024.**Gelechia thyraula**, *Meyr.**G. thyraula*, Meyr., Trans. N.Z. Inst., xviii., p. 167.**Gelechia brontophora**, *Meyr.**G. brontophora*, Meyr., Trans. N.Z. Inst., xviii., p. 168.**Gelechia schematica**, *Meyr.**G. schematica*, Meyr., Trans. N.Z. Inst., xviii., p. 168.**Gelechia paraplura**, *Meyr.**G. paraplura*, Meyr., Trans. N.Z. Inst., xviii., p. 168.**Gelechia pharetria**, *Meyr.**G. pharetria*, Meyr., Trans. N.Z. Inst., xviii., p. 169.**Gelechia monophragma**, *Meyr.**G. monophragma*, Meyr., Trans. N.Z. Inst., xviii., p. 169.

*Gelechia lithodes*, *Meyr.*

*G. lithodes*, *Meyr.*, *Trans. N.Z. Inst.*, xviii., p. 170.

*Gelechia achyrota*, *Meyr.*

*G. achyrota*, *Meyr.*, *Trans. N.Z. Inst.*, xviii., p. 170.

**Anisoplaca**, *Meyr.*

*Anisoplaca ptyoptera*, *Meyr.*

*A. ptyoptera*, *Meyr.*, *Trans. N.Z. Inst.*, xviii., p. 171.

**Epiphthora**, *Meyr.*

*Epiphthora melanombra*, *Meyr.*

*E. melanombra*, *Meyr.*, *Trans. N.Z. Inst.*, xx., p. 77.

Family DEPRESSARIADÆ.

**Phæosaces**, *Meyr.*

*Phæosaces compsotypa*, *Meyr.*

*P. compsotypa*, *Meyr.*, *Trans. N.Z. Inst.*, xviii., p. 172.

*Phæosaces apocrypta*, *Meyr.*

*P. apocrypta*, *Meyr.*, *Trans. N.Z. Inst.*, xviii., p. 172.

*Phæosaces liochroa*, *Meyr.*

*P. liochroa*, *Meyr.*, *Trans. N.Z. Inst.*, xxiii., p. 98.

ÆCOPHORIDÆ.

**Nymphostola**, *Meyr.*

*Nymphostola galactina*, *Feld.*

*Cryptolechia galactina*, *Feld., l.c.*, pl. cxl., fig. 34; *Butl., Proc. Zool. Soc. Lond.*, 1877, p. 406, and *Cist. Ent.*, ii., p. 511. *Nymphostola galactina*, *Meyr.*, *Trans. N.Z. Inst.*, xvi., p. 6.

**Proteodes**, *Meyr.*

*Proteodes carnifex*, *Butl.*

*Cryptolechia carnifex*, *Butl.*, *Proc. Zool. Soc. Lond.*, 1877, p. 406. *Proteodes carnifex*, *Meyr.*, *Proc. Linn. Soc. N.S.W.*, 1882, p. 493, and *Trans. N.Z. Inst.*, xvi., p. 6. *Cryptolechia rufosparsa*, *Butl.*, *Proc. Zool. Soc. Lond.*, 1877, p. 406.

**Eulechria**, *Meyr.*

*Eulechria zophoëssa*, *Meyr.*

*E. zophoëssa*, *Meyr.*, *Proc. Linn. Soc. N.S.W.*, 1882, p. 515, and *Trans. N.Z. Inst.*, xvi., p. 8.

*Eulechria photinella*, *Meyr.*

*E. photinella*, *Meyr.*, *Proc. Linn. Soc. N.S.W.*, 1882, p. 541, and *Trans. N.Z. Inst.*, xvi., p. 9.

**Atomotricha**, *Meyr.*

*Atomotricha ommatias*, *Meyr.*

*A. ommatias*, *Meyr.*, *Trans. N.Z. Inst.*, xvi., p. 10.

**Brachysara**, *Meyr.*

*Brachysara sordida*, *Butl.*

*Æcophora sordida*, *Butl.*, *Proc. Zool. Soc. Lond.*, 1877, p. 405. *Brachysara sordida*, *Meyr.*, *Trans. N.Z. Inst.*, xvi., p. 11.

**Phlæopola**, Meyr.Phlæopola dinocosma, *Meyr.**P. dinocosma*, Meyr., Trans. N.Z. Inst., xvi., p. 12.**Trachypepla**, Meyr.Trachypepla leucoplanetis, *Meyr.**T. leucoplanetis*, Meyr., Trans. N.Z. Inst., xvi., p. 14.Trachypepla euryleucota, *Meyr.**T. euryleucota*, Meyr., Trans. N.Z. Inst., xvi., p. 14.Trachypepla conspicuella, *Walk.**Gelechia conspicuella*, Walk., l.c., xxix., p. 651; Butl., Cat. Lep. N.Z., p. 23, and Cist. Ent., ii., p. 560. *G. taongella*, Feld., l.c., pl. cxl., fig. 450. *Trachypepla conspicuella*, Meyr., Trans. N.Z. Inst., xvi., p. 15.Trachypepla spartodeta, *Meyr.**T. spartodeta*, Meyr., Trans. N.Z. Inst., xvi., p. 16.Trachypepla nyctopis, *Meyr.**T. nyctopis*, Meyr., Trans. N.Z. Inst., xvi., p. 16.Trachypepla galaxias, *Meyr.**T. galaxias*, Meyr., Trans. N.Z. Inst., xvi., p. 17.Trachypepla hieropis, *Meyr.**T. hieropis*, Meyr., Trans. N.Z. Inst., xxiv., p. 218.Trachypepla protochlora, *Meyr.**T. protochlora*, Meyr., Trans. N.Z. Inst., xvi., p. 18.Trachypepla aspidephora, *Meyr.**T. aspidephora*, Meyr., Trans. N.Z. Inst., xvi., p. 19.Trachypepla anastrella, *Meyr.**T. anastrella*, Meyr., Trans. N.Z. Inst., xvi., p. 19.Trachypepla lichenodes, *Meyr.**T. lichenodes*, Meyr., Trans. N.Z. Inst., xvi., p. 20.**Aschleta**, Meyr.Aschleta psychra, *Meyr.**A. psychra*, Meyr., Trans. N.Z. Inst., xvi., p. 21.**Peltophora**, Meyr.Peltophora amenena, *Meyr.**P. amenena*, Meyr., Trans. N.Z. Inst., xx., p. 78.**Semiocosma**, Meyr.Semiocosma mystis, *Meyr.**S. mystis*, Meyr., Trans. N.Z. Inst., xx., p. 79.Semiocosma peroneanella, *Walk.**Gelechia peroneanella*, Walk., l.c., xxix., p. 658; Butl., Cat. Lep. N.Z., p. 24, and Cist. Ent., ii., p. 510. *Cryptolechia lichenella*, Walk., l.c., xxix., p. 769; Butl., Cat. Lep. N.Z., p. 24. *Ecophora huttonii*, Butl., Cist. Ent., ii., p. 511. *Semiocosma peroneanella*, Meyr., Trans. N.Z. Inst., xvi., p. 22.



*Semiocosma picarella*, *Walk.*

*Ecophora picarella*, *Walk.*, *l.c.*, xxix., p. 699; *Butl.*, *Cat. Lep. N.Z.*, p. 24, and *Cist. Ent.*, ii., p. 561. *Psecadia teras*, *Feld.*, *l.c.*, pl. cxi., fig. 23. *Semiocosma picarella*, *Meyr.*, *Trans. N.Z. Inst.*, xvi., p. 23.

*Semiocosma epiphanes*, *Meyr.*

*S. epiphanes*, *Meyr.*, *Trans. N.Z. Inst.*, xvi., p. 24.

*Semiocosma prasophyta*, *Meyr.*

*S. prasophyta*, *Meyr.*, *Trans. N.Z. Inst.*, xvi., p. 25.

*Semiocosma austera*, *Meyr.*

*S. austera*, *Meyr.*, *Trans. N.Z. Inst.*, xvi., p. 25.

*Semiocosma apodoxa*, *Meyr.*

*S. apodoxa*, *Meyr.*, *Trans. N.Z. Inst.*, xx., p. 79.

*Semiocosma platyptera*, *Meyr.*

*S. platyptera*, *Meyr.*, *Trans. N.Z. Inst.*, xx., p. 80.

*Semiocosma caustopa*, *Meyr.*

*S. caustopa*, *Meyr.*, *Trans. N.Z. Inst.*, xxiv., p. 219.

*Semiocosma paraneura*, *Meyr.*

*S. paraneura*, *Meyr.*, *Trans. N.Z. Inst.*, xxiv., p. 219.

**Lathicrossa**, *Meyr.*

*Lathicrossa leucocentra*, *Meyr.*

*L. leucocentra*, *Meyr.*, *Trans. N.Z. Inst.*, xvi., p. 26.

**Thamnosara**, *Meyr.*

*Thamnosara chirista*, *Meyr.*

*T. chirista*, *Meyr.*, *Trans. N.Z. Inst.*, xvi., p. 27.

**Gymnobathra**, *Meyr.*

*Gymnobathra coarctatella*, *Walk.*

*Cryptolechia coarctatella*, *Walk.*, *l.c.*, xxix., p. 768; *Butl.*, *Cat. Lep. N.Z.*, p. 24. *Gymnobathra coarctatella*, *Meyr.*, *Trans. N.Z. Inst.*, xvi., p. 28.

*Gymnobathra sarcoxantha*, *Meyr.*

*G. sarcoxantha*, *Meyr.*, *Trans. N.Z. Inst.*, xvi., p. 29.

*Gymnobathra parca*, *Butl.*

*Ecophora parca*, *Butl.*, *Proc. Zool. Soc. Lond.*, 1877, p. 405.  
*Gymnobathra parca*, *Meyr.*, *Trans. N.Z. Inst.*, xvi., p. 29.

*Gymnobathra tholodella*, *Meyr.*

*G. tholodella*, *Meyr.*, *Trans. N.Z. Inst.*, xvi., p. 30.

*Gymnobathra calliploca*, *Meyr.*

*G. calliploca*, *Meyr.*, *Trans. N.Z. Inst.*, xvi., p. 30.

*Gymnobathra flavidella*, *Walk.*

*Gelechia flavidella*, *Walk.*, *l.c.*, xxix., p. 655; *Butl.*, *Cat. Lep. N.Z.*, p. 23. *Ecophora utuella*, *Feld.*, *l.c.*, pl. cxi., fig. 46. *Ge. flavidella*, *Butl.*, *Cist. Ent.*, ii., p. 560. *Gymnobathra flavidella*, *Meyr.*, *Trans.*, *N.Z. Inst.*, xvi., p. 31.

*Gymnobathra hamatella*, *Walk.*

*Ecophora hamatella*, *Walk.*, *l.c.*, xxix., p. 700; *Butl.*, *Cat. Lep. N.Z.*, p. 24. *Gymnobathra hamatella*, *Meyr.*, *Trans. N.Z. Inst.*, xvi., p. 31.

Gymnobathra hyetodes, *Meyr.**G. hyetodes*, Meyr., Trans. N.Z. Inst., xvi., p. 32.Gymnobathra philadelphia, *Meyr.**G. philadelphia*, Meyr., Trans. N.Z. Inst., xvi., p. 33.Gymnobathra habropis, *Meyr.**G. habropis*, Meyr., Trans. N.Z. Inst., xx., p. 80.Gymnobathra omphalota, *Meyr.**G. omphalota*, Meyr., Trans. N.Z. Inst., xx., p. 81.**Æcophora, Z.**Æcophora pseudospretella, *Stainton.**Æ. pseudospretella*, Stainton; Meyr., Trans. N.Z. Inst., xvi., p. 34.Æcophora scholæa, *Meyr.**Æ. scholæa*, Meyr., Trans. N.Z. Inst., xvi., p. 35, and xxi., p. 187.Æcophora letharga, *Meyr.**Æ. letharga*, Meyr., Trans. N.Z. Inst., xvi., p. 35.Æcophora chloritis, *Meyr.**Æ. chloritis*, Meyr., Trans. N.Z. Inst., xvi., p. 36.Æcophora epimyliæ, *Meyr.**Æ. epimyliæ*, Meyr., Trans. N.Z. Inst., xvi., p. 36.Æcophora contextella, *Walk.**Gelechia contextella*, Walk., l.c., xxix., p. 656; Butl., Cat. Lep. N.Z., p. 23. *Æcophora contextella*, Meyr., Trans. N.Z. Inst., xvi., p. 37.Æcophora hemimochla, *Meyr.**Æ. hemimochla*, Meyr., Trans. N.Z. Inst., xvi., p. 38.Æcophora griseata, *Butl.**Æ. griseata*, Butl., Proc. Zool. Soc. Lond., 1887, p. 405; Meyr., Trans. N.Z. Inst., xvi., p. 39.Æcophora plegophylla, *Meyr.**Æ. plegophylla*, Meyr., Trans. N.Z. Inst., xvi., p. 39.Æcophora oporæa, *Meyr.**Æ. oporæa*, Meyr., Trans. N.Z. Inst., xvi., p. 40.Æcophora horæa, *Meyr.**Æ. horæa*, Meyr., Trans. N.Z. Inst., xvi., p. 40.Æcophora armigerella, *Walk.**Æ. armigerella*, Walk., l.c., xxix., p. 698; Butl., Cat. Lep. N.Z., p. 24; Meyr., Trans. N.Z. Inst., xvi., p. 41.Æcophora apantes, *Meyr.**Æ. apantes*, Meyr., Trans. N.Z. Inst., xvi., p. 41.Æcophora anæma, *Meyr.**Æ. anæma*, Meyr., Trans. N.Z. Inst., xvi., p. 42.Æcophora macarella, *Meyr.**Æ. macarella*, Meyr., Trans. N.Z. Inst., xvi., p. 43.Æcophora homodoxa, *Meyr.**Æ. homodoxa*, Meyr., Trans. N.Z. Inst., xvi., p. 43.Æcophora siderodeta, *Meyr.**Æ. siderodeta*, Meyr., Trans. N.Z. Inst., xvi., p. 43.

*Œcophora hoplodesma*, *Meyr.*

*Œ. hoplodesma*, *Meyr.*, *Trans. N.Z. Inst.*, xvi., p. 44.

*Œcophora chrysogramma*, *Meyr.*

*Œ. chrysogramma*, *Meyr.*, *Trans. N.Z. Inst.*, xvi., p. 44.

*Œcophora politis*, *Meyr.*

*Œ. politis*, *Meyr.*, *Trans. N.Z. Inst.*, xx., p. 81, and xxi., p. 187.

*Œcophora nycteris*, *Meyr.*

*Œ. nycteris*, *Meyr.*, *Trans. N.Z. Inst.*, xxii., p. 219.

**Cretnogenes**, *Meyr.*

*Cretnogenes oxyina*, *Meyr.*

*C. oxyina*, *Meyr.*, *Trans. N.Z. Inst.*, xvi., p. 45.

*Cretnogenes aphrontis*, *Meyr.*

*C. aphrontis*, *Meyr.*, *Trans. N.Z. Inst.*, xvi., p. 46.

*Cretnogenes siderota*, *Meyr.*

*C. siderota*, *Meyr.*, *Trans. N.Z. Inst.*, xx., p. 82.

Family GLYPHIPTERYGIDÆ.

**Helioſtibes**, *Z.*

*Helioſtibes illita*, *Feld.*

*Atychia illita*, *Feld.*, *l.c.*, pl. cxi., fig. 32. *Helioſtibes illita*, *Meyr.*, *Trans. N.Z. Inst.*, xx., p. 83.

*Helioſtibes atychioides*, *Butl.*

*Tachyptilia atychioides*, *Butl.*, *Proc. Zool. Soc. Lond.*, 1877, p. 405, pl. xliii., fig. 14. *Helioſtibes atychioides*, *Meyr.*, *Trans. N.Z. Inst.*, xx., p. 83.

*Helioſtibes electrica*, *Meyr.*

*H. electrica*, *Meyr.*, *Trans. N.Z. Inst.*, xxi., p. 157.

**Simæthis**, *Leach.*

*Simæthis microlitha*, *Meyr.*

*S. microlitha*, *Meyr.*, *Trans. N.Z. Inst.*, xx., p. 84.

*Simæthis marmarea*, *Meyr.*

*S. marmarea*, *Meyr.*, *Trans. N.Z. Inst.*, xx., p. 85.

*Simæthis symbolæa*, *Meyr.*

*S. symbolæa*, *Meyr.*, *Trans. N.Z. Inst.*, xx., p. 85.

**Glyphipteryx**, *Hübner.*

*Glyphipteryx zelota*, *Meyr.*

*G. zelota*, *Meyr.*, *Trans. N.Z. Inst.*, xx., p. 86.

*Glyphipteryx acronoma*, *Meyr.*

*G. acronoma*, *Meyr.*, *Trans. N.Z. Inst.*, xx., p. 86.

*Glyphipteryx leptosema*, *Meyr.*

*G. leptosema*, *Meyr.*, *Trans. N.Z. Inst.*, xx., p. 87.

*Glyphipteryx nephoptera*, *Meyr.*

*G. nephoptera*, *Meyr.*, *Trans. N.Z. Inst.*, xx., p. 87.

**Phryganostola**, Meyr.Phryganostola ataracta, *Meyr.**P. ataracta*, Meyr., Trans. N.Z. Inst., xx., p. 88.**Circica**, Meyr.Circica cionophora, *Meyr.**C. cionophora*, Meyr., Trans. N.Z. Inst., xx., p. 88.Circica xestobela, *Meyr.**C. xestobela*, Meyr., Trans. N.Z. Inst., xx., p. 89.**Pantosperma**, Meyr.Pantosperma holochalca, *Meyr.**P. holochalca*, Meyr., Trans. N.Z. Inst., xx., p. 89.

## Family PLUTELLIDÆ.

**Protosynæma**, Meyr.Protosynæma eratopis, *Meyr.**P. eratopis*, Meyr., Trans. N.Z. Inst., xviii., p. 174.Protosynæma steropucha, *Meyr.**P. steropucha*, Meyr., Trans. N.Z. Inst., xviii., p. 174.**Orthenches**, Meyr.Orthenches chlorocoma, *Meyr.**O. chlorocoma*, Meyr., Trans. N.Z. Inst., xviii., p. 175.Orthenches prasinodes, *Meyr.**O. prasinodes*, Meyr., Trans. N.Z. Inst., xviii., p. 176.Orthenches porphyritis, *Meyr.**O. porphyritis*, Meyr., Trans. N.Z. Inst., xviii., p. 176.**Plutella**, Schrk.Plutella cruciferarum, *Z.**P. cruciferarum*, *Z.*; Meyr., Trans. N.Z. Inst., xviii., p. 177.Plutella sera, *Meyr.**P. sera*, Meyr., Trans. N.Z. Inst., xviii., p. 178.Plutella psammochroa, *Meyr.**P. psammochroa*, Meyr., Trans. N.Z. Inst., xviii., p. 179.**Compsistis**, Meyr.Compsistis bifaciella, *Walk.**Gelechia bifaciella*, *Walk.*, l.c., xxix., p. 657; *Butl.*, Cat. Lep. N.Z., p. 24. *Compsistis bifaciella*, Meyr., Trans. N.Z. Inst., xx., p. 90.

## Family MICROPTERYGIDÆ.

**Mnesarchæa**, Meyr.Mnesarchæa paracosma, *Meyr.**M. paracosma*, Meyr., Trans. N.Z. Inst., xviii., p. 180.Mnesarchæa loxoscia, *Meyr.**M. loxoscia*, Meyr., Trans. N.Z. Inst., xx., p. 90.

*Mnesarchæa hamadelpha*, *Meyr.*

*M. hamadelpha*, *Meyr.*, *Trans. N.Z. Inst.*, xx., p. 91.

**Palæomicra**, *Meyr.*

*Palæomicra chalcophanes*, *Meyr.*

*P. chalcophanes*, *Meyr.*, *Trans. N.Z. Inst.*, xviii., p. 182.

*Palæomicra chrysargyra*, *Meyr.*

*P. chrysargyra*, *Meyr.*, *Trans. N.Z. Inst.*, xviii., p. 182.

*Palæomicra zonodoxa*, *Meyr.*

*P. zonodoxa*, *Meyr.*, *Trans. N.Z. Inst.*, xx., p. 91.

*Palæomicra doroxena*, *Meyr.*

*P. doroxena*, *Meyr.*, *Trans. N.Z. Inst.*, xx., p. 92.

**Eutoma**, *Meyr.*

*Eutoma caryochroa*, *Meyr.*

*E. caryochroa*, *Meyr.*, *Trans. N.Z. Inst.*, xxi., p. 158.

*Eutoma symmorphia*, *Meyr.*

*E. symmorphia*, *Meyr.*, *Trans. N.Z. Inst.*, xxi., p. 158.

**Dolichernis**, *Meyr.*

*Dolichernis chloroleuca*, *Meyr.*

*D. chloroleuca*, *Meyr.*, *Trans. N.Z. Inst.*, xxiii., p. 99.

Family TINEIDÆ.

**Ereunetis**, *Meyr.*

*Ereunetis technica*, *Meyr.*

*E. technica*, *Meyr.*, *Trans. N.Z. Inst.*, xx., p. 92.

**Erechthias**, *Meyr.*

*Erechthias melanotricha*, *Meyr.*

*E. melanotricha*, *Meyr.*, *Trans. N.Z. Inst.*, xx., p. 93.

*Erechthias erebistis*, *Meyr.*

*E. erebistis*, *Meyr.*, *Trans. N.Z. Inst.*, xxiv., p. 220.

**Decadarchis**, *Meyr.*

*Decadarchis monastra*.

*D. monastra*, *Meyr.*, *Trans. N.Z. Inst.*, xxiii., p. 100.

**Endopthora**, *Meyr.*

*Endopthora omogramma*, *Meyr.*

*E. omogramma*, *Meyr.*, *Trans. N.Z. Inst.*, xx., p. 94.

*Endopthora pharotoma*, *Meyr.*

*E. pharotoma*, *Meyr.*, *Trans. N.Z. Inst.*, xx., p. 94.

*Endopthora mesotypa*, *Meyr.*

*E. mesotypa*, *Meyr.*, *Trans. N.Z. Inst.*, xx., p. 94.

*Endopthora agriopa*, *Meyr.*

*E. agriopa*, *Meyr.*, *Trans. N.Z. Inst.*, xx., p. 95.

**Habrophila, Meyr.**Habrophila compseuta, *Meyr.**H. compseuta*, Meyr., Trans. N.Z. Inst., xxi., p. 161.**Sagephora, Meyr.**Sagephora phortegella, *Meyr.**S. phortegella*, Meyr., Trans. N.Z. Inst., xx., p. 96.Sagephora steropastis, *Meyr.**S. steropastis*, Meyr., Trans. N.Z. Inst., xxiii., p. 100.**Blabophanes, Z.**Blabophanes ethelella, *Newman.**Tinea ethelella*, Newm., Trans. Ent. Soc. Lond., iii. (N.S.), 288.  
*T. rectella*, Walk., l.c., xxviii., p. 482; Butl., Cat. Lep. N.Z., p. 22, also Proc. Zool. Soc. Lond., 1877, p. 404, and Cist. Ent., ii., p. 560. *Blabophanes namuella*, Feld., l.c., pl. cxi., fig. 44. *B. ethelella*, Meyr., Trans. N.Z. Inst., xx., p. 97.Blabophanes ferruginella, *Hübner.**B. ferruginella*, Hübner.; Meyr., Trans. N.Z. Inst., xx., p. 97.Blabophanes ornithias, *Meyr.**B. ornithias*, Meyr., Trans. N.Z. Inst., xx., p. 97.**Tinea, Z.**Tinea tapetiella, *L.**T. tapetiella* (*tapetzella*), L. *T. palæstrica*, Butl., Proc. Zool. Soc. Lond., 1877, p. 404. *T. tapetiella*, Meyr., Trans. N.Z. Inst., xx., p. 98.Tinea grammocosma, *Meyr.**T. grammocosma*, Meyr., Trans. N.Z. Inst., xx., p. 98.Tinea belonota, *Meyr.**T. belonota*, Meyr., Trans. N.Z. Inst., xx., p. 99.Tinea certella, *Walk.**T. certella*, Walk., l.c., xxviii., p. 484; Butl., Cat. Lep. N.Z., p. 22; Meyr., Trans. N.Z. Inst., xx., p. 99.Tinea mochlota, *Meyr.**T. mochlota*, Meyr., Trans. N.Z. Inst., xx., p. 100.Tinea fuscipunctella, *Hw.**T. fuscipunctella*, Hw.; Meyr., Trans. N.Z. Inst., xx., p. 100.Tinea terranea, *Butl.**T. terranea*, Butl., Cist. Ent., ii., p. 510; Meyr., Trans. N.Z. Inst., xx., p. 100.**Tineola, H. S.**Tineola biselliella, *Hüm.**T. biselliella*, Hüm.; Meyr., Trans. N.Z. Inst., xx., p. 101.

## Family LIPUSIDÆ.

**Scoriodyta, Meyr.**Scoriodyta conisalia, *Meyr.**S. conisalia*, Meyr., Trans. N.Z. Inst., xx., p. 102.

**Mallobathra**, Meyr.

Mallobathra crataea, *Meyr.*

*M. crataea*, Meyr., Trans. N.Z. Inst., xx., p. 102.

Mallobathra metrosema, *Meyr.*

*M. metrosema*, Meyr., Trans. N.Z. Inst., xx., p. 103.

Mallobathra microphanes, *Meyr.*

*M. microphanes*, Meyr., Trans. N.Z. Inst., xx., p. 103.

Mallobathra homalopa, *Meyr.*

*M. homalopa*, Meyr., Trans. N.Z. Inst., xxiii., p. 100.

Family ANAPHORIDÆ.

**Titanomis**, Meyr.

Titanomis sisyrota, *Meyr.*

*T. sisyrota*, Meyr., Trans. N.Z. Inst., xx., p. 104.

Family HYPONOMEUTIDÆ.

**Lysiphragma**, Meyr.

Lysiphragma mixochlora, *Meyr.*

*L. mixochlora*, Meyr., Trans. N.Z. Inst., xx., p. 105.

Lysiphragma epixyla, *Meyr.*

*L. epixyla*, Meyr., Trans. N.Z. Inst., xx., p. 105.

**Archyala**, Meyr.

Archyala paraglypta, *Meyr.*

*A. paraglypta*, Meyr., Trans. N.Z. Inst., xxi., p. 159.

**Endrosis**, Hüb.

Endrosis lacteella, *Schiff.*

*E. lacteella*, Schiff. *Gelechia subditella*, Walk., *l.c.*, xxix., p. 657;  
Butl., Cat. Lep. N.Z., p. 24. (?) *G. adaperrella*, Walk., *l.c.*, xxix., p. 653;  
Butl., Cat. Lep. N.Z., p. 23. *Endrosis lacteella*, Meyr., Trans. N.Z.  
Inst., xxi., p. 160.

**Butalis**, Tr.

Butalis epistrota, *Meyr.*

*B. epistrota*, Meyr., Trans. N.Z. Inst., xxi., p. 161.

Family ARGYRESTHIADÆ.

**Hofmannia**, Walk.

Hofmannia sphenota, *Meyr.*

*H. sphenota*, Meyr., Trans. N.Z. Inst., xxi., p. 162.

**Circostola**, Meyr.

Circostola copidota, *Meyr.*

*C. copidota*, Meyr., Trans. N.Z. Inst., xxi., p. 163.

**Cateristis**, Meyr.

Cateristis eustyla, *Meyr.*

*C. eustyla*, Meyr., Trans. N.Z. Inst., xxi., p. 164.

**Bedellia, St.**

*Bedellia somnulentella*, *Z.*

*B. somnulentella*, *Z.*; Stainton, Man. Brit. Butt. and Moths, ii., p. 395; Meyr., Trans. N.Z. Inst., xxi., p. 164.

*Bedellia psammimella*, *Meyr.*

*B. psammimella*, *Meyr.*, Trans. N.Z. Inst., xxi., p. 165.

## Family ELACHISTIDÆ, St.

**Vanicela, Walk.**

*Vanicela disjunctella*, *Walk.*

*V. disjunctella*, *Walk.*, l.c., xxx., p. 1039; Butl., Cat. Lep. N.Z., p. 24; Meyr., Trans. N.Z. Inst., xxi., p. 166.

*Vanicela xenadelpha*, *Meyr.*

*V. xenadelpha*, *Meyr.*, Trans. N.Z. Inst., xxi., p. 166.

**Stathmopoda, St.**

*Stathmopoda holochra*, *Meyr.*

*S. holochra*, *Meyr.*, Trans. N.Z. Inst., xxi., p. 168.

*Stathmopoda phlegra*, *Meyr.*

*S. phlegra*, *Meyr.*, Trans. N.Z. Inst., xxi., p. 168.

*Stathmopoda campylocha*, *Meyr.*

*S. campylocha*, *Meyr.*, Trans. N.Z. Inst., xxi., p. 168.

*Stathmopoda skelloni*, *Butl.*

*Boocara skelloni*, *Butl.*, Cist. Ent., ii., p. 562. *Stathmopoda skelloni*, *Meyr.*, Trans. N.Z. Inst., xxi., p. 169.

*Stathmopoda epichlora*, *Meyr.*

*S. epichlora*, *Meyr.*, Trans. N.Z. Inst., xxi., p. 169.

*Stathmopoda caminora*, *Meyr.*

*S. caminora*, *Meyr.*, Trans. N.Z. Inst., xx., p. 219.

**Calicotis, Meyr.**

*Calicotis crucifera*, *Meyr.*

*C. crucifera*, *Meyr.*, Trans. N.Z. Inst., xxi., p. 170.

**Thylacosceles, Meyr.**

*Thylacosceles acridomima*, *Meyr.*

*T. acridomima*, *Meyr.*, Trans. N.Z. Inst., xxi., p. 171.

**Zapyrastra, Meyr.**

*Zapyrastra calliphana*, *Meyr.*

*Z. calliphana*, *Meyr.*, Trans. N.Z. Inst., xxi., p. 172.

**Limnœcia, Stainton.**

*Limnœcia phragmitella*, *Stainton.*

*Laverna phragmitella*, *Stt.*, l.c., ii., p. 397. *Limnœcia phragmitella*, *Meyr.*, Trans. N.Z. Inst., xxi., p. 173.

**Syntomactis, Meyr.**

*Syntomactis deamatella*, *Walk.*

*Gelechia deamatella*, *Walk.*, l.c., xxix., p. 654; *Butl.*, Cat. Lep. N.Z., p. 23. *Syntomactis deamatella*, *Meyr.*, Trans. N.Z. Inst., xxi., p. 173.



**Proterocosma**, Meyr.

*Proterocosma apparitella*, *Walk.*

*Gelechia apparitella*, *Walk., l.c.*, xxx., p. 1027; *Butl., Cat. Lep. N.Z.*, p. 24. *Proterocosma apparitella*, *Meyr., Trans. N.Z. Inst.*, xxi., p. 174.

*Proterocosma ællotricha*, *Meyr.*

*P. ællotricha*, *Meyr., Trans. N.Z. Inst.* xxi., p. 175.

*Proterocosma anarithma*, *Meyr.*

*P. anarithma*, *Meyr., Trans. N.Z. Inst.*, xxi., p. 175.

**Elachista**, Stainton.

*Elachista melanura*, *Meyr.*

*E. melanura*, *Meyr., Trans. N.Z. Inst.*, xxi., p. 177.

*Elachista gerasmia*, *Meyr.*

*E. gerasmia*, *Meyr., Trans. N.Z. Inst.*, xxi., p. 177.

*Elachista thallophora*, *Meyr.*

*E. thallophora*, *Meyr., Trans. N.Z. Inst.*, xxi., p. 178.

*Elachista helonoma*, *Meyr.*

*E. helonoma*, *Meyr., Trans. N.Z. Inst.*, xxi., p. 178.

*Elachista exaula*, *Meyr.*

*E. exaula*, *Meyr., Trans. N.Z. Inst.*, xxi., p. 178.

*Elachista ombrodoca*, *Meyr.*

*E. ombrodoca*, *Meyr., Trans. N.Z. Inst.*, xxi., p. 179.

*Elachista archæonoma*, *Meyr.*

*E. archæonoma*, *Meyr., Trans. N.Z. Inst.*, xxi., p. 179.

**Batrachedra**, Stainton.

*Batrachedra eucola*, *Meyr.*

*B. eucola*, *Meyr., Trans. N.Z. Inst.*, xxi., p. 180.

*Batrachedra arenosella*, *Walk.*

*Gracilaria arenosella*, *Walk., l.c.*, xxx., p. 857; *Butl., Cat. Lep. N.Z.*, p. 85. *Batrachedra arenosella*, *Meyr., Trans. N.Z. Inst.*, xxi., p. 181.

*Batrachedra psithyra*, *Meyr.*

*B. psithyra*, *Meyr., Trans. N.Z. Inst.*, xxi., p. 181.

Family GRACILARIADÆ.

**Gracilaria**, Z.

*Gracilaria chrysis*, *Feld.*

*G. chrysis*, *Feld., l.c.*, pl. cxi. *G. adelina*, *Meyr., Proc. Linn. Soc. N.S.W.*, 1880, p. 142. *G. rutilans*, *Butl., Cist. Ent.*, ii., p. 561. *G. chrysis*, *Meyr., Trans. N.Z. Inst.*, xxi., p. 183.

*Gracilaria chalcodelta*, *Meyr.*

*G. chalcodelta*, *Meyr., Trans. N.Z. Inst.*, xxi., p. 183.

*Gracilaria linearis*, *Butl.*

*G. linearis*, *Butl., Proc. Zool. Soc. Lond.*, 1877, p. 406, pl. xliii., fig. 16; *Meyr., Trans. N.Z. Inst.*, xxi., p. 183.

Gracilaria leucocyma, *Meyr.*

*G. leucocyma*, Meyr., Trans. N.Z. Inst., xxi., p. 184.

Gracilaria ællomacha, *Meyr.*

*G. ællomacha*, Meyr., Trans. N.Z. Inst., xxi., p. 184.

Gracilaria æthalota, *Meyr.*

*G. æthalota*, Meyr., Proc. Linn. Soc. N.S.W., 1880, p. 143, and Trans. N.Z. Inst., xxi., p. 185.

### Coriscium, Z.

Coriscium miniellum, *Feld.*

*C. miniellum*, Feld., l.c., pl. exl.; Meyr., Trans. N.Z. Inst., xxi., p. 185. *Gracilaria ethela*, Meyr., Proc. Linn. Soc. N.S.W., 1880, p. 152.

### Conopomorpha, Meyr.

Conopomorpha cyanospila, *Meyr.*

*C. cyanospila*, Meyr., Trans. N.Z. Inst., xviii., p. 183.

### Family NEPTICULIDÆ.

#### Nepticula, Z.

Nepticula tricentra, *Meyr.*

*N. tricentra*, Meyr., Trans. N.Z. Inst., xxi., p. 187.

Nepticula ogygia, *Meyr.*

*N. ogygia*, Meyr., Trans. N.Z. Inst., xxi., p. 187.

Nepticula propalæa, *Meyr.*

*N. propalæa*, Meyr., Trans. N.Z. Inst., xxi., p. 187.

---

### APPENDIX A.

Mr. Meyrick, in "Transactions of the New Zealand Institute," vol. xvi., p. 108, refers to the following species of *Geometrina* in these words: "The following have been described or figured as New Zealand species, and are not yet identified; probably most are synonyms of species previously described; a few seem to have been recorded in error; there may, perhaps, be two or three additional species among them":—

91. *Ennomos ustaria*, *Walk.*
92. *Ischalis thermochromata*, *Walk.*
93. *Panagra hypenaria*, *Guén.*
94. *Panagra promelanaria*, *Walk.*
95. *Panagra venipunctata*, *Walk.*
96. *Aspilates euboliaria*, *Walk.*
97. *Larentia subductata*, *Walk.*
98. *Larentia infusata*, *Walk.*
99. *Larentia lucidata*, *Walk.*
100. *Larentia* (?) *quadristrigata*, *Walk.*; *Larentia interclusa*, *Walk.*

101. *Coremia robustaria*, *Walk.*
102. *Coremia plurimata*, *Walk.*
103. *Coremia* (?) *inductata*, *Walk.*
104. *Campptogramma correlata*, *Walk.*
105. *Phibalapteryx suppressaria*, *Walk.*
106. *Scotosia denotata*, *Walk.*; *Scotosia humerata*, *Walk.*;  
    *Phibalapteryx parvulata*, *Walk.*
107. *Scotosia subobscurata*, *Walk.*
108. *Scotosia subitata*, *Walk.*
109. *Cidaria* (?) *rudisata*, *Walk.*
110. *Chalastra pellurgata*, *Walk.*
111. *Cidaria ascotata*, *Feld.*
112. *Cidaria adonata*, *Feld.*
113. *Microdes toriata*, *Feld.*
114. *Cidaria semilineata*, *Feld.*
115. *Larentia* (?) *falcata*, *Butl.*
116. *Coremia heliacaria*, *Guén.*
117. *Melanthia arida*, *Butl.*
118. *Coremia casta*, *Butl.*

But in vol. xvii., pp. 66 and 67, he identifies—

- 91 with *Lyrcea alectoraria*, *Walk.*
- 95 with *Larentia psamathodes*, *Meyr.*
- 96 with *Aspilates subocharia*, *Walk.*
- 99 and 102 with *Larentia psamathodes*, *Meyr.*
- 103, 106, and 108 with *Pasiphila bilineolata*, *Walk.*
- 107 with *Larentia petropola*, *Meyr.*
- 110 with *Azelina streptophora*, *Meyr.*
- 117 with *Cidaria chaotica*, *Meyr.*

And he notes as distinct species the following—

97. *Larentia subductata*, *Walk.*
100. *Larentia quadristrigata*, *Walk.* = *Larentia interclusa*,  
    *Walk.*
105. *Phibalapteryx suppressaria*, *Walk.*, *l.c.*, xxvi., p. 1721.
115. *Larentia falcata*, *Butl.*, *Cist. Ent.*, ii., p. 501.

#### APPENDIX B.

The following have been recorded as New Zealand species, but Mr. Meyrick has been unable to identify them as such:—

- Pielus hyalinatus*, *Herr. Schæff.*
- Politeia junctilinea*, *Walk.*, *l.c.*, xxxii., p. 643.
- Alysia specifica*, *Guén.*, *Ent. Mo. Mag.*, v., p. 3.
- Nitocris limbosa*, *Guén.* } *idem*, p. 5.
- Nitocris exundans*, *Guén.* }
- Notocris nuna*, *Guén.* } *idem*, p. 6.
- Notocris epiplecta*, *Guén.* }
- Xylocampa inceptura*, *Walk.*, *l.c.*, xv., p. 1736

- Xylina canescens*, *Walk., l.c.*, xxxiii., p. 757.  
*Hymenia recurvalis*, *Fabr.*  
*Ischnurges illustralis*, *Ld.*, Wien. Ent. Mon., vii., pl. 15,  
 fig. 12.  
*Mecyna polygonalis*, *Treits.*  
*Scoparia minualis*, *Walk., l.c.*, xxxiv., p. 1504.  
*Panagra hypenaria*, *Guén.*, Phal., ii., pp. 128, 1125.  
*Panagra promelanaria*, *Walk., l.c.*, xxvi., p. 1666.  
*Larentia infusata*, *Walk., l.c.*, xxiv., p. 1199.  
*Scoparia objurgalis*, *Guén.*, 425, pl. x., fig. 10.  
*Scoparia australialis*, *Guén.*, 426.  
*Eupithecia inexplata*, *Walk., l.c.*, xxvi., p. 1708.  
*Coremia robustaria*, *Walk., l.c.*, xxv., p. 1320.  
*Campptogramma correlata*, *Walk., l.c.*, xxv., p. 1330.  
*Nephopteryx subditella*, *Walk., l.c.*, xxxv., p. 1720.  
*Teras punctilineana*, *Walk., l.c.*, xxxv., p. 1780.  
*Teras (?) abjectana*, *Walk., l.c.*, xxxv., p. 1781.  
*Teras contractana*, *Walk., l.c.*, xxxv., p. 1782.  
*Teras servana*, *Walk., l.c.*, xxviii., p. 306.  
*Teras priscana*, *Walk., l.c.*, xxviii., p. 3.  
*Teras antiquana*, *Walk., l.c.*, xxviii., p. 3.  
*Teras (?) maoriana*, *Walk., l.c.*, xxviii., p. 308.  
*Teras (?) accensana*, *Walk., l.c.*, xxx., p. 983.  
*Tortrix innotatana*, *Walk., l.c.*, xxviii., p. 333.  
*Sciaphila fusiferana*, *Walk., l.c.*, xxviii., p. 355.  
*Sciaphila spoliatana*, *Walk., l.c.*, xxviii., p. 356.  
*Sciaphila infimana*, *Walk., l.c.*, xxviii., p. 357.  
*Olindia (?) vetustana*, *Walk., l.c.*, xxviii., p. 358.  
*Pedisca morosana*, *Walk., l.c.*, xxviii., p. 382.  
*Argua scabra*, *Walk., l.c.*, xxviii., p. 448.  
*Simæthis combinatana*, *Walk., l.c.*, xxviii., p. 456.  
*Simæthis (?) abstitella*, *Walk., l.c.*, xxx., p. 997.  
*Tinea flavifrontella*, *L.*  
*Endosis fenestrella*, (?).  
*Tinea tapetzella*, *L.*  
*Tinea contactella*, *Walk., l.c.*, xxxv., p. 1813.  
*Tinea plagiatella*, *Walk., l.c.*, xxviii., p. 485.  
*Tinea derogatella*, *Walk., l.c.*, xxviii., p. 485.  
*Tinea bisignella*, *Walk., l.c.*, xxx., p. 1007.  
*Tinea pusilella*, *Walk., l.c.*, xxx., p. 1008.  
*Tinea maoriella*, *Walk., l.c.*, xxx., p. 1008.  
*Incurvaria basella*, *Walk., l.c.*, xxviii., p. 492.  
*Sabatica incongruella*, *Walk., l.c.*, xxviii., p. 511.  
*Cerostoma terminella*, *Walk., l.c.*, xxviii., p. 548.  
*Cerostoma fulguritella*, *Walk., l.c.*, xxviii., p. 548.  
*Gelechia innotella*, *Walk., l.c.*, xxix., p. 652.  
*Gelechia monospilella*, *Walk., l.c.*, xxix., p. 653.  
*Gelechia sublitella*, *Walk., l.c.*, xxix., p. 654.

- Gelechia collitella*, *Walk., l.c.*, xxix., p. 655.  
*Gelechia convulsella*, *Walk., l.c.*, xxix., p. 656.  
*Gelechia contextella*, *Walk., l.c.*, xxix., p. 656.  
*Gelechia contritella*, *Walk., l.c.*, xxix., p. 657.  
*Gelechia copiosella*, *Walk., l.c.*, xxx., p. 1028.  
*Cecophora apertella*, *Walk., l.c.*, xxix., p. 698.  
*Cecophora ademptella*, *Walk., l.c.*, xxix., p. 698.  
*Cryptolechia colligatella*, *Walk., l.c.*, xxix., p. 768.  
*Izatha attractella*, *Walk., l.c.*, xxix., p. 787.  
*Tingena bifaciella*, *Walk., l.c.*, xxix., p. 810.  
*Glyphypteryx externella*, *Walk., l.c.*, xxx., p. 841.  
*Glyphypteryx scintellella*, *Walk., l.c.*, xxx., p. 841.  
*Argyresthia transversella*, *Walk., l.c.*, xxx., 849.  
*Argyresthia stibella*, *Walk., l.c.*, xxx., p. 849.  
*Gracilaria frontella*, *Walk., l.c.*, xxx., p. 856.  
*Elachista subpavonella*, *Walk., l.c.*, xxx., p. 898.  
*Pterophorus deprivatalis*, *Walk., l.c.*, xxx., p. 946.
-



### III.—B O T A N Y.

ART. XXXVIII.—*Description of a New Species of Drimys.*

By T. KIRK, F.L.S.

[Read before the Wellington Philosophical Society, 14th July, 1897.]

#### **Drimys traversii.**

A COMPACT shrub, 3 ft.—4 ft. high, with rather stout branches. Bark reddish, rugose or almost verrucose, slightly viscid when fresh. Leaves rather crowded and overlapping, coriaceous, oblong-obovate or oblong-spathulate, about 1 in. long by less than  $\frac{1}{2}$  in. broad, subacute or obtuse, rarely acute, narrowed into a short appressed petiole, glaucous beneath, dotted; margins slightly thickened, rarely recurved. Flowers numerous, very small, axillary; pedicels solitary or geminate, very short. Calyx saucer-shaped, entire, obscurely 5-angled. Torus conical. Petals 5, linear or broadly obovate, rounded at the tips. Stamens 5, clavate. Ovary obovate, compressed. Berry spherical, depressed. Seeds about 6, pyriform, flat on the inner face, rugose or coarsely punctulate on the convex face.—*Hymenanthera traversii*, Buchanan, in *Trans. N.Z.I.*, xv. (1882), 339, t. 28.

South Island: Nelson: Collingwood district, *H. H. Travers*. Medora Creek, Wakamarama Range, to the Gouland Downs, 2,000 ft.—3,000 ft., *J. Dall*!

Until recently my knowledge of this interesting plant was restricted to Buchanan's description referred to above, and to a small sterile specimen for which I am indebted to his kindness. Recently my friend Mr. Dall has favoured me with fresh specimens, obtained at considerable trouble. Amongst them I found a few expanded flowers and one or two ripe fruits, which enable me to refer it to its proper genus, and to prepare an amended description.

It differs from *D. axillaris* and its variety *colorata* in the smaller size, the compact habit, and the red bark. The leaves, moreover, are close-set and often overlapping, while the stout petioles are closely appressed to the branchlets. The flowers, also, are often solitary, and the fruits are depressed when fully mature. It is, however, more closely allied to the variety than to the typical form, as it approaches the former

in the smaller leaves, which are invariably glaucous. The calyx is almost identical in both, while it further resembles var. *colorata* in the reduced number of the flowers, and especially of the carpels, which appear to be solitary in the present plant. It is, however, abundantly distinct from both, and from any other species. It is, I believe, the smallest member of the genus.

---

ART. XXXIX.—*Remarks on Gunnera "ovata," Petrie, and G. flavida, Colenso, in Reply to Mr. Petrie.*

By T. KIRK, F.L.S.

[Read before the Wellington Philosophical Society, 16th February, 1898.]

IN the last volume of the "Transactions of the New Zealand Institute" Mr. Petrie takes exception to my pointing out his error in confusing two distinct plants under the name of "*Gunnera ovata*," combining the flowers of one with the fruit of the other. As a careful re-examination of the facts of the case has fully confirmed this conclusion, I have to offer a few observations in support of it.

The only fact advanced by Mr. Petrie in support of his contention is that the fruit of Colenso's *G. flavida* has fleshy drupes, while *G. "ovata"* has drupes "which are hard and almost stony, with no fleshy exocarp or covering of any kind."

The putamen of the drupes of almost any *Gunnera* is "hard and almost stony," and if picked in December or January will certainly be destitute of a "fleshy exocarp." If it be gathered during March or April the fruit of *G. "ovata"* will probably, but not invariably, have a pulpy or juicy sarcocarp. This is the simple explanation of the error into which Mr. Petrie has fallen.

No New Zealand species of *Gunnera* has the fruits invariably fleshy. I have before me Southland specimens of *G. flavida*, collected in January, which are quite hard, and specimens from the same locality, collected in April, which show the thin epicarp loose on the putamen, owing to the absorption of the pulpy juice. The earlier specimens are almost as deeply coloured as those fully mature.

From this it will be evident that I cannot accept Mr. Petrie's dictum that fleshy drupes constitute a "most important differential character." It is at best but a secondary character of comparatively little importance. Mr. Petrie will remember at one time having been inclined to attach a similar

---

\* Trans. N.Z. Inst., xxix., p. 422, art. xxxvi.



degree of importance to the absence of the juicy sarcocarp in certain specimens of *Nertera setulosa* which he was good enough to send me. In some species of *Podocarpus* and *Dacrydium* pulpy fruits are extremely rare in many seasons; so also in small-flowered varieties of *Pratia angulata* and other plants.

But Mr. Petrie has further confused the subject by raising the question of the distinctness of *G. prorepens*, Hook. f., and *G. flavida*, Col., but without offering the slightest argument in evidence beyond the statement that he "entertains no doubt as to their identity, and that the same opinion is held by the authorities at Kew." Now, I should be sorry to seem to cast doubt on the value of conclusions adopted by members of the staff of that institution, even although I might not be able to agree with them; but in the present case Mr. Petrie must be under some misapprehension. I did not forward specimens of *Gunnera* to Kew until after my revision of the New Zealand species of *Gunnera* had been printed, so had not the advantage of their being compared with other forms. Somewhat earlier, however, at the request of the Director, I forwarded seeds of several species, and received a memorandum written by Mr. Hemsley stating that he considered *G. flavida*, Col., identical with *G. prorepens*, Hook. f. When next communicating with Kew I pointed out the impossibility of maintaining this opinion, and received through the Director a memorandum written by Mr. N. E. Brown, who stated that the two plants had always been considered distinct at Kew, and that Mr. Hemsley had no recollection of having expressed an opinion to the contrary, while he was unable to find any specimen of *G. flavida* with the name of *G. prorepens* attached. It is evident, therefore, that this opinion is not entertained at Kew at the present time.

Mr. Petrie states that the drupes of *G. prorepens* are fleshy, but I have never found them so, and they are not so described by Hooker. His assertion that Mr. N. E. Brown's opinion respecting the undetermined *Gunnera* mentioned in the Handbook has been ascribed to him by me is equally misleading. His opinion is expressly stated to be "on the authority of Mr. N. E. Brown" (p. 346, Trans. N.Z. Inst., vol. xxvii.). Other similar assertions might be mentioned, and for one at least there is absolutely no excuse. Mr. Petrie states, "Mr. Kirk no doubt means to say that a number of specimens sent him by me under the name of *G. ovata* contained, in his opinion, two distinct plants, which is a very different thing, and may or may not be the fact." This should not have been written, since on receipt of his specimens—two in flower and four in immature fruit—I at once informed him by letter that he had two distinct plants.

## ART. XL.—On New Australian and New Zealand Lichens.

By JAMES STIRTON, M.D., F.L.S., &amp;c.

Communicated by T. W. Naylor Beckett, F.L.S.

[Read before the Philosophical Institute of Canterbury, 2nd June and 3rd November, 1897.]

THE materials for the determination of the lichens forming the subject of the present paper have been sent to me from time to time through a long series of years, ranging as far back as 1863, not long after my graduation. The first small parcel is memorable as containing two or three characteristic lichens sent by Mr. James Johnstone, a fellow-student in Edinburgh University, who died shortly after the despatch of his parcel. One lichen from him while in New Zealand is recorded here, to which I have appended his pet name of *kelica*—viz., *Lecidea kelica*. This lichen was first described by me in the "Transactions of the Glasgow Field Naturalists" for 1874; afterwards in the "Journal of the Linnæan Society" for 1876. Dr. Nylander, of Paris, published, in 1889, a description of the same lichen, under the name *Lecidea stillata*, Nyl.

Since the death of Mr. Johnstone I have had several correspondents in New Zealand and Australia, and notably Mr. John Buchanan, of the Museum, Wellington, who sent to me much the largest and most interesting collection of mosses, as well as lichens. The names of the others will be mentioned in connection with their several discoveries.

Before entering upon the description, in systematic order, of the entire collections, I shall give a synopsis of a group of lichens with red or rubricose apothecia, having characteristics in common, of sufficient importance to warrant my giving a new grouping of them under the generic name *Miltidea*, a name rendered conformable to *Lccidea*. This group of lichens, of which *Lecidea rubricatula* (Strn., Journ. Linn. Soc., 1876) may be reckoned the type, has engaged my attention for a considerable time. It is characterized, more particularly, by its members having a peculiarly constituted perithecium. By perithecium I mean a cup-like receptacle which surrounds (at the sides as well as the base) the hymenium proper, including under this term the hypothecium from which this receptacle is, more especially, distinct. This perithecium, in the group of lichens under discussion, is composed of rods or staffs set perpendicularly to the general surface of the thallus, and, of

course, in a line with (although beneath) the paraphyses and hypothecium. These staffs, whose thickness varies from 0·0025 mm. to 0·0045 mm. are generally roughish on the surface, and are, accordingly, pretty closely matted together. They are much more distinctly defined in the lower part of the receptacle or perithecium. Upwards, towards the sides, they become somewhat confused, and often degenerate into oblongish cells, and in a few instances are merely cellular and granular. The upper and, especially, the lower extremities of these rods are generally of a different colour from the rest, such as red, yellow, or citrine, as viewed under the microscope. In another group of lichens, described apart from the present one, the extremities are blue, or bluish-black, &c. As a rule, this perithecium is destitute of gelatine, as indicated by iodine, but contains abundance of chrysophanic acid, especially in the lower extremities. Meanwhile, for want of a better term, I shall call the lower and better-defined part of the perithecium the hypoperithecium, a term which sufficiently indicates its position. In two or three examples, such as *Lecidea rubricatula*, the upper extremities are also slightly coloured red, &c. Hence my mistake in calling the hypothecium of this lichen "*rufulum*."

The present group includes lichens with very differently constituted spores. These vary from simple through septate or locular up to muriform, all, however, colourless, or nearly so, so far as investigated.

I have always deprecated the tendency of various authors to constitute genera solely on the basis of the structure of the spores. This group, which it must be allowed is a very natural one, gives to the spores a secondary place of consideration.

I may be allowed at this stage to strengthen the basis of the present classification by quoting a tendency of another group to a divergence of the purely septate or loculate form of spores towards the muriform.

*Lecanora punicea*, with its two or three varieties, is a well-known tropical and subtropical lichen. Its allies in the more northern regions are *L. hæmatomma* and *L. ventosa*. About fourteen years ago Dr. George Watt sent me, amongst a vast collection of lichens from India and the Himalayas, a *Lecanora* from the latter region growing on twigs of *Rhododendron*, whose external characters were exactly those of *L. punicea*—viz., the red apothecia, with white border, &c. In this the septate blocks were broken up into muriform constituents. Its diagnosis is the following: *Lecanora wattii*, Strn. Thallus albidus, rugulosus; apothecia rosea, plana, margine thalino albo, prominulo, integro, nonnihil inflexo cincta; sporæ (4-8)næ, incolores, fusiformes, undulatæ vel

bis tortæ extremitatibus attenuatæ, medio expansæ, (15–25)-septatæ (septis præsertim mediis (2–4)-divisis), 0·065–0·1 mm.  $\times$  0·008–0·011 mm.; paraphyses graciles, nonnihil irregulares apicibus coccineis (K purpurascentibus, colore evanescente). Hypothecium incolor.

The spores show a tendency to become muriform even towards the extremities.

Several authors would constitute this the type of a new genus; but its evident close affinity to *L. punicea* shows sufficiently the absurdity of such a proceeding. The shape and general configuration of the spores are exactly those of this *Lecanora*, as well as the rest of the constitution of the hymenium, and, as indicated above, the external characters are identical. It is merely the breaking-up of the septate blocks into different particles that gives even the warrant to specific, but certainly not to generic, distinction.

I shall now enumerate the various lichens comprehended under this, to which I give the generic name *Miltidea*. As regards those members of it already described, I shall merely append some remarks on the different peculiarities that present themselves under each species. I shall begin with those species having simple colourless spores.

1. *Lecidea (Miltidea) cinnabarina*, Smrft.
2. *Lecidea (Miltidea) russula*, Ach.

There is very little otherwise to distinguish these two except the greater thickness of the spores of the latter.

3. *Lecidea (Miltidea) læta*, Strn.

Thallus albidus nonnihil granulosis, tenuis. Similis *L. cinnabarinæ* sed sporis longioribus, cylindræcis, 0·013–0·019 mm.  $\times$  0·003–0·0035 mm. The spores of *L. cinnabarina* are obtusely fusiform, and 0·008–0·01  $\times$  0·002–0·003 mm. Tasmania (*Mrs. H. MacEwen*), 1892; on branches of trees.

Under *L. rubricatula* are several forms. One of these is *L. cinnabarodes*, Nyl. (*Lich. N.Z.*, 1889). Nylander describes the thallus of his lichen as being “albidus opacus tenuissimus.” With one exception this description does not tally with any condition of the thallus I have seen. The thallus as described by me in *Journ. Linn. Soc.*, 1876, agrees much more nearly with the numerous specimens from New Zealand in my herbarium—viz, “griseo-pallescentis crassus diffracto-areolatus.” In this paper I have given the dimensions of the spores as rather too great. They may be described as 0·014–0·022 mm.  $\times$  0·007–0·011 mm. The dimension, 0·016 mm., there given is a misprint for 0·013. It is exceedingly difficult to get a specimen in this species having fully-developed spores.

One species has a peculiar thallus.

*Miltidea subrutila*, Strn.

Thallus pallide cervinus, tenuis, hinc inde discontinuus vel in lineis undulatis angustis percurrens. Sporæ, 0·011–0·013 mm. × 0·007–0·0085 mm.

*Miltidea rutilescens*, Strn.

Thallus albus tenuissimus indeterminatus; sporæ ovales, 0·011–0·014 mm. × 0·005–0·006 mm.; paraphyses vix ullæ distinctæ apicibus fulvo-rufis. Thalamium K purpurascens. Ad lignum decorticatum prope Wellington (*J. Buchanan*).

The staffs of the perithecium in this species are nearly as indistinct as the paraphyses, and neither are rendered more distinct by K.

The two following lichens are peculiar, and may be included under this group.

*Miltidea venusta*, Strn.

Thallus albidus vel pallescens tenuis K flavens. Apothecia fusco-rufa mediocria vix marginata dein convexula; sporæ 8næ simplices, incolores, ellipsoideæ, 0·01–0·015 mm. × 0·005–0·0065 mm.; paraphyses, distinctæ, creberriter granuloso-inspersæ. Hypothecium incolor. Iodo g.h. intense cærulescens. Hymenium K flavens. Hypoperithecium late flavidum K flavens vel etiam citrinum. New Zealand, prope Wellington (*J. Buchanan*).

*Miltidea venustula*, Strn.

Thallus griseo-rufescens vel obscure rufescens, crassiusculus, rimoso-diffractus, minute granulatus; sporæ, 0·016–0·022 mm. × 0·008–0·012 mm. Hypoperithecium flavens K citrinum sub microscopio visum. Apothecia cinnabarino-coccinea. New Zealand, prope Wellington (*J. Buchanan*).

Before concluding this section of the group I shall describe another, the diagnosis of which is imperfect, inasmuch as it is doubtful whether the spores are matured, although the apothecia appear fully developed.

*Miltidea consanguinea*, Strn.

Thallus albidus vel pallide lutescens, minute rimuloso-diffractus (K fl. dein rubens); apothecia mediocria rufo-rubricosa, plana, leviter marginata (K. purpurascens); paraphyses haud discretæ, pallide rufescentes, apice rufæ; hypothecium fere incolor. Iodo g.h. intense cærulescens; sporæ 20–30 vel ultra in thecis saccatis, sphaericæ, 0·0025 mm. diam. Ad lignum decorticatum Australiæ (*Hugh Paton*).

In only one instance were the spores seen in a theca as given above. Throughout the field of the microscope such minute bodies thickly scattered are almost always seen.

From species with simple spores we pass on to those having loculi in single series. Of these the first in order is *Lecidea aureola*, Tuck. The spores are colourless, fusiform, (5-9)-locular, 0.022-0.032 mm.  $\times$  0.004-0.006 mm. The thallus is generally yellowish or reddish-orange, and is tinged purpur-ascenscent by K. I have not got this species from New Zealand or Australia, but only from Southern Africa, where it seems abundant.

*Mitidea domingensis*, Ach., is a very abundant tropical and subtropical species. The spores are elliptical, colourless, (6-10)-locular. The size of the spores varies very considerably according to climate and number in each theca. This number ranges from 2 to 8. Mostly, however, the number varies from 2 to 4, and the average size may be stated as 0.03-0.04 mm.  $\times$  0.009-0.012 mm.

*Mitidea vulpina*, Tuck.—The only difference between this and *M. domingensis* is the breaking-up of the loculi of the spores into particles, so as to render them muriform, and the more constant reduction of the number of spores in each theca—viz., from 2 to 4, though I have seen as many as 6.

As showing the close relationship of the two preceding lichens, I have a specimen from near Brisbane, Queensland, sent by Mr. F. M. Bailey, of the Museum there. In this may be seen in the same apothecium thecæ containing simple loculate spores as in *M. domingensis*, and in others a mixture of both kinds; while in some all the spores are muriform. This is another instance of the futility of founding genera on the constitution of the spores. The average size of the spores in this species is 0.032-0.045 mm.  $\times$  0.011-0.015 mm.

*Lecidea bifera*, Nyl., and *L. parabola*, Nyl., from New Caledonia, belong, in all likelihood, to the group of which *R. vulpina* is the type, but, as I have not seen specimens of either, the matter must lie in abeyance.

*Lecidea leucoxantha*, Spr., and *L. fuscolutea*, Dicks., belong to the present group. The former is mainly distinguished from the latter by the border being paler than the disc of the apothecium, as well as in the much finer particles into which the muriform contents of the spores are divided; whereas in the latter the border is of a uniform colour with the disc, or at times a little darker, and the spores are coarsely divided.

The New Zealand specimens of *L. leucoxantha* have facies of their own, the thallus being nearly always pale-cervine or rufescent-cervine and roughish.

I have two rather peculiar forms of *M. leucoxantha*, both from tropical and Southern Africa, where the disc of the apothecium is pale-green or dingy-green pruinose. The thallus is pale or pallido-glaucous, thin, much the same as in

normal specimens from Texas. This form may be called "var. *chloroxantha*, Strn."

Very probably several other lichens may be included in this genus.

From Victoria, in Western Tropical Africa, I have a lichen which has been referred to *Lecidea chloritis*, Tuck. The thallus, which is pale-glaucous, has not, however, the tubercles scattered over it, of a yellow colour within, as Tuckermann states with regard to his species, but they are white within. As the name *chloritis* is scarcely apposite in this instance, perhaps it should be characterized by a separate name, as *L. endolenticis*.

In this lichen the hypoperithecium especially has somewhat undulated staffs tipped a deep-blue colour. A thin section of an apothecium shows a wine-coloured stratum at their upper extremities when viewed through a magnifying lens. Here also there is a close relationship of structure with the members of the first section just described, but the colour is different, and as there is no visible reaction by means of K on this lower blue colour there is, in all likelihood, a different chemical constitution. I observe also that New Zealand specimens of *Lecidea grossa* show an almost identical organization within with *L. chloritis*. These two, and very probably others, may well constitute a subsection of *Miltidea*, which may be distinguished by the name of *Cyanopsis*.

Before proceeding to describe in systematic order the rest of the collections it might be as well, for the sake of reference, to enumerate the various papers I have written on New Zealand and Australian lichens: Three papers in Trans. Glasgow Field Naturalists, for 1873, 1875, 1876; Journ. Linn. Soc., 1876; Trans. Glasgow Phil. Soc., 1877; Journ. Royal Soc., Victoria, 1880; "Scottish Naturalist," 1877 and succeeding years. With several exceptions, I have omitted to describe anew those lichens a diagnosis of which had already been given in the various papers enumerated above. The exceptions are instances where additional information is reckoned necessary, or where the original papers are now less accessible.

*Calycidium cuneatum*, Strn., Trans. Glasgow Phil. Soc., 1877; Chatham Islands (*Travers*).

This lichen is identical with *Coniophyllum colensoi* (Müll. Arg.), first described by the late Professor J. Müller (1892) in a paper on Dr. Knight's New Zealand lichens.

*Usnea florida* (L.), Fr.

Rather common in New Zealand.

*Usnea xanthophana*, Strn. "Scottish Naturalist," 1883.

Similis *U. floridae* et similiter ramosa, sed gracilior et magis

elongata, et differt colore ochroleuco, thallo lævigato (K—, C flavente); axis pallidus, mediocris; fibrillæ medullares compactæ K—; I—. Sat frequenter apud montem Tararua, N.Z. (*J. Buchanan*), Akaroa Heads (*T. W. N. Beckett*).

I have been tempted to separate the New Zealand plant from that of the Northern Hemisphere, owing to the striking contrast in colour and appearance.

*Usnea subfloridana*, Strn. Scot. Nat., 1882.

Similis omnino *U. floridæ* sed fibrillæ medullares K flaventes, I—. Soredia K flaventia. New Zealand (*J. Buchanan*).

*Usnea acromelana*, Strn.

Similis *U. floridæ* vel potius *U. perplexanti*, Strn., sed minute et creberriter obscure vel nigro-articulata vel annulata, apicibus ramulorum frequenter nigris vel maculatim nigris. Axis crassus pallidus, K extus et intus flavens dein rubens vel sanguineus, I—.

This lichen bears a considerable resemblance to *Neuropogon melaxanthus* (found also in New Zealand), but the axis is pale and continuously solid, while that of the latter, especially in the main stems, is slightly fuscous, and has lacunæ throughout, and often an irregular central canal. Selwyn Gorge, Canterbury, N.Z. (*T. W. N. Beckett*).

There is another *Usnea* from Mount Wellington, Tasmania, gathered by Mr. W. S. Campbell, which partakes of the characters of *U. xanthophana* and *Neuropogon*, but I shall meanwhile, in the absence of fructification, refer it to *Usnea chlorotella*.

*Usnea lutescens*, Strn.

Thallus rigidus, erectus, flavens vel interdum aurantiaco-flavens, ramosus sicut in *U. floridæ*, basi niger, supra sæpe tenuiter annulatum niger, apicibus concolor non denigratus; axis crassus, corneus, pallidus vel versus basin leviter fuscens; fibrillæ medullares compactæ, albidæ, K—C—. Thallus extus K—C flavens.

The axis is solid and very tough, but not hollow.

*Usnea perplexans*, Strn. Scot. Nat., 1881.

Similis fere *U. floridæ* sed rigidior et magis sorediata. Axis crassulus, densus, pallidus; fibrillæ medullares albidæ densæ. K flav. dein rubentes. Prope Wellington, N.Z. (*J. Buchanan*).

*Usnea constrictula*, Strn. Scot. Nat., 1881.

Thallus pallide cinereo-glaucescens vel (N.Z.) pallide lutescens, rigidiusculus, erectus, basi crassiusculus, opacus, ramosus et ramulosus, ramulis plerumque divaricatis et sorediosis,



articulatus et ibi constrictus sed non inflatus; axis centralis pergracilis; fibrillæ medullares, arachnoideæ, K flav. dein rubentes, I violascentes; soredia K—. Tararua, N.Z. (*J. Buchanan*); Insula Regis (*E. Spong*).

*Usnea mollis*, Strn. Scot. Nat., 1881.

Thallus pallide cinereo-glaucescens, basi crassiusculus, erectus, ramosus ut in præcedente sed ramulis longioribus; axis centralis gracilis; fibrillæ medullares K—, I—; soredia K—. Tararua, N.Z. (*J. Buchanan*).

This lichen presents a rare exception to the rule—viz., “Soredia K flaventia.”

*Usnea subsordida*, Strn. Scot. Nat., 1881.

Similis *U. ceratinae*, erecta, rigida, thallo sæpissime obscuriore (cervino) et apotheciis pallidis vel pallide glaucescentibus, majusculis; sporæ, 0·01–0·014 mm. × 0·007–0·0095 mm. Axis centralis gracilis; fibrillæ medullares K fl. dein rubentes. In Himalaya (*Dr. G. Watt*).

*Usnea subsordida*, \* *tenebrosa*, Strn.

Thallus obscurior, luridus vel fusco-luridus vix papilloso-asper; apothecia parviora, albida vel cæsiopruinosa, receptaculo thallino longe radiato-fabrilloso, fibrillis sæpe ramosis; sporæ parviores, 0·009–0·011 mm. × 0·006–0·007 mm. Axis gracilis sæpe rufescens, præsertim infra et fibrillis medullaribus arachnoideis. Prope Brisbane, Queensland (*F. M. Bailey*).

*Usnea sublurida*, Strn. Scot. Nat., 1881.

Similis *U. floridae* sed densior, dendritico-ramosa, stipitibus et ramis rubiginis, at ramulis cinereo-glaucescentibus vel cenereis, creberriter sed minute sorediosis; axis crassus, pallidus; fibrillæ medullares albidæ, compactæ, K flaventes, I cærulescentes. Prope Brisbane, Queensland (*F. M. Bailey*).

*Usnea pectinata*, Strn. Scot. Nat., 1883.

Thallus pallidus, pallide ochroleucus vel glaucescenti-pallidus, rigidus, erectus (altit. 0·5–2 pollicum), acute et parce ramosus, densissime et rigide ramulosus fere pectinatus. Axis crassus, densus; fibrillæ medullares K—C—; I—. Thallus extus K—C bene flavens. Apud montes Grampian Victoriae (*Sullivan*).

*Usnea spilota*, Strn. Scot. Nat., 1882.

Thallus rigidus, erectus vel prostratus, varie ramosus, non vel vix fibrilloso-strigosus, minute et prominule sorediosus, maculatim rufus vel rufo-rubiginosus; axis crassus, pallidus; fibrillæ medullares albæ, firmæ, K flav. dein rubentes; I fibrillæ versus axin violaceæ. Insula Regis Australiae (*E. Spong*).

*Usnea rubescens*, Strn. Scot. Nat., 1883.

Similis *U. floridæ* et similiter ramosa sed elongata et pendula vel prostrata (longit. interdum pedalis). Thallus cinerascenti-pallidus, sæpius minute papilloso-sorediatus, passim rufo-ferrugineus. Axis medioeris vel crassus, intus K passim rubro-maculatus; fibrillæ medullares albidæ, compactæ I—, K fl. dein rubentes. Ad rupes in New South Wales Australiæ (*Kirton*); in Insula Regis (*Müller*); Wellington (*J. Buchanan*); Victoria (*Bullii*).

This lichen tends to merge throughout into a rufo-ferrugineous colour, especially after being retained for a time in the herbarium.

*Usnea rubescens*, \* *subrubescens*, Strn.

Similis *U. rubescenti* sed trunci et rami non vel vix fibrilloso-ciliati; axis pallidus, crassiusculus; fibrillæ medullares compactæ, albidæ, K— sed eæ axin versus K flaventes. N.Z. (*J. Buchanan*).

*Usnea elegans*, Strn. Trans. Royal Soc. Victoria, 1880.

Thallus (K—C—vel pallide flav.) pallide flavescens, teres, firmus, erectus (altit. 1–2-pollicaris), parcissime divisus, interdum simplex et tunc rigidus, undique densissime et breviter fibrillosus; axis gracilis, interdum filiformis; fibrillæ medullares arachnoidæ K—C—; apothecia pallida et cæsio-pruinosa, plerumque terminalia, plana (latit. 4–13 mm.), receptaculo thallino fibrilloso præsertim margine; sporæ 8næ, incolores, ellipsoideæ vel late ellipsoideæ, simplices, 0.008–0.011 mm. × 0.006–0.008 mm. Iodo gel. hym. intense cærulescens. Corticola, Girorie Mts., Darling Downs (*F. M. Bailey*); Canal Brook Australiæ (*Hartman*).

*Usnea consimilis*, Strn. Scot. Nat., 1882.

Similis præcedenti sed humilior, magis compacta ramis arcuatis et crebrius breviusque fibrilloso-ciliatis; axis centralis nonnihil crassior et fibrillæ medullares K fl. C fl. Sporæ 0.009–0.011 mm. × 0.006–0.007 mm. In Australia (*Rev. M. Anderson*).

*Usnea oucodes*, Strn. Scot. Nat., 1881.

Thallus lutescens aut lutescenti-cervinus vel etiam rufescens, nitidus, rigidus, crassiusculus, erectus, ramosus, ramis et ramulis prominule et creberriter cæsio-sorediosis; axis centralis filiformis; fibrillæ medullares K fl. dein ferrugineo-rubentes, I violaceæ. New Zealand (*J. Buchanan*).

The thallus has the smooth aspect of *U. articulata*, and, at times, slightly inflated.

*Usnea molliuscula*, Strn. Scot. Nat., 1883.

Similis *U. ceratinæ* sed parcius papilloso-aspera, flavescens vel sordide flavescens; axis gracilis pallidus; fibrillæ medullares arachnoideæ K — C —. Discus apotheciorum albidus, leviter casio-pruinosis, K — C flavens. In Victoria Australiæ, haud rara (*McCann*).

*Usnea chætophora*, Strn. Scot. Nat., 1882.

Similis *U. plicatæ* et longit. interdum sesquipedalis, sed fibrillæ medullares K fl. dein aurantiaco-rubentes vel etiam rubentes. Axis mediocris, pallidus; fibrillæ medullares minus compactæ interdum fere arachnoideæ. Ben Lawers Scotiæ, etc.

*Usnea chætophora*, \* *propinqua*, Strn. Scot. Nat., 1883.

Similis typo sed robustior, crassior et minus ramosa, sæpius creberriter et minute albo-sorediata; soredia K fl. dein rubentia. Thallus pallescens ad flavescens mergens. In Victoria Australiæ a *Cl. H. Paton* lecta.

*Usnea longissima*, Ach.

Found in various localities in Australia, Queensland, and New Zealand.

*Usnea himantodes*, Strn. Scot. Nat., 1883.

Similis *U. longissimæ* sed truncis et ramis primariis lævigatis, teretibus, sed hinc inde articulatis et longius parciusque fibrillosis. Thallus ochroleucus vel pallide cinerascens, firmior, rigidior, pendulus, elongatus (pedalis et ultra). Axis crassus (ut in *U. longissima*), fuscenscens I —; fibrillæ medullares parvæ, condensatæ K flaventes, I cærulescentes. Corticola in New South Wales (*Kirton*).

A very characteristic lichen. The reactions by iodine differ entirely from those by the same reagent on *U. longissima*, inasmuch as the axis is not affected, while the medullary fibres (which are scanty) are rendered by it an intense blue, then violascent.

*Usnea torquescens*, Strn. Scot. Nat., 1883, sub nomine *U. undulata*, Strn.

Thallus pallescens vel ochroleucus, undulatus, pendulus vel prostratus, elongatus (pedalis et ultra). Similis *U. longissimæ* et similiter fibrilloso- et divaricato-ramulosa, sed trunci et rami primarii angulati et spiralter costati, sed non evidenter vel tantum obsolete articulati. Axis crassus pallidus I —; fibrillæ medullares I —, K fl. dein rubentes. Adrupes in New South Wales Australiæ (*Kirton*).

Another very distinct lichen, having also affinities to

*U. longissima*, but differing, as may be observed, in various respects.

*Cladonia retipora*, Flk., \**arcuata*, Strn. Scot. Nat., 1885.

Podetia albida vel pallida vel (præsertim subtus) fulvescentia, rigida, conferta, erecta vel procumbentia (alt. circiter 30 mm.), cylindrica, arcuato-vel sinuoso-divisa et ramosa, reticulato-terebinata (K fl. C fl. vel intensius tincta). In Victoria Australiæ (*Falck*).

The habit is peculiar, and altogether different from *retipora*. The divisions of the stems, primary and secondary, are all arcuate, almost semicircular, and very rigid as well as brittle, the whole constituting an almost coralloid tuft.

*Ricasolia beckettii*, Strn.

Thallus crassus, firmus, cervinus vel rufo-cervinus et marginem versus lurido-cervinus, amplus (latit. fere pedalis), laciniato-lobatus, laciniis hinc inde imbricatis, marginibus sinuato-incisis et crenatis, spermogoniis semilobatis, prominulis instructus; subtus luridus vel nigricans, tomento rhizineo fere vellere præsertim versus marginem, etiamque rhizinis pallidis fasciculatis longis præditus; cyphellis pallidis veris fundo nonnihil farinoso adpersus; apothecia sparsa, rufa (latit. 1-3 mm.), receptaculo thallino, extus rugosulo et margine crenulato, demum fere integro cincta; sporæ 8næ, incolores, fusiformes, 3-septatæ, 0.03-0.038 mm. × 0.008-0.013 mm. Gonidia flavescentia; diam. 0.008-0.017 mm. Medulla albida, K - C -. Corticola, Banks Peninsula, New Zealand, a *T. W. N. Beckett* lecta.

This lichen is allied to *Ricasolia wrightii*, Tuck., but is distinct in the spores, thelotremoid cyphellæ, &c. It has been named in honour of Mr. T. W. Naylor Beckett, Fendalton, Christchurch, who has sent me recently some very interesting specimens from Banks Peninsula. Mr. Beckett has also sent two parcels of another *Ricasolia*, which I can only refer to *R. beckettii*, as varieties, or at most as sub-species.

*Ricasolia beckettii*, Strn., \**consentiens*, Strn.

Thallus tenuior, adpressus, pallidus vel pallide glaucescens, ad fulvescentem hinc inde mergens, mediocris (latit. (3-6)-pollicaris), lævis, laciniato-lobatus, lobis interdum imbricatis, sinuato-divisis et crenatis, subtus pallidus, versus centrum fuscescens; apothecia carneo-lute sparsa, margine thallino fere integro cincta. Cætera ut in *R. beckettii*. Corticola, Banks Peninsula (*T. W. N. Beckett*).

*Ricasolia asperula*, Strn. Trans. Phil. Soc. Glasgow, 1877.

This lichen has very often glomeruli, composed of narrow lacinuli scattered pretty thickly over its upper surface. This

is, in all likelihood, what Babington calls *R. glomulifera*, Light. It is, however, quite distinct from it. The breadth of the spores is not quite so much as stated in the paper. I find the dimensions expressed by the formula  $0\cdot03-0\cdot042$  mm.  $\times 0\cdot005-0\cdot008$  mm. Medulla pale, K - C pale-red. Gonidia flavescens; diam.  $0\cdot005-0\cdot008$  mm.

I possess a very curious variety of *R. montagnei*, Bab. Thallus lurido-cervinus vel lurido-fuscescens, ad nigricantem mergens, corrugatulus, subtus nigricans, fere undique minutissime et brevissime nigro-tomentellus, et pseudo-cyphellis minutis, albidis prominulis creberriter adspersus; medulla alba vel albida K flavens. Sporæ fuscae, fusiformi-ellipsoidæ, 1-septatæ, interdum polari-biloculares,  $0\cdot022-0\cdot028$  mm.  $\times 0\cdot008-0\cdot01$  mm.

Apices of paraphyses often fusco-clavate, and rendered violaceous by K. Spermogonia situated in small prominences with blackish osteoles. Corticola, near Wellington, New Zealand (*J. Buchanan*).

This form may meanwhile at least be distinguished by the name *Ricasolia luridescens*, Strn. I see the hypothecium is often fulvescent. Perhaps this colour is owing to age.

NOTE.—The type specimens of the New Zealand species named by Dr. Stirton have been deposited in the herbarium of the Canterbury Museum.—J. W. NAYLOR BECKETT.

---

ART. XLI.—*A New Classification of the Genus Pyxine.*

By JAMES STIRTON, M.D., F.L.S.

Communicated by T. W. Naylor Beckett, F.L.S.

[*Read before the Philosophical Institute of Canterbury, 3rd November, 1897.*]

THE genus *Pyxine*, the species of which are so widely distributed throughout tropical and subtropical countries, is a very perplexing one, inasmuch as there is apparently an interchange of characters amongst the seven or eight species constituting it. The different elements for the discrimination of these species are—First, the appearances presented by the medulla—viz., white, pale-yellow through orange, and orange-red to coccineous; second, the constitution and size of the spores; third, the colour of the upper surface of the thallus; fourth, the presence or absence of soredia; fifth, the chemical reactions by K—i.e., *liquor potassæ*—on the thallus and

medulla; sixth, the different tints presented by the hypothecium, as well as differences in its constitution, as indicated by K; seventh, the presence or absence of purplish masses beneath the hypothecium.

The hypothallus, including the rhizinæ, can only indicate secondary differences, as the elements are very variable. The reactions by K on the upper thallus are of use in some instances. For the most part there is no reaction whatever; in others a distinct yellow reaction. The reactions by K on the medulla are all negative in the instances having a white medulla. In the pale-yellow or yellow medulla K renders the colour paler, or obliterates it. Where orange or orange-red is presented K develops a faint purplish colour, while in the coccineous medulla a full purple or violaceous colour is developed. The constitution of the spores presents one or two characteristic differences. In one—viz., *P. cocois*—the spores are merely bilocular, without any distinct traces of a middle septum, the loculi large, and not connected by any apparent tube. In all the others the presence of this connecting tube is more or less manifest, especially after the application of K. The differences in the size of the spores are so great that very little significance can be attached to them, although authors, especially Kreppehüber, have endeavoured to found specific distinction on such differences. I cannot agree with him or them. Apart from size there is, in this genus, more uniformity in the constitution of the spores than in almost any other. Each nucleus may break into two, as in *P. eschweileri*, Tuck., but this peculiarity is not constant. One specimen may show bilocular and quadrilocular spores intermingled, although I have seen in one instance almost all the spores quadrilocular.

In this genus there are three fairly-well-defined groups of the species—First, those which have apothecia throughout all the stages of development and growth with a permanent thalline border; second, those where the apothecia are at first covered by a thalline veil, their eruption through this veil leaving a thalline border, which ultimately blackens or disappears; third, those species which are lecidine and black through all the stages. In all the specimens of the first group which I have examined the epithecium is never coloured violaceous by K, but shows the apices of the paraphyses fuscous or, rarely, lutescent. In the other two divisions the epithecium is bluish or bluish-black under the microscope, and this colour is turned to a beautiful permanent purpuraceous or purpureo-violaceous colour by K.

The members of the first division are *Pyxine picta* and *P. confluens*, between which I can scarcely see any differences of sufficient importance to warrant specific distinction. Tucker-

man, in his Lich. of N. America (1882), gives a third species under the name *P. frostii*, Tuck., which has more pretensions to distinction. I fear, however, this species develops ultimately a blackened border to the apothecium. In the absence of authentic specimens I am compelled to separate from it a species from Queensland, inasmuch as the latter shows a blackened border, and otherwise has all the characteristics of the species ranked under the second division, as given above. Hitherto authors have not done much to elucidate or define the species, but rather to confuse them. I give only one instance amongst several that might be adduced. Nylander, in his Lich. New Granada, vol. ii., speaks of the apothecia of *P. sorediata* as seated on a yellow, then on a white, and lastly on a flavo-rufescent stratum. With reference to this purpurascens or rufescent mass beneath the hypothecium, I have not seen it present in any specimen having a yellowish medulla, but merely an extension upwards of this same yellow medulla beneath the apothecium. This distinctive mass occurs only in those species with white medulla. In *P. coccifera*, Fée, the red medulla is in all likelihood prolonged upwards beneath the apothecium, but, apart from it, there is no separate or differently coloured mass.

I omit the descriptions of those members of the genus already described by Nylander in vol. ii. of his Syn. Meth. Lich.

**Pyxine consimilis**, Strn. = *Physcia consimilis*, Strn., Trans. Phil. Soc. Glasgow (1879).

Thallus cinereus vel obscure cinereo-virescens (K flavens), adpressus, rugulosus, sorediis parvis et isidiis parvis coralloideis sæpe creberriter adpersus, versus centrum squamosus squamis imbricatis, margine sæpe coralloides-dissectis, ambitu laciniatus; medulla albida (K-); apothecia nigra, sæpissime cæcio-pruinosa, lecanorina, mediocria (latit. 0.6-1.5 mm.), plana, margine prominulo, pallido vel pallide rufescente, lævigato, fere integro cincta; sporæ 8næ fuscæ, simplices, sæpe spurie 1-septatæ, 2-nucleatæ, oblongæ vel obtuse fusiformes, 0.014-0.023 mm. × 0.006-0.007 mm., paraphyses distinctæ, graciles apicibus lutescentibus clavatulis rarius leviter fusciscentibus, non inspersis (K-); hypothecium crassum fusconigrum. Iodo gel. hym. intensive cærulescens. Corticola prope Chinsurah Indiæ Dr. G. Watt lecta.

Although near *P. picta*, I consider this lichen distinct.

**Pyxine cognata**, Strn., Trans. Phil. Soc. Glasgow (1879).

Similis *P. meissneri* sed thallus glaucescens vel pallide glaucescens, stellato-laciniatus (K-); medulla aurantiaca vel rufo-aurantiaca, K leviter vel obsolete purpurascens; apothecia

nigra, plana, acute marginata, dein convexula et immarginata, omnino lecideina; sporæ fuscae, 1-septatae, binucleatae (nucleis sæpius tubulo tenui junctis), variantes, 0·017–0·027 mm.  $\times$  0·0065–0·009 mm.; paraphyses confertae, graciles apicibus caeruleo-nigris (K violaceis). Hypothecium fuscum (K—). Iodo gel. hym. caerulescens. Corticola Nilgherries Indiae (G. Watt).

There are no reddish masses beneath the hypothecium, but merely the reddish-yellow medulla. The black perithecium is seen to curve round the apothecium and to cover it beneath, unless at the point of attachment to the thallus, where it is interrupted.

### **Pyxine rugulosa**, Strn.

Thallus pallidus vel cinereo-pallidus (K flavens), margine laciniatus, adpressus, versus centrum crustaceo-congestus, rugulosus, crassiusculus, intus flavus; apothecia nigra, primum thallino-marginata, demum lecideina, plana, vix marginata, dein mox convexa et immarginata (latit. 1–1·5 mm.); sporæ 8næ fuscae, 1-septatae, binucleatae, interdum 4-nucleatae spatiis apicalibus sæpius subincoloribus, oblongae vel fusiformi-oblongae, 0·016–0·023 mm.  $\times$  0·006–0·007 mm.; paraphyses sat discretæ apicibus nigris vel caeruleo-nigris (K violaceis). Hypothecium fuscum vel fusco-nigrum (K—); Iodo gel. hym. intensive caerulescens. Queensland, prope Jimbour (F. M. Bailey).

In this lichen traces of a slender connecting-tube can only be seen after the application of K. There is no rufescent mass beneath the hypothecium. No soredia are to be seen. This *Pyxine* is allied to *P. meissnerina*, Nyl., Lich. Insul. Andam. (1874), p. 5, but the apothecia are lecanorine at first and not *lecideine* throughout, as in *P. meissnerina*, &c.

### **Pyxine subvelata**, Strn.

Thallus albidus vel pallidus, versus centrum ochroleucus vel testaceus, lacinatus laciniis (latit. circiter 1·5 mm.) crenatis vel dissectis, centro congestis et convexulis (K—), intus albidus, subtus niger et rhizinosus; apothecia nigra, plana, tenuiter marginata, primum thallino-velata dein erupta et thallino-marginata demum lecideina, sed sæpe infra marginem albida et lævia; sporæ 8næ, fuscae 1-septatae, binucleatae, sæpius polari-biloculares et quasi 3-septatae, oblongae vel fusiformi-oblongae, 0·015–0·022 mm.  $\times$  0·005–0·007 mm.; paraphyses graciles, distinctae apicibus clavatulis sordide caerulescentibus (K late violaceis). Hypothecium fusco-rubricosum (K sordide violaceum). Iodo gel. hym. caer. Corticola Queensland, prope Jimbour (F. M. Bailey).

Beneath the hypothecium, and enclosed nearly entirely by



a blackish envelope, is seen a purplish-red mass under a Coddington lens. This is tinged in many instances by K a purpureo-violaceous colour. The thallus of this lichen resembles much that of *P. frostii*, Tuck. A thin section of an apothecium reveals, from above downwards, the hymenium proper with its rufo-fuscous hypothecium, then a reddish purpurascens mass. This mass is thickish, and tinged a deeper purpurascens colour by K. Beneath this mass is often seen a yellow mass not affected by K. Beneath this again is a more or less complete exciple surrounding all below, composed of densely-compacted moniliform fibres or rods, about 0.003 mm. thick, capped beneath by bluish-coloured heads (K purpurascens), at times nearly colourless, resembling somewhat the apices of paraphyses. The yellow mass or stratum is mainly composed of gonidia of a peculiar yellow colour with non-granular contents. The basal portion of it is not always seen, but the lateral very generally.

***Pyxine cocoës***, Sw., from Gasparilla, Trinidad (*G. Brodie*), has not the reddish masses beneath; accordingly I have made this lichen from Trinidad the typical *P. cocoës*, more especially as it has apothecia nearly entirely lecidine throughout.

***Pyxine prominula***, Strn.

Similis *P. subvelata* sed thallo albido vel pallido-lutescente, lobato-laciniato, adpresso (K-). Medulla albida (K-); apothecia nigra (ab initio), plana, obtuse marginata dein convexula et immarginata; sporæ fuscae, oblongae, 0.015-0.02 mm. × 0.0045-0.006 mm.; paraphyses graciles apicibus caeruleo-nigris (K violaceis). Hypothecium fuscum K sordide violaceum. Corticola prope Chinsurah Indiae (*G. Watt*).

The purple mass continues down to the hypothallus, and the yellow masses are thus excluded, but appear on the lower lateral aspects, on each side, and presumably surround the purple mass. In this respect also it differs from *P. subvelata*.

***Pyxine subcinerea***, Strn.

Thallus pallidus vel cinereo-pallidus, crassiusculus (K -), laevis, breviter laciniatus vel squamosus praesertim versus centrum, laciniis crenato-dissectis, nonnihil imbricatis, centro congestis, creberriter albido-sorediosis, intus pallido-flavens (K -); apothecia sessilia vel elevato-sessilia, nigra, plana et vix marginata, dein convexa (latit. 0.6-1 mm.), omnino lecidinea; sporæ 8nae, fuscae, oblongae, 1-septatae, binucleatae nucleis saepe tubulo junctis, 0.016-0.022 mm., rarius 0.024 mm. × 0.0045-0.006 mm.; paraphyses graciles, sat discretæ apicibus caerulescentibus (K violaceis), clavatulis. Hypothecium

fuscum vel fusco-nigrum. Iodo gel. hym. cærulescens. Queensland (*F. M. Bailey*).

There are no reddish masses beneath the hypothecium. This lichen has the thallus of *P. sorediata*, but I have separated it from the latter, owing to the internal organization both of the thallus and apothecia; besides, the external thallus has a negative reaction by K, while that of *P. sorediata* has a yellow reaction.

---

ART. XLII.—*New Zealand Musci: Notes on a New Species of Moss belonging to the Genus Seligera.*

By R. BROWN.

[*Read before the Philosophical Institute of Canterbury, 5th May, 1897.*]

Plate XLI. (in part).

THE small inconspicuous plant which is the subject of this paper was discovered by me in March, 1891, growing on limestone rocks near Castle Hill, West Coast Road, and again in March, 1893, near the pseudo-Maori paintings in the Weka Pass, on rocks of a similar character to those at Castle Hill. In the Weka Pass habitat it was extremely scarce, I having collected only a small patch with one capsule there; but it is more than probable that it will be found in other parts of this district, which is almost entirely of a limestone formation, and is very suitable for this plant's germination.

This moss is interesting from its small size, being only  $\frac{1}{32}$  in. high, and has thus far been found only on calcareous rocks, growing along with a few other species of mosses, and is apparently wholly confined to such habitats. This is the first-recorded occurrence of the European genus *Seligera* (to which this new species belongs) in New Zealand. I have named the new species *S. cardotii*, after I. Cardot, the well-known French muscologist.

The figures given are of 25 diameters, with the exception of the peristome, which is drawn to 50 diameters.

***Seligera cardotii*, sp. nov.** Plate XLI., fig. 1.

*Plants* perennial, growing in dense green patches  $\frac{1}{32}$  in. high. *Leaves* erecto-patent, subulate, acuminate, concave. *Margins* entire. *Nerve* excurrent. *Lamina* ending in one row of oblong cells towards the apex; scarcely altered when dry. *Perichætial leaves* similar to the stem leaves. *Fruit* terminal. *Fruitstalk*  $\frac{1}{16}$  in. long, pale. *Capsule* turbinate.

*Peristome* single, 16, pale, small, entire, fragile, triangular, obtuse. *Operculum* conico-rostrato, oblique, nearly as long as the capsule. *Calyptra* cucullate.

*Hab.* Limestone rocks, Castle Hill; March, 1891. Weka Pass, limestone rocks; March, 1893. Oamaru, 1897. Collected by R. B.

---

DESCRIPTION OF PLATE XLI. (IN PART).

Fig. 1. *Seligera cardotii*.

1. Whole plant.
  2. Perichæatial leaves.
  3. First leaf outside perichæatial.
  4. Upper stem leaves.
  - 5, 6. Middle and lower leaves.
  7. Capsule.
  8. Peristome.
- 

ART. XLIII.—*New Zealand Musci: Notes on the Genus Tortula, with Descriptions of New Species.*

By R. BROWN.

[Read before the Philosophical Institute of Canterbury, 4th August, 1897.]

Plates XXXV.—XL.

THE genus *Tortula* is closely allied to *Trichostomum*, but may be readily distinguished from it, thus: First, the capsule of *Tortula* is nearly always stouter; second, the peristome consists of 32 filiform teeth spirally twisted to the left; and third, the cells of the operculum are also spirally arranged.

In the greater number of New Zealand species the teeth cohere towards the base, forming a tube varying in length. This fact will be found very useful in arriving at identification.

The range of this genus is very wide, extending from the sea-level to an altitude of between 2,000 ft. and 3,000 ft. At the sea-level plants are usually found on damp sand; inland on damp rocks, banks, and on the bark of trees.

As all the work previously done in this genus has been done outside the colony no authenticated specimens of those plants described in the "Handbook of the Flora of New Zealand" were available in the preparation of this paper, so that mistakes in the identification of some may very possibly have happened. Although I have collected a very large number of plants of this genus all over New Zealand I have failed

altogether to identify *T. chloronotos*, *T. torquatus*, *T. crispifolia*, and *T. australæ*.

The New Zealand plant which I have figured in this paper as *T. papillosa*, Wills (Plate XXXV., fig. 1), is the one which has generally been accepted as it. Although approaching closely to that moss, as described and figured in the "Bryologia Britannica," it differs in the gemmæ being sessile, the nerve not being papillose, and the upper areola being dense, whilst in the British plant the gemmæ are stalked and the nerve papillose. Not having specimens of the typical plant, I am unable to determine whether the New Zealand species is a variety of *T. papillosa* or a distinct species. It is common near Dunedin and Christchurch, growing on the bark of trees, and in these situations has always been found barren.

#### SECTION A.

(Plants having piliferous leaves.)

**Tortula acuta**, sp. nov. Plate XXXV., fig. 2.

*Plants* perennial, monœcious, brownish-green, growing in small patches about  $\frac{1}{4}$  in. high. *Stems* branching near the base, branches fastigate. *Leaves* erecto-patent, imbricating round the stem, oblong-acute or shortly piliferous, slightly concave. *Margins* entire. *Nerve* excurrent. *Areola*: Upper dense, lower oblong, crisp when dry. *Perichætil leaves* smaller than the upper ones, inner one smallest, oblong-acute or mucronate. *Acrocarpous*. *Fruitstalk* erect or inclined,  $\frac{5}{16}$  in. long, red. *Capsule* cylindrical, straight or slightly curved. *Operculum* conico-subulate, two-thirds the length of capsule. *Peristome* twisted, teeth 32, about twice the length of the tube. *Calyptra* cucullate.

*Hab.* Port Lyttelton hills, on rocks. Collected, August, 1890, by R. B.

**Tortula pulvinata**, sp. nov. Plate XXXV., fig. 3.

*Plants* perennial, monœcious, brownish-green, growing in small pulvinate tufts  $\frac{1}{4}$  in. high. *Stem* branched near the base. *Branches* short, fastigate. *Leaves* erecto-patent, imbricating all round the stem, oblong, rounded at the apex into a hyaline hair-point, concave. *Margins* recurved to near the apex. *Nerve* excurrent. *Areola*: Upper dense, subrotund; lower oblong near the base; crisp when dry. *Perichætil leaves* smaller than the upper-stem ones, but otherwise similar in outline. *Acrocarpous*. *Fruitstalk*  $\frac{3}{8}$  in. long, reddish-brown. *Capsule* elliptic, small. *Peristome* twisted, teeth 32, without a tube, united at the base. *Operculum* stout, conico-subulate, half the length of capsule, oblique. *Calyptra* cucullate.

*Hab.* Damp rocks, Port Lyttelton hills; October, 1889. Collected by R. B.

**Tortula elliptotheca**, sp. nov. Plate XXXV., fig. 4.

*Plants* perennial, monœcious, brownish, growing in small pulvinate tufts  $\frac{1}{4}$  in. high. *Stem* branched near the base. *Branches* fastigiate. *Leaves* imbricating all round the stem, erecto-patent, oblong-oval, with a hyaline hair-point, concave. *Margins* entire. *Nerve* stout, excurrent. *Arcola*: Upper small, dense; lower oblong; crisp when dry. *Perichæatial leaves* oblong, subacute, with a hyaline hair-point. Acrocarpous. *Fruitstalk*  $\frac{3}{16}$  in. long, pale-brown. *Capsule* elliptic, short. *Operculum* stout, oblique, conico-subulate, two-thirds the length of the capsule. *Peristome* twisted, teeth 32, two and a half times longer than the tube. *Calyptra* cucullate.

*Hab.* On damp rocks, Port Lyttelton hills; October, 1889. Collected by R. B.

**Tortula oblongifolia**, sp. nov. Plate XXXV., fig. 5.

*Plants* perennial, monœcious, growing in small pulvinate tufts  $\frac{1}{4}$  in. to  $\frac{1}{2}$  in. high, brownish-green. *Stems* branched near the base. *Branches* fastigiate. *Leaves* imbricating all round the stem, erecto-patent, slightly recurving, oblong-oval, ending in a hyaline hair-point, concave. *Margins* entire, plain. *Nerve* excurrent. *Arcola*: Upper small, dense; lower oblong; crisp when dry. *Perichæatial leaves* erect, sheathing, similar in outline to the stem ones. Acrocarpous. *Fruitstalk*  $\frac{3}{8}$  in. long, reddish. *Capsule* cylindrical. *Peristome* twisted, teeth 32, two and a half times longer than the tube. *Operculum* not found. *Calyptra* cucullate.

*Hab.* Damp rocks, Port Lyttelton hills; October, 1889. Collected by R. B.

**Tortula maudii**, sp. nov. Plate XXXVI., fig. 6.

*Plants* perennial, monœcious, growing in irregular tufts, brownish-green,  $\frac{1}{4}$  in. to  $\frac{1}{2}$  in. high. *Stem* branched near the base. *Branches* fastigiate. *Leaves* imbricating all round the stem, erecto-patent, oblong-oval, with a toothed hyaline hair-point, incurving near the apex and very concave, base erect. *Margins* entire, flat. *Nerve* excurrent. *Arcola*: Upper dense, subrotund; lower oblong; crisp when dry. *Perichæatial leaves* erect, sheathing, smaller than the upper ones, innermost smallest, ovate-lanceolate, obtuse, with a toothed hyaline hair-point. Acrocarpous. *Fruitstalk* dark-red,  $\frac{1}{2}$  in. long. *Capsule* large, cylindrical, unequal near the base, slightly curved. *Peristome* twisted, teeth 32, three times longer than the tube. *Operculum* conico-subulate, nearly one-half the capsule. *Calyptra* cucullate.

Named after Mrs. Leonard Cockayne.

*Hab.* In crevices of damp rocks, Port Lyttelton hills; October, 1886. Collected by R. B.

**Tortula binnsii**, sp. nov. Plate XXXVI., fig. 7.

*Plants* perennial, monœcious, growing in small dark patches  $\frac{1}{4}$  in. to  $\frac{1}{2}$  in. high. *Stems* branched. *Branches* short. *Leaves* spreading from an erect base, imbricating, oblong-oval, with a hyaline hair-point, minutely papillose, slightly concave. *Margins* recurved to near the apex. *Nerve* excurrent. *Areola*: Upper dense, subrotund; lower oblong near the base; crisp when dry. *Perichæatial leaves* slightly narrower than the upper ones, otherwise similar to them. Acrocarpous. *Fruitstalk*  $\frac{1}{2}$  in. long, brownish. *Capsule* cylindric, slightly curved. *Peristome* twisted, teeth 32, tube very short. *Operculum* conico-subulate, one-third the length of the capsule, oblique. *Calyptra* cucullate.

*Hab.* On damp banks, near Christchurch; November, 1882. Collected by R. B.

**Tortula synecia**, sp. nov. Plate XXXVI., fig. 8.

*Plants* perennial, synœcious, growing in small brownish-green tufts  $\frac{1}{3}$  in. to  $\frac{1}{4}$  in. high. *Stems* branched near base. *Branches* fastigiate. *Leaves* imbricating all round the stem, erecto-patent, upper and middle ones subspathulate, with a hyaline hair-point, concave. *Margins* recurved to near the apex. *Nerve* excurrent. *Areola*: Upper dense, subrotund; lower oblong; crisp when dry. *Perichæatial leaves* oblong-oval, with a hair-point, erect, sheathing. Acrocarpous. *Fruitstalk*  $\frac{1}{4}$  in. long, brown. *Capsules* subcylindric, unequal. *Peristome* twisted, teeth 32, tube very short. *Operculum* conico-subulate, about one-half the length of capsule. *Calyptra* cucullate.

*Hab.* Damp rocks, Port Lyttelton hills; October, 1892. Collected by R. B.

**Tortula panduriforma**, sp. nov. Plate XXXVI., fig. 9.

*Plants* perennial, monœcious, growing in loose patches  $\frac{1}{4}$  in. to  $\frac{1}{2}$  in. high, green or brownish. *Stems* branched near the base. *Branches* fastigiate. *Leaves* imbricating all round, erecto-patent, panduriform, with a hyaline hair-point, slightly toothed. *Margins* entire, recurved at the middle. *Nerve* stout, excurrent. *Areola*: Upper dense, lower oblong, crisped when dry. *Perichæatial leaves*, inner one smallest, otherwise similar to the stem ones. Acrocarpous. *Fruitstalk* pale-brown,  $\frac{1}{4}$  in. long. *Capsule* cylindric, straight or curved. *Peristome* twisted, teeth 32, twice as long as the tube. *Operculum* stout, half the length of the capsule. *Calyptra* cucullate.

*Hab.* On damp rocks, Port Lyttelton hills; October, 1893. Collected by R. B.

**Tortula searlii**, sp. nov. Plate XXXVIII., fig. 10.

*Plants* perennial, monœcious, growing in dense patches from  $\frac{1}{2}$  in. to 1 in. high, green above, brown below. *Stems* branching, fastigiate. *Leaves* imbricating all round the stem, erecto-patent, subspathulate, with a hyaline toothed hair-point. *Margins* flat, minutely crenate. *Nerve* excurrent. *Areola*: Upper dense, lower oblong. *Perichæcial leaves* spathulate, with a toothed hyaline hair-point, smaller than the comal ones, inner smallest. *Acrocarpous*. *Fruitstalk* yellowish,  $\frac{3}{8}$  in. long. *Capsule* more or less curved, cylindrical. *Peristome* twisted, teeth 32, slightly longer than the tube. *Operculum* conico-subulate, about half the length of the capsule. *Calyptra* cucullate.

*Hab.* Damp rocks, Port Lyttelton hills; October, 1893. Collected by R. B.

**Tortula bealeyensis**, sp. nov. Plate XXXVII., fig. 12.

*Plants* perennial, monœcious, growing in loose patches 1 in. to  $1\frac{1}{2}$  in. high, yellowish-green above, brown below. *Stems* branched, fastigiate. *Leaves* imbricating all round, spreading, recurving from an erect base, linear-lanceolate, acuminate, with a short hair-point, concave. *Margins* entire, flat or recurved in the middle. *Nerve* excurrent. *Areola*: Upper small, dense; lower oblong; crisp when dry. *Perichæcial leaves* similar to the upper ones, hair-point longer. *Acrocarpous*. *Fruitstalk* reddish,  $\frac{3}{8}$  in. long. *Capsule* cylindrical, sometimes swollen near the base. *Peristome* twisted, teeth 32, short, tube twice as long as the teeth. *Operculum* conico-subulate, about half the length of the capsule. *Calyptra* cucullate.

*Hab.* On wet banks, Bruce's Creek, near the Bealey; February, 1889; Otarama, 1895. Collected by R. B.

**Tortula gulliverii**, sp. nov. Plate XXXVIII., fig. 13.

*Plants* perennial, monœcious, growing in small tufts  $\frac{3}{16}$  in. to  $\frac{1}{4}$  in. high, green. *Stems* nearly simple. *Leaves* imbricating all round the stem, erecto-patent, ligulate-acute or rounded into a hyaline hair-point, concave. *Margins* recurved from near the base unto the apex. *Nerve* excurrent. *Areola*: Upper small, dense; lower oblong; incurved when dry. *Perichæcial leaves* smaller than the comal ones, but otherwise similar. *Acrocarpous*. *Fruitstalk* nearly erect,  $\frac{1}{2}$  in. long, red. *Capsule* cylindrical, straight or slightly curved. *Peristome* twisted, teeth divided to the base, 32. *Operculum* subulate, two-fifths the length of the capsule. *Calyptra* cucullate.

*Hab.* On stones, near Greymouth; 1896. Collected by Mr. Gulliver.

## SECTION B.

(Plants having the leaves acute or acuminate.)

**Tortula minuta**, sp. nov. Plate XXXVIII., fig. 14.

*Plants* perennial, monœcious, growing in small loose patches, dark-green,  $\frac{1}{10}$  in. high. *Leaves* imbricating all round the stem, erecto-patent, slightly incurved near the apex; upper ones shortly ovate-lanceolate, acute; middle lanceolate-acute or apiculate, concave. *Margins* entire. *Nerve* stout, continued to the apex. *Areola*: Upper small, dense; lower oblong near the base; appressed when dry. *Perichætal leaves* smaller, lanceolate-acute, nerved to the apex. Acrocarpous. *Fruitstalk* yellowish,  $\frac{3}{16}$  in. long. *Capsule* ovate. *Peristome* twisted, tube extremely short. *Operculum* stout, oblique, conico-subulate, nearly half the length of the capsule. *Calyptra* cucullate.

*Hab.* On damp banks, Port Lyttelton hills; August, 1892. collected by R. B.

**Tortula lancifolia**, sp. nov. Plate XXXVIII., fig. 15.

*Plants* perennial, monœcious, growing in small dark-brown tufts  $\frac{1}{4}$  in. to  $\frac{1}{2}$  in. high. *Stem* branched near the base, fastigiate. *Leaves* erecto-patent, imbricating all round, oblong-lanceolate, acute or ligulate-acute, concave. *Margins* entire. *Nerve* continued to the apex. *Areola*: Upper small, dense; lower oblong near the base; crisp when dry. *Perichætal leaves* lanceolate-acute, about the size of the comal ones. Acrocarpous. *Fruitstalk*  $\frac{3}{16}$  in. long, reddish-brown. *Capsule* cylindrical, subventricose. *Peristome* twisted, tube very short. *Operculum* conico-subulate, half the length of the capsule. *Calyptra* cucullate.

*Hab.* On rocks, Port Lyttelton hills; October, 1882. Collected by R. B.

**Tortula linearifolia**, sp. nov. Plate XXXVIII., fig. 16.

*Plants* perennial, monœcious, growing in small dense pulvinate tufts, pale-brown,  $\frac{3}{16}$  in. to  $\frac{5}{16}$  in. high. *Stems* branched, fastigiate. *Leaves* erecto-patent, imbricating all round the stem, ligulate-acute, concave, deeply towards the apex. *Margins* entire, with a pellucid border disappearing near the apex. *Nerve* stout, upper portion minutely toothed, upper half of leaves papillose on the back. *Areola*: Upper small, dense; lower large, oblong; crisp when dry. *Perichætal leaves* smaller than the comal ones, ligulate-acute, very concave at the apex. Acrocarpous. *Fruitstalk*  $\frac{1}{4}$  in. long, reddish. *Capsule* elliptic. *Operculum* conico-subulate, oblique, two-fifths the length of the capsule.



*Hab.* On rocks, Port Lyttelton hills; November, 1883. Collected by R. B.

***Tortula brevitheca***, sp. nov. Plate XXXIX., fig. 17.

*Plants* perennial, monœcious, dark-green, growing in pulvinate tufts  $\frac{1}{4}$  in. to  $\frac{1}{2}$  in. high. *Stems* branched, short, fastigiata. *Leaves* erecto-patent, imbricating all round the stem, oblong-lanceolate-acute, base erect, slightly concave. *Margins* entire. *Nerve* continued to the apex. *Areola*: Upper small, dense; lower oblong; crisp when dry. *Perichæcial leaves*, inner smallest, oblong-lanceolate-acute. Acrocarpous. *Fruitstalk*  $\frac{1}{8}$  in. to  $\frac{1}{4}$  in. long, red. *Capsule* subelliptic. *Peristome* twisted, teeth about six times longer than the short tube. *Operculum* subulate, about half the length of the capsule. *Calyptra* cucullate.

*Hab.* Limestone rocks, near Castle Hill; January, 1897. Collected by R. B.

***Tortula stevensii***, sp. nov. Plate XXXIX., fig. 18.

*Plants* perennial, monœcious, growing in loose patches  $1\frac{1}{2}$  in. high, brownish-green, subdichotomously branched. *Leaves* spreading, recurved, imbricating all round the stem, ovate-lanceolate, acuminate, base erect, concave. *Margins* recurved from the base to the middle, entire. *Nerve* stout, red, excurrent. *Areola*: Upper small, dense; lower oblong; crisp when dry. *Perichæcial leaves* small, inner smallest, ovate-lanceolate, acuminate. Acrocarpous. *Fruitstalk*  $\frac{1}{2}$  in. long, red. *Capsule* cylindric, slightly curved. *Peristome* twisted, teeth four times longer than the tube. *Operculum* stout, conico-subulate. *Calyptra* cucullate.

*Hab.* Damp banks and rocks, Port Lyttelton hills; October, 1893. Collected by R. B.

***Tortula bellii***, sp. nov. Plate XXXIX., fig. 19.

*Plants* perennial, monœcious, growing in tufts, yellowish-green,  $\frac{1}{4}$  in. to  $\frac{1}{2}$  in. high. *Stems* branched, fastigiata. *Leaves* erecto-patent, imbricating all round the stem, ovate-lanceolate, long acuminate, base erect, concave. *Nerve* ending near the apex. *Margins* recurved. *Areola*: Upper small, dense; lower oblong near the base; very crisp when dry. *Perichæcial leaves* longer and narrower than the comal ones, inner one narrowest, linear-lanceolate, tapering into a slender point. Acrocarpous. *Fruitstalk* red,  $\frac{1}{2}$  in. long. *Capsule* cylindric, straight or curved. *Peristome* twisted, teeth 32, tube very short. *Operculum* oblique, conico-subulate. *Calyptra* cucullate.

*Hab.* Damp banks, Weka Pass; November, 1886. Collected by R. B.

**Tortula dioica**, sp. nov. Plate XL., fig. 22.

*Plants* perennial, diœcious, growing in loose patches, yellowish-brown, 2 in. high. *Stems* slender, simple or branched slightly. *Leaves* spreading, recurving from an erect base, imbricating loosely, oblong or narrowly lanceolate-acuminate, keeled, concave. *Margins* toothed towards the apex. *Nerve* continuous or excurrent. *Areola*: Upper small, lower oblong, crisp when dry. *Perichæcial leaves*, inner one smallest, oblong or lanceolate-acuminate. Acrocarpous. *Fruitstalk* red, 1 in. long. *Capsule* stout, cylindric. *Peristome* twisted, teeth one and a half times the length of the tube. *Operculum* stout, conico-subulate. *Calyptra* cucullate.

*Hab.* Damp banks, Craigieburn, West Coast Road; March, 1891. Collected by R. B.

**Tortula walkeri**, sp. nov. Plate XL., fig. 24.

*Plants* perennial, monœcious, growing in dense brownish-green patches  $\frac{1}{2}$  in. to 1 in. high. *Stems* branched, short, fastigiæte. *Leaves* erecto-patent, imbricating all round the stem, ovate or oblong-lanceolate, acute, concave. *Margins* entire. *Nerve* stout, continued to the apex. *Areola*: Upper small, dense; lower linear-oblong; crisp when dry. *Perichæcial leaves* convolute, sheathing, with a short acuminate apex. Acrocarpous. *Fruitstalk* slender, 1 in. long. *Capsule* small, elliptic. *Peristome* twisted, teeth seven times longer than the tube. *Operculum* subulate, as long as the capsule. *Calyptra* long and narrow, cucullate.

*Hab.* On sandy soil near Mason's Bay, Stewart Island. Collected by R. B.

**Tortula kowaiensis**, sp. nov. Plate XXXVII., fig. 26.

*Plants* perennial, monœcious, growing in loose patches  $\frac{1}{2}$  in. to  $1\frac{1}{2}$  in. high. *Stems* scarcely branched. *Branches* fastigiæte. *Leaves* erecto-patent, imbricating all round the stem, ovate-lanceolate, acuminate, erect at the base, middle ones oblong, acute, concave. *Margins* recurved in the middle of the leaf, upper part flat, entire. *Nerve* excurrent. *Areola*: Upper small, dense; lower oblong; crisp when dry. *Perichæcial leaves* oblong-lanceolate, acuminate. Acrocarpous. *Fruitstalk* red,  $\frac{1}{2}$  in. to 1 in. high. *Capsule* cylindric, swollen near the base. *Peristome* twisted, teeth about the same length as the tube. *Operculum* conico-subulate. *Calyptra* cucullate.

*Hab.* Damp rocks near the river-course, Mount Torlesse; January, 1886. Collected by R. B.

**Tortula torlessensis**, sp. nov. Plate XL., fig. 27.

*Plants* perennial, monœcious, growing in brownish patches  $\frac{1}{4}$  in. to  $\frac{1}{2}$  in. high. *Stems* branched. *Leaves* erecto-patent, im-

bricating all round the stem, oblong-lanceolate, acuminate, concave. *Margins* with a border of yellowish oblong cells, and minutely serrated towards the apex. *Nerve* stout, excurrent. *Areola*: Upper small, dense; lower large, oblong; crisp when dry. *Perichætical leaves* smaller than the comal ones, the inner smallest, narrowly oblong-lanceolate, acuminate. *Acrocarpous*. *Fruitstalk*  $\frac{1}{2}$  in. long, reddish. *Capsule* cylindric, straight or slightly curved. *Annulus* small, persistent. *Peristome* twisted, teeth short, 32, tube twice the length of the teeth.

*Hab* On damp bank, Mount Torlesse, and near Broken River; March, 1891. Collected by R. B.

## EXPLANATION OF PLATES XXXV.—XL.

## PLATE XXXV.

Fig. 1. *Tortula papillosa*, Wills.

1. Upper leaves.
2. Middle leaf.
3. Lower leaf.

Fig. 2. *Tortula acuta*, sp. nov.

1. Capsule.
2. Peristome.
3. Perichætical leaves.
4. First leaf outside perichætical.
5. Upper and middle leaves.

Fig. 3. *Tortula pulvinata*, sp. nov.

1. Capsule.
2. Peristome.
3. Perichætical leaves.

4. First leaf outside perichætical.
5. Upper leaf.

Fig. 4. *Tortula elliptotheca*, sp. nov.

1. Capsule.
2. Peristome.
3. Perichætical leaves.
4. First leaf outside perichætical.
5. Upper leaf.
6. Middle leaf.

Fig. 5. *Tortula oblongifolia*, sp. nov.

1. Capsule.
2. Perichætical leaves.
3. Upper leaf.
4. Middle leaf.

## PLATE XXXVI.

Fig. 6. *Tortula maudii*, sp. nov.

1. Capsule.
2. Peristome.
3. Perichætical leaves.
4. First leaf outside perichætical.
5. Upper leaf.
6. Middle leaf.

Fig. 7. *Tortula binsii*, sp. nov.

1. Capsule.
2. Peristome.
3. Perichætical leaves.
4. First leaf outside perichætical.
5. Upper leaf.
6. Middle leaf.

Fig. 8. *Tortula synecia*, sp. nov.

1. Capsule.
2. Peristome.
3. Perichætical leaves.
4. First leaf outside perichætical.
5. Upper leaf.

Fig. 9. *Tortula panáuriforma*, sp. nov.

1. Capsule.
2. Peristome.
3. Perichætical leaves.
4. First leaf outside perichætical.
5. Upper leaf.
6. Middle leaf.

## PLATE XXXVII.

Fig. 11. *Tortula muelleri*, Br.

1. Capsule.
2. Peristome.
3. Perichæatial leaves.
4. First leaf outside perichæatial.
5. Upper leaf.

Fig. 12. *Tortula bealeyensis*, sp. nov.

1. Capsule.
2. Peristome.
3. Perichæatial leaves.
4. First leaf outside perichæatial.
5. Upper leaf.
6. Middle leaf.

Fig. 23. *Tortula serrulata*, Hook. and Grev.

1. Capsule.
2. Perichæatial leaves.
3. First leaf outside perichæatial.
4. Upper stem leaf.
5. Middle stem leaf.

Fig. 26. *Tortula kowaiensis*, sp. nov.

1. Capsule.
2. Operculum.
3. Perichæatial leaves.
4. Leaf outside the perichæatial, enclosing antheridia.
5. Upper leaf.

## PLATE XXXVIII.

Fig. 10. *Tortula searlii*, sp. nov.

1. Capsule.
2. Peristome.
3. Perichæatial leaves.
4. First leaf outside perichæatial.
5. Upper leaf.
6. Middle leaf.

Fig. 13. *Tortula gulliverii*, sp. nov.

1. Capsule.
2. Operculum.
3. Perichæatial leaves.
4. First leaf outside perichæatial.
5. Upper leaf.

Fig. 14. *Tortula minuta*, sp. nov.

1. Capsule.
2. Peristome.
3. Perichæatial leaves.

4. First leaf outside perichæatial.
5. Upper leaf.
6. Middle leaves.

Fig. 15. *Tortula lancifolia*, sp. nov.

1. Capsule.
2. Peristome.
3. Perichæatial leaves.
4. First leaf outside perichæatial.
5. Upper leaf.
6. Middle leaves.

Fig. 16. *Tortula linearifolia*, sp. nov.

1. Capsule.
2. Perichæatial leaves.
3. First leaf outside perichæatial.
4. Upper leaf.
5. Middle leaf.

## PLATE XXXIX.

Fig. 17. *Tortula brevitheca*, sp. nov.

1. Capsule.
2. Operculum.
3. Perichæatial leaves.
4. First leaf outside perichæatial.
5. Upper leaf.
6. Middle leaves.

Fig. 18. *Tortula stevensii*, sp. nov.

1. Capsule.
2. Peristome.
3. Perichæatial leaves.
4. First leaf outside perichæatial.
5. Upper leaf.
6. Middle leaf.

Fig. 19. *Tortula bellii*, sp. nov.

1. Capsule.
2. Operculum.
3. Perichæatial leaves.
4. First leaf outside perichæatial.
5. Upper leaf.

Fig. 20. *Tortula knightii*, Mitten.

1. Capsule.
2. Peristome.
3. Perichæatial leaves.
4. First leaf outside perichæatial.
5. Upper leaf.
6. Middle leaves.

## PLATE XL.

Fig. 21. *Tortula rubra*, Mitten.

1. Capsule.
2. Operculum.
3. Perichæatial leaves.
4. First leaf outside perichæatial.
5. Upper leaf, serration enlarged.

Fig. 22. *Tortula dioica*, sp. nov.

1. Capsule.
2. Peristome.
3. Perichæatial leaves.
4. First leaf outside perichæatial.
5. Upper leaf.
6. Middle leaf.

Fig. 24. *Tortula walkeri*, sp. nov.

1. Capsule.
2. Operculum.
3. Calyptra.

4. Perichæatial leaves.

5. First leaf outside perichæatial.
6. Upper stem leaves.

Fig. 25. *Tortula calycina*, Schwægr.

1. Capsule.
2. Operculum.
3. Perichæatial leaves.
4. First leaf outside perichæatial.
5. Upper leaves.
6. Middle leaf.

Fig. 27. *Tortula torlessensis*, sp. nov.

1. Capsule.
2. Perichæatial leaves.
3. First leaf outside perichæatial.
4. Upper leaf.
5. Middle leaf.

ART. XLIV.—*New Zealand Musci: Notes on the Genus Streptopogon, Wills, with Description of a New Species.*

By R. BROWN.

[Read before the Philosophical Institute of Canterbury, 4th August, 1897.]

Plate XLI. (in part).

THIS genus is a South American one, and is closely allied to the genus *Tortula*, the principal point of difference being the shape of the calyptra, which in *Tortula* is cucullate and in *Streptopogon* mitriform. So far there has only been one plant of this genus noted in New Zealand, and that was doubtfully identified by Sir Joseph Hooker from a small barren scrap as *St. minioides*, Schw., which is a South American species. Unfortunately, it has been described in the "Handbook of the Flora of New Zealand," in a footnote, as European, which is incorrect.

The New Zealand species, which I have named *St. hookerii*, after Sir Joseph Hooker, is very abundant all over Banks Peninsula, on rocks and trees, but is rarely found in fruit there; but at Moa Creek, Milford Sound, West Coast, &c., it fruits freely, evidently requiring a great deal of moisture. In its barren condition it may readily be mistaken for an *Orthotrichum*, which it then closely resembles.

It is unfortunate that no specimens of the South American plant are available for comparison with the New Zealand one, as I much prefer personal examination to being obliged to resort to written descriptions only.

I note that in the New Zealand plant the perichæatial leaf sheathes the fruitstalk to the base of the capsule, which is often subimmersed. This is not given as a characteristic of *St. minioides*. Also, the former is monœcious, while the latter is described as diœcious.

*St. minioides* is described in the "Journal of the Linnæan Society (Botany)," vol. xii., 1896, p. 179.

The two plants are very similar, with the exception of those two points which I have noted; hence I am bound to assume that they cannot be identical.

***Streptopogon hookerii*, sp. nov.** Plate XLI., fig. 2.

*Plants* perennial, monœcious, growing in small loose or dense tufts  $\frac{1}{4}$  in. to 2 in. high, dark or yellow-green, subdichotomously branched. *Leaves* spreading from an erect sheathing base, flexuous, closely or loosely imbricating round the stem, ovate-lanceolate, acuminate, concave. *Margins* entire, with a border of oblong pellucid cells continued to near the apex. *Nerve* excurrent, gemmaceous near the apex. *Areola*: Upper small, subrotund; lower rectangular; crisp when dry. *Perichæatial* oblong or linear-lanceolate, acuminate, sheathing the fruitstalk to the base of the capsule. *Fruit* terminal. *Fruitstalk* short. *Capsule* elliptic. *Peristome* twisted teeth, about six times longer than the tube. *Operculum* slender, conico-subulate, more than half the length of the capsule. *Calyptra* mitriform, lobed at the base. *Male inflorescence* terminal on separate branches, gemmaceous.

*Hab.* Damp rocks and trees; common; Banks Peninsula, Moa Creek, Milford Sound, Clinton, Lake Te Anau, &c. Collected by R. B.

---

DESCRIPTION OF PLATE XLI. (IN PART).

Fig. 2. *Streptopogon hookerii*.

1. Capsule.
  2. Operculum.
  3. Calyptra.
  4. Inner and outer perichæatial leaves.
  5. First leaf outside perichæatial.
  6. Stem leaves.
-

ART. XLV.—*New Zealand Musci: Notes on New Genus Dendia.*

By R. BROWN.

[Read before the Philosophical Institute of Canterbury, 4th August, 1897.]

Plate XLI. (in part).

THIS paper records the finding of a new species of moss in the neighbourhood of Sumner in August, 1896. It was found growing in small gregarious patches close to the Heathcote Estuary, on sandy soil, and liable to be occasionally submerged at high tides. When first found it was immature, and had the appearance of a *Phascum*, there being no ring on the capsule, nor any indications of a deciduous operculum, the cells being all uniform in size, and the cell-walls rather membranous; subsequently matured specimens were obtained, in which dehiscence had taken place, the division being horizontal along the apex of a row of cells about the middle of the capsule, leaving the mouth minutely crenate by the projecting of the upper ends of the cells. The walls of the capsule consist of one row of cells, and there is no peristome.

This plant, which I have made the type of a new genus, appears to me to occupy a position half-way between the *Phascaceæ* and the *Bryaceæ*.

I have named the new genus *Dendia*, after Dr. Dendy, Professor of Biology, Canterbury College, and this species *maritima*, from its being found growing close to the sea.

## DESCRIPTION OF GENUS.

*Dendia*, gen. nov.

Capsule ovate, membranous, without any indication of a deciduous operculum, dehiscing in the middle of the capsule. Operculum oblique, conico-rostrate. Calyptra cucullate.

## DESCRIPTION OF PLANT.

*Dendia maritima*, sp. nov. Plate XLI., fig. 3.

*Plants* monœcious, growing in gregarious patches  $\frac{1}{3}$  in. high, gemmaceous. *Stem* simple. *Leaves* nearly erect, incurving towards the apex, imbricating, oblong, acute, concave. *Nerve* ending below the apex. *Margins* entire. *Areola* lax, incurved when dry. *Perichæcial leaves*, inner smallest, oblong, acute. *Fruit* acrocarpous. *Fruitstalk*  $\frac{1}{16}$  in. long, erect, red. *Capsule* ovate, bright-red, membranous, dividing

in the middle when mature, gymnostomous. *Mouth* minutely crenate by the projection of the cells. *Operculum* oblique, conico-rostrate. *Calyptra* cucullate.

*Hab.* Damp sandy soil, Heathcote Estuary; August, 1896; collected by R. B. Near Godley Heads; September, 1896; collected by R. Trist Searell. At present these are the only habitats known of this plant.

---

DESCRIPTION OF PLATE XLI. (IN PART).

Fig. 3. *Dendia maritima*.

1. Whole plant and capsule dehisced.
  2. Entire capsule.
  3. Calyptra.
  4. Perichætical leaves.
  5. Stem leaves.
- 

ART. XLVI.—*Notes on New Zealand Musci, and Descriptions of two New Species.*

By R. BROWN.

[*Read before the Philosophical Institute of Canterbury, 3rd November, 1897.*]

Plate XLI. (in part).

Genus **Anacalypta**, Röhl.

THIS genus, which has not previously been recorded as belonging to the flora of New Zealand, is a European one, consisting of a few annual or biennial plants, the generic characters of which are an oval capsule, a single peristome, consisting of sixteen teeth, united at the base by a membrane, entire or perforated, and without a medial line. *Calyptra* cucullate.

The two New Zealand plants which I have placed in this genus, and described in this paper, are fragile, inconspicuous plants, and very easily overlooked when collecting; they are found in fruit during the spring months, from the end of September till November. After that period they are generally dried up. Their habitat is in warm, sheltered situations on damp argillaceous soil, which has been turned over during the winter months and not overgrown with other vegetation.

*A. zealandica* of this paper was very common in a portion of the Christchurch Domain in 1883, but since that



time it has almost entirely disappeared from that locality, and it is now very difficult to find a single specimen. It agrees very well with the generic description of *Anacalypta*, although the peristome is always found imperfect. The upper portion of it appears to be very membranous, and gets dissipated by the dehiscence of the operculum, leaving only short stumps composed of one or two superimposed cells.

*A. stevensii* (the other plant here recorded) was found growing on damp banks, Port Lyttelton hills, October, 1892, near the small gully leading to the Dry Bush. This plant considerably resembles the previous one. I have some doubt in placing this plant in the present genus, owing to the peristome being deeply bifid, although it has no medial line, but this is the only genus that it is closely associated with.

1. *Anacalypta zealandiæ*, sp. nov. Plate XLI., fig. 4.

*Plants* monœcious, annual, growing in loose patches  $\frac{1}{8}$  in. high, green. *Stem* simple. *Leaves* small, imbricating round the stem, erecto-patent, slightly decurved from an erect base, lanceolate or oblong-lanceolate, acute, concave. *Margins* entire, keeled. *Nerve* shortly excurrent. *Upper areola* small, slightly crisp when dry. *Perichætal* leaves similar to the upper ones, acrocarpous. *Fruitstalk* erect, reddish, about  $\frac{1}{8}$  in. long. *Capsule* small, ovate, reddish. *Peristome* single, 16, short, very imperfect, consisting of one or two superimposed cells. *Operculum* short, conic. *Calyptra* small, cucullate.

*Hab.* Sandy soil in the Christchurch Domain. Collected by R. B.

2. *Anacalypta stevensii*, sp. nov. Plate XLI., fig. 5.

*Plants* monœcious, annual (?), gregarious, pale-green, about  $\frac{1}{8}$  in. high, with one or two small branches from the base. *Leaves* few, imbricating round the stem, erecto-patent, shortly ovate-lanceolate, acute, or acuminate, concave. *Margins* entire. *Nerve* narrow, continued to the apex, erect when dry. *Perichætal* leaves nearly erect, sheathing at the base, slightly smaller than the upper ones, otherwise similar to the others, acrocarpous. *Fruitstalk*  $\frac{1}{16}$  in. long. *Capsule* oval. *Peristome* single, 16, teeth deeply bifid, divisions slender, without medial line. *Operculum* slightly oblique, conico-rostrate, two and a half times shorter than the capsule. *Calyptra* small, cucullate.

*Hab.* Damp banks, Port Lyttelton hills; October, 1892. Collected by R. B.

## DESCRIPTION OF PLATE XLI. (IN PART).

Fig. 4. *Anacalypta zealandica*.

1. Plant.
2. Perichætical leaves.
3. First leaf outside perichætical.
4. Upper leaves.
5. Middle leaves.
6. Peristome.

Fig. 5. *Anacalypta stevensii*.

1. Plant.
2. Peristome.
3. Perichætical leaves.
4. First leaf outside perichætical.
5. Upper leaf.
6. Middle leaf.
7. Calyptra.

ART. XLVII.—*On the Botany of Hikurangi Mountain.*

By JAMES ADAMS, B.A.

[Read before the Auckland Institute, 6th September, 1897.]

HIKURANGI is a high mountain on the Raukumara Range. It stands out so well defined on the sky from any open ground that it is a landmark for the East Cape district. The Maoris, impressed by its towering height and the pyramids of bare rock on its summit, called it "Hikurangi" ("The end of the sky") and "Mahikurangi" ("The land on which the sky rests"). On this mountain it is said that the Maori people took refuge during a flood, and that all would have been drowned but that Hinemakura drank the flood. In the legends published by Sir George Grey it is said to be the first land that Maui drew up from the deep, and thus it was regarded as the holy mountain, as on it fell the first faint light of the eyes of heaven (the sun and moon).

In the Rev. R. Taylor's book on New Zealand he says that there is a native legend that one of the canoes that brought the first Maoris to the Island is still on the top of Hikurangi. This was a very safe statement to make, for even now, with an open sheep country near the base, the mountain has never been ascended by any animal except man.

The directions for ascending the mountain are simple enough: Follow the Mokoivi Stream to its source and you are on the top of the mountain. In order to reach this stream Mr. Petrie and I, having landed at Hicks Bay under the guidance of my friend Mr. Lee, followed a fairly good road to Kawakawa, and camped on the Awatere River.

At Hicks Bay we found *Senecio perdicoides*, *Carmichaelia williamsii*, and a great variety of plants; but near the mouth of the Awatere was a far better botanical hunting-ground. The *Calceolaria sinclairii* was abundant, and *Danthonia cun-*

*ninghamii* covered the sides of the cliffs. There was some rare plant at almost every step, and for this reason we expected that the whole road to the mountain would be equally interesting. But in this we were disappointed, for Maraehara and the banks of the Mata, near Mr. Lee's house, were the only places with any variety of plants. This scarcity is owing to constant burning, that is required to keep the country open and well grassed for sheep. There were even blazing logs not many yards from the spot where the packhorses were unloaded on the banks of the Mokoivi, where the swagging began.

We could now see the mountain rising up before us, and it was only a matter of ascending the creek. At first the bed was open and rather rough, but after a time the stream was narrowed in, and rushed down over large boulders. There is no fear now of losing the way, as it is up the creek itself; for the underwood on each side is so thick and the ground so rugged that a track along the margin is impossible. The ascent of the stream is also rather steep, so that the mode of travelling is to wade a few feet, then scramble up a high boulder, then step from boulder to boulder for some yards, when the rocks become so steep and the water at the base so deep that a way must be forced along the side of the stream; but here the work is so great in forcing a way through underwood and over boulders that one is glad to get back to the bed of the stream, that is at least open. After this scrambling and fording there will sometimes succeed a patch of shingle, with the stream foaming along at one side and the trees bending so gracefully over still water at the other side that all the roughness of the road is forgotten, and nothing but a pleasant open road for the rest of the way is expected. But a few steps further on brings one to the boulders that must be climbed, the deep water that has to be forded, and the dead trees that have to be "Blondinized" over. I suppose without swags it is possible to get up the creek and to the foot of the mountain in five hours, but loaded as our Maoris were it took twelve hours for actual walking, and a night that we camped on the boulders near the stream.

The vegetation in the creek had nothing very interesting. It is almost entirely composed of tupaki, koromiko, karamu, and toi. The complete list from my note-book is: *Coriaria ruscifolia*, *Fuchsia excorticata*, *Schefflera digitata*, *Coprosma robusta*, *Cassinia leptophylla*, *Brachyglottis repanda*, *Veronica salicifolia*, *Arundo conspicua*, and young trees of *Fagus fusca*. This vegetation extends for many yards away from the stream, as in fact the whole country is covered with large sharp-edged boulders. We found this when we camped while making the place under the tent level enough to spread on it the clumps of toi for bedding, because the deep holes had to be bridged

with sticks. This arrangement of the toi clumps so far above the soil seemed to have disturbed all the insects that find their home among the leaves, and they proved much more troublesome than usual.

There were two plants not so common that were appearing all the way—*Cardamine hirsuta* and *Senecio latifolius*. As we approached the foot of the mountain some stragglers from the summit began to appear, such as *Veronica laevis*, *Aciphylla squarrosa*, *Cordyline indivisa*, and also live trees from the primeval forest of *Olea montana* and *Fagus fusca* occasionally lay across the stream.

The forest itself we did not get a glimpse of until we reached the foot of the hill. Then, after climbing about 200 ft. above the bed of the stream, we found large trees of three species of *Fagus*—viz., *Fagus fusca*, *F. menziesii*, *F. cliffortioides*—a large and lofty *Libocedrus doniana*, and *Cordyline indivisa* with tall well-grown stems. And on the edge of the ridge above the shingle slopes were patches of *Euphrasia cuneata*, *Ourisia macrophylla*, and *Callixene parviflora*.

Our camp near the foot of the hill was 30 ft. above the bed of the creek, but the plants around were those of a deserted clearing—makomako (*Aristotelia racemosa*), tupaki (*Coriaria ruscifolia*), and pukapuka. There were, however, a number of prostrate and upright trunks of dead trees that showed how periodic floods rise perhaps to a height of 50 ft., and cause a widespread destruction of the vegetation. The cause of the floods is plain enough. The mountain is composed of stratified beds of sandstone, clay, and limestone, and these dip at a large angle towards the east. The rain that is almost always falling on this mountain sinks into the loose strata, and forms a reservoir in the recesses of the rocks. In course of time this reservoir bursts and sweeps down an immense mass of the mountain to the bottom, where rocks and clay and trees form a dam. Behind this dam the streams from the mountain cause the water to rise higher and higher, and in course of time the enclosed water acquires such force that it sweeps everything before it for some distance, when the *débris* forms another dam, and the driving of the mass of rocks and trees is continued.

It is on account of these periodic floods that the plants found near the stream, and for some distance above it, are all second growth, and it is from the same cause that the redistribution of boulders has isolated the mountain from the surrounding country. So that neither cow nor horse nor sheep nor pig has ever desecrated the summit of the mountain or disturbed there the designs of nature in the manner of the growth of plants.

We found by an aneroid barometer that the ascent of the creek itself was about 3,000 ft., but this made little difference in the plants near its bed, for, with the exception of an occasional *Aciphylla squarrosa* and *Veronica levis*, the plants are the commonest found in the north. We had, however, plenty of time to climb in all directions from our camp at the foot of the mountain, for though we reached the camping-place at midday on Monday there was not a suitable day for ascending the mountain till Thursday. In this way we collected some plants that do not extend higher than the *Fagus* forest, and some that we found afterwards on the summit of the mountain.

On Tuesday we got specimens from the summit, for my friend Mr. Lee made an ascent of the mountain, in spite of the heavy fog and drizzling rain, and brought down a good collection of plants. The weather, however, got worse. At first it began to blow so that we all feared during the night that the lofty dead trees that stood near the tent would fall and crush us; then the rain poured in such torrents that the creek soon rose, and the roar of the creek soon became louder than that of the wind. It is an awkward place to be caught in bad weather, for in flood the creek cannot be attempted, and in the best weather a way over the mountain has never been tried. Then, when there are five men to feed, a stock of provisions very soon runs low.

The heavy rain continued through the night, and even at 12 o'clock next day there was no sign of better weather. It was then seriously discussed whether the better plan from all points of view was not to pack up the things and make our way down the creek when it had fallen low enough, rather than run the risk of being trapped there, not only without food, but even without the power to leave. However, at 2 p.m. things looked more hopeful, and the next day the weather was all that could be desired.

I know that to many persons it will appear absurd to speak of the difficulties of a climb of 2,000 ft. or 3,000 ft., but it ought to be borne in mind that the way up the mountain is over a landslip, and in some parts along a stream from the summit, and that save in the stream itself the soil is so loose that it makes the ascent difficult and the descent in some places really dangerous. Any one that steps on a projection more treacherous than usual, as I did, may experience the sensation of hanging over a fall of 40 ft. or 50 ft. with a certainty of getting to the bottom in a more or less shattered condition unless some brave friend is near to give a helping hand.

After ascending to a height of 4,700 ft. we came out on a much older part of the slip, where there was some genuine

mountain vegetation—*Ranunculus insignis*, *Coriaria angustissima*, *Oreomyrrhis colensoi*, *Aciphylla colensoi*, *A. squarrosa*, *Craspedia fimbriata*, *Veronica salicifolia* (var.), *Veronica lyallii*, *Euphrasia cuneata*, *Danthonia semiannularis* (var. *alpina*), *Poa anceps*.

The last stage in the ascent is across and up a shingle slip, and then, after a sharp turn through a gate-like opening in the rocks, the mountain-top is seen, covered with thickly-growing *Aciphylla*, through which there is a genuine thorny road.

From the summit there was a panoramic view of the district to the north and west. On the right bank of the Tapuae-wairoa there was open land, numerous rivers, and enclosed and tilled fields; on the left bank a wide undulating area of sombre-hued virgin forest that will no doubt soon disappear before the squatter and his sheep. The mountain itself seems to be rapidly falling away. Large slips appear on all sides of it, ending abruptly in precipices, and the bare pointed rocks on the summit show the fate that awaits the whole mountain.

The special characteristic of the summit from a botanical point of view is that no animal but man has ever been to the top, and thus we find the plants in their natural mode of growth both in position and arrangement. *Aciphylla colensoi* and *A. squarrosa* grow everywhere, but most thickly in stony ground. *Senecio elaeagnifolius* and *S. bidwillii* almost cover the slopes of the saddle, where the older branches are dead from the effect of the snow that lies for four months of the year on the summit of the mountain. Then there are broad patches of *Veronica laevis*, *V. tetragona*, and *Olearia nummularifolia*.

On the level ground, where no doubt the snow lies longest, there are no plants with woody stems, but a thick sward is formed of *Ligusticum aromaticum*, *Uncinia compacta*, *Poa australis*, *P. colensoi*, with round masses of *Oreobolus pumilio*, and here and there the flowers of *Gentiana saxosa*.

The luxuriant growth of some grasses on parts of the summit is also very striking. The three species of *Trisetum*—*T. antarcticum*, *T. subspicatum*, *T. youngii*—*Danthonia raoulii*, *D. semiannularis*, *Hierochloa redolens*, *H. alpina*, and *Festuca duriuscula*, all grow in great profusion. Then, the effect of the white flowers of *Celmisia spectabilis* and *C. incana*, and *Helichrysum leontopodium* (the New Zealand *edelweiss*), shining out in the different shades of green, surpassed anything in artificial growing. This effect was heightened by a veil-like covering of *Racomitrium* moss that softened and blended the colours.

The east side of the hill, looking towards Tologa and

Gisborne, is carpeted with *Celmisia incana*, *C. spectabilis*, *Veronica tetragona*, *Phyllocladus alpina*, *Oreomyrrhis colensoi*, and *Schœnus pauciflorus*. There were also specimens of *Geum urbanum*, and the one abundant orchid was *Prasophyllum nudum*. I also saw *Pterostylis banksii* and *P. puberula*.

In the bed of a creek flowing east, where I expected some rich finds, there was nothing on or near the boulders of coarse sandstone. This creek no doubt carries off the water of the snow melted in spring, and is then a genuine mountain torrent.

The trig. station lies at the south end of the mountain-top, and round it tower up some bare pyramidal rocks. At the foot of these rocks the ground is soft with patches of leather-plant (*Celmisia spectabilis*), vegetable sheep (*Raoulia grandiflora*), heaths (*Pentachondra pumila*, *Dracophyllum urvilleanum*), gentians (*Gentiana pleurogynoides*, *G. saxosa*), forget-me-nots (*Myosotis spathulata* and *M. antarctica*), and a koromiko like whip-cord (*Veronica tetragona*).

The only one of the party that climbed to the trig. station was my friend Mr. Lee, and he brought down from the very highest spot on the mountain the following plants: *Epilobium rubescens*, *Oreomyrrhis colensoi*, *Ligusticum haastii*, *Helichrysum leontopodium*, *Hierochloa alpina*, *Danthonia cunninghamii*, *D. semiannularis* (var. *alpina*), *Trisetum antarcticum*; but the plant that held the highest spot of all was not a native, but the common dandelion.

The whole country from Hikurangi to Waipiro shows a rapid disintegration of the land. The landslips on the mountain, and the loose and movable nature of the soil, are characteristic of the whole district. The higher ground on the banks of the Mata and of the Tapuaewairoa is ever on the move, and the fresh landslips near the stream show how insecure is the soil near the bank. A striking example of this movement is given at Waipiro, where all the ground about the hotel, and the hotel itself, is slowly travelling to the sea. The hotel, not many years built, and the grounds, were formerly enclosed by a strong wire fence that has now a very ridiculous appearance. The posts are wildly irregular, and the wire either hangs loose or is stretched at right angles to its original direction. The part of the hotel-grounds near the sea is split up, and apparently folded, while three successive lines of depression show the drains that were successively made in order to carry away the rain-water. The hotel itself, with its loosened floors and its strained and unstable verandah-posts, is in perfect harmony with its surroundings. The cause of all this may be a dyke of igneous rocks, as Sir James Hector has said, that lies beneath the Jurassic formation, and the most striking manifestation that it exists is in the appearance of hot springs

that lie about six miles from the township of Waipiro. These springs are not on the sea side of the coast range, but on the west side, and they are drained by a stream that flows east into the Waiapu. The site of the springs is well marked by a curious rock formation that at a distance looks like a castle in ruins. The springs lie on all sides of the base of this rock, but more especially on the east and south sides. The rock is carbonate of lime, called travertine, and has stood the weather better than the softer Jurassic formation. The latter has been washed away with such rapidity that the travertine now stands as a mass of rocks through which a hot spring once bubbled; in fact, gas is still issuing through a funnel far above the level of the springs. This gas, being lighted with a match, burns with a low murmur, and is thus used for boiling the "billy" of whatever health-seeker is camped near the springs.

At a lower level than the springs is a small lake of very brackish or salt water. The plants in the neighbourhood are the ordinary ericetal plants of fern-hills, but near the springs and salt lake are genuine seaside plants, such as *Cotula coronopifolia*, *Samolus repens*, *Chenopodium glaucum*, *Triglochin triandrum*, *Scirpus maritimus*. I have noticed the same kind of plants near the Te Aroha hot springs, but not to the same extent.

The neighbourhood of the hot springs is at present very desolate; but it is safe to prophesy that it will, in the near future, be one of the great health resorts of the North Island, for, speaking from experience, the effect of a bath in these springs is not to enervate, as is often the case elsewhere, but rather to revive and invigorate. Then, there are many springs with plenty of water, and the temperature varies from very hot to pleasantly warm. We visited them in the middle of summer, when running water near Waipiro had disappeared, and the river-beds were dry roads; but at the springs, though far above the level of the river-beds, there was abundance of water. Another point in favour of their becoming a great health resort is that the locality is protected from the strong sea-breeze by a range of hills 200 ft. or 300 ft. high. There are, however, two serious drawbacks—the want of a supply of good drinking-water and some difficulty in reaching Waipiro, either by land or sea.

Of course, no one can botanize in any part of New Zealand, and especially in the East Cape district, without being continually reminded of the work of that eminent botanist the Rev. W. Colenso, who fifty years ago so well explored the whole district, even to the summit of Hikurangi, that he left little for others to do. For this reason, before writing this paper, I thought it a duty to tell him what I intended to do,



and I hoped to receive from him some account of his ascent of the mountain in those early days that would make this paper somewhat interesting; but I regret to say that at that time he was suffering so severely from an accident that he could not write, nor could he give any account of his ascent of the mountain without consulting his notes, which were not then at hand. It is only by going over the ground that Colenso has trodden, and by studying the work that he has done, that we can estimate the honour that belongs to that highest of all titles "Fellow of the Royal Society," and we should feel a pride in thinking that there are in New Zealand a few who, by their original research in various branches of science, have already gained this enviable title.

---

CATALOGUE OF PLANTS OBSERVED (AND THEIR LOCALITIES NOTED) BY MR. D. PETRIE AND MR. JAMES ADAMS ON MOUNT HIKURANGI AND IN THE EAST COAST DISTRICT.

[The plants whose names are marked with an asterisk have not been hitherto observed in the East Cape district, as they are not mentioned in Mr. Kirk's list of East Cape plants, published in the last volume of the Transactions.]

RANUNCULACEÆ.

- Clematis indivisa*, Willd. Hicks Bay.  
 " *hexasepala*, DC. Waiapu River.  
 " *fœtida*, Raoul. Hiruhama.  
 " *parviflora*, A. Cunn. Not uncommon.  
*Ranunculus insignis*, Hook. f. Summit and sides of Hikurangi.  
 " *plebeius*, Br. Lowlands.  
 " *macropus*, Hook. f. Mokoiwi River.  
 " *rivularis*, Banks and Sol. Swampy places.  
 " *acaulis*, Banks and Sol. Hicks Bay and Kawakawa.

MAGNOLIACEÆ.

- Drimys axillaris*, Forst. Lowlands.

CRUCIFERÆ.

- Cardamine hirsuta*, L. Mokoiwi to summit of Hikurangi.

VIOLARIÆÆ.

- Viola filicaulis*, Hook. f. Base of Hikurangi.  
 " *cunninghamii*, Hook. f. Summit of Hikurangi.  
*Melicytus ramiflorus*, Forst. Abundant.  
 " *micranthus*, Hook. f. Lowlands.  
 \**Hymenantha crassifolia*, Hook. f. Summit of Hikurangi.

## PITTOSPOREÆ.

- Pittosporum tenuifolium*, *Banks and Sol.* River-banks.  
 " *ralphii*, *T. Kirk.* Woods near the sea.  
 " *eugenioides*, *A. Cunn.* Awatere River.  
 " *cornifolium*, *A. Cunn.* Hicks Bay.  
 " *crassifolium*, *A. Cunn.* Hicks Bay.

## CARYOPHYLLEÆ.

- Stellaria parviflora*, *Banks and Sol.* Hills near Hiruhama.  
 \* " *gracilentata*, *Hook. f.* Summit of Hikurangi.  
 \* *Colobanthus billardieri*, *Fenzl.* Summit of Hikurangi.

## HYPERICINEÆ.

- Hypericum japonicum*, *Thunb.* Swamps near Waiapu River.

## MALVACEÆ.

- Plagianthus divaricatus*, *Forst.* Sea-coast.  
*Hoheria populnea*, *A. Cunn.* Woods in lowlands.

## TILIACEÆ.

- Entelea arborescens*, *R. Br.* Hicks Bay, Taitai.  
*Aristolelia racemosa*, *Hook. f.* Common.  
 \* " *fruticosa*, *Hook. f.* Summit of Hikurangi.  
*Elæocarpus dentatus*, *Vahl.* Common in forests.

## GERANIACEÆ.

- Geranium dissectum*, *L.* Puhunga.  
 " *molle*, *L.* Kawakawa.  
 " *microphyllum*, *Hook. f.* Summit of Hikurangi.  
*Pelargonium australe*, *Willd.* Open lands.  
*Oxalis corniculata*, *L.* Common.  
 " *magellanica*, *Forst.* Puhunga.

## RUTACEÆ.

- Melicope ternata*, *Forst.* Hicks Bay.  
 " *simplex*, *A. Cunn.* River-banks.

## MELIACEÆ.

- Dysoxylum spectabile*, *Hook. f.* Common.

## OLACINEÆ.

- Pennantia corymbosa*, *Forst.* River-banks, Mata.

## RHAMNEÆ.

- Pomaderris phyllicifolia*, *Lodd.* Dry hills.

## SAPINDACEÆ.

- Dodonæa viscosa*, *Jacq.* Common.  
*Alectryon excelsum*, *DC.* Lowlands.

ANACARDIACEÆ.

*Corynocarpus lævigata*, *Forst.* Sea-coast.

CORIARIÆÆ.

*Coriaria ruscifolia*, *L.* Common.

\* " *angustissima*, *Hook. f.* Hikurangi.

LEGUMINOSÆ.

*Carmichaelia williamsii*, *T. Kirk.* Hicks Bay.

" *flagelliformis*, *Col.* Banks of rivers.

*Sophora tetraptera*, *Ait.* Common.

ROSACEÆ.

*Rubus australis*, *Forst.*, *var. cissoides*, *A. Cunn.* Both forms common to high elevations.

*Geum urbanum*, *L.* Mata River.

" *parviflorum*, *Commerson.* Summit of Hikurangi.

*Potentilla anserina*, *L.* Common in wet places.

*Acæna sanguisorbæ*, *Vahl.* River-banks to the foot of Hikurangi.

SAXIFRAGÆÆ.

*Quintinia serrata*, *A. Cunn.* Slopes of Hikurangi.

*Ixerba brexioides*, *A. Cunn.* Slopes of Hikurangi.

*Carpodetus serratus*, *Forst.* River-banks.

*Weinmannia racemosa*, *Forst.* Wooded hills.

HALORAGÆÆ.

*Haloragis alata*, *Jacq.* Common.

\* " *tetragyna*, *var. β*, *Labill.* Dry hills.

\* " *depressa*, *Hook. f.* Puhunga.

" *micrantha*, *Br.* Dry hills.

\* *Myriophyllum pedunculatum*, *Hook. f.* River-banks.

" *variæfolium*, *Hook. f.* Marshy places.

\* *Gunnera monoica*, *Raoul.* River-banks.

MYRTACEÆ.

*Leptospermum scoparium*, *Forst.* Common.

" *ericoides*, *A. Rich.* Common.

*Metrosideros florida*, *Sm.* Kawakawa.

" *hypericifolia*, *A. Cunn.* Hicks Bay.

\* " *colensoi*, *Hook. f.* Tologa.

" *robusta*, *A. Cunn.* Not uncommon.

" *tomentosa*, *A. Cunn.* Sea-coast.

" *scandens*, *Banks and Sol.* Near Tologa.

*Myrtus bullata*, *Banks and Sol.* Lowlands.

" *obcordata*, *Hook. f.* River-banks.

## ONAGRARIÆ.

- Fuchsia excorticata*, *L. f.* From sea to summit of Hikurangi.  
*Epilobium nummularifolium*, *A. Cunn.* Sea to 3,000 ft.  
 " *pedunculatum*, *A. Cunn.* Not uncommon.  
 " *rotundifolium*, *G. Forst.* Common.  
 " *junceum*, *Forst.* Swamps.  
 " *pubens*, *A. Rich.* Swamps.  
 " *billardierianum*, *Ser.* Swamps.  
 \* " *insulare*, *Haussk.* Swamps.  
 " *erubescens*, *Haussk.* Hikurangi.  
 \* " *chloræfolium*, *Haussk.* Hikurangi.  
 \* " *tenuipes*, *Hook.* Hikurangi.

## PASSIFLOREÆ.

- Passiflora tetrandra*, *Banks and Sol.* Mata River.

## FICOIDEÆ.

- Tetragonia expansa*, *Murray.* Kawakawa Bay.

## UMBELLIFERÆ.

- Hydrocotyle elongata*, *A. Cunn.* Not uncommon.  
 " *asiatica*, *L.* Common.  
 " *novæ-zealandiæ*, *DC.* Maraehara.  
 " *moschata*, *Forst.* Waipu River.  
 \* " *microphylla*, *A. Cunn.* Awatere River.  
*Azorella roughii*, *Hook. f.* Hikurangi Mountain.  
*Apium australe*, *Thouars.* Sea-coast.  
*Oreomyrrhis colensoi*, *Hook. f.* Hikurangi to summit.  
 \* *Crantzia lineata*, *Nutt.* Hicks Bay.  
*Ligusticum aromaticum*, *Hook. f.* Hikurangi, 4,000 ft. to 6,000 ft.  
*Aciphylla colensoi*, *Hook. f.* Hikurangi Mountain.  
 " *squarrosa*, *Forst.* Summit of Hikurangi.  
*Angelica rosæfolia*, *Hook. f.* Hicks Bay, Waipiro Spring.  
*Daucus brachiatus*, *Sieber.* Hikurangi.

## ARALIACEÆ.

- Panax simplex*, *Forst.* Hikurangi Mountain.  
 " *anomalum*, *Hook.* Hikurangi Mountain.  
 " *crassifolium*, *Hook. f.* River-banks.  
 " *lessonii*, *DC.* Hicks Bay.  
 " *colensoi*, *Hook. f.* Summit of Hikurangi.  
 " *arboreum*, *Forst.* Ascending to 4,000 ft.  
*Schefflera digitata*, *Forst.* Ascending to 4,000 ft.

## CORNEÆ.

- Corokia cotoneaster*, *Raoul.* Hicks Bay.  
*Griselinia lucida*, *Forst.* Hikurangi.  
 " *littoralis*, *Raoul.* Hikurangi.

## CAPRIFOLIACEÆ.

*Alseuosmia macrophylla*, *A. Cunn.* Maraehara.

## RUBIACEÆ.

- Coprosma lucida*, *Forst.* Hikurangi.  
 " *grandifolia*, *Hook. f.* Hikurangi.  
 " *baueri*, *Endlich.* Hicks Bay, Tologa.  
 " *robusta*, *Raoul.* Hikurangi.  
 " *densifolia*, *Hook. f.* Hikurangi.  
 " *tenuifolia*, *Cheeseman.* Hikurangi.  
 " *spathulata*, *A. Cunn.* Marshy ground.  
 " *rotundifolia*, *A. Cunn.* River-banks.  
 " *tenuicaulis*, *Hook. f.* Lowlands.  
 " *rhamnoides*, *A. Cunn.* River-banks.  
 \* " *parviflora*, *Hook. f.* Not common; lowlands.  
 " *foetidissima*, *Forst.* Hikurangi.  
 " *colensoi*, *Hook. f.* Hikurangi.  
 " *propinqua*, *A. Cunn.* Waiapu River.  
 " *cuneata*, *Hook. f.* Summit of Hikurangi.  
 " *acerosa*, *Col.* Sea-level to 3,000 ft.  
 \* " *linariifolia*. River-banks.  
 " *areolata*, *Cheeseman.* River-banks.  
 \* " *rigida*, *Cheeseman.* River-banks.  
 \* " *ranulosa*, *Petrie.* Hikurangi.  
 \* " *repens*, *Hook. f.* Summit of Hikurangi.  
 \* " *banksii*, *Petrie*, n.s. Base of Hikurangi.  
*Nertera cunninghamii*, *Hook. f.* Awatere River.  
*Galium tenuicaule*, *A. Cunn.* Maraehara.  
 " *umbrosum*, *Forst.* Waipiro; rare.

## COMPOSITEÆ.

- Lagenophora forsteri*, *DC.* Bare hills.  
 \* " *petiolata*, *Hook. f.* Bare hills.  
*Olearia colensoi*, *Hook. f.* Summit of Hikurangi.  
 " *furfuracea*, *Hook. f.* River-banks.  
 " *nitida*, *Hook. f.* Hikurangi.  
 " *ilicifolia*, *var.*, *Hook. f.* Hikurangi.  
 " *cunninghamii*, *Hook. f.* Hicks Bay.  
 \* " *nummularifolia*, *Hook. f.* Summit of Hikurangi.  
 " *solandri*, *Hook. f.* Tologa Bay.  
*Celmisia incana*, *Hook. f.* Hikurangi.  
 " *spectabilis*, *Hook. f.* Summit of Hikurangi.  
 " *longifolia*, *Cass.* Mr. Lee, from Aorangi.  
*Vittadinia australis*, *A. Rich.* Mata River.  
*Gnaphalium kerienense*, *A. Cunn.* River-banks.  
 " *luteo-album*, *L.* Hikurangi.  
 " *involutratum*, *Forst.* Not common.  
 " *collinum*, *Labill.* Not common.

- \**Gnaphalium filicaule*, *Hook. f.* Dry hills.  
 \**Raoulia tenuicaulis*, *Hook. f.* River-banks to 4,500 ft.  
 \* " *grandiflora*, *Hook. f.* Summit of Hikurangi.  
*Helichrysum bellidioides*, *Hook. f.* Hikurangi.  
 " *leontopodium*, *Hook. f.* Summit of mountain  
 " *glomeratum*, *Bentham and Hook. f.* Valleys.  
*Cassinia retorta*, *A. Cunn.* Hicks Bay.  
 " *leptophylla*, *Br.* Matahura, Waipiro.  
*Craspedia fimbriata*, *DC.* Summit of mountain.  
*Cotula coronopifolia*, *L.* Near sea-coast.  
 \* " *squalida*, *Hook. f.* Matahura.  
 \**Centipeda minuta*, *DC.* Wet places.  
*Erechtites prenanthoides*, *DC.* River-banks.  
 " *quadridentata*, *DC.* Puhunga.  
*Brachyglottis repanda*, *Forst.* Common.  
 \**Senecio latifolius*, *Banks and Sol.* Common ascending to  
 summit.  
 " *lautus*, *Forst.* Sea-coast.  
 \* " *odoratus*, *Hornemann.* Tologa Bay.  
 " *kirkii*, *Hook. f.* Hikurangi.  
 " *perdicioides*, *Hook. f.* Hicks Bay.  
 " *elæagnifolius*, *Hook. f.* Hikurangi.  
 " *bidwillii*, *Hook. f.* Hikurangi.  
*Sonchus oleraceus*, *L.* From sea-level to summit.

## STYLIDEE.

- \**Forstera tenella*, *Hook. f.* Hikurangi.  
 \**Phyllachne colensoi*, *Hook. f.* Summit of mountain.

## CAMPANULACEÆ.

- Selliera radicans*, *Cav.* Sea-shore and hot springs.  
*Pratia angulata*, *Hook. f.* Sea-level to summit.  
*Lobelia anceps*, *Thunb.* Sea-shore.  
*Wahlenbergia gracilis*, *A. Rich.* Lowlands.

## ERICEE.

- Gaultheria antipoda*, *Forst.* Sea-coast to 4,000 ft.  
 \* " *rupestris*, *Br.* Summit of mountain.  
*Cyathodes acerosa*, *R. Br.* Dry hills.  
 \* " *empetrifolia*, *Hook. f.* Hikurangi.  
 \**Pentachondra pumila*, *Br.* Summit of mountain.  
*Leucopogon fraseri*, *A. Cunn.* Dry hills.  
 " *fasciculatum*, *A. Rich.* Dry hills.  
*Dracophyllum latifolium*, *A. Cunn.* Hikurangi.  
 \* " *traversii*, *Hook. f.* Hikurangi.  
 " *longifolium*, *R. Br.* Kawakawa.  
 " *urvilleanum*, *var. scoparium*, *A. Rich.* Sum-  
 mit of mountain.

PRIMULACEÆ.

*Samolus repens*, *Pers.* Sea-coast and hot springs.

MYRSINEÆ.

*Myrsine salicina*, *Heward.* Maraehara.

" *urvillei*, *A. DC.* River-banks.

\* " *divaricata*, *A. Cunn.* Hikurangi.

JASMINEÆ.

*Olea cunninghamii*, *Hook. f.* Waipiro.

" *lanceolata*, *Hook. f.* Hikurangi.

" *montana*, *Hook. f.* Maraehara.

APOCYNÆÆ.

*Parsonsia albiflora*, *Raoul.* Hicks Bay.

" *rosea*, *Raoul.* Puhunga.

LOGANIACEÆ.

*Geniostoma ligustrifolia*, *A. Cunn.* Hikurangi.

GENTIANÆÆ.

*Gentiana bellidifolia*, *Hook.* Hikurangi.

BORAGINEÆ.

\* *Myosotis antarctica*, *Hook. f.* Summit of mountain.

\* " *saxosa*, *Hook. f.* Summit of mountain.

CONVOLVULACEÆ.

*Calystegia sepium*, *L.* Mata.

" *tuguriorum*, *Forst.* Hicks Bay.

" *soldanella*, *L.* Sea-shore.

*Dichondra repens*, *Forst.* Waipiro.

SOLANÆÆ.

*Solanum aviculare*, *Forst.* Kawakawa.

" *nigrum*, *L.* Kawakawa.

SCROPHULARINEÆ.

*Calceolaria sinclairii*, *Hook.* River-banks to Hikurangi.

*Gratiola peruviana*, *A. Cunn.* Marshy ground.

\* *Limosella aquatica*, *L.* Kawakawa.

*Veronica salicifolia*, *Forst.* Common.

" *parviflora*, *Vahl.* Kawakawa.

\* " *lævis*, *Benth.* Summit of Hikurangi.

" *tetragona*, *Hook.* Summit of Hikurangi.

" *lyallii*, *Hook. f.* Hikurangi.

*Ourisia macrophylla*, *Hook.* River-banks to summit.

\* " *cæspitosa*, *Hook. f.* Summit.

*Euphrasia cuneata*, *Forst.* Hikurangi, Tawhiti, Tologa.

## VERBENACEÆ.

- Myoporum lætum*, *Forst.* Hicks Bay and near the sea.  
*Vitex littoralis*, *A. Cunn.* Hicks Bay.

## LABIATÆ.

- Mentha cunninghamii*, *Benth.* Awatere, Mata.

## PLANTAGINEÆ.

- Plantago spathulata*, *Hook. f.* Summit of Hikurangi.  
 " *raoulii*, *Dec.* Common.

## CHENOPODIACEÆ.

- Chenopodium glaucum*, *L.* Waipiro Springs.  
 \**Salsola australis*, *Forst.* Waipiro Bay.

## POLYGONEÆ.

- Polygonum aviculare*, *L.* Not rare.  
 " *minus*, *Huds.* Wet grounds.  
*Rumex flexuosus*, *Forst.* Waipiro.  
*Muhlenbeckia adpressa*, *Lab.* Common.  
 " *complexa*, *Meisn.* Hicks Bay.

## PIPERACEÆ.

- Piper excelsum*, *Forst.* Hicks Bay, Mokoiwi.  
*Peperomia urvilleanum*, *A. Rich.* Hicks Bay.

## LAURINEÆ.

- Laurelia novæ-zealandiæ*, *A. Cunn.* Not rare.  
*Hedycarya dentata*, *Forst.* Common on low lands.  
*Beilschmeidia tawa*, *Benth. and Hook. f.* Common.

## PROTEACEÆ.

- Knightia excelsa*, *R. Br.* Hicks Bay.

## THYMELEÆ.

- Pimelea longifolia*, *Banks and Sol.* Awatere River.  
 " *buxifolia*, *Hook. f.* Hikurangi.  
 " *arenaria*, *A. Cunn.* Sea-coast.  
 \* " *prostrata*, *Vahl.* Hicks Bay to summit of Hikurangi.  
 \**Drapetes dieffenbachii*, *Hook.* Summit.

## LORANTHACEÆ.

- Loranthus colensoi*, *Hook. f.* Base of Hikurangi.  
*Tupeia antarctica*, *Cham. and Schl.* Mokoiwi.



EUPHORBIACEÆ.

*Euphorbia glauca*, *Forst.* Kawakawa.

URTICEÆ.

*Paratrophis microphyllus*, *Blume.* Waipiro, Tologa, Cook's Cave.

*Urtica incisa*, *Poiret.* Spurs of Hikurangi.

CUPULIFERÆ.

*Fagus menziesii*, *Hook. f.* Spurs of Hikurangi.

" *fusca*, *Hook. f.* Spurs of Hikurangi.

" *cliffortioides*, *Hook. f.* Spurs of Hikurangi.

CONIFERÆ.

*Libocedrus bidwillii*, *Hook. f.* Spurs of Hikurangi.

\**Phyllocladus glauca*, *Carr.* Spurs of Hikurangi.

" *trichomanoides*, *Don.* Puhunga.

" *alpina*, *Hook. f.* Sides and summit of Hikurangi.

*Dacrydium cupressinum*, *Sol.* Hicks Bay.

" *bidwillii*, *Hook. f.* Summit of Hikurangi.

*Podocarpus nivalis*, *Hook. f.* Summit of Hikurangi.

" *totara*, *A. Cunn.* River-sides, Hikurangi.

" *ferruginea*, *Don.* Common.

" *spicata*, *R. Br.* Not rare.

" *dacrydioides*, *A. Rich.* Maraehara.

\* " *hallii*, *Kirk.* Spurs of Hikurangi.

ORCHIDEEÆ.

*Earina autumnalis*, *Hook. f.* Common.

" *mucronata*, *Lindl.* Mokoivi.

*Dendrobium cunninghamii*, *Lindl.* Maraehara.

\**Gastrodia sesamoides*, *Br.* Awatere River.

*Acianthus sinclairii*, *Hook. f.* Puhunga.

\**Cyrtostylis oblonga*, *Hook. f.* Puhunga.

*Corysanthes triloba*, *Hook. f.* Puhunga.

\* " *rotundifolia*, *Hook. f.* Awatere River.

\* " *macrantha*, *Hook. f.* Hikurangi.

*Microtis porrifolia*, *Spreng.* Puhunga.

*Pterostylis banksii*, *R. Br.* River-banks to summit.

" *trullifolia*, *Hook. f.* Mata River.

*Thelymitra longifolia*, *Forst.* River-banks to summit.

\**Prasophyllum nudum*, *Hook. f.* Summit.

\**Orthoceras solandri*, *Lindl.* Puhunga.

IRIDEÆ.

*Libertia ixioides*, *Spreng.* Hicks Bay.

" *micantha*, *A. Cunn.* Hikurangi.

## PANDANEÆ.

*Freycinetia banksii*, *A. Cunn.* River-banks.

## TYPHACEÆ.

*Typha angustifolia*, *L.* Awatere River.

## NAIADEÆ.

*Lemna minor*, *L.* Manutahi Swamp.

*Potamogeton cheesemanii*, *A. Benn.* Awatere River.

\**Ruppia maritima*, *Linn.* Waipiro Springs.

## LILIACEÆ.

*Rhipogonum scandens*, *Forst.* Common.

\**Callixene parviflora*, *Hook. f.* Hikurangi.

*Cordylina australis*, *Hook. f.* Common.

" *banksii*, *Hook. f.* Awatere River.

" *indivisa*, *Kunth.* Hikurangi, near summit.

*Dianella intermedia*, *Endl.* Hicks Bay.

*Astelia cunninghamii*, *Hook. f.* Not uncommon.

\* " *solandri*, *A. Cunn.* Common.

\* " *banksii*, *A. Cunn.* Hicks Bay.

\* " *trinervia*, *Kirk.* Hikurangi.

*Arthropodium cirrhatum*, *Br.* Hicks Bay.

" *candidum*, *Raoul.* Puhunga.

*Phormium tenax*, *Forst.* Maraehara; not common.

" *colensoi*, *Hook. f.* Common.

## PALMEÆ.

*Areca sapida*, *Sol.* Hicks Bay.

## JUNCEÆ.

*Juncus maritimus*, *Lam.* Coast.

" *communis*, *E. Meyer.* Common.

" *planifolius*, *R. Br.* Swampy ground.

" *bufonius*, *L.* Not uncommon.

\* " *novæ-zealandiæ*, *Hook. f.* Awatere River.

\* " *tenuis*, *Willd.* Maraehara.

\* " *cæspiticius*, *Br.* Kawakawa.

*Luzula campestris*, *var. picta*, *DC.* Awatere River.

\* " *oldfieldii*, *Hook. f.* Summit of Hikurangi.

## RESTIACEÆ.

*Leptocarpus simplex*, *A. Rich.* Hicks Bay, Tologa Bay.

## CYPERACEÆ.

*Cyperus ustulatus*, *A. Rich.* Common.

*Eleocharis acuta*, *R. Br.* Common.

" *multicaulis*, *Smith.* Waiapu River.

- Scirpus nodosus*, *Rottb.* Common near the sea.  
 \* " *inundatus*, *Poir.* Not uncommon.  
 \* " *riparius*, *Br.* Seaside, Waipiro Springs.  
 " *pungens*, *Vahl.* Tologa Bay.  
 " *maritimus*, *L.* Hicks Bay, Waipiro Springs.  
 " *lacustris*, *L.* Tologa, Waiapu River.  
*Desmoschœnus spiralis*, *Hook. f.* Hicks Bay, Kawakawa.  
 \* *Schœnus pauciflorus*, *Hook. f.* Summit of mountain.  
 \* *Carpha alpina*, *Br.* Summit of mountain.  
 \* *Cladium teretifolium*, *Br.* Hicks Bay.  
 \* " *junceum*, *Hook. f.* Not common.  
 " *sinclairii*, *Hook. f.* Awatere River.  
*Gahnia hectori*, *Kirk.* Not rare.  
 " *lacera*, *Steudel.* Summit of Hikurangi.  
 \* " *setifolia*, *Hook. f.* Maraehara.  
 \* *Uncinia compacta*, *Br., var. divaricata*, *Boott.* Summit of mountain.  
 " *australis*, *Persoon.* Common.  
 \* " *banksii*, *Boott.* Hikurangi.  
 \* *Carex acicularis*, *Boott.* Summit of mountain.  
 \* " *inversa*, *Br.* Lowlands.  
 \* " *paniculata*, *Linn.* Common.  
 " *ternaria* (two forms), *Forst.* Common.  
 " *lucida*, *Boott.* Not uncommon.  
 \* " *dipsacea*, *Bergg.* Waiapu River.  
 " *pumila*, *Thunb.* Seaside, in sand.  
 " *forsteri*, *Wahl.* Mokoivi River.  
 \* " *neesiana*, *Endl.* Common.  
 " *dissita*, *Sol.* Not rare.  
 " *lambertiana*, *Boott.* Near Tologa.  
 \* " *vacillans*, *Sol.* Maraehara; rare.  
 " *comans*, *Bergg.* Maraehara.

## GRAMINEÆ.

- Microlæna stipoides*, *R. Br.* Common.  
 " *avenacea*, *Hook. f.* Base of Hikurangi.  
*Hierochloë redolens*, *R. Br.* Mata River; summit.  
 \* " *alpina*, *Rœm. and Schul.* Summit of mountain.  
*Spinifex hirsutus*, *Labill.* Sea-shore.  
*Oplismenus setaceus*, *Beauv.* Rare; in lowland bush.  
 \* *Isachne australis*, *Br.* Manutahi Swamp.  
*Zoysia pungens*, *Willd.* Common near the sea.  
*Echinopogon ovatus*, *Sol.* Common.  
*Dichelachne crinita*, *Hook. f.* Common.  
*Sporobolus indicus*, *R. Br.* Rare; Kawakawa, Hicks Bay.  
 \* *Agrostis dyeri*, *Petrie.* Summit of mountain.  
*Deyeuxia forsteri*, *Kunth.* Hikurangi; common.  
 " *billardieri*, *Kunth.* Kawakawa.

- \**Deyeuxia setifolia*, *Hook. f.* Summit; abundant.  
 " *quadriseta*, *Br.* Puhunga.  
*Arundo conspicua*, *Forst.* Common.  
   *var. fulvida*, *Buch.* Not rare.  
*Danthonia* " *cunninghamii*, *Hook. f.*; very like *D. bromoides*.  
   Ordinary form on Hikurangi.  
 \* " *raoulii*, *Steud.* Summit.  
 \* " *pilosa*, *Br.* Puhunga.  
 " *semiannularis*, *R. Br.* Kawakawa.  
 \* " " *var. alpina.* Hikurangi.  
*Trisetum antarcticum*, *Trin.* Spurs of Hikurangi; a curious series of forms found here.  
 \* " *subspicatum*, *Palisot.* Summit of mountain.  
 \* " *youngii*, *Hook. f.* Summit of mountain.  
 \**Eragrostis imbecilla*, *Forst.* Hiruhama, Hikurangi.  
*Poa anceps*, *Forst.* Kawakawa, Hikurangi.  
 \* " *australis*, *Br.* Hicks Bay.  
 \* " *colensoi*, *Hook. f.* Summit of mountain.  
 \* " *pusilla*, *n.s. Bergg.* Matahia, Waiapu River.  
*Schedonorus littoralis*, *Palisot.* Coast.  
 \**Festuca duriuscula*, *L.*  
*Triticum multiflorum*, *Banks and Sol.* Up to 3,000 ft.; rare.  
 \* " *scabrum*, *Br.* Up to 3,000 ft.  
 \**Gymnostichum gracile*, *Hook. f.* Open bush.

## FILICES.

- Cyathea medullaris*, *Swartz.* Hicks Bay.  
 " *dealbata*, *Swartz.* Hicks Bay.  
*Dicksonia squarrosa*, *Swartz.* Kawakawa, Hikurangi.  
*Hymenophyllum polyanthos*, *Swartz.* Hikurangi.  
 \* " *villosum*, *Col.* Summit of mountain.  
 " *demissum*, *Swartz.* Awatere, Hikurangi.  
 " *tunbridgense*, *Sm.* Hikurangi.  
 " *bivalve*, *Swartz.* Hikurangi.  
*Trichomanes reniforme*, *Forst.* Puhunga.  
*Adiantum affine*, *Willd.* Hicks Bay, Awatere.  
*Hypolepis distans*, *Hook.* Hicks Bay.  
*Pellaea rotundifolia*, *Hook.* Hiruhama.  
*Pteris tremula*, *R. Br.* Awatere.  
 " *aquilina*, *L.* Common.  
 " *scaberula*, *A. Rich.* Hicks Bay.  
 " *macilenta*, *A. Rich.* Hicks Bay.  
 " *incisa*, *Thunb.* Maraehara.  
*Lomaria discolor*, *Willd.* Hikurangi.  
 " *lanceolata*, *Spreng.* Hiruhama.  
 " *alpina*, *Spreng.* Summit of mountain.  
 " *procera*, *Spreng.* Mata, Hikurangi.  
 " *fluviatilis*, *Spreng.* Hikurangi.

- Lomaria membranacea*, Col. Taitai.  
*Asplenium obtusatum*, Forst. Hiruhama.  
 " *falcatum*, Laun. Mokoivi.  
 " *bulbiferum*, Forst. Awatere, Hikurangi.  
 " *flaccidum*, Forst. Hikurangi.  
*Aspidium richardi*, Hook. Awatere, Hikurangi.  
 \* " *cystostegia*, Hook. Summit of mountain.  
*Nephrodium decompositum*, R. Br. Mata River.  
 " *glabellum*, A. Cunn. Hicks Bay.  
 " *velutinum*, Hook. f. Mata River.  
 " *hispidum*, Hook. Manutahi Swamp.  
*Polypodium australe*, Mettenius. Hikurangi.  
 \* " *crassum*, T. Kirk. Summit of mountain.  
 " *tenellum*, Forst. Awatere River.  
 " *serpens*, Forst. Hikurangi.  
 " *rugulosum*, Lab. Hikurangi.  
 " *pustulatum*, Forst. Hicks Bay.  
 " *billardieri*, Br. Mata, Hikurangi.  
*Todea hymenophylloides*, Rich. Mata, Hikurangi.  
 \* *Lycopodium selago*, L. Summit.  
 " *varium*, Br. Hiruhama.  
 " *densum*, Labill. Taitai.  
 \* " *cernuum*, L. Hiruhama.  
 " *magellanicum*. Summit of mountain.  
 " *volubile*. Hiruhama.

## MARSILEACEÆ.

- Azolla rubra*, R. Br. Awatere River.

---

 ART. XLVIII.—Description of a New Native Species of Coprosma.

By D. PETRIE, M.A., F.L.S.

[Read before the Auckland Institute, 2nd August, 1897.]

**Coprosma banksii**, sp. nov.

A compact much-branched shrub, 10 ft. high or less. Bark of young twigs yellowish or brownish-grey, marked by two broad velvety bands of short stiff rusty-red hairs, decurrent from the stipules. Leaves in opposite pairs, sometimes crowded by the slight growth of the internodes, shortly petiolate, linear, bluntly obtuse and frequently retuse, rather coriaceous,  $\frac{1}{2}$  in. to 1 in. long,  $\frac{1}{16}$  in. to  $\frac{1}{12}$  in. broad, usually slightly re-

curved at the margin; midrib evident, veinless. The leaves of younger shoots are broader, less obtuse, usually slightly ciliate at the tip, and somewhat lozenge-shaped. Stipules broadly subulate, grey or brown, nearly glabrous. Flowers not seen. Drupe terminal, pendulous, oblong, dark-red,  $\frac{1}{2}$  in. long, springing from an involucre bearing two conspicuous subspathulate bracts.

*Hab.* Ruahine Mountains, 3,500 ft.; February, 1889. Mount Hikurangi (East Coast), 3,000 ft.—4,000 ft.; January, 1897.

The foliage is very variable, young vigorous shoots having much longer, wider, less obtuse, and somewhat lozenge-shaped leaves. In old branches the nodes are crowded, the bark is often cracked and broken, and the glabrous bands of the bark are much less prominent. The twigs, moreover, are very commonly covered by a dark-brown growth of fungus that obscures their natural colour. The species appears to be intermediate between *C. propinqua*, A. Cunn., and *C. colensoi*, Hook. f., and I think it probable that Sir Joseph Hooker has confounded it with the latter. This would account for our being unable to find plants that satisfactorily match the description of *C. colensoi* as given in the Handbook. In shape and size the drupes resemble those of *C. rubra*, mihi, and in colour they match those of *C. rhamnoides*, A. Cunn. The broad bands of rusty-red pubescence recall those occurring in *C. retusa*, mihi, but they are of a different colour.

---

ART. XLIX.—*On Curious Forms of New Zealand Fern.*

By H. C. FIELD.

[Read before the Wellington Philosophical Society, 4th August, 1897.]

MR. F. LAURENSEN, of Wellington, has lately sent me several specimens of ferns to identify, and they seem to me worth noting, for the assistance of other collectors. The first is a frond about 9 in. long, with pinnæ almost circular and rather more than 1 in. in diameter. The upper and terminal pinnæ have entire edges, but the lower ones are slightly indented into rounded lobes. The bluish-green colour and long straight sori mark it as a form of *Asplenium obtusatum*, while the slight indentations of the lower pinnæ indicate it as passing into var. *lyallii*. It was found growing in a cleft among the rocks at Worsler Bay.

Three others are forms of *Asplenium flaccidum* or *As-*

*plenium richardi*, ferns which always seem to me to be the same plant merely changed in its habit, according as it grows pendent on a tree-trunk or erect in rocky soil. The specimens sent me by Mr. Laurenson, however, are very much broader in their pinnae than any which I ever saw before, being in one case fully 1 in. wide, and actually overlapping each other considerably. They were gathered at unspecified places near Wellington.

Another is clearly *Aspidium capense*, but the frond, which is about 10 in. long, is long-lanceolate in form, instead of the usual deltoid or rhomboidal one.

Mr. Laurenson also informs me that he has gathered *Asplenium lyallii* at Evans Bay, where I and the Rev. A. Stock and Mr. F. Logan obtained it many years ago, showing that it still holds its ground there. He also mentions having found the proliferous form of *Asplenium flaccidum* near Otai-hanga, which occurs also at Waitotara, and which clearly connects *A. flaccidum* with *A. bulbiferum*.

---

ART. L.—On the Freezing of New Zealand Alpine Plants :  
Notes of an Experiment conducted in the Freezing-chamber,  
Lyttelton.

By L. COCKAYNE.

[Read before the Philosophical Institute of Canterbury, 3rd November,  
1897.]

TOWARDS the close of last year (1896) Dr. Pairman, of Lyttelton, most kindly undertook to procure for me the use of the Lyttelton Harbour Board's freezing-chamber, so that I might make some investigations into the effect of more or less continuous cold upon New Zealand alpine plants, and so, in the first place, add possibly some facts of importance to our scanty knowledge of the physiology of New Zealand alpiners, and, in the second place, furnish some information which might be of commercial value.

With regard to this latter I may quote one instance: It is customary in Europe generally, and to a very large extent in Great Britain, to cultivate certain bulbous plants in spring for the sake of their flowers, such plants after flowering being usually destroyed. This has led to an enormous industry in Holland, Southern France, and Italy, also to one of very considerable extent in California and Japan. In New Zealand a similar trade could be developed with regard to our splendid flowering-plant *Ranunculus lyallii*, Hook. f. Rhizomes of this

collected in its native habitat in September would be in perfect condition for yielding large masses of bloom. Such dormant rhizomes landed in England in December should flower as well as in their native land, and as the demand for such a unique spring flower would be very great a new industry would be established in this country. And so with many others of our alpine plants now by ordinary methods most difficult to export in good condition.

Both the New Zealand Agricultural Department and the Lyttelton Harbour Board readily granted Dr. Pairman's request, and the Secretary of the first-mentioned department was pleased to write, "The Government Biologist is of opinion that such experiments will be most interesting, and may have results of great economic value." Unfortunately, I was not in a position to commence operations before the 10th December, since nearly all the alpine plants I had ready for the experiment being in a greenhouse, it was necessary to harden them off. On the 10th December the following plants were put in a cool-chamber adjacent to the one used for freezing dairy produce. (This chamber is kept at a low temperature by that freezing process known as the "Linde process," and which consists in forcing a stream of brine, cooled by the evaporation of ammonia, through a number of pipes passing along the ceiling of the chambers):—

No.	Name of Plant.	Where collected.	Altitude.
1	* <i>Podocarpus nivalis</i> , <i>Hook. f.</i> ..	Craigieburn Mountains	900 m.
2, 3	† <i>Fagus cliffortioides</i> , <i>Hook. f.</i> ..	Castle Hill .. ..	720 m.
4	† <i>Raoulia tenuicaulis</i> , <i>Hook. f.</i> ..	Mount Grey Downs ..	240 m.
5	‡ <i>Luzula pumila</i> , <i>Hook. f.</i> ..	Craigieburn Mountains	1,800 m.
6	‡ <i>Cotula atrata</i> , <i>Hook. f.</i> ..	"	1,500 m.
7, 8	* <i>Helichrysum grandiceps</i> , <i>Hook. f.</i>	"	1,050 m.
9	* <i>Ranunculus ensyii</i> , <i>T. Kirk</i> ..	Big Ben Range ..	900 m.
10	‡ <i>Celmisia bellidioides</i> , <i>Hook. f.</i> ..	Craigieburn Mountains	900 m.
11	‡ " <i>laricifolia</i> , <i>Hook. f.</i> ..	"	1,200 m.
12	* " <i>spectabilis</i> , <i>Hook. f.</i> ..	"	1,050 m.
13	* <i>Senecio elaeagnifolius</i> , <i>Hook. f.</i>	Kelly's Hill, Westland	900 m.
14	† <i>Epilobium crassum</i> , <i>Hook. f.</i> ..	Mount Torlesse ..	1,200 m.
15	† <i>Fagus solandri</i> , <i>Hook. f.</i> ..	Otarama .. ..	450 m.
16	‡ <i>Coprosma propinqua</i> , <i>A. Cunn.</i>	Otira Valley ..	336 m.

These plants were all in pots, plunged in earth in a shallow box, and, regarding moisture, rather dry than otherwise. They were removed from the cool-chamber (temperature, 4·44° C.) to the freezing-chamber (temperature, - 1·1° C.) on the 12th December. Here they were kept till the 18th De-

\* Plants with very little young growth.

† Plants with considerable young growth.

‡ Plants with medium young growth.



ember, when they were transferred to the cool-chamber (temperature, 5° C.), and allowed to thaw gradually. Upon examination I found that all were dead, or nearly so. *H. grandiceps* and *L. pumila* alone doubtfully showed signs of life.

The following table shows the amount of cold the plants had been exposed to (temperature taken from log-book of the engineer to the Harbour Board):—

			Morning Temperature.	Evening Temperature.
December 12	..	..	-1.1° C.	-5.5° C.
" 13	..	..	-1.6° C.	-6.6° C.
" 14	..	..	-4.4° C.	-5.5° C.
" 15	..	..	-3.8° C.	-5.5° C.
" 16	..	..	-3.8° C.	-4.4° C.
" 17	..	..	-2.7° C.	-5.5° C.
" 18	..	..	-2.22° C.	..

Owing to the abnormal condition in which these plants were at the time of their exposure to the cold their death in nearly every instance was only what could be expected; so, considering the experiment so far as it had gone of little moment, I proceeded, in company with Mr. R. Brown, to Mount Torlesse, the nearest point at which alpine plants could be easily procured, hoping to collect some at a high altitude in a dormant condition, or, at any rate, in a much more suitable condition for the experiment than those first used, although the season was rather too far advanced. The weather proved adverse, and we only reached an altitude of 1,250 m., in a fog so dense as to make further progress out of the question. The spot reached, however, was eminently suitable for retarding growth, being exposed fully to all cold and cutting winds. The plants were cut out of the ground in blocks about 6 cm. deep and 11 cm. wide, each block containing several plants. This was done so that the plants in each block would not feel their removal. I shall refer to the objection to this mode of treatment at the end of the paper. The following is a list of the plants in each block, with altitudes, &c. :—

No.	Name of Plant.	Situation, &c.	Altitude.
1	<i>Oxalis magellanica</i> , <i>Forst.</i>	.. Shady gully, facing south	1,160 m.
2	<i>Gaultheria antipoda</i> , <i>Forst.</i>	}	}
	<i>Ligusticum aromaticum</i> , <i>Banks and Sol.</i> (var. with very coriaceous leaves)		
3	<i>Ourisia cæspitosa</i> , <i>Hook. f.</i>	}	}
	<i>Geranium microphyllum</i> , <i>Hook. f.</i>		
	<i>Gaultheria antipoda</i> , <i>Forst.</i>		
	<i>Oxalis magellanica</i> , <i>Forst.</i>		

No.	Name of Plant.	Situation, &c.	Altitude.
4	<i>Pozoa hydrocotyloides</i> , <i>Hook. f.</i>	Shady gully, facing south	1,160 m.
5	<i>Ranunculus monroi</i> , <i>Hook. f.</i> , <i>var. sericeus</i> , <i>T. Kirk</i>	" "	"
6	<i>Pozoa hydrocotyloides</i> , <i>Hook. f.</i> <i>Brachycome sinclairii</i> , <i>Hook. f.</i>	Grassy slope, facing south-east	960 m.
7	<i>Pentachondra pumila</i> , <i>Br. ..</i>	Ditto .. ..	"
8	<i>Raoulia subsericea</i> , <i>Hook. f. ..</i>	" .. ..	"
9	<i>Pratia macrodon</i> , <i>Hook. f.</i> <i>Viola cunninghamii</i> , <i>Hook. f.</i> <i>Danthonia semiannularis</i> , <i>Br. )</i>	Shady gully, facing south	1,120 m.
10	<i>Euphrasia monroi</i> , <i>Hook. f.</i> <i>Danthonia semiannularis</i> , <i>Br. )</i> <i>Gaultheria antipoda</i> , <i>Forst.</i> <i>Epilobium confertifolium</i> , <i>Hook. f.</i> <i>Ourisia cespitosa</i> , <i>Hook. f.</i> <i>Ligusticum aromaticum</i> , <i>Banks and Sol.</i>	" "	"
11	<i>Dracophyllum prostratum</i> , <i>T. Kirk</i> <i>Drapetes dieffenbachii</i> , <i>Hook. f.</i> <i>Cotula pectinata</i> , <i>Hook. f.</i> <i>Poa, sp. .. ..</i>	Wind-swept plateau, exposed to south-west	1,250 m.
12	<i>Drapetes dieffenbachii</i> , <i>Hook. f.</i> <i>Ligusticum aromaticum</i> , <i>Banks and Sol.</i> <i>Gaultheria antipoda</i> , <i>Forst.</i> <i>Poa, sp. .. ..</i>	Ditto .. ..	"
13	<i>Ligusticum aromaticum</i> , <i>Banks and Sol.</i> <i>Gaultheria antipoda</i> , <i>Forst.</i> <i>Leucopogon frazeri</i> , <i>A. Cunn. )</i>	" .. ..	"
14	<i>Aciphylla monroi</i> , <i>Hook. f. ..</i>	" .. ..	"
15	<i>Raoulia eximia</i> , <i>Hook. f. ..</i>	Shingle-slip, facing south-west	1,090 m.

It will be seen that a great many well-known alpine plants are absent from this list, notably the following genera: *Celmisia*, *Veronica*, *Senecio*, and *Olearia*. The first named of these I was debarred from using, since the department pledged me to use no plant having a strong odour, and *Celmisia* is usually very aromatic; and the remaining genera, being mostly more or less tall shrubs, could not well be removed in small blocks of earth without being injured. The blocks of earth, with their contained plants, were plunged in soil in a shallow box and placed in the cool-chamber (temperature, 8·9° C.) on the 18th December. On the 21st December, at 2.55 p.m., the box was transferred to the freezing-chamber (temperature at the time, - 2·2° C.) and protected with a sheet of newspaper. Here the

plants were kept during the first period until the 24th December.

## TEMPERATURE OF FREEZING-CHAMBER DURING FIRST PERIOD.

			Morning Temperature.	Evening Temperature.
December 22	..	..	.. 0° C.	- 1.11° C.
" 23	..	..	.. 0° C.	0° C.
" 24	..	..	.. 0° C.	- 1.11° C.

Removed plants into cool-chamber (temperature, 4.4° C.) on the 24th December (temperature of freezing-chamber at time of removal, - 1.67° C.), and, after thawing, examined, and found all in a perfectly healthy condition. Removed the paper, and placed them in freezing-chamber for the second period.

## TEMPERATURE OF FREEZING-CHAMBER DURING SECOND PERIOD.

			Morning Temperature.	Evening Temperature.
December 25	..	..	0.55° C.	- 1.11° C.
" 26	..	..	1.11° C.	0° C.
" 27	..	..	1.11° C.	- 1.11° C.
" 28	..	..	0.55° C.	- 3.33° C.
" 29	..	..	1.11° C.	- 5.55° C.
" 30	..	..	- 1.11° C.	- 6.67° C.
" 31	..	..	- 1.11° C.	..

On the 31st December the box was removed from the freezing-chamber at 2.15 p.m. (the temperature at the time being - 5.55° C.) into the cool-chamber: temperature, 6.67° C. This temperature is 3.67° C. higher than that recorded by Sachs, which killed leaves of beet and cabbage frozen at from - 4° C. to - 6° C., and referred to in Vine's "Lectures on Physiology of Plants," 1886, pages 273, 274. I examined the plants at 5.45 p.m., at which time the soil was only partially thawed, but the leaves of the plants quite thawed. Delayed the detailed examination till next day, 1st January, at 7.45 p.m., when I found all in perfect health, excepting *Aciphylla monroi*, Hook. f. (slightly blackened at tip of leaf); *Euphrasia monroi*, Hook. f. (similarly blackened); *Oxalis magellanica*, Forst. (also a little blackened, but in less degree); and *Pozoa hydrocotyloides*, Hook. f. (one or two leaves slightly blackened). None had received any serious damage. It is worthy of note that the blooms on *Euphrasia monroi*, Hook. f., had developed partly during their stay in the freezing-chamber, and were quite unblackened; also, *Oxalis magellanica*, Forst., only in bud at the time of first putting into the freezing-chamber, was now fully expanded and unhurt. Replaced the box in the freezing-chamber for its third and final period.

## TEMPERATURE OF FREEZING-CHAMBER DURING THIRD PERIOD.

			Morning Temperature.	Evening Temperature.
January 2	..	..	- 1.11° C.	- 6.67° C.
" 3	..	..	- 1.67° C.	- 5.55° C.
" 4	..	..	- 1.11° C.	- 6.67° C.
" 5	..	..	0° C.	- 5.55° C.
" 6	..	..	- 1.11° C.	- 4.44° C.
" 7	..	..	0° C.	- 5.55° C.
" 8	..	..	- 1.67° C.	- 3.33° C.
" 9	..	..	- 3.33° C.	- 4.44° C.
" 10	..	..	- 2.78° C.	- 4.44° C.
" 11	..	..	- 3.33° C.	- 6.67° C.
" 12	..	..	- 2.22° C.	- 6.11° C.
" 13	..	..	- 3.33° C.	- 5.55° C.
" 14	..	..	- 2.22° C.	- 6.67° C.
" 15	..	..	- 2.22° C.	- 6.67° C.
" 16	..	..	- 3.33° C.	- 6.67° C.
" 17	..	..	- 4.44° C.	- 6.67° C.
" 18	..	..	- 4.44° C.	- 6.67° C.
" 19	..	..	- 4.44° C.	- 6.67° C.
" 20	..	..	- 2.22° C.	- 5.55° C.
" 21	..	..	0° C.	- 5.55° C.
" 22	..	..	0° C.	- 5.55° C.
" 23	..	..	- 0.55° C.	- 5.55° C.
" 24	..	..	- 1.11° C.	- 5.55° C.
" 25	..	..	- 1.67° C.	- 5.55° C.
" 26	..	..	- 1.11° C.	- 5.55° C.
" 27	..	..	- 1.11° C.	- 6.67° C.
" 28	..	..	- 1.67° C.	- 6.67° C.
" 29	..	..	- 1.11° C.	..

On the 29th January I removed the plants into the cool-chamber, and, after thawing them gradually, brought them to my garden at New Brighton. Next day I examined each block of soil, with the following result (the numbers of the blocks are as given before):—

No. 1. *Oxalis magellanica*; dead.

No. 2. *Gaultheria antipoda*; alive. *Ligusticum aromaticum*; alive.

No. 3. *Ourisia cæspitosa*; dead. *Geranium microphyllum*; dead. *Gaultheria antipoda*; very little damaged. *Oxalis magellanica*; dead.

No. 4. *Pozoa hydrocotyloides*; damaged, but alive in places.

No. 5. *Ranunculus monroi*, *var. sericeus*; dead. *Pozoa hydrocotyloides*; as above.

No. 6. *Brachycome sinclairii*; just showing trace of life.

No. 7. *Pentachondra pumila*; dead.

No. 8. *Raoulia subsericea*; dead.

No. 9. *Pratia macrodon*; dead. *Viola cunninghamii*; dead. *Danthonia semiannularis*; alive.

No. 10. *Euphrasia monroi*; dead. *Danthonia semiannularis*; alive. *Gaultheria antipoda*; alive, not much damaged.

*Epilobium confertifolium*; dead. *Ourisia cæspitosa*; dead. *Ligusticum aromaticum*; alive, somewhat damaged.

No. 11. *Drapetes dieffenbachii*; partially damaged, but not quite killed. *Dracophyllum prostratum*; very much damaged, but with trace of life. *Cotula pectinata*; dead. *Poa, sp.*; alive.

No. 12. *Drapetes dieffenbachii*; as before. *Ligusticum aromaticum*; alive and little damaged. *Gaultheria antipoda*; alive. *Poa, sp.*; alive.

No. 13. *Ligusticum aromaticum*; alive. *Gaultheria antipoda*; alive. *Leucopogon frazeri*; dead.

No. 14. *Aciphylla monroi*; much damaged, but not quite dead.

No. 15. *Raoulia eximia*; condition doubtful.

Of the plants showing faint signs of life, and even some of the others whose leaves and stems were quite vigorous, the roots were usually so much damaged that the plants could not be expected to survive even with the most careful after-treatment. As a matter of fact, I did not attempt to grow any of them, since it was the eve of my departure on a botanical excursion to the Otago lakes. This excessive damaging of the roots would not take place in a state of nature, but was the result of exposure, owing to the small size of the blocks of earth. Those parts of any plant protected by earth, or its own leaves or those of an adjacent plant, invariably suffered least from the cold. In some instances—for example, with *Raoulia eximia*—it was difficult to tell whether the plant was alive or not. I have not made any summary to show the average temperature the plants endured, since there is no self-registering thermometer in the chamber, and the mean between evening and morning temperature would not be reliable. It was during the third period that all the second batch of plants perished, and this seems to have been caused more by the greater length of this period than by any considerably lower temperature. Possibly had the plants been in a dormant condition the result of the experiment would have been very different; at any rate, the method of employing small blocks of earth with plants contained is a very bad one, but under the circumstances no other could be practised. The freezing-chamber also is completely dark, and so the plants were exposed to very different conditions to what they experience in nature.

A rather interesting fact noticed was that all the plants were damaged by the cold when in the freezing-chamber and not by the subsequent thawing process. This was ascertained by an examination of each plant previously to the thawing taking place, the black leaves and stems of those damaged being very evident.

Such an experiment as that described here is, at best, a very rough one, and could, of course, be much better conducted in a biological laboratory, where the exact conditions could be regulated. Still, a freezing-chamber offers an easy place for such experiments, and granted plants in the dormant condition, and so arranged that the portion of the plant underground would not get excessive freezing, valuable data as to the cold-resisting powers of our plants might be arrived at. My results are for the most part negative, but they may perhaps induce others to work in the same field, and to avoid the errors inseparable from a first experiment.

I cannot conclude without expressing how much indebted I am to Dr. Pairman for his invaluable assistance; to Mr. R. Brown, who accompanied me to Mount Torlesse and helped in the hard work; to Professor A. Dendy, for assistance regarding literature relating to freezing plants; to Mr. A. Milne, chief engineer of the Lyttelton Harbour Board, and his assistants, who gave every help in their power; and to the Department of Agriculture and the Lyttelton Harbour Board.

---

ART. LI.—Notes on the Wangapeka Valley, Nelson.

By R. I. KINGSLEY.

[Read before the Nelson Philosophical Society, 30th August, 1897.]

ON the 15th February, 1897, I was able to carry out a plan for visiting the interesting district forming the dividing-range between the Wangapeka and Karamea Rivers. My companions were Mr. W. H. Bryant and Mr. D. Grant. The first part of the journey to Chandler's was made in a buggy, the remainder on foot, with a pack-horse for our tents, &c. (with the exception of the Kiwi trip, in which Bryant and myself carried our baggage). Near Chandler's I found *Senecio hectori*, also *Veronica linifolia*, the latter in flower. The geological features have been frequently described; there is therefore no necessity for dwelling upon that subject now. The whole valley of the Wangapeka consists of a narrow gorge, with here and there a small river-flat. Apparently the bed of the river is auriferous nearly to its source.

One of the most conspicuous objects in passing up the valley is Mount Patriarch (5,500 ft.), a bold mountain with precipitous sides, very difficult (as we found afterwards) to ascend.

The second night we stopped at an empty hut at the junction of the south branch, fifteen miles from Chandler's. Near here we found good specimens of *Hymenophyllum pulcherrimum* and *rufescens*, *Panax lineare*, *Olearia excorticata*, and other more or less uncommon plants.

Continuing our journey the next morning, near the bridge were observed splendid specimens of *Rubus parvus* in fruit. This is a most striking plant, and little known. Both the leaf and fruit are very handsome; the flower I have not yet seen.

From the bridge to the saddle the track is steep. On the way several interesting plants were noticed, *Cordyline indivisa* being fairly plentiful. I fixed my camp in the red-birch on the saddle (3,300 ft.). From this point I despatched Mr. Bryant and the packer to a marl plateau at the head of the Mokihinui River, myself and Grant ascending Saddle Hill and Mount Nugget.

The timber is principally birch. Near the bush limit were fine specimens of *Usnea barbata* in fruit, whilst on the grass country above the bush we found a most beautiful display of sub-alpine flora, the *Veronica macrantha* and gentians being unusually luxuriant. *Fostera tenella* was also well in flower.

From the summit we obtained a view of a grand mountain, unsurveyed and unnamed, to the west of the Karamea River. On comparing notes with Mr. Bryant, I found the district visited by him had been found to surpass in its wealth of floral beauty that which I had visited: he described it as being one magnificent garden. Amongst other specimens he brought *Veronica cheesemanii* in flower, *Celmisia lateralis*, *laricifolia*, and *sessiliflora*, and fine specimens of *Helichrysum grandiceps*.

On the following morning a journey of several miles was made down the Karamea River, in which are some picturesque cascades. In a band of micaceous sandstone a number of fossils occur—*Naticidae*, &c.—and curious spherical balls of various sizes.

Other hill-tops in the vicinity were visited, and on the return journey Mr. Bryant and myself camped on the banks of the Kiwi Creek, from whence visits were made to Mount Luna and Mount Patriarch. On the former there is a lake, as well as several tarns, and many interesting botanical specimens—*Geum uniflorum* and others. On Mount Patriarch *Traversia baccharoides* was plentiful; also *Ozothamnus microphyllus*, *Veronica gilliesiana*, and other sub-alpine shrubs and plants.

Just below the summit I found the shells of a mollusc—*Flammulina thaisa*. From its position it is evident the animal must pass at least seven or eight months of its existence under the snow.

Our time was far too short to see much of the flora of the district, but the little I was able to see convinced me that a thorough inspection would well repay the trouble and expense of the journey, there being a great extent of country practically unvisited for botanical purposes. We found traces of seams of coal in the Kiwi just below the saddle leading into the Crow, and near Mount Nugget there is a seam of what appears to be good coal. I believe the men employed in forming the track used it for smith's work, and found it admirable.

I hope at no distant date to pay a further visit to the district, when I trust I may be more successful with the camera, several untoward circumstances preventing successful pictures on this my first trip.

---



#### IV.—GEOLOGY.

ART. LII.—Notes on a Specimen of *Euryapteryx* from Southland.

By A. HAMILTON.

[Read before the Otago Institute, 22nd November, 1897.]

IN the study of the extinct birds of New Zealand there has been, of necessity, a great deal of speculative reconstruction in the description and definition of the species proposed at the present time. Taking the species found in both Islands of New Zealand, there are at least thirty nominal species, and these have been in many cases reduced from others. In only a few cases have species been described from fairly complete individual skeletons. It is only under exceptional circumstances that individual skeletons are found with all, or nearly all, the bones together and not mixed with those of other species.

In all the great deposits, such as Glenmark, Hamilton, Enfield, and Kapua, in the South Island, and Te Aute, in the North Island, it has been possible to reconstruct specimens that in all probability fairly represent the species they are assigned to, especially since the publication of the researches of the late Professor T. J. Parker on the skulls, the paper of Captain Hutton on the axial skeleton, and the catalogue of the moa-bones in the British Museum by Mr. Lydekker.

It is, however, specimens like the Tiger Hill specimen of *Dinornis robustus*, now in the York Museum; the two skeletons of the same species in the Otago University Museum; the specimen of *D. maximus* recently found at Invercargill; and what is known as the Stevenson moa, from the Waitaki, that give definite fixed results which may be taken as standards for those species.

It is when we are dealing with individual specimens of this kind that we feel that we are on firm ground, and consequently it gave me great pleasure to disinter, with the help of some lady friends, an entire skeleton\* of *Euryapteryx ponderosa* (or *Emeus*, sp. a., of Lydekker, British Museum Catalogue), from

---

\* Wanting only a few small and unimportant bones.

the sandy piece of country known as the Riverton Beach, a few miles south of Invercargill, close to where No. 1 skeleton of *D. maximus* was found by Mr. C. A. Ewen in 1895.\* Only a portion of the pelvis was exposed, but by digging away the moist sand the majority of the bones were obtained, those missing being comparatively unimportant. The pelvis was slightly distorted by the pressure of the sand, having a slight twist to the right. The skull was in good condition; the upper maxilla was, however, separated from the calvarium, and one quadrate and the great part of the maxillo-jugal arch and the maxillo-palatines were destroyed in digging out the bones. Those on the lower side, being saturated with moisture, were easily damaged. The axis vertebra was with the skull, but was, unfortunately, lost in bringing the bones to Dunedin. There are also a few phalanges missing, and two ribs. The condition of the bones indicates that the specimen is that of a mature individual, and the general measurements of the bones and skull agree best with the described bones of *Euryapteryx ponderosa* of Captain Hutton's papers and the *Emeus*, sp. a, of the British Museum Catalogue (Lydekker). The feet were somewhat disarranged, but, as far as I could make out, there were only four phalanges in the outer toe, in this respect agreeing with individual feet from Shag Point. Only one foot was sufficiently perfect to give any satisfactory indication on this point. No other bones were found within a chain of the spot, but there were numerous crop-stones and tracheal rings.

The specimen has now been mounted, and is deposited in the Otago University Museum.

#### Measurements.

*Femur*.—Length, 12·25 in. = 312 mm.; width at distal extremity, 5·1 in. = 130 mm.; circumference at middle of shaft, 6·6 in. = 168 mm.

*Tibio-tarsus*.—Length, 20 in. = 510 mm.; distal width, 3½ in. = 90 mm.

*Tarso-metatarsal*.—Length, 8·5 in. = 220 mm.; width at middle, 2·1 in. = 55 mm.; across distal trochlear, 4·6 in. = 118 mm.

*Sternum*.—Width below costal border, 6 in. = 152 mm.; length of body of sternum, 8·25 in. = 210 mm.

*Pelvis*.—Greatest length, 20 in. = 510 mm.; greatest width, 10 in. = 255 mm.

---

\* Trans. N.Z. Inst., vol. xxviii., p. 651.

ART. LIII.—*Notes on the Recent Earthquake.*

By H. C. FIELD.

[*Read before the Wellington Philosophical Society, 22nd December, 1897.*]

THE frequency of earthquakes in New Zealand affords its inhabitants better opportunities for observing the particulars of these phenomena than fall to the lot of residents of most countries, and I think it well to place such particulars on record, for the guidance of those who seek to ascertain the origin and nature of seismic action. We have evidently several centres of such action in the colony. In the South Island there are certainly two—one of these being a few miles west of the Hanmer Plain, and the other about twenty miles south-west of Nelson. In the North Island there are no doubt several in the volcanic districts, and one apparently near Gisborne, as I have several times seen notices in the newspapers of shocks being experienced at that town which did not appear to have been felt at any distance from it; but none of these have apparently been located. The main centre of seismic action, however, seems unquestionably to be that fixed by Mr. Hogben as beneath Cook Strait, about half-way between Kapiti and D'Urville Island, from which the shocks felt at Wanganui and Wellington proceed. It seems strange, however, that on different occasions the force originating from this centre should operate in different directions, yet this is evidently the case. One would naturally suppose that at equal distances from the centre, and under corresponding conditions, the force would be equally felt; yet the shocks are sometimes more severe in Wellington, and sometimes in Wanganui.

Old whalers who settled on the shores of Cook Strait between the years 1820 and 1840, and some of whom were alive till within the last few years, spoke of having felt severe shocks from time to time, but seemed unable to give reliable information as to their direction, &c. We have better information, however, respecting the shocks which have occurred since the New Zealand Company's settlers came to this part of the colony.

The first shock of any consequence which they experienced occurred in 1841. It does not appear to have attracted much notice in Wellington, but was very severely felt in Wanganui. Several persons who were there at the time have assured me that they were not only thrown down,

but had to catch hold of the grass or fern to avoid being rolled about on the ground.

The next one, in October, 1848, was evidently far more severely felt at Wellington than at Wanganui, as it did much damage in the infant city, and caused many people to leave it; while in Wanganui no injury was sustained of any consequence, and but little notice was taken of it.

That of the 23rd January, 1855, though severely felt in Wanganui, was evidently far worse in Wellington and its neighbourhood; and the same has evidently been the case in at least two shocks which have lately occurred, and have injured brick buildings in Wellington, while at Wanganui they scarcely attracted notice. A shock which occurred about fifteen years ago did much damage at Wanganui and Foxton, but apparently little or none in Wellington.

That of Wednesday last (8th December) has been of the very opposite character, as its effects have chiefly been felt at Wanganui. I had been awake for a few minutes when, at about 2.40 a.m., I heard a low rumbling sound, such as might proceed from a doctor's gig coming up the road on its way to the house of a sick person, the direction being from the south-west as usual. Doubt as to its character, however, was immediately set at rest by the commencement of strong undulatory and oscillatory movements, which rapidly increased in intensity, and in about a minute were of extreme violence. As I built my house myself, and my experience of the earthquake of 1855 had shown me the necessity of buildings being well put together, I had no fear of a collapse, and therefore contented myself with sitting up in bed to note what occurred. When the vibrations had lasted about a minute, and seemed slackening, the house seemed to give a sudden tremendous lurch or plunge, as if falling over towards the north-west, followed immediately by a similar and almost equally violent plunge towards the north-east. By the first of these it is said that a heavy piano in a house on St. John's Hill was sent almost across a room, whilst the whole of the books on a neighbour's book-shelves were thrown on the floor. In my own house a heavy wooden bedstead, without castors, was shifted about a foot from the wall at its head, and a chest of drawers about 4 ft. high, in another room, was thrown on its face. Downstairs the books on the shelves were all displaced, the upper and smaller ones to the extent of fully 3 in., though none were thrown down; articles of furniture were slightly moved, the piano being shifted a hand's breadth from the wall; and, of course, flower-vases and similar articles were thrown down or broken. Similar, though slighter, lurches to south-east and south-west followed at intervals of about a second, it seeming evident that this

gyratory action arose from the earth settling down again to its normal level after being upheaved by the undulatory motion. After this the motion became extremely irregular, being a compound of gyratory and oscillatory as it died away. Nearly the whole of the chimneys in the houses around were thrown down, or so damaged that they will have to be rebuilt, though my own fortunately remained uninjured. It is estimated that at least a thousand chimneys in the town and suburbs will have to be rebuilt, and I think this is an underestimate rather than otherwise, while, of course, those similarly damaged in the country around will greatly increase the number. Those chimneys which were not thrown down are mostly broken horizontally, their upper portions being twisted round, in some cases at right angles to their original position. A brick wall, 80 ft. long by 10 ft. high, bonded with hoop-iron, which forms the north-east side of the Fruit-evaporating Works, is split horizontally from end to end about half-way up, the lower portion being forced outwards 2 in. or 3 in., while the upper portion inclines inwards to about the same extent. The end wall of the same building facing north-west was thrown bodily outwards and shattered to pieces, while the arch of the long evaporating-oven collapsed, the bricks falling on the travelling table beneath. Houses on brick or concrete foundations seem to be generally slightly shifted and twisted aside, and in some cases the foundations themselves are injured. Much glass was broken in windows of shops and houses, and this not by articles falling against it, but by the motion and straining of the buildings. The gyratory lurches evidently caused this, as the broken windows face in all directions. The town water-mains are also evidently broken, though only one small break has yet been located. Of course, the damage to goods in the stores has been very great.

In a former paper, describing the earthquake of 1855, I mentioned that the whole foreshore of the river in front of the business portion of the town, from the quay roadway to low-water mark, appeared next morning like an ill-ploughed field, cracks having opened at distances of 1 ft. or 18 in. asunder, and the whole foreshore having evidently slipped outwards towards the deeper water. The whole of this foreshore, for about half a mile in length, has since been reclaimed, in the same manner as that at Wellington, and a wharf constructed along more than half this length, from the town bridge downwards; yet, notwithstanding this, it is evident that a similar outward slipping has occurred beneath the reclamation, which, when daylight appeared on Wednesday morning, was found to consist of a series of undulations, the difference of level between the highest and lowest points being estimated to amount to as much as 3 ft.; in fact, the appearance of the rails was de-

scribed as being like a switchback railway. The rails were also shifted laterally, in some parts to the extent of 2 ft. or more, and some of the fish-plates connecting them were broken. At its lower end, near the cattle wharf, the reclamation had subsided fully 18 in., while numerous cracks, one of them about 15 chains long by 5 in. or 6 in. wide, opposite the railway-station and Customhouse, had been opened. The wharf and stone facing of the reclamation had also evidently been forced outwards. On the roads in the vicinity of Wanganui a great many cracks have been formed, and in some places the outer portion of a side-cutting has slipped away, while in others water springs have broken out where roads ran along flats in valleys.

The whole of this damage was done by the one shock, the violent part of which only lasted about two minutes, though slight tremors continued for several minutes afterwards.

No further shocks, or, at all events, not more than one very slight one, have since occurred; while in 1855 there were an immense number of such shocks, extending over many weeks.

The nurses at the Hospital and others say that a vivid flash of lightning immediately preceded the shock, and the same is also stated in a letter since received from Feilding.

One point which appears worthy of notice is the difference in the intensity of the shock in different places, this depending evidently on the nature of the soil. On clay soils the buildings are much damaged, the chimneys being everywhere ruined, and in many cases having fallen through the roof; and the same has happened on the low ground near the river, while houses standing on the sand-ridges have sustained no damage whatever. This evidently arises from the difficulty of transmitting a force through sand. The new hospital, a large brick building on a sandy formation, had only the plaster cracked in a few places and a small piece shaken down. Where the soil consisted of old swamp, which is now greatly reduced in thickness, and rests on a clay subsoil, the damage to buildings is nearly as great as on the clay hills. The pumice-sand formation, which forms the upper stratum in the Wanganui Valley, to a depth of about 10 ft., is of so coherent a nature that a face of it will stand when not only vertical, but even overhanging considerably. Thus vibrations are transmitted through it almost as well as through hard clay, as is evident when vehicles pass along the road, causing tremors to a considerable distance. Thus the houses all up the river-side were much damaged, and much injury is done to the contents.

I have thought these particulars worth notice, as the difference in the intensity of the shock being dependent upon

the nature of the geological formation has not, I think, been much noticed, and may tend to explain why earthquakes appear to be so differently felt along different points on the same line.

The water in the river continued to rise and fall several inches for some time after the shock, indicating that a number of considerable waves must have come ashore on the coast.

#### FURTHER NOTES.

I learn that at the meeting of the Philosophical Society at which the subject of the earthquake was discussed Sir James Hector said the shock came to Wellington from south of east, and that if it came from south of west at Wanganui either it must have changed its direction between the two places, or else that the severe shake felt at Wanganui must have been a second one, started by that felt in Wellington. The shock which reached Wanganui most certainly came from the south-west, and the waves of it seemed to travel north-eastward at the rate of about three per second. I could be under no mistake about this, because I was sitting up with my face towards the north-west when the waves were passing, and they certainly came from my left side. The alteration in the reclaimed land proves the same thing.

The Wanganui River, in front of that portion of the town, flows very nearly from north-north-east to south-south-west, and the reclamation extends along it for rather more than half a mile. For about two-thirds of this distance there are four lines of rail laid longitudinally along it, and it was these which, when daylight came, presented the appearance of a switchback railway, owing to the surface of the ground having been transformed into a succession of waves, lying transversely to the rails. As I am, unfortunately, at present almost totally blind with cataract I was unable to examine the place for myself, so as to ascertain the length and height of the waves, and their exact direction in reference to the rails, which would have enabled me to fix by compass the exact bearing of the point from which the shock came. All that I could ascertain was that there were certainly three or four of these waves in a distance of about 28 chains, and that their height was estimated at about 3 ft., which I think may have been an exaggeration. No one, in fact, who saw them at an early hour seemed to have taken any careful note of these particulars, and, as the railway authorities at once set a large number of men to work to level and straighten everything, by the time I reached town at midday it would have been useless for me to visit the spot in company with any one who could have described its then appearance to me.

The general direction of these waves, however, shows clearly that the undulatory movement came from the south-west. In fact, with a single exception, every shock which has been felt in Wanganui since November, 1851, has come from that direction, even that which originated near the Haumer Plain. The single exception I observed at the time came from farther west than usual, and I learnt a day or two afterwards that it had done much damage at Nelson, and subsequently that it had originated some distance south-west of that city.

Had the shock of the 8th December come from the south-east the waves on the reclaimed land would have been in the opposite direction, and the general level of the rails would not have been appreciably altered. The shock, too, in that case, should have been more severely felt at Turakina, Marton, Birmingham, Ashurst, Woodville, &c. ; while, as a matter of fact, no chimneys seem to have been shaken down beyond the Wangaehu Valley. In the same way, in its onward progress it should have destroyed the chimneys at Waitotara, Waverley, &c. ; but it has not done so. The shock, in fact, may be said to have followed generally the direction of the Wanganui Valley, its violence not extending many miles on either side. The lurching motion which followed seemed clearly to come from the south-east, as the articles of furniture moved were so towards the north-west, which was also the direction in which chimneys generally seem to have fallen, and in which the end wall of the fruit-evaporating building was thrown out.

At the same time, I am unable to feel certain whether these things arose from the ground being suddenly canted towards the north-west, or whether it was, as it were, suddenly pulled beneath us towards the south-east. All that I can be perfectly certain of is that, as I sat up, facing north-west, I was first thrown forward, then to the right, then backward, and lastly to the left, with violent jerks, after which the motion, though less violent, seemed to go all ways in turn. The cracks on the reclaimed land were also, all of them, in the direction of its length, showing that the cause which produced them operated transversely to the undulatory movement.

The principal crack, about a quarter of a mile in length, was along the junction of the reclamation with the old river-bank, and seems to me to have been caused as follows : The undulatory movement had weakened the cohesion of the reclamation with the old foreshore underlying it, which it would do the more easily because, no doubt, the thin layer of mud between the two has always been kept wet and slippery by the tidal water. Thus, when the great lurch to the north-west occurred, the bank and old foreshore moved in that direction ;



but the *vis inertiae* of the reclamation, and of the railway-station and rolling-stock upon it, coupled with the difficulty of transmitting force through the sand of which the reclamation is formed, caused them to lag behind, as it were, and so produced the fracture. Beyond the upper or north-east end of this crack the junction passes under large mercantile stores and the abutment of the town bridge, and these seem to have held the surface together and prevented the crack extending any farther. At this part, too, the old river-bank became so low as to be scarcely discernible, while along the line of the crack it was from 4 ft. to 5 ft. high. The cracks farther towards the river seem all to have been between the railway-lines, and not under them, indicating that, though the increased depth of the reclamation outwards caused further fissures to form, from the same cause as the main one, the sleepers of the rails held the ground together underneath them.

It has occurred to me that possibly it was only this transverse movement that was felt in Wellington, the undulations coming in this direction. What I regard as the principal damage in Wanganui is that to the water-mains, which, so far as I can judge, must be leaking to a very great extent at their socket-joints, as since the earthquake the water-pressure is only about one-third of what it was previously. Thus far there have been no subsequent shocks.

A neighbour told me to-day of the most curious effect of the earthquake of which I have yet heard. A stream called the Tauraroa flows into the Wanganui River from the northward about nine miles above the town. The stream runs in a little gully some 30 ft. or 40 ft. deep, and perhaps a couple of chains in width. On the east of this there is a flat from 10 to 15 chains wide, which forms the general level of the valley; and east of this again there is a hill-face of over 400 ft. high, rising up to the table-land, known as Strafford's Flat. The flat in the valley has been for many years in grass, but I learn that since the earthquake 2 or 3 acres of it, half a mile or more from the river, appear as if they had been shot violently upward into the air to some height, and fallen back in fragments, as large lumps of papa, many of them several feet in diameter, are scattered about in all directions, and the grass has entirely disappeared from that area. I suggested to my informant that possibly the damage might have been caused by a large slip of the hill-face, but he said that the face, which is covered with light bush, was unaltered, and that the damage did not extend to the foot of it. In fact, he said he was perfectly confident that the effect could only have been produced by an explosive force acting from below.

During the earthquake of 1855 sand and water were thrown up through cracks in the ground, and were scattered

on the surface to a width of many feet, and to a depth of some inches, but there were no fissures on that occasion through which lumps of papa such as described could have been projected, and, in fact, were on alluvial flats. The place would be well worth examining, and I will endeavour to get more information about it.

---

SINCE I last wrote I have been able to gather the following particulars, which seem worth recording. First, as regards the direction, Mr. G. F. Allen, formerly of the Government survey staff, and now a settler in the Upper Wangaehu Valley, informs me that directly the shock occurred he lighted a candle, and went to see what damage, if any, had been done in his house. On entering his dining-room he found that a lamp, suspended from the ceiling, was still swinging steadily to and fro. He therefore laid a long straight-edge on the table immediately beneath the lamp, and exactly in the direction in which it was vibrating. When daylight returned he took the bearing of this straight-edge, and found it to be as nearly as possible south-south-west to north-north-east, the shock having come from the former direction.

The shock was severely felt over a much larger area than I had first supposed, several chimneys having been shaken down in the Upper Wangaehu Valley, the farthest of which was at least fifty miles north-east of Wanganui. Several houses in the Paraekaretu district, between the Turakina River and Hunterville, and fully twenty miles east of Wanganui, also lost their chimneys. In this locality, too, one house which stands on sandy ground escaped injury, while those all around were thus damaged. Chimneys were shaken down at Waverley, twenty-five miles west of Wanganui.

In my first paper I mentioned how the upper portions of chimneys were twisted aside, but I had at first some difficulty in ascertaining the direction in which the twisting occurred. One person who had been engaged taking down several chimneys thus damaged said at first, in reply to my question, that they were twisted all manner of ways, but on my pointing out to him that the force which caused the twisting must have acted in all cases in the same direction he took more notice, and subsequently informed me that the twisting in every case was from left to right, the opposite of the sun's apparent motion, and others whom I induced to take similar notice all said the same. As the twisting evidently arises from the *vis inertiae* of the upper part of the chimney preventing its accompanying the lower portion in its motion, it is evident that the gyratory movement which caused the twist must have been in the opposite direction. The lurching motion I believe to be

really a gyratory one, its apparent angular motion being caused by that of the walls of buildings.

I have now experienced seven severe earthquake shocks at intervals of about seven years, and in every case the undulatory movement has been followed by the plunging gyratory one. Hence it is that I have come to the conclusion that the former movement upheaves the ground, and that the latter occurs during subsidence. When the plug is removed from the bottom of a basin or bath gyration is immediately set up during the descent of the water, and the same phenomenon may be observed in the sand running down from an hour-glass.

I have thought a good deal on the question as to whether this motion is really in its apparent direction or the reverse, and have come to the conclusion that the latter is actually the case—*e.g.*, when the first violent lurch made it appear that the house was falling over towards the north-west I believe that what really occurred was that the ground was moved suddenly and violently towards the south-east. To explain my meaning try the following experiment: Lay a sheet of cardboard on a table, and on it place some object of which the height considerably exceeds the base. Then draw the cardboard suddenly towards you, and the object standing on it will fall in the opposite direction, just as if the end of the cardboard furthest from you had been depressed, or the nearer one uplifted. It appears to me that a mistake may thus occur as to the actual direction from which a shock proceeds, and that possibly even a seismograph may thus give a wrong indication. I have never seen an instrument of this kind, but from a description of one which I read some years ago it appears to me that in this way the apparently strange fact of the earthquake having seemed to come to Wellington from a different point from that from which it came to us may be accounted for, and the point seems to me worthy of consideration.

In my last paper I mentioned that a remarkable disturbance in the Tauraroa Valley had been reported to me, and subsequent information led me to believe that it was far more extensive than had been represented. On my mentioning it to Mr. Allen he took the trouble to visit the place, in company with Mr. Charles Smith, a member of our society, to whom the land belongs. I find that my first impression, that a landslip on a very large scale had occurred, was the correct one. The high table-topped ridge called Mount Trafford, which rises on the north-east side of the Tauraroa to a height of fully 400 ft. above the valley, has till now always been supposed to consist entirely of papa. This, however, is not the case; its lower portion is of soft sandstone, a perpendicular, or nearly perpendicular, face of which, fully 50 ft. in extreme

height and more than a quarter of a mile in length, is now exposed.

The existence of this sandstone formation has been hitherto unknown, through its being overlaid by papa, and its face being hidden behind the immense mass of *débris* which during countless ages had slipped down from above, and formed the lower and flatter portion of the hill-face. This sandstone face is deeply scratched or furrowed by the substances—no doubt tree-roots—which have descended along it. In front of the face there is now a pool which Mr. Allen estimates as about 25 chains long by 50 yards wide, and 2 ft. to 3 ft. deep, from the northern end of which a strong stream flows into the Tauraroa. Outside of the pool there is a high ridge fully 30 ft. in height, and outside of this again two or three smaller ridges, evidently caused by the crumpling of the soil as it slipped. Beyond this again the soil is upheaved for some distance in a most irregular manner, and thence to the edge of the gully in which the Tauraroa flows the flat presents the appearance of having been ploughed into large furrows by a gigantic plough, many of the furrows being turned completely over. Mr. Allen estimates the whole disturbed area as containing certainly not less than 25 acres. The conclusion to which he and Mr. Smith came, after carefully examining the whole, was that the spring rains must have caused a large quantity of water or saturated earth to accumulate beneath the foot of the hill-face in front of the sandstone. This has doubtless always been the case, as Mr. Smith stated that there had always been a number of soakages all along the hill-foot at the back of the flat, by which the water escaped gradually during dry weather. The earthquake, however, set the whole of this water or saturated earth in motion, and thus caused the whole of the hill-foot for the length above stated to slide outwards to the width of the present pool, crumpling up the soil before it in its progress. Mr. Allen informed me that some large trees on the slipped earth are still standing erect, whilst the majority are thrown down, and many turned upside down. Mr. Allen also says that all along the valley there are traces of similar disturbances in the past, though none on so large a scale as the present one. In consequence of Messrs. Smith and Allen's visit to the spot, mention has been made of the disturbance in a local paper, and photographs have been taken, prints from which are announced to appear on Friday next. The newspaper paragraph speaks as if the scene of the disturbance had been the focus of the earthquake, and mentions sulphurous fumes as rising from the ground. The above description, however, as given to me by Mr. Allen, is unquestionably the correct one.

The disturbance appears to me interesting from a geological point of view, as affording an excellent illustration, on a small scale, of the manner in which mountain-ranges and secondary ranges, with hummocky ground beyond, have been formed by the crumpling and folding of the earth's crust when set in motion from any cause. When a young man I visited the great landslip at Lyme Regis, in Dorsetshire, which caused much talk in England about fifty years ago. In that case about 7 acres of the lower portion of a by no means steep hill-face slid bodily down on to the flat below. The movement was so gradual that the surface of the slipping ground remained unbroken, so that when the movement ceased the wheat on the 7 acres was still standing erect, just as when it started on its travels. That wheat was said to have been the most remunerative crop ever grown in England, as thousands of visitors, not only from the surrounding country, but from distant places, who went to see the strange sight purchased small bunches of the ears to carry away with them as mementoes.

It shows the colonial apathy as regards natural occurrences that while a bicycle race or cricket match is telegraphed all over the colony in a few hours, a disturbance such as I have been describing should have happened within an hour's ride of an important town like Wanganui, and yet should not have been reported for more than a month to a person like myself, known to take great interest in such matters, while nearly another month elapsed ere it was mentioned in the local paper, and then only through my having got a friend to visit the spot and tell me what had really occurred

---



## V.—PHYSICS.

---

ART. LIV.—*On the Screening of Electro-motive Force in the Fields produced by Leyden-jar Discharges.*

By J. A. ERSKINE.

[*Read before the Canterbury Philosophical Institute, 3rd November, 1897.*]

THE apparatus used in these experiments was that used in the previous experiments on screening of magnetic force (described in "Wiedemann's Annalen," 1897, vol. 62, p. 145), the needle, however, being replaced by a small coil which was connected with another coil outside the coil of the primary circuit. In this second coil the detector needle\* was placed.

The length of the coil placed inside the coil of the primary circuit was 6 cm., its internal diameter 1 cm. It had 22 windings. The length of the coil to which it was connected was 8 cm., its internal diameter 7 cm., and it had 31 turns.

In certain cases it was found that the reduction of deflection with the needle placed in direction *b* was greater than when it was placed in direction *a*.† When, however, the auxiliary coil was placed in a coil of fewer turns per centimetre, the greater reduction took place in direction *a*. The same thing occurs when the capacity of the primary circuit, or the spark-length, is decreased. It thus appears that the direction for which the effect is greater depends on the strength of field.

This anomaly may be explained by considering the demagnetizing action of the ends of the needle. If the field be strong a very considerable demagnetization is produced by the first semi-oscillation. The second semi-oscillation remagnetizes the outer layer, but is opposed by the demagnetizing action of the interior, which was unaffected by the first semi-oscillation. The weaker the field the greater will be the volume of this core unaffected by the first semi-oscillation, and the greater the demagnetizing action opposing remagnetization by the second semi-oscillation.

To test this explanation experiments were made with needles of different lengths. The demagnetizing action is

---

\* Rutherford, *Trans. N.Z. Inst.*, 1894, vol. xxvii., p. 488.

† Erskine, "Wiedemann's Annalen," 1897, vol. 62, p. 145.

greater the shorter the needle. A needle of length 60 mm. was taken; the secondary coil was placed in the coil of 2 turns per centimetre of the primary circuit, and the needle in the exterior coil connected to the secondary coil. The reduction of deflection was 11 greater for direction *b* than for direction *a*. When the length was reduced to 50 mm. the excess in direction *b* was 9 scale divisions. With a length of 35 mm. the excess was only 3. With a length of 28 mm. the excess was 1 division in direction *a*, and with a length of 20 mm. 4 divisions in direction *a*.

As is to be expected, the screening of electro-motive force obeys the same laws as the screening of magnetic force. The values of the screening of electro-motive force for different capacities and spark-lengths in the primary circuit and for different thicknesses of screen are contained in the following tables.

Table I. gives the variation of the screening, with capacity, the spark-length remaining throughout 0.4 cm.

TABLE I.

Thickness of Screen.	Percentage Screening.					
	Direction <i>a</i> .			Direction <i>b</i>		
	Capacity			Capacity		
	$\frac{1}{2}$ .	1.	2.	$\frac{1}{2}$ .	1.	2.
0.00111 cm.	59	44	35	71	68	55
0.00222 cm.	71	61	48	91	80	72
0.00333 cm.	81	75	69	100	90	89
0.00555 cm.	87	82	78	..	94	96
0.00888 cm.	94	88	85	..	100	100
0.01332 cm.	100	92	90	..	..	..

Table II. shows the screening for different spark-lengths, the condenser consisting of two jars arranged in parallel.

TABLE II.

Thickness of Screen.	Percentage Screening.					
	Direction <i>a</i> .			Direction <i>b</i> .		
	Spark-length =			Spark-length =		
	0.2 cm.	0.4 cm.	0.6 cm.	0.2 cm.	0.4 cm.	0.6 cm.
0.00111 cm.	34	35	31	54	55	53
0.00222 cm.	51	48	39	74	72	71
0.00333 cm.	69	69	63	86	89	85
0.00555 cm.	76	78	77	93	96	92
0.00888 cm.	83	85	83	..	..	..
0.01332 cm.	90	90	88	..	..	..



The percentage screening is given roughly by the formula  $100(1 - e^{-cx})$ , where  $x$  is the thickness of the screen and  $c$  a constant. The values given by this formula are, however, too small when  $x$  is small, too great when  $x$  is great.

Tables III. and IV. compare the observed values of the screening with those given by the formula.

TABLE III.  
Condenser, 1 jar ; spark-length, 0·4 cm.

Thickness of Screen.	Percentage Screening.			
	Direction <i>a</i> .		Direction <i>b</i> .	
	Observed.	Calculated ( $c=420$ ).	Observed.	Calculated ( $c=840$ ).
0·00111 cm.	44	38	68	61
0·00222 cm.	61	61	80	85
0·00333 cm.	75	75	90	94
0·00555 cm.	82	90	94	99
0·00888 cm.	88	98	..	..

TABLE IV.  
Condenser, 2 jars in parallel ; spark-length, 0·4 cm.

Thickness of Screen.	Percentage Screening.			
	Direction <i>a</i> .		Direction <i>b</i> .	
	Observed.	Calculated ( $c=350$ ).	Observed.	Calculated ( $c=700$ ).
0·00111 cm.	35	32	55	54
0·00222 cm.	48	54	72	79
0·00333 cm.	69	69	89	90
0·00555 cm.	78	85	96	98
0·00888 cm.	85	95	..	..

It will be observed that the screening is in all cases much greater for direction *b* than for direction *a*, but that the difference is not so great as in the case of screening of magnetic force (*cf.* tables, pp. 149 and 150, "Wiedemann's Annalen," 1897, vol. 62). This difference between the two cases is an additional proof of the importance of the first term on the right-hand side of equation (3), p. 152, "Wiedemann's Annalen," 1897, vol. 62.

We may investigate the difference of the screening of electro-motive force for directions *a* and *b* as follows (letters with the suffix <sub>s</sub> refer to the secondary coil, those with the suffix <sub>g</sub> to the screen) :—

The current in the secondary circuit when no screen is interposed has the form

$$L_2 = F_2 e^{-\frac{R_2}{L_2} t} - G_2 e^{-at} \sin (pt + \theta + \eta_2). \quad \text{Equation 3 } loc. cit.$$

As the secondary coil is small it will not affect appreciably the current in the screen, so when the screen is interposed the current in it will have the form

$$L_s = F_s e^{-\frac{R_s}{L_s} t} - G_s e^{-at} \sin (pt + \theta + \eta_s).$$

If  $M_{12}$ ,  $M_{2s}$  be the mutual inductances of the primary and secondary and secondary and screen respectively, then the current in the secondary is given by the equation

$$L_2 \frac{dt_2}{dt} + R_2 L_2 + M_{12} \frac{dt_1}{dt} + M_{2s} \frac{dt_s}{dt} = 0.$$

The solution is

$$L_2 = k e^{-\frac{R_2}{L_2} t} - \frac{\frac{R_s}{L_s} F_s}{\frac{R_s}{L_s} - \frac{R_2}{L_2}} e^{-\frac{R_s}{L_s} t} - H e^{-at} \sin (pt + \theta + \eta_2) \\ + K e^{-at} \sin (pt + 2\theta + \eta_2 + \eta_s).$$

Now, the periodic terms may be combined, and  $L_2$  takes the form

$$k e^{-\frac{R_2}{L_2} t} - f e^{-\frac{R_s}{L_s} t} - g e^{-at} \sin (pt + \theta + \eta_2 - \nu).$$

This shows that when the screen is interposed the phase difference between the secondary and primary currents approaches more nearly half a period, and since the initial value of the periodic terms is equal to the sum of the initial values of the other terms the periodic term is for small values of  $t$  relatively greater than before. Now, the effect of the non-periodic part of the current is to diminish the amplitude of the first and odd semi-oscillations of the secondary current, while it increases those of the second and even. Thus the screening of electro-motive force will be greater for direction  $b$  than for direction  $a$ .

---

ART. LV.—*On the Relative Commercial Values of Pumice and Charcoal for Purposes of Insulation.*

By W. T. FIRTH.

[*Read before the Auckland Institute, 6th September, 1897.*]

A VERY interesting series of experiments, to ascertain the relative values of pumice and charcoal, was performed by Professor Brown, and the results detailed in diagram form, and explained in a lecture delivered by the professor at the Auckland Institute on the evening of Monday, the 12th July.\* From his observations it will be seen that in the three first results charcoal shows itself to be a much more active conductor of heat than pumice, the figures in favour of pumice as an insulator being 15·0, 14·4, 13·1.

The professor stated he obtained these samples from the New Zealand Shipping Company, and it is to be presumed that they were in the condition in which they are used for insulation purposes.

As stated in Professor Brown's lecture, the coarser samples of both pumice and charcoal were then dried for a whole day in the laboratory, and, on being put through a similar test for transmission of heat, showed a conductivity of—charcoal, 31·3; pumice, 38·2.

Deducting these figures respectively from those obtained from similar samples in commercial condition, viz. :—

Charcoal	...	52·1	Pumice	...	39·0
"	...	31·3	"	...	38·2
		20·8			0·8

there results a difference in insulating power in the case of charcoal of 20·8 between the commercial article and the laboratory-dried sample; while in the case of pumice the increase in the insulating power amounts to only 0·8 when treated in a similar way.

To avoid wearying you by bringing any further calculations before you I may state that this amounts to a change in conductivity of charcoal as 100 is to 60·08, and pumice as 100 is to 97·95.

Now, charcoal, when freshly burnt, contains no moisture, but when exposed to the atmosphere rapidly absorbs from 9 to 18 per cent. of its weight in water, of which the commercial article usually contains about 12 per cent. This accounts for

\* See Art. VI., above.

the condition in which the commercial charcoal is nearly always found, as no matter how many times it may be dried it always rapidly reabsorbs moisture to the percentage indicated above.

The pumice, on the other hand, is subjected to a red heat for a period of ten minutes, which expels all but an exceedingly small fraction of the water originally in the pumice. And it is shown by Professor Brown's experiments that it does not reabsorb water from the atmosphere, as the sample of pumice experimented upon had been stored for a period of over twelve months.

As we have already seen, charcoal contains no moisture when freshly burnt, but has such a tendency to absorb water that commercial charcoal always contains about 12 per cent. of it. It also absorbs various gases, condensing them within its pores. Of oxygen it is capable of absorbing nine and a quarter volumes. This may so increase the tension between the absorbed oxygen and the carbon of the charcoal that spontaneous ignition may occur if there is not a sufficient amount of absorbed water present. This indicates that it is highly dangerous to put freshly-burnt charcoal into the walls of refrigerating-chambers before it has had an opportunity of absorbing moisture from the atmosphere.

On the other hand, when water is absorbed the charcoal is rendered a conductor in the ratio of 31.3 (freshly-burnt charcoal) to 52.1 (commercial charcoal), or, to reduce to unity, from 1.0 to 1.66.

As is well known, charcoal is an absorber of noxious gases arising from animal and vegetable matter. An accumulation of organic matter is thereby formed in the charcoal, which thus gradually becomes a breeding-ground for microbes. Dealing with the moisture contained in commercial charcoal, as every refrigerating engineer knows, the lining-boards in freezing-chambers insulated with charcoal become damp in a short time, which sooner or later will rot the boards, keeping the air of the insulating-chamber contaminated. This water that saturates the lining-boards is drawn from the moisture contained in the charcoal.

The charcoal on losing its moisture absorbs oxygen, thus creating a tendency to spontaneous combustion. Thus we see that charcoal becomes charged with either water, oxygen, or organic matter, or a combination of all three, and if it contains less of one substance there will be a corresponding increase of the others. The objections to charcoal may be summed up thus: If water is absorbed it becomes an inefficient insulator; if condensation of oxygen occurs it is liable to spontaneous combustion; if organic matter is accumulated it becomes a reservoir of contagion.

Calced pumice, which is absolutely sterilised in the process of treatment, is free from any and all of these objections, and, as a commercial article, has entirely driven charcoal out of New Zealand and Australia, and is now being largely used in South Africa. This preference for calced pumice by the proprietors of freezing-works is sufficient answer to the question as to which is the best insulator, and, if further proof is required, it is furnished by the fact that a well-known pioneer in the frozen-meat trade is at the present moment replacing charcoal in his freezing-works with calced pumice.

---

ART. LVI.—*Notes on the Vertical Component of the Motions of the Earth's Atmosphere.*

By Major-General SCHAW, C.B. (late R.E.).

[*Read before the Wellington Philosophical Society, 13th October, 1897.*]

Plate XLV.

THE very exhaustive observations which have been made in a great number of places on the earth's surface on the varying conditions of the atmosphere have resulted in a very great advance in our knowledge of the laws which govern its motions; but hitherto meteorologists have mainly investigated the horizontal motions in their velocity and direction, and in their relation to the atmospheric pressures as evidenced by the barometer. The isobaric charts compiled from the recorded facts at the same hour at a number of stations scattered over a wide area are most valuable in forecasting the probable weather conditions for a day or two in advance, and in giving us some insight into the horizontal circulations of the atmosphere. Complicated as these motions are, they are probably more simple and regular in the Australasian district than in any district of similar area (about  $70^{\circ}$  of longitude by  $40^{\circ}$  of latitude) where regular observations are established in any other part of the world.

Situated on the borderland between the two great belts of anticyclonic and cyclonic circulations in the Southern Hemisphere, and without any land-surfaces to interfere with the full development of the latter until the south-eastern part of the Australian Continent and Tasmania are reached, and with a fresh set of observations on the line of advance of the cyclones and anticyclones along the extensive barrier of New Zealand, and finally at Chatham Island, the conditions are

exceptionally favourable both for the normal circulation and for its observation.

In studying this horizontal circulation with the aid of the most valuable weather-charts prepared by Mr. Wragge at Brisbane, corrected by the completer information recorded in New Zealand and the Chatham Islands for that sub-district, I have been increasingly persuaded to believe that the phenomena exhibited in these charts of horizontal motion and atmospheric pressure need for their elucidation a knowledge also of the vertical circulation, and of the connection between barometric readings and upward or downward motions of the atmosphere. We know experimentally that atmospheric pressure diminishes as we attain higher levels above the earth's surface, and so by the indications of the barometer, or the temperature at which water boils, we can obtain approximately the heights of mountains; but we know also that the heights so obtained vary considerably. May not these variations be due in some measure to upward or downward motions of the atmosphere, which diminish or increase the pressure locally? Is it not also probable that low barometric readings observed over a large area of the earth's surface may be caused in some measure by an upward circulation of the atmosphere there, and high readings by a downward circulation? If such a view be permissible, it enables one to understand a little better what is going on in a cyclonic disturbance. It is evidently impossible that the air is merely gyrating with great velocity inwards and downwards towards the centre from all sides; it must get out somewhere, and the only outlet is upwards.

In a small whirlwind we can observe this upward motion in the centre, where light bodies are whirled upwards; but in a great cyclone, with an external diameter of perhaps a thousand miles or more, and where there is always a comparatively small central area, it is not easy to conceive how the great horizontal circular motion of the wind is maintained, unless there be also a vertical circulation, probably descending on the outside of the storm area and ascending on the inside. In our antarctic cyclones the southerly winds are cold and the northerly winds are warm, which would seem to indicate that the horizontal circulation has not extended round a considerable part of the circle.

Some meteorologists conceive that these antarctic cyclonic disturbances are not true cyclones, but are portions of cyclones open to the south, where we know there is a belt of low pressure, and the observed fact that, even at the southern extremity of New Zealand, easterly winds are rare gives support to this view. On the other hand, we have the not infrequent complete development of the closed cyclonic circuit in storms

which were traced along the south coast of Australia, the centre passing over New Zealand, and over or near Chatham Island, as on the 18th to the 22nd August; on the 3rd to the 6th, and probably on the 14th to the 16th, September; also on the 6th, 7th, and 8th October; and again on the 12th October, in 1897.

It would seem, therefore, that to extend our knowledge we require to extend our observations further to the south, and also to adopt some method by which we may note the vertical inclinations of the motions of the wind as well as its horizontal directions and its velocity. The difficulty which meets us at the outset of such an inquiry is the very limited height of the stratum or shell of air which we can easily observe. Ascending currents must be fed from below, and descending currents must be deflected horizontally or upwards when they reach the ground. At first sight it would seem best to use mountain observatories, but on consideration I think it will be admitted that the observations made in such localities, although most instructive, will be found somewhat less reliable than those made on level plains, or low islands or promontories, because horizontal winds striking the sides of mountains must always be deflected upwards. Stationary balloons or kites offer the best positions for such observations, if suitable recording instruments can be devised. I believe, however, that much valuable information can be obtained from observing the motions of a wind-vane so constructed as to show the true direction of the wind both vertically and horizontally, and fixed on a pole (at least 30 ft. high) on an open level site. I have observed the indications of such a wind-vane for the last few months, and already I have learned much from it. By the courtesy of Mr. Ferguson, the secretary and engineer of the Wellington Harbour Board, it has been placed on the lightning-rod above the time-ball on a wooden tower by the wharf, and at a height of about 70 ft. above the water. The principle of the vane is that the directing tail has a horizontal blade in addition to the usual vertical blade, and that it is pivoted at its balancing-point, so that it is free to move in the vertical and also in the horizontal plane, and to take up the true direction of the wind in both planes. (See Plate XLV.)

The first information derived from the motions of the vane is that the air moves in waves generally. These waves vary notably in inclination and period, the inclinations varying from  $1^{\circ}$  to at least  $30^{\circ}$  above or below the horizontal, the period being sometimes reckoned by minutes, sometimes by seconds, or even fractions of a second. At times the upward or downward inclination is steady (or with waves) for hours at a time, or, again, there may be for hours no regular deviation from the horizontal. These facts are of great importance, of course, in

architectural and engineering works, where the force and inclination of the wind have to be provided for. Hitherto, I think such great inclinations above or below the horizontal have not been recognised.

The wave-motions, too, must immensely increase the difficulties connected with flying-machines. Birds, I have no doubt, with their exquisitely adapted organism, are able instantaneously to detect the wave-motions of the air, and to utilise the waves in their soaring flight by varying correspondingly the inclination of the surface of the wing, and a young bird soon learns to balance itself and move on its wings as a land animal does on its feet. But evidently the problem how to make a machine that will balance itself *in* the moving waves of the air as a ship does *on* the moving waves of the sea is one of extreme difficulty.

The shore of Wellington Harbour, situated as it is in an amphitheatre of high hills, and close to Cook Straits, with their special local winds, is not favourable for obtaining reliable general information on the vertical component of wind motion, or on its relation to barometric indications; my observations, also, have as yet been extended over only a very short period; but so far they seem to indicate that in a marked V depression, particularly if, as often happens at Wellington, the depression assumes the form of a wide head of a valley with a narrow outlet, the inclination of the wind is upward; and in the contrary case, when the isobars are convex towards the "low," the inclination is downward.

On the only occasion when I have as yet been able to observe the vane while the calm centre of a cyclone was passing over Wellington—on the 20th August last—there was a decided but slow upward current of air, although at the level of the vane there was no perceptible horizontal current. On the other occasions before mentioned, when the centre of a cyclone passed over Wellington lately, either the vane had not yet been set up or the centre passed at night, and the indications were not observed, and this leads me to the question of how it may be possible to make the indications of such a vane self-recording. I have devised two methods—one electrical, the other mechanical—by which it might probably be accomplished, and Mr. Ferguson has suggested a third, by the agency of light reflected from a mirror fixed to the vane; but the motions are often so quick that the ribbon moved by clock-work, on which the record would be made, must move at great speed, and the record would be very voluminous, and the greater part would be valueless. Perhaps it might be so arranged as to be set in action by electricity by a distant observer for a short time when considered advisable. In any case a system of record would be somewhat expensive, and



would require skilled workmen to make the necessary apparatus. A simple vane, observed even once a day at the ordinary hour of observation at various suitable localities, would give, I believe, much important information if the records were collated in a central office. More frequent observations would be often very useful under special weather conditions.

In fine calm weather here the mechanism of land- and sea-breezes is well illustrated by the wind-vane, which shows the sea-breeze as an ascending current taking the place of the warm air heated by contact with the land, and rising. The descending land-wind follows late in the day. The regular fall and rise of the barometer which I have noticed at coast stations in the tropics, and which in settled weather is so marked and so regular that it indicates the hours like a clock, is doubtless due to the strong ascending and descending currents of air caused by the great heating of the land by day and its rapid radiation of heat at night. Here I have observed the barometer to fall  $\frac{1}{10}$  in. in a short time during a sea-breeze, shown by the vane to be ascending. The barometer rose again when the breeze ceased, and the vane became horizontal, or showed a descending current. On the other hand, I have observed the barometer to fall 0.13 in. in about seven hours during a northerly gale, while the wind-vane showed no regular inclination in the motion of the lower stratum of air, but only wind waves. This diminution of pressure must therefore have been caused either by a decrease in the total height of the atmosphere or by upward movement in the vertical circulation of higher strata of the atmosphere. The latter appears to me the more probable cause. Occasional abnormal differences between the barometric readings at stations very near each other—as, for instance, at Auckland and Manukau, Christchurch and Lyttelton, Dunedin and Port Chalmers—are, I think, caused by up and down movements of the lower atmosphere produced by the deflection of the wind striking on steep hillsides, rising up on one side and falling on the other. These are, it is true; minor irregularities, which do not materially affect the greater circulations; but they are instructive if they establish the principle that barometric readings do not depend entirely upon the total height of the atmosphere at the place of observation, but also in part on the vertical components of the motions of the atmosphere above the station.

The following experimental observation on the effect of a strong upward current of air on the barometer was made here lately: The signal-station on the summit of Mount Victoria, on the south side of Wellington Harbour, is 640 ft. above high-water mark by survey. The hill rises very steeply from

the water's edge, having an inclination of 1 in 3.5 approximately. A northerly gale striking the hill is forced upwards at this inclination, whatever the previous direction of the wind may have been with reference to the horizontal plane.

On the 8th November, 1897, it was blowing a moderately strong gale from the north, and the following observations were made by Mr. F. W. Rutherford with a good small aneroid barometer at about noon:—

Place of Observation.	Reading of Aneroid. Inches.	Difference of Height by Scale on Aneroid.	Addition and Resulting Height above Sea.	True Height, and Errors.
At foot of Mount Victoria, 10 fr. above high-water mark, both before and after summit reading	29 675	..	..	True height, 640 ft.
At summit of Mount Victoria, varying according to wind force—				
From ..	28 850	725 ft.	+ 10 = 735	Errors, + 95.
To ..	28 800	770 ft.	+ 10 = 780	" + 140.
Mean ..	28 825	750 ft.	+ 10 = 760	" + 120.
			[or] 757	" + 117.
At the back of the crest, under shelter of a wall	28 900	680 ft.	+ 10 = 690	" + 50.

The velocity of the wind was, of course, much greater at the summit of the hill than it was at the bottom, where no variation was observed between the readings before and after the ascent, nor was there any fluctuation in the pressure at the sea-shore producing the variations in the readings (or "jumpings" of the barometer) at the summit, which were there so marked.

This experimental observation seems to indicate that a strong upward current in the air reduces considerably the pressure of the atmosphere, and gives an abnormally low barometric reading. It shows that the heights of mountains taken by means of the barometer in windy weather are liable to considerable error, and that this will probably be in excess, and may be as great as nearly one-fourth of the height in low altitudes, perhaps not so large a proportionate error in high altitudes.

The observation also seems to indicate on a small scale the effect of upward or downward movements in the upper atmosphere, in its vertical circulation, on barometric indica-

tions generally. These experimental results were confirmed by a second experiment when the wind-force was about half of that in the first experiment. The details were as follows:—

Second experiment made at noon on the 22nd November, 1897, at the same place. The weather was fine, with a north breeze, fresh to strong. The wind-vane showed that the inclination was about  $20^\circ$  upward, with a slowly falling barometer as the sea-breeze increased in strength.

Place of Observation.	Reading of Aneroid. Inches.	Difference of Height by Scale on Aneroid.	Addition and Resulting Height above Sea.	True Height, and Errors.
At foot of Mount Victoria, 10 ft. above sea-level, both before and after summit reading	29·775	..	..	True height, 640 ft.
At summit of Mount Victoria	28·975	710 ft.	+10 = 720	Error, + 80 ft.
On southern slope, about 30 ft. below, and 100 ft. behind crest	29·035	650 ft.	+10 + 30 = 690	" + 50 ft.

The errors in this case are less than those in the first experiment, corresponding with the lesser force of the wind, but they are in the same direction. The reduced pressure caused by the upward deflection of the air was similarly less evidenced at 100 ft. in rear of the crest (a greater distance than was tried in the first experiment). The "jumpings" or fluctuations in the readings of the aneroid, which were so marked in the first experiment, were not observed under the more favourable conditions prevailing during this experiment.

A subsequent experiment was made on the 3rd December. The wind was a light north-west breeze, shown by the wind-vane to be generally ascending, while the barometer was falling. A large aneroid, by Casella, was compared with the small instrument before used. The results were as follows:—

Place of Observation.	Large Aneroid.	Small Aneroid.
(1.) 4 ft. above high-water mark ..	30·092 in.	30·18 in.
Summit of Mount Victoria ..	29·405 in.	29·38 in.
(2.) 4 ft. above high-water mark ..	30·058 in.	30·12 in.
Corrected height by (1) ..	636 ft.	704 ft.
Corrected height by (2) ..	600 ft.	644 ft.
Mean height, and error ..	618 ft. (– 22 ft.)	674 ft. (+ 34 ft.)

No corrections have been made for temperature, which varied between  $50^{\circ}$  and  $60^{\circ}$  in all the observations.

From these last it would appear that the heights given by the small aneroid are always somewhat in excess; but the principle is confirmed that the vertical component of the motion of the air strongly affects barometric readings.

It is only by establishing facts by observations on a small scale that we can obtain a firm basis for reasoning out the atmospheric motions in their great circulations, and I am in hope that some experienced meteorologists will take up this line of investigation, and follow it out to the discovery of the vertical systems of circulation of the atmosphere as fully as those in a horizontal direction have been traced. The combination of the two motions, or their resultants, will no doubt be found to be very complicated and intricate curves, and probably some new method, or some addition to the present system of isobars, may be found necessary to show graphically the approximately true circumstances of atmospheric circulation from time to time; but a new field of investigation appears to me to be open to meteorologists, the results of which no one can predict. This line of investigation has, indeed, been attacked already in some measure by observations of cloud motion, but the results have as yet been small. The weakness of this method is due to the constant changes in the forms and masses of the clouds as the vapour in the atmosphere becomes visible or invisible by varying temperature, and also to the difficulty of making simultaneous observations of any identical part of a cloud from the two ends of a measured base. The motions and the forms of clouds at different elevations do, however, give valuable information. A peculiar form of cirro-stratus cloud which is almost always seen here previous to the arrival of an antarctic cyclonic storm seems to indicate a vertical circulation on the advancing edge of the storm. These clouds have a rounded upper surface, peculiarly smooth and somewhat similar to a fish, or sometimes to an eel when several are joined lengthways. I imagine that these "fish" clouds are formed where ascending currents from the storm area curve over and fall again on the outside as they are cooled down in the higher atmosphere.

I have not read in any publication on meteorology of this peculiar form of cloud as associated with the advancing edge of a cyclonic storm, and it is possible that some local peculiarity at Wellington may give rise to them. It would be interesting and instructive to know if they are noticed on the southern coast of Australia and the west coast of Tasmania.

It is a matter of common observation that the upper clouds are sometimes seen to be moving in the opposite direction to that in which the lower clouds are moving—sometimes even a

third direction of movement may be observed in a third and higher cloud stratum. It seems quite probable that when two strata of clouds are seen to be moving in opposite directions the observer is favourably placed for observing the upper and under surfaces of a vertical circulation, the upper being visible through the spaces between clouds in the lower, and the curved ascending and descending parts in the circulation being distant, and probably obscured in clouds caused by the contact between strata at different temperatures.

Such a circulation may be observed on a small scale and at a low level when a sea-fog rolls inland in opposition to the direction of the wind and clouds above. The rapidly rising cumulus clouds, often seen before a thunderstorm, seem to show the upward movement in part of a local vertical circulation.

It appears to me improbable that variations in the atmospheric pressure at an observing-station, as shown by the barometer, are caused chiefly by variations in the total height of the atmosphere over the station. The evidence brought forward in this paper, as far as it goes, seems to show that upward or downward currents in the lower stratum of the atmosphere affect very decidedly the pressure, as shown by the barometer locally. If similar observations made in other places confirm these results we may infer that what holds good locally on a comparatively small scale is also true as regards the circulation of the atmosphere in cyclones and anti-cyclones, and also in the still more extensive circulation between the poles and the equator, and that the isobars in our charts do not represent absolutely greater or less heights of the atmosphere, like contour lines of a map showing hills and valleys; but that they indicate greater or less pressure, caused partly, if not mainly, by the downward or upward movements of the air in its vertical circulation.

The idea of using a balanced wind-vane with a horizontal tail-plate in addition to the vertical tail suggested itself to me in connection with these investigations after reading an article in a late number of the "Journal of the Royal Geographical Society" describing the exploration of the Gobi Desert by a Russian expedition, which was driven back by intense heat and drought. On their return to the country bordering this hot desert they noticed that a cool wind blew *from* the desert. They extemporised some sort of wind-vane, which was not described, but which showed them that this cool wind was falling at a steep inclination. It was evidently an overflow of the heated air, which had been cooled down at a high level, and what they observed was a portion of a vertical circulation, which they do not seem to have investigated further, having other objects in view.

The following are the principal points which occur to me as worthy of observation by means of balanced wind-vanes established in favourable position in connection with meteorological observatories:—

(1.) The periods of wind-waves in winds of different velocities.

(2.) The inclinations of wind-planes either in rapid or in long-period waves, or in more steady air-motions.

(3.) The connection between barometric indications of pressure and ascending or descending currents in the lower stratum of the atmosphere.

(4.) The special wind inclinations peculiar to the different parts of the horizontal circulation of cyclones and anti-cyclones.

(5.) Extension of these observations to higher levels by mountain observatories, or kites, or balloons.

(6.) The effects of slopes of mountains in deflecting the wind upwards (or, it may be, downwards on reverse slopes) with reference to measurements of heights by barometers.

Other points will probably suggest themselves to other minds, and probably some better form of instrument may be devised than that which I have used, and also some means of automatic record. For this latter the mechanical arrangement which I have thought out seems to me the more likely to be successful, and of this I will give a brief description, which may possibly be useful to any meteorologist who has the means to have the apparatus constructed and installed. The principle is that the standard on which the vane is placed should be tubular, and that a light stiff rod (probably of aluminium, about No. 10 B.W. gauge) should pass up through its axis, the weight of the rod being supported by a spiral spring at its lower end, adjusted so as to keep the upper end always in light but firm contact with the lower edge of the metal disc on which the vane is pivoted. The lower edge of this disc would be formed into a cam, or eccentric curve, so that when the tail end of the vane is depressed the rod will be depressed, and when the tail rises the rod will rise by the force of the spiral spring. A projecting ring on the lower end of the rod would influence the shorter arm of a balanced lever, the longer arm of which would carry a pen or pencil recording the upward and downward motions on a paper ribbon moved by clockwork, and ruled with parallel lines. These lines might probably be nine in number, corresponding with elevations or depressions of  $10^\circ$ ,  $20^\circ$ ,  $30^\circ$ ,  $40^\circ$  above or below the horizontal.

The mechanical defects of the arrangement are obvious:

- (1.) Friction between the cam and the head of the rod.
- (2.) The tangent to the cam surface is not perpendicular to

the axis of the rod. (3.) The inertia of the rod retarding its movements.

Nevertheless, the arrangement is comparatively simple, and it would, I think, record the principal vertical movements of the lower atmosphere on a ribbon moving at a moderate speed—say, a minimum of 1 in. an hour, or 2 ft. in twenty-four hours. The wave-motions of the air are so rapid at times that to record them a speed of from 3 in. to 6 in. a minute would seem necessary. Possibly the kinematograph, in combination with the velocity of the wind given by the anemometer, during the short period occupied in taking the series of photographs, would best afford data for constructing graphically the wind-waves at any particular time as shown by the wind-vane.

The record of the more enduring inclinations of the wind-motions would be very much confused by the wave-motions on a slow-moving ribbon, and I only suggest the slow motion to avoid the inconvenience of the great length of ribbon necessary to record fully and clearly the whole of the motions. Experiment only can decide the best speed to adopt.

During sixty-eight days in September, October, November, and December, on which observations have been made at Wellington, there were thirty-four days on which the wind-current was upward, five days on which it was downward, and twenty-nine days on which it was horizontal. At Lincoln, Canterbury, of the twenty-four days on which observations were taken up to the present date, the current was upward on nine days, downward on two days, and horizontal on thirteen days. The preponderance of upward over downward movement is very marked in both places, and this preponderance is also reported to exist at Odessa by Professor Klossovsky.

In Wellington the phenomenon of sea-breezes, as before mentioned, may partially account for it, and the fact that both Christchurch and Wellington are frequently in the V depressions which run up the east coast of the South Island when antarctic storms pass farther south may eventually prove to be a connected fact, but the connection between horizontal and vertical movements in the air is still very obscure.

I observe in *Nature* of the 7th October, 1897, p. 551, that Professor A. Klossovsky, of the Odessa Observatory, has made some interesting experiments upon "the ascending and descending currents of the atmosphere by means of an anemometer turning in a vertical direction." This method occupied my attention for some time, but I was unable to devise any plan by which the motion caused by ascending currents could be distinguished from that resulting from descending currents, as both would be in the same direction. Apparently, the

professor has solved the difficulty, but no information is given on the subject in the paragraph in *Nature*. Probably the details will be found in the "Annales of the Odessa Observatory" for 1896, to which, unfortunately, I am unable to refer, as the work is not sent to New Zealand.

#### CIRCULATION OF THE ATMOSPHERE.

Since writing my paper for the Sydney Scientific Congress, my observations of the balanced wind-vane and of cloud-motions have led me to the following conclusions:—

1. That in addition to and in connection with the great primary vertical circulation of the earth's atmosphere, by which an interchange is constantly being effected between the equatorial and polar zones, and the secondary vertical circulations, apparently in three divisions in each hemisphere, by which the primary circulation is effected, there are numerous minor circulations frequently taking place both in a vertical and a horizontal manner in the different strata of the atmosphere. During anticyclonic weather at Wellington, New Zealand, with the prevailing northerly winds, cloud movements often show minor local circulations at a level of from 5,000 ft. to 10,000 ft. above the sea. The movement is usually upwards on the north side and downwards on the south side, while horizontally the movement is cyclonic; but sometimes the circulation both horizontally and vertically seems to be reversed. The mass of air involved in these minor circulations is variable, but seems to average not more than half a mile in diameter, often probably much less. These small circulations are within and subordinate to the third order of circulations, which are concerned in our cyclones and anticyclones.

2. At present, then, we have indications of at least four orders of magnitude in atmospheric circulations. It is very probable that there may be many more.

3. We have indications also from experiment and observation that barometric variations in pressure depend on the resultant of the masses and velocities of the air in upward or downward motion in the different strata of the atmosphere over the place and at the time of the observation.

From the above considerations it would seem that balanced wind-vanes at low levels can only give information regarding the fourth order of circulations, in which I include the circulations involved in land- and sea-breezes, and that the cyclonic and anticyclonic circulations of a higher order may be so much modified locally by these minor circulations that the balanced wind-vane may often not give reliable indications concerning them. Even at high levels the minor circulations will, I think, often affect the indications of the wind-vane, which, however valuable, must always be limited in their range.



ART. LVII.—*The Histories of the Storms of the 30th January and the 16th April, 1897.*

By Major-General SCHAW, R.E., C.B.

[*Read before the Wellington Philosophical Society, 14th July, 1897.*]

Plates XLII.—XLIV.

DURING our last session I read a paper before this Society on the general subject of our New Zealand storms,\* illustrated by a series of the weather-charts prepared at the Meteorological Office at Brisbane, under the direction of Mr. Wragge. In that paper I showed the comparatively regular sequence of cyclonic disturbances which follow one another throughout the year in these latitudes, moving from west to east, and I drew attention to some of their peculiarities. I also gave a brief statement of our present knowledge of the circulation of our atmosphere, and I ventured to bring forward some theoretical views of my own as to the origin of our cyclones and anticyclones.

On this occasion I propose to bring before you in some detail the histories of the two storms which visited this North Island, and did so much damage, at the end of January and at Easter this year. But before doing so I will make a few observations on the subject generally, especially having reference to remarks made by Sir James Hector after my former paper. He observed that most of our antarctic storms appear not to be closed circuits, but great atmospheric disturbances forming incomplete circulations open towards the south. This is undoubtedly the case, and it is not easily explained. I believe, however, that the apparent anomaly is capable of explanation.

The very great extent in width from west to east, often included in the circulation as we trace it southwards, and as it appears on our charts, is indeed in some degree more apparent than real, as most of our charts are on Mercator's projection, in which the meridians of longitude are shown as parallel straight lines, instead of curves converging and meeting at the pole, and hence the width of the circulation southwards is really less than is shown on the charts. Still it is often very great in our latitude, covering a thousand miles or even more, and evidence is wanting to show that a *sensible* completion of the circuit exists far south in the case of these wide depressions which so frequently occur. How, then, is

---

\* Trans. N.Z. Inst., xxix., p. 61.

the circulation completed? I have little doubt that the completion of the circuit is in the upper strata of the atmosphere. The plane in which the circulation is carried on is bent upwards towards the south, or it may be regarded as not being bent down there to conform with the curved surface of the earth. The vertical component of the circulation of the air, of which I treated in my former paper, comes into play, and the circulation may be really complete, although the southern part of the circle is too high above the earth's surface to be felt as wind there. This is the probable explanation as it presents itself to my mind; but, until antarctic exploration gives us definite information by observations of cloud-motions at different heights in far southern latitudes, we can obtain no certainty on this difficult question.

I will proceed now to give the history first of the great storm which was felt here on the 30th January and the following days, and which was, in fact, a combination of an antarctic storm which reached us from Hobart and of a tropical hurricane which reached us from New Caledonia. Of the sources from which I have obtained the information here compiled I will speak later on. The regular telegraphic communications failed, as the telegraphs were wrecked in the North Island by each of these storms. (See Plate XLII.)

The weather-charts prepared at Brisbane by the Government Meteorologist, Mr. Wragge, show on the 26th January a cyclonic depression north-west of New Caledonia; on the 27th it had moved southwards, and the centre lay to the west of the north end of New Caledonia. The lowest barometric reading there was 28·9, but the grade was very steep, and it had developed into a tropical hurricane. On the 28th Mr. Wragge's chart indicates that the hurricane had nearly exhausted itself, but this was a mistake due to the lack of telegraphic communication with Norfolk Island (which exists with New Caledonia); the storm was in full force, but it had moved southwards. The reports furnished to Brisbane from Norfolk Island as opportunity offers, of which I have been favoured with a copy, show that at 9 a.m. on the 28th the storm had reached that island; the barometer had fallen to 29·15 with a violent east-south-east wind. The eye of the storm passed directly over the island, the wind veering from east-south-east to east, east-north-east, north-west, and thence to west-south-west. The wind dropped at 9 p.m., with barometer at 28·55, and veered from north-west with a further fall of barometer, which at 2 a.m. on the 29th stood at the extremely low level of 28·43. A violent west-south-west gale had then set in, and continued, gradually moderating, until at 9 a.m. on the 30th the weather was fine, with a south-west moderate gale and a barometric reading of 29·58. During the storm

5·45 in. of rain fell, and the sea, especially on the north side of the island, was the most terrific ever remembered there. The solid crests of the waves rose 30 ft. above high-water mark, completely destroying the pier and whaling-station. Of course, orchards, banana plantations, &c., suffered very severely.

It appears that the track of the storm southwards was not perfectly straight. It approached New Caledonia from the north-west; then bent, and approached Norfolk Island from the north; bent then again and approached New Zealand from the north-west; but upon the whole the track was from north-north-west to south-south-east until it reached New Zealand. At 9 a.m. on the 29th the southerly edge of the storm had reached Cape Maria van Diemen as a moderate easterly gale, with a barometric reading of 29·58 (the same as it was at the same hour at Norfolk Island with a moderate west-south-west gale).

The diameter of the disturbance was therefore about five hundred miles, or the distance between the two places. The form at that time was approximately circular or oval. As it advanced over New Zealand (North Island) it seems to have been considerably distorted, both by the irregularities of the land surface and by the opposing atmospheric pressures and currents there met with, and also to have partially filled up; for the lowest barometric readings noted in New Zealand were 28·8 at Hastings at 4 a.m. on the 30th, and 28·86 at Tauranga on the same day. At Auckland, New Plymouth, Taupo, Napier, Gisborne, and Waipiro the lowest pressure seems to have occurred on the morning of the 30th, between 4 a.m. and 9 a.m., and to have been between 28·8 and 29·15. Roughly, the centre of the storm at 9 a.m. on the 30th had assumed the form of a T, the head facing southwards from New Plymouth to Napier and Gisborne, the tail or stem stretching from Taupo to Auckland.

But the track of the tropical storm was here arrested and diverted to the north-east by the presence of an antarctic cyclone which at the same time reached Cook Strait from the south and west, and by anticyclones, of which one lay to the south and east of the North Island and the other over the Tasman Sea. Of the antarctic cyclone we have full information from the logs of the warships which were crossing from Hobart about this time. It had reached Hobart on the 27th January from the west (the same day that the tropical cyclone was at New Caledonia) with a barometric reading of 29·4. On the 29th it had reached New Zealand, and, as generally happens, it had divided into two depressions, rushing northwards up the west and east coasts of the South Island, with a northerly gale on the west and a southerly gale on the east

coast. At 9 a.m. on the 30th the westerly arm of this storm had passed New Zealand and been replaced by an anticyclone of high pressure. The easterly arm, combined with the westerly, was in and south of Cook Strait, where there was a heavy gale and a terribly confused sea, caused by the meeting of the two storms, with their opposing air- and wave-motions.

In what proportion the energy of this antarctic storm and the comparatively passive resistance of the anticyclones were effective in arresting the southward progress of the tropical storm and diverting it to the north-east I am unable to say, but I think that the anticyclones were largely instrumental. It is to be noticed that tropical hurricanes very rarely travel as far south as New Zealand—their progress southward seems to be limited by the band of high-pressure anticyclones which, with more or less regularity, surround our earth at about the latitude of  $35^{\circ}$  south. It has so happened, from far-reaching causes which we do not at present know, that this belt of high pressure was displaced further south than usual at the beginning of this year—at least in about our longitude—and this apparently left the course clear for the hurricane which reached us. I have not been able to trace a similar instance in past years. The circular storms which sometimes pass over the North Island, with their easterly gales and rain, are generally antarctic storms, which, owing to a displacement northwards of the barrier of anticyclones, or of a gap between them, have worked up northwards over the Tasman Sea, or, as in the last storm which caused the disastrous Hawke's Bay floods in April, the antarctic storm passed northwards through Cook Strait in an atmospheric valley between two anticyclones, which lay to the east and south and to the north and west of it, and so swept across the North Island in its eastward course. This happened, unfortunately, to be its line of least resistance.

The course of the antarctic storm which met the tropical storm on the 30th January was deflected to the south-south-east instead of passing on to the east over Chatham Island; so that the two storms seem to have acted upon one another as two billiard-balls would act after coming into collision in a similar manner, one passing away to the north of the anticyclone, over Chatham Island, and the other to the south of that anticyclone.

A few noteworthy points connected with this storm are the following:—

1. The eye of the storm covered a very large area, embracing nearly all the central part of the North Island and a portion of the sea near Gisborne. The comparative quiet in this central part of the circulation was very beneficial to

the passengers by the "Rotomahana," which left Napier on the evening of the 29th, before the storm had reached that latitude. On the passage to Gisborne the storm struck them as a rapidly-increasing north-east gale. When off Gisborne on the early morning of the 30th Captain Gibb thought it impossible to communicate with Gisborne, and stood out to sea in the face of what he considered the most violent gale he had ever experienced, although the waves were short, as if newly formed. At 9 a.m. the barometer had fallen to 28.9, and the gale was too severe for him to make any headway. It soon, however, began to moderate, and by noon the wind had almost ceased. The sea went down quickly, and he was able to go into Gisborne and be tendered without the slightest difficulty or inconvenience. The eye of the storm had advanced so far south that he was within its area. But soon a south-westerly gale sprung up, before which he ran until he had rounded East Cape, and before the ship reached the Hauraki Gulf the storm had passed, and there was fine weather. At the same time that the "Rotomahana" was in the calm at Gisborne, the full force of the easterly violent gale was destroying a part of the Napier Breakwater, and actually lifted a man who was sitting on the breakwater and threw him some distance, injuring him considerably.

2. I would note the effect of land in influencing the circulation. The form of the hurricane circulation corresponded markedly with the general form of the North Island, and, as we have seen, the antarctic storm was divided by the South Island.

3. Where the two storms met at Cook Strait the south-east circulation of the hurricane prevailed mainly in the Strait, the opposing north-west circulation of the antarctic storm being approximately limited by the southern shores of the Strait.

4. The hurricane travelled southwards at the rate of about five hundred miles in the twenty-four hours, or about twenty miles an hour. The antarctic storm travelled eastwards about three hundred miles on the 27th-28th, about five hundred and fifty miles across the Tasman Sea on the 28th-29th, and on the 29th-30th its motion was rather a concentration to the east of the southern island than an advance. Its progress eastward was checked by the anticyclone over Chatham Island, and its northward motion by the opposing hurricane.

We may now pass on to review the history of the Easter storm. The series of charts (Plates XLIII. and XLIV.) show the storm apparently in this instance sensibly circular near the Bluff on the 14th April. We could go a little further back in its history, but it would serve no purpose. We know that it has been travelling eastward, and that

its tendency is still eastward. About its origin and its motive force we have no certain knowledge, only inferences and theories. On the evening of that day—14th April—I noticed a peculiar steely blue in the clouded sky to the south-east, which seemed to portend an approaching storm. Rain began at night, and the following day, the 15th, a southerly gale began, which increased in force, and blew all Good Friday, the 16th, with heavy rain. The rain was very exceptionally heavy in the district north and west of Napier, producing the disastrous floods from the effects of which so many are still suffering.

You will notice in the weather-chart for the 15th that there was a depression—a sort of air-pond—north of Cook Strait, while to the east, the direction in which the storm was travelling, there was an extensive anticyclonic high: thus the line of least resistance for the cyclonic storm was northwards, and it rushed into the air-pond and thence forced its way across the North Island, and eventually worked round to the south-east, passing over Chatham Island, as we see in the succeeding charts.

The general form of the circulation in the storm assumed on the morning of the 16th approximated to that of the storm of the 30th January. We observe the same general conformity with the shape of the North Island; but for some reason the indentation of the Bay of Plenty was greatly exaggerated, the barometric reading at Rotorua remaining high (29.8), while in the centre of the storm the average was 29.3. The lowest recorded reading was at Levin, where it was 29.2.

In the centre of the storm area it was calm, while the rainfall was exceptionally heavy, with hail and lightning, but the force of the gale was very great on its circumference. Thus the schooner "Waiapu" was becalmed off Castlepoint this morning at the same time that the "Zuleika" was being driven on to the rocks in Palliser Bay by the south-east gale, and the "Pirate" was wrecked on Portland Island, at the Mahia Peninsula, by the violence of the north-east gale there.

It is curious to note how the circulation from south to north was bent westwards in an elbow over the northern part of the South Island, a corresponding eastward elbow from the following anticyclone projecting across the centre of that Island. The south wind, in its westerly bend, followed the Hurunui River valley and the Otira Gorge. The outer edge of the storm included the Chatham Islands in a long shallow depression, forming a forerunner to the storm in its future course.

On the 17th the shape of the circulation was not materially

altered. The depth of the central depression was slightly reduced, but extended in area to the south-east, towards which the whole storm moved a little; but it still clung mercilessly to the North Island in its western end, while the eastern end had nearly reached Chatham Islands. On the 18th the western end of the storm was at Chatham Island in its extreme depression, and only its shallow extremity still lingered over the centre of the North Island of New Zealand.

I must observe that in the chart for the 16th April I have shown the isobars for 29.9 as open to the south, indicating that part of the original storm still remained down there, and that only the northern part had been cut off and formed the circular storm which we experienced; but we have really no evidence to prove this, and it is very probable that the whole of the active disturbance travelled northwards, and then to the east and south-east. In this case the isobars 29.9 should be connected by the short dotted lines near the latitude of Christchurch.

One very interesting question is suggested by the behaviour of the two storms which met at Cook Strait on the 30th January. They did not unite, but apparently repelled one another. We might suppose that the opposing currents of air on the outskirts of the two storms—that of the tropical hurricane on its southern side being from the east, while that on the northern side of the antarctic storm was from the west—were the cause of this repulsion. But in the constantly-recurring cases which happen in the antarctic storms following one another we observe that, when a storm is retarded by an anticyclone to the east of it, the following storm, when it overtakes it, in some way blends with it, and reinforces it—yet the westward edge of the first storm is a south wind, while the eastward edge of the following storm which unites with it is a north wind. On the other hand, the two antarctic storms are both travelling eastward on the same circle of latitude.

Whether we look on these antarctic storms as circulations open towards the south, like spokes of a great wheel with a large felloe in the region of the antarctic circle, or whether we regard them as closed circuits, we can in some measure understand how each south-and-east-going particle of air in the following storm as it comes up to the north-and-east-going current in rear of the storm it has overtaken should curve round and follow the north-and-east-going current; and that so the whole of the front edge of the following storm joins into and reinforces the storm it has overtaken, the rear edge of the following storm having of course no change of direction to perform. The track or general direction of the circulating

system is the same in both the storms, and so they unite. But in the case of the two storms of the 30th January last their tracks were nearly in opposite directions, one from the north, the other from the south, although both had an eastward tendency. I think it most probable that there is a limiting angle within which storms which collide blend and unite, but outside which they must diverge. If this be so, it was well for us that the angle of collision on the 30th January was so great; had it been within the limiting angle, and the two storms had combined, the destruction wrought would have been very much greater.

Another question of great interest is, What is the condition of the atmosphere in the centre of one of these circular storms? As regards horizontal motion, it is, as we have seen, nearly still; but has it any vertical motion? Is it rising upwards; and, if so, with what degree of velocity? As I remarked in my former paper, we sorely need some accurate means for ascertaining and registering the vertical components of the motions of our atmosphere. If any inventive genius can provide such an instrument he has a certain fortune as the result of his patent.

In the storm of last Easter we have an example of the way in which an antarctic storm may convert the peaceful valley between two neighbouring anticyclones into a most unpleasantly active centre of motion and destructive force. But I have observed lately two cases in which similar valleys of depression lying over the Tasman Sea between two anticyclones, on the east and west sides of that sea, have developed cyclones without any extraneous aid. We know that the friction between opposing currents of air in close proximity to one another is very small. We have noticed how closely opposing currents may approach to one another in a horizontal direction without neutralising one another, as, for instance, in Cook Strait on the 30th January last. And we often see the same fact in regard to vertical superposition of opposing currents of air by the opposing directions of motion of different strata of air. But, as we have seen must evidently be the case with regard to the opposing currents in the rear edge of a retarded antarctic cyclone and the front edge of the following cyclone which overtakes and blends with it, so there evidently are conditions under which a cyclonic circulation is set up in a valley between two anticyclones. What the favouring conditions may be which produce the phenomenon we do not know; but we may naturally suppose that one cause at least may be pressure caused by the eastward movement of the western anticyclone.

My attention was drawn to the subject by the log of the "Talune" in her voyage to Sydney last month. I had a



nephew on board, who wrote to me from Sydney explaining the weather they had experienced. They left this in fine anticyclone weather with north breeze, and when they reached Sydney it was similar weather with south breeze; but during the middle passage—12th and 13th June—they passed through the southern part of a moderate cyclone with wind veering from north by east to south and rough sea.

Mr. Wragge's charts give no indication of this; he had no information; but on the 16th and 17th a moderate cyclone, no doubt the same, passed round the extreme north of New Zealand, over which an anticyclone was lying. The cyclone developed in the valley was circling round the anticyclone. I had often read of such attendant cyclones circling round anticyclones, but this was the first instance that had come under my notice. Apparently its origin was as above mentioned.

The other instance of a cyclone developed between two anticyclones occurred about a month previously. The German warship "Olga," on her passage from Sydney to Auckland, fell in with a similar circular storm about half-way across; but it was stationary, or moving so slowly that she passed through it into fair weather again as she neared Cape Maria van Diemen. Of this storm there were no indications in New Zealand or Australia, but the conditions were the same as in the other case—an anticyclone on either side of the Tasman Sea with a valley in the middle, and evidently in this atmospheric valley the cyclonic storm must have had its origin.

As a practical question, outside the laws of storms, I was much struck, on examining the map at the time of the Hawke's Bay floods, by the very great extent of the district the drainage of which converges on Napier. It is clearly inevitable that the very fertile valleys watered by all those converging watercourses must be subject to floods; but has not the clearing of the forests from the steep and comparatively useless mountain-sides of that great fertile basin exposed the good low-lying land to much more sudden and certain disaster than if the forests had been preserved? The experience of centuries has shown the regulating influence of rough wooded country compared with cleared land in absorbing rain and delaying the flow of rain-fed watercourses. I am certain that every additional acre of bush felled on the high land surrounding that district must deteriorate in value the low-lying land to a far greater extent than anything that is gained by the clearing in extent of grazing land. I sincerely hope that the remaining bush land on the upper edges of this great basin may be carefully conserved.

Whether we shall ever be able to forecast more accurately the approach of storms in these islands (than is now accomplished by Captain Edwin's admirable work) is somewhat

doubtful. The Tasman Sea lies to the west of us, and all our storms, with very rare exceptions, approach us from the west and south. We learn by telegraph the weather conditions on the other side of the sea, from Hobart to Sydney and Brisbane, but how long it will take a storm existing there to reach us, where it will strike our shores, and whether it will reach us at all, are questions shrouded in much uncertainty, depending as they do on the energy of the storm and the varying resistances it may meet with on its passage eastwards. Much, however, has been accomplished, and it is only by long-continued and patient observation, and careful comparison, that we can make further progress towards the end in view. Had Norfolk Island been in telegraphic communication with Australia or New Zealand we certainly should have been forewarned of the approach of the exceptional tropical storm of the 30th January last; but unfortunately we have no outlying island to the west of us to give us information as to the approach of our ordinary storms. Chatham Island enables us to trace the courses of storms as they leave us, and the reports from there told us that the tropical hurricane passed away far to the north of it, and the opposing antarctic storm passed away to the south of it, while the Easter storm passed right over to the island; but it could not help us in forecasts, even if in telegraphic communication.

It only remains for me to return my best thanks to all who have been so good as to assist me in this investigation by the valuable observations they have communicated to me. Sir James Hector and his kind assistant Mr. Gore placed all the records furnished to the Museum at my disposal, and also the logs of H.M. warships on the passage from Hobart, which Sir James Hector had obtained through the Admiral. The Union Steamship Company authorised Captain Gibb to give me the particulars of his voyage through the storm. I am equally indebted to Mr. J. N. Williams and Mr. Galway, of Hastings; to Mr. H. Hill and Mr. D. Fox, of Napier; and to Captain Kerr and Mr. Burrows, of Tauranga; to Archdeacons Dudley and Palmer; and to Mr. Nobbs, of Norfolk Island.

---

## VI.—CHEMISTRY.

---

ART. LVIII.—*On the Distillation Products of the Blackball Coal.*

By Dr. W. P. EVANS.

[*Read before the Philosophical Institute of Canterbury, 3rd November, 1897.*]

### PART I.

THE Blackball coal possesses physical characteristics agreeing in many respects with those of a cannel, and its relationship to the cannel family is also shown by the nature and amount of its distillation products. In some points, however, its behaviour is, as far as I am aware, unique.

The present paper deals with—(1) The distillation of the coal at a low temperature; (2) the subsequent fractionating of the crude tar so obtained; and (3) the distribution of sulphur between the main products.

#### (1.) *The Distillation of the Coal.*

As some quantity of tar was needed for the fractional distillation, a horizontal iron-tube retort (internal measurement, 40 cm. by 5 cm.) was used instead of the normal hard-glass retort (Schweelretorte), and a comparatively large charge of 200 grammes used at each operation. For this reason the results obtained represent far more closely those to be expected on the manufacturing scale. The head of the retort carried a diminisher and a T-piece, both of iron. One branch of the T was connected with a metallic condenser, with water-jacket, while the other allowed a thermometer to be fixed with its bulb directly in the path taken by the gases leaving the retort. The mouth of the retort was closed by an iron cap and stirrup-screw, and was rendered gastight by means of thin asbestos-paper washers.

The following table gives the results of the first eight experiments :—

No. of Experiment.	Coal, in Grammes.	Tar and Water, in Grammes.	Coke, in Grammes.	Gas and Loss (as Difference).
1 .. ..	200	59	117	24
2 .. ..	200	55·4*	117	27·6
3 .. ..	200	57	116	27
4 .. ..	200	59	113	28
5 .. ..	200	56·5*	113·5	30
6 .. ..	200	60	115	25
7 .. ..	200	58	114	28
8 .. ..	200	60·4	114	25·6
Totals ..	1,600	465·3 Consisting of	919·5	215·2
		Tar. 314	Water. 151·3	
Average percentage	100	19·62	9·45	57·46
				13·45

\* In these experiments (Nos. 2 and 5) leakage occurred at the mouth of the retort.

It will be seen from above table that the yield of tar is remarkably high. Over twenty similar distillations have since been carried out, the maximum yield being 60·5 and the minimum 58 gr. of tar from 200 gr. of coal. The tar is almost entirely specifically lighter than water, but separates a smaller portion which is slightly heavier than water.

### (2.) Fractional Distillation of Tar.

As the tar was nearly all lighter than water it was fractionated as a paraffin tar. The results show that its constitution is somewhat peculiar:—

Fraction 1 (below 250° C.).			Fraction 2 (250°-300° C.).		
= Per Cent. of Tar.	Specific Gravity at 20° C.	Phenols.&c., extracted by NaOH.	= Per Cent. of Tar.	Specific Gravity at 16·8° C.	Freezing-point.
24·7	0·881	19 per cent. vol.	15·2	0·967	Below 0° C.
Fraction 3 (over 300° C.).			Coke.	Gas and Loss.	
= Per Cent. of Tar.	Specific gravity at 45° C.	Freezing-point.	= Per Cent. of Tar.	= Per Cent. of Tar.	
54·9	0·991	23° C.	2·9	2·3	

Specific gravity of tar at 25° C., 0·977. Correction for small differences, =  $\pm 0\cdot001$  per 1° C.

A second smaller quantity worked up to pitch at 400° C., when useful paraffin oils were still coming off, gave—

Total distillate	..	..	..	= 81·86	per cent.
Pitch	..	..	..	= 14·92	"
Gas and loss	..	..	..	= 3·22*	"

The tar is evidently an extremely useful one, giving clean distillates and an upper fraction which appears to be extraordinarily rich in valuable paraffin. The middle and upper fractions should furnish an excellent gas-oil.

### (3.) *Distribution of Sulphur.*

This point seemed of especial interest, owing to the high percentage of sulphur contained in the coal. The results obtained are very striking:—

Percentage of sulphur in coal (Eschka method)	=	4·63
Percentage of sulphur in crude tar (Carius method)	.. .. .	= 2·48
Percentage of sulphur in coke (of coal)	..	= 3·14
Percentage of sulphur originally in coal remaining in the tar	.. .. .	= 10·5 (10·49)
	Percentage of sulphur originally in coal remaining in the coke	.. .. .
Percentage of sulphur originally in coal escaping during distillation	.. .. .	= 50·5 !

These figures point undoubtedly to the fact that the coal is far better suited for distillation at low temperature as here described (preparation of solvent oils, gas-oils, paraffins, &c.) than for use as a gas-coal at high temperature. At high temperatures the greater part of the sulphur is given off as carbon-bisulphide and escapes more or less the action of the purifiers, unless these are very carefully worked, while at a low temperature the sulphur, as direct tests showed, comes off almost entirely as sulphuretted hydrogen, and may be easily dealt with.

At 190° C., by thermometer in neck of retort, the issuing gas was so highly charged with SH<sub>2</sub> as to be of direct use in the laboratory!

Further experiments are now being carried out to determine the amount of volatile matter distilling at certain maximum temperatures; the nature of the gases given off; the composition of the various tar-fractions; and the effect of injecting superheated steam into the retort during the process of distillation.

\* Caused, in part, by flask cracking at 370° C.

## PART II.

The following table gives the results of the next ten distillations similar to those numbered 1-8 in the previous table. It will be seen that, though the yield of tar and water together is almost the same, a better method of separation raised the tar alone from 19·62 to 21·00 per cent., the water at same time sinking from 9·45 to 8·25 per cent. :—

## DISTILLATION OF COAL AT LOW TEMPERATURES.—SECOND SERIES.

No. of Experiment.	Charge of Coal, in Grammes.	Tar and Water, in Grammes.	Coke, in Grammes.	Gas and Loss (as Difference).
9	200	57	115	28
10*	200	59	115	26
11	200	60·2	114	25·8
12†	200	58	114	28
13‡	200	60·5	113	26·5
14	200	58	115	27
15§	200	58·3	114·5	27·2
16	200	58	114·5	27·5
17	200	57	115·5	27·5
18¶	200	59	114·5	26·5
Totals	2,000	585 Consisting of Tar. 420   Water. 165	1145	270
Average percentage	100	21·00   8·25	57·25	13·50

\* At 180° C., by thermometer in neck, 46 gr. had collected; at 220° C., 53 gr.; and at 250° C., 59 gr. No further appreciable yield of tar on heating to redness for some time.

† At 220° C. 53 gr. had collected.

‡ Between 190° C. and 210° C. the gas given off consisted mainly of SH<sub>2</sub>.

§ Slight leak at neck owing to stoppage in condenser. After 57 gr. had been obtained, retort kept at full heat (moderate red) for two hours. Strong evolution of ammonia, but only 1·3 gr. more tar.

|| Duration of distillation, 10½ hours. First nine hours between 166° C. and 245° C.; then raised to 330° C.

¶ Duration of distillation, five hours. First four hours at 190°-220° C.; then to 350° C.

The tar, when fractionated (light and heavy portions mixed in natural ratio), gave—

1. Fraction under 250° C.	..	..	= 23·20 per cent.
2. " 250° C. to 300° C.	..	..	= 20·23 "
3. " over 300° C.	..	..	= 48·36 "
Pitch (beginning to coke)	..	..	= 7·06 "
Gas and loss	..	..	= 1·14 "

That is, the addition of the heavy tar increased the upper fractions, as was to be expected.

## COMPOSITION OF TAR-FRACTIONS.

## FRACTION 1; BELOW 250° C.

Fraction 1 from the first series (light tar only) was washed, as usual, with caustic soda, and fractionated after neutralisation, while fraction 1 from the second series (light and heavy tars together) was fractionated without any previous treatment.

## FRACTIONATION OF CRUDE-TAR FRACTION 1 (WASHED, AND CONTAINING NO HEAVY TAR).

Number of Fraction.	Temperature in Deg. C., Minimum to Maximum.	Percentage of Whole Fraction.	Colour.
1	Below 120 .. ..	5.35	Light-yellow.
2	120-160 .. ..	31.16	"
3	160-200 .. ..	31.27	"
4	200-250 .. ..	23.53	Brownish-yellow.
5	Over 250 .. ..	8.29	Dark-brown.
6	Loss during distillation	0.40	

## FRACTIONATION OF CRUDE-TAR FRACTION 1 (UNWASHED, AND CONTAINING HEAVY TAR).

Number of Fraction.	Temperature in Deg. C., Minimum to Maximum.	Percentage of Whole Fraction.	Colour, Odour, &c.
1	80 .. ..	3.79	{ White, somewhat milky; odour normal. Amount under 80°, very small. (So-called 90 per cent. benzole.)
2	80-100 .. ..		
3	100-120 .. ..	1.21	White; odour normal. (So-called toluole.)
4	120-160 .. ..	14.65	White; odour normal. (So-called solvent-naphtha.)
5	160-200 .. ..	29.98	Light straw-yellow; odour scarcely perceptible. (Lighting oil.)
6	200-250 .. ..	36.30	Brownish-yellow; odour decided. (Lighting oil.)
7	Residue .. ..	13.84	Dark-brown; odour strong. (To be carried on to fraction 2.)
8	Loss during distillation	0.23	Fluidity perfect in all cases.

The first fractions are small, the total quantity under 120° C. being only 5 per cent. of the main fraction 1, or 1.16 per cent. of the crude tar. The whole distillate from the tar could be used as a gas-oil without previous fractionation, if such a course were desirable. This, however, would probably be a wasteful method of treating the upper fractions.

## FRACTIONATION OF CRUDE-TAR FRACTION 2 (250° C. TO 300° C.).

Number of Fraction.	Temperature in Deg. C., Minimum to Maximum.	Percentage of Whole Fraction.	Colour, &c.
1	250 .. ..	32.75	Clear brown-yellow.
2	250-275 .. ..	34.75	Clear brown.
3	275-300 .. ..	20.33	Solid at ordinary temperature; to go to next fraction.
4	Residue .. ..	11.80	..
5	Loss during distillation	0.37	..

Left in melting ice for several hours fractions 1 and 2 remained perfectly fluid and clear; fraction 3, however, became buttery, owing to the separation of crystalline paraffin.

## ESTIMATION OF PARAFFIN IN TAR-FRACTION 3 (OVER 300° C.).

N.B.—Owing to want of proper material the following results can only be looked upon as roughly approximate. The laboratory results are here also as a rule not so close to the results obtained on the manufacturing scale as in other cases.

For hard paraffin the fraction was filtered (under 0.7 atmosphere) at 10° C. The well-defined crystalline mass formed 23 per cent. of the total fraction.

For remaining soft paraffin the filtrate was treated by the ether-alcohol precipitation method, and gave another 14 per cent. of paraffin (vaselines), with only slight evidence of crystallization.

An attempt was made to filter at a low temperature, but even at 0° C. the whole fraction became too solid to filter except under high pressure.

## PART III.

*Distillation at Low Temperatures by Aid of Superheated Steam.*

*Apparatus.*—The retort (*f*) \* used in the first series of experiments was adapted to distillation in a current of steam by brazing a 5 mm. pipe through the cap (*d*). This pipe (*e*) extended right along the floor of the retort, and carried twenty steam-jets. Its outer end was connected by a brass union-joint to a thermometer-box (*c*) and the lower end of the superheating coil (*b*). The upper end of the coil was in its turn connected directly with the glass flask (*a*) in which steam

\* See accompanying diagram, which shows apparatus as set up for use.



was generated. The thermometer (*g*) and metal condenser (*h*) at the neck of the retort were again used, but the condenser was supplemented by a second longer one (*k*) of glass. Less than 1 gramme of distillate was got from this second condenser.

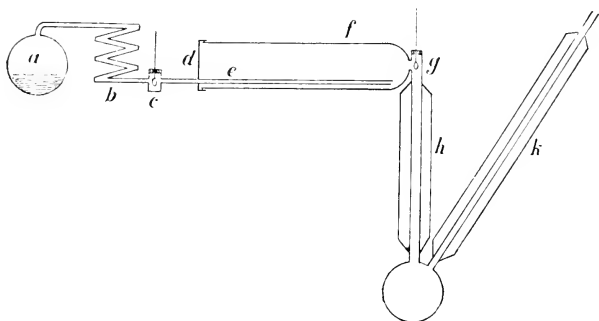

The retort was filled in an inverted position, the cap (with steam-pipe now, of course, at the top) screwed firmly home, and the retort then gently turned through  $180^\circ$  into the right position for work. The temperature of the steam could, by means of a Fletcher's Argand-Bunsen, be easily raised to over  $400^\circ$  C., and could be kept fairly uniform for a number of hours.

The charge of coal used was, as before, 200 grammes, the temperatures of the steam and the retort, as well as the time of distillation, being varied considerably.

The following table gives the results of six typical experiments.

Experiments 7 and 8 of the table are types of the check experiments carried out as a help towards estimating the quantities given in column V.

Column VI. gives the minimum yield on the supposition that no steam reacts with the carbon.

No 4 experiment probably represents the effective working conditions for the coal—viz.: (1) Fairly quick distillation; (2) temperature of gases not rising much above  $250^\circ$  C.; (3) injected water nearly equal to the weight of the coal, and so forming about 75 per cent. of the total distillate.

The coal is evidently eminently suitable for distillation purposes.

Number of Experiment.	I. Charge of Coal, in Grammes.	II. Coke, in Grammes.	III. Total Liquid Distillate, in Grammes.	IV. Water Injected as Steam, in Grammes.	V. Estimated Number of Grammes of Water in Combination.	VI. Minimum True Distillate = (III - IV).	VII. Estimated True Distillate = (III - IV + V).	VIII. Gas and Loss, estimated = (I - II - VII).	Conditions of Distillation.				Duration, in Hours, of Distillation.	Water Injected per Hour as Percentage of Charge.
									Temperature of Injected Steam in Deg. C.		Temperature of Retort-neck in Deg. C.			
									Initial.	Final.	Initial.	Final.		
									Initial.	Final.	Initial.	Final.		
1	200	111	312	255	7	57	64	25	140	220	180	320	5½	22.15
2	200	123	271	214	5	57	62	15	170	190	190	230	5¼	20.3
3	200	133.5	242	187	5	55	60	6.5	110	160	200	220	3¾	24.9
4	200	114	272.5	209	4.5	63.5	68	18	130	320	195	320	3	34.7
5	200	119.5	349	290	6	59	65	15.5	100	260	200	260	3¼	41.5
6	200	124.5	387	334	8.5	53	61.5	14	180	360*	200	280	2¾	71.5
7	Sides of the retort lined with coke.	..	110	115	..	..	..	Actual Loss, 5	..	..	..	..	..	Passed at average rate.
8		..	92.6	95	..	..	..	2.4	..	..	..	..	..	..

\* NOTE.—Tar actually separated from the total distillate of Nos. 1-6 weighed 282 grammes, giving an average yield of 23.5 per cent.

## ART. LIX.—On a Convenient Form of Oil-bath for studying the Influence of Definite Temperatures on Solids.

By Dr. W. P. EVANS.

[Read before the Philosophical Institute of Canterbury, 3rd November, 1897.]

THIS apparatus may be shortly described as a Meyer's bath, through the body of which two tubes pass horizontally. The body measures 15 cm. long, 10 cm. broad, and 7.5 cm. deep, while each tube is of 2.5 cm. internal diameter. The first tube is open at both ends, but can be closed at one, if necessary, by means of a screw-cap and washer, the other end being turned to receive a cork. This tube, when closed by its cap, can be used at once as a small retort, or can, in the case of a substance which would attack copper, carry a tightly-fitting glass tube.

The second tube is, at one end, connected by a reducing-cap to a tube of 0.4 cm. bore, which re-enters the bath, is bent backwards and forwards twice inside the body, and leaves it on the same side as it enters. This tube, with its attached heating-coil, serves for drying at definite temperature in a current of gas already heated to that temperature before it reaches the drying-tube proper, or for distillation in steam or neutral gases.

A 12.5 cm. ball-condenser, with 0.5 cm. vapour space, enables a large Bunsen to be kept at full power under the bath without allowing a trace of vapour to escape. So perfect is the condensation, in fact, that with only a small flow of water through the ball, and *water* boiling hard in the bath, the free end of the condenser may be tightly corked, and so left without fear, thus preventing any contamination of the boiling liquid by dirt, &c.

As bath liquids, toluol, anilin, &c., may, of course, be used, and by fractionating the common harvester oils a fraction boiling near 400° C. may be easily obtained.

The accompanying figures give a longitudinal section

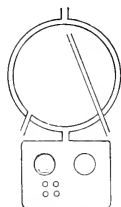

Trans. vert. section

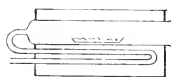

Long. vert. section

through the second tube and a transverse section in the plane of the condenser; both sections vertical.

The bath is made of stout copper, brazed throughout, and has already proved itself a handy and trustworthy piece of apparatus.

---

ART. LX.—*On the Error introduced by using a Coal-gas Flame while determining the Percentage of Sulphur in Coals, with Especial Reference to the Methods "Eschka"\* and "Nakamura."†*

By DR. W. P. EVANS.

[Read before the Philosophical Institute of Canterbury, 1st September, 1897.]

THE total sulphur in coals is generally determined, at present, by some modification of one of the above methods. In each case an error is introduced if gas be used to heat the crucible instead of spirit, but it is only small if the gas complies with the sulphur clauses of the Metropolitan Gas Referees, and is, for technical purposes, often neglected.

As a gas flame is, if allowable, much more handy in use than a spirit flame, it seemed advisable to determine the error caused by using the fairly sulphurous gas supplied in Christchurch. For this purpose 6 grammes of pure sodium carbonate (10 gr. gave no trace of a barium-sulphate precipitate) were heated over an ordinary gas Bunsen for three hours, and then treated exactly as in a regular sulphur determination. The barium-sulphate precipitate obtained weighed 0.0057 grammes, equivalent to 0.00078 grammes of sulphur. As the average amount of coal taken for a sulphur determination is 1.5 grammes the error introduced is slightly over 0.05 per cent., and is evidently negligible in ordinary technical analyses.

As, moreover, four separate test experiments varied only by 0.004 per cent., it is evidently quite allowable, even when using a coal-gas fairly rich in sulphur, to make a blank experiment, and deduct in any subsequent actual determination the amount of sulphur found in the blank.

The above experiments were made with a platinum crucible supported by an asbestos plate in such a manner that two-thirds of the crucible projected below the plate. The

---

\* Chem. News, 40, 237.

† Dingl., 1874, 212, 403.

asbestos was inclined at an angle of about  $30^\circ$  to the horizontal. If no shield be used the error is considerably increased, and also varies much more in different experiments.

ART. LXI.—On an Improved Adjustable Drip-proof Bunsen Burner.

By DR. W. P. EVANS.

[Read before the Philosophical Institute of Canterbury, 1st September, 1897.]

THERE are so many modifications of the ordinary vertical Bunsen that some apology is needed for adding yet one more to their ranks. The writer has been compelled by a recent publication of Dr. Hugh Marshall\* to publish an account of the modification at which he has been working, although it is still in the experimental stage. The main idea of the burner is a *side gas* combined with a *central air supply*, each being made as *axially symmetrical* as possible.

The base of the burner consists of two turned metal cones, which screw one over the other, allowing the gas to enter through the annular opening between them. Over these cones is situated the ordinary mixing-tube. The bore of this tube is also carried downwards completely through the inner cone. The gas-supply may be

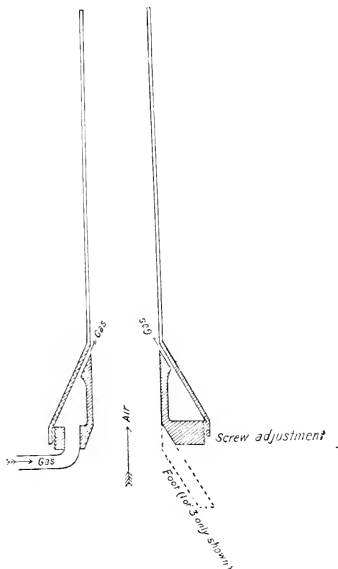

\* Journal Soc. Chem. Ind., 1897, 16, 395.

readily and accurately adjusted by means of the screw-thread of the cones. In the smaller sizes, as while the gas-supply varies with the diameter the air-supply practically varies as the square of the diameter, the ordinary side-holes may also be used to gain an increased supply of air. Details of construction are evident from the accompanying figure.

If the gas-supply is constant, the burner can be easily and economically constructed out of sheet brass, naturally without any screw-thread on the cones.

The modification would seem specially adapted for high-power Bunsens, the short mixing-tube necessary proving here a great advantage. Instead of drip-proof it may truthfully be described as shower-proof, even a beaker full of water having but little effect on it.

---

ART. LXII.—*On the Electro-deposition of Gold upon the Gold of our Drifts.*

By WILLIAM SKEY, Analyst to the Department of Mines.

[Read before the Wellington Philosophical Society, 22nd December, 1897.]

IF among the many strange and fanciful theories that the ancient digger and the masterful miner have invented for the explanation of the various phenomena that they have observed in the solitudes of nature's laboratory there is one that as first presented to us appears the strangest—the farthest fetched of any of these—it is, I think, the one which maintains that the nuggets of our drifts have generally grown, or been formed therein, and that even all gold can also grow therein—that is, *in situ*—and this by a kind of selective process, by which it accretes to itself the gold from its solution in the auriferous waters that flow around it—that, in fact, under favouring conditions every particle of gold acts as a nucleus for any soluble gold that it comes in contact with—that in reality gold as present in our spring waters has the same tendencies to go to gold in its *uncoined* state in the domain of nature as it has in its *coined* state in the hands of those who have it.

Nor was this wild theory of the digger and the miner merely a speculative one, for they believed in it to such an extent that they acted up to it by purposely leaving gold—a little “seed-gold,” as they termed it—in their tailings to draw the precious metal to itself for a profitable rewashing thereof.

The first scientist, so far as I am aware, who had the hardihood to patronise this theory—to father it, I may say—was Dr. Selwyn, Secretary to the Mines Department, Victoria. This was in the sixties. His precise theory, as stated before the Royal Society of Victoria,\* is thus given: “That nuggets may be formed, and particles of gold may increase in size, through the deposition of gold from the meteoric waters percolating the drifts, which water, during the time of our extensive basaltic eruptions, must have been of a thermal and probably of a highly saline character, favourable to their carrying gold in solution.”

Thus Dr. Selwyn; and though he did not furnish anything in its favour of a very convincing kind—nothing much more, in fact, that had already been adduced—he had performed the signal service of giving to this wild and unproven theory an air of respectability—the sanction of a great name: he had brought it to the forefront of science, and it was not long before converts to these views were made, one of whom, and the first, I believe, was Professor Ulrich, who gave much attention to the subject, and his remarks thereon appear in the work on the “Goldfields of Victoria,” by Mr. R. Brough Smyth, F.G.S., pp. 356–57. In these he particularly draws attention to these three facts—(1) That nuggets even above 1 oz. in weight are of rare occurrence in quartz reefs; (2) that a tremendous cataclysmic force would be required to move large nuggets to the situation in the drifts that we find them in; and (3) that there is a great difference in the standard of fineness between alluvial and reef gold.†

But whatever quantity of evidence had been adduced geologically for this accretion of gold on gold, one thing was lacking, for the theory had no solid ground to rest upon so long as the chemist did not, or could not, show some natural process by which was effected this building-up of gold on gold in the coherent reguline lustrous form that all nuggets and particles of native gold have taken.

Years passed away, and no evidence of this kind was forthcoming, when, about the year 1871, the scientific world was startled by an announcement from Mr. Daintree of a very singular and unexpected circumstance that he had observed bearing on the question. Professor Ulrich states the matter thus: “Mr. Daintree’s discovery consisted in the fact that a speck of gold lying in a solution of chloride of gold increased

---

\* Trans. and Proc. of the Royal Society of Victoria, vol. ix., p. 53.

† It appears very improbable that nuggets of reef gold can ever have any notable proportion of their silver substituted by gold when they get into our drifts, as the atomic volumes of the two metals are practically the same.

several times its original size after a small piece of cork had accidentally fallen into the solution.”\*

Here, then, appeared to be the “one thing that was wanted” to show how gold can accrete gold to itself in a natural way, and discovered by one of those accidents that luckily had an observer, and one who was competent to see the full significance of it. Thus, it appears that all we require for this accretion of gold on gold in our drifts is a weak solution of gold in an acid, organic matter therein of a somewhat unstable character, and metallic gold. I say here “it appears,” for it will be noted there is a tantalizing lack of detail, of precision, and, indeed, of certainty, in the description of the circumstances of the case that detracts greatly from the value of the evidence; and yet there was such a promise of useful knowledge to be gathered by a careful investigation of the case that I among others attempted it, but, for myself, was quite unable to realise the promise—in fact, I was unable to repeat the phenomenon as described. I got nothing to indicate that gold is nuclear to itself in solutions that contain organic matter, whether in a solid or in a dissolved form. The effect of such matters (organic), I found, was rather to disperse any gold it reduces than to concentrate such gold in a nuggetty form.

The results of these researches of mine were contained in a paper which was read before the Wellington Philosophical Society in 1872, and from this paper I make the following quotations:† “So far, therefore”—alluding to results just stated—“gold reduced from solution of its chloride by aid of organic matter, such as cork or wood, does not in the manner of its deposition exhibit such a notably selective power for metallic gold as the description of Mr. Daintree’s results lead us to suppose. It does not, indeed, show any such selective process at all—that is, to a greater extent than can be attributed to the action of surfaces generally regardless of their nature; and in support of this I believe I am quite correct in stating that the whole sum of our experiences (omitting those of Mr. Daintree) is directly against this theory. . . . So far as I am aware, we only produce by these means (organic matters) fine incoherent powder—minute crystals or films of exceeding thinness, nothing at all nuggetty.”

I have since learned that Mr. Cosmo Newberry, late Analyst to the Geological Survey of Victoria, has confirmed the general accuracy of these assertions of mine by showing

---

\* “The Goldfields of Victoria,” by R. Brough Smyth, Secretary of Mines, Victoria.

† *Trans. N.Z. Inst.*, vol. v., p. 372.



that gold is not nuclear to gold under the circumstances given by Mr. Daintree.

Thus it seems that, after all, as yet we have got nothing more than the hazy, crude idea of the Old-World digger of the growth of nuggets in our drifts, an idea that many geological facts support, while others are antagonistic to it. And this growth of the nugget has been asserted by scientists to have been produced by nuclear action. Nuclear action, indeed! *alias* nuclear force! I take it to be of the same misbegotten fraternity as the centrifugal and centripetal forces of our oldest school-books—those learned terms that only obscured the truth they were invented to show.

A long period of time again passed; the subject had apparently dropped out of mind, when a second time the scientific world was startled by a communication on the same subject, and for the same object. This time it was Mr. Charles Wilkinson, of the Geological Survey, and evidently the theory of Mr. Daintree, above detailed, had worked in his mind, and inspired its operations—the possible or probable nuclearity of gold for gold as in our drifts (that is, under natural conditions) had yet to be proved. But, as he thought, why limit the problem to gold? Why not try some of the native minerals that frequently exist along with gold? Filled with this idea, he, after making numerous unsuccessful experiments, at length tried the metallic sulphides, and was handsomely rewarded. He had, as he thought, got the key to the problem. His results are given in a paper entitled “On the Formation of Gold Nuggets.”\* Shortly stated, this paper informs us that cupreous and iron sulphides, arsenical pyrites, galena, zincblende, stibnite, wolfram, and molybdenite act as gold does for nuclei to gold as reduced and precipitated from its chloride in water by organic matter.

The accuracy of these statements thus given by Mr. Wilkinson was soon afterwards vouched for by Mr. Cosmo Newberry. Here, then, at last it appeared that this so-called “nuclear action” of a solid substance for gold had been sheeted home—that certain kinds of minerals can accrete, can attract, as it were, unto themselves the minute particles of gold that organic matters liberate from auric chloride, and mould these to the coherent, the crystalline, the massive form of the metal as we see it in the nugget; and thus the idea of a nuclear action of gold itself for gold, as Mr. Daintree’s observation favours, receives apparently a further accession of proof.

These results that Mr. Wilkinson obtained very much in-

---

\* Trans. Roy. Soc. Vict., vol. viii., art. ii.

terested me, and I repeated them with such variations as my previous knowledge of the subject, and particularly of the dispersing effect of organic matter on gold solution, led me to make.

Leaving out, then, the organic matter, I simply introduced a crystal of pyrites into the weak solution of gold trichloride in distilled water, when after a two-hours contact I found that this crystal was completely gilded over. The metal thereon was lustrous and coherent, and the crystal had all the appearance of solid gold. I afterwards found that the metallic sulphide arsenides generally as used without organic matter had the same effect as pyrites. Thus it was proved that derelict atoms of gold are not required for the accretion of gold on gold in the concrete form which obtains in our auriferous drifts.\*

The explanation of this liberation of gold from its solution is simple. For this we must look upon the gold in solution as being a part of the combination—hydrochloride of oxide of gold, or hydrated trichloride of gold, the oxygen of which oxidizes both the sulphur and the metal of these sulphides so as to leave the gold upon them at the scene of action in the metallic state.

But this, though explanatory of the reduction of gold, is not explanatory of the fact that the gold thus reduced is (the greater part at least) close and reguline, in place of its particles being more or less discrete, as they would be in the case of a deposit by simple reduction. This, I find, however, is explained by the fact that after the first few seconds of contact of the metallic sulphide with the auriferous solution the gold is deposited electrically—that, in fact, an electrical current is produced by the oxidation of the sulphide, and so the process is an electrolytic, an electro-gilding one.

In all this we have a proper rendering of the terms “nuclear action” or “nuclear effect” if we wish to keep them up in all their absurdity—gold can be nuclear to gold only as under the influence of an electric current.

Thus it comes about as probable—indeed, as a certainty, I think—that if the nuggets and particles of gold in our drift formations do accrete gold—do exercise a “nuclear effect,” as it is termed, for gold—it is under the directing influence of an electric current, or perhaps I should say it is simultaneously with the production of an electric current at the seat of action. In regard to this, we have seen that in our metallic sulphides as associated with auriferous solutions we have the

---

\* Although I have some twenty years ago published this fact—viz., that organic matter is not necessary for the gilding of pyrites, &c., in this way—authors of works on gold do not correct the old idea by this later knowledge.

means for producing electric currents—that is, electrolytic action; but, except in the case of our deeper-seated reefs, we do not get these sulphides, and, as in contact with the gold of our drifts we only get it rarely, therefore the question we have is this: Does there exist a general agency in these drifts for the production of electric currents in or in juxtaposition to the gold of these drifts? This question that I have just worked up, and in such a way as to incorporate here the historical facts above stated, I shall endeavour to answer, and in the affirmative. I shall, as I think, show that there are in these auriferous drifts generally the means whereby the electro-deposition of gold on gold can be accomplished, and this in a general, a natural way; and I shall also endeavour to show what these means are.

Now, it is on record\* that in 1876 I communicated to this Society a knowledge of the fact I had just then discovered, that electrical currents are generated by platina when paired with graphite in alkaline and also in saline solutions; a fact that, by the way, I afterwards found had just a little prior to this time been announced both by Professors Becquerel and Gauguain† in publications to which I had not access for years afterwards. At that time I attributed these currents to chemical action at the surface of the platina, and not to a mere polarisation of the metal, as Professor Becquerel maintained. Thoroughly believing my view of the case to be correct, it occurred to me, in view of the question before us, to carry my investigation of the subject far enough to ascertain whether any of our noble metals do give, in alkaline solutions, electric currents sufficiently strong and persistent to decompose acid solutions of gold and deposit the metal in the form in which we find it in our auriferous drifts. For my first—my tentative—experiment I made choice of platina as the metal that, if it did give me any results at all, would exhibit them with unmistakable clearness. Thoroughly cleaning a wire of this metal in suitable acids, I waxed it to within  $\frac{1}{2}$  in. of each extremity, and then plunged one end of it in a weak solution of caustic potash, and the other end I placed in a very weak solution of auric chloride, making the interpolar connection between the two vessels containing these solutions with stiff gelatine in a U-shaped glass tube, when, after the expiration of four hours, I found the platina wire was gilded up to the waxed part, while in twenty-four hours all the gold of the solution had been electro-deposited on the platina wire. The gold was in the highest degree solid, lustrous, and reguline.

This was very encouraging, so I at once continued the

\* Trans. N.Z. Inst., vol. viii., page 332.

† Watt's Dic. Chemistry, 2nd supplement, page 444.

investigation by experimenting upon gold, and the results of this I herewith state as shortly as I can, and in the order that I obtained them :—

1. When pure gold in weak or strong solutions of an alkali is electrically connected with gold in a weak solution of the terchloride of that metal a deposit of gold (out of the metallic solution) upon the gold therein occurs, and this gold is both lustrous and coherent.

2. When the ordinary acids, such as hydrochloric, sulphuric, and acetic acids, also the neutral salts generally, are substituted for the alkali the same effects are produced, but at a much slower rate.

3. Common spring water and distilled water may be substituted for the acids with similar but, of course, far less pronounced effects.

4. The same results as those above stated are also to be obtained if the solution of gold is feebly alkalized with an alkaline bicarbonate.

5. No such deposit occurs if the auric chloride or bicarbonate is replaced by an alkaline aurate.

6. A large sheet of gold in the auric chloride, coupled with a small sheet of gold in the same solution and of the same strength, deposits gold on the small sheet.

7. With gold in a weak solution of the auric chloride, as against gold in a strong solution of this salt, this metal is precipitated on the gold in the strong solution.

8. If gold or platina in auric chloride be connected with platina or gold that is in good contact with any ordinary soil it receives a deposit of bright solid gold thereon in a few hours, while the metal that is in the soil becomes coated with a thin but continuous film of peroxide of iron in most cases.

9. Gold in an alkaline solution is electro-positive to gold in acid solutions generally.

In every case the gold or the platina that stood in the auric chloride solution was coated with wax to well below the surface of the liquid, to guard against any irregular deposit of gold brought about by differences in the surroundings of the metal.

It was proved that the gelatine used for the interpolar connections in these experiments had no part (by its deoxidizing properties) in the production of these metallic deposits.

These results, as a whole, show very clearly that gold can be nuclear to itself in the popular meaning of the term—that, in fact, it can either of itself, or assisted in some way that at present we do not understand, slowly build gold upon gold in that solid coherent form that our nuggets are in. They

show, besides, that, whatever the means are by which this is produced, these will exist throughout all the drifts in which native gold occurs. Thus, any particle or nugget of gold lying in the bed, or partly in the bed, of a stream that contains gold in solution, will certainly become coated with gold, and this because it is in such a position that the upper and lower surfaces of it are in a saline solution of a different nature, the water being acidic from the presence of free carbonic acid, while the sand and earth are more or less alkaline, the alkaline solution, as we have seen, being especially favourable to the liberation of gold from acid solutions of it. This liberation is a chemical act, and therefore is accompanied by an electric current, by which the gold is electro-deposited on the upper part of the particle or nugget of gold.

All this signifies that for the deposition of gold we have here there must be the "seed-gold," or auriferous nuclei, to start with; but it is not necessary to go to the reef for this. In any strong proto-compound of iron or metallic sulphide, or even organic matter, we have in conjunction with such auriferous water the means to insure the small particles—the nuclei, the seed-gold—necessary for this metallic accretion.

Thus far I have carefully restricted myself to showing the single fact that particles and nuggets of gold in our drifts must generally enlarge by the accretion of gold thereon from its solution in the waters which permeate these drifts: the question as to how these accretions are effected, or, rather, what initiates the process, I have abstained from trenching upon; but this question I now, in due course, discuss.

We have seen that during these deposits of gold that I have shown to occur under the conditions here cited currents of electricity are generated—that, in fact, it is by these currents that the gold is deposited in the concrete—the massive form in which nuggets are in. All I have to do, then, is to show how these currents are produced.

I will note here, in the first place, that these currents are of a different class to those described by Professors Becquerel and Gaugain, which are currents produced by immersing the plates of platina in different physical conditions into acid or alkaline solutions or distilled water, and are acknowledged by these investigators to be merely ephemeral, and so are not of that determinate character necessary for the work here demanded of them.

Now, in our Transactions for 1875 I showed that platina in an alkaline solution is electrically positive to platina in an acid or in a neutral solution. The currents, however, obtained in this way appear to be like those treated by Professor Becquerel, above described; but I found that if the platina in the alkaline solution were coupled with platina or gold in

nitric acid or in auric chloride the electric current was not of an ephemeral character, but, on the other hand, was regular and continuous, so long as there was nitric acid or the gold salt present. The currents, then, may properly be termed permanent, and, being so, the difficulty of accounting for them appears greater than in the case of Professor Becquerel's currents, for they cannot be properly referred to any polarization of the surfaces of the metals or to any condensation of gas thereon, as he supposes takes place for the production of his currents, but they demand the even, the constant, expenditure of some power, and which, under the circumstances, must involve chemical action, and this absolutely contiguous to the metal—at least, to one of the metals—that is, to one of the poles used. Being so, then the only thing left to do is to determine what are the two substances to which this chemical is due, and what substances form this chemical combination in the immediate vicinity of the metal. Now, it is quite certain that neither of these substances is the platina or the gold itself, for they do not suffer, to any determinate extent, loss during the reaction, nor can they be oxidized except very superficially. (See addenda for further notes on this matter.)

The chemical action, then, that is necessary to produce the current must be produced in one of the three following ways:—

1. By the (chemical) combination of the free oxygen and nitrogen gases present as air at the surface of the metal.

2. By the oxidation of nitrogen by the oxygen of the water.

3. By the oxidation of the alkali or the acid present by the oxygen of water.

Now, in regard to the first theory, it has to be considered that the deposition of gold in these cases being, as we have seen, an electrolytic effect, an electrolysis of both solutions is demanded, and I cannot see how the mere combination of oxygen and nitrogen could effect this; the only result would be a minute production of heat.

We have therefore, as I conceive, only the two remaining theories to consider, and, as both involve a decomposition of water, it is only a question whether the nitrogen gas present is oxidized, or the potash is oxidized to the binoxide, or the acid is further oxidized by the oxygen of the water so as to produce the chemical action—the electrolytic effect—that we require. This question I have to leave for the present undetermined for want of leisure and suitable apparatus, but I shall take the matter up again shortly, and the results of this further investigation I will acquaint you with in due course; meanwhile I will here describe the results of two experiments made to settle the question.

Two platina plates, one in a gold solution the other in a potash solution, were connected through a galvanometer, and the deviation of the needle marked when it had attained constancy. A stream of oxygen was then passed through the potash solution, when it was ascertained that the deflection of that needle was neither notably increased nor decreased, a fact that appears to prove that it is not the nitrogen which is oxidized.

In another experiment I found that the potash solution had not bleached organic matters—litmus paper, &c.—at all, even after the deposition of gold had extended over eight hours.

These results are conflicting. However, these experiments are merely of a tentative character; but, as I say, I hope very soon to be able to make further and complete investigations on the subject.

There is one circumstance in connection with the alleged discovery of Mr. Daintree of a nuclear action of gold for gold as liberated by organic matter from its chloride that, in conclusion, I would like to make a few observations upon, and this in justice to the memory of that scientist. It may be remembered by some here that I did not hesitate to avow a certain amount of incredulity as to the alleged growth of the particle of gold that Mr. Daintree left in the solution of gold that he had prepared; but just lately, in further considering the case in connection with the facts that I have here stated before you, I could not but think that probably, after all, this scientist's statement as to a certain palpable increase in the size of this gold residue might be correct. The question was, then, if correct, to what was this increase due? Now, it did not appear very likely, under the circumstances, that all this increase was due to differences in the strength or nature of the solution itself whereby action would, as we have seen, be set up; so it occurred to me to try whether or not contact of the gold with the vessel itself had anything to do with it. Binding, therefore, some clean platina wires round small pieces of white porcelain, glass, and white quartz respectively, I placed these pairs in the trichloride of gold, while a similar wire I wrapped in filter-paper and immersed it in the same solution of gold, when in four hours I observed that the wires that were attached to the porcelain and glass were feebly gilded, whilst that attached to the quartz was thickly gilded, but the wire unattached did not exhibit any trace of gold thereon. Gold in place of platina in these experiments also accretes gold to itself, which is clearly revealed by the altered appearance that in a few hours it presented.

As the quartz was of the pure white variety I was led at

first to suppose that it at least possessed the same property in relation to the electro-deposition of gold above noted as the noble metals do, but I soon ascertained that this was simply owing to the presence in the quartz of a minute proportion of some proto-compound of iron, for on igniting the quartz, or digesting it with hydrochloric acid before placing it (as wired with platina) in the solution of gold, the gold was deposited upon the wire. The same negative results occurred in the case of the glass when similarly treated prior to the immersion.

These results, as I think, clearly show that any gold that had deposited upon the normal gold in the case that Mr. Daintree gives us had in greater part, if not wholly, been electro-deposited there by means of a chemical combination set up by the oxidation of the protoxide of iron of the glass vessel upon which that normal or original piece of gold lay.

The fact that the whitest and purest quartz at my disposal did, when thus coupled with platina or gold, become solidly gilded when placed in an auric-chloride solution is, I think, rather a remarkable one, for the quartz thus appears to act as the positive pole of an electric circuit. Had it not thus acted we should have had the gold liberated from the auriferous salt by the oxidation of iron deposited in minute disconnected granules on and partly in the body of the quartz, in place of the reguline deposit on the metal attached thereto, as in my results.

In regard to this, some here may contend that the general idea is that all bodies are electric conductors in the same sense that the metals are, but it seems to me that if this were really the case we should be able to electro-deposit gold on quartz, which, as I said above, I have been unable to do. The whole matter, however, requires further research. Meanwhile we have the knowledge that particles and nuggets of gold in auric chloride do increase their size when they have full contact with quartz, glass, and siliceous substances generally that contain ferrous oxide, and this circumstance fully explains how any small increase which obtained in the size of Mr. Daintree's residual gold was brought about.

#### *Addenda.*

The following facts may prove interesting, and also useful, for enabling one to understand some of the phenomena above described :—

If a piece of pure bituminous coal is immersed in a weak solution of auric chloride, and rested clear of the containing vessel—say, on filter-paper—no deposit of gold occurs on the coal; but if this coal is allowed to have contact with quartz, earthenware, or glass, in a short time it will be tinged



brown near the junction of the two solids, and in a few hours the whole of the coal is well gilded. Here it is shown that the coal is a pretty fair conductor of weak electric currents.

If pure platina be coupled with pure gold in equal-sized plates in an auric chloride solution no deposit of gold occurs—at least, I found none; a fact which goes towards proving that these metals in all the experiments I describe here only act as inert poles—as mere “ways and means” for the passage of electric currents.

The electric current is stronger when the gold in the potash is paired with gold in auric chloride than with gold in hydrochloric acid, a circumstance no doubt due to the easier decomposition of the gold salts than the acid.

When the platina of a zinc-platina couple is connected with a platina pole in the alkali solution, and the zinc of this couple is connected with the other platina pole (that which is in the gold solution), the deposition of gold on the platina was not stopped, but was only retarded. Using a copper-zinc couple instead of the zinc-platina one, the rate of the deposition of gold was but little, if at all, affected.

A copper-zinc couple in sulphuric acid connected with two gold plates in the auric-chloride solution deposits gold only at a very slow rate, and this even when the copper and zinc plates are much larger than the gold plates.

From the results above stated it appears that the electromotive power yielded by potash and auric chloride with gold or platina plates is of considerable strength—at any rate, is stronger than that given by the copper-zinc couple in sulphuric acid.



ART. LXIII.—*On the Decomposition of Water by Tannic Acid in conjunction with an Alkali.*

By WILLIAM SKEY, Analyst to the Department of Mines.

[*Read before the Wellington Philosophical Society, 16th February, 1898.*]

THOUGH tannic acid, when alkalized, rapidly combines with free oxygen, it has not hitherto been supposed capable of combining directly with the oxygen of water—that is, of decomposing water for its oxygen—under any circumstances. This decomposition, however, of water by tannin can be easily brought about, and in the following manner: A sheet of metal—say, platina—is partly immersed in an alkalized solution of tannin, over which is a layer of oil to shut off the atmosphere, and thus prevent interference with the results.

This sheet is clamped to another sheet of the metal standing in another vessel that contains water feebly acidulated—say, with hydrochloric acid. The two vessels are then connected by a bent glass tube full of gelatine in a firm but gelatinous condition, when a lively evolution of gas proceeds from the platina in the hydrochloric acid, while the tannin solution acquires a deep-brown tint in the immediate vicinity of the metal. The gas is hydrogen. If the acid solution is changed for a solution of auric chloride or cupric sulphate, metal is rapidly deposited upon the platina there. Evidently water\* has been decomposed, its oxygen combining with tannin, and its hydrogen depositing the metal in the other vessel: we have, in fact, a galvanic cell formed in this way and brought into action.

In this experiment I take it that the metals do not contribute to the results by any so-named catalytic action† or condensation of oxygen, but only by affording the means by which the chemical combinations in the liquids may produce, not heat, but electricity, and electricity in the current or dynamic form—that is, speaking more in accord with the electrical theories of the day, a series of electrical polarizations. Of course, it is only the tannin that is in absolute contact with the metal that acts on the water—that is, in fact, oxidized.

In accordance with the custom of designating new forms of voltaic cells after some distinguishing or novel feature in them, I propose to name the apparatus here described the “tannin cell”; a group of these, the “tannin battery.”

---

ART. LXIV.—*On the Liberation of Hydrogen in a certain Variation of the Apparatus used for cyaniding Gold.*

By WILLIAM SKEY, Analyst to the Mines Department.

[*Read before the Wellington Philosophical Society, 16th February, 1898.*]

Two theories have been formulated to explain how gold becomes dissolved in the cyanide process. One is that given by a joint patentee of the process, Mr. MacArthur. This assumes that water is decomposed, its oxygen being used to replace the

---

\* I take here the most liberal view of the electric liberation of hydrogen from acidulated water. The case may really, so far as we know, be one where decomposition of the acid is effected—one that science has yet to settle.

† May not many of our cases of catalytic action be, in reality, electrical action as in this case.

cyanogen necessary to cyanide the gold, while its hydrogen is evolved. Now, this theory is that of the minority, and is still, I believe, held by its author. My own experiments in this matter gave, as I have already stated,\* results entirely against it, and I have seen no reason to alter my expressed opinion in this matter—that is, as regards the practical working of the process; but by an apparently trivial and unimportant variation in cyaniding gold we actually do get a liberation of hydrogen. For this it is only necessary to so arrange that the negative gold of the cyanide apparatus (the voltaic cell, as it really is) shall be placed in an acid solution—say, in hydrochloric, sulphuric, or acetic acid. The diagram here given explains what I mean. A is a vessel containing potassic cyanide of any strength, in which is a sheet of gold-leaf (gummed to paper). B is another vessel, containing the acid in water heavily salted to drive out the oxygen that might interfere with the result. In this vessel is a gold wire *d*, which is connected with the gold-leaf *c*. Interpolar connection is completed by the bent glass tube *e*, that is full of hydrated, but almost solid, gelatine, slightly salted for conducting purposes, if necessary.

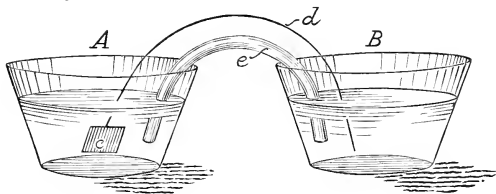

Soon after this arrangement is set up a stream of gas may be observed issuing from the gold or platina wire. This is hydrogen, and the evolution goes on continuously till all the gold-leaf is dissolved. It is necessary to have a small cathode and a large anode to be certain of success in the experiment, as cyaniding is at the best a slow process, and even concentrated solutions of the acids and salts let in oxygen fast enough to oxidize hydrogen to a notable extent, and thus prevent its liberation being noticed. It is a singular fact that if potash, or any alkaline solution, were substituted for the acid in B I was unable to observe any evolution of gas, yet the currents formed appear as strong as when the acid was used. It is possible, however, that potash, by its great affinity for water, so rapidly determines the oxidation of hydrogen that none is to be seen escaping.

\* Mines Report for 1895, p. 88.

These results, while they clearly show the unexpected fact to many that hydrogen can be liberated in a cyanide process, show just as clearly that in the process as carried on at the mines the gas is never evolved, but is, so to speak, only transferred in a liquid form to the oxygen present at the anode. The process demands that the oxygen shall be present there and in quantity, while the alkalinity of the solutions around them favours the rapid union of this gas with oxygen before it can assume the gaseous form, or even before it can in reality become free.

It should be stated that a brisk evolution of hydrogen is afforded by cyaniding copper, even when the anode is in an alkaline solution. This branch of the investigation requires further researches.

---

ART. LXV.—*On the Rapid Action of Strong Cyanide Solutions on Gold superficially.*

By WILLIAM SKEY, Analyst to the Mines Department.

[*Read before the Wellington Philosophical Society, 16th February, 1898.*]

A VERY singular phenomenon may be observed in regard to the action of the cyanide solution upon gold such as that which Professor Faraday used for his experiment. This gold is deposited from very weak solutions of its chloride by phosphorus or hydrogen in such finely divided particles that they were indistinguishable—in fact, invisible—under the highest-powered microscope of that time; they are able to remain in suspension in water for an indefinite period, and it was only by reflected light Faraday could observe them. Now, if we neutralise, or slightly alkalize, this red-looking auriferous fluid (we cannot designate it as a solution), then divide into two parts, and mix one part with, say, three volumes of the dilute solution, and mix the other part with a strong cyanide solution—say, the concentrated solution—it will be found that it is the gold in the strong cyanide that first disappears from view. Nor is it a neck-and-neck affair by any means, for in the strong solution three seconds may suffice to complete the operation, while in the case of the orthodox dilute solution the time required will be about five minutes—that is, about one hundred times longer. This is, of course, just what one would have expected a few years ago, before our working cyaniders had taught us the extraordinary potency of the dilute solution over the strong solution as a gold-dissolver.

Both the blue and the red gold of Faraday give the results stated.

These results clearly prove that, even in the supposed inert solutions of the cyanide, the strong solutions rapidly act upon gold to a limited extent. It is not a matter of superior causticity, for it was found that strongly alkalizing the weak cyanide did not hasten the dissolution of the gold.

The explanation of this enigma is, I think, this: In the strong solution cyaniding goes on at once, but only so far as to produce a colourless cyanide of gold that is insoluble, or but very slowly soluble, in the liquid. I have before shown that gold taken out of a strong cyanide solution refuses to amalgamate, or, at least, but very slowly amalgamates, showing, as I said, that an insoluble saline film of some gold-cyanide has enveloped it. In further support of this idea I would note here the fact (which may or may not have been observed before) that gold-leaf upon a strong cyanide solution, in disappearing, leaves floating thereon a pale white ghostly-looking figure of its departed self, exact to the shape. In the case before us, however, there is no transmutation of a vast number of metals—nor even of one: the white floating mass left by the gold is its cyanide, and it is this substance that, I believe, always forms upon gold in strong cyanide solution, thus preventing or retarding its dissolution.

In the strong solution, then, we have not only the limited supply of oxygen against the cyanider, as Maclaurin has shown, but we have also the rapid enfiling of the gold by a salt that is but very slowly removed therefrom.



## VII.—ADDENDA.

---

[NOTE.—The following papers were received too late for insertion in their proper place in the volume.]

ART. LXVI.—*On the Hawke's Bay Plain : Past and Present.*

By H. HILL, B.A., F.G.S.

[*Read before the Hawke's Bay Philosophical Institute, 12th July, 1897.*]

IN a former communication on "Denudation as a Factor of Geological Time" (vol. xxviii., Trans. N.Z. Inst.) I brought under the notice of this society some of the surface changes that had recently taken place along the east coast of the North Island, in consequence of the unusual rainfall and subsequent floods that were experienced in certain parts of the district in December, 1893. The summary of results appended to the paper was based upon returns made by the larger landholders, who supplied estimates of "breakaways" in their lands as the result of the excessive rainfall that then took place. Since December, 1893, the Hawke's Bay District has on several occasions suffered much from unusual falls of rain, which have caused sudden risings in the rivers. The present year, however, appears to have reached a climax in this direction. The long period of drought towards the closing months of 1896 was broken at the end of January, and Hawke's Bay, or more particularly the town of Napier as a centre, experienced a cyclonic storm of unusual severity. Rivers were flooded, much damage to property took place, and some of the low-lying country in the vicinity of the river-mouths was under water. This storm, however, though serious in its effects to many, was hailed with feelings akin to pleasure, as the whole district benefited in many ways. The storm was followed by what may appropriately be termed a second spring. Fruit-trees—such as apple, cherry, peach, plum—came into bloom; gardens were once more gay with roses, lilacs, laburnums, and many other varieties of flowers; whilst deciduous trees like the oak, elm, and poplar donned a fresh robe of green leaves. Following the spring came a period of delightful weather which continued till mid-autumn, when it broke and another storm of almost unprecedented severity overtook the district.

The storm began on Thursday, the 5th April, about noon, and continued without a break until the evening of the following day (Good Friday). The rainfall during the whole time had been heavy in Napier, but it was small in comparison to the quantity that fell in the western parts of the district, more particularly within the higher areas of the basins of the three rivers—Tukituki, Ngauroro, and Tutaekuri, all of which empty themselves into Hawke's Bay within a short distance of the town of Napier. The annual rainfall in Hawke's Bay does not exceed 40 in. on the average, but during the thirty hours that the storm lasted 21 in. of rain are reported to have fallen in certain portions of the basins named. The results of such a rainfall can only be measured by the disasters that followed, more especially in the low-lying portions of the district locally known as the Heretaunga Plain. These, however, need not be enumerated here; but the country, and Napier in particular, has to deplore loss of life and property beyond anything previously experienced in the history of settlement in Hawke's Bay. An event like this, fraught as it is with such serious consequences to a community, cannot be passed by and forgotten. The stake at issue is too great. The interests of the settlers, and, in a large measure, the welfare of the district, are jeopardized by the possible recurrence of similar floods, and it becomes the bounden duty of every citizen to inquire into a matter of so much importance, with a view to the adoption of measures to safeguard the lives and property of those who reside within the limits of the present deltoid area of the three rivers.

A slight acquaintance only with the topography of this district is necessary to become aware of the fact that what is locally known as the "inner harbour," and extending from Petane to the south-west in the direction of the Quarantine Island, is the remnant of an area which at one time included what is now the whole of the Heretaunga Plain, as far as Pakipaki and Maraekakaho. The surface features of the higher lands have altered comparatively little since the sea-waves broke on a shingle beach which ran round this inland bay; but all the flat lands have been made, and the sea has had to recede before the *débris*-laden rivers, that have brought down their loads of fertility from the back-country and deposited them within the area now known as the celebrated Heretaunga Plain. And all this great work has been done by the direct action of flooded rivers—in fact, had there been no flooded rivers there would have been no Heretaunga Plain, for the one is the complement of the other.

In studying the formation and geological growth of the Heretaunga Plain it is necessary to become acquainted with



the topographical and surface features generally of the surrounding district. A walk to Petane, to Tangoio, to Redcliffe near Taradale, to Havelock, and the Kidnappers will supply an ordinary observer with ample evidence of the fact that there were extensive deposits of shingle, of mud, pumice, and blue-clay sands long before the Heretaunga Plain-making period began. Everywhere in the places named are to be found shingle deposits of a special type and kind. The small island known as The Watchman, in the inner harbour, equally with the one near the Petane Bridge, displays the characteristic features of what is geologically known as "the Kidnapper conglomerates." And no one who is acquainted with the distribution of the beds corresponding in age to the Kidnapper conglomerates would for a moment suppose that the beds forming the Heretaunga Plain belonged to the same period of deposition and growth, and yet in some respects the sequence of bedding is very similar in both.

Anterior to the time when the present Heretaunga Plain and that portion of it which is still covered with sea formed a deep bay or gulf it was an area of land, and formed one continuous whole, as shown on the map of Hawke's Bay where the present Kidnapper is seen to continue as land in the direction of what is now the Mahia Peninsula. The limestones on the south side of the bay joined those on the north, and Napier, or, rather, what is known as Scinde Island, formed a part of a connected whole. Thus the sea-area known as Hawke's Bay was once covered with marls and limestones and conglomerates in part. Go where you choose within the limits of the district named and the evidence is complete that at no distant date in the order of geological time the portion of Hawke's Bay now covered by sea was a mass of elevated land through which a river flowed in a south-westerly direction. That river, which I would name the Wairarapa, had the Mohaka, Tutaekuri, Ngauroro, and Tukituki as its tributaries. Since then earth-movements along the east coast have been extensive, and they appear to have been contemporary with the period of greatest volcanic activity in the interior of the Island. The bay, such as it is now known, is essentially an area of subsidence, and during such subsidence river-basins were undergoing important modifications. The great river-valley was broken up into a series, and as subsidence proceeded Hawke's Bay, or the area between the old coast and Woodville, became great inland lakes, into which were carried immense deposits of volcanic material from the central portions of the Island. The history of the Heretaunga Plain as a plain begins as subsidence proceeds within the limits of the bay, and the work of plain-making is yet far from complete. The large flat country

extending from Napier to Pakipaki contains about 70,000 acres, but in reality the plain is much larger than this. The whole formation has to be taken into account, and underneath the bay there is an area of river material of great extent which has been brought down by the rivers and deposited in time of flood. It is curious to notice the gradual deepening of the sea. At one mile from the shore the depth is 24ft., at two miles it is 48 ft., at four miles the depth is 60 ft., at six miles it is 72 ft., at eight miles 120 ft., at ten miles 128 ft., and at twelve miles 144 ft. If the ocean-waters could be shut out from this portion of the bay there would appear an area of land nearly equal in extent and with a slope no greater than now exists on the Heretaunga Plain between Roy's Hill and the "wash-out." This plain has grown at the same time and under similar conditions to the Heretaunga Plain, and, geologically considered, it forms an integral part of that plain.

The height of the Heretaunga Plain varies considerably, although between the "washout" and Pakipaki it appears to be almost a dead level. I am indebted to Mr. Rochfort, C.E., our townsman, for the following facts as to the height of the plain: At the head of the plain, near Roy's Hill, the height is 166.4 ft. above sea-level. For our purpose this may be set down as the highest point on the plain. From this place to the "washout," four miles along the beach to the south of Napier, the distance is about twelve miles. Between Pakipaki and the "washout" the distance is about ten miles. Pakipaki is 32.39 ft. above sea-level. Havelock, at the bridge on the Hastings-Havelock Road over the old Ngaruroro river-bed, is 34 ft. above the sea; East Hastings, at the junction of the Karamu and Havelock Roads, is 39.9 ft.; West Hastings is 44 ft. Omaha, at the Ngaruroro Bridge, is 73 ft.; at the pa, 63 ft.; and at the old mill, 48.2 ft. At the junction of the Clive-Havelock and Clive-Hastings Roads the height is 15.36 ft. At the Clive Bridge Hotel it is 11.54 ft.; and at the Waitangi Bridge the height is 7.29 ft. Taradale, at the junction of the Meeanee and New Taradale Roads, is 16.63 ft.; and Meeanee, near the hotel, is 5.31 ft. From these data it is possible to give some idea as to the general slope of the plain in the direction of the "washout." Thus, between the latter place and the railway-crossing midway between Hastings and Pakipaki, a distance of ten miles and a half, the fall is 26.10 ft., or less than 3 ft. per mile. Between Roy's Hill and the "washout" the distance is twelve miles, and the fall is 13.2 ft. per mile. Between Roy's Hill and Havelock Bridge the distance is eleven miles, and the fall is 132.4 ft., or 12 ft. per mile. From these data we gather—(1) That there is a gradual slope along the plain of 159.1 ft. between Roy's Hill

and the "washout"; (2) that there is a slope from north-west to south-east across the plain; (3) that there is a greater slope from south-west to north-east; (4) that the slope of the plain points to the probability that the Ngaruroro and Tutae-kuri Rivers discharged their waters into the bay between the Omaha Bridge and Mr. Donnelly's house at a comparatively recent period; and (5) that most of the material now forming the plain has been brought down by these rivers.

These conclusions are of considerable importance, as showing how the plain has grown, and the general direction which the rivers have taken as they have extended themselves further and further into the sea. Under ordinary conditions it would be difficult, perhaps, to trace the line of growth as the rivers followed the extension of the plain, but the discovery that the underlying beds through the plain area are water-bearing has enabled geologists to supply undoubted testimony that the plain began to grow from the direction of Roy's Hill and Omaha. From these centres the material brought down by the rivers spread out fan-like over the bay. The beds that were laid down from time to time deepen as they proceed seawards, whether the starting-point be taken at Roy's Hill or at Pakipaki, and just as the land rises in the direction of these places so the water-beds die out, or, what amounts to the same thing, the marl- and clay-beds underlying the deltoid deposits shallow as the hills are approached. The sequence of the beds in different parts of the plain illustrate in a marked manner the depth and variety of the material which the rivers have brought down. A good illustration of the kind of material now brought down by the Rivers Ngaruroro and Tutae-kuri may be seen at Port Ahuriri, where the Harbour Board dredger is at work. The sandy material is barely distinguishable from the sands passed through by well-sinkers when putting down their bores for water in the lower parts of the plain.

From what has been stated it will be inferred that the Heretaunga Plain, such as we know it to-day, is of recent growth, and that it is growing even now must be evident to the most ordinary among observers. The shingle beach that now forms such a characteristic feature along the coast between Tangoio and the Kidnappers really forms no portion of the plain. Its history began after Scinde Island had been separated from the mainland in the direction of Battery Point, and the shingle really represents the resultant of the parallelogram of forces such as came into play after the above separation had taken place. The shingle is limited both in depth and breadth. Its depth varies from 60 ft. to 90 ft., and its breadth, on the average, does not exceed 300 yards. If this beach were taken away, and it were possible to expose the whole of

the river deposits which are as yet below the sea, there would be a valley plain certainly more than twenty miles long and nine miles broad, so flat and with such a gradual slope that the most perfect eye would be unable to distinguish the inclination of the beds. The average depth of this plain is not less than 200 ft., and the whole of the material has been brought down by the rivers, not during their normal flow, but during periods of excessive rainfall. The full area of the plain—that above and that below the sea-level—may be set down at 125,000 acres, or 605,968,000 square yards, and, taking the average thickness of the deposit at 200 ft., the cubical contents amount to 40,397,870,000 cubic yards. All the beds that go to make up this enormous mass of fluvatile material have been deposited in a constantly diminishing, or, rather, a constantly varying, thickness as they go further and further from the source of supply, which at the beginning of the plain-making period was in the direction of Roy's Hill as a centre.

It needs no explanation on my part to account for the thinning-out and overlapping of beds as they proceed fan-like over the district from the ever-changing and extending river-mouths. Any one can see the same thing happening daily wherever water is removing *débris* and redepositing it under conditions where movement is free. The series of irregular beds underlying the plain supply evidence of the varying distribution of material such as rivers like those in this district bring down in time of flood. Shingle may be deposited in one place, pumice in another, sand and mud in another, and the finest sediment in another, the deposits being modified as much by surface irregularities as by differences in the specific gravity of the material brought down. But all the products, of whatever kind, are the direct result of abnormal conditions in the rainfall within the basin-areas of the rivers which pour their waters into the bay through the plain. If the whole of the products of a flooded river like the Ngaruroro or Tutaekuri could be collected into a single deposit the quantity, both in bulk and variety, would be surprising. But it might be possible by such means to estimate the probable length of time that has elapsed for the accumulation of such deposits. The estimate, however, could only be a relative one at the best, for, although the same physical causes now operate as agencies such as were in operation in the ages gone by, the results are necessarily dissimilar. The rate of growth in the earlier history of the Heretaunga Plain was certainly greater than in these latter days. We have fifty years of unbroken history in the settlement of this district, and the changes that have come over the facies of the plain during this period must be set down as very great and striking. The flood that was so disastrous in April

is not exceptional or even unusual, and we may look for a recurrence with as much certainty as we look for changing seasons. That the plain is growing at a rapid rate there is certain proof.

As far as the evidence of Europeans is concerned, it is possible to go back to the year 1844, when the Rev. Mr. Colenso, F.R.S., one of our worthiest and most active members, came to dwell in the district. He is still resident amongst us, and I only regret that sickness prevents his being present to-night to relate some of his experiences of floods in this district. At the date of his arrival the Heretaunga Plain was an uninhabitable swamp, and the larger portion of it was as true a delta as is the Sunderbunds of India to-day. If you could cover the swamp-area between Meeanee and Clive with scrub, sedge, cyperus, flax, and raupo, you would have a type of what the whole plain was like fifty years ago. A network of creeks running across swampy areas and joining together in one impassable tangle the lower areas of the Rivers Tukituki, Ngaruroro, and Tutaekuri—such was the picture that met the gaze of the earliest settlers, and such it would have been to-day had not man's industry and intelligence combined and devised those means which have made a large portion of the Heretaunga Plain the pride of Hawke's Bay. So great, indeed, has been the change that Mr. Colenso, in a paper he has published describing a journey of his across the Ruahine Mountains in 1845, incidentally refers to the changes in the following words: "I have mentioned the trackless mountain forests of the Ruahine Range, but, if anything different, some of the open swampy plains near the sea in Hawke's Bay were worse . . . all but impassable. I may particularly notice the plain lying between Farndon and Pakowhai. Words fail me to show the original state of that land . . . I have often of late years asked myself, when contemplating from the hill (Scinde Island) the rising township of Napier and the inland grassy plains, with their many houses, gardens, and improvements, which of the two wonderful alterations—the building of the town of Napier or the great transformation of those swamps—I consider the most surprising, and I have always given it in favour of the plains."

In the year 1844 the plain as now known was really not occupied by the natives. Their settlements were mostly along the sea-beach, as they appear to have been when Captain Cook first visited the bay. There were settlements at the mouths of the Maraetotara Stream and of the Rivers Tukituki and Tutaekuri, on the Tongio Beach, and in certain small coves of the inner harbour. The Waitangi Creek, which has lately come into so much prominence, differed widely from what it now is. At high water canoes and small boats could

be taken through it, but at low water the place where the old traffic-bridge stood before the recent flood could be crossed without wetting one's boot-tops. On the Farndon side of the Waitangi was a small triangular piece of ground reserved by the various native hapus of the district as a common preserve for wild pigs. This spot, being a kind of "No Man's Land" among the natives, was allotted to Mr. Colenso for a dwelling-place, so that his services might be free to all. There Mr. Colenso dwelt from 1844 to 1854. On the Napier side of the Waitangi Creek, near its mouth, and extending in the direction of Napier, stood a large and important native settlement known as "Te Awapuni." The name is a suggestive one, for it means "a river whose mouth is closed or stopped." Still nearer Napier stood a large native church, and adjoining it, and covering a portion of the very area now known as the "washout," was the native burying-ground. I was anxious to obtain a history of this locality, because on visiting the site of the "washout," along the beach, a few days following the great flood, I collected a number of bones which were embedded in the swamp muds and blue sandy clays that are now exposed at low water in the vicinity, and from which the shingle has been entirely swept away. On taking the bones home I found that certain of them were human, and to clear up the mystery I interviewed Mr. Colenso in his sick-room at Woodville a few days ago, and from him the above facts were gleaned. It is interesting to find that the site of the "washout" has a history, but all traces of settlement had long since been obliterated, nor perhaps would any of the facts concerning the place have been made known had not the accidental discovery of a few bones led me to pursue my inquiries further when studying to unfold the geological growth of the plain.

But the site of the "washout" presents other aspects of importance interesting to the geologist and of great moment to the residents of Napier and surrounding district. This place is the weak spot in the line of sea-beach, and it has been sadly weakened in past years by the improper usage by the railway authorities of the shingle exactly in the line where the deposit is weakest. If the shingle beach were away the sea would flow at spring tide over a large portion of the flat lands between the Meeanee and Waitangi Bridges. The shingle beach is a protection against the inroads of the sea; but just as it provides a protection, so also it introduces a source of danger to settlement. Moving shingle at the mouths of rivers is a distributing factor in time of flood, and the opening of a single mouth for the two rivers Ngaruroro and Tukituki constitutes a line of weakness by the possible denudation of the shingle between Napier and the Waitangi Creek. To the north of the latter creek frequent changes

have taken place, and it was the weakening of the shingle deposits just at their junction with the alluvial beds which brought about the "washout," and produced such marked results in the shore deposits between Waitangi Creek and Napier during the Easter floods.

We have now to deal with the growth of the Heretaunga Plain in terms of time. If it were possible to measure the cubical contents of the material carried down by a river under specified conditions the task of finding out the number of years it has taken for the building-up of the Heretaunga Plain would be an easy one. But there are so many causes operating and so many contingencies acting as modifiers that whatever estimate is made as to the number of years it has taken for the plain to grow must be approximate only. The geological record is a long one, and, though the geologist may be certain as to the actual changes that have taken place within a specified area, he cannot be certain of the years that have passed between any two changes, because climatic conditions are not constant, and denudation depends entirely upon such varying conditions. As already explained, the annual rainfall in Hawke's Bay is under 40 in. on the average, but it is seldom that the average is just reached in any year. Often there is a diminished rainfall, and this may continue for several years, to be followed by a period of excess. These ever-varying results modify the action of rivers as denuding agencies in a striking manner. The denuding-power of moving water varies very greatly. This can readily be seen by pouring water down an inclined plane raised from the horizontal 1 in., and afterwards pouring down a similar quantity when raised 2 in. and 4 in. respectively. The velocity of the water is much increased, and just as the velocity is increased, so is its carrying-power as well as its wearing-power. It has been estimated that the carrying-power of water increases sixty-four times by simply doubling its velocity or rate of flow, and if the rate is trebled its carrying-power is increased no less than 729 times. It will readily be understood what wide differences may exist within a river-basin in the quantity of denuded products that may be carried down by a river when the flow is doubled and quadrupled beyond the normal flow. For example, during the late flood it is said on the best authority that portions of the district had a rainfall of 21 in. in forty hours. Very little of this quantity passed into the ground by soakage, as the lands were partially saturated from previous rains. The surface drainage passes into the main stream at a greater rate than it did a few years ago.

The diminution of forest lands, clearing, burning, and grassing of fern lands, and the drainage of swamps have

increased the tendency to quicker movement of the surface waters, and every act of the settler as he moves further and further back towards the watershed of the country operates in a like manner. Within the basins of the Rivers Tukituki, Ngaruroro, and Tutaekuri it may be assumed without exaggeration that not less than 10 in. of rainfall passed directly into the rivers during the forty-eight hours beginning at noon on the Thursday before Easter of this year. The drainage area of the three rivers amounts to 2,100 square miles, or 1,344,000 acres. As the quantity of water that flowed from each acre of land would on this estimate be 1,000 tons, the total quantity that found its way across the plains and eventually into the sea was not less than 1,344,000,000 tons, which is equivalent to 1,790,000,000 cubic yards. But how much silt may we suppose was contained in so much flooded water? Those who have been over the lower portions of the district will be able to form some estimate of the large quantity of sediment which the Ngaruroro and Tutaekuri Rivers brought down. There are places where the land has been raised 3 ft. and even 4 ft., and hundreds of acres have been covered with silt to a depth of 18 in. or more. A visit to Mr. Nelson's paddocks, between Pakowhai and Tomoana, on the plains, will show in some measure how heavily laden with silt the waters were when they reached the lower parts of the plain. The rapid diminution in the slope of the river-bed between Omaha and Pakowhai and between Redcliffe and Meeanee causes a sudden accumulation of water in the low-lying areas, and the waters are so heavily laden with sediment that deposition begins at once. On the assumption that one part in every two hundred by volume, or one part in every hundred by weight, of what the rivers brought down consisted of silt and *débris* of some kind, there were 8,960,000 cubic yards of sediment and shingle brought down by the combined rivers during the Easter floods. It has been explained that the estimated area of the whole of the fluvial deposits above and below the sea is not less than 125,200 acres, and the solid contents of this mass, supposing it to be 200 ft. in average depth, is 40,397,870,000 cubic yards. On this estimate, and supposing, further, that the rivers have carried down year by year, on the average, a similar quantity of material, it would have taken 4,515 years for the plain to have reached its present state. The period may seem long to those unaccustomed to deal with geological questions, especially when one sees on every hand such vast accumulations of mud as the result of a single storm. But the area over which the deposition has actually taken place is small compared with the size of the plain itself; but it is better to err on the side of over-duration in an estimate of this kind,



although we have positive proof of the rapid growth of river deltas in countries where occupation has been continuous for centuries, and the records are beyond cavil.

And here let me point out what is too often forgotten in considering the Heretaunga Plain such as it now appears to us. We see the rivers to-day emerging from the hill country, the Tutaekuri at Redcliffe and the Ngaruroro at Maraekakaho; but these rivers have been constantly pouring their waters into a receding ocean by ever-changing mouths. In all deltoid rivers the leading channels change from time to time as the land is raised or the bed becomes silted. The study of the contour lines of the plain is full of interest. One can imagine the direction of the main line of growth of the plain as it extends outwards from the openings among the hills at Omahu and Roy's Hill. With a fan-like extension the plain is seen to expand towards the south, south-east, east, and north-east, a central ridge of higher land running like the central piece in a Chinese fan along the plain westward from Hastings. From this ridge there is a gradual slope, a long one and a comparatively short one, towards the sea, the long slope following the old course of the river by way of Havelock, and the short one the line of the present flow.

I have brought the history of the plain to the present day. Man is now in possession, and the question has become a utilitarian one. Every one recognises that rivers will continue to flow, but what man wants is that the rivers may flow, and fertilise it may be, without injuring himself or his interests and prospects. In considering this aspect of the question it is needful to inquire into the rate at which the rivers flow. It is estimated that the slope of a navigable river ought barely to exceed 10 in. a mile, and Geikie says that the great rivers of the globe have a less slope than 24 in. a mile. Then, the River Thames, in England, has a slope of 21 in. to the mile; the Shannon, in Ireland, 11 in.; the Nile, below Cairo, 4.35 in.; and the Volga, 3 in. Now, the rivers that pour their waters into the bay near Napier have a much greater fall than either of these, for there is no portion of the plain where the slope does not exceed 20 in. or even 30 in. a mile. If, for example, we take the Ngaruroro and trace its course, it will be found to partake more of the character of a torrential stream than of a river such as is generally understood by this term. The length of the river is about sixty miles, and it rises at an elevation of 1,800 ft., at the back of the Kaweka Mountains. For four-fifths of its course it has a fall equal to about 40 ft. a mile; between Omahu and Pakowhai the fall would be about 8 ft. a mile; and between Pakowhai and the sea the fall is less than 4 ft. a mile. It will be noticed from these facts how much greater is the slope

of the Ngaruroro than either of the rivers named above, and what has been remarked of the Ngaruroro is especially true of the Tukituki and Tutaekuri Rivers.

Whatever the trouble may be in the lower portion of the plain, it all resolves itself into this one difficulty of slope. We have to deal with torrential streams where the flow, as illustrated by the movement of water on a sloping table, has a high inclination for four-fifths of the course, and is then suddenly checked by a foot-like expansion in the lower course. Between the upper and middle course the rate of flow is as 5 to 1, between the upper and lower it is as 10 to 1, and between the middle and lower as 2 to 1. It will be readily understood from these facts how overflows occur in the lower parts of the river when it is remembered that the rate of flow is not merely proportional to slope, but that the carrying-capacity varies directly as the sixth power of the rate. The quantity of water that flows down the rivers under notice during their normal condition is so small that it merely has the effect of keeping the beds partially filled along their lower reaches; but the case is different in times of excessive rainfall, and it is this difficulty that presents itself for solution.

Everywhere over the Heretaunga Plain there ought to be no difficulty whatever as to drainage, nor would there be but for the devastating flood-waters which cover the plain at irregular intervals. These waters for the greater part of their course are swollen by numerous mountain streams, and they reach the plain at a rate which makes it impossible for the beds in the lower course to carry them away without spreading over the plain. Being full of sediment, deposition begins at once; the beds become partially silted, and a deltoid area is formed in the direction of the general flow to the sea. In the case of the Ngaruroro River the shingle bar at its mouth presents a difficulty of a real kind, but were there an open mouth floods would still continue, for the plain-making period is yet far from being closed.

It has been pointed out that the question to be considered is not what ought to be done under normal conditions of flow. But what is it that is necessary to safeguard the interests of settlers during floods such as that experienced in April? Floods are as certain to recur as are the changes of day and night, and as settlement proceeds we must expect rivers to rise and fall even more suddenly than now. The bush is rapidly disappearing from within the basins of each river under notice, and the very mountains are losing, in many places, their capping of vegetable soil. Blowhard, near Kuri-papanga, and the Kereru, are cases in point. Denudation under such conditions is most rapid, and the scour in the rivers will increase in intensity unless the settlers themselves

replace in certain areas what has been in too many cases wantonly destroyed. I refer to the destruction of scrub and small bush areas. Planting along the banks of rivers and streams is becoming a necessity, and were this carried out in the upper parts of the river-basins in Hawke's Bay it would be one sure and economical way of retarding the flow of water into the rivers at times of excessive rainfall.

It should not be forgotten that other countries suffer from floods similar to those experienced here, and people have endeavoured from time immemorial to regulate waters within the delta of rivers such as the Rhine, the Nile, and the Po. Low-lying areas similar to the Whare-o-maraenui Swamp are found along the eastern coast of England in what is known as the fen district, as also in Holland. It would be needless to point out what has been done in England and Holland to make habitable lands far lower than those in the vicinity of Napier. Tens of thousands of acres of fens and polder lands are now utilised, and the same could be done here at little cost and with great advantage to the district under efficient administration.

But for an example corresponding to our special case we must go to the plains of northern Italy, where the Rivers Po and Adige flow. These rivers drain the whole of northern Italy, and pour their turbid waters into the Adriatic by a delta extending along the coast for many miles. A continuous history of these rivers can be traced from the days of the Roman Republic till now, and it is known that large marshes and lakes that once covered the plains have been filled by the sediment brought down, whilst the rivers themselves have changed their courses during historic times. To stay if possible the great changes that were constantly going on the people adopted a system of embankment by which the Adige and the Po and most of their tributary streams were confined within artificial banks. By this means the velocity of the rivers seaward was increased, and more sediment was carried down from the land to the sea. But the plan did not stay the deposition of sediment in the bed of the river, so that silting began, and, to keep pace with the silting, banks had to be raised, and even the river-channels had to be cleared of the sand and mud as each flood season or period passed by. "Streams traverse the country," says Sir Charles Lyell, "on the top of high mounds, and at Ferrara the surface of the Po is higher than the roofs of the houses." By this means the water has been kept under control, but it is by a very heavy expenditure of time and money.

I do not think that a similar plan, were it adopted for the regulation of the rivers passing through the Heretaunga Plain, would be of the slightest use. The enormous quantity of

sediment that is brought down by the Ngaruroro and Tutae-kuri Rivers during the few hours in which they are usually in flood could not be carried away by any plan of artificial embankment. The torrential waters from the upper reaches of the rivers are overcharged with sediment, and so soon as the flat lands are reached sedimentation begins at a rapid rate, for the reasons already stated. Here the difficulty is not merely one of an over-supply of water, but an over-supply of sediment. Nothing would be more advantageous to the land embraced within the deltoid area of the plain were it possible to distribute the sediment brought down in time of flood in such a manner that no injury to settlers would ensue, and after all it is this aspect that must receive attention at the instance of engineers. Were it to the advantage of the district to send all flood-waters seawards no doubt a plan could be devised to bring this about, but it should be remembered that, as in Italy, the expenditure and the danger of such a scheme must ever be on the increase. Could the slope of the Ngaruroro in the lowest portion be made to correspond with the slope in the middle portion there would still be overflows, and the deposition of sediment from the rivers in time of flood. The river-beds that pass through the plains are much smaller than the beds among the hills, where the waters have worn wide and extensive channels, and every year the tendency is for the rivers to increase their rate of flow, there being no obstacles to encounter such as were common in the earlier days of settlement.

Planting along the main streams and the numerous tributaries has become a necessity, and this should form a part of any river-conservancy scheme, otherwise there will certainly be more marked changes in the coming years over the Heretaunga Plain than even the past half-century has shown. From the present contour of the Heretaunga Plain it is known what direction the flood-waters are likely to take on the overflow of the Rivers Tutae-kuri and Ngaruroro. If we suppose that no action of any kind will be taken to regulate the flow, the flood-waters will make for themselves new channels, anticipatory, as it were, of the time when the old channels will have become choked with sediment. The present Ngaruroro River even now occupies the bed of what is known as the Waitio Stream, it having left its own bed, which flows past Havelock, at Roy's Hill many years ago. During the April flood the river overflowed its left bank near the Omaha Pa, and its right bank between Roy's Hill and the limestone hill near the Omaha Bridge. The Tutae-kuri also broke through the right bank at the Moteo, and came down near Mr. Donnelly's home-stead, and joined with the overflow waters from the left bank of the Ngaruroro. This combined stream passed Mr. Kittow's

at Waima, and Mr. Hollis's, Papakura, and covered the whole of the country extending from the right bank of the Tutaekuri at Redcliffe to the Ngaruroro below Omaha, and thence to the sea. Those who choose to study the contour of the plain will see that this flow of waters represents the natural slope of the plain which includes the deltoid area, and it is this area that requires the particular attention of those who serve on the several Conservancy Boards.

It has already been pointed out that the site near the mouths of the Tukituki and Ngaruroro Rivers, and now known as the "washout," is one of special interest, and I desire here to emphasize the opinion that it should be held as criminal to break the shingle cap which slopes towards the lagoon near this spot. Through many years the beach has received the washings from floods and the dust from westerly storms. The interstices of the shingle have become partially stopped, and so far as the surface is concerned the percolation of the water from the ocean has practically ceased. If those who take any interest in such apparently small things will visit the "washout" they will see by the wayside a deposit of fine mud of varying thickness. This mud, when drying, has cracked, and shows lines of cleavage in a remarkable manner. The mud is impervious to water, or nearly so, and just as this deposit is of extreme value in the way of strengthening the beach, so the dust and mud which have passed down through the shingle in years gone by are of great value, and under no consideration should a break be permitted, otherwise, like an old wound, it will enlarge its borders, and produce further mischief. But of the "washout" something more must be said. I am no engineer; but, as a close observer, and as one who is acquainted with the detailed topography of the district, it seems to me that the late flood has shown those interested in river conservancy what course they should adopt. Is it not possible to construct channels of ease for the surplus waters of the rivers? It has been shown that the rivers contain so much suspended material that as soon as they reach the middle course, where the fall per mile is one-fifth that of the upper course, sedimentation begins. A constructed channel in the line of direction such as the waters would naturally take under free conditions of flow could be formed so that the overflow waters from the rivers might be led to the same place, that place being the "washout." I have named this place because there is no other along the whole line of beach so weak and yet so possible to control. The "washout" is land forming an integral part of the plain. The beds exposed do not extend under the shingle in the direction of Napier, and were a breach to be made, say, at Awatoto for the benefit of the Tutaekuri River it would be

impossible to keep an open mouth, as might be done at the "washout," where a little engineering skill could easily provide for a permanent mouth in the thin line of shingle beach close to the place where the Tukituki and Ngaruroro now empty their waters.

To me it is a very unwise thing to neglect the factor of sedimentation in considering the question of flood-waters. Let every effort be made to devise a plan so as to lessen the loss and inconvenience from flooded lands; but the sooner sedimentation is allowed full play the sooner will the areas now subject to floods be above their reach. When people are made aware that floods are certain to occur, they should anticipate the danger in the construction of their houses, the arrangement of their fences, the planting of their trees, and the direction of their drainage. Information bearing on these important matters should be supplied to settlers either by Government or Conservancy Boards, and, above all things, the drainage over the entire district should form part of a connected whole, no settler being permitted to drain his lands except on one general and approved plan, devised for the common good. In any case the plain will go on increasing. Men can modify nature's plans, but they cannot stay nature's operations. Science is nature's schoolmaster, and there appears no reason why, under proper organization, something cannot be devised to regulate the rivers in such a way that in time of flood their devastating effects may be minimised, or, rather, so used that their burden of fertility may be spread over the deltoid area, and so anticipate the time that is to be, when the Whare-o-maraenui and other parts of the Napier swamp will be the abode of an industrious and, let us trust, a prosperous people.

The following summary shows the changes that have taken place in the geological evolution of the Heretaunga or Hawke's Bay Plain:—

1. The area of sea now known as Hawke's Bay, together with the Heretaunga Plain, was once covered with limestone.
2. The Kidnappers, Portland Island, Te Mahia, and the surrounding areas were then united.
3. A period of subsidence began. It was a time of great volcanic activity in the interior of the Island, and during subsidence large quantities of volcanic material were deposited at the Kidnappers and other places within the subsiding area.
4. Subsidence produced modification in the drainage areas. The Ngaruroro and Tutaekuri began to flow as now, except that the bay then extended to Maraekakaho, and perhaps beyond.
5. The Tukituki River still flowed south as a branch of the Manawatu.

6. As the plain—a deltoid area—grew the Tukituki found its way through the fractured and subsiding limestones at the back of Havelock. At this time the Ruataniwha Plain was a lake-like area.

7. The discovery of artesian wells shows the general character of the beds forming the plain as they were deposited fan-like within the area of sedimentation.

8. The Rivers Ngaruroro and Tutaekuri flowed into the bay between Omahu and Mr. Donnelly's homestead.

9. The rivers altered their direction from time to time, and the Tutaekuri wore through the soft limestones between Puketapu and Redcliffe, and began to flow into the bay from this point.

10. The shingle beach is separate as a formation from the plain, the material for which is provided by the Tukituki River and the washings from the Kidnapper conglomerates.

11. The slope of the plain is generally east by south and east by north, and the "washout" may be taken as the central point seaward.

12. The high slope of the rivers is the cause of floods, and only channels of ease can modify their possible effects within the deltoid area.

13. Planting should be carried out along the banks in the upper course of the rivers, under the direction of a Conservancy Board, whose work should also include the supervision of drainage within a specified area.

14. The mouth of the Tukituki River, including the "washout," should be kept open, and all drainage should be directed towards the mouth.

15. The shingle beach should not be disturbed on the inner side.

[This article was accompanied by the following illustrations, which were received too late for reproduction. They are fortunately not necessary for the interpretation of the author's very lucid descriptions: Map of Hawke's Bay District; geological and topographical map of Here-taunga Plain; section showing Kidnapper conglomerates; section of artesian wells, showing bedding of plain; map of Hawke's Bay extended, with Kidnapper and Mahia joined; section showing growth of plain; cross-section of same plain.—ED.]

---

ART. LXVII.—*On Swallows and Martins at Hicks Bay.*

By H. HILL, B.A., F.G.S.

[Read before the Hawke's Bay Philosophical Institute, 1st April, 1898.]

IN Sir Walter Buller's "History of New Zealand Birds" there are several interesting accounts given of the appearance of the Australian tree-swallow (*Pterochelidon nigricans*) and the Australian swift (*Cypselus pacificus*). Specimens of the former were seen at Taupata, near Cape Farewell, on the 14th March, 1856, at Wakapuaka, in the vicinity of Nelson, in 1851, and on the banks of the Opawa River, near Blenheim, on the 9th June, 1878. In vol. xxvii. of the Transactions, page 108, Sir Walter Buller gives two other instances of the appearance of the Australian tree-swallow as seen by Mr. Guthrie-Smith at the Mahia in August, 1893, and by Mr. James Dale, of Collingwood, in June of the same year. Of the latter, only one instance of its appearance is recorded—viz., that by Major W. B. Messenger, who, in a letter to Sir Walter Buller, relates that in December, 1884, he shot an Australian swift near the Town of New Plymouth. Both birds are common in Australia, but the above records show how rarely they are met with on the New Zealand coast.

A recent appearance of each variety in this colony has lately come under my notice. Mr. Henderson, sheep-farmer, of Matakawa, Hicks Bay, has informed me that in April last he saw a number of swallows flying about for several days near his homestead. They were somewhat of a russet-brown on the back, and slightly smaller than the swallow seen in the south of England. They remained in the vicinity of his house for several days. Curiously, in the first week of June following martins made their appearance, and they also flew about for several days near the house, and then apparently took their departure northward, for he noticed them moving in the direction of the Bay of Plenty. This is the only occasion on which Mr. Henderson has observed these birds, although a resident in Hicks Bay for a number of years. Should they again make their appearance an effort will be made to obtain specimens of each for the purpose of seeing whether they belong to Australia or to the islands of the Pacific.

---



ART. LXVIII.—*On Maori Middens at Wainui, Poverty Bay.*

By F. HUTCHINSON, Jun.

[*Read before the Hawke's Bay Philosophical Institute, 13th September, 1897.*]

LEAVING Gisborne by the Gisborne–Tolago Road, a pleasant walk of about three miles brings one out on to the sandhills of the coast at Wainui. Amongst these sandhills, both up and down the coast, are to be found great heaps of shells, with burnt stones, flakes of obsidian or native glass, and flint chips, mixed with great numbers of bird, fish, and other bones, marking old native camping-places, or middens as they are sometimes called. Many interesting details of the ways of primitive man have been made out from the contents of the old Danish kitchen-middens, and these middens of our own country will be found no less instructive. Some of these cooking-places are of quite recent date, as is evident from the presence of the bones of cattle, large dogs, and other imported animals; but there are also the refuse-heaps of a vastly older period, telling of the times when the great moas ranged through the adjacent thickets and swamps, and on the hills that remarkable lizard, the tuatara, was plentiful; while the little brown native rat, the *kiore Maori*, abounded in the bush, and was used as an article of food.

The greater part of these old middens lies buried under the low hills of shifting sand, but here and there the winds, and in places the sea, have swept the old land-surface bare, leaving exposed a wonderful collection of bones and shells, showing what varied fare these old moa-hunting lizard-eating men lived on. About the best exposure of this kind lies down the coast, about a quarter of a mile from where the road first reaches the sandhills. Here, on the south side of the creek that drains an extent of flats that open out on to the coast, is a space of a few acres swept clear of sand, cut into four levels or terraces, each about 3 ft. high. These terraces face seawards; the uppermost is on a level with the surrounding flats, and the lowest merges into the sand of the beach. They are formed of a hard brown sandy loam, and are literally white with the multitude of bones and shells upon them.

Human bones are plentiful, grim tokens of many a wild cannibal feast; also numbers of moa-bones, and quantities of the fragments of their shells. Here, too, are the neat little saw-like jawbones and cupped vertebræ of the tuatara, a lizard some 20 in. in length. It is said to have been com-

mon here till some sixty years ago, but is now extinct on the mainland; it is still found on a few of our outlying islands, but nowhere else in the world. Rat remains are plentiful, skulls, jawbones, and delicate incisors forming, with their other bones, tiny drifts, in places inches thick. The *kiore Maori* must have been much smaller and slighter than our grey Norway rat, judging from these bones. With these are vast numbers of the bones of land-birds, sea-birds, fish, and piles of the shells of pupus, pipis, pawas, and others, mixed with flint and obsidian flakes and cooking-stones.

The human and moa remains seem confined to the three lower terraces; they are all much worn, and when freshly extracted from the soil were, with the exception of the lower mandible of a moa, very brittle, crumbling away if not carefully handled. The moa-egg shells occur in little piles of fragments varying from 1 in. to  $2\frac{1}{2}$  in. in diameter. So sound are they and the markings are so distinct that it is hard to realise that they have lain buried for years, probably centuries. The highest of these little terraces has evidently been occupied quite recently, as mixed with lizard-bones, which are the only ancient remains, are the bones of cattle, large dogs, seals, and whales, all apparently having been eaten there within the last twenty or thirty years. The flint and obsidian flakes or knives so common here are all more or less worn and blunted by use and the action of the wind-blown sand, but must have made, in the absence of metals, most efficient tools for skinning, shaving, tattooing, and other light work. A large block of obsidian was kept in every camp, and each made his own knife by tapping off flakes till a suitable one was procured. These knives were used till blunt and then thrown away, not treasured up and sharpened again and again like the worked-up stone adzes and meres. We hunted long and carefully in the hopes of finding one of these obsidian blocks; but in vain, only securing a small flint core from which a few flakes had been roughly chipped.

Amongst the bone drifts one can easily distinguish the beaks, breast-bones, &c., of kakas, pukekos, wekas, and a host of smaller land-birds; also the strange flattened tarsi of penguins, and the slender pipe-like wing-bones of the strong-flying sea-birds; while amongst the fish are the teeth of whales and sharks, the hoof-like grinders of the stingaree, the long serrated fin-spines of the elephant-fish, besides a host of others too numerous to mention.

These terraces run under low sandhills which extend for about a quarter of a mile southwards, where they are stopped by a spur of the coastal range. There is a deep hollow between the sandhills and the spur. This hollow reminds one of the description of the Roc's Valley in "Sinbad the

Sailor," so full is it of dead men's bones, which have worked down from a layer which shows out some 30 ft. up the face of the spur. The layer is said to be the level of an old burying-ground, which seems likely enough, as, with the exception of a few lizard-bones and obsidian flakes, the remains are all human, unmixed with cooking-stones. These bones are in a much better state of preservation than the larger kinds of bones on the terraces below, and are very thick and massive, particularly the skull-bones, of which we found many fragments but no perfect specimens, the perfect skulls having no doubt been carried off long ago. Stone weapons and bone and wood combs have been found here, but we were unsuccessful in getting any, probably from the same reason that we found no perfect skulls.

This spur ends precipitously over the beach, and is the first of a succession of sea-faces of grey marl. The remains of a terrace runs along these faces for some distance, at a height of about 100 ft. above the sea. In the black soil of this terrace are again the burnt stones of the "copper Maoris"\* and heaps of shells, but we could find no human, moa, or lizard remains. If it had not been for the unmistakably burnt stones and shells I should have put it down as a raised beach, as, further up the coast, beyond Turehau, are beds of shells at quite as great a height, wonderfully fresh in appearance, that have undoubtedly been left by the sea.

A curious feature here is the immense numbers of the bleached shells of land-snails amongst the other remains. The greater part of them are the tiny fellows so common in our shady gullies, ranging from  $\frac{1}{8}$  in. to  $\frac{1}{3}$  in. across, but having amongst them one large species (*Rhytida greenwoodi*) measuring nearly 1 in. in diameter. It puzzles me to account for their presence here in such numbers. Nowadays great numbers may be found in the drifts left by floods on the banks of streams draining suitable country, but they are too evenly distributed here to be accounted for in this manner. The smaller species may have found a living on the old land-surface when it was covered with herbage; if so, it is curious that they are so well preserved, as the shell soon rots away, as a rule, when the occupant is dead. I have never seen a living specimen of the large *Rhytida* in Poverty Bay, though I have heard of a shell answering to its description from the Tolago Bay district. In Taranaki, where it is fairly common, it haunts the dankest and darkest gullies, where under rotten logs and dead nikau-heads it and its tiny lime-shelled eggs may be found; but I never saw it in the class of vegetation that would clothe these middens. On asking a Maori of North

---

\* ? Kapura Maori.—Ed.

Auckland if the great purangi, our largest land-shell (*Paryphanta busbyi*), was edible, the answer was a decided negative, in which disgust and amusement mingled, so that it is hardly probable that this smaller species was collected for food.

There is one land-shell that this locality thoroughly suits—that is, *Helix aspersa*, the garden snail. It swarms under the sparse vegetation of the sandhills, and numbers of its dead shells lie mixed with the moa- and lizard-bones of the middens—a strange contrast.

One of my visits was at low tide, and all down the coast great stretches of slippery shining reefs, with fascinating pools and weed-clad ledges, lay shining in the sun, teeming with the life of the sea. These ancient shell-eaters had their harvest right at their doors, and the shell-heaps show how varied were their takings. Even the sea-slugs were laid under contribution, as I found fine specimens of the duck's-bill limpet (*Parmophorus*) on the heaps. It is common under the stones on the reef, the black, slimy, slug-like body in which the flat white shell is deeply immersed looking anything but inviting for food.

In conclusion, I would say that a much pleasanter though rather longer route to these middens is by going out past the Gisborne Breakwater and up the beach till opposite what is called "the island," where an old tramway-track runs through a saddle in the coast range and joins the coast road within half a mile of the middens. This route, however, is only available at low tide, as at full tide the sea washes right up to the low cliffs on the town side of the island.

---

NEW ZEALAND INSTITUTE



# NEW ZEALAND INSTITUTE.

---

## TWENTY-NINTH ANNUAL REPORT.

MEETINGS of the Board were held on the 21st July, 1896, and on the 11th January and 12th March, 1897.

The incorporated societies, in compliance with clause 7 of the Act, elected for the year Major-General Schaw, C.B., R.E., Mr. S. Percy Smith, F.R.G.S., and Mr. James McKerrow, F.R.A.S., to represent them on the Board.

The following gentlemen were elected honorary members of the Institute to fill the vacancies caused by the death of the late Professor Riley and the late Baron Sir F. von Mueller, viz.: Professor Richard Lydekker, B.A., F.R.S., of the British Museum, on account of the eminent service he has rendered to science in New Zealand by the publication of his invaluable descriptive catalogue of fossil reptiles and birds, which deals largely with collections that have been made in this country; also Professor Horatio Hale, M.A., F.R.S., of Clinton, Ontario, Canada, on account of the eminent service he has rendered to science in New Zealand by the publication of his researches in philology, especially embodied in the volumes of Commodore Wilkes's United States Exploring Expedition in the Pacific.

Before the certificate of election had reached its destination, unfortunately Professor Hale died, and the vacancy was filled by the election of Professor S. P. Langley, Secretary to the Smithsonian Institution, in recognition of the great assistance scientific workers receive from him in his official capacity as successor to our late honorary member, Professor Spencer Baird, and of the brilliant additions he has made to astronomical science.

During the past year the Institute has lost another honorary member by the death of the late Admiral Sir G. H. Richards.

The members now on the roll are: Honorary members, 29; Auckland Institute, 173; Hawke's Bay Philosophical

Society, 79; Wellington Philosophical Society, 137; Philosophical Institute of Canterbury, 79; Otago Institute, 122; Nelson Philosophical Society, 21; Westland Institute, 53: making a total of 693.

During the year the death of a generous donor to the Institute, Mr. Charles Rooking Carter, has taken place. Mr. Carter, prior to his death, presented about nine hundred separate works, consisting of nearly fifteen hundred volumes. All these works relate more or less to New Zealand affairs, and form one of the most valuable collections of the kind in existence. A full catalogue of the whole library, including Mr. Carter's collection, is now in the printer's hands. Mr. Carter also left a sum of money to assist in preserving the collection, and a further sum for the establishment of an astronomical observatory in Wellington.

An important event in the work of the Institute is the publication of the first part of an illustrated work on "Maori Art," by Mr. A. Hamilton. This important descriptive work is the result of much hard labour, and at an expense not wholly borne by the Institute. The author has, with his camera, visited many outlying parts of Maoriland with great enterprise and success. He has also been accorded liberal aid by the custodians of public museums and owners of private collections in making his illustrations thoroughly complete. Part I. describes the canoes of the Maoris, and has an introductory chapter giving a structural and historical account of the Maori canoes and of the wonderful display of art, knowledge, and labour used in their construction. This part contains ten photo-process plates, representing twenty-seven characteristic carvings, and each illustration has its description on the page opposite to the plate. There are also many illustrations distributed in the text of the introductory chapter and letterpress. The whole part contains sixty-eight quarto pages. Five parts will complete the volume, and the succeeding parts will be devoted to the following subjects: Part II., Dwellings; Part III., Weapons; Part IV., Dress and Decoration; Part V., Social Life. Upwards of five hundred photographs have already been secured for the illustration of this national work, and steps are being taken to secure all that are required to preserve for future reference the intellectual and artistic achievements of the Maori race before they are lost. The printing of this fine work is being done by Messrs. Fergusson and Mitchell, of Dunedin, in an admirable manner.

The volumes of Transactions now on hand are: Vol. I. (second edition), 235; Vol. V., 10; Vol. VI., 18; Vol. VII., 100; Vol. IX., 100; Vol. X., 130; Vol. XI., 29; Vol. XII.,



30; Vol. XIII., 32; Vol. XIV., 55; Vol. XV., 165; Vol. XVI., 165; Vol. XVII., 165; Vol. XVIII., 140; Vol. XIX., 155; Vol. XX., 158; Vol. XXI., 90; Vol. XXII., 90; Vol. XXIII., 165; Vol. XXIV., 170; Vol. XXV., 170; Vol. XXVI., 175; Vol. XXVII., 178; Vol. XXVIII., 200; Vol. XXIX., not yet fully distributed.

The volume (XXIX.) just published contains sixty-two articles, together with addresses and abstracts which appear in the Proceedings. The work consists of 680 pages and 48 plates.

The following gives a comparison of the contents of the present volume and that for last year:—

			1897.	1896.
			Pages.	Pages.
Miscellaneous...	...	...	178	204
Zoology	...	...	154	286
Botany	...	...	208	134
Geology	...	...	32	64
Chemistry	...	...	18	28
Proceedings	...	...	45	47
Appendix	...	...	45	45
			—	—
			680	808

The cost of printing Vol. XXVIII. was £485 6s. 2d. for 808 pages, and that for the present volume (XXIX.) £433 6s. 9d. for 680 pages. This includes the preparation and printing of the plates.

The Honorary Treasurer's statement of accounts shows that there is a balance in hand in the current account of £3 8s. 11d.

The amount appropriated for the publication of memoirs and postponed papers (according to resolution) is now £744 1s. 1d.

JAMES HECTOR,  
Manager.

Approved by the Board.  
THOMAS MASON,  
Chairman.

3rd September, 1897.



# PROCEEDINGS



## WELLINGTON PHILOSOPHICAL SOCIETY.

FIRST MEETING: 30th June, 1897.

Mr. W. T. L. Travers, F.L.S., President, in the chair.

*New Member.*—Mr. A. C. Gifford.

A copy of Vol. XXIX. was laid on the table.

An address was delivered by the President "On Material and Scientific Progress in New Zealand during the Victorian Era." (*Transactions*, p. 1.)

Major-General Schaw moved a vote of thanks to the President for his excellent address. It brought before them in a most interesting and instructive manner a *résumé* of scientific work and the general progress of the colony during the period named.

Mr. Hustwick, in seconding the vote of thanks, said it was a most interesting address, and one could not but admire the zeal and energy displayed by the President during so many years in the cause of science. He could indorse what was said regarding chemistry: it had revolutionised our manufactures and industries, and improved the health of the people in all countries.

Sir J. Hector spoke of the long and distinguished services of the President, who had that evening delivered his sixth Presidential address. During the thirty years the Society had been in existence Mr. Travers had contributed forty original papers, filled with original thought and original research. The work of the President should be an encouragement to younger members, who were greatly mistaken if they supposed that the field of research in this colony was exhausted. The surface had so far been merely skimmed. In chemistry the world was now on the verge of enormous discoveries. In palæontology there was room for all the scientific skill and observation that could be brought to bear. We might look forward to still greater triumphs of science, for no half-century in the world's history had seen such solid advance as the last.

Mr. Maskell complimented the President for his very able address. In respect to the advance made in chemistry, mentioned in the address, he said that certain students of the New Zealand University had distinguished themselves in that branch of science. One of these, Mr. E. Rutherford, was already known as one of the foremost men in physical science. He referred also to other workers in science in New Zealand who had distinguished themselves.

Mr. Tanner said he was quite sure that it gave all present great pleasure at hearing such a capital address.

Mr. Travers returned thanks for the vote, and stated what he had done had been a labour of love. He gave an account of the history of the New Zealand Institute, which had been established to gather together and place on record the observations and researches of scientific men.

Sir James Hector exhibited and explained the following additions to the Museum collection, prepared and mounted by Mr. A. Yuill, the taxidermist:—

1. *Histiogaster labiosus*, a rare fish cast up during the Easter gale at Island Bay, and presented by Mr. Hurcomb.
2. Eagles, adult and young (*Haliæetus leucocephalus*), from San Mateo.
3. King penguin (*Aptenodytes pennantii*), from Macquarie Island.
4. *Nesonetta aucklandica* (flightless duck), from Auckland Island.
5. *Eudyptes chrysocomus* (penguin), from Antipodes Island.
6. *Ocydromus earli* (woodhen), from Dusky Sound.
7. *Carpophaga novæ-zealandiæ*, a brown variety of the native pigeon, presented by Mr. Elder.

---

SECOND MEETING: 14th July, 1897.

Mr. W. T. L. Travers, F.L.S., President, in the chair.

*New Member*.—Mr. Digby A. Jenkins.

*Papers*.—1. "Histories of the Storms of the 30th January and the 16th April, 1897," by Major-General Schaw, C.B., R.E. (*Transactions*, p. 477.)

Sir James Hector thoroughly agreed with the author that the weather-charts require to be drawn on a spherical and not a Mercator's projection. It would be found, as he had previously stated, that the compression of the degrees of longitude, and the rapid easterly progress of the cyclonics, would tend to eliminate these easterly winds, and cause them to appear as curves open to the south, so that all the winds would be westerly. This was no doubt the cause of the "roaring forties." All observations, however, taken towards lat. 80° S. show that there is a great belt of permanently low pressure about 15° from the South Pole, and south of which easterly and south-east winds prevail. He thanked the author for the great labour he had bestowed on this interesting investigation.

Mr. Tanner quite agreed that it was uncertain to go altogether by observations taken on the surface of the land, and this applied especially to the direction of the wind. He pointed out how he had once been lost on Kapiti Island in a fog which was driven in opposite directions, and made it difficult to find his true position.

Major-General Schaw said the observations made by Sir J. Hector on the probable cause of the absence of the easterly element in most of the antarctic storms which reached us were extremely interesting and valuable. It might be that he had hit upon the cause of the phenomenon; yet at present he (General Schaw) did not feel able to accept his explanation, because the onward motion appeared to him to partake of the nature of a wave, while the wind or circulation of the air in the storm had the nature of a current, and the one very slightly influenced the other. The

discussion of the question was mainly theoretical now, because they had but few facts to guide them, but the discussion was far from being useless, as it would give hints to interpret the additional facts which they might hope to obtain in the near future.

2. "Description of a New Species of *Drimys*" (*Drimys traversii*), by T. Kirk, F.L.S. (*Transactions*, p. 379.)

After reading the paper the author described how, in 1578, in the time of Elizabeth, this plant had been found by a Captain Winter, and the bark used by his crew for scurvy. He took a supply away with him. On Cook's second voyage Forster collected it in South America.

Sir James Hector was surprised that Mr. Kirk proposed to throw over *Drimys colorata* as a good species. It could not be well confounded with *D. axillaris* in the field. The new plant just described was not uncommon in the uplands at the source of the Aorere, and grew with the habit of *Veronica*.

Mr. Travers knew the country where this plant came from. It should be thoroughly examined by botanists. There was almost a distinct flora there. In Gollan Downs and the Taitapu he had found orchids, and sent them to Sir J. Hooker. They were disappearing.

Mr. Kirk, in reply, said there were no well-marked differences between the North and South Island forms of these plants, so that he could not find sufficient characters to distinguish them. He was, however, inclined now to alter his opinion since examining this new species, and to lean more to the opinions held by Sir J. Hector, Mr. Colenso, and Mr. Buchanan.

3. "On the Higher Physical and Social Laws," by Coleman Phillips. (*Transactions*, p. 122.)

Mr. Tanner said the author deserved credit for his efforts to bring forward this question of vital force. Had there been time, some of Mr. Phillips's theories would be challenged.

Sir J. Hector, in reference to one part of the paper, described how the beavers cut down trees and selected their homes.

### THIRD MEETING: 4th August, 1897.

Mr. W. T. L. Travers, F.L.S., President, in the chair.

*Papers.* — 1. "On Marsh-lights," by R. C. Harding. (*Transactions*, p. 87.)

Mr. McLeod said marsh-gas was stated in a recent publication to be caused by the mingling of animal and vegetable decomposition, called phosphuretted hydrogen, which, coming in contact with air, ignited. Chlorine gas was one of the few substances known to destroy it. Will-o'-the-wisp was first noted by Franklyn in 1764, and by Campi in 1767.

Sir James Hector said the subject was interesting, but required further observations. The accepted view was that it was the combustion of small escapes of marsh-gas, or methane; but it was more probable to be the phosphorescence caused by a mixture of that gas with hydrogen phosphide. He reminded the Society that the late Mr. J. C. Crawford had described the flickering light that hung in the drains he cut in swampy ground on the Miramar Peninsula.

Mr. Tregear said that what Mr. Harding had seen was a different light from that usually called Will-o'-the-wisp, or it was seen under

different conditions. These lights were also known as "prison candles," and were supposed to have a bad omen. There were several varieties, and Mr. Harding's light seemed to be quite new.

Mr. Maskell said it was difficult to understand how gas coming from dry stony ground could be marsh-gas. He thought the light described by Mr. Harding was what was known as Will-o'-the-wisp. He hoped Mr. Harding would make further observations.

Mr. McKay had seen something akin to this in the dry ground in the Waipiro district. The dull flame covered over half a square mile of ground.

Mr. Hustwick could hardly see how the phosphorous element would be supplied, as the amount of decomposed animal matter would be very small compared with the vegetable. As marsh-gas (light carburetted hydrogen) was a compound of hydrogen and carbon, and possessed no property of luminosity, and as phosphuretted hydrogen would ignite on coming into contact with the atmosphere, it might therefore be that soil producing marsh-gas might contain sufficient of the phosphorus element derived from decomposing animal matter to cause spontaneous ignition, and so produce the *ignis fatuus*. But the remarkable part of Mr. Harding's paper was his description of the birth of the luminous gas-bubble with its clearly defined form, which, in spite of the well-known law of the diffusion of gases, preserved its individuality and separate existence instead of being absorbed by the surrounding atmosphere, and also that it, with the other luminous forms mentioned, should accompany his footsteps so persistently, and even anticipate the direction he intended to take.

Mr Harding briefly replied.

2. "On the Manu Mea, or Red Bird of Samoa," by the Rev. J. B. Stair; communicated by E. Tregear, F.R.G.S. (*Transactions*, p. 293.)\*

Sir James Hector said this was a most interesting and useful paper. As regards the old travellers not having known this bird, it was equally strange that Captain Cook could not have observed the kiwi in New Zealand, although several other birds had been noticed.

Mr. Travers remarked that it was curious that, although Mr. Stair drew attention to the rarity of this bird, in one part of the paper he said that he often heard them flying in the woods, and that they made a noise like distant thunder.

---

\* NOTE.—Mr. F. W. Christian states as follows: "There are very few wild cats in Samoa. The truth is that the natives do not care to enter the bush very much for fear of the *aitu*, or spirits of the mountain wilderness. The manu mea (*mea* = Malay *mera*, red) is a shy bird, and keeps very much on the Fale-aliti and Fale-latai side, whither very few of the white residents have the energy to track it. The months of February, March, and April would probably be the most suitable, during the flowering of the 'alo'alo-ngatae (*Erythrina indica*), and the fruiting of sundry *Myristica* and *Elæocarpi*, on the berries of which trees the bush pigeons feed. It may interest scientists to know that a parakeet of exactly the same cinnamon-red or ferruginous colour occurs in Ponape, in the Eastern Carolines, called 'cherret,' or 'terrepicho' (*icho* = 'prince' or 'king'; cf. Maori 'torete' and 'tarepo'). Savaii, the great imperfectly explored island, should be a good hunting-ground. Try the Faa-Saleleanga district and the back of Fale-a-Lupo. In 1893 I sent Home three carefully prepared specimens of the manu mea to England from Samoa."—ED.



3. "Notes on *Regalecus*, sp.," by S. H. Drew. (*Transactions*, p. 253.)

Sir James Hector pointed out that this was only the fourth specimen obtained in New Zealand, the first one having been taken near Nelson by Mr. Travers. It came ashore like the frost-fish.

Mr. Maskell said there was a complete specimen in the Otago Museum, and a skeleton in the Christchurch Museum.

4. "Curious Forms of New Zealand Ferns," by H. C. Field. (*Transactions*, p. 434.)

The following addition to the Museum was exhibited:—Coral lichen (*Cladonia retipora*), from Catlin River. Presented by Mr. L. F. Ayson.

FOURTH MEETING: 25th August, 1897.

Mr. W. T. L. Travers, F.L.S., President, in the chair.

*Paper*.—"Under the Southern Cross, or Life in the South Seas; Fairy Tales and Folk-lore,"\* with limelight views, by F. W. Christian, B.A.; communicated by Sir James Hector. (*Transactions*, p. 93.)

Mr. Tregear said he felt great pleasure in being asked to move a vote of thanks to Mr. Christian, because, as secretary of the Polynesian Society, he welcomed him as one of their corresponding members on his return from arduous travel, undertaken partly for the Society. When some years ago he became acquainted with Mr. Christian he had just returned from the Marquesas, where he had been gathering vocabularies and folk-lore. His great facility in acquiring and noting dialects, and his peculiarly sensitive ear for the soft Polynesian vowels of the Eastern groups, marked him out, in his opinion, as one whose services would be of the highest value in philological research. He was a scholar also, and knew along what lines and in what directions to make inquiries. He (Mr. Tregear) then begged him to make his next journey in the direction of the little-known islands of the north-west Pacific. Mr. Christian was one of those men that were rarely found among us busy colonial people—he was a man of means, who could afford to go in any direction wherever his love of exploration and research might lead him. He went away. He (Mr. Tregear) heard from him in Japan, then at Hongkong, then he disappeared into darkness, and the lands of the savage swallowed him up. Great, therefore, was his delight when a short time ago he heard from him again on his emergence from among the barbarians at the Caroline Islands, and when he found that he was on his way to New Zealand, bringing with him photographs, vocabularies, and collections he had procured in his travels. Of course, the greater part of his work was not popular, but technical, and he felt sure that it would one day make him famous, as fame went among specialists in scientific research. They welcomed him back as one who, at great expense, with tireless industry and risk to his life, had pursued his studies in lands

\* In the *Transactions* the title has been changed by the author to "On the Outlying Islands."—ED.

almost unknown to Europeans, and brought to them the first-fruits of his harvest of knowledge.

Mr. Maskell, in seconding the vote of thanks, said it was a good thing that there were men to be found who were willing to give up the ordinary business of life and the accumulation of money for the purpose of making explorations, with the view of acquiring knowledge and imparting it to their fellow-men. They owed a debt of gratitude to any traveller who did such work as Mr. Christian had done, and they were especially fortunate in having made known to them the first-fruits of his knowledge. He hoped Mr. Christian would publish the result of his valuable work. Mr. Christian's object, he supposed, was to ascertain the whence of the natives of the Pacific Islands, and the origin of the wonderful ruins found on some of the islands, especially at Easter Island. How they came to be there has never been satisfactorily explained.

Mr. Harding said it was strange that so little, if any, ancient stonework had been found in New Zealand when it was so abundant elsewhere in the Pacific. He mentioned the extraordinary stone rampart seen by the Rev. Mr. Colenso some years ago when crossing the Ruahine, on the summit of that range. Though it might have been a natural feature, it was so suggestive of human handiwork that Mr. Colenso regretted that the heavy snow and his failing provisions compelled him to hurry past without a careful examination.

Sir James Hector said that stone fortifications were not wholly unknown to the Maoris, and he described a remarkable example in Taranaki. Other ancient works of the kind doubtless existed in New Zealand, buried like those already described in forest growth. He had suggested to Mr. Christian, who intended shortly to set out with a number of scientists on a voyage of exploration to the South Sea Islands, that he should carry with him a phonograph, and by this means place on record the languages spoken by the natives of the various groups. Sir James Hector also stated that the mission of Mr. S. Percy Smith amongst the islands of the Pacific was to locate the base from which the Maoris issued to come to New Zealand, and to trace the path by which they made their way here. Before departure, Mr. Smith expressed his firm conviction that he would succeed in securing a complete chain of evidence in regard to the matter.

Mr. Tanner offered his thanks to the author for his admirable paper. The monuments spoken of were most interesting; he supposed they were carved by the natives to while away their idle moments, and not with any special purpose. There were fortifications at Kapiti like some of those described.

After some remarks by the Chairman, the motion was put and carried.

---

#### FIFTH MEETING: 22nd September, 1897.

Mr. W. T. L. Travers, F.L.S., President, in the chair.

*New Members.*—Mr. C. A. Ewan, Mr. Alan Loxton.

*Papers.*—1. "Demonstration of Pathological Specimens, illustrating Diseases of Domesticated Animals," by G. H. Barker.

#### ABSTRACT.

In the course of his remarks Mr. Barker said there was no authenticated case of the death of a horse being caused by the bot-fly, although

the fly was a contributory cause of death. He quoted an American authority who had laid it down that bots in horses aided digestion, that they did not injure a horse until they became diseased, and that anything given to a horse to kill the bots was just as likely to kill the horse. Some truth and a great deal of nonsense was mixed up in these statements. The Agricultural Department had found that nothing would kill bots except nitric acid and boiling water, but these remedies were calculated to damage the horse. The fly was natural to horses, and pestered them for ten months in the year. Regarding the Queensland tick, he expressed the opinion that there was no fear of its affecting New Zealand, for climatic reasons. He said that cancer in meat was not so common as most people imagined. The vegetarians would be disturbed to learn that hospital statistics in London go to prove that there are quite as many cases of cancer among vegetarians as among those who eat animal food. There was no instance, as far as he knew, where cancer had been communicated from animal to man or man to animal, and he did not think any one need feel alarmed for fear of cancer from meat in New Zealand. In any case, thorough cooking of meat and milk would abolish all danger of infection from animal diseases.

Mr. Maskell said the Agricultural Department did not seem to know, or they forgot, that last year he had pointed out that we had nothing to fear from the invasion of the Queensland tick.

Sir J. Hector said the results of the investigations of the Agricultural Department would allay any anxiety felt as to the danger of acquiring disease from our food-producing animals. It was satisfactory that diseases were found to be so moderately developed in so large a stock-producing country.

Mr. Barker explained that he had not been long connected with the department, and so was not aware of the valuable work done by Mr. Maskell, or he would have referred to it.

2. Exhibition and description of *Xiphias gladius*, the northern sword-fish, cast ashore at Otaki in April last, and presented to the Museum by Mr. E. T. Atkinson, compared with *Histiophorus herschelli*, or the antarctic sword-fish, by Sir James Hector.

Sir James Hector said the Scomboroids, or mackerels, to which the sword-fish belonged, were pelagic fishes of temperate and tropical seas. It was one of the four families of fishes most useful to man, the others being the Gadoids (cod and haddock), the Clupeoids (herring, pilchard, sardine, &c.), and the Salmonoids (salmon, trout, &c.). The Scomboroids were active fishes of prey, and had enormous swimming-powers. They had red blood like that of birds and mammals, so that they were not cold-blooded like other fish. The natural history of the sword-fish was very scanty, on account of the paucity of specimens. They were generally found in open seas, far from land, and were extraordinarily active and vigilant, and swim with extreme velocity. They were very seldom captured, and only rarely were cast ashore. Only two genera were known, one having ventral fins (*Histiophorus*), and the other none (*Xiphias*). Many species have been named, but nearly all from mutilated specimens, so that they were very doubtful. There is, however, a marked distinction between the genera, which, although partially pointed out by the late Dr. Fred. Knox in a paper read to this Society twenty-eight years ago (vol. ii., p. 13), has not yet been recognised in any of our standard works—that is, the manner in which the supra-spinal rays have been deformed and become bifid, so that they form a trough or socket in which the dorsal fin can be moved at the will of the fish by a muscular effort, so that it can erect or depress the fin and make it rigid in the

vertical plane at pleasure, so that it will act like the barb of an arrow, and keep the body of the fish on a straight course after it has taken its aim for striking its victim.

4. "Description of Recent Earthquakes, especially that of the 21st instant," by Sir James Hector.

Mention was made of the new instruments for recording earth shocks lately ordered from London. One was to be placed in the North and one in the South Island.

A female New Zealand quail from near Otaki was exhibited.

---

SIXTH MEETING: 13th October, 1897.

Mr. W. T. L. Travers, F.L.S., President, in the chair.

Before proceeding with the business, the President stated that he had heard that on the evening of the earthquake—the 21st September—a party from Government House, returning from an excursion somewhere round the harbour, had observed an unusual wave in the sea like a tidal wave. This might have been caused by the earthquake. He thought he ought to mention it.

*Papers.*—1. "On *Regalecus argenteus*, found on the Taranaki Coast," by F. E. Clarke. (*Transactions*, p. 253.)

The President said this fish had already been described, and there was a very fine specimen in the Otago Museum. There was not much known as to its habits, but it had been found in several places, including the West Indies. He had himself found portions of it many years ago at Nelson. It was a deep-sea fish, and very brittle.

2. "On Vertical Wind-motion," by Major-General Schaw, C.B., R.E. (*Transactions*, p. 465.)

Sir James Hector said, from an engineer's point of view, the wind-motion was, no doubt, important, but for meteorological purposes the vertical motion was not of such consequence. The clouds indicated that motion quite well enough; and, then, the wind was affected by the surface features of the ground. The Swiss and French observations on vertical winds had not proved successful. Unless you could get level plains the observations would not be of much value, and even then not of much use as an adjunct to meteorological science.

Mr. Tregear thought these so-called vertical winds were merely horizontal winds converted by the shape of the land into upward and downward winds. He did not think they would occur on plains.

General Schaw, in reply, said he hoped observations would be taken to try this instrument. Wellington was not a good place, on account of the hills. The Tay Bridge was wrecked by an upward wind.

3. "On *Patellida* found in Lyall and Island Bays," by W. T. L. Travers, F.L.S. (*Transactions*, p. 309.)

Sir J. Hector said this paper brought into prominence the necessity of establishing a properly equipped marine biological station in New Zea-

land, which would afford valuable information, especially as to our fish-food supply, about which little was as yet known.

4. "Notes on Bird Life in the West Coast Sounds: Woodhens and Kiwis," by R. Henry; communicated by Sir J. Hector. (*Transactions*, p. 279.)

General Schaw said it would be worth while trying whether these woodhens could be used instead of the sea-birds to keep our gardens free from insects.

The President said they might do for this, but they were rank thieves. He and Sir James Hector described how to cook these birds for food; they were good when properly prepared.

#### SEVENTH MEETING: 3rd November, 1897.

Mr. W. T. L. Travers, F.L.S., President, in the chair.

Major-General Schaw, C.B., R.E., was nominated to vote in the election of Governors of the New Zealand Institute for the ensuing year.

Part II. (double part) of "Maori Art" was laid on the table.

Before proceeding with the ordinary business of the meeting, the President called attention to a paper recently read by Mr. R. C. Harding on Will-o'-the-Wisps, and in connection therewith read an extract giving the experience of a general (Marbot) in the retreat of the French from Moscow, who was under the impression that he had suddenly come upon the bivouac-fires of the enemy. He was relieved on discovering them to be Will-o'-the-wisps. This account bore out what Mr. Harding had described as having seen in New Zealand. (*Transactions*, p. 92.)

Mr. Harding was glad to hear this extract, and he would like to have it appended to his paper.

"On the Industries of Animals," by G. Heriot Barker.

Sir James Hector said this was a useful paper, as it drew attention to the study of natural history, and induced others to take up the subject. There was perhaps nothing new in the paper, but it was very interesting.

Mr. Maskell did not think such a paper was of any real use. The statements made by the author could be found in many books. The paper did not pretend to prove anything, although there was one object in writing it clearly indicated, and that was that the author considered there was little or no difference between man and other animals, and with this he (the speaker) entirely disagreed.

Mr. Harding said Mr. Maskell's criticism was too severe. No doubt there should be a definite object in the paper, but in a popular society it would be wrong to prevent such subjects being brought forward.

Mr. Richardson hoped that Mr. Barker would continue the subject.

The President said that such a paper was useful. The habits of the same animals in different countries vary very considerably, and he gave instances of this. Such a paper directed attention of observers to similar research. The paper might not be printed, but it had its use in other ways.

---

EIGHTH MEETING: 24th November, 1897.

Mr. R. C. Harding, Vice-president, in the chair.

*Paper.*—"Did the Maoris discover the Greenstone in New Zealand?" by Joshua Rutland. (*Transactions*, p. 29.)

Sir J. Hector said this paper raised a question of very wide interest, but did not give much help towards its solution. Greenstone, or jade, seemed to have been used in all parts of the world in early ages, before metals were discovered. Jade was almost the only earthy mineral or rock that was both hard and not brittle, and so resembled a metal, and could be used for making tools and weapons with cutting edges. There was no good reason why the first Maoris who settled in New Zealand should not have brought a knowledge of greenstone with them. The name "*Te Wahi Pounamu*," or "locality of the greenstone," which they gave to the South Island, points in this direction. The idea of a previous race who taught the Maoris, as the author suggests, did not help matters, as the question of who taught that race would still remain. It was chiefly found on the west coast of the South Island.

Mr. Tregear said the paper was full of interest, but it touched upon many debatable points. Investigation was still going on into many of those, and, till much more time and labour had been expended in searching inquiry, they should still be considered as open questions—for instance, until quite lately the fact of the Maoris having been in New Zealand only five hundred years was accepted as proved by their genealogies, but since the Polynesian Society started, about six years ago, an immense mass of evidence has been accumulated, notably by Judge Gudgeon and Mr. Elsdon Best, proving that New Zealand must have been inhabited for many centuries before that period. Who the inhabitants were and to what race they belonged it must be the work of anthropologists to attempt to discover. That because the Maoris did not make pottery their ancestors had never known the use of pottery is "not proven." As to their discarding bark-cloth, and not making advance in spinning and weaving, it is doubtful if they ever wore bark-cloth, and any one who has seen the beautifully woven fine Maori mats of flax could hardly say that no advance in weaving had been made, if it ever be proved that the strips of the bark of trees beaten into cloth was once their only material for making garments. Mr. Rutland appeared convinced there were two distinctly marked periods in the occupation of New Zealand—viz., that of the pit-dwellers and of the modern Maoris. The evidence for the pit-dwellers had been mainly collected by Mr. Rutland himself, and the general consent of Maori scholars to the theory had not yet been expressed. Moreover, the very important point had to be settled as to the race to which the pit-dwellers belonged. Were they Maoris of a prior migration to that we know of as the migration from Hawaiki—when the Arawa, Tainui, Aotea, and other canoes came? Were they autochthones or Melanesians? Was it certain that they used palæolithic instead of neolithic tools and weapons? A people that employed chipped stones as tools would probably have no knowledge of greenstone, a material that needed grinding in the manner we call

"neolithic." There seemed no reason for the Maoris to have brought reverence for jade with them to New Zealand in order to make it valuable in their eyes. It was true that in many parts of the ancient world—Egypt, Europe, China, America, &c.—jade was looked upon as a sacred as well as a precious stone, but its rarity in New Zealand would make it considered of high value even if the few articles of that material handed down from time immemorial had not been hallowed by passing through the hands of mighty ancestors. For instance, one well-known ear-drop of greenstone named "Raukaumatua" was supposed to have been brought here by Ngahue, the discoverer of New Zealand, and to have been part of his celebrated "fish." Another piece of jade in the shape of a hatchet, having the name "Awhiorangi," was not only valuable because brought hither by Turi, in the Aotea canoe, but was regarded as the identical tool with which were fashioned the props, the supports, on which the sky rested to prevent it coming crushing down on the earth. When the knowledge of the locality where plenty of greenstone existed became known beyond the small tribe of Ngatiwairangi it soon spread. Parties set out with goods to trade for the stone, and expeditions went from other places to fight for its possession. Even when it became comparatively common its extreme hardness, its usefulness, its beautiful appearance, the reputation or sanctity which attached to the successful weapons of great warriors, and the fact that the ornaments had been worn by mighty chiefs, would induce a reverence for some of these greenstone articles quite sufficient to account for the high value placed upon them, without our having recourse to the supposition that jade was a sacred stone to them because they had inherited the belief from having dwelt in other lands. He had mentioned that the Maoris considered greenstone as a "fish"; he did not know why. They also believed that when found it was quite soft, but that it grew hard when exposed to the air. This showed that until comparatively modern times they really knew nothing of the material, and that they only judged by the few and rare ancestral heirlooms. The paper was of value, as all Mr. Rutland's papers were, because they evoked discussion; and if he wished (as he certainly did) to know more himself and to impart knowledge to others, he could not do better than by continuing writing his thoughtful papers. It was only by discussion and by free scope being given to dissentient views that they could peer into these interesting anthropological matters with hope of any profit or a chance of finding matter worth investigation.

Mr. Hustwick said this was a very interesting paper. He would like to know the origin or composition of this greenstone, and to what its colour is due.

Sir James Hector replied that it was an anhydrous silicate of magnesia, and the colour was due to chrome. The New Caledonia jade was only slightly stained, probably by nickel. In Sir George Grey's collection there were three kinds of greenstone. In Barn Bay there was a vein of it, and they cut it up to take to China, but it did not sell. It was marked with chromic iron, and was quite different from greenstones from other places. There was a fine block in the Museum from the west coast of the South Island.

The President said that in a pamphlet published thirty years ago Major Heaphy described how the Maoris worked up the greenstone into ornaments. It would be a good thing to reprint that pamphlet. Mr. Colenso said the natives thought the greenstone lived, and some called it a fish. There were sacred stones in almost every country.

Sir James Hector exhibited—(1.) A fine skeleton of the sea-leopardess, captured at Island Bay; also parts of other seals.

He said that up to the present there were only three kinds on these coasts—viz., the leopard-seal, the sea-lion, and the fur-seal.

(2.) *Scorpio afer*, the largest scorpion known, from India.

There was a small species in New Zealand, and he had received a specimen from Taranaki. In the specimen exhibited the pincers were very powerful; it breathed by two pairs of pulmonic sacs, and had sounding organs like a *Cicada*; viviparous; venomous; sting with two perforations and double glands. Poison acts on the red blood corpuscles, so that they become agglutinated in masses that were too large to pass through the capillaries. The antidote was ammonia. Not usually fatal to man except under unfavourable circumstances. Food, chiefly eggs of other insects. There were four families and thirty-one genera.

Major-General Schaw had lived in India some years, and had not known the big black scorpion to be dangerous to man.

(3.) *Parmophorus unguis*.

Lives in shallow water, but in rock enclosures on the outside coast. Allied to *Haliotis* or pawa. The anatomy was interesting from the cirri round the mouth and sessile eyes on the outer base of short stout tentacles.

## (4.) A fish's tooth, from Ponape (Caroline Islands), presented by Mr. Christian.

It was one of the upper pharyngeal plates of a species of *Pseudoscarus*. The only species yet obtained from the Caroline Islands was only known from a drawing. These fish were commonly known as parrot-fish, or parrot-wrasses. Dr. Günther tells us in his "Study of Fishes" that the Mediterranean species were highly esteemed by the ancients, and Aristotle gives a long account of its feeding habits. The kind most esteemed by the Romans was interesting, being one of the first fish to be acclimatised. This was done by Elipentius, in the reign of Claudius, who brought the fish from the Troad and put them into the sea at Ostium. For five years all that were caught in nets were thrown back again, so that it soon became an abundant fish. Pliny thought it the best of fish (*nunc Scaro datur principatus*). Its flesh was esteemed delicate and easy of digestion, and was thus highly esteemed in the Greek Archipelago. It fed by scraping the animal growth off seaweed, for which its outer jaws were adapted. The material was then ground by the pharyngeal teeth, just as a cow chewed the cud. There was a myth that even the excrements of this fish were eaten by the gods. In New Zealand waters there were two species of closely allied fish with similar feeding habits, locally known as butter-fish (*Coridodax pullus* and *Odax vittatus*). They were most excellent food-fishes, being delicate and free from oily matter. He wished to know if Mr. Christian could give him the derivation of the native name of the fish "kamaik." The New Zealand butter-fish was called "marare."

A number of fishes, insects, &c., were exhibited, preserved in formol.

Mr. Mestayer said he had known a solution with only 2 per cent. of formol keeping good for six months. It was very useful for microscopic preparations, but it was very irritating to the eyes.



NINTH MEETING: 22nd December, 1897.

Mr. W. T. L. Travers, F.L.S., President, in the chair.

*New Members.*—Mr. George Moore and Mr. Thomas Pringle.

It was reported that Major-General Schaw had been again elected a Governor of the New Zealand Institute to represent the Society for the coming year.

Sir James Hector was appointed to represent the Society at the meeting of the Australasian Association for the Advancement of Science, to be held at Sydney in January.

Sir James Hector exhibited the skeleton of a sea-lioness, and described how it differed from that of the sea-leopardess exhibited at the previous meeting.

He did not think that two finer specimens existed in any collections in other parts of the world. Another exhibit consisted of a few examples from the collection of three hundred specimens of Samoan fishes, presented to the Museum by Sir Walter Buller. They were beautifully mounted by Mr. Yuill by the formol method. These fishes had not yet been identified.

*Papers.*—1. "Thoughts on Comparative Mythology," by E. Tregear, F.R.G.S. (*Transactions*, p. 50.)

Mr. Maskell said that, in bringing together a number of illustrations from this part of the world to help Professor Max Müller in his work in England, Mr. Tregear was doing a good thing. The Society could congratulate itself on having a member who could give such assistance. Granting that the principles from which they started were correct, the writings of Professor Müller and Mr. Tregear were magnificent. But he (Mr. Maskell) did not admit that their first principles were correct. In veiled phrases Mr. Tregear attacked the essentials of Christianity. Other members were debarred from replying to him, as the rules of the Society forbade the introduction of religion in discussions at the meetings.

Mr. Harding said that Mr. Tregear's paper was in all respects valuable and suggestive. That it went to the genesis of the subject, however, he doubted. He thought it far more probable that the so-called native myths were the decayed form of an earlier symbolism. What, for example, was signified by the strife between light and darkness, found in every primitive mythology? Exactly what was understood by the same expression in the figurative speech of to-day—one of the fundamental subjects of all intelligent thought—the struggle between good and evil, ignorance and knowledge of the truth—a battle in which our own Institute was taking its own particular part. Mr. Tregear's paper was very far-reaching, but did not, he thought, go far enough.

Mr. Tregear, in reply, disclaimed the slightest wish to introduce religion. There was a little band of people who said, "Whether we believe in religion or not we are going to discuss the religions of savage peoples from an unbiassed point of view."

Mr. Maskell did not think that was possible.

Mr. Tregear said he had no intention to bring religion into the discussions at these meetings.

2. "On the Recent Earthquake (8th December, 1897)," by H. C. Field. (*Transactions*, p. 447.)

Sir James Hector said the paper was interesting. It was a good thing that such observations should be recorded; but if the statements made did not quite agree with what was known on the subject the discrepancies should be pointed out. Most of the vibrations felt in Wellington came from the south-east, and not from the south-west, as stated by Mr. Field. Mr. W. Hogben founded his statement that there must be an earthquake centre somewhere west of Cook Strait upon observations of one single earthquake, and he never intended it to apply to the whole of the earthquakes felt in New Zealand. The reason why more earthquakes appeared to be felt in Wellington than in other places in New Zealand was simply because the records here were more accurately kept. The direction of the recent earthquake in Wellington was most distinctly from south-by-east. Now, Wellington, though many persons did not seem to know it, lay sixteen miles to the west of Wanganui. Therefore, if the earthquake arrived at Wanganui from the south-west it must have changed its direction or come from another source. The earth-wave came to Wellington from south-by-east. In its passage northward it probably started some fracture or slip in the earth's crust, which struck Wanganui, and did the damage reported. The consideration of the influence of the different kinds of soil and rock in connection with the transmission of earthquakes had not been neglected, as Mr. Field's paper might lead one to believe, but had been very carefully gone into. If the recent Wellington earthquake came from the south it proved what he (Sir James) had suggested—that the Wanganui shake must have been a fresh one produced by the progress of the wave, which gave only a slight shock here. The shock in Wellington, though prolonged, was slight so far as movement was concerned. Nothing was disturbed in the Museum, although articles were placed in rickety positions to catch any passing shock. It had been settled by observations in Japan and elsewhere that buildings on sand or clay were more in danger than those built on solid rock. In a great earthquake in Jamaica buildings on a limestone plateau escaped injury, whilst those on a surrounding belt of sea-drift disappeared.

The President said he could make out the direction of the late shock quite distinctly, and the duration was about fourteen seconds.

3. "On the Electro-deposition of Gold upon the Gold of our Drifts," by W. Skey. (*Transactions*, p. 498.)

---

ANNUAL MEETING: 16th February, 1898.

Mr. T. Kirk, F.L.S., in the absence of the President, took the chair, which later on he left in favour of Mr. Travers, who arrived.

The report and balance-sheet was read and adopted. The balance-sheet set forth the receipts for the year (including the balance brought forward, £81 8s. 8d.) to be £187 9s. 8d., the expenditure £113 8s. 3d., and the balance £74 1s. 5d., to which has to be added £32 7s. 3d. lodged in

the bank at interest as a "Research Fund": making a total credit balance of £106 8s. 8d.

ELECTION OF OFFICERS FOR 1898.—*President*—E. Tregear; *Vice-presidents*—Sir W. Buller, G. V. Hudson; *Council*—T. Kirk, Major-General Schaw, Sir J. Hector, R. L. Mestayer, H. B. Kirk, G. Denton, W. M. Maskell; *Secretary and Treasurer*—R. B. Gore; *Auditor*—T. King.

*Papers.*—1. "Further Notes on Coccids," by W. M. Maskell. (*Transactions*, p. 219.)

2. "Criticism of Mr. P. Marshall's Paper on *Dodonidia helmsi*," *Fereday*, printed in vol. xxviii. of the *Transactions*,\* by E. F. Hawthorne.

#### ABSTRACT.

Before proceeding to deal with the paper itself, I would wish to refer to the plate (vol. xxviii., pl. xv.) accompanying it. I must, of course, assume that this plate is, upon the whole, a faithful representation of Mr. Marshall's original drawing. Its most striking feature is, perhaps, the totally unsegmented body represented in fig. 1. I am unable to discover in this figure the faintest trace of even the three primary divisions of the body into head, thorax, and abdomen. This unprecedented structure may, of course, exist in Mr. Marshall's specimens. An interesting feature of fig. 2 (which is intended to represent the under-side of *D. helmsi*) is that the markings are unsymmetrical. This is, in Mr. Marshall's figure, especially noticeable in the series of three ocelli extending at nearly a

right angle from the costa of the hind-wing. The outlines of figs. 1 and 2 are likewise unsymmetrical. The neurulation as represented in figs. 3 and 4 is positively misleading. It cannot possibly be urged too forcibly that the very greatest care should be exercised in making drawings of neural structures, as slight differences in the arrangement of the veins are sometimes of considerable classificatory significance. The following corrections in Mr. Marshall's fig. 3 are necessary: Vein 1, instead of rising from the base of the cell, should rise separately; vein 6, instead of having a common origin with 7 and 8, as represented by Mr. Marshall, really rises out of 10. Again, veins 9, 10, and 11, according to fig. 3, are stalked, and originate from the cell at about  $\frac{2}{3}$ ; in the insect itself vein 11 originates from the cell at about  $\frac{1}{3}$ , and veins 7, 8, 9, and 10 have a common stalk. In fig. 4, supposed to represent the neurulation of the hind-wing, vein 1a is not shown at all. Vein 7 does not

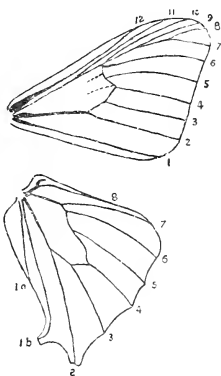

Neurulation of *Dodonidia helmsi*.

\* See *Trans. N.Z. Inst.*, xxviii., Art. xxvii., p. 312.

rise from beyond the upper angle of cell, as alleged by Mr. Marshall, but from a point a short distance from it. Vein 8 has not an independent origin, but, as is usual in the *Papilionina*, rises out of the cell at base. Furthermore, there is in fig. 4 no sign of the precostal spur, which is a family character of some importance. The accompanying figure, made from a careful drawing by myself, showing the correct neurulation of *D. helmsi*, may prevent any one being misled by Mr. Marshall's figures. Leaving the plate, and turning to the text, the first thing to be noticed is that Mr. Marshall omits to mention several localities where *D. helmsi* has been taken. He says, quite correctly, that it was first captured by Mr. Helms, but does not say where that gentleman took it. As a matter of fact, Mr. Helms obtained his specimen on the Paparoa Range, near Greymouth. The butterfly has since been taken by Mr. A. P. Buller on the Wainuiomata Road, Wellington; by Mr. G. V. Hudson on the Dun Mountain, near Nelson; by Mr. C. W. Palmer on the Mount Arthur table-land, in the Nelson District; and by myself at Silverstream, in the Hutt Valley, Wellington District. I understand it was also taken some years ago in the Wanganui district. Mr. Marshall says (p. 313) that he was "unable to find any larvæ or pupæ of the insect, but from the way the imago hovers over *Brachyglottis repanda* and *Fuchsia excorticata* it would seem probable that the larvæ feed on the foliage of one of these trees." It may, perhaps, be worth while to mention that it is well known that the larvæ of the *Satyridæ* are grass-feeders. The larva of *D. helmsi* was discovered by Mr. Hudson on the 29th December, 1895, on *Galinia setifolia*, one of the sedges. The last paragraph in Mr. Marshall's paper is worthy of study. Apparently he seems to think that if the name of one genus bears a certain amount of resemblance to that of another genus the two genera are "closely allied." On this system (to mention only a single instance) the genus *Strepsicerates*, in the *Tortricina*, would be "closely allied" to the genus *Strepsiceeros*, in the *Mammalia*! One would have thought that the conclusion at which Mr. Marshall arrived through this novel process of reasoning—viz., that *D. helmsi* belongs to the family *Erycinidæ*—was sufficiently remarkable to have made him at least doubtful of its logical validity. I am not aware upon what grounds Mr. Marshall places the insect under discussion in the *Nymphalidæ* instead of in the *Satyridæ*; but, as the two families are somewhat doubtfully separable, the fact of his having so placed it is not a matter of much importance. In conclusion, I may remark that, whilst it cannot but be regarded as a pity that such an interesting insect as *D. helmsi* should have been made the subject of hasty and perfunctory work, I much regret having to appear hostile towards Mr. Marshall. He will, however, I hope, bear in mind that the soul of science is criticism, and that he who has the advancement of knowledge at heart ought not to object to his work being freely criticized, even though that work suffer much in the process.

### 3. "On New Zealand Sponges," by H. B. Kirk, M.A. (*Transactions*, p. 313.)

Mr. Kirk explained briefly the nature of the paper, and gave drawings showing the growth of sponges.

Sir James Hector said this was a most interesting and valuable paper, and he hoped the author would be able at some future time to give a longer account of sponges generally. It would be a good thing if other members would follow Mr. Kirk's example, and take up other branches of zoology for study.

Mr. Travers said he had collected a number of sponges from time to time, and he would gladly hand them over to Mr. Kirk for examination. The subject of the growth and cultivation of sponges was of great economic interest.

4. "Remarks on *Gunnera ovata*," by T. Kirk, F.L.S. (*Transactions*, p. 380.)

5. "On *Solanum hamiltonii*," by T. Kirk, F.L.S.

Mr. Kirk gave a short description of the latter plant; it had a beautiful violet flower, and would be a great addition to our cultivated plants.

6. "On the Decomposition of Water by Tannin under certain Conditions," by W. Skey. (*Transactions*, p. 509.)

7. "On the Rapid Superficial Action of Strong Solutions of Potassic Cyanide upon Gold," by W. Skey. (*Transactions*, p. 512.)

8. "On the Evolution of Hydrogen by Cyaniding of Gold in a certain Manner," by W. Skey. (*Transactions*, p. 510.)

Sir J. Hector exhibited a fine skeleton specimen of *Ap-teryx australis*, prepared by Mr. A. Yuill. He gave a description of the kiwi generally.

Mr. Denton exhibited large tusks of a boar, almost joined in a circle.

Mr. Mestayer exhibited a collection of Chitons found in Lyall Bay, named by Captain Hutton, and collected by Miss Mestayer.

## AUCKLAND INSTITUTE.

---

FIRST MEETING: 7th June, 1897.

E. Robertson, M.D., President, in the chair.

*New Members.*—A. R. Carnie, A. Montgomery, S. C. Streeter.

The President delivered the anniversary address:—

The first part of the address referred to matters connected with the management of the Institute and Museum. Reference was made to the increased prosperity of the Auckland District, which to some extent had affected the revenue of the Institute, through the leasing of endowments for mining purposes. A hope was expressed that the limited endowment might be increased by private generosity in the future as it had been in the past. The necessity for more space in the Museum had been met by the erection of a hall for the statuary, the expense of which was to be met by an annual appropriation from the ordinary revenue. For some years this would place a heavy burden on a limited income. Of late years a large expenditure had been made in order to add to the ethnological collection, in view of the increasing difficulty of obtaining specimens of Maori work, through the activity of the agents of foreign collectors. The natural history department of the Museum required a large expenditure, particularly in the way of setting up specimens now packed away. The library also could not, with the present income, be added to in a manner suitable to the growth of the Museum. As time went on, the increased cost of maintenance would still further limit the amount of income available for the purchase of specimens or enlargement of the Museum. Private generosity must be looked to for a continuation of the progress which had already been made. In a commercial centre like Auckland the Museum should afford full evidence of the natural resources of the colony. It was a matter of congratulation that, through the liberality of Mr. T. Russell, an adequate exhibit of the minerals of the Hauraki Mining District would soon be placed in the Museum. In the absence of a local technical museum the value of our own institution would be considerably enhanced by a similar exhibit connected with the timber, coal, and kauri-gum industries.

The President then went on to deliver his address proper, "On the State Prevention of Consumption." (*Transactions*, p. 66.)

---

SECOND MEETING: 30th June, 1897.

E. Robertson, M.D., President, in the chair.

Professor Talbot Tubbs delivered a popular lecture entitled "A, a Passage in Archæology," in which he dealt with the history and development of alphabetic writing.

THIRD MEETING: 12th July, 1897.

E. Robertson, M.D., President, in the chair.

Professor F. D. Brown read a paper on the relative conductive values of pumice and charcoal for insulating purposes. (*Transactions*, p. 44.)

---

FOURTH MEETING: 19th July, 1897.

E. Robertson, M.D., President, in the chair.

Mr. A. Montgomery gave a popular lecture on "Ore-deposits."

---

FIFTH MEETING: 2nd August, 1897.

D. Petrie, Vice-president, in the chair.

*Papers.*—1. "Description of a New Species of *Coprosma*," by D. Petrie, F.L.S. (*Transactions*, p. 433.)

2. "The Tides, the Ocean Currents, and the Moon," by W. Buchanan. (*Transactions*, p. 79.)

The author endeavoured to show that the theories generally accepted respecting the tides and the ocean currents were not in all cases satisfactory, and could not be accepted as generally correct.

---

SIXTH MEETING: 16th August, 1897.

E. Robertson, M.D., President, in the chair.

Mr. P. Marshall, F.E.S., gave a popular lecture on "Insect Life in Gardens."

---

SEVENTH MEETING: 6th September, 1897.

E. Robertson, M.D., President, in the chair.

*Papers.*—1. "On the Botany of Hikurangi Mountain," by James Adams, B.A. (*Transactions*, p. 414.)

2. "The Relative Commercial Values of Pumice and Charcoal," by W. T. Firth. (*Transactions*, p. 463.)

3. "The History of Taipari's Carved House at Parawai, Thames," by Captain G. Mair, N.Z.C. (*Transactions*, p. 41.)

## EIGHTH MEETING: 20th September, 1897.

E. Robertson, M.D., President, in the chair.

Professor F. D. Brown delivered a popular lecture, illustrated by experiments, on "The Ether."

---

## NINTH MEETING: 4th October, 1897.

Mr. James Stewart, C.E., in the chair.

*Papers.*—1. "Tuhoe Land," by Elsdon Best. (*Transactions*, p. 33.)

2. "The Influence of the Ideal," by E. A. Mackechnie. (*Transactions*, p. 109.)

---

## TENTH MEETING: 18th October, 1897.

E. Robertson, M.D., President, in the chair.

Professor A. P. Thomas gave a popular lecture on "Corals and Coral Reefs."

---

## ANNUAL MEETING: 28th February, 1898.

## ABSTRACT OF ANNUAL REPORT.

The number of members on the roll at the present time is 167, of whom twelve are life-members and 155 annual subscribers. Five new members have been elected during the year, and eleven names have been removed—five from death, three from resignation, and three from non-payment of subscription for more than two consecutive years.

The Council are sorry to state that the list of deaths contains the names of several gentlemen who have taken a prominent part in the affairs of the Institute. Mr. J. C. Firth joined the Institute in the year after its foundation. He was President in 1875, and for several years subsequently served on the Council. He was a frequent contributor to the *Transactions*, his last communication appearing in the volume for 1896. During the whole period of his membership he was an active supporter of the society; and in the early part of its history, when its position was struggling and ill-assured, his frequent and liberal contributions to its funds materially aided its progress. It is only due to his memory to mention that at his own request the particulars of several of these benefactions were never made public. By his death the Institute loses a sincere and zealous friend. The Rev. Canon Bates was also for many years a member of the Council, and a frequent contributor of papers or lectures. His loss is a severe one, both as a man of broad and liberal views and as an earnest supporter of any movement tending towards the social or educational progress of Auckland. The other members removed by death are Mr. T. Ball, Mr. L. Ehrenfried, and Mr. C. J. Leaf.

The financial position of the Institute must be regarded as satisfactory. The total revenue of the working account, excluding the balance of



£164 17s. 10d. in hand at the commencement of the year, has been £1,176 7s. 6d. Last year the amount was £1,207 7s. 8d., so that there has been an apparent decrease of £31 0s. 2d. But, as pointed out in the report for 1896-97, the receipts for that year were swollen by the payment of some arrears of interest which should have been paid during the previous twelve months. Making due allowance for that, it will be seen that the revenue really shows a considerable increase. The interest yielded by the invested funds of the Costley Bequest has been £413 0s. 4d., while the Museum endowment has contributed in rents and interest on investments £619 15s. 11d. The members' subscriptions have amounted to £127 1s., a sum slightly below that received in 1896-97. The total expenditure has been £1,201 10s. 5d., leaving a credit balance of £139 14s. 11d. in the Bank of New Zealand. The invested funds of the Institute now amount to £13,280, showing an increase of £65 during the year. With the exception of a few hundred pounds, the whole of this sum is invested in mortgage on freehold property, and it is believed that the securities are exceptionally good and stable.

The Crown Lands Board have not been able to do much in the way of utilising the remainder of the endowment. A few township allotments have been sold and the proceeds handed over to the Institute for investment. The Tihitihī Block, at Whangarei, the largest of the rural endowments, has been divided into small grazing-runs and leased. In the future it will bring in a small though regular income. The Waikanae Block, near Coromandel, which was taken up for mining purposes a couple of years ago, has yielded a very satisfactory income; but, as several of the leases have been abandoned, it is hardly probable that the amount received during the coming year will be so large.

Ten meetings have been held during the year, at which fourteen papers were read and discussed.

There has been a satisfactory attendance of visitors at the Museum. The register kept by the attendant on Sunday afternoons shows that 13,093 people entered the building on that day, or an average of 251 for each Sunday. This is a slight increase on the number for the previous year. The largest attendance was 388 on the 25th April, and the smallest thirty-seven on the 3rd October. On week days the visitors can only be occasionally counted, and accurate statistics cannot therefore be given, but the average attendance may be safely estimated at one hundred. Taking this number as a basis for calculation, the approximate week-day attendance would be 31,300, and the total for the whole year 44,393. The greatest attendance recorded on any one day was 403, on the 24th May (Queen's Birthday).

In last year's report the Council stated the reasons that had induced them to arrange for an enlargement of the Museum. Since then the new addition has been completed, and was opened to the public for the first time on the 19th October. It consists of a hall 50 ft. square adjoining the eastern side of the ethnological hall, with which it is connected by an archway. In structural details it agrees with the ethnological hall, being built of brick, with a concrete floor and iron and glass roof. The contract price was £800, to which, however, has to be added the cost of gas-fittings, architect's commission, and a few extras. The funds required for its erection have been temporarily borrowed from the Costley Bequest, with the proviso that the amount shall be gradually repaid by instalments from each year's income; and in fulfilment of this agreement £100 has just been paid into the Investment Account. The primary reason for the erection of the hall was to accommodate the Russell collection of plaster casts from the antique. This collection, which is in many respects an admirable one, was altogether buried in its former location in the centre of the main hall. It is now well placed and well lighted, and when the final colouring of the walls is completed will be seen to great

advantage. The new hall will also be used as a meeting-room until the funds of the Institute are sufficient to warrant the erection of a properly equipped lecture-room, and some expenditure will shortly be incurred in providing a movable platform, and other necessary conveniences. The space gained in the main hall by the removal of the statues will ultimately be devoted to the exhibition of groups of the larger mammals, suitably arranged in glass pier cases. This is a work, however, which can only be slowly accomplished, unless some generous friend of the Museum will largely supplement its scanty resources.

The chief additions made to the Museum during the year have been in the department of ethnology. The Council would draw special attention to a collection of Maori carvings and other articles obtained by purchase from the East Cape district. Among other things it contains two huge *tikis* or carved figures of a type now extremely rare and difficult to obtain; a beautiful example of the carved central post of a large whare; a large carved doorway of an unusual pattern; and an antique *paepae* or carved threshold of a house, probably considerably over a hundred years old. The Council have also been able to obtain the carved figure-head of the well-known canoe Taheretikitiki. It belongs to a peculiar type of figure-heads known as *Toiere*, and is believed to be the only specimen in a public collection. A large number of small articles of Maori workmanship have been obtained during the year, partly by purchase and partly by donation. Some of these are specially valuable, and arrangements are now being made for their suitable exhibition. In foreign ethnology the most interesting addition is an unusually fine example of an inlaid canoe from the Solomon Islands. It is about 15 ft. in length, and is beautifully inlaid throughout with pearl shell, and adorned with drawings of birds and fishes. Such canoes are only made on the Island of Ulawa, and are now extremely difficult to procure. The thanks of the Institute are due to the Rev. R. B. Comins and the Rev. W. G. Ivens, through whose good offices the canoe was obtained.

In the zoological department several additions of importance have been made. A fine mounted skeleton of an ostrich has been obtained in exchange from Professor Ward, of Rochester, U.S.A. It will be useful for comparison with the moa skeletons. An interesting collection of Chatham Island birds, including several rare species, and notably *Sphenacacus rufescens*, has been acquired. Several small lots of New Zealand bird-skins have been received. There are also many minor additions.

In last year's report the Council stated that Mr. T. Russell, C.M.G., had most liberally promised to expend the sum of £100 in some desirable addition to the Museum. During a visit to New Zealand, made shortly after the last annual meeting, Mr. Russell decided that his presentation should take the shape of a mineral collection to illustrate the resources of the Hauraki Mining District. At the request of Mr. Russell's agents the Curator has made a tour of visits to most parts of the district, collecting a full suite of specimens, Mr. Russell defraying the whole of the expenses. Over fifteen hundred specimens have been obtained, and have been catalogued and roughly determined. In a few weeks' time the collection will be finally arranged and placed on exhibition. It will include a series illustrating the general geological structure of the whole district; also local collections from the smaller districts, or from groups of mines, showing the character of the "country" rock and the various lodes traversing it; and, finally, selected specimens of the various minerals occurring in the lodes or elsewhere. The Council consider that the thanks of the whole community are due to Mr. Russell for providing funds for a purpose that cannot fail to be of immense practical importance.

An expenditure of about £70 has been incurred in the purchase of

standard scientific books. It was mentioned in the previous report that the Imperial Government, acting on the advice of the Royal Society, had decided to present to the library a complete set of the publications of the "Challenger" Expedition. This has been received during the year, and forms an addition the importance of which can hardly be overestimated. The usual exchanges and presentations from foreign societies have been received, together with a few miscellaneous donations. The Institute also continues to subscribe to several of the leading scientific periodicals and magazines.

The bare and uninviting appearance of the library has often been represented to the Council. Steps will shortly be taken to renovate and furnish it in an appropriate manner. By a comparatively small expenditure it can be converted into an attractive and comfortable room.

A large amount of consideration has been given to the maintenance of the Little Barrier Island as a reserve for the preservation of the flora and fauna of New Zealand. Yielding to the urgent representations of the Council, the Crown Lands Department authorised a special grant of £250 for the erection of a suitable residence for the curator. The material was conveyed to the island by the "Hinemoa," and the house is now completed. With respect to the avifauna, the presence of a resident curator and the removal of the Maoris appear to have altogether checked the surreptitious collecting previously carried on, and the birds have remained unmolested during the year. Mr. Shakespear, the curator, reports that with one exception he has noticed all the species observed by Mr. Reischek, many of them being present in considerable numbers. Wild cats and other vermin are not so numerous as was supposed, and are being destroyed whenever opportunity offers. With proper care and attention—and this the Institute hopes to give as long as the island remains in its charge—there seems to be no reason why many of our rarer birds may not find a secure home on the island for very many years to come.

In conclusion, the Council have to thank the members and others for the assistance and encouragement which they have given to the objects of the Institute, and which it is hoped will be again rendered during the coming year.

ELECTION OF OFFICERS FOR 1898.—*President*—Professor H. A. Talbot Tubbs; *Vice-presidents*—E. Robertson, M.D., D. Petrie, F.L.S.; *Council*—G. Aickin, J. Batger, W. Berry, Professor F. D. Brown, C. Cooper, E. A. Mackechnie, T. L. Murray, T. Peacock, J. Stewart, C.E., Professor A. P. Thomas, F.L.S., J. H. Upton; *Trustees*—E. A. Mackechnie, S. P. Smith, F.R.G.S., T. Peacock; *Secretary and Curator*—T. F. Cheeseman, F.L.S., F.Z.S.; *Auditor*—W. Gorrie.

---

## PHILOSOPHICAL INSTITUTE OF CANTERBURY.

---

FIRST MEETING: *5th May, 1897.*

Dr. Thomas, President, in the chair.

*New Members.*—C. Coleridge Farr, J. B. Mayne, T. W. Adams, Robert Nairn, Dominick Brown, Dr. T. W. Pairman.

*Papers.*—1. "The New Zealand *Musci*"; Paper No. XII., by R. Brown. (*Transactions*, p. 398.)

2. "On an Objection to Le Sage's Theory of Gravity," by C. Coleridge Farr. (*Transactions*, p. 118.)

3. "Note on the Ancient Maori Dog," by Captain F. W. Hutton. (*Transactions*, p. 151.)

Captain Hutton exhibited a skull, and photographs of a skull, of the Maori dog.

Professor Dendy exhibited some micrometric rulings.

---

SECOND MEETING: *2nd June, 1897.*

Dr. Thomas, President, in the chair.

*New Members.*—Walter Kitson and Dr. Manning.

*Address.*—Professor E. J. Mathew, M.A., LL.B., delivered an address on the "Science of History."

*Paper.*—"New Australian and New Zealand Lichens," by Dr. James Stirton; communicated by T. W. Naylor Beckett. (*Transactions*, p. 382.)

Dr. Thomas exhibited specimens of printing in small letters.

---

THIRD MEETING: *7th July, 1897.*

Dr. Thomas, President, in the chair.

*New Members.*—C. Ogilvie Lillie and Hastings Mayo Lee.

*Address.*—Mr. R. M. Laing, M.A., delivered an address on "Some New Zealand Seaweeds," illustrated by diagrams and specimens.

*Paper.*—“Synopsis of the New Zealand *Hemiptera*,” by Captain F. W. Hutton. (*Transactions*, p. 167.)

Mr. L. Cockayne exhibited specimens of winter-flowering iris and hybrid hellebore.

Captain Hutton exhibited a mounted skeleton of a sloth and a nest of a weaver bird.

---

FOURTH MEETING: 4th August, 1897.

Dr. Thomas, President, in the chair.

*New Member.*—Ambrose L. Taylor.

*Address.*—Captain F. W. Hutton, F.R.S., delivered an address on “Maori Stone Implements.” (*Transactions*, p. 130.)

*Papers.*—1. “On the Genus *Tortula*, New Zealand *Musci*,” by R. Brown. (*Transactions*, p. 399.)

2. “On the Genus *Streptopogon*, New Zealand *Musci*,” by R. Brown. (*Transactions*, p. 409.)

3. “On a Proposed New Genus *Dendia*,” by R. Brown. (*Transactions*, p. 411.)

Captain Hutton exhibited a collection of Maori stone implements from the Museum.

Mr. Carlisle exhibited a very fine stone adze from the Waimakariri Gorge.

Professor Dendy exhibited two Maori stone adzes and an Australian stone adze, and called attention to the peculiar S-shaped curvature of the edge in the latter.

Mr. R. Brown exhibited a flowering plant of *Niassonia*.

---

FIFTH MEETING: 1st September, 1897.

Dr. Thomas, President, in the chair.

*Papers.*—1. “On the Magnetic Force in Solenoids,” by C. Coleridge Farr. (*Transactions*, p. 121.)

2. “On the Grasshoppers and Locusts of New Zealand,” by Captain Hutton. (*Transactions*, p. 135.)

3. “On a Collection of Insects from the Chatham Islands,” by Captain Hutton. (*Transactions*, p. 155.)

4. “On the Neglect of the Study of Nature,” by Dominick Brown.

5. "On the Error introduced by using a Coal-gas Flame while determining the Percentage of Sulphur in Coals," by Dr. W. P. Evans. (*Transactions*, p. 496.)

6. "On an Improved, Adjustable, Drip-proof, High-power Bunsen," by Dr. W. P. Evans. (*Transactions*, p. 497.)

Professor Dendy exhibited and described a collection of marine animals lately thrown up on the New Brighton Beach. (*Transactions*, p. 320.)

Mr. H. Suter exhibited some of the rarer marine animals occasionally met with at New Brighton.

Mr. Bishop exhibited fossil shells of *Zenatia* and *Panopea* similar to those found at New Brighton.

---

SIXTH MEETING: 6th October, 1897.

Dr. Thomas, President, in the chair.

*New Member.*—Henry Suter.

*Address.*—Mr. S. Hurst Seager, A.R.I.B.A., delivered an address on the "Evolution of Art," illustrated by diagrams and lantern-slides.

Professor Dendy exhibited and made remarks upon a small collection of mammals from the Central Australian desert, including the marsupial mole (*Notoryctes typhlops*), recently received from Professor Baldwin Spencer.

---

SEVENTH MEETING: 3rd November, 1897.

Dr. Thomas, President, in the chair.

*New Member.*—A. D. Austin.

*Papers.*—1. "On the Freezing of New Zealand Alpine Plants," by L. Cockayne. (*Transactions*, p. 435.)

2. "On the Sponges described in Dieffenbach's 'New Zealand,'" by Professor Dendy. (*Transactions*, p. 316.)

3. "On Distillation Products of Blackball Coal," by Dr. W. P. Evans. (*Transactions*, p. 487.)

4. "Notes on the *Musci* of New Zealand: Genus *Anacalypta*," by R. Brown. (*Transactions*, p. 412.)

5. "The *Phasmidæ* of New Zealand," by Captain F. W. Hutton. (*Transactions*, p. 160.)

6. "New Australian and New Zealand Lichens: Part 2," by Dr. James Stirton; communicated by T. W. Naylor Beckett. (*Transactions*, p. 382.)

7. "On the Screening of Electro-motive Force in Fields of High Frequency," by J. A. Erskine. (*Transactions*, p. 459.)

8. "On the Genus *Pyxine*," by Dr. James Stirton; communicated by T. W. Naylor Beckett. (*Transactions*, p. 393.)

9. "On a Convenient Form of Oil-bath for studying the Influence of Definite Temperatures on Solids," by Dr. W. P. Evans. (*Transactions*, p. 495.)

Professor Dendy exhibited original types of the sponges described in Dieffenbach's "New Zealand," received from the British Museum, together with photographs of the same.

Mr. T. W. Naylor Beckett exhibited a fine collection of New Zealand lichens, which he presented to the Canterbury Museum.

Captain Hutton exhibited and made remarks upon a collection of palæolithic implements from Africa.

Professor Dendy exhibited and made remarks upon a collection of *Limulus polyphemus* received from America.

---

ANNUAL MEETING: 6th April, 1898.

Dr. Thomas in the chair.

Captain Hutton moved the following resolution: "The Philosophical Institute of Canterbury wishes to express its deep sense of the loss science has sustained by the death of Mr. Thomas Kirk, F.L.S., and to place on record its high appreciation of the work he accomplished in the botany of New Zealand. It also requests the President to convey to Mrs. Kirk and her family its sympathy with them in their bereavement."

The resolution was seconded by Mr. Cockayne, and carried by the members standing.

A number of mineral specimens from Western Australia were exhibited, having been presented to the Institute by Mr. C. J. Wentworth Cookson, and a letter was read from that gentleman to Dr. Pairman in which they were described. It was resolved to present the specimens to the Canterbury Museum.

## ABSTRACT OF ANNUAL REPORT.

During the year seven ordinary meetings have been held. At these meetings twenty-three papers have been read, which may be classified as follows: Botany, 9; zoology, 7; physics, 4; chemistry, 2; miscellaneous, 1. At four of these ordinary meetings addresses have also been delivered—viz.: "On the Science of History," by Professor Mathew; "On Some New Zealand Seaweeds," by Mr. R. M. Laing; "On Maori Stone Implements," by Captain Hutton; and "On the Evolution of Art," by Mr. S. Hurst Seager. The attendance at the ordinary meetings has averaged 27.5. Both in the number of papers read and in the average attendance there has been a slight increase on the previous year.

In addition to the ordinary meetings the following have been held during the year: On the 7th April the annual general meeting, when Professor Dendy delivered his Presidential address on "Some Recent Progress in Biology." On the 22nd September (in the Art Gallery) a special popular lecture on "The Daffodil," by Mr. L. Cockayne, illustrated by photographs, diagrams, and lantern-slides, and a magnificent collection of Narcissi, which was very highly appreciated by the general public, who were admitted by ticket. On the 20th October (in the chemistry lecture theatre of the Canterbury College) an illustrated address on the "Displacement of Engraving by Photography" was delivered at a special meeting by Mr. J. von Gottfried. A special general meeting was held on the 3rd November, when it was resolved to alter law xvi., so as to allow the Council or President to call additional ordinary meetings during the summer months.

The Council on the 30th November passed the following resolution: "The Council of the Philosophical Institute of Canterbury wishes to express its deep sense of the great loss sustained by the scientific world through the untimely death of Dr. T. J. Parker, F.R.S., late Professor of Biology in the Otago University, and Curator of the University Museum."

The Council nominated your President, Dr. Thomas, to vote in the election of Governors of the New Zealand Institute for the ensuing year.

The number of members at the close of the year was seventy-seven, the apparent decrease of one since last year being due to the fact that the law with regard to arrears of subscriptions has been rigidly adhered to in making up the list, and thus a number of names have been removed which were merely dummies. As a matter of fact, thirteen new members were elected during the year.

The balance sheet shows that the total receipts for the year have been £83 3s. 5d., and the expenditure £81 5s. 10d., leaving the Institute with a balance of £21 17s. 3d., including £16 19s. 8d. carried forward from last year. The receipts have thus been more than double what they were in the preceding year, an improvement which must be attributed to the fact that your Treasurer has taken the question of finance into his own hands, and dispensed with the services of a collector.

During the year an arrangement has been entered into with the Board of Governors of the Canterbury College whereby the old rooms in the Public Library have been abandoned. The ordinary meetings and Council meetings have been held in the Biological School of the Canterbury College, and the library of the Institute has been removed to the Canterbury Museum, where it still remains the property of the Institute, and is available for use by members as before.

The additions to the library by presentation and purchase have taken place as usual, and the sum of £20 has been expended upon binding. The honorary librarian, Dr. Evans, has thoroughly rearranged the



library in its new quarters, and completed a manuscript catalogue, so that the use of the library by members has been greatly facilitated.

During the past year the photographic section has held six meetings.

At its last meeting the Council of the Institute appointed a sub-committee to consider the programme for the ensuing year, and this sub-committee recommends to the incoming Council a continuation of the methods adopted during the past two years, with a view to making the meetings of the Institute of more general interest. Captain Hutton has kindly consented to deliver a special popular lecture on "The New Darwinism," while Professor Bickerton, Mr. R. Speight, Mr. J. B. Mayne, and Mr. L. Cockayne have accepted invitations to deliver short addresses on subjects of general interest at the ordinary meetings.

ELECTION OF OFFICERS FOR 1898.—*President*—Dr. W. P. Evans; *Vice-presidents*—Mr. R. Speight and Mr. L. Cockayne; *Hon. Secretary*—Professor Dendy; *Hon. Treasurer*—Captain Hutton; *Council*—Dr. Thomas, Messrs. H. R. Webb, R. M. Laing, T. W. Naylor Beckett, J. B. Mayne, and Dr. Symes.

*Presidential Address.*—The retiring President, Dr. Thomas, delivered an address on "Hypnotism."

---

## OTAGO INSTITUTE.

---

FIRST MEETING: *11th May, 1897.*

Professor J. Shand, President, in the chair.

*New Members.*—Mr. F. W. Hilgendorf, M.A., and Mr. T. Pearce, M.A.

The President announced that Dr. J. R. Don had been compelled, owing to his removal from Dunedin, to resign the Presidential chair, and that the Council had elected Professor J. Shand as President, Mr. F. R. Chapman Vice-president, and Mr. Crosbie Smith as ordinary member of Council.

The Hon. Secretary, Professor Parker, exhibited and made some remarks—(a.) On a mounted skeleton of *Harpagornis*, collected at Castle Rock, Southland, and deposited by him in the Museum. (b.) The first part of a work on “Maori Art,” by Mr. A. Hamilton, published by the Governors of the New Zealand Institute. (c.) The prospectus of Mr. W. H. Hudson’s “Butterflies and Moths of New Zealand.”

The Secretary announced that the next meeting of the Australasian Association for the Advancement of Science would open at Sydney on the 8th January, 1898, and laid on the table a number of papers in connection with the arrangement.

Professor T. J. Parker then delivered an address: “Some Chapters in the History of Zoology.” A number of books showing the character of the zoological literature of the sixteenth and seventeenth centuries were shown in the course of the lecture.

---

SECOND MEETING: *8th June, 1897.*

Mr. A. Hamilton, Vice-president, in the chair.

The Hon. Secretary, Professor Parker, exhibited and made remarks on the following additions to the Museum:—

(a.) Portions of the skin, preserved in alcohol, of the great ribbon-fish (*Regalecus argenteus*).

The fish from which the specimens were taken came ashore at Portobello, Otago, on the 28th May last, and was presented to the Museum by the finder, Mr. Octavius Harwood, jun. It was a remarkably fine specimen, 13 ft. in length. This is the second example of this fish which

has been recorded from this locality. The first was found, also by Mr. Harwood, in June, 1887, almost exactly ten years ago, and is now in the Museum (see Transactions, vol. xx., p. 20). The present specimen agrees with it in all essential respects. Two other specimens have just been reported from other parts of the harbour. Another example not hitherto recorded was captured by some fishermen just outside the Otago Heads in June of last year, and was purchased for the Museum; it was 10 ft. 5 in. in length, and its other dimensions were considerably less than those of the fishes referred to previously.

Mr. Hamilton exhibited a very curious figure of *Regalecus* given in Imperator's book describing his museum, a folio work published in 1697. It is there called *Spada marina*.

(b.) A specimen of unusually large size ( $23\frac{1}{2}$  in.) of *Haplodactylus meandratus*, mounted as a stuffed specimen.

(c.) The mutilated skin of a plectognathous fish used by the natives of the Kingsmill Islands for making defensive belts in conjunction with their well-known cocoanut-fibre armour; presented by Mr. Hyams.

(d.) A ceremonial mask from New Britain, deposited by Mr. A. Hamilton.

*Paper.*—The Hon. Secretary, Professor Parker, then read a paper: "Notes on a Specimen of the Scaled Tunny (*Lepidothynnus huttoni*)."

The paper was illustrated by a well-stuffed specimen of this very rare fish, which was caught just at the Otago Heads. Particular attention was drawn to the great difference in size between the heart of the common tunny and that of this species. Preparations were shown of the scales and of some of the internal organs.\*

Mr. A. Hamilton then exhibited and described a large number of casts of engraved gems and medals, ancient and modern, from his own collections. Some specimens were also lent for exhibition by Mr. Laing, who presented a fine cast of the so-called Gemma Augusta at Vienna, a splendid large onyx of superior workmanship. The meaning of the work is in its details very uncertain. The commonest and most probable explanation of the figures is as follows:—

In the upper division the Emperor Augustus on a throne, as Jupiter, with sceptre and eagle, and holding in his right hand the Augur's staff. Above him the sign of Capricornus, the constellation under which he was born. Next to him Roma (or, according to another interpretation, Pallas, or Livia, the consort of Augustus, in the character of Pallas or Roma), with helmet, shoulder-belt, shield, and lance. Behind Augustus a veiled figure crowning him, sometimes described as Mother Earth, sometimes as Cybele, or Livia in the character of Cybele. In front of her a bearded male figure, Oceanus or Neptunus: by some supposed to be Agrippa in the character of Neptunus. In the foreground a half-naked female figure seated, with a cornucopia, and next to her two naked little boys. This is supposed to be Abundantia, or Tallus, or the elder Agrippina with

\* Another specimen has since been captured in Blueskin Bay.

her two sons, Nero and Drusus. On the left, descending from a war-chariot, which is driven by a winged Victory, Tiberius in the act of entering upon his Pannonian triumph, awarded to him in the year 9 A.D., but not celebrated till the year 12 A.D. Next to the horses, and standing in front of the throne, the still youthful Germanicus. In the lower division conquered barbarians sitting chained (explained also as Pannonia and the Danube personified); the erection of a trophy; the carrying-off and ill-treatment of the prisoners.

---

THIRD MEETING: 13th July, 1897.

Professor J. Shand, LL.D., President, in the chair.

*Papers.*—1. In the absence of the author, the Honorary Secretary read a paper by Mr. F. W. Hilgendorf, M.A., "On the Hydroids of the Neighbourhood of Dunedin," stating that the paper was originally written as a thesis for the honours degree in arts of the New Zealand University. (*Transactions*, p. 200.)

2. A second paper by Mr. Hilgendorf, "On the Occurrence of *Pedicellina* in New Zealand," was also read by the Secretary. (*Transactions*, p. 218.)

3. Mr. A. Bathgate read a paper entitled "Notes on Acclimatisation in New Zealand." (*Transactions*, p. 266.)

A brief discussion ensued, in which Mr. F. R. Chapman suggested that the paper should be as widely diffused as possible, as the subject was one of interest and importance to all. Mr. G. M. Thomson, in referring to the subject of introducing birds and animals into the colony, said the matter was one that required extraordinary care, and there should be no new importations entered upon without a very careful selection and due consideration beforehand.

---

FOURTH MEETING: 10th August, 1897.

Mr. A. Hamilton, Vice-president, in the chair.

*New Member.*—Mr. George Wharton.

*Papers.*—1. Mr. G. M. Thomson, F.L.S., read a paper: "Notes on New Zealand Fisheries"; and in the course of his remarks referred to the proposal to establish a fish-hatchery at Purakanui. He continued:—

There are two directions in which a station at Purakanui may be utilised. First, for observation and experiment on native fishes. I have pointed out repeatedly that fishery legislation, if it is to be of any value, must be based on actual knowledge, and knowledge on these and all similar matters can only be acquired by observation and experiment. I have not yet come upon any fisherman who knows—(1) The time of spawning of our native fishes; (2) the sort of ova they produce (3) the localities in which they spawn; or (4) the metamorphic changes they

undergo in development from the egg up to the mature stage. Nor do any scientific men know any of these facts; still less do our legislators. We may infer much about these facts, and with probably a considerable amount of accuracy, from observations made elsewhere upon allied species; yet the only way to arrive at the truth on such points is by properly conducted observation and experiment. The restrictions laid down by an Order in Council (2nd May, 1895) as to size of fish which may be "taken, bought, sold, exposed for sale, or found in possession of any person," under a penalty not exceeding £20, remain in force. The following limits of size are put on some of our common fishes: Barracouta, 8 oz.; blue-cod, 8 oz.; red-cod, 8 oz.; horse-mackerel, 4 oz.; trevally, 4 oz.; mullet, 4 oz.; butterfish, 4 oz. The bearing of these regulations has often been pointed out, also their absolute absurdity. There are in this colony somewhere about six hundred fishermen, or one to every nine miles of coast-line. Take the first fish mentioned—the barracouta. This is a fish which ranges over the whole of the Antarctic Ocean, being common in the seas to the south of Australia, at the Cape of Good Hope, and in South America. It comes here in vast shoals. No amount of these fish—large or small—that all our fishermen could take would make any appreciable difference in their numbers, and it is nonsense to protect them by legislative enactment, and to fine a man for bringing a small fish ashore. Then probably every barracouta, in the course of its stay in these waters, eats more small-sized blue- and red-cod, horse-mackerel, trevally, mullet, butterfish, &c., than each fisherman takes in his net or on his lines in the same time. We do not know anything about the migrations of the barracouta, or why the species should be plentiful one season and scarce in another. The reasons advanced or suggested by local fishermen as to change of currents due to change of wind are based on very generalised and often imperfect observation. The whole question is still *in nubibus*. The same remarks apply in a lesser degree to the other fishes I have mentioned. But in the case of many of these it would be an extremely simple matter, were a suitable station established, to undertake a research on their breeding habits and development. Particularly would this be the case in regard to coastal fishes, such as the rock-cod. There are no enemies to small fishes so destructive as large ones. The groper along our coast here eat far more soles than our fishermen ever catch. Just to take an instance: I was at Port one day when a fishing-boat came in, the morning's catch for three men being eighteen groper. On opening these fish there were taken out some 4 doz. soles (many of them over the limit of 9 in., but others smaller), besides remains of many more. Then, no groper is to be sold under 5 lb. weight, but a mature groper with fully developed ova may be taken, and thus a few million embryos be destroyed. The whole thing is absurd. Herring are not to be taken under 5 in. in length. I do not know what fish is meant, but the species of *Clupea* all occur in vast shoals, and visit our shores in such quantities that they are driven on the beaches by their innumerable enemies—both birds and fishes—in hundreds or thousands of tons. The individuals must number billions which are thus destroyed. Coming to the flat fishes—soles and flounders—on which a length limit of 9 in. has been placed, it is worthy of note that during the year a local inspector has been appointed to see that the law is adhered to. This is a more difficult question to deal with, because the localities in which flounders especially are got, being all inshore or in shallow bays and estuaries, it would be possible to fish out a particular part of it were it within easy reach of a number of fishermen. But I question whether this holds good for soles, which do not come into the land-locked waters to the same extent as the flounders do. In any case, I believe it would be a better plan, if protection is needed, to simply prohibit seine-fishing in certain localities for a given length of time, and thus let the fish attain a good

size on such grounds, than to attempt to regulate the catch as is now done. If an 8 in. flounder gets into a seine-net, and is thrown overboard by the fisherman, as the law says it must be, the chances of its surviving are very small. In this connection I wish again to draw attention to a matter which I have more than once brought privately before members of the acclimatisation society. There are in this harbour and in the bays outside the heads numbers of salmon or sea trout (the true *Salmo trutta*), the finest fish which can be got here. I do not mean brown-trout, which are also abundant. The society prohibits the sale of these fish (which the fishermen locally call salmon) except on payment of a fee for a license, which, however, no one takes out. The fish is not infrequently taken in the seine-nets, and it is absolutely certain that if once caught it is as good as killed. There is no chance of its surviving if thrown out again into the sea, and it is no wonder that the fishermen carefully hide it when caught. It is often smuggled up to town, and the men know where they can place them, and get a good price for them. But I say it is utterly wrong to put such temptation in the way of these men. The fisherman's trade is a hard enough and precarious enough one in all conscience without harassing them by legislation. And, again, if the fish were allowed to be sold openly, some people would get them now who never see them at all, and they would not, as at present, be secured by persons who have no conscience in the matter. There is not the slightest chance of reducing the number of these fine fish to any extent. They are most difficult to catch, and it is only stray ones which get into seine-nets which are taken. They are not taken by bait, but it would perhaps be worth while to try whether they would not take the fly, as such fish do in Britain in bays and estuaries. I commend the subject to the council of the Acclimatisation Society. Referring again to the question of flat fishes, a hatching-station would be a suitable locality at which to study the whole question of the development of these fishes, and no doubt also from such an establishment young fish could be distributed, were it considered desirable, to any special locality. I repeat again that until we know something more definite as to the life-history of fishes legislation is apt to be worthless. The other direction in which a fish-hatchery at Purakanui would be utilised is in the special one already referred to of receiving and hatching out of imported fish-ova. So far attention has been directed only to cod, turbot, and herring. During the course of last session a meeting of members of the Legislative Council and of the House of Representatives was called to interest themselves in this matter, and secure their co-operation when the time came for it. After consideration of the matter as far as possible, the pertinent question was asked, "How long can the ova of marine fishes be retarded in development? because there is no use bringing ova unless they can be kept alive over a certain period—say, forty-five or fifty days. I could not answer, so I undertook to make inquiries, but the American Fish Commission could not give me any information. Dr. Fulton, of the Scotch Fisheries Board, gave fuller information, but the nett result was arrived at that the point had not been considered. As nothing was to be gained by over-hurry, and as we could do nothing here till an establishment had been got ready, we resolved to accept Dr. Fulton's offer to conduct observations for us, and I was authorised by the committee of the council to write and ask him to carry out a set of experiments on the retardation of ova. These would probably commence at Dunbar in March of this year, and were, no doubt, completed some time ago; but no results have been communicated so far. We have also been considering the means of conveyance of ova, fish-fry, and fish in different stages. Ova like those of herring, which are laid on the sea-bottom, could be easily conveyed in boxes similar to those in which salmon-ova are brought out, only being supplied with cooled sea

water instead of fresh water. But to carry the floating ova of cod and turbot is a more difficult problem, and one which may not be easily solved. It will also be a somewhat difficult matter to bring out round fishes like cod, as they are so apt to get knocked about in a tank. But Dr. Fulton anticipates little difficulty with flat fishes. Finally, the ground on which it is proposed to erect a hatchery has been kindly marked off by Mr. G. M. Barr, and the Council of this Institute and the council of the Acclimatisation Society have each voted a sum of £250 towards the undertaking conditionally. There the matter rests so far as we are concerned, and I hope that before very long there will be considerable advance to report. I notice that some of the northern societies are mooted, in an indefinite sort of way, the advisability of importing foreign sea-fish. No doubt the idea has been suggested by what we have done so far. Apart from all considerations of precedence, &c., there is one point of geographical importance which I have already advanced, and which, I think, marks out a station on this coast as the best from a colonial point of view, and that is the fact of the southerly current which flows up the coast at the rate of a mile and a half an hour. As so many species of fishes during their earliest stages of development are pelagic, swimming near the surface of the ocean, any such organisms getting into this current would be distributed along the coast, and so would readily find their way north. But any fish-fry liberated, say, at Cook Strait would certainly not work their way southwards. The question is, of course, not merely a local one; it is mainly a colonial one, and must be treated from this point of view.

Mr. F. J. Sullivan, who spoke by request of the Chairman, said he went there to listen and learn, but was not prepared to discuss. He was very pleased to learn that Mr. G. M. Thomson, who had had such exceptional opportunities to study this subject, had come to the same conclusions as practical fishermen had already arrived at in regard to the knowledge required as to the habits of our sea-fishes before good legislation was possible. Our legislators had evidently forgotten they had a Creator, and that He willed that fishes of all kinds should multiply at the enormous rate at which they did, and that He willed that they should also consume each other in their struggle for existence. To have arranged otherwise it would have meant that in course of time the ocean would have been so crowded with fishes that instead of being an ocean it would have been all fish and no ocean. Our legislators proposed to have all these natural laws altered by human laws, which was impossible. He quite agreed with Mr. Thomson when the latter stated that the present legislation was entirely unnecessary, and could not possibly attain the object the framers had in view, and was most harassing to a struggling industry. The proposal to establish hatcheries at, say, Purakauui would have the sympathy and assistance of all practical, intelligent fishermen. If such a station were established the habits of our fishes could be carefully followed by scientific gentlemen, who would then be able to explain the present mysteries of the ocean-life on our coast, and as opportunities occurred various kinds could be imported from other parts to acclimatise here; and there would then be some data for our legislators to go on. He proposed to visit Great Britain shortly, and he took that opportunity to place his services at the disposal of the Institute in obtaining any information he possibly could on the subject; and, as it was his intention to visit a considerable number of the fishing-stations at Home, in order to, if possible, improve our fish-supply and the conditions under which the men now worked here, he thought he would have exceptional opportunities to be of use to them. The Government could reasonably be asked to subsidise the liberal amount voted by the Institute and the Acclimatisation Society to build these hatcheries, especially as they had now no bonus to pay on cured fish exported, for want of a profitable outlet. If

they would divert these funds to the Institute he was sure the colony generally would reap a greater advantage than they did by paying export bonuses on fish. The fishermen were better paid with a small price for a large quantity of fish than with a small quantity of fish at a dear price. When fish were very scarce the fishermen, salesmen, buyers, and every one interested were dissatisfied, and therefore they all agreed on the one point, that fish in plenty was desirable; so let them unite and point out the mistakes of legislation to those in power, so that they would listen to the voice of the people and remove the present unjust laws from the statute-book; and until they did so there was no security for capital to invest in and develop this industry, or yet for a greater number of men to find profitable employment. The position had been so ably put by Mr. Thomson that he found it very difficult, even with his long experience, to point out any omissions on his part. He thanked them for giving him the opportunity of listening to the reading of Mr. Thomson's valuable paper.

Messrs. Melland, Bathgate, and Hamilton also spoke on the subject, and it was resolved, "That it is desirable that Mr. Thomson's paper be printed, and that he should submit to the Council a statement, to be used in facilitating the alteration of the existing legislation on fisheries."

2. Mr. G. M. Thomson, F.L.S., then read a paper on "Recent Researches on *Anaspides*."

He said the species referred to (*Anaspides tasmanica*) was found by the author in pools on the top of Mount Wellington, near Hobart, in 1892, and had since been collected by Mr. Leonard Rodway in the Hartz Mountains, Huon district, and at Lake Field, about forty miles from Hobart. All the localities were at an elevation of about 4,000 ft. Originally described and figured by the author in the "Transactions of the Linnean Society of London," it had since been the subject of a second memoir by W. T. Calman, of Dundee. This remarkable shrimp combined in itself the characters of several groups of Crustacea, and threw light upon certain Palæozoic forms which palæontologists had hitherto been unable to refer satisfactorily to any family. It was believed to represent a survival from a very ancient group of Crustacea, presenting generalised characters, and of very wide distribution, its fossil allies having been found in the coal measures of North America and of Central Europe.

On the motion of the Vice-president, a hearty vote of thanks was accorded Mr. Thomson for his interesting remarks.

A small crustacean was exhibited, which had been forwarded to the Museum as a young English lobster. It, however, belongs to a totally different genus from the lobster, and is known as *Munida subrugosa*.

It is closely allied to the red crustacean or "whale-feed" (*Grimothea gregaria*), which is so abundant in Dunedin Harbour in the summer months. So far no young lobsters have been met with, and the chances are against their being found; but, as the species takes six or seven years to reach maturity, there has not yet been time to test whether the experiment of introducing them has been a failure or not. Should, however, the efforts of the Institute be successful in establishing a fish-hatchery at Purakanui, the chances of such experiments being carried out with a greater prospect of certainty will be greatly increased.

---



## FIFTH MEETING: 12th October, 1897.

Professor J. Shand, LL.D., President, in the chair.

*Papers.* — 1. Mr. A. Hamilton read a paper "On Rock Pictographs in South Canterbury," and showed drawings and photographs of a large number from the rocks at the Tengawai Gorge and the valley of the Opihi River. (*Transactions*, p. 24.)

2. Mr. A. Hamilton laid on the table a paper containing a list of *Bryozoa*, recent and fossil, collected by him in various parts of New Zealand. (*Transactions*, p. 192.)

3. Mr. Hamilton laid on the table a paper on the extinct goose of New Zealand (*Cnemiornis calcitrans*), and exhibited series of the principal bones, including the sternum of another species from Te Aute (*C. minor*).

4. Mr. J. S. Tennant, B.A., B.S., read a paper on some New Zealand fresh-water *Algæ* collected by him, and exhibited a series of specimens.

5. Mr. Crosbie Smith gave an account of some seaweeds collected by him in the neighbourhood of Dunedin, exhibiting a large and well-preserved collection.

At the close of the meeting Mr. Tennant and Mr. Smith exhibited microscopical preparations of several of the more interesting *Algæ* in the collection.

---

ANNUAL MEETING: 22nd November, 1897.

Professor J. Shand, LL.D., President, in the chair.

The President, in opening the meeting, made allusion to the recent death of the Honorary Secretary, Professor T. Jeffery Parker, and moved the following resolution: "That this Institute place on record its sorrow for the death of Professor T. Jeffery Parker, who has been for the last eighteen years a member of the Council, and an indefatigable supporter of the Institute, and who has also occupied the President's chair, and discharged for many sessions the duties of Honorary Secretary; its deep sense of the loss which not only this Institute but the cause of scientific education in New Zealand has sustained by Dr. Parker's untimely removal; its admiration of Dr. Parker's technical skill and accurate observation as a scientific investigator, as well as of his lucidity of thought and felicity of illustration as an expounder of scientific principles; and its high esteem for the personal qualities which endeared Dr. Parker to his friends and fellow-workers."

The motion was seconded by Mr. F. R. Chapman, who added a few words expressing his respect and esteem for the late Professor.

The motion was put from the chair, and carried by a rising vote of those present.

The following papers were then brought forward, and, being mainly of a technical character, were taken as read, the author shortly explaining the object of the paper:—

1. "Notes on the New Zealand *Brachyura*," by G. M. Thomson, F.L.S.

2. "A Revision of the New Zealand *Anomoura*," by G. M. Thomson, F.L.S.

3. On a New Marine Alga (*Nitophyllum microphylla*), by J. Crosbie Smith.

A very small species of the genus, found at Green Island.

4. "Notes on an Individual Skeleton of *Euryapteryx ponderosus*, from the Riverton Beach," by A. Hamilton. (*Transactions*, p. 445.)

This very complete skeleton is now mounted, and deposited in the Otago University Museum. It was exhibited at the meeting; and also a collection of silver-ores from Mount Reid, Tasmania, presented to the Museum by Mr. Trythall.

The Acting Secretary, Mr. A. Hamilton, then read the annual report.

#### ABSTRACT OF ANNUAL REPORT.

During the present session five general meetings of the members and seven meetings of the Council have been held.

Eighteen papers were brought forward.

At the last annual meeting Dr. J. R. Don, D.Sc., was elected President of the Institute, but at the beginning of the year he resigned the office, on his removal from Dunedin to Oamaru. Professor Shand, LL.D., was appointed to the Presidential office for the remainder of the year, Mr. F. R. Chapman was elected Vice-president, and Mr. Crosbie Smith to the vacancy in the Council.

The Committee on the Establishment of a Fish-hatching Station at Purakanui made a further report on the matter, and the following resolution was carried: "That this Institute vote the sum of £250 for the erection of a fish-hatchery at Purakanui, conditional—(1) On the Otago Acclimatisation Society voting a like amount; (2) on the Government giving a grant of pound for pound on the amount raised here; (3) on the Government undertaking to provide the means to carry on the establishment for a period of, say, ten years, the management to be vested in a Board to consist of six members, two to be nominated by the Government, two by the Acclimatisation Society, and two by the Otago Institute."

The fisheries committee were requested to proceed with the necessary arrangements for bringing the matter forward at a meeting of the Acclimatisation Society, and to interview the local members of the House of Representatives on the subject. A full statement of what has been done in the matter will be appended to this report.

Further representations have been made to the Directors of the New Zealand Institute about the publication of the *Transactions*, and separate

copies of the Proceedings of this Institute have been received and distributed. This will be done in the future, so that members at a distance from Dunedin will be kept better informed of the work of the Institute. It is also proposed that the Proceedings shall include in the future a collection of short notes on subjects of interest to the society which may be sent in by members.

During the year a number of books have been added to the library, and the binding of the serials is now well in hand.

The number of members belonging to the Institute is not at all satisfactory, and compares very unfavourably with that of the other branches. Only three new members have been elected, and a large number have been struck off the roll, by resignation, removal, and by death. One very great loss has been sustained by the Institute in the death of Professor T. Jeffery Parker, D.Sc., F.R.S., who, for nearly eighteen years, has been closely connected with the society, and whose work on its behalf will long be remembered by those with whom he was associated. The Council desire to record their deep regret at the loss of one who had held the office of President of the Institute, and who, at the time of his death and on many previous occasions, had held the office of Secretary. The Institute has also to regret the loss of Mr. John Allan, Dr. Fergusson, and Dr. Jeffcoat, all of whom have been for many years members of the Institute.

Your Council are pleased to notice that the number of papers brought forward is an increase on the number presented last session, and they are also pleased to see that some of the members of the Dunedin Field Club have brought to the meetings collections of botanical specimens of much interest, showing that good work is being done by the club in the practical investigation of the natural history of the district. The success of the Field Club is always a matter of interest to the Institute, and should naturally result in an accession of members in due time.

Mr. James McKerrow was nominated to represent the Institute on the Board of Governors of the New Zealand Institute.

The balance-sheet shows the receipts for the year to be £87 3s., making, with the balance from last year, a total of £109 10s. 8d. The expenditure for the year was £82 1s. 5d., of which £44 13s. 6d. was spent on new books, periodicals, &c., leaving a credit balance of £27 9s. 3d.

On the motion of Mr. Hamilton, seconded by Dr. Hocken, the report and balance-sheet, as read, were adopted.

Mr. G. M. Thomson submitted the following report of the committee appointed to further the establishment of a marine fish-hatchery at Purakanui:—

In our last report it was stated that communications had been addressed to the Scientific Director of the Scotch Fishery Board and to the United States Commissioner for Fisheries regarding the extent to which it would be possible to retard—by chilling or otherwise—the hatching-out of certain fish-ova. No information on the subject was available from America, but Dr. Fulton was of opinion that retarding the ova could be accomplished to a certain extent, and suggested that experiments could be undertaken at Dunbar with the object of testing the question if the Institute would pay the cost of the ice required. Your committee agreed to do so, and passed a vote of £10 to cover expenses of the experiment, and on the 22nd December, 1896, Dr. Fulton was written to and asked to undertake the experiments during the following summer. We have not heard yet as to the results.

Early in this year the committee brought before the Council of the Institute proposals for the establishment of the hatchery, and that body voted the sum of £250 towards it on the following conditions: (1) That the Otago Acclimatisation Society vote a similar sum; (2) that the Go-

vernment grant a sum of £500 towards it, and undertake to carry on the station for a term of, say, ten years. The matter was similarly laid before the Otago Acclimatisation Society, and that body also voted the sum of £250 on the same conditions.

The matter was then put in the hands of the Hon. W. M. Bolt, M.L.C., and Mr. J. A. Millar, M.H.R., to lay before the Government. Meanwhile your committee, together with Mr. G. M. Barr, C.E., visited Purakanui and marked off the piece of channel which it was desirable to secure, and it was suggested to our representatives in Parliament that this ground be reserved. The area indicated is a strip of about 6 acres, extending along the east side of the inlet from the outer side of Hill Street (Purakanui Township) to a line in continuation of that separating Sections 10 and 11, Block III., and reaching from high-water mark a distance of 2 chains into the channel. It was further suggested that the reserve and all buildings to be erected on it be vested in a Board of six members, two to be nominated by the Governor, two by the Council of the Otago Institute, and two by the Council of the Otago Acclimatisation Society.

This is the stage to which the matter has now been carried by your Committee.

ELECTION OF OFFICERS FOR 1898.—*President*—F. R. Chapman; *Vice-presidents*—Professor J. Shand and A. Bathgate; *Hon. Secretary*—A. Hamilton; *Hon. Treasurer*—J. S. Tennant; *Council*—Professor J. H. Scott, A. Wilson, E. Melland, Dr. T. M. Hocken, G. M. Thomson, J. Crosbie Smith, B. C. Aston; *Auditor*—D. Brent.

Mr. F. R. Chapman, after thanking the members for his election, took the chair, and the retiring President, Dr. Shand, delivered a most interesting address on the "Undulations of the Ether."

---

## HAWKE'S BAY PHILOSOPHICAL INSTITUTE.

---

FIRST MEETING: *10th May, 1897.*

T. C. Moore, M.D., President, in the chair.

The President read an inaugural address, taking as his subject "The Civilisation of the Saracens, and what we owe to them."

At the conclusion of his address the President expressed a hope that more life might be infused into the Institute's meetings, and announced that the Council intended to arrange a series of popular addresses, which he contended was an important part of the work of the Institute.

---

SECOND MEETING: *14th June, 1897.*

H. Hill, B.A., F.G.S., in the chair.

Mr. T. Tanner gave an address on "The Sun as a Star, and its Place in the Heavens."

---

THIRD MEETING: *12th July, 1897.*

T. C. Moore, M.D., in the chair.

*Papers.*—1. "On the Formula for the Construction of Bicycle Tracks," by C. E. Adams, B.Sc.

2. "The Hawke's Bay Plains, Past and Present; and the Recent Floods," by H. Hill, B.A., F.G.S. (*Transactions*, p. 515.)

The latter paper was illustrated with plans and sketches thrown on the screen.

---

FOURTH MEETING: *9th August, 1897.*

T. C. Moore, M.D., in the chair.

*Papers.*—1. "Germs and their Relation to Disease," by Dr. J. H. E. Jarvis.

2. "The Ray Trace Method of Triangulation," by C. E. Adams, B.Sc.

The former paper was illustrated by a number of microphotographs thrown on the screen.

---

FIFTH MEETING: *13th September, 1897.*

A. Milne-Thomson, M.B., C.M., in the chair.

*Papers.*—1. "The Illustration of Books," by W. Dinwiddie.

2. "Some Kitchen-middens in Poverty Bay," by F. Hutchinson. (*Transactions*, p. 533.)

The former paper was illustrated by a number of photographs thrown on the screen.

---

SIXTH MEETING: *11th October, 1897.*

T. C. Moore, M.D., in the chair.

*Papers.*—1. "The Fleeing Maru-iwi walk over Glenshea Cliff at Night," by Taylor White.

2. "Have we Remains of a Swimming Swan-like Moa?" by Taylor White.

3. "The Ceremony of Rahui," by Taylor White.

4. "Moa—the Bird and the Tree," by Taylor White.

5. "The Customs of the Australian Aborigines," by Dr. Leahy.

6. "A Comparison of New Zealand and Australian Mortality," by C. E. Adams, B.Sc., A.I.A.

7. "A Comparison of the Mortality in New Zealand from 1850–70, and from 1870–90," by C. E. Adams, B.Sc., A.I.A.

---

SEVENTH MEETING: *5th November, 1897.*

T. C. Moore, M.D., in the chair.

*Paper.*—"The Röntgen Rays," by A. Milne-Thompson, M.B., C.M.

This paper was illustrated by numerous apparatus and experiments.

## ANNUAL MEETING: 14th February, 1898.

## ABSTRACT OF ANNUAL REPORT.

During the past year seven ordinary meetings were held. The number of papers read was thirteen. The membership stands at sixty-six, a still further decrease on last year's roll. There is a large amount of subscriptions outstanding which will cover the indebtedness shown in the liabilities and leave a handsome surplus when collected. The Council, however, urge members to bring the advantages of the Institute under the notice of their friends, and so endeavour to extend the membership. A small increase in our income would enable us materially to extend our sphere of usefulness. Owing to the very successful attempt made last year to provide a series of popular addresses on scientific subjects the attendance at our ordinary meetings was very largely increased, and the Council hope that by pursuing the same course during the ensuing season a greater interest may be aroused in the work of the Institute. The Council have this matter now under consideration, and hope to provide an attractive programme for the coming session. They are of opinion that this is an important branch of the work of the Institute. Mr. Large has become a life-member of the Institute under section 6 of the constitution. The Council desire to record the services of Dr. Thomson, whose lecture on "The Röntgen Rays" was of considerable assistance to the Institute.

The balance-sheet showed a total receipt of £109 3s. 5d., including £8 6s., balance from preceding year, while the expenditure was £100 15s. 5d., leaving a balance in hand of £8 8s.

ELECTION OF OFFICERS FOR 1898.—*President*--A. Milne-Thomson, M.B., C.M.; *Vice-president*--T. Tanner; *Council*--W. Dinwiddie, H. Hill, B.A., F.G.S., J. Hislop, J. E. H. Jarvis, M.R.C.S., T. C. Moore, M.D., G. White; *Hon. Secretary*--C. E. Adams, B.Sc., A.I.A.; *Hon. Treasurer*--J. W. Craig; *Hon. Auditor*--J. R. Crerar.

---

## WESTLAND INSTITUTE.

---

THE annual meeting of the Westland Institute was held in the library yesterday evening, and was fairly well attended.

### ABSTRACT OF ANNUAL REPORT.

The report conveyed the present position and future prospects and exhaustively dealt with the many wants and requirements, the most pressing one being a better public recognition of its great utility.

The balance-sheet showed the receipts from all sources were £119 10s. 6d., which was balanced by the expenditure amounting to exactly the same sum.

The trustees accorded their thanks to the Borough Council for the subsidy granted in aid of the free reading-room, and likewise to the Harbour Board for their donation.

The members' roll now contains fifty names, comprising thirty-four annual, twelve half-yearly, two junior, and two honorary.

The trustees have held eight committee meetings, which have been well attended, and considerable interest has been taken in the working of the society.

The library has had an addition of about a hundred volumes, but still there is a general demand for something new.

The Museum, though not a source of profit to the society, still attracts numerous visitors.

ELECTION OF OFFICERS FOR 1898.—*President*—Mr. D. Macfarlane; *Vice-president*—Mr. T. H. Gill; *Hon. Treasurer*—Mr. G. Sinclair; *Trustees*—Messrs. A. H. King, W. Heinz, A. Mahan, J. Chesney, J. J. Clarke, T. W. Beare, H. L. Michel, A. J. Morton, J. S. Dawes, H. R. Lawry, Dr. Macandrew, and Rev. S. Hamilton.



## NELSON PHILOSOPHICAL SOCIETY.

---

FIRST MEETING: 30th August, 1897.

The Bishop of Nelson, President, in the chair.

*New Member.*—Mr. W. Martin.

*Papers.*—1. "Notes on New Zealand Starfishes," by H. Farquhar. (*Transactions*, p. 187.)

2. "Notes of a Trip to the Watershed of the Wangapeka and Karamea Rivers," by R. I. Kingsley. (*Transactions*, p. 442.)

The author showed a series of lantern-views of the district visited.

*Donations.*—1. By Mrs. Ponsonby, Nelson: A collection of shells from the Pacific Islands; several clubs and spears from the Pacific Islands.

2. By Mr. Chandler, Wangapeka: Specimen of fossil resin.

3. By Mr. Wastney, Wakapuaka: Curious crystals in basalt.

4. By Mr. Davis, late of the Sherry: Fine specimen of magnetite from Baton.

5. By Mr. F. Johnston: Black petrel (*Majaqueus parkinsonii*).

6. By Mr. H. Farquhar: Specimens of New Zealand starfishes.

7. By Mr. R. I. Kingsley: (a) Fossils from Wangapeka and Sherry; (b) *fac-simile* reprints of the first and second letters of Christopher Columbus.

---

ANNUAL MEETING: 24th January, 1898.

The Bishop of Nelson, President, in the chair.

### ABSTRACT OF ANNUAL REPORT.

During the year only two meetings have been held. Notwithstanding the small membership, the Society was doing a good work, and fulfilling a useful mission, both in collecting and diffusing valuable information, which without the Society probably could not by other means be accomplished.

The balance-sheet shows the total receipts (including a balance of £9 8s. 10d. from last year) to have been £26 4s. 10d. The expenditure includes £11 15s. 6d. expended on the public Museum. The balance carried forward is £14 8s. 4d.

The Museum was described as being in good order.

ELECTION OF OFFICERS FOR 1898.—*President*—The Bishop of Nelson; *Vice-presidents*—Mr. A. S. Atkinson and Dr. Mackie; *Council*—Dr. Boor, Rev. F. W. Chatterton, Messrs. Gibbs, Lukins, and Bartell; *Hon. Secretary*—R. I. Kingsley; *Hon. Treasurer*—Dr. Hudson; *Hon. Curator*—R. I. Kingsley; *Assistant Curator*—E. Lukins.

Dr. Hudson moved a resolution "That the Nelson Philosophical Society propose to amalgamate with the Nelson Institute, on condition that the latter becomes affiliated with the New Zealand Institute, and that a sub-committee of three members from the Society confer with the officers of the Nelson Institute and draw up terms of amalgamation." After considerable discussion, the consideration of the resolution was postponed for six months.

---

---

# APPENDIX



METEOROLOGY.  
COMPARATIVE ABSTRACT for 1897 and Previous Years.

STATIONS.	Barometer at 9.30 a.m.		Temperature from Self-registering Instruments read in Morning for Twenty-four Hours previously. Fahr.				Computed from Observations.		Rain.		Wind.		Cloud. (0 to 10).	
	Mean Reading.	Extreme Range.	Mean Temp. in Shade.	Mean Daily Range of Temp.	Ex- tremo Range of Temp.	Max. Temp. in Sun's Rays.	Min. Temp. on Grass.	Mean Elastic Force of Vapour.	Mean Degree of Moisture (Saturation = 100).	Total Fall in Inches.	No. of Days on which Rain fell.	Average Daily Force in Miles For Year.		Maximum Velocity in Miles in any 24 hours, and Date.
Auckland... ..	30.023	1.350	58.8	12.7	42.0	145.0	34.0	0.366	72	45.361	187	230	974 on 13th Oct.	5.4
Previous 33 years ...	29.993	...	59.1	...	...	...	...	0.386	72	42.075	182	...	...	...
Wellington ... ..	29.916	1.369	55.5	12.3	50.0	145.0	21.0	0.316	71	48.495	184	231	730 on 3rd Nov.	4.4
Previous 33 years ...	29.929	...	54.8	...	...	...	...	0.333	73	51.331	160	...	...	...
Dunedin ... ..	29.791	1.608	50.2	14.5	55.0	139.0	24.0	0.277	75	38.110	152	167	570 on 8th Nov.	5.4
Previous 33 years ...	29.967	...	50.1	...	...	...	...	0.275	73	37.216	158	...	...	...

AVERAGE TEMPERATURE OF SEASONS compared with those of the Previous Year.

STATIONS.	SPRING. September, October, November.		SUMMER. December, January, February.		AUTUMN. March, April, May.		WINTER. June, July, August.	
	1896.	1897.	1896.	1897.	1896.	1897.	1896.	1897.
Auckland ... ..	56.7	56.4	60.8	66.1	61.3	60.4	53.1	52.4
Wellington ... ..	53.4	54.3	62.4	62.1	56.5	56.6	49.2	48.9
Dunedin ... ..	48.8	49.8	57.8	57.9	48.8	50.5	42.4	42.7

## REMARKS ON THE WEATHER DURING 1897.

JANUARY.—Heavy rain in North, with strong prevailing N.E. and S.W. winds; also showery and strong N.W. winds over centre; and generally fine in South.

FEBRUARY.—Generally wet weather and strong winds in North; in South fine, with light showers.

MARCH.—On the whole fine weather, though showery during latter part of month; strong wind over centre from N.W.; rather changeable in South.

APRIL.—Fine in North; heavy rain and wind from S.E. causing floods over centre; and fine in South.

MAY.—Showery weather in North and strong S.W. winds, also thunder; over centre generally fine, with variable wind, and at times strong; in South fine, with light showers.

JUNE.—Pleasant weather in North, and light showers; over centre fine, with light showers, frequent fogs; very fine in South.

JULY.—A showery month, prevailing S.W. and W. winds and frequently stormy in North; over centre generally pleasant, with showers at intervals; fine and dry in South.

AUGUST.—Wet weather in latter part of month in North, but otherwise fine; over centre generally showery, but at times pleasant, prevailing S.E. wind; in South middle of month showery, but otherwise fine and clear, with light N.E. winds.

SEPTEMBER.—Generally fine seasonable weather, but heavy rain over centre during latter part; winds moderate.

OCTOBER.—Showery weather generally, and strong S.W. winds in North and South; strong winds from N.W. over centre.

NOVEMBER.—Fine weather in North and over centre, but strong N.W. winds at latter, and very showery in South; winds S.W. and W.

DECEMBER.—Generally fine weather throughout during this month.

## EARTHQUAKES reported in NEW ZEALAND during 1897.

PLACE.	Jan.	Feb.	Mar.	April.	May.	June.	July.	Aug.	Sept.	Oct.	Nov.	Dec.	Total.
Auckland	..	..	..	..	..	..	..	..	..	..	22*	8*	2
Matata	..	..	..	..	..	..	..	..	21*	..	..	..	1
Rotorua	..	..	..	10	..	..	26	..	..	..	25	..	3
Taupo	..	..	..	..	20*	..	..	..	9,* 17*	7,* 17*	..	..	5
Gisborne	8*	..	..	..	..	..	..	28*	..	..	..	..	2
New Plymouth	..	..	8*	..	..	..	..	15*	21	..	..	8*	4
Napier	..	..	..	..	..	..	13*	..	..	14	..	8*	3
Hawera	..	..	..	..	..	..	..	..	21*	..	..	8*	2
Manaia	..	..	..	..	..	..	..	..	..	..	..	8*	1
Patea	..	..	..	..	..	..	..	..	..	..	..	8*	1
Wanganui	..	..	..	..	..	..	..	..	21*	..	..	8*	2
Marton	..	..	..	..	..	..	..	..	..	..	..	8*	1
Feilding	..	..	..	..	..	..	..	..	..	..	..	8*	1
Waipawa	..	..	..	..	9*	24*	..	..	..	..	..	8*	3
Woodville	..	..	..	..	..	24*	..	..	..	..	..	8*	2
Pahiatua	..	..	..	..	..	..	..	..	13*21*	..	..	8*	3
Palmerston N.	..	..	..	..	9*	..	..	..	..	..	..	8*	2
Tinui	..	..	..	..	..	..	..	..	..	14	..	..	1
Mauriceville	..	..	..	..	..	..	..	..	..	..	..	8*	1
Masterton	..	..	..	..	..	..	..	..	21*	14*	15*	8*	4
Carterton	..	..	..	..	..	..	..	..	..	..	..	8*	1
Greytown	..	..	..	..	..	..	..	..	21*	..	..	..	1
Featherston	..	..	..	..	..	..	..	..	21*	..	..	..	1
Wellington	14	27*	20	..	9	8	30	13, 21*	14, 18	11, 15	3, 8*	27	15
Havelock	..	..	..	..	..	..	..	..	21*	..	..	..	1
Blenheim	..	27*	..	..	..	..	..	..	21*	..	..	8*	3
Wakapuaka	..	27	..	..	..	..	..	..	13*21*	..	..	8*	4
Nelson	..	..	..	..	..	..	..	..	..	..	..	8*	1
Kaikoura	..	27	..	..	..	..	..	..	..	..	..	8*	2
Christchurch	..	27	..	..	..	..	..	..	..	..	..	8*	2
Hokitika	..	27*	..	..	..	..	..	..	15	..	..	8*	3
Reefton	..	27*	..	..	..	..	..	..	..	..	..	..	1
Ngahere	..	27*	..	..	..	..	..	..	..	..	..	..	1
Greymouth	..	27*	..	..	18*	..	..	..	..	..	..	..	2
Westport	..	27*	..	..	..	..	..	..	..	..	..	..	1
Dunedin	..	..	..	..	..	..	..	..	..	..	2	..	1
Milford Sound	..	..	..	..	18*	..	..	..	..	..	..	..	1

NOTE.—The figures denote the day of the month on which one or more shocks were felt. Those with the asterisk affixed were described as *smart*. The remainder were only slight tremors, and no doubt escaped record at most stations, there being no instrumental means employed for their detection. These tables are therefore not reliable as far as indicating the geographical distribution of the shocks.

# NEW ZEALAND INSTITUTE.

## HONORARY MEMBERS.

1870.

FINSCH, OTTO, Ph.D., of Bremen. | HOOKER, Sir J. D., G.C.S.I., C.B.,  
FLOWER, Sir W. H., K.C.B., F.R.S., | M.D., F.R.S.  
F.R.C.S.

1872.

GREY, Sir GEORGE, K.C.B., P.C., D.C.L.

1873.

BOWEN, Sir GEORGE FERGUSON, | CAMBRIDGE, The Rev. O. PICKARD,  
G.C.M.G., P.C. | M.A., C.M.Z.S.  
GÜNTHER, A., M.D., M.A., Ph.D., F.R.S.

1874.

McLACHLAN, ROBERT, F.L.S. | NEWTON, ALFRED, F.R.S.

1875.

SCLATER, PHILIP LUTLEY, M.A., Ph.D., F.R.S.

1876.

ETHERIDGE, Prof. ROBERT, F.R.S. | BERGGREN, Dr. S.

1877.

SHARP, Dr. D.

1878.

MÜLLER, Professor MAX, F.R.S.

1883.

Lord KELVIN, F.R.S. | ELLERY, ROBERT L. J., F.R.S.

1885.

SHARP, RICHARD BOWDLER, M.A., | WALLACE, A. R., F.L.S.  
F.L.S.

1888.

McCoy, Professor Sir F., K.C.M.G., Sc.D., F.R.S.

1890.

NORDSTEDT, Professor OTTO, Ph.D. | LIVERSIDGE, Professor A., M.A.,  
F.R.S.

1891.

GOODALE, Professor G. L., M.D., | DAVIS, J. W., F.G.S., †F.L.S.  
LL.D.

1894.

DYER, Professor THISELTON, C.M.G., | CODRINGTON, Rev. R. H., D.D.  
M.A., F.R.S.

1895.

MITTEN, WILLIAM, F.L.S.

1896.

LYDEKKER, RICHARD, B.A., F.R.S. | LANGLEY, S. P.



## ORDINARY MEMBERS.

## WELLINGTON PHILOSOPHICAL SOCIETY.

[\* Life-members.]

- |  |  |
|--|--|
| Adams, Dr.                                       | Ewen, C. A.                                  |
| Allen, F.  | Farquhar, H.                                 |
| Atkinson, A. R.                                  | Ferard, B. A., Napier                        |
| Atkinson, A. S., Nelson                          | Ferguson, W., C.E.                           |
| Baldwin, P. E.                                   | Field, H. C., Wanganui                       |
| Barker, G. H.                                    | Fraser, F. H.                                |
| Barnes, R. J.                                    | Freeman, H. J.                               |
| Baron, J. Suckling                               | Gifford, A. C.                               |
| Barraud, W. F.                                   | Gordon, H., F.G.S.                           |
| Barton, W.                                       | Gore, R. B.                                  |
| Batkin, C. T.                                    | Grace, Hon. M. S., C.M.G.,<br>M.D.           |
| Beetham, G.                                      | Hadfield, E. F.                              |
| Beetham, W. H.                                   | Hanify, H. P.                                |
| Bell, E. D.                                      | Harcourt, J. B.                              |
| Bell, H. D.                                      | Harding, R. Coupland                         |
| Best, E., Hadfield                               | Hastie, Miss J. A.*                          |
| Blair, J. R.                                     | Hawthorne, E. F.                             |
| Bold, E. H., C.E., Napier                        | Haylock, A.                                  |
| Bothamley, A. T.                                 | Hector, Sir James, K.C.M.G.,<br>M.D., F.R.S. |
| Brandon, A. de B.                                | Henley, J. W.                                |
| Brown, W. R. E.                                  | Herbert, W. H.                               |
| Buchanan, John, F.L.S.*                          | Hislop, Hon. T.                              |
| Buller, Sir W. L., K.C.M.G.,<br>D.Sc., F.R.S.    | Holmes, R. L., F.R. Met. Soc.,<br>Fiji*      |
| Caldwell, R.                                     | Holmes, R. T., Masterton                     |
| Campbell, J. P.                                  | Hudson, G. V., F.E.S.                        |
| Chapman, Martin                                  | Hulke, C., F.C.S.                            |
| Chapple, Dr.                                     | Hustwick, T. H.                              |
| Chudleigh, E. R.                                 | Inwood, D., Canterbury                       |
| Clarke, F. E., New Plymouth                      | Jenkins, Digby A.                            |
| Cohen, W. P.                                     | Johnson, G. Randall*                         |
| Colenso, Rev. W., F.R.S.,<br>F.L.S., &c., Napier | Kenny, Hon. Captain C.                       |
| Connal, E.                                       | King, T.                                     |
| Davy, Dr. T. G., Kumara                          | Kirk, H. B., M.A.                            |
| Dawson, B.                                       | Kirk, T., F.L.S.                             |
| Denton, George                                   | Kirk, T. W., F.L.S.                          |
| Drew, S. H., Wanganui                            | Krull, F. A., Wanganui                       |
| Elliot, Major E. H. J.                           | Lambert, T. S.                               |
| Evans, W. P., M.A., Ph.D.                        | Lee, H. M.                                   |
| Ewart, Dr.                                       |  |

- |   |                                     |
|---|-------------------------------------|
| Lee, R.                                 | Pringle, T.                         |
| Liffiton, E. N., Wanganui               | Reid, W. S.                         |
| Litchfield, A. J., Blenheim             | Richardson, C. T.                   |
| Lomax, H. A., Wanganui                  | Rowse, Rev. W., Greytown            |
| Loxton, A.                              | Roy, R. B., New Plymouth*           |
| Mackenzie, F. Wallace, M.B.             | Rutherford, A. J.                   |
| Marchant, J. W. A.                      | Rutherford, W. G.                   |
| Martin, Dr. A.                          | Rutland, Joshua, Marlborough        |
| Maskell, W. M.                          | Samuel, E.                          |
| Mason, Thomas, Hutt                     | Schaw, Major-General, C.B.,<br>R.E. |
| Maxwell, J. P., M.Inst.C.E.             | Simcox, W. H., Otaki                |
| McDougall, A.                           | Sinclair, J.                        |
| McKay, Alexander, F.G.S.                | Skerman, Dr. Sydney, Marton         |
| McLeod, H. N.                           | Skey, W.                            |
| McWilliam, Rev. J., Otaki               | Smith, Charles, Wanganui            |
| Mestayer, R. L., M.Inst.C.E.            | Smith, S. Percy, F.R.G.S.           |
| Molineaux, B. M.                        | Stewart, J. T., Wanganui            |
| Moore, G.                               | Stowell, H. M.                      |
| Moorehouse, W. H. S.                    | Stuart, A. P.                       |
| Morison, C. B.                          | Tait, P. W.                         |
| Murdoch, R., Wanganui                   | Talbot, Dr. A. G.                   |
| Nairn, C. J., Hawke's Bay               | Tanner, Cyril                       |
| Newman, Alfred K., M.B.,<br>M.R.C.P.    | Tod, Andrew, Wanganui               |
| Ogg, Rev. C. S.                         | Travers, W. T. L., F.L.S.           |
| Orr, Robert                             | Tregear, E.                         |
| Park, R. G.*                            | Turnbull, A. H., London             |
| Pearce, E.                              | Turnbull, R. T.                     |
| Pharazyn, C., Wairarapa                 | Turnbull, Thomas                    |
| Phillips, Coleman                       | Waley, A. S., London                |
| Pierard, C. H.                          | Wallace, James                      |
| Pollen, Hugh                            | Waterhouse, G. M., F.R.G.S.         |
| Powles, C. P.                           | Wilton, G. W.                       |
| Poynton, J. W.                          | Woodhouse, Alfred James,<br>London  |
| Prendergast, Sir J., Chief Jus-<br>tice | Young, J.                           |

---

 AUCKLAND INSTITUTE.

[\*Honorary and life members.]

- |                             |                                       |
|-----------------------------|---------------------------------------|
| Adams, J., B.A., Thames     | Bakewell, R. H., M.D., Devon-<br>port |
| Aickin, G., Auckland        | Ball, W. T., Auckland                 |
| Aitken, W., „               | Bartley, E., Devonport                |
| Allen, T., „                | Bates, T. L., Newcastle,<br>N.S.W.*   |
| Argall, W. H., Coromandel   | Batger, J., Auckland                  |
| Bagnall, L. J., Thames      |                                       |
| Baker, Rev. S. W., Auckland |                                       |

Beere, D. M., C.E., Gisborne	Eastham, S., Ponsonby
Berry, W., Auckland	Edson, J., Devonport
Best, Elsdon, Te Whaiti	Egerton, Prof. C. W., Auckland
Boscawen, H., Auckland	Ewington, F. G., Auckland
Brett, H., Auckland	Farmer, J., London
Briffault, R., Auckland	Fenton, F. D., Kaipara
Brigham, J. M., F.R.G.S., F.I.S., Auckland	Fidler, W., Northcote
Brookes, E. S., jun., Wharehine	Fowlds, G., Auckland
Broun, Captain T., F.E.S., Drury	Garlick, R.            ,,
Brown, Prof. F. D., Auckland	Girdler, Dr.            ,,
Brown, J., Epsom	Goldie, D.             ,,
Buchanan, J., Auckland	Gorrie, W.             ,,
Buchanan, W., Devonport	Gray, A., Remuera
Buckland, A., Auckland*	Haines, C. H., M.D., F.R.G.S., Auckland
Burgess, E. W., Devonport	Haines, H., F.R.C.S., Auckland
Burton, Colonel, Lake Takapuna*	Hardie, J., Auckland
Cameron, R., Auckland	Harding, S., C.E., Auckland
Campbell, H.             ,,	Harris, J. D., Blenheim
Campbell, J. L., M.D., Auckland	Haszard, H. D. M., Thames
Carnie, A. R., Auckland	Henton, J. S., Auckland
Carr, R. A.             ,,	Hesketh, E.            ,,
Cheal, P. E.             ,,	Herbert, T., Parnell
Cheeseman, T. F., F.L.S., Auckland	Hill, W. J., Auckland
Ching, T., Remuera	Johnson, H. D., Wellington
Cochrane, W. S., Auckland	Keesing, M., Auckland
Colbeck, Captain, Epsom	Kenderline, J., Auckland
Combes, F. H., Auckland	Kidd, A.                ,,
Cooper, C.             ,,	Kirk, T., F.L.S., Wellington*
Cooper, T.             ,,	Kirker, J., Auckland
Cowie, Rt. Rev. W. G., D.D., Bishop of Auckland	Kitt, T. W., London*
Cozens, G., Auckland	Lennox, J. M., Auckland
Craig, E.                ,,	Lennox, N. G., Sydney*
Cussen, L., Hamilton	Leys, T. W., Auckland
Danneford, S., Auckland	MacArthur, J. P., London
Darby, P.                ,,	Mackechnie, E. A., Auckland
Davies, Rev. H. S., Northcote	Mackellar, E. D., M.D., Parnell
Dawson, F. W. E., M.R.C.S. Eng., Auckland	MacMillan, C. C., Auckland
Dignan, P. L., Auckland	Mahoney, T.            ,,
Dufaur, E. T.            ,,	Mair, Captain G., Thames
Duthie, D. W.            ,,	Mair, R., Whangarei
	Mair, Major W. G., Auckland
	Major, Rev. H. D. A., Remuera

Marshall, P., F.G.S., Auckland	Shakespear, R. H., Little Barrier Island
Martin, J., F.G.S., Auckland	Shaw, H., Auckland
Masefield, T. T. „	Shrewsbury, H., Parnell
McCullough, Hon. W. „	Sinclair, A., Auckland
McDowell, W. C., M.D., Auckland	Smith, A. A. „
McLachlan, J. M., Auckland	Smith, H. G. S., Auckland
McLaurin, J. „	Smith, S. P., F.R.G.S., Wellington*
Mitchell, J. „	Smith, T. H., Auckland
Monro, H. A. H., Parnell	Steel, T., Sydney
Montgomery, A., Auckland	Stewart, J., C.E., Auckland
Moody, T. P., Hikurangi	Streeter, S. C. „
Morrin, T., Auckland	Talbot-Tubbs, Professor H.A., Auckland
Morton, H. B. „	Thomas, Prof. A. P. W., F.L.S., Auckland
Moss, F. J., Rarotonga	Thornton, Mrs. D. B., Mangakawa
Mueller, G., Auckland	Tibbs, J. W., Auckland
Munro, G. C., Sandwich Islands	Tinné, H., London*
Murdoch, D. L., Auckland	Tinné, T. F. S., London
Murray, T. L., Thames	Upton, J. H., Auckland
Nathan, L. D., Auckland	Urquhart, A. T., Karaka
Park, James, F.G.S., Auckland	Wade, H. G., Auckland
Patterson, G. W. S., Kaikohe	Walker, W. R., Parnell
Peacock, T., Auckland	Walsh, Rev. P., Waimate
Petrie, D., F.L.S., Auckland	Webster, J., Hokianga
Philcox, W., Devonport	Weetman, S., F.R.G.S., Blenheim*
Pond, J. A., Auckland	Will, W., Auckland
Potter, A. T., Whangarei	Williams, T. O., M.D., Thames
Purchas, Rev. A. Guyon, M.R.C.S. Eng., Auckland	Williams, Right Rev. W. L., Bishop of Waiapu, Napier
Pycroft, A. T., Bay of Islands	Williamson, C., Auckland
Rechnagel, R., Auckland	Wilson, G., Thames
Reed, J. R., Auckland	Wilson, H. M., Warkworth
Reid, J., Auckland	Wilson, W. S., Auckland
Robertson, E., M.D., Auckland	Withy, E., Parnell*
Rose, R. „	Wright, G. W., Auckland
Russell, James „	Yates, E., Auckland
Russell, T., C.M.G., London*	Yates, J. E., Auckland
Scheidel, Dr., Thames	
Seegner, C., Auckland	
Segar, Professor H. W., Auckland	

PHILOSOPHICAL INSTITUTE OF CANTERBURY.

[Life-members marked thus \*.]

Adams, T. W.	Garsia, Captain
Anderson, Gilbert	Gray, G., F.C.S.
Austin, A. D.	Hall, Sir John, K.C.M.G.
Murray-Aynsley, H. P.	Hardcastle, J.
Murray-Aynsley, Dr.	Hogben, G., M.A.
Baines, A. C.	Hutton, Capt., F. W., F.R.S.*
Bealey, S.	Kitson, W.
Beckett, T. W. Naylor, F.L.S.	Laing, R. M., M.A.
Bickerton, Prof. W. A., F.C.S.	Lee, H. M.
Binns, F. C.	Lillie, C. O.
Bishop, F. C. B.	Lomax, Dr.
Bishop, R. C.	Manning, Dr.
Blakiston, C. R.	Mathew, Prof. E. J.
Bone, D.	Mayne, J. B.
Booth, G. T.	Meddings, W. F.
Bourne, C. F., M.A.	Meeson, J. T., B.A.
Bowen, Hon. C. C.	Mollett, T. A.*
Boyd, Dr.	McLaren, D. B.
Bridges, G. G.	Nairn, R.
Brown, D.	Page, S.
Brown, R.	Pairman, Dr. T. W.
Campbell, Dr. G.	Palmer, J.
Carew, W. A.	Purnell, C. W.
Carlisle, W. J.	Roper, E. W.
Chilton, Dr. C., D.Sc.*	Seager, S. H., A.R.I.B.A.
Cockayne, L.	Smith, W. W.
Cook, Prof. C. H. H., M.A.	Sparkes, W.
Cresswell, W. J.	Speight, R., M.A.
Cuthbert, E.	Suter, H.
Deans, J.*	Symes, Dr. W. H.*
Dendy, Prof. A., D.Sc.	Taylor, A. L.
Denniston, Mr. Justice	Thomas, Dr. W.
Diamond, Dr.	Townend, Dr.
Duxfield, R. D.	Wakefield, C. M., F.L.S., F.E.S.
Enys, J. D.	Walton, W.
Evans, Dr. W. P.	Waymouth, F.
Farr, C. C.	Webb, H. R., F.R.M.S.
Fereday, R. W.	Wood, W. D.
Foster, T. S., M.A.	

## OTAGO INSTITUTE.

[\* Life-members.]

Adams, C. W., C.E.	Hunter, F. A.
Allen, Dr. W. H.	Jackson, Howard
Allen, James, M.H.R.	Joachim, G.*
Allen, John	Kidston-Hunter, A. G.
Angus, John	King, Dr. Truby
Armstrong, F.	Langmuir, J.
Aston, B. C.	Lusk, F. W.
Barnett, Dr. L. S.	Macdonald, Dr. Gordon
Barningham, S.	Mackenzie, M. J. Scobie, M.H.R.
Batchelor, Dr. F.	Marchant, Miss E. A.
Bathgate, Alexander*	McConnochie, W.
Beal, L. O., C.E.	McKerrow, J.
Bell, A. D.	McLean, John*
Bell, G.	McLeod, J. G.
Beverley, A.	McNicol, D.
Bews, D. J.	Melland, E.*
Black, Professor J. G., D.Sc.	Milne, W. D.
Blair, John	Neville, Bishop
Brent, D.*	Ogston, Dr. F.
Brown, Dr. William	Pearce, T. D.
Brown, W.	Petrie, D., F.L.S.*
Browning, Miss K.	Rattray, James
Buchanan, N. L.*	Reid, Donald, jun.
Campbell, R.	Reid, George
Chapman, C. R.	Reynolds, Hon. W. H., M.L.C.
Chapman, F. R.	Richardson, C. R.
Cavell, Theo.	Ritchie, J. M.
Clarke, David	Roberts, Dr. W. H.
Collins, T. J.	Roberts, George
Colquhoun, Dr. D.	Roberts, John
Don, Dr. J. R.	Russell, George G.
Duncan, Peter	Sale, Professor G. S.
Dunn, J. D.	Sandelands, R.
Ewing, John	Scott, Professor J. H.
Fenwick, George	Shacklock, John
Ferguson, Dr. H. Lindo	Shand, Professor J., LL.D.
Fitzgerald, W. S.	Shenman, Watson
Fulton, S. W.*	Sidey, John
Gibbons, Prof. F. B.	Sim, W. A.
Goyen, P.	Sise, G. L.
Hay, P. S.	Skey, H.
Hay, Robert	Smith, Dr. W.
Hamilton, A.	Smith, J. Crosby
Hocken, Dr. T. M.	Stewart, A.
Hosking, J. H.	

Stewart, Hon. W. D., M.L.C.	Ulrich, Prof. G. F. H.
Stephenson, Dr. R. S.	Wales, N. Y. A.
Stout, Sir Robert, K.C.M.G.	Wharton, G.
Stilling, F. R.	Whetter, R. G.
Tennant, J. S.	White, D. R.
Thomson, G. M.*	Wilson, Alexander
Thomson, J. C.	Williams, Mr. Justice*

---

WESTLAND INSTITUTE.

Agnew, Captain	Little, A.
Barton, C. A.	Lynch, J. D.
Batten, Miss	Macandrew, Dr.
Beare, T. W.	Macfarlane, D.
Bignell, Captain	Macfarlane, J. C.
Brown, Mrs.	Mahan, A.
Bruce, T. W.	Malfroy, J.
Burke, J. J. L.	Mardle, J.
Campbell, E. B.	Martin, Rev. Canon
Chesney, J.	Maunders, J.
Clarke, J. J.	Michel, H. L.
Dawes, J. S.	Morton, A. J.
Douglas, Rev. William	Murray, W. G.
Douglas, St. John	Northeroft, L.
Flannery, M.	Owens, J.
Folley, W.	Park, J.
Gale, T. H.	Paul, Miss
Gill, T. H.	Pollock, M.
Ginger, Rev. B.	Robbie, Miss M.
Greville, Miss	Roberts, G. J.
Hamilton, Rev. S.	Ross, R.
Harper, J. F.	Sinclair, G. K.
Harrop, A. N.	Tait, Miss
Heinz, W.	Teichelman, Dr.
Hughes, H. E.	Ward, Miss
Jack, Miss	Williams, W.
Keller, J. C.	Whitehouse, Rev. E.
King, A. H.	Winchester, W.
Lewis, J. B.	

---

## HAWKE'S BAY PHILOSOPHICAL INSTITUTE.

[\* Life-members. † Honorary life-member.]

Adams, C. E., B.Sc., A.I.A.	Hutchinson, F.
Ashcroft, R. H.	Jacobson, H. C. F.
Bernau, Dr. H. F.	Jarvis, Dr. J. E. H.
Binsfield, Rev. Father, Meeanee	Large, J. S.*
Birch, W. J., Erewhon	Leahy, Dr.
Bull, H., Gisborne	Loughnan, I. H., Tukituki
Burnett, H., Woodville	Luff, A., Wellington
Campbell, Hugh, Poukawa	Matthews, Miss
Canning, Charles, Petane	McLean, R. D. D., M.H.R.
Carlile, J. W., M.A.	Milne-Thomson, Dr. A.
Caughley, J.	Moore, Dr. T. C.
Chambers, J. B., Te Mata	Morgan, T.
Chambers, J., jun., Mokopeka	Newton, J. K.
Chambers, W. K., Poverty Bay	Noake, R. W.
Coleman, J. H.	Norris, A.
Colenso, Rev. W., F.R.S., F.L.S.†	Ormond, G., Mahia
Cooke, J. C., Waipukurau	Ormond, Hon. J. D., M.L.C.
Cooper, T. R.	Paterson, Rev. J. G.
Craig, J. W.	Ringland, J.
Crerar, J. R.	Russell, Captain W.R., M.H.R., Flaxmere
De Lisle, Dr. F. I.	Smith, H. Guthrie, Tutira
Dinwiddie, W.	Smith, J. H., Orlig*
Donnelly, G. P., Crissoge	Tanner, T.
Gilberd, J. G.	Tiffen, G. W., Puhatikotiko, Gisborne
Gold-Smith, Eric C.	Tregelles, F. A., C.E.
Gray, W., B.A.	Townley, J., Gisborne
Hamilton, A., Dunedin*	Walker, R. T.
Hall, T.	White, G.
Harding, J., sen., Mount Ver- non	White, T., Wimbledon
Hill, H., B.A., F.G.S.	Whitelaw, T.
Hislop, J.	Williams, F. W.
Holder, H. R., Woodville	Williams, J. N., Frimley, Hastings
Hovell, De Berdt, Very Rev. Dean of Waiapu	Younghusband, J.



NELSON PHILOSOPHICAL SOCIETY.

Atkinson, A. S., F.L.S.	Hudson, Dr. J.
Bartel, J. G.	Huffam, T. B.
Boor, Dr. L.	Joynt, J. W.
Browning, J. S.	Kempthorne, Rev. J. P.
Chatterton, Rev. F. W.	Kingsley, R. I.
Cock, H.	Lukins, E.
Curtis, W. S.	Mackie, Dr. W. J.
Fell, C. Y.	Martin, W.
Gibbs, F. G.	Mules, Right Rev. C. O.,
Holloway, J.	Bishop of Nelson

---

---

## LIST OF INSTITUTIONS AND PERSONS

TO WHOM

THIS VOLUME IS PRESENTED BY THE GOVERNORS OF THE  
NEW ZEALAND INSTITUTE.

---

His Excellency the Governor, President of the Institute.  
 Governors of the Institute (eleven).  
 Honorary Members (thirty).  
 The Prime Minister.  
 The Colonial Secretary.  
 The Colonial Treasurer.  
 The Minister of Lands.  
 The Minister for Public Works.  
 The Postmaster-General.  
 The Attorney-General.  
 The Minister of Education.  
 The Under-Secretary for the Colony.  
 The Under-Secretary for Lands.  
 The Legislative Council.  
 The House of Representatives.  
 The Colonial Office, London.  
 The Agent-General, London.  
 The Imperial Institute.  
 Messrs. Kegan, Paul, Trench, Trübner and Co. (Agents),  
 Paternoster House, Charing Cross Road, London.  
 British Museum Library, London.  
 British Museum, Natural History Department, South Ken-  
 sington, London, S.W.  
 Linnean Society, London.  
 Royal Society, London.  
 Royal Geographical Society, London.  
 Royal Asiatic Society, London.  
 Royal Society of Literature of the United Kingdom.  
 Royal Colonial Institute, London.  
 Royal Statistical Society, London.  
 Geological Society, London.  
 Zoological Society, London.  
 Anthropological Institute of Great Britain and Ireland,  
 London.  
 Entomological Society, London.  
 Geological Survey of the United Kingdom, London.  
 Editor of *Nature*, London.  
*Geological Magazine*, London.  
*Geological Record*, London.

Imperial Institute, London.  
*Zoological Record*, London.  
Victoria Institute, London.  
Institution of Civil Engineers, London.  
Library of Patent Office, London.  
Marine Biological Association of the United Kingdom.  
Philosophical Society of Leeds, England.  
Leeds Geological Association, Meanwood, Leeds.  
Literary and Philosophical Society, Liverpool, England.  
Biological Society, Liverpool.  
Norfolk and Norwich Naturalist Society, Norwich, England.  
University Library, Oxford, England.  
University Library, Cambridge, England.  
School Library Committee, Eton, England.  
School Library Committee, Harrow, England.  
School Library Committee, Rugby, England.  
Natural History Society, Marlborough College, England.  
Clifton College, England.  
North of England Institute of Mining and Mechanical  
Engineers, Newcastle-upon-Tyne.  
Royal Society, Edinburgh.  
Royal Botanic Garden Library, Edinburgh.  
Geological Society, Edinburgh.  
University Library, Edinburgh.  
Royal Physical Society, Edinburgh.  
Royal College of Physicians, Edinburgh.  
Philosophical Society of Glasgow.  
Natural History Society, Glasgow.  
Royal Irish Academy, Dublin.  
Royal Society, Dublin.  
Asiatic Society of Bengal, Calcutta.  
Geological Survey of India, Calcutta.  
Bombay Natural History Society.  
Royal Society of New South Wales, Sydney.  
Linnæan Society of New South Wales, Sydney.  
Public Library, Sydney.  
Library of Australian Museum, Sydney.  
Department of Mines, Sydney.  
Engineering Association of New South Wales, Sydney.  
University Library, Sydney.  
Agricultural Department, Sydney.  
Library, Botanic Gardens, Sydney.  
Royal Geographical Society of Australasia, Sydney.  
Royal Society of Victoria, Melbourne.  
Public Library, Melbourne.  
University Library, Melbourne.  
Geological Survey of Victoria, Melbourne.  
Field Naturalists' Club, Melbourne.

Australian Institute of Mining Engineers, Melbourne.  
 Gordon Technical College, Geelong, Victoria.  
 Legislative Library, Adelaide.  
 Royal Society of South Australia, Adelaide.  
 University Library, Adelaide.  
 Public Library of Tasmania, Hobart.  
 Royal Society of Tasmania, Hobart.  
 Royal Society of Queensland.  
 Queensland Museum, Brisbane.  
 Botanic Garden Library, Brisbane.  
 Queensland Branch, Geographical Society of Australasia,  
 Brisbane.  
 Free Public Library, Capetown.  
 Canadian Institute, Toronto.  
 Hamilton Association, Canada.  
 Geological Survey of Canada, Montreal.  
 Literary and Historical Society of Quebec, Canada East.  
 Nova-Scotian Institute of Natural Science, Halifax.  
 Natural History Society of New Brunswick, St. John's.  
 Institute of Jamaica, Kingston.  
 Science College, Imperial University of Japan, Tokyo.  
 Literature College, Imperial University of Japan, Tokyo.  
 National Library, Honolulu.  
 The Colony of Tahiti.  
 His Excellency the Governor, Pakeite, Tahiti.  
 Society of Natural Sciences, Batavia.  
 Boston Society of Natural History, U.S.A.  
 Connecticut Academy, New Haven, U.S.A.  
 Johns Hopkins University, Baltimore, U.S.A.  
 Academy of Science, Wisconsin, U.S.A.  
 Natural History Society, New Brunswick.  
 Smithsonian Institution, Washington, D.C.  
 Department of Agriculture, Washington.  
 United States Geological Survey, Washington, D.C.  
 American Geographical Society, New York.  
 American Museum of Natural History, New York.  
 Natural History Museum, Central Park, New York.  
 New York Academy of Sciences.  
 Second Geological Survey of Pennsylvania.  
 American Philosophical Society, Philadelphia.  
 American Institute of Mining Engineers, Philadelphia.  
 Franklin Institute, Philadelphia.  
 Academy of Natural Sciences Library, Philadelphia.  
 Wagner Free Institute of Science of Philadelphia.  
 Academy of Natural Sciences, Buffalo, State of New York.  
 Academy of Natural Sciences, San Francisco.  
 Stanford University, California.  
 Academy of Natural Sciences, Davenport, Iowa.

- Harvard College, Cambridge, Massachusetts.  
 Director of Library of Missouri Botanical Gardens, St. Louis, Mo.  
 Natural History Society of Frankfurt à O.  
 Royal Society of Literature and Arts of Belgium, Brussels.  
 Royal Imperial Institute for Meteorology and Earth-Magnetism, Hohe-Warte, Vienna.  
 Jahrbuch der Kaiserlich-königlichen Geologischen Reichsanstalt, Vienna.  
 Ornithological Society, Vienna.  
 Botanical Society of the Province of Brandenburg, Berlin.  
 Dr. Bastian, Berlin.  
 Royal Library, Berlin.  
 Geographical Society, Berlin.  
 Societas regia Scientiarum Bohemica, Prague.  
 Imperial German Academy of Naturalists, Dresden.  
 Physico-economic Society of Königsberg, E. Prussia.  
 Royal Zoological, Anthropological, and Ethnographical Museum, Dresden.  
 Verein für vaterländische Naturkunde in Württemberg, Stuttgart.  
 Society of Geography, Leipzig.  
 Redaktion des Biologischen Centralblatts, Erlangen.  
 Biblioteca e dell' Archivio Tecnico del Ministero Córdoba dei Lavori Pubblici, Roma.  
 R. Accademia dei Lincei, Rome.  
 Imperial Museum of Florence.  
 Royal Geographical Society of Italy, Florence.  
 Orto e Museo Botanico (R. Istituto di Studi Superiori) in Firenze.  
 Tuscan Natural Science Society, Pisa.  
 Museum of Zoology and Comparative Anatomy of the Royal University of Turin.  
 Editor of *Cosmos*, Turin.  
 Academy of Science, Modena.  
 Società Africana d'Italia, Naples.  
 Stazione Zoological, Naples.  
 National Library, Paris.  
 Société de Géographie, Paris.  
 Entomological Society of France, Paris.  
 Museum of Natural History of France, Paris.  
 Société Zoologique de France, Paris.  
 Natural History Museum, Bordeaux.  
 Natural History Society, Angers.  
 Naturhistorischer Verein in Bonn.  
 Museum of Natural History, Geneva.  
 Die Naturforschende Gesellschaft in Bern.  
 Imperial Society of Naturalists, Moscow.

Société des Naturalistes, Kieff, Russia.  
 Société des Sciences de Finlande, Helsingfors.  
 Royal Academy of Science, Stockholm.  
 Geological Survey of Sweden, Stockholm.  
 University of Christiania, Norway.  
 Bergen Museum, Norway.  
 Royal Danish Academy of Sciences and Literature of  
 Copenhagen.  
 Natural History Society of Copenhagen.  
 Dr. Lutkin, Copenhagen.  
 Natural History Museum of Hamburg.  
 M. Teyler, Haarlem.  
 Naturwissenschaftlicher Verein, Bremen.  
 Academia Nacional de Ciencias de la Republica Argentina.  
 School of Mines, Rio de Janeiro.  
 Society of Engineers, Rio de Janeiro.  
 Zoological Society of Brazil, Rocha.  
 Musen Paulista, San Paulo, Brazil.  
 Zoological Society, Brazil.

*Libraries and Societies in New Zealand.*

Library, Auckland Institute.  
 Library, Hawke's Bay Philosophical Institute.  
 Library, Wellington Philosophical Society.  
 Library, Nelson Philosophical Society.  
 Library, Westland Institute.  
 Library, Philosophical Institute of Canterbury.  
 Library, Otago Institute.  
 General Assembly Library.  
 Executive Library.  
 Library, New Zealand Institute.  
 Library, University College, Auckland.  
 Library, University College, Christchurch.  
 Library, University College, Dunedin.  
 Library, Auckland Museum.  
 Library, Wanganui Museum.  
 Library, Canterbury Museum.  
 Library, Otago Museum.  
 Library, Otago School of Mines.  
 Library, Thames School of Mines.  
 Library, Reefton School of Mines.

*Publishing Branch.*

Editor.		Lithographer.
Assistant Editor.		Government Printer.
Draughtsman.		Photo-lithographer.

# I N D E X .

## AUTHORS.

### A.

Adams, C. E., 585, 586  
Adams, J., 414

### B.

Barker, G. H., 550, 553  
Bathgate, A., 266  
Best, Elsdon, 33  
Brown, Dominick, 569  
Brown, Professor F. D., 44, 564  
Brown, R., 398, 399, 409, 411, 412  
Buchanan, W., 79

### C.

Christian, F. W., 93, 548  
Clarke, F. E., 254  
Cockayne, L., 435  
Cookson, J. Wentworth, 571

### D.

Dendy, Professor A., 316, 320, 569,  
570, 571  
Dinwiddie, W., 586  
Drew, S. H., 253

### E.

Erskine, J. A., 459  
Evans, Dr. W. P., 487, 495, 496,  
497

### F.

Farquhar, H., 187  
Farr, C. Coleridge, 118, 121  
Fereday, R. W., 326  
Field, H. C., 434, 447  
Firth, W. T., 463

### H.

Hamilton, A., 24, 192, 445, 575, 581  
Harding, R. Coupland, 87

Hawthorne, E. F., 559  
Hector, Sir J., 546, 551, 552, 555,  
556, 557, 558, 561  
Henry, R., 279  
Hilgendorf, F. W., 200, 218  
Hill, H., 515, 532  
Hutchinson, F., 533  
Hutton, Captain F. W., 130, 135,  
151, 155, 160, 167, 568, 571

### J.

Jarvis, Dr. J. H. E., 585

### K.

Kingsley, R. I., 442  
Kirk, H. B., 313  
Kirk, T., 379, 380, 561

### L.

Laing, R. M., 568  
Leahy, Dr., 586

### M.

Mackechnie, E. A., 109  
Maier, Gilbert, 41  
Marshall, P., 563  
Maskell, W. M., 219  
Mathew, Professor E. J., 568  
Mestayer, R. L., 556, 561  
Mokomoko, Mereana, 41  
Montgomery, A., 563  
Moore, Dr. T. C., 585

### P.

Parker, Professor T. Jeffery, 574,  
575  
Petrie, D., 421, 433  
Phillips, Coleman, 122

- |  |  |
|--|--|
| <p style="text-align: center;">R.</p> <p>Robertson, Dr. E., 66, 562</p> <p>Rutland, J., 29</p> <p style="text-align: center;">S.</p> <p>Schaw, Major-General, 465, 477</p> <p>Seagar, S. H., 570</p> <p>Shand, Professor J., 584</p> <p>Skey, W., 498, 509, 510, 512</p> <p>Smith, J. Crosbie, 581, 582</p> <p>Stair, Rev. J. B., 293</p> <p>Stirton, Dr. J., 382, 393</p> <p>Suter, H., 325</p> | <p style="text-align: center;">T.</p> <p>Tanner, F., 585</p> <p>Tennant, J. S., 581</p> <p>Thomas, Dr., 573</p> <p>Thomas, Professor A. P., 564</p> <p>Thomson, G. M., 576, 580, 582</p> <p>Milne-Thompson, Dr. A., 586</p> <p>Travers, W. T. L., 1, 92, 309, 553</p> <p>Tregear, E., 50, 554</p> <p>Tubbs, Professor Talbot, 562</p> <p style="text-align: center;">W.</p> <p>White, Taylor, 303, 586</p> |
|--|--|

---

### SUBJECTS.

- |  |   |
|--|---|
| <p style="text-align: center;">A.</p> <p>"A," a Passage in Archæology, 562</p> <p>Acclimatisation in New Zealand, 266, 576</p> <p>Addenda, 515</p> <p>Africa, Palæolithic Implements from, 571</p> <p>Alga, A New Marine, 582</p> <p>Algæ, On New Zealand Freshwater, 581</p> <p><i>Anacalypta</i>, On New Species of, 412</p> <p><i>Anaspides</i>, Recent Researches on, 580</p> <p>Animals, On the Industries of, 553</p> <p><i>Anomoura</i>, A Revision of New Zealand, 582</p> <p>Appendix, 591</p> <p>Archæology, "A," a Passage in, 562</p> <p>Art, The Evolution of, 570</p> <p>Atmospheric Motion, On Vertical, 465, 552</p> <p>Auckland Institute, xviii., 562, 564, 567, 598</p> <p>Auckland Museum, Progress of, 562</p> <p>Australian Aborigines, Customs of, 586</p> <p>Australian Lichens, New, 382</p> <p>Australian Mammals, 570</p> <p>Australian Stone Adze, 569</p> <p>Australian and New Zealand Mortality compared, 586</p> <p style="text-align: center;">B.</p> <p>Bicycle-tracks, Formula for constructing, 585</p> <p>Bird-life in the West Coast Sounds, 279, 553</p> <p>Blackball Coal, Distillation Products of, 487</p> | <p>Books, The Illustration of, 586</p> <p>Botanical Papers, 379</p> <p>Brachyura, Notes on New Zealand, 582</p> <p>Bryozoa, Recent and Fossil, 192</p> <p>Bunsen Burner, An Improved Adjustable Drip-proof, 497</p> <p style="text-align: center;">C.</p> <p>Canterbury, Philosophical Institute of, xviii., xix., 568, 572, 573, 601</p> <p><i>Carpophaga novæ-zealandiæ</i>, Brown Variety of, 546</p> <p>Charcoal and Pumice, their Relative Values for Insulation, 463</p> <p>Chatham Island Insects, 155</p> <p>Chemistry Papers, 487</p> <p><i>Cnemidornis calcitrans</i>, On, 581</p> <p><i>Cnemidornis minor</i>, 581</p> <p>Coal, Distillation Products of Blackball, 487</p> <p>Coals, On the Error introduced by using a Coal-gas Flame while determining the Percentage of Sulphur in, 496</p> <p>Coccidæ, New Species of, 219</p> <p>Cold Stores, Insulation of, 44</p> <p>Consumption, State Prevention of, 66</p> <p>Contents, v.</p> <p><i>Coprosma</i>, On a New Species of, 433</p> <p>Corals and Coral Reefs, 564</p> <p>Currents, Tides, and Moon, 79</p> <p>Cyanide Solutions on Gold, On the Rapid Action superficially of Strong, 512</p> <p>Cyaniding Gold, on the Liberation of Hydrogen in a Variation of the Apparatus used for, 510</p> |
|--|---|



## D.

- Dendia*, On New Genus, 411  
 Disease, Germs and their Relation to, 585  
 Diseases of Domesticated Animals, 550  
 Distillation Products of Blackball Coal, 487  
*Dodonidia helmsi*, On, 559  
 Dog, On the Ancient Maori, 151, 568  
 Domesticated Animals, Diseases of, 550  
*Drimys*, New Species of, 379, 547

## E.

- Earthquake of 8th December, 1897, On the, 447, 558  
 Earthquakes in New Zealand during 1897, 595  
 Earthquake of 21st September, 1897, On the, 552  
 Electro-deposition of Gold upon Gold, 498  
 Electro-motive Force, Screening of, in Fields of High Frequency, 459  
 Ether, On the, 564  
 Ether, Undulations of the, 584  
*Euryapteryx*, On a Specimen from Southland, 445, 582

## F.

- Ferns, Curious Forms of, 434  
 Fisheries, Notes on New Zealand, 576  
 Fish-hatchery, Proposed Marine, 583  
 Fool's Candle, 87, 547  
 Formol, Preserving Qualities of, 556  
 Freezing Chambers, Insulation of, 44  
 Freezing of New Zealand Alpine Plants, 435

## G.

- Gardens, Insect Life in, 563  
 Gems and Medals, On Some, 575  
 Geological Papers, 445, 515  
 Germs and their Relation to Disease, 585  
 Gold, Electro-deposition of Gold on, 498  
 Gold, On the Liberation of Hydrogen in a Variation of the Apparatus used for cyaniding, 510  
 Gold, On the Rapid Action superficially of Strong Cyanide Solutions on, 512

- Grasshoppers of New Zealand and Kermadec Islands, 135  
 Gravitation, On Le Sage's Theory of, 118  
 Greenstone, Did the Maori discover, 29, 554  
*Gunnera ovata*, Remarks on, 380

## H.

- Haplodactylus meandratus*, Large Specimen of, 575  
*Harpagornis*, On a Skeleton of, 574  
 Hawke's Bay Philosophical Institute, xviii., xx., 585, 587, 604  
 Hawke's Bay Plain, Past and Present, 515  
 Hemiptera described before 1896, List of New Zealand, 167  
 Hikurangi Mountain, Botany of, 414  
*Histiopteris labiosus*, 546  
 History, The Science of, 568  
 Hotunui, Building of, 41  
 Hydroids from Dunedin, 200  
 Hypnotism, 573

## I.

- Ideal, Influence of the, 109  
*Ignis fatuus*, 87, 547  
 Insects from the Chatham Islands, 155  
 Insect Life in Gardens, 563  
 Insulation of Cold Stores, 44  
 Insulation, Relative Values of Pumice and Charcoal for, 463

## K.

- Kermadec Islands, Grasshoppers and Locusts of, 135  
 Kingsmill Islanders, Armour of the, 575  
 Kirk, The late Mr. T., F.L.S., Resolution regarding, 571

## L.

- Lepidoptera, List of New Zealand, 326  
*Lepidothygnus huttoni*, On, 575  
 Lichens, New Australian and New Zealand, 382  
*Limulus polyphemus* from America, 571  
 Locusts of New Zealand and Kermadec Islands, 135

## M.

- Magnetic Force parallel to the Axis in the Interior of Solenoids, On the, 121  
 Manu Mea, or Red Bird of Samoa, On the, 293, 548  
 Maori, The, did he discover Greenstone, 29, 554  
 Maori Dog, On the Ancient, 151, 568  
 Maori Middens at Poverty Bay, 533  
 Maori Stone Implements, 130, 569  
 Marine Animals from New Brighton, 320, 570  
 Marine Fish-hatchery, Proposed, 583  
 Marsh Lights, 87, 547  
 Martins at Hicks Bay, 532  
 Maru-iwi, The Fleeing, 586  
 Medals and Gems, On Some, 575  
 Meteorology of New Zealand, 593  
 Miscellaneous Papers, 1, 533  
 Moa, Have we Remains of a Swimming Swan-like, 586  
 Moa, The Bird and the Tree, 586  
 Moon, Tides, and Currents, 79  
 Mortality in New Zealand, 586  
 Mortality of Australia and New Zealand compared, 586  
 Mosses of New Zealand, 398, 399, 409, 411, 412  
 Mythology, Thoughts on Comparative, 50, 557  
*Munida subrugosa*, 580

## N.

- Nature, Neglect of the Study of, 569  
 Nelson Philosophical Society, xviii., xxi., 589, 590, 605  
 New Brighton, Marine Animals from, 320, 570  
 New Zealand Institute, Accounts of, 542  
 New Zealand Institute, Election of a Governor of, 557  
 New Zealand Institute, Honorary Members of, 596  
 New Zealand Institute, Nomination of a Governor of, 553  
 New Zealand Institute, Ordinary Members of, 597  
 New Zealand Institute, Recipients of Free Copies of Transactions of, 606  
 New Zealand Institute, Report of, 539

- New Zealand Institute, Rules and Statutes of, xv.  
 New Zealand, Material and Scientific Progress in, during the Victorian Era, 1, 545  
 New Zealand, Mortality in, 586  
 Ngatiawa build Hotunui, 41  
*Nitophyllum microphylla*, On, 582

## O.

- Oil-bath for studying the Influence of Definite Temperatures on Solids, 495  
 Ore-deposits, 563  
 Otago Institute, xviii., xix., 574, 582, 584, 602  
 Outlying Islands, 93, 549

## P.

- Parker, The late Professor T. Jeffery, F.R.S., Resolution regarding, 572, 581  
*Parnophorus unguis*, 556  
 Parrot-fish Tooth, On a, 556  
 Patellidæ found near Wellington, 309, 552  
*Pedicellina*, Its Occurrence in New Zealand, 218  
 Phasmidæ of New Zealand, 160  
 Physics, Papers on, 459  
 Pigeon, Brown Variety of New Zealand, 546  
 Plants, Freezing of New Zealand Alpine, 435  
 Presentations of Transactions, List of, 606  
 Proceedings, 543  
*Pseudoscarus*, On a Tooth of, 556  
 Pumice and Charcoal, their Relative Values for Insulation, 463  
*Pyxine*, New Classification of, 393

## Q.

- Quail, Occurrence of New Zealand, 552

## R.

- Rahui, the Ceremony of, 586  
 Rats nesting in Trees, 303  
 Red Bird of Samoa, On the, 293, 548  
*Regalecus argenteus*, Occurrence of, 254, 574  
*Regalecus* sp., Notes on, 253, 549  
 Rock-pictographs in Canterbury, 24  
 Röntgen Rays, On the, 586

## S.

- Samoan Natural History, Romance of; relating to the *Manu Mea* or Red Bird, 293, 548  
 Saracens, Civilisation of the, and what we owe to them, 585  
*Scorpio afer*, 556  
 Screening of Electro-motive Force in Fields of High Frequency, 459  
 Sea-leopardess, Occurrence of, 555  
 Sea-lioness, Description of, 557  
 Seaweeds from Dunedin, On, 581  
 Seaweeds, Some New Zealand, 568  
*Seligera*, On a New Species of, 398  
*Solanum hamiltonii*, On, 561  
 Solenoids, On the Magnetic Force parallel to the Axis in the Interior of, 121  
 Solids, Oil-bath for studying the Influence of Definite Temperatures on, 495  
 Southland Institute, xviii., xxi.  
 South Sea Islands, Life in the, 93, 549  
 Sponges described in Dieffenbach's "New Zealand," 316, 571  
 Sponges of New Zealand, 313, 560, 571  
 Starfishes, 187  
 Storms of January and April, 1897, Histories of, 477, 546  
*Streptopogon*, On a New Species of, 409  
 Swallows and Martins at Hicks Bay, 532  
 Sword-fish, On *Xiphias gladius*, the Northern, 551  
 Sulphur in Coals, On the Error introduced by using a Coal-gas Flame while determining the Percentage of, 496  
 Sun, The, as a Star, and its Place in the Heavens, 585

## T.

- Taipari's Carved House at Thames, 41  
 Tides, Currents, and Moon, 79  
*Tortula*, On New Species of, 399  
 Triangulation, The Ray Trace Method of, 586  
 Tuhoe Land: Notes on the Urewera Tribe, 33  
 Tunny, On the Scaled, 575

## U.

- Urewera Tribe, Notes on the, 33

## V.

- Vital Force, Upon a Common, 122

## W.

- Wangapeka Valley, Botanical Notes on, 442  
 Water, Its Decomposition by Tannic Acid in Conjunction with an Alkali, 509  
 Wellington Philosophical Society, xviii., 545, 558, 559, 597  
 Western Australia, Minerals from, 571  
 West Coast Sounds, Bird-life in the, 279, 553  
 Westland Institute, xviii., xx., 588, 603  
 Will-of-the-wisp, 87, 547  
 Wind-motion, On Vertical, 465, 552

## X.

- Xiphias gladius*, On, 551

## Z.

- Zoological Papers, 135, 532  
 Zoology, Some Chapters in the History of, 574



L. 4ft.

Fig 1

L. 18in

Fig. 2



Fig. 3

L. 3ft

Fig 4

L. 2ft. 6in.

Fig. 5

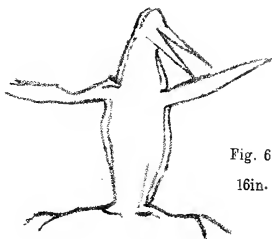

Fig. 6

16in.

Hamilton, del.

ROCK PICTOGRAPHS.  
TENGAWAI GORGE.





L. 9in.

Fig. 1

Fig. 2

L. 4ft. 4in.

Fig. 3

L. 2ft.

Fig. 5

L. 13in.

Fig. 4

L. 2ft.

Fig. 7

L. 3ft 6in.

Fig. 6

10in.

Hamilton, del.





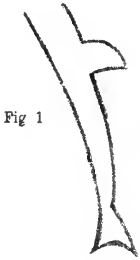

Fig 1



Fig. 2

L 15 in.

Fig. 3

Fig. 4

L 2ft.

Fig. 5

L. 1ft.

Fig. 7

12in.

Fig. 6

16in.

Hamilton, del



Fig. 1

f

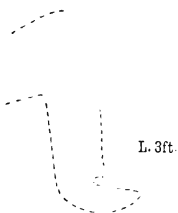

Fig. 2

Fig. 3

Fig. 6

Fig. 5

Fig. 4

2ft.

Hamilton, del

ROCK PICTOGRAPHS.  
TOTARA CREEK, OPIHI RIVER.

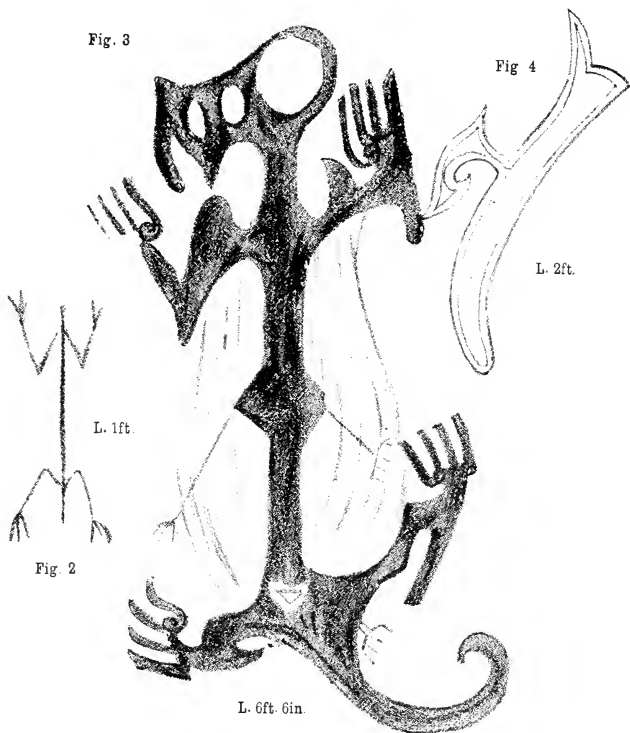

Fig. 1

L. 2ft. 3in.

Fig. 3

Fig 4



L. 1ft.

L. 2ft.

L. 6ft. 6in.

Hamilton, del.

ROCK PICTOGRAPHS.

OPIHI RIVER & HOWELL'S CREEK, OPIHI RIVER.



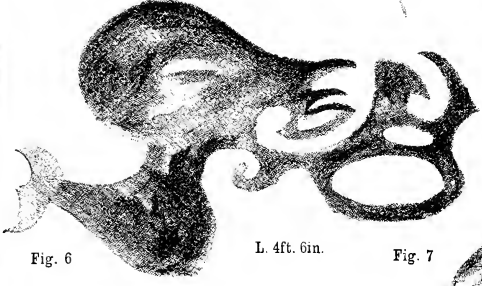
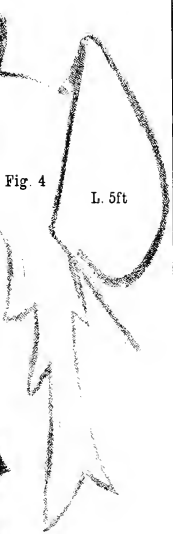
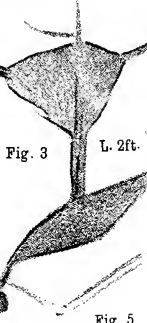
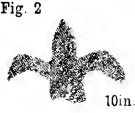
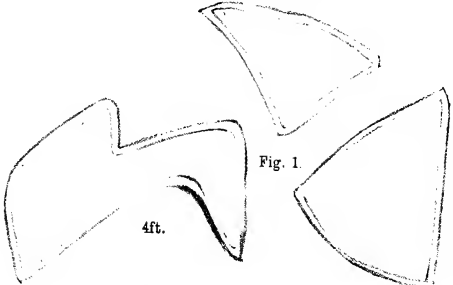

Hamilton, del.

ROCK PICTOGRAPHS.  
HOWELL'S CREEK, OPIHI RIVER.





Fig. 1

Fig. 2

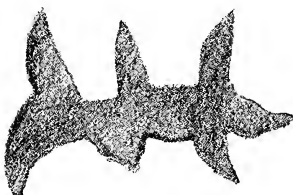

Fig. 3

L. 2ft 8in.

18in.

Fig. 4

L. 3ft 6in.

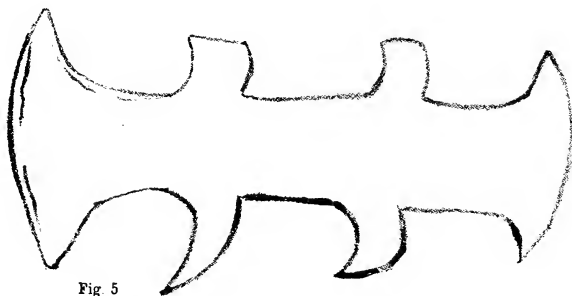

Fig. 5

L. 3ft 9in.

Hamilton, del.

ROCK PICTOGRAPHS.  
HOWELL'S CREEK, OPIHI RIVER.



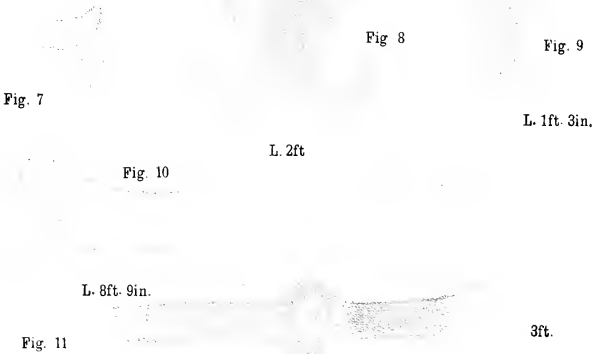
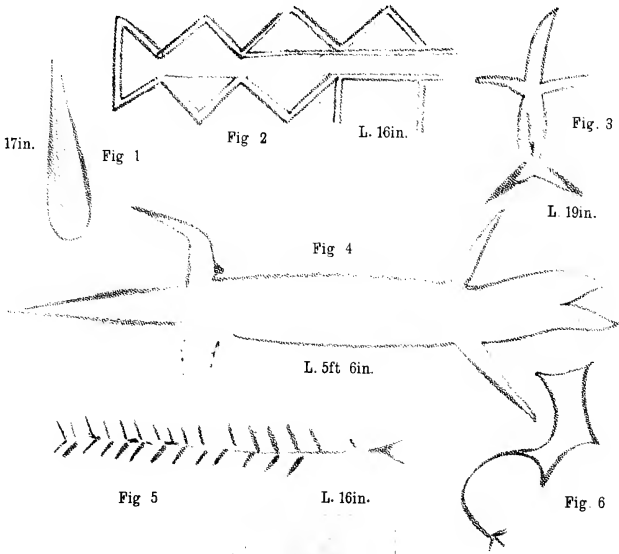

Hamilton, del

ROCK PICTOGRAPHS  
HOWELL'S CREEK. & NOAH'S ARK, OPIHI RIVER.



L 15ft.

Fig 1

Fig 3

Fig 2

L. 6ft

Fig 4

L. 2ft. 4in.



L. 5ft.

Fig 5

L 4ft.



Fig 6

Fig 7

L 2ft.

Fig 8

L. 16in.

Hamilton, del

ROCK PICTOGRAPHS  
NOAH'S ARK, OPIHI RIVER.



L. 6ft.

Fig. 1

Fig. 2

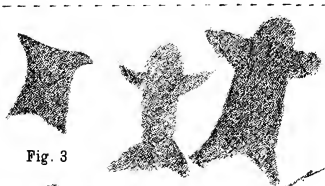

Fig. 3

L. 2ft. 6in.



Fig. 5

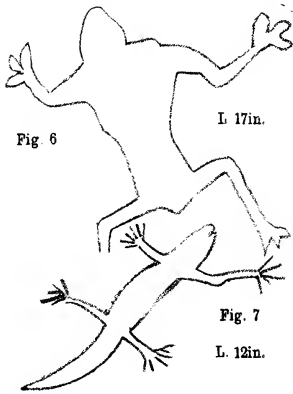
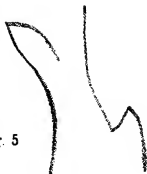

Fig. 6

L. 17in.

Fig. 7

L. 12in.



Fig. 4

L. 16in.

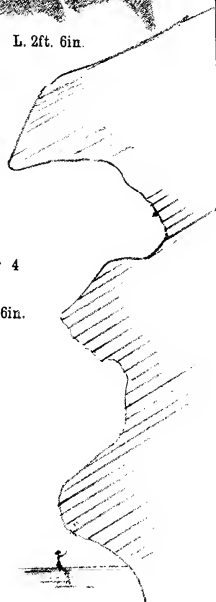

Hamilton. del.

ROCK PICTOGRAPHS  
RIGHT BANK OF OPIHI RIVER,  
AND SECTION OF CAVE SHELTER.





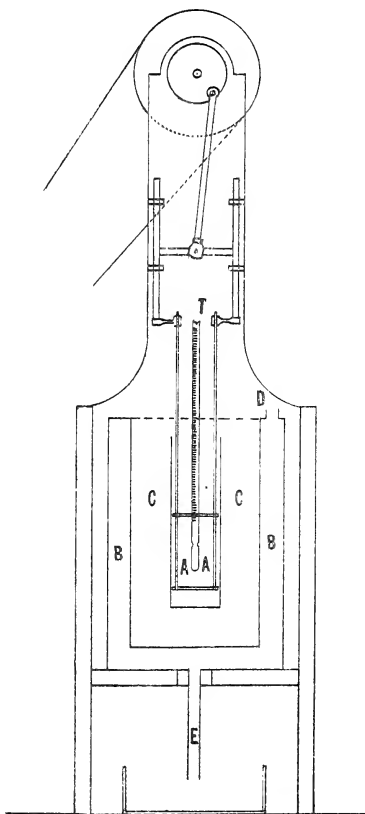

F. D. Brown, del

TO ILLUSTRATE INSULATION OF COLD STORES.



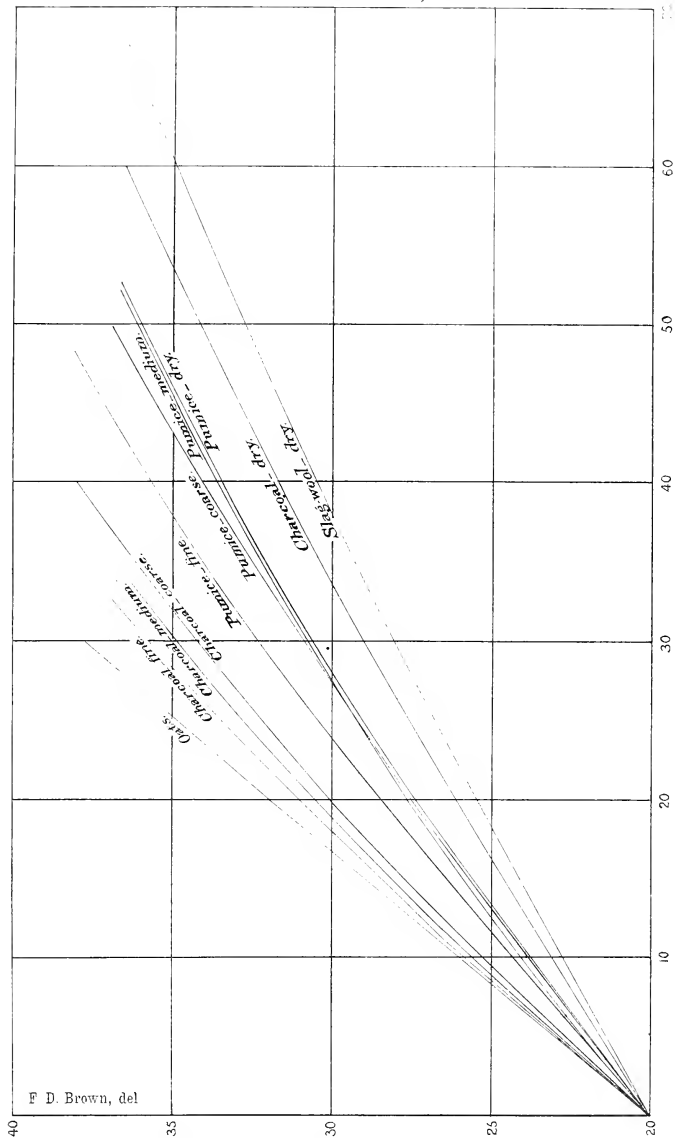

F D. Brown, del

TO ILLUSTRATE INSULATION OF COLD STORES.



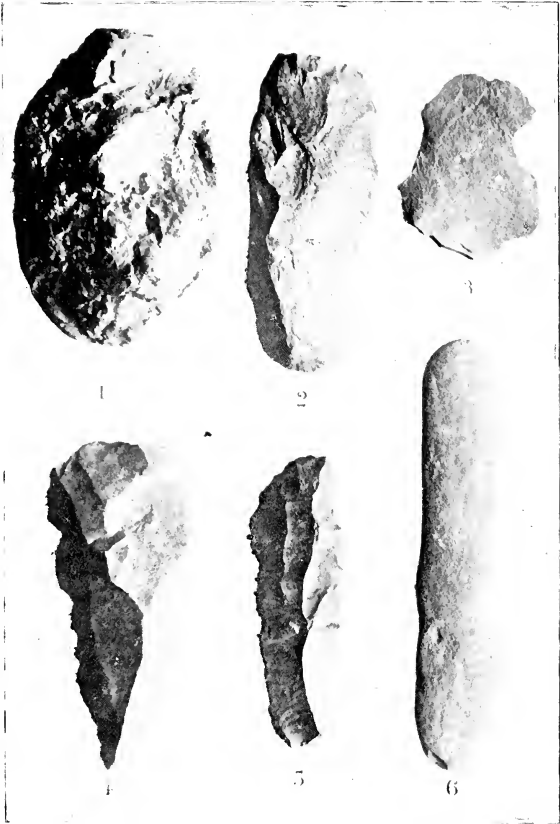

MAORI STONE IMPLEMENTS  
Hutton

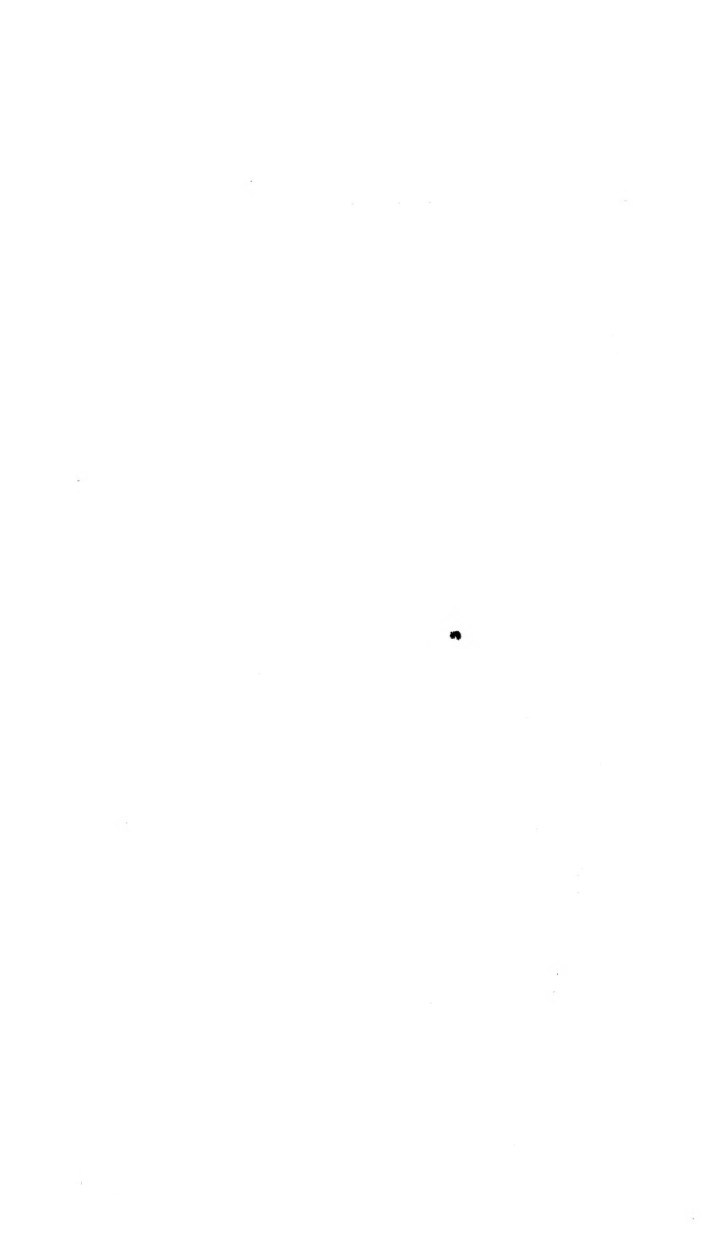

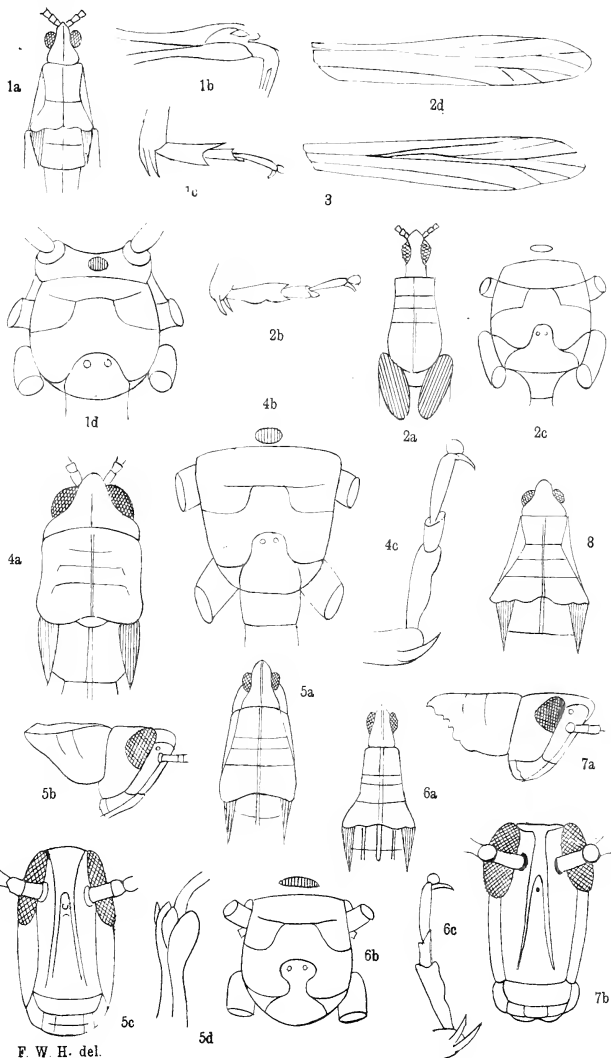

F. W. H. del.

N.Z. GRASSHOPPERS.





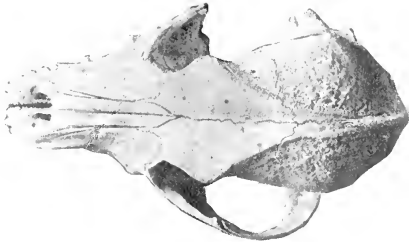

MAORI DOG SKULLS  
Hutton



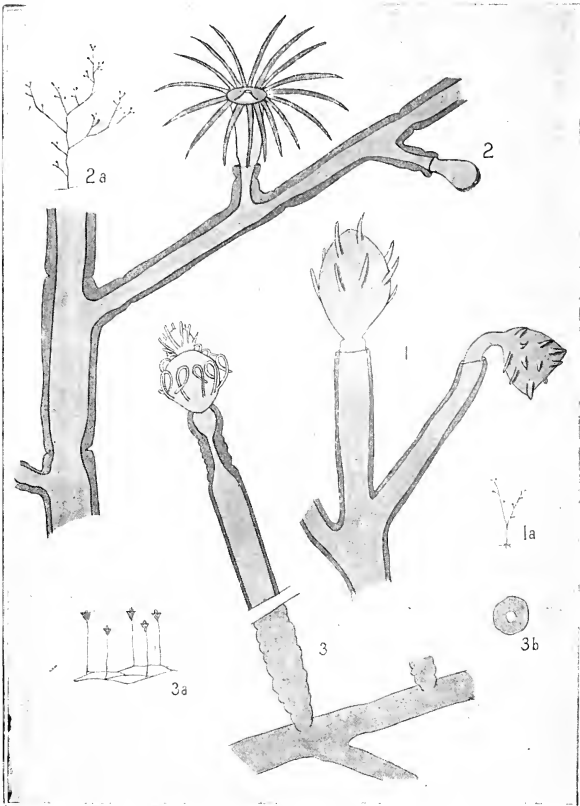

HYDROIDS  
Hilgendorf.



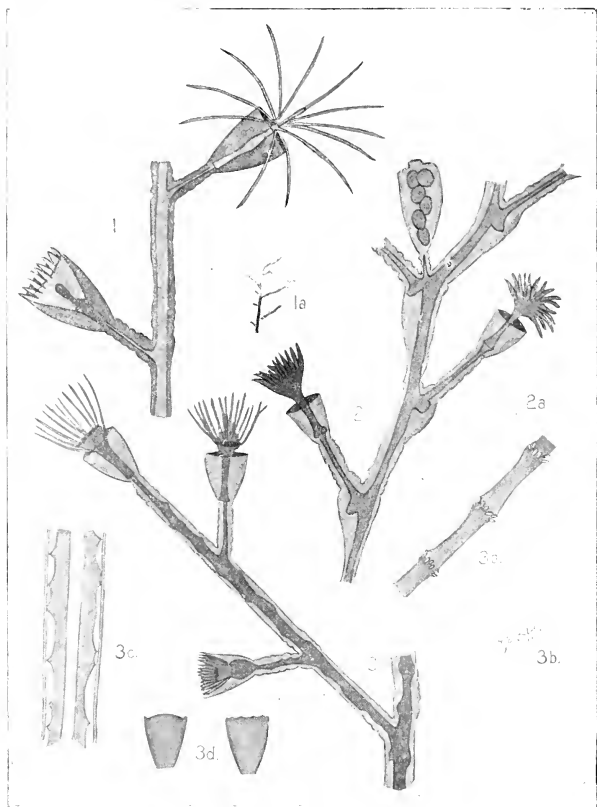

**HYDROIDS**  
Hilgendorf



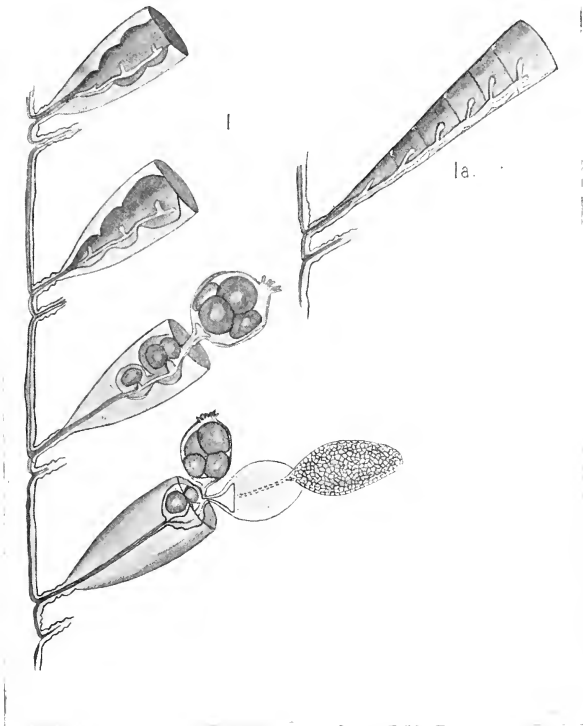

**HYDROIDS**  
Hilgendorf





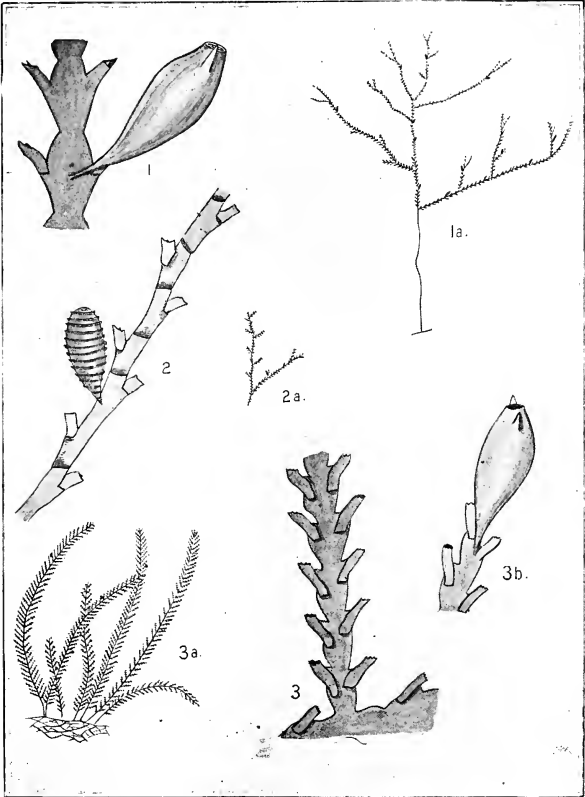

HYDROIDS  
Hilgendorf



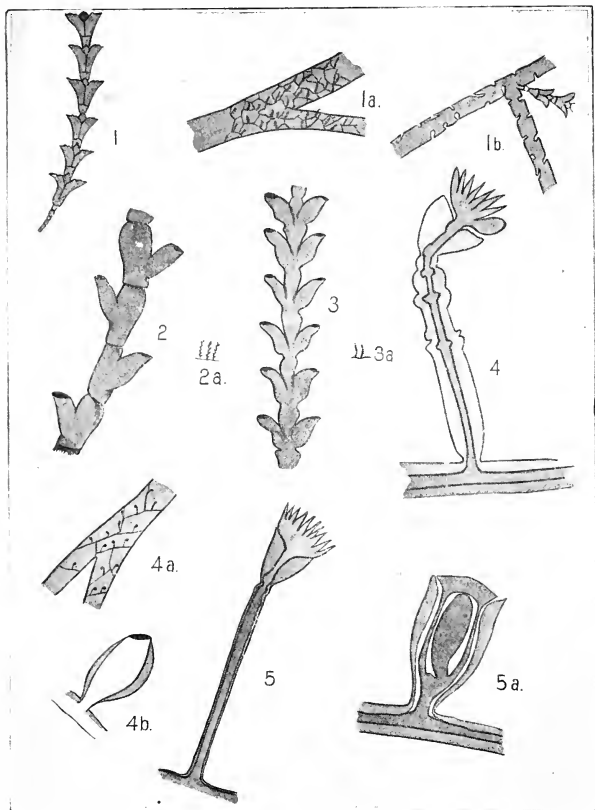

HYDROIDS  
Hilgendorf



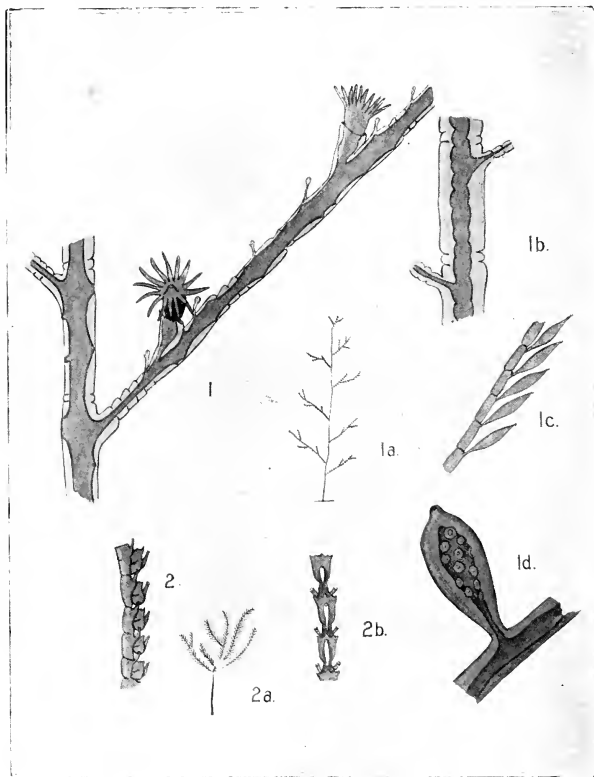

**HYDROIDS**  
Hilgendorf



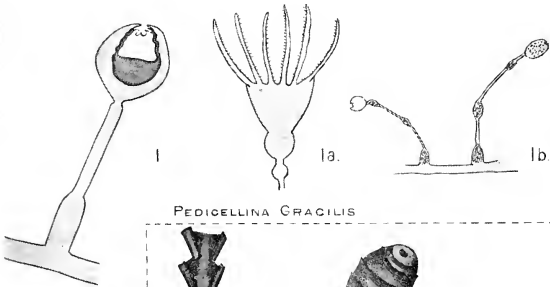

PEDICELLINA GRACILIS

Continuation of Plate 20



6



6a.



7



7a.



7b.

HYDROIDS  
Hilgendorf





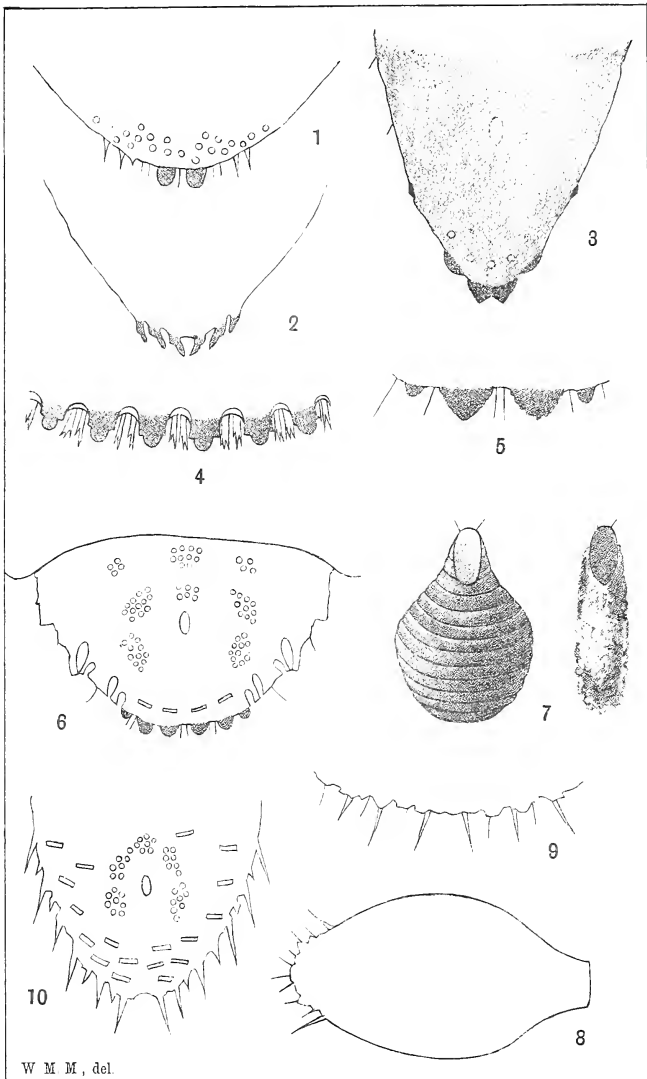



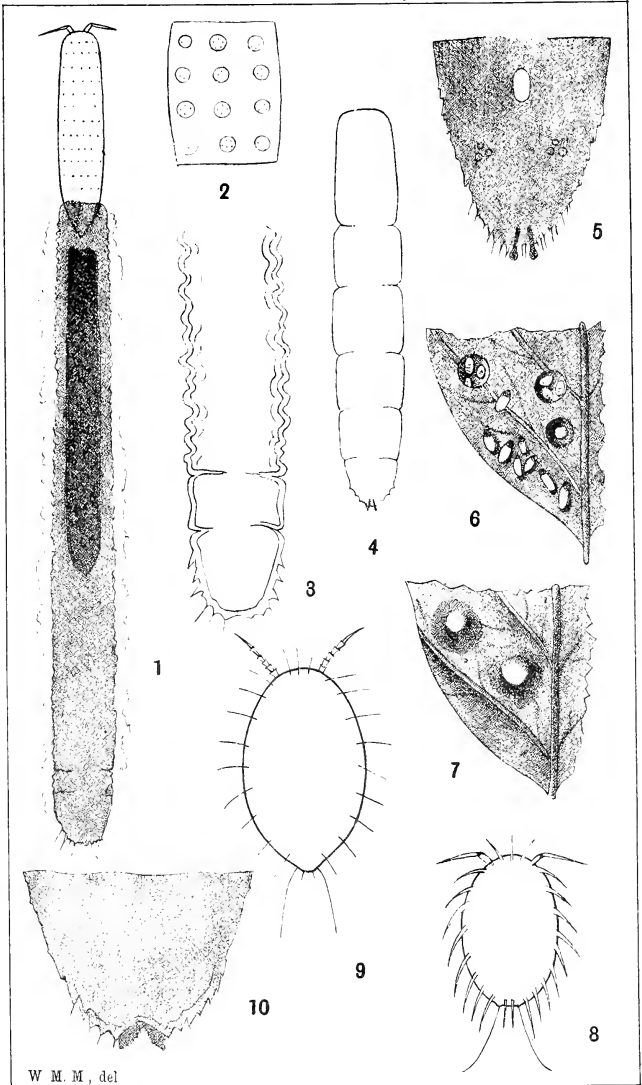

W. M. M., del.

COCCIDÆ.



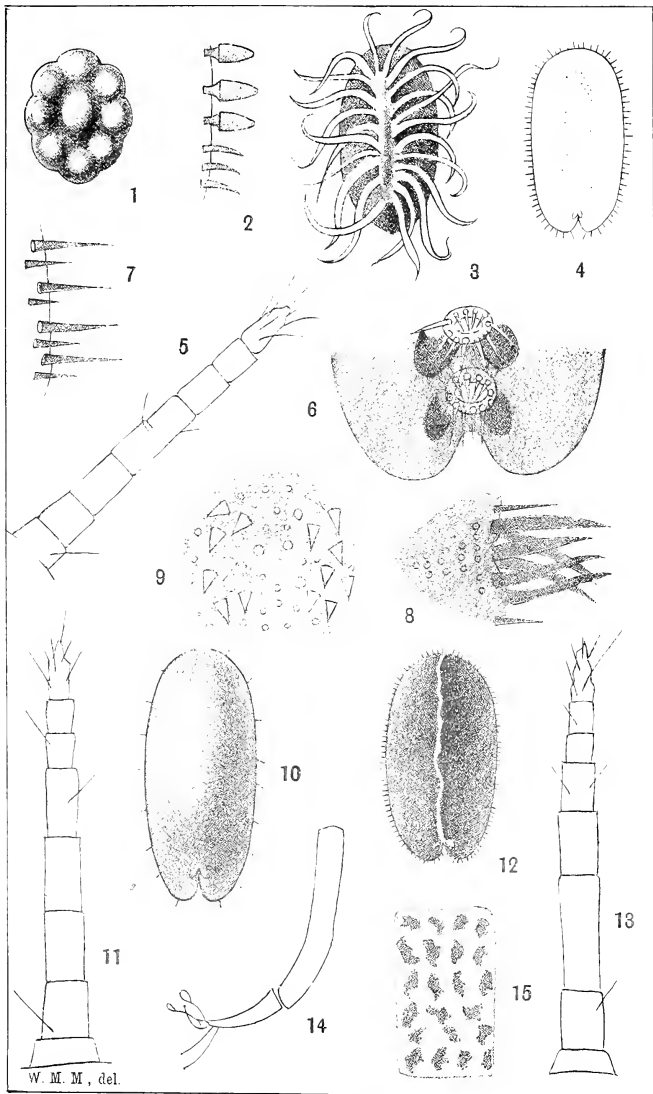

COCCIDÆ.



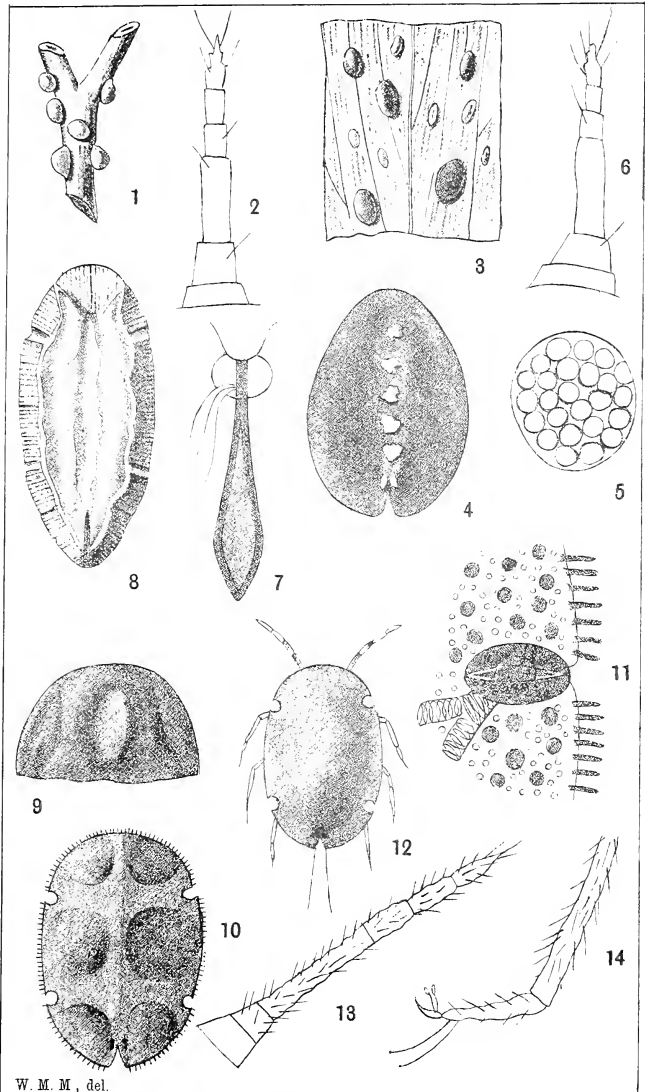

W. M. M., del.

COCCIDÆ.





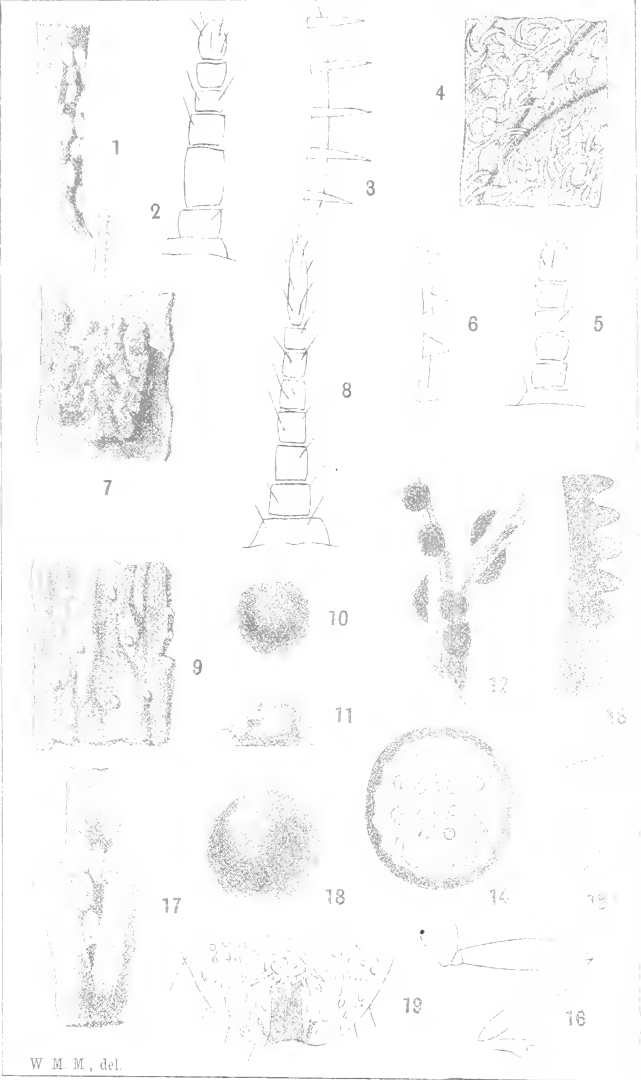

W. M. M., del.

COCCIDÆ.



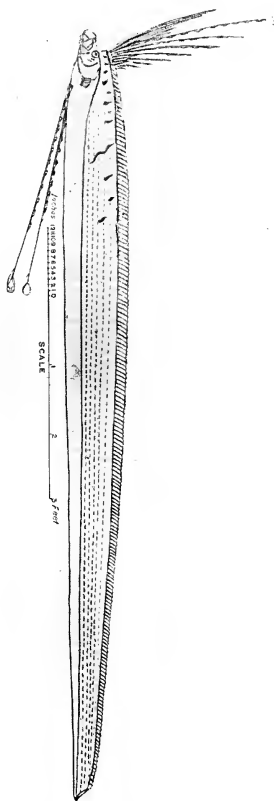

REGALECUS ARGENTEUS  
Clarke



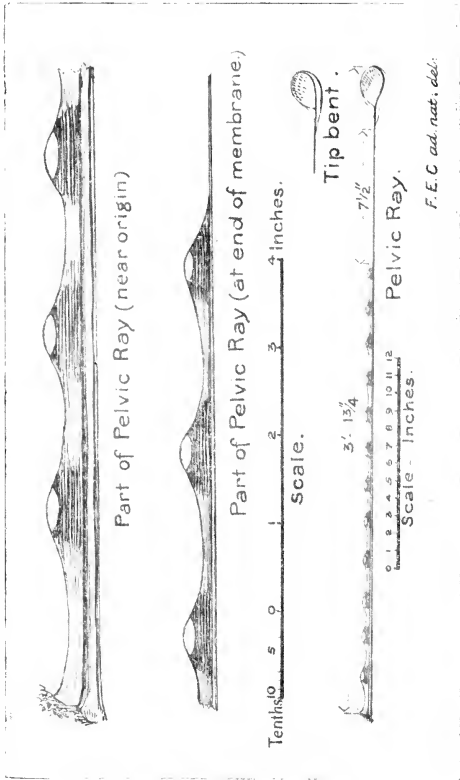

REGALECUS ARGENTEUS  
Clarke



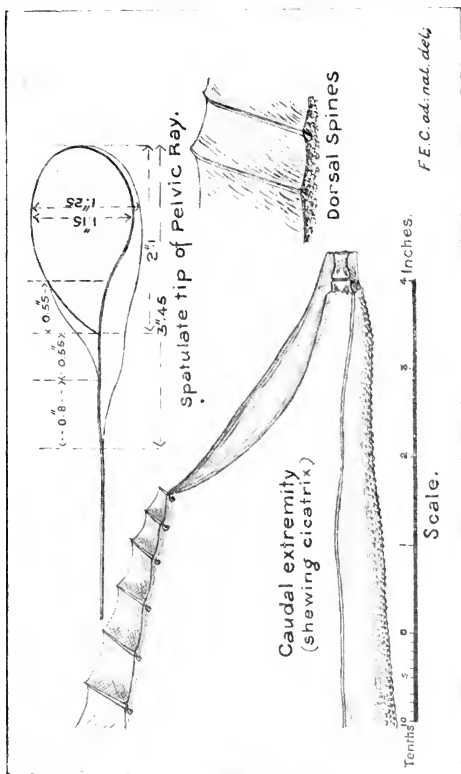

REGALECUS ARGENTUS  
(Clarke)





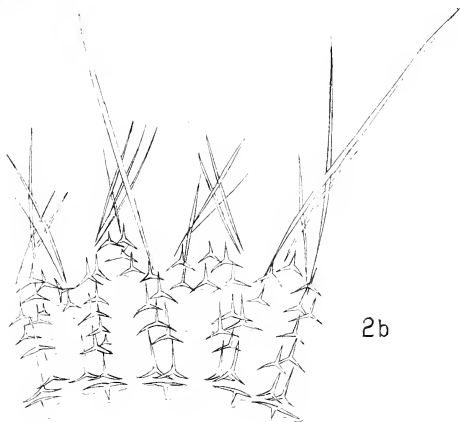

H B. K., del.



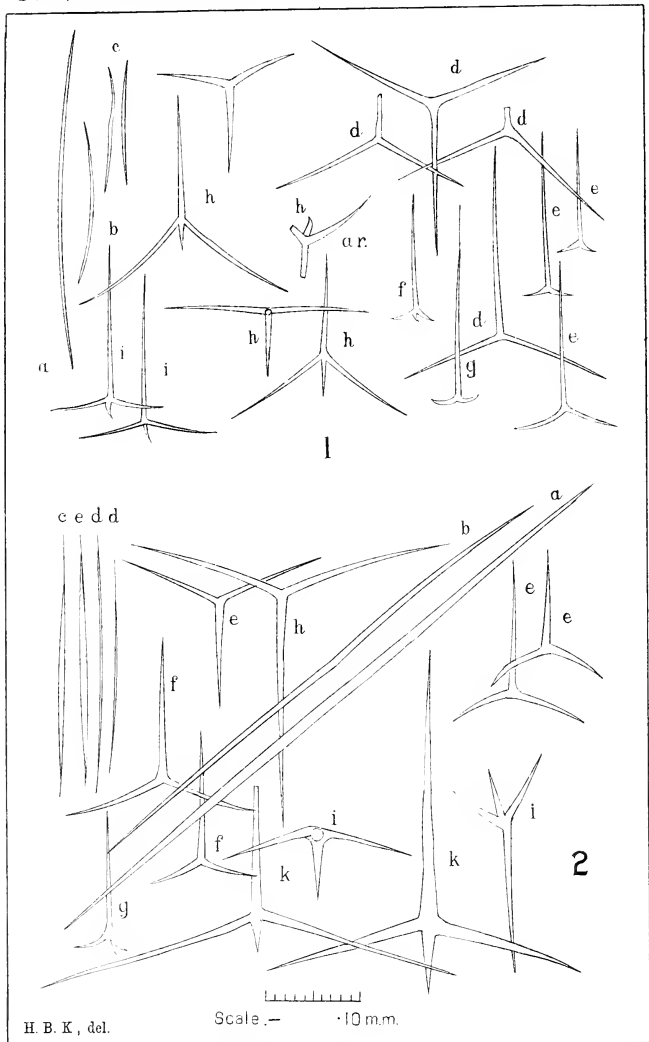

I. SYCON PEDICELLATUM. 2. S. ORNATUM



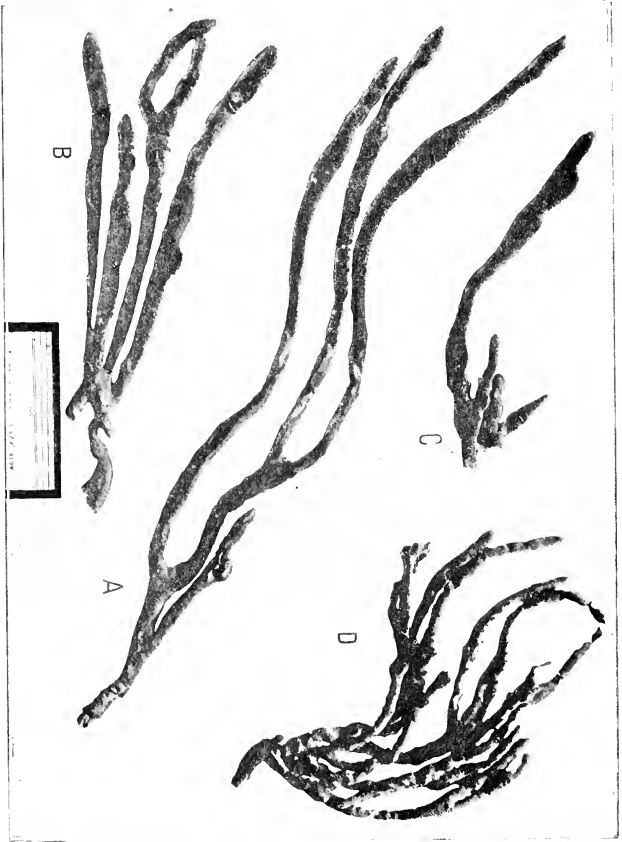

N.Z. SPONGES  
Dendy



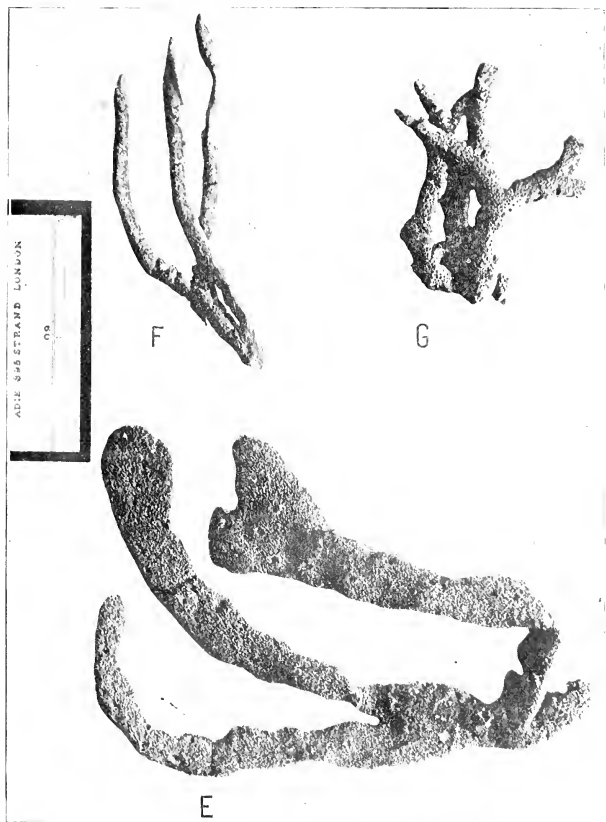

N.Z. SPONGES  
Dendy





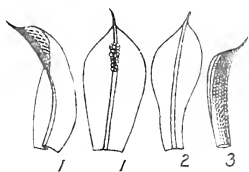

Fig 1. *Tortula papillosa*, Wills.

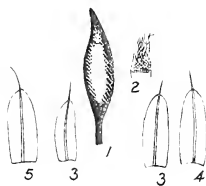

Fig 3. *Tortula pulvinata*, sp. nov.

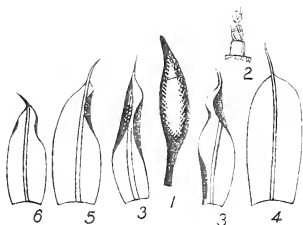

Fig 4. *Tortula elliptotheca*, sp. nov.

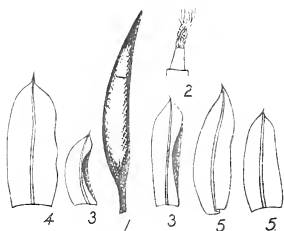

Fig 2. *Tortula acuta*, sp. nov.

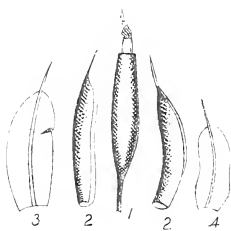

Fig 5. *Tortula oblongifolia*, sp. nov.

R. Brown, del



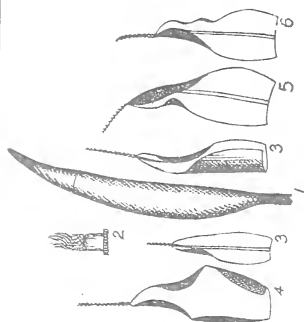

Fig. 6 *Tortula mandii*, sp. nov.

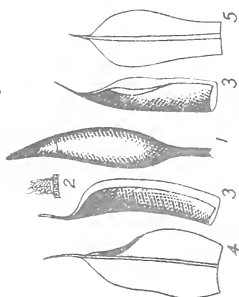

Fig. 8 *Tortula synecia*, sp. nov.

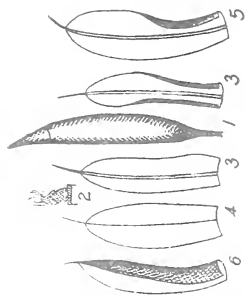

Fig. 7 *Tortula binsii*, sp. nov.

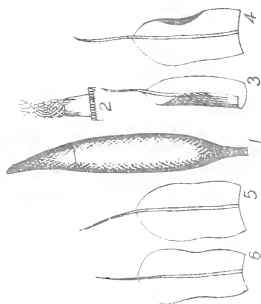

Fig. 9 *Tortula panduriformis*, sp. nov.

R. Brown, del



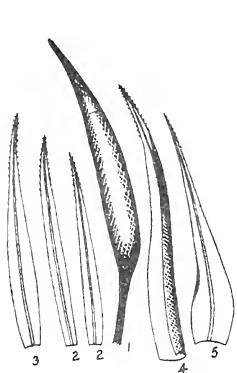

Fig 23 *Tortula serrulata*. Hook. and Grev.

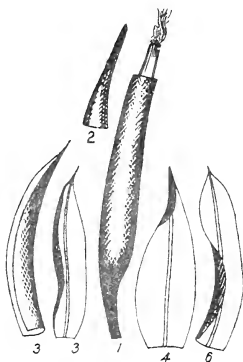

Fig. 26 *Tortula kowaiensis*, sp. nov.

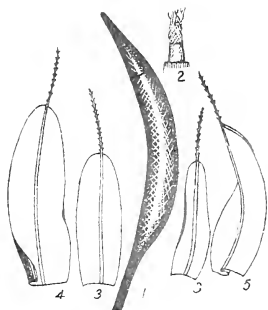

Fig 11 *Tortula muelleri*, Br.

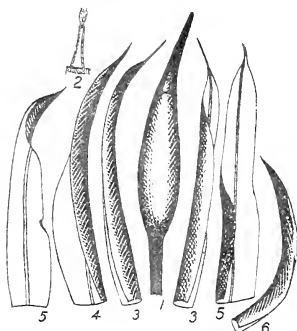

Fig. 12 *Tortula bealeyensis*, sp. nov

R Brown. del



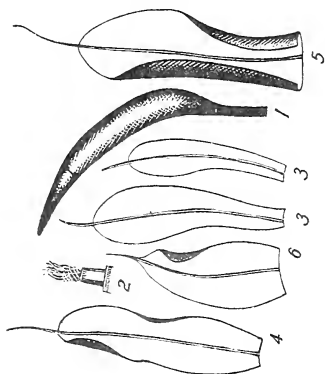

Fig. 10 *Tortula scarpii*, sp. nov.

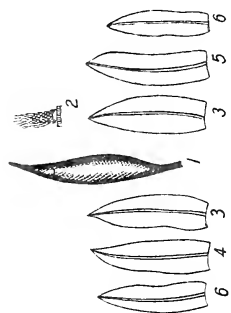

Fig. 15 *Tortula lancifolia*, sp. nov.

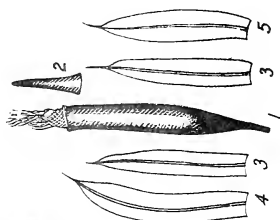

Fig. 13 *Tortula gulliverii*, sp. nov.

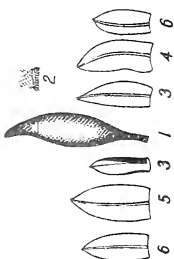

Fig. 14 *Tortula minuta*, sp. nov.

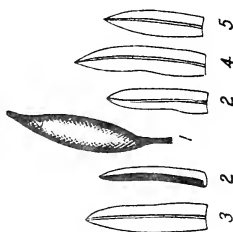

Fig. 16 *Tortula linearifolia*, sp. nov.





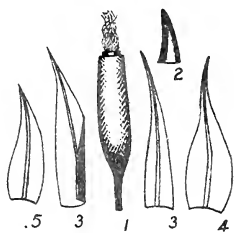

Fig. 19 *Tortula bellii*, sp. nov.

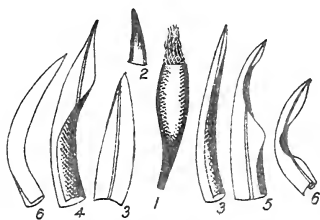

Fig. 17 *Tortula brevitheca*, sp. nov.

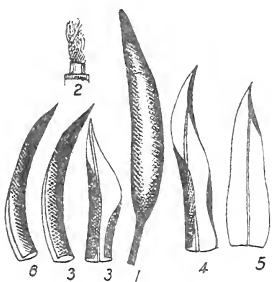

Fig. 18 *Tortula stevensii*, sp. nov.

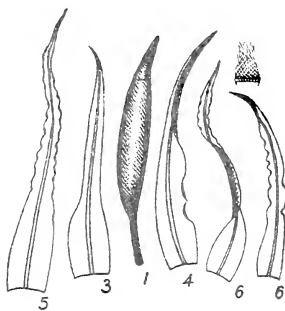

Fig. 20 *Tortula knightii*, Mitten

R Brown. del



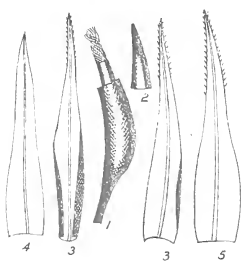

Fig 21 *Tortula rubra*, Mitten

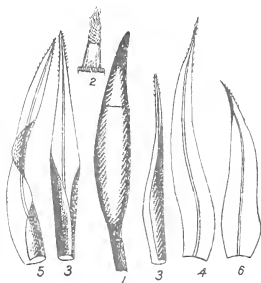

Fig 22 *Tortula dioica*, sp. nov.

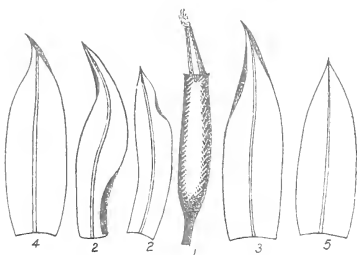

Fig 27. *Tortula toriessensis*, sp. nov.

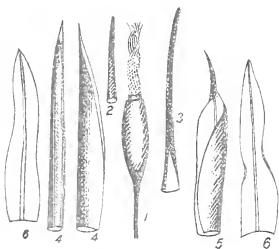

Fig 24 *Tortula walkeri*, sp. nov.

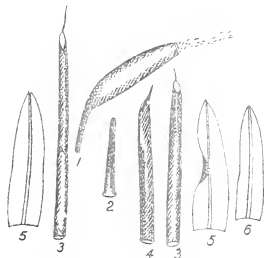

Fig 25. *Tortula calycina*, Schwaegr.

B. Brown, del



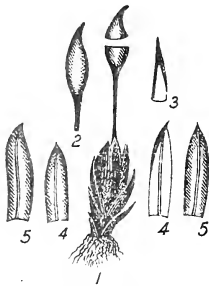

Fig. 3 *Dendia maritima*

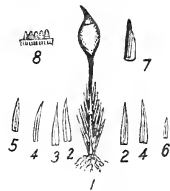

Fig 1 *Seligera cardotii* sp. nov.

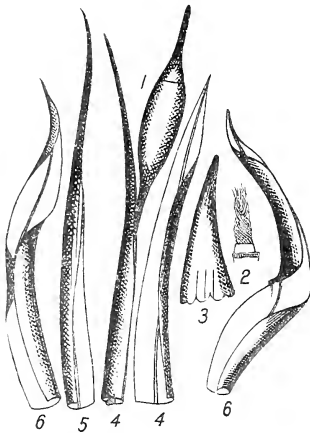

Fig. 2 *Streptopogon hookerii*

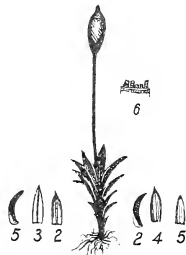

Fig. 4 *Anacalypta zealandiae*

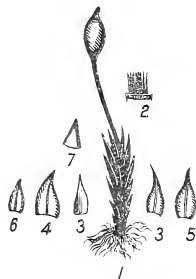
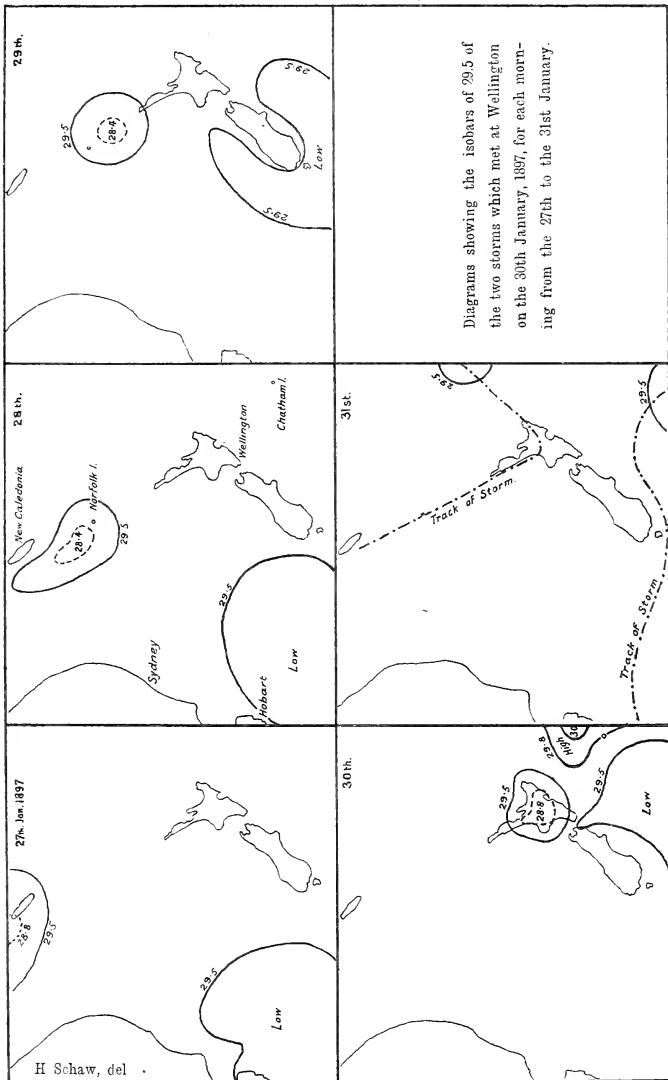

Fig. 5 *Anacalypta stevensii*

R. Brown, del





H Schaw, del .

DIAGRAMS OF STORMS.





15 April, 1897.



16 April, 1897.

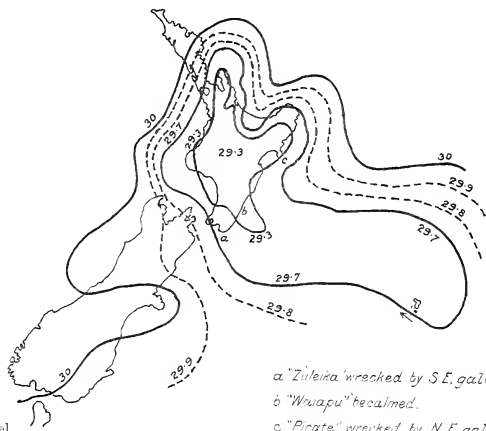

- a "Zuleika" wrecked by S.E. gale.
- b "Wwapu" becalmed.
- c "Pirate" wrecked by N.E. gale.

H Schaw, del

DIAGRAMS OF STORMS



17 April, 1897



18 April, 1897

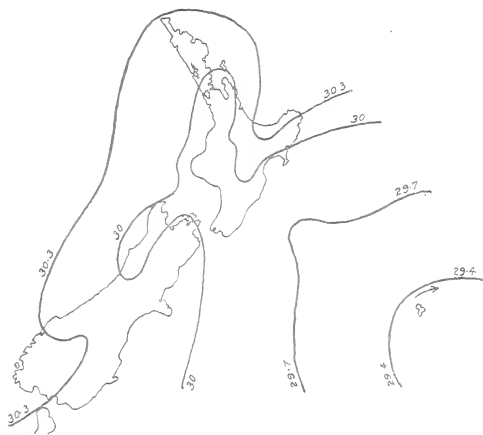

H. Schaw, del.

DIAGRAMS OF STORMS.



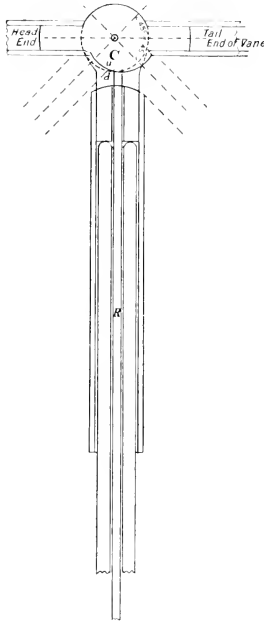

Section showing the cam C and the rod R, which actuate the recorder.

The length of the rod may probably not exceed 12 feet, if the recording instrument be fixed in a small round house with a conical roof, on an elevated platform, or tower, or flat roof.

The eccentricity of the cam is shown such as to make the rod rise to *u*, or sink to *d*, a total range of .15 in., corresponding with an angular range of  $90^\circ$ , from an elevation of  $45^\circ$  to a depression of  $45^\circ$ .

The mechanical defects of the method would be less felt if the eccentricity of the cam were less, and probably the range might be reduced to .10 in.

H. S.



PROPERTY OF  
Z. P. METCALF

PROPERTY OF  
Z. P. METCALF





