

Digitized by the Internet Archive  
in 2007 with funding from  
Microsoft Corporation

A TREATISE  
ON  
O R D N A N C E

AND  
A R M O R :

EMBRACING  
DESCRIPTIONS, DISCUSSIONS, AND PROFESSIONAL OPINIONS  
CONCERNING THE  
MATERIAL, FABRICATION,  
REQUIREMENTS, CAPABILITIES, AND ENDURANCE OF EUROPEAN AND AMERICAN  
GUNS FOR NAVAL, SEA-COAST, AND IRON-CLAD WARFARE,  
AND THEIR  
RIFLING, PROJECTILES, AND BREECH-LOADING.

ALSO,  
RESULTS OF EXPERIMENTS AGAINST ARMOR,  
FROM OFFICIAL RECORDS.

WITH  
AN APPENDIX,  
REFERRING TO GUN-COTTON, HOOPED GUNS, ETC. ETC.

BY ALEXANDER L. HOLLEY, B. P.

With 493 Illustrations.

NEW YORK:  
D. VAN NOSTRAND, 192 BROADWAY.

LONDON:  
TRÜBNER & COMPANY.  
1865.

Entered according to Act of Congress, in the year 1864,

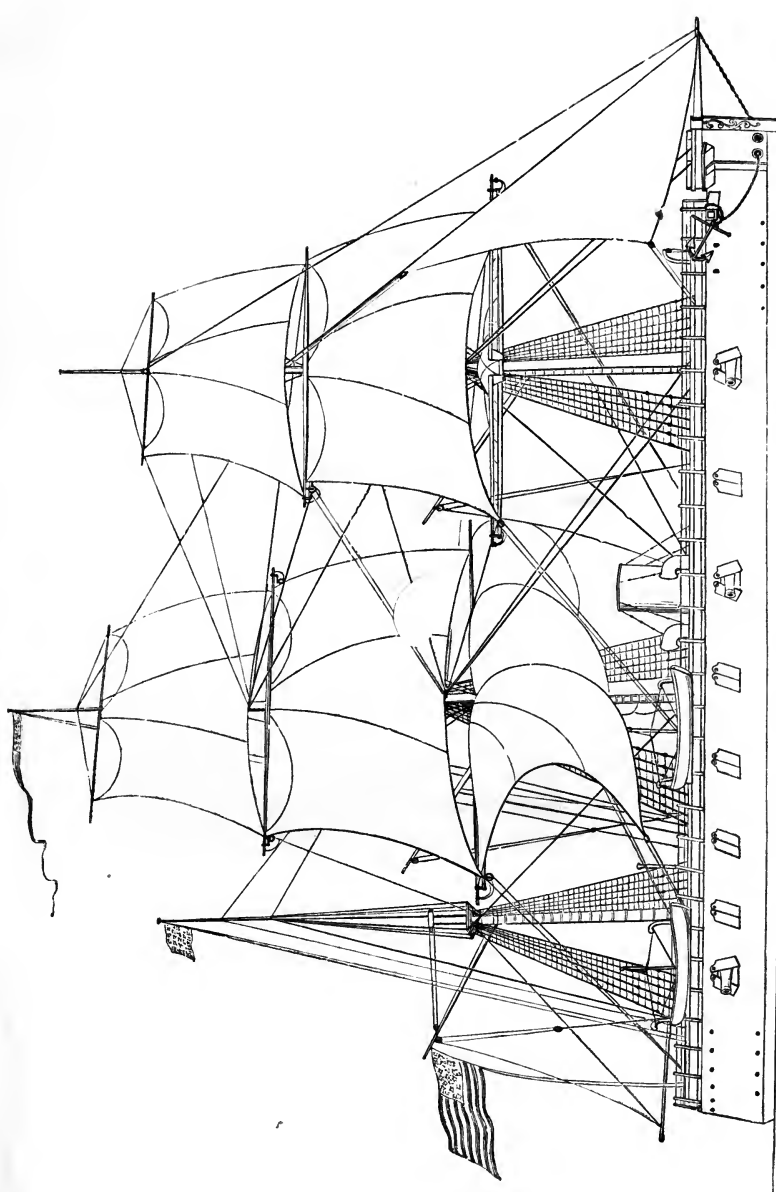
By D. VAN NOSTRAND,

In the Clerk's Office of the District Court of the United States for the Southern  
District of New York.

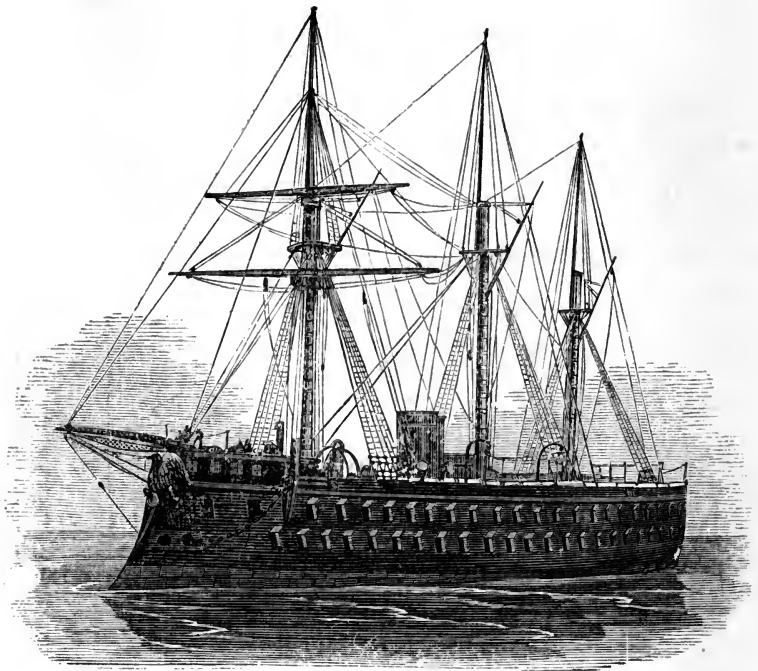
GIFT

G. A. ALVORD, ELECTROTYPYPER AND PRINTER.





THE "NEW IRONSIDES."



THE "SOLFERINO."

UF560  
H6

DEDICATION.

---

John F. Winslow, Esq.

MY DEAR SIR:

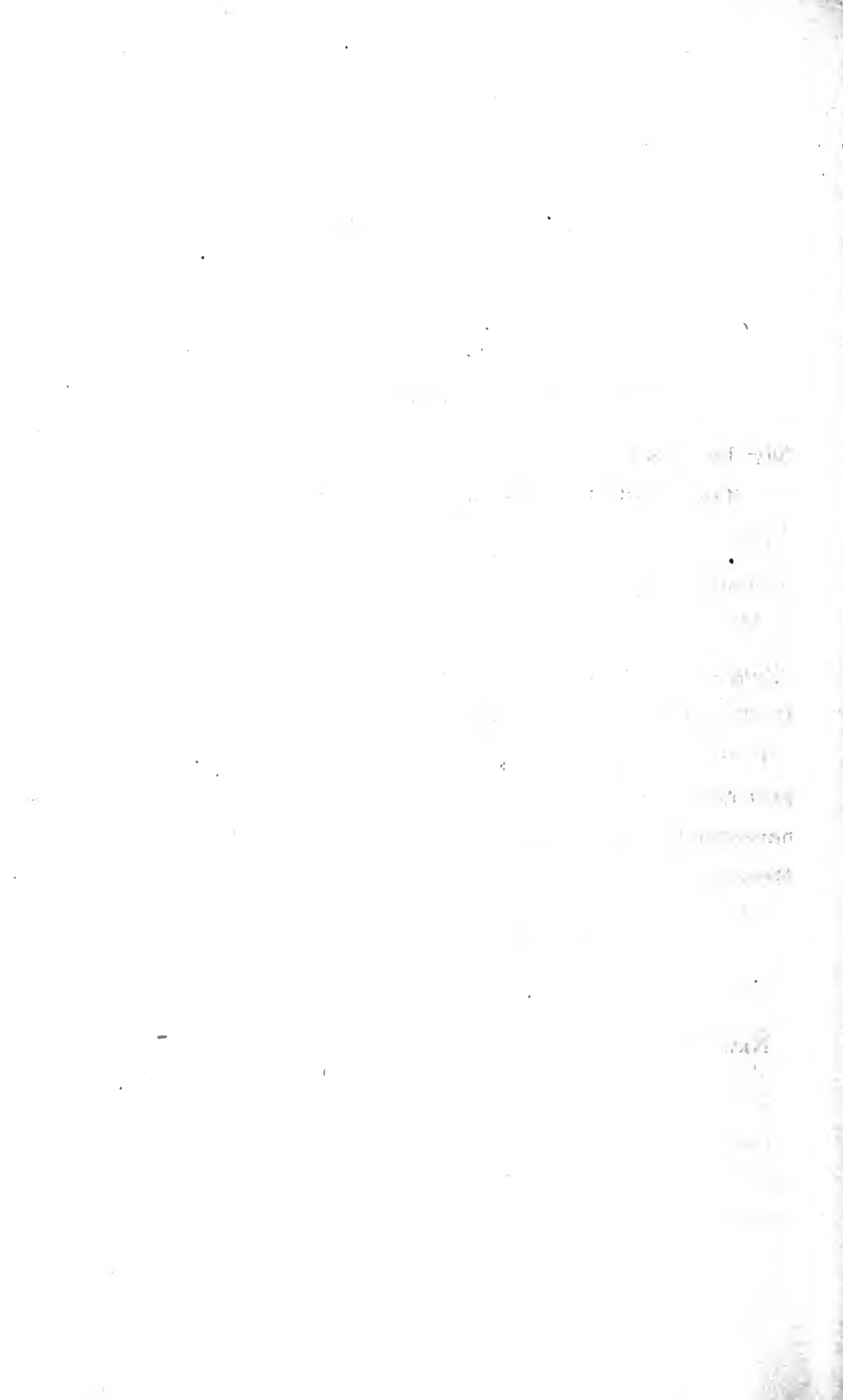
THE inscription of your name in this work on ORD-  
NANCE AND ARMOR, is not only gratifying to me on personal  
grounds, and appropriate from a civilian student in the Art  
of War, to a civilian ever foremost in improving and devel-  
oping the matériel of war; but it is an expression of that  
respect, shared by my country at large, for the liberality  
and enterprise to which, together with the efforts of your  
associates, we are indebted for the *timely* "Monitor," the first  
home-made steel Ordnance, and the introduction of the  
Bessemer process.

I am, dear Sir,

Very respectfully your friend,

A. L. HOLLEY.

NEW YORK, *September 21, 1864.*



## P R E F A C E.

---

ALTHOUGH the want of a work on the construction, requirements, and results of modern Ordnance, will be generally admitted, the attempt of a Civil Engineer to supply it, demands a word of explanation.

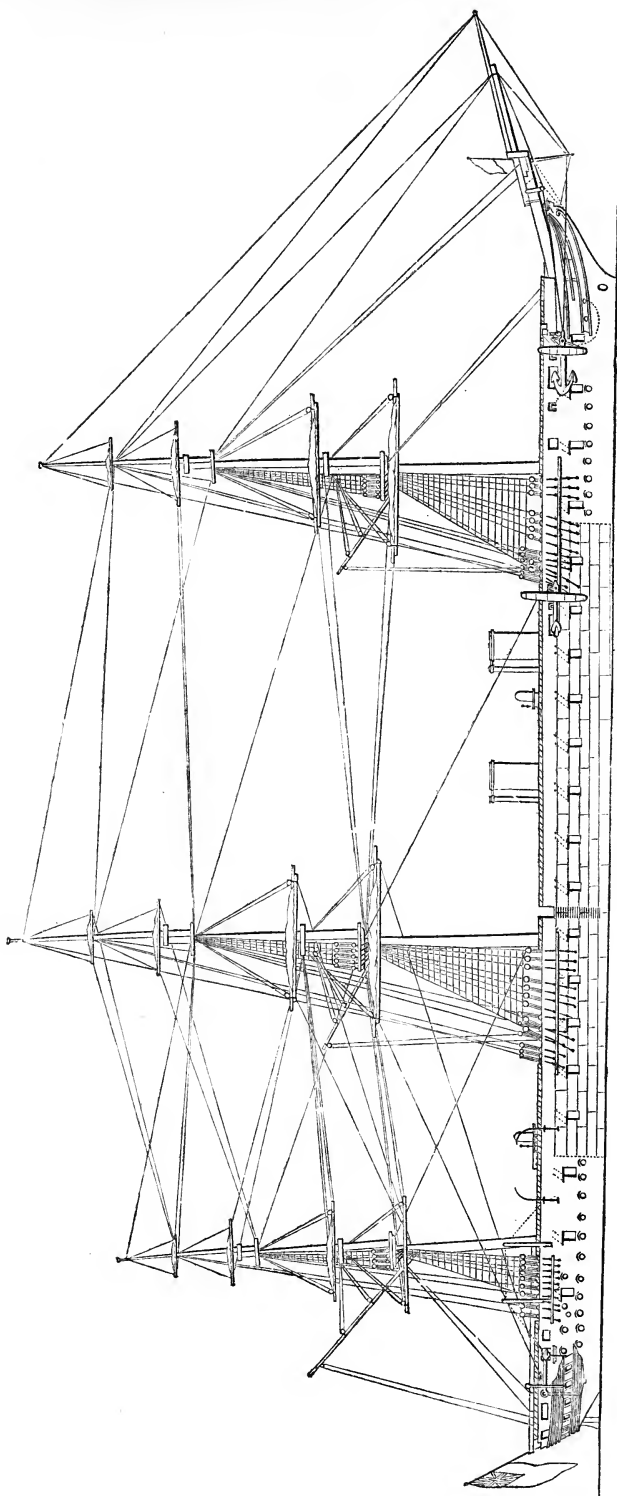
In Europe, the improvement and fabrication of ordnance, and in America, the additional occupation of war, have so engrossed the attention of the profession, that the compilation and publication of the results and the practice, have been almost necessarily neglected.

During several visits to Europe, with reference to his own profession, the author had various and perhaps extraordinary facilities for acquiring information on the subject. His first intention, seeing that many of the facts had not been published, was to throw them together in the form of one or more pamphlets, with enough comment to make them homogeneous. But some account of the American practice appeared indispensable; then an abstract of the opinions of experts, professional and otherwise, was obviously appropriate and useful; and, as only the intervals in professional pursuits were devoted to the compilation of the matter, time was constantly developing new facts and phases, which should of course be considered; so that what was originally

intended as a mere record of results has, unintentionally, and perhaps unavoidably, grown into the present treatise.

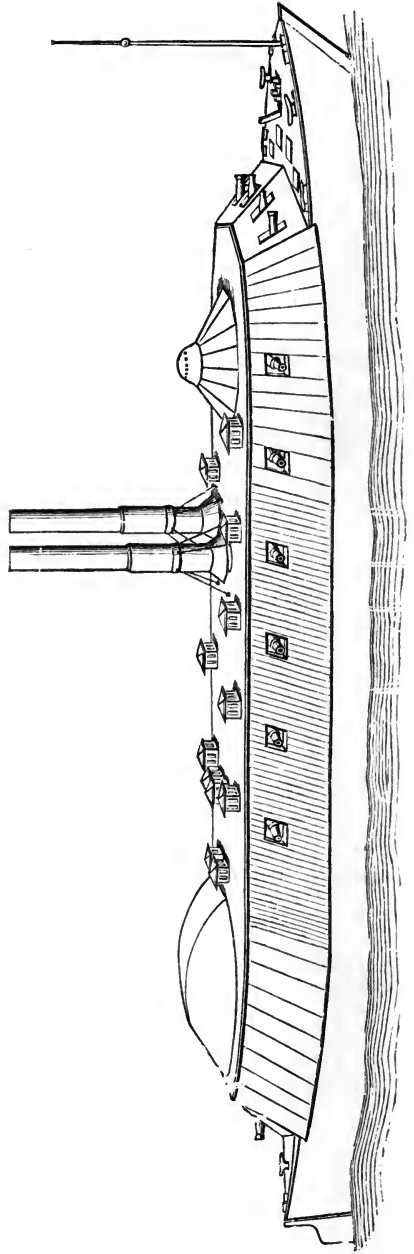
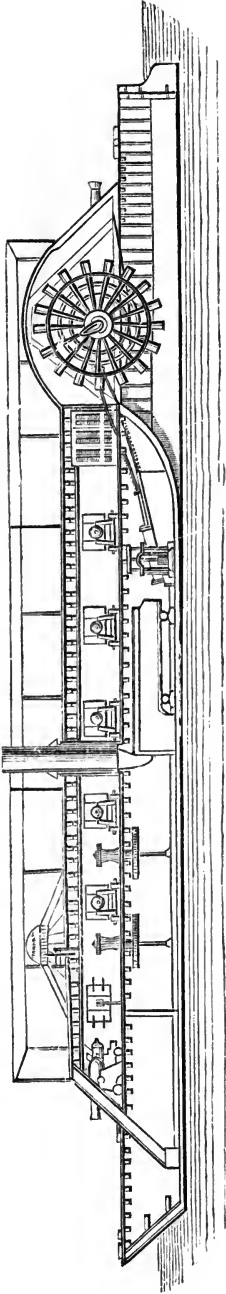
If the voluminous and, certainly, the important facts, have been so presented as to aid the profession in improving the great art of Defence, the highest expectation of the author will have been realized.

As to the discussions and conclusions, he should say, in justice to himself, that, although they have not been aided by professional training and experience, they certainly have not been influenced by partisanship, nor by professional traditions and prejudices.

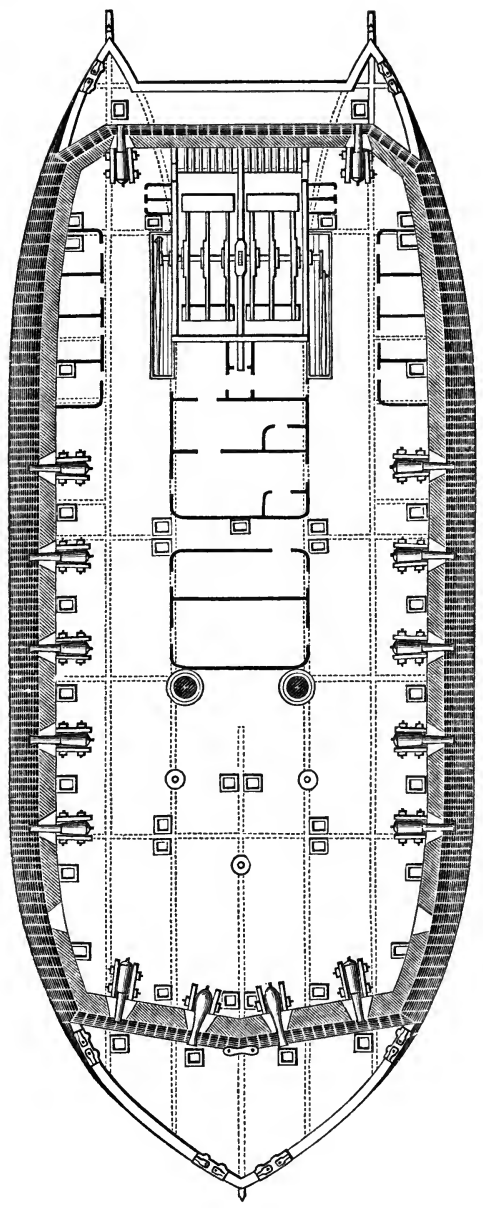
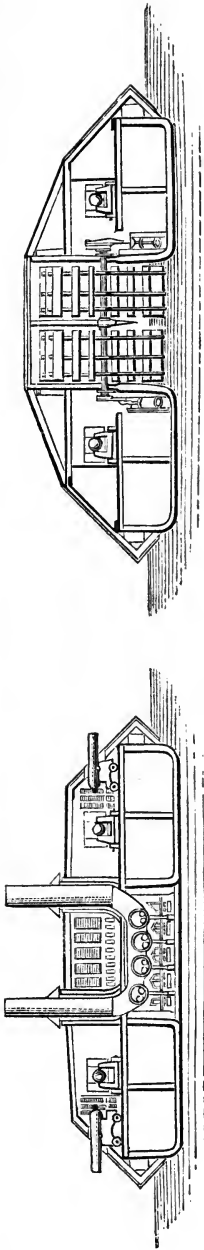


THE "WARRIOR."

THE MISSISSIPPI IRON-CLAD "BENTON."

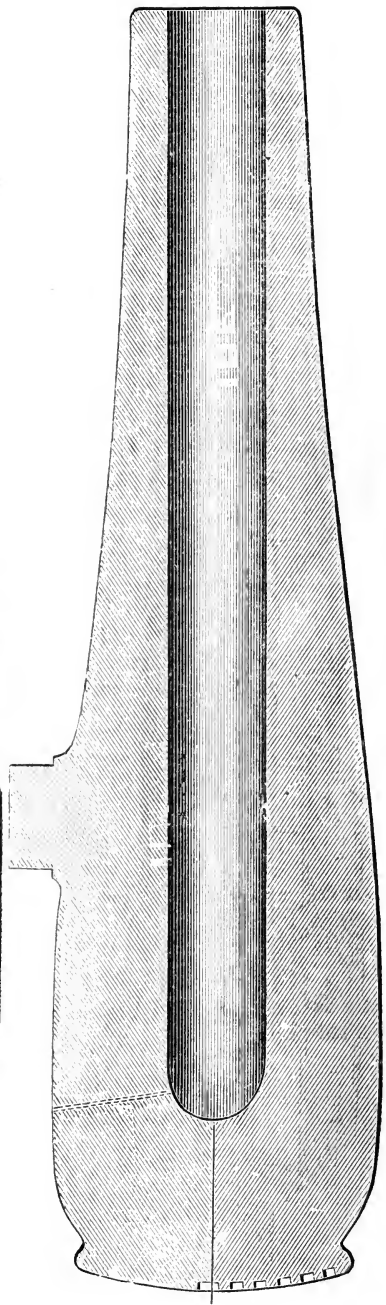
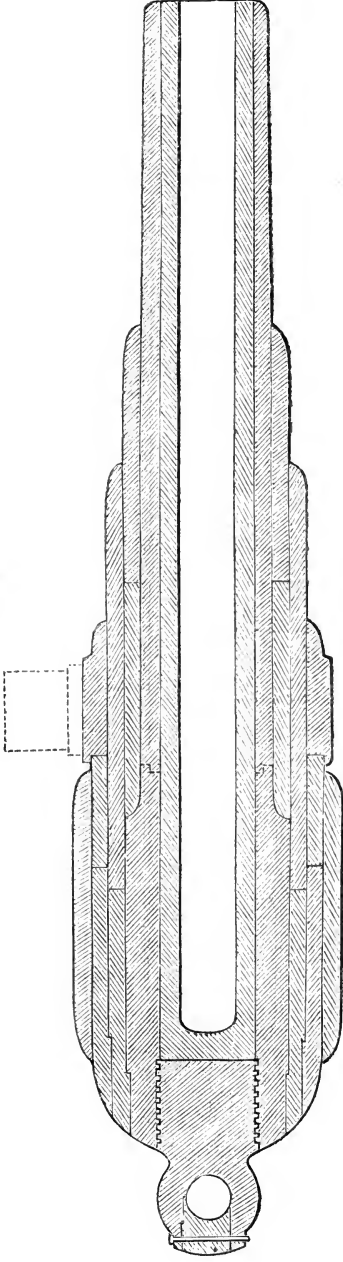






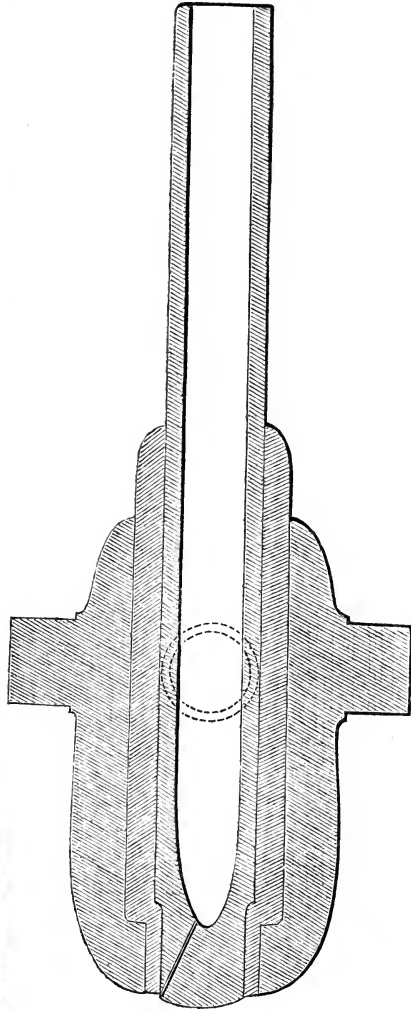
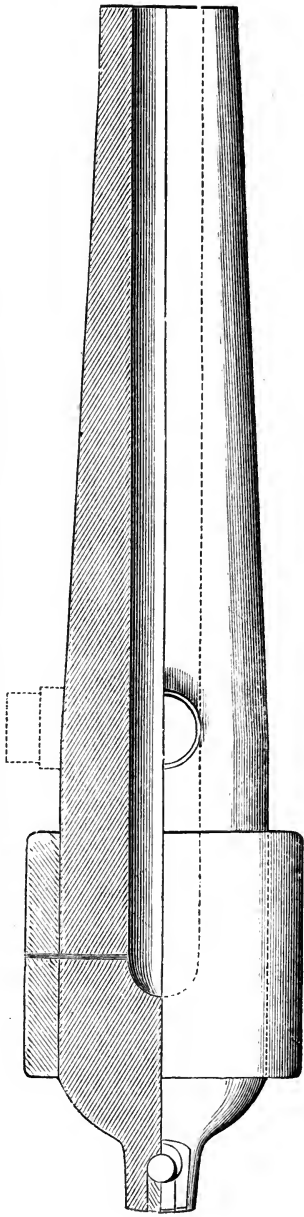
THE MISSISSIPPI IRON-CLAD "BENTON."

BRITISH STEEL-LINED COIL GUN.



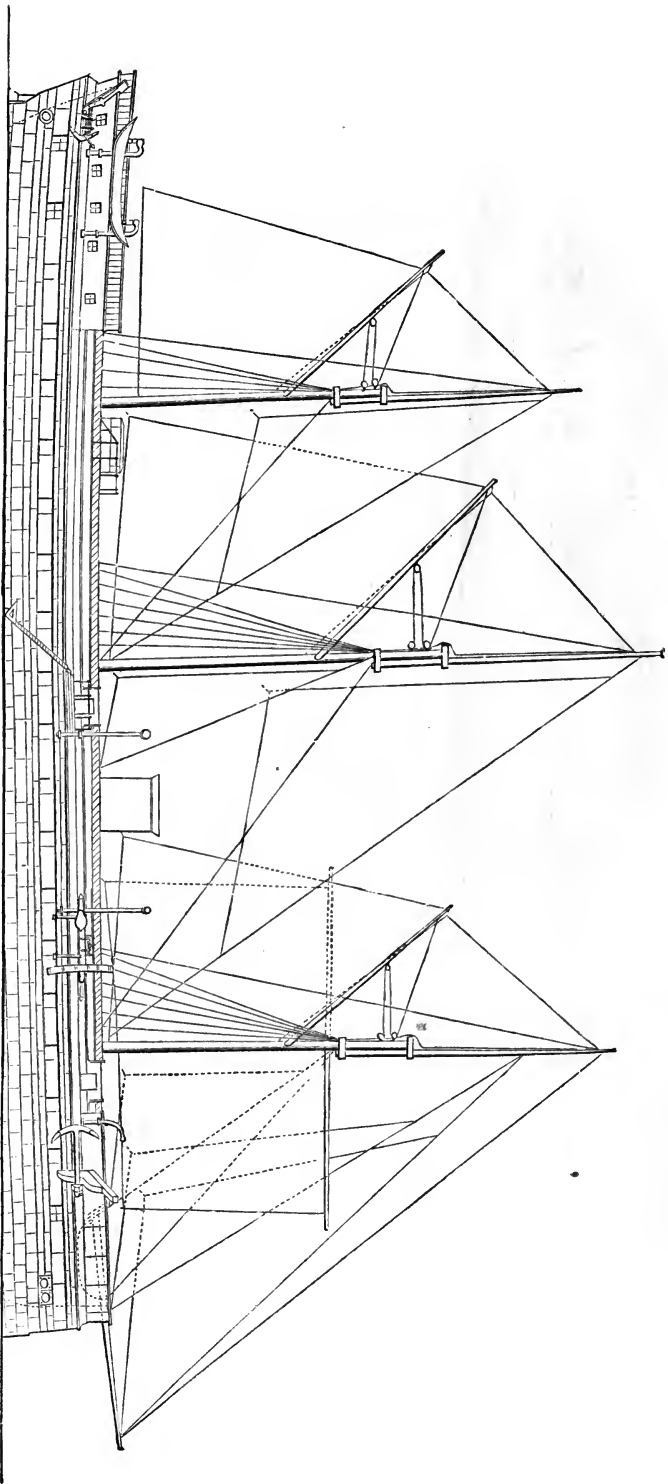
U. S. HOLLOW-CAST COLUMBIAD.

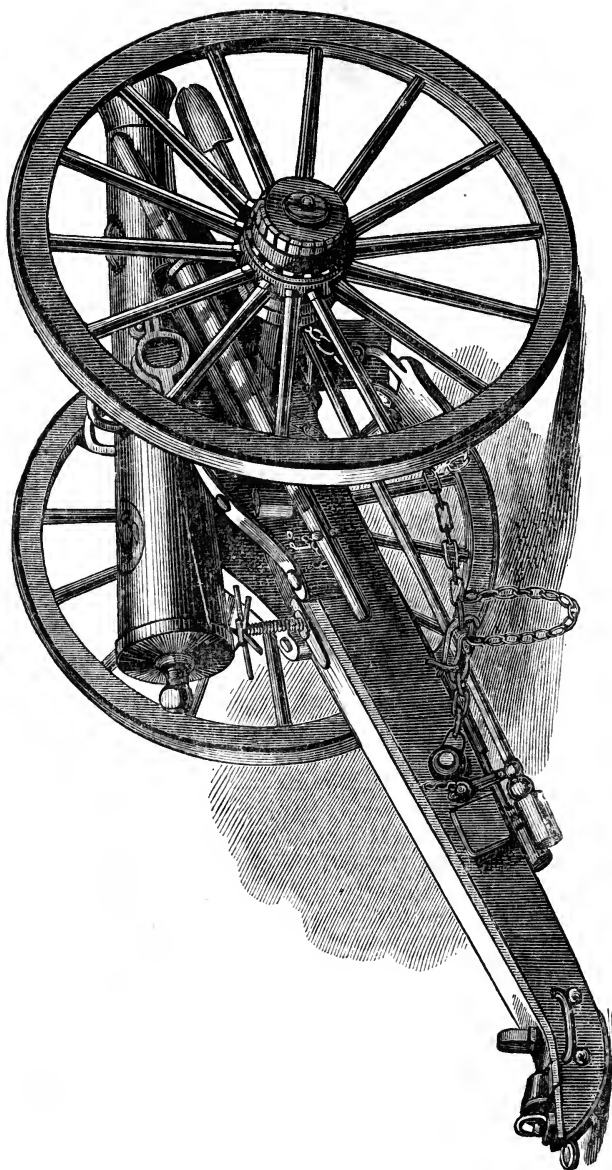
U. S. HOLLOW-CAST HOOPED PARROTT GUN.



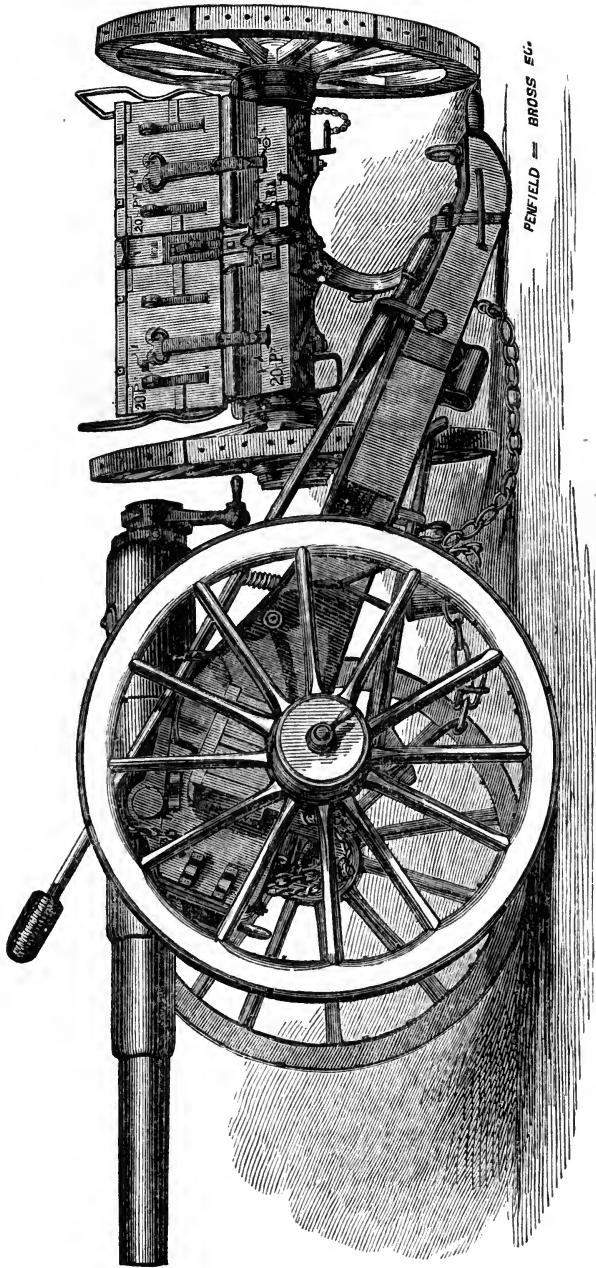
BLAKELY STEEL AND CAST-IRON GUN.

“LA GLOIRE,”





FRENCH FIELD-GUN, MOUNTED. (FROM A PHOTOGRAPH.)



THE ARMSTRONG 20-POUNDER GUN AND LIMBER. (FROM A PHOTOGRAPH.)

# CONTENTS.

## PART FIRST.

### ORDNANCE.

#### CHAPTER I.—STANDARD GUNS AND THEIR FABRICATION DESCRIBED.

##### Section I.—Hooped Guns.

	PAGE
I. THE ARMSTRONG GUN.—Details of Fabrication; Breech-Loading; Rifling; Particulars, Charges, and Number made; Proof; Service and Experimental Guns described; Cost; Endurance; the new British Gun.....	1
II. THE WHITWORTH GUN.—Principles; Fabrication; Rifling; Particulars and Charges; Notes on History and Cost.....	27
III. THE BLAKELY GUN.—Structure; Two Principles involved; Particulars and Charges; Description of Guns; Treatment of Steel and Fabrication; Early Experiments.....	36
IV. THE PARROTT GUN.—Fabrication; Material; Particulars; Ammunition; Rifling; Endurance.....	50
V. MISCELLANEOUS HOOPED GUNS.—Spanish Guns—Structure and Endurance; French Guns—Structure, Particulars, and Endurance; Particulars and Endurance of Cast-Iron Guns tested by Ordnance Select Committee; Longridge's Wire-wound Guns and Cylinders—Details of Structure and Experiments; Brooke's Hooped Gun—Particulars; Attick's Bronze Reinforce; Atwater Gun; Bumford 12-in. Gun hooped; Mallet's 36-in. Mortar.....	56

##### Section II.—Solid Wrought-Iron Guns.

I. THE MERSEY STEEL AND IRON COMPANY'S GUNS.—The Horsfall Gun—Fabrication, Particulars, and Endurance; the Prince Alfred Gun; Brooklyn Navy Yard 12-in. Gun; New Guns for British Government—Particulars and Endurance. II. THE STOCKTON GUNS. III. MISCELLANEOUS SOLID WROUGHT-IRON GUNS—Thomas's, Ericsson's, Ames's.....	81
---	----

##### Section III.—Solid Steel Guns.

KRUPP'S GUNS.—Fabrication; Relative Strength; Weight and Cost; Description of 8 and 9-in. Guns, and Guns for Russia; Details of Endurance in England and France; Capacity of Works. BESSEMER GUNS.—Production and Character of the Material; Test; Prices; Naylor, Vickers & Co.'s Gun-Steel; Details of Test of 20-Pounder; Mushet and Clare's 20-Pounder; Endurance. MERSEY PUDDLED-STEEL GUNS.....	90
---	----

### Section IV.—Cast-Iron Guns.

	PAGE
RODMAN and DAHLGREN GUNS.—Figure, Fabrication, and Test of Hollow-Cast Guns; Test of New Ordnance; Columbiads; New Guns—20-in. Guns; Particulars and Charges of U. S. Army and Navy Ordnance; British Cast-Iron Guns—Endurance, Particulars, and Charges; Miscellaneous Cast-Iron Guns and Mortars—Particulars and Charges; Russian Cast-Iron Guns—Cost of Guns..	106

## CHAPTER II.—THE REQUIREMENTS OF GUNS—ARMOR.

### Section I.—The Work to be Done.

Necessity of Iron-Clads; Unsettled State of the Question; Two Systems of destroying an Iron-Clad Enemy—Racking and Punching—Defined and Illustrated; Effect of Velocity; One Gun cannot do both Kinds of Work. ....	132
---	-----

### Section II.—Heavy Shot at Low Velocities.

EXPERIMENTS.—15-in. Ball, 10-in. Iron; 11-in. Ball, 10-in. Iron; 11-in. Ball, 14-in. Iron; 15 and 11-in. Balls and Parrott 150-lb. Bolt—Various Plates—Late Experiments; 15-in. Ball, Iron-Clad <i>Atlanta</i> ; 13-in. Steel Shell, <i>Warrior</i> Target; 13-in. Steel Bolt, 11-in. Iron; 13-in. Ball, 4 $\frac{3}{4}$ -in. Iron; 13-in. Ball and 131-lb. Steel Shot, <i>Warrior</i> Target; 10 $\frac{1}{2}$ -in. Ball, <i>Warrior</i> Target; 150, 230, and 307-lb. Bolts and 113-lb. Ball, and 12 and 13-in. Target; 300 and 330-lb. Bolt, 7 $\frac{1}{2}$ -in. Target; 10 $\frac{1}{2}$ -in. Ball, Scott Russell's Target; 10 $\frac{1}{2}$ -in. Ball, <i>Minotaur</i> Target; 301-lb. Bolt and 150-lb. Ball, Chalmers Target; 150-lb. Ball and 300-lb. Bolt, <i>Bellerophon</i> Target; 110-Pounder, Plates on Masonry. ....	138
DETACHING ARMOR BY HEAVY SHOT, CONSIDERED.—Quality of Plates; Fastening Armor; Targets compared as to Effect of Vibration; 15-in. Ball better than Rifle-Bolts. ....	151
SOLID AND LAMINATED ARMOR.—Strength compared; Inferior Resistance of Laminated; 68-Pounder and 110-Pounder against Laminated 6-in. and 10-in. Targets; Backing; 130-lb. Ball against 6 $\frac{1}{2}$ -in. Laminated Target compared with 150-lb. Ball on 4 $\frac{1}{2}$ -in. Solid Plate; Cause of greater Resistance of Solid Plate; Solid and Laminated Armor combined; Wire-Rope Bolt. ....	154
SMASHING SHIPS' SIDES BY HEAVY SHOT, CONSIDERED.—Cannot be judged from Small Targets; Illustrations; Popular Theory of Destroying Armor by Shot of Medium Weights and Velocities—its Error; Local Effect prevents Distributed Effect, and <i>vice versa</i> ; Examples; Object not to destroy Armor, but the Enemy within it. ....	158
DUCTILITY OF ARMOR SAVES THE VESSEL UNDER VERY LOW VELOCITIES OF SHOT.—Effect of Rams; Ductility illustrated by Thames Iron Works Plate; Difference in Quality of Armor illustrated by American and English Plates. ....	167
DIFFICULTY OF ADAPTING THE HEAVY SHOT SYSTEM.—Difference in Range and Armor changes Conditions of Useful Effect; Other Defects of the System; Too much Time required; Armor hurt more than the Enemy; Illustrations; Broken Plates still a Protection against Shells; Greater Strains in Large Guns; Blakely's and Scott's Calculations. ....	171



	PAGE
ADVANTAGE OF SINGLE HEAVY SHOT OVER MANY LIGHT SHOT.—Commander Scott's Results; Effect of Salvos; Recapitulation.....	176

### **Section III.—Small Shot at High Velocities.**

EXPERIMENTS.—Law of Resistance; Quality of Armor; 10½-in. Ball, <i>Warrior</i> Target; 10½-in. Ball, <i>Minotaur</i> Target; 13-in. Ball, <i>Warrior</i> Target; 301-lb. Bolt, Chalmers Target; 130-lb. Steel Shell, <i>Warrior</i> Target; 151-lb. and 130-lb. Steel Shells, 4½ and 5½-in. Plates; 288-lb. Steel Shell, 5½-in. Plate; 148-lb. Steel Shell, 5½-in. Plate; 300-lb. Steel Shells, 4½-in. Plate (Russian Experiments); 610-lb. Bolt, <i>Warrior</i> Target; 15-in. Ball, 6-in. Iron; 11-in. Ball, 4½-in. Plate, Wood Backing and Facing .....	179
AMERICAN ARMOR-PUNCHING GUNS CONSIDERED.....	188
CONDITIONS OF GREATEST EFFECT.—Law of Penetration; Examples; Conditions of High Velocity; Mr. M. Scott's and Sir W. Armstrong's Views; Velocity of Round and Rifled Shots; Remediable Defects of the Smooth-Bore; Captain Fishbourne's Views; Greater Liability of Balls to waste Power in Self-Destruction, and their greater Penetrating Area; Effect of Lead Shot on Iron Plates; Merits and Defects of Light Elongated Projectiles; Sub-Calibre Projectiles; Necessity of Rifling; Armor-Punching Shells; Long Range Fighting; Loss of Velocity of Round Shot.....	192
RANGE OF IRON-CLAD WARFARE.—Probability of Short Range; Importance of Rifles for other Purposes; Kind of Rifles required.....	203
SHOT OF LARGE DIAMETERS.—Ranges of Large Balls—13-in., 15-in., 9·22-in.; Strain of Large Balls on the Gun; Professor Treadwell's Views.....	205
MERITS AND DEFECTS OF THE SYSTEM.—Least Power Wasted by High Velocities and at Short Ranges; Destructive Effects in Turrets; Splinters; Illustrations; Sir Howard Douglass's Views; Advantage of Laminated Armor in this regard; Punching below Water; Mr. Whitworth's Experiments; Armor-punching Shells; Effects considered.....	212

### **Section IV.—The Two Systems combined.**

Merits and Defects of each Reviewed; the Two Kinds of Shot prepare the Way for each other, and less Power is Wasted.....	218
GENERAL CONCLUSIONS.....	220

### **Section V.—Breaching Masonry.**

ABSTRACT OF REPORT OF ORDNANCE SELECT COMMITTEE ON BREACHING MARTELLO TOWERS WITH SMOOTH-BORED AND RIFLED GUNS.—Towers, Guns, and Charges; Expenditure of Ammunition; Masonry Displaced; Times of Flight; Velocity; Conclusions on the Value of Different Projectiles.....	222
BREACHING FORT PULASKI (From the Report of General Gillmore).—Description of Work; Shot fired; Guns; Penetration; Conclusions.....	227
BREACHING FORT SUMTER (From the Report of General Gillmore).—The Work; Ranges and Nature of Batteries; Projectiles thrown; Character of Breach...	229
BREACHING FORT WAGNER (From the Report of General Gillmore).—Metal required to remove Sand Armor .....	230

## CHAPTER III.—THE STRAINS AND STRUCTURE OF GUNS.

**Section I.—Resistance to Elastic Pressure.**

	PAGE
PRESSURE.—Four Kinds of Strains brought on Guns, and their Relation . . . . .	233
I. INCREASING THE THICKNESS OF THE WALLS.—Rule for Increase of Strength; Illustrations; Captain Blakely's, Professor Treadwell's, and Mr. Longridge's Demonstrations . . . . .	234
II. HOOPS WITH INITIAL TENSION.—Theory; Professor Treadwell's Plan; Another Use of Hoops . . . . .	240
DEFECTS OF THE SYSTEM.—Want of Continuity; Mr. Longridge's Demonstration; Theoretical Accuracy of Tension; Difficulty of attaining it . . . . .	245
FORCING ON HOOPS.—Shrinking on Hoops; Unequal Shrinkage of Metal; Experiments; Want of Continuity of Substance; Permanent Enlargement of Hoops under Strain; Elasticity; Safety due to Ductile Hoops; Influence of Ranges of Elasticity in Different Parts; Defects of Wrought-Iron Hoops in this Regard . . . . .	250
LONGITUDINAL STRENGTH.—Dahlgren's Breech-Strap; Views of Siemens, Blakely, Parsons, and Lancaster; How Provided by Whitworth, Lancaster, Blakely, Parrott, and Armstrong; Length of Hoops . . . . .	256
WIRE-WOUND TUBES.—Defects and Advantages . . . . .	264
III. HOOPS WITH VARYING ELASTICITY.—Theory; Advantages; Notes on the Origin of the System; Experiments; Mr. Parsons's Method and Demonstration; Defects; Captain Palliser's Theory, Method, and Experiments; Captain Blakely's Specification and Practice . . . . .	266

**Section II.—The Effects of Vibration.** 281**Section III.—The Effects of Heat.**

Theory; Mr. Wiard's Views; Remedy . . . . .	283
CONCLUSIONS . . . . .	285

## CHAPTER IV.—CANNON METALS AND PROCESSES OF FABRICATION.

**Section I.—Elasticity and Ductility.**

ELASTICITY.—Use; Limit of in Metals—Experiments; Heavy and Light Forgings; Statements of Colburn, Clark, Mallet, and Anderson . . . . .	288
DUCTILITY.—Gain of Strength by Stretching—Experiments; Effect of Sudden Vibration and Different Rates of Application of Force; Experiments; Safety of Ductility in Guns; Work done in Stretching Metals to and beyond the Elastic Limit; Mr. Mallet's Reasoning and Illustrations . . . . .	292

**Section II.—Cast Iron.**

Weakness a Serious Objection; Tensile Strength; American and British Irons; Rifled Guns; Endurance of Guns; Greater Shrinkage of Strong Irons—Experiments—Cause; Want of Uniformity in the Same and Different Irons; Chemical Differences; Detection of Failure in Guns . . . . .	308
---	-----

**DEFECTS IN FOUNDED.—Solid-Cast Guns; Initial Strains; Effect of Time in Removing Strains; Effect of Heat of Firing; Want of Density in the Gun.** . . . . . 318

**IMPROVEMENTS IN FOUNDED—RODMAN'S PROCESS.—Hollow Casting; Objects; Requirements; Effects of Rapid and Slow Cooling; Defects from Exterior Cooling; Actual State of Strain in the Gun; Advantages; Effects of Heat of Firing; Density of Metal.** . . . . . 322

**WIARD'S PROCESS.—Object; Structure of Gun; Probable Advantages and Defects; State of Strain; Effect of Heat of Firing.** . . . . . 326

**SHAPE OF GUNS.—Effect of Re-entering Angles on Initial Strength.** . . . . . 331

**RESISTANCE TO CONCUSSION AND WEAR.** . . . . . 332

**WEIGHT AND COST.** . . . . . 332

**Section III.—Wrought Iron.**

**Tensile Strength; Uniformity; Deterioration—Causes; Detection of Weakness; Safety; Resistance to Compression and Wear; Experiments; Testimony about Armstrong Guns; Compression of Gun-Chambers; Hardness; Manner of Corrosion.** . . . . . 334

**WANT OF HOMOGENEITY.—Welds; Strength of Coils in Armstrong Gun; Shape; Weight and Cost of Guns.** . . . . . 344

**SYSTEMS OF FABRICATING WROUGHT-IRON GUNS—SOLID FORGING.—Defects—Imperfect Welds; Causes; Maintained Heat; Longitudinal Direction of Fibre; Effect of; Small Hammers; Effects of; Unequal Cooling and Contraction; Experiments and Illustrations; Strength of Iron in Large Forgings; Advantages of the Process; Failure of Forged Guns; the "Peacemaker;" Fabrication; Appearance of Fracture; Strength of Metal; Professional Opinions.** . . . . . 348

**HOLLOW FORGING AND ROLLING.—Mersey Iron and Steel Company's Process; Griffen's Process; Rolling up a Gun from a Plate; Yeakel's Plan; Ames's Process.** . . . . . 363

**THE ARMSTRONG GUN.—Process of Fabrication; Leading Features; Advantages of the System; Strength and Endurance of Guns; Guns Returned for Repair; Nature of Injury.—Defects of the System; Failures before Issue; Softness and Compression by the Powder-Gas; Examples; Stretching of Hoops; Fracture due to Vibration; Failure of 10½-in. Guns; Causes; Defects of 120-Pounder Shunt and Small Guns; Defective Welds; Resistance to Enemies' Shot; the System for Heavy Guns Considered; Great Cost of the Process.** . . . . . 366

**WELDING.—Nature of the Process; How to perfect it; Cinder; Shape of Surfaces; Exclusion of Oxide; Gas Welding; Bertram's Process and Results.** . . . . . 382

**HITCHCOCK'S SYSTEM OF FABRICATING GUNS.—Description; Principles; Comparison with Armstrong System; Making Hoops of Iron and Steel.** . . . . . 385

**Section IV.—Steel.**

**High and Low Stee. Defined; Uses of Elasticity and Ductility—Iron and Steel Compared; Work of Guns and Armor-Plates Compared; Steel Hoops; Cost, Weight, Quality; Improvements and Prospects of the Steel Manufacture; Causes of Previous Failure of Steel Guns; Strength of Steel; Uniformity; Temper—Test by Specific Gravity; Effect of Treatment; Resistance to Compression and Wear; Strains on a Homogeneous Tube—Remedies.** . . . . . 388

	PAGE
METHODS OF PRODUCING STEEL.—Puddled Steel; Low Crucible Steel; Krupp's Steel—Specimens Exhibited; Bessemer Steel—Process Illustrated—To be used in America—Specimens produced; Aboukoff's Steel; French and American Experiments.....	406
SYSTEMS OF FABRICATION.—Solid Forging; Forging Hollow; Compressing by Hydraulic Machinery; Rolling and Joining Hoops; Solid Cast-Steel Guns...	414

### Section V.—Bronze.

Properties; Fitaess for Guns; Strength; Difficulties of Manufacture; Where and how successfully used.....	418
---	-----

### Section VI.—Other Alloys.

Phosphorus and Aluminium with Copper—Properties and Strength; Sterro-Metal; Austrian and English Experiments on its Strength and Properties.....	422
CONCLUSIONS.....	428

## CHAPTER V.—RIFLING AND PROJECTILES—STANDARD FORMS AND PRACTICE DESCRIBED.

### Early Experiments.

Russian; Cavalli's; Wahrendorf's; Timmerhaus's; Germs of all the Present Systems.....	431
---	-----

### The Centering System.

Explanation; Modifications; FRENCH, Early, Present, and Experimental; Field and Naval Guns.....	432
AUSTRIAN.—Early; Modern for Gun-Cotton; Eccentric Shot; RUSSIAN; SPANISH; French System in other European Countries.....	437
LANCASTER.—in the Crimea; Experimental. <i>Haddan</i> ; Early and Experimental..	440
WHITWORTH.—Principles and Improvements Illustrated; Machine-dressed Projectiles; Standard Projectiles; Tables of Practice.....	442
SCOTT'S "Central" System; Explanation; Experimental Projectiles; Lynall Thomas's New System; like Scott's; Practice.....	447
SAWYER; PATTISON.....	449

### The Compressing System.

Explanation; Early PRUSSIAN.....	451
ARMSTRONG.—Principles and Changes; Going out of Use; Coating Projectiles with Lead; Segmental Shell; Cartridges; Tables of Practice; Armstrong and Whitworth Competition.....	452
SHUNT.—Principles and Operation; Changes; Table of Practice; Particulars and Results of 600-Pounder; <i>Russian</i> Shunt Rifling; Particulars.....	460

**The Expansion System.**

	PAGE
Explanation; American System; JAMES; HOTCHKISS; LYNALL THOMAS'S Early Results; SCHENKL; REED; BLAKELY.....	470
PARROTT; Particulars; Diagrams of Accuracy; Tables of Range, Pressure, Practice, and Endurance.....	477
STAFFORD, BUCKLE, JEFFERY, BRITTEN; Experiments and Charges.....	478

**Armor-punching Projectiles.**

WHITWORTH; Manufacture of Shot and Shells; How Shells are fired; Early Practice.....	492
SCOTT; PARROTT; STAFFORD; BATES.....	495

**Shells for Molten Metal.**

LANCASTER; SCOTT.....	500
-----------------------	-----

**Competitive Trial of Rifled Guns, 1862.**

Description of Guns; Britten; Thomas; Jeffery; Haddan; Lancaster; Scott; French; Shunt; Cost of Projectiles; Tables of Particulars; Endurance; Accuracy; Adaptation to Round Shot; Efficiency of Shell; Liability to Injury; Velocity, etc.; Conclusions of Committee.....	500
--	-----

**DUTY OF RIFLED GUNS.**

General Uses—especially, Use in Naval Warfare; Velocity the most Important Consideration; Object of Rifling.....	516
ACCURACY.—Effects of Want of Symmetry, and Remedy; Position of Centre of Gravity; Friction against the Air; Drift; Rate of Twist; Views of Mr. Longridge, Captain Blakely, Mr. Whitworth, etc.; Character of the Projectile—Expanded and Compressed Shot; Views of Major Owen, Commander Scott, etc.....	520
RANGE.—Conditions; Mr. Britten's Conclusions; Form of Projectile; Results of Experiments.....	530
VELOCITY.—Conditions; Systems Compared; Disadvantages of Armstrong's; Windage—Advantages in Rifled Guns—French Experiments—Atwater Gun.....	536
STRAIN.—Failure of Cast-Iron Guns; Weight of Projectile; Twist of Rifling; Wedging of Projectile; Lancaster and Whitworth Guns—Experiments at Woolwich; Character of Groove—Scott's System—Shunt; Increasing Twist; Character of Projectile; Systems Compared.....	544
LIABILITY OF PROJECTILE TO INJURY.—Systems compared.....	560
FIRING SPHERICAL SHOT FROM RIFLED GUNS.—Systems of Rifling Compared.....	562
MATERIAL FOR ARMOR-PUNCHING PROJECTILES.—Cause of Superiority of Steel; Results of Experiments.....	564
SHAPE OF ARMOR-PUNCHING PROJECTILES.—Mr. Fairbairn's Experiments.....	568
CAPACITY AND DESTRUCTIVENESS OF SHELLS.....	569
ELONGATED SHOT FROM SMOOTH-BORES.—Mr. Michael Scott's Views; Schemes—Bessemer's—Mackay's.....	570
CONCLUSIONS.....	572
VELOCITY OF PROJECTILES (Table).....	576

## CHAPTER VI.—BREECH-LOADING.

**Advantages and Defects of the System.**

	PAGE
The Practice with Large Guns against it in the United States, Russia, and England; Small Breech-Loaders in France and on the Continent.....	580
Material not Adequate in Large Guns Weakened by Breech-Loading Parts.....	581
Gun Strained by Heat of Gases when rapidly fired—Remedy; Minor Objections; Professional Opinions.....	582
Great Advantage—Fast Firing; Sighting takes more Time; When Fast Firing is Important; Time of Firing with Breech-Loaders and Smooth-Bores, Large and Small; Probability of quicker Loading Heavy Guns from the Muzzle....	583
Convenience of Breech-Loading in Turrets.....	586

**Rapid Firing and Cooling Guns by Machinery.**

Advantages; Fewer Guns and more Rounds; Stevens's Steam Loading and Cooling Machinery Described; Use on the <i>Naugatuck</i> ; Experiments; Many Plans for Working Heavy Guns allow Steam Loading and Cooling.....	587
--	-----

**Standard Breech-Loaders Described.**

ARMSTRONG.—Screw Breech-Loader Described; Material; Gas-Check; Defects; Endurance; Wedge Breech-Loader Described; Rapidity of Fire.....	595
KRUPP.—Breech-Loader Described; Forms of Gas-Check; Good Endurance of Trial Guns; Advantages.....	602
BROADWELL; STORM.....	605
FRENCH.—Adapted from American Plan; Description; Why old Plan failed; Adopted in England; Advantages.....	608
BLAKELY; NASMYTH—Failure of Ordinary Screw.....	610
WHITWORTH; Similar Plans; CLAY; CAVALLI; WAHRENDORF; PRUSSIAN; ADAMS; CONCLUSIONS.....	612

## PART SECOND.

## EXPERIMENTS AGAINST ARMOR.

**Account of Experiments from Official Records, in Chronological Order.**

Stevens, U. S., 1812; Paixhans, France; Ford on Protected Masonry, England....	623
Stevens, 1841; Thin Plates, England, 1846 to 1856, and $\frac{5}{8}$ -in. Plates, 1850, and $4\frac{1}{2}$ -in. Plates, 1854.....	624
Totten, U. S., Embrasures, 1853 to 1855.....	626
Floating Batteries, Kinburn, 1855; Stevens, U. S., 1856; Burgoyne, French....	627
Cast-Iron Blocks, England, 1857.....	629
4-in. Iron—Steel, England, 1856-7.....	630
Firing through Water, England, 1857.....	631
Comparison of 68-Pounders and 32-Pounders; Whitworth; 8-in. Plate, England, 1858.....	632

	PAGE
Thornycroft 14-in. Target, England, 1859.....	636
Special Committee, England, 1859; various Plates.....	636
The <i>Trusty</i> .....	637
4½-in. Plates, Armstrong Gun, 1859.....	638
Jones's Inclined Target.....	639
Comparison of Elongated and Spherical Projectiles, 1860.....	642
Thornycroft 10-in. Target.....	643
Iron Embrasure, Special Committee, 1861.....	643
Thornycroft 10-in. and 8-in. Shields.....	646
Different Qualities of Iron and Steel, England.....	653
Armor on Brick-work.....	654
Inclined Plates; 6½-in. and 4½-in. Plates; Roberts's Target; Fairbairn's First Target, England, 1861.....	665
Captain Cole's Cupola.....	667
Various Backings, England, 1861.....	668
<i>Warrior</i> Target, England, 1861.....	669
Hawkshaw's 6-in. and 10-in. Laminated Shields; <i>Warrior</i> Target, and "Alfred" Gun.....	673
Conclusions up to 1862.....	674
Stevens's Laminated Armor, U. S., 1862.....	679
"Committee" Target, England, 1862.....	680
<i>Warrior</i> and "Committee" Targets, England, 1862.....	684
2-in., 2·35-in., 3-in., and 4·5-in. Plates; Scott Russell's and Samuda's Targets, England, 1862.....	690
<i>Minotaur</i> Target, England, 1862.....	697
<i>Warrior</i> Target; Whitworth Shells, England, 1862.....	703
<i>Warrior</i> Target; Horsfall Gun, England, 1862.....	713
Firing through Water, England, 1862.....	716
Inglis's Shield, England, 1862.....	717
Millboard Backing, England, 1862.....	723
Wire Target; Inclined Laminated Targets; 4½-in. Plates, and Rubber and Oak Backing, U. S., 1862.....	724
8-in. Plate, Parrott Gun; Iron-Clad <i>Atlanta</i> ; 10-in. Solid and Laminated Targets; 15 and 11 inch Guns, U. S., 1863.....	733
14-in. Target; Laminated Target; 4½-in. Plate; Nashua Target. U. S., 1863.....	734
5½, 6½, and 7½ in., Brown's Target, England, 1863.....	737
4½-in. Solid Plate, Rubber Facing and Wood Backing, U. S., 1863.....	744
Chalmers's Target; Clark's Target; England, 1863.....	746
4½-in. Plate, 12-in. Oak Facing, 20-in. Backing; Sandwiched Iron and Rubber, U. S., 1863.....	753
<i>Warrior</i> Target, St. Petersburg, 1863.....	757
<i>Bellerophon</i> Target, England, 1863.....	760
13-in. 610-lb. Shell, 4½-in. Plate, 11-in. Plate, and 6½-in. Plate, England, 1863-4..	765
15-in. and 11-in. Balls and Parrott Shot; Various Plates, U. S., 1863-4.....	766
Steel Shot against Armor, England, 1863-4.....	766
Nasmyth's Wool Target, England; Brady's Hog's-hair Target, U. S., 1864.....	772
Mantelets for Embrasures.....	775
<i>La Flandre</i> Target.....	778

## APPENDIX.

**Report on the Application of Gun-Cotton to Warlike Purposes—British Association, 1863.**

	PAGE
Chemical Considerations.....	785
Mechanical Considerations.....	789
Practical Applications; Experiments against Palisades, Bridges, and Ships.....	791
System of Manufacture as carried on in Austria.....	797
Composition and Properties.....	799
Hydroscopic Qualities.....	803
Information given by Baron Lenk, concerning Manufacture, Nature, and Application.....	806
Report by Professors Redtenbacher, Schrötter, and Schneider.....	822

**Manufacture and Experiments in England.**

Nature, Application, and Theory of Explosion—Scott Russell.....	832
---	-----

**Guns Hooped with Initial Tension—History.**

Thiéry, 1834.....	837
Chambers, 1849.....	852
Treadwell, 1855.....	855
Blakely, 1855.....	860
Armstrong, Blakely, Treadwell—Evidence from the Report of the "Select Committee on Ordnance," on the Question between Blakely and Armstrong, as to Hooping and Material; Treadwell <i>vs.</i> Armstrong, as to the Method of making Wrought-iron Tubes.....	863
Parrott's Patents of 1861 and 1862.....	870

<b>How Guns Burst, by Mr. Wiard.....</b>	<b>874</b>
--	------------

<b>Lyman's Accelerating Gun.....</b>	<b>885</b>
--------------------------------------	------------

<b>Endurance of Parrott and Whitworth Guns at Charleston.....</b>	<b>886</b>
---	------------

<b>Hooping old United States Cast-iron Guns.....</b>	<b>887</b>
--	------------

<b>Endurance and Accuracy of the Armstrong 600-Pounder.....</b>	<b>888</b>
---	------------

<b>Competitive Trials with 7-in. Guns.....</b>	<b>889</b>
--	------------



## LIST OF TABLES.

---

NO.	PAGE
I. Particulars of Service Armstrong Guns.....	12
II. Service Ammunition of Service Armstrong Guns.....	12
III. Armstrong Guns issued for Service—showing where made.....	13
III. A. Particulars of Armstrong Guns of the Latest Elswick Patterns.....	15
IV. Return showing the Amount of Money expended on Plant at Woolwich, for the Manufacture of Armstrong Guns and for other Purposes, from the Commencement of the Manufacture, in March, 1859, to the 31st March, 1862.....	22
V. Cost of Labor and Material, including all Incidental Expenses, to produce one 100-Pounder Armstrong Gun, ready for Proof, with two Vent-Pieces.....	24
VI. Return showing the Prices of the Armstrong Guns Manufactured by the Elswick Ordnance Company to March 31, 1862.....	25
VII. Statement showing the Cost of Armstrong Guns made in the Royal Gun Factories, in which Indirect Expenses on Labor and Material, and Depreciation, are charged.....	26
VIII. Particulars and Charges of Whitworth Guns.....	34
IX. Return of Sums paid on Account of Experiments connected with Mr. Whitworth's Proposals.....	37
X. Particulars of Blakely All-Steel Ordnance and Ammunition.....	48
XI. Trial of Blakely early 9-Pounder with Service Iron and Brass 9-Pounders	49
XII. Particulars and Ammunition of the Parrott Guns.....	55
XIII. Particulars and Endurance of the Strengthened Cast-Iron Guns tested by Ordnance Select Committee since 1858.....	61, 62
XIV. Experiments on Longridge's Brass Cylinders.....	66
XV. XVI. Results of Experiments on Wire-wound Cylinders.....	72, 74
XVII. Experiments with Longridge's 2-96-in. Gun.....	76
XVIII. Approximate Proportions of Dimensions, Weights, and Prices of Krupp's Solid Cast-Steel Blocks and of Guns.....	97
XIX. Proof of Krupp's 110-Pounder Rifle.....	98
XX. Proof of Krupp's 20-Pounder Rifle.....	99
XXI. Proof of Krupp's 40-Pounder Rifle.....	100
XXII. Particulars and Charges of U. S. Hollow Cast-Iron Army Ordnance....	119
XXIII. Particulars and Charges of U. S. Heavy Cast-Iron Navy Ordnance in Service.....	120
XXIV. Guns burst at Sebastopol and Sweaborg.....	124
XXV. Particulars and Charges of British Cast-Iron Guns.....	126-129

NO.	PAGE
XXVI. Particulars and Charges of British Mortars .....	130
XXVII. Cost of Guns .....	131
XXVIII. Principal Experiments on Smashing and Dislocating Armor, chiefly by Heavy Shot at Low Velocities .....	162-165
XXIX. Weight of Shot that may be Fired from Various Wrought-Iron Smooth- Bored Guns without Straining the Metal more than that of Service Guns is Strained .....	175
XXX. Showing the Advantage of one Heavy Shot over several Light Shots.	177
XXXI. Principal Experiments with Shot at High Velocities, and Shells against Solid Armor .....	190, 191
XXXII. Velocities of Parrott (6.4-in.) 100-Pounder, May 1, 1862.....	194
XXXIII. Effect of Reducing Windage.....	195
XXXIV. Point-Blank Ranges of 68-Pounder, 100-Pounder, and 13-in. Gun....	196
XXXV. Experiments at West Point on Lead Shot against Armor.....	200
XXXVI. Work done by Different Guns, the 68-Pounder being taken as Unity.	205
XXXVII. Ranges, etc. Armstrong Muzzle-Loading Smooth-Bore 9.22-in. 100- Pounder.....	208
XXXVIII. Guns and Charges used in Breaching Martello Towers.....	222
XXXIX. XL. Ammunition expended in Breaching Martello Towers.....	223
XLI. Masonry displaced in Breaching Martello Towers .....	223
XLII. Range, Velocity, Ammunition, etc., of Projectiles used in Breaching Martello Towers.....	225
XLIII. XLIV. Relative Values and Bursting Charges of Projectiles, and Work done in Breaching Martello Towers.....	225, 226
XLV. Comparative Penetration of Armstrong Rifled and Spherical Projectiles into Brick-Work at 1032 Yards.....	226
XLVI. Number, Character, and Range of Shots fired in the Breaching of Fort Pulaski .....	227
XLVII. Penetration in Brick-Work—Fort Pulaski.....	228
XLVII. A. Range and Nature of Batteries employed in Breaching Fort Sumter..	230
XLVIII. Radii of Rings for Hooping Guns.....	249
XLIX. Calculation of the Strength of an Ordinary Service 68-Pounder Cast- Iron Gun, by Mr. Parsons.....	272
L. Calculation of the Strength of the same 68-Pounder, strengthened by a Wrought-Iron Lining Tube.....	273
LI. Relation of Elastic Limit and of Extension to Ultimate Cohesion....	290
LII. Resisting Powers of Krupp's Cast-Steel as Compared with other Metals for constructing Ordnance.....	290
LIII. Resistant Vis Viva of Elasticity and of Rupture by Tension of the Metals Applicable to the Construction of Ordnance.....	291
LIV. Properties of Light and Heavy Wrought-Iron Forgings.....	294, 295
LV. Endurance of a United States 9-inch Shell Gun.....	312
LVI. Tensile Strength of Wrought Iron—Whildin.....	334
LVII. Tensile Strength of Wrought Iron—Kirkaldy.....	335
LVIII. Resistance of Iron and Steel to Compression—Anderson.....	341
LIX. Expansion of the 40-Pounder Rifle made by the Mersey Iron and Steel Company .....	343

no.	PAGE
LX. Strength of Heavy and Light Forgings—Kirkaldy .....	356
LXI. Strength of Heavy and Light Forgings—Mallet.....	357
LXII. Strength of Iron in the "Peacemaker" Gun.....	359
LXIII. Strength of Iron in the Horsfall Gun.....	362
LXIV. List of all Armstrong Guns returned to Woolwich and requiring Repairs, to June 3, 1863.....	372, 373
LXV. List of Armstrong Guns rendered unserviceable by proving Vent- Pieces .....	374
LXVI. The Work done in Stretching to Rupture several of the best Speci- mens of Iron and Steel, as tested by Kirkaldy..	392
LXVII. Tensile Strength of Low Steel—Kirkaldy .....	400
LXVIII. The Uniformity and Extensibility of Wrought Iron and Steel Com- pared .....	401
LXIX. Showing that decreasing the Specific Gravity of Steel increases its Ultimate Tenacity and diminishes its Ductility.....	403
LXX. Showing the Effects of Treatment on Steel.....	404
LXXI. Hardness of Cannon Metals.....	405
LXXII. Various Qualities of Cannon Metals.....	405
LXXIII. Tensile Strength of Sterro-Metal—Experiments of Polytechnic Insti- tution, Vienna.....	424
LXXIV. Tensile Strength of Sterro-Metal—Experiments at the Arsenal, Vienna .....	425
LXXV. Analysis of Austrian Sterro-Metal.....	425
LXXVI. Composition and Strength of Sterro-Metal, Woolwich.....	427
LXXVII. Experimental Practice—Whitworth Breech-Loading 80-Pounder, Southport, July 25 and 26, 1860.....	446
LXXVIII. Ranges of Whitworth Rifled Guns.....	446
LXXIX. Range and Deflection of Lynall Thomas's 9-in. Gun, Shoeburyness, Nov. 20, 1863 .....	450
LXXX. Range and Deflection of Whitworth and Armstrong Guns.....	457
LXXXI. Experimental Practice—Armstrong Breech-Loading 12-Pounder, Shoeburyness, April 2, 1861.....	458
LXXXII. Experimental Practice—Whitworth Breech-Loading 12-Pounder, Shoeburyness, April 2, 1861.....	459
LXXXIII. Range and Accuracy of Long and Short Armstrong 12-Pounders, H. M. Ship <i>Excellent</i> , May 22, 1861 .....	460
LXXXIV. Range and Deflection—Armstrong Side Breech-Loading and Service 40-Pounders .....	461
LXXXV. Range and Deflection of the Armstrong Side Breech-Loading 70- Pounder.....	461
LXXXVI. Range and Deviation of the Armstrong 600-Pounder.....	462
LXXXVII. Range and Deflection of the Armstrong 70-Pounder Muzzle-Loading 6-Grooved Shunt Gun.....	467
LXXXVIII. Range and Deviation of 70-Pounder Side Breech-Loading Armstrong Gun.....	468
LXXXIX. Practice with Armstrong's 7-in. Shunt-Rifled Mortar—Shells with Copper and Zinc Ribs.....	470

NO.	PAGE
XC. Range of, and Pressure in, the Parrott 6·4-in. 100-Pounder Rifle, West Point, July 22-28.....	478
XCI. Trial of Parrott 6·4-in. 100-Pounder Rifle, by firing it 1000 times with 100-lb. Projectile and 10-lbs. charge, West Point, July 1 to July 19, 1862.....	483
XCII. Trial of Parrott 8-in. 200-Pounder Rifle, West Point, commenced May 28, and ended April 2, 1862.....	485
XCIII. Trial of Parrott 10-in. 300-Pounder Rifle, West Point, March, 1863.....	488
XCIV. Endurance of Competitive Rifled Guns.....	502
XCV. Endurance of Cast-Iron Guns Rifled on Mr. Britten's System.....	504
XCVI. Particulars of Rifling of Competitive Guns.....	505
XCVII. Windage of Competitive Rifled Guns.....	506
XCVIII. Bursting Charges of Shells—Trial of 1861.....	506
XCIX. Practice with Rifled 32-Pounder Cast-Iron Guns with Improved Projectiles and $\frac{1}{10}$ Charges, 1861-'62.....	508
C. Practice with Rifled 32-Pounder Cast-Iron Guns with Improved Projectiles, 1859-61.....	510
CI. Velocities of Projectiles—Trial of Rifled Cast-Iron Guns, 1861-2.....	511
CII. Practice with Rifled 32-Pounder Cast-Iron Guns, with Improved Projectiles and proposed Service Charges, 1861.....	512
CIII. Showing that the Rifle is more accurate than the Smooth-Bore with Spherical Shot.....	516
CIV. Twist and Deviation.....	522
CV. Ranges of Large and Small Rifled Projectiles.....	532
CVI. Resistance of Bodies to the Atmosphere.....	535
CVII. Resistance of Bodies to the Atmosphere.....	536
CVIII. Comparative Ranges of Jeffery and Armstrong Projectiles—Jeffery....	539
CIX. Strain due to Various Kinds of Rifling.....	551
CX. Windage of Round Shot in Rifled Guns.....	563
CXI. Resistance of Plates to Flat and Round Punches.....	569
CXII. Velocities of Projectiles, as determined by the Electro-Ballistic Pendulum; and Particulars of Guns—compiled from British and U. S. Artillery Records.....	576
CXIII. Penetration of Water and Wood—Whitworth 24-Pounder Rifled Howitzer	631
CXIV. Penetration of Water and Wood—Whitworth 24-Pounder Rifled Howitzer	632
CXV. Penetration of Water and Wood—Whitworth 24-Pounder Rifled Howitzer	633
CXVI. Whitworth 68-Pounder against 4-in. Plates—H. M. S. <i>Excellent</i> , Oct. 3, 1858.....	635
CXVII. Experiments against Jones's Inclined Target, Aug. 21, 1861.....	640
CXVIII. Experiments against Jones's Target placed Vertically, Sept. 18, 1861..	642
CXIX. Experiments against the Thorneycroft 8-in. and 10-in. Targets, June 6, 1861.....	649
CXX. Experiments against Masonry protected by Iron, May 9, 1861.....	658
CXXI. Experiments against the <i>Warrior</i> Target, Oct. 21, 1861.....	671
CXXII. Experiments against the "Committee Target," March 4, 1862.....	682
CXXIII. Experiments against the <i>Warrior</i> Target, April 18, 1862.....	685
CXXIV. Experiments against the "Committee Target," April 18, 1862.....	687

NO.	PAGE
CXXV. Experiments against 2-in., 2·35-in., 3-in., and 4·5-in. Plates with 12-Pounder and 40-Pounder, and against Mr. Scott Russell's Target and Mr. Samuda's Target, June 26, 1862.....	694
CXXVI. Experiments against the <i>Minotaur</i> Target, July 7, 1862.....	699
CXXVII. Experiments with Whitworth 12-Pounder, 70-Pounder, and 120-Pounder, against the <i>Warrior</i> Target, etc., Sept. 16 and 25, 1862.	706
CXXVIII. Experiments with the Whitworth 120-Pounder and 70-Pounder against 4½-in. and 5-in. Plates, and the 12-Pounder against 2½-in. Plates, Nov. 13, 1862.....	888
CXXIX. Experiments against Captain Inglis's Second Shield, March 3, 1863.	720
CXXX. Experiments against Wire Target.....	725
CXXXI. Experiments against Laminated Target.....	728
CXXXII. Experiments against Inclined Iron and Rubber Target.....	729
CXXXIII. Experiments against Inclined Iron and Rubber Target.....	730
CXXXIV. Experiments against Solid 4½-in. Plate, with Rubber and Oak Backing.....	731
CXXXV. Experiments against 5½, 6½, and 7½-in. Plates, rolled by Messrs. John Brown & Co.....	740
CXXXVI. Experiments against 4½-in. Plate, backed with Rubber.....	745
CXXXVII. Shot and Shell that struck the Chalmers Target.....	747
CXXXVIII. Experiments against the Chalmers Target.....	749
CXXXIX. Experiments against 4½-in. Plate faced with 12-in. Oak.....	753
CXL. Competitive Test of Armor-Plates, Portsmouth, Feb., 1864.....	770
CXL. A. Experiments with Steel Shot on Gunner Ship <i>Excellent</i> , Feb. 24 and 25, 1864.....	773
CXLI. Ordnance Committee's Experiments since October, 1859, on Mantellets for Embrasures to protect Gunners against the Enemy's Riflemen.....	775
CXLII. Experiments with Gun-Cotton, Initial Velocities, etc., in 12-Pounder Gun.....	814
CXLIII. Analysis of Austrian Gun-Cotton—Laboratory of Engineers' Committee, 1861.....	823
CXLIV. Analysis of Gun-Cotton of Various Years.....	824
CXLV. Analysis of the Gases of Gunpowder and Gun-Cotton.....	827
CXLVI. Comparison of Pressures and Velocities with Loose and Compressed Powder.....	890
CXLVII. British Cannon Powder.....	893



# LIST OF ILLUSTRATIONS.

	PAGE
THE "NEW IRONSIDES".....	v
THE "SOLFERINO".....	vi
THE "WARRIOR".....	xi
THE "BENTON," perspective view.....	xii
"    "    longitudinal section.....	xii
"    "    horizontal section.....	xiii
"    "    cross section through boilers.....	xiii
"    "    cross section through paddle-wheels.....	xiii
British steel-lined coil gun. Longitudinal section.....	xiv
U. S. hollow-cast Columbiad.....	xiv
U. S. hollow-cast hooped Parrott gun. Longitudinal section.....	xv
Blakely steel and cast-iron gun.....	xv
"LA GLOIRE".....	xvi
French field-gun, mounted. From a photograph.....	xvii
Armstrong 20-pounder gun and limber. From a photograph.....	xviii
The Armstrong 600-pounder.....	xlvi
Parrott 100-pounder, mounted.....	ccxxxii

## Armstrong Gun.

- FIG.
1. Bar for coil. Section.
  2. Bar coiled to make a hoop. Elevation.
  3. Hoop welded and recessed to fit others. Elevation.
  4. Furnace for welding hoops into a tube. Section.
  5. Weld thus formed. Section.
  6. 110-pounder. Longitudinal section,  $\frac{6}{10}$  in. to 1 ft.
  7. 12-pounder. Longitudinal section.
  8. Field-gun of 1859. Longitudinal section.
  - 9, 10, 11. Top, side, and end of early 12-pounder.
  - 12, 13. 12-pounder rifling four times enlarged. Section.
  15. Thread of breech-screw. Section.
  16. 12-pounder vent-piece, chamber, and projectile. Longitudinal section,  $\frac{1}{3}$ d size.
  17. 110-pounder, showing breech-loading. Longitudinal section,  $\frac{6}{10}$  in. to 1 ft.
  18. 110-pounder, showing breech. Longitudinal section,  $\frac{3}{4}$  in. to 1 ft.
  19. 110-pounder, showing breech. Plan,  $\frac{3}{4}$  in. to 1 ft.
  20. 110-pounder, behind vent-piece. Cross section,  $\frac{3}{4}$  in. to 1 ft.
  21. 110-pounder, behind vent-piece. Rear elevation,  $\frac{3}{4}$  in. to 1 ft.
  22. 10 $\frac{1}{2}$ -inch gun; 300-pounder when rifled. Longitudinal section,  $\frac{7}{16}$  in. to 1 ft.
  23. 10 $\frac{1}{2}$ -inch gun (the first built) after bursting. From a photograph.
  24. 600-pounder mounted. From a photograph.
  25. 10 $\frac{1}{2}$ -inch gun; Arsenal construction. Half-longitudinal section.

**Whitworth Guns.**

Fig.

26. 7-inch 120-pounder, as made by Mr. Whitworth. Elevation.  
 27. 7-inch gun as built at Woolwich, and rifled for Mr. Whitworth. Longitudinal section,  $\frac{6}{10}$  in. to 1 ft.  
 28. 7-inch gun as designed by Mr. Whitworth. Longitudinal section,  $\frac{6}{14}$  in. to 1 ft.  
 29. Breech of muzzle-loader. Longitudinal section.  
 30. Breech-loader. Elevation.  
 31. New 70-pounder. Elevation.  
 32. 70-pounder shot and rifling. Cross section, full size.

**Blakely Gun.**

- 32 A.  $8\frac{9}{16}$ -inch gun in the Great Exhibition of 1862. From a photograph.  
 32 B.  $7\frac{1}{2}$  inch rifle, captured at Shipping Point, 1862. Long. section,  $\frac{7}{8}$  in. to 1 ft.  
 32 C. 9-inch rifle. Low-steel barrel, hooped by high-steel and cast-iron. Longitudinal section,  $\frac{7}{8}$  in. to 1 ft.  
 32 D. 8-inch steel 200-pounder. Longitudinal section,  $\frac{6}{10}$  in. to 1 ft.  
 33. 5·8-inch steel rifle. Longitudinal section,  $\frac{7}{8}$  in. to 1 ft.  
 34. 900-pounder ( $12\frac{3}{4}$ -in.) rifle sent to Charleston. Longitudinal section,  $\frac{7}{8}$  in. to 1 ft.  
 35. 11-inch rifle for Russia. Longitudinal section,  $\frac{7}{8}$  in. to 1 ft.  
 36. Rifling of 9-inch gun. Cross section, full size.  
 37. Machine for rolling hoops from solid cast-steel rings.  
 38. Experimental 18-pounder. Longitudinal section.  
 39. Experimental 9-pounder. Longitudinal section.  
 40. Dundas's experimental wrought-iron gun. Cross section.  
 41. 132-pounder of 1857. Longitudinal section,  $\frac{6}{10}$  in. to 1 ft.

**Parrott Gun.**

42. Coil as wound. Section.  
 43. 100-pounder (6·4-inch) rifle. Longitudinal section,  $\frac{7}{8}$  in. to 1 ft.  
 44. 10-inch rifle. Longitudinal section,  $\frac{7}{8}$  in. to 1 ft.  
 45. 8-inch rifle. Longitudinal section,  $\frac{7}{8}$  in. to 1 ft.

**Miscellaneous Hooped Guns.**

46. Spanish steel-hooped gun. Longitudinal section,  $\frac{6}{10}$  in. to 1 ft.  
 47. French steel-hooped gun (Carron. de 30). Longitudinal section,  $\frac{6}{10}$  in. to 1 ft.  
 48. Rifle-groove and stud of (Carron. de 30). Cross section, full size.  
 49. Armstrong hooped cast-iron naval gun. Longitudinal section,  $\frac{6}{10}$  in. to 1 ft.  
 50. 68-pounder, hooped at Woolwich. Longitudinal section,  $\frac{6}{10}$  in. to 1 ft.  
 50 A. Armstrong cast-iron 70-pounder of 1860. Longitudinal section,  $\frac{6}{10}$  in. to 1 ft.  
 51. Mr. Longridge's experimental brass cylinder. Longitudinal section.  
 52. Mr. Longridge's experimental wire-wound 3-pounder. Longitudinal section.  
 53. Mr. Longridge's experimental wire-wound cylinder. Longitudinal section.  
 54. Mr. Longridge's experimental wire-wound cylinder. Longitudinal section.  
 55. Mr. Longridge's experimental wire-wound 2·96-inch gun. Longitudinal section.  
 56. Brooke's 7-inch hooped gun, made for Confederate service at Richmond, Va. Longitudinal section,  $\frac{7}{8}$  inch to 1 ft.  
 57. Brooke's 7-inch hooped gun, made for Confederate service at Richmond, Va. Breech-plan,  $\frac{7}{8}$  in. to 1 ft.



FIG.

58. Brooke's 7-inch hooped gun. Rifling. Cross section.  
 59. Attick's bronze reinforce. Longitudinal section,  $\frac{6}{10}$  in. to 1 ft.  
 60. The Bumford 12-inch cast-iron gun, hooped. Longitudinal section,  $\frac{6}{10}$  in. to 1 ft.  
 61. Mallet's 36-inch wrought-iron mortar. Elevation.

### Solid Wrought-Iron Guns.

62. "Horsfall" solid forged 13-inch gun. Longitudinal section,  $\frac{7}{8}$  in. to 1 ft.  
 63. "Horsfall" solid forged 13-inch gun. Elevation,  $\frac{7}{8}$  in. to 1 ft.  
 64. "Horsfall" solid forged 13-inch gun. Pile for forging. Cross section.  
 65. "Prince Alfred" hollow-forged 10-inch gun. Elevation,  $\frac{7}{8}$  in. to 1 ft.  
 66. 12-inch gun in Brooklyn Navy Yard. Longitudinal section,  $\frac{7}{8}$  in. to 1 ft.  
 67. Lynall Thomas's 7-inch gun. Mode of fabrication. Cross section.  
 68. Ames's 50-pounder. Longitudinal section,  $\frac{7}{8}$  in. to 1 ft.

### Solid Steel Guns.

69. Krupp's 9-inch gun in the Exhibition of 1862. Longitudinal section,  $\frac{7}{8}$  in. to 1 ft.  
 70. Krupp's 9-inch gun in the Exhibition of 1862. Plan,  $\frac{7}{8}$  in. to 1 ft.  
 71. Krupp's 9-inch gun for Russia. Longitudinal section,  $\frac{7}{8}$  in. to 1 ft.  
 72. Krupp's 12-pounder after being hit by shot. Cross section.  
 73. Krupp's jacketed gun burst at Woolwich. Longitudinal section.  
 74. Krupp's jacketed gun burst at Woolwich, after fracture. Longitudinal section.  
 75. Bessemer steel gun. Longitudinal section,  $\frac{6}{10}$  in. to 1 ft.

### Cast-Iron Guns.

76. British 8-inch (68-pounder) laid over United States 8-inch Columbiad. Half-longitudinal section of each,  $\frac{7}{8}$  in. to 1 ft.  
 77. U. S. Army 15-inch Columbiad. Longitudinal section,  $\frac{7}{8}$  in. to 1 ft.  
 78. U. S. Army and Navy 13-inch guns. Half-longitudinal section of each,  $\frac{7}{8}$  in. to 1 ft.  
 79. U. S. Army 10-inch Columbiad. Longitudinal section,  $\frac{7}{8}$  in. to 1 ft.  
 80. U. S. Army 4.2-inch rifled siege-gun. Longitudinal section,  $\frac{7}{8}$  in. to 1 ft.  
 81. U. S. Navy 15-inch gun. Longitudinal section,  $\frac{7}{8}$  in. to 1 ft.  
 82. U. S. Navy 11-inch Dahlgren gun. Longitudinal section,  $\frac{7}{8}$  in. to 1 ft.  
 83. U. S. Navy 7 $\frac{1}{2}$ -inch Dahlgren rifle. Longitudinal section,  $\frac{7}{8}$  in. to 1 ft.  
 84. U. S. Navy 7 $\frac{1}{2}$ -inch Dahlgren rifle. Cross section,  $\frac{7}{8}$  in. to 1 ft.  
 85. Dahlgren's breech strap for 7 $\frac{1}{2}$ -inch rifle. Plan,  $\frac{7}{8}$  in. to 1 ft.  
 86. Dahlgren's breech-strap for 7 $\frac{1}{2}$ -inch rifle. Elevation,  $\frac{7}{8}$  in. to 1 ft.  
 87. British 68-pounder (8-inch), 95 cwt. gun. Longitudinal section,  $\frac{6}{10}$  in. to 1 ft.  
 88. British 8-inch shell-gun. Longitudinal section,  $\frac{6}{10}$  in. to 1 ft.  
 89. Russian 120-pounder. Elevation,  $\frac{6}{10}$  in. to 1 ft.  
 90. Russian 56-pounder. Longitudinal section,  $\frac{6}{10}$  in. to 1 ft.  
 91. British and U. S. 13-inch sea-service mortars. Half-longitudinal section of each,  $\frac{7}{8}$  in. to 1 ft.  
 92. British 13-inch mortar, burst at Sweaborg. Longitudinal section.

**Projectiles against Armor.**

- FIG.
93. 10-inch target for 15-inch gun. Side elevation,  $\frac{1}{16}$  in. to 1 ft.
94. 10-inch target for 15-inch gun. Front elevation,  $\frac{1}{16}$  in. to 1 ft.
95. 10-inch target for 15-inch gun. Cross section,  $\frac{1}{2}$  in. to 1 ft.
96. 10-inch target as struck by 11-inch shot. Front elevation.
97. Ericsson 14-inch target. Cross section.
- 97 A. Confederate iron-clad *Atlanta*. Cross section.
98. The *Warrior* target. Side elevation,  $\frac{1}{8}$  in. to 1 ft.
99. Scott Russell's target. Front elevation,  $\frac{1}{8}$  in. to 1 ft.
100. Scott Russell's target. Cross section,  $\frac{1}{4}$  in. to 1 ft.
101. Chalmers's target. Horizontal section.
- 101 A. The *Bellerophon* target. Cross section,  $\frac{1}{4}$  in. to 1 ft.
102. Hawkshaw's 10-inch laminated target. Cross section.
103. 6 $\frac{1}{2}$ -inch laminated target punched by Dahlgren 10-inch gun. Cross section.
104. Target, Fig. 103. Side and front elevations,  $\frac{1}{16}$  in. to 1 ft.
105. Shot-hole through laminated armor. Cross section.
106. Shot-hole through solid armor. Cross section.
107. Scott Russell's armor. Cross section.
108. The *Warrior's* armor. Cross section.
109. Wire-rope bolt for armor. Elevation.
110. Thames Iron Works plate after two 68-pounders. End elevation.
111. Thames Iron Works plate after two 68-pounders. Front elevation.
112. Thames Iron Works plate after two 68-pounders. Plan.
113. Thames Iron Works plate after two 68-pounders. Rear elevation.
114. 4 $\frac{1}{2}$ -inch Dahlgren target "No. 5" after firing. From a photograph.
115. Nashua Iron Works target. Cross section.
116. Nashua Iron Works target after 6-inch shot. Front elevation.
117. Thames Iron Works "A 2" plate after test. Front elevation.
118. John Brown & Co.'s "V good A 3" plate after test. Front elevation.
119. *Warrior* target. Side section,  $\frac{1}{8}$  in. to 1 ft.
120. Whitworth's flat-fronted armor-punching shell. Elevation.
- 121, 122. Whitworth's flat-fronted armor-punching shell. Longitudinal sections.
- 122 A. 4 $\frac{1}{2}$ -inch plate; wood backing and facing, after an 11-inch shot. From a photograph.
- 122 B. 4 $\frac{1}{2}$ -inch plate; wood backing and facing, after an 11-inch shot. Cross section.
- 122 C. The *Warrior's* side and armor at cross bulkhead. Horizontal section.
- 122 D. The *Warrior's* side and armor through ports. Horizontal section.
123. 9 $\frac{1}{4}$ -inch cannon chamber with 100-lb. ball and 35-lb. cartridge. Longitudinal section.
124. 7 $\frac{1}{2}$ -inch cannon chamber with 50-lb. ball and 34-lb. cartridge. Longitudinal section.
125. Fracture of spherical shot upon striking armor.
126. Flat-fronted Whitworth projectile. Elevation.
127. Stafford's sub-calibre shot. Longitudinal section.
128. Armor of the *Galena* (wooden vessel). Cross section,  $\frac{1}{4}$  size.

**Concerning the Strains and Structures of Guns.**

- 129-135. Illustrations of the superior stretching and strain of the inner layers of cylinders subjected to internal elastic pressure. Cross section.

Fig.

136. Cylinder burst by internal pressure. Cross section.  
 137. Diagram illustrating the strain on a homogeneous gun.  
 138-142. Diagram illustrating strain due to want of continuity of hoops.  
 143. Wrought-iron cylinder after 20 heatings and coolings. Elevation.  
 144. Dahlgren breech-strap. Plan.  
 145. Dahlgren breech-strap. Elevation.  
 146. Breech-screw of Whitworth gun. Longitudinal section.  
 147. Armstrong hooped cast-iron naval gun. Longitudinal section,  $\frac{6}{10}$  in. to 1 ft.  
 148. Lancaster's strengthened 32-pounder. Longitudinal section,  $\frac{6}{10}$  in. to 1 ft.  
 149. Lancaster's hooping to give longitudinal strength. Longitudinal section.  
 150. Armstrong trunnion-hoop. Longitudinal section.  
 151. Gun burst under a seam in the hooping. Longitudinal section.  
 152. 68-pounder, hooped as proposed by Commander Scott. Longitudinal section.  
 153. 68-pounder, shrunk over wrought-iron tube, at Woolwich, 1860. Longitudinal section.  
 154. 68-pounder, strengthened by Parsons's internal tube. Longitudinal section,  $\frac{7}{8}$  in. to 1 ft.  
 155. 68-pounder, strengthened by Captain Palliser's internal tube. Longitudinal section,  $\frac{7}{8}$  in. to 1 ft.  
 156. 68-pounder, strengthened by Captain Palliser's internal tube. Plan of muzzle,  $\frac{7}{8}$  in. to 1 ft.  
 157. Captain Blakely's breech-loading gun with internal strengthening tube. Longitudinal section.  
 158. Captain Blakely's 9-inch high and low steel and cast-iron gun. Longitudinal section,  $\frac{7}{8}$  in. to 1 ft.

### Concerning the Materials and Fabrication of Guns.

159. Illustration of the effect of different rates of applying force.  
 160. Diagram illustrating the "work done" in stretching metals within and beyond their elastic limits.  
 161. Diagram illustrating the increase of weight by decreasing the strength of cannon metals.  
 162. Wiard's cast-iron gun. Elevation.  
 163. Wiard's cast-iron gun. Longitudinal section  
 164. Wiard's cast-iron gun. Cross section.  
 165. Cast-iron gun distorted to show the effects of irregular cooling and bad shape.  
 166. Forging for Mallet's 36-inch mortar-chamber. Elevation.  
 167. Pile for Mallet's 36-inch mortar-chamber. Cross section.  
 168, 169. Rents from cooling, in forged masses. Cross section.  
 170. Rents from cooling, in Mallet's mortar-chamber. Longitudinal section.  
 171. The "Peacemaker" 12-inch wrought-iron gun. Longitudinal section,  $\frac{7}{8}$  in. to 1 ft.  
 172. The "Peacemaker," fragment after bursting, showing defects. Longitudinal section.  
 173. Sheet of iron rolled up to form a gun. Cross section.  
 174. Armstrong hoop. Elevation.  
 175. Armstrong coil. Elevation.  
 176. Armstrong 110-pounder. Longitudinal section,  $\frac{6}{10}$  in. to 1 ft.  
 177. Armstrong's 10 $\frac{1}{2}$ -inch gun (the first). Longitudinal section,  $\frac{7}{8}$  in. to 1 ft.

## Fig.

178. Armstrong's 10½-inch gun (the first), after bursting. From a photograph  
179-181. Illustrations of the effect of shape of surfaces in welding.  
182. Hitchcock's machinery for forging cannon. Longitudinal vertical section.  
183. Armstrong coil. Elevation.  
184. Krupp's method of making solid rings.  
185. Bessemer converting vessel. Front elevation.  
186. Bessemer converting apparatus. Plan.  
187. Machine for rolling hoops.  
188. Krupp's method of making solid rings.

**Rifling and Projectiles.**

189. Cavalli rifled breech-loader. Longitudinal section.  
190. Cavalli projectile. Elevation.  
191. Wahrendorf's lead coating. Section.  
192. Timmerhaus's expanding shot. Longitudinal section.  
193. Beaulieu's, or first French service rifle-shot. Longitudinal section.  
194. Early French rifling for ordnance. Cross section.  
195. French rifling of 1860. Cross section.  
196. French projectile of 1860. Elevation.  
197. French shell in British competitive trials of 1861. Longitudinal section.  
198. French field-gun, mounted. From a photograph.  
199. Present French groove and stud, *Canon de 30*. Cross section. Full size.  
200. Austrian shell for 3-inch field-gun. Gun-cotton. Longitudinal section.  
201. Austrian shell for 3-inch field-gun. Gun-cotton. Cross section.  
202. Austrian fuze for shell. Elevation.  
203. Austrian 3-inch field-gun and rifling. Cross section.  
204. Russian studded shell. Elevation.  
205. Russian studded shell. Cross section.  
206. Russian rifle-groove. Cross section.  
207. Spanish rifled gun. Cross section.  
209. Spanish shell. Half-longitudinal section.  
210. Lancaster's rifling. Cross section.  
211. Lancaster's shell; competitive trials of 1861. Longitudinal section.  
212. Haddan's rifling. Cross section.  
213. Haddan's shell; competitive trials of 1861. Longitudinal section.  
214. Haddan's projectile for wood sabot. Longitudinal section.  
215. Whitworth's rifling. Cross section.  
216. Whitworth's short round-fronted projectile. Elevation.  
217. Whitworth's long round-fronted projectile. Elevation.  
218. Whitworth's long flat-fronted projectile. Elevation.  
219. Whitworth's 70-pounder shot and rifling. Cross section. Full size.  
220, 221. Scott's rifling. Cross section.  
222. Scott's rifling; projectile leaving the gun. Cross section. Full size.  
223. Scott's groove and rib on the projectile. Cross section.  
224. Scott's shell; competitive trials of 1861. Longitudinal section.  
225. Sawyer's projectile. End elevation.  
226. Sawyer's projectile. Side elevation.  
227. Pattison's projectile. Longitudinal section.  
228. Pattison's projectile. Cross section.

- Fig.  
229. Early Prussian rifling. Cross section.  
230. Early Prussian lead-coated shot. Half-longitudinal section.  
231. Original Armstrong rifling. Cross section.  
232. Adopted Armstrong rifling. Cross section.  
233. Armstrong rifling of 1861. Cross section.  
234, 235. Armstrong rifling, 6 and 12 pounder. Cross section, four times enlarged.  
236. Armstrong 12-pounder chamber, projectile, and vent-piece. Longitudinal section, one-third size.  
237. Armstrong undercut lead-coated projectile. Half-longitudinal section.  
238. Armstrong segmental shell. Longitudinal section.  
239. Armstrong segmental shell. Cross section.  
240. Armstrong 14-lb. cartridge and Boxer's lubricator for 110-pounder. Longitudinal section.  
241. Armstrong 14-lb. cartridge and Boxer's lubricator for 110-pounder. Elevation.  
242. Armstrong 12-lb. cartridge and Boxer's lubricator for 110-pounder. Longitudinal section.  
243. Armstrong shunt projectile with rib to hold zinc strip. Elevation.  
244. Armstrong shunt projectile going in. Cross section at muzzle.  
245. Armstrong shunt projectile coming out. Cross section at muzzle.  
246. Armstrong shunt rifling—development of groove. Plan.  
247. Armstrong shunt shell—competitive trials of 1861. Longitudinal section.  
247 A. Armstrong shunt rifled mortar. From a photograph.  
248. Russian shunt rifling. Cross section at muzzle.  
249. Russian shunt rifling. Cross section at 36 in. from muzzle.  
250. Russian shunt rifling. Cross section at 92 in. from muzzle.  
251. Russian shunt rifling. Cross section at 124 in. from muzzle.  
252, 253. Russian shunt steel shells. Elevations.  
254. Rifling of 4.2-inch U. S. siege-gun. Cross section. Full size.  
255. James's projectile. Perspective.  
256. James's projectile without packing. Perspective.  
257. James's shell. Longitudinal section.  
258. James's new shell. Longitudinal section.  
259. Hotchkiss's shell. Longitudinal section.  
260. Lynall Thomas's early projectile; competitive trials of 1861. Longitudinal section.  
261. Schenkl projectile without sabot. Perspective.  
262. Schenkl projectile with *papier maché* sabot. Perspective.  
263. Reed's shell. Longitudinal section.  
264. Blakely's projectile. Longitudinal section.  
265. Blakely's rifling for 9-inch gun. Cross section. Full size.  
266. Brooke's rifling for 7-inch gun. Cross section.  
267. Blakely's rifle-groove for 12 $\frac{3}{4}$ -inch gun at Charleston. Cross section. Full size.  
268. Parrott's hollow shot. Elevation.  
269. Parrott's 100-pounder shell. Elevation.  
270, 271. Targets showing accuracy of Parrott 100-pounder shell at 200 yards. Elevation.  
272. Stafford's new projectile, rear. Longitudinal section.  
273. Buckle's new projectile, rear. Longitudinal section.  
274. Jeffery's shell; competitive trials of 1861. Longitudinal section.  
275. Jeffery's rifling. Cross section.

- FIG.  
 276. Britten's rifling. Cross section.  
 277. Britten's shell; competitive trials of 1861. Longitudinal section.  
 278. Rifling used with Britten's and other expanding projectiles. Cross section.  
 279. Britten's early projectile. Cross section.  
 280. Whitworth's flat-fronted armor-punching projectile. Elevation.  
 281, 282. Whitworth's flat-fronted armor-punching projectile. Longitudinal section.  
 283. Whitworth's round-fronted projectile. Elevation.  
 284. Scott's steel shell for armor-punching. Longitudinal section.  
 285. Parrott's chilled flat-headed cast-iron shot for armor-punching. Elevation.  
 286. Stafford's sub-calibre shot for armor-punching. Longitudinal section.  
 287. Stafford's sub-calibre shell for armor-punching. Longitudinal section.  
 287 A. to 287 E. Bates and Macy's sub-calibre ordnance and projectiles.  
 288. Lancaster's loam-lined shell for molten metal. Longitudinal section.  
 289. Scott's loam-lined shell for molten metal. Longitudinal section.  
 290-294. Diagrams explaining the causes of the deviation of projectiles and the effects of rifling.  
 295-304. Diagrams of projectiles with reference to their resistance by the atmosphere.  
 305. " illustrating the shape of projectiles. Cone.  
 306. " " " " Conoid.  
 307. " " " " Ogival.  
 308. " " " " Newton's form.  
 309. " " " " Piobert's form.  
 310. Atwater's rifling near the chamber. Cross section.  
 311. " " near the muzzle. Cross section.  
 312-314. Diagrams illustrating the strain due to rifling, in different grooves.

## EXPERIMENTAL BORES AND PLUGS TO TEST THE STRAIN OF RIFLING.

315. Lancaster. Cross section.  
 316. Decagon. Cross section.  
 317. 3 grooves. Shunt. Cross section.  
 318. 3 grooves. Scott. Cross section.  
 319. Whitworth. Cross section.  
 320. 3 grooves. Scott. Cross section.  
 321. 2 grooves. Experimental. Cross section.  
 322. 3 ribs. L. Thomas. Cross section.  
 323. 3 grooves. Scott. Cross section.  
 324. 10 grooves. Shunt. Cross section.  
 325. Three rounded grooves. Cross section.  
 326. Square groove and rib. Cross section.  
 327. Scott's groove and rib. Cross section.  
 328-335. Diagrams showing the amount of the original bore untouched by different systems of rifling.  
 336, 337. Bessemer's elongated projectile for smooth bores. Elevation.

**Breech-Loading.**

- 337 A. French iron-clad two-decker, *Solferino*. From a photograph.  
 338. Stevens's steam loading and cooling apparatus. Longitudinal section.  
 339. Stevens's gun-carriage on the *Naugatuck*. Elevation.  
 339 A. Stevens's steam gunboat *Naugatuck*. Longitudinal section.

## FIG.

- 339 B. Stevens's steam gunboat *Naugatuck*. Cross section.  
 339 C. Hyde's method of running in guns. Plan.  
 339 D. Brown's method of running in guns. Plan.  
 340. Breech of Armstrong 110-pounder. Longitudinal section.  
 341. " " " Plan.  
 342. " " " Cross-section behind vent-piece.  
 343. " " " Rear elevation.  
 344. Armstrong 110-pounder. Longitudinal section.  
 345. Breech of Armstrong 40-pounder. From a photograph.  
 346. Armstrong 20-pounder gun—mounted, and limber. From a photograph.  
 346 A. Armstrong 110-pounder on barbette carriage. Elevation.  
 347. Alger's breech-loader. Horizontal section through breech.  
 348. Krupp's breech-loader. Horizontal section through breech.  
 349. Krupp's gas-check. Horizontal section.  
 350. Krupp's breech-loader. Breech-wedge in. From a photograph.  
 351. Krupp's breech-loader. Breech-wedge out. From a photograph.  
 352. Krupp's breech-loader wedge or sliding-block. From a photograph.  
 353. Broadwell's breech-loader. Horizontal section through breech.  
 354. Storm's breech-loader. Longitudinal vertical section through breech.  
 355. Storm's breech-loader. Plan of breech.  
 356. Castmann's breech-loader. Elevation.  
 357. Castmann's breech-loader, with plug out. Perspective.  
 358. Blakely's breech-loader, with inner strengthening tube. Longitudinal section.  
 359. Whitworth's breech-loader. Elevation.  
 360. Screw breech-loader. Rear elevation.  
 361. Screw breech-loader. Longitudinal section.  
 362. Clay's breech-loader. Longitudinal section.  
 363. Cavalli breech-loader. Longitudinal section.  
 364. Cavalli breech-loader. Plan of breech.  
 365. Cavalli breech-loader. Wedge. Horizontal section.  
 366. Cavalli breech-loader. Wedge. Elevation.  
 367. Wahrendorf breech-loader. Breech. Horizontal section.  
 368. Wahrendorf breech-loader. Longitudinal vertical section.  
 369. Prussian breech-loader. Horizontal section.  
 370. Prussian breech-loader of 1861. Wedge out. Horizontal section.  
 371. Prussian breech-loader of 1861. Wedge in. Horizontal section.  
 372. Adams's loading and cooling from the breech.

**Experiments against Armor.**

373. The floating battery *Trusty*. From a photograph.  
 374. Jones's inclined target. Elevation.  
 375. Thorneycroft 8-in. target. Front elevation.  
 376. Thorneycroft 8-in. target. End elevation.  
 377. Thorneycroft 8-in. target. Bar. Cross section.  
 378. The *Warrior*. Side at ports. Horizontal section.  
 379. The *Warrior*. Armor. Cross section.  
 380. Hawkshaw's 10-inch target. Cross section.  
 381. Scott Russell's target. Elevation.  $\frac{1}{2}$  in. to 1 ft.  
 382. Scott Russell's target. Cross section.  $\frac{1}{4}$  in. to 1 ft.

## FIG.

383. Scott Russell's armor. Cross section.  
 384. *Warrior* target. Cross section.  $\frac{1}{8}$  in. to 1 ft.  
 385. Hodge's wire target before firing. Cross section.  
 386. Hodge's wire target after two 11-in. shot. Elevation.  
 387, 388. Laminated inclined target, backed by rubber and timber.  
 389. Solid 8-in. target after a 10-in. Parrott shot. Elevation.  
 390. Solid 8-inch target, after a 10-in. Parrott shot. Cross section.  
 391, 392. Target of bars before and after firing. Elevation and section.  
 393. Confederate iron-clad *Atlanta*. Cross section.  
 394, 395, 397. Ten-inch target, Washington Navy Yard. Elevation.  
 396. Ten-inch target, Washington Navy Yard. Cross section.  
 398. Fourteen-inch target, Washington Navy Yard. Cross section.  
 399. Laminated 6 $\frac{1}{2}$ -inch target, after 10-inch ball. Cross section.  
 400. Dahlgren 4 $\frac{1}{2}$ -inch target, No. 5, after firing 11-in. shot, etc. Elevation.  
 401. Nashua Iron Works target after firing. Elevations.  
 402. Solid 4 $\frac{1}{2}$ -inch plate, faced with 4 inches of rubber, and backed. Elevation.  
 403. Chalmers target. Cross section.  
 404, 405. Solid 4 $\frac{1}{2}$ -inch plate, faced with 12-inch oak, and backed with 20-inch oak. Elevation.  
 406. *Warrior* target, fired against at St. Petersburg. Elevation.  
 407. *Bellerophon* target. Cross section.  
 408. *Bellerophon* target. Frame of ship. Cross section.  
 409. The *Bellerophon*. Elevation.

**Gun-Cotton.**

410. Palisade, 12 and 8-inch, cut down by 25 lbs. of gun-cotton. Elevation.  
 411, 412. Bridge, 12-inch scantling, 24 feet span, cut down by 25 lbs. of gun-cotton, before and after firing. Elevation and plan.  
 413. Ship and 400-lb. gun-cotton torpedo. Elevation.  
 414, 415. Bridge destroyed by gun-cotton, showing local effect. Plan and elevation.  
 416, 417. Gun-cotton cartridge. Elevation and cross section.  
 418. Gun turned down to measure the pressure of gun-cotton. Elevation.  
 419. Austrian rifled field-gun for gun-cotton. Cross section.  
 420. Austrian rifled projectile for gun-cotton. Cross section.  
 421, 422. Rife-musket cartridge. Gun-cotton. Cross section and elevation.  
 423. Palisade opened by 25 lbs. of gun-cotton. From a photograph.  
 424. Palisade opened by 25 lbs. of gun-cotton. Before firing. From a photograph.  
 425. Palisade opened by 25 lbs. of gun-cotton. After firing. From a photograph.

**Miscellaneous.**

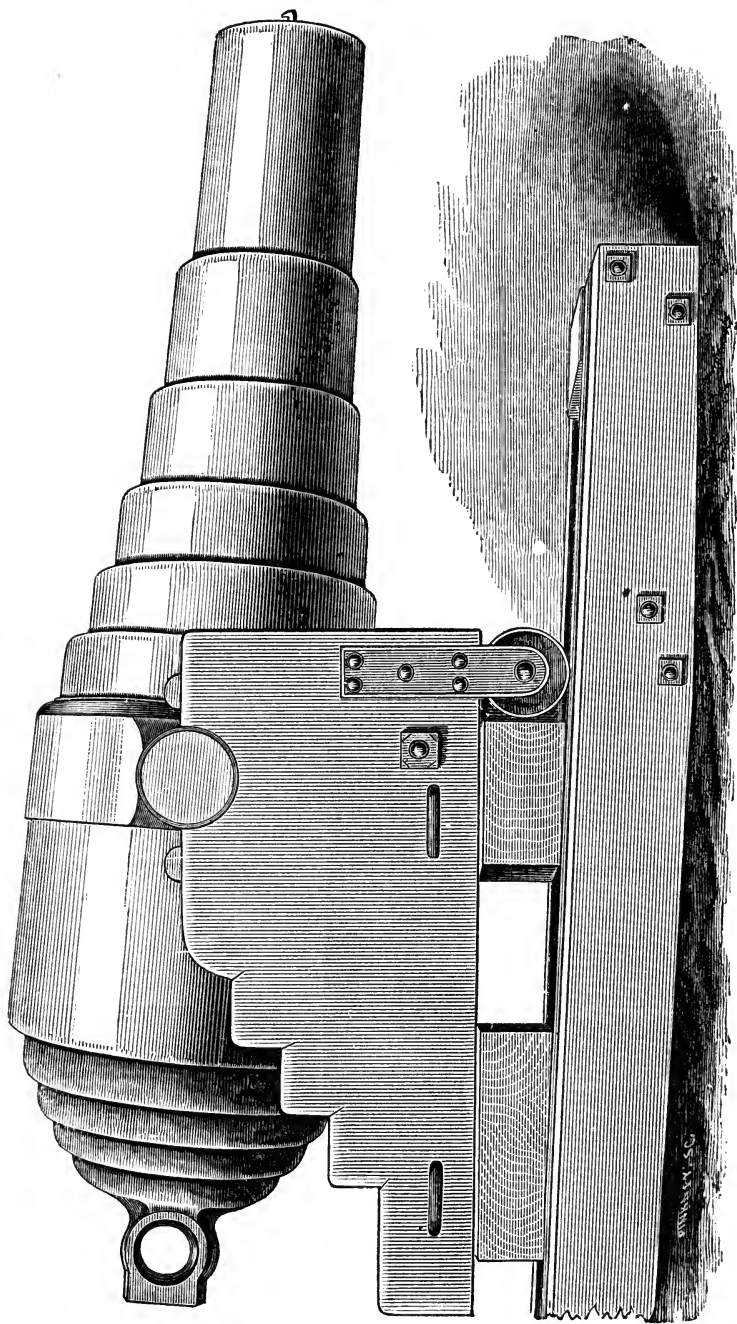
426. Thiéry's hooped gun, 1834. Elevation.  
 427. Chambers hooped gun, patented 1849. Longitudinal section.  
 428. Treadwell's hooped gun, patented 1855. Longitudinal section.  
 429. Blakely's hooped gun, patented 1855. Longitudinal section.  
 430. Parrott's hooped gun, patented 1861. Longitudinal section.  
 431-450. Diagrams illustrating Mr. Wiard's theory of the bursting of guns by the heat of firing.  
 451. Lyman's accelerating gun. Longitudinal section.

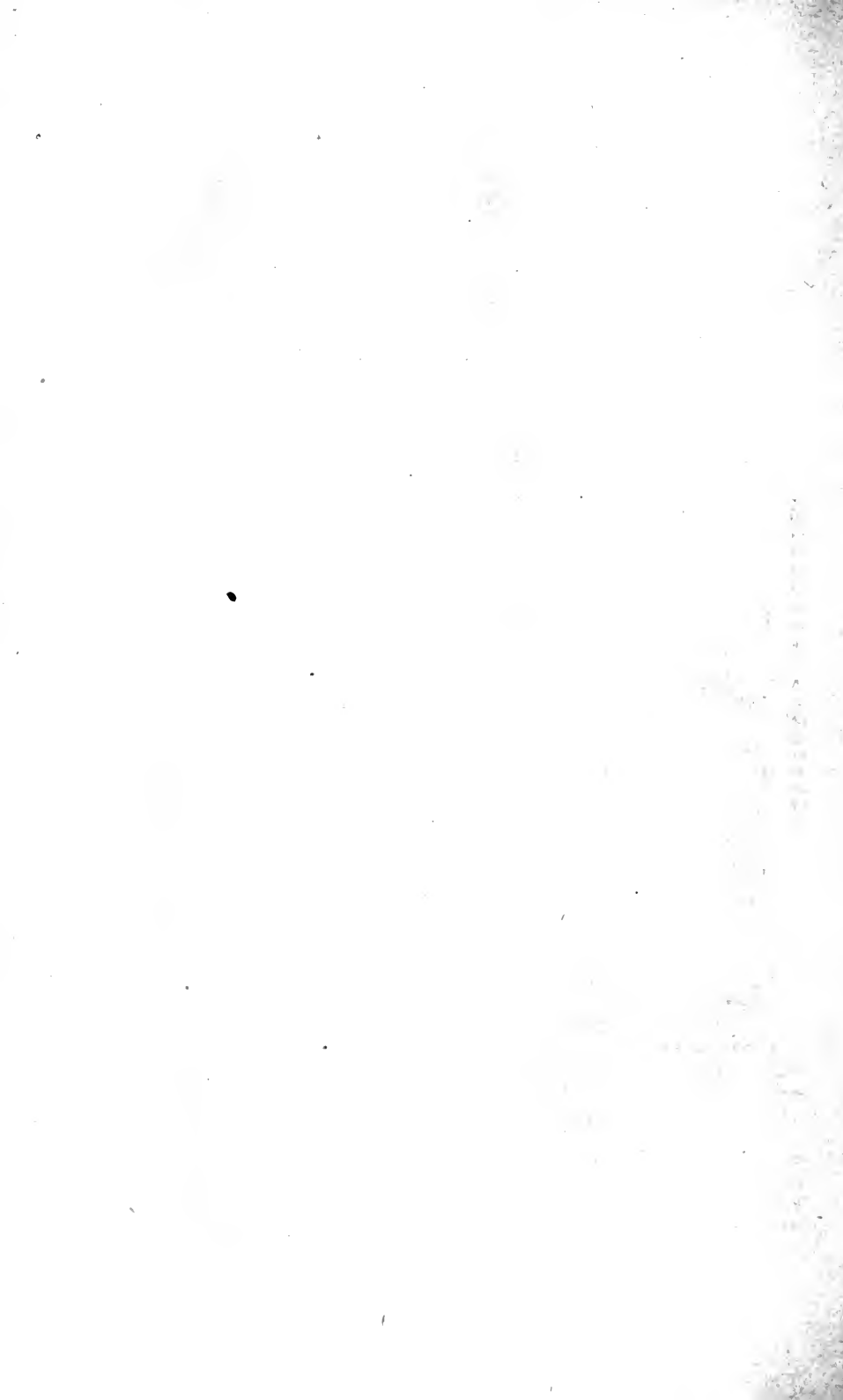


PART I.  
ORDNANCE.



ARMSTRONG 600-POUNDER.





# PART FIRST.

# ORDNANCE.

---

## CHAPTER I.

### STANDARD GUNS AND THEIR FABRICATION DESCRIBED

---

#### SECTION I. HOOPED GUNS.

**1. I. The Armstrong Gun.** This celebrated Artillery has been fabricated only for the British Government,\* at the Royal Gun Factory, Woolwich, under the superintendence of Mr. John Anderson, and at the Elswick Works, Newcastle-upon-Tyne, under the superintendence of Sir William G. Armstrong.†

**2.** After the production of nearly 3000 guns, the manufacture of what may be strictly called the Armstrong Gun is at present entirely discontinued, partly because the Army is well supplied with them, and partly because the larger sizes have not, considering their cost, successfully endured the vibration and pressure due to heavy charges.‡ Their comparative liability to injury,

\* By special act of Parliament, Sir William Armstrong's patents have never been made public. These patents are now the property of the British Government. The history of the invention is more fully referred to in the Appendix.

† Previous to his resignation, February 5th, 1863, Sir William Armstrong was Superintendent of the Royal Gun Factory, and also the Government "Engineer for Rifled Ordnance." Mr. Anderson was then "Inspector of Machinery" at Woolwich.—*Report of Select Committee on Ordnance*, 1862.

‡ It should not be argued from this fact, that the Armstrong guns on hand do not constitute a formidable armament. When the manufacture was started, the British Government was without a rifled cannon, and had nothing more powerful as a naval gun, or as a gun of position, than the 68-pounder, while Continental Powers were well supplied with rifled artillery. To remedy this alarming defect, the Government

from dampness and rough usage, is a further objection urged against the breech-loaders especially, as Naval guns.\*

**3.** While some of the distinctive features of the Armstrong gun are retained in the heavy ordnance at present constructing (41), the principal improvements, indicated both by practice and experiment, are the use of a larger amount of steel and of a smaller number of parts.

**4.** Ample appropriations, and over eight years' experience in the selection of iron and the improvement of processes and tools, have contributed to bring the *manufacture* of the Armstrong gun to a degree of perfection hardly surpassed in any other branch of machine building. Any immediately remediable defects in the gun would therefore appear to be due to the materials or to the design, and not to the workmanship.

The defects and improvements referred to will be considered more at length, and in order, in following sections (432).

**5.** The Armstrong gun is a series of concentric wrought-iron† tubes made from spiral coils. All the service Armstrong guns are rifled with fine grooves, to carry lead-coated projectiles. Some 9.22 in. and 10.5 in. experimental guns are smooth bores. The service guns up to 7 in. bore are breech-loaders; the muzzle-loaders, generally of larger bore, are as yet experimental guns, excepting, perhaps, the 10.5 in. gun.

**6.** The specification to the makers of the iron prescribes "a tenacity (ultimate) of about 26 tons (58240 lbs.) per square inch, not over 27 tons (60480 lbs.), nor under 25 tons (56000 lbs.); elongation not to become permanent under 13 tons (29120 lbs.)

felt obliged to resort to great and perhaps unnecessary haste and expense. In the present time of better preparation and greater security, the Government is experimenting, at no inconsiderable cost, with reference to future improvements.

\* The recent bombardment of Kagosima is said to have demonstrated the weakness of the Armstrong gun in this particular.

† The original Armstrong gun—a 3-pounder, delivered in July, 1855—was a breech-loader, having an inner barrel of steel throughout its length. This was hooped with one thickness of coils from the muzzle to the trunnion-ring, and with three coils over the chamber, giving it a maximum diameter there of 9 in. The bore was  $1\frac{1}{2}$  in. These facts are obtained from the Report of the Select Committee on Ordnance, 1863.

tension per square inch, nor compression to become permanent under 14 to 15 tons (31360 to 33600 lbs.) pressure on like surfaces.”\*

The greater part of the iron, especially that for the inner tubes, is supplied by Messrs. Taylor Brothers, of Leeds, at the cost in the bar, delivered at Woolwich, of £20 per ton,† and is a mixture of about 85 per cent. of Yorkshire, and about 15 per cent. of cold-blast, Swedish, charcoal pig.\* Mr. Anderson states that this is the best of seven or eight sorts of iron tried, and that it is quite uniform, and “does not blister at all.”† The forgings are supplied by Messrs. Taylor, Messrs. Cammell of Sheffield, and the Low-Moor Iron Company.†

7. FABRICATION.—All parts of the gun proper, except the breech-piece and the trunnion-ring, are formed from bars about 3 by 5 in., made in 30-foot lengths, welded end to end so as to be, say, 120 feet long, and of the section shown at Fig. 1. The upper or narrower side of the bar is placed next a revolving mandrel of the inner diameter of the intended tube, so that when the bar is wound round the mandrel, the upsetting of its thinner side, and the drawing of the other, will change its section to rectangular.

The bar is drawn hot upon the mandrel, and coiled around it into a close spiral of any required diameter (Fig. 2). The spiral is heated in a reverberatory furnace, placed upon end under a broad-faced six-ton steam-hammer,‡ and “upset” into a hoop (which, for convenience

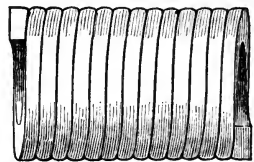
of handling, and to prevent excessive bulging, is limited in length to three to four feet for the small rings, and four to five feet for

FIG. 1.



Section of bar for coil.

FIG. 2.



Bar coiled to make a hoop

\* “Practical Mechanics’ Journal. Record of the Great Exhibition, 1862.”

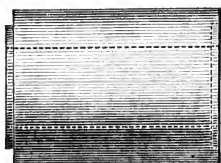
† Evidence of Mr. Anderson.—*Report of Select Committee on Ordnance, 1862.*

‡ Mr. Anderson states that the Elswick hammer weighs ten tons, and that the new hammer at Woolwich weighs twelve tons.—*Report of Select Committee on Ordnance, 1862.*

the large ones), the sides of the adjacent coils thus being welded together.\* The hoop is also "patted" on its periphery by a steam-hammer, to smooth down any large bulges, and to preserve its cylindrical form.

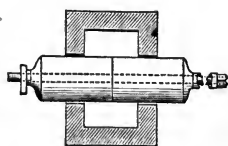
8. It is then recessed in a lathe about half an inch on each end (Fig. 3), so that one hoop will fit into the end of another.

FIG. 3.



Hoop recessed to fit others.

FIG. 4.



Furnace for welding hoops into a tube.

Two hoops are thus set end to end, squeezed together by a heavy bolt passing through them, and placed in a narrow reverberatory furnace (Fig. 4), where the joint receives a welding heat. The nut on the bolt being then tightened by the

FIG. 5.



Section of weld.

power of say ten men, applied to a wrench ten or twelve feet long, the joint is upset (Fig. 5) longitudinally (460). The hoops are then slipped over a loose mandrel, and patted under a steam-hammer, to perfect the weld and the shape of the short tube thus formed.† Another hoop is then slipped over the mandrel, and added to the tube by the same process, and so on until the required length is reached. Except for the 110-pounder, only the hoops forming the inner tube are welded together in this manner; and in all the guns, the outer courses of hoops are not welded end to end. In the Armstrong gun of 1859 (Fig. 8), the second tube from the bore was formed of two slabs, semi-cylindrical in section, welded together lengthways.‡

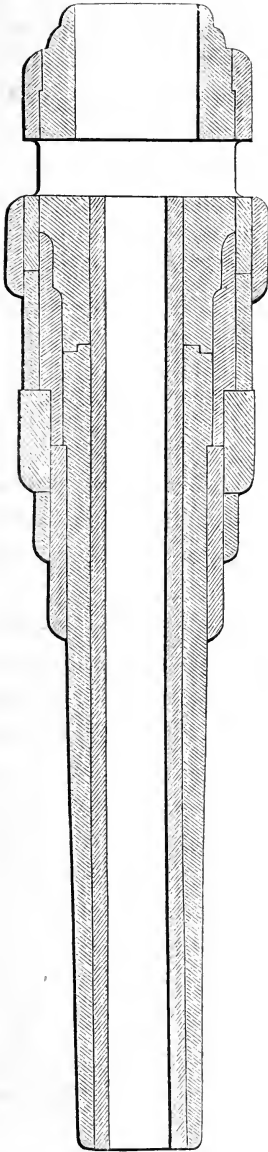
\* The same process has been very successfully applied in France for the manufacture of locomotive tyres.—*Mr. Longridge, "Construction of Artillery," Inst. Civil Engineers, 1860.*

† During this process, much iron is oxydized, as the scale is jarred off as fast as it forms, exposing fresh surfaces.

‡ Capt. Blakely.—*Journal Royal United Service Inst., March, 1861.*



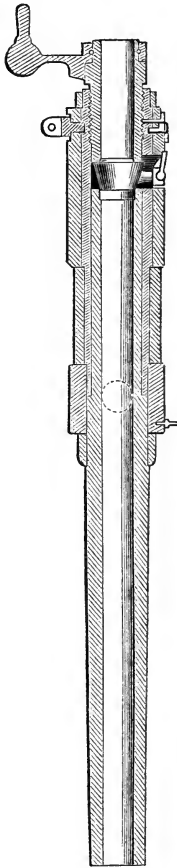
FIG. 6.



Armstrong 110-pounder.  
 $\frac{1}{10}$  in. to 1 ft.

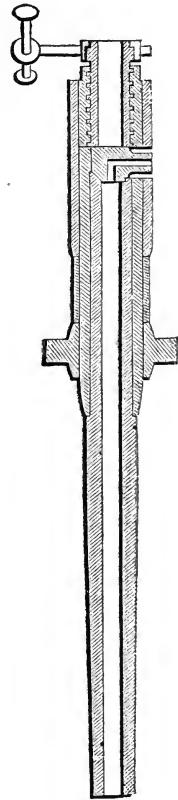
9. Inasmuch as the fibre of the iron runs spirally around the gun, and the welds are perpendicular to the bore, the structure is thus far very strong radially, but extremely weak longitudinally. To prevent the breech from being blown off by the explosion of the powder, the breech-piece (in which the breech-

FIG. 7.



Armstrong 12-pounder.  
 $\frac{1}{10}$  in. to 1 ft.

FIG. 8.



Armstrong Field-gun  
 of 1859.

screw turns, C D, Fig. 17) is forged solid and bored out, so that its fibre is parallel with the bore; it is also made thicker than the other tubes. It is welded to the second tube from the inside, in the same manner that the rings are welded into a tube. The breech-piece was formerly made of a slab bent into a cylindrical form, and welded at the edges.\*

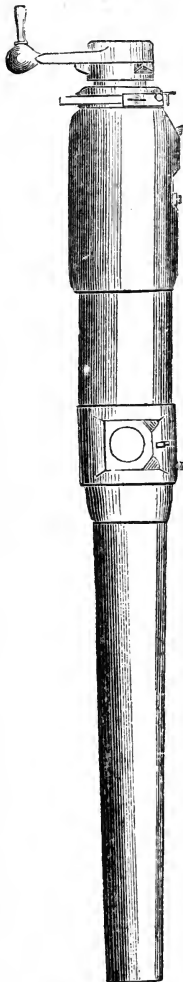
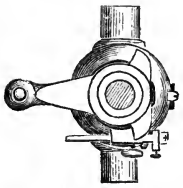
The breech-piece of the new 70-pounder, and of other small guns, is not welded to the adjacent tube-end, but retains its position solely by the friction of the tubes around it. Since the breech of the 10½ in. gun pulled apart in its thickest section without fracturing its welded joint with the tube which formed a continuation of it, the longitudinal strength of the piece, due to the grip of the rings upon each other, would appear to be sufficient, so long as that grip is not impaired. (See 300, 304, and Figure 23.) Indeed, the whole rear of the gun has been, in some cases, prevented from blowing out—in other words, the pressure of the powder gas upon the bottom of the chamber has been transferred to the trunnions—by the friction of the tubes upon each other.

**10.** Generally, however, the trunnion-ring (which is welded up and shrunk on in the usual way) is slightly recessed (Fig. 25) to fit a corresponding projection on the ring beneath it, and is slipped on when sufficiently expanded by heat. The outer rear ring is also flanged over the breech-piece (Fig. 6).

**11.** The outer tubes and rings thus formed are turned and bored without taper; the inner tube, for the recent class of guns, is slightly largest at the breech end, so that it may not be slipped forward by the enormous friction of the Armstrong projectile. The tubes and rings are shrunk together in the following manner:—A tube, turned accurately without, is set on end; a larger tube, turned smoothly within and roughly without, is heated to redness by standing on end over a wood fire, of which it forms the chimney. This larger tube is then raised by a travelling crane, placed above the other, and then slipped home. Water

\* Construction of Artillery.—*Inst. Civil Engineers*, 1860.

FIGS. 9 & 10.



jets are then turned on to shrink the outer tube. The mass is then accurately turned without, to receive other tubes and rings in like manner. Short tubes and rings are heated in a reverberatory furnace.

FIG. 11.

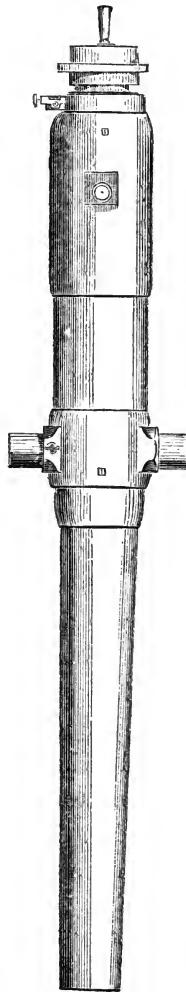


FIG. 12.



Armstrong Rifling (four times enlarged).

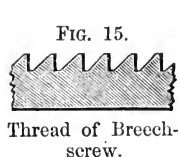
FIG. 13.



Top, side, and end of early Armstrong 12-pounder.

**12.** Sir William Armstrong has stated that he did not attach much importance to giving the tubes and rings successively higher initial tension, but that "they were simply applied with a sufficient difference of diameter to secure effective shrinkage,"\* and that a little variation in accuracy of shrinkage does not involve very bad results.† This principle of construction will be discussed in a following chapter.

**13.** BREECH-LOADING.—Two forms of loading at the breech‡ are employed—the screw, and the wedge or side breech-loader. The screw, which is used in all the service guns, is generally illustrated by Figs. 9 to 11, and 17 to 21. The rear of the powder-chamber is closed by a movable stopper called the vent-piece, which is held in place by the hollow breech-screw behind it. When the vent-piece is lifted up, the hollow screw forms a continuation of the bore, through which the charge is inserted from the rear.



The breech-screws for the smaller guns are solid forgings of steel. For the 40-pounders and 110-pounders, they are iron, with steel ends to bear against the vent-pieces. The threads are thus shaped (Fig. 15) to prevent their wedging.

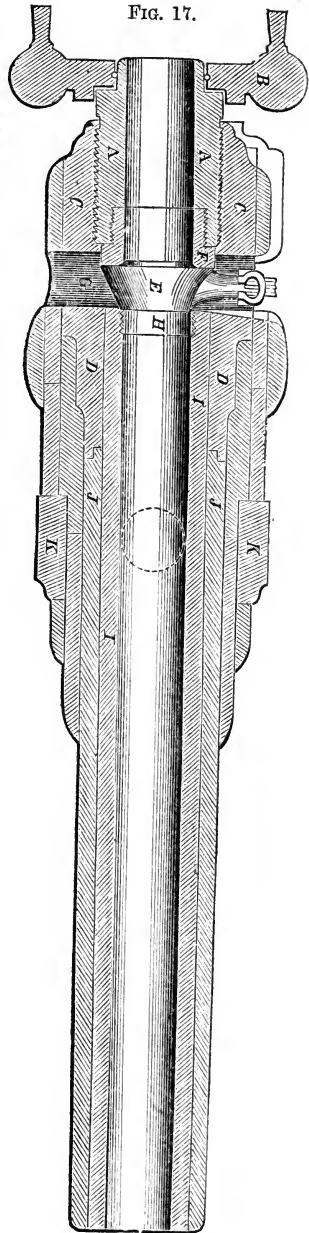
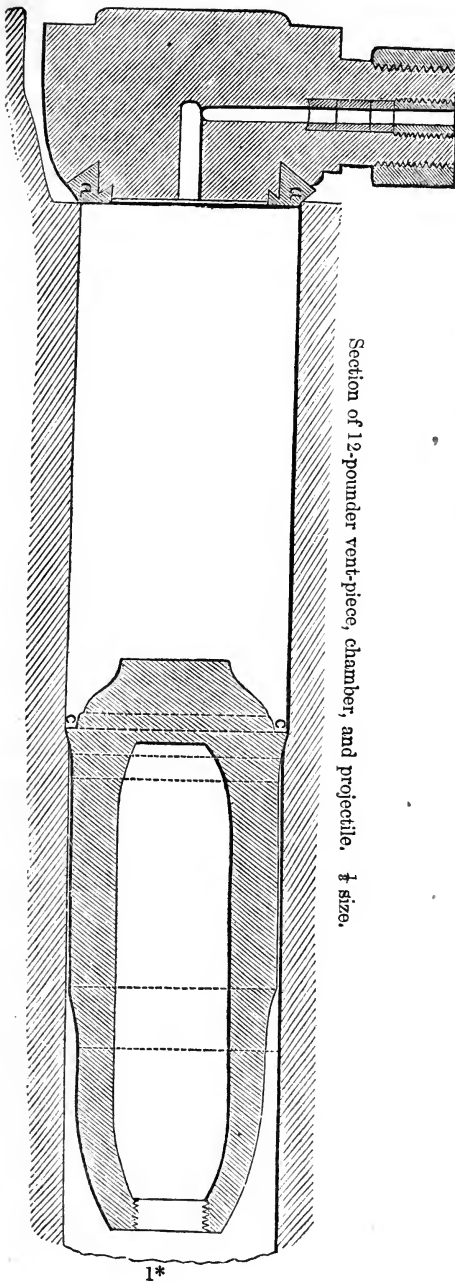
The vent-pieces have usually turned out to be the weakest parts, especially of the larger guns. Steel has long been used for the smaller guns; but until steel toughened in oil was tried, C ( and C. Swedish iron was the only material that would stand at all in the 110-pounders. Some vent-pieces of sandwiched iron and steel were unsuccessful.

Fig. 16 shows the 12-pounder vent-piece in section. The copper ring *a* is jammed by the screw against the bevelled end of the inner tube, to prevent the escape of gas. No copper ring is used on the 110-pounder, 70-pounder, or 40-pounder vent-pieces. On the 110-pounder, a thin cup of tin is inserted behind

\* Discussion on "Construction of Artillery."—*Inst. Civil Engineers*, 1860.

† Evidence before Select Committee on Ordnance, 1863.

‡ Both these forms and their results will be fully described in the chapter on "Breech-loading."



Armstrong 110-pounder.  
 $\frac{6}{10}$  in. to 1 ft.

the cartridge, to stop the escape of gas past the vent-piece. This cup only stands one round. The vent is made in the vent-piece, and can thus be easily renewed.

**14. RIFLING.**—The rifling of the Armstrong gun is peculiar, and will be discussed farther on. The twist of the grooves is a regular screw, having one turn in 37 calibres for the 110 pounder, and about the same pitch for the field pieces. Figs. 12 and 13 show standard forms of Armstrong rifling four times enlarged. The depth of the grooves in the 12-pounder is  $\cdot 045$  in.; their width,  $\cdot 148$  in. The number of grooves in the 110-pounder is 76; in the 12-pounder, 38. The shape and size of grooves in all the service guns, from 6-pounders to 110-pounders, is nearly the same.

The object of the multigroove system is to give a large bearing for the soft covering (lead hardened with tin) of the Armstrong projectiles, so as to prevent their stripping.

The "shunt" rifling consists of a smaller number of larger grooves, arranged to centre and compress the shot as well as rotate it. The projections on the shot were, at first, cast on and faced with zinc. Zinc strips, or brass or other studs, let into the shot, are now used.

**15.** The bore of the Armstrong breech-loader has several different diameters (Fig. 18). The powder-chamber, at the rear, is the largest part (in the 110-pounder it is 7.2 in.), and has no grooves. The shot-chamber is slightly smaller (in the 110-pounder, 7.075 in.) than the powder-chamber, but it is larger than the adjacent part of the bore forward (7 in. in the 110-pounder), and has, at its front, the commencement of the lands of the rifling. Beyond the shot-chamber, the grooves of the rifling extend with uniform depth to the muzzle; but from a point a few inches in front of the shot-chamber, to a point a few inches in rear of the muzzle, the bore is slightly enlarged, that is to say, the tops of the lands are cut down a little. The object is to mould the lead covering of the shot at the first instant of motion, to give it freedom in traversing the remainder of the bore, and to nip it and centre it at the muzzle.

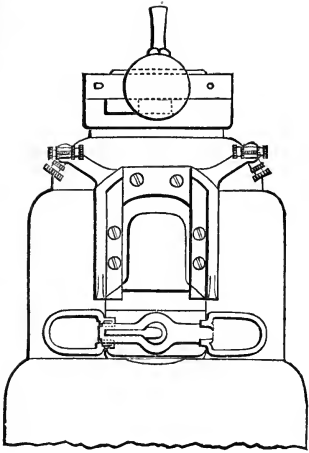


Fig. 19. Plan of breech.

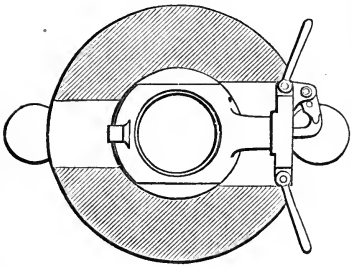


Fig. 20.

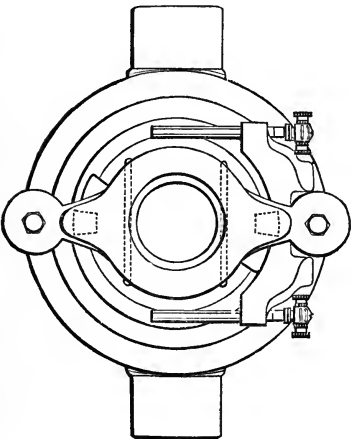
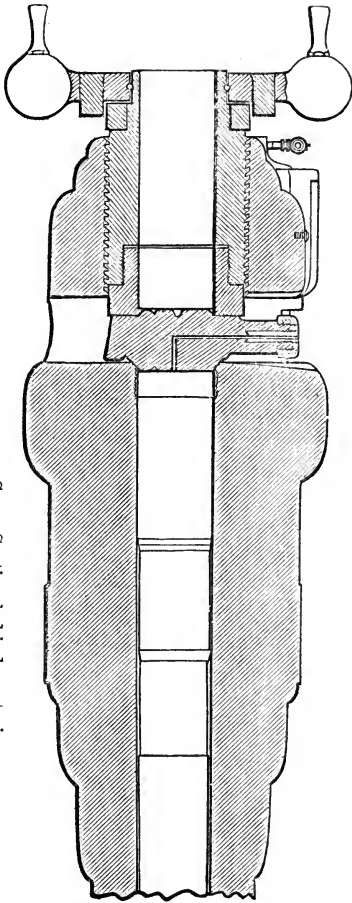
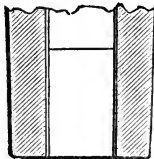


Fig. 21. Rear view.



Cross Section behind vent-piece.

Fig. 18. Section of breech of 110-pounder—scale 1/4 in. to 1 ft.



The rifling is at present done by a cutter that planes two grooves at once. A tool for cutting 76 grooves at once was shown in the Great Exhibition, but has not been put into service.

TABLE I.—PARTICULARS OF SERVICE ARMSTRONG GUNS.

NAME OF GUN	Weight.	Diameter of bore.	Length of bore.	No. of grooves.	Twist of rifling.
	lbs.	in.	in.		1 turn in calibres.
110-pounder.....	9184	7'	120	76	1 in 37
40-pounder, old.....	3640	4' 75	120	56	1 in 36½
40-pounder, new.....	3986	4' 75	120	56	1 in 36½
20-pounder.....	1792	3' 75	96	44	1 in 38
12-pounder.....	952	3'	84.125	38	1 in 38
9-pounder.....	689.25	3'	62	38	1 in 38
6-pounder.....	336	2' 5	60.15	32	1 in 30

TABLE II.—SERVICE AMMUNITION OF SERVICE ARMSTRONG GUNS.

NAME OF GUN.	Charge for shot.	Charge for shell.	Weight of shell total.	Bursting charge.	Weight segmental shell.	Bursting charge segmental shell.	No. of segments.
	lbs.	lbs.	lbs.	lbs.	lbs.	lbs.	
110-pounder.....	14*	12	106	8	101	3	111
Do. light.	10	12	106	8	101	3	111
40-pounder .....	5	5	41	2½	lbs. oz. 39 10	oz. 10	72
20-pounder .....	2½	2½	21½	1	19 11.23	1.23	56 or 14
12-pounder .....	1½	1½	....	....	10 8.98	.98	42 or 6
9-pounder .....	1½	1½	....	....	8 15.68	.68	35 or 6
6-pounder .....	¾	¾	....	....	5 7.41	.41	12 or 18

**16. PROOF.**†—The proof of the Armstrong gun was, till within about a year, as follows: Two rounds with double service charge and one service shot, and five rounds with one shot and

\* This charge has generally been reduced to 12 lbs.

† Evidence, Select Committee on Ordnance, 1863.



a charge of one-sixth the weight of the service shot. The present proof is two rounds with service charge and shot, and three rounds with service shot and a charge of one-sixth the weight of the service shot.

TABLE III.—ARMSTRONG GUNS ISSUED FOR SERVICE, SHOWING WHERE MADE.

*From the Report of the Select Committee on Ordnance, 1863.*

NAME OF GUN.	No. issued Elswick Ordnance Co.	No. issued Royal Gun Factory.	Total No. issued.
110-pounders.....	179	620	799
40-pounders.....	535	106	641
20-pounders, land service.....	9	16	25
20-pounders, sea service .....	1	231	232
12-pounders, land service.....	79	313	392
12-pounders, sea service .....	.....	178	178
9-pounders.....	.....	66	66
6-pounders.....	.....	37	37
Grand total.....	803	1567	2370

**17. GUNS DESCRIBED.\***—The tables 1 and 2 are compiled from the latest British Artillery records.

\* *From the testimony of Col. Lefroy, 2d July, 1862, before the Select Committee on Ordnance:*

"*Chairman.* Can you inform the Committee what wrought-iron and steel guns have been introduced into the service since the beginning of 1858?—An Armstrong 110-pounder gun; another Armstrong 110-pounder gun somewhat heavier, called the strengthened pattern; an Armstrong 40-pounder gun. Another shorter 40-pounder Armstrong gun; two varieties of 20-pounder Armstrong guns.

"*Col. Dunne.* Are those all rifled?—Yes. An Armstrong 12-pounder weighing 8½ cwt.; another weighing 8 cwt.; another weighing 6 cwt.; of the latter, only a few were made for service in China. An Armstrong 9-pounder, weighing 6 cwt.; an Armstrong 6-pounder, 3½ cwt.; those are all the wrought-iron rifled guns which have been introduced into the service, and they are all breech-loaders. There are other experimental guns which are not yet introduced. I find that in that enumeration I have omitted one 7 in. howitzer.

"*Sir John Hay.* Will you now mention the experimental guns which have not been introduced into the service?—A wrought-iron muzzle-loading Armstrong gun of 120 lbs.; a side breech-loading 110-pounder; an 80-pounder, or 6 in. gun; an

**21.** There are two classes of 110-pounders: the light gun, weighing 8400 lbs., of which about 100 only were made, but not issued; and the heavy service gun, described in the foregoing table. The maximum diameter of the latter is 27 in.; diameter at the muzzle, 13 in. Some 110-pounders, weighing 9632 lbs., have been constructed, but the standard weight is 9184 lbs.

Armstrong 70-pounder, with a new breech-loading arrangement; and another, a muzzle-loader; an Armstrong 40-pounder, with new breech-loading arrangement; the Armstrong 150-pounder, smooth-bored gun, lately tried at Shoeburyness, which, if rifled, will be a 300-pounder; and three guns known as the 18-pounder, 24-pounder, and 32-pounder, which were produced in the early stage of the inquiry."

The following extracts are from a "Memorandum by the Director of Ordnance" (Major-General Tulloh), on trials of and changes in the Armstrong gun.—*Report of Select Committee on Ordnance, 1862:*

"The 6-pounder gun was adopted at the same period as the 12-pounder; a few guns of this nature have been made for the naval service, but its use on land being limited to mountain service, the manufacture has not proceeded to any great extent.

"The 12-pounder was recommended for adoption into the service by the Special Committee on Rifled Cannon, in their Report dated the 16th November, 1858.

"The 25-pounder was adopted into the service in 1859; a gun of nearly similar calibre, 3.25 inches (the 25-pounder being 3.75), had been very extensively tried by the Rifled Cannon Committee in 1858, for range, accuracy, penetration, and endurance, the results being most satisfactory. Since 1859, the rifling of this class of gun has been slightly modified, being now one turn in 37 calibres, instead of one in 33, as originally. \* \* \* The gun itself has undergone no alteration, further than that above specified; these experiments have, however, led to the adoption of a lighter projectile (viz., about 21 lbs.) than that originally used, and the designation of the gun has been accordingly changed to a 20-pounder.

"The 40-pounder gun was recommended as a calibre for adoption in the navy by the Special Committee on Iron Plates and Rifled Cannon (Colonel St. George, C. B., President) on the 24th September, 1859. As in the case of the 20-pounder, the 40-pounder class sprang from a model gun which had been tried with success by the Rifled Cannon Committee in 1858 (viz., a 32-pounder of 4 in. bore). In October, 1860, it was deemed desirable to strengthen the 40-pounder by the addition of another coil at the breech, more as a matter of precaution than from any symptoms of weakness in the guns as originally constructed.

"The 100-pounder may be said to have originated in the 80-pounder of 63 cwt., which was made by Sir Wm. Armstrong early in 1859, and tried at Shoeburyness. The original weight of the 100-pounder, as recommended by the above committee, was 65 cwts., but an extra coil was subsequently added at the breech, which brought the weight up to 81 cwts. Three hundred 100-pounders were ordered to be made in the year 1860-61, to supply the very urgent demands of the navy.

"In the course of subsequent experiments with 100-pounder guns, it was found that a solid shot of 110 pounds weight could be fired from them with 14 lbs. charge, without causing any excessive strain upon the gun, or unmanageable recoil; the provisional adoption of this projectile was therefore authorized in July, 1861, and a standard pattern having been subsequently approved, the designation of the gun has been changed to 110-pounder."

TABLE III A.—PARTICULARS OF ARMSTRONG GUNS OF THE LATEST ELSWICK PATTERNS.

*From Official Drawings.*

NAME OF GUN.	Length of Gun.	Length of Bore.	Diam. of Bore.	Diameter over powder chamber.	Diam. at Muzzle.	Weight.	Preponderance.
	ins.	ins.	ins.	ins.	ins.	lbs.	lbs.
12-pounder Breech Loader...	83	73'5	3	9'75	5'75	918	.....
12-pounder Muzzle Loader..	76	67'75	3	10'9	5'6	996	60
25-pounder Breech Loader..	96	93	3'75	12'75	6	1882	123
40-pounder Do. ..	121	106'5	4'75	16'4	7'75	3696	392
70-pounder Muzzle Loader..	126'5	103'0	6'4	25'3	12'4	9016	548
150-pounder Do. ..	129'75	102'25	8'5	31	15'4	14896	504
300-pounder Do. ..	156	124	10	38'3	19	26880	.....
600-pounder Do. ..	183	145'25	13'3	51'5	21'5	51296	952

**22.** Two experimental 120-pounder shunt rifles, of 7 in. bore, have been constructed; the one a muzzle-loader, and the other a side breech-loader.

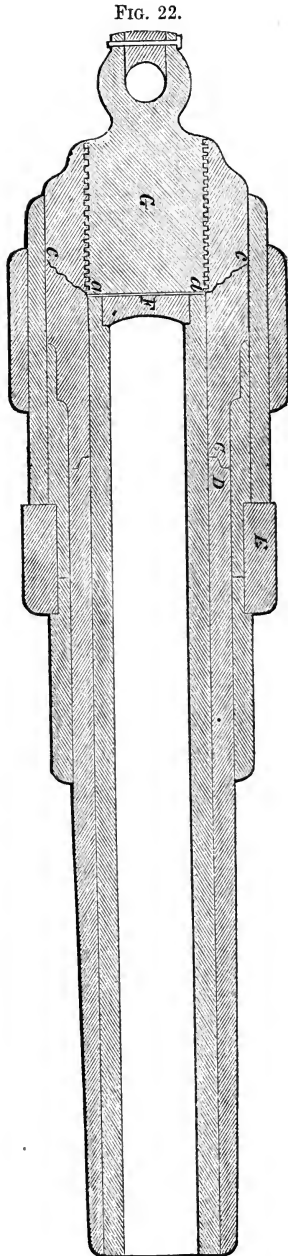
**23.** A  $7\frac{1}{2}$  ton 7 in. muzzle-loading gun, called the Cupola Gun, or New Naval Gun, has been completed. The inner barrel is a solid steel tube. The reinforce is excessively heavy, being 38 in. in diameter. The size suddenly decreases in front of the trunnions. At the muzzle the diameter is 13 in. The length of bore is 108 in. The rifling of this class of ordnance will depend upon the results of experiments with trial 7 in. guns lately constructing. Some fifty 100-pounders of this general construction have been ordered. (41.)

**24.** An experimental 6'4 in. gun has been constructed at Woolwich, to be rifled and loaded at the breech on Mr. Westley

NOTES.—The old 25-pounder land-service gun was changed to the present service 20-pounder.

One 70-pounder muzzle loader has been rifled on the shunt plan with 6 grooves.

Two 80-pounders of 6-in. bore have been constructed. One was used in the breaching experiments at Eastbourne. (273.)



Armstrong  $10\frac{1}{2}$  in. gun.  
 $\frac{1}{16}$  in. to 1 ft.

Richards' plans. It is about 18 feet long, and will weigh nearly ten tons, thus having an enormous margin of metal in proportion to its calibre.

**25.** A 200-pounder side breech-loader has also been the subject of trial. The particulars of this gun are as follow :

Weight.....	18648	lbs.
Preponderance.....	1132.4	"
Calibre.....	8.5	in.
Length.....	126.5	"
Length from breech to trunnions.....	49.5	"
Diameter of trunnions.....	10	"
Between trunnions.....	35.2	"
Maximum thickness of walls.....	13.35	"
Minimum thickness of walls.....	4.75	"
Length of chamber.....	19	"
Diameter of chamber.....	8.58	"
Diameter of bullet-chamber.....	8.52	"
Breech opening.....	12	"

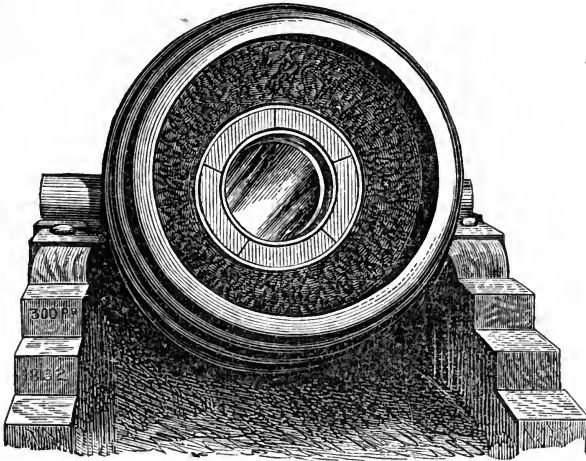
Rifling, eight grooves ; one turn in 55 diameters, or 467.5 in. : solid cast-iron shot, with false conical head, weight 130 lbs. : extreme length, 15.2 in. : charge, 28 lbs. : cartridge, 18 in. long : common shell, 173 lbs. : bursting charge, 12.8 lbs., or 185.8 lbs. total : charge, 24 lbs.

**26.** A 200-pounder (9.22 in.) gun has been constructed by placing a steel tube in a gun of the exterior dimensions of the 300-pounder (29).

**27.** A 9 in. muzzle-loading shunt gun, rifled with six grooves, has been completed, but not tested. This is the 100-pounder smooth-bore gun (31), rifled.

28. A 9½ in. 20-ton gun, with a steel barrel, is completed, but not tested.

FIG. 23.



The first 10½ in. gun after bursting. (From a photograph.)

29. The 300-pounder muzzle-loading shunt gun is the 10½ in. gun (Fig. 22), rifled with ten shunt grooves, so as to throw zinc-ribbed elongated shot. Besides the first smooth bore gun (Figs. 22 and 23), which burst after 26½ rounds, fourteen others were constructed. Two of these only were rifled. Their particulars are as follow: (32 See also Fig. 25).

Weight of gun.....	26880	lbs.	Length of bore.....	125.	in.
Preponderance .....	1142.4	"	Diameter of trunnions.....	12.	"
Length over cascabel.....	156	in.	Between trunnions.....	36.	"
Length from trunnions to } muzzle.	88.2	"	Diameter over chamber... ..	38.	"
Diameter of bore.....	10.5	"	Thickness of metal at muzzle..	4.5	"
			Thickness of metal at breech..	13.75	"

Ten grooves, one turn in 65 diameters, or 682.5 in. The shot (flat-headed, with false conical head) has ten bearing and ten driving ribs, and ten studs at the base; is 18.7 in. long, and weighs 230 lbs. The common shell weighs 278.6 lbs., and holds a 21.75 lbs. bursting charge = 300.35 lbs. total. The steel solid shot, 300 lbs., is 13.56 in. long. The service charge intended was 45 lbs. (20 in. long), but has been reduced to 35 lbs.

**30.** The 600-pounder\* muzzle-loader (Fig. 24), is a gun constructed similarly to the 300-pounder, of the following dimensions :

Length over all.....	15 ft. 3 in.	Weight of gun .....	51296 lbs.
Length behind centre of trunnions .....	6 " 2.5 "	Weight of breech-piece (for- ging) .....	19040 "
Length of bore.....	12 " 7.25 "	Preponderance.....	952 "
Diameter of bore.....	13.3 "	Weight of charge .....	70 "
Diameter over breech .....	4 " 3.5 "	Weight of shell.....	601 "
Diam. over trunnion-hoop	4 " 5.5 "	Burfting charge of common shell.....	45 to 47 "
Diameter of muzzle.....	1 " 9.5 "	Burfting charge (steel shell).....	24 "
Width over trunnions.....	6 " 2.5 "	Burfting charge (segmental shell, 510 segments).....	15 "
Thickness of trunnion-hoop	6 "	Length of shell .....	30.25 in.
Width of trunnion hoop...	16.5 "	Length of charge .....	23 "
Length of breech-piece.....	6 " 8.25 "	Number of grooves.....	10
Diameter of breech-piece...	2 " 6.3 "	Depth of grooves (muzzle) .....	.08 in.
Sectional area breech-piece	458 sq. "	Twist of rifling (turn in cali- bres).....	1 in 65 "
Sectional area of coils also receiving longitudinal strain .....	125 "		

The bore extends throughout the length of the gun, and is closed at the breech by a wrought-iron plug fitted into the bore, behind which there is a wrought-iron plug, faced with a steel disc, and screwed into the breech-piece. The trunnion-ring is shrunk on the 6th course of cylinders. The outer coil was made from a bar 5 × 4 in. and 125 feet long, weighing 71 cwt. The gun was turned after adding the respective cylinders, up to the 5th course; the 3 other cylinders, having been turned to proper sizes beforehand, were put on without removing the gun from the contracting pit. Its cost was \$19000.

The brass studs on the shot are of .85 in. diameter flattened to .65 in. and are stamped into holes undercut in the projectile, and placed in 10 rows, 5 or 6 in a row.

**31.** The above-mentioned guns are all rifles. Several muzzle-loading Armstrong smooth-bores, of 9.22 in. bore, to carry a 100 lb. spherical shot, were made with 106 in. length of bore, and 12544 lbs. weight.† A new lot, of 10 ft. length and 13514 lbs.

\* This gun was fired sixteen rounds for range (see chapter on "Rifling and Projectiles") on November 19, 1863.

† Journal of Royal U. Service Inst., 1862.

FIG. 21. 600-pounder Gun, from a photograph.

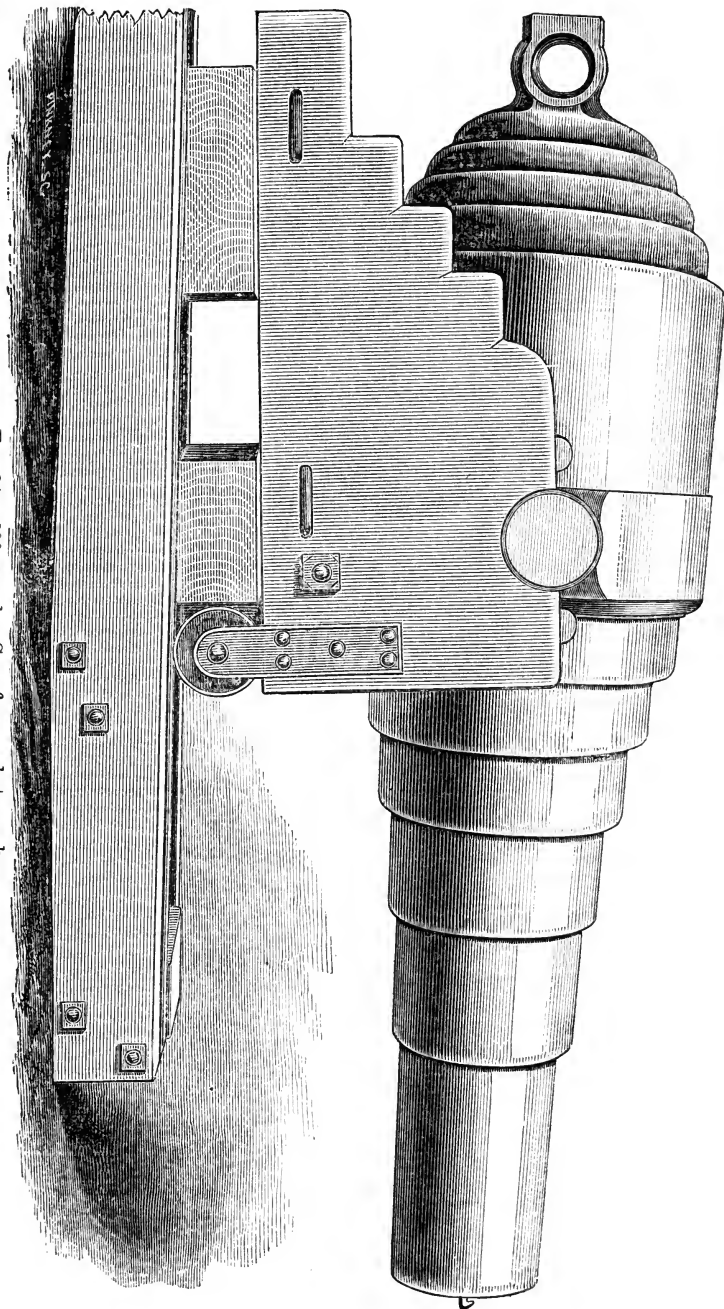
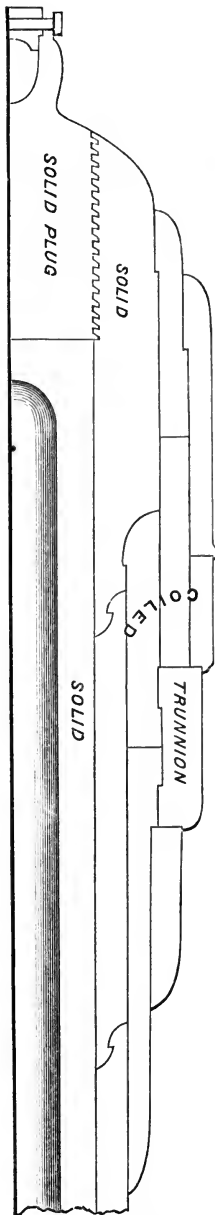


FIG. 25.



10½ in. gun.  
Arsenal construction.

weight, has been constructed. The range and test of one of them is given farther on. It is stated that fifty more of these guns, to weigh 118 cwt., and to have inner steel tubes, have been ordered.

**32.** The 150-pounder, smooth-bore (Fig. 22) is the "300-pounder" without rifling. Of the fifteen guns of this size constructed, only two were rifled (29). Two of the four constructed at Woolwich had internal tubes with closed ends, and were not rifled. The difference between the Arsenal and Elswick plans, for constructing these guns will be understood by comparing Figs. 25 and 22. In the former, the closed inner tube is a complete gun in itself; in the latter, the breech-plug, which is disconnected from the inner tube, forms the bottom of the barrel. The steel spherical shot for these guns weighs 167 lbs.; diameter, 10.435 in.; charge, 50 lbs.; cartridge, 22 in. long. The cast-iron shot weighs 152 lbs., and is 10.435 in. diameter. The cast-iron shell weighs 114.3 lbs.; bursting charge, 5.25 lbs.; thickness of wall of shell, 1.7 in.; charge, 30 lbs.

**33.** Several guns, constructed upon the Armstrong plan in most particulars, but modified chiefly in the rifling, have been fabricated at Woolwich. One of them, the Whitworth 120-pounder (44), which threw shells through the Warrior target, weighs 16660 lbs., and is rifled on Mr. Whitworth's plan, the bore being 7 in. across the corners, and 6.4 across the flats.

**34.** A 9-in. gun of 35840 lbs. weight, with a solid wrought-iron inner tube, closed at



the end, was rifled on Mr. Lynall Thomas's plan, with three projections to fit corresponding grooves in the shot. This gun has fired bolts as heavy as 330 lbs. weight, with 50 lbs. of powder, at armor plates.

**35. STEEL TUBES HARDENED IN OIL.**—The substitution of a solid-forged steel barrel for the Armstrong coiled tube\* has often been attempted by Mr. Anderson, although he did not succeed well with steel, until the process of hardening in oil was adopted. The apparatus for this process is very simple. An iron tank, filled with oil, and made deep enough to take in the tube vertically, is set within a tank of water, to keep the oil cool. Within the orbit of the crane for lifting the tube is a heating furnace with a wood fire. The temperature of the oil is raised to 280° by a 110-pounder inner tube. The effects of hardening in oil will be farther considered under the head of steel.

**36.** One 110-pounder, and two or three guns to be used for testing vent-pieces, have been constructed on this principle; and four 7 in. guns, thus fabricated, and rifled respectively on Scott's, Lancaster's, Britten's, and the French system, are nearly ready for trial.†

**37. COST.**—The process by which the Armstrong gun is constructed involves so much labor and such an extensive plant, that, however closely managed, it must be very costly.

In addition to this, the manufacture has been carried on in a government establishment (which, as a rule, is not an economical system of production), and in a private establishment guaranteed against loss by the Government. In fact, the Report of the Select Committee of 1863 indicates that \$1200000 might have been saved on an expenditure of about \$3000000, had all the ordnance required for the navy been supplied from Woolwich instead of Elswick.

\* The inner tube of the earliest successful gun (18-pounder) was made of steel (Sir Wm. Armstrong, "Construction of Artillery," Inst. Civil Engineers, 1860), but the particular kind used was perhaps too brittle for the purpose.

† It is stated that the fifty muzzle-loading guns of 9-inch bore, weight 118 cwt., ordered in the autumn of 1863, are to have inner tubes hardened in oil. They will fire a 100 lb. round ball.

TABLE IV.—RETURN showing the amount of money expended on PLANT at Woolwich, for the manufacture of ARMSTRONG GUNS, and for other purposes, from the commencement of the manufacture, in March, 1859, to the 31st March, 1862, from the Report of the Select Committee on Ordnance, 1862.

Date.	Buildings.			Machinery.			Total.			Remarks.
	£	s.	d.	£	s.	d.	£	s.	d.	
1859-60.....	11342	...	...	68553	7	7	79895	7	7	The whole of this plant has been used in the manufacture of Armstrong Guns.
1860-61.....	1970	...	...	66453	5	8	68423	5	8	
1861-62.....	2840	...	...	19941	1	2	22781	1	2	
Total.....	£16152	...	...	£154947	14	5	£171099	14	5	
	\$80760			\$774738	60		\$855498	60		

To analyze these expenses in much detail would hardly be important, since the values of labor and materials, and the employment of labor-saving machinery in the two countries cannot be closely compared, while no probable amount of cost is to be considered objectionable, if this or a similar process of construction should finally produce the best guns.

The whole sum expended at Woolwich and Elswick, in plant and in producing about 3000 Armstrong guns, with the necessary carriages and ammunition, up to the time of the Select Committee's Report, in 1863, was \$12697739.41.\*

**38.** According to Mr. Anderson, the average cost of the 110-pounder, for materials and labor, during 1860 and 1861, was

\* "1. The sum of £965117 9s. 7d. has been paid to the Elswick Ordnance Company for articles supplied.

"2. After giving credit for the value of plant and stores received from the company, a sum of £65534 4s. has been paid to the Elswick Ordnance Co. as compensation for terminating the contract.

"3. The outstanding liabilities of the War Office to the Elswick Ordnance Co., for articles ordered, amounted on the 7th of May last to the sum of £37143 2s. 10d.

"The whole of these payments and liabilities amounts to the sum of £1067794 16s. 5d.

"4. The sum of £1471753 1s. 3d. has been expended in the three manufacturing departments at Woolwich on the Armstrong guns, ammunition, and carriages, making altogether a grand total of £2539547 17s. 8d."—*Report of Select Committee on Ordnance, 1863.*

\$1575 (£315) per gun; but including contingent expenses, it was \$2000, while for the depreciation of plant and buildings, \$200 more should be added, making a total of \$2200 per gun. During 1862-3, the cost would be \$2195.75 (£439 3s.), not including rent and profits. The Woolwich establishment could turn out thirty such guns per week.\*

The cost of the 150-pounder smooth-bores (10½ in. gun) and of the 300-pounder rifles (the same 10½ in. gun, rifled) is about \$9000 each. The 200-pounder breech-loader costs about \$6000.

The cost of the larger Armstrong guns is from 24 cts. to 34 cts. per pound. (See table of cost of guns.)

**39.** ENDURANCE.—The strength and endurance of the Armstrong gun will be considered more in order, after the discussion of cannon metals, in a following chapter. (443.)

In general terms, the gun is very strong to resist bursting strains acting in the direction of the radii, but it is not proportionately strong longitudinally.

The wrought iron permanently changes its figure, under high charges, both in the chamber of the gun and in the rings. With wrought iron, certainly, the "built-up" principle seems to have been carried too far; the guns want homogeneity and *mass* to resist the destructive effects of relaxation and vibration.

Both the enormous pressure and strain due to forcing the shot through the multigroove rifling, and the shock due to the centering and nipping of the shot in the shunt rifling, aggravate these effects.

The least trustworthy part of the gun is the breech-loading apparatus. The muzzle-loaders of moderate bore, perhaps up to 9·22 in., are likely to prove very formidable, although they cannot be relied on for long service, without frequent repair and readjustment of tubes and rings—that is to say, rebuilding.

**40.** But although the Armstrong gun is costly in construction and maintenance, it is not likely to burst without warning, or to seriously injure the men or things immediately around it when it does give way. Not one of the 3000 guns built and tested has,

\* Report of Select Committee on Ordnance, 1862.

TABLE V.—COST OF LABOR AND MATERIAL, including all Incidental Expenses, to produce One 100-pounder Armstrong Gun, ready for Proof, with Two Vent-Pieces.  
(From the Report of the *Select Committee on Ordnance*, 1862.)  
[But the repairs of any defects developed at proof would be an extra charge.]

Description.	Material.			Labor.			Total.		
	<i>Cwt. gr. lbs.</i>	<i>£ s. d.</i> <i>Rate.</i>	<i>£ s. d.</i>	<i>£ s. d.</i>	<i>£ s. d.</i>	<i>£ s. d.</i>	<i>£ s. d.</i>	<i>£ s. d.</i>	<i>£ s. d.</i>
Gun iron for coils and tubes (contract price).....	108 ... ..	20 ... ..	108 ... ..						
Breech-piece and breech-screws (contract price).....	43 1 ... ..	30 6 ... ..	65 19 1½						
Vent-pieces, two (contract price).....	4 2 ... ..	... ..	6 17 3						
Breech screw end, do .....	2 ... ..	72 ... ..	9 ... ..						
Coals, do .....	... ..	... ..	21 12 ...						
Trunnion piece, lever, and tappet.....	21 2 ... ..	<i>Ton.</i> 60 ... ..	3 4 6						214 12 10½
<p><i>Note.</i>—These forgings are made from scrap, which has already been charged to the department in the form of gun iron. The price shown is the actual cost required to convert these scraps into slabs for manufacture into forgings.</p>									
Operations in the manufacture of the gun by piece-work .....							62 17 3		
Operations in the manufacture of the gun by day-work..							12 ... ..		
Departmental expenses, including indirect material, foremen, writers, miscellaneous labor, office, sick pay, funerals, travelling, postage, telegrams, carriage of stores, repairs, gas, water, police, horses, carts, etc., at 48.94 per cent.....							£74 17 3		
							36 9 6		
								111 6 9	
									£325 19 7½

[Signed]

J. ANDERSON,

Assistant Superintendent, R. G. F.

Royal Gun Factories, March, 1862.

TABLE VI.—RETURN showing the PRICES of the ARMSTRONG GUNS manufactured by the ELSWICK ORDNANCE COMPANY, from the commencement of the manufacture up to the 31st March, 1862. (From the Report of the *Select Committee on Ordnance*, 1862.)

Nature of Gun.	Original price.		Subsequent prices.				Remarks.
	£	¢	£	¢	£	¢	
12-pounder...	850	(170)	.....	.....	.....	.....	Complete with two vent-pieces and fights.
20 do ...	1100	(220)	.....	.....	.....	.....	
40 do ...	1750	(350)	1640	(328)	1425	(285)	Complete with two vent-pieces, but without fights.
100 do ...	3500	(700)	3250	(650)	.....	.....	

as Sir William Armstrong puts it,\* “burst explosively.” This feature, obviously due to the ductility of the metal, and the number of the concentric tubes, is of great importance, especially in the case of turret or casemate guns.

**41. The New British Gun.** Early in 1863, the fabrication of Armstrong service guns was entirely suspended both at Woolwich and at Elswick. The small amount of work done at the Royal Gun Factories was upon repairs and experimental guns. Towards the close of the year, the results of experimental steel tubes hardened in oil had been so favorable, that fifty 7-ton muzzle loaders of 9-in.† bore, and fifty 7-ton 9 cwt. 7-in. guns, resembling Fig. 27 in exterior size and form, were ordered. The Armstrong coiled outer hoops and rings and the forged breech-piece are to be retained; but the coiled, welded, soft wrought-iron inner barrel, with an open breech end, is replaced by a solid homogeneous forging of steel, forming a complete gun in itself. The rifling of these guns had not been determined upon.

\* “The safety of the principle I consider has been established by the fact that out of nearly 3000 guns made on this principle, no one gun has burst explosively, and, in fact, no one gun has failed, under the most trying tests, excepting by a gradual process, which has given timely notice of the approaching destruction of the gun, and has prevented any possibility of a dangerous accident.”—*Evidence of Sir William Armstrong: Report of Select Committee on Ordnance*, 1863.

† The original 100-pounder muzzle-loader had 9·22 in. bore, and weighed 6½ tons.

*Royal Gun Factories, July 14, 1862.*  
 TABLE VII.—STATEMENT showing the Cost of ARMSTRONG GUNS made in the ROYAL GUN FACTORIES, from March, 1859, to 31st March, 1862, in which the Indirect Expenses are charged both on Labor and Material, and the Depreciation and Interest on the entire Cost. (From the Report of the *Select Committee on Ordnance, 1862.*)

Description of Guns.	Number of Guns made.	Cost of Labor.		Cost of Material.		Indirect Expenses on Labor and Material.		Total Cost of Guns. Cost per Gun.		Depreciation on Buildings and Machinery, and Interest on Capital.		Final Cost per Gun.		Final Cost per Gun.	
		£	s. d.	£	s. d.	£	s. d.	£	s. d.	£	s. d.	£	s. d.		£
1860-61.															
6-pounders.....	46	2018	5 3	776	... ..	637	1 10	3431	7 1	74 11	10½	6 1 3	80 13	1½	403 28
12 do .....	364	13952	4 9	9904	... ..	5234	... 5	28190	5 2	77 8	10	6 5 11	83 14	9	418 68
20 do .....	116	8220	1 9	7525	... ..	3589	17 7	19334	19 4	166 13	7	13 11 ...	180 4	7	901 14
1861-62.															
9-pounders.....	66	1809	1 9	1657	3 4	693	5 ...	4159	10 1	63 0	5	4 9 7	67 10	...	337 50
12 do .....	254	7817	6 5½	7887	12 6½	3140	19 9	18845	18 9	74 3	11	5 5 8	79 9	7	397 39
20 do .....	201	7778	16 7½	10799	1 2½	3715	11 7	22293	9 5	110 18	3	7 17 8	118 15	11	593 97
1860-61.															
1861-62.															
110-pounders.....	575	55410	8 2½	125889	14 1½	41839	10 6	227139	12 10½	395 ...	6	7½ per cent.	424 13	1	2123 27
	1622														

[Signed]

JOHN ANDERSON,  
Asst. Supt. R. G. F.

The principal features of the Armstrong system of ordnance would thus appear to be going out of use. The hooping of a *steel* barrel with wrought iron was patented by Captain Blakely, before Sir William Armstrong's practice commenced. (See Appendix.)

And since wrought iron, even when placed over a steel barrel, has shown some tendency to fail, on account of its greater ductility and softness, while the effects of vibration are much more serious upon separate layers of metal than upon solid masses, the opinion is gaining ground in England that coiled wrought-iron tubes will be entirely abandoned, and that a smaller number of solid steel tubes will be employed. The recent and most satisfactory development of the steel manufacture in Sheffield (see chapter on Cannon Metals), and the excellent endurance of the steel guns lately tested at Woolwich, also favor this conclusion.

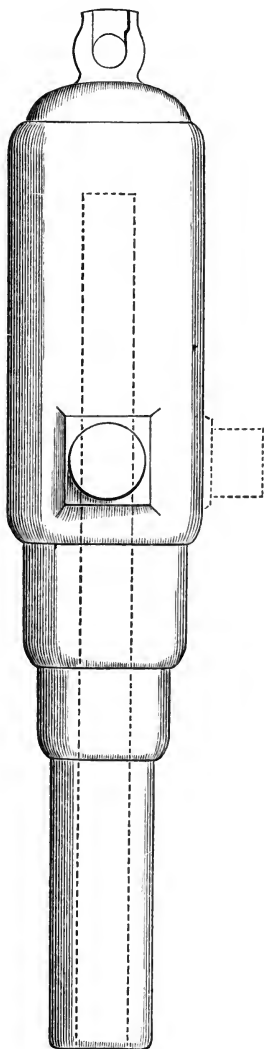
**42. II. The Whitworth Gun.** The inventions of Mr. Joseph Whitworth, the distinguished mechanical engineer, with reference to Artillery, have consisted chiefly in his system of rifling and projectiles, and will be considered under that head. His celebrity is now beginning to extend to the manufacture of guns, especially to the fabrication of built-up steel guns. Although Mr. Whitworth has 7 in. and 9 in. cannon of this kind in hand, his 5½ in. (70-pounder) gun is the largest that has been regularly proved and adopted. Above thirty pieces of this calibre have been fabricated.\*

**43.** The 120-pounder (sometimes called 130-pounder and 150-pounder) gun (Fig. 27), from which Whitworth projectiles were fired through the *Warrior* target, was fabricated at the Royal Gun Factory, Woolwich, on the Armstrong plan, except that the inner tube was a solid wrought-iron forging, bored out. This gun is a muzzle-loader, of 31 in. maximum diameter, and weighs 16660 lbs.

The 120-pounder of Mr. Whitworth's manufacture (Fig. 26) is a much lighter gun, weighing but six tons.

\* Evidence of Mr. Whitworth, Select Committee on Ordnance, 1863.

FIG. 26.



Whitworth 7-in. 120-pdr.

**44. PRINCIPLES.**—Mr. Whitworth's principle of construction, and the features which distinguish it from the similar system of Sir William Armstrong, are thus set forth by Mr. Anderson,\* in his description of the 120-pounder proposed by Mr. Whitworth (Fig. 28), and the 120-pounder referred to above, as actually built at Woolwich (Fig. 27), and rifled on Mr. Whitworth's plan:

“The two guns—viz., that which Mr. Whitworth would have preferred, and that which was constructed in the Royal Gun Factory—differ in the following particulars: *First*, Mr. Whitworth's gun consists of twenty-four distinct parts; the Royal Gun Factory gun, of twelve distinct parts. *Second*, Mr. Whitworth's gun was intended and designed for being put together by hydraulic pressure; the Royal Gun Factory gun was designed for and put together by shrinkage. *Third*, In Mr. Whitworth's gun, the parts that had to be united were connected by screws; in the Royal Gun Factory's, the parts to be joined were united by the process of welding. *Fourth*, In the one gun the inner tube or barrel is open at the breech end and closed by a screw; in the Woolwich gun it is solid and close, and without any joint. *Fifth*, The first gun is without any part tech-

\* Evidence before the Select Committee on Ordnance, 1863. Mr. Whitworth having stated that the *gun* as well as the rifling were essentially his, and the Armstrong party having denied it, a considerable portion of this committee's labors were devoted to ascertaining the facts.



FIG. 27. 7-in. gun as built at Woolwich and rifled for Mr. Whitworth. Scale  $\frac{6}{17}$  in. to 1 ft.

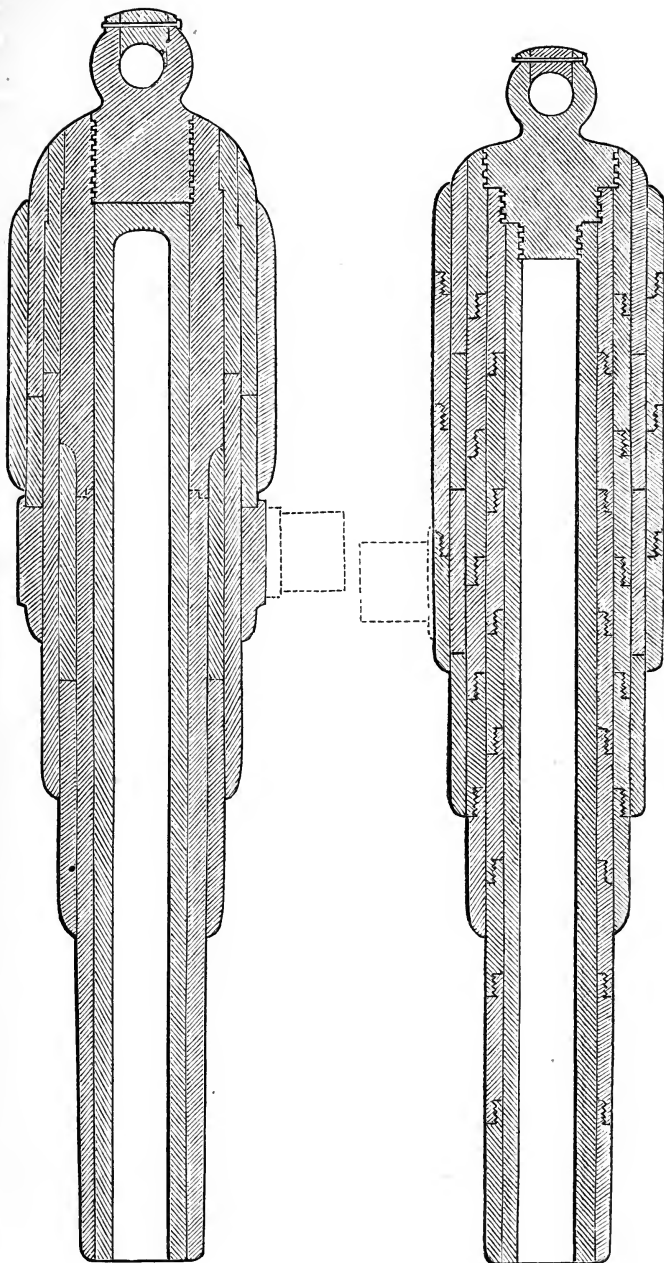


FIG. 28. 7-in. gun as designed by Mr. Whitworth. Scale  $\frac{6}{17}$  in. to 1 ft.

nically termed the breech-piece; in the other gun, the breech-piece is one of the leading characteristics. *Sixth*, The breech-plug of Mr. Whitworth's gun consists of three screws of different diameters, formed on one stem, and made to take hold not only of the inner tube, but also of the second and third layers of tubes; the breech screw of the Royal Gun Factory gun is of one diameter throughout, and is screwed into the breech-piece only, and butting hard against the solid end of the inner barrel. *Seventh*, The second tier of tubes in Mr. Whitworth's gun consists of eight parts, all screwed together into one long tube, which extends from the breech to the muzzle, and is screwed upon the second diameter of screw formed upon the breech-plug; the second tier of the Royal Gun Factory gun consists of one long tube extending from end to end of the gun—that at the breech having the iron of double thickness, with the fibre placed longitudinally, the remainder being of coil of lesser thickness, with the fibre running circumferentially, which is the great leading feature of this gun. *Eighth*, The third tier of Mr. Whitworth's gun consists of six pieces, all screwed together into one piece, and extending to the extremity of the breech, and screwed upon the breech-plug; the third tier of the Royal Gun Factory gun consists of two pieces, and only extends a little beyond the trunnion, the remaining space being made up by the greater thickness of the breech-piece, which is a part of the second tier. *Ninth*, The fourth tier of Mr. Whitworth's gun consists of four pieces not united; the fourth tier of the Royal Gun Factory gun comprises three pieces not united, but with the last breech-hoop made to hook on to the breech-piece, thus giving to the breech-piece increased security. *Tenth*, The fifth tier of Mr. Whitworth's gun consists of three plain pieces and one trunnion piece all screwed together into one long piece; the fifth tier of the Royal Gun Factory gun consists of two plain pieces and the trunnion piece—the last of the plain pieces being hooked on the hoop\* under it, and which again is hooked on the breech-piece, thus tying all three together.

\* The trunnion hoop.

*Eleventh*, There is no sixth tier upon Mr. Whitworth's gun; the sixth tier of the Royal Gun Factory gun consists of one large hoop to strengthen the gun over the powder-chamber. In addition to the above, the two guns differ in the distribution of the material, and also in the disposition of the materials for resisting both lateral and longitudinal strain.\*

**45.** FABRICATION.—The smaller Whitworth guns are forged solid, and the principal piece or barrel for the larger guns is forged from a single ingot of low steel, also called "homogeneous metal," and made by Messrs. Firth, of Sheffield.† This metal is made chiefly from bars of Swedish iron, cut into short lengths, melted in crucibles with a very small addition of carbonaceous material, and cast into round ingots.

**46.** Mr. Whitworth attaches the greatest importance to annealing the steel.‡ After the work is roughly finished, it is annealed from three to four weeks. Mr. Whitworth states§ that he has for some time made musket-barrels so ductile that they bulge instead of cracking when the charge is fired with the bullet half way home, and that now his 7 in. gun barrels are equally good, and will stretch instead of breaking under pressure.

**47.** The breech, in case of the large guns, is hooped with a harder and higher steel than that used for the barrel. The 70-pounder (5½ in.) gun has one hoop; the 120-pounder proposed by Mr. Whitworth was to have four tiers of hoops.

**48.** These hoops are formed by hammering hollow castings of steel over a mandrel, or by rolling them in a machine similar to a tyre rolling machine (69). The short lengths thus produced

\* It was further shown before this committee, that the gun finally made of wrought iron was so strained and indented by the twenty or thirty high charges (25 lbs. to 27 lbs.) it had fired, as to be in a condition to require extensive repairs.

† Homogeneous metal is said to have been made by Mr. David Mushet over fifty years ago.

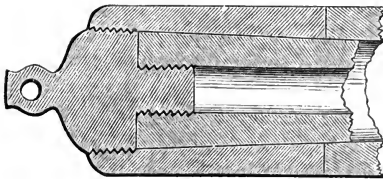
‡ Sir William Armstrong stated before the Select Committee on Ordnance, 1863, that he has no faith in annealing; that it injures the steel. After annealing, the carbon is found, by the microscope, to be deposited between the crystals. (See, also, chapter on Cannon Metals.)

§ Evidence before the Select Committee on Ordnance, 1863.

are screwed together end to end, instead of being welded (or merely stuck, as the case may be) like the Armstrong hoops.

**49.** The principle discussed in a succeeding chapter, of reinforcing a tube with hoops having successively increasing initial tension, so that they will all be equally strained at the instant of explosion, was not fully utilized in Mr. Whitworth's earlier practice. He put on his hoops with as great initial tension as the iron would bear without injury—up to point of permanent set—so that the force of the explosion altered the condition of the gun. The first 80-pounder\* cracked from this cause.† The principle of initial tension is now well carried out.

FIG. 29.



Section of breech of Whitworth muzzle-loader.

(Fig. 28) is undoubtedly superior to any plan except solid forging. The breech-plug is screwed not only into the inner tube, but into the next tube or ring, which cannot be pulled off without being also burst, on account of the taper. Or the breech-plug may screw into the ends of three or four concentric rings.

The breech-loading apparatus (Fig. 30) is not now largely used. It is operated successfully, though not very rapidly, on field-pieces, but was unsuccessful on the larger guns. It consists of a cap screwed on externally. This cap works in a hoop which is hung by a hinge to the side of the breech. The vent is in the centre of the breech-piece.

**51.** Of the 70-pounders (muzzle-loading, Fig. 31), one was recently the subject of experiment at the Washington Navy Yard. Several others, captured from the Confederates, have been in ser-

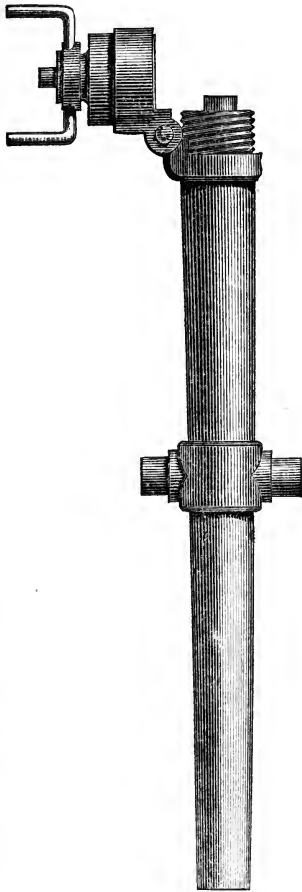
**50.** Instead of shrinking on the hoops, Mr. Whitworth tapers the inner barrel one inch in 100 inches (Fig. 29), and forces them on cold by hydrostatic pressure, with great care and accuracy (295).

The method of closing the breech of the muzzle-loader

\* The breech hoops of this gun were made from Clay's puddled steel.

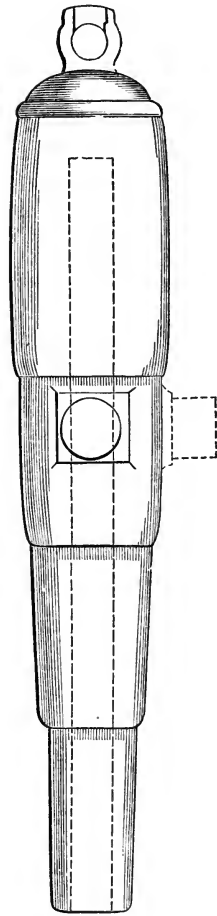
† Mr. Longridge.—*Journal of the R. U. S. Inst.*, March, 1861. See note ‡, page 35.

FIG. 30.



Whitworth breech-loader.

FIG. 31.



Whitworth new 70-pdr.

vice before Charleston and elsewhere, but their adaptation to warfare has not been remarkable. The 70-pounder that pierced the *Warrior* plates at Shoeburyness was fabricated at Woolwich.

The bore of the Whitworth guns is usually hexagonal (Fig. 32); the projectiles are planed by special machine-tools to fit the rifling. The twist is very sharp, in order to give a sustaining rotation to long projectiles. (See Rifling, and note in Appendix.)

The particulars of the standard guns are given in Table VIII.

TABLE VIII.—PARTICULARS AND CHARGES OF WHITWORTH GUNS.

Name of Gun.	Bore.		Length.	Windage on going in, half sides.	Weight.	Twist of Rifling.	Weight of Charge.	Weight of Projectile.	Length of Projectile.	Bursting Charge of Shell.	Price.
	Across Flats.	Across Angles.									
120-pounder*.....	Ins. 6.4	Ins. 7	144	Ins.† .06	Lbs. 16660	1 turn in inches. 1 in 130	Lbs. 27†	Lbs. 151†	Ins. 20.5	Lbs. 5	§ **
70-pounder.....	5	5.5	118	.035	8582	1 in 100	13†	81†	19	3 lbs. 12 oz.	3500
12-pounder.....	2.75	3	104	.02365	1092	1 in 55	1.75	12 lbs. 2½ oz.	7	6 oz.	700

The 80-pounder has 118 in. length, and 5 in. diameter of bore, with 1 turn in 120 in. Charge, 10 lbs.

The 3-pounder has 72 in. length of bore, 1.5 in. bore across the flats, and is rifled with 1 turn in 40 in. Charge, 8 oz.

\* Made at Woolwich, on the Armstrong principle.

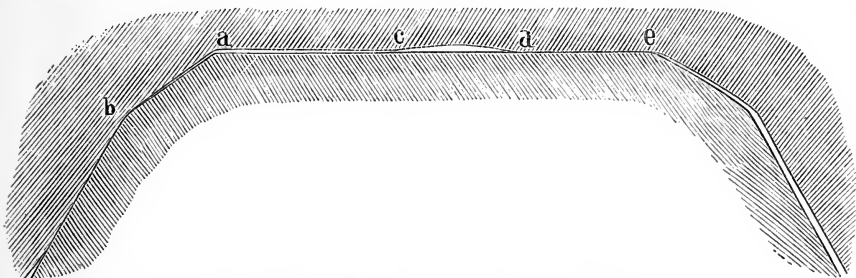
† Iron targets at Shoeburyness. Maximum charge.

‡ See Fig. 32.

\*\* Not determined.

**52.** The proof charge is one-quarter more than the service charge, one round, and then the service charge with a 6-caliber projectile, one round.\*

FIG. 32.



Full-sized section of Whitworth's 70-pounder shot and rifling.

**53.** Mr. Whitworth states\* (May, 1863) that the Whitworth Ordnance Co. have in hand 100 guns of calibres varying from  $1\frac{1}{4}$  to 9 inches. Thirty 70-pounders had been fabricated.

**54.** As to the history of Mr. Whitworth's gun,† it was shown before the Select Committee on Ordnance, 1863, that his experiments with muskets were so satisfactory as to elicit a request from the Government, in 1856, that he would rifle some brass guns on this system. Their trial led to the rifling of several cast-iron guns, which, however, did not show sufficient endurance. Mr. Whitworth then made some steel guns. The smaller calibres were very satisfactory, but the 80-pounder breech-loader cracked.‡

\* Evidence of Mr. Whitworth, Select Committee on Ordnance, 1863.

† The Select Committee on Ordnance (1862) having reported that "the committee possesses an hexagonally bored rifle, dated Enfield, 1843; the more modern and perfect development of the system is known to have originated with the late Mr. Brunel," Mr. Whitworth stated before the Committee of 1863 that he claims polygonal rifling only in connection with spiral segments forming the gun. He also stated that Mr. Westley Richards was requested, in 1852, by Mr. Brunel, to make an octagonally bored rifle with an increasing pitch. This he made in 1854. Mr. Richards showed it to Mr. Whitworth in 1855. It had sharp corners, and had a pitch of 1 in 90 to 1 in 30 or 35. Mr. Whitworth's system, patented in 1854, was pronounced different from this by Mr. Brunel; and Mr. Richards took a license from Mr. Whitworth.

‡ This was attributed by a committee appointed to examine it, to an air space between the shot and the charge.—"Story of the Guns."

As to Mr. Whitworth's early ideas about constructing cannon, his patent of December 1st, 1854, specifies a gun made of segments, held together by hoops, and states that "the danger of a gun bursting from an overcharge of gunpowder will be

Meanwhile, the Armstrong *gun* having been adopted, the Armstrong rifling and projectiles naturally came with it; and while neither the gun nor the rifling of Mr. Whitworth have been as yet adopted by the British Government, his rifling has been experimented with at considerable cost,\* in guns constructed on the Armstrong plan. Mr. Whitworth's late adaptation of low steel to the fabrication of cannon is more likely to become standard than his system of rifling.

**55. III. The Blakely Gun.** Captain T. A. Blakely is recognized in England as one of the first to invent and the very first to demonstrate mathematically and reduce to a working system, the reinforcing of guns with hoops placed under initial tension, so that each hoop compresses what is within it (287). Captain Blakely appears also to have first proposed guns formed of concentric tubes having different degrees of elasticity (320), the inner tube being the most elastic because it has to stretch most. Both these systems, when perfected, bring the entire metal of the gun into equal tension at the instant of firing, and both may be applied, in a certain degree, to the same gun, with advantage. Upon the combined systems, the modern Blakely guns are constructed. The principles involved will be further considered in another chapter.

**56.** Most of the earlier Blakely guns were constructed by Messrs. Fawcett, Preston & Co., of Liverpool. These and other makers in England, and the Blakely Ordnance Co. in London, are now fabricating these guns for State governments in the United States (64), and for the Confederate Government, as well as for Russia and other European Powers. Captain Blakely

obviated, because the strain will be distributed throughout the length of the segments, and by forcing the hoops or bolts to give way, will cause the joints of the segments to open longitudinally, thus acting as safety valves, allowing the gases generated by the explosion to escape through the joints so opened."

\* Mr. Whitworth states that he has received £15885 for "experiments connected with rifle barrels, and £4735 for ordnance supplied" the Government, but that his company have charged him £10482, which the Government has not returned, for experiments of a similar nature.—*Select Committee on Ordnance*, 1863. (For remainder of Note, see Table IX.)



TABLE IX.—Return of all sums paid, or Expenses incurred, on account of Experiments connected with Mr. Whitworth's Proposals, stating for what particular Service each Payment has been made, and distinguishing ORDNANCE from SMALL ARMS. From Report of *Select Committee on Ordnance*, 1862.

ORDNANCE.		SMALL ARMS.	
Nature of Service or Experiment.			
	Cott of experiments up to 31 December, 1859 ( <i>vide</i> House of Commons Sessional Paper, 386, 1860).....	£	s. d.
	1860-1 Paid Mr. Whitworth for 80-pounder breech-loading gun.....	4247	... 11
	“ Paid Mr. Whitworth for 12-pounder breech-loading gun.....	1000	... ...
	“ Paid Mr. Whitworth for 12-pounder breech-loading gun.....	170	... ...
	“ Cott of constructing two 70-pounder muzzle-loading guns, on Mr. Whitworth's plan, in the Royal Gun Factory.....	1732	13 1
	“ Paid Mr. Whitworth for two similar guns, after deducting the value of material of one of them, which burst.....	933	13 7
	“ Cott of coils made in the Royal Gun Factory for ditto.....	274	15 ...
	“ Cott of erecting oak target for experiments at Shoeburyness.....	250	... ...
	“ Cott of telling 80-pounder breech-loading gun.....	19	11 7
	“ Cott of experiments with 70-pounder muzzle-loading gun, authorized, 27 3 6 <sub>2</sub> , till in progress.....	465	19 ...
1862...	Cott of constructing 7-inch muzzle-loading gun, on Mr. Whitworth's plan, in Royal Gun Factory.....	1184	18 9
		£10278	11 11
	Paid to Mr. Whitworth for buildings erected at Manchester.....	1854-5	5707 9 2
	“ Ditto, for experiments, apparatus, and rifles.....	“	1270 18 6
	“ Ditto, for experiments, machines for manufacturing rifle barrels.....	“	871 1 ...
	“ Ditto, for experiments, apparatus, and rifles.....	1855-6	4296 18 3
	“ Ditto, for his expenses between 31 5 56 and 31 12 57.....	1858-9	3054 5 1
	“ Ditto, ditto, 1 1 58 and 31 5 58	“	612 6 6
		£15758	18 6
Expenditure on Ordnance.....		£10278	11 11 = \$51392 97
Ditto Small Arms.....		15758	18 6 = 78794 62
Total.....		£26037	10 5 = \$130187 59

stated before the Ordnance Select Committee, in 1863, that he had made over 400 guns in England for foreign governments; half the number were of steel, and half of cast-iron strengthened with steel.

**57. STRUCTURE.**—No wrought iron is used in the fabrication

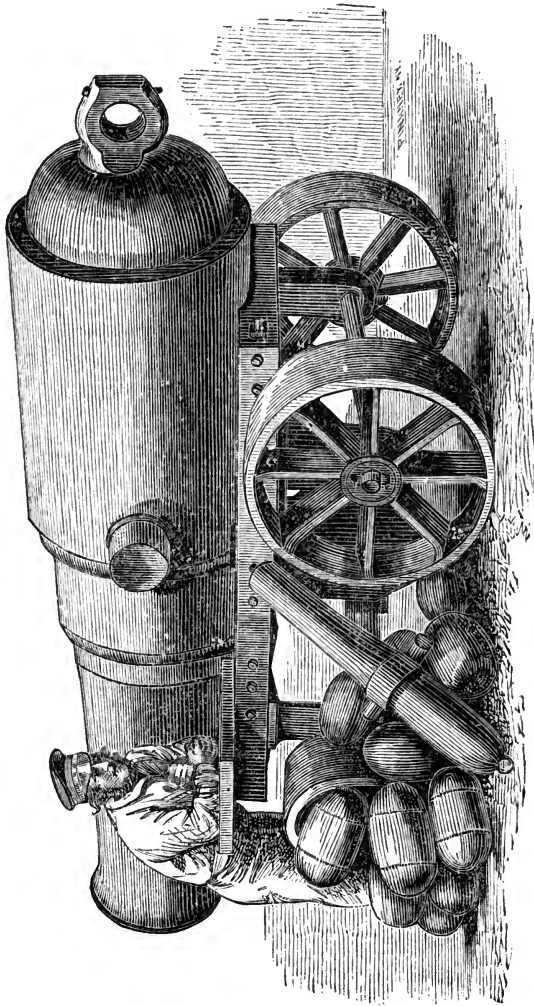
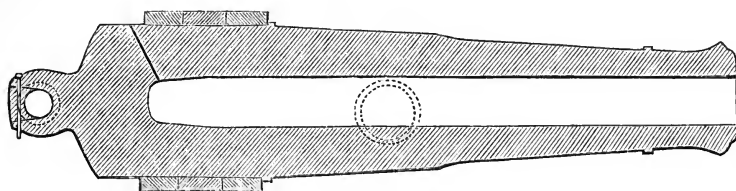


Fig. 32 A. Takely 3 $\frac{2}{3}$  in. gun in the Great Exhibition of 1862.

of these guns,\* on account of its liability to become permanently stretched. The simplest form of hooping is a series of narrow steel rings (Fig. 32 B) shrunk over the chamber of a cast-iron gun.

FIG. 32 B.



Blakely  $7\frac{1}{2}$  in. rifle, captured at Shipping Point, 1862. Scale,  $\frac{7}{16}$  in. to 1 ft.

The engraving shows the  $7\frac{1}{2}$  in. rifle captured at Shipping Point. It has a reinforce  $17\frac{1}{2}$  in. long and  $1\frac{3}{4}$  in. thick, composed of three steel rings; length of bore,  $100\frac{5}{8}$  in.

**58.** A larger use of steel is shown in Fig. 32 C—a low-steel barrel hooped by a tube of higher steel, outside of which is a cast-iron jacket carrying the trunnions. This gun—a 9 in. rifle (the engraving, Fig. 32 C, is made from drawings of Fawcett, Preston & Co.'s Nos. 195 and 196)—has an inner low-steel tube of 15 in. diameter, embraced by a higher steel tube of  $22\frac{3}{4}$  in. diameter, over which there is a cast-iron jacket of 38 in. maximum diameter. Length of gun, 12 ft.; length of bore,  $131\frac{1}{2}$  in.; weight,  $11\frac{3}{4}$  tons.

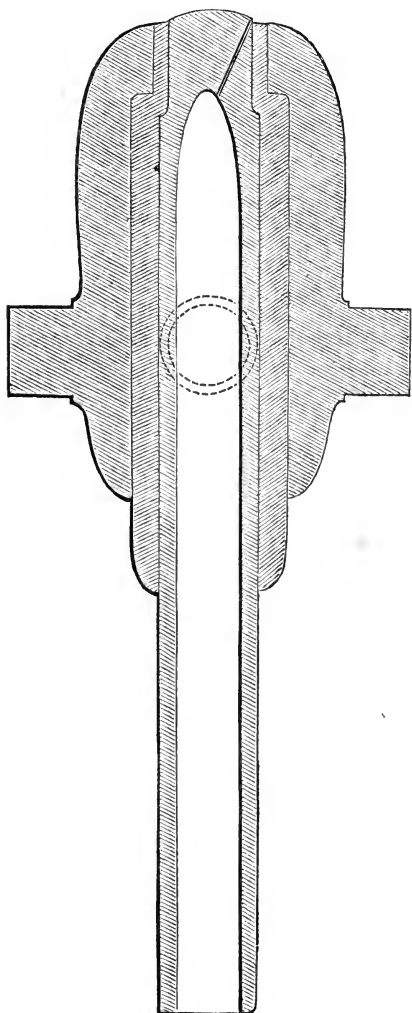
**59.** This gun combines the two principles of initial tension and varying elasticity.† The two inner tubes are stretched unequally by the pressure of the powder. If both tubes are of the same metal, their resistance to the elastic pressure is inversely as the squares of their diameters, so that to do equal work, the outer one must be previously stretched (287). But if the outer tube is of a metal that does as much work in stretching a little as the inner tube does in stretching more—if the capacity of the metal to stretch is proportioned to the amount of elongation which it must

\* The first gun made by Captain Blakely for the Confederates (73) was hooped with wrought iron.

† This method of construction has recently been patented by Captain Blakely in the United States.

actually undergo, no initial tension is required (320). Now, 1st,

FIG. 32 C.



Blakely's 9-inch rifle. Low steel bore, hooped  
by high steel and cast iron.  
Scale,  $\frac{7}{8}$  in. to 1 ft.

it is difficult to give metal hoops the exact tension required, especially by shrinking them, and they are likely to become relaxed under maintained high tension; 2d, the elasticity of metals does not vary exactly as required. But if the layers of a gun are arranged with the best degree of varying elasticity that can be attained, a little initial tension will put the metal into the condition of greatest resistance, and the principal disadvantages of both systems will be avoided.

**60.** The inner tube of the gun (Fig. 32 C) is made of a low steel having considerable, but not quite enough elasticity. The next tube, of a high steel with less elasticity, is shrunk upon the first with just sufficient tension to compensate for the insufficient difference of elasticity between the two tubes. And the outer cast-iron jacket, which is least elastic of all, is put on with only the shrinkage attainable by warming it over a fire. In-

deed, the cast-iron could not be highly heated without permanently stretching and warping.

**61.** The construction of the heavier all-steel guns is illustrated by Fig. 32 D. The hoops and tubes are, if possible, all put together at one heat. The object is to lessen their liability to fracture, by giving them better surface contact. If both the surfaces are hot and soft, they will both yield to each others' irregularities; but a cold mass not only will not yield itself, but chills the surface of the hoop placed over it.

**62.** Besides the guns enumerated in Table X. (of which all except the 12 in. gun have been produced entirely of steel), a number of the following classes of guns have been fabricated: The all-steel 5.8 in. rifle (Fig. 33) has 97 in. length, 82½ in. length of bore, 10.875 in. diameter of inner tube, and 18 in. maximum diameter.

**63.** The following are the particulars of the Blakely 8 $\frac{9}{16}$  in. gun (Fig. 32 A) in the Exhibition of 1862. The barrel of the gun was an Armstrong cast-iron block (91), having a cylindrical breech 50¼ in. long, and of a smaller diameter than the chase. This was hooped by Messrs. Fawcett, Preston & Co., with a steel jacket hooking over the breech end of the cast-

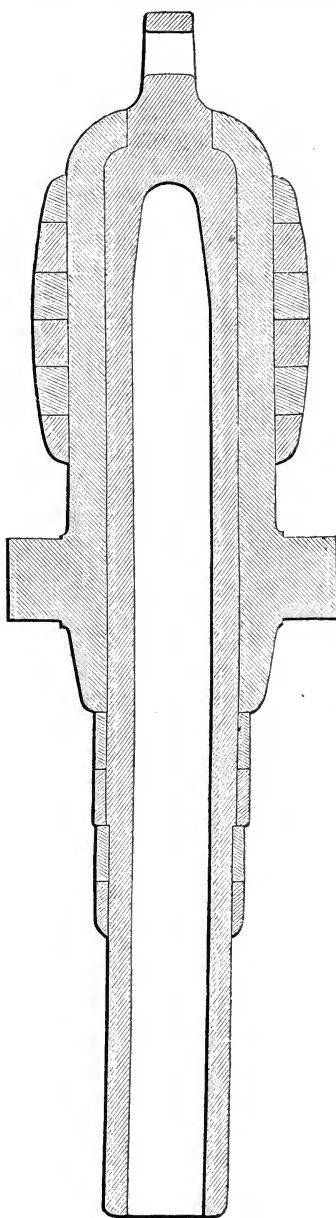
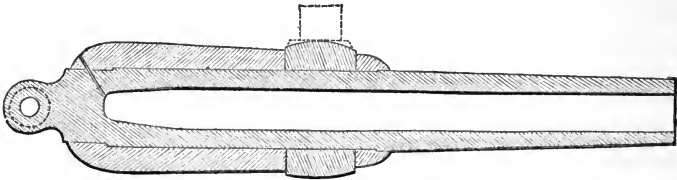


Fig. 32 D. Blakely's steel 8-inch 200-pounder. Scale,  $\frac{1}{16}$  in. to 1 ft.

iron, and extending forward under and beyond the trunnion-ring. Over this steel jacket were seven steel hoops. In front of the trunnion-ring three steel hoops were shrunk over the cast-iron.

Length of cast-iron barrel, without cascabel.....	122 $\frac{3}{8}$ inches.
Diameter do. at the breech.....	16 $\frac{1}{2}$ "
Diameter do. in front of trunnions.....	20 $\frac{1}{8}$ "
Diameter do. at rear of muzzle swell. ....	16 $\frac{3}{4}$ "
Length of steel jacket over the cast-iron.....	50 $\frac{1}{4}$ "
Outer diameter do.....	23 $\frac{3}{8}$ "
Length of 7 hoops behind trunnions (4 $\frac{3}{4}$ inches each).....	33 $\frac{1}{2}$ "
Outer diameter do.....	29 $\frac{3}{8}$ "
Length of 3 hoops in front of trunnions.....	18 "
Thickness do.....	1 $\frac{1}{4}$ "

FIG. 33.

Blakely 5.8 inch steel rifle. Scale,  $\frac{7}{16}$  in. to 1 ft.

**64.** A 9 in. cast-iron gun, hooped with steel rings, is of the following dimensions :

Length of bore.....	11 ft. 3 in.
Length of gun.....	12 " 6 $\frac{1}{2}$ "
Diameter of cylindrical cast-iron part under the rings.....	26 "
Diameter over rings.....	36 "
Diameter in front of trunnion ring.....	27 $\frac{1}{2}$ "
Diameter of muzzle.....	19 "
Weight.....	11 tons.

The rings extend from the trunnion-hoop to the end of the breech, in one tier. The vent enters the chamber from behind the rings.

The Blakely guns made for the State of Massachusetts\* are eight 9 in. guns and four 11 in. guns, constructed of Naylor,

\* A 7 in. gun substantially on this plan has been constructed for the United States Navy Department.

Vickers & Co.'s steel. Of the 9 in. guns, the inner barrel is 18 in. diameter, forged solid. This is reinforced by a jacket forged hollow, of 27 in. diameter, hooking over the barrel at the breech, and extending forward under the trunnion-ring, which is of cast-iron. In front of this jacket there is a course of rolled hoops (68). Behind the trunnion-ring, and over the jacket, are two courses of rolled hoops, breaking joints, and making a total diameter of 38 in. The bore is 11 ft. long; the rifling is that of the 9 in. gun (67). The charge for these guns is 30 lbs. of powder and a 248-lb. bolt. The proof was 45 lbs. of powder and a 375-lb. bolt.

The 11 in. gun has a solid forged steel barrel of 22 in. diameter. This is reinforced by a steel jacket of 33 in. diameter, cast hollow, but not hammered. The other hooping and the rifling are the same as those of the 9 in. gun, the maximum diameter being 48 in. The service charge is  $37\frac{1}{2}$  lbs. of powder and a 375 lb. shot. This gun has fired 525-lb. shots, with  $52\frac{1}{2}$  lbs. of powder, through 45 feet of earth.

**65.** The following are particulars of the 11 in. guns (Fig. 35) furnished by Captain Blakely to the Russian Government. The guns are of cast-iron, hooped with steel, and rifled on the shunt plan with eighteen grooves. The trunnion-rings are of wrought iron.

Total length of gun.....	17 ft. ... in.
Length of cast-iron barrel.....	16 " 1 "
Length of bore.....	15 " ... "
Length of steel hooping.....	6 " 9 "
Maximum diameter of cast-iron barrel.....	33 "
Diameter of hooping, over chamber.....	$47\frac{1}{2}$ "
Diameter of trunnion hoop.....	53 "
Diameter of bore.....	11 "
Diameter of muzzle.....	19 "

**66.** The largest guns at present fabricated under Captain Blakely's specifications are the  $12\frac{3}{4}$  in. rifles, called 900-pounders (Fig. 34), made by Messrs. George Forrester & Co., Vauxhall Foundry, Liverpool, and sent to Charleston. The guns have cast-iron barrels hooped with cast-iron, put on with slight ten-

FIG. 34.

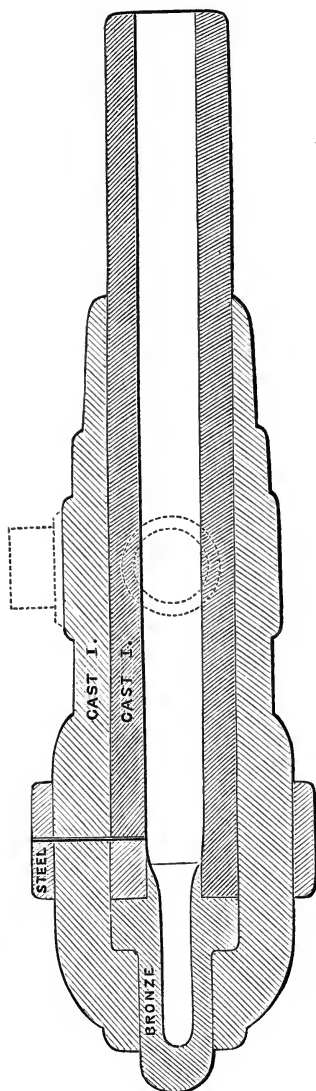


FIG. 35.

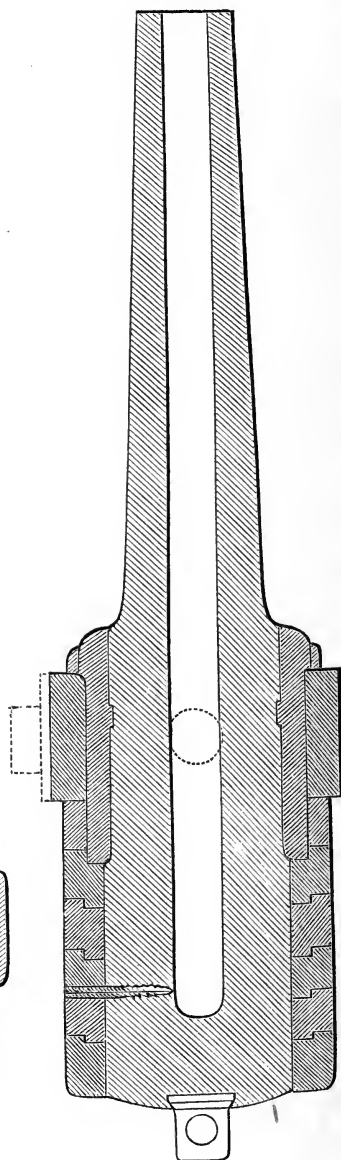


FIG. 34.—Blakely 900-pdr. ( $12\frac{3}{4}$  in.) rifle, sent to Charleston. Scale,  $\frac{7}{16}$  in. to 1 ft.  
 FIG. 35.—Blakely 11-in. rifled gun for Russia,  $\frac{7}{16}$  in. to 1 ft.



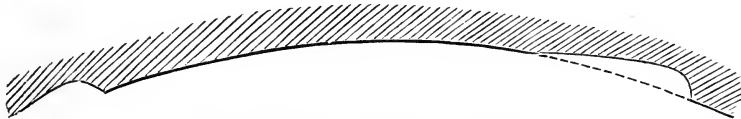
sion. There is an outer steel hoop over the powder-chamber. A bronze air-chamber, of  $6\frac{1}{2}$  in. bore, is placed in the breech, as shown.

Total length of gun.....	16 ft. 2 in.
Total length of bore to bronze chamber.....	12 " $7\frac{1}{2}$ "
Total length of bore to bottom of chamber.....	15 " 4 "
Maximum diameter of cast-iron.....	44 "
Diameter of cast-iron muzzle.....	24 "
Diameter over steel hoop.....	51 "
Diameter of bore.....	$12\frac{3}{4}$ "
Diameter of air chamber.....	$6\frac{1}{2}$ "
Weight.....	27 tons.

The guns were intended for shell firing; the charge is stated to be 50 lbs., with a 700 lbs. shell. The first of these guns burst at Charleston with 40 lbs. of powder and a 700 lbs. shell; but this is attributed by Captain Blakely to filling the air-chamber with powder, thus leaving an air space between the charge and the projectile, instead of behind the charge, as intended.

**67.** The rifling of the 9 in. gun is shown full size by Fig. 36. A copper disc at the rear of the projectile is forced into the

FIG. 36.



Rifling of 9-inch Blakeley gun, full size.

grooves by the explosion of the powder. (See chapter on Rifling and Projectiles.)

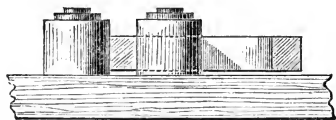
**68. TREATMENT OF THE STEEL.**—The steel employed is usually that of Messrs. Naylor, Vickers & Co., Sheffield. Krupp's, Bessemer's, and Firth's steels are also used. The short rings are rolled without a weld from circular ingots by Messrs. Naylor, Vickers & Co. This is done in a machine similar to the ordinary railway-tire rolling-machine.\* The process is simply illustrated by Fig. 37. A circular ingot is squeezed between a pair of short rolls until its section is reduced, and its diameter increased. The

\* Steel railway-tires are made in the same machine.

metal is also condensed, and an endless grain is developed in the direction of the circumference.

**69.** The steel tubes or jackets are cast hollow, and hammered over steel mandrels, under a steam hammer. During this process

FIG. 37.



Machine for rolling hoops from solid cast-steel rings.

they are elongated 130 per cent. Much difficulty was at first experienced in preventing the sticking of the mandrels, but the manufacture has been so far developed, that the tubes can be drawn and condensed like a solid ingot, with the great advantage over piled or coiled iron, of no weld. The steel jackets sometimes extend over the breech of the inner barrel; the mandrel is withdrawn when the solid end of such a jacket is hammered. In some cases the jackets are not hammered, but are simply annealed, bored, and turned as they come from the mould. Messrs. Naylor, Vickers & Co. are perhaps more skilled than any other steel makers, except the Bochum Company in Prussia, in the art of casting large masses of all shapes, such as tubes, bells, wheels, &c., sound and uniform throughout. It is considered, however, that the increase of strength by hammering will always warrant the expense of the hammering in gun work.

**70.** All the steel parts are annealed. This process makes the crystallization finer, and increases the specific gravity, the result of which is less absolute tenacity, but far greater ductility. (See chapter on Cannon Metals.)

**71.** The results of the Blakely gun are not very generally known, for several reasons. First, the greater part of those in actual use are in the Confederate service, so that detailed facts will only be made public after the war. Second, the Continental governments that have bought these guns, keep their artillery practice very secret. Third, although repeatedly urged, the British Government has made no experiments with the late Blakely ordnance.\* The fact that Sir William Armstrong was

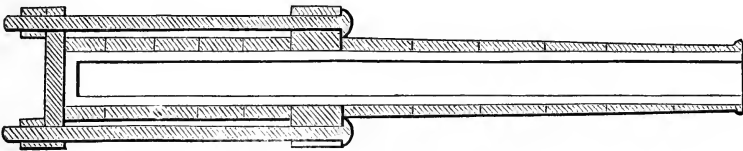
\* A 11 in. Blakely gun has recently been the subject of experiments at Woolwich (at the maker's expense), but the results have not been officially reported.

Engineer for Rifled Ordnance, and that Captain Blakely's patent covered Sir William Armstrong's first gun and circumscribed his manufacture, may have had some influence in this direction.\*

The first gun sent to the Confederates (73) is stated to have fired above 3000 rounds.

**72. CAPTAIN BLAKELY'S EARLY EXPERIMENTS WITH HOOPED GUNS.**—"Captain Blakely's first gun was an 18-pounder (Fig. 38),

FIG. 38.



Blakely experimental 18-pounder.

consisting of one series of wrought-iron rings, shrunk on a cast-iron cylinder,  $5\frac{1}{2}$  in. inside diameter, and  $1\frac{3}{4}$  in. thick. The wrought-iron rings were from 2 in. thick downwards. The total thickness of the breech was  $3\frac{3}{4}$  in., that of the ordinary 18-pounder service gun being  $5\frac{3}{4}$  in. This gun was fired frequently, and stood well. It was then bored out as a 24-pounder, but not being truly bored, the cast-iron was reduced, on one side, to only  $\frac{1}{2}$  in. thick. In this state it sustained, without injury, several hours' firing, with charges varying from one shot and 4 lbs. of powder to one shot, two wads, and 8 lbs. of powder. At the third round, with this latter charge, it burst. This gun had a thickness of only  $2\frac{1}{4}$  in. round the charges, as compared with a service 24-pounder, of 6 in. in thickness."†

\* Captain Blakely stated before the Select Committee on Ordnance (1863) that he had offered to lend the Government, for trial, free of charge, a 12 in. 10-ton gun, to fire 700 lb. shot and 70 lbs. of powder, and a 9 in. gun; but as a condition was that he should submit the plans to a committee embracing Sir William Armstrong, he refused; also, that he offered to lend the Government a 200-pounder (8 in.) that would pierce iron-plated ships, but that they refused to test it.

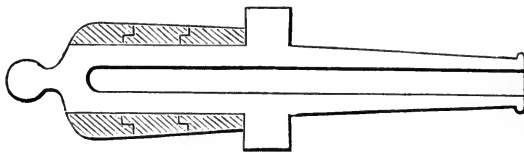
The author saw at Woolwich, in September, 1862, several bursted cast-iron hooped guns, resembling the Armstrong cast-iron gun (91), but distinctly marked "Blakely" with paint. Upon questioning Captain Blakely in the matter, the fact was elicited that the Government never had any of his guns. Captain Blakely now attributes this singular proceeding to a mistake on the part of some under-official.

† "Construction of Artillery."—*Inst. C. E.*, 1860.

TABLE X.—PARTICULARS OF ALL-STEEL BLAKELY ORDNANCE AND AMMUNITION.  
FURNISHED BY THE BLAKELY ORDNANCE COMPANY.

NAME OF GUN.	Weight.	Diameter of bore.	Length of bore.	No. of grooves.	Twist of rifling.	Weight of projectile.		Market price, October, 1868.
	lbs.	in.	in.			lbs.	lbs.	
100-pounder.....	8000	6.4	96	8	48	100	10	\$5000
120-pounder.....	9600	7	100	8	48	120	12	6000
200-pounder.....	17000	8	{ 144 to 156 }	12	48	200	20	10000
250-pounder.....	24000	9	do	12	48	250	25	11250
350-pounder.....	30000	10	do	15	48	350	35	17500
550-pounder.....	35000	11	do	12	36	550	55	27500
700-pounder.....	40000	12	do	12	36	700	70	35000

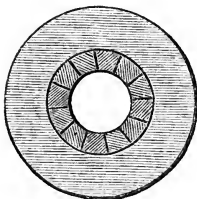
FIG. 39.



Blakely experimental 9-pounder.

Captain Blakely's next gun\* was a 9-pounder (Fig. 39) of 4 in. bore, turned down from the trunnions to the breech to  $10\frac{1}{2}$  in. diameter. This he hooped with a tube of  $\frac{1}{10}$  in. less than  $10\frac{1}{2}$  in. bore, and tapering outside from the breech end. The tube was made of wrought iron, and, for convenience, in three pieces. This gun was fired at Shoeburyness, in 1855-6, round for round with a cast-iron service gun of the same size and weight, and with a gun (Fig. 40) made by Mr. Dundas of wrought-iron staves hooped

FIG. 40.



Mr. Dundas' wrought iron gun.

\* "A cheap and simple method of manufacturing strong cannon." 1858.

together, and with a brass service gun. Table XI.\* gives the result:

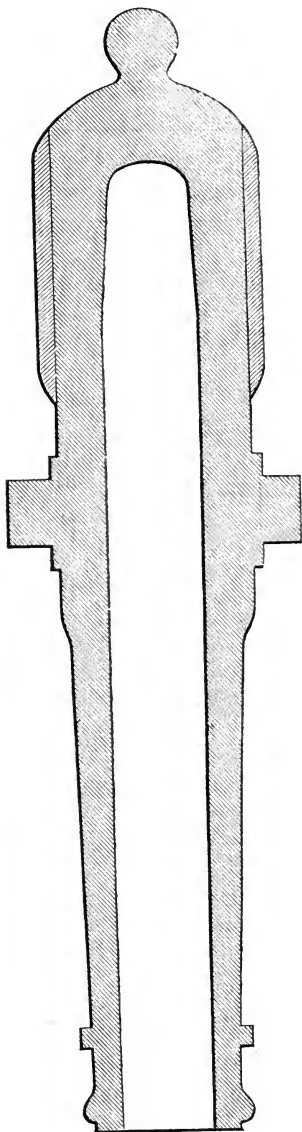
TABLE XI.—TRIAL OF BLAKELY HOOPED 9-POUNDER, WITH SERVICE CAST-IRON AND BRASS 9-POUNDERS.

No. of shot. Blakely.	Charge of powder.	No. of Shot.	No. of rounds fired.		No. of shot fired from Service Gun.
			Blakely's.	Service.	
4	Lbs. 8	2	2	2	4
86	3	1	86	86	86
26	4	1	26	26	26
5	5	1	5	5	5
10	5	2	5	5	10
636	6	2	318	110	Burst 220
3	6	3	1	...	...
4	6	4	1	...	...
5	6	5	1	...	...
6	6	6	1	...	...
7	6	7	1	...	...
8	6	8	1	...	...
9	6	9	1	...	...
1580	6	10	158	...	...
2389			607	234	351

Thus it appears that Captain Blakely's gun stood 607 rounds, and the government service gun only 234 rounds—the number of shot thrown being 2389 and 351 respectively, or nearly as 7 to 1. Mr. Dundas's gun burst at the third round with 6 lbs. of powder and two shot. The brass gun became unserviceable after 174 rounds.

\* "Construction of Artillery."—*Inst. C. E.*, 1860. Also, "Report of Select Committee on Ordnance," 1863.

FIG. 41.



Blakely's 132-pounder of 1857.  
Scale,  $\frac{1}{10}$  in. to 1 ft.

The class of guns fabricated by Captain Blakely after these experiments is illustrated by Fig. 41. (See, also, table X.)

**73.** The following are particulars of the first gun sent by Captain Blakely to the Confederates, obtained from a drawing dated May 15, 1860. The gun, made by Fawcett, Preston & Co., was of cast-iron, reinforced by a solid *wrought-iron* hoop made thin at the edges.

Total length of gun.....	84 in.
Length of bore.....	73.5 "
Diameter of bore.....	3.5 "
Diameter of cast-iron under hoop.....	9.1 "
Maximum diameter of hoop.....	12.1 "
Length of do....	22.2 "
Diameter of muzzle.....	6.0 "

**74. IV. The Parrott Gun.**  
FABRICATION.—This artillery is fabricated exclusively by Captain R. P. Parrott, at the West Point Foundry, Cold Spring, N. Y., a private establishment\* of great celebrity. A

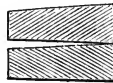
\* Captain Parrott, who had long made cast-iron ordnance for the Government, started the manufacture of rifled guns in 1860. (See table of cost of guns.) The British Government has spent on Ordnance and Plant since 1859 over twelve millions of dollars, and although it has acquired a gun capable of higher charges for a few hundred rounds, and what is more valuable, the experience which will enable it to fabricate the best steel cannon without further risk, it is still without a trustworthy naval gun, or gun of position,

cast-iron gun of the ordinary shape, except a little lighter at the breech, is reinforced over the chamber with a wrought-iron hoop made from a coil substantially like the Armstrong coil in proportion and manufacture.

The 100-pdr. and the 8-in. and 10-in. guns are now cast hollow on Captain Rodman's plan, the advantages of which will be further considered. (373.)

The bar of iron from which the coil is made is rectangular in section when straight, but becomes wedge-shaped (Fig. 42), when bent into a coil, thus leaving a space for cinder to be squeezed out when the coil is upset. This feature is directly contrary to, and an evident improvement upon, the Armstrong plan.

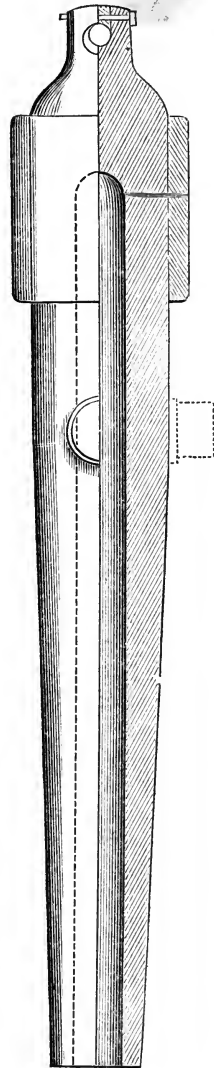
FIG. 42.



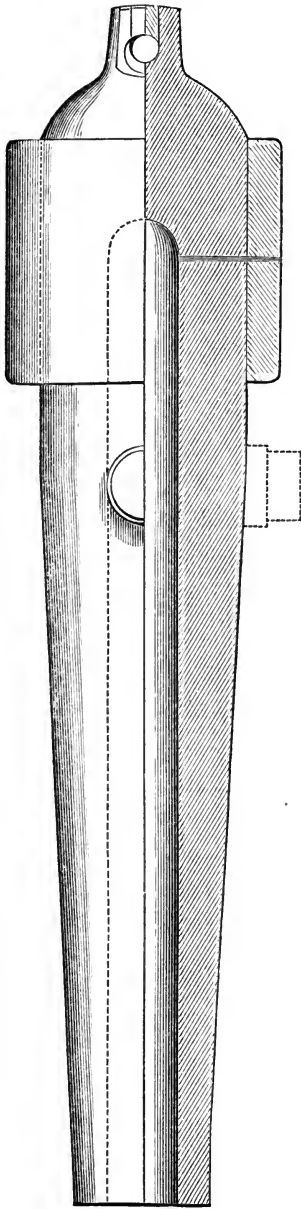
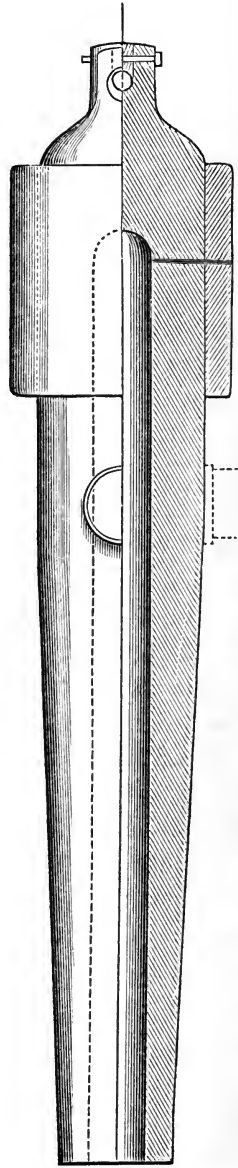
**75.** The hoops are shrunk on without taper, the difference in diameters being  $\frac{1}{16}$  in. in 1 ft. They are fastened to the cast-iron only by the adhesion due to their tension, and have never been loosened during test or in action. When a hoop is to be adjusted, it is heated and slipped over the breech, the gun being slightly depressed. A stream of cold water is then run into the bore, not for the purpose of cooling the hoop from the interior, but to prevent the expansion of the cast-iron.

**76.** The length of the reinforce, which in the 100-pounder is but 27 in., is believed by Captain Parrott to be sufficient to take the first and severest pressure of the powder in starting the projectile. A short reinforce is not loosened, as a long tube would be, by longitudinal shrinking when first put on.

FIG. 43.



Parrott 6.4 inch "100-pounder" rifle,  $\frac{7}{16}$  in. to 1 ft.

FIG. 44. Parrott 10-inch rifle.  $\frac{7}{8}$  in. to 1 ft.FIG. 45. Parrott 8-inch rifle.  $\frac{7}{8}$  in. to 1 ft.



**77.** Great care is taken in the selection of the material. The cast-iron part of a 100-pounder that was fired 1000 consecutive rounds without injury even to the rifle-grooves, was composed of

Greenwood Iron, No. 1 .....	4480 lbs.
Greenwood Iron, No. 2 .....	3360 "
Salisbury Iron .....	2352 "
Scotch Iron .....	336 "
Gun Heads .....	2240 "
	12768 "

#### BAR.

Density .....	7.3750
Tensile strength .....	29897 lbs.

#### HEAD.

Density .....	7.2848
Tensile strength .....	36975 lbs.

The metal was  $2\frac{1}{2}$  hours in fusion. The reinforce was made from a bar 76 ft. long and  $4 \times 4$  in. in section. It measured, finished, 27 in. long and 3.2 in. thick, and weighed 1725 lbs.

**78.** All Parrott guns are rifles.\* The sole object of the reinforce is to enable a cast-iron gun to stand a rifled projectile with the service charge that would be employed for a spherical shot; for instance, to enable a 6.4 in. gun to carry a 100 lb. shot, instead of a 32 lb. shot, with 10 lbs. of powder. The gun is cheap, and has proved very serviceable, although not as formidable as much of the experimental artillery that promises to become standard. It is intended, not to exhaust the capabilities of the system of initial tension,† but to utilize that system as far as possible without greatly increasing the cost of the standard ordnance, and without serious risk of damage by exposure and maltreatment in the hands of green artillerymen.

\* The system of rifling and projectiles is described in the following chapter on that subject.

† In attempting to exhaust the capabilities of that system, Sir William Armstrong and others have carried it so far, that the proper initial tension is soon impaired by the vibration and stretching of the metal (335).

For land service, several sizes of small guns are in extensive use. (See table XII.) The larger guns, suited to naval warfare, are shown by Figs. 43, 44, and 45. The 100-pounder is largely employed in both the Army and the Navy. The 8 in., called a "200-pounder," a gun of more recent date, already used in turrets alongside the 11 in., 13 in., and 15 in. smooth-bores, is a favorite gun in the Navy. Several 10 in. guns, called "300-pounders," are in service. One of them is understood to have done most of the work in breaching Fort Sumter.

Since the commencement of the war, up to April 1st, 1864, about two thousand Parrott guns had been fabricated at this establishment, viz. :

10-pounders .....	336	100-pounders.....	444
20 do. ....	507	200 do. ....	112
30 do. ....	572	300 do. ....	4
60 do. ....	10		

**79.** The 8 in. rifled gun has thrown spherical smooth shell, filled with earth to weigh  $52\frac{1}{2}$  lbs., with papier-maché sabots, at the initial velocity of 1809 feet per second; charge, 16 lbs.—the same charge that fires the 152 lb. elongated shot at 1200 feet. With a charge of 25 lbs., the gun fires a 68 lb. to 70 lb. cast-iron or steel spherical shot at above 1800 feet per second, with about the same strain, and no less safety. This gun may, therefore, be pronounced the most formidable *service* gun extant. Neither the English 68-pounder (8 in.), nor the French Naval gun (6.5 in.), nor the U. S. cast-iron 8 in., 9 in., and 10 in. guns can endure such charges; the Armstrong 110-pounder (7 in.) cannot fire spherical shot, and the U. S. Navy 10 in., and the new English steel-lined 7 in. and 9 in. guns are not yet service guns. Capability of throwing spherical shot is of course chiefly due to the form of rifling, and will be further considered.

**80.** ENDURANCE.—A 100-pounder, before mentioned, and to be further referred to under the head of "Rifling," stood 1000 consecutive rounds, with service charge of 10 lbs. of Dupont's No. 7 grain powder, and projectiles averaging 100 lbs.\* The gun

\* This gun was the 100-pounder exhibited at the New York fair for the Sanitary Commission.

## HOOPED GUNS.

TABLE XII.—PARTICULARS AND AMMUNITION OF THE PARROTT GUNS.

NAME OF GUN.	Length of Bore.	Diameter of Bore.	Diameter over Reinforce.	Weight.	No. of Grooves.	Depth of Grooves.	Twist of Rifling (Increasing.)	Charge.	Weight of Projectile.	Price of Gun in 1868.
10-pounder .....	Ins.	Ins.	Ins.	Lbs.		Ins.	1 turn in ft. at muzzle.	Lbs.	Lbs.	\$
10-pounder .....	70	3*	11.3	890	3	$\frac{1}{10}$	10	1	{ Shot, 10 $\frac{1}{2}$ Shell, 9 $\frac{1}{2}$ }	180
20-pounder .....	79	3.67	14.5	1750	5	$\frac{1}{10}$	10	2	{ Shot, 19 $\frac{1}{2}$ Shell, 18 $\frac{1}{2}$ }	380
30-pounder, Army.....	120	4.20	18.3	4200	7	$\frac{1}{10}$	12	3 $\frac{1}{2}$	25 to 30	520
30-pounder, Navy.....	96.8	4.20	18.3	3550		$\frac{1}{10}$				
60-pounder, Navy .....	105	5.3	21.3	5360	7	$\frac{1}{10}$	15	6	55	800
100-pounder.....	130	6.4	25.9	9700	9	$\frac{1}{10}$	18	10	70 to 100	1200
8-inch .....	136	8	32	16300	11	$\frac{1}{10}$	23	16	132 to 175	1900
10-inch .....	144	10	40	26500	15	$\frac{1}{10}$	30	25	230 to 250	4500

\* Formerly 29.

remained in good condition, the greatest enlargement by the star-gauge being  $\cdot 023$  in., near the seat of the brass ring on the base of the projectile, and opposite the forward end of the reinforce. Another 100-pounder has endured 1400 rounds in action; a 30-pounder has been fired 4606 times with service charges, and at the very high elevation of forty degrees; the second 300-pounder sent to Charleston has fired 600 service rounds. All these guns are still in service, and apparently in perfect condition.

The bursting of a shell within the chase of the first 300-pounder, at the siege of Charleston, broke off the muzzle; but the gun was repaired and in action within forty-eight hours. In fact, the principal source of injury to the Parrott guns has been the premature explosion of loaded shells within the bore, thus blowing off the muzzles, or destroying the cast-iron in some other part forward of the reinforce. Much has recently been done towards remedying this difficulty. Very few of the guns have burst through the reinforce.‡

**81. V. Miscellaneous Hooped Guns.\* Spanish Guns.** Cast-iron guns hooped with steel are extensively fabricated and highly approved by the Spanish Government. Commander Scott says on this subject:† “Spain has also followed the example of France in hooping her heavy ordnance, having previously ascertained that the unhooped cast-iron guns rapidly deteriorated, and ultimately burst at less than 200 rounds, but that the hooped guns, when properly fitted, which was arrived at by careful experiment, always stood more than 1000 successive discharges.”

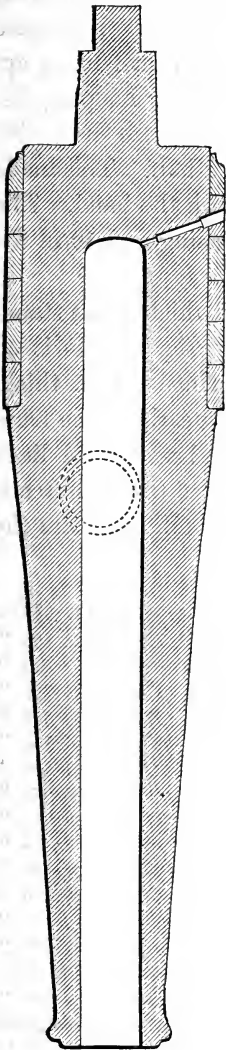
**82.** The following extracts from “a series of reports from Spanish officers to their Minister of War” were read by Captain Blakely before the Select Committee on Ordnance, 1863. On the 2d of January, 1860, they say: “Cast-iron by itself, as is clearly proved to us by the bursting of the guns we fired, is not strong enough to resolve the question of rifled cannon of large calibre, unless the charge of powder be much reduced,

\* See ¶ 127, also Appendix.

† Journal Royal U. Service Inst., April, 1862.

‡ See note in Appendix.

FIG. 46.



Spanish steel hooped gun.  
Scale,  $\frac{1}{10}$  in. to 1 foot.

and even then it must remain subject to the distrust of the gunners; besides the difficulty of obtaining sound large masses of forged iron, that metal has not the necessary hardness for the bore of the gun. The path we must follow, then, is clearly indicated: cast-iron guns hooped, a most simple manufacture, which, once established, only requires great care in bringing the hoops to the exact diameter. The difference between the diameters of the hoops and of the cast-iron part must be determined by calculation aided by experiment."

Another report, signed Gabriel Pellicer, First Commandant and Director, is as follows: "The proof of the rifled cannon of  $6\frac{1}{2}$  in. bore, and weighing 62 cwt.,\* has been continued with a charge of 6 lbs. 9 oz. of powder, a wad, and an elongated projectile. It has now completed 1000 rounds with the same charge. At the 967th round a steel vent-plug was inserted. The state of the gun is perfect, except a few scratches observed in the end of the bore close to the vent, and caused without any doubt by the premature destruction of the vent-plug."

**83.** The Spanish 6.4 in. gun (Fig. 46) is stated by Captain Blakely† to have stood 1366 rounds, with an average charge of 7 lbs. of powder and a 61 lb. projectile, before bursting. The Ordnance Select

\* This gun was cast-iron, hooped with steel.

† Journal of the U. Service Inst., March, 1862.

Committee of Spain say in their report: "Although the 1366 rounds fired with the above charge of powder and an elongated shot of 61 lbs. are sufficient proof of the satisfactory resistance of the gun, the following observations will render still more apparent its excellence, and consequently that of the hooping system. During the first days of proof, 100 rounds were fired with intervals of only from one to one minute and a half. This made the gun so hot that it could not be touched with the hand. The following days 50 rounds were fired in the morning and 50 in the evening, with the same rapidity."

**84. French Guns.** The "Canon de 30," which is the standard French rifled navy gun, is represented by Fig. 47. It is of cast-iron, hooped with seven separate steel rings 4.4 in. thick, forming a reinforce from the rear of the breech nearly to the trunnions. In the later naval guns, the rear of the breech is a little longer than shown in the engraving; the rear of the reinforce is rounded, and the muzzle swell is omitted. The following are the dimensions:\*

Total length of gun.....	(3.25 )	127.985 in.
Length of bore.....	(2.75 )	108.295 "
Length of cascabel.....	(.260 )	10.239 "
Length, rear of cascabel to rear of steel reinforce.....	(.375 )	14.767 "
Length of steel reinforce.....	(.975 )	38.395 "
Length, front of steel reinforce to centre of trunnions.....	(.105 )	4.135 "
Distance of trunnion below axis of bore.....	(.090 )	3.544 "
Distance between rimbasses.....	(.560 )	22.053 "
Length of trunnions.....	(.170 )	6.695 "
Diameter of trunnions.....	(.180 )	7.088 "
Distance of vent (vertical), forward of rear of chamber.....	(.065 )	2.560 "
Diameter of bore.....	(.1647)	6.489 "
Diameter of cast-iron under hoop.....	(.488 )	19.217 "
Diameter of steel reinforce.....	(.6 )	23.628 "
Diameter of cast-iron in front of steel reinforce.....	(.580 )	22.840 "
Diameter of muzzle.....	(.310 )	12.208 "
Weight.....	(3737 k.)	8239 lbs.
Preponderance.....	(230 k.)	506 "

**85.** The rifled siege guns and guns of position are of the same calibre, but are mostly of cast-iron without hoops.

\* Official drawings, dated 1863.

**86.** Many of the rifled navy guns are said to be the old 30-pounders No. 1, weighing about 56 cwt.\*

An efficient breech-loading apparatus has been applied to many of the French guns. It will be described in another chapter.

**87.** The rifling consists of three grooves (Fig. 48) with increasing pitch, commencing at 0 and ending at 1 turn in 30 diameters. The cast-iron conical-headed shot, of two calibers length, weighs about 60 lbs.\* Projectiles of 100 lbs. weight are employed, and flat-headed steel bolts are fired at armor. The projectile has three studs, faced with zinc, by which it centres itself in the grooves of the gun. The results of this method of rotating the shot are very satisfactory, and will be considered in a following chapter.

**88.** The usual charge is stated to be from 7 lbs. to 8 lbs.; but higher charges are known to be used. Captain Blakely states\* that 27 lbs. to 28 lbs. of powder are used in firing 92 lbs. to 100 lbs. shot at armor-plates, and that in the experiments of August 9th, 1861, 99 lbs. steel flat-fronted shot were fired with 27½ lbs. of powder, at 1089 yards range, through a 4½ in. plate with 18 in. wood backing and 1 in. skin.

**89.** Captain Blakely also states that some of these guns have endured 2000 rounds.

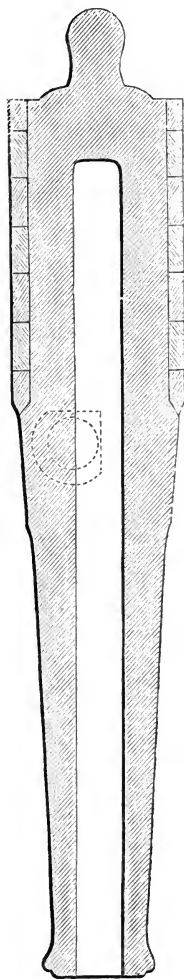
**90.** It will be observed that the gun is not weakened longitudinally by cutting away the cast-iron under the hoops, as in the British guns (Table XIII.) The use of steel hoops instead of iron, and the very careful adjustment of the hoops, must account for the very satisfactory strength and endurance of these guns.†

\* Evidence before the *Select Committee on Ordnance*, 1862.

† The French guns of large calibre are 10-inch bronze smooth-bores, but their charges are small.

The question is naturally asked—Why is France content with a 6·5 inch naval gun, whatever its endurance? The probable reason is, that the Emperor, being unable to produce suitable steel in France, will not import it, knowing that England would then adopt steel, and, by developing her own manufactures, place the production of an indefinitely large steel armament under her own control. So long as England has nothing better than wrought-iron coils and complex breech-loading, France feels safe with a gun that is simple, cheap, and trustworthy—if it is small—

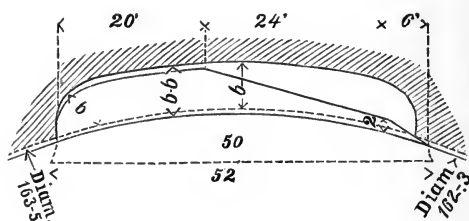
FIG. 47



French hooped 6.5 in.  
100-pounder. (Ca-  
non de 30)

**91.\* Armstrong Hooped Cast-Iron Naval Gun.** Several 68-pounder blocks, shaped at the breech as shown by Fig. 49, were hooped on a plan proposed by Sir William Armstrong. The hoops were shrunk on without reference to their tension, and the thickness of the cast-iron under them was suddenly reduced by five inches. The result of their test is detailed in Table XIII., and was so unsatisfactory that the plan was abandoned. Captain Blakely said before the Select Committee on Ordnance, in 1863, that the French had made a long series of similar experiments, which had similarly failed.

FIG. 48.



Rifle groove and stud of Canon de 30. Full size.

**92.** Another plan of hooping tried at Woolwich (Fig. 50) is mentioned in Table XIII. The ring, of wrought-iron, was so thin and ductile, that in one instance the cast-iron burst without fracturing it.

The Ordnance Select Committee, in the report on the competitive trials of rifled guns in 1861, say, with reference to these English

until some better system is developed at some one else's expense, or until France can produce steel. It is understood that great efforts are making to this end.

Since the above note was written, England has begun to adopt steel and muzzle-loading, and France has begun to order 300-prs. from England.

\* For recent orders to hoop old guns in the U. S., see Appendix.





68-pounder, smooth-bored gun, with internal tube of wrought iron.....	6.5	101 0 0	6 Nov., 1860	16	68	1010 101010101010	1	....	71ft
Smooth-bore block, cast specially for hooping, strengthened with envelope of gun metal, on a plan proposed by Capt. Coffin, R. N.....	6.5	120 3 0	20 Nov., 1860	16	35	1010 2	....	....	22d
Another similar gun.....	6.5	120 3 0	28 Dec., 1860	16	35	1010 10 1	....	....	31ft
70-pounder cylinder, strengthened by Capt. Blakely, and rifled to fire Mr. Buhjey Britten's projectiles.....	6.5	78 2 14	24 Mar., 1862	{ 7.5 90	{ 90	1010* 10 4	....	....	†
32-pounder block, strengthened by Capt. Blakely, and rifled to fire Mr. B. Britten's projectiles.....	6.5	68 1 18	16 July, 1862	{ 8.0 67½	{ 67½	50	....	....	†
32-pounder block, proved in a smooth bore, 18-pounder calibre, and afterwards turned, slightly tapering from trunnions to breech, and hooped on a plan proposed by Col. St. George, C. B., and then bored up to a 32-pounder calibre.....	6.5	68 1 18	16 July, 1862	{ 5.0 48	{ 48	1010‡ 101010101010	3	....	†
Another similar gun.....	6.5	68 1 18	16 July, 1862	{ 8.0 67½	{ 67½	50	....	....	†
32-pounder smooth-bored gun, strengthened with wrought-iron jacket and hoops by Mr. Lancaster.....	6.375	60 0 2	1 Nov., 1860	10	32	1010 1010101010	7	....	67th
Smooth-bore block (70-pounder), cast specially for hooping, strengthened with wrought-iron hoops by Mr. Lancaster.....	6.375	60 0 0	8 Dec., 1860	10	32	1010 101010 9	....	....	59th
32-pounder smooth bore, with internal lining of wrought iron.....	5.26	62 0 0	13 Aug., 1862	10	32	1010 101010101010	4	....	**

\* In this experiment the cylinders were increased by the weight of half a shot only, every ten rounds, instead of by the weight of one shot, as in other cases.

† 50th, with 8 lbs. charge and shot—67½ lbs.

‡ Burst at 84th.

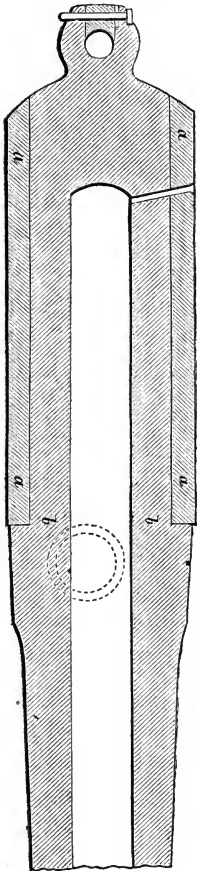
§ Cylinders increased by half-shots.

¶ 50th, with 8 lbs. charge and shot—67½ lbs.

\*\* Burst at 188d.

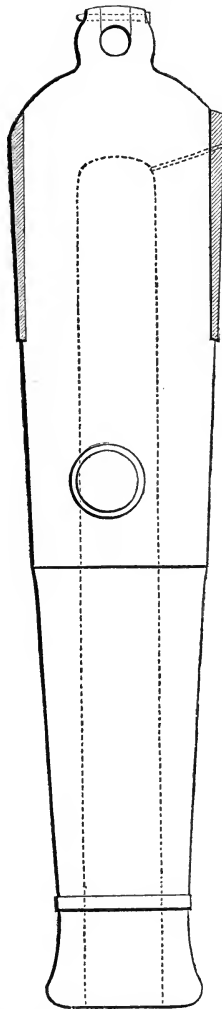
\*\* At the 74th round, inner tube moved forward, cutting off vent and stopping firing; lining cracked, and deep flaws and fissures in bore.

FIG. 49.



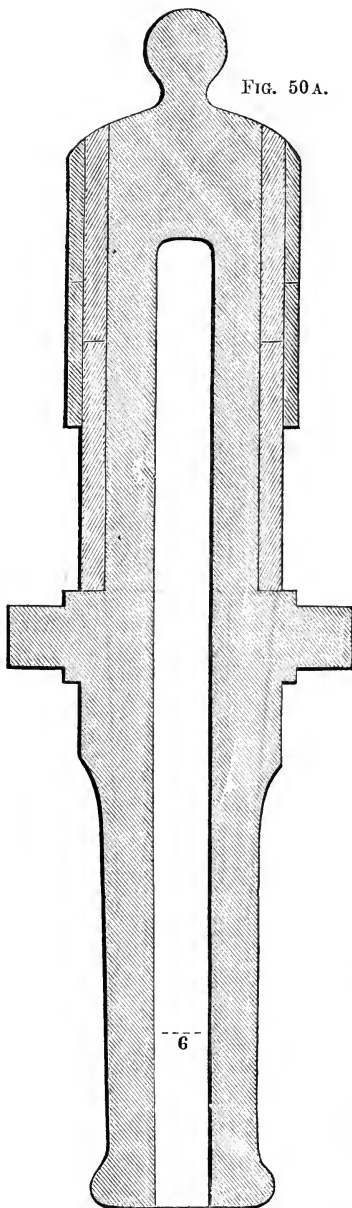
Armstrong hooped cast-iron naval gun. Scale,  $\frac{6}{10}$  in. to 1 ft.

FIG. 50.



68-pounder, hooped at Woolwich. Scale,  $\frac{6}{10}$  in. to 1 ft.

experiments on hooping cast iron, as follows: They “have very little confidence in proposals to strengthen cast iron by external envelopes of steel or wrought iron. The process of gradual destruction commences with small fissures around the vent; and when these have proceeded to a certain extent, the



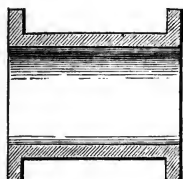
Armstrong cast-iron 70-pounder of 1860.  
Scale  $\frac{1}{16}$  in. to 1 ft.

entry of gas at an enormous pressure tends to rend the metal as if by a wedge. No external envelope will prevent the action. Its only advantage here seems to be to make its effect less destructive. The external envelope adds to the strength of a cast-iron gun when there are no fissures and no rending action; but this is not the ordinary cause of guns bursting. Guns condemned as unserviceable are almost invariably condemned for the state of the metal around the vent, and explosions must be generally attributed to that cause."

**93. Mr. Longridge's Experiments with Wire-wound Guns and Cylinders.** Mr. Longridge, whose deductions on the subject of hooped guns will be further referred to (286 & 292), gave the following description of his experiments, in a paper on the "Construction of Artillery," before the Institution of Civil Engineers, in 1860. The cylinders used were prepared according to the formula  $t = T \frac{\psi^2 - r^2}{\psi^2}$ , based upon Mr. Barlow's investigation. The method of conducting the experiments was as follows: "A number of brass cylinders (Fig. 51) were prepared exactly of the same dimensions, viz., internal diameter, 1 in.; external diameter,  $1\frac{3}{16}$  in.; thickness of brass,  $\frac{3}{32}$  in.

“These cylinders were accurately turned and bored, and had a flange  $\frac{1}{4}$  in. in depth and  $\frac{1}{8}$  in. in thickness at each end. Each end was widened out, so as to afford seating to two gun-metal balls, which were accurately ground to fit them.

FIG. 51.



The total content of each cylinder, with the balls in their places, was 300 grains of best sporting powder, which was alone used in this series of experiments. When the powder was put into the cylinder, and the balls were placed at each end, the whole was bound together by a very strong wrought-iron strap, similar to the strap

of a connecting rod, with a jib and cotter. The cotter was driven tightly home, and the powder was then fired through a small touch-hole, left in the side of the seating. The first experiments were to ascertain the effect of the powder on the cylinders, without any wire. They were commenced with charges of powder, beginning at 50 grains, and increasing till the cylinder burst. After this, cylinders with different thicknesses of iron wire were tried in a similar manner. The results are given in Table XIV.:

**94.** “The strength of the wire used in these experiments was ascertained, by trial, to be as resisting a dead tension—

$\frac{1}{8}$ wire	. .	23 lbs. = 120000 lbs. per square inch.		
$\frac{1}{32}$ wire	. .	70 lbs. = 92000 lbs.	“	“

**95.** “If now the expansive force of powder be taken to be inversely as the volume, its ultimate strength may be approximately arrived at from the last experiment. The powder then could not burst the cylinder. Now the strength of the cylinder, supposing all the material to be equally strained, could not exceed the following per lineal inch of cylinder—

Wire	. . . . .	17920 lbs.
Brass	. . . . .	3136 lbs.
		<u>21056 lbs., or 9.4 tons.</u>

And as the internal diameter was exactly 1 in., it shows that the ultimate force of the material in Experiment 23, did not exceed

TABLE XIV.—EXPERIMENTS ON LONGRIDGE'S BRASS CYLINDERS.

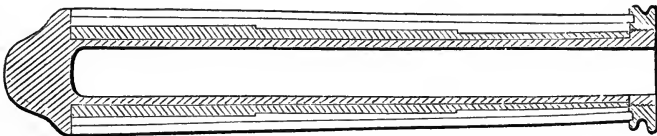
No. of Experiment.	No. of Cylinder.	Condition.	Charge of Powder.	Effect.
			Grains.	
1	1	Without wire.....	50	Slightly bulged.
2	do.	Ditto.....	60	Bulged a little more.
3	do.	Ditto.....	70	Ditto external diameter $1\frac{6}{16}$ .
4	do.	Ditto.....	80	Ditto ditto $1\frac{7}{16}$ .
5	do.	Ditto.....	90	Burst.
6	2	2 coils of wire $\frac{1}{64}$ inch.....	90	No effect.
7	do.	Ditto, one end loose.....	100	Bulged at loose end.
8	3	Without wire.....	70	Bulged to $1\frac{1}{2}$ .
9	4	Six coils $\frac{1}{64}$ wire.....	100	No effect.
10	do.	Ditto.....	110	Ditto.
11	do.	Ditto.....	120	Ditto. One end of wire came loose.
12	do.	Same cylinder, with one } coil of $\frac{1}{32}$ wire..... }	100	{ Burst, the end of the wire being badly fastened. Wire not injured.
13	5	2 coils of $\frac{1}{32}$ wire.....	100	No effect.
14	do.	Ditto.....	120	Ditto.
15	do.	Ditto.....	130	Ditto.
16	6	4 coils $\frac{1}{32}$ wire.....	120	Ditto.
17	do.	Ditto.....	130	Ditto.
18	do.	Ditto.....	140	Ditto.
19	do.	Ditto.....	150	Ditto.
20	do.	Ditto.....	160	Ditto.
21	do.	Ditto.....	170	Ditto.
22	do.	Ditto.....	180	Ditto.
23	do.	Ditto.....	200	Ditto.

9·4 tons per square inch. Assuming the law, as above, the ultimate pressure, supposing the cylinder to have been full, could not exceed  $9·4 \times \frac{3000}{100}$  or 13 tons per square inch.

“The enormous strain to which these cylinders were subjected is evidenced by the effects upon the gun-metal balls, which were more or less cut away by the gases, where they touched the cylinders.

**96.** “These experiments, made on the 17th May, 1855, were so satisfactory, that the author proceeded to one on a larger scale. This consisted of a brass cylinder, of nearly the same internal dimensions as a 3 lb. mountain gun, say 3 inches diameter and about 36 inches long. The drawing of this cylinder has unfortunately been lost, but it is approximately represented in Fig. 52,

FIG. 52.



Mr. Longridge's experimental wire-wound 3-pounder.

from which it will be seen that the thickness of the brass was  $\frac{1}{4}$  inch. At the breech end it was covered with six coils of steel wire, square in section, and of No. 16 wire gauge, or  $\frac{1}{16}$ th of an inch. These coils extended about 15 inches along the cylinder, and were gradually reduced to two coils only, towards the muzzle. Consequently the thickness of the cylinder was as follows :

At the breech,  $\frac{1}{4}$  in. brass +  $\frac{3}{8}$  in. iron =  $\frac{5}{8}$  in.  
 At the muzzle,  $\frac{1}{4}$  in. “ +  $\frac{1}{8}$  in. “ =  $\frac{3}{8}$  in.

“The thickness of the 3-pounder gun, with which it may be compared, being—

At the breech, . . . . . 2·37 in.  
 At the muzzle, . . . . . 0·75 in.

“It will be seen that this cylinder was not mounted as a gun. It had no trunnions. It was cleaded with wood ; and the object

of the deep steel ring, which was screwed on the muzzle, was simply to cover the ends of the cleading. The cleading had nothing to do with the principle involved, and was only used to screen the construction from general observation.

“This cylinder was proved with repeated charges, varying from  $\frac{1}{2}$  lb. of powder and one round shot to  $1\frac{1}{2}$  lb. of powder and two shots. The cylinder was simply laid on the ground with a slight elevation, its breech abutting against a massive stone wall, so as to prevent recoil. It stood the proof without injury, and the author, on the 19th June, 1855, addressed a letter to Lord Panmure, then Secretary of War, describing the experiments and the results, and offering the invention to the country.”

Mr. Longridge then describes its journey through the circumlocution office. It was finally tested in the absence of Mr. Longridge, and the following is the report of the Ordnance Select Committee:

**97.** “The gun was clamped on a block of oak with iron clamps, and allowed to recoil on a wooden platform. Two rounds were fired, the first with a charge of 1 lb. powder, 1 shot (fixed to wood bottom), and one wad over the shot: the recoil was 7 feet; the gun was found to have slightly shifted its position on the block; a trifling expansion of the wire had also taken place at the breech.

“At the second round the gun was fired with 2 lbs. of powder, 1 shot, and 1 wad, and burst: the separation took place about two inches in front of the base ring; the breech was completely separated from the rest of the gun, and was blown 90 yards directly to the rear. The wire was unravelled to the length of three or four feet; the brass cylinder burst in a peculiar manner, turning its ends upwards and outwards. It also opened slightly at the centre of the gun; but the wire did not give way at that point.

“The ordinary proof charge for a gun of this diameter would be  $1\frac{1}{4}$  lb., 1 shot, and 1 wad.

“In order to try more particularly the effect of the wire in giving strength to the cylinder, this gun was, after bursting, sawn



in two at the centre, and one end of each portion was plugged with a brass plug, which was secured in its place by iron bands and several coils of wire: these guns were then secured to slides of wood as in the former instance; they were placed opposite the proof butt, and that made from the breech end was loaded with  $\frac{1}{2}$  lb. powder and shot. It burst, the breech being blown out and the wire uncoiling to a considerable extent.

“The muzzle portion was then loaded with a similar charge; it did not burst, but was much shaken by the discharge, and portions of the iron bands gave way. It was then loaded with a charge of 1 lb. of powder and 1 shot, which on discharge burst in two places, the breech being completely separated from the gun, and the slide on which it had been fired was rent into several pieces.”

Upon examination of the method of mounting the cylinder, Mr. Longridge found that the recoil was resisted by the ring around the muzzle; in other words, that the gun was hung up by the muzzle-ring, and that the cylinder had not *burst* at all, but was torn asunder endwise by the recoil. The second “burstings” were merely the blowing out of the plugs.

**98.** This was enough for the Department, however, and Mr. Longridge, after repeated endeavors, could get no further trials. He then obtained possession of the fragments of his cylinder, and made the following experiments upon them. “A piece of the cylinder, about two feet long, was stripped of the wire, with the exception of two coils. It was then a brass tube 2 ft. long and  $\frac{1}{4}$  in. thick, with two coils of square steel wire, each  $\frac{1}{16}$  in. thick, making together  $\frac{1}{4}$  inch of brass, and  $\frac{1}{8}$  inch of wire.

“In the middle of this he put  $1\frac{1}{2}$  lb. of Government cannon powder, and the ends were filled up with close-fitting wood plugs, fixed tightly with iron wedges. A trench 3 feet deep was then dug in stiff clay, and the cylinder was laid at the bottom. At each end a railway sleeper was driven firmly into the clay, and the trench was then filled in with clay, well pounded with a heavy beater. The powder was then fired by means of a patent fuze. The wood plugs and sleepers were thrown out with great

violence, and a large mass of clay at each end was blown out; but the cylinder was uninjured. Determined, if possible, to burst it, the author next put in two pounds of powder, filled up the ends with close-fitting iron plugs, and bound the whole together with an iron strap of a sectional area of 5 square inches. The powder was then fired, and the iron strap was torn asunder, but the cylinder was uninjured, except at the ends, where, from the wire being imperfectly fastened, it uncoiled, and the cylinder was torn open. If the tensile force of the iron strap be taken at 18 tons per square inch, the force of the powder must have been above 13 tons per square inch, and yet this was resisted by  $\frac{1}{4}$  inch of brass and  $\frac{1}{8}$  inch of steel wire. The diametral strain must have been 39 tons, and taking the brass at 10 tons per square inch, it leaves 34 tons for the steel wire, which, divided over the two sides, or  $\frac{1}{4}$  inch, would give, for the ultimate resisting strength of the wire so employed, not less than 136 tons per square inch of section. This wire, it should be observed, was of the finest quality."

Mr. Longridge then describes his second series of experiments made in March, 1856. Two sets of cylinders were prepared, for the following reasons; 1st:

**99.** "Many of those to whom he had described the experiments above recorded, whilst admitting the great increase of strength obtained, were yet of opinion that it would be only practicable to apply the wire, in combination with a metal of a soft, yielding nature, such as yellow brass, or pure copper. It was maintained, that it would be impossible to use the wire in combination with cast-iron, owing to the assumed brittleness of that material, and it was objected that the soft brass, or copper, would soon be worn out by the action of the shot, and the guns be rendered useless."

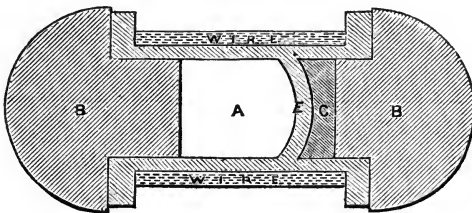
His views were different: "He looked on the inner shell simply as a means of confining the gases, and of transmitting the internal pressure to the wire; and knowing that cast iron would resist a crushing force of 40 tons, he was not afraid of subjecting it to a strain in a normal direction, which, at the outside, could not ex-

ceed the strength of powder, or 17 tons per square inch. But he was quite aware that no reasoning would suffice. Therefore, in his second series of experiments, he resolved to use cast iron alone, in its hardest form,—as produced in a thin casting.”

**100.** “As it might be desirable, for practical reasons, to separate the gun itself from the mass of material intended to absorb the recoil, Mr. Longridge wished to ascertain how far it was practicable to transmit the force through a thin breech or diaphragm of a hard brittle substance, like cast iron, to a soft yielding material, like lead, and through it to the absorbing mass behind the breech. He did not expect to diminish the amount of recoil materially, but to avoid those vibrations, which are so destructive between two hard metals in contact, and which always shake loose any system of bolting, or riveting, however perfect originally.”

“The first set of cylinders was intended to try the possibility of transmitting pressure, as just stated, through a thin diaphragm. The cylinders were of the dimensions shown in Fig. 53, in which

FIG. 53.



A is the powder-chamber; B B, cast-iron plugs which were bound together by a heavy strap and key; and C, the space filled up with a soft material, between the bottom of the powder-chamber and the plug B. The object was to ascertain whether the diaphragm at E would be shattered by the force of the explosion. Six cylinders were thus prepared, and loaded, and fired, with charges varying from 50 to 250 grains of Government cannon powder, the total contents of the cylinders being 310 grains. Table 15 gives the results.

TABLE XV.—RESULTS OF EXPERIMENTS WITH WIRE-WOUND CYLINDERS.

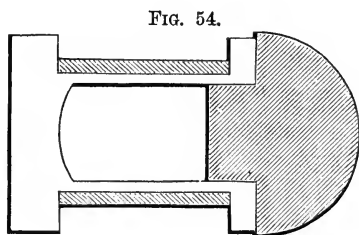
Cylinder.	Wire.	Charge.	Results.	Material behind the diaphragm.
No. 0.	2 coils.	Grains. 50	No effect.....	Lead.
		50	Ditto.....	Ditto.
		100	Ditto.....	Ditto.
		120	Ditto.....	Ditto.
		150	Burft.....	Ditto.
“ 1.	4 coils.	150	No effect.....	Ditto.
		180	Top flange burft.....	Ditto.
“ 3.	6 coils.	180	No effect.....	Ditto.
		200	Ditto.....	Ditto.
		220	Ditto.....	Ditto.
		240	Flange burft... ..	Ditto.
“ 6.	8 coils.	240	Ditto.....	Ditto.
“ 8.	8 coils.	200	No effect.....	Gutta-percha.
		220	Burft.....	Gutta-percha, softened by heat.
“ 9.	10 coils.	240	No effect.....	Lead.
		250	Flange burft.....	

“Iron wire, No. 21 wire gauge, or  $\frac{1}{8}$  inch diameter, was used. Its breaking strain was 60 lbs. In no case was the bottom of the cylinder injured, except in the second experiment with cylinder No. 8, when the gutta-percha was softened by the heat of the first explosion.”

The lead transmitted the force perfectly in every case; showing conclusively that there is no practical difficulty in transmitting the force through even so thin a diaphragm as  $\frac{1}{8}$  of an inch, even when of so brittle a material as cast iron. After these ex-

periments, Mr. Longridge states that he “needed no others to satisfy himself of the suitability of even very hard cast iron to transmit the force of gunpowder to wire, or any other absorbing material.” As, however, other cylinders had been prepared, he proceeded to try their strength.

**101.** These cylinders are shown in Fig. 54. “They each contained 305 grains, when full to the plug. The plugs were made to fit accurately, and the powder was fired through a small vent, or touch-hole, not larger than a small pin. The results are given in Table 16.



“In these experiments iron wire, No. 21 wire gauge, or  $\frac{1}{8}$  inch diameter, was used. Its breaking strain was 60 lbs., consequently the actual strength of the material in the cylinder per lineal inch was :

No.	o.	Cast iron	$0.10 \times 2 \times$ tons =	1.76 tons.		1.76 tons.
				Nil.		
“	2.	{ Cast iron	as above	1.76 “	}	7.76 “
		{ Wire	$4 \times 28 \times 2 \times \frac{6.0}{2 \frac{1}{4}}$	6.00 “	}	
“	7.	{ Cast iron		1.76 “	}	13.76 “
		{ Wire	$8 \times 28 \times 2 \times \frac{6.0}{2 \frac{1}{4}}$	12.00 “	}	
“	5.	Same as No. 7				13.76 “
“	4.	Same as No. 2.				7.76 “
“	10.	{ Cast iron		1.76 “	}	16.76 “
		{ Wire	$10 \times 28 \times 2 \times \frac{6.0}{2 \frac{1}{4}}$	15.00 “	}	

“The enormous force of the expansive gases, in these experiments, was shown by their action on the plugs, which, although accurately fitted and of hard iron, were chiselled and grooved out in an extraordinary manner, as may be seen in one specimen exhibited. The vents, too, were rapidly enlarged.”

**102.** The results, as regards strength, were so conclusive, that Mr. Longridge proceeded to construct a small gun (Fig. 55). This gun was 2.96 inches bore and 36 inches long in the clear; it had on it twelve coils of No. 16 W. G. iron wire, at the breech, decreas-

TABLE XVI.—RESULTS OF EXPERIMENTS WITH WIRE-WOUND CYLINDERS.

No. of Cylinder.	Wire.	Charge.	Results.	Remarks.
No. 0.	None.	40	No effect.	
	Ditto.	50	Ditto.	
	Ditto.	60	Ditto.	
	Ditto.	70	Ditto.	
	Ditto.	80	Burft.	
" 2.	4 coils.	130	No effect.	
	Ditto.	150	Flange burft.	
" 7.	8 coils.	200	No effect.	A wrought-iron flange, $\frac{1}{4}$ in., contracted on flange.
	Ditto.	220	Ditto.	
	Ditto.	240	Ditto.	
	Ditto.	250	Ditto.	
	Ditto.	260	Ditto.	
	Ditto.	270	Ditto.	
	Ditto.	280	Ditto.	
	Ditto.	290	Ditto.	Hoop on flange shifted
" 5.	8 coils.	200	No effect.	
	Ditto.	220	Ditto.	
	Ditto.	230	Ditto.	
	Ditto.	240	.....	Flange cracked.
" 4.	4 coils.	200	No effect.	
	Ditto.	250	.....	Flange cracked.
" 10.	10 coils.	310	No effect.	

ing to four coils at the muzzle. The thickness of cast iron was  $\frac{11}{8}$  of an inch at the breech and  $\frac{1}{2}$  inch at the muzzle. The gun was cast hollow, and a recess was left in the thick part of the breech, in which an india-rubber washer,  $\frac{3}{4}$  inch thick, was placed. The trunnions formed no part of the gun, but consisted of a strap passing round the breech, with two side rods extending about one-third of the length of the gun, and terminating in the trunnions themselves. Thus, the whole force of the recoil was transmitted through the heavy mass at the breech, then through the india-rubber, and along the side rods to the trunnions. The whole was then mounted on a wood carriage, on four roller wheels, about 8 inches diameter. The weight of the gun and wrought-iron trunnion strap was 3 cwt., and the carriage 2 cwt. 0 q. 15 lbs., making a total of 5 cwt. 0 q. 15 lbs.

The shot were cast as nearly the size of the bore as possible, so as to move freely, but with very little windage. The spherical shot weighed  $3\frac{5}{8}$  lbs., and the conical shot from 6 to  $7\frac{1}{2}$  lbs. Table 17 gives the results with  $7^\circ$  elevation, the powder used being Government cannon powder.

**103.** These trials were only intended to be preliminary, but an accident similar in nature to that which destroyed Krupp's steel gun—the breaking and wedging of the shot—tore the gun asunder endwise, throwing the muzzle 15 yards forward, with the shot in it. But the wire, although uncoiled, was not broken. No farther experiments have been made with wire-wound guns.

FIG. 55.

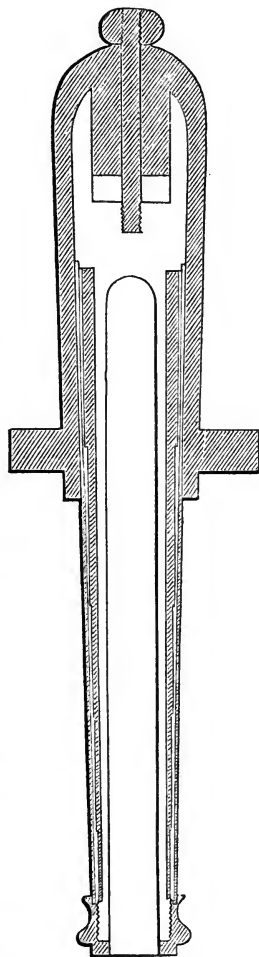
Longridge's experimental  
2.96-in. wire-wound gun.

TABLE XVII.—EXPERIMENTS WITH LONGRIDGE'S 2.96-IN. GUN, FIRING ON CAMBOIS SANDS, JUNE 4, 1856.

No.	Description of Shot.	Weight.		Charge of Powder.	Range to First Graze.
		lbs.		oz.	
9	Round.	3 $\frac{5}{8}$	7°	11	1400 yards.
4	Elongated.	6 $\frac{1}{2}$	7°	11	1200 yards.
5	Ditto.	6	7°	8	1220 yards.
6	Ditto.	7 $\frac{1}{2}$	7°	11	1542 yards.
8	Ditto.	7	7°	11	Loft beyond 1500 yards.
8	Ditto.	7	7°	16	Loft beyond 1800 yards.
10	Ditto.	6 $\frac{1}{2}$	7°	16	1500 yards.
11	Ditto.	6 $\frac{1}{2}$	7°	16	Loft beyond 1800 yards.

**104. Brooke's Hooped Guns.** Figs. 56 and 57 represent the 7-in. cast-iron gun, hooped with wrought-iron rings, as fabricated by Mr. John M. Brooke, "Lt. C. S. Navy," at the Tredegar Works, Richmond, Virginia.\* The other calibres are similar in design. The excellent quality of the cast-iron guns formerly made for the U. S. Government at the Tredegar Works, renders it probable that these guns, although slightly hooped, are capable of a considerable endurance. This class of gun is used with 14 lbs. of powder and 80 lb. shell. One gun is stated to have fired double charges without injury. The following are the particulars of the 7-in. guns:

Total length.....	146.05 inches.
Length of bore.....	119.9 "
Length of wrought-iron reinforce.....	30. "
Length, muzzle to centre of trunnions.....	80.5 "
Length, centre of trunnions to forward end of reinforce.....	10.9 "
Diameter of bore.....	7. "
Diameter of muzzle.....	14.55 "
Diameter of cylindrical part of casting under reinforce.....	27.2 "
Diameter over reinforce.....	31.2 "

**105.** The rifling consists of 7 grooves (Fig. 58)  $\frac{1}{10}$  in. deep, very

\* The engravings were reduced, by the author, from official drawings in London.



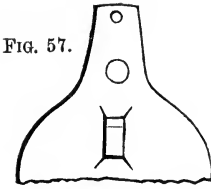


FIG. 57.

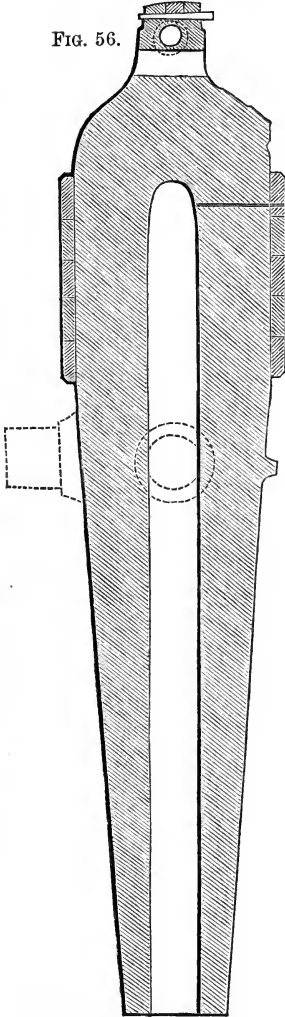
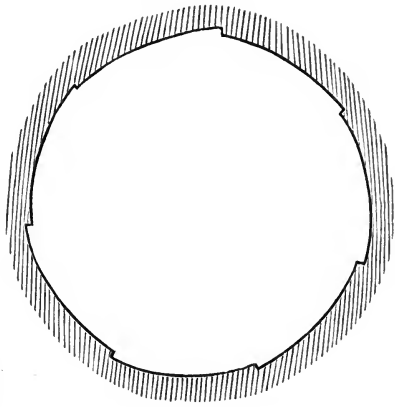


FIG. 56.

FIG. 56.—Brooke's 7-in. hooped gun, made for Confederate Service, at Richmond, Va. Scale,  $\frac{1}{8}$  in. to 1 ft.  
FIG. 57.—Breech plan of Brooke's gun.

FIG. 58.



Rifling of Brooke's 7-in. gun.

slightly rounded at the corners, with 1 turn in 40 feet. The grooves vanish as they approach the chamber.

**106. Attick's Bronze Reinforce.**—The present rifled gun of the Stevens gunboat *Naugatuck*\* was fabricated by the Ames Manufacturing Co., Chicopee, Mass., and is shown by Fig. 59. It is an old cast-iron 42-pounder with a "composition" hoop forced on by hydrostatic pressure. The exact material of the hoop is not made public. The inventors have since made a bronze said to have a tensile strength of 80,000 lbs. per square inch. This gun has been tried with 100 lb. projectiles (James's) and 16 lb. charges. The

\* The *Naugatuck* is illustrated in another chapter.

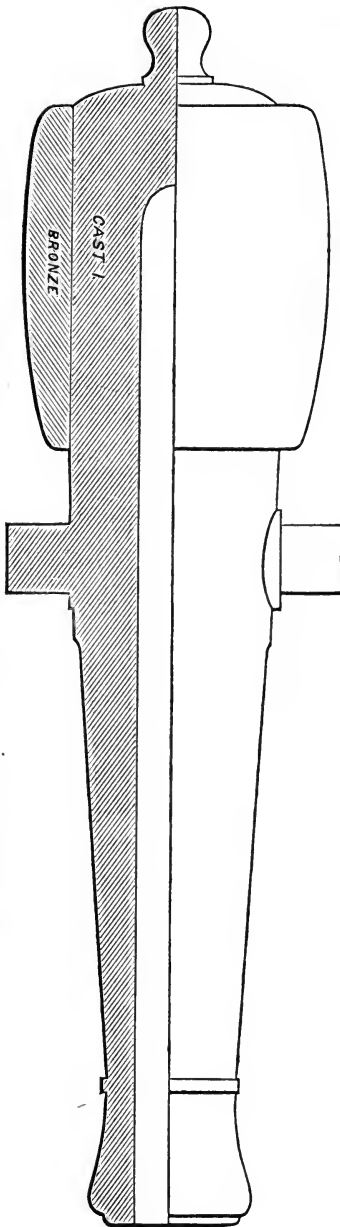


FIG. 59.—Attick's bronze reinforce. 100-pounder Scale  $\frac{5}{16}$  in. to 1 ft.

service charge is 14 lbs. No test of the gun has been made, and the vessel has not been in action since receiving it; but its endurance can hardly be assured from the results of similar experiments in England. (See Table 13.)\*

**107. Atwater's Gun.** A 5.85-in. (80-pounder) hooped gun, experimented with at the Washington Navy Yard, is rather remarkable in its rifling, which will be farther mentioned. It is a cast-iron gun, 21 in. diameter at the breech, with a tier of 6 wrought-iron hoops  $6 \times 2$  in. each, shrunk on, and a second tier of 5 similar hoops over the first tier. Length of bore, 12 ft.; weight, 11,625 lbs.

**108. The 12-Inch Bumford Gun.** A somewhat celebrated gun cast at South Boston in 1846, and thus designated from the name of its designer, is illustrated by Fig. 60. It is a 12-in. smooth-bore of 134 in. total length, 116.2 in. length of bore and chamber, 38.2 in. diameter over the chamber, and 25,510 lbs. weight. Before it was hooped, the greatest enlargement of the chamber with 20, 25, and 28 lbs. powder and

\* Since the above was written, this gun burst after a short service.

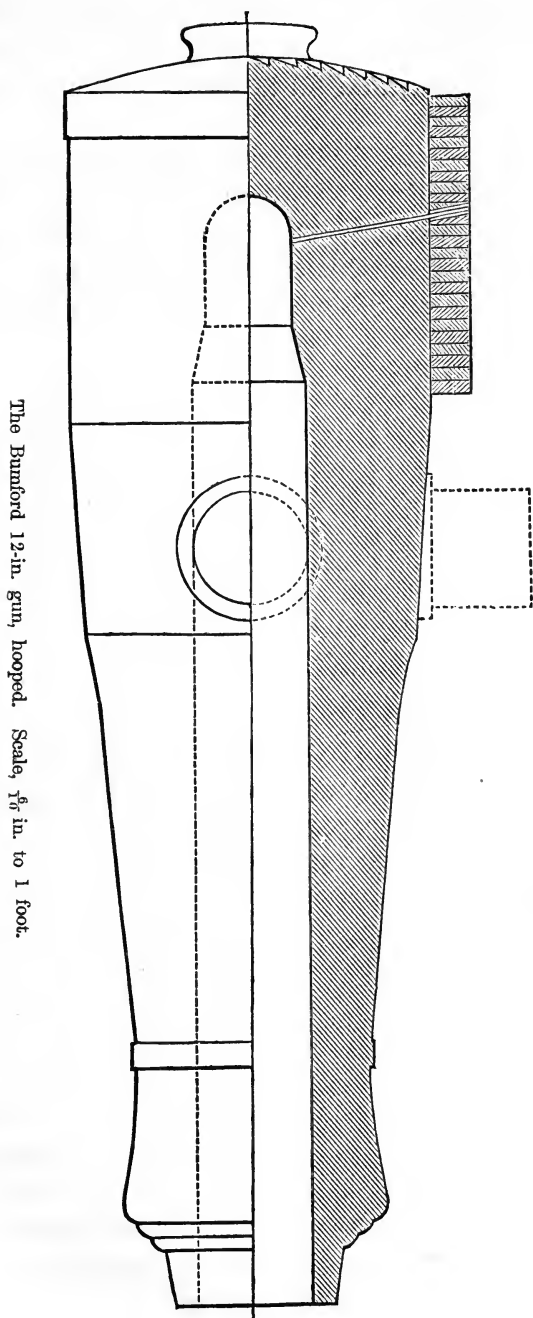


FIG. 60.

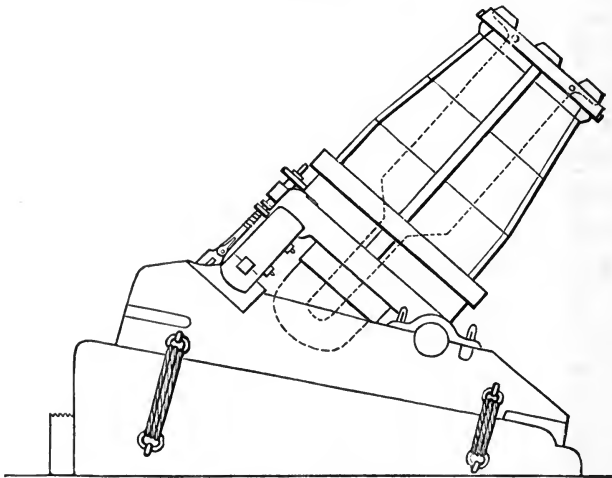
The Bamford 12-in. gun, hooped. Scale,  $\frac{1}{16}$  in. to 1 foot.

a 150 lb. shell, after 93 fires, was  $\cdot005$  in., and the greatest enlargement at the lodgment of the shell,  $\cdot074$  in. The maximum range in ricochet fire, with 181 lb. shell and 28 lbs. powder, was 5800 yards.

This gun was hooped in 1862 with wrought-iron rings, about 1 inch wide each, making a reinforce  $31\frac{3}{4}$  in. long, 4 in. thick, and 46 in. in total diameter. The gun has not been put into service.

**109. Mallet's Wrought-Iron 36-Inch Mortar.** The monster mortar, Fig. 61, consists of wrought-iron hoops shrunk

FIG. 61.



Mallet's 36-inch wrought-iron mortar.

together with definite initial tension. It is made in 6 sections (so as to be transportable), which are fitted gas-tight, with rabbeted joints, and bound together by 6 staves. The chase is  $2\frac{1}{2}$  calibres long. The chamber is a solid forging, set in a cast-iron base of 11 tons weight. The total weight of the piece is 113533 lbs., or about 52 tons. Its cost is stated at £14000. It was completed in 1857, and is now mounted at the Woolwich Arsenal. The chamber and barrel are in good condition, although one of the bolts connecting the muzzle with the base is broken, after limited practice;\* the mortar is generally considered a failure.

\* Mr. Mallet has stated that this could be repaired for £30.

The practice with 36-in. shells will be given in another chapter. The mortar has fired shells of 2481 lbs. weight, holding a 480 lb. bursting charge, above 2 miles, with 80 lbs. of powder.

## SECTION II. SOLID WROUGHT-IRON GUNS.

**110. I. The Mersey Steel and Iron Co.'s Guns.** THE HORSFALL GUN.—The most remarkable piece of this manufacture is the "Horsfall Gun" (Figs. 62, 63), fabricated in 1856, and recently made famous in target practice at Shoeburyness.

FABRICATION.—This gun is a solid forging of wrought iron, bored out. The trunnions are forged upon a separate ring, which is held in place by a key, as shown in the engraving.

**111.** The dimensions of the gun are:—Length, 15 feet 10 in.; diameter over chamber, 3 feet 7 in.; length of bore, 13 feet 4 in.; diameter of bore,\* 13·014 in. The weight\* is 53846 lbs. 2·21 oz. The usual windage is ·2 in. The gun is not rifled.

**112.** The mass of forged iron in the rough, was a rude conic frustum, about 17 feet in length, rather more than 4 feet in diameter at the breech end, and above 3 feet at the other. "Puddled rough bars were made from the best selected Scotch and North Wales pig-iron, and were worked as little as possible before being sent to the forging department. The puddle balls were hammered, then rolled into No. 1 bar iron, and that was cut up, piled, and again rolled into No. 2 bars. \* \* \* A core, formed of a fagot of square bars, was first welded up and rounded to about 15 in. diameter. Upon this, three several coats or piles of V-shaped or voussoir bars were laid on, and welded in succession; so that the fagots might finally be supposed to have a section something like that shown in Fig. 64. The extreme diameter of the breech end was produced by welding slabs over these again, where the mass exceeded 32 inches in diameter."† The forging was done under a "15-ton" hammer, and the heating in a rever-

\* Report of *Ordnance Select Committee*, Feb. 5, 1857.

† "On the coefficients of elasticity and rupture in massive forgings." MALLET. *Inst. Civil Engineers*, March, 1859.

FIG. 62.

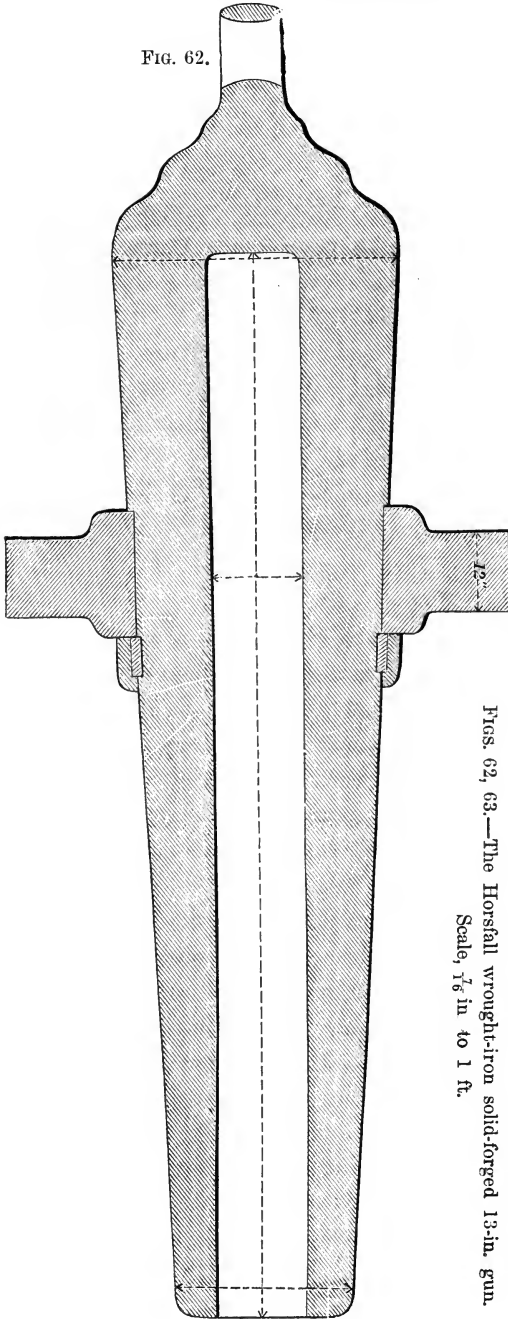
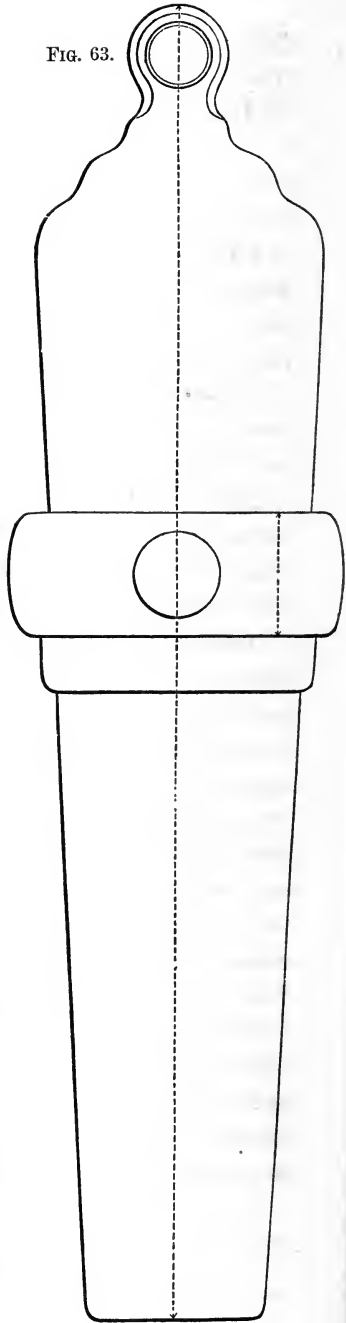


FIG. 63.



FIGS. 62, 63.—The Horsfall wrought-iron solid-forged 13-in. gun.  
Scale,  $\frac{1}{16}$  in to 1 ft.

beratory furnace. Fifty tons of iron were used, and the process occupied seven weeks.

**113. ENDURANCE.**—Above 8000 lbs. of powder, and 60000 lbs. of 282 lb. solid shot have been fired from this gun at various rounds; among others, there have been 90 rounds with 50 lbs. of powder, 21 rounds with 40 lbs., and 6 rounds with 50 lbs., at Shoeburyness; 2 rounds with 80 lbs., at Liverpool; 13 rounds with 20 to 45 lbs., and 40 rounds with 30 lbs. With 45 lbs. of powder, a number of shell were fired loaded with lead to weigh 310 and 318 lbs.

The unequal shrinkage of the solid breech of this gun, during its fabrication, caused a crack, which was afterwards covered with a breech-plug or false bottom in the chamber, to prevent the lodgment of any burning material. The defects of the gun, before the experiments of 1862, were stated as follows, in the report of the Inspector of Artillery:\*

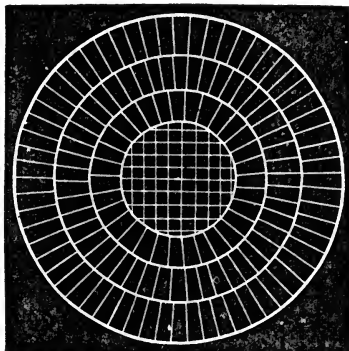
“A plug (8·4 in. diameter) is inserted in the bottom of the bore (driven back ·05 in. after the experiment of the 16th of September, 1862).

“*Right.*—A hole, 1·8 in. long, ·65 in. wide, and 13·75 in. deep, extends from the edge of the plug; another, 1·5 in. from the edge of the plug, is ·55 in. long, ·25 in. wide, and ·2 in. deep.

“*Left.*—A hole from the edge of the plug, ·5 in. long, ·5 in. wide, and 3·75 in. deep; another, 1·5 in. from the edge of the plug, ·8 in. long, ·3 in. wide, and 5·75 in. deep. (Dimensions of this flaw, after the experiments of 16th of September, ·65 in. long, ·35 in. wide, and 6·5 in. deep.)

“*Left of Down.*—One hole at the end of the bore ·5 in. long, ·15 in. wide, and ·1 in. deep.

FIG. 64.



Section of pile of Horsfall gun.

\* British Artillery Records, 1862.

“In the bottom of the bore a flaw commences at the edge of the plug, about  $\cdot 2$  in. wide and  $\cdot 2$  in. deep at the largest part, and extends 25 inches along the bore (this flaw has slightly increased in size).

“In addition to these flaws, small longitudinal fissures, such as are usually found in wrought-iron ordnance, are visible all round the bore at 35 inches from the breech.”

**114.** After the gun had endured these tests, and had been presented to the British Government by the makers, it was left unprotected on the beach at Portsmouth. By renewed exertions, the Mersey Company at last obtained permission to fire it at the *Warrior* target. It was found nearly buried with shingle and much injured by rust. Having been taken to Shoeburyness, it fired several rounds of 282 lb. shot with 74 lbs. of powder, with terrific effect at short range. (Tables 28 and 31.)

The cost of such guns, in England, would be about \$12500.

**115. The Prince Alfred Gun,\*** Fig. 65, shown in the Great Exhibition of 1862, was forged hollow, on a plan patented by Lt.-Col. Clay, of the Mersey Iron Works, and intended principally to overcome the defect of unequal shrinkage and initial strain and rupture (429). Broad plates, bent to the proper curve, were laid and welded upon a barrel made of rolled staves.

**116.** Its dimensions are: length (without cascable), 151 in.; length of bore, 137 in.; diameter over chamber,  $31\frac{3}{4}$  in.; diameter at muzzle,  $14\frac{1}{2}$  in.; diameter of bore, 10 in.; weight, 24094 lbs.

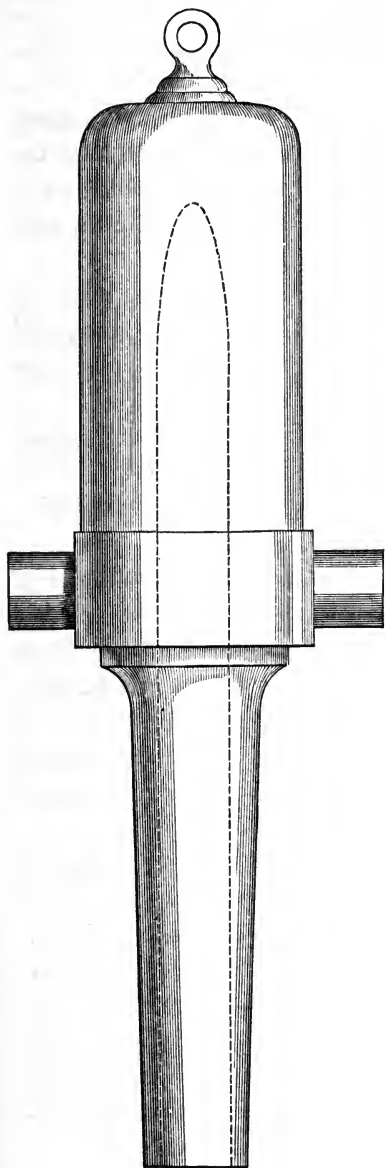
The gun is rifled on a plan intended to be Commander Scott's, with 3 grooves  $\frac{1}{4}$  in. deep, but cut the wrong way, so that the projectile would be rotated by the inclined instead of the radial surface of the grooves. It will therefore have to be bored out to  $10\frac{1}{2}$  in., and will then carry a 156 lb. spherical shot.

**117.** This gun has been fired but twice, and then as a smooth-bore; 1st, with a 140 lb. shot and 20 lbs. of powder, and 2d, with the same shot and 30 lbs. of powder. The test proposed by the makers is 1 round with 1 shot and 100 lbs. of powder. The price of this gun is \$5000 in England.

\* The Prince Alfred Gun has recently been purchased by Captain Blakely.

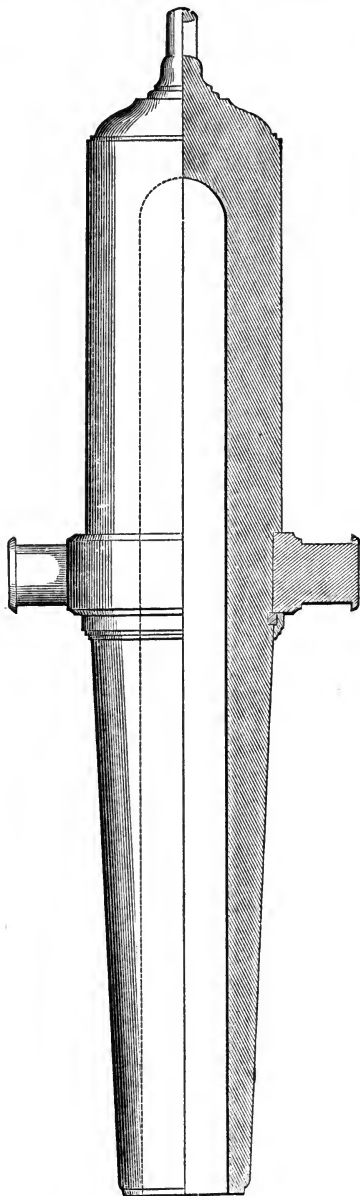


FIG. 65.



The "Prince Alfred" 10-in. wrought-iron hollow-forged gun. Scale,  $\frac{1}{8}$  in. to 1 ft.

FIG. 66.



The Mersey 12-inch gun in the Brooklyn Navy Yard. Scale,  $\frac{1}{8}$  in. to 1 ft.

**118. Brooklyn Navy Yard Gun.** The 12-in. wrought-iron gun, in the Brooklyn Navy Yard, Fig. 66, was forged like the Horsfall gun, by the Mersey Iron Works, in 1845, to replace the Stockton gun. Its dimensions are: total length, 14 feet 1 in.; diameter over the chamber, 28 in.; length of bore, 12 feet; diameter of bore, 12 in.; weight, 16700 lbs. It was received after the bursting of the Stockton gun, of which it is a copy, in shape, and has never been mounted for service. It has been fired once with two 224 lb. shot and 45 lbs. of powder.

**119.** A 6-INCH WROUGHT-IRON SMOOTH-BORE GUN, made at these works for the Russian Government, stood a 300 lb. elongated projectile and 16 lbs. of powder. The metal of the chamber was compressed, but no other damage was done.

**120.** The Mersey Works have also constructed several experimental wrought-iron guns by the rolling process. One of these, 2½ inches bore, was fired with 22 balls and a cylinder projecting 12 inches from the muzzle; charge, 1½ lbs.\*

**121.** THE BRITISH GOVERNMENT has ordered several guns of 6½ inches bore, to be forged hollow, like the Alfred gun. One of these, weighing 9282 lbs., was fired 10 rounds with a 68 lb. 10 oz. shot; 10 rounds with a 136 lb. 8 oz. shot; 10 with a 204 lb. shot; 10 with a 273 lb. shot; 10 with 340 lb. 8 oz. shot; 10 with 410 lb. shot; and 10 with a 476 lb. shot. At the 70th round the gun burst into eight pieces. Subsequent experiments on the metal gave a tensile strength of 45359 lbs. per sq. inch.

**122.** Another block, forged to the shape of the Armstrong 12-pounder, and rifled and fitted as a 12-pounder, was subjected to the usual proof, but exhibited in the chamber "holes and dents to an extent which, if taking place in an Armstrong gun, would not be passed for service."† A 40-pounder block, forged from the same iron, and finished like the Armstrong 40-pounder, was "fired 100 rounds with the service charge of 5 lbs., and cylinders increasing in weight from 40 lbs. to 400 lbs; also 17 rounds with the

\* Col. Clay. Construction of Artillery, Inst. C. E., 1860.

† Report of Select Committee on Ordnance, 1863.

double service charge, viz., 10 lbs., and with the 40-pounder service shot; total, 117 rounds. The result is, that the bore is deeply fissured all round, from 75 in. from the muzzle to the breech end of the powder-chamber. The powder and shot chambers are also expanded.”\* This expansion was .068 in. maximum, in diameter, at the powder-chamber, and .374 in. maximum at the shot-chamber.

**123.** The committee, however, say, that “both these guns have shown an endurance, if not fully equal to guns made on the coil system, yet at least ample for the requirements of the service, if it is accompanied by the power of resisting a very great number of service charges;” and in a subsequent report, that by the employment of the Mersey blocks instead of the Armstrong coil, “a saving in the cost of manufacture will be effected to the extent of about £74 (\$370) per 40-pounder gun, and £15 (\$75) per 12-pounder gun.”\*

**124. II. The Stockton Guns.**—Three 12-inch wrought-iron guns were made some years since, under the direction of Commodore Stockton, for the U. S. Government. They are all illustrated by Fig. 66.

**125.** The first, called the “Oregon” gun, was forged in England. After considerable use with charges of 20 to 30 lbs. of powder and 216-lb. balls, it cracked through the reinforce, but was hooped and fired afterwards without injury. This gun is now in the Navy Yard at Philadelphia.

**126.** The “Peacemaker” was forged in the United States, by Messrs. Ward & Co. The greater part of the iron was in 4-in. bars, 8½ ft. long. Of these, 30 were laid up in a fagot, welded, and rounded into a shaft 20 to 21 in. in diameter. Iron in the form of segments, varying in weight from 200 to 800 lbs., and usually large enough to reach ¼ round the gun, was welded on, there being two strata of segments over the breech. The hammer used weighed 15000 lbs. The time occupied in the forging, during which the iron was kept more or less highly heated, was

\* Report of Select Committee on Ordnance, 1863.

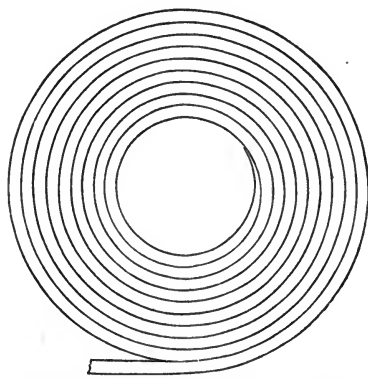
45 $\frac{1}{4}$  days. This gun burst on board the U. S. steamer *Princeton*, after a few discharges.\*

The third Stockton wrought-iron gun is the Mersey Iron Works' gun, already described. (118.)

**127. III. Miscellaneous Solid Wrought-Iron Guns.—**

**LYNALL THOMAS'S 7-INCH GUN.**—Although there are many field-pieces composed of wrought iron piled and treated in various ways, no heavy ordnance—than that described above—has been fabricated, excepting Mr. Lynall Thomas's 7-inch gun, which recently burst at Shoeburyness.

FIG. 67.



Lynall Thomas's 7-inch gun—mode of fabrication.

This gun was rolled, by Messrs. Morrison and Co., Newcastle, into a tube, from a plate of inch iron, as illustrated by Fig. 67. There were 14 or 15 layers of plate forged into a mass over an internal cast steel tube. Over the breech were two hoops, 13 inches long by 3 inches thick. Length of gun, 11 ft. 6 in.; total diameter, 26 in. It was rifled with 3 projecting ribs, 1 $\frac{1}{2}$  in. wide each, the diameters of the bore being 7 and 6.6 in. The gun burst in firing at the Inglis target, on Dec. 29, 1862, at the

second round, with a 27 $\frac{1}{2}$ -lb. charge and a 138-lb. shot.†

**THE NEW ERICSSON GUN.**—Two 13-inch guns, designed by Mr. Ericsson‡ as a part of the armament of the iron-clads *Puritan* and *Dictator*, are nearly completed. The gun is a solid wrought-iron barrel, forged from a very superior iron (specially tested for

\* An abstract of the report of the Committee of the Franklin Institute on the condition of this gun will be found in a following chapter. (426.)

† This process of manufacture will be further described under the head of "Wrought Iron." (430.)

‡ Capt. Ericsson "is to receive nothing for these guns, unless they burn over 50 lbs. of powder. \* \* \* He is confident of being able to burn 100 lbs."—*Army and Navy Journal*, Sept. 26, 1863.

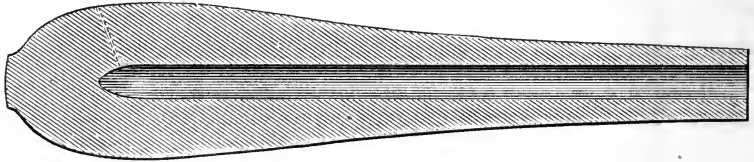
the purpose), at Bridgewater, Mass., and reinforced with a series of thin washers, forced on with accurately determined tension by hydrostatic pressure. Upon the end of the breech is forged a solid flange, against which the washers abut. The washers are cut out of  $\frac{3}{8}$ -in. boiler plate, and extend forward to the middle of the chase, where a nut, embracing and screwed upon the chase, presses them against the solid flange, and into close contact with each other. The following are the particulars of this gun:

	Ft.	Ins.
Length, total.....	12	8
Length of reinforce of washers.....	8	
Length of maximum diameter.....	3	6
Diameter, maximum.....	3	11
Diameter of muzzle.....	1	10
Diameter of bore.....	1	1
Diameter of barrel under reinforce.....	2	4 $\frac{1}{2}$
Thickness of hoops or washers.....		$\frac{3}{8}$
Thickness of walls of barrel.....		7 $\frac{1}{2}$
Total thickness of wall of gun.....	1	5
Weight.....		47000 lbs.

**128. AMES'S WROUGHT-IRON GUN.**—Mr. Horatio Ames, of Salisbury, Conn., has forged several experimental cannon of 6 in. bore, out of the celebrated Salisbury iron, by a new process of his own. A slab 10 in. square and six inches thick, piled and hammered in the usual way, and rounded and turned to form a short cylinder, receives a 3-in. hole in the middle, and a welded ring, 6 × 6 in. in section, is shrunk upon the outside. The disk thus made is welded to a mass of iron, forged on the end of the staff by a horizontal steam-hammer equivalent to an ordinary 6-ton hammer. Other disks are thus welded to the first, till the requisite length is attained. The gun is also hammered by an upright 6-ton steam-hammer. A pin is driven through the hole in each disk, after it is welded on, into the corresponding hole in the next disk, to open and preserve the line of the bore. The forging is upset to two-thirds of its original length, and increased in diameter two inches. The shape of the gun is that of the Dahlgren 50-pounder (Fig. 68). The trunnions are put on with Dahlgren's breech-strap (305).

**129.** One of these guns was fired 1630 times with a 37-lb. rifle shot and  $3\frac{1}{2}$  lbs. of powder—the service charge. Another

FIG. 68.

Ames's wrought-iron 50-pounder. Scale,  $\frac{7}{16}$  in. to 1 ft.

gun of the same dimensions was bored out to 8-in. calibre, and fired 438 times with the 80-pounder service charge—a 67-lb. rifle shot and 5 lbs. of powder—without bursting. Other guns have been subjected to very severe tests at the works. The chambers of these guns show some stretching at the welds, but it is not certain that there are serious flaws.

The manufacture is, of course, not fully developed.\*

### SECTION III.—SOLID STEEL GUNS.†

**130. Krupp's Guns.**—The mild steel made by Mr. Fried. Krupp, at Essen, Prussia, is probably more remarkable than any other product of this nature, chiefly on account of the immense size of the solid masses produced. Mr. Krupp's cannon are, indeed, the only solid steel guns that have acquired a special celebrity, although it is probable that some of the Sheffield manufacturers make an equally good material, and will soon produce ingots of equal size. The first of Mr. Krupp's guns was the one in the Great Exhibition of 1851. Mr. Krupp patented this application of steel to ordnance in England, on Dec. 17, 1861.

**131. MANUFACTURE.**—The great feature of the manufacture is

\* It is stated that Mr. Ames is now forging fifteen guns of 15-inch calibre for the United States Government.

† The nature and manufacture of steel by different processes will be considered under the head of "Cannon Metals."

FIG. 69.—Section of Krupp's 9-inch solid steel gun in the Exhibition of 1862. Scale,  $\frac{1}{8}$  in. to 1 ft.

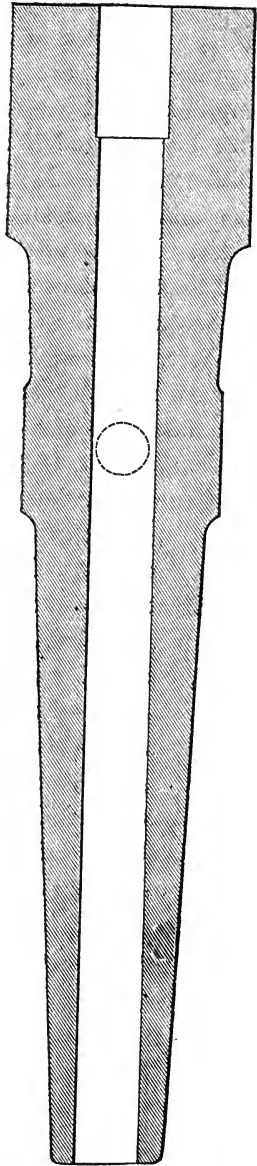
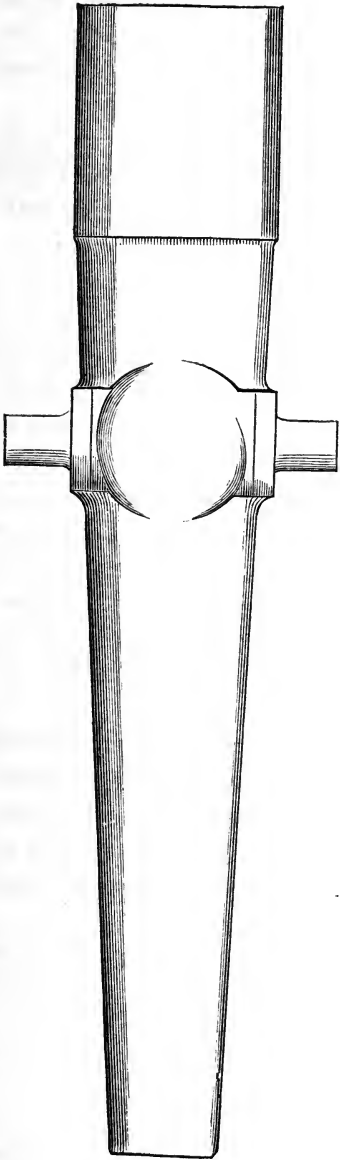


FIG. 70.—Plan of Krupp's gun—Fig. 69.



the forging of large masses from single homogeneous ingots, without seams or welds. An ingot of 21 tons weight, and 44 in. diameter, was shown at the Great Exhibition of 1862. Similar castings are forged every day into shafts, cannon, etc. The head of Krupp's heaviest hammer is said to weigh 40 tons.\*

**132.** Figs. 69 and 70 represent the 9-inch gun shown in the Exhibition of 1862. It was at that time the largest cannon forged at this establishment, and by far the largest gun ever forged without welds. It was intended for a Krupp breech-loader, but is adapted to other plans of breech-loading or to conversion into a muzzle-loader by the simple insertion of a breech-plug. It is a smooth-bore, and was intended for a 200-pounder to 250-pounder rifle. Its dimensions are: total length, 13 ft. 8½ in.; diameter over chamber, 27¾ in.; diameter at muzzle, 15½ in.; diameter of bore, 9 in.; weight, 18000 lbs.; price, \$10125.

**133.** The other large Krupp guns in the exhibition were an 8·12-in. gun, weighing 8365 lbs., and a 7-in. gun, weighing 7709 lbs. Artillery of smaller calibres, especially for field-service, has been made at this establishment, in great quantities, for the Prussian, French, Belgian, Austrian, Russian, Egyptian, Swiss, Dutch, Bavarian, Norwegian, and other governments, all of which has given entire satisfaction.

**134.** Mr. Krupp is now making a large number of solid-steel guns for Russia; † among them fifty 9-in. guns (Fig. 71), of 18480 lbs. weight and 15 ft. length of bore, and a larger number of 8-in. guns, of 16800 lbs. weight and 13 ft. 2 in. length of bore, and of 6-in. guns of 8900 lbs. weight and 10 ft. 8 in. length of bore.

\* In a circular dated January, 1861, Mr. Krupp says that the capabilities of the works admit of a daily production of

	18	blocks	(not bored),	suitable	for	guns	of	3·00-in.	bore
or	12	"	"	"	"	"	"	3·50	"
or	8	"	"	"	"	"	"	4·50	"
or	4	"	"	"	"	"	"	5·75	"
or	2	"	"	"	"	"	"	8·00	"

or half these numbers of finished guns, turned, bored, and rifled.

† In addition to these, the Russian government has made extensive preparations, at enormous cost, to produce steel guns in Russia, and has ordered a large number of steel and other hooped guns from Captain Blakely.



They are all muzzle-loaders, of the form shown by Fig. 71, and rifled on the shunt plan.\* Mr. Krupp is also making for Russia several 11-in. guns, fitted with his own plan of breech-loading apparatus, which will be described in another chapter; and, it is stated, though not officially, several 15-in. guns, at a cost of 87 cents per pound.†

The experiments on armor-plates, with the 9-in. steel guns, at St. Petersburg, will be referred to under that head.

**135. ENDURANCE.** — The British Government has also experimented with Krupp's guns of various calibres. The most severe test to which the metal has been subjected, occurred at Woolwich, in 1862-3. Three guns were furnished by Mr. Krupp, upon his own system of breech-loading, and at his own expense, viz., a 20-pounder, a 40-pounder, and a 110-pounder, of 3.75, 4.75, and 7 inches bore, respectively. They were all rifled upon the Armstrong multi-groove system, with 44, 56, and 76 grooves respectively, and fired with Armstrong compressing projectiles, which is a rather severe test in itself. The proof is recorded in Tables 19, 20, and 21.

\* The rifling of the 9-inch guns, a number of which were delivered in the autumn of 1863, will be illustrated in another chapter.

† The following circular has been issued by Mr. Krupp:

(See next four pages.)

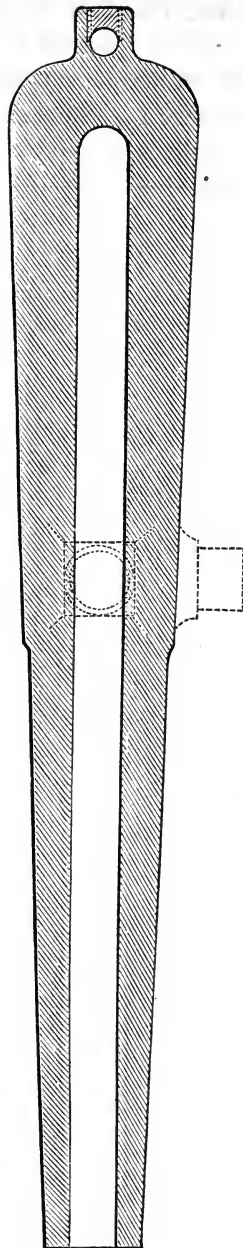


FIG. 71.—Krupp's 9-inch gun for Russia. Scale,  $\frac{1}{8}$  in. to 1 ft.

**136.** The first of the 9-in. guns supplied to the Russian government\* is reported to have fired 70 rounds of 300-lb. shells with 50 lbs. of powder, up to the close of the armor-plate experiments of October 17, 1863, and to have even fired several shots through 5½-in. plates without exhibiting any deterioration. Meanwhile,

CAST-STEEL WORKS, NEAR ESSEN, RHENISH PRUSSIA, January, 1861.

On distributing the enclosed Price List for Cast-Steel Guns, I beg to furnish the following extract from a pamphlet by Dr. H. Scheffler, entitled "Elastic Proportions of Barrels, Tubes, etc." (Kreidel and Niedner, Wiesbaden, 1859), particularly referring to guns, and the rules laid down therein; directing, also, to my works for reply to questions relative thereto.

FRIEDR. KRUPP.

The author (Dr. Scheffler) confirms the rule of Lamé as being correct for calculating the thickness of metals for cylindrical tubes

Stating by

- b the thickness of metal;
- r the interior radius of the tube;
- p the interior pressure of the gun per square inch;
- f the absolute resistance of the metal;
- n the coefficient of safety;

$\frac{1}{n} f = s$ , the greatest tension to which the material can be strained at the most dangerous part, viz., the interior surface of the gun,

and neglecting the pressure acting upon the gun from the exterior, which will not be sensibly felt on guns, hydraulic cylinders, etc., where the exterior atmospheric pressure, compared with that in the interior, is so slight; thus *Lamé's Formula* furnishes a corresponding proportion of the thickness of metal and interior radius of the tube the value:

$$\frac{b}{r} = \sqrt{\frac{s+p}{s-p}} - 1 = \sqrt{\frac{\frac{1}{n}f+p}{\frac{1}{n}f-p}} - 1$$

The tube will therefore burst from the pressure  $p$ , as soon as  $s = f$  (and of course  $n = 1$ ).

This formula contains this most important result for practice, that there exists for every material a highest amount of interior pressure, which cannot be exceeded; and this highest amount of pressure, at which the gun will burst, however great may be its thickness of metal, is  $p = f$ , that is, equal to the absolute resistance of the metal.

Supposing, then, the absolute resistance of  $f$  to be—

of cast iron.....	19000 lbs. per square inch,
" bronze metal.....	34000 " " "
" cast steel.....	120000 " " "

\* The statement in the English journals of November, that the first 9-in. gun had burst, is contradicted by Mr. Krupp's agent, in the *Times* of November 30, 1863.

the 7-in. wrought-iron gun, built on the Armstrong plan, and rifled on the Whitworth plan, which has also thrown shells through armor, requires repairs, from the indentation of the bore, after less than 30 rounds.

and calculating the pressure of one atmosphere = 15 lbs. per square inch, a gun will certainly burst when the interior pressure becomes greater than :

with cast iron	$\frac{19000}{15}$	=	1266 atmospheres	
“ bronze	$\frac{34000}{15}$	=	2266	“
“ cast steel	$\frac{120000}{15}$	=	8000	“

Following Lamé's rule, supposing the thickness of metal to be given as b, or the proportion  $\frac{b}{r}$ , it results for the greatest tension s, per square inch, which the metal has to sustain under the interior pressure, the expression

$$s = \frac{1}{n} f = p \cdot \frac{\left(\frac{b}{r} + 1\right)^2 + 1}{\left(\frac{b}{r} + 1\right)^2 - 1}$$

from which, the absolute resistance of cast steel being about six times as great as that of cast iron, and three and a half times as that of bronze metal, it results, *that with the same diameter and thickness of metal, and with the same interior pressure, a CAST-STEEL GUN warrants a safety against bursting of six times greater than a cast-iron gun, and three and a half times greater than a bronze metal gun.*

If, for instance, the gun shall be subjected to an interior pressure of 1000 atmospheres, that is, p = 15000 pounds per square inch, it results :

for b = ∞ (infinite)	s =	p =	15000 lbs. per square inch.
“ b = 3r, .....	s =	$\frac{17}{15}p$	= 17000 “ “ “
“ b = 2r, .....	s =	$\frac{5}{4}p$	= 18750 “ “ “
“ b = r, .....	s =	$\frac{5}{3}p$	= 25000 “ “ “
“ b = $\frac{1}{2}r$ , .....	s =	$\frac{13}{5}p$	= 39000 “ “ “
“ b = $\frac{1}{7}r$ , .....	s =	$\frac{113}{15}p$	= 113000 “ “ “
“ b = $\frac{1}{8}r$ , .....	s =	$\frac{145}{17}p$	= 128000 “ “ “

**137.** In 1857, two 4.88-in. 12-pounder smooth-bore muzzle-loaders were put to extreme test in Paris;\* it was impossible to burst them or to injure them by firing. In a former trial, an experimental 12-pounder of this manufacture had endured 1400 rounds

---

While, therefore, a *cast-iron* gun, strained by an interior pressure of 1000 atmospheres, even with an infinitely great thickness of metal, warrants only a safety  $\frac{19000}{15000} = 1.26$  times, but with a thickness of metal  $b = 3r$  would already be burst; and while such a gun of *bronze* metal, with an infinitely great thickness of metal, warrants a safety  $\frac{34000}{15000} = 2.26$  times, with  $b = 2r$  a 1.82 times, and with about  $b = \frac{5}{8}r$  would be burst, a *cast-steel* gun warrants, with an infinitely great thickness of metal, a safety  $\frac{120000}{15000} = 8$  times, and even with  $b = 2r$  6.4 times, with  $b = r$  4.8 times, and even with  $b = \frac{1}{2}r$  still a safety three-fold, and would not be burst with the small thickness of metal  $b = \frac{1}{7}r$  to  $b = \frac{1}{8}r$ .

As the interior pressure which a gun has to stand during the firing may often reach or surpass 1000 atmospheres, it cannot of course surprise that cast-iron guns, even of cast iron of the most superior quality, the resistance of which is greater than 19000 lbs. per square inch, very often burst, and that also bronze metal guns are not so often burst; while this accident is not to be apprehended with good cast-steel guns, even of very small thickness of metal.

For other apparatus which have to sustain as high pressures as guns (such as, for instance, the cylinders for hydraulic presses), Dr. Scheffler observes, in his pamphlet, that cast steel is invaluable, as its greater natural resistance cannot be equalled by any increase of the thickness of the less resistible metals. (See also Table XVIII.)

---

\* The following account of the experiment is extracted from the Report of the Secretary of the Committee of Artillery, dated Paris, July 12, 1857. A similar 12-pounder, made by Mr. Krupp, had been previously tested with the following results: It "was fired 1400 times with the service charge (about 2 $\frac{1}{2}$ , or 4.4 lbs.), 600 times with the charge of 1 $\frac{1}{2}$ , 500 (3.3 lbs.), and 1000 times with the charge of 1 $\frac{1}{4}$ , 400 (3 lbs.); in all, 3000 discharges, which it resisted perfectly. A verification, made by the star-gauge, demonstrated that the piece had not suffered the least injury; no alteration was found either in the bore or in the external form. It has not been the same with the vent, which at first consisted of a simple hole pierced in the metal of the piece: after 500 discharges the hole was considerably enlarged; it was strongly crooked, and furrowed with longitudinal slits, which were enlarged more and more at each fire. The greatest diameter of its exterior orifice was 15 to 16 millimetres ( $\frac{1}{16}$  in.), instead of 5 mil. 6. ( $\frac{1}{48}$  in.), its original diameter. A new vent was substituted, pierced in a cylinder of cast steel, incased in a cylinder of copper, screwed to the piece; but this vent did not endure better than the first; it was unserviceable after 600 fires, and replaced by a  
(See page 98.)

(*Mr. Krupp's Circular—continued.*)

TABLE XVIII.—APPROXIMATE PROPORTIONS OF DIMENSIONS, WEIGHTS, AND PRICES OF KRUPP'S SOLID CAST-STEEL BLOCKS AND OF GUNS FINISHED AND RIFLED, TO BE LOADED FROM THE BREECH OR MUZZLE, ASSUMING THAT THE GENERAL CONTOUR OF THE GUNS IS CYLINDRICAL, CONICAL, PLAIN, AND WITHOUT MOULDINGS, OR RELIEFS.

\*.\* In giving orders for finished guns, the special proportions, particularly the number and form of rifle grooves, must be expressly prescribed, as the proprietor of the works is not authorized to communicate independently to other governments the various forms and constructions of which he has obtained the knowledge through supplying his cast-steel guns.

Diameter of the bore.	Thickness of metal at the powder-chamber.*	Length of the bore.	APPROXIMATE WEIGHT		PRICES	
			Of the block roughly turned and not bored.	Of the finished gun, turned, bored, and rifled, without breech-closing apparatus.	Of a pure block, roughly turned, not bored.	Of the finished gun, turned, bored, and rifled, without breech-closing apparatus
Inches.	Inches.	Inches.	Prussian pounds.	Prussian pounds.	£ s. d.	£ s. d.
2.50	1.75	50	450	315	33 15 0	60 0 0
2.50	2.50	50	650	490	45 15 0	76 10 0
3.00	2.15	55-70	725-950	525-675	} 56 5 0 to	86 5 0
3.00	3.00	55-70	1000-1300	765-975		185 0 0
3.25	2.30	50-55	750-825	555-615	} 56 5 0 to	86 5 0
3.25	2.70	50-55	900-1000	680-755		to
3.25	3.25	50-55	1050-1175	800-895	} 86 5 0 to	120 0 0
3.50	2.50	65-70	1220-1295	825-875		129 15 0
3.50	3.50	65-70	1625-1750	1200-1300	} 131 5 0 to	174 0 0
3.75	2.70	80-85	1740-1860	1240-1340		174 15 0
3.75	3.75	80-85	2350-2475	1710-1825	} 165 0 0 to	217 10 0
4.50	2.70	90-95	2200-2300	1425-1500		210 0 0
4.50	3.00	90-95	2480-2600	1670-1750	} 150 0 0 to	to
4.50	4.50	90-95	3775-4000	2725-2900		277 10 0
5.00	3.40	100	3400	2200	240 0 0	311 5 0
5.00	5.00	100	5200	3825	367 10 0	441 0 0
5.75	3.60	100-105	4180-4325	2700-2800	} 292 10 0 to	382 10 0
5.75	4.00	100-105	4700-4900	3225-3350		to
5.75	5.75	100-105	6900-7300	5075-5400	} 525 0 0 to	622 10 0
8.00	6.00	110	11300	8000		810 0 0

\* The corresponding smallest thickness of metal at the muzzle of the gun is presumed to be about half this largest thickness.

Larger guns than 8" bore can be also manufactured from solid cast-steel blocks.

with 4.4 lbs. of powder, 600 with 3.3 lbs., and 1000 with 3 lbs., without alteration. It afterwards burst at the 4th round, with 2 balls and 6.6 lbs. of powder. The two guns referred to were fired 3000 times each with 3 lbs. of powder and one ball. One of them was then fired at and indented, and finally broken to pieces. The other was fired 20 rounds with 6.6 lbs. of powder and 2 balls, 10 rounds with 6.6 lbs. and 3 balls, and 6 rounds with 13.2 lbs. and 6 balls. Neither of the guns was altered in the slightest degree by all these rounds; and it was determined not to burst the one that remained whole.

TABLE XIX.—PROOF OF KRUPP'S 110-POUNDER RIFLE. BORE 7 IN. WOOLWICH, FEB., 1863.

No. of rounds.	Weight of charge.	Weight of shot.	Remarks.
1	18 lbs. 15 oz.	110 lbs.	"Developing round."
2	27½ lbs.	110 "	"Proof rounds."
4	18 lbs. 15 oz.	110 "	"Developing charge."
10	14 lbs.	110 "	} 100 rounds "Destructive proof." The projectiles were cylinders with leaded base to take the rifling. Length of cylinder, last 10 rounds, 8 ft. 9½ in.
10	14 lbs.	200 "	
10	14 lbs.	300 "	
10	14 lbs.	400 "	
10	14 lbs.	500 "	
10	14 lbs.	600 "	
10	14 lbs.	700 "	
10	14 lbs.	800 "	
10	14 lbs.	900 "	
10	14 lbs.	1000 "	

The gun was not injured in the above proof.

vent pierced in a cylinder of ordinary copper, like that used for bronze cannon. This resisted perfectly until the end of the experiments, and was still fit for service when the gun was caused to burst.

To study the extreme limits of resistance of the cast-steel gun, it was necessary (See page 100.)

TABLE XX.—PROOF OF KRUPP'S 20-POUNDER RIFLE. BORE 3·75 IN. WOOLWICH, SEPT. AND NOV., 1862.

No. of rounds.	Weight of charge.	Weight of shot.	Remarks.
1	3 lbs. 10 oz.	20 lbs.	"Developing round."
2	5 lbs.	20 "	"Proof rounds."
4	3 lbs. 10 oz.	20 "	"Developing rounds."
10	2½ lbs.	20 "	} 100 rounds "Destructive proof." The projectiles were wrought-iron cylinders with the base leaded to take the rifling.
10	2½ lbs.	40 "	
10	2½ lbs.	60 "	
10	2½ lbs.	80 "	
10	2½ lbs.	100 "	
10	2½ lbs.	120 "	
10	2½ lbs.	140 "	
10	2½ lbs.	160 "	
10	2½ lbs.	180 "	
10	2½ lbs.	200 "	
3	5 lbs.	20 "	} 30 rounds with increasing cylinders and double charges.
3	5 lbs.	40 "	
3	5 lbs.	60 "	
3	5 lbs.	80 "	
3	5 lbs.	100 "	
3	5 lbs.	120 "	
3	5 lbs.	140 "	
3	5 lbs.	160 "	
3	5 lbs.	180 "	
3	5 lbs.	200 "	

The gun was not injured in the above proof. The enlargement of the chamber was ·12 inches.

TABLE XXI.—PROOF OF KRUPP'S 40-POUNDER RIFLE. BORE 4.75 IN. WOOLWICH, FEB., 1863.

No. of rounds.	Weight of charge.	Weight of shot.	Remarks.
1	6 lbs. 12 oz.	40 lbs.	"Developing round."
2	10 lbs.	40 "	"Proof rounds."
4	6 lbs. 12 oz.	40 "	"Developing rounds."
10	5 lbs.	40 "	} 100 rounds "Destructive proof." The projectiles were cylinders with a leaded base to take the rifling. Length of cylinder, last 10 rounds, 7 ft. 7 in.
10	5 lbs.	80 "	
10	5 lbs.	120 "	
10	5 lbs.	160 "	
10	5 lbs.	200 "	
10	5 lbs.	240 "	
10	5 lbs.	280 "	
10	5 lbs.	320 "	
10	5 lbs.	360 "	
10	5 lbs.	400 "	

The gun was not injured in the above proof.

to fire 20 charges of 3<sup>k</sup> (6.6 lbs.) with 2 balls. The piece resisted very well the first three fires, showing no wear nor the least fissure that could indicate an approaching rupture; but at the fourth fire it burst into a great number of pieces, several of which were thrown to a distance of 150 metres (500 feet), and nearly all were found.

Two other guns of the same (121 millimetres, or 4.84 in.) calibre were delivered rough forged, and finished at Strasburg, to the interior and exterior dimensions of a 12-pounder. The star-gauge showed a variation in the bore of only  $\frac{1}{10}$  of a millimetre. "The weight of the pieces was about the same—551<sup>k</sup> (1212.2 lbs.) for one, and 550<sup>k</sup> (1210 lbs.) for the other."

EXPERIMENTS. *First Series.*—"The two pieces, placed on light 12-pounder carriages with strengthened cheeks, were put in battery at 600 metres (1968 feet) from the target. They were aimed point-blank, and fired each 3000 times with 1<sup>k</sup>400 (3 lbs.) of powder. The weight of the charges was verified, as well as the mean range of the powder, which was 225 metres (737 feet). The trials were made twice each day; and at each trial each piece was fired fifty times. After each trial, the pieces being sponged and cleaned as well as possible, an examination was made of the state of the vents, that of the pieces, and the damage sustained by the carriages.

"The pieces suffered a considerable recoil, which was limited by means of fascines placed in the direction of the recoil. There was also a great pounding of the breech



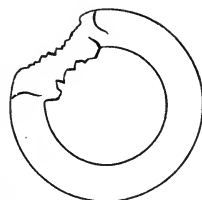
upon the sighting-screw; and to this may be ascribed the breakage of several screws, which had to be replaced during the trials. This pounding was due to the too slight preponderance of the breech relative to the 12-lb. balls which were fired. After 200 discharges of each piece they were examined anew by means of the star-gauge, and each examination showed that the bore had not suffered any injury. The state of the vents was also perfect. The carriages did not begin to fail until after 500 discharges. That of No. 1 having had its trail broken, it was removed, and replaced by one nearly new. The firing was continued during the following trials without any result requiring particular notice. Each piece was examined after each series of 200 discharges; and each examination showed an absolute resistance of the steel; for it was impossible to discover the least alteration, either with the naked eye or with the aid of the star-gauge; the bore remained always polished, and resumed its brightness when sufficiently cleaned. \* \* \* In this way 1400 rounds were fired with the same powder without producing the least alteration in the pieces. \* \* \* In the following trials there were no injuries except to the carriages, some of which were so great as to put these carriages out of service, and it was necessary to replace them. \* \* \* The firing was continued to the end without producing the least alteration in the interior or exterior of the two pieces. When they had been fired 3000 times each, they were examined by the star-gauge. A comparison of the interior diameters found by this test with the measures taken before the trials, showed but an inappreciable difference; the calibre remained 121 millimetres (4.84 inches) through the whole length of the bore; and the difference detected by the instrument, .2 of a millimetre at most, is so small that it may be said, without error, that after the firing the bores of the two pieces were identically the same as they were before its commencement.

"This first series of tests is therefore altogether favorable to cast steel, and demonstrates its absolute resistance to the diverse causes of degradation of the bore in ordinary firing.

"*Second Series.*—This series was for the purpose of ascertaining if cast steel would resist the enemy's shot as well as bronze does. The gun No. 2 was fired at by a 12-pounder field-gun with the ordinary service charge. It was placed horizontally upon blocks at a distance of about 100 metres (328 feet), with its muzzle turned towards the gun which was to fire at it, the axes of the two pieces being in the same vertical plane. \* \* \* The first shot struck on the muzzle, knocking off a piece about a quarter of the circumference, and battering inward a burr to the extent of nearly an inch, which would prevent the insertion of a ball. The effect would have been the same on a bronze gun. The second ball hit exactly in the same place, increasing the effect of the first, and, in addition, producing deep irregular fissures all around the muzzle, extending to the neck. The piece was then placed so that the trunnions were vertical; one of them was struck fairly and knocked off by the ball. It would have been the same with a bronze trunnion. The shot having struck fairly, the shock caused the muzzle to fall off, the fissures having nearly detached it.

"The gun was then placed across the line of fire, and received five balls in its broadside. These balls all struck fairly, and produced indentations of about a third of the diameter of the ball in depth (Fig. 72), and ragged projections inside the bore. \* \* \* On examining closely the fragments, it was seen that the fracture presented everywhere a fine grain, quite homogeneous, and of a regular brilliant and saccharoid crystallization. In the open air the fractured surfaces oxidized, but much more slowly than the surfaces of wrought or cast

FIG. 72.



(See page 103.)

Fig. 73.—Krupp's jacketed gun, burst at Woolwich.

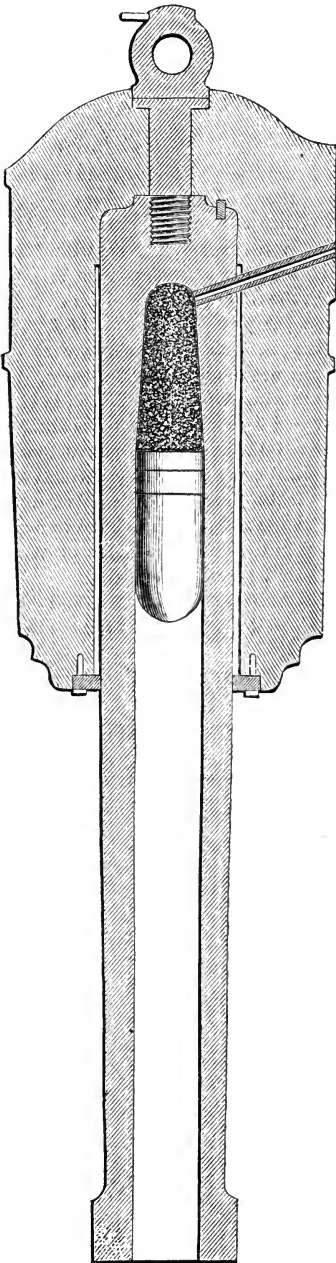
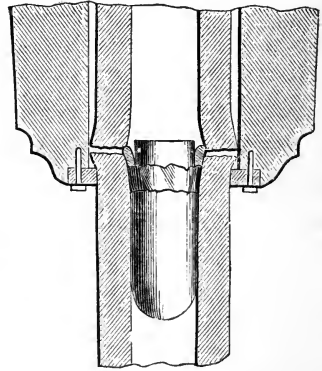


FIG. 74.



Krupp's gun (FIG. 73) after fracture.

**138.** Fig. 73 represents an 8-in. gun designed for a 68-pounder, and mounted in a cast-iron jacket. The jacket did not touch the chamber nor impart any strength to it, but was added for weight. The walls were from 4 to  $4\frac{1}{2}$  in. thick. The gun was burst at Woolwich, with 25 lbs. of powder and a 259-lb. shot.

Fig. 74 explains the cause of the disaster. The shot had a wrought-iron ring, V-shaped in section, fitted upon its end. When the explosion of the powder took place, this ring was broken, and was forced along the body of the shot, cutting up the cast iron to the extent of from 6 to 8 inches. The pieces of the shot thus cut

off, together with the broken ring, completely wedged the shot into the gun at the point shown. The shot was not forced out of the gun, but was carried, with the muzzle, to the proof-butt, and was here jerked out of the broken end and thrown some distance forward.\* The steel was afterwards found to have a tensile strength of 72000 lbs. per square inch.

**139.** A 12-pounder, sent by Mr. Krupp to Woolwich for test, was filled to the muzzle with powder, shot, and broken shells, but could not be burst, and was returned with the cascable knocked off, the gun having been thrown high in the air by the force of the explosion.†

**140.** Mr. Krupp expresses his readiness to fabricate 13 or 15-inch guns, and states that there are now no mechanical difficulties in

---

iron. \* \* \* This second series therefore proves that cast steel is neither better nor worse than bronze, but is much better than cast iron to withstand the effect of shot.

*Third Series.*—To find the extreme limit of resistance of cast-steel cannon, No. 1 was tested with extra charges, in the following progression:

20	rounds with	3k	(	6.6	lbs.)	powder	and	2	balls.
10	"	"	3k	(	6.6	"	"	3	"
5	"	"	6k	(	13.2	"	"	6	"

and it was intended to continue the firing until it burst, using 12<sup>k</sup> (26.4 lbs.) powder, and as many balls as the barrel would admit.

"After each fire the state of the bore and of the exterior surface were examined: the test with the star-gauge after the 20 fires showed that the bore was uninjured. In the next trial, 10 rounds with 3 balls, the gun resisted perfectly; only a slight enlargement of the vent was observed. Finally, 5 rounds with 6 balls were fired; the powder occupying 80 centimetres (32 in.) of the bore, and the balls occupying 70 centimetres (28 in.), so that the bore was filled within 30 centimetres (12 in.) with powder and balls. The explosion produced by these fires was enormous; the balls broke against each other in a thousand pieces; and the recoil of the gun was arrested only by the gabionade constructed in the rear; and the gun was buried in the ground so deeply that great labor was required to get it out, and replace it on the timbers after each fire. The gun was again examined after the five shots, and found to have resisted perfectly, the bore not having suffered the least deterioration.

"Preparations were made to fire with 12<sup>k</sup> (26.4 lbs.) powder and as many balls as possible, when an order was received to stop the test, and not to burst the gun: it would, in fact, have been a misfortune to destroy a piece that had so well borne these severe tests."

The report concludes by recommending a substitution of cast steel for bronze, especially for rifled cannon.

---

\* A similar accident occurred to one of Mr. Longridge's wire-bound guns, known to be excessively strong. (103.)

† "Construction of Artillery," Inst. C. E., 1860.

the way. The breech of muzzle-loaders of any size would be left solid, as the gun would be forged in the shape of a cylinder, and bored out. It may be remarked, that the weight of forged masses of a given quality has been increased nearly 10 times within a decade. Mr. Krupp sent a 5000-lb. block to the Exhibition of 1851, and one of above 44000 lbs. to the Exhibition of 1862.

**141. Bessemer Steel Guns.**—The Bessemer process of making steel direct from the ore, or from pig-iron, promises to ameliorate the whole subject of Ordnance and engineering construction in general, both as to quality and cost. This product has not yet been used for guns to any great extent, although Mr. Krupp, the leading steel maker, has introduced it. Captain Blakely and Mr. Whitworth have also experimented with it, and expressed their faith in its ultimate adoption. Messrs. John Brown & Co., Sheffield, have made over 100 gun-forgings, some of them weighing above 3 tons, from solid ingots of this steel. During the present year, their production of Bessemer steel will exceed 400 tons per week. With the two new converting vessels then in operation, solid ingots of 20 tons weight can be fabricated. A large establishment about to be started in London, with a 50-ton hammer, and a capacity to pour 30-ton ingots, will afford the best possible facilities for the development of this process.

**142.** The pig-iron is run into a converting vessel, where it receives a blast of air for 15 or 20 minutes, to burn out the carbon and silicium. It is then cast into an ingot, which is heated and forged into a gun.\*

**143.** The piece shown at Fig. 75 was made for the Belgian Government, quite early in Mr. Bessemer's practice. Its dimensions were: length of bore, 7 feet; diameter of bore, 4.75 in.; maximum diameter, 9.5 in.; thickness of walls, 2.37 in.; weight, 1070 lbs.—a very light gun. The test was 3 rounds with 2 spherical shot, 3 rounds with 3 shot, 3 rounds with 4 shot, 3 rounds with 5 shot, 3 rounds with 6 shot, 3 rounds with 7 shot, and 2 rounds with 8 shot, the powder being 2.2 lbs. in each case, when the gun

\* See chapter on "Cannon Metals—Steel."

broke in the chase, 39 inches from the muzzle, from the wedging of the shot. There was no alteration in the chamber.

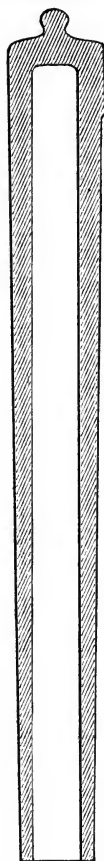
**143.** Among the Bessemer forgings in the Great Exhibition of 1862, was "a 24-pounder steel gun in the rough, with the trunnions formed upon it. This gun is the 92d made by Messrs. Henry Bessemer & Co.;"\* also, "a 24-pounder steel gun, bored and finished by Messrs. Fawcett, Preston, & Co., of Liverpool, for whom a dozen of the same size are in the course of being forged."\*

**144.** The present English prices for Bessemer gun-steel are, for a plain 1-ton forging, 9 cents per lb.; for the same, with trunnions forged on, 11 cents; for a 3 to 5-ton ingot, forged into a cylinder, 11 to 13 cents.

**145. Naylor, Vickers, & Co.'s Steel Gun-Forgings.**—At the establishment of Messrs. Naylor, Vickers, & Co., Sheffield, low steel of a very superior quality is made in ingots as heavy as 5 tons weight. In new works, to be in operation in 1864, ingots and forgings weighing 10 tons will be produced.

**146.** The following is from the official account of the trial of a 20-pounder (3.75 in.) gun of 1832 lbs. weight, rifled with 44 grooves, made from a forging of this steel:—"The Committee have the honor to report that the cast-steel block ordered from Messrs. Naylor & Vickers, of Sheffield, in December, 1859, but not delivered till July, 1862, has been duly converted into a 20-pounder Armstrong gun in the Royal Gun Factory, and has resisted 100 rounds fired with the service charge of  $2\frac{1}{2}$  lbs., and cylinders increasing in weight every 10th round from 20 lbs. to 200 lbs. The last 10 cylinders of 200 lbs. were 71.5 inches long, or only 14.125 inches less than the length of the bore. The block

FIG. 75.

Bessemer  
steel gun.\* London *Engineer*, May 2, 1862.

having been delivered without trunnions, a trunnion-coil was shrunk on in the Royal Gun Factories, and confined by a wrought-iron coil 14.5 inches long in front, corresponding to the 3 B coil of an ordinary gun, to which, in other respects, it corresponded in dimensions.

“The gun is still serviceable, and not perceptibly affected by the firing. It required rebouching at the 40th round, and there was at different periods of the proof a very considerable escape of gas, arising from the wear of the copper rings on the gun and on the vent-pieces.\*

“The Committee have to report that the 20-pounder Armstrong gun (exptl.), made in a block of cast steel supplied by Messrs. Naylor & Vickers, has completed the second series of proof-rounds, and is still entire. This series consisted of 10 rounds with double charge and service shot, and 27 rounds with double charge, and cylinders increasing every third round from the weight of 2 shot up to 10 shot—total, 37 rounds, or, including the trial previously reported, 137 rounds; the only effect upon the gun itself is, that the powder and shot chambers have expanded a little (about 0.008 inch). The bore is free from flaws.”†

**147. MUSHET AND CLARE'S 20-POUNDER.**—This gun, constructed and rifled like the above, was subjected to extreme proof, but did not endure the 100 rounds.

**148. MERSEY PUDDLED-STEEL GUN.**—An 8-in. gun of 7 tons weight was forged at the Mersey Works, from puddled steel, for Mr. Lynall Thomas. It burst after a few rounds, with a 145-lb. shot and a 25-lb. charge.

#### SECTION IV. CAST-IRON GUNS.‡

**149. Rodman and Dahlgren Guns.**—Although the United States Government has made little progress in the adaptation of

\* Report of the Ordnance Select Committee, Dec. 10, 1862.

† Report of the Ordnance Select Committee, May 13, 1863.

‡ Some facts about the endurance of cast-iron guns are given in a note under the head of cast iron (357). A 12-inch gun, cast for Commodore Stockton after the failure of the *Princeton's* wrought-iron gun (426), burst after a few fires, with 25 lbs. of powder.

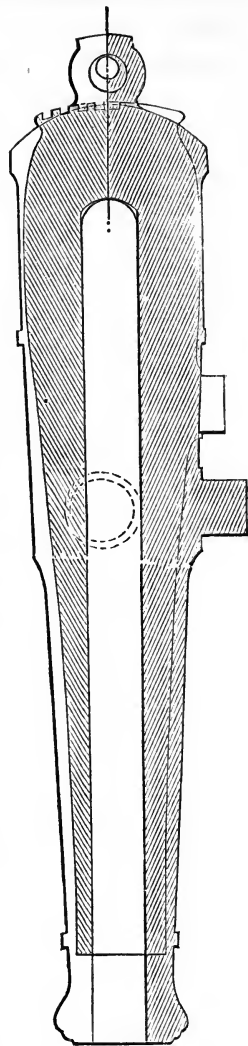
wrought iron and steel to cannon-making, it has certainly attained to a remarkable degree of perfection in the figure, material, and fabrication of its cast-iron guns. While constructors in Europe have carefully preserved the traditional shapes and ornamentation of early times—shapes that once had a significance, but are now only sources of weakness—the aim in America has been to ascertain the exact amount and locality of *strain*, and to proportion the parts with this reference, to the entire abandonment of whatever is merely fanciful and traditional.\*

The consequent saving of weight with a given strength at the point of maximum strain, is well illustrated by placing a section of the British 8-in. gun (68-pounder) over that of the United States army 8-inch columbiad, Fig. 76.

**150.** Equal attention has been paid to the selection and treatment of the material. The best American iron is admitted by English authorities to be superior to the best English: a good quality of iron for cannon is certainly the more abundant in America (355).

**151.** Major Rodman's process of casting guns hollow and cooling them from within (373), for the purpose of modifying the initial strains, when added to the advantages of good proportion and strong material, produces nearly or quite the best result attainable with simple cast iron. But the tension of this material at its elastic limit is so low (352), that it will not alone endure the pressure necessary to give the

FIG. 76.



Section of British 8-in. (68-pdr.) laid over section of U. S. 8-in. Columbiad. Scale,  $\frac{1}{16}$  in. to 1 ft.

\* See foot note under ¶ 236.

highest velocities to the heavy projectiles demanded by iron-clad warfare.

**152.** Considering, however, the failure of such a large proportion of the heavy wrought-iron guns (425, 426, 444 to 446), both built-up and solid, and the present scarcity and enormous cost of steel masses of the proper quality, it is by no means certain that the cast-iron barrel lined with steel, or as so largely and successfully used in America, France, and Spain, strengthened by hoops, is not the best temporary resort.

**153.** Hollow casting, the most obvious means of improvement, is not deemed important for heavy ordnance alone. The 4·2-inch rifled United States siege-gun is cast hollow and cooled from within. Indeed, the advantages of the process can be better realized in the 8 or 10-inch barrel cast for hooping, than in the 15-inch columbiad.

**154. Hollow-Cast Guns.**—All United States army guns down to 4·2 in. bore are hollow-cast. The 20 inch, 15-inch, and the successful 13-inch navy guns have been cast hollow. Recently, many of the chief officers of this department have strongly recommended hollow casting for all navy guns, and have begun to practise it in the construction of 10 and 11-inch guns.

The following abstract of official reports\* will explain the conduct and results of the hollow-casting process. Its merits and possible improvements are discussed in a succeeding chapter† (373).

On the 4th of August, 1849, two 8-inch columbiads were cast at the Fort Pitt Works, from the same iron. No. 1 was cast solid, in

\* "Reports of Experiments on Metals for Cannon," 1856.

† It is officially stated that the experimental *solid-cast* 13-in. guns for the navy have all burst at proof. The test prescribed was 500 rounds with service charges. One of the hollow-cast 13-in. guns fired 700 rounds.

The *Scientific American* gives the following account of the test of one of the *hollow-cast* 13-in. guns:—"The test applied was 30 lbs. of powder for the first 10 rounds, 40 lbs. for the second 10 rounds, and 50 lbs. for the remaining 158 rounds. The powder employed was much finer than is used in the service, and, of course, its explosive power was proportionately greater. The gun burst at the 178th round." The weight of the shot was 280 lbs.

Of two British 13-in. mortars, one cast hollow stood 2000 rounds without bursting, while one cast solid burst at the 533d round.



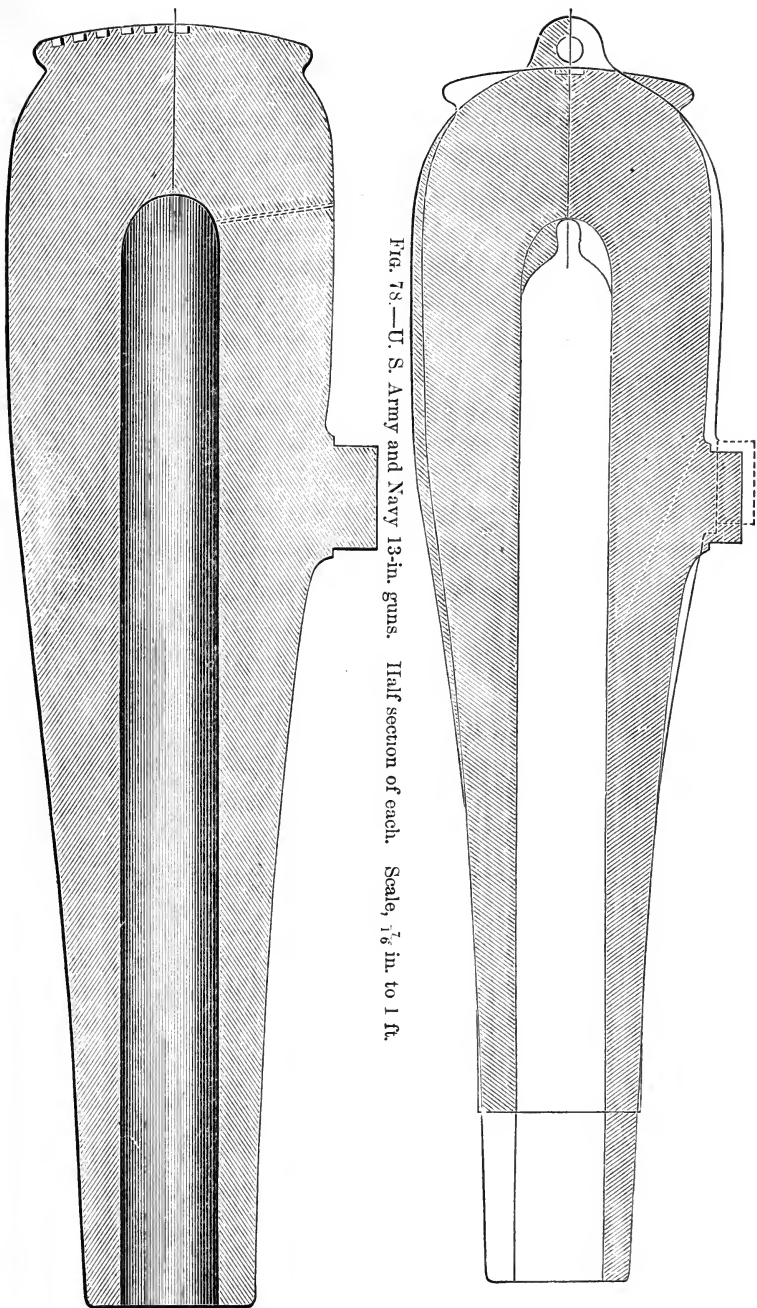


Fig. 77.—U. S. Army 15-in. Columbiad. Scale,  $\frac{1}{8}$  in. to 1 ft.

Fig. 78.—U. S. Army and Navy 13-in. guns. Half section of each. Scale,  $\frac{1}{8}$  in. to 1 ft.

FIG. 79.

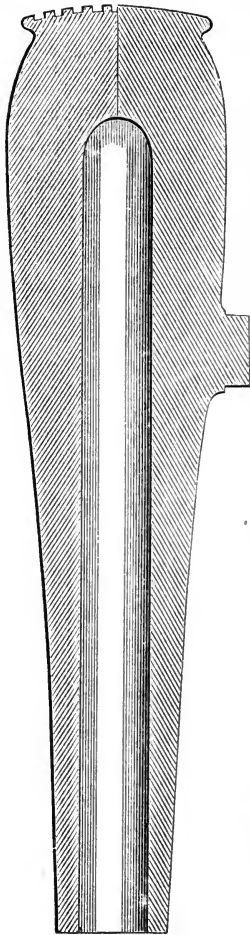
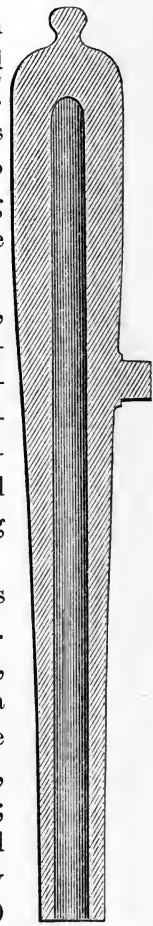
U. S. Army 10-in. Columbiad. Scale,  $\frac{1}{16}$  in. to 1 ft.

FIG. 80.

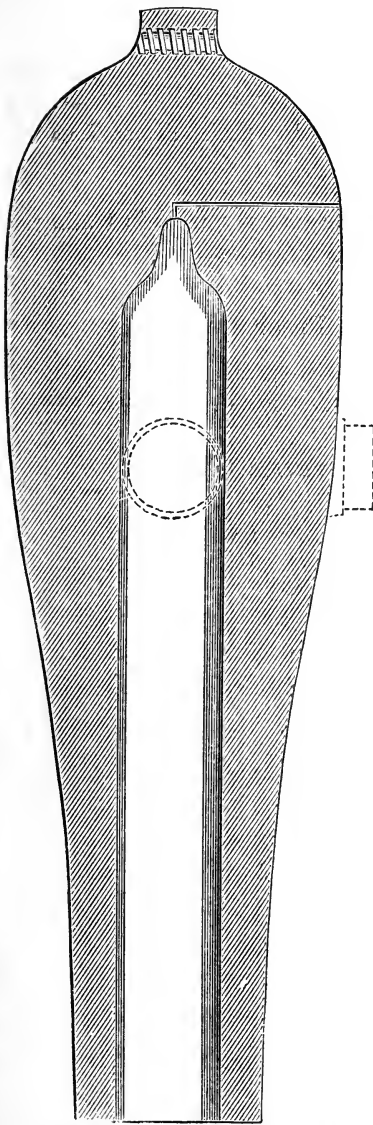
U. S. A. 4.2 in. siege-rifle. Scale,  $\frac{1}{16}$  in. to 1 ft.

the usual manner; No. 2 was cast on a hollow core, through which a stream of water passed while the metal was cooling. The iron for both castings was melted at the same time in two air furnaces, each containing 14000 lbs. After melting, the liquid iron remained in the furnaces, exposed to a high heat, for one hour; it was then discharged into a common reservoir, whence it issued in a single stream, which, after proceeding a few feet, separated into two branches, one leading to each mould.

**155.** The solid casting was cooled as usual, in an open pit. "The hollow casting was cooled, in the interior, by passing a stream of water through the core, for a period of 40 hours, when the core was withdrawn; after which the water passed through the interior cavity formed by the core, for 20 hours. The average quantity of water passed through during

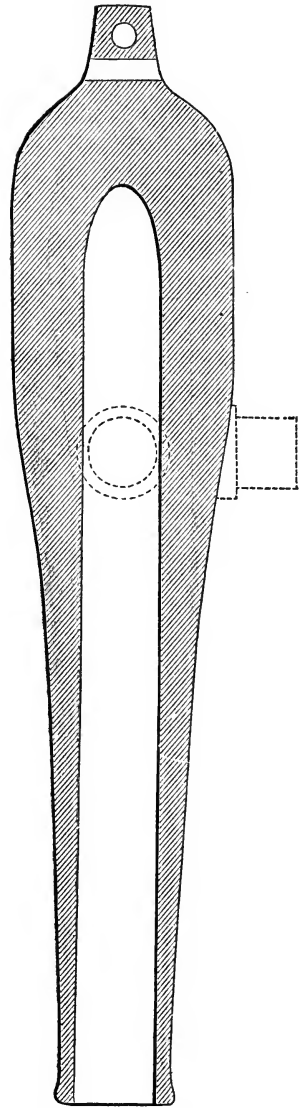
the whole period was 1.66 cubic feet per minute, or 100 feet per hour; making in all 6000 cubic feet, weighing 187 tons. The temperature of the water was increased  $20^{\circ}$  during the first hour;  $13^{\circ}$  during the 20th hour;  $8^{\circ}$  during the 40th hour; and  $3^{\circ}$  during the 60th and last hour. The weight of the water passed through is 30 times the weight of the casting; and the heat imparted by the casting to the water, and carried off by the

FIG. 81.



U. S. Navy 15-in. gun. Scale,  $\frac{1}{16}$  in. to 1 ft.

FIG. 82.

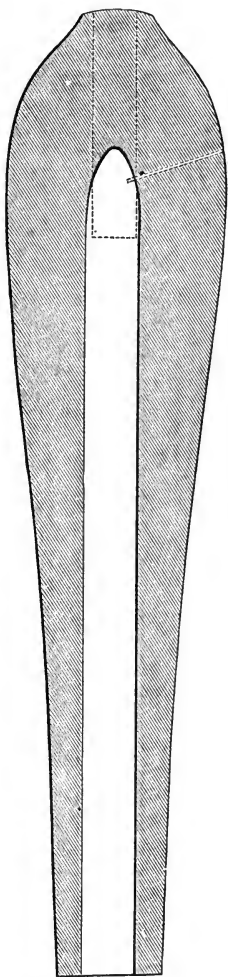


U. S. Navy 11-in. Dahlgren gun. Scale,  $\frac{1}{16}$  in. to 1 ft.

latter, is equal to  $10^\circ$  on the whole quantity of water used. The mould for this casting was placed in a covered pit, which had

been previously heated to about  $400^{\circ}$ ; and this heat was kept up as long as the stream of water was supplied. Both columbiads were completed and inspected September 6th, and were found to be accurate and uniform in their dimensions and weights."

FIG. 83.



Dahlgren  $7\frac{1}{2}$ -in. rifle. Scale,  
 $\frac{1}{16}$  in. to 1 ft.

**156.** The charges used in testing the guns were as follows:—

#### PROOF CHARGES.

- 1st fire, 12 lbs. powder, 1 ball, and 1 wad.  
2d fire, 15 lbs. powder, 1 shell, and 1 sabot.

#### SERVICE CHARGES.

- 10 lbs. powder, 1 ball, and 1 sabot.  
Mean weight of balls used,  $63\frac{1}{2}$  lbs.  
Mean weight of shells used, 49 lbs.  
Mean proof range of powder used, 298 yards.

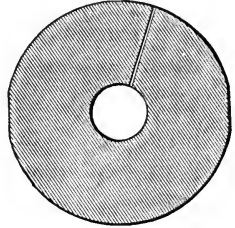
The guns were fired alternately, up to the 85th fire, at which columbiad No. 1, cast solid, burst. Then the proof proceeded with No. 2, which burst at the 251st fire, having endured nearly 3 times as much service as the other.

**157.** On the 30th of July, 1851, two more 8-inch columbiads were cast at the same foundry, and under similar circumstances; the one was cast solid, and the other hollow. The iron for both (Greenwood) remained in fusion  $2\frac{1}{2}$  hours, exposed to a high heat.

**158.** The core for the hollow gun was formed upon a water-tight cast-iron tube closed at the lower end. The water descended to the bottom of this tube by a central tube open at the lower end, and ascended through the annular space between the tubes. "The

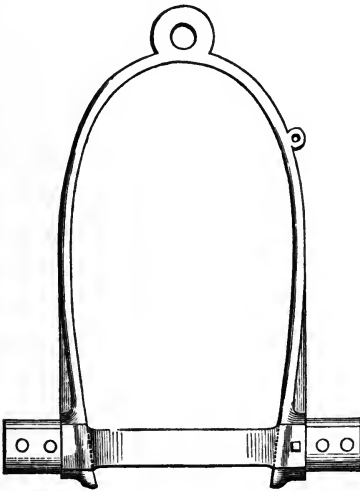
water passed through the core at the rate of  $2\frac{1}{2}$  cubic feet per minute, or 150 feet per hour. At 25 hours after casting, the core was withdrawn, and the water thereafter circulated through the interior cavity formed by the core, at the same rate for 40 hours; making 65 hours in all. The whole quantity of water passed through the casting was nearly 10000 cubic feet, weighing about 300 tons, or about 50 times the weight of the casting. The heat imparted by the casting to the water, and carried off by the latter, is equal to  $6^\circ$  on the whole quantity of water used.

FIG. 84.



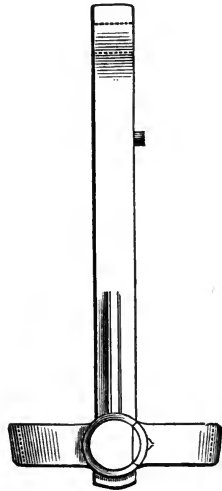
Cross-section Dahlgren  
7 $\frac{1}{2}$ -in. rifle. Scale,  $\frac{1}{16}$   
in. to 1 ft.

FIG. 85.



Dahlgren breech strap for 7 $\frac{1}{2}$ -in. rifle. Scale,  $\frac{1}{16}$  in. to 1 ft.

FIG. 86.



“A fire was kindled in the bottom of the pit directly after casting, and was continued 60 hours. The pit was covered, and the iron case containing the gun-mould was kept at as high a temperature as it would safely bear, being nearly to a red heat, all the time.”

**159.** Shortly afterwards (August 21st) two 10-inch columbiads were cast, of the same iron, the one solid, and the other hollow. Both moulds were placed in the same pit, and all the space in the pit, outside of the moulds, was filled with moulding-sand and rammed. "This was done because the iron cases of the moulds were not large enough to admit the usual thickness of clay in the walls of the mould. It was apprehended that the heat of the great mass of iron within, would penetrate through the thin mould, and heat the iron cases so much as to cause them to yield and let the iron run out of the mould." The external cooling of the 10-inch hollow gun, by the contact of the flask with green sand, was therefore much more rapid than that of the 8-inch hollow gun.

**160.** "Water was passed through the core at the rate of about 4 cubic feet per minute, or 240 feet per hour, for 94 hours; amounting in all to 22560 feet, weighing about 700 tons, or 70 times the weight of the casting. The mean elevation of the temperature of all the water passed through the core in 94 hours, was about  $3\frac{1}{2}^{\circ}$ . At the end of this period an attempt was made to withdraw the core from the casting, which proved unsuccessful. The contraction of the iron around it held it so firmly, that the upper part of it broke off, leaving the remainder imbedded in the casting. The stream of water was then diminished to about 2 feet per minute, which continued to circulate through the core for 48 hours. The supply of water allotted to and circulated through both the 8-inch and 10-inch guns was equal, in weight, to the weight of each casting, in about 1 hour and 20 minutes."

**161.** The proof of the 8-inch guns commenced August 28th; that of the 10-inch guns, October 7th. "Eighty fires per day were easily made with 7 men, in 5 hours, from the 8-inch gun; and with 9 men, 60 fires were made in the same time from the 10-inch gun. \* \* \* Fifteen fires were sometimes made from the 8-inch gun in 30 minutes. \* \* \* The two guns making the pair to be compared were fired alternately, one discharge from each, in regular succession, until one of them burst, when the firing of the survivor was continued by itself alone. The powder of the

cartridges of each pair was of the same proof range, and taken from the same cask."

### PROOF CHARGES.

8-inch.	{	1st fire, 12 lbs. powder, 1 ball and sabot, and 1 wad.
		2d fire, 15 lbs. powder, 1 shell with sabot.
10-inch.	{	1st fire, 20 lbs. powder, 1 ball and sabot, and 1 wad.
		2d fire, 24 lbs. powder, 1 shell with sabot.

### SERVICE CHARGES.

8-inch	10 lbs. powder, 1 ball with sabot.
10-inch	18 lbs. powder, 1 ball with sabot.
	Weight of 8-inch balls, $63\frac{1}{2}$ lbs.; of shells, $48\frac{1}{2}$ lbs.
	Weight of 10-inch balls, 124 lbs.; of shells, 91 lbs.

"The number of fires made from each gun, including proof charges, was as follows:—

8-inch gun, No. 3,	cast solid, 73 fires.
8-inch gun, No. 4,	cast hollow, 1500 fires.
10-inch gun, No. 5,	cast solid, 20 fires.
10-inch gun, No. 6,	cast hollow, 249 fires.

"Each of them, excepting the 8-inch gun No. 4, cast hollow, burst at the last fire; and that remains unbroken, and apparently capable of much further service.

"On comparing the enlargements of the bores (made by an equal number of fires) of the guns cast solid with those cast hollow, it will be seen that, in both pairs of guns, the enlargement is least in those cast hollow. \* \* \*

**162.** "The less endurance of the 10-inch hollow gun than that of the 8-inch hollow one, is accounted for by the fact that the 10-inch gun had no fire on the exterior of the flask while cooling, it having been rammed up in the pit, where it was supposed, at the time of casting, the heat of the gun would have been retained by the sand until the interior should have been cooled by the circulation of water through the core-barrel. This supposition was found to be erroneous on digging out the sand, as its temperature was found to be much lower than had been expected."

**163. TEST OF NEW ORDNANCE.**—The proposals for army guns, 1863, specify that the iron is to have a tenacity of not less than 30000 lbs., and that a trial-gun is to endure 1000 rounds with service charges, 200 rounds to be with solid shot, and 800 rounds with shells. In the Navy Department the test is as follows:—The maker is required to provide sufficient iron of uniform make and quality to execute the entire order. Five guns are cast, and the iron is tested. The strength of that which is nearest the average of the five specimens is prescribed as the standard of strength. This should be about 30000 lbs. per square inch. A variation of 2500 lbs. each way, that is, from 27500 lbs. to 32500 lbs., is allowed. A similar rule is observed with regard to the specific gravity, which should be about 7.23. The proof for the smaller guns is, that one gun out of the whole order shall endure 1000 rounds with service charges. For guns of 13-in. bore and upwards, 500 rounds are required.\*

One of the 15-inch navy guns was fired 900 times at elevations from 0 to 5°. The charge commenced at 35 lbs. It was then increased to 50 lbs. With 60 lbs. 220 rounds were fired. The gun at length burst with 70 lbs. The shot in all cases was 440 lbs. After the first 300 rounds, the chamber (Fig. 81) was bored out to a nearly parabolic form, and the chase was turned down 3 inches, so as to fit the port designed for the 13-in. gun.

**164. COLUMBIADS.**—“The columbiads are a species of sea-coast cannon, which combine certain qualities of the gun, howitzer, and mortar; in other words, they are long, chambered pieces, capable of projecting solid shot and shells, with heavy charges of powder, at high angles of elevation, and are therefore

\* “No gun has been accepted as a *standard*, which has not been subjected to the ordeal of 1000 rounds of service charges. With this standard thus established, all the guns of a contract must coincide in their composite elements. The only exception to the rule has been in the case of the 15-inch guns cast upon the plan of Major Rodman, of the United States Army. Time did not admit of this proof being applied, and the guns were necessarily accepted and put into service, after having endured, however, somewhat more than the tests prescribed by the army regulations.”—*From the Report of the Chief of Ordnance, U. S. Navy Department, Oct. 20, 1863.*



equally suited to the defence of narrow channels and distant roadsteads.

“The columbiad was invented by the late Colonel Bumford, and used in the war of 1812 for firing solid shot. In 1844 the model was changed, by lengthening the bore and increasing the weight of metal, to enable it to endure the increased charge of powder, or  $\frac{1}{2}$  of the weight of the solid shot. Six years after this, it was discovered that the pieces thus altered did not always possess the requisite strength. In 1858 they were degraded to the rank of shell guns, to be fired with diminished charges of powder, and their places supplied with pieces of improved model.

**165.** “The changes made in forming the new model, consisted in giving greater thickness of metal in the prolongation of the axis of the bore, which was done by diminishing the length of the bore itself; in substituting a hemispherical bottom to the bore and removing the cylindrical chamber; in removing the swell of the muzzle and base ring; and in rounding off the corner of the breech.”\* The present model, as illustrated, was proposed by Captain Rodman, in 1860.

**166. New Guns—20-Inch Guns.**—In addition to the heavy ordnance illustrated in the accompanying engravings, the Navy Department has introduced a superior gun of 10-inch calibre, called a 125-pounder. The exterior dimensions are nearly the same as those of the 11-inch gun, except that the maximum diameter of the reinforce is continued farther forward (3 calibres). The first of these guns was cast solid, and endured 47 lbs. of powder and 125-lb. balls for some hundred rounds. The new 10-inch gun is cast hollow; charge, 40 lbs.; shot, 125 lbs. Its dimensions are given in Table 23.

The chambers of the navy 13 and 15-in. guns, as shown in the engravings, have recently been changed to a shape nearly parabolic.

The Navy Department has four 12-in. rifles, cast hollow, of about the exterior dimensions of the 15-inch gun. It is believed

\* “Ordnance and Gunnery,” Benton, 1862.

that they will have satisfactory endurance with 50-lb. charges and 600-lb. bolts.

Twenty-inch guns for the army and navy have recently been cast at Pittsburg. The following are the particulars of the metal and the fabrication of the first 20-inch (army) gun:—

The iron was high No. 2, warm blast (200°) hematite, from Blair county, Pennsylvania. The smelted pigs were remelted and cast into pigs, which were again melted in three air-furnaces. The weight of iron was 172000 lbs.; the time of melting,  $7\frac{1}{2}$  hours; the time of casting, 23 minutes. Water, run through the core at the rate of 30 gallons per minute, during the first hour was heated from 36° to 92°; during the second hour, at the rate of 60 gallons per minute, water emerged at 61°. From the 15th to the 20th hour after casting, the water was heated 21·5°. After the 26th hour the core-barrel was removed, and air was forced into the bore at the rate of 2000 cubic feet per minute. The metal was considered too high to be cooled by the direct contact of water. At the 50th hour after casting, the air emerging from the gun was 130 seconds in rising 60° to 212°. The gun was cast on the 11th of February, 1864. On the 17th, the difference in the temperature of the entering and emerging air was 100°; on the 20th it was 33°. Air circulated through the bore till the 24th.

The mould, 5 to 6 inches in thickness, was made in a two-part iron flask,  $1\frac{1}{2}$  in. thick. On the 23d the upper part of the mould was removed; on the 24th the lower part was removed; on the 25th the gun was removed from the pit.

The density of the metal taken from the casting was 7·3028. The tenacity was 28737 lbs. per square inch.

NOTE.—“The only establishments in the country, which were prepared for the work of founding heavy cannon when the rebellion took place, were at the South Boston, Fort Pitt, and West Point foundries. \* \* \* In addition to the above-named foundries, the bureau has now, as sources of supply, the establishment at Providence, R. I., known as the Builders' Iron Foundry; the foundries of Messrs. Hinkley, Williams & Co., of Boston, and the Portland Co. of Portland, Maine; and at Reading, Pa., the Scott Foundry of Messrs. Seyfert, McManus & Co.”—*From Report of the Chief of Ordnance, U. S. Navy Department, Oct. 20, 1863.*

At the Fort Pitt foundry, over 2000 cannon, among them 108 fifteen-inch guns, have been cast since the outbreak of the rebellion (Sept. 1864.)

TABLE XXII.—PARTICULARS AND CHARGES OF U. S. HOLLOW-CAST IRON ARMY ORDNANCE.

THE HEAVY GUNS HAVE NO PREPONDERANCE.

(See also Table of Parrott Guns.)

NAME OF GUN.	Length.		Length of bore.		Maximum diameter.		Weight.		Service charge.*		Bursting charge. Shell.		Weight of shot.		Weight of shell.		Remarks.	
	in.	in.	in.	in.	in.	in.	lbs.	lbs.	lbs.	lbs.	lbs.	lbs.	lbs.	lbs.	lbs.	lbs.		
SMOOTH-BORES.																		
20-inch Columbiad.....	243.5	210	64	115200	100	100	.....	1000	.....	.....	.....	.....	.....	.....	.....	.....	.....	{ Weight of shell not determined. Cored shot.
15-inch do.* .....	190	165	48	49100	{ 50 { .6 grain. }	17	{ 440 { 425 }	330	224	100	68	48	30	30	30	30	{ Twist uniform. 1 turn in 15 feet. Preponderance 300 lbs.	
13-inch do. ....	177.6	155.94	41.6	32731	30 No. 5.	7	{ 300 { 280 }	224	100	127½	100	48	10	10	10	10		
10-inch do. of 1860.....	136.66	105.5	32.	15059	{ 15 for shell. { 18 for shot. }	3	.....	30	.....	.....	.....	.....	.....	.....	.....	.....	RIFLES.	
8-inch do. ....	123.5	110	25.6	8465	10	1½	.....	30	.....	.....	.....	.....	.....	.....	.....	.....		
4½-inch Siege-Gun of 1860† .....	133	120	16	3450	3½	.....	.....	30	.....	.....	.....	.....	.....	.....	.....	.....	* Above one hundred 15-inch army guns are in service.	
3-inch Field - Gun of 1861.....	72.65	65	9.7	830	1	.....	.....	10	.....	.....	.....	.....	.....	.....	.....	.....		

† The bore of the rifled siege-guns is reduced to 4.20 in.

TABLE XXIII.—PARTICULARS AND CHARGES OF U. S. CAST-IRON NAVY ORDNANCE IN SERVICE.

NAME OF GUN.	Length of bore.	Maximum diameter.	Weight.	Service charge.	Maximum charge.	Weight of shot.	Weight of shell.*	Remarks.
SMOOTH-BORES.								
20-inch Gun	163	64	100000	Probably 100	.....	1000	lbs.	Shell not determined. Cored shot and gun cast hollow.
15-inch do.	130	48	42000	35	60	400	330	Cast hollow. Cored shot.
13-inch do.	130	44.7	36000	40	.....	280	224	Cast hollow.
11-inch do.	132	32	16000	15	20	170	130	Lately cast hollow.
10-inch do.	119½	29.1	12000	12½	16	125	100	Cast solid.
9-inch do.	107	72.2	9200	10	13	93	70	Cast solid.
125-Pdr. (10-in.)	117½	33.25	16500	40	.....	125	100	Cast hollow.
RIFLES.								
Parrott 10-inch	144	40	26500	25	.....	230 to 250	250	The Parrott guns are hooped with wrought iron, and are lately cast hollow.
" 8-inch	136	32	16300	15	.....	132 to 175	152 to 175	
" 100-Pdr. (6.4-in.)	130	25.9	9700	10	.....	70 to 100	100	

\* Windage with shells, 0-15 in.; with shot, 0-2 in. in shell guns. The above smooth-bores are all shell-guns except the 125-pdr. The cost of the smooth-bores is 74 to 84 cents per pound.

† Note.—The following are the instructions relative to the charges of the 15-inch gun:—"No useful effect in *shell*-firing is to be expected by increasing the charge beyond 35 lbs., except in cases where the shell will not reach the object without such increase; and 50 lbs. cannon powder is the maximum charge which can be burnt in the 15-inch gun with a *shell*. *Cored shot* should never be used except against masonry at short ranges, and then with 50-lb. charges, using a sabot, and taking care that *the plug of the core-hole is outward*. *Solid shot* should always be used against iron-clads, and with 60-lb. charges, but never fired on any other occasion. At close quarters—say 50 to 150 yards—40 lbs. may be used for 20 rounds of *solid shot*. *Cannon powder* only should be used, as 35 lbs. of this kind gives a greater range than 50 lbs. manmoth powder; and this charge of the latter cannot be burnt in the gun."

The gun closely resembles the 15-in. gun in figure; the particulars are as follows :

Length of gun.....	20 ft.	3½ in.
“ bore .....	17 “	6 “
“ trunnions .....		6½ “
Diameter, maximum.....	5 “	4 “
“ muzzle .....	2 “	10 “
“ bore .....	1 “	8 “
“ trunnions .....	1 “	6 “
Distance over rimbases.....	5 “	4.2 “
Weight .....	115200	lbs.
Chamber ellipsoidal, length.....		15 in.

The particulars of the 20-inch navy gun are as follows :

Length of gun.....	17 ft.
“ bore .....	13 “ 7 in
“ trunnions.....	6 “
Diameter, maximum .....	5 “ 4 “
“ muzzle.....	2 “ 10 “
“ bore .....	1 “ 8 “
“ trunnions .....	1 “ 4 “
Distance over rimbases.....	5 “ 4 “
Weight (about).....	100000 lbs.

**167. British Cast-Iron Guns.**\*—(See Table 25.) The standard cast-iron gun in England—in fact, the standard Naval Gun—is the 95 cwt. 68-pounder of 8 in. diameter and 113.9 in. length of bore, and 26.2 in. diameter over the chamber (Fig. 87). Its cost is about \$500.

**168.** At the siege of Sebastopol, the 68-pounders were, on the whole, very satisfactory in their results and endurance. Only two of them burst, both at high elevations, and one after having fired over 2000 rounds. (See Table 24.) Some of those landed from the “*Terrible*” fired as many as 4000 rounds, usually with 16 lbs. of powder, and very rapidly. Some of them were rebouched twice.†

The other ordnance used in this siege, 911 pieces in all, consisted of 24-pounders and 32-pounders, which had little effect on masonry—8-in. and 10-in. shell-guns, and 13-in., 10-in., and 8-in. mortars.

\* It is stated that 100 new 68-pounders have been recently ordered, on account of the failure of the Armstrong gun as a naval weapon.

† Military Commission to Europe, Major Mordecai, 1860.

FIG. 87.—British 68-pounder (8-in.) 95 cwt. Scale,  $\frac{1}{16}$  in. to 1 foot.

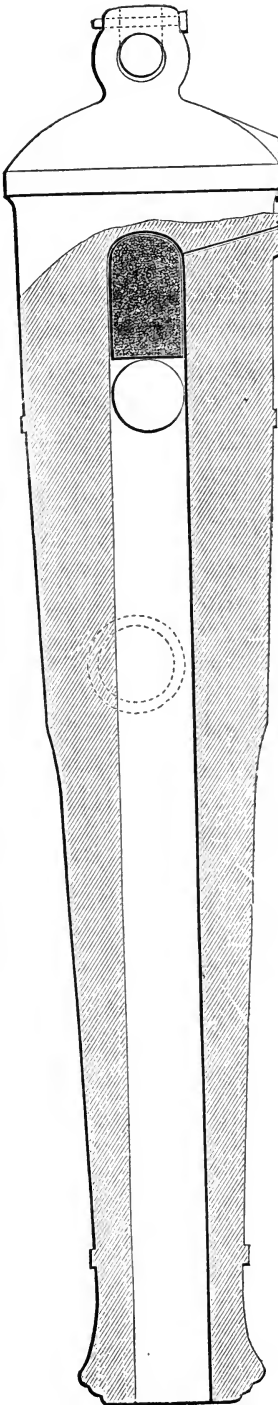
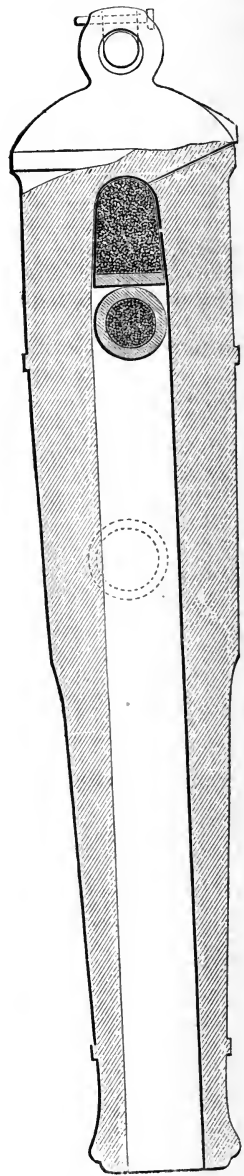


FIG. 88.



British 8-in. shell gun.  
Scale,  $\frac{1}{16}$  in. to 1 ft.

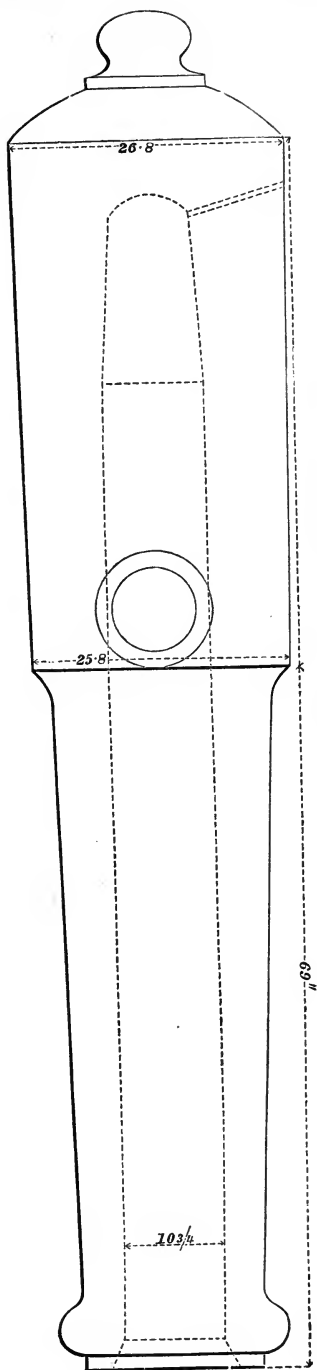
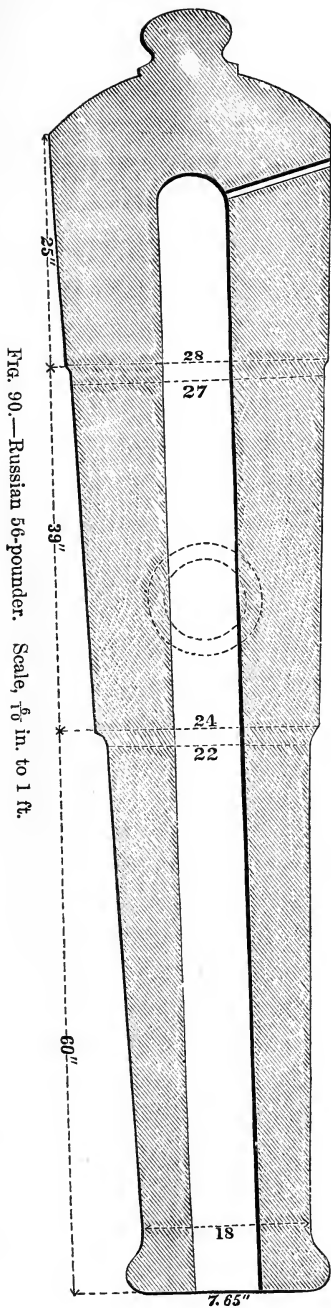


TABLE XXIV.—GUNS BURST AT SEBASTOPOL AND SWEABORG.

These guns were all of cast iron, unstrengthened.

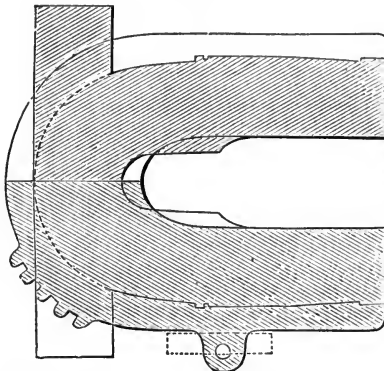
No. burst.	Description and calibre.	No. of rounds fired.	Cause of bursting.
1	13-inch Mortar, old pattern	No information.	No information.
2	10-inch Mortar, old pattern	No information.	No information.
2	68-pounder, 95 cwt.	1st, Fired over 2000 rounds. 2d, No information.	Fired at high elevation. Enemy's shell burst in muzzle.
1	10-inch Gun, 85 cwt.	No information.	No information.
1	32-pounder, 56 cwt.	No information.*	No information.
2	24-pounder, 50 cwt.	No information.†	No information.
3	Lancaster 8-inch Guns.	No information.	No information.

\* The 32-pounders averaged 1500 rounds each.

† The 24-pounders averaged 950 rounds each.

**169. Miscellaneous Cast-Iron Guns\* and Mortars.**—The Russian 120-pounder shell-gun is illustrated by Fig. 89. Its length (to end of reinforce) is 130 in.; diameter over the chamber, 26·8 in.; diameter of bore, 10·75 in. The 56-pounder, illustrated

FIG. 91.



British and U. S. 13-inch sea-service mortars. Half section of each. Scale,  $\frac{7}{16}$  in. to 1 ft.

by Fig. 90, is intended as both a shot and shell gun. The particulars of it are: length (to end of reinforce) 124 in.; diameter over the chamber, 28·7 in.; diameter of bore, 7·65 in.; weight, 13700 lbs. The other modern Russian cast-iron guns are chiefly of the calibres of 40-pounders and 96-pounders.†

**170.** Fig. 91 illustrates the difference in figure between the British and the United States 13-in. sea-service mor-

\* The Wahrendorf and Cavalli breech-loading cast-iron guns will be illustrated under the head of Breech-Loading.

† Military Commission to Europe, Major Mordecai, 1860.



tars.\* The particulars and charges of British mortars are given in Table 26. The United States 13-in. mortar weighs 17120 lbs.; length of bore, 2·7 diameters. It has no preponderance. The charge is 20 lbs.; projectile, 220 lbs. The 10-in. and 8-in. mortars have bores  $1\frac{1}{2}$  diameters long, measured from the bottom of the projectile, and their weight is about 20 times that of the shell.

\* The faulty form of the British mortar is thus referred to by Commander Scott, in a lecture before the Royal United Service Institution:—"The effect produced by this faulty form was seen in the bombardment of Sweaborg, when nearly the whole of the mortars employed either burst, or were rendered unserviceable; the best, that of the *Growler*, cast in 1813, standing 355 rounds only.

"By a reference to Fig. 92, it will be seen that the trunnions prevent the expansion of the iron at the places where they unite with the piece; hence, as the iron warms, it expands at the bottom, and the mortar being supported upon its trunnions, a severe shock is thrown upon that part which is in the line of least metal. and has been further weakened by expansion; the result is, a gradual disturbance of particles and rapid deterioration, until at length the mortar opens and generally splits in two pieces, much as if chopped down by some instrument.

An inspection, however, of the remains of the mortars will afford convincing proof that some cause was at work to produce such very similar results, and will show how little our mortars are to be relied on for continuous bombardment."

The cast-iron mortar of 24-inch bore, and 17904 lbs. weight, made at Liege for the siege of Antwerp, in 1832, burst after a few rounds.

Several 18-inch mortars were cast hollow on 14-inch cores, by Messrs. Forrester & Co., for the British government. They have not been in service.

Nearly twenty years ago, Messrs. Walker, of the Gospel Oak Foundry, cast a 20-in. mortar for Egypt.

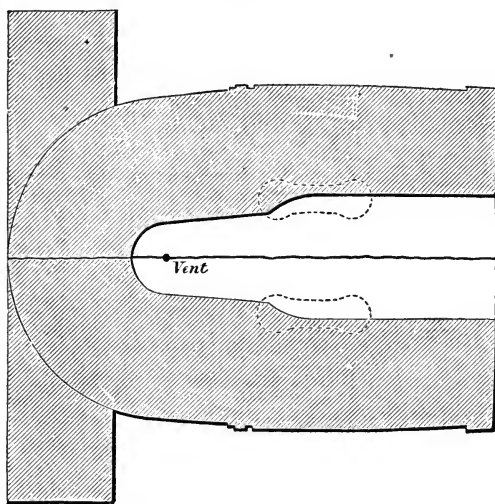


FIG. 92.

British 13-in. mortar burst at Sweaborg.

TABLE XXV.—PARTICULARS AND CHARGES OF BRITISH CAST-IRON GUNS.

NAME OF GUN.	Weight.	Preponderance.	Diameter over rear of chamber.	Length of bore.	Diameter of bore.	Diameter of chamber at rear.	Length of trunnions.	Diameter of trunnions.	Proof charge.	Service charge.	Windage.
	cwt.	cwt.	in.	in.	in.	in.	in.	in.	lbs.	lbs.	in.
10-inch Gun, No. 1.....	87	9	25.86	109.33	10	7.5	6	7.25	20	12	0.16
10-inch Gun, No. 2.....	84	8.25	25	109.33	10	7.5	6	7.25	18	12	0.16
68-pounder Gun, No. 1.....	113	10.784	27.56	123.4	8.12	8.12	6.5	8.12	30	20	0.2
68-pounder Gun, No. 2.....	96	10.536	26.2	113.9	8.12	8.12	6.5	8.12	28	16	0.2
68-pounder Gun, No. 3.....	87	8.536	25.62	107.85	8.12	8.12	6.5	8.12	25	14	0.2
8-inch Gun, No. 1.....	65	7.8	22.3	105.27	8.05	5.89	6	7.25	20	10	0.125
8-inch Gun, No. 2.....	60	6.1875	21.76	103.35	8.05	5.89	6	7.25	20	10	0.125
8-inch Gun, No. 3.....	52	6.679	21.7	93.7	8.05	5.89	6	7.25	16	8	0.125
8-inch Gun (short).....	50	7.125	21.5	80.5	8.05	6	6	6	14	8	0.125
56-pounder Gun, No. 1.....	97	10.286	26.35	124.86	7.65	7.65	6.5	7.65	28	16	0.175
56-pounder Gun, No. 2.....	85	9.0625	25.92	113.08	7.65	7.65	6.5	7.65	25	14	0.175

42-pounder Gun, No. 1.....	84	9	24.7	114	6.97	6.97	6	6.97	25	14	0.2
42-pounder Gun, No. 2.....	75	7.036	23.3	114	6.97	6.97	6	6.97	25	12	0.2
42-pounder Gun, No. 3.....	67	6.5625	22.78	108.73	6.97	6.97	6	6.97	23	10 lbs. 8 oz.	0.2
32-pounder Gun, No. 1.....	56	5.09	20.12	107.2	6.41	6.41	6.61	6.41	21 lbs. 8 oz.	10	0.233
32-pounder Gun, No. 2*.....	46	6	19.1	102.5	6.41	6.41	6	5.823	12	6	0.173
32-pounder Gun, No. 3.....	48	4.536	20.73	89.22	6.41	6.41	6.6	6.4	21 lbs. 8 oz.	8	0.233
32-pounder Gun, No. 4†.....	41	5.214	19.2	90	6.375	6.375	6	5.823	12	6	0.198
32-pounder Gun, No. 5†.....	39	3.5	19.2	84.6	6.375	6.375	6	5.823	12	6	0.198
32-pounder Gun (58 cwt.).....	58	6.0375	21.03	108.65	6.375	6.375	6.61	6.41	18	6	0.198
32-pounder Gun, A.....	50	6.75	20.86	103.08	6.375	6.375	5.75	6.35	18	6	0.198
32-pounder Gun, B.....	45	6	20.4	97.23	6.35	6.35	5.75	6.35	16	7	0.173
32-pounder Gun, C.....	42	5.75	20.35	91.25	6.35	6.35	5.75	6.35	14	6	0.173
32-pounder Gun (short), No. 1.....	25	3.625	17.42	67.64	6.3	6.3	4.25	5.292	9	4	0.123
32-pounder Gun (short), No. 2§.....	32	3.25	18.41	72.3	6.3	6.3	5.9	5.823	10	5	0.123
32-pounder Gun (short), No. 3.....	25	2.714	17	64.1	6.3	6.3	4.25	5.292	9	4	0.123
Congreve's 24-pounder Gun.....	41	3.41	20.25	83.95	5.823	5.823	6	5.823	15	6	0.211

\* Bored up from 24-pdr. of 48 cwt.

† Bored up from 18-pdr. of 42 cwt.

‡ Bored up from 24-pdr. of 40 cwt.

§ Bored up from 24-pdr. of 33 cwt.

$\left. \begin{matrix} 10 \\ 8 \\ 5 \end{matrix} \right\}$

TABLE XXV.—CONTINUED.

NAME OF GUN.	Weight.	Preponderance.	Diameter over rear of chamber.	Length of bore.	Diameter of bore.	Diameter of chamber at rear.	Length of trunnions.	Diameter of trunnions.	Proof charge.	Service charge.	Windage.
	cwt.	cwt.	in.	in.	in.	in.	in.	in.	lbs.	lbs.	in.
Congreve's Bored up to 32-pounder Gun.....	40	3.5	20.25	84.2	6.32	6.32	6	5.823	12	6	0.173
24-pounder Gun, No. 1.....	50	4.5	19.05	107.41	5.823	5.823	6	5.823	18	8	0.211
24-pounder Gun, No. 2.....	48	4.5	19.1	101.5	5.823	5.823	6	5.823	18	8	0.211
24-pounder Gun (33 cwt.).....	33	3.25	18.41	71.79	5.823	5.823	5.9	5.823	12	6	0.211
18-pounder Gun, No. 1.....	42	3.625	17.95	101.75	5.292	5.292	5.42	5.292	15	6	0.193
18-pounder Gun, No. 2.....	38	3.5	17.92	89.74	5.292	5.292	5.42	5.292	15	6	0.193
18-pounder Gun, No. 1*.....	22	3.161	15.33	79.42	5.17	5.17	4.2	4.2	7	3	0.071
18-pounder Gun, No. 2†.....	20	2.5	15.68	67.356	5.17	5.17	4.623	4.623	7	3	0.071
18-pounder Gun, No. 3†.....	15	1.95	13.93	61.84	5.17	5.17	4.2	4.2	5	2	0.071
12-pounder Gun, No. 1.....	34	3.5	16.22	102.23	4.623	4.623	4.72	4.623	12	4	0.096
12-pounder Gun, No. 2.....	33	3.0625	16.26	96.221	4.623	4.623	4.75	4.623	12	4	0.096
12-pounder Gun, No. 3.....	29.5	2.625	16.45	84.25	4.623	4.623	4.75	4.623	12	4	0.096
12-pounder Gun, No. 4.....	21	2.143	15.68	66.515	4.623	4.623	4.623	4.623	10	4	0.096

\* Bored up from 9-pdr. of 25 cwt.

† Bored up from 12-pdr. of 21 cwt.

‡ Bored up from 9-pdr. of 18 cwt.

9-pounder Gun, No. 1 .....	28.5	2.759	15.27	96.48	4.2	4.2	4.33	4.2	9	3	0.12
9-pounder Gun, No. 2.....	26	2.357	15.4	84.435	4.2	4.2	4.33	4.2	9	3	0.12
9-pounder Gun, No. 3.....	25	2.125	15.33	78.48	4.2	4.2	4.33	4.2	9	3	0.12
9-pounder Gun, No. 4.....	18	1.607	14.85	60.75	4.2	4.2	4.33	4.2	8	3	0.12
6-pounder Gun, No. 1.....	21	1.893	13.79	84.96	3.668	3.668	3.8	3.668	6	2	0.118
6-pounder Gun, No. 2.....	20	1.964	13.8	78.952	3.668	3.668	3.8	3.668	6	2	0.118
6-pounder Gun, No. 3.....	17	1.49	13.83	66.97	3.668	3.668	3.8	3.668	6	2	0.118
10-inch Howitzer.....	42	5	22.5	57.21	10	7.55	6	7.81	12	7	0.16
8-inch Howitzer.....	50	.....	22.7	76	8.05	6	6	7.25	14	8	.....
24-pounder Howitzer.....	15.5	1.4375	16.2	36.39	5.68	5.1	5	5.1	6	2 lbs. 8 oz.	0.085
Cochorn Howitzer.....	2.375	.38	7.345	20.86	4.52	2.26	3.1	2.89	1	8 oz.	0.066
58-pounder Carronade.....	3.65	2.2857	21.79	61.73	8.05	6.79	10.375	7.04	13	5	0.125
42-pounder Carronade.....	22	1.0357	18.42	52.126	6.79	6.2	8.75	5.94	9	3 lbs. 8 oz.	0.073
32-pounder Carronade.....	17	.4375	16.9	47.710	6.25	5.63	8	5.47	8	2 lbs. 11 oz.	0.073
24-pounder Carronade.....	13	.25	15.22	43.40	5.68	5.04	7.25	4.97	6	2	0.068
18-pounder Carronade.....	10	.27	13.82	39.26	5.16	4.47	6.625	4.515	4	1 lb. 8 oz.	0.061
12-pounder Carronade.....	6.75	.75	12.15	32.361	4.52	4.06	5.76	3.955	3	1	0.056
6-pounder Carronade.....	4.75	.3125	10.93	33	3.6	3.2	4.59	3.15	1 lb. 8 oz.	10 oz.	0.05

TABLE XXVI.—PARTICULARS AND CHARGES OF BRITISH MORTARS.

NAME OF MORTAR.	Weight.	Length.	Diameter over chamber.	Diameter at muzzle.	Length of bore.	Diameter of bore.	Length of chamber.	Diameter of chamber. Front.	Diam. of chamber, rear of taper.	Length of trunnions.	Diameter of trunnions.	Proof charge.	Service charge.	Windage.
	ewt.	in.	in.	in.	in.	in.	in.	in.	in.	in.	in.	lbs. oz.	lbs. oz.	in.
13-inch Sea-service Mortar	100	52·8125	34·95	34·525	39	13	15·14	9·75	7·5	8·531	11·375	20 11	20	0·16
10-inch Sea-service Mortar	52	45·625	26·925	26·78	35	10	11·68	7·5	5·75	6·56	8·75	9 8	9 8	0·16
13-in. Land-service Mortar	36	39·65	25·35	25·35	32·5	13	14	13	7·6	8·5	9·75	9	9	0·16
10-in. Land-service Mortar	17	28·125	20·56	20·28	20	10	10·8	10	5·3	5	7·5	4	4	0·16
10-in. Land-service Mortar	18	31·53	20	20	25	10	10·8	10	5·82	5	7·5	4	4	0·16
8-in. Land-service Mortar	8·5	22·5	16·5	16·25	16	8	8·8	10	4·35	4	6	2	2	0·14
8-in. Land-service Mortar	9	25·23	16	16	20	8	8·75	10	4·425	4	6	2	2	0·14
Cochorn Mortar.....	1	12·7125	6 to 7·25	7·24	10·17	4·52	5	4·52	2·48	2·25	2·25	5	4	0·066
Royal Brass Mortar.....	1·25	15·1	7 to 8·25	8·33	11·94	5·62	6·2	5·62	3·1	3·3	2·84	8	8	0·025

TABLE XXVII.—COST OF GUNS.

NAME OF GUN.	Material.	Bore.	Weight.	Cost per pound.	Total cost.
		in.	lbs.	cts.	\$
Armstrong 10½-in. gun	Wrought-iron coils in hoops .....	10.5	26880	33.6	\$9000.00
Armstrong 110-pdr. gun	Wrought-iron coils in hoops .....	7.	9184	23.9	2195.75
Horsfall gun.....	Wrought iron forged solid .....	13.	53846	23.2	12500.00
Alfred gun.....	Wrought iron forged hollow .....	10.	24094	20.7	5000.00
Krupp's 15-in. gun*...	Cast steel forged solid..	15.	33600	87.5	29400.00
Krupp's 9-in. gun ....	Cast steel forged solid..	9.	18000	56.2	10125.00
Bessemer forging....	Cast steel forged solid..	7 to 8	11200	13.0	1466.00
Blakely 12-in. gun.....	Cast steel hooped with steel .....	12.	40000	87.5	35000.00
Blakely 11-in. gun. . .	Cast steel hooped with steel .....	11.	35000	78.5	27500.00
Blakely 10-in. gun.....	Cast steel hooped with steel .....	10.	30000	58.3	17500.00
Blakely 120-pdr. gun..	Cast steel hooped with steel .....	7.	9600	62.5	6000.00
Whitworth 120-pdr. ...	Cast steel hooped with steel .....	7.	13440	37.2	5000.00
Parrott 100-pdr. gun...	Cast iron hooped with wrought iron.....	6.4	9700	12.4	1200.00
Parrott 8-in. gun.....	Cast iron hooped with wrought iron .....	8.	16300	14.1	2300.00
Parrott 10-in. gun.....	Cast iron hooped with wrought iron.....	10.	26500	17.0	4500.00
Rodman 15-in. gun.....	Cast iron cast hollow...	15.	49100	13.2	6500.00
Rodman 10-in. gun.....	Cast iron cast hollow...	10.	15059	9.75	1468.00
Rodman 8-in. gun.....	Cast iron cast hollow...	8.	8465	9.75	825.00

\* This is the weight and price unofficially reported. The price is, probably, not far wrong.

The Armstrong 600-pr. (13.3-in.) cost \$19000, or 37 cents per pound.

## CHAPTER II.

## THE REQUIREMENTS OF GUNS—ARMOR.

## SECTION I.—THE WORK TO BE DONE.

**171.** If the introduction of 11-in. shell-guns had not rendered wooden walls, and even iron hulls without armor, impracticable for war-vessels, the American experiments with 15-in. guns, and the promise of larger calibres, plainly indicated that the great accuracy, long range, and enormous bursting charges of modern shells would add to the power of ordnance, more than high speed by steam would add to the power of ships. A moving object was indeed an uncertain mark, but *one* 15-inch projectile, rightly planted, was likely to destroy or seriously cripple any vessel.\* More recently, the penetration and shattering of masonry by rifle projectiles at long range, demonstrated the fatal weakness of the present forts.

From these causes, a new and additional feature of defence became indispensable. The cuirass of ancient times was restored, but instead of defending the breasts of single warriors from hostile spears, it was expanded over whole frigates and fortifications—their armament, men, and machinery—and thickened to resist shells and even solid shot of ordinary power.

So rapidly have these changes occurred, and so much absorbed are engineers in the improvement of the rival systems—offensive and defensive—that the fundamental and comprehensive character of this revolution in warfare is hardly appreciated. The experimental fight of the armored batteries at Kinburn, so late as 1855, was neglected by the profession at large, and the subsequent commencement of iron-clad vessels in France and England was

\* *One* 15-in. projectile destroyed the iron-clad *Atlanta*. (181 B.), and another shattered the side of the iron-clad *Tennessee*.



hardly acknowledged by its authors to be a revolutionary proceeding. Nor was it the actual beginning of the new system. The three years of the great rebellion in America, and the contemporary and comprehensive experiments of the British Government upon the resistance and fabrication of armor, have witnessed its real inauguration, and pointed out the direction and settled many of the fundamental principles of its further improvement.

Whether new weapons of offence will again overcome the armor-carrying power of practicable ships, as gunpowder overcame that of men, so that fortresses which, being fixed, can carry armor enough to resist any conceivable projectile, will be relied on for ultimate defence; or whether the embarrassments that beset the gunmaker will so rapidly increase and multiply that practicable ships can always carry armor enough to resist projectiles, is not an essential feature of the present discussion.

**172.** The present duty demanded of guns, is to penetrate or remove, in such a way as to cripple the enemy within it, the armor now used on ships, and the armor that in the present state of the art is likely to be fabricated and to be supported by seaworthy vessels.

The importance of carrying some purely *shell*-guns of large calibre, to destroy transports or vessels that may not be iron-clad, and to operate against towns, temporary works, and troops on shore, is not to be questioned. Such guns are comparatively perfect.\* At least, the means of improving horizontal shell-firing are well understood.

The great problem remains unsolved. Indeed, engineers are looking for its solution in diverse or opposite directions. Seeing that the results of experiments, and especially of warfare, in testing guns against armor are developing new features of strength and weakness every day; that these results are still somewhat uncertain, and that time enough has not elapsed to enable the profession at large to collect and digest what facts there are, few if any *first principles* are universally recognized. This is still more the

\* Since the above was written, the power of the U. S. 11-in. guns against wooden walls has been illustrated in the destruction of the *Alabama* by the *Kearsarge*.

case since, from motives of gain, pride, or official conservatism, many persons have taken advantage of the limited knowledge on the subject to establish their own schemes, by arranging experiments to show their favorable side and to conceal the other, or by publishing one class of facts and ignoring those of a conflicting character.\* Or sometimes reticence and a show of mystery are maintained, ostensibly to withhold information from foreign governments, when it is very well known that *governments* find means of acquainting themselves with each other's practice. The real loser is the government that, in concealing the truth, withholds it from its *own* people—from the great mass of ingenious and skilful men in civil life who would turn it to good account.

The somewhat chaotic state of professional opinion on the question of the best gun to destroy armored ships, may perhaps be narrowed down to two general theories, the strength of the gun being the common starting-point:—

**173.** TWO SYSTEMS OF DESTROYING IRON-CLADS.—*First.* It is contended that the most feasible method of attack is to waste no power in racking the whole side of the ship, but to devote the power exclusively to punching the armor—with shells if possible.

**174.** *Second.* It is contended that the better method is to waste no power in punching mere holes, but to so increase the weight of the shot (a given strain being imposed upon the gun by means of reducing the velocity), that the entire blow shall be expended in straining, loosening, and dislocating the armor, and breaking its fastenings, thus tearing it off, after which the vessel will be easily destroyed by shells; and at the same time racking and breaking the ribs and side of the vessel, and thus rendering her unseaworthy.

**175.** Both the theory and the practice appear to indicate, 1st, that these two distinct results—*punching*, and what we will call *racking*—can be respectively produced by excessive velocities and excessive weights of projectiles—the power, which is limited by the respective strains imposed upon the gun-metal, being the

\* The readers of British scientific journals, for instance, will observe the number and general fairness of these complaints.

same in both instances; and 2d, that in case of a given projectile, whatever power is employed in racking the side of the vessel, does nothing towards penetration, and *vice versa*.

These effects may be roughly illustrated by throwing a 32-lb. ball and firing a bullet at a light board or piece of thin sheet-iron, supported at the corners. The ball will split the board or break it across the grain, or both; or it will double up the sheet-iron and tear it away from its supports, without showing any signs of penetration. The bullet will make a clean hole, without splitting, bulging, or loosening either the board or the iron.

**176.** A simple way of explaining these phenomena is as follows:—In the case of the high velocity, the effect was wholly *local*, because the surrounding material had no time to propagate the vibrations throughout the mass. In other words, the cohesion of the material was not sufficient, in the time allowed, to overcome the inertia of the surrounding mass. The *distribution* of the effect, in the other case, was due to the low velocity.\* In both cases, the work done might have been the same.

**177.** The following extract from a paper by Captain Noble, R. A., contains important facts and illustrations upon this subject:

“The work done may be stated to be as  $WV^2$ ,  $W$  being the weight of the shot, and  $V$  its velocity at the moment of impact.

“The work done at 200 yards distance by the 110-pounder Armstrong rifled gun, with 14 lbs. charge, when  $W=111$  lbs. and  $V=1178$  ft., and the 68-pounder smooth-bore gun, with 16 lbs.

\* As these phenomena of local and distributed effect—of punching and racking armor by different sorts of cannon-shot, are represented to be somewhat mysterious and uncertain by unprofessional people (all men are critics of *warfare*), various other experiments will show the correctness and distinctness of the two principles involved. A board set on its edge unstably, so that a pistol-ball thrown by the hand will overturn it, may be riddled with pistol-balls fired at short range with high charges, without being overturned. A small table-cloth may be *jerked* from under the dishes without perceptibly stirring them. It is hardly necessary to state what would be the result of pulling the cloth off slowly. The card snapped from under a coin balanced on the finger; the punching of clean, small holes in roofing-slate, by a rapid stroke, when a lighter and slower stroke would smash the whole mass; and many other every-day experiments and processes illustrate the fact, that the element of *time* essentially modifies the effects of moving forces.

charge, when  $W=66$  lbs. and  $V=1422$  ft., is in favor of the former gun in the proportion of 11·5 to 10, nearly; but we find that the penetration is in favor of the smooth-bore 68-pounder. Again, at the same distance, the 110-pounder forcing a bolt of 200 lbs. with a charge of 10 lbs., when  $W=200$  lbs. and  $V=780$  ft., in comparison with the 68-pounder, as before, will be as 10 to 11, nearly, the 68-pounder thus having a slight advantage; yet the penetration of the 68-pounder is far greater, that of the 200 lbs. bolt being almost nothing.

“How comes it, then, that although the work done by each shot varies so little, the penetrations show such a marked difference? I think that the following explanations will throw a light on the subject:—

**177 A.** “The actual work done by each shot is, as we have seen, nearly the same; but one does its work *in much less time than the other*. This explains the whole matter.

“The 200-lb. bolt, *with a low velocity*, strikes a heavy blow on a spot in the target; but it takes a certain length of time to accomplish that blow; so that, during this interval, all the surrounding particles of iron have ample time to sustain the point struck; the force of the blow is thus spread over a large surface of the target, and the cohesion of the particles is undisturbed, as each particle is enabled to contribute the force of its attraction towards uniting the whole.

“The 68-pounder, on the contrary, strikes the target with a high velocity, and the surrounding particles have not time to sustain one another before the work is accomplished, so as to support the point struck; the consequence is, that the penetration is greater at the point struck, although the actual amount of work done may be the same.

“Lest this language should appear too figurative, I will express it in other words, thus:—Let us suppose the matter of which any body is composed, to be comprised of an indefinite number of atoms or particles united together by a certain force.

“Call one of these atoms A, and the contiguous atoms B and C; these last have also contiguous atoms, D and E, and so on. Sup-

pose the atom A receives a blow, it instantly endeavors to transmit some of the effects of this blow to B and C, which again in  
 o o o o o their turn transmit to E and D; thus a sort of war of  
 E C A B D motion takes place between the particles, and each atom bears some of the effect of the blow. But a certain time must have transpired before the wave communicates its effect to E and D. If there is sufficient time to enable B, C, D, E, to take up some of the effect, A will, in a corresponding degree, be relieved; but if there is not sufficient time, A will have a greater force to contend with than it is able to resist, consequently it must yield to that force, and alter its position with regard to the contiguous particles." \* \* \*

**177 B.** "The mean penetration of the 68-pounder (in the *Warrior* target) was 2.46 in.; that of the 110-pounder Armstrong, with a shot of 111 lbs. and 14 lbs. charge, 1.6 in.; while the penetration of the 200-lb. bolt was almost inappreciable. What was the penetration of the 'shunt' gun, with a shot of 140 lbs. and 20 lbs. of powder? Not much more than the 68-pounder, although the work done was nearly as 17 to 10. But the time of doing this work was longer in one case than the other." \* \* \*

**177 C.** "The champions of the 'heavy weights' say that the heavy shot at low velocities will shake the plate off and break all the bolts; and no doubt such results would be most effective—*if they took place*. However, up to the present date, these results have not taken place; the plates in the most obstinate manner refuse to be shaken off, even when fired at directly."\*

**177 D.** The *popular* notion is, that the future gun must accomplish two things: 1st. It must smash a hole in the enemy's ship. But even the 7-in. Whitworth shot made only a clean, small hole through the *Warrior* target, and the gun now requires repairs after some 30 heavy charges. And the 13-in. Horsfall gun, which made a ragged hole through the same target and otherwise injured it, represents the utmost power of the present experimental ordnance. The target, at the same time, by no means rep-

\* It is obvious that the author had not studied the *racking* effect of very heavy projectiles. In fact, few had been fired at plates at that time.

resents the maximum resistance of the present armor. 2d. The future gun is popularly expected to shatter and dislocate the whole side of the enemy's ship.

Supposing that the same shot could perfect both these results, it must be remembered that all that the best ordnance can do, is to disable the best average armor, by devoting its whole power in *one* direction,—without attempting to inflict *two* kinds of punishment at a blow. Considering the known results of iron-clad warfare, and the known facilities for improving armor as compared with those for improving ordnance, the obviously safe course is to perfect one method of attack or the other before attempting to combine both in the same weapon.

The consideration of guns for iron-clad warfare, therefore, involves the two extreme systems, viz., Punching, and the combined operations (174) which we have grouped under the head of Racking. It is proposed to compare the results and the probable efficiency of these systems, with reference to obvious improvements in armor, for the purpose of getting at least an approximate idea of which will inflict the greater damage upon an enemy's ships, and how far the two may be successfully combined.

## SECTION II.—HEAVY SHOT AT LOW VELOCITIES.

**178. EXPERIMENTS.**—Only a few very heavy shots have been fired at targets. In no cases have the target and the circumstances been of such a character as to afford complete data for *comparing* results. So that, as far as experiments are concerned, the racking system requires farther demonstration. Much may be learned, however, from what has been done.\*

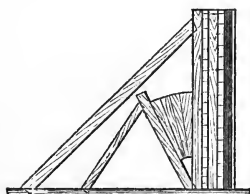
It should also be borne in mind that this is not strictly a comparison between large and small projectiles, but between high and low velocities. Obviously, the smaller projectile can receive the higher velocity with a given strain upon the gun. But a 13-inch ball fired with 90 lbs. of powder, at 1760 feet velocity (181 D), or a 13-inch ball fired with 74·4 lbs. of powder, at 1631 ft. velocity (183), or a

\* A complete official account of the more important experiments here mentioned, will be given in a following chapter.

15-inch ball fired with 60 lbs. of powder, at 1480 feet velocity (181 A)—velocities which rather penetrated than racked the targets at which they were fired—are not proper illustrations of the system under consideration. They devoted so much of their power to local effect, that they reserved little for distributed work—for the general smashing and dislocation of the ship's sides. And therefore their destructive results may be attributed chiefly to their high velocities.

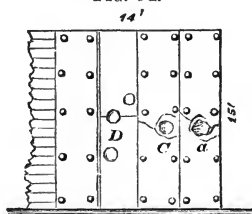
**179. 15-INCH BALL; 10-INCH TARGET, 20-INCH OAK BACKING.**—In the spring of 1863, at the Washington Navy Yard, a 15-in. spherical shot, weighing 400 lbs., was fired at 200 yards range,

FIG. 93.



Side of 10-in. target for 15-in. gun.  
Scale,  $\frac{1}{8}$  in. to 1 foot.

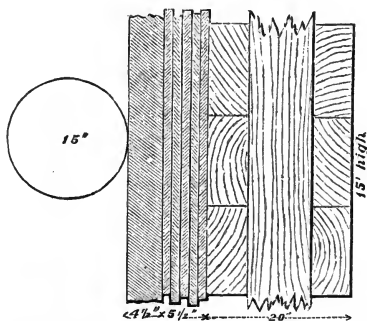
FIG. 94.



Front of 10-in. target.

with 40 lbs. of ordinary cannon-powder, at a target (Figs. 93, 94, and 95) composed of a  $4\frac{1}{2}$ -in. plate,  $3\frac{1}{2}$  ft. wide and 15 ft. high, backed with  $5\frac{1}{2}$  in. of 1·1-in. plates (10 in. of iron in all) and 20 in. of oak. A disk was broken out of the  $4\frac{1}{2}$ -in. plate (*a*, Fig. 94), and the thin plates were indented, but not broken. The wood was a little crushed; but the shock was so great that nearly all the bolts were jerked out or broken, and the plate was ready to be dislodged and thrown off by a slight additional vibration.

FIG. 95.



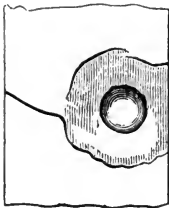
Section of 10-in. target and backing.  
Scale,  $\frac{1}{2}$  in. to 1 foot.

**180. 11-INCH BALL; 10-INCH TARGET.**—Shortly afterwards, an 11-in. spherical cast-iron

169-lb. shot was fired at another similar plate (C, Fig. 94) in the same target, at the same range, with 30 lbs. of powder. A disk was broken out of the 4½-in. plate, leaving an indentation 3½ in. deep (Fig. 96), and about half the bolts were broken and some of them were thrown out.

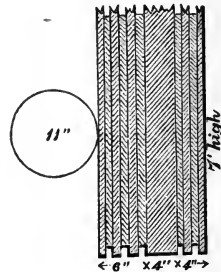
**181. 11-INCH BALL ; 14-INCH TARGET.**—About the same time, an 11-in. 169-lb. spherical cast-iron shot was fired at about 50 yards range, with 30 lbs. of powder, at a target (Fig. 97) 14 in. thick and about 7 ft. square, composed, where the shot struck it, of six 1-in. plates, one 4-in. plate, and four 1-in. plates, without wood backing. The target was planted against a heavy timber framework which abutted against the cap-stones of a sea-wall.

Fig. 96.



11-in. shot on 10-in. target.

Fig. 97.



Ericsson 14-in. target.

The blow of the shot produced a small local effect. The indentation was about 5 in. ; the outer 1-in. plate was cracked across, and the back plates were bulged 2 or 3 in. But the whole target and framework, and the earth and sea-wall behind it, were shoved bodily backwards several inches. Nearly all the through-bolts, some 40 in number, were loosened, and many of them were broken off in the thread of the screw at the rear.

**181 A. 15-INCH AND 11-INCH BALLS AND PARROTT 150-LB. BOLT ; VARIOUS PLATES ; LATE EXPERIMENTS.**—Some important experiments with the above projectiles have very recently been made at the Washington Navy Yard. The Department has determined not to make public the details of these experiments at present. The general results are as follows :



A target composed of 30-in. oak backing and a solid 6-in. French plate, made by Messrs. Petin, Gaudet & Co., was cracked, smashed, and completely penetrated by a 15-in. 400-lb. cast-iron ball, fired at about 50 yards range, with 60 lbs. of powder, at an initial velocity of 1480 feet per second. A target composed of six 1-in. plates, backed by 10 × 10-in. iron beams, was torn in two and thrown down by similar projectiles. Laminated targets, composed of 1-in. plates, up to 13 inches aggregate thickness, and backed by 24 to 30 inches of oak, have been ruptured and shattered through and through, though not completely penetrated, by the same shot and charges. The 15-in. ball has also knocked down, displaced, and shattered various targets of considerable thickness but not of large size, and therefore not exactly representing the mass and continuity of a ship's side. The 15-in. gun has not been fired at the *Warrior* target or at any 4½-in. target.

The 11-in. gun has recently been fired at various targets with 30-lb. charges and 169-lb. cast-iron balls. At 50 to 100 yards range, this gun penetrates 4½-in. solid plates of ordinary quality, but does not make a clean breach through the best plates (215).

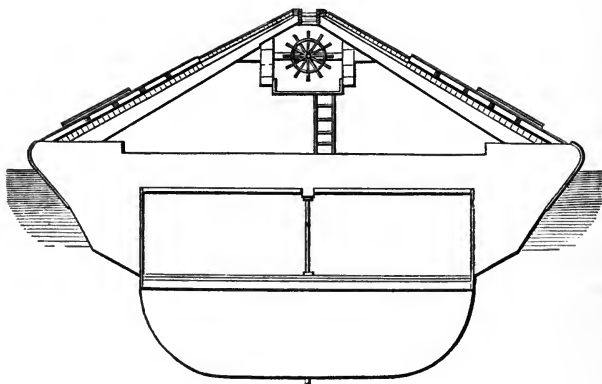
The Parrott 8-in. rifle, with 150-lb. bolts and 16 lbs. of powder, breaks through but does not punch the best 4½-inch plates, and does not seriously injure the backing.

These late experiments have also shown that the convex target, representing the *Monitor* turret, offers very much greater resistance to both punching and racking than the flat target, composed of the same materials.

**181 B.** 15-INCH BALL; IRON-CLAD ATLANTA, 4½-INCH ARMOR AND 2½-FEET PINE BACKING.—In 1863, a 15-in. ball from the "Monitor" *Weehawken* smashed in, at about 300 yards range, the armor of the Confederate iron-clad *Atlanta* (Fig. 97 A), and completely disabled her. An 11-in. 169-lb. ball, with 20 lbs. of powder, did not break through the same armor. The casemate of the *Atlanta* was inclined 35° from the horizon, and was composed of laminated armor of the aggregate thickness of 4½ inches, backed by 2½ feet of yellow pine, as shown.\*

\* In the late action off Mobile, a 15-in. ball shattered and splintered the armor of the *Tennessee*—5 in. of iron bars and 2 ft. of oak. No other shot injured it.

FIG. 97 A.

Cross section of the Confederate iron-clad *Atlanta*.

**181 C.\*** 13-INCH 610-LB. STEEL SHELL;  $4\frac{1}{2}$ -INCH PLATE; 18-INCH BACKING.—On December 11, 1863, a 610-lb. steel shell was fired from the Armstrong 13-inch gun, with 70 lbs. of powder, at the *Warrior* target (Fig. 98); range, 1000 yards. This projectile smashed a 20 by 24-inch hole entirely through the target, splintering the backing and supports, starting all the plates, breaking nearly all the bolts, and slewing round the entire structure. The shell contained a 24-lb. bursting charge, and exploded at the instant of its passage through the plate. This, however, should be considered a punching rather than a racking shot, so great was the disparity between the power of the projectile and the resistance of the target.

**181 D.\*** 13-INCH 344 $\frac{1}{2}$ -LB. STEEL SHOT, 11-INCH PLATE.—On the 10th of March, 1864, a 344 $\frac{1}{2}$ -lb. spherical steel ball was fired from the same gun with 90 lbs. of powder—initial velocity, 1760 feet per second; range, 200 yards—at an 11-in. plate 3 ft. 5 in.  $\times$  2 ft. face, supported at the rear by two 12-in. oak posts. The ball struck the centre of the plate, breaking it in two, indenting it 4.9 in., and dislodging and splintering the supports. But the

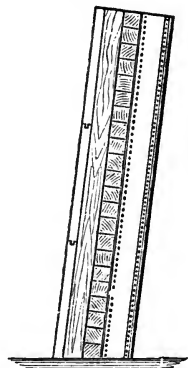
\* The accounts of these two experiments were not obtained from official sources.

shot was flattened to 15·2 in. maximum and 10 in. minimum diameter, and thrown back towards the gun.

**182.** 13-INCH BALL;  $4\frac{3}{8}$ -INCH PLATE.—At Liverpool, in 1856, the Horsfall 13-in. spherical shot of 279·5 lbs. weight was fired with 25 lbs. of powder, at a plate  $4\frac{3}{8}$  in. thick, 3 feet 9 in. long, and 2 feet 9 in. wide, weighing about 2000 lbs., and supported by 9 balks of timber, each 6 feet long and 14 in. square, laid together with planks, and abutting in a large bank of sand. The range was 120 yards. About a third of the plate was broken to pieces, and fragments of about 1 cwt. each were thrown in all directions. The timbers were driven into the sand, and one of them “sent to a distance of 300 yards straight on end in the shore.”\*

**183.** 13-INCH BALL, AND 131-LB. WHITWORTH RIFLE-SHOT; WARRIOR TARGET.—A spherical shot was fired (September 25, 1862) from the same (13-in.) gun at the *Warrior* target, Fig. 98—a  $4\frac{1}{2}$ -in. plate, 18-in. teak backing, and a  $\frac{5}{8}$ -in. skin—with 74·4 lbs. of powder, and 1631 ft. initial velocity, but at 800 yards range. A Whitworth 131-lb. rifle-shell was on the same occasion fired with 25 lbs. of powder, at the same target, at 600 yards range. Although the total power stored up in the 13-in. shot at starting was much greater than in the rifle-shot, it lost more velocity in a given range (since it had a greater cross-sectional area in proportion to its weight), and had 200 yds. farther to go. In addition to this, it struck the ground in front of the target, and ricocheted. So that the two shots afford an approximate basis for comparing the two systems. The 13-in. shot did not penetrate, but smashed the iron and the teak, ripped open the inner skin, and broke 7 through-bolts and 2 ribs; its effect was more distributed. The rifle-shell made a clean hole, producing only a local effect upon the target. But it burst inside the target.

FIG. 98.



The *Warrior* target.  
Scale,  $\frac{1}{8}$  in. to 1 ft.

\* Mr. Clay. “Report of the Defence Commissioners,” 1862.

Another 13-inch ball, on the same occasion, broke off a corner of the plate  $2 \times 1\frac{1}{2}$  ft., starting 2 bolts, shaking the whole target violently, and doubling up a rib. The damage extended 5 ft. down the target.

**184.** 10½-INCH BALL; WARRIOR TARGET.—An Armstrong 10½-in. 150-lb. spherical shot was fired in April, 1862, at the *Warrior* target, with 40 lbs. of powder and 1586 ft. striking velocity; range, 200 yards. The first shot bulged the plate considerably, made cracks in it 18 to 36 in. long, crushed the iron over a surface of 3 or 4 square feet, smashed the teak, broke 2 ribs, tore the skin, broke two bolts, and lodged in the backing. The second shot hit near the first, and did similar but greater local damage, smashing another rib and covering the ground with splinters. The following shot was fired with 50 lbs. of powder and made a clean breach, with less distributed effect. The fourth shot, fired with 40 lbs. of powder, struck where the target was supported by 2 sq. ft. of solid timber, which it could not penetrate, but only crack; it therefore shook the whole target, and the solid masonry behind the abutting beams.

**185.** 150, 230, AND 307-LB. RIFLE AND 113-LB. ROUND-SHOT; 12 AND 13-INCH TARGET.—On the 3d of March, 1863, some heavy shots were fired, at 200 yards range, against Captain Inglis's proposed armor for forts,—a target peculiarly adapted to suffer from vibration. A part of the target consisted of a front row of vertical slabs of wrought iron, 8 ft. high, 20 in. wide, and 8 in. thick, backed by horizontal slabs 11 ft. long, 20 in. wide, and 5 in. thick. The vertical slabs in another part were 7 in. thick, and backed by the same horizontal 5-in. slabs. Behind the slabs were ribs 9 in. wide and 5 in. deep. The whole was fastened together by 3-in. bolts, with conical heads and nuts. Washers of lead, rubber, iron, and plaited wire were respectively placed under some of the nuts.

The 1st shot from the Whitworth 7-in. rifle was a solid flat-headed 148-lb. steel shot; charge, 25 lbs.; striking velocity, 1240 ft.; it struck the 13-in. part of the target, slightly bulging and smashing it, cracking two 8-in. plates and bending a frame-piece, but not breaking any bolts, nor seriously straining the fastenings.

2d. A 113-lb. spherical wrought-iron shot from the Armstrong 9·22-in. gun was fired, with 25 lbs. of powder and 1462 feet striking velocity, at the 13-in. part of the target. It indented  $2\frac{1}{2}$  in., cracked both the 8-in. and the 5-in. plates, bent the  $9 \times 5$  frame-bar 2 in., broke off one bolt-head (a new bolt was afterward put in), and strained the target perceptibly.

The 3d shot, a 230-lb. conical cast-iron bolt, 19 in. long, was fired, with 45 lbs. of powder and 1400 feet striking velocity, from the new  $10\frac{1}{2}$ -in. muzzle-loading, shunt-rifled Armstrong gun. It struck the 12-inch part, cracked both the 7 and the 5-in. plates, curved, dislocated, and drove in the slabs and frame-bars, broke several bolts, but did not throw off any of the slabs. The indent was only  $1\frac{1}{2}$  in.

The 4th shot of wrought iron, weighing 150 lbs., was fired from Lynall Thomas's 7-inch rifle (127), with 25 lbs. of powder and 1218 feet striking velocity. The shot was greatly upset, and the target was indented 1·8 in., and sprung and cracked, but not very seriously shaken.

The 5th was a Whitworth 150-lb. shot, similar to the first. It struck a  $24 \times 21 \times 8$ -in. plate under the embrasure, bent out the  $9 \times 5$  in. frame-bar previously started, broke 2 bolts and threw out one. The lead washers of other bolts were flattened. The plank struck was driven in an inch, and both planks were cracked; effect mostly local.

The 6th was an Armstrong 307-lb. shot, fired from the  $10\frac{1}{2}$ -in. gun with 45 lbs. of powder; striking velocity, 1228 ft. It struck on a point a few inches above shot No. 1, cracked the 8-in. plate, broke one bolt, and bulged and shook the slabs and frame-pieces considerably.

Mr. Lynall Thomas's 7-in. gun was then laid, but burst with  $27\frac{1}{2}$  lbs. of powder and a 133-lb. shot.

**186.** 300 AND 330-LB. RIFLE-SHOT;  $7\frac{1}{2}$ -INCH TARGET.—On the 17th of March, 1863, another target of solid plates, rolled by Messrs. John Brown & Co., was tested with heavy projectiles at 200 yds. range. It consisted of a lower horizontal plate  $6\frac{1}{2}$  in. thick, a middle plate  $7\frac{1}{2}$  in. thick, and an upper plate  $5\frac{1}{2}$  in.

thick, each about 4 ft. high and 12 ft. long, their faces being flush. One side of the target was backed only by vertical iron ribs; the other by 10 in. of teak, a 1-in. plate, a 1½-in. plate and vertical ribs. A heavy horizontal girder extended across the back of the vertical ribs. The target was held upright by heavy timbers extending between it and a bank of earth behind. The through-bolts were 2½ in. diameter.

After 3 rounds with 68-pounder spherical shot and 3 with 65½-lb. steel shot from the Armstrong 7-in. rifle (110-pounder)—charge, in each case, 16 lbs.; indentation, 2½ to 3 in.; no perceptible racking observed—a conical 301-lb. steel shot, fired by 45 lbs. of powder from the 10½-in. Armstrong gun, struck the centre of the 7½-in. backed plate *over a rib*, with a velocity of 1293 feet; made an indentation 13 in. wide by 6·2 in. deep; bent the plate, throwing the ends out nearly an inch, and loosening and breaking one bolt and 20 rivets; cracked and bent the inner skin and ribs; broke and jarred the horizontal girder, and shook the structure violently.

The 8th and 9th rounds were fired through the 5½-in. plate, and burst in the backing. These will be referred to under another head.

The 10th shot was from Lynall Thomas's 9-in. rifle, and missed the target.

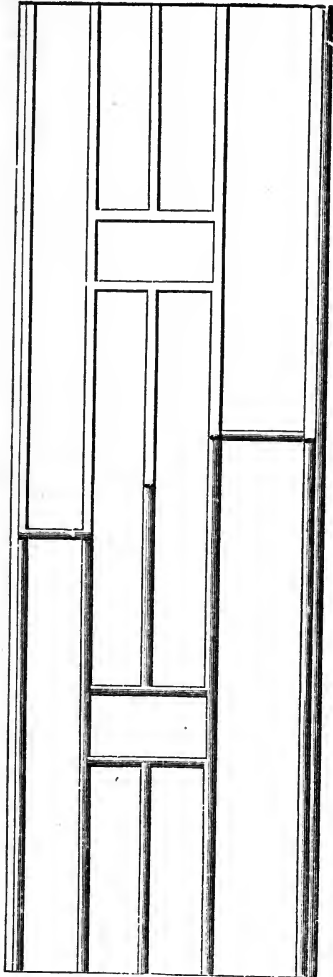
The 11th, a 302-lb. wrought-iron bolt, 18½ in. long, was fired from the same gun, with 50 lbs. of powder, and struck the junction of the 7½ and 6½-in. plates where they were not backed, making several cracks and an indentation of 5½ and 6 in. in a length of 7½ ft., and bending and vibrating the plates so much as to break several rivets and angle-irons and a vertical rib. The shot rebounded 25 yards and was much upset.

The 12th shot, a steel 330-lb. bolt, was fired from the same gun with 50 lbs. of powder, and struck the edge of the 7½-in. plate, where there was no wood backing, at 1220 feet velocity. It smashed a piece 21 × 12 in. out of the plate, making an indent 7½ in. deep. One rib was broken and 2 were bent. The girder previously started was thrown out of place, and 2 bolts were broken.

The 13th shot was a spherical 163-lb. ball fired at the unbacked

$7\frac{1}{2}$ -inch plate from the  $10\frac{1}{2}$ -in. Armstrong gun, with 45. lbs of powder, at a striking velocity of 1627 feet. The effect was of course chiefly local.

FIG. 99.



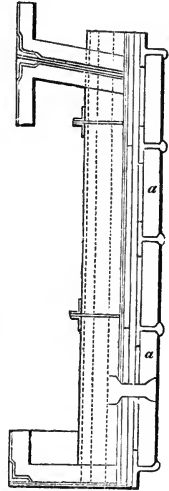
Scott Russell's target. Front.  
Scale,  $\frac{1}{8}$  in. to 1 ft.

The plate was deeply indented and torn, horizontally and vertically. The cracks at the rear were 2 in. wide.

**187.**  $10\frac{1}{2}$ -INCH BALL; SCOTT RUSSELL'S TARGET. (Figs. 99 and 100.)—On the 26th of June, 1862, a  $10\frac{1}{2}$ -in. wrought-iron ball was fired with 50 lbs. of powder—range 200 yards—at Mr. Scott Russell's target. This was composed of

4 rows of plates  $4\frac{3}{8}$  in. thick, and about 2 feet wide, making a wall 29 ft. 10 in.  $\times$  9 ft. 9 in., with 2 ports or embrasures. The backing was composed of three 1-in. plates and two  $\frac{3}{8}$ -in. plates, which represented the skin of the ship, making  $8\frac{1}{8}$  in. of iron in all. The construction of the target at the rear consisted of 2 longitudinal stringers  $5\frac{1}{2}$  in. deep, one above and the other below the port; also 2 iron water-ways representing the upper and main decks. The vertical ribs were  $10\frac{1}{2}$  in. deep and  $21\frac{1}{4}$  in. apart. A lining of half-inch iron was placed on the upper part of the target; the remainder was left open to allow the skin to be examined. Between the armor-

FIG. 100.



Scott Russell's target. Section.  
Scale,  $\frac{1}{4}$  in. to 1 ft.

plates were T-irons riveted to the iron backing, and upset over the edges of the plates to hold them in place, instead of bolts. There were 4 rivets through one plate, but no bolt nor other rivets.

The shot (162-lb. spherical) struck with about 1600 ft. velocity, breaking a hole through one armor-plate and cracking another. Two feet of the continuous riveting was sheared off. At the back, a vertical rib and the skin were broken through, and *the whole mass was moved back  $\frac{1}{4}$  inch.* The shot, much flattened, was thrown 5 yards forward towards the gun.

**188.** 10½-INCH BALL; MINOTAUR TARGET.—On the 7th of July, 1863, the 10½-in. Armstrong smooth-bore was fired at the *Minotaur* target, composed of 3 plates, each 12 ft. 6 in.  $\times$  3 ft. 4 in.  $\times$  5½ in. thick, backed by 9 in. of teak and  $\frac{5}{8}$ -in. skin, supported on ships' frames. Range, 200 yards.

The 1st shot, a 150-lb. cast-iron ball—charge, 50 lbs.—knocked a 12-in. disk out of the middle plate and 13 in. into the backing. The whole plate was driven in about 1 in.; 9 bolts and 11 rivets were started in the plate struck, and in the other plates; 2 ribs were broken; the horizontal girder was carried away; and the target was generally strained and bent.

The 2d and 3d shots—same weight and charge—smashed clean holes through the target, starting more bolts and somewhat straining the target; but the effect was mostly local.

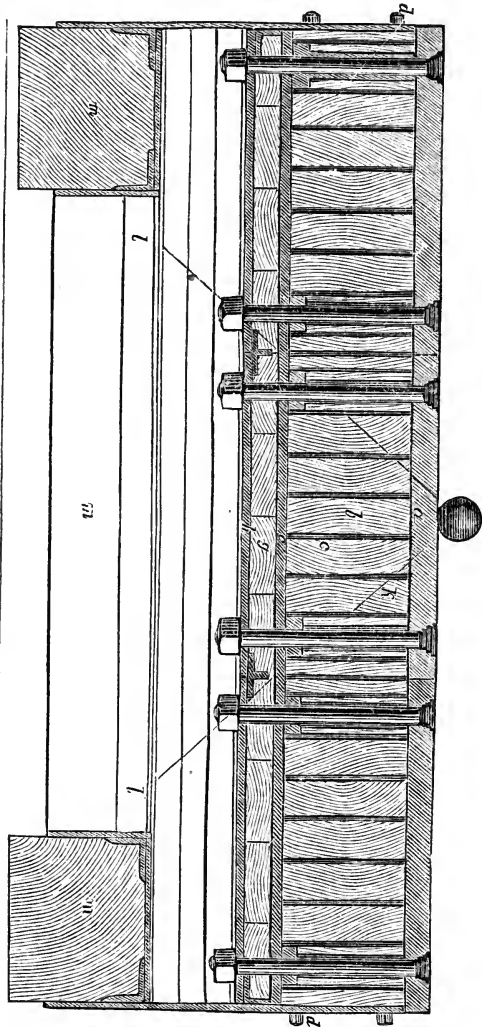
The 4th shot, a 162-lb. wrought-iron ball—charge, 50 lbs.—struck near the 1st, broke through the outer plate, and remained in the indent. The plate was much buckled and the backing smashed to 6 in. thick. The whole target was tremendously shaken; 2 ribs and the horizontal girder were bent; the skin was bulged but not torn; 4 bolts were broken. The local effect was much less than No. 1, but the shock was distributed over a block of masonry in the rear, on which it leaned through intervening struts.

**189.** 301-LB. RIFLE-SHOT AND 150-LB. BALLS; CHALMERS TARGET.—On April 27th, 1863, the following heavy shot were fired at 200 yards range, at the Chalmers target (Fig. 101). This target was composed of 3¾-in. armor-plates backed by alternate layers



of timber and iron  $10\frac{3}{4}$  in. thick, placed horizontally and bolted together; then a 2d armor-plate  $1\frac{1}{4}$  in. thick, with a cushion of timber  $3\frac{3}{4}$ -in. between it and the  $\frac{5}{8}$ -in. skin. The iron plates between the 1st and 2d armor-plates stood edgewise, and were  $\frac{3}{8}$  in. thick and 5 in. apart. The bolts were  $2\frac{1}{4}$  in. diameter, with elastic washers.

FIG. 101.



The Chalmers target.

After 26 rounds from the 68-pounder smooth-bore and 110-pounder rifle, a 301-lb. solid steel shot was fired with 45 lbs. powder from the Armstrong  $10\frac{1}{2}$ -in. rifle. It struck at the junction of two plates and made a clean breach through the target, bulging it considerably, smashing one rib, and breaking bolts and rivets.

The next shot was a 150-lb. cast-iron sphere—from the same gun—charge, 50 lbs. It smashed an indent to a depth of 11 in.; broke 2 bolts and 5 rivets, bulged out 2 ribs and the skin, and affected the backing over a space of  $3 \times 2$  feet.

The last shot, the same as the above, smashed to the depth of 12 in., and broke up; 2 bolts, 3 rivets, and 1 rib were broken; the corner of the plate struck was detached and forced into the backing. The skin was slightly cracked.

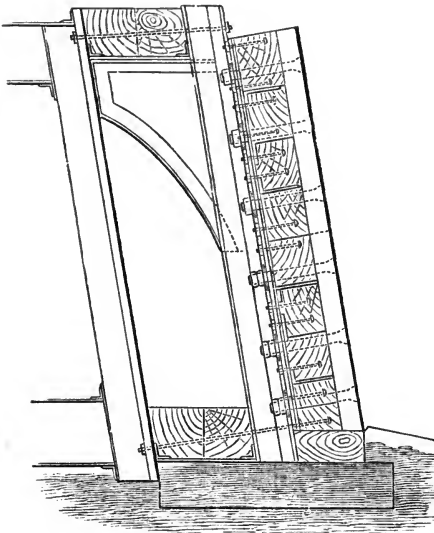
This is considered the strongest plan of armor, for a given weight, that has been tried in England.

**189 A.** 150-LB. BALL AND 300-LB. BOLT; BELLEROPHON TARGET.—On the 8th of December, 1863, various projectiles were fired at a target (Fig. 101 A), consisting of 6 inches of solid iron, 10 inches of oak, and 1½-in. skin held by heavy ribs;\* range, 200 yards. A 10½-in. 150-lb. steel ball—charge, 35 lbs.—struck the target on the joint of two plates, which it punched, imbedding itself in the backing, breaking a rib and two bolts, slightly cracking the skin, and bulging it 2 in. The effect was wholly local. A cast-

iron ball from the same gun, with the same charge, broke through the plate, and slightly bulged the skin.

A 300-lb. bolt from the same gun, with the same charge, struck near the centre of a plate, and indented it only 2·8 in. The plate was driven in 2·1 in. in a length of 5 feet at the bottom, started out 4 in. in a length of 2 ft. at the top, and cracked for a length of 18 in.; but no through-bolts were broken, and the target, considered as the side of a ship, was almost uninjured.

FIG. 101 A.



The *Bellerophon* target. Scale,  $\frac{1}{4}$  in. to 1 ft.

\* See chapter on Experiments against Armor.

**190.** A few of the English experiments with smaller guns, throw some light on this question; for instance, those of May 16, 1861, with the 110-pounder Armstrong rifle against 2-in.,  $2\frac{1}{2}$ -in., and  $3\frac{1}{2}$ -in.  $\times$   $5\frac{1}{2}$   $\times$   $2\frac{1}{2}$  ft. plates laid upon masonry. The first 6 shots struck bolts or former fractures or the corners or junctions of plates, and produced wholly local effects. The 7th shot hit the *centre* of the lower  $3\frac{1}{2}$ -in. plate, started 1 bolt 1 in.; plate very slightly bent; depth of indent very small indeed; plate not damaged at all; *a great deal of masonry shaken down from the top*. Nearly all the following shots up to the 27th hit upon previously damaged parts. The 27th hit the 3d plate, upper, near the centre; broke away the lower half, leaving the piece supported by 1 bolt; broke away and shattered the masonry around, and started the plates and brought down some more masonry.

**191. Detaching Armor by Heavy Shot Considered.**—The *penetration* of plates up to 6 inches thickness by 13-in. and 15-in. balls, does not establish the advantages of this particular system of destroying iron-clads. It is, on the contrary, the highest result of the punching system. To shatter or to strip the target, the powder must propel more weight at a lower velocity, or the target must offer so much *local* resistance that the effect of the blow will be distributed over the structure and fastenings. Only a few of the foregoing experiments illustrate the system under consideration. For instance, the effect of the 15-in. shot upon the 10-inch target, clearly indicates the weak point of solid plates merely bolted to the ship—the *Warrior* system. The shot cracked and broke through the  $4\frac{1}{2}$ -in. outer plate, backed as it was with 6 in. of iron, besides 20 in. of oak; and experiments have clearly demonstrated that iron backing saves the plate struck. After breaking through the  $4\frac{1}{2}$ -in. plate, it still had the 6 in. of iron and 20 in. of oak before it, instead of the *Warrior's* 18 in. of teak and  $\frac{5}{8}$ -in. iron skin. On the other hand, the American  $4\frac{1}{2}$ -in. plate was undoubtedly inferior to the British  $4\frac{1}{2}$ -in. plate—not as iron, but as armor.\*

\* This subject will be further discussed. Like the early British plates, the American thick plates are nearly all too hard.

The former cracked without bending much; the *Warrior* plates are greatly indented, bent, and upset by shot, before serious fracture occurs (212). Again, the iron backing of the 10-in. target diminished the local effect of the blow. But the less power a shot devotes to local effect, the more it reserves for racking the whole structure. The 110-pounder did not shake down the masonry until it struck a plate that it could neither penetrate nor greatly indent. Hence the 10-in. target was peculiarly adapted to suffer racking, while the ductility and the elasticity of the *Warrior's* side are better calculated to resist it.

**192.** After all, it is not so much a question of plates as of bolts. If the 15-in. shot goes *through* the *Warrior*, no matter about the fastenings; if not, the greater the bending of the plates, and the elasticity of the structure, the greater the strain upon the bolts. And if *one* plate is thrown off, the ship is at the mercy of 15-in. shells. It is thus clear that with the *Warrior* system of armor, up to 6 inches thickness, there is a very unsatisfactory margin of safety between penetration on the one hand and displacing the armor on the other. While the superior resistance of solid, as compared with laminated armor, to *punching*, has been demonstrated at great cost (197), the difficulty of properly fastening it, although encountered to some extent, with light shot, has only been appreciated after whole British and French iron-clad fleets, and several American vessels on the same plan, have been completed. It may hardly turn out to be a fatal defect; it will certainly prove to be a serious embarrassment.

**193.** As compared with the 10-in. target (179) struck by the 15-in. shot, the Inglis 12 and 13-in. target (185) was better calculated to resist local effect and to suffer distributed racking and vibration. Although it was perforated with many large bolt-holes, and the slabs were so thick and narrow as to be easily cracked, it was excessively rigid. The outer slabs, already thick, had a backing of 5-in. slabs and 7 × 9-in. beams, which should reduce the punching effect of a shot as compared with the 6 flexible 1-in. plates and the 20 in. of oak behind the outer plate of the 10-in. target. And, while the latter backing was both elastic and ductile, so as to yield

locally, the solid iron backing of the Inglis target could not yield locally, but had to shiver all over when it was hit. Still, the local effect—the evidence of power locally expended—was greater upon the Inglis target than upon the 10-in. target, and the distributed effect was less, which only shows that the simple 15-in. cast-iron ball, at the moderate velocity of 900 feet, is better for racking purposes than the costly rifle-bolts, which require enormous charges and excessively strong guns. Even the heavy and the light rifle-bolts produced this effect in a greater or less degree, respectively, although the velocity of all of them was too high to exert much distributed effort. On the other hand, the bolts of the yielding 10-in. target and of the comparatively elastic  $7\frac{1}{2}$ -in. target (186) were more likely to be thrown out than those of the rigid Inglis armor.

The  $7\frac{1}{2}$ -in. target was perhaps more likely to be thrown apart by vibration than the 10-in. target, because it was best of all the three to resist punching, the plates being both thick and large. It did suffer rather more from vibration than the Inglis target, but less than the 10-in. target, considering that the latter received but one shot; which further proves the superiority of heavy balls for this particular work.

On the whole, the 15-in. ball appears to have been capable of doing the greatest damage by vibration to either of the three targets (see Table 28), although the bolts were perhaps thrown out of the 10-in. target that it did strike, more easily than they would have been, by a similar blow, out of the Inglis and the  $7\frac{1}{2}$ -in. targets, which had elastic washers. This latter defect, however, may be remedied (204), so that, 1st, the general straining and weakening of a ship's side, and the leakage and the more gradual reduction of resistance to shot due to it, are likely to be the principal effects of vibration. 2d, the 15-in. ball at 900 ft. velocity is more formidable in this regard than the 200 to 300-lb. rifle-bolt at 1100 to 1300 ft. velocity. And hence it is fair to presume that the 20-inch ball, at a still lower velocity, will be the most formidable weapon at present known for this kind of attack.

**193 A.** A fine illustration of the effects and advantages of

light shot at high velocities, as compared with heavy shot at low velocities, was given in the experiments against the *Bellerophon* target. A 150-lb. steel ball punched the 6-inch solid iron at the junction of two plates, embedding itself in the backing, *breaking a rib* and two bolts, and cracking open and bulging the skin. A cast-iron ball—gun and charge the same—also went through into the backing and bulged the skin. But a 300-lb. bolt, from the *same gun with the same charge*, indented the plate 2·8 in.; started the corners of it out less than half an inch and made a crack; but broke no through-bolts. The target, considered as a ship, was uninjured.

The 150-lb. ball struck at the junction of two plates, which undoubtedly increased its penetration; but it must also be considered, 1st, that the 300-lb. bolt wasted less power locally in striking the centre of a plate than if it had also struck a joint; and 2d, that it strained the gun very much more than the 150-lb. ball strained it. With a 50 or 60-lb. charge, and the same strain upon the gun, the 150-lb. ball would obviously have broken through the target.

**194.** SOLID AND LAMINATED ARMOR.—Whatever may be the relations of the present guns and the present armor, both are to be vastly improved. The fabrication of great guns that will stand proportionate charges is beset with formidable difficulties, while the particular weakness of ships that great guns discover may be remedied by simply improving the fastenings of armor. Laminated armor—layers of thin plates breaking joints—takes hold of a large area of the ship's side, and has great continuity and tenacity compared with single rigid detached slabs, held each by its own fastenings without aid from the rest. In addition to this, laminated armor forms a practically continuous girder to resist the other strains brought upon the vessel, while detached solid plates are loosened by the working of the hull in a sea-way.

**195.** Americans, having great guns and knowing their effects, at once selected laminated armor for the purpose of resisting *these effects*; Europeans, having the guns necessary for high velocities, adopted solid armor to resist *punching*. But laminated armor can be most easily punched: then—the American theory is—it

must be made thicker, for a given weight, by being reduced in area—in short, the *Monitor* principle of low decks and turrets or short casemates must be substituted for the *Warrior*, or more especially the *Minotaur* system, of thin armor over all.

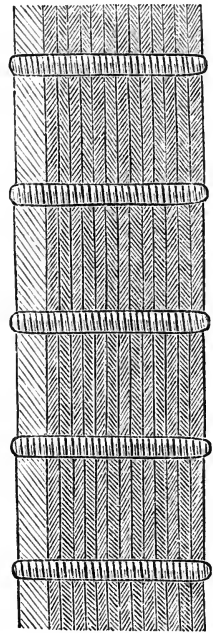
**196.** The inferior resistance of laminated armor as compared with solid armor, to cannon-shot, has been demonstrated by a number of experiments, which will be more fully described in a following chapter.

**197.** In 1861, a target proposed by Mr. Hawkshaw, composed of a front  $1\frac{1}{2}$ -in. plate and seven  $\frac{5}{8}$ -in. plates (total thickness, 6 in.), fastened together by alternate rivets and screw-bolts  $8\frac{1}{2}$  in. apart all over the target, and without wood backing, was completely punched by both the 110-pounder—charge, 14 lbs., and the 68-pounder—charge, 16 lbs.—at 200 yards.

**198.** Another target constructed on the same principle, of a  $1\frac{1}{2}$ -in. plate and thirteen  $\frac{5}{8}$ -in. plates (Fig. 102), the measured thickness being 10 in., and similarly screwed together, without wood backing, was broken through at the back and much indented by the 110-pounder and the 68-pounder—charges and range as before. The material in both these targets was the best boiler-plate, and, being thin, was of course sound and well worked.

**199.** There have been no experiments in England with the *better class* of  $4\frac{1}{2}$ -in. solid plates without wood backing; so that the merits of solid and laminated armor cannot be absolutely determined from these experiments. But it is absurd to suppose that 18 in. of teak backing\* is equivalent in any particular to the

FIG. 102.

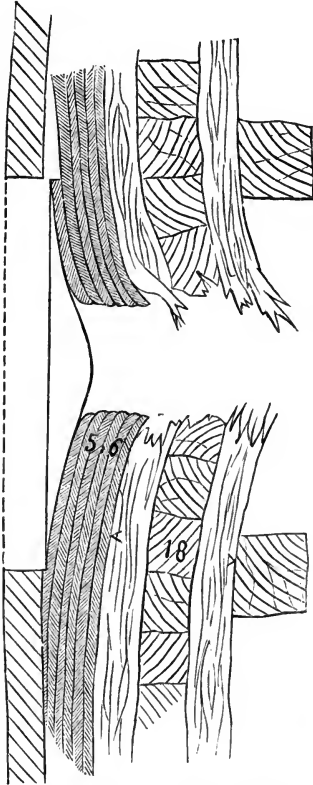


The Hawkshaw 10-in. target.

\* *Backing.* In a paper read before the British Association in 1863, Professor Pole stated what is generally considered in England to be the true office and value of wood backing. It does not add any appreciable strength or resistance to the armor-plate, but, 1st, It distributes the blow;

5½ in. of iron behind the front 4½ in. of the Hawkshaw target; and it is well known that a good 4½-in. plate backed with 18 in. of teak, is

FIG. 103.



Section of 6½ in. laminated target.

neither punched nor much fractured by the 110-pounder or the 68-pounder at 200 yards (177 B).

**200.** But certain American experiments are more conclusive on this subject. At the Washington Navy Yard, in the spring of 1863, a 10-in. 130-lb. cast-iron spherical shot was fired with 43 lbs. of powder—range, 200 yards—through a target (Fig. 103) composed of six plates making an aggregate thickness of 6½ in., backed by 18 in. of oak. The target was about 15 ft. square, and was the same as that used in the experiment with the 15-in. shot (179), except that the outer 4½-in. plate was removed (Fig. 104). The shot made a clean breach, as shown by Fig. 103, and passed some 100 yards to the rear.

**201.** One only of two 10½-in. 150-lb. balls fired with 50 lbs. of powder, and therefore more powerful than the 130-lb. ball last mentioned, was able to penetrate the *Warrior* target at Shoeburyness—a 4½-in. plate backed with 18 in. of teak and a ½-in. skin. And two 150-lb. balls fired with 40 lbs. of powder did not get through the backing of the *Warrior* target.

**202.** The reason why laminated armor is more easily pierced

2d, It is a soft cushion to deaden the vibration and save the fastenings;

3d, It catches the splinters; and

4th, It still holds the large disks that may be broken out of a plate, firmly enough to resist shells (203).



than solid armor, is thus explained:—In a punching machine, the resistance of a plate to punching is directly as the fractured area,

FIG. 104.



Side and front of 6½-in. laminated target.

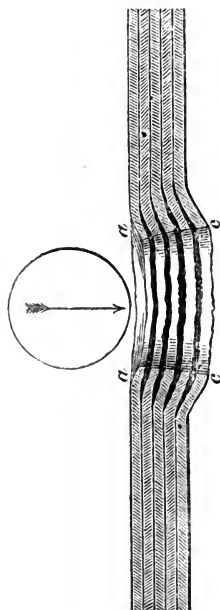
that is to say, directly as the thickness of the plate, for a given diameter of hole. But the resistance of a plate to punching-shot is found to be about as the square of its thickness. Now, in a machine there is a die under the plate, which prevents the metal around the punch from breaking down. Under an armor-plate there is no such die; the metal under the punch carries the adjacent metal with it, and the hole at the back is very much larger than the hole at the front.\* So that, while in a machine the fractured area (Fig. 106) would be  $a c$ , under the blow of a ball it would be  $a e$ , or at least so much larger than the united fractured areas of the thin plates forming the laminated armor (Fig. 105) as to account for the superior resistance of solid plates. Fig. 104 represents a 10-in. shot-hole made at the Washington Navy Yard through a laminated target. As there was no continuity of substance, the plates received no aid from each other.

**203.** It should be remarked, however, in favor of the solid armor, that so long as the shot is not powerful enough to make a clean breach through backing and all, the large disk broken out of the solid plate remains fixed in the backing, and is still a good protection against common shells and light missiles, while the disks broken out of laminated plates, are not large enough to remain

\* It is possible to imagine velocities so great that the metal around the shot would not have time to be carried away. See also 261

upright and solid in the backing, nor massive enough to stop the smallest cannon missiles.

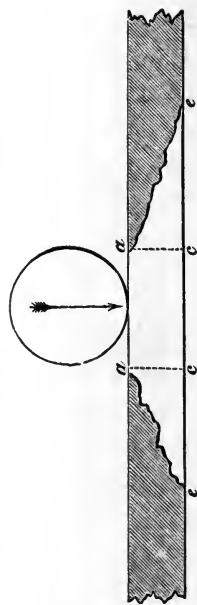
FIG. 105.



Section of shot-hole through laminated armor.

**204.** The thin armor-plates employed to give continuity to the side of a ship, need not constitute the entire protection. The 14-in. armor (181)—six 1-in. plates, one 4-in. plate, and four 1-in. plates—illustrates the principle of the *Dictator's* armor. The outer thin plates, breaking joints, may be compared to a continuous elastic skin which holds the thick resisting plates in their places. The inner thin plates are an elastic backing, which gives room for the thick plate to yield without breaking the ribs, and prevents damage from splinters. Mr. Scott

FIG. 106.



Section of shot-hole through solid armor.

Russell's armor (Fig. 107) is a vast improvement on the *Warrior's* (Fig. 108) in this regard. The plates would have to be broken into small pieces before they could be thrown out by the vibrations of the ship's side. The elastic bolt (Fig. 109) will obviously relieve the effects of heavy shot.

**205. Smashing Ship's Sides by Heavy Shot Considered.**

—The more remediless but difficult work expected of heavy shot is to smash the side of the ship—to cripple the armor, tear open the skin, break the ribs, and shake the whole structure so violently as to cause either serious leaks or an impaired resistance to farther blows.

**206.** The resistance of a ship's side to this kind of assault cannot be truly ascertained by firing at small targets. The large

mass has the greater inertia and presents the greater resistance to fracture when the blow is slow enough to allow the surrounding elasticity and tenacity to be called into service. It is possible that the 10-in. target (179) was so well braced and had so much inertia (it was about 15 feet square, but only half its face was plated), that greater size would not have added to its strength. But it was neither overturned by the 15-in. shot, nor violently shattered except in the fastenings of the plates. The Inglis target (185) and the 7½-in. target (186) were assaulted with excessive violence, and

FIG. 108.

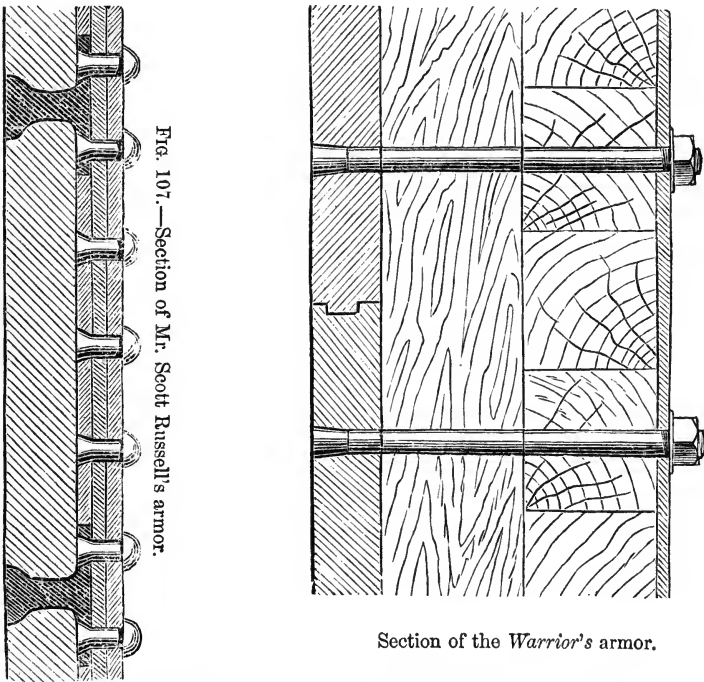


FIG. 107.—Section of Mr. Scott Russell's armor.

Section of the *Warrior's* armor.

were certainly racked and crippled; but they held their ground, and the plates were not thrown off. Although the straining and breaking of the ribs would probably have caused leakage, it by no means follows that the buoyancy of a ship with many compartments would have been seriously impaired.

FIG. 109.



Wire-rope bolt for armor.

The 14-in. target (181) was so rigid that the 11-in. shot produced less local and more distributed effect. The whole mass, with its framing and the sea-wall behind it, was moved bodily. But it was a small target. The fact that it moved is evidence that greater size—the continuity and elasticity of a ship's side—would have modified the result. Mr. Scott Russell's target (Figs. 99 and 100) was a heavy structure, but not heavier in proportion to the power of the shot than the 14-in. target; and it was shoved bodily to the rear a quarter of an inch, because, 1st, the shot could not penetrate it, and 2d, it had not the continuity of a ship's side.

The targets at which the 15-inch shot were lately fired (181 A) were too small to illustrate the dislocating effects of such projectiles on a casemate incorporated with the whole structure of the ship. The 13-inch Armstrong ball, with 90 lbs. of powder (181 D), did not overturn nor remove a plate of only  $41 \times 24$  inches face. (See note on page 187.)

But while experimenters may deceive themselves with small targets, they may also deceive themselves with *flat* targets. The curved sides of the *Monitor* turrets have been found to resist both smashing and punching better than a flat target of the same thickness.\*

**207. POPULAR THEORY OF DESTROYING ARMOR BY SHOT OF MEDIUM WEIGHTS AND VELOCITIES: ITS ERROR.**—Before proceeding farther in this consideration, it is important to notice a popular error regarding the work demanded of guns. Indeed, some of the practice in the adaptation of naval guns appears to contemplate the destruction of armor by heavy, although not the heaviest shot, at medium velocities. The aim is not to perfect both means of attack—racking and punching—by trying to get double the power out of one gun, but, with the same power—the same charge of powder—to barely punch the armor, and to devote the residue of the power to shattering and straining the surrounding structure. If the projectile is too heavy to receive quite a punching velocity, it is certainly heavy enough to do some pretty formidable racking. If

\* This fact is proved by several recent American experiments, the details of which the Government declines to make public.

the range happens to be short, and the armor thin, it makes a large hole, while a small shot, at say double the velocity, would make its little hole not only so suddenly that the surrounding parts would not be shattered, but with a small portion of its power, the remainder being lost, or at least not expended on the armor. This theory is to be carried out, not by the small projectiles at high velocities, nor heavy projectiles at low velocities, but by a happy intermediate system of ordnance, that will "waste no power" in any case, but inflict the maximum damage upon the enemy, when the circumstances are favorable.

**208.** LOCAL EFFECT PREVENTS DISTRIBUTED EFFECT, AND VICE VERSA.—A very important element has obviously been omitted in this calculation. The *same* power that indents a plate cannot dislocate it. Whatever effort is added to the one kind of destructive effect, is subtracted from the other. The probability of penetration has been reduced by making the shot large, and hence slow. If it does not actually penetrate, a large part of its power has been employed in the fruitless local work of partial penetration, and only the residue of it can be utilized in racking the structure elsewhere. Or, in other words, the probability of racking and straining the whole structure—of serious *distributed* effect—has been reduced by making the shot light and fast enough to devote much of its power to a local effort that is useless, because it is incomplete. Had, for instance, the 150-lb. Armstrong spherical shot, in all the cases in Table 28, been either much lighter or much heavier, it would have employed the whole force of the powder in one way or the other. Its local effect was certainly tremendous, but it neither shook off the plates nor went through any strong target. The same may be said of all the shots from similar guns. Indeed, the whole table is full of instruction on this point. Notwithstanding the tremendous assault upon the 13-in. and the 7½-in. targets, they were neither punched nor shaken down. The projectiles were just heavy enough to prevent the first effect, and just light enough to avoid the other.

But it is seriously argued that if a shot does not go entirely through a plate, its velocity is so reduced while passing into the

TABLE XXVIII.—PRINCIPAL EXPERIMENTS ON SMASHING AND DISLOCATING ARMOR, CHIEFLY BY HEAVY SHOT AT LOW VELOCITIES.

No.	CHARACTER OF GUN.	Range in yards.	Weight of projectile, lbs.	Character of shot.	Charge, lbs.	Velocity in feet.	Iron in Target. Inches.	Wood backing, Inches.
1	15-in. Rodman smooth bore..	200	400	Cast-iron cored sphere.	40	Initial, about 1000	4½ in. × 3½ × 15 ft. solid, and 5 plates 1.1 each=10 in. iron.	20
2	15-in. Rodman smooth-bore..	50	400	Cast-iron cored sphere.	60	Initial, 1480	6 in. solid plate.	30
3	11-in. U. S. Navy smooth-bore .....	200	169	Cast-iron solid sphere.	30	Initial, about 1400	4½ in. × 3½ × 15 ft. solid, and 5 plates 1.1 each=10 in. iron.	20
4	11-in. U. S. Navy smooth-bore .....	50	169	Cast-iron solid sphere.	30	Initial, 1400	14-in. target 7 ft. square. 6 plates of 1 in., 1 of 4 in., and 4 of 1 in.	None.
5	13-in. Horsfall smooth-bore..	120	279.5	Cast-iron solid sphere.	25	.....	4½ in. solid, 2000 lbs. weight.	None.
6	13-in. Horsfall smooth-bore..	800	279.5	Cast-iron solid sphere.	74.4	{ Initial, 1631 Ricocheted.	Warrior target. 4½ in. solid, ⅝-in. skin, and Warrior ribs.	18
7	13-in. Horsfall smooth-bore..	800	279.5	Cast-iron solid sphere.	74.4	Striking, 1300	Warrior target.	18
8	13-in. Armstrong rifle.....	1000	610	Elongated steel shell.	70	About 1200	Warrior target.	18
9	13-in. Armstrong rifle.....	200	344.5	Spherical steel ball.	90	1760	11 in. solid plate 41 × 24 in.	2 12-in. oak posts.
10	10½-in. Armstrong smooth-bore .....	200	150	Cast-iron solid sphere.	40	Striking, 1586	Warrior target.	18
11	10½-in. Armstrong smooth-bore .....	200	162	Wrought-iron sphere.	50	Striking, about 1600	{ Scott Russell's target. 4⅝-in. plate and iron backing of three 1 in. and two ⅝ plates. No bolts. Continuous riveted ribs between plates.	None.

No.	10½-in. Armstrong smooth-bore	200	162	Wrought-iron sphere.	50	Striking, about 1600	Striking, about 1650	5½-in. plate, ⅝-in. skin; <i>Minotaur</i> ribs.	9
12	10½-in. Armstrong smooth-bore	200	162	Wrought-iron sphere.	50	Striking, about 1600	Striking, about 1650	<i>Minotaur</i> target. 5½-in. plate, ⅝-in. skin; <i>Minotaur</i> ribs.	9
13	10½-in. Armstrong smooth-bore	200	150	Cast-iron sphere.	50	Striking, about 1650	Striking, about 1650	<i>Minotaur</i> target. (Chalmers's target, 3¾-in. plate backed by ⅝-in. plates on edge, 5-in. apart, and wood between (this backing 10⅞ in. thick), resting on 1¼-in. plate, 3¾-in. wood, and ⅝-in. skin.)	9
14	10½-in. Armstrong smooth-bore	200	150	Cast-iron sphere.	50	Striking, about 1650	Striking, about 1650	.....	.....
RESULT.									
1	4½-in. plate broken through; others indented a little. Nearly all bolts broken and jerked out; wood crushed a little; target violently shaken.								
2	Target cracked, smashed, and completely penetrated.								
3	4½-in. plate broken through. Indent, 3½ in. deep. About half the bolts broken and a few thrown out.								
4	Slight local effect. Target framing and sea-wall moved bodily several inches. Nearly all bolts broken and loosened.								
5	9 balks of 14-in. timber formed a partial backing. Plate broken and scattered. Balks driven into sandbank.								
6	Smashed plate and backing; tore skin and broke 7 bolts and two ribs. Did not go through.								
7	Broke off corner 2 × 1½ ft.; started 2 bolts; doubled up a rib; shook target. Damage extended 5 ft. down.								
8	Shell burst in passing through; hole through target 20 × 24 in.; plate started; many bolts broken, and target slewed round.								
9	Plate broken in two; supports splintered; ball flattened and thrown toward gun.								
10	Bulged and crushed plate over a surface of 3 or 4 sq. ft.; bent ribs; tore skin; broke several bolts and lodged in backing. Where the plate was backed with beams 2 ft. sq., similar shot did less local damage; but target and masonry shaken.								
11	Hole broken through front plate; 2 ft. riveting sheared off; vertical rib and skin broken; shot thrown forward; whole structure moved back ¼ in.								
12	After No. 13 and 2 other shots clean through, smashed hole and lodged in it; backing smashed; no hole through; 2 ribs and 4 bolts broken; local effect less than No. 13; effect distributed on masonry in rear; target much shaken.								
13	Smashed a disk out of plate 13 in. into backing; plate driven in 1 in.; 9 bolts and 11 rivets started; 2 ribs broken; horizontal girder carried away; general strain and bend.								
14	After a punching shot, smashed indent 11 in. deep; broke 2 bolts and 5 rivets; bulged out 2 ribs and backing.								

TABLE XXVIII.—CONTINUED.

No.	CHARACTER OF GUN.	Range in yards.	Weight of projectile. lbs.	Character of shot.	Charge. lbs.	Velocity in feet.	Iron in Target. Inches.	Wood backing. Inches.
15	10½-in. Armstrong smooth-bore .....	200	150	Cast-iron sphere.	50	Striking, about 1650	Chalmers's target.	.....
16	7-in. Whitworth rifle.....	200	150	Elongated steel.	25	At 563 ft. 1241	Ingليس's target. 8-in. vertical and 5-in. horizontal slabs, and 7-in. vertical and 5-in. horizontal slabs, 9 × 5-in. ribs, and 3-in. bolts. No wood.	.....
17	10½-in. Armstrong rifle. ....	200	230	Elongated conical cast iron	45	At 563 ft. 1400	Ingليس's target.	.....
18	10½-in. Armstrong rifle.....	200	307	Elongated cast iron.	45	At 563 ft. 1228	Ingليس's target.	.....
19	10½-in. Armstrong rifle.....	200	301	Elongated conical steel.	45	Striking, 1293	Brown's target. Upper plate 5½ in., middle plate 7½ in., lower plate 6½ in. 2½-in. skin behind backing on one side. Iron ribs and horizontal girder.	.....
20	10½-in. Armstrong rifle.....	200	300	Elongated cast iron.	35	.....	<i>Bellerophon</i> target. 6 in. solid; 1½-in. skin; heavy ribs.	10
21	9-22-in. Armstrong rifle.....	200	113	Wrought-iron sphere.	25	At 563 ft. 1462	Ingليس's target.	.....
22	7-in. Lynall Thomas's rifle..	200	150	Elongated wrought iron.	25	At 563 ft. 1218	Ingليس's target.	.....
23	9-in. Lynall Thomas's rifle..	200	302	Elongated wrought iron.	50	Not ascertained.	Brown's target.	.....
24	9-in. Lynall Thomas's rifle..	200	330	Hardened steel bolt.	50	At 563 ft. 1220	Brown's target.	.....



No.	RESULT.
15	After 2 shots, smashed indent 12 in. deep and broke up; 2 bolts, 3 rivets, and 1 rib broken; corner of plate struck and detached; skin cracked.
16	After 5 shots, struck an 8 × 24 × 21-in. plate under embrasure; bent 9 × 5-in. rib previously started; broke 2 bolts; threw out one; cracked both plates and drove in front plates 1 in.
17	After 2 shots, cracked 7-in and 5-in. plates, and bent, drove in, and dislocated them and the ribs; several bolts broken; indent, 1½ in.; no plates thrown off.
18	After 5 shots, struck joint near Whitworth No. 16; cracked plate, broke, and threw out a bolt; bulged and shook planks and frame-pieces considerably.
19	After 3 rounds with 68-pounder and 3 with 65½-lb. 7-in. Armstrong rifle, shot struck over a rib; 13 × 6 in. indent in 7½ in. backed plate; a bolt and 20 rivets broken; bent plate and ribs; broke the horizontal girder, and shook the whole violently.
20	After 11 heavy and light shot, struck centre of plate; plate driven in 2 1 in. for 5 ft. and started out 4 in. for 2 ft., and crack 18 in. long; no through bolts or skin broken.
21	After 1 shot, indent 2½ in. cracked 8 in., and 5-in. plate; bent rib; broke 1 bolt; perceptible strain.
22	After 3 shots, indent 1 8 in. plate cracked and sprung, but not much shaken; shot much upset.
23	After 1 shot, struck junction of 7½ and 6½ plates not backed; indent 6 in. in 7½ ft. length; several cracks; several rivets and angle-irons and a vertical rib broken; shot rebounded 25 yards; shot much upset.
24	After 2 shots, smashed a piece 21 × 12 in. out of 7½-in. plate not backed; shook horizontal girder out of place; broke one and bent 2 ribs; 2 bolts broken.

plate, that the surrounding metal will have time to distribute the shock. Undoubtedly; and if the shot were still slower and heavier, so that it would indent the plate less, there would be more shock to distribute. To drive a shot half way through an iron target, or even to considerably indent it, which any conceivable cannon-shot however slow must do, certainly absorbs, neutralizes, uses up a certain and no inconsiderable amount of power. *That* power does nothing else, and it is only the fraction of power remaining in the shot that inflicts other damage upon the target. If all the shot could be expected to strike in the same place, or if an iron-clad battle could be expected to last long enough to *wear out* armor by perpetual hammering, this system would be less objectionable.

**209.** The less a target resists local effect, the more it resists distributed effect. The 13-in. shot at 800 yards neither punched nor overturned the *Warrior* 4½-in. target nor shook off its plates, because the target was simply smashed through within a small area. The shield was shattered, but it saved the enemy behind it. The 150-lb. ball did not shake the *Warrior* target and its supporting masonry, until it struck in front of solid timber backing 2 ft. square, which it could not penetrate. A salvo from three 110-pounders, two 68-pounders, and one 140-pounder, smashed a hole entirely through the "Committee target," but did not loosen a single bolt. The effect was wholly local. The 300-pounder bolts racked the 7½-in. target very little until the 301-lb. steel bolt struck over a rib, so that its indentation was only 6 inches. Then a bolt, 20 rivets, and the horizontal girder were broken, the plates thrown out at the ends, and the whole target was violently jarred. The 150-lb. ball could not get through Mr. Scott Russell's target; so it shoved the target bodily to the rear. The wrought-iron 162-lb. ball was too soft to penetrate the *Minotaur* target, and therefore shook it more violently than the cast-iron shots of the same size which retained their figure until they got through. The 13-in. Horsfall shot, at 200 yards range and 1631 ft. initial velocity, smashed a 2½-ft. hole through a new *Warrior* target *without buckling the plate struck*. All the American

experiments with heavy shot and very thick targets lead to the same conclusion.

**210.** The plan of intermediate weights and velocities is founded, to a certain extent, in another error, viz. :—that the object of projectiles is to destroy *armor*. On the contrary, armor is in itself harmless; the active enemy is the guns and the propelling machinery behind it. If only the shield is shattered, iron-clad defences have accomplished their object. Undoubtedly *armor* could be most completely destroyed by knocking off the corners of the plates, and dislocating and upsetting them all over with cracks and indentations. But, to disable the enemy, swift projectiles must strike him *through* his shield, or the tremendous vibrations of heavy balls must tear his shield away from him.

**211.** THE DUCTILITY OF THE ARMOR SAVES THE VESSEL UNDER EXCESSIVELY LOW VELOCITIES OF SHOT.—The opposite extreme is to increase the weight of the projectile to the utmost extent, and therefore to decrease its *velocity* (the strength of the gun being the limit) in proportion. But it is impossible to avoid expending much power in simply local distortion of the armor. A gun capable of throwing a hundred-ton ball would not be attempted, in the present state of the art, and yet a 7000-ton ram, at the velocity of 16 miles an hour, or less than 24 feet per second, would not shatter the whole side of a ship. The principal effect of collisions is local.

The elasticity and ductility of the vessel's side and of the armor may neutralize the effect of the projectile, if it is slow enough. A very swift shot completes its work before these qualities can be called into action. Even a plate of copper or of gold will break short instead of being bulged by a rifle-shot. The ductility of wrought iron peculiarly fits it for this service. After its limit of elasticity is overcome, it will continue to stretch or compress, as the case may be, instead of going instantly to pieces. At the same time it is hard enough to oppose great resistance to change of figure. Mr. Mallett, in illustrating the safety of soft wrought iron for cannon (because so much "work done" is required to stretch it through its great range of tenacity), (352), much more clearly

proves its fitness for armor, because a part of an armor-plate once strained beyond the limit of its elasticity may not be hit again, while the strains of each fire are repeated upon the same parts of a gun. If a shot moves slowly enough to allow the iron to stretch even beyond the limit of elasticity, the armor on the side of the ship may still absorb its power without even fracture. So that this extreme is equally unfavorable to the racking of the ship.

As to jarring and shaking off the armor, the 7000-ton ram at 24 feet per second would be the wrong instrument, even if it were blunt pointed. Such a projectile, however, is so excessively powerful, as compared with the resistance of a vessel's side, that no cannon-ball can be likened to it. Estimating the work done to be as the weight multiplied into the square of the velocity, the ram would do nearly 28 times as much as a 15-in. shot at 900 ft. per second. Estimating it as the weight multiplied into the velocity, which the advocates of heavy shot believe to be correct, the ram would do above 1000 times the work of the shot.

**212.** That the ductility of very soft metal is brought into service, even when the velocities of shot are excessively high, is proved by the bulging of the Thames Iron Works plate (Figs. 110 to 113), by the blow of a 68-lb. 8-in. wrought-iron spherical shot with 22 lbs. of powder and a velocity of above 1800 feet per second, at 50 yards range, and a cast-iron 68-lb. shot with 16 lbs. of powder and a velocity of 1579 feet. The flattening of the wrought-iron shot from 8 to 9 in. diameter across the front of the indentation, is evidence in the same direction.

FIG. 110.

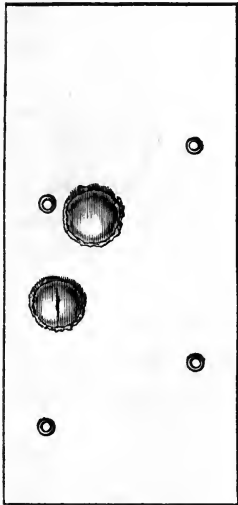


Thames Iron Works plate; end view.

**213.** Inasmuch as a shot cannot be instantly arrested, the grand aim in the construction of armor is to increase this ductility. In the earlier practice, "steel-clad" ships were talked of, naturally enough, because steel was superior to iron for all engineering purposes. But, upon experiment, steel was not indeed punched instantly; it cracked, and crumbled, and thus failed as armor. Wrought iron of high tenacity, known in other construction as

the best, also failed in a similar manner, in proportion to its resemblance to steel. On the other hand, excessive ductility is accompanied by too much softness; copper is too easily punched.

FIG. 111.



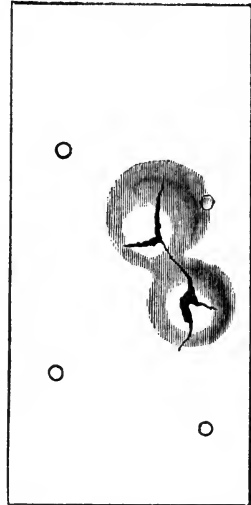
Thames plate; Front.

FIG. 112.



Thames plate; Top.

FIG. 113.



Thames plate; Back.

But thick plates of wrought iron, however soft, fail by cracking. As the velocities of projectiles increase, this tendency will of course diminish.

**214.** So that the aim of armor-plate makers is to provide toughness rather than tenacity. The difference between the early American plates (the early English plates were equally bad) and the better class of American plates, is illustrated by comparing the experiments with the  $4\frac{1}{2}$ -in. Dahlgren target No. 5 (Fig. 114), and those with the Nashua plate (Figs. 115 and 116). The former target, composed of a  $4\frac{1}{2}$ -in. plate,  $98\frac{1}{2}$  in. long and 48 in. wide, backed with 20 in. of white-oak and a 1-in. skin, was set against a bank of earth and knocked to pieces, as shown, by the following shot, viz. :—

- 1 cored cast-iron, spherical, 11-inch 163-lb. shot.....30 lbs. powder.
- 1 steel, flat-fronted, 40·7-lb. shot..... 8 lbs. powder.
- 1 wrought-iron, spherical, 53-lb. shot.....17 lbs. powder.
- 1 solid cast-iron, spherical, 11-inch 169-lb. shot.....30 lbs. powder.

**215.** The Nashua Iron Works forged plate (Figs. 115 and 116) was 40 in. wide,  $4\frac{1}{2}$  in. thick, and 16 ft. long. It was backed by 20 in. of oak and a 1-in. iron skin. At the range of 30

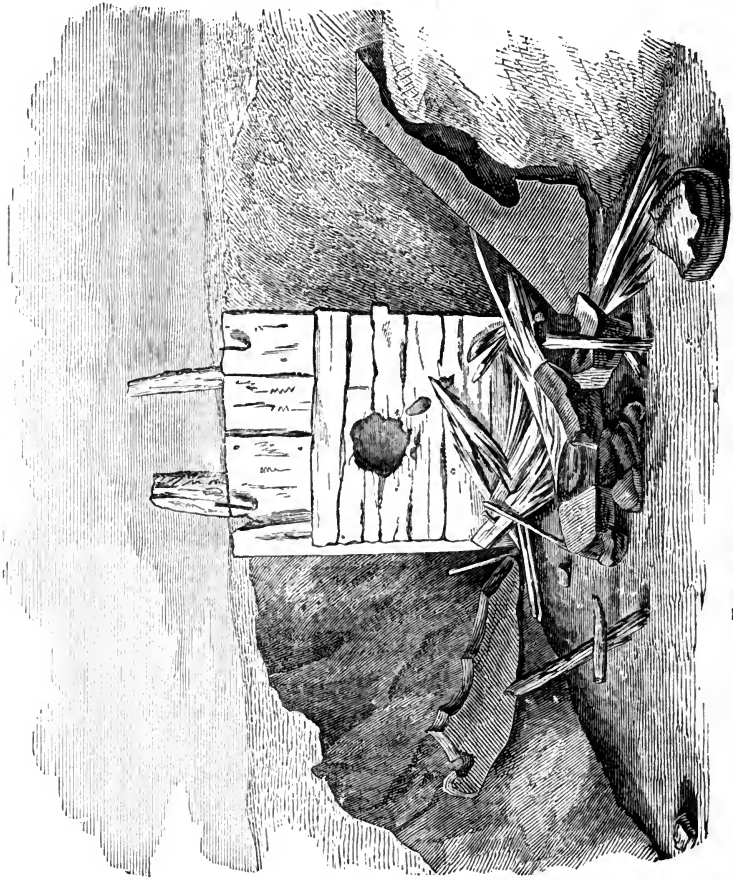


Fig. 114.—4½-in. Dahlgren target. No. 5.

yards, three 11-in. 169-lb. cast-iron balls, and three 186-lb. wrought-iron balls were fired in the order marked on the engraving, with 30 lbs. of powder. The plate was considerably bulged, and cracked, and was broken to pieces at one end by the 5th shot. No breach was made through the entire target.

**216.** The better class of modern English plates is shown by

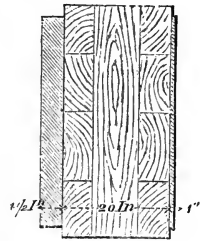
Figs. 117 and 118. The former plate, backed like the *Warrior* target, with 18 in. of teak and a  $\frac{1}{2}$ -in. skin, received six 68-pounder balls with 16 lbs. of powder, at 200 yards range, in a space 27 in. square, without breaking through. Brown's plate, which is by no means his best, and is marked "A 3," was broken through by 4 balls (charge, backing, and range the same), striking within a space about  $17 \times 27$  in.

**217. DIFFICULTY OF ADAPTING THE HEAVY SHOT SYSTEM.**—In order to waste no power by the heavy shot system—in order to produce the most destructive racking with the least local effect—both a medium velocity, and an excessively low velocity with the weights of shot that the respective guns will endure, must be avoided;—which does not leave much margin. The former wastes too much power in fruitless local effort; the latter enables the elasticity and ductility of the metal to prevent the destruction of the vessel; and if it could be made so excessive as to be compared to a ram, it would not *jar* the plates and joints loose.

**218.** Now, supposing the weight and velocity of the projectile to be adapted to any particular range and armor:—a longer or a shorter range and a thicker or a thinner armor would obviously be equivalent to giving the shot too much or too little velocity. The contemplated circumstances of greatest effect might not occur once in a whole battle. What is the *proper* weight and velocity, considering the wide diversities of range and resistance? What one gun, or, if it were practicable to multiply varieties, what system of guns can be expected to hit this narrow and ever-changing mark of maximum effect? Do we not discover in these inquiries the serious incompleteness of the system?

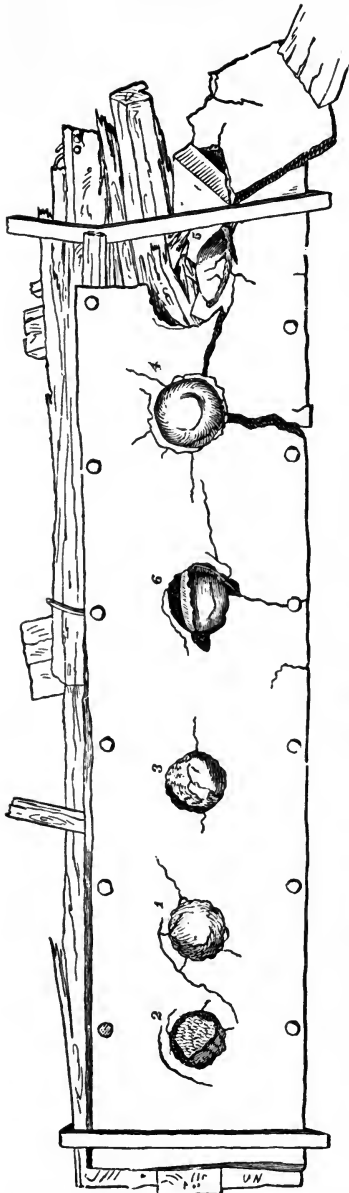
If, on the contrary, the highest attainable velocity (modified in some degree by other considerations which will be further mentioned) were given to the projectile, it would waste the least power on the *armor*, and reserve the most to devote to the active *enemy* within it—the men, guns, and machinery.

FIG. 115.



Section of Nashua target.

FIG. 116



Front of Nashua target after six 11-in. shot with 30 lbs. powder at 30 yards.

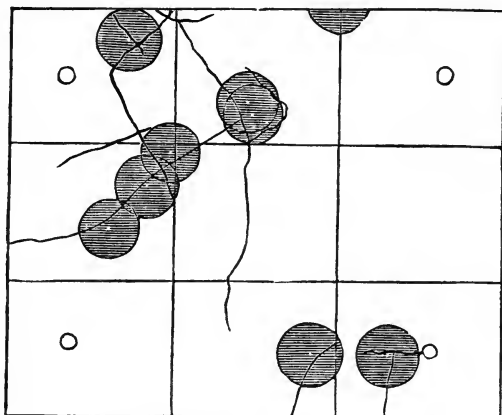
**219. OTHER DEFECTS OF THE HEAVY SHOT SYSTEM.**—Supposing the heavy shot to accomplish the first result aimed at—dislocating the armor—a reasonable supposition only in the case of the *Warrior* class of armor. The enemy's shield is then torn away from him, and, as we have said, he is at the mercy of heavy shells with enormous bursting charges. But the shells must be thrown, and must be well aimed. There is no question about their result if they can be properly placed, and the accuracy of 15-inch spherical projectiles, not to mention that of modern rifle-shells, especially from the Armstrong 600-pdr. (see Chapter on Projectiles), is remarkable; still the work is not done at a stroke, and the enemy has *time* to turn away his wounded side, or to better his position by some other manœuvre.

Or, supposing the heavy shot to accomplish the second result aimed at—the racking of the vessel's side, or the shattering of a portion of her side—still the active enemy is unharmed. His ship may leak, and his shield may be crumbling, but his guns and machinery are yet in action. The old wooden walls were riddled and torn for hours before fighting and manœuvre.



ring had to be suspended. It was not until shells blew great chasms in their sides, or set them to sinking or to burning, or slaughtered their crews, that their power of offence was gone.

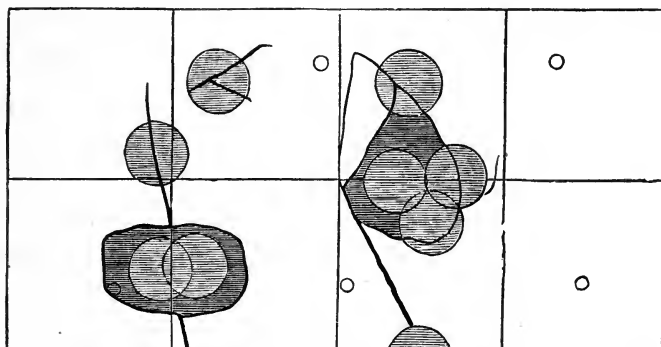
FIG. 117.



Thames Iron Co.'s plate. "A. 2."

But the bursting of shells will not destroy *armor*—nor the enemy within it, if they do not go through it; iron ships will not burn;

FIG. 118.



John Brown & Co.'s plate. "V. Good A. 3."

nor will ships with many bulkheads, both vertical and horizontal, sink, until they are shattered from end to end, below water. The

*Galena* (262) was put *hors de combat*, and the *Keokuk* was sunk, and the *Atlanta* was disabled, by punching; not by smashing or racking. The *Merrimac* is supposed to have been discomfited by 11-in. shot at very low velocities, although her *leaking* is believed to have been principally due to the strains she inflicted upon herself in trying to run over the *Monitor*. She was, moreover, a weak vessel, hastily covered with the ill-adapted materials at hand.

This method of attack would probably prolong a battle to such an extent that rams, torpedoes, mortars, and various means of disabling the locomotive power of ships, might decide it after all. But the real danger of a prolonged battle is, that the enemy might get within shelling distance of cities.

**220.** Breaking a disk out of a plate and driving it into the backing, is a frequent result of firing heavy shot at the *Warrior* class of armor; it occurred when the 169-lb. (11-in.) spherical shot was fired at the 10-in. target (180). But this disk, although detached, still remains between the opposing projectiles and the men and machinery within the ship; and it is amply sufficient to keep out ordinary shells (203).

**221.** GREATER STRAINS IN LARGE GUNS.—The greater strains imposed upon large guns; their greater weight, size, and cost; the increased risk of defective material in large masses, and the enormous weight (or else limited supply) of heavy projectiles to be handled or transported as cargo, are serious arguments against the heavy-shot system. Of course, spherical shot can be thrown at given velocities with less power, as they present a larger area to the powder than elongated projectiles of the same weight.

As to the greater strain upon large calibres, for a given work done, Captain Blakely says:\* “In the 32-pounder, the shot moves from its position just fast enough to enable the gas of the gunpowder to expand as it burns, so as never to press more than about 5 tons per inch, the combustion being complete when the shot has moved about 24 inches. At this period a gas which, if confined in a length of the bore but 8 inches long, would give a pressure

\* “A Cheap and Simple Method of Manufacturing Strong Cannon.” 1858.

of 3000 atmospheres or 20 tons per inch, having four times so much room can only press 750 atmospheres or 5 tons per inch. In an 8 or 10-inch gun, the shot moves more slowly from rest, while the powder burns more rapidly in proportion, so that for an instant the pressure would exceed 5 tons per inch. In much larger cannon the shot would move so leisurely that the pressure might reach 18 or 19 tons per inch."

Mr. Michael Scott gives the table (29) as the result of his investigations on this subject. His explanations are appended in a note. (See also 258 notes and 259.)

TABLE XXIX.—WEIGHT OF SHOT THAT MAY BE FIRED FROM VARIOUS WROUGHT-IRON SMOOTH-BORED GUNS WITHOUT STRAINING THE METAL MORE THAN THAT OF SERVICE GUNS IS STRAINED. BY MR. MICHAEL SCOTT.

Bore of gun. inches.	Weight of shot for velocity of			Weight of sphere. lbs.	Weight of elongated shot. lbs.	Velocity of elongated shot. feet.	Force of blow of elongated shot.	Momentum of recoil from elongated shot (Col. 6).	Weight of gun, to give same extent of recoil.
	feet. 2000	feet. 1750	feet. 1100						
	Ordinary 68-pounder.								
8	lbs.	lbs.	lbs.	70	.....	1600	1 0	1 0	5 0
7	118	154	390	47	93	2253	2 64	1 87	9 35
8	135	176	446	70	140	1964	3 c2	2 46	12 30
9	152	198	502	100	202	1734	3 40	3 13	15 65
10	168	220	555	131	273	1565	3 75	3 82	19 10
11	185	242	611	174	366	1422	4 13	4 65	23 25
1	2	3	4	5	6	7	8	9	10

In exhibiting this table before the Royal United Service Institution (Jour. R. U. S. I., June, 1862), Mr. Michael Scott said:—"Column 1 gives the bore of the gun in inches; column 2 gives the weight of the shot which may be fired with a velocity of 2000 feet per second; column 3 gives the weight of the shot which may be fired at the velocity of 1750 feet per second; and column 4 gives the weight of the shot which may be fired at the velocity of 1100 feet per second. The next column gives the weight of a sphere of the diameter stated in the first column; the next is the weight of an elongated shot of two diameters' length, but not solid, hollow behind; the next gives the velocity of that elongated shot; and the next gives the force of the

**222.** ADVANTAGE OF SINGLE HEAVY SHOT OVER SALVOS OF LIGHT SHOT.—In so far as it is intended, not to punch armor, but to shatter it in the highest degree, one heavy shot is more effective than a very much greater weight of light shot. Commander Scott says\* on this subject:—“The size of the gun is of vast importance, more than is generally assigned to it, and for this reason—20 guns, each a 1-pounder, are fired at a target of iron 1½-in. thick, and produce no effect; one gun, a 20-pounder, is fired and smashes it, the velocity in both cases being equal—in both cases the same amount of metal is used, and on this principle an official record of experiments at Portsmouth states that one 68-pounder produced more destruction than five 32-pounders. Arguing from this, it appears that one 150-pounder is more effective than ten 68-pounders, one 330-pounder is equal to seven 150-pounders, and a broad-side of three 330-pounders is more destructive than 10½ *Warriors*.” On this principle, Commander Scott constructs Table 30.

**223.** The effect of a salvo, however, is very much greater than that of the same shots fired consecutively. And while the construction and convenient mounting of 300-pounders, for instance, present some serious difficulties, the effects of their shot may be approximately realized by taking more pains to concentrate a simultaneous fire from such guns as we have.

blow, that of the 68-pounder ball, taken at 70 pounds in round numbers, moving at 1600 feet per second, being taken as one.

“The principle upon which this table is calculated is very simple; but it involves a great number of figures. I have stated publicly on previous occasions, and I do not know that it has ever been disputed—I do not know that it can be disputed, because there does not seem to be any dispute whatever with respect to the theory, namely—that the power of the shot is the *vis viva* of the shot, the living energy, the weight multiplied by the square of the velocity. If that be so, then the only other element is the diameter of the gun. The force of the blow (column 8)—and it is somewhat important—varies very considerably. The argument is this: assuming wrought-iron, in the first place, and assuming that wrought-iron is three times as strong as cast-iron, that without straining the metal of the gun more than the metal of an ordinary 68-pounder is strained by firing a 70-lb. shot at 1600 feet per second, this is the effect. These numbers represent the force of the blow, or the effect produced by the shot from these varieties of gun. \* \* \* It is quite irrespective of charge. The question has nothing to do with the quantity of powder. It is a relative question—not an absolute.”

\* Jour. Royal United Service Inst. June, 1863.

TABLE XXX.—SHOWING THE ADVANTAGE OF ONE HEAVY SHOT OVER SEVERAL LIGHT SHOTS. CON-  
STRUCTED FROM A TABLE BY COMMANDER SCOTT, R. N.

(Journal of the Royal United Service Inst., June, 1863.)

No.	Guns.	WEIGHT.			Powder and shot.	Cost.	No.	Gun.	WEIGHT.			Powder and shot.	Cost.
		Tons.	Powder lbs.	Shot lbs.					Tons.	Powder lbs.	Shot lbs.		
5	32-prs.	14½	50	160	2 1	.....are equal to.....	1	68-pr.	4¾	16	68	0 14	
10	68-prs.	47½	160	680	7 0	.....are equal to.....	1	150-pr.	12	40	150	1 13	
7	150-prs.	84	280	1050	11 10	.....are equal to.....	1	330-pr.	26	80	330	3 8	
350	68-prs.	1662½	5600	11200	490 0	.....are equal to.....	5	330-pr.	130	400	1650	17 0	
20	68-prs.	95	320	1360	14 0	.....are equal to.....							

Warrior's broadside.

Captain Selwyn says\* on this subject:—"Strange it is, that even now, with all the experiments which iron-plate committees have tried, they have never, so far as I can learn, tried this (the effect of salvos), so that we have still to theorize on the subject. I find that four 100-pounder shot fired, not together, but consecutively, broke through into the cupola of Captain Coles; that several shot together, as regards the place of striking, injured the plates very much; that on one occasion when six guns were fired as a salvo, the effect was enormously greater, as might have been expected, than when the same guns were fired consecutively; but on no occasion can I find that any thing like even a heavy corvette's broadside was concentrated and fired at an armor-plate.

"Now, this is the very first expedient or experiment which would probably be tried in war; and till we can say that it has been fairly examined into, we really know nothing of the true value of armor."

**221. RECAPITULATION.**—As far as results can be compared, the simple 15 in. cast-iron ball at a moderate velocity appears to be capable, with much less strain upon the gun, of inflicting much more of the kind of damage under consideration, than the more powerful and costly rifle-bolts, because it wastes less power in local effect. The system of intermediate weights and velocities is least damaging, because it neither hits the enemy behind the shield nor tears the shield away from him: it spends so much power in smashing the place struck, that little is reserved to rack the structure. The first result expected from heavy shot—dislocating the plates by breaking their fastenings—may be modified or prevented by improving the fastenings on the plan of the *Dictator* armor (204), for instance, and by other tested means. The other result—shattering the whole ship's side to a dangerous degree—is not fairly represented by the displacing of small targets by heavy shot, and presupposes shot of such excessively low velocities that the ductility and elasticity of ordinary armor will enable it to take advantage of that grand element in resistance to projectiles—*time*.

\* Jour. Royal United Service Inst. June, 1863.

**225.** The disadvantages of the system\* are therefore as follows:—

1st. Every change in the quality and distance of the shield to be disabled, disturbs the designed relation of shot to armor, thus either wasting much power in fruitless local effect, or preventing serious damage by allowing the ductility and elasticity of the shield to come to the rescue; in fact, both these results must follow any moderately heavy and slow cannon-shot. But a fast, punching shot, wastes the least possible power in getting through the armor; and what it has left when it gets through, is available upon the naked enemy.

2d. Even supposing the enemy's side to be finally made vulnerable or to be dangerously strained and shattered—this operation wastes valuable *time*, during which the enemy's fleet may manœuvre to his own advantage.

At the same time, the destructive effect of heavy projectiles at low velocities, particularly upon the *Warrior* class of armor, has been seriously underrated, especially in Europe. (177 C.)

### SECTION III.—SHOT AT HIGH VELOCITIES.†

**226.** EXPERIMENTS.‡—British and American experiments have well tested the punching capacities of various systems of ordnance and the resistance of many kinds of armor. It has already been shown that the resistance of plates to punching is as the squares of their thickness; for example, that two 2-inch plates laid together, are but half as strong as one 4-inch plate (202). It should also be remembered that the hard iron of which the early English

\* This is, of course, no argument against large shot, provided they certainly *punch* the armor instead of merely mutilating it.

† Armor-punching projectiles must obviously go faster than projectiles intended to distribute their effects over a ship's side; they must therefore be smaller for a given strain upon the gun. So long as a punching velocity is obtained, the larger the hole or the shell which enters it the better. The punching theory does not contemplate small shot, except in so far as reduction of weight is essential to high velocity.

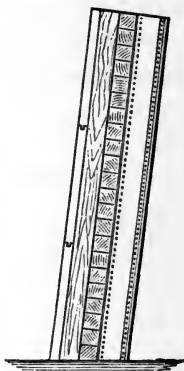
‡ A more complete account of these experiments, derived from official records, will be given in a following chapter.

and nearly all the American thick plates have been made, is quickly disabled by cracking and crumbling, while soft and ductile iron is greatly bulged, mashed, and upset before breaking (212 to 216)—effects which do not harm the enemy behind it, nor the plate itself in a very great degree. Until this kind of armor was adopted, the 8-in. 68-lb. shot, with 16 lbs. of powder and about 1422 feet striking velocity, was more than a match for the 4½-in. plate at 200 yards. The Thames Iron Works plates (212), although not the best now manufactured, show the quality of the better class of armor-iron. During the last year the rolling process, especially at the Atlas Works, Messrs. John Brown & Co., Sheffield, and at the Mersey Iron and Steel Works, Liverpool, has produced very superior plates.

**227. 10½-INCH BALL; WARRIOR TARGET.**—The first memorable advance in the power of ordnance was demonstrated (April, 1862) in the effect of the Armstrong 10½-in. 150-lb. spherical cast-iron shot, with 50 lbs. of powder and about 1600 feet striking velocity per second, upon the *Warrior* target at 200 yards (Fig. 119). The target weighed above 32 tons (341 lbs. per square foot), and was composed of 3 plates, each 3½ × 12 ft. and 4½ in. thick, bolted one above the other against 18-in. teak backing composed of timbers 9 × 9 in.; the inner tier being laid horizontally, and the outer tier vertically. Behind this were the ⅝-in. iron skin and the 18-in. iron ribs of the ship. The whole was supported by diagonal braces. There was an embrasure in the centre of the target.

The first and second shots at this target were made with 40 lbs. of powder, and lodged in the backing. The third shot—charge, 50 lbs.—was aimed at a plate that had not been struck before, and punched an 11-in. hole through the whole structure. The fourth shot struck where it could not penetrate, and therefore shook the target violently.

FIG. 119.

The *Warrior* target.  
Scale, ¼-in. to 1 ft.



**228.** 10½-INCH BALL; MINOTAUR TARGET.—In July following, the same gun—range 200 yards—was fired at the *Minotaur* target, composed of 3 plates, each 12 ft. × 3 ft. 4 in., and 5½ in. thick, backed by 9 in. of teak and  $\frac{1}{8}$ -in. skin. The upper plate was rolled by Messrs. John Brown & Co.; the second was forged at the Thames Iron Works; the lower one was forged by Messrs. Beale & Co. Each plate was fastened by 3 rows of 1½ and 1¾-in. bolts. One 10-in. and one 16-in. strip, 1¼ in. thick, were attached to the back by the same bolts at the junction of the plates.

The first shot, a 150-lb. cast-iron ball, with 50 lbs. of powder, struck the middle plate, but did not go through the target. The second—weight and charge the same—hit the top plate, and made a 12½ × 13-in. hole through the structure. The third shot struck the lower plate and punched a 13-in. hole through the target. The hole and rent at the back were together 16 × 30 in. The fourth shot has been referred to (188).

**229.** 13-INCH BALL; WARRIOR TARGET.—The next formidable demonstration was made by the the 13-in. Horsfall gun at 200 yards, September 16th, 1862, against a new *Warrior* target, constructed (without an embrasure) of 3 tongued and grooved plates, 12 ft. 3 in. × 3 ft. 8 in. to 4 ft. 5 in. wide and 4½ in. thick. These were backed by a layer of 9 × 9-in. teak timber standing vertically, another lying horizontally, a  $\frac{3}{8}$ -in. skin and 15-in. vertical ribs 15-in. apart. The target “tumbled home” or inclined inward 1 foot in 8 feet height, and was set up against the old *Warrior* target. The shot was of cast iron not turned; weight 279·5 lbs.; charge, 74·4 lbs. of powder; initial velocity, 1631 feet. It struck the centre of the target, smashed a 2 ft. 1½-in. × 2 ft. 4 in. ragged hole entirely through it, making several cracks, breaking off 2 ribs, and cracking another; driving in 3 feet square of the skin, breaking over 20 bolts, and dislocating the parts of the target. But the plate struck was not buckled (209).

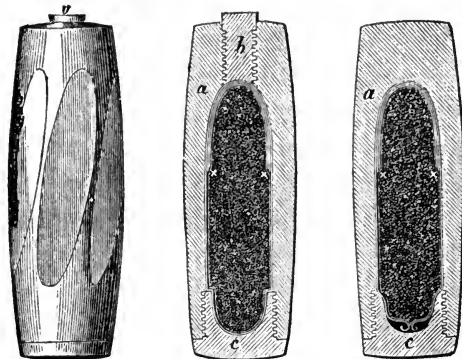
On September 26, the same gun was fired at this target under similar circumstances, except that the range was 800 yards. The result has already been specified (183); the structure was not punched.

**230.** 301-LB. RIFLE-SHOT; CHALMERS TARGET.—On April 27th, 1863, after 26 rounds with 68 and 110-pounders, a 301-lb. steel shot was fired with 45 lbs. of powder and 1293 ft. striking velocity, from the Armstrong 10½-in. rifle—range, 200 yards—at the *Chalmers* target (189), which was composed of a 3¾ in. plate backed by ¾-in. plates on edge, 5 in. apart, with wood between (this entire backing was 10¾ in. thick), the whole resting on a 1¼-in. plate backed by 3¾-in. wood and a ¼-in. skin.

The shot struck the junction of the centre and upper plates, and smashed a 13 × 14½-in. hole through the front, and a 1½ × 2-ft. hole through the back of the target, driving to the rear fragments of plate and backing. A rib was smashed and driven back 18 in.

**231.** 130-LB. STEEL SHELL; WARRIOR TARGET.—The results of the Whitworth and Armstrong experiments with rifle-shot and shell are specially important. On September 25th, 1862, the *Warrior* target last described (229) was completely punched at 600 yards by a Whitworth 130-lb. flat-headed shell. The gun (43, 44) was fabricated at Woolwich, of wrought iron, upon the Armstrong plan, except that it had a solid-forged internal tube.

FIGS, 121, 122, 123.



Whitworth's armor-punching steel shells.

It was rifled on Mr. Whitworth's plan, the bore measuring 6·4 in. across the flats, and 7 in. across the corners. The projectile\* (Figs. 120, 121 and 122), was 17 in. long, and solid for about ¼ its length. It was loaded with a 3-lb. 8-oz. bursting charge, fired with 25 lbs. of powder, and had a velocity of 1268 feet at the distance of 580 yards from the gun. The shell struck the centre plate, making

\* See description in chapter on Rifling and Projectiles.

a  $7\frac{1}{2} \times 8\frac{1}{2}$ -in. hole, and burst in passing through the backing. Two cracks were made in the plate, and 2 bolts were started. At the back of the target the hole was 13 in. in diameter. Portions of the shell and the piece of iron punched out of the armor-plate were picked up inside the target, in what represented the hull of the ship; some old oakum on the ground was set on fire. One rib was broken, and the wood backing was much shattered. The shell burst into about 14 pieces.

This plate (from the Parkhead forge) was afterwards proved by the 68-pounder to be of an inferior quality. The indentation of the 68-pounder shot in good  $4\frac{1}{2}$ -in. plates with *Warrior* backing is  $2\frac{1}{2}$  in.; the indentation in this case was 4.05 in., with considerable damage in the vicinity of the blow.

**232.** 151 AND 130-LB. STEEL SHELLS;  $4\frac{1}{2}$  AND  $5\frac{1}{2}$ -INCH PLATES; WARRIOR BACKING.—On the 13th of November, 1862, further experiments were made of a similar character. The target was constructed for this experiment, of 3 stories of plates,  $9\frac{1}{2}$  ft. high in all, and 12 ft. long, secured by 2-in. bolts at the edges, so as to weaken the plates as little as possible. The 18-in. backing was composed of 12 and 6-in. teak. Behind the  $\frac{5}{8}$ -in. inner skin, a box  $10 \times 6$  ft. was formed, to represent the 'tween-decks of a ship. The two lower plates, of 5 in. thickness, were rolled at the Atlas Works. The upper  $4\frac{1}{2}$ -in. plate was forged at a Government dock-yard.

A 151-lb. steel shell, with a bursting charge of 5-lbs., fired with 27 lbs. of powder, from the same gun (120-pounder), with a striking velocity of 1170 feet at 800 yards, penetrated the middle of the centre (5-in.) plate, and burst in the wooden backing into 14 large and 9 small pieces. The base and some pieces of the shell were blown out in front of the target; other pieces, and fragments of the skin and debris, were blown into the ship, but did no serious damage.

The 2d shell—charge and weight the same—struck  $7\frac{1}{2}$  in. from the bottom of the top ( $4\frac{1}{2}$ -in.) plate, nearly in line with one of the ribs, penetrating the target and driving out the rib. The shell burst while passing through the inner skin, and blackened the chamber as well as shattering the skin and the wooden backing.

The butt of the shell stuck in the hole, but 46 pieces of shell and skin were scattered about the 'tween-decks in every direction.

The 3d shell was cast iron, and broke up, not without considerable distributed effect. The 4th, of steel—weight, 130 lbs.; charge, 27 lbs.; striking velocity, 1227 feet—penetrated the centre (5-in.) plate; hole in front,  $7\frac{1}{2} \times 8$  in.; hole at the back, 14 in. diameter; skin forced out 9 inches. The shell burst as it broke the skin, and blackened the chamber; it broke into 19 pieces, which, together with many of their fragments, passed into the ship.

**233.** 288-LB. STEEL SHELL;  $5\frac{1}{2}$ -INCH PLATE.—On the 17th of March, 1863, after 6 rounds with the 110-pounder and 68-pounder, and a 301-lb. bolt, the  $10\frac{1}{2}$ -in. Armstrong rifle was fired at Messrs. John Brown & Co.'s target, which consisted of a lower horizontal plate 6 in. thick, a middle plate  $7\frac{1}{2}$  inches thick, and an upper plate  $5\frac{1}{2}$  in. thick, each 4 ft. high and 12 ft. long, their faces being flush. One side of the target was backed by vertical iron ribs; the other by 10-in. of teak, a 1-in. plate, a  $1\frac{1}{2}$ -in. plate, and vertical ribs. A heavy horizontal girder extended across the back of the vertical ribs. The target was held upright by heavy timbers extending between it and a bank of earth behind.

A 288-lb. flat-ended steel shell, 20 in. long, with a thin cast-iron hemispherical head—bursting charge, 11 lbs.—was fired with 45 lbs. of powder at 1318 ft. striking velocity. It penetrated the  $5\frac{1}{2}$ -in. plate and the backing to a depth of 14 in., and burst in the backing, the hole being filled with portions of the shell. The plate was somewhat cracked and dislocated. The backing at the point of the explosion was completely splintered and set on fire. At the back a rib was broken, and the skin was rent and bulged.

**234.** 148-LB. STEEL SHELL;  $5\frac{1}{2}$ -INCH PLATE.—On the same occasion, a 148-lb. steel shell was fired at the same target from the Whitworth 7-in. rifle with 25 lbs. of powder—bursting charge, 5.12 lbs.—at a velocity, at 524 ft. distance from the gun, of 1268 feet. It punched the  $5\frac{1}{2}$ -in. plate,  $5\frac{1}{2}$ -in. (outside to outside) from the last hole, and burst in the backing, which was completely blown out at the top. The skin at the back was more opened, and wooden splinters were driven through.

**235.** 300-LB. STEEL SHELLS;  $4\frac{1}{2}$ -INCH PLATE.\*—On the 17th of October, 1862, the following experiments were made at St. Petersburg, with 9-in. cast-iron and steel shells against  $4\frac{1}{2}$ -in. plates made for the Russian Government by Messrs. John Brown & Co., Sheffield:

“First, a series of cast-iron shells, 300 lbs. each, were fired at different ranges, and then shells made by Krupp were fired at the  $4\frac{1}{2}$ -inch armor-plates. The first shell, of hard cast steel, was  $22\frac{1}{2}$  inches long (two and a half diameters), with a flat end four inches in diameter. Fired with 50 lbs. of powder at 700 ft. distance, it passed through the plate, oak and teak backing, and broke into many pieces, although filled with sand only. The second and third shells were also of Krupp’s steel, the same length, but with  $6\frac{1}{2}$ ” ends. These shells pierced plates, wood, &c., and also went to pieces, although only filled with sand. The fourth shell was made by M. Poteleff, of puddled steel, on Aboukoff’s system, the same dimensions as the second and third, and went through iron, teak, &c., but was only bulged up from 9” to 12”, and the end flattened; not a single crack being visible in the shell. The fifth shell, the same as the fourth, passed through iron, teak, and the second target, and went at least a mile beyond. The sixth and seventh shells were from Krupp, and were charged with powder; they were quite flat-ended, 9” diameter. One exploded in the plate, the other in the wood. The eighth and ninth shells were of cast iron, and, although they passed through the plates, were of course destroyed. Evening prevented further trials, which will yet be made on the same plate.”

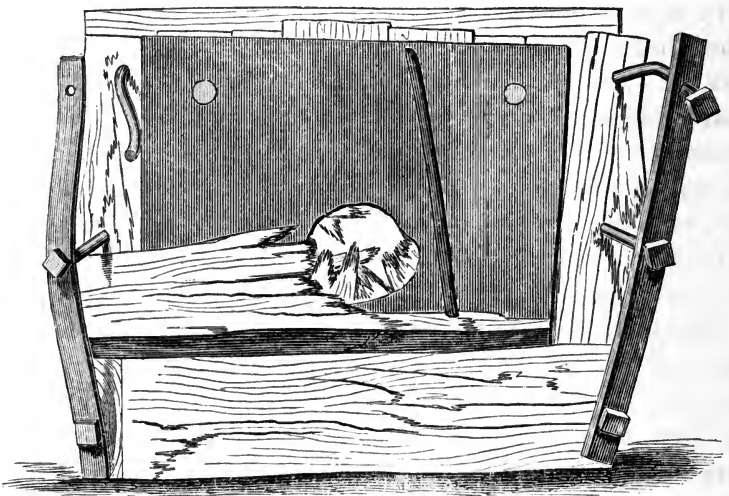
**235 A.** 610-LB. 13-INCH BOLT; WARRIOR TARGET.\*—On December 11th, 1863, a 600-lb. steel shell was fired from the 13-in. Armstrong gun, with 70 lbs. of powder, at the *Warrior* target. Range, 1000 yards; initial velocity, about 1200 feet, bursting charge of shell, 24 lbs. The shell burst on entering the target, and smashed a  $20 \times 24$ -in. hole entirely through it (181 C).

\* The account of these experiments, unlike the others mentioned, is not official, but is understood to be trustworthy.

**235 B.** 15-INCH BALL; 6-INCH PLATE; 30-INCH BACKING.—More recently, a 400-lb. cast-iron ball was fired from the 15-in. United States navy gun, with 60-lbs. of powder, through a 6-in. solid plate and its 30-in. backing. Range, about 50 yards; initial velocity, 1480 ft. The target was otherwise smashed and shattered (181 A).

**235 C.\*** 11-INCH BALL; 4½-INCH SOLID PLATE; 12-INCH WOOD FACING AND 20-INCH BACKING.—On the 28th of May, 1863, this target was punched at the Washington Navy Yard (Figs. 122 A,

FIG. 122 A.



4½ in. plate, with wood backing and facing.

and 122 B). The shot was a 168-lb. cast-iron 11-in. ball, fired with 30 lbs. of powder; range, 90.2 ft. The target was a 4½-in. solid plate, only 4 feet square, forged from scrap, and having upon its outer surface 12 inches of oak fastened with 6 bolts, and upon its inner surface 20 in. of oak backing, resting against a solid bank of clay. The shot struck 16 in. from the top of the target, and 16½ in. from its right edge, shattering the top and middle course of facing, and tearing off the upper part, throwing two

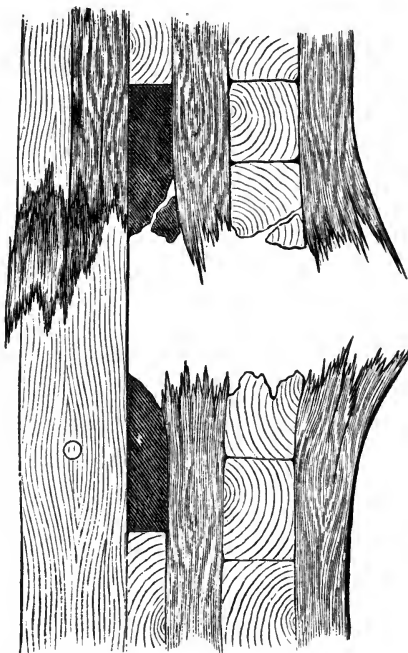
\* These facts and engravings were published officially in the "Scientific American."

timbers 30 ft. forward and one piece of plate 102 ft. forward. Two bolts were broken.

FIG. 122 B.

The indentation around the shot-hole was  $\frac{5}{8}$  to  $\frac{7}{8}$  inch. The shot was fractured and flattened, but did not break up.

It should be remarked with reference to this, as well as other experiments with English and American targets, that a target of this size *cannot* represent the continuity and strength of a ship's side, or of a complete turret or casemate.\* It is also well settled in England, that large area of plate, iron box-backing (see *Chalmers* and *Bellerophon*

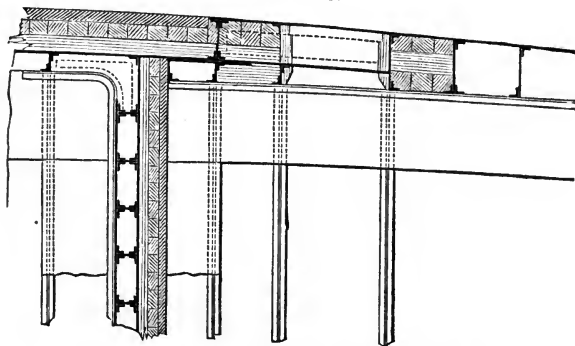


4½-in. plate, with wood backing and facing.

targets) in addition to wood backing, and great ductility of armor, are all essential features of good armor.

\* Figs. 122 C, and 122 D, represent horizontal sections of the *Warrior's* side at the junction of the armor-plated athwart-ship bulkhead with the side armor, and between

FIG. 122 C.

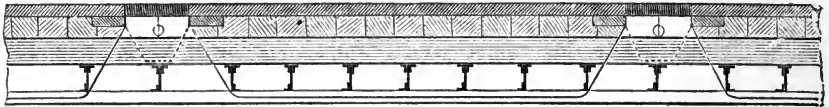

 Horizontal section of the *Warrior's* armor.

**236. American Armor-Punching Guns.\***—The American guns that are capable of giving very high velocities to shot of large diameters, have not been fired at a *Warrior* target. But their effects may be approximately arrived at from their charges.

The Parrott 10-in. rifle (78) fires a 300-lb. projectile† with 25 lbs. powder. It may therefore be considered capable of carrying a spherical 130-lb. ball with nearly as much effect as the 10½-in. Armstrong gun, which made a clean breach through the *Warrior* target. The new 10-in. Dahlgren cast-iron gun fires a 130-lb. ball, with 40 to 43 lbs. of powder, at about 1600 feet velocity. Its effect would be nearly  $\frac{7}{8}$  that of the 10½-in. Armstrong, at the same range. The first gun of this class was cast solid, and burst after less than a hundred rounds; but the gun has now been remodelled and strengthened, and is cast hollow. The first 10½-in. Armstrong gun burst after 264 rounds. The 11-in. ball, with 30 lbs. of powder and 1400 feet velocity, would give about 80 per

the ports. These illustrations show, at a glance, the probable resistance of a ship as compared with a small detached plate of iron resting on short sticks of backing with-

FIG. 122 D.



Horizontal section of the *Warrior's* armor.

out lateral or vertical support, and without a convex and continuous structure of ribs, bulkheads, and decks, in the rear.

\* A writer in the *Edinburgh Review* (April, 1864), who is obviously not prejudiced in favor of English Ordnance, expresses what is certainly the common although not the universal sentiment of England with regard to American Ordnance. After the Dahlgren and Rodman 11 and 15-inch guns and the Parrott 100-pounder have endured the thousand test rounds, and in view of the unprecedented scientific accuracy with which the figure, material, and fabrication (hollow casting, and cooling from within), of the Rodman and Dahlgren guns have been perfected, the writer referred to remarks as follows:—"The Americans appear to have a natural predilection for what is big, and they have applied themselves to the production of huge guns, made on every variety of pattern, with very little scientific uniformity and direction. If we are correctly informed, none of these guns have shown that durability which is essential to permanent service, nor have their effects corresponded to the cost and labor bestowed on them."

† The ordinary projectile of the Parrott 10-in. gun weighs 250 lbs.



cent. of the penetrating effect of the 10½-in. Armstrong ball with 50 lbs. of powder, this effect being, according to all authorities, as the weight multiplied into the square of the velocity. Inasmuch as a spherical shot always breaks a hole larger than its own diameter, the resistance to all these shots would not very materially differ on account of their small differences in sectional area. The greater part of the *work* is undoubtedly done before the ball gets half way through the plate.

The 11-in. shot has been fired through a number of 4½-in. plates backed like those of the *Warrior*; but the quality of the iron was in some cases very inferior for *plates*. The target (200), compared with the English plates (212 to 216), is a sufficient illustration of this fact. High steel is certainly an invaluable material for many uses, but it makes the worst possible armor. Hard iron of high tensile strength resembles steel in this particular. The plates struck by the 11-in. shot exhibited their unfitness by cracking all over, and they sometimes actually crumbled into small pieces where they were struck.\*

Other American 4½-in. plates, of better quality, have not been completely punched by the 11-in. shot and 30 lbs. of powder (214).

Quite recently, the 15-in. gun has been found capable of enduring 60-lb. charges, which give a velocity of nearly 1500 feet to its spherical projectiles, enabling them to completely punch targets much thicker than the sides of the *Warrior*. The following are extracts from the United States Navy Ordnance Instructions for 15-in. guns:—

“*Solid shot* should always be used against iron-clads, and with 50-lb. charges, but never fired on any other occasion.

“At close quarters—say 50 to 150 yards—60 lbs. may be used for 20 rounds of *solid shot*.

“*Cannon-powder* only should be used, as 35 lbs. of this kind

\* This defect in American thick plates is admitted, and can be remedied. The prolonged and costly experiments by which hard iron was proved inadequate in England, ought not to be repeated in America. At the suggestion of the author, Admiral Dahlgren some time since sent for a number of English sample-plates, for target practice, that he might more accurately compare his own with foreign guns.

TABLE XXXI.—PRINCIPAL EXPERIMENTS WITH SHOT AT HIGH VELOCITIES AND SHELLS AGAINST SOLID ARMOR.

NOTE.—This table represents the maximum penetrating power of Ordnance, since much thicker laminated armor has been punched by both similar and lighter shot at lower velocities.

No.	CHARACTER OF GUN.	Range in yards.	Weight of shot in lbs.	Character of projectile.	Charge, lbs.	Velocity in feet.	Iron in Target. Inches.	Wood backing. Inches.
1	15-in. Rodman smooth-bore..	ab't	400	Cast-iron solid sphere.	60	1480	6 in. solid French plate.	30
2	13-in. Armstrong rifle.....	50 1000	610	Elongated steel shell.	70	About 1200	Warrior target. 4½ in. solid; ⅝ in. skin; 18 in. iron ribs.	18
3	13-in. Horsfall smooth-bore..	200	275.5	Cast iron solid sphere.	74.4	Initial, 1631	Warrior target.	18
4	11-in. U. S. Navy gun.....	30	168	Ditto.	30	Initial, about 1400	4½ in. solid plate.	{ 12 in. facing, 20 in. backing.
5	10½-in. Armstrong smooth-bore .....	200	150	Ditto.	50	Striking, 1600	Warrior target.	18
6	Ditto.	200	150	Ditto.	50	Do.	Minotaur target. 5½-in. plate; ⅝ skin behind backing; 18 in. iron ribs.	9
7	10½ in. Armstrong rifle.....	200	301	Solid steel elongated shot.	45	Striking, 1293	Chalmers's target. 3½-in. plate backed by ⅝-in. plates on edge 5 in. apart; wood between (this backing 10⅝ in. thick) resting on 1¼-in. plate, 3⅝ in. wood and ⅝ in. skin.	.....
8	Ditto.	200	288	Elongated steel shell. Bursting charge, 11 lbs.	45	Striking, 1318	Brown's target. (See No. 13.)	.....
9	Whitworth rifle (120-pdr.) ...	600	130	Elongated steel shell; 3 lbs. 8 oz. bursting charge.	25	Striking, 1268	Warrior target. Inferior plate.	18
10	Ditto.	800	151	Do.; 5 lbs. bursting charge.	27	Striking, 1170	Upper plate, 4½ in.; 2 lower plates 5 in.; 2 bolts at edges. ⅝ in. skin.	18

No.	RESULT.							
11	Ditto.	800	151	Ditto.	27	Do.	Ditto.	18
12	Ditto.	800	130	Ditto.	27	Striking, 1227	Ditto.	18
13	Ditto.	200	148	Elongated steel shell 5 lbs. 25 12 oz. bursting charge.	25	Striking, 1268	Brown's target. Upper plate, 5½ in.; middle do., 7½ in.; lower do., 6½ in.; iron ribs and horizontal girder. 2½ in. skin behind backing on one side.	10 in. be-
1	Target completely penetrated and badly smashed.							
2	Shell burst in passing through; hole through target, 20 × 24 in.; plates started; bolts broken.							
3	2½ ft. ragged hole through target; broke 3 ribs and 20 bolts; plate struck not buckled.							
4	15½-in. hole through target, and 3 ft. 6 in. into bank; most of facing thrown off; 2 bolts broken.							
5	11-in. hole through entire target.							
6	12½ × 13-in. hole through the target.							
7	Struck junction of plates. 13 × 14½ in. hole through front, 1½ × 2 ft. through backing; rib broken.							
8	Clean hole in 5½-in. plate, and burst in backing, setting it on fire, and tearing open skin and breaking rib.							
9	Clean hole through; burst in backing, setting it on fire; debris driven through skin; oakum fired; 1 rib broken.							
10	8-in. hole in 5-in. plate, and through all, shell burst outward and inward. No damage within.							
11	Penetrated 4½-in. plate over rib, driving it out; shell burst passing through skin; 46 pieces of shell and skin scattered between decks.							
12	Penetrated 5-in. plate; 14-in. hole at back; burst in skin; fragments driven through.							
13	Struck near the 288-pdr. (No. 8); burst in backing and blew it out at top; skin opened.							

gives a greater range than 50 lbs. mammoth powder; and this charge of the latter cannot be burnt in the gun."

**237. Conditions of Greatest Effect.**—The measure of the penetrating force is stated by all the authorities to be the weight of the shot multiplied by the square of the velocity at the moment of impact.\* Referring to table (31), it will be observed that the 288-lb. Armstrong shell fired with 45 lbs. powder, at 1318 feet striking velocity, went through a 5½-in. plate; while the 150-lb. spherical ball, fired with 50 lbs. of powder from a similar gun with, say, 1600 feet striking velocity, only went through a 4½ in. plate and its backing. But it must be remembered that the gun was very much less strained by the latter shot. (239.) To produce a strain upon it equal to that of a 288-lb. shot with 45 lbs of powder, the 10½-in. Armstrong gun first made was fired with a 150-lb. shot and 90 lbs. of powder, giving a velocity of 2010 ft. The work done by the 150-lb. ball at 2010 ft., as compared with that of the 288-lb. shot at 1318 ft., would be about as 6 to 5. While the 288-lb. shot, at 1318 ft. velocity, only penetrated a 5½-in. plate, the 275-lb. Horsfall shot, at only about 200 feet more velocity per second, smashed a 2-ft. hole through a 4½-in. plate and its backing.

**238. CONDITIONS OF HIGH VELOCITY.**—MERITS AND DEFECTS OF SPHERICAL AND RIFLE SHOT.—To insure a high velocity, the shot must be light. According to Professor Treadwell, the strain produced by heavy and light projectiles, with a given charge, is as the cube roots of their respective weights,† and their velocities are inversely as the cube roots of their weights.

\* Commander Scott states (Journal Royal United Service Institution, April, 1862), that "a very high velocity seems to produce an effect far beyond what the formula velocity<sup>2</sup> × weight gives."

† Mr. Michael Scott says, on this subject, in his pamphlet "On Projectiles and Guns," 1862:—"Without at present attempting any investigation as to the pressure of the gas formed by the explosion of gunpowder, or the rate at which that pressure diminishes as the gas expands, it may be affirmed that the pressure required to produce, in a given length of gun, a certain velocity, will vary as the square of the velocity, as is the case when a constant force acts; and, if the pressure be given, the weight to be thrown will be inversely as the square of the velocity. (P being the pressure, M the mass, S the space, then  $\frac{P}{M} = \frac{V^2}{2gS}$ ; or  $P \propto V^2$  if M be given,  $M \propto \frac{1}{V^2}$  if

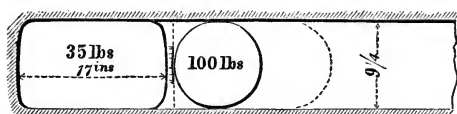
**239.** The spherical shot presents the greatest area of any practicable solid shot to the powder, for a given weight, and hence receives the higher velocity.

P be given.) Therefore, if a shot of 140 lbs. be fired from a 7-in. gun, with a velocity of 1100 ft. per second, the weight which can be fired with the same strain upon the gun with a velocity of 1600 feet per second, is only  $140 \times \frac{1100^2}{1600^2} = 66$  lbs.

Sir William Armstrong said, in a discussion before the Royal United Service Inst. (*Jour. R. U. S. Inst., June, 1862*):—

“I will now endeavor to explain why it is that a rifled gun must be heavier than a smooth-bore, and, for this purpose, I will direct your attention to the longitudinal diagram which I have drawn (Fig. 123), showing the bore of a gun of  $9\frac{1}{4}$  in. in diameter, with a cartridge containing 35 lbs. of powder, and measuring in length 17 inches, and

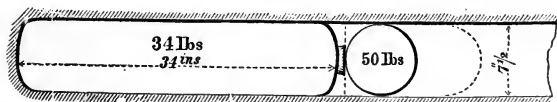
FIG. 123.



having a round shot placed before it weighing 100 lbs. Now, if I were to rifle that same gun, and substitute for the round shot a rifled shot of twice the weight, then it must be clear that, the powder having a greater mass to move, the gas will meet with a greater resistance, and will get up a greater pressure behind the shot, and it will be necessary to add additional strength to resist that extra strain upon the gun. \* \* \*

“But, it may be said, why not keep the weight of the shot the same, and reduce the bore, so as to enable the same proportions to be retained? Now, we will try that alternative; and here we have it represented. I have in this case taken the bore at  $7\frac{1}{2}$  in., which, I believe, is approximately correct for a round shot of 50 lbs. (See Fig. 124.) In this case, by making the projectile of the same proportion as in the other case, we make its weight 100 lbs., or the same as the sphere in the other case. Now, to apply the same cartridge—the same quantity of powder—because that is the condition,—the area of the bore being only one-half what it was before, it is necessary to make the cartridge twice the length, as represented here. Hence, therefore, although the circumferential area exposed to the pressure of the powder is diminished in the proportion of  $7\frac{1}{2}$  to  $9\frac{1}{4}$ , yet the longitudinal surface is increased in the proportion of two to one; and, consequently, we have a far greater surface exposed to the pressure of the gas at the first instant of ignition in the one case than we have in the other. The strength of the gun must therefore be continued farther forward. But not only that, after the shot of the smaller bore has travelled through once the length of its

FIG. 124.



cartridge, the length of bore filled by the gas will be twice 34 inches, or 68 inches; whereas, when the other has travelled through once the length of the cartridge, so as

**240.** The strain on the Parrott 6.4-in. gun, as measured by Captain Rodman's instrument, at West Point, was about 86400 lbs.

TABLE XXXII.—VELOCITIES OF PARROTT (6.4-INCH) 100-POUNDER BY BENTON'S ELECTRO-BALISTIC PENDULUM, MAY 1, 1862.

Elevation.	Charge, lbs.	Projectile.	Initial velocity.
	(Dupont $\tau$ )	Weight, lbs.	Feet per second.
$4\frac{1}{2}^{\circ}$	10	100-lb. shell	1254
$4\frac{1}{2}^{\circ}$	10	100-lb shell	1244
$4\frac{1}{2}^{\circ}$	10	80-lb. shot	1374
$4\frac{1}{2}^{\circ}$	10	80-lb. shot	1381
$4\frac{1}{2}^{\circ}$	11	80-lb. shot	1405
$4\frac{1}{2}^{\circ}$	10	32-lb spherical shot papier-maché sabot	1829
$4\frac{1}{2}^{\circ}$	10	Ditto	1829
$4\frac{1}{2}^{\circ}$	10	Ditto	1799

to give double capacity for the powder behind, it will only have travelled 34 inches; and therefore we must bring forward the corresponding strength of the gun in the one case to 68 inches, and only to 34 inches in the other case. It is clear, therefore, that we gain nothing by reducing the bore, but rather the contrary."

In the discussion last referred to, Mr. Bashley Britten gave the following illustration on this subject:—

EFFECT OF EQUAL CHARGES IN LARGE AND SMALL BORES.

(A.) ARMSTRONG 40-POUNDER.

Charge.....5 lbs.  -----12 inches.-----	Bore.....4' Area.....12.5 Initial velocity....1200	Pressure on shot, 163 tons Ditto on gun...1964 " Shot, 40 lbs.
--	--	--

(B.) BRITTEN'S 50-POUNDER. RIFLED 32-POUNDER SERVICE.

Charge, 5 lbs.  -----4½-----	Bore..... 6.875 Area..... 31.9 Initial velocity..1209 2	Pressure on shot ..... 415 Tons. Ditto on sides of gun .....1204 Shot, 50 lbs.
---------------------------------	---	--

Pressure assumed, 13 tons per inch.

for the 100-lb. bolt, with the same quantity and kind of powder that gave 28000 lbs. pressure for the 32-lb. spherical shot. So that the pressures were nearly as the weights.

The velocities, as measured, were nearly with equal charges, inversely as the cube roots of the weights of the shots.

**241.** Captain Fishbourne, in discussing the merits of rifled and smooth-bore guns,\* mentions the low velocity of the rifle-shot and its greater strain upon the gun as serious defects, and then refers to the merits and possible improvements in the smooth-bore, as follows:—

“Now I only propose that the causes of the errors in round shot shall be directly removed. These are: an'undue amount of windage, imperfect sphericity, and absence of homogeneity. Table 33 shows the effect of the reduction of windage:—

TABLE XXXIII.—EFFECT OF REDUCING WINDAGE.

NATURE OF GUN.	Length.	Weight of powder	Windage.	Elevation.		
				1°	2°	5°
	ft. in.	lbs.	parts of inches.	yds.		
*32-pounder, 56 cwt.....	9 6	10	·233	700	1130	1964
{ 32-pounder, 40 cwt.....	8 0	6	·175	‡731	.....	.....
56-pounder, Monk, 97 cwt.....	11 0	16	·175	†930	1340	2200
110-pounder Armstrong .....	.....	12	Nil.	530	920	1970

\* From Aide Memoire to the Military Sciences.

† Hand-book for Field Service.

‡ Height above plane, 15 feet.

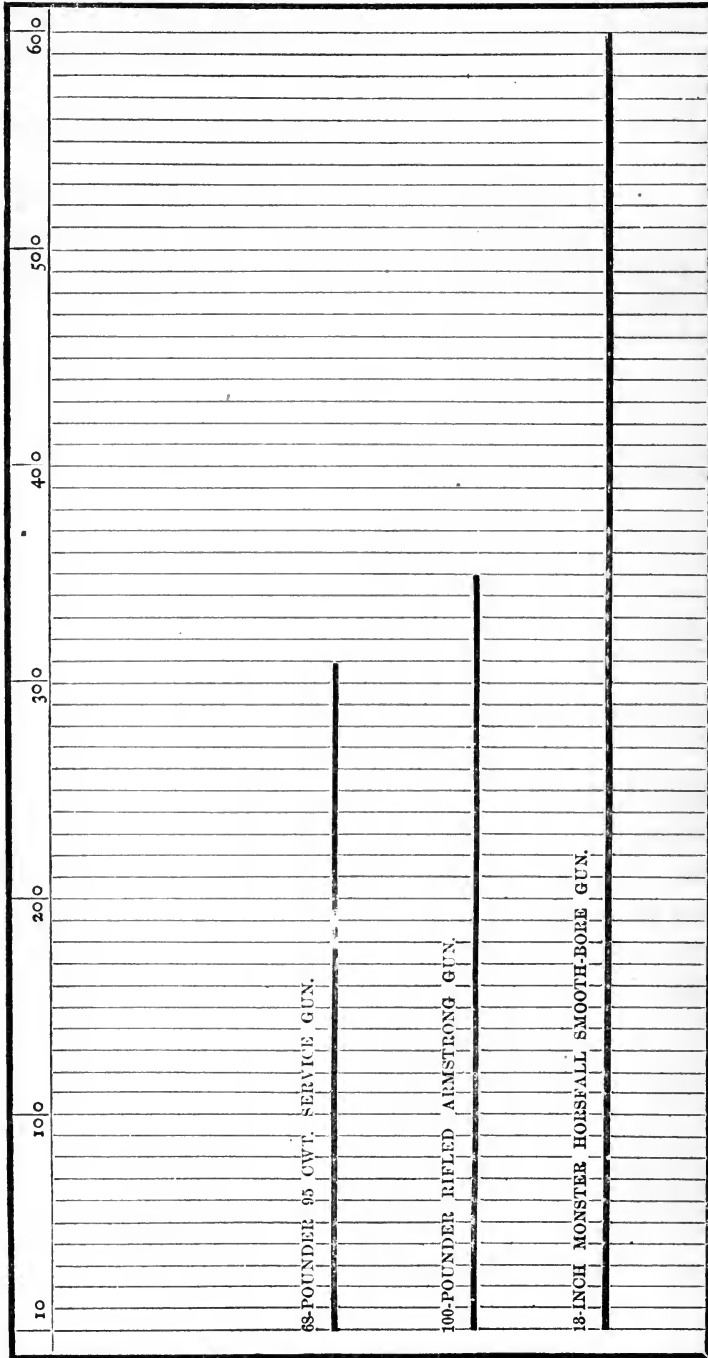
§ Height above plane, 8 feet.

|| From Royal Naval Official Ranges.

Table 34 shows the ranges and particulars of Horsfall's 280-pounder; this table shows the point-blank range as compared

\* Jour Royal United Service Inst., June, 1862.

TABLE XXXIV.—POINT-BLANK RANGES OF 68-POUNDER, 100-POUNDER, AND 13-INCH GUN.



Ranges of 68-pounder and 100-pounder taken from the Hand-book for Field Service, 1862.  
 The range of the Horsfall 13-inch Gun taken from the official Report to the War Office, dated 5th February, 1857.

Height of axis of bore above the plane, the 68-pounder gun not stated.  
 " " " " " "  
 " " " " " "  
 100-pounder Armstrong, 17 ft.  
 13-inch Horsfall, 20 ft.  
 The ranges given are in yards.



with those of the service 68-pounders and Armstrong 110-pounder. The 68-pounder appears to a disadvantage; its range was taken at a height of only 8 ft.; the other two, Sir William Armstrong's at 17 ft., and Horsfall's at 20 ft. This would make a considerable difference in their range against that of the 68-pounder. The time of flight of Horsfall's smooth-bore is about half that of the other, and shows, abundantly, to what perfection smooth-bore guns may be brought. The windage in the 68-pounder is  $\cdot 198$ , that in Horsfall's is only  $\cdot 08$ .

**242.** "In the field it is admitted that the difficulty of judging distances, and other disturbing circumstances, are such as to confine the ranges of projectiles for military purposes to 2000 yards; afloat, the disturbing causes, *which are constant*, are greater, from which the various movements in rifle-sights become causes of error; therefore the most useful ranges cannot be greater than those obtained by Mr. Horsfall's gun at little above point-blank, and with powder only one-sixth the weight of shot, while the elevation of rifle-guns is considerable for the same distances. Then, as the angles of descent are great, the chances of striking an object are scarcely worth the powder used. The smashing effect of this gun would be three times that of the 150-pounder.

"The former conclusion Sir H. Douglas arrived at *some time* since, for he says—'The main principle which should govern our choice of naval guns is, to prefer those which, with equal calibre, possess the greatest point-blank range.' This was the correct view to have taken before the introduction of iron-coated ships; since that, we have no choice, as no other guns will be completely effective against iron plates, if against other ships either

**243.** "Imperfect sphericity, another cause of error in round shot, may be removed in working scrap-iron into wrought-iron shot, made requisite by the introduction of iron-plated ships; a nearer approach to homogeneity will at the same time be made, while the expense of such will still be far below the cost of any of the elongated shot.

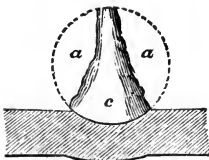
"Since this paper was written, I have seen a pamphlet on this subject, in which the value of smooth-bore guns and improved

shot are set forth. It is by Mr. M. Scott, C. E., and shows the turn which the public mind is taking.

**244.** "To the extent that we have adopted rifle-guns, to the exclusion of smooth-bores, for the navy, we have given up the substantial advantages of low trajectories, straight ricochet, smashing force, simplicity, and economy, for the very occasional advantages of long range. Therefore, for efficiency, no less than for economy, we must revert to the smooth-bore in principle, and invest talent and money to develop its merits.

**245.** "But rifle-guns and elongated shells, especially of small and medium calibre, have decided advantages, because of the greater quantity of powder these shells are capable of containing, and long range is also sometimes very important for the support of troops and for breaching purposes; we should therefore endeavor, if possible, to combine the advantages of the round-shot with those of the elongated, in one description of gun; but even for the simplicity which this would bring with it, no sacrifice of initial velocity is admissible. So that, unless a mode of rifling can be found that will not involve undue windage, we must have both descriptions of gun, in numbers proportionate to the relative importance of each: little windage, then, must be the ruling qualification in the selection. Such is that proposed by Captain Scott, R. N.; such is that used by the French in their rifle-gun that admits of the use of round balls. It should be a muzzle-loader, simple of construction, strong, and as little liable to get out of order as possible; for neither ships nor fleets can take factories to sea with them."

FIG. 125.



Fracture of a spherical shot upon striking armor.

**246.** The spherical shot, Fig. 125, as compared with the flat-fronted shot, Fig. 126, is more likely to waste power in self-destruction. When it strikes a plate, the mass *c* is directly arrested and supported; but the overhanging mass *a a*, having no support, often breaks away, and having failed to impart its momentum to *c*, strikes a large area of the plate, in a salvo of small pieces, with greatly diminished velocity

and effect.\* A wrought-iron shot wastes power in changing its figure (209).

**247.** This defect may be greatly diminished, or perhaps remedied, by making the ball of steel.† In fact, both the rifle and the spherical shot should be of a harder and tougher material than has yet been employed in service. The experimental shot recently made of Bessemer steel, and those used by Mr. Whitworth (231), have almost doubled the power upon armor of the present guns. Hardness even to brittleness is better than softness and ductility. Even cast-iron balls do more damage to plates than wrought-iron of given weight and velocity in any form (212). It is true that candles have been fired through boards, and that a 40-lb. lead shot was fired through a target made of four 1-in. plates. But the resistance in these cases was slight compared with the velocity. A 5-in. lead shot, fired at a stronger target, was mashed to 11 in. diameter. (See Table 35.)

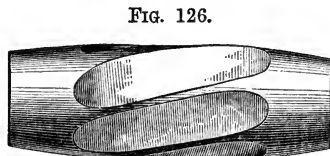


FIG. 126.

Flat-fronted Whitworth projectile.

**248.** The spherical shot, in case it does not break up, also presents the greater area to the armor. The power required to punch plates in a machine, is chiefly as the sheared area. The cross-sectional area of a 100-lb. spherical shot is about double that of the 100-lb. Parrott bolt. (236.)

To obviate these defects, an effective elongated projectile must be made as light as a spherical projectile. This has already been approximately accomplished by Sir William Armstrong. In the experiments of March 17th (186), 65½-lb. bolts were fired from the 110-pounder 7-in. gun, and produced rather more effect than the

\* The particles composing a cone, the base of which is the surface of contact, are arrested by the impact; the remaining particles of the projectile, composing a ring surrounding this cone, move on, after impact, by their inertia, until the ring breaks into pieces, which fly off from the reflecting surface. The ring generally breaks into 5 pyramidal pieces, separated by as many meridian planes; these pieces are thrown at various distances, depending on the velocity of the projectile and the surface of impact.—*Ordnance and Gunnery. Benton. 1862.*

† This subject is more fully considered in the chapter on Rifling and Projectiles.

TABLE XXXV.—EXPERIMENTS AT WEST POINT WITH LEAD SHOT AGAINST ARMOR UNDER THE SUPERINTENDENCE OF CAPTAIN BENÉT.

*(From Official Reports.)*

I. JULY 29, 1862.—A lead shot, in form a right cylinder weighing 32 lbs., with an india-rubber sabot; charge, 8 lbs. mortar powder; fired at a solid wrought-iron plate 46 in. long  $\times$  23 in. wide,  $4\frac{1}{2}$  in. thick, inclined  $4\frac{1}{2}^\circ$  from a vertical. Distance from the muzzle of the gun, 92 ft. The plate was strongly supported by timbers. The lead shot struck the plate in the centre, penetrating  $1\frac{1}{2}$  in., the indentation being 8 in. diameter. The plate was bent, and dished, and cracked in the rear clear across, and nearly through its entire thickness, besides short radial cracks. The back of the plate was bulged 2 in. to 3 in. The plate was overturned and thrown 10 ft. to the rear.

II. AUG. 14.—A 40-lb. lead shot, a right cylinder in form,  $5\frac{1}{4}$  in. long  $\times$  5 in. diameter, with an india-rubber sabot 4 in. long—charge, 8 lbs. mortar powder—was fired at a vertical target 5 feet square, made of 4 wrought-iron plates, each an inch thick (total 4 in.), bolted to oak timbers 6 in. thick, all propped by heavy logs, and situated 108 ft. from the muzzle. The shot went through the target and backing, and was found in the earth 10 ft. in its rear. The shot was reduced by its passage from 40 lbs. to 22 lbs. weight, preserving to a great degree its cylindrical form. The orifice was  $5\frac{1}{2}$  in. diameter. Pieces of the plates, cut off by the shot, were found beyond the target.

III. AUG. 21.—A cylindrical lead shot, of  $40\frac{1}{2}$  lbs. weight, with india-rubber sabot 6 in. long, charge 10 lbs., was fired at a vertical target  $18 \times 20$  in., made of 12 half-inch plates (total 6 in. wrought iron), and bolted on 20 in. of oak by 16 bolts. The whole was backed by timbers and a stone of 3 or 4 tons' weight. Range, 103 ft. The shot struck in the centre, broke one plate, cracked the second slightly, broke 10 bolts, dished the target considerably, and made a total indentation of  $3\frac{3}{4}$  in. deep  $\times$   $8\frac{1}{2}$  in. wide. The shot was flattened to the diameter of 9 and 11 in. Target and backing knocked out of place.

IV.—Lead shot, 40 lbs.; 4-in. india-rubber sabot; charge, 9 lbs.; fired at 109 ft. range, at  $4\frac{1}{2}$ -in. solid plate, No. I., with about the same results. The target had been made immovable. Indentation,  $6\frac{1}{2}$  in. wide  $\times$   $1\frac{1}{2}$  deep.

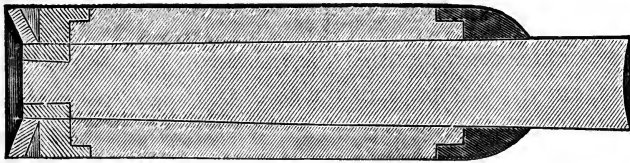
V.—Cylindrical steel shot 50 lbs., and 3-in. india-rubber sabot; charge, 9 lbs. mortar powder; fired at  $4\frac{1}{2}$ -in. solid plate, No. I., at 109 ft. range. The plate broke square across. Indentation,  $1\frac{1}{2}$  in. deep  $\times$   $6\frac{1}{2}$  in. diameter.

68-lb. 8-in. ball. The initial velocity attained by 68-lb. bolts from the 110-pounder, with 16 lbs. of powder, is 1433 ft.; that of the 111-lb. bolt being 1307 ft.

**249.** A very short rifle-bolt is unfit for long range; but this is not required in iron-clad warfare. (See Rifling.) (254.) A valid objection against short bolts is their large cross-sectional area in proportion to their weight, i. e., loss of velocity. In fact, they possess no advantage over the round steel ball, except greater accuracy, which is hardly necessary at very short range; their dis-

advantages are, greater friction in and strain upon the gun. Hollowing out the rear of the shot is the method usually proposed to lighten it. This renders it more liable to fracture upon striking, if it is not made of some extremely dense and tough material. And if the balls are thin enough to reduce the weight much, they are liable to be sprung open by the powder, thus increasing the friction and strain on the gun. Hollowing out a 7-in. 100-lb. bolt through  $\frac{2}{3}$  of its length, so as to reduce its weight one-half, would leave the walls only about  $\frac{3}{4}$  in. thick. The sub-calibre system, Fig. 127, which has been adopted by Mr. Stafford (see chapter on

FIG. 127.



Stafford's sub-calibre shot.

Rifling and Projectiles), and modified by others, appears to be the proper system of firing the best punches at the highest velocities; for while the area pressed by the powder may be as large as that of the spherical shot, the area that strikes the plate may be smaller than that of a full-calibre rifle-bolt, the weights being the same in each case. But the sub-calibre system will not allow the use of the most effective shells; and this modification of it does not reduce the area of the shot to the air, as well as to the target. The wooden covering of the shot is only torn off when the shot enters the armor.

**250.** An elongated shot, in the present state of the art, must be fired from a rifle, in order to go end on and accurately.\* Rotating the shot takes power, especially with the Armstrong system of rifling, but need not greatly reduce the velocity.

\* See chapter on Rifling and Projectiles.

The Armstrong and Whitworth guns were rifled for two reasons :

*First.* To carry punching-shells. Since a solid sphere will break upon striking armor (246), the thin walls of a shell and its greater overhanging weight would insure its being smashed. Shells must, therefore, be elongated; and being elongated, must be revolved about their major axes, in order to be kept end on, at least at long range. Hence the necessity of rifled guns.

It is also held by Mr. Whitworth and others, that the spinning motion of an elongated bolt is necessary to keep it end on while passing through armor.

**251.** *Second.* The Armstrong and Whitworth guns were rifled for long-range fighting. The advantages of the spherical shot, considered above, refer to short ranges. The proceedings of the Defence Commissions, and the discussions on this subject in England generally, indicate a belief that iron-clad warfare will be conducted chiefly at long ranges, say 3000 yards. As far as this is the case, the rifle-bolt will have the advantage; its velocity decreases much less rapidly than that of the sphere, because it presents but about half the area (as ordinarily proportioned) to the resistance of the atmosphere for a given weight. By experiment, the 68-lb. 8-in. ball loses 25·7 ft. at 30 yards' distance from the gun, 91 ft. at 100 yards, 157 ft. at 200 yards, and 581 ft. at 1000 yards, the initial velocity being 1579 ft. The Armstrong 111-lb. 7-in. bolt, with an initial velocity of only 1125 ft., has, at 1000 yards, the same velocity as the 68-lb. ball, viz., 981 feet. (See Table of Velocities.)

**252.** Sir William Armstrong said, before the Defence Commission :\*—"I am now making a gun (30) adapted for a shot twice the weight [of the 10½-inch]. If we used that gun with the same relative charge, it would be fired with 100 lbs. of powder; the round-shot for that gun would weigh 300 lbs. With such a gun in the smooth-bore state, we may expect to produce, at 1300 yards, as great an effect as was obtained against the *Warrior* target, in

\* Report of the Defence Commissioners, 1862.

the late experiment, at 200 yards (227). The rifle-shot for the same gun will weigh not less than 600 lbs., and would produce, at 3000 yards, the same effect as the round-shot at 1300 yards. I calculate the velocity of impact to be 1200 feet per second for the 300-lb. round-shot, at 1300 yards, and 850 feet per second for the 600-lb. rifle-shot, at 3000 yards."

**253.** RANGE IN IRON-CLAD WARFARE.—Effective iron-clad fighting will undoubtedly be done at short range. There are, certainly, many arguments to the contrary, of which the following, by Captain Noble, R. A., is an example:

"But by what right is it assumed that naval actions are to be fought at short distances for the future? Is it because it suits the smooth-bore guns? No doubt it would have suited the *Macedonian* much better if she had fought her action with the *United States* at short distance rather than at long; but the American would not follow suit, and by keeping at a distance, and taking advantage of his long-range guns, he gained the day. Exactly the same thing occurred in the action between the *Essex* and the *Phæbe*, except that in this case the British captain took advantage of his long-range 18-pounders, chose the distance that suited his guns, and in a very short time compelled his enemy to surrender. In this action, the 32-pounder carronades, which formed the armament of the *Essex*, would have been very formidable at short ranges, but they were almost useless at the distance at which the action was fought."

**254.** But it is evident, *First*, that sufficient velocity to punch armor cannot be obtained at long range, even from rifles. Only the comparatively thin *Warrior* and *Minotaur* targets have as yet been punched, by the best guns, at short range.

*Second.* Sufficient accuracy of aim\* to hit small turrets, the low sides of *Monitors*, or even the high sides of casemated frigates, when these objects are rapidly changing position and direction by steam, can hardly be expected, especially when with low velocities, high elevations, and curved trajectories, shot can only drop upon the object aimed at (242).

\* "Out of the entire programme,"—firing at 1000 yards at the *Warrior* target—"with the 13.3-in.-gun and the 10.5 in.-gun, only 1 shot struck the 14 ft. target, the others grazing the target, or missing altogether. And yet the guns were laid by the most experienced Shoeburyness gunners, and the target was moored in smooth water."—*The Dock-yards, Ship-yards, and Marine of France.*—Barry, 1864.

Besides, opposing vessels will be trying to ram one another. The *Monitor* and the *Merrimack* were hardly a dozen yards apart during the greater portion of their fight, and were several times in contact.

The old sailing-vessels were so embarrassed by sluggish locomotion and vulnerable sides, that the victory was simply a question of the longest arms. But it is hardly to be expected that steam-rams, clad in modern armor, will do either one of three things:—1st, they will not stand still to be shot at; 2d, they will not waste time by firing at a distance at which their shots will make no impression on the enemy, while they have the power and appliances for other manœuvres; 3d, they will not lose the opportunity of smashing the enemy's side in with their prows. One or the other vessel can do this; whichever attempts it, makes the battle hand to hand. So that, irrespective of the calculations of artilleryists, their missiles will not have far to go; and they will not be likely to go far after striking, if much power is wasted on projecting heavy masses and spinning them at high velocities.

**255.** At *very* short ranges, it is probable that well-balanced elongated shells and light elongated shot would go end-foremost, with sufficient accuracy. (See chapter on Rifling.) For mere punching, such ranges would give the spherical shot nearly every advantage. Hence a large number of rifle-guns are not required for mere iron-clad warfare. Still, there may always be some work to be done—camps, earthworks, and towns to be shelled, and masonry to be penetrated, at 3 to 5 miles' range—and still more work at 300 to 1000 yards. So that some rifle-guns for ordinary shells, for light punching-bolts, such as Stafford's sub-calibre shot (249), and for armor-punching shells, should form a part of every ship's armament.

**256.** Where the number of guns is limited, as it must be in small turrets and casemates (room for guns must be limited in well-protected ships of practicable size), it is important to utilize all guns for all purposes. This would be accomplished by a system of rifling and rifle projectiles that would neither weaken the gun nor impair its efficiency for spherical-ball firing.



If the bore for smashing and racking purposes were of considerable diameter, it would involve the use of a full-calibre rifle-shot of large diameter. This shot would have to be very short, in order to bring a safe strain upon the gun, and would then be unfit for very long ranges. Its diameter would also be too great to punch thick armor. So that the sub-calibre system (249) would seem to be indispensable to the perfect utilization of one very large-bore gun for both spherical and elongated projectiles.

TABLE XXXVI.—WORK DONE BY DIFFERENT GUNS, THE 68-POUNDER BEING TAKEN AT UNITY.

NATURE OF GUN.	Charge.	Weight of solid shot.	Work done at 1000 yds.	Work done at 1000 yds. by 150-pdr. rifle in comparison with 68-pdr and 150-pdr. smooth-bore at 200 yards.
	lbs.	lbs.	yds.	
68-pounder, smooth-bore ...	16	66	1.00	
110-pounder, Armstrong.....	12	111	1.69	
Ditto.	14	111	1.98	
150-pounder, smooth-bore. ...	40	150	3.24	
150-pounder, rifle.....	40	150	5.24	
68-pounder, smooth-bore...	16	66	.....	1.00 at 200 yards.
150-pounder, rifle .....	40	150	.....	2.50 at 1000 yards.
150-pounder, smooth-bore.....	40	150	.....	1.00 at 200 yards.
150-pounder, rifle .....	40	150	.....	0.88 at 1000 yards.

**257. SHOT OF LARGE DIAMETER.**—A large diameter of punching projectile is desirable for several reasons:—

1st. To punch a large hole, thus driving a great volume of splinters into the ship, or making a dangerous leak, if the shot is at the water-line.

2d. To allow shells of practicable length to carry high bursting charges, and still have thick, strong walls.

3d. A spherical shot of large diameter has a greater weight, in proportion to its cross-sectional area, than a small spherical shot; in other words, the weight increases as the cube of the diameter.

while the resistance opposed by air increases as the square of the diameter, and that opposed by iron as the diameter. So that the large shot has the greater range, penetration, and accuracy.

**258. RANGES OF LARGE BALLS.**—Mr. Clay says, as to the range of the 13-in. Horsfall gun: \* “Up to  $12^\circ$  of elevation, the monster gun has the most decided advantage, more especially in shorter ranges; after  $12^\circ$  the rifled gun takes the lead. \* \* \* At point-blank, the 68-pounder (smooth-bore) ranged about 310 yards, the Armstrong (110-pounder rifle) about 350 yards, and the monster gun about 600 yards. At  $1^\circ$  elevation, the 68-pounder ranges 730 yards, the Armstrong to 670, and the Horsfall gun reaches 1030. At  $3^\circ$  elevation, the 68-pounder ranges 1470; the Armstrong, 1330; and the 300-pounder gun, 1800 yards. At  $5^\circ$  elevation, the 68-pounder ranges 2000 yards; the Armstrong gun, 1990 yards; and the 13-in. gun, 2430. At  $7^\circ$  elevation, the 68-pounder ranges 2440 yards; the Armstrong then reaches a distance beyond the 68-pounder, and ranges 2570 yards; the 13-in. gun ranges 2980 yards. At  $10^\circ$  elevation, the 68-pounder ranges 2930 yards; the Armstrong, 3470; and the 13-in. gun, 3530. At  $12^\circ$  elevation, the 68-pounder ranges 3200 yards. The Armstrong gun then takes the lead by a considerable distance, and ranges 4040 yards; and the 13-in. gun ranges 3870 or 3880. \* \* \* The time of flight for the Armstrong 100-pounder, at point-blank, is  $\frac{3}{10}$  second, and for the monster gun, 1 minute and 1 second; at  $10^\circ$  elevation, the Armstrong takes  $12\frac{3}{10}$  seconds; and the monster gun  $12\frac{1}{10}$  seconds; the monster gun ranging slightly farther in  $\frac{2}{10}$  of a second less time; therefore the average velocity of that shot must have been slightly superior to the Armstrong. \* \* \* The 13-in. gun shows great superiority in this comparison (the proportionate weight of powder and shot). In the 68-pounder, I think the charge was 16 lbs. of powder to 66 lbs. of shot—about  $\frac{1}{3}$ ; and the proportion of powder to the shot in the 13-in. gun was 50 lbs. of powder to 282 lbs. of shot—about  $\frac{1}{5}$ .”

The practice with the 15-in. Rodman gun shows the following

\* Report of Defence Commission, 1862. See also Table 34.

results: "In firing for accuracy, with the minimum charges mentioned (35 lbs.), at a target 2000 yards distant, with 6° elevation, the shot (328 lbs.) struck the ground about 8 feet below the level of the gun, at (5 trials) 2017, 1937, 1902, 1892, 1873 yards. The lateral deviations were 1, 3,  $\frac{3}{2}$ , 5 yards to the right and 5 yards to the left, showing at this range of  $1\frac{1}{2}$  miles a very great accuracy as regards horizontal deviations, to test which the firings were made. The vertical deviations were probably due to varying initial velocities, or perhaps to some difference in the weight of the shells fired. Had the shot been intercepted at the target by a vertical plane, they would have been found included in a vertical extent of about 6 yards, not much over the height of a three-decker.

"The ranges with maximum elevation of 28° 35'—shells of 334 lbs. and 50 lbs. of Rodman's perforated cake-powder—were as follows: 5298, 4950, 5375 yards. With 40 lbs. large-grained powder they were 5435, 5062, 5730 yards, and the time of flight about 37 seconds. With 10° elevation and 40 lbs. large-grained powder, they were 2700, 2900, 2754, 2760 yards. These ranges do not exhibit any decided advantage of those obtained from the 10-in. gun up to 10° elevation. Beyond that elevation the gain is considerable, and may be estimated at about 600 yards for the elevation of 28° 35'. With 39° elevation, and a charge of 40 lbs. of large-grained powder, it is probable a range considerably beyond 4 miles might be obtained."\*

The ranges of the 15-in. spherical shell, according to late experiments with the navy gun, are as follows:

Charge.	1°	2°	3°	4°	5°	6°	7°
	yds.	yds.	yds.	yds.	yds.	yds.	yds.
35 lbs. (cannon) .....	620	920	1200	1470	1700	1900	2100
50 lbs. ( do. ) .....	—	—	1300	—	1920	2180	2420

The great range and accuracy of the 9·22-in. Armstrong smooth-bore (Table 37), as compared with the smaller smooth-bore is attributed partly to the greater proportionate weight of the shot to the resistance, and partly to the reduction of windage.

\* "Notes on Sea-Coast Defence."—Gen. Barnard. 1861.

TABLE XXXVII.—RANGES, &c., ARMSTRONG MUZZLE-LOADING SMOOTH-BORE 9·22-INCH 100-POUNDER. LENGTH, 10 FEET; WEIGHT, 13514 LBS.; CHARGE, 33 LBS.; WINDAGE, 0·065; MUZZLE, 17·5 FEET ABOVE PLANE

No. of rounds.	Elevation as to point of impact.	Mean reduced time of flight.	RANGES.			Mean difference of range.	Mean observed deflection.	Mean reduced deflection.
			Min.	Max.	Mean.			
	° /	sec.	yds.	yds.	yds.	yds.	yds.	yds.
5	1 20	2·36	919	1024	980	38·0	1·3	1·4
20	2 14	3·18	1306	1598	1430	61·5	5·8	5·1
20	5 8	7·75	2314	2584	2409	26·7	15·2	7·4
20	10 6	13·41	3304	3695	3514	88·5	32·3	23·8
9	22 4	24·1	4748	4923	4833	62·2	122·4	85·2
1	22 9	25·4	.....	.....	5253	.....	64·0	.....

The gun was perfect after these rounds. The greater accuracy of the large gun as compared with the 32-pdr., with proportional charge, is attributed to the greater weight of the large shot for a given resisting area, and to the reduced windage, viz., 0·014 of the area of the bore, that of the 32-pdr. being 0·061 of the area of the bore.

**259. STRAIN OF LARGE BALLS UPON THE GUN.**—On the other hand, the large spherical shot presents the smaller area to the powder for a given weight, and thus receives a lower velocity. A velocity that would insure its penetration, would also increase the strain upon the gun. As to the whole subject of strain upon the gun, by large and small shot, Professor Treadwell says:\*

“It is perfectly well known that, if we have a pipe or hollow cylinder of say two inches in diameter, with walls an inch thick, and if this cylinder will bear a pressure from within of 1000 pounds per inch, another cylinder, of the same material, of 10 inches in diameter, will bear the same number of pounds to the inch if we increase the walls in the same proportion, or make them five inches thick. A cross-section of these cylinders will present an area proportional to the squares of

\* “The Practicability of Constructing Cannon of Great Calibre,” &c. 1856.

their diameters; and if the pressure be produced by the weight of plungers or pistons, as in the hydrostatic press, the weight required in the pistons will be as the squares of the diameters, or as 4 to 100.

“Now carry this to two cannon of different calibres, and take an extreme case. Suppose the calibre of one to be 2 inches in diameter and the other 10 inches, and that the sides of each gun equal in thickness the diameter of its calibre. Then, to develop the same force, per inch, from the powder of each gun, the inertia of the balls should be as the squares of the diameters of the calibres, respectively; that is, one should be 25 times as great as the other. But the balls, being one 2 and the other 10 inches in diameter, will weigh 1 pound and 125 pounds respectively; the weights being as the cubes of the calibres. Hence, each inch of powder in the large gun will be opposed by 5 times as much inertia as is found in the small gun. This produces a state of things precisely similar to that of loading the small gun with 5 balls instead of 1; and although the strain thrown upon the gun by 5 balls is by no means 5 times as great as that by 1 ball, there can be, I think, no doubt that the strain produced by different weights of ball is in a ratio as high as that of the cube roots of the respective weights.\* This would give, in the example before us, an increase of from 1 to 1.71, or the stress upon the walls of the 10-inch gun would be 71 per cent. greater than upon those of the 2-inch gun.

“The foregoing statement and comparison, however, do not

\* “Hutton inferred that the velocities of balls of different weights with the same charges of powder, were inversely as the square roots of the weights; and Captain Mordecai, in his excellent book of experiments, makes the same inference. This would give no increase to the force of the powder, and must be impossible; and I find, from comparing their experiments, and computing the forces developed by the same charges of powder with shot of different weights, that the forces are almost exactly as the cube-roots of the shot. Thus Hutton’s experiments with balls of 1.2 lb. and 2.9 lb., velocities 973 and 749, give forces almost exactly proportional to the cube roots of 1.2 and 2.9. Captain Mordecai’s experiments with balls of 4.42 lb., 9.28 lb., and 21 lb., velocities 2696, 2150, and 1520, all furnish, by computation, forces very nearly proportional to the cube roots of the respective weights of the balls. Every one knows that a small increase in the weight of the shot in a fowling-piece increases in a sensible degree the recoil, and the stress upon the gun. This is so universally received as true by ordnance officers, that it is a common practice to use two or more balls, instead of an increased charge, in proving guns.”

present the whole case; for they are made upon the supposition that the charge of powder, in each instance, is as the square of the diameter of the shot, or that the cartridges of the 2 and the 10-inch guns are of the same length. This, if we take the charge of the small gun at  $\frac{1}{3}$  of a pound, would give but  $8\frac{1}{3}$  pounds for the large, or  $\frac{1}{15}$  of the weight of the shot. The velocity obtained from this charge would produce neither range nor practical effect, and to obtain these results, that is, 1600 feet a second, we must either increase the force through the whole length of the gun to 5 times that required for the small gun, or, the force remaining the same, we must provide for its acting through 5 times the space. Neither of these conditions can be practically accomplished. However, by an increase of both the charge and the length of the bore, the result may, in the limits under consideration, be attained. Thus, taking the large bore, if we double its length and make the cartridge 5 times as long, increasing the weight from  $8\frac{1}{3}$  to  $41\frac{2}{3}$  pounds,—or perhaps, having an advantage from the comparative diminution of windage and the better preservation of the heat, with a charge of from 30 to 35 pounds,—we may obtain the full velocity of 1600 feet a second. But this, again, increases enormously the strain upon the gun.

“It does not appear obvious, at a first view, how an increase in the charge should increase the tension of the fluid produced from it, if the cavity enclosing it be proportionably enlarged. If a steam-pipe a foot long will sustain the pressure of a given quantity of steam, of a given temperature, a pipe two feet long, of the same thickness and diameter, will sustain the pressure produced by a double weight of steam from the same boiler. Why, then, should the pressure upon a cannon be increased by a double length of cartridge? The difference seems to be this: with the steam, the pressure is as in a closed cavity; with the powder, the tension depends upon the movement of the shot while the fluid is forming. Now, whether the charge be large or small, the motion of the shot commences while the pressure is the same in both cases, and before the charge is fully burned, and with the same velocity in both cases; but with the large charge the fluid is formed faster

than with the small, while the enlargement of the cavity by the movement of the shot is nearly the same in both cases. This destroys the proportion between the sizes of the two cavities, and the tension must increase faster, and become greater, from the larger charge. The law of this increase cannot, from the complicated nature of the problem, be stated with any reliable exactness; but we may, I think, conclude, from the increased velocity of the shot, and many other effects, that the stress thrown upon the gun by different charges of powder, within ordinary limits, will not vary essentially from the square roots of those charges.\* If, then, we increase, in the example under consideration, from a charge of  $8\frac{1}{2}$  pounds to one of 32 pounds, the stress upon the gun, being as the square roots of these numbers, is raised from 2.88 to 5.65, or from .1 to 1.96. Having already increased the stress upon the gun, by the shot, from 1 to 1.71, if we multiply these together, we have a total increase of from 1 to 3.35. That is to say, if, under the conditions here stated, we load a gun of 2 inches calibre with 1 shot and  $\frac{1}{2}$  of a pound of powder, and a gun of 10 inches calibre with 1 shot and 32 pounds of powder, the stress upon each square inch of the bores will be 3.35 times greater with the large than with the small gun; when at the same time, if the walls of both have a thickness proportional to the diameters of the calibres in each, the large gun will be incapable of sustaining a greater pressure per inch than the small one. Even with a charge of 12 pounds of powder, the stress upon the large gun must be more than double that upon the small gun when charged with one-third the weight of its ball.

\* "Hutton gives the velocities of the balls as the square roots of the charges, and the experiments of Captain Mordecai, although giving the velocities of the larger charges somewhat below this ratio, do not wholly contradict it. This assigns to the charges an effect, or power, that is, pressure multiplied by the space, which is directly as the charge. Now this result cannot be produced, with the larger charges, wholly by the continuance of the pressure during the last part of the passage of the ball through the bore, although a large portion of it may be derived from that source; but there must be a great increase of the tension in the fluid during the first part of the ball's motion, and an equal increase of the strain upon the gun. It appears to me that the hypothesis stated above, and the ratio of force there assigned to different charges, are in perfect accordance with these and other experiments."

“The preceding examination does not, I think, present the difficulties to be overcome in increasing the size of cannon as greater than they really are; and although the results that I have arrived at are from extreme cases, and may be said to be mere deductions, yet they are deductions legitimately drawn from the most reliable experiments that have been made.” (See also 221 and 238.)

**260.** One other consideration is involved in determining the diameter of projectiles. It has been stated that projectiles much less in diameter than the thickness of the iron target, are not likely to penetrate it, with the highest velocities at present attained; so that the size of guns and projectiles can hardly be decreased below the present class of what we may call armor-punching guns—the Whitworth 7-in., the Parrott 8-in., and the Armstrong, Dahlgren, and Parrott 9 to 10½-in. guns.

**261. Merits and Defects of the System.**—The obvious disadvantages of the “racking” system, by means of heavy projectiles at low velocities, are loss of power and loss of time. The velocities of light shot, with a given strain upon the gun, are so high, that little power is wasted in distributed effect. When such a shot goes through a plate, it shears out a piece of the plate, in substantially the same manner that a hand-punch shears a disk out of a sheet of iron laid on a wooden block. The block prevents the sheet of iron from being bulged, distorted, and racked bodily; the inertia of the surrounding ship’s side, as well as the backing, prevent the plate struck by a projectile from being acted upon bodily. The hole is punched before there is time to bring the elasticity and ductility of the target into service. Whatever power the gun is able to stand, is concentrated upon the smallest possible area, and therefore meets with the smallest possible resistance, instead of being distributed to the crippling of a large surface and the vibration of the whole ship’s side. Supposing heavy shot at low velocities to shake off a portion of the enemy’s armor, leaving his skin bare, or to so smash and rack his side as to cause dangerous weakness and leakage: time—perhaps hours—may elapse before the fatal shell can be planted in the one case, or the fatal battering be inflicted in the other. Meanwhile, the enemy’s fleet



has at least a *chance* to manœuvre to its final advantage, or to fight its way to within shelling distance of a city. But the penetrating shot accomplishes its whole work at a blow, if at all; and since its whole work is concentrated upon the smallest area, that blow represents the maximum destroying power of the gun. If the velocity of a shot were infinitely fast, it would waste no power at all; if it were infinitely slow, and the shot infinitely heavy, it would utilize none; it would simply push the ship bodily.

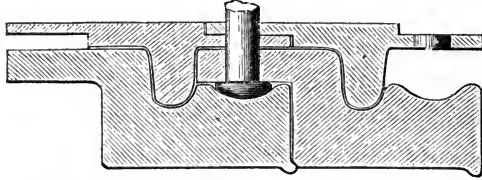
Suppose, however, that the range is so great or the armor so resisting, that the strongest gun will not penetrate it. Racking is then the only resort; and since the small shot, intended to punch, wastes much of its power in fruitless local effect, it has little left for distributed effect. In such a case, the importance of a heavier and slower battering shot, in connection with the others, is obvious (267).

**262. EFFECT OF PUNCHING-SHOT IN TURRETS.**—It is a common mistake to attach little importance to the effect of small solid shot, even if they do punch the armor of a ship. It is said, truly enough, that mere shot, passing in at one side of a vessel without armor, and out at the other, were not considered formidable in comparison with shells. Of course, the few men that happened to be in the line of a shot, were killed; but that did not put the ship out of action. Besides, small holes are easily plugged. A distinguished British naval officer, in expressing Jack's contempt for all sorts of pounders, from 18's to 68's, when firing solid shot, added, "but, for God's sake, keep out the shells!" This is the text of many discourses on the subject.

What may be true of a vessel without armor, is not necessarily true of a vessel covered with plates; and the case of a whole ship, with men and machinery distributed throughout its length, is essentially different from that of a small turret or casemate, into which the vitality of the ship is crowded. It is the thin line instead of the close column. The armor, it is true, is only punched by a swift shot; but the part punched out is generally broken to pieces, and the shot is broken to pieces, and the backing and skin are torn into splinters, every one of which is a missile of sufficient

power to put *men*, if not machinery, *hors de combat*. This was actually the case in the thinly-clad *Galena* (Fig. 128), when pierced

FIG. 128.

Section of the armor of the *Galena* (built of wood).  $\frac{1}{4}$  size.

by the fire of Fort Darling, on the James River. The debris of the armor spread on all sides of the line of the shot, in the form of a cone. Although the shot-hole may be little larger than the projectile, in the front of the plate, it is invariably much larger in the rear (202). A 68-lb. ball drove a hole that measured  $8\frac{1}{2}$  in. diameter in front and 20 in. at the back, through one of the earlier  $4\frac{1}{2}$ -in. plates.\* This increased diameter of the part driven out of the plate is equivalent, if it passes through the backing and skin (as it did in several cases mentioned in Table 31), to a projectile of this diameter fired into the ship.

Again, the shot that penetrates merely the wooden or iron skin of a ship without armor, loses, in so doing, so little of its velocity, that the inertia of the parts surrounding that immediately struck holds them together. But after passing through *armor*, the velocity of a shot is so much reduced that its remaining power and the power of all the new projectiles that it makes out of the pieces of the armor, have *time* to be communicated to the surrounding parts, and thus to drive in an expanding column of splinters. Sir Howard Douglass says, on the subject:† “In close action, shot discharged from large guns with the full quantity of powder, tear off fewer splinters than balls fired from the same nature of guns with reduced charges. \* \* \* In firing into masses of timber, or any solid substance, that velocity which can but

\* London “Engineer.”

† “Naval Gunnery.” 1860.

just penetrate will occasion the greatest shake, and tear off the greatest number and largest splinters. \* \* \* This is particularly the case with respect to the impact of shot on plates of iron."

**263.** The necessity of reducing the exposed length of the armored portion of a vessel for the purpose of making it thicker, with a given buoyancy, is now very generally admitted. The men and the machinery for working the guns—the vital fighting parts—are thus crowded into a small space. Now if one shot, of say 7 to 10 in. diameter, can be made to just penetrate this narrow casemate or turret, the splinters can hardly fail to be driven all over it. A backing behind the main armor-plate, of several elastic and ductile inch plates, as in the turret of the *Dictator*, would, of course, modify the result. A laminated target may be torn and bulged, but it is not separated into fragments like a solid plate.

But the *Dictator* turret has also laminated armor on the *outside* of the main armor-plate, so that it offers no advantage to the heavy shot at low velocities. (194.)

**264.** It has been objected to the racking system (218), that a class of guns adapted to certain conditions, would be ineffective under different circumstances. The same objection cannot be urged against punching-guns. If their shot go too fast through the armor to make many splinters, they have all the more power left to break the guns, carriages, and other vital parts within the armor.

Still, the effect of solid shot within the armor of existing European iron-clads, which are, for the most part, casemated from end to end, is not all that could be desired by opposing artillerymen. The *Galena*, a United States vessel of the same class, was not driven out of action by being punched some 30 times in the action at Fort Darling. Without employing her locomotive powers in such a way as to render herself an uncertain mark, she fought an earthwork, situated upon a high bluff, for several hours. Had her antagonist been an iron-clad vessel of equal offensive and defensive power, there would have been an opportunity for one or the other to have settled the matter by manœuvring instead of brute force. It is not desirable to give an enemy, within gunshot of a

town or navy yard, for instance, a chance to manœuvre, if there can be any means devised to silence or cripple him at once.

**265. PUNCHING BELOW WATER.**—The most formidable work of bolts, at high velocities, is the punching of a vessel below the water-line, or below her armor. The admission of water may, indeed, be stopped, since the holes will be necessarily small. But a shot in a *boiler* is a most serious calamity. It not only destroys the locomotive power of the vessel, leaving her without the means of manœuvring, or escaping from rams, or stranding, but it is likely to cause great destruction of life. Several converted vessels and transports with exposed boilers, several light-draught Western iron-clads with boilers necessarily above water, and one or two gunboats of which the draught could not be made to accommodate the height of a certain patented boiler, have been thus pierced by shot during the present war.

Mr. Whitworth stated, before the Defence Commissioners,\* that he had fired, from a 24-lb. brass howitzer that was rifled, a flat-pointed 32-lb. shot, with  $2\frac{1}{2}$  lbs. of powder, through 30 feet of water and 8 inches of oak situated 3 feet below the surface, and that flat-pointed projectiles will go straight through water.

Then, of course, a similarly shaped projectile, fired with 25 to 50 lbs. of powder, from the present Whitworth, Armstrong, or Parrott guns, would, at a range short enough to give the necessary depression, penetrate the skin of a vessel, if it was not protected by heavy side armor or by a very sharply rising floor; or it might penetrate the side-armor of a vessel, if made, as is usual in England, thinner below than above the water-line. Precautions have been taken against both these results in some of the new American designs. Should the accelerating gun (See Appendix) give as good results on a larger scale as it has given on a small scale, tapping the boilers, or breaking the engines of the present iron-clads, at least, would be comparatively easy work. The position of the boilers may generally be inferred by the enemy from the position of the chimney.

\* "Report of the Defence Commissioners," 1862.

The spherical shot and the slow shot, of any form, will do very little mischief under water. The former loses velocity rapidly, because its area is so great in proportion to its weight, while water is practically non-elastic, and must be displaced instead of compressed.

**266. ARMOR-PUNCHING SHELLS.**—Finally, it appears from the experiments (231 to 235), that shells can be thrown through armor nearly as well as shot. In the Whitworth experiments of Sept. 25, 1862, a 129-lb. solid steel shot, with 23 lbs. of powder, did not penetrate the inner skin of the *Warrior* target, while a 130-lb. steel shell, with 25 lbs. of powder and 3 lbs. 8 oz. bursting charge, made a ragged hole in the skin and backing at the same range. In the experiments of Nov. 13th, the shot punched a clean hole through the target; but the shell, with an equal charge, did considerable damage inside the ship, by bursting in the backing. In the experiments of March 17, 1863, no solid shot were fired at the 5½-in. plate; but the 10½-in. 288-lb. Armstrong steel shell, as well as the Whitworth steel shell, penetrated the plate and backing. (See Table 31.)

Comparing the 150-lb. spherical shot and the 288-lb. shell from the same gun (10½-in.), the 150-lb. shot obviously made a wider breach and drove a greater volume of splinters through the *Warrior* target than if it had been fired with 90 lbs. of powder and 2010 feet of velocity, so as to fully utilize the strength of the gun. The shell went through a 5½-in. plate that had one-third greater resistance (as the square of the thickness) than the *Warrior* 4½-in. plate; and it is obvious that if its subsequent explosion had not been resisted by an unusually thick skin, instead of the ½-in. *Warrior* skin, the damage inside of a small turret or casemate would have been excessive.

The bursting charge of the 288-lb. shell was 11 lbs.; that of the 15-in. columbiad shell is but 17 lbs., and that of the 13-in. mortar shell 7 lbs. But the shell that has been fired through armor is so shattered, that its bursting charge has less resistance, and consequently does less damage. The defect of the Whitworth armor-piercing shells was their inadequate size. 1. The cavity in the

rear was too small to hold an adequate bursting charge. 2. The cavity was large enough to weaken the walls of the shell, so that the bursting charge was fired as much backward as forward into the ship. But the Armstrong 10½-in. shell, with a 11-lb. bursting charge, remedied the defect in a great degree, and showed what might be expected from higher velocities. (See Gun Cotton—Appendix.

#### SECTION IV. THE TWO SYSTEMS COMBINED.

**267.** The maximum utilization of power and time, and the consequent infliction of the maximum damage upon an enemy's iron-clad fleet, appear to demand projectiles of moderate weight, so that they may have high velocity with a given strength of gun. At the same time, there may be circumstances under which the heavy shot, at a low velocity, will be the more formidable missile.

What has been said in the preceding pages refers to the exclusive use of one system or the other. But it will appear that two forces may prepare the way for each other, so as to produce a more formidable result than when they are independently exercised. The defect of the light-shot system, when the range is very long or the armor very thick, and of the heavy-shot system when the range is even very short, and the armor is laminated or so constructed as to suffer little from racking and shaking, is the waste of power in producing local effect that is fruitless, because it is incomplete. Another defect of the heavy-shot system is its waste of power in overcoming only the elasticity and ductility of materials, without straining it to the point of rupture. Nor is the punching system all that could be desired in its destructiveness of the fighting and manœuvring powers of an enemy's ship. *Wearing out* the resistance of a ship's armor, or the seaworthiness of her frame, and projecting small columns of splinters into her vitals by means of small shot and weak shells, take too much time and involve too much risk.

**268.** Light, fast shot may riddle armor without dislocating it as a whole; but if it is not previously weakened, heavy shot cannot smash it in. What is more obvious than the combina-

tion—weakening the armor by the loss of substance, tenacity, and continuity, until the heavy shot *can* carry in a large section of it bodily? At the same time the general straining and cracking of plates produced by the heavy shot makes punching all the easier. Meanwhile, the light shots that do penetrate are doing good work upon the enemy within, without reference to the weakening of his shield.

There have been no experiments made with any direct reference to this method of fighting iron-clads. But the case is so simple, that the result can be pretty confidently predicted. When a bar is to be broken, it is nicked, bored, or otherwise weakened at the point of the intended fracture, either by the loss of material or the reduction of its cohesion, or both. The thick targets (Table 28) were not torn down, because they had so much *continuity* of substance and support. If the plates could have been previously fractured, or punched, or partially punched, and the bolts broken, and the backing splintered, and the ribs cracked in different places around the part intended to be carried away, the tenacity and elasticity of so much of the structure would have been overcome, and fractures would have been already started in the rest.

As a part of *this system*, the very shots which do least damage by themselves, contribute most usefully to the general result. *Nearly* punching a small hole does no damage to the enemy, and affords no aid to the next small shot that may strike quite near it, for the *local* strength of the particular spot it strikes is what the swift shot has to overcome. Any amount of elasticity and tenacity, or weakness and fracture, five or six feet away from it, does not lighten its labor any. A very heavy and slow shot may be fired at laminated armor without materially reducing the work to be done by those that are to follow. The strain is so widely distributed and absorbed by the elasticity and ductility of the fabric, that it produces no essential damage at any one spot. But even nearly punching a small hole almost entirely destroys the strength of some part of the square yard or square rod of a ship's side that resists the racking blow of the heavy shot.

After a time, the remaining continuity of strength is insufficient to resist the smashing blow, and a section of the iron wall is driven in, crushing men and machinery, and opening the enemy's side to the sea and to every projectile which can be thrown with tolerable accuracy—bullets, grape, and the enormous shells of these very battering guns.

**269.** It will be objected that this process is wasteful of time, and that each great gun occupies the room and buoyancy of two lighter or punching guns. This objection would not be well founded. The present improvements in armor, and the obvious means of increasing its resistance to all kinds of strains, may yet place artillerists in the following position: a fight must indeed be brief, or the enemy will manœuvre himself into shelling range of a city or navy yard. During a brief action they cannot batter and shake down his side with heavy shot, and they cannot punch it with light shot. The only thing that they can do is to weaken his armor so much in detail that they can at last smash it in. No one class of projectiles can do this. There must be two classes. Besides, if guns are all of small calibre, no matter how much powder they will stand, they cannot throw the most formidable shells at vessels without armor, or at fortifications, and troops, and buildings, on shore. The usefulness of some heavy guns in fighting the present class of European iron-clads—peeling them—is obvious from the experiments already detailed.

**270. General Conclusions.**—The work demanded of guns for iron-clad warfare, is not the mutilation of armor, but the disabling of the active enemy—men, guns, and machinery—within it.

With a given strength of gun-metal, *first*, attempting by means of very heavy shot, at velocities necessarily very low, to shake off the enemy's armor, for the purpose of shelling him afterwards, gives the elasticity and ductility of the material time to absorb much of the power of the shot.

*Second.* Attempting to render an enemy's vessel untenable and unseaworthy by smashing his sides with shot too heavy and too slow to actually punch them, wastes the greater part of the power in local effect that is fruitless, because it is incomplete (207).



*Third.* Both these processes involve dangerous delays, during which the enemy may fight or manœuvre himself into shelling range of towns and navy yards.

*Fourth.* Punching-shot of moderate diameter, and light enough to receive a high velocity, meet with the least resistance and waste the least power in uselessly mutilating and vibrating the armor; they strike the enemy at once.

*Fifth.* The destructive effects of shot, after passing through armor, are very serious, especially when men and machinery are (as they must be) crowded together in small turrets or casemates.

*Sixth.* Some rifled guns are required to throw shells through armor, and for other purposes, at long range.

*Seventh.* To utilize space and buoyancy, a system of rifling is required that will not impair the efficiency of the gun as a smooth-bore.

*Eighth.* Flat-fronted bolts, at high velocities, can be fired through vessels below water.

*Ninth.* Shells can be thrown through armor with nearly as much facility as solid shot.

*Tenth.* The combination of the two systems—heavy racking and smashing shot, and smaller punching-shot—utilizes both. The latter, without losing its independent usefulness, renders the heavy shot effective.

*Eleventh.* Some guns of large calibre are also necessary to shell towns, earthworks, and vessels without armor, most effectively.

**271.** In the present state of the art of gun-making, a 10 to 12-in. gun, rifled so as to carry spheres without injury, to fire steel and cast-iron balls at short range, and light sub-calibre punching-bolts and shells at high velocities, and long, heavy shells, with large bursting charges and small propelling charges, at long range, would appear to be the greatest concentration of offensive power (339).

But if two kinds of naval guns are to be used—and this would appear to be the better system—a smaller gun would stand higher relative charges, and thus give higher velocities to punching-shot, and a larger gun—perhaps a greater calibre than 20 inches—would

most promptly and effectually smash in a ship's side, throw off her armor, and impair her sea-going as well as her defensive qualities, especially when her armor was riddled, or shattered and weakened at different points, by smaller and swifter projectiles.

### SECTION V. BREACHING MASONRY.

**272.** In addition to destroying iron-clads, modern cannon will be expected to destroy masonry. The relative merits of rifles and smooth-bores, for this purpose, have been well settled by careful experiments in England, as well as by actual warfare in America. The following facts render an extended discussion of the subject quite unnecessary:

**273. Abstract of the Report of the Ordnance Select Committee, January 25, 1861, on Breaching Experiments against Martello Towers.**—The towers were of brick, 40 ft. diameter at the top, 46 ft. at the bottom, and 32 ft. high. Least thickness at the foot, 7 ft. 3 in.; at the springing on the vault, 5 ft. 6 in.

The object of the experiments was to compare the effect of spherical with that of rifled projectiles.

TABLE XXXVIII.—GUNS AND CHARGES USED IN BREACHING MARTELLO TOWERS.  
SMOOTH-BORES AGAINST TOWER NO. 49.

68-pounders, of 95 cwt.	Charge, 16 lbs.	Shell, 49½ lbs.	Burster, 2½ lbs.
32-pounders, of 58 cwt.	Charge, 10 "	Shell, 22½ "	Burster, 1 lb.

#### RIFLED GUNS AGAINST TOWER NO. 71.

6-in. 80-pdr. Armstrong gun.	Charge, 10 lbs.	Shot, 82 lbs	.....
6-in. 80-pdr. Armstrong gun.	Charge, 9 "	Shell, 77 "	Burster, 5 lbs. 8 oz.
7-in. Armstrong howitzer.	Charge, 9 "	Shell, 100 "	Burster, 8 "
40-pdr. Armstrong gun.	Charge, 5 "	{ Shot, } 41 lbs.	Burster. 2 " 8 "
		{ Shell, }	

The range was, in both cases, 1032 yards.

**With Spherical Shot.**—“Expenditure of ammunition, 271 rounds; of which took effect as follows. (Tower No. 49).

TABLE XXXIX.

NATURE OF GUN.	Round shot.	Blind shells.	Live shells.	Total.
68-pounder, smooth-bore.....	40	11	44	95
32-pounder, smooth-bore.....	24	9	35	68
Total .....	64	20	79	163

“Corresponding generally to the undermentioned detail of Armstrong projectiles which took effect against Tower No. 71:—

TABLE XL.

NATURE OF GUN.	Solid shot.	Blind shells.	Live shells.	Total.
80-pounder gun, rifled.....	19	8	36	63
7-inch howitzer, rifled.....	0	2	29	31
40-pounder gun, rifled.....	20	1	43	64
Total .....	39	11	108	158

**With Smooth-Bore Guns,** “the surface of the tower was generally demolished, but unequally. The superficial area of one face or semicircle of the tower is about 2020 square feet; effect was visible over 1072 square feet of this surface; and the depth of masonry penetrated having been very carefully measured over the whole surface, by Lieut.-Col. Lennox, R. E., the following is the result:

TABLE XLL.—MASONRY DISPLACED TO A DEPTH OF

Less than 1 foot on .....	240 square feet.
Between 1 foot and 2 feet on .....	367 “ “
Between 2 and 3 feet on.....	220 “ “
Between 3 and 4 feet on.....	112 “ “
Between 4 and 5 feet on.....	33 “ “
Over 5 feet on .....	56 “ “

“The average depth of broken surface was found to be 1·91 feet, and the cubic quantity of masonry removed, 2168·8 feet. \* \* \*

“Taking no account, at present, of the shells which burst near the muzzle of the gun, the above effect was produced by the expenditure of 9684 lbs. of iron, in shot and shell, and 3720 lbs. of gunpowder, of which 245 lbs. in bursters; or, counting only those rounds in which the tower was struck, by 7192 lbs. of iron, and 2500 lbs. of gunpowder, of which 134 lbs. in bursters.”

**274. With Armstrong Rifled Guns** the expenditure up to the 41st round, when the entire side from course 60 (answering to 54 on this [No. 49] tower) had fallen away, making an open breach of 20 feet wide, was 2593 lbs. of iron and 511 lbs. of powder. Before, however, a strict comparison can be made, it is necessary to take account of the comparative breaching power of the several projectiles, as measured by the product of their weight into the square of the velocity of the shot or shell at the moment of impact. This velocity may be assumed, for the present purpose, to be the same as the mean velocity of the same projectile for a range of  $2 \times 1032 = 2064$  yards, because such mean velocity represents very nearly the actual velocity of the projectile at the middle point of its trajectory, and will be sensibly the same for the same projectile in striking any object at that distance, although in a slightly different trajectory. As the initial velocity of the larger Armstrong projectiles has not yet been ascertained, and there are neither practical nor theoretical data for calculating the remaining velocity at given ranges, this mode of proceeding is the only one open.

In Table 42 are data given by observation of times of flight:

“Taking the effect of the 68-pounder solid shot as unity, the foregoing data give the following as the order and relative value of the several projectiles under comparison, which we will call W:

“These numbers, multiplied by the number of projectiles of each nature fired, will represent, approximately, the *work done* upon each tower, and are as follows:

“By which it appears that, irrespectively of the superior concentration of the fire of the rifled guns, and its consequently greater

TABLE XLII.

NATURE OF GUN.	Charge.	Range observed.	Elevation.	Observed time of flight.	Mean velocity due to time.	Nature and weight of projectile.
	lbs.	yds.	° ' "	sec.	feet.	lbs.
Armstrong 7-in. howitzer..	9	2099	7 12	7.80	807	.....
Armstrong 80-pdr. gun.....	10	2153	5 17	7.00	923	.....
Armstrong 40-pdr. gun.....	5	2100	5 5	6.85	920	.....
Service 68-pdr gun.....	16	2112	5 37	7.50	812	shot 68
Service 68-pdr. gun.....	16	2008	5 45	7.75	832	shell 51½
Service 32-pdr. gun.....	10	2184	5 10	8.17	784	shot 32
Service 32-pdr. gun.....	10	1982	6 20	7.83	743	shell 23½

TABLE XLIII.

PROJECTILE.	Relative value. W.	Bursting charge of shell.
80-pounder solid shot (elongated).....	1.52	5 lbs. 8 oz.
100-pounder shell (elongated).....	1.42	8 0
68-pounder solid shot (spherical).....	1.00	.....
40-pounder solid shot (elongated).....	0.76	2 8
68-pounder naval shell (spherical).....	0.78	2 4
32-pounder solid shot (spherical).....	0.43	.....
32-pounder naval shell (spherical).....	0.28	1 0

effect, they actually performed half as much work again as the smooth-bored guns, with the diminished expenditure of iron and gunpowder noticed in a previous paragraph.”

“The Metz experiments of 1834, gave for 1000 metres (1094 yards) a mean penetration of 18.2 in. into good rubble masonry, to be increased three-fourths for brick-work. This would give 1 ft. 9.2 in. for brick-work, with a projectile of 36 lbs., charge, 12 lbs. The increased penetration of the rifled projectiles is in a far higher

TABLE XLIV.

TOWER 71.—ARMSTRONG GUNS.			TOWER 49.—SMOOTH-BORES.		
Nature of Projectile.	Took effect N.	Work N × W.	Nature of Projectile.	Took effect N.	Work N × W.
80-pdr. shot.....	19	28·88	68-pdr. shot.....	40	40·00
80-pdr. shell.....	44	66·88	68-pdr. shell.....	57	44·46
7-in. howitzer shell..	31	44·02	32-pdr. shot.....	24	10·32
40-pdr. shot.....	20	15·29	32-pdr. shell.....	44	12·32
40-pdr. shell.....	44	33·44		165	107·10
	158	188·51			

TABLE XLV.—APPROXIMATE TABLE OF THE COMPARATIVE PENETRATIONS OF ARMSTRONG AND SPHERICAL PROJECTILES, RESPECTIVELY, INTO BRICK-WORK OF THE BEST QUALITY, AT 1032 YARDS:

ARMSTRONG.				SMOOTH-BORES.			
Nature of Projectile.	Weight.	Charge.	Penetration.	Nature of Projectile.	Weight.	Charge.	Penetration.
	lbs.	lbs.	ft. in.		lbs.	lbs.	ft. in.
7-in. shell.....	100	9	3 8	68-pdr. shot.....	68	16	1 8
6-in. shot.....	82	10	7 6	68-pdr. shell.....	51	16	1 9
6-in. shell.....	77	9	4 3	32-pdr. shot.....	32	10	1 4
40-pdr. { shot } ..	41	5	4 1	32-pdr. shell.....	23½	10	1 4

ratio than theory could assign to them. It is plain, therefore, that we must look for some other cause than their superior *vis viva*, and this is furnished by their rotation on their longer axis. The 6-in. projectile leaves the muzzle of the gun spinning at the rate of about 63 turns per second. It is not probable that this rate diminishes as fast as the motion of translation. It will be very little reduced in 3 or 4 seconds, or at 1032 yards, and must materially aid penetration."

**275. Breaching of Fort Pulaski, Georgia, April, 1861.**

—The following is compiled from the official report of General Gillmore:

Fort Pulaski is a brick work of five sides, casemated on all sides; walls  $7\frac{1}{2}$  ft. thick and 25 ft. high, with one tier of guns in embrasures and one tier *en barbette*. At the time of the siege, it contained 48 guns, 20 of which bore on the attacking batteries, viz., five 10-in. and five 8-in. columbiads, and four 32-pounders, all smooth-bores, one 24-pounder Blakely rifle, and two 12-in. and three 10-in. sea-coast mortars. The work was breached in 3 half-days, and surrendered on the second day.

TABLE XLVI.—NUMBER, CHARACTER, AND RANGE OF SHOTS FIRED IN THE BREACHING OF FORT PULASKI.

NAME OF BATTERY.	Dis- tance in yards.	Projectiles.	Charge.	Burst- ing charge.	No. of shots.
			lbs.	lbs.	
Battery Stanton....	3400	13-in. Mortar shells.	$14\frac{1}{2}$	7	255
Battery Grant.....	3200	Ditto.	$13\frac{1}{2}$	7	282
Battery Burnside..	2750	Ditto.	$10\frac{1}{2}$	7	155
Battery Sherman..	2650	Ditto.	10	7	232
Battery Halleck...	2400	Ditto.	11	8	220
Battery Totten.....	1650	10-in. Mortar shells.	$4\frac{1}{2}$	3	588
Battery Lyon.....	3100	10-in. Columbiad shells.	17	3	321
Battery Scott.....	1740	{ 10-in. Columbiad shot. 8-in. Columbiad shot.	20 10	..... .....	501
Battery Lincoln...	3045	8-in. Columbiad shells.	10	$1\frac{1}{2}$	428
Battery McClellan	1650	{ 84-lb. James shot and shells. 64 " do. do. do.	8 6	..... .....	793
Battery Sigel.....	1670	{ 48-lb. James shot and shells. 30 " Parrott do. do.	5 $3\frac{1}{2}$	..... .....	1500

These shot did all the work.

Of the breaching guns, the two 84-pounders, the two 64-pounders, and the 48-pounder, were, respectively, old unhooped 42, 32,

and 24-pounders, rifled with broad flat grooves. There were 5 Parrott 30-pounders.

TABLE XLVII.—PENETRATIONS IN BRICK-WORK.

KIND OF GUN.	Range.	Projectile.	Elevation.	Charge.	Penetration.
	yds.			lbs.	in.
Old 42-pdr. rifled..	1650	James 84-lb. shot.	4½°	8	26
Old 32-pdr. rifled..	1650	James 64-lb. shot.	4°	6	20
Old 24-pdr. rifled..	1670	James 48-lb. shot.	4½°	5	19
Parrott 30-pdr.....	1670	Parrott 30-lb. shot.	4½°	3½	18
10-in. smooth-bore	1740	128-lb. solid shot.	5°	20	13
8-in. smooth-bore	1740	68-lb. solid shot.	5°	10	11

The following deductions must be made, to estimate the amount of metal expended, viz.:

“*First.* For the shots expended upon the barbette guns of the fort in silencing their fire.

“*Second.* For 10 per cent. of Parrott’s projectiles which upset, from some defect which, I know from personal observation, has been entirely removed by the recent improvements of the manufacturer.

“*Third.* For nearly 50 per cent. of the 64-lb. James shot, due to the fact that one of the two pieces from which they were thrown had, by some unaccountable oversight, been bored nearly ¼ in. too large in diameter, and gave no good firing whatever.

“Making these deductions, it results that 110643 lbs. of metal were fired at the breach.”

Fifty-eight per cent. of the metal was fired from rifled guns.

The weight of metal thrown per lineal foot of breach was 2458 lbs.

Two casemates were fully opened, say 30 feet in aggregate width, the scarp wall was battered down in front of 3 casemate piers, and the wall of the fort was badly shattered for 25 or 30 feet on each side of the breach.



Lieutenant Porter, Chief of Ordnance and Artillery, states, in his report, that the 8-in. and 10-in. columbiads, throwing solid-shot at 1740 yards, "performed their part admirably in the demolition of the masonry;" and that it was after the rifles had perforated the walls, "that the columbiads performed their true office in crushing out the immense masses of masonry."

**276.** General Gillmore concludes that—

"*First.* Within 700 yards, heavy smooth-bores may be advantageously used for breaching, either alone or in combination with rifles.

"*Second.* Within the same distance, light smooth-bores will breach with certainty, but rifles of the same weight are much better.

"*Third.* Beyond 700 yards, rifled guns, exclusively, are much superior for breaching purposes to any combination of rifles and heavy or light smooth-bores.

"*Fourth.* Beyond 1000 yards, a due regard to economy in the expenditure of manual labor and ammunition, requires that smooth-bores, no matter how heavy they may be, should be scrupulously excluded from breaching batteries."

"*Fifth.* In all cases when rifled guns are used exclusively against brick walls, at least one-half of them should fire percussion shells. Against stone walls shell would be ineffective."

The mortars did very little damage to the work. Their fire was inaccurate. Not one-tenth of the 13-in. shells dropped inside the fort. A few struck the terreplein over the casemate arches, but without producing any serious results.

**276 A. Breaching of Fort Sumter, South Carolina, August, 1863.\***—This was a brick work, similar in construction to Fort Pulaski, before described, except that it had another tier

\* General Gillmore has kindly allowed the author to copy the following statements from his official report, in advance of its publication. They form a complete summary of the facts in the case that strictly belong to the subject under consideration, although in a military and an engineering point of view, General Gillmore's narrative of the conduct of the siege and the transportation of 100 to 300-pounder rifles over swamps and open sands, in the face of the enemy, will be found singularly important and interesting.

of casemates. These, however, were not armed. The capacity of the fort was 135 guns; how many guns were mounted it is impossible to state, as the Federal forces are not yet in possession of the ruins.

TABLE XLVII. A.—RANGES AND NATURE OF BATTERIES EMPLOYED IN BREACHING FORT SUMTER.

Name of Battery.	Nature of Guns.	Range in yds.
Battery Brown.....	Two 8-in. Parrott Rifles.....	3516
Battery Rosecrans.....	Three 100-pdr. Parrott Rifles.....	3447
Battery Meade.....	Two 100-pdr. Parrott Rifles.....	3428
Naval Battery.....	{ Two 80-pdr. Whitworth Rifles..... Two 8-in. Parrott Rifles..... }	3938
Battery Hays.....	{ One 8-in. Parrott Rifle..... Two 100-pdr. Parrott Rifles.. .. }	4272
Battery Stevens.....	Two 100-pdr. Parrott Rifles.....	4278
Battery Strong.....	One 10-in. Parrott Rifle.....	4290

Number of guns, 17. Average range, 3881.3 yards.

The whole number of projectiles thrown was 5009.

Weight of projectiles thrown, 552683 lbs.

Number of projectiles that struck the masonry, 2479.

Number of projectiles that struck the gorge wall and helped to form the breach, 1668.

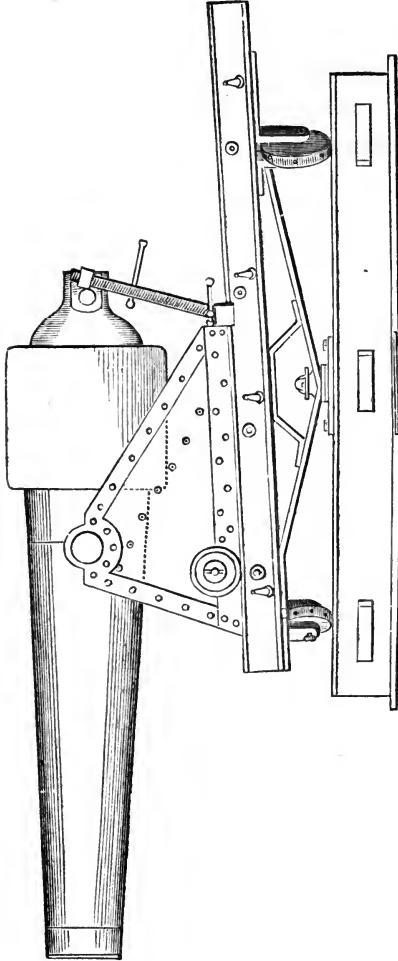
Weight of metal that formed the breach, 289986 lbs.

Firing opened Aug. 17, 1863; closed August 23, 1863.

The precise effect of these projectiles cannot, of course, be stated; but it is certain that about one-third of the face of the gorge wall, for about one-third of its depth, fell down, mostly outward, forming a *practicable breach* from 70 to 80 yards long, and from 10 to 13 feet deep.

**276 B. Breaching Fort Wagner. Sand Armor.**—During this siege, the bomb-proof of a rebel work occupying the entire

breadth of Morris Island, and mostly constructed of sand, was, with great difficulty, breached by similar rifled projectiles. The four breaching batteries were located at 1330, 1460, 1830, and 1920 yards range respectively. Upon the capture of this work, it was ascertained by careful measurement that 165 cubic yards of sand had been removed by  $54\frac{1}{2}$  tons of projectiles, which is equal to 1 lb. of metal for the removal of every 3.27 lbs. of sand. The slope was quite flat, and the greater part of the sand knocked away fell back in place again.



Parrott 100-pounder, on wrought iron sea-coast carriage.

## CHAPTER III.

## THE STRAINS AND STRUCTURE OF GUNS.

## SECTION I. RESISTANCE TO ELASTIC PRESSURE.

**277.** The strains to which cannon are subjected by the pressure of the powder are thus stated by Captain Benton:\*

“1. The *tangential* strain, which acts to split the piece open longitudinally. \* \* \* 2. The *longitudinal* strain, which acts to pull the piece apart in the direction of its length. \* \* \* 3. A strain of *compression*, which acts from the axis outward, to crush the truncated wedges of which a unit of length of the piece may be supposed to consist. \* \* \* 4. A *transverse* strain, which acts to break transversely, by bending outward the staves of which the piece may be supposed to consist. \* \* \*

“If  $p$  be the pressure on a unit of surface of the bore, and  $s$  the tensile strength of the metal, it can be shown by analysis that the tendency to rupture, or the pressure on a unit of length of bore, divided by the resistance which the sides are capable of offering to rupture, for a piece of one calibre thickness of metal, will be as follows:

$$\text{Tangential, } \frac{3p}{2s};$$

or, rupture will take place when three times the pressure is greater than twice the tensile strength.

$$\text{Longitudinal, } \frac{p}{2s};$$

or, rupture will take place in the direction of the length, when the pressure is greater than twice the tensile strength.

$$\text{Transverse, } \frac{2p}{3s};$$

\* “Ordnance and Gunnery,” 1862.

or, rupture will take place when twice the pressure is greater than three times the tensile strength.

“From the above it appears that the tendency to rupture is greater from the action of the tangential force than from any other; and for lengths above two, or perhaps three calibres, the tangential resistance may be said to act alone, as the aid derived from the transverse resistance will be but trifling for greater lengths of bore or stave.”

**278. I. Increasing the thickness of the walls.**—The most obvious means of enabling any vessel to sustain a greater elastic pressure, such as the gas of exploded gunpowder, is to simply thicken its sides, thus increasing the area of substance to be torn asunder. This rule is founded upon the practical facts of every-day engineering, which usually deal with comparatively low pressures and *thin walls*. Even in case of guns of small calibre, it has proved tolerably safe. But when these conditions are greatly changed—when the problem is, for instance, to throw projectiles of 13 to 15 inches' diameter at the rate of 1500 to 1800 feet per second, and the gun is proportionally thickened to stand the excessive strain due to both the increased pressure per square inch and the increased number of square inches pressed upon, another law, unobserved in ordinary practice, assumes a very serious importance. This law is thus clearly explained by Captain Blakely:\*

**279.** “To obtain much greater strength by casting guns heavier is impossible, because in cast guns (whether of iron, brass, or other metal) the outside helps but very little in restraining the explosive force of the powder tending to burst the gun, the strain not being communicated to it by the intervening metal. The consequence is, that, in large guns, *the inside is split, while the outside is scarcely strained*. This split rapidly increases, and the gun ultimately bursts.

“This will be more easily understood by considering the case of a much more elastic tube; for instance, an India-rubber cylin-

\* “A Cheap and Simple Method of Manufacturing Cannon,” 1858.

der 10 inches in internal diameter and 10 inches thick, therefore 30 inches in external diameter. Such a cylinder might be strained by pressure from within till the inside stretched to double its original circumference. The diameter would, of course, also be doubled, and would be 20 inches instead of 10.

“Now it is evident that the outside circumference and diameter cannot be doubled at the same time, or else the latter must become twice 30 or 60 inches, which would give a thickness of 20 inches, quadrupling the mass of material, which is impossible. A moment’s reflection shows that the thickness must diminish as the circumference is increased by pressure from within; for, if the thickness remain 10 inches when the internal diameter has become 20, the external diameter must be 20 plus twice 10, or 40 inches. This could not be, unless we imagine what seems impossible, viz., that the bulk of the material is considerably enlarged, as each inch in length of the cylinder would now contain 1200 cylindrical inches (the difference between the squares of 40 and 20, the external and internal diameters), whereas originally it only contained 800 inches, the difference between the squares of 30 and 10.

“Yet, even if the thickness could remain the same, notwithstanding the increase of circumference, the outside layer could only be strained one-third as much as the inside one, because three times as long. The same elongation, which would cause a strain of one ounce or one pound in the longer circumference, would cause a strain of three ounces or three pounds in the shorter one, and the elongation which would but moderately strain the one would break the other.

“This reasoning is equally applicable to the minute extension of iron; the increase of  $\frac{1}{16}$  of an inch in the outer circumference of a 10-inch gun being possible without fracturing that part,

FIG. 129.

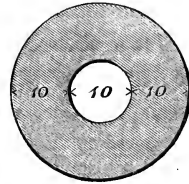
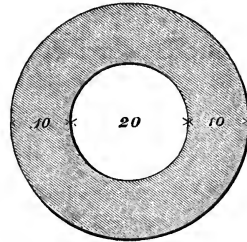


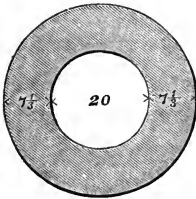
FIG. 130.



being an elongation of but 1 in 940; whereas the same extension must crack the inside, as no iron could stand an elongation of  $\frac{1}{10}$  in  $31\frac{1}{2}$ , or 1 in 314.

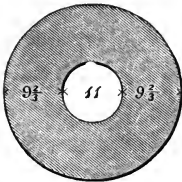
“Even on this showing, then, the outside of a thick tube cannot do its share of work; a closer examination, however, must convince us that this is an over-estimate of it, for *the thickness of material must diminish as the circumference is increased*. When the inner diameter of the 10-inch cylinder becomes 20 inches, the thickness must diminish from 10 to 7.32 inches, the cross-section of the cylinder remaining the same. This cross-section was originally 800 circular inches, 800 being the difference between the squares of 30 inches, the outer diameter, and 10 inches, the inner, or 900 minus 100. When stretched, the area of the cross-section must continue to be 800 round inches. Now a thickness of 7.32 inches gives us an external diameter of twice 7.32 or 14.64 added to 20, the internal diameter,

FIG. 131.



in all 34.64 inches, the square of which is 1200. Subtracting 400, the square of 20, leaves 800 round inches as before. In this case the outside of the cylinder is stretched but 4.64 in 30, about one in seven, when the inside is stretched to double its original size. If the inner diameter be only stretched to 11 inches, the thickness must be diminished from 10 to 9.674 inches,

FIG. 132.



the outer diameter becoming 30.348 inches, the cross-section remaining 800 round inches, as before, the difference between the squares 30.348 and 11. Here the outer layer is elongated .348 in 30, or 1 in 86; whereas the inner is extended 1 in 10, showing a strain or an exertion of power  $8\frac{1}{2}$  times greater.

“In the minute extension of metals the disproportion is still more striking. Thus in cast-iron the 10-inch inner diameter may become  $10\frac{1}{100}$ , which would extend the outer diameter only from 30 to  $30\frac{1}{100}$ , the cross-section remaining 800 inches, and the thickness diminishing from 10 inches to  $9\frac{2}{3}$ . Here



the outside would only be stretched  $\frac{1}{30}$  in 30, or 1 in 9000, the inside being stretched  $\frac{1}{10}$  in 10, or 1 in 1000, exerting, therefore, nine times as much power as the outside. *It is evident that a slight increase of pressure from within would break the inside, while the outside could help but little in restraining the disruptive force.*

**280.** "If we make equidistant circular marks on the end of an India-rubber cylinder (Fig. 134), and stretch it, we can see plainly how much more the inside is strained than the outside or even the intermediate parts. The spaces between the marks will become thinner, each space becoming less thin than that inside of it, but the inner space much thinner than the others (see Fig. 135), showing that when the inside is strained almost to breaking, the intermediate parts are doing much less work, and those far removed almost none.

**281. LAW OF STRENGTH OF CYLINDERS.**  
 "In the first volume of the 'Transactions' of the Institute of Civil Engineers, p. 133, there is a paper by Professor Peter Barlow, F.R.S., on the Strength of Cylinders. The law he deduces is, that '*in cylinders of metal the power exerted by different parts varies inversely as the squares of the distances of the parts from the axis.*' Thus, in a 10-inch gun, when the inside, which is 5 inches from the axis, is fully strained, the metal 2 inches from the inside, or 7 inches from the axis, can only exert a force  $\frac{25}{49}$ , or little more than half as much; 3 inches further, 10 inches from the axis, the force exerted diminishes to  $\frac{25}{100}$ , or but a quarter of that exerted by the inside; and if the gun be 12 inches thick, *the outside,*

FIG. 133.

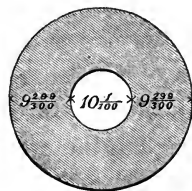
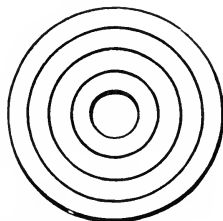
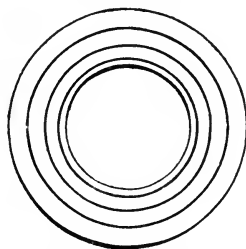


FIG. 134.



India-rubber cylinder, with equidistant concentric marks.

FIG. 135.



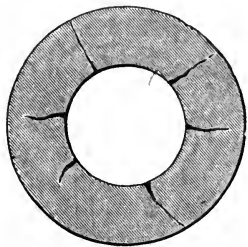
The same cylinder, stretched by internal pressure; the concentric marks show the inferior stretch of the exterior.

which is 17 inches from the axis, can exert but  $\frac{2\frac{5}{8}}{17}$ , or about  $\frac{1}{12}$  as much power as the inside. Of course, casting the gun still thicker would add but very little to its strength; we cannot, therefore, be astonished that it has been found in practice that cylinders for hydraulic presses, with a thickness equal to about  $\frac{1}{2}$  the diameter of the piston, are very nearly as strong as if ten times as thick.

**282.** "In 1855, Dr. Hart, of Trinity College, Dublin, investigated the problem. His calculations (see note W, p. 259 of Mr. R. Mallet's work on the Construction of Artillery) give greater strength to the inner parts, but still less to the outer, than those of Professor Barlow. Both these gentlemen, as well as General Morin, and Dr. Robinson the astronomer, who have also studied the question, agree that *no possible thickness can enable a cylinder to bear a pressure from within greater on each square inch than the tensile strength of a square inch bar of the material*; that is to say, if the tensile strength of cast iron be 6 tons per inch, a cylinder of that metal, however thick, cannot bear a pressure from within of 6 tons per inch."

**283.** The report of experiments made by the United States Government in bursting hollow cylinders by internal pressure states that "the general range of the results appears to sustain Mr. Barlow's hypothesis."\*

FIG. 136.



Cylinder burst by internal pressure.

**284.** In further proof of the foregoing facts, Capt. Blakely cites the actual fracture of some cylinders (Fig. 136) made by Mr. Longridge, of iron wound with wire. The cracks were "much more open at the inside, and some not extending to the outside."

**285.** The law of diminution in the power of resistance is also illustrated by Professor Treadwell, who states it as follows:† "Suppose such a cylinder to be made up of a great number of thin rings or hoops, placed one within another.

\* Reports of Experiments on Metals for Cannon, 1856.

† "The Practicability of Constructing Cannon of Great Calibre, etc.," 1856.

Then the resistance of these rings, compared one with another, to any distending force, will be inversely as the squares of their diameters. If we make a cylinder of 41 concentric hoops of equal thickness, disposed one within another, and exactly fitting, so that the particles of each hoop shall be in equilibrium with each other, the diameter of the largest being 5 times that of the smallest, then the force of each, beginning with the innermost, to resist distension, will be represented by the following numbers :

1000.....	250.....	111.....	61
826.....	225.....	104.....	59
694.....	207.....	98.....	56
591.....	189.....	92.....	54
510.....	174.....	87.....	51
444.....	160.....	82.....	49
391.....	148.....	77.....	47
346.....	137.....	73.....	45
309.....	128.....	69.....	43
277.....	119.....	65.....	41
			.....40

“An inspection of these numbers must, I think, impress any one with the fact that it is impossible to increase essentially the strength of cannon by a simple increase of thickness.”

**286.** The weakness of a homogeneous cylinder, and the remedy, (which will be considered in the following article), have been mathematically investigated, with great care, by Dr. Hart, of Trinity College, Dublin, and Mr. C. H. Brooks, from whose calculations it has been illustrated and made the subject of a paper by Mr. James Atkinson Longridge, followed by an important discussion before the Institution of Civil Engineers.

Mr. Longridge says:\* “If, in Fig. 137, A B C D represent a portion of a section of an 8-inch gun, of which A G B is the inner, and D F C the outer circumference, the state of tension of any particle between G and F may be denoted by ordinates drawn at the points in question, those above G F representing tension and those below compression.

“If now the gun be of any homogeneous material, such as cast

\* “Construction of Artillery,” Inst. C. E., 1860.

iron, the state of tension at the time of explosion, and when the gun is about to burst, will be denoted by a curve  $H I$ , or  $H i$ ,

FIG. 137.

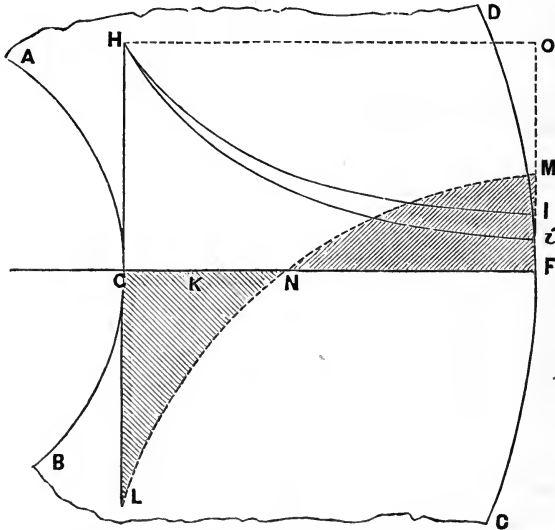


Illustration of strain on a homogeneous gun.

the former calculated according to Professor Hart, and the latter according to Professor Barlow's formula. Then, supposing the tensile force of the material to be 12 tons per square inch, and the thickness of the gun  $6\frac{1}{2}$  inches, when the strain at  $G$  is  $G H$ , or 12 tons, at  $F$  it is  $F I = 3$  tons, or  $F i = 1\frac{3}{4}$  tons, according as the one or other formula is adopted. The areas of these curves give the total strengths of the gun at the bursting point, and are found to be 36.72 tons and 30.871 tons respectively, instead of 78 tons, which it would have been if uniformly strained at 12 tons per square inch."

**287. II. Hoops with initial tension to resist elastic pressure.**—This system consists in making a gun of concentric tubes, by putting on each successive layer, proceeding outward from the centre, with an initial tension exceeding that of those below it, or so that each hoop or tube shall compress what is within it. The

inner layer is thus, in its normal state, in compression, while the outer layer is in the highest tension. Then, by the law illustrated in the foregoing paragraph, the inner layer, being in compression, is able to sustain the first and greatest stretch, and the outer layer, although stretched less by the explosion of the powder, has already been stretched into high tension, and thus has to do an equal amount of work. The intermediate layers bear the same relations to the initial strain and the strain of the powder, so that, in short, all the layers contribute equally of their tensile strength to resist the strain of the explosion.

**288. PROFESSOR TREADWELL'S PLAN.** Professor Treadwell, who was one of the first to propose this method of constructing cannon,\* thus specifies his proposed gun and its strength.†

"I propose to form a body for the gun, containing the calibre and breech as now formed of cast iron, but with walls of only about half the thickness of the diameter of the bore. Upon this body I place rings or hoops of wrought iron, in one, two, or more layers. Every hoop is formed with a screw or thread upon its inside, to fit to a corresponding screw or thread formed upon the body of the gun first, and afterwards upon each layer that is embraced by another layer. These hoops are made a little, say  $\frac{1}{1000}$ th part of their diameters, less upon their insides, than the parts that they enclose. They are then expanded by heat, and being turned on to their places, suffered to cool, when they shrink and compress, first, the body of the gun, and, afterwards, each successive layer all that it encloses. This compression must be made such, that, when the gun is subjected to the greatest force, the body of the gun and the several layers of rings will be distended to the fracturing point at the same time, and thus all take a portion of the strain up to its bearing capacity.

"There may, at the first view, seem to be a great practical difficulty in making the hoops of the exact size required to produce the necessary compression. This would be true if the

\* The claims of Professor Treadwell, Capt. Blakely, Mr. Longridge, and others, as to priority in this invention, will be stated in the Appendix.

† "On the Practicability of Constructing Cannon of Great Calibre," Dec., 1856.

hoops were made of cast iron, or any body which fractures when extended in the least degree beyond the limit of its elasticity. But wrought iron and all malleable bodies are capable of being extended, without fracture, much beyond their power of elasticity. They may, therefore, be greatly elongated without being weakened. Hence we have only to form the hoops *small in excess*, and they will accommodate themselves under the strain without the least injury. It will be found best in practice, therefore, to make the difference between the diameters of the hoops and the parts which they surround, considerably more than  $\frac{1}{100}$ th part of a diameter. The fixing the hoops in their places by the screw, or some equivalent, is absolutely necessary, not merely to reinforce the body against cross fracture, but to prevent them from starting with every shock of the recoil. I know, by experiment, that the screw-thread will fix them effectually. The trunnions must, of course, be welded upon one of the hoops, and this hoop must be *splined*, to prevent its turning by the recoil. Small *splines* should likewise be inserted under every hoop. It will, moreover, be advantageous to make the threads of the female screws sensibly finer than those of the male, to draw, by the shrink, the inner rings together endwise. \* \* \*

**289.** “With these facts, principles, and laws, thus stated, I proceed to give some calculations to show the strength of a cannon constructed in the way that I have pointed out, as compared with one made in the usual manner. Take a cannon of 14 inches’ calibre, which will carry a spherical solid ball of 374 pounds, with sides 14 inches thick, made up of 7 inches of cast iron, and two hoops or rings,  $3\frac{1}{2}$  inches each, of wrought iron. The external layer of cast iron will, from its position, as before explained, possess but one-fourth of the strength of the inner layer, or whole strength of the iron, and the mean strength of the whole will be reduced one-half. Take cast iron at 30000 pounds to the inch area, and we have  $30000 \times \frac{1}{2} = 15000$  pounds to the inch. The thickness of both sides is 14 inches, and  $15000 \times 14 = 210000$  pounds for the strength of the casting, to each inch of its length. The first hoop has its strength reduced from 1 to a mean of .8.

Take the strength of wrought iron at 60000 pounds to the inch, and we have  $60000 \times .8 = 48000$  pounds to the inch. The thickness of both sides is 7 inches, and  $48000 \times 7 = 336000$  pounds. The outside ring must be reduced in strength by the same rule, for its mean, from 1 to .832, which gives it 49920 pounds per inch, and for the 7 inches 349440 pounds. We have then, for each inch in length,

Cast-iron body of the gun.....	210000 pounds.
Inner wrought-iron hoop.....	336000 "
Outer wrought-iron hoop.....	349440 "
	895440 "

"The diameter of the bore being 14 inches, we have  $\frac{325440}{14} = 63960$  pounds, as the resistance to oppose to each square inch of the fluid from the powder. The gun will bear, then, a pressure of 4264 atmospheres.

"The resistance to cross fracture at the part nearest to the breech will be, from the cast iron,  $28^2 - 14^2 = 784 - 196$  circular inches, equal to 460 square inches. Cohesive force, unreduced, 30000 pounds, and  $30000 \times 460 = 13800000$  pounds, the whole strength. The bore contains 153 square inches, and  $\frac{13800000}{153} = 90196$  pounds to resist each square inch more than is provided to resist longitudinal fracture; and this excess will be further reinforced by the wrought-iron rings, which, being screwed upon the casting, and the outer layer breaking joint over the inner, will add to the resistance to a great amount, which, however, need not be computed.

"Let us now examine a gun made of a single casting, of the dimensions given above—that is, of 14 inches bore and 14 inches thick. Taking the normal strength of cast iron, as before, at 30000 pounds per inch, we must reduce it according to the laws before explained (see the preceding article), to  $\frac{1}{3}$ , or a mean of 10000 pounds per inch; and the thickness of both sides being 28 inches, we have  $10000 \times 28 = 280000$  pounds for the whole strength, and  $\frac{280000}{14} = 20000$  pounds to each inch of the fluid pressure, or 1333 atmospheres, or  $\frac{20000}{1333}$ , or less than  $\frac{1}{3}$  of the first

example. Against a cross fracture, the cast gun will possess a great excess of strength, which I do not like to call useless, although I do not perceive how it can be of any essential practical advantage. \* \* \*

“The following columns show the stress that the several kinds of guns, as mentioned, will bear, by calculation, and the pressure required to give the velocity of 1600 feet a second. The third column shows the proportion between the required and the actual strength:

	Atmospheres.	Atmospheres.	
Hooped cannon for 14-inch shot will bear.....	4266;	required 2133	100 : 200
Cast-iron gun, 14-inch shot, will bear.....	1333;	“ 2133	100 : 62
Cast-iron 32-pounder cannon, 6½ inches thick, will bear.....	1333;	“ 920	100 : 142
Hooped cannon, 30 in. diameter, 3670 lb. shot.....	4266;	“ 4266	100 : 100

“By this it appears that a common cast-iron 32-pounder, having but 42 per cent. more strength than is required, is less reliable than a hooped gun of 14 inches. It will be recollected that the numbers given above, in the second column, as showing the required strength, represent the utmost force ever exerted by a charge intended to produce a velocity of 1600 feet a second.”

**290.** ANOTHER USE OF HOOPS. Commander Scott, R. N., mentions another service rendered by hoops.\*

“Many experiments have shown the destructive effects on cast-iron ordnance from continuous firing, as also the increased strength resulting from long rest; and, by allowing two or three months or more to intervene between the series of discharges, a very much greater number of rounds may be safely attained than in case of almost daily practice with the same gun. At page 218 of the work on ‘The Useful Metals,’ published in 1857, it is stated that ‘pieces cast some years before testing stood several times the quantity of firing of other pieces cast but a few months previously.’ The tensile properties of the metal did not explain the difference; and the form, dimensions, weight, method of casting and cooling, and the manner of proving, were the same in all the pieces tried.

\* Journal Royal United Service Inst., April, 1862.



\* \* \* All guns properly cast are sufficiently strong to resist a few rounds of heavy charges; but by using them, the particles of iron would be disturbed, and then would not rearrange or resettle themselves, unless a period of long rest were given. \* \* The object, therefore, to be arrived at is, to *prevent the disturbance of the particles*, and the consequent deterioration of the piece; and this is what the hooping *does* effect, when the gun is fired with the charges which the hoops are calculated to withstand."

**291. Defects of the Hooping System—Remedies.** Each hoop or tube, taken by itself, has the element of weakness considered in a foregoing paragraph—its inner circumference is more stretched and strained than its outer circumference. Absolute perfection would necessitate infinitely thin hoops; and practically, the thinner the layers, the greater the strength (313) provided the mechanical difficulties in constructing, and more especially in applying, a great number of thin strata, with the proper tension, do not outweigh their advantages. This subject has also been mathematically illustrated by Mr. Longridge, in the paper before referred to. Some years since, Mr. Longridge constructed a number of guns and other cylinders to be subjected to pressure, by winding square steel wire upon homogeneous metallic cylinders, the successive layers of wire having an increased initial tension, and corresponding in their functions to a great number of very thin hoops similarly applied (93). He compares the wire reinforce with the thick hoops used by Captain Blakely and others, in two particulars,—the actual strength for a given thickness of metal, and the practicability of construction.\*

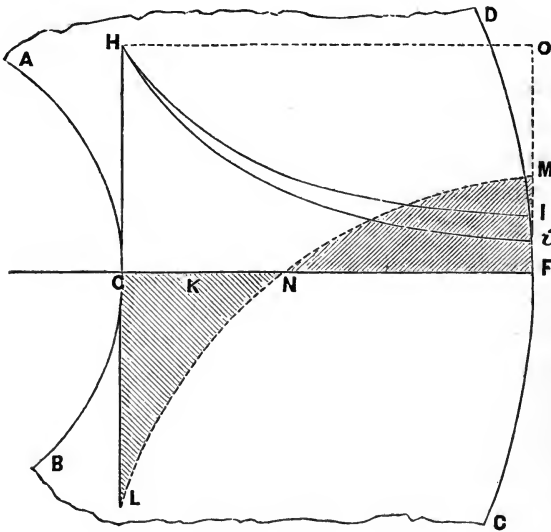
**292. WANT OF CONTINUITY.**† "In the first place, then, there is an objection to the use of hoops from the want of continuity." (Here follows an explanation of the weakness of a homogeneous cylinder, previously given.) "Now the object sought to be attained in the method of construction under consideration, is that each particle, such as K (Fig. 138), shall, when explosion takes

\* The results of Mr. Longridge's experiments have been given in Chap. I.

† "Construction of Artillery," Inst. Civil Engineers, 1860.

place, be equally strained with G. In order that this may be so, the initial state of the tension must be such as is represented by

FIG. 138.



Strain due to want of continuity of hoops.

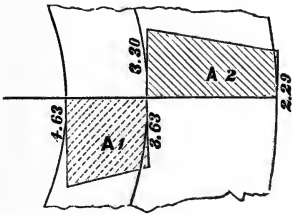
the curve L N M, those between G and N being in compression, whilst those between N and M are in tension. \* \* \* What took place where the explosion occurred might be thus described: L was raised to H, and every point from G to F was raised up to the tension denoted by its projection on the line H O. The total strength was represented by the area L H O M N L, which was equal to the rectangle G H O F. That was the way to get, theoretically, the strongest gun. \* \* \*

“If now it be attempted to accomplish this by means of hoops, it will be found impossible, inasmuch as each hoop is a homogeneous cylinder, and follows the same law throughout its thickness, as is represented by the curve H I. Figs. 139, 140, and 141 represent the successive state of stress of four rings, put on so that when the explosion takes place, they shall all be equally strained at their inner circumferences.

“The figures denote the strains in tons per square inch.

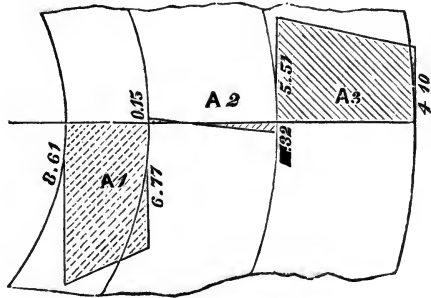
“From this it will be seen that when the four rings are put on,

FIG. 139.



Shows two rings on.

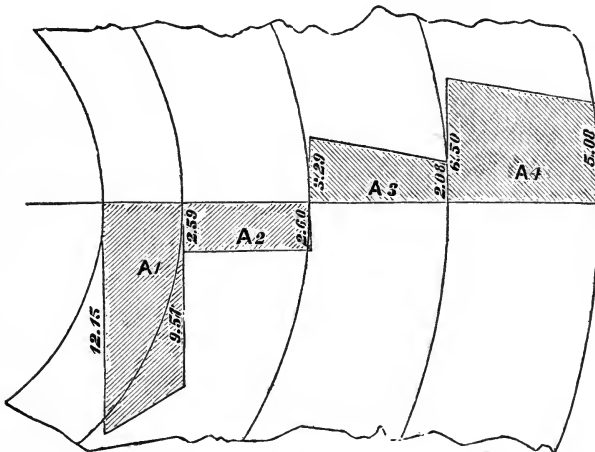
FIG. 140.



Shows three rings on.

instead of the curve L N M of Fig. 138, there are a series of abrupt changes, the two inner rings being in compression, and the two

FIG. 141.

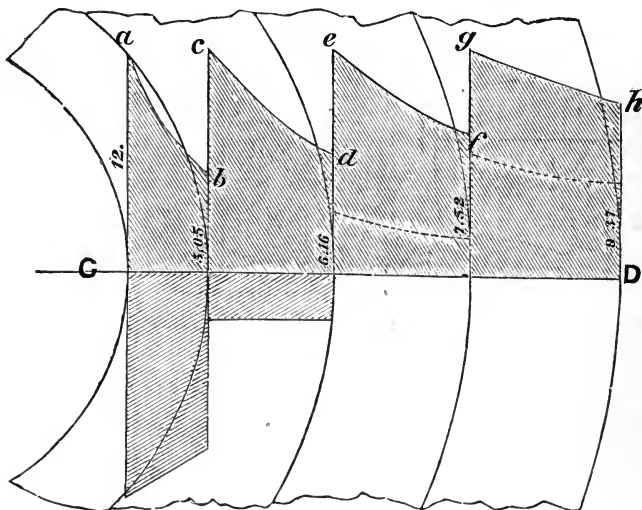


Shows four rings on.

outer in tension. When the explosion takes place, the state of maximum strain is represented by the next diagram, Fig. 142. The area between the dotted and full lines shows the work done

by the explosion, and taking the total thickness of the gun, it amounts to 10.1 tons per inch of thickness; whereas, had the con-

FIG. 142.



struction been of very thin rings, or of small wire, it would have been represented by the area between the dotted line *L N M O H* (Fig. 138), and would have been = 12 tons per inch of thickness, showing a superiority of about 20 per cent. in favor of the wire over the hoops. This is upon the supposition that the workmanship of the hoops is perfect, which in practice cannot be attained."

The objection, which amounts to this—that when the number of hoops is small enough to make a cheap gun, an extra weight of material is required to secure the requisite strength—can hardly be considered a serious defect in the armament of forts and iron-clad vessels. The subject of weight will be further referred to.

**293. THEORETICAL ACCURACY OF TENSION.** Mr. Longridge then discusses the practicability of constructing hooped guns with the accuracy necessary to impart proper strength. "To afford some idea of the accuracy required, the radii of the several rings, shown in the above diagram, are given in Table XLVIII.

TABLE XLVIII.—RADII OF RINGS FOR HOOPING GUNS.

No. of Ring.	Inner Radius.	Outer Radius.	Thickness.	Differences.
1	4.0000	5.3222	1.3222	$R_1 - \rho_2 = .0031$
2	5.3191	7.2928	1.9737	$R_2 - \rho_3 = .0035$
3	7.2893	9.4633	2.1740	$R_3 - \rho_4 = .0035$
4	9.4598	11.8247	2.3649	

“Thus, it appears, that in order to give the requisite amount of initial stress, the external radius of the first ring must be  $\frac{3}{1000}$ ths of an inch, or about  $\frac{1}{300}$ th of an inch larger than the internal radius of the second: the external radii of the second and third  $\frac{3}{1000}$ ths of an inch greater than the internal radii of the rings next to them. Therefore, whilst the whole effect depends upon so small a quantity as about  $\frac{1}{300}$ th of an inch, it is evident that a very small error in workmanship will materially affect the result, and may tend to the most serious deviations from the proper initial strains.”

Mr. Longridge concludes that if the outer ring of the gun (Fig. 142) is made  $\frac{1}{300}$ th of an inch too small “before explosion, the maximum compression of the inner ring is increased from 10.086 tons to 11.244 tons, and the maximum tension of the outer ring from 5.778 tons to 7.823 tons per square inch; whilst at the time of maximum strain, during explosion, the tension of the same ring is only 2.268 tons, although the outer ring is strained to 12 tons, its assumed ultimate strength. The absolute strength of the gun is thus reduced from an average of 10.5 tons to 6.0 tons per inch of thickness, or about 40 per cent., by an error of only  $\frac{1}{300}$ th of an inch, in a ring of about 17 inches diameter.”

**294.** This extreme accuracy is not deemed of practical importance by Captain Blakely, Sir William Armstrong, and other makers of hooped guns. Perhaps this is the reason why their guns do not often come up to the theoretical standard of strength. Referring to the ordinary use of wrought iron, under strain, and

to its known ductility, or capacity of receiving a permanent change of figure under strain, this nicety is pronounced absurd by practitioners. On the other hand, the want of regard for mathematical nicety is the great cause of failure in mechanical experiment and construction. The hooped guns of Mr. Whitworth, who is noted for the "truth" of his workmanship, and who acknowledges the greatest care and the most accurate processes in the application of the hoops, are stronger to resist statical pressure than some others of similar construction and material.

**295.** FORCING ON HOOPS. Supposing this nicety in the tension of the layers of a gun to be important, Mr. Longridge fails to prove it more difficult of accomplishment with hoops than with wire. Mr. Whitworth forces on the rings by hydrostatic pressure. Captain Blakely also advocates the same method.\* As to which Mr. Longridge says: "Here again occurs the practical difficulty of the attainment of extreme accuracy of workmanship, involving the highest class of skilled labor, and the greatest vigilance of supervision." On the contrary, the forcing of a slightly conical ring over a correspondingly conical tube, obviates the necessity of great accuracy in the *diameter* of either piece. The truth of the *cone* depends upon the correctness of the lathe, and may be removed from the interference of the workman. The truth of the surfaces is also a question of good tools. The tension of the ring depends on the distance to which it is forced upon the conical tube, and this may be regulated to a pound, *by the weight upon the safety-valve of the hydrostatic press*. With special tools, which are economical in any extensive establishment, such as a Government gun-factory, or even with the common machine tools, modified and set permanently for a given duty, the most inexpert workman could hardly fail to make a good job (300). The adjustment of Mr. Longridge's Prony brake, to give the proper tension to each coil of wire, is certainly simple and adequate, but it is not automatic, like the safety-valve of a hydrostatic press.

\* "Construction of Artillery," Inst. C. E., 1860.

**296. SHRINKING ON HOOPS. UNEQUAL SHRINKAGE OF METAL.**

If hoops are put on by shrinking, two embarrassments arise. 1. As Mr. Longridge says: "Hoops must be accurately bored, and after each layer is put on, the gun must be placed in the lathe, and the hoops be turned on the outside. Great accuracy of workmanship is indispensable, and not only is the amount of labor much greater, but it must be of a far higher, and, consequently, of a more expensive class." 2. "The process of shrinking on is not to be depended upon. Not only is there a difficulty in insuring the exact temperature required, but scarcely any two pieces of iron will shrink identically."\*

The fitting of hoops, with the nicety of adjustment theoretically necessary, would be difficult; practically, it would not be done.

But the chief embarrassment, even when there is less accuracy sought, is the unequal effect of heat. This subject may be considered under three heads:

**297. First.** Heating the hoops over a fire to expand them, subjects one part to more heat than another part; the temperatures of the surface and the interior are unequal, thus causing irregular strains. This may be remedied by boiling the hoops in water—under pressure, if a greater expansion than  $212^{\circ}$  will give is required; or in oil they may be boiled at a temperature of  $600^{\circ}$ , until all parts of all the hoops are uniformly heated. The oil would toughen as well as expand the hoops.

**Second.** The Armstrong hoops are often heated to redness, so that they scale freely when exposed to the air. Even at a black heat, a considerable oxidation occurs. Thus the internal diameter of the hoop is increased, and scale is left between some parts, and not between others, thus sensibly deranging the accuracy prescribed by theory (293).

**Third.** Cast iron and steel sensibly and permanently enlarge, in proportion to the carbon they contain, when subjected to heat.

\* Lt.-Col. Clay, of the Mersey Iron Works, specially refers ("Construction of Artillery," Inst. C. E., 1860) to this defect. "He knew that iron and steel differed much in their expansion and contraction, and he thought it would be the case with iron generally, according as the crystallized or fibrous structure predominated."

The same cause would contribute to the minute inaccuracy deprecated by Mr. Longridge, even in case of the low steel employed for guns.

**298.** A recent series of experiments on the change of figure of metals by heating and cooling, is so remarkable in its results, that many of the failures of guns hooped at high temperature may, perhaps, be traced to this cause. An abstract of the experiments is certainly appropriate in this connection, especially as the hoops of the Armstrong and other guns are cooled so as to produce, in some degree, the effects described.

“ON THE CHANGE OF FORM ASSUMED BY WROUGHT IRON AND OTHER METALS WHEN HEATED AND THEN COOLED BY PARTIAL IMMERSION IN WATER.”\* “The experiments were made on cylinders of wrought iron, of different dimensions, both hollow and solid, immersed, some to one-half of the depth, others to two-thirds; also on similar cylinders of cast iron, steel, zinc, tin, and gun metal. The specimens experimented on were all accurately turned in a lathe to the required dimensions, which were carefully noted; they were then heated to a red heat in a wood furnace, used for heating the tires of wheels. As soon as they had acquired the proper heat, they were taken out and immersed in water to one-half or two-thirds their depth. The temperature of the water ranged from 60° to 70° Fahr. The specimens were allowed to remain in the water about two minutes, at which time the portion in the air had lost all redness, and that in the water had become sufficiently cool to handle. These alternate heatings and coolings were repeated till the metal showed signs of cracking or giving way.”

Fig. 143 is one of the illustrations given by Lt.-Col. Clerk. It represents a 12-in. wrought-iron cylinder,  $\frac{1}{2}$  in. thick and 9 in. deep, after being heated to redness, and cooled by immersing its lower half in cold water—these operations having been repeated 20 times. The upper edge of the cylinder (in the air) did not alter; the lower edge (in the water) contracted .6 in. in the

\* Lt.-Col. H. Clerk, R. A., F. R. S. “Proceedings of the Royal Society.”



circumference, and at about 1 in. above the water-line the circumference was reduced 5.5 in.

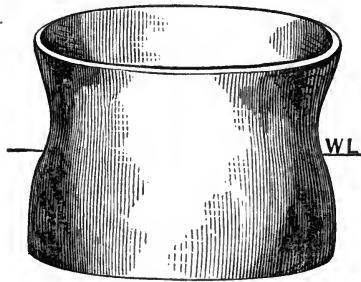
The general effects mentioned in the paper are "a maximum contraction of the metal about 1 in. above the water-line; and this is the same whether the metal be immersed one-half or two-thirds its depth, or whether it be 9, 6, or 3 in. deep. With wrought iron, the heatings and coolings could be repeated from 15 to 20 times before the metal showed any signs of separation; but with cast iron, after the fifth testing, the metal was cracked, and the hollow cylinder separated all round just below the water-line after the second heating. Cast steel stood 20 heatings, but was very much cracked all over its surface.

"As respects the change of form of cast iron and steel, the result was similar to that in wrought iron, but not nearly so large in amount. Tin showed no change of form, there being apparently no intermediate state between the melting point and absolute solidity. Brass, gun metal, and zinc showed the effect slightly; but instead of a contraction just above the water-line, there was an expansion or bulging.

"The specimens of wrought iron were submitted by Mr. Abel (chemist to the War Department) to chemical analysis, and he informs me that he found nothing noteworthy in the composition of the metal, nor was there any appreciable difference in the specific gravity of the metal taken from different parts of the specimen. It appears, therefore, to be simply a movement of the particles whilst the metal is in a soft or semifluid state."

**299.** WANT OF CONTINUITY OF SUBSTANCE. During the last two years the grand defect of many hoops—many parts—in a gun—has been developed in the fracturing and shaking loose of the Armstrong hoops, under the tremendous vibration due to firing

FIG. 143.



Wrought-iron cylinder, after twenty heatings and coolings.

large charges (335). This subject will be further referred to, in order, and some of the facts will be stated under the head of Wrought Iron.\*

It is but just to say that the result was predicted in the discussion on artillery (1860) already quoted. Mr. Longridge says: "Hoops must always possess the defect of want of continuity of substance. However perfect the workmanship at first, in large guns, the concussion of repeated firing would ere long shake them loose. Those who have had to do with heavy machinery subject to violent jars, such as in rolling mills and forge hammers, know well how impossible it is to keep iron and iron, however well fitted, working together for any length of time without shaking loose. The only remedy is, to separate the pieces of iron from each other by a packing of elastic material, so as to take off the jar. Now the concussions in such machinery are insignificant as compared with those in a large piece of ordnance, and therefore the use of hoops for large guns cannot prove satisfactory." Sir Charles Fox, in the same discussion, considers that this objection would "destroy all the advantages of so expensive a mode of construction," if the separate parts were not united by soldering or welding. Professor Treadwell anticipated and provided against it to some extent, by screwing the hoops together. The defect—"want of strength and solidity in the union of the different parts"—is also mentioned by Captain Benton.†

**300.** PERMANENT ENLARGEMENT OF HOOPS UNDER STRAIN. The experience with hooped guns having initial tension is too limited to warrant the conclusion that vibration would not loosen hoops of a very elastic metal not strained beyond the limit of its elasticity. Still, the loosening of the hoops by the permanent stretching of a metal like wrought iron, would appear to be the

\* The official report of the experiments, at Southport, with the Whitworth 80-pdr., says that the gun was made of homogeneous metal, and strengthened throughout its whole length by wrought-iron rings, and that "we observed, at the close of the practice, an oily substance oozing out at the junctions of the rings which strengthen the gun on the chase; and also at the face of the piece where the outer and inner cylinders meet."

† "Ordnance and Gunnery," 1862.

beginning of this kind of failure. The permanent enlargement of hoops under strain not only destroys the original accuracy of tension by reason of its inequality, but actually prevents their hugging the inner barrel after long use. Sir Charles Fox, among others, presented this view of the case in the discussion referred to before the Institution of Civil Engineers. Dr. Hart (286) also expresses the same opinion.\*

This defect may be remedied in the case of conical rings, which can be tested and set up if required, from time to time, without dismounting the gun, by a comparatively light hydrostatic press that can be transported from fort to fort, or aboard ship.

Practically, perfect elasticity would remedy the defect, and this is undoubtedly attainable by the use of steel rings. Hence the practice is changing from iron to steel. Mr. Whitworth and Captain Blakely use steel, and consider wrought iron unfit. Indeed, one manufacturer of guns compares iron hoops, in this particular, to leather. The excellent wrought iron used by Captain Parrott for hoops is nearly as elastic and strong as low steel, so that the embarrassment under consideration has not been experienced with his guns.

A high, elastic steel, however, is likely to burst without warning if at all; while soft wrought iron, especially in the form of concentric tubes, will indicate coming failure by stretching, and will, in fact, fail altogether without doing serious damage. In various instances, the outer rings of the Armstrong guns have broken without dangerously reducing the resistance of the gun to bursting (445). The first 10½-in. gun was fired several times after the bursting of an outer hoop, before the gun failed, and then it failed by the blowing out of the breech, after the strain of a 90-lb. charge.

**301.** A strong wrought-iron tube, placed loosely outside the steel hooping, would prevent, or at least modify, the disastrous character of an explosion—the killing and demoralization of men, and the disabling of adjacent machinery by flying fragments.

\* Letter to the author, Sept. 8, 1862.

Sir William Armstrong's assertion, before the *Select Committee on Ordnance* (1863), that none of the 3000 guns manufactured had "burst *explosively*," is important in this connection. The low elasticity of the wrought iron caused many failures; but its high ductility prevented many disasters. It may be practicable to realize the advantages of both these qualities by loosely hooping a steel gun with iron. The additional mass of the hoops would be of farther use in checking the vibration of the barrel.

**302.** The range of elasticity in the respective tubes, with reference to their distance from the centre of the gun, has an important bearing on the durability of the gun. Supposing the inner tube to have a low range, and the outer tube a high range of elasticity. The inner metal, which is required by the pressure of the powder to stretch most (280), can only stretch least; and the outer tube, required to stretch least, can elongate far beyond the demand without injury. The result is that the outer tube must be put and kept under an *initial* tension nearly up to its working load, in order that the "work done" by its minute elongation may be equal to that of the inner tube. This severe and permanent strain on the outer tube obviously tends to relax it. On the other hand, if the inner tube *can* stretch very much without injury, and the outer tube can only stretch a little, the initial and permanent stress upon all parts of the gun, in order that it may be uniformly strained under fire, will be very slight, and the tendency to relaxation very limited. (59.)

Cast iron, hooped with wrought iron, or with a low steel having a great range of elasticity, is therefore likely to lose its correct initial tension (91). Cast-steel inner tubes, hooped with wrought iron—the new Armstrong guns—have the same defect.

**303.** But if a wrought-iron or steel tube be placed within a cast-iron casing, and then strained beyond the limit of its elasticity, or, in other words, permanently stretched, this change of figure will strengthen rather than weaken the gun, as it will place the outer casing in a state of initial tension. This principle of construction will be further considered (320).

**304.** LONGITUDINAL STRENGTH. The longitudinal strain that

would be imposed upon a gun by statical pressure would occur between the trunnions and the chamber, since, as the internal pressure would tend to carry the shot forward and the chamber backward, the chamber would be prevented from going to the rear only by the tension of that part of the tube which connects it with the trunnions. If the trunnions were behind the chamber, or if the recoil was resisted at the cascable, the longitudinal strain would be due only: 1. To the tendency of the shot to carry forward, by friction, the part of the gun in contact with it. 2. To the inertia of the part of the gun in front of the shot. Under the sudden pressure of powder, this inertia of course imposes a considerable strain.

The theoretical resistance of a cylinder under internal pressure, to cross fracture, is four times as great as its resistance to splitting longitudinally, if the tenacity of the metal is the same in all directions, and if the resistance of the cylinder to bursting is not aided by the strength of the ends or heads of the cylinder.

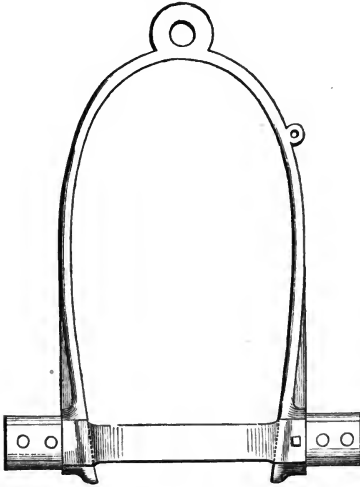
**305.** Longitudinal weakness may obviously be modified by placing the trunnions at the rear, at the expense of some complexity in the carriage or machinery for elevating the gun. But the same result is attained without this complexity—without disturbing the usual and convenient preponderance—by a strap connecting the breech with a separate trunnion-ring. A very strong and cheap breech-strap of this kind is applied by Admiral Dahlgren to all the U. S. Navy cast-iron rifled guns, except the Parrott guns. It is made of bronze, and cast in two pieces; one piece constituting the strap, half the trunnion-ring and the greater part of the trunnions; the other constituting the opposite half of the trunnion-ring and the remainder of the trunnions. The two parts are riveted together at the trunnions, as shown by Figs. 144 and 145.

This breech-strap was designed to remedy another and greater defect of cast-iron guns than longitudinal weakness—the unsoundness of the casting around the trunnions (390).

Mr. C. W. Siemens proposes the following construction, resembling Professor Treadwell's (288) in principle, to meet this defect.

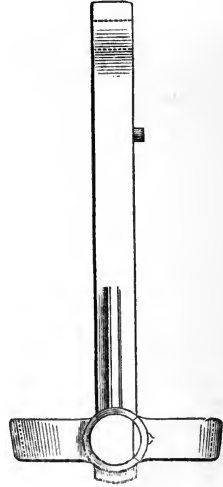
“The longitudinal strength of the gun might be much increased, if, instead of winding wire upon it, it was bound with corrugated bands of steel, put on spirally. He estimated that two-thirds of

FIG. 144.



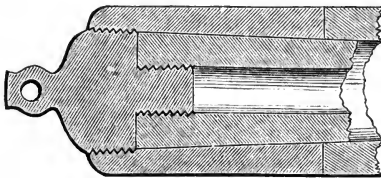
Dahlgren's breech-strap—plan.

FIG. 145.

Dahlgren's breech-strap  
—elevation.

the whole tensile strength of these bands would thus be made available for longitudinal strength. He proposed that the core of the gun should be turned with spiral grooves, extending backward beyond the bore, and

FIG. 146.



Breech-screw of Whitworth gun.

fitting the longitudinal ribs or corrugation of the strips. The strips should be put on under varying tension, while the gun rotated in a bath of solder, in order to unite the several layers.”\*

**306.** The longitudinal strength of Mr. Whitworth's hooped gun (Fig. 146) is made

\* “Construction of Artillery,” Inst. Civil Engineering, 1860.

ample—much greater than that possible in a wire-wound tube, or a tube hooped by plain cylinders, by screwing the breech-plug not only into the central tube, but into one or more of the hoops (44), which, being conical, must be burst, or at least stretched, before they can be drawn backward.

**307.** Captain Blakely says on this subject:\* “Care must be taken to have sufficient longitudinal strength. For this purpose some circumferential strength may well be sacrificed, by casting one part the length of the entire gun, and of adequate thickness. For various reasons it seems better that this single large piece should be the inside, cast iron being admirably suited for the bore of a gun, whereas wrought iron generally has some defect in the welding, which would certainly be penetrated by the gas of the powder. In some cases, for instance in breech-loading guns, it may, however, be preferable to have the longitudinal strength outside. The latter construction has the advantage of giving greater circumferential strength; for (strange though it may seem) an ordinary cast gun, whether of iron or brass, would be strengthened at the breech by removing one-quarter of the thickness from the inside, and replacing the metal with even lead or pewter. The reason of this apparently paradoxical increase of strength is, that each remaining portion could do more work without any part giving way in the proportion of  $3^2$  to  $2^2$  or 9 to 4, when the inner part (which must yield first) is larger than as at present in the ratio of 3 to 2. The gain of power by thus permitting the outside to exert more of its force is greater than the loss by removing the inner parts, which must have cracked before the outer could be moderately strained. A brass lining near the breech of a gun would evidently add much to its strength. This would also be a convenient way of strengthening mortars already cast.”

**308.** In his pamphlet on tubes with varying elasticity (324), Mr. Parsons says: “In guns on the compound system, made of cast iron, with the breech and reinforce turned down and

\* “A Cheap and Simple Method of Manufacturing Strong Cannon, 1858.”

wrought-iron or steel hoops shrunk or forced on it, one of two things must be the result, viz.: either the cast iron must be turned down to an extent which would render the gun too weak longitudinally, in order to allow it to be compressed sufficiently to obtain any additional transverse strength from the hoops, or, if enough of the cast iron is retained, to provide the requisite longitudinal strength, all the wrought-iron rings that can be put on outside will add but little to the transverse strength; for, unless the cast iron is compressed very considerably, the wrought-iron rings will not come into play before the interior is overstrained or ruptured: on the well-known law, that the amount of extension of any lamina of metal at the interior is to that of the exterior, inversely as the squares of their respective diameters, and when it is remembered that the reinforce, although turned down smaller to receive the rings, is supported by the solid part of the breech at one end, and part of the reinforce remaining its original size at the other end, it is easy to understand that the wrought-iron rings would make but little impression in compressing the cast iron, if left of sufficient size to provide the requisite longitudinal strength; however, the best proof of the fallacy of this system will be found in the number of burst guns, embodying this principle in an almost endless variety of form, lying for inspection in Woolwich Arsenal."

**309.** Mr. Lancaster, whose name is well known in connection with the Lancaster gun, states some important experiments with reference to the longitudinal weakness of cast-iron guns as hooped at Woolwich, and a plan for remedying the defect. It must be remarked, however, that some, at least, of the guns referred to, were turned down very small before the hoops were applied. Commander Scott says of them:\* "Instead, however, of hooping the existing ordnance on a plan which had proved successful, a new pattern weapon, which was thick in front of the trunnions and very thin at the breech, was applied. But as the hooping *a a* (Fig. 147) did not unite the cast iron to the wrought-iron bands, the weapons had

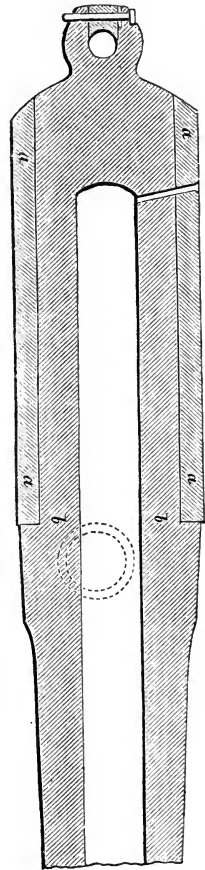
\* Journal Royal United Service Institution, April, 1862.



so little longitudinal strength, and were so weak at *b b*, where the thickness of cast iron was suddenly reduced to two or three inches, that the guns proved unsafe." Mr. Lancaster\* says: " \* \* From time to time many experiments have taken place at Woolwich, and I believe in the course of the experiments some £10000 of public money was expended to see if it was possible to produce a strengthened cast-iron gun. \* \* \* If you leave the end of the gun in its normal state, and merely depend on the tensile strength of so many inches of cast iron, of course it is no use strengthening it on the periphery of the gun, and that gun will burst as near as possible in the same time as if it were wholly of cast iron. That was the result of these experiments, and so much so, that, in the results at the proof-butts at Woolwich arsenal, guns burst after 51 rounds of destructive proof. \* \*

"A gun was prepared in which the rear end of the gun was turned down over an inch and a half on the posterior quarter, and a longitudinal truss was fitted over it, in this way enveloping the ends an inch and a half, and completely embracing the gun, the wrought-iron hoops being then shrunk on over the longitudinal truss. A very remarkable result was given by this experiment. The gun immediately went up in the scale of strength, under the same condition of 10 pounds of powder, the unit of projectile of a 32-pounder, and so on, increasing every 10 rounds 1 unit; it went up to 81 rounds instead of 51." Mr. Lancaster therefore proposes the wrought-iron casing (Fig. 148) sup-

FIG. 147.



Armstrong hooped cast-iron naval gun. Scale,  $\frac{6}{10}$  in. to 1 ft.

\* Journal Royal United Service Institution, June, 1862.

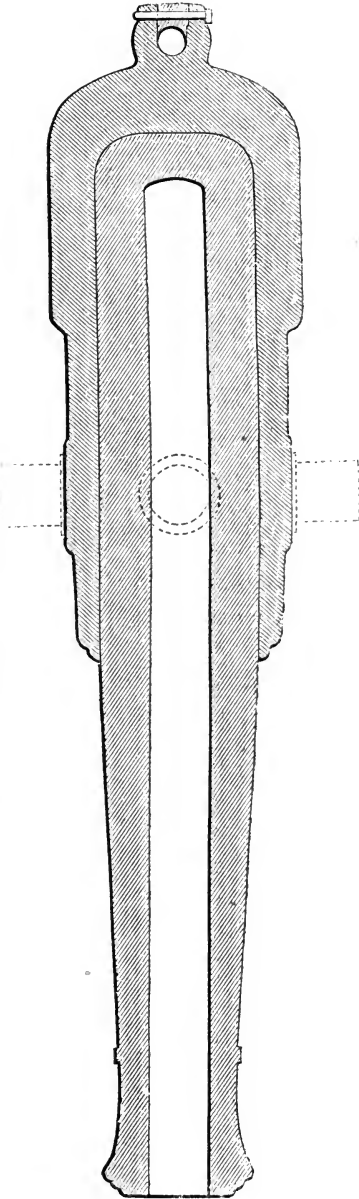


FIG. 148. Lancaster's strengthened 32-pounder.

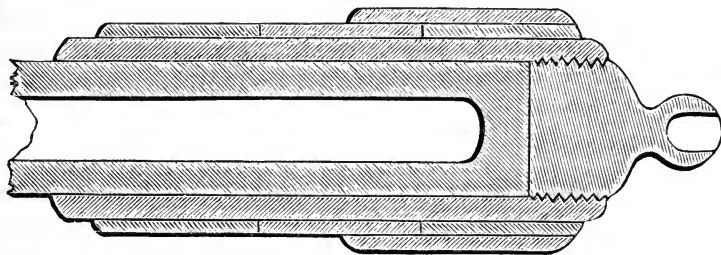
porting the whole rear of the gun. Another plan of hooping, patented by Mr. Lancaster, and designed to give great longitudinal strength, is shown by Fig. 149. Captain Blakely also uses a jacket, similar to Fig. 148, in some of his later guns.

**310.** If such a casing could be made strong at a feasible cost, and put on tight, it would obviously overcome the difficulty of longitudinal weakness, and provide the other advantage—resistance to bursting—of a long hoop. Steel is already cast solidly into these forms. Messrs. Naylor, Vickers & Co. cast tubes with closed ends, sound enough to be used for hydrostatic presses without hammering. The Bochum Company (Prussia) have cast bells of 20000 lbs. weight, from steel very like Krupp's, and made from the same materials, and by substantially the same process—hence the best materials for guns. These castings can be farther compressed by rolling, or, if cast solid, by forging. But it would be impracticable to

turn and bore the parts with accuracy enough to secure the proper

tension, if they were tapered and forced on by hydrostatic pressure; the contact of the end of the tube with the bottom of the

FIG. 149.



Lancaster's hooping, to give longitudinal strength.

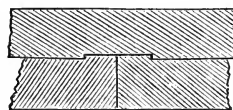
casing would prevent any adjustment of the tension. If the chamber was shrunk on, it would be likely to shrink unequally, on account of the difference of mass at the two ends. But it would be drawn very tightly over the end of the tube by shrinking longitudinally, if it was first cooled at the trunnion end so as to nip the tube at that point. This method has been practised at Woolwich, in shrinking together some of the recent experimental guns.

**311.** The Parrott gun is not weakened longitudinally, like the gun referred to by Mr. Lancaster, because the full diameter of the cast-iron breech is preserved. The increased diameter of the hoop requires certain modifications in the carriage; but this is not a serious objection. (See note in Appendix.)

The longitudinal strength of the Armstrong gun is secured:

1. By making the breech-piece a thick, solid forging with longitudinal grain (9). 2. By notching the trunnion-ring (Fig. 150) over the tubes within it. And 3, by flanging the outer ring over the rear of the breech-piece. (See Fig. 25.)

FIG. 150.

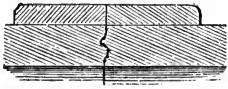


Armstrong trunnion-ring.

**312. LENGTH OF HOOPS.** Hoops of considerable length are desirable, to add to the frictional surface, thus giving longitudinal strength to the gun. But length, or continuity, is chiefly desi-

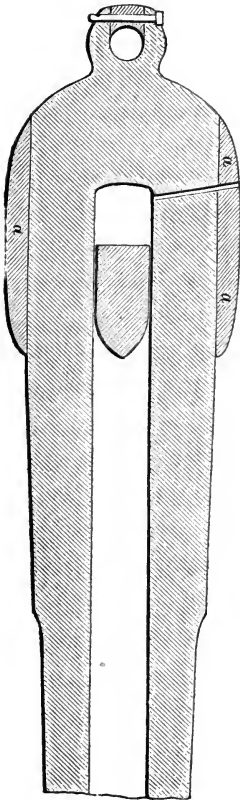
rable to transfer the strain upon one point to a large resisting area. Several guns, reinforced as shown in Fig. 151, were burst at Woolwich.

FIG. 151.



Gun burst under a seam in the hooping.

FIG. 152.



68-pounder, hooped as proposed by Commander Scott.

The fracture occurred in the direct line of the joint between the hoops. The long tube (Fig. 152), made from a coil, like the hoops of the Parrott and Armstrong guns, is for this reason proposed by Commander Scott, for reinforcing old guns, instead of the short hoops used upon the early Blakely ordnance, each one of which opposes to a strain at any given point only the strength of its own sectional area, without aid from the rest.\*

**313.** An obvious disadvantage of a large number of hoops is that the transverse strength of the gun (277) is reduced. The resistance of the staves of a gun to pressure is like that of beams, as the squares of their depths, and their stiffness is as the cubes of their depths.

**314. Wire-wound Tubes.** Mr. Longridge's plan of winding square steel wire upon a tube with the proper tension, has already been referred to (93). The method of fabrication was "to coil a quantity of wire on a drum, fixed with its axis parallel to that of a lathe on which the gun was placed. On the axis of this drum there was another drum, to which was applied a brake, similar in principle to Prony's dynamometric brake,

\* Hooped guns will be further referred to in connection with the strains imposed by unequal expansion, due to the heat of firing.

so adjusted as to give the exact tension required for each successive coil of the wire. The whole apparatus was extremely simple, and the wire was laid on with great regularity. Indeed, it is evident the apparatus might be so arranged, as that the process would proceed with the same ease and regularity as winding thread on to a bobbin, and at the same time with the greatest accuracy as regards the initial tension."

**315.** The first advantage of wire, then, is that it may be cheaply put on with the exact strain theoretically required. A second advantage is that there is less waste material due to want of continuity (292). Another advantage is the superior strength of the material. A piece of iron which will bear a tensile force of 20 tons per square inch in the bar, will bear 40 tons per square inch when made into small wire; and steel wire has borne 120 to 130 tons per square inch. Mr. Bramwell states that in No. 22 music-gauge steel wire the strength ran as high as 142 tons (318080 lbs.) per square inch.\*

**316.** Although advocating hoops, Captain Blakely recognizes the advantages of wire, and in the discussion referred to,\* "fully agreed that greater strength could be obtained by the use of wire than in any other manner. Indeed, if monster cannon were wanted—mortars to throw shells of several tons' weight, to a distance of several miles, for example—recourse must be had to wire. He believed that such guns could be made by that system; but he doubted if they could be manufactured in any other way."

**317.** The first great defect of wire is want of longitudinal strength. This must be supplied by the inner barrel or by some additional outer material; it cannot, as in the case of hoops, depend on the material that reinforces the barrel. When it is considered that the breech of the 10½ inch Armstrong gun (446) was blown out by a strain intended for ordinary practice, pulling apart in the direction of the fibre, a tube of wrought iron 28 in. in diameter with walls nearly 6 in. thick, the necessity of avoiding longitudinal weakness becomes evident. Mr. Longridge proposes

\* "Construction of Artillery," Inst. C. E., 1860.

to supply this strength by material outside of the gun proper. Indeed, he considers this plan better for all built-up guns.

**318.** The second defect of wire is the uncertainty of fastening it in such a manner as to prevent its uncoiling.\* This difficulty becomes serious if the gun is hit by an enemy's shot, and dislocated or broken at various places. To avoid it, an exposed gun must be heavily jacketed, which adds to its weight all that would be saved by the superior strength and more accurate tension of the wire. Mr. Longridge fastened the wire in his experimental guns by solder, and secured the ends by placing them in a hole drilled into the casting.

**319.** If the inability of the Armstrong gun to resist the destructive effects of vibration is due mainly to its great number of layers—to its want of homogeneity—irrespective of the low elasticity of the wrought iron of which it is made, then the wire-wound gun is certain to fail from this cause. But as far as a high degree of elasticity can remedy the defect, steel wire is obviously the best material. The practice is thus far too limited to warrant very positive conclusions on this subject. The experimental wire guns already described (96 ; 102) did not show any remarkable weakness in this direction ; but they were very small guns.

A method of placing the laminæ of a solid gun under the proper initial strains, realized to some extent by Captain Rodman in his hollow-cast guns, will be considered under the head of Cast Iron.

**320. III. Hoops with varying elasticity.** Let us now suppose the hoops or tubes forming a gun to be fitted together accurately, but without tension. If the inner hoop is very elastic, and the next less elastic, and so on throughout the series, the outer hoop being least elastic, and the degree of elasticity exactly proportioned to the degree of elongation by internal pressure, all the hoops will be equally strained by the powder, and none of their strength will be wasted. Supposing the inner hoop to be

\* This objection was specially mentioned by Mr. Gregory, V. P., and Mr. John Anderson, in the discussion referred to.

stretched by the pressure  $\frac{1}{16}$  inch, and the outer hoop  $\frac{1}{16}$  inch (280), the material of the inner hoop should have such elasticity that it would be no nearer its breaking point when stretched  $\frac{1}{16}$  inch, than the less elastic outer hoop when stretched  $\frac{1}{16}$  inch. Both hoops would then be equally strained by the powder, and oppose an equal resistance to it.

The distinction between regularly increasing elasticity, as described, and uniform elasticity, should be clearly made. Supposing both hoops to be capable of safely stretching  $\frac{1}{16}$  inch, the outer hoop is, in actual practice, stretched only  $\frac{1}{16}$  inch, and hence brings but  $\frac{1}{16}$  of its strength into action when the inner hoop is stretched to the limit of safety. If the elasticity regularly increases from the centre outward, the outer hoop is stretched still less when the inner hoop is at the point of bursting.

**321.** There are, at present, no proper materials having the respective ranges of elasticity necessary to perfectly carry out this principle. But if the inner tube of a gun were made of a very elastic steel, and the outer tube of cast iron, the relative strain and stretch would be approximately correct, and a small weight of steel within the cast iron would be much better employed than a greater weight outside of it. In the first case, the heat of the burning powder would, by expanding the steel, and so putting the cast iron into tension, compensate for any want of elasticity in the steel, thus realizing, to a certain extent, the advantages of hoops with initial tension. In the other case, the heat would stretch the steel reinforce beyond its proper tension (that having already been adjusted), and unequally strain the thick cast-iron barrel by expanding its inner layers.

**322.** In case of the steel lining, the trunnions could be cast with the reinforce, and the total thickness of the gun could be adjusted to the strain at all points, without re-entering angles, by preserving, approximately, the Dahlgren shape. In the other case, the trunnions (if the reinforce was long, as the English gun-makers prefer it) would have to be forged upon a separate ring, and secured at a considerable cost, and the exterior of the gun would be a series of sharp angles and short curves.

The steel lining could be applied to old guns without changing their appointments.\* Applying a steel reinforce to an old gun would increase its preponderance to an inconvenient or impracticable degree, or else require new trunnions, and it would necessitate alterations in the carriage.†

\* Such a lining in a gun is likely to prevent *explosive* bursting—the flying of pieces in case the cast-iron or steel shell fractures. Captain Palliser states that he has burst the outer cast-iron gun without bursting the inner wrought-iron tube (on account of its greater ductility), and that the cast-iron pieces did not fly.

It has been lately proposed, by Mr. J. K. Fisher, of New York, to secure the necessary difference in elastic range, by hardening the inner part of a solid steel gun in oil, or by otherwise tempering a solid gun, so that the ranges of elasticity in the different layers would be proportioned to their required elongation.

† The author deems it just to state that the above was written before the publication of Captain William Palliser's patent for this improvement, dated Nov. 11, 1862, and of Mr. M. P. Parsons's patent, dated June 5, 1862—a patent in which Mr. Parsons described a structure by which he now proposes to carry out the improvement, but in which he did not specify the principle of varying elasticity.

Upon further investigation, it appears: 1. That Captain Palliser *cast* guns over wrought-iron tubes as early as September, 1854. In a letter to the *Times*, written Oct. 1, 1863, he says: "Having, during the years 1853 and 1854, been engaged in experimenting with elongated shot designed for smooth-bored cannon, I soon found that it was dangerous to fire such heavy projectiles from cast-iron guns with full service charges; and thus it happened that my attention was directed, at such an early date, to strengthening those guns. I had, some time previously, witnessed the manufacture of wrought-iron twist barrels at the forge of Messrs. Truelock and Harris, gunmakers, of Dublin, and at the same time was informed of the great strength that was acquired by this mode of manufacture. I commenced my first experiments in September, 1854, by casting some small cast-iron guns over tubes of wrought iron similarly constructed. I found that guns made in this manner were enormously strong, and, in fact, that they could not be burst by any fair means. After I had concluded these experiments, I constructed a model gun, which I have still in my possession, and which was completed on the 10th of November, 1854, as the accompanying letter will show:

"15 GATE STREET, LINCOLN'S-INN-FIELDS, *Sept. 23.*

"*Sir*,—On referring to our books, we find that we finished turning a model cannon for you on the 10th of November, 1854; the cannon was of cast iron, cast over an internal tube of wrought iron.

"We are, *Sir*, yours faithfully,

"CLARK & CO., *Engineers.*

"CAPTAIN PALLISER."

"Now, this model was completed before any patent had been taken out for strengthening or constructing guns on any method in the least degree similar."

Still, *casting* a gun over a wrought-iron tube, although it involves the principle of varying elasticity, involves also such mechanical difficulties and objections, that it has not been practised, even by Captain Palliser.



**323.** In 1860, a cast-iron 68-pounder gun (Fig. 153) was bored out and *shrunk* over a wrought-iron tube, at Woolwich. The endurance—71 rounds with increasing charges—was very satisfactory, seeing that the cast iron was necessarily warped and strained by the heating. In 1862, a 32-pounder was similarly treated, and stood 74 rounds with increasing charges. The details of the experiment are given in Table XIII.

**324.** MR. PARSONS'S METHOD.—The principle of variable elasticity is thus stated by Mr. Parsons :\*—

“Wrought iron may be extended about  $\cdot 0015$  of its length

2. It farther appears that Captain Blakely proposed, not very fully, but quite distinctly, to strengthen guns by inner tubes of a more elastic material, in a pamphlet entitled “A Few Remarks on the Science of Gunnery,” published in 1857. After proposing to construct guns upon the theory of definite initial tension, as already explained, and specifying several ways of doing it, Captain Blakely says, “*or, a more elastic material may be put into a less elastic one, with no initial strain, or very little.*”

3. Captain Blakely also specifies the improvement very fully in an addition, dated April 4, 1860, to his French patent of June 28, 1855.

4. In January, 1863, Captain Palliser issued, for private circulation, a pamphlet with drawings, explaining, in considerable detail, the principle and the means of carrying it out. A 68-pounder cast-iron gun (332) has since been strengthened on his plan, at Woolwich, and tested with great success.

5. In the autumn of 1863, Mr. Parsons issued an illustrated pamphlet entitled “Guns *versus* Armor Plates,” explaining the principle and his plan (patented before Captain Palliser's) of adapting it to service.

The three publications last named will be farther referred to and quoted.

The foregoing facts are not intended as an exhaustive history of the invention. Great credit is due to Captain Palliser for obtaining an official trial, and for achieving so much success in strengthening old cast-iron ordnance.

The following singular arrangement of metals is described in Simpson's “Ordnance and Naval Gunnery,” 1862: “Mr. J. C. Babcock, of Chicago, suggests another way of arranging the metal for the spirals, wrapped around the cast-iron core, founded on the different expansive properties of metals. He recommends that the core be of cast iron; on this shrink a layer of wrought-iron rings; these, with the cylinder, should form about one-half of the thickness of the gun. Bands of steel should now be wound spirally, in alternate layers, to the required thickness, reversing the winding of each layer, so as to break joints.

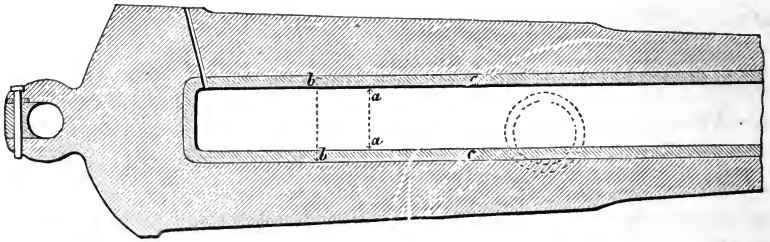
“The arrangement of the materials in the order of their expansive properties gives more work to the exterior of the gun, for cast iron is doubly more expansive than wrought iron, and wrought iron even doubly more expansive than steel. All parts of the wall of the gun would thus bear a strain at the same time, and there could be no bursting by successive layers, as has been shown, in an earlier portion of this work, is the case with a cast-iron gun where the expansive capacity of the wall is constant throughout the entire thickness.”

\* “Guns *versus* Armor Plates, etc.,” 1863.

without injury to its elasticity, and it requires a strain of about 14 tons per square inch, or about  $\frac{5}{8}$  of its ultimate breaking weight to effect this.

“Cast iron is permanently injured if stretched from about  $\cdot0004$

FIG. 153.



68-pounder shrunk over wrought-iron tube, at Woolwich, 1860.

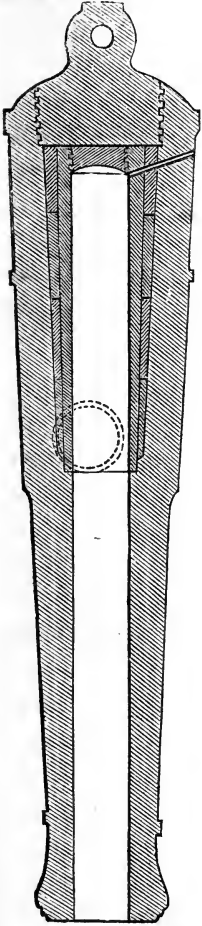
to  $\cdot0005$  of its length, which is effected by a strain of about  $\frac{1}{3}$  of its ultimate breaking weight, or from  $2\frac{1}{2}$  tons to 4 tons per square inch. Therefore, wrought iron may be stretched three times as much as cast iron, and will offer from three and a half to six times the resistance to the force applied, within the limits of elasticity.

“Now the strain on a gun is greatest on the metal at the reinforce immediately surrounding the bore, and gradually decreases towards the exterior where it is least, the strain on any particular circumference or layer being inversely as the square of its diameter. It is therefore evident that if the wrought iron is placed inside, and the cast iron out, they will each be arranged in the best position to sustain the strain without injury, and an investigation of the relative extensions of both under strain, will show, that in this position the two metals will, if properly proportioned as to size, work together, and each sustain its proper tensile strain, without being subjected to any initial tension, and consequently without the risk and uncertainty of the correct amount being applied.”

**325.** This method proposed by Mr. Parsons of strengthening a 68-pounder cast-iron gun, is illustrated by Fig. 154. He says:

“A conical recess of the form shown is bored out of the breech end of the gun, and a tube of wrought iron is turned and fitted

FIG. 154.



68-pounder, strengthened by Parsons's internal tube. Scale,  $\frac{7}{16}$  in. to 1 ft.

into the recess, and secured in its place by the breech-plug. In guns of this size, I recommend the lining tube to be made up of an inner tube, surrounded by hoops or tubes, shrunk, forced, or screwed on, and then turned to the proper size. The lining tube has a breech-plug of its own, which is for the purpose of preventing the explosive gases getting between the end of the lining tube and the breech-screw, and by acting on its larger area endangering its security. It is not requisite for the lining tube to be forced into the recess made in the reinforce of the gun, in order to produce an initial strain on it and the cast iron (as will be shown by the calculations of its strength), all that is necessary is to make it a fair and easy fit, but its length is so adjusted, that by screwing up the breech-screw it may be compressed longitudinally between it and the shoulder of the recess by which the entire longitudinal strength of the cast iron is imparted to it. \* \* \* Again, the strain is considerably greater at the breech end of the bore than on any other portion of its length, the pressure of the explosive gases being but about one-fourth when the projectile has reached a distance of about 4 times that occupied by the powder of the charge, so that it will be only necessary for the lining tube to extend about this distance.”

**326.** It would appear safer, however, in view of the known weakness of breech-loading guns, to allow the lining tube to extend the whole length of the gun. Unnecessary strength at the muzzle is better than want

of continuity and homogeneity at the seat of the maximum pressure. An objection to extending the tube to the muzzle of the gun is, that the cast iron would there, being bored out to a mere shell, possess little resistance to the enemy's shot. But in turrets and modern casemates, a gun is little exposed. Indeed, the greater part of the cast-iron chase might be removed entirely without weakening the gun, thus allowing the use of smaller embrasures. Captain Palliser, it will be observed (329), allowed the internal tube to project beyond the old cast-iron muzzle, thus securing the additional advantage of greater length of bore.

**327.** Mr. Parsons makes the following calculation of the strength of an ordinary cast-iron 68-pounder, and of the same gun strengthened as shown in Fig. 154 :

TABLE XLIX.—“CALCULATION OF THE STRENGTH OF AN ORDINARY SERVICE 68-POUNDER CAST-IRON GUN.

*Transverse Strength at Reinforce.*

Diameter of bore..... 8 inches.  
 Outside diameter..... 26 inches.

“Supposed to be divided into 9 rings or layers each 1 inch thick. The first ring being strained to the full amount of its elastic limit, taking a unit in length of 1 inch, we have :

	Inch.	Sides.	Sq. in.	Tons.	Tons.
1st Layer.....	1	× 2	= 2	× 4	= 8.00
	Inversely.				
2d Layer as.....	8 <sup>2</sup>	: 8	:: 10 <sup>2</sup>	:	5.12
3d do. ....	8 <sup>2</sup>	: 8	:: 12 <sup>2</sup>	:	3.56
4th do. ....	8 <sup>2</sup>	: 8	:: 14 <sup>2</sup>	:	2.61
5th do. ....	8 <sup>2</sup>	: 8	:: 16 <sup>2</sup>	:	2.00
6th do. ....	8 <sup>2</sup>	: 8	:: 18 <sup>2</sup>	:	1.58
7th do. ....	8 <sup>2</sup>	: 8	:: 20 <sup>2</sup>	:	1.28
8th do. ....	8 <sup>2</sup>	: 8	:: 22 <sup>2</sup>	:	1.06
9th do. ....	8 <sup>2</sup>	: 8	:: 24 <sup>2</sup>	:	.89

Transverse strength of a unit in length of 1 inch.....Tons.....26.10

Tons.  
 26.10

and  $\frac{26.10}{8} = 3.26$  Tons = Transverse strength per each square inch of the bore.  
 8 in. diameter of bore.

*Longitudinal Strength.*

Area of 26 inches (outside diameter) — area of 8 inches (diameter of bore)

$$\begin{aligned} & \text{Sq. in.} \quad \text{Sq. in.} \quad \text{Sq. in.} \quad \text{Tons.} \\ & = 530 - 50 = 480 \times 4 = 1920 \text{ Tons, and} \\ & \quad \quad \quad 1920 \\ & \quad \quad \quad \text{---} = 38.4 \text{ Tons} = \text{longitudinal strength per each square} \\ & \quad \quad \quad \text{sq. in. 50 area of bore} \end{aligned}$$

inch of the area of the bore.”

TABLE L.—“CALCULATION OF THE STRENGTH OF THE SAME 68-POUNDER CAST-IRON GUN, STRENGTHENED BY A WROUGHT-IRON LINING TUBE.

“In putting together the lining tube of the strengthened 68-pounder gun, the outer rings are shrunk on to the inner tube, and their sizes so adjusted, that, by contraction of the outer rings in cooling, there will be an initial tensile strain equal to about half the elastic limit of the metal, which will produce a nearly corresponding amount of compression on the inner ring, so that when the inner surface of the inner ring is strained to the full extent of its elasticity, the inner surface of the outer ring will be equally strained.

“Following, then, the same method of calculation, and dividing the gun into imaginary layers 1 inch thick, as before, we have:

*Lining Tube—Transverse Strength.*

## First ring

	Inch.	Sides.	Sq. in.	Tons.	Tons.
1st Layer.....	1	2	= 2	× 14	= 28.00
					Tons.
2d Layer as.....	8 <sup>2</sup>	:	28	:	10 <sup>2</sup> : 17.92

## Second ring

	Inch.	Sides.	Sq. in.	Tons.	Tons.
1st Layer.....	1	2	= 2	× 14	= 28.00
					Tons.
2d Layer as.....	12 <sup>2</sup>	:	28	:	14 <sup>2</sup> : 20.57

Transverse strength of a unit in length of 1 inch of lining tube—Tons..94.49

*“Cast-Iron Casing.*

“When the interior of the lining tube is strained to its elastic limit, which will extend it about  $\cdot0015$  of its length, the relative extension of any layer being inversely as the square of its diameter, it follows that the extension of the outer surface of the lining tube at the same time will be inversely, as  $8^2 : \cdot0015 :: 16^2 : \cdot00038$ , or nearly  $\cdot0004$ , and the lining tube being inserted into the breech a fair fit, without any material initial strain being put on either it, or the cast iron encasing it, the extension of the interior surface of the cast iron will be the same, or nearly the same, as the exterior of the lining tube.

“Now, with an extension of about  $\cdot00042$ , cast iron is strained to about the full limit of its elasticity; or, taking the same coefficient as before, to about 4 tons per square inch, and continuing the calculations of the cast-iron cylinder of the reinforce on the same system, we have:

*Transverse Strength.*

	Ins.	Sides.	Sq. in.	Tons.	Tons.
1st Layer.....	1	2	= 2	× 4	= 8.00
				Tons.	
2d Layer as.....	16 <sup>2</sup>	8	:	8	:
3d do. ....	16 <sup>2</sup>	8	:	20 <sup>2</sup>	:
4th do. ....	16 <sup>2</sup>	8	:	22 <sup>2</sup>	:
5th do. ....	16 <sup>2</sup>	8	:	24 <sup>2</sup>	:
				Tons.....	27.23
Add strength of lining tube.....					94.49
Transverse strength of a unit in length of 1 inch.....				Tons...	121.72

	Tons.	Tons.
and $\frac{121.72}{8} = 15.21 =$ Transverse strength per each square inch of the bore.		

*Longitudinal Strength.*

“The longitudinal strength, taking the section through the weakest part of the cast-iron shell, will be:

Ins.	Ins.	Sq. ins.	Sq. ins.	Sq. ins.
Area of 23	— area of 12	= 415	— 113	= 302

Sq. ins.	Tons.	Tons.	Tons.
and 302 × 4	= 1208	and	1208
	sq. ins.	50 area of bore	= 24.16 Tons

= longitudinal strength per each square inch in the area of the bore.

“This is not taking credit for any longitudinal strength derived from the lining tube; so that the strengthened gun shows a strength nearly five times as great as the same gun in its ordinary state.

“To effect this, about 13½ cwt. of wrought iron, made into a coiled tube and rings, and about 6 cwt. of cast iron will be required.”

**328. CAPTAIN PALLISER'S METHOD.**—In his patent dated November 11, 1862, Captain Palliser thus states the principle of varying elasticity: “My general principle for the construction of ordnance consists in forming the barrel of concentric tubes of different metals or of the same metal differently treated, so that, as nearly as possible, owing to their respective ranges of elasticity, when one tube is on the point of yielding all the tubes may be on the point of yielding. It thus differs essentially from the method hitherto prevalent of equalizing strains on concentric tubes by placing an initial or permanent strain on the exterior ones. Since the power of any substance to resist an impulsive strain is measured by the product of the resistance it offers while stretching into the distance through which it can stretch; and since the interior surface of a gun stretches most, it will follow that an extensible substance at the interior of a gun will offer the greatest resistance to the impulsive pressure of the discharge, while it will evoke the greatest amount of assistance from the exterior portions of the gun; I therefore make the interior of the barrel of a tube of the most ductile wrought iron coiled round a mandrel, so that the grain or fibres of the iron may run circumferentially or spirally.”

There appears to be some confusion of terms in this specification. A wrought-iron tube does not accomplish the purpose spe-

cified because it is very *ductile*, but because it has a high range of *elasticity*, *i. e.*, because it stretches to a comparatively great distance before its ductility is called into action—before it reaches the limit of its elasticity. Ductility involves the idea of *permanent* change of figure; in fact, the ductility of wrought iron is utilized in another way, by Captain Palliser; and his obvious meaning is explained by reference to his pamphlet.\*

**329.** Since, in practice, the elasticity of the wrought-iron inner tube is not proportioned to its greater elongation, it has been found necessary to supply the deficiency by putting it under slight compression, so that it can stretch to a greater distance. This compression is given in the Blakely guns constructed on this principle (60, 61) by shrinking the tubes together. Captain Palliser accomplishes it by permanently stretching the wrought-iron tube while it is within the cast-iron tube, by means of heavy proof-charges. He also proposes tapering the tubes and forcing them together by a screw, as shown in the engraving of his gun, Figs. 155 and 156.

**330.** When the elastic limit of wrought iron has been exceeded, and it has acquired a permanent elongation, it will “set” no farther by a repetition of the same strain. This was found to be the case by Mr. Edwin Clark, in case of the chains for raising heavy weights, and by Captain Palliser, who tested it at follows: “I constructed a tube-gun which was  $1\frac{1}{2}$  in. diameter of bore, and threw a  $1\frac{1}{2}$  lb. cylindro-conoidal shot. The tube was accurately fitted into the gun to within 1 inch from the bottom, and was screwed home with ease by means of the nut at the muzzle. I fired a series of charges increasing in severity from this gun, and after each discharge I took out the tube and examined it. After the last and most severe discharge, I found that there was some power required to unscrew the nut, owing to the tube having become slightly jammed. I then reinserted the tube and ground it back to its place as before, with fine emery and oil. On using the same charge in the gun as that which had previously enlarged the tube, I found that it produced no farther effect on the latter,

\* “A Treatise on Compound Ordnance,” 1863.



which can be taken out and reinserted with the same ease as at first."

**331.** Captain Palliser's pamphlet thus describes the principles and construction of his gun: "The manner in which I propose to satisfy the conditions already enunciated is by introducing into the cast-iron gun a barrel or hollow cylinder of coiled wrought iron, of such thickness in proportion to its calibre that the residual strain borne by this tube shall bear a relation to the strain it transmits to the surrounding cast iron which shall be most suitably proportioned to their respective elasticities. The precise proportions will depend on various circumstances; the excessive expansion of wrought iron due to heat, also the greater range between the limits of elasticity and rupture of this metal, and that the cast iron will have to do nearly all the longitudinal work. I shall presently show that by varying the thickness of the tube we can regulate the transmitted strains to the greatest nicety. \* \* \*

"The mechanical method by which I propose to insert the tube is by making it very slightly taper and placing it in the gun, whose bore is tapered

FIG. 155.

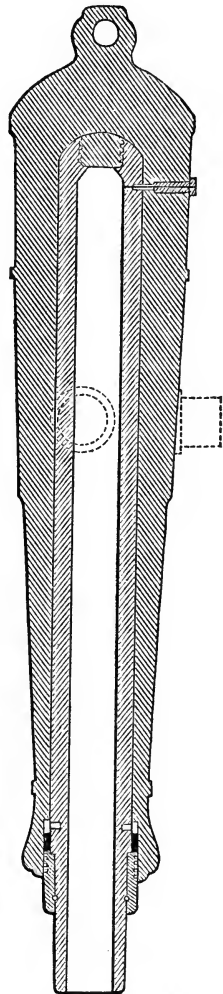
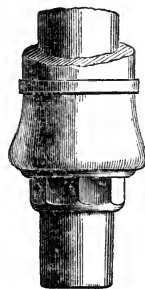


FIG. 156.

End view of  
Fig. 155.

68-pounder, strengthened by Palliser's internal tube. Scale,  $\frac{7}{16}$  in. to 1 ft.

correspondingly: as soon as the tube comes into contact with the gun throughout its length, a screw washer round the muzzle will screw it home into its place. Since the amount of taper as well as the distance the tube is driven by the washer, is known, and that the increment or decrement in cast or wrought iron due to any pressure is also known, we shall in this manner be able to measure most accurately the strain placed on the cast-iron outer gun.

“This tube may in the larger guns be divided into two or more concentric tubes, and these may be forced one over the other in such a manner that the work done by each tube may be equalized; and a third tube made of some suitable steel for a part of its length placed firmly over these. The distance of the inner surface of this tube from that of the gun will be fixed by its elasticity, or, in other words, the thickness of the interior tubes will depend on the elasticity of the steel tube.

“In the very largest guns I should wish the innermost tube to be constructed of the softest and most ductile wrought iron, such as Bradley (L) charcoal iron; the next might be of a stronger and harsher nature; and the third of steel for some distance from the chamber. These tubes may merely fit each other accurately, and the whole tube be fired with a charge equal to any that the gun when completed will have to withstand. The tube will, during this proof, abut against some substance to prevent the breech blowing off. The bore of the inner tube will be found to be very slightly enlarged. The tube will now be rebored up to the proper size, rifled, and placed in the gun. The tubes will be found to have become immovably fixed in each other, and thus a useful strain will be placed on each. This strain or set in the inner tube will never be increased by an equal charge, even were the tube not placed in the gun.”

**332.** The 68-pounder (8-inch) cast-iron gun first strengthened by Captain Palliser (Fig. 155) was bored out to 13 in., and received a wrought-iron tube (Armstrong coil) of 9 in. bore and 2 in. thickness.

It was tested in the usual way—10 rounds with cylinders of 68

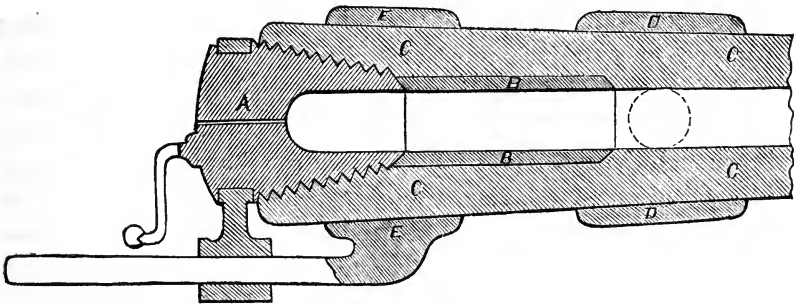
lbs. weight and the service-charge of 16 lbs., 10 rounds with cylinders of 136 lbs., &c. It resisted the 100 rounds with cylinders increased by the weight of 1 shot every 10 rounds, and afterwards burst at the 7th round with double charges and single cylinders.

Captain Palliser's second gun had an internal steel tube and a wrought-iron tube between the steel and the cast-iron shell. The wrought iron of course yielded beyond the capacity of the steel to stretch, and the gun burst at the first round.\*

Early in the year 1864, a 10 in. cast-iron shell-gun which had been rejected as worn out, was strengthened on this plan by the introduction of two wrought-iron coiled tubes—bore was  $6\frac{1}{2}$  in. It was tested with increasing charges, and burst at the 81st round with a 612 lb. cylinder and 16 lbs. of powder. Other guns on Captain Palliser's plan are in process of construction at Woolwich.

**333. CAPTAIN BLAKELY'S METHOD.**—In the addition, dated

FIG. 157.



Blakely's breech-loading gun, with internal strengthening tube.

April 4, 1860, to his French Patent of June 28, 1855, Captain Blakely thus explains the principle of varying elasticity:

“I sometimes form the internal tube or part of it of wrought

\* The object of this construction, if it was not to demonstrate the certain failure of deviating from the principle laid down by Captain Palliser, can hardly be accounted for. In addition to the improper arrangement of the materials with reference to their elasticity and ductility, the softness of the wrought iron rendered it perfectly unfit to transfer the pressure from the steel to the cast iron.

iron or steel (by preference in welded spiral coils) or of brass—or of brass or iron or steel covered with coils of wire—and I sometimes cast on the outer tube after warming the inner, and sometimes force it on cold, making the exterior of the inner tube slightly conical. Sometimes the inner, and sometimes the outer tube only extends a short distance from the breech. The outer tube, when it forms the principal part of the gun, I prefer to make of rolled iron or steel, with the fibres laid longitudinally.

“Breech-loading cannon I make with the screwed breech-plug hollow open to the front and closed behind. It thus adds to the circumferential strength of the gun. I prefer to make this plug taper towards the front for facility of putting it into its place.

“The annexed drawing (Fig. 157) shows a section of a gun thus built. A is the hollow breech-plug, B B an internal tube which, being compressed by the tube C C, which forms nearly the whole gun, adds much to its strength. The amount of the compression must depend on the kind of metal used and on the thickness of the inner tube. I have found by experiment that when the inner tube is one-third as thick as the diameter of the bore, its outer parts are only strained about one-third so much as its inner parts, and when two-thirds as thick as the bore, then the outer parts are only strained one-seventh as much as the inner. I therefore try how much the material of both tubes can be stretched without injury and adjust the size of each tube, so that before the inside of the inner one is fully strained the inside of the outer one shall be so. If, for example, the inner tube be 6 inches in bore and 2 inches thick, and made of coils of good steel which will stretch 1 in 300, then I know that when the inner diameter of the tube is stretched to  $6\frac{1}{3}$  inches, the outside will only be stretched to  $10\frac{1}{9}$  inches. If now the outer tube be made of the same steel but with the fibres laid longitudinally so that it can only stretch say one in 600, then I make its inner diameter 9.995, so that when it becomes  $10\frac{1}{9}$  it shall be fully strained. D D is a ring bearing the trunnions also adding strength to the gun as does the ring E E, to which is attached a support for the breech-plug when withdrawn from the gun. A hole through the plug will admit of the powder

being ignited by suitable means. I prefer a needle to strike detonating powder, as is now much practised for small arms."

**334.** The manner in which Captain Blakely at present utilizes the varying elasticity of metals, by combining it with the system of initial tension, has already been described (59, 60). Fig. 158 is a 9 in. gun; the inner tube is made of a highly elastic steel, the second tube of a less elastic steel, and the outer jacket of cast iron which is least elastic. The deficiency in elasticity of the inner tubes is compensated by shrinking all the tubes together with a slight initial tension.

## SECTION II. THE EFFECTS OF VIBRATION.

**335.** Both the means above considered, of increasing the resistance of a gun to mere *pressure*, are perfected only in proportion to the number of separate tubes or layers employed. But increasing the number of parts, lessens the resistance of a body to another effect of strain, especially of sudden strain.

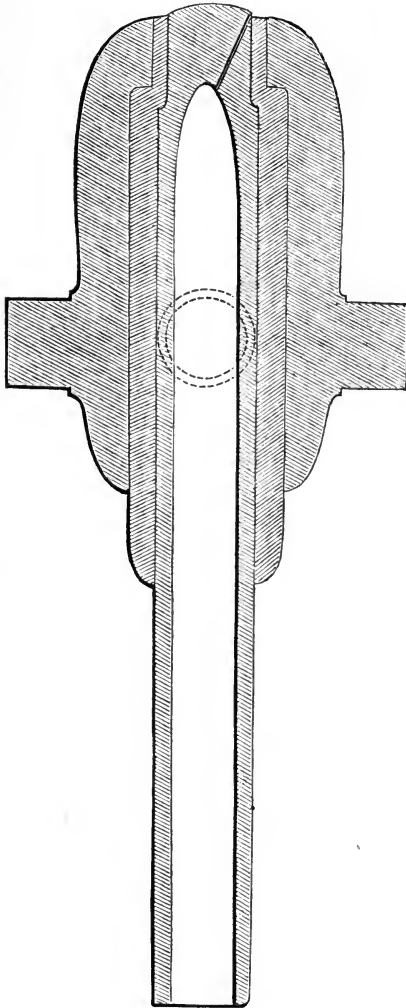
If a thick armor-plate, composed of layers placed in close contact but not fastened nor welded together, is struck by a shot, two kinds of motion will be imparted by the shot. The observed result will be (supposing for the moment that the figure of the parts is not permanently changed), that if the plate is 100 times heavier than the shot, and the shot has a velocity of 1000 feet per second, the plate will be moved bodily at the rate of 10 feet per second. But before this occurs, the whole force of the shot will have been communicated through the mass from one layer to the other, by a wave moving at about the velocity of sound. The layer struck will be for an instant reduced in thickness and extended in its other dimensions. When it recovers its original figure by its elasticity, it will in turn compress the next layer, and so on, until the last layer receives the shock. When this last layer is compressed (its inertia tends to hold it in place until it is compressed) it is then in the condition of a spring pressing equally in both directions, and resisted by a heavy mass on one side, but by only its own weight on the other; so that it jumps violently to the rear. But if the layers were welded together, this ten-

endency to separation would be overcome by the cohesion of the metal.

This phenomenon occurs when a gun is fired. The shock is propagated from layer to layer, in a wave. If the layers are already detached tubes, the outer one has no help from the rest in resisting vibration. Of course, the shock on the outer layer is not as great as the first shock upon the interior, because it has been distributed over more space, and diminished in overcoming the ductility of the interior. The obvious method of modifying the effect of the wave of strain upon the outer layer, is to give it *mass*, and hence great inertia.

But in case the outer tube is in high initial tension, this effect of vibration is probably much aggravated. The initial tension of the outer tube certainly increases the resistance of the whole series of tubes to a statical internal pressure, but its *individual* resistance to strain is lessened, and it opposes only its individual resistance to the wave of strain.

FIG. 158.



Blakely 9-inch high and low steel and cast-iron gun. Scale,  $\frac{7}{16}$  in. to 1 ft.

These facts would appear to account for the failure of many outer tubes of the Armstrong guns—of the 300-pounder, for instance—tubes which are understood to be put on with less tension, even, than that required by statical pressure alone.

In addition to this instantaneous wave of strain, other vibrations, like those of musical strings, undoubtedly take place in the pieces of a gun, and these vibrations are unequal, being proportioned to the size and tension of the parts. It is known in engineering, that fractures are likely to occur where parts under vibration suddenly increase in size; for instance, where the plates of a boiler overlap.

The character and circumstances of the failure of hooped guns are too indefinitely understood, at present, to warrant any very positive conclusions on the subject; but it is certainly reasonable to suppose that the building up principle may be carried too far—that there must be a certain amount of mass and continuity of structure to resist waves of force and vibration, as well as a certain division of parts to resist statical pressure.

### SECTION III. THE EFFECTS OF HEAT.

**336.** The heat of gunpowder when exploded within its original volume, is estimated to be about  $7000^{\circ}$  Fahr. Exactly, or even approximately, what the temperature in a gun is, and how long it acts on the walls of the gun, has not been ascertained, but in the case of rifled guns, especially when the inertia and friction of the projectile are great while the area pressed upon is small, there is obviously an excessive temperature, and an appreciable time for the reception of heat by the surrounding metal. The heat of the exploded gas may be felt outside a thin field-gun immediately after the first discharge.

Whatever heat there may be, expands the interior of the gun, and, if the walls are without strain, it puts the interior into compression, and the exterior into tension, thus strengthening the piece, up to a certain point. When a gun is cast or forged solid, and therefore left, by the quicker cooling of the exterior, in a state of *external* compression (364), the heating of the interior, by

the powder gas, strengthens the gun in a still greater degree. But when the strains of a hooped gun are once properly adjusted, this internal expansion by heat disarranges them, by increasing the compression of the interior parts and the tension of the exterior parts, thus weakening the gun to an extent which is worthy of consideration, when, as Mr. Longridge proves (293), an error of  $\frac{1}{5000}$  inch in the diameter of a 17-inch hoop decreases its strength 40 per cent.

At the same time, the interior of the gun is expanded longitudinally, which also tends to rupture it, if it is solid. But if the heated inner tube can slip endways without disturbing those outside of it (the inner tubes of Armstrong guns do slip in this way, from various causes), the longitudinal expansion may not be a source of direct strain, although the dislocation of the parts would injure the gun in other respects.\*

**337.** The guns in an iron-clad ship must be few in number, because turrets and casemates thick enough to resist shot must be of small dimensions. It is therefore obvious, especially in view of the limited offensive qualities of the *Monitors* before Charleston, that effective iron-clad warfare must depend on very rapid firing. This rapid increase of heat—the intense and maintained heat due to heavy charges and elongated projectiles—in guns with thick walls, would appear to be sufficiently dangerous to warrant at least a thorough experimental investigation of the subject.† In

\* Sir William Armstrong says, in his report of July 14, 1855, on wrought-iron rifled field guns, that his gun "was remarkably free from tendency to become heated by firing, a fact which can only be explained upon the supposition that the heating of a cannon is occasioned, not by the contact of the flame, but by some molecular action of the metal, produced by the explosion, and more effectually resisted by wrought iron than by cast iron or bronze; but possibly the compound structure of this gun may also operate to deaden vibration, and prevent the evil in question."

† It is, however, stated, that in the Crimea, some 68-pounders were fired rapidly, and endured 2000 rounds; that the cast-iron guns at the siege of San Sebastian stood 300 rounds a day, and that many of the large British siege-mortars have stood 2000 rounds with 20 lb. charges, fired very rapidly.

Captain Blakely says that a Spanish cast-iron hooped gun, that stood 1366 rounds, with a 61 lb. elongated shot and 7 lbs. of powder, was fired on the first day 100 rounds, at intervals of 1 minute to  $1\frac{1}{2}$  minutes, which made the gun so hot it could not be touched with the hand. On the following days, 50 rounds were fired in the morning, and 50 in the evening, with the same rapidity.—*Jour. Royal U. Service Inst., June, 1862.*



the absence of all direct experiment, it is impossible to assign the proper importance to this obvious cause of weakness in large ordnance, especially when placed under initial strains. Mr. Norman Wiard, of New York, has treated the subject with great ingenuity; his views and illustrations will be found in the appendix. Other authorities\* have referred to the effects of rapid firing upon the durability of cannon. Mr. Mallet says: "The expansion of the interior of the gun, acting tangentially, exercises against its rigidly resisting exterior a powerful splitting strain. The elongation of the interior of the chase, from the same cause, drags or forces the exterior to elongate along with it."†

**338.** Mr. Wiard proposes to remedy this cause of failure in two ways: 1st, by shaping the gun so that it can expand without excessive strain. This plan will be referred to under the head of cast iron (383). 2d, Mr. Wiard proposes to make the tubes of a gun of different metals, arranged with reference to their respective elongation by heat. An inner tube of steel, although in direct contact with the heated gases, would not expand much more than an outer, less exposed tube of bronze; so that the initial strain would be little disturbed.

The most obvious and simple remedy is, to cool the interior of the gun with water after each discharge. Automatic machinery to do this has been designed. (See Chapter on Breech-Loading.)

**339.** CONCLUSIONS.—It has been clearly demonstrated that merely thickening the walls of a gun, beyond a point nearly if not quite reached in practice, adds very little to its resistance to internal pressure. A homogeneous gun, in a state of initial repose, cannot, however thick, sustain a pressure per square inch greater than the tenacity of a square inch of the metal of which it is composed. The reason is, that the inner layers of metal are more stretched, and hence strained, than the outer

\* "On the Construction of Artillery," 1856.

† Mr. Longridge says: "This is, probably, the cause of guns being more liable to burst when they get hot. It is not that the iron is weaker, for Mr. Fairbairn has shown that up to 600° the strength of cast iron is not materially diminished; but when the gun is heated, the gunpowder gets warmed and burns more rapidly, and the force is generated and applied more suddenly."—"Construction of Artillery," *Inst. C. E.*, 1860.

layers, by an internal pressure, in the inverse proportion of the squares of their diameters. Therefore, the layers must be placed under such initial strain, or must possess such varying elasticity, that all parts of the gun will be equally worked at the instant of firing. Both these conditions are perfectly carried out, in proportion to the number of separate layers or tubes thus treated.

But the wave of force (in distinction from statical pressure), and the effects of unequal vibration, distress a gun in proportion to the number of its parts; so that the building-up principle cannot be carried far without depriving the gun of the necessary mass and continuity of substance.

It is probable that, with the present materials, and given weights, a gun composed of two tubes, although not as strong to resist statical pressure as one composed of five or six tubes, would resist a greater number of heavy charges of gunpowder, and prove a more trustworthy and valuable weapon. At the same time, it would be very much stronger than a single homogeneous tube.

The system of hoops with initial tension, although theoretically perfect, and an acknowledged improvement in the construction of ordnance, involves certain practical difficulties. It is difficult to obtain, and, with the present materials, difficult to preserve, the proper accuracy of tension. When several thicknesses of hoops are employed, the maintenance of the proper longitudinal strength is an embarrassing problem—witness the history of the Armstrong gun. The hooping of old cast-iron guns requires either a change in the position of the trunnions, or an inconvenient preponderance,\* and a change in the structure of the gun-carriage.

Lining a cast-iron gun with a tube, elastic in proportion to the elongation it receives, strengthens the gun vastly more than it could be strengthened by a hoop of the same cost and weight, and requires no change in the trunnions and carriage. And, unlike

\* Turning down the reinforce of a cast-iron gun, and making up the original diameter with wrought iron, instead of hooping outside the original thickness of cast iron, for the purpose of maintaining the proper preponderance, or even for the purpose of avoiding changes in the gun-carriage (which would appear to be the only excuse for the construction adopted by Sir William Armstrong—see Fig. 49), is obviously the most expensive proceeding possible, for it simply ruins the gun.

the hoop, the lining tube is not under a constant deteriorating tension. Such a lining is also likely to prevent explosive bursting.

But, with the present materials, it would be almost impossible to insure uniformly a degree of elasticity in the different layers exactly proportional to their respective elongation under fire.

Therefore, the hooping system, so modified as to avoid some of its defects, may be brought to the aid of the system of varying elasticity. If the internal tube of a gun cannot stretch to the extent required without injury, placing the external tube in slight tension will remedy the defect. Then the inner tube will have a greater safe range of elongation, and the outer tube will take a greater share of the strain.

The system of varying elasticity is most conveniently and cheaply carried out (even in connection with the system of initial tension) by placing the finer and more costly metals within, and the coarser and cheaper metals without. A heavy mass of cast iron, where weight and large size are not a serious embarrassment, is, perhaps, the best outer jacket. A mass of steel, cast hollow and not hammered, is stronger than cast iron, and but about half as expensive as a hollow-forged jacket.\* In either case, this exterior *mass* not only performs the work demanded of the outer jacket, but overcomes the other grand defect of hooped guns. Its great weight and inertia absorb the wave of force (335), which would fracture the thin ring under initial tension.

On the whole, a steel tube, so tempered (probably by hardening in oil) as to have the greatest possible elongation within its elastic limits, and forced into (or otherwise compressed within) a heavy cast-iron jacket of good shape, like the United States 15-in. hollow-cast Navy gun, with trunnions and cascable cast on for cheapness—the slight initial compression of the steel being sufficient to compensate for its want of safe elongation (59)—would appear to be the best system of fabricating strong, cheap, and trustworthy cannon of large calibre.

\* The cost of hollow-cast jackets for 11-inch guns is \$350 per ton; that of jackets hammered over mandrels, \$600.

## CHAPTER IV.

## CANNON METALS AND PROCESSES OF FABRICATION.

## SECTION I. ELASTICITY AND DUCTILITY

**340. Elasticity.** It has long been known that the ultimate tenacity of metals is only an approximate indication of their safe working load. All metals used for cannon have an appreciable elasticity, but the range of this elasticity—the extent to which they may be elongated by pressure before permanently changing their figure—is very diverse for different metals, and very indefinitely determined for all.

The use of elasticity is, that it allows space for the power to act in, without permanently stretching and thus injuring the metal. Upon the application of any force, metal having no elasticity would either permanently stretch, or else it would instantly break.

**341. ELASTIC LIMIT OF METALS.**—There is no doubt that iron, in all forms, has some positive elasticity—that it will resume its figure, when strained to a certain extent, so nearly, that for all practical purposes its elasticity may be called perfect. Mr. Colburn says on this subject, in his valuable paper before the Society of Engineers:\* “It is commonly held that within certain limits of strain, iron is perfectly elastic. No matter how often it may be stretched or deflected up to a certain point, the general belief is that it will come back to its original form every time the load is taken off. There are high authorities, however, who maintain that iron takes a permanent set under even very moderate strains. If we are to understand that the set is exceedingly small, this may be true. \* \* \* Mr. Edwin Clark has experimented on a wrought-iron bar 10 ft. long and 1 in. square. Under a strain of 3 tons per square inch, he gives the permanent set as nearly the  $\frac{1}{4000}$  part of

\* “On the relation between the safe load and the ultimate tensile strength of iron,”  
March 2, 1863.

an inch in 10 feet. With 8 tons, the permanent set is given as about the  $\frac{1}{1280}$  of an inch in 10 feet, and it was not until a strain of 13 tons per square inch had been applied that a set of  $\frac{1}{32}$  inch in 10 feet became apparent. With such exceedingly minute measurements, we may perhaps doubt if there was really any permanent set at all, with strains under 9 or 10 tons per square inch. An increase of temperature in the bar, of perhaps a single degree, while the measurements were being made, would more than account for some of the reported sets, even under considerable strains. Thus, Mr. Edwin Clark gives the permanent set of his bar, after a strain of 8 tons per square inch, as the  $\frac{1}{153840}$  part of its length; and this is almost exactly what the extension of the bar would have been had its temperature been raised but a single degree between the observations. Iron is heated in the very act of straining it, and a sudden breaking strain will generally leave the broken ends too hot to be handled. Such a slight apparent extension might also have occurred while the shackles by which the bar was strained were coming to their bearings. But even if such a microscopic permanent set really existed, it is one of which no engineer would take the slightest notice, as affecting the strength of the bar in which it was observed."

**342.** So few experiments have been made to determine the elastic limit of different metals, that no general rule has been adopted. Mr. Colburn says: "When we come to the question of safe working strength, much difference of opinion exists among engineers, the permanent supporting power of iron being variously estimated at from  $\frac{1}{10}$  down to  $\frac{1}{16}$  of its breaking strength. \* \* \* What information we have goes to show that there is no settled relation between the elastic limit and the breaking weight of iron; the former is more variable than the latter, and can hardly be expressed as an average result, as it ranges from less than  $\frac{1}{4}$  to more than  $\frac{2}{3}$  of the breaking weight: or, if the elastic limit be taken irrespective of the breaking weight, the instances cited show that the power varies from  $3\frac{1}{4}$  up to  $24\frac{1}{2}$  tons per square inch in different qualities of iron, although the range in ordinary bar iron and plate iron is not nearly as great."

Tables (51, 52, and 53) are given by Mr. Mallet in his "Construction of Artillery."\*

TABLE LI.—RELATION OF ELASTIC LIMIT AND OF EXTENSION TO ULTIMATE COHESION, ACCORDING TO CONTINENTAL EXPERIMENTS, IN ENGLISH MEASURES.

Nature of Metal, and Authority.	Elongation at limit of Elasticity. Length of bar 1·0.	Corresponding Strain in pounds per sq. inch.	Ratio to the ultimate Cohesion.	Value of Co-efficient of Elasticity in lbs. per sq. in.
Wrought-iron Bars, highest.....	·00167	30000	0·63	34133400
Ditto (Duleau), mean.....	·00062	17634	0·36	28444500
Ditto (Lagerhjilm), mean.....	·00072	21349	0·40	29440100
Strong Bars (Navier).....	·00093	25600	0·45	25591165
Iron Wire (1·2 mil diam.) hard.....	·00084	21300	0·33	26026718
Ditto (Ardant), soft.....	·00088	21300	0·50	24177825
Cast Steel, English, blue temper, mean (Morin)	·00222	93866	0·67	42666750

TABLE LII.—RESISTING POWERS OF KRUPP'S CAST STEEL AS COMPARED WITH OTHER METALS FOR CONSTRUCTING ORDNANCE. FROM A REPORT BY THE PRUSSIAN MINISTRY OF WAR.

Metal.	Ultimate Resistance to Tension per square inch.	Ultimate Resistance to Torsion.	Angle of Torsion before Rupture	Value of Tr deduced.†
Krupp's Cast Steel, No. 1 (Einkron).....	117213	36300	207°	3757050
Do. Do. 2.....	110393	40140	128°	3652740
Do. Do. 3.....	107516	34620	221°	3825510
Wrought Iron.....	73138	25020	322°	4028220
Cast Iron.....	19341	17510	12°	105060
Gun Metal, 10 per cent. Tin.....	43536	20430	400°	4086000
Do. 9 Do. ....	41454	20810	386°	4016330
Do. 11 Do. ....	36615	20320	315°	3200400
Do. 12 Do. ....	32334	18300	130°	1189500

\* The elongation of wrought iron and steel at the point of rupture, and the corresponding pressure, will be further considered.

† Tr=foot-pounds to produce *rupture* by tension, after the limit of elasticity has been exceeded.

TABLE LIII.—RESISTANT VIS VIVA OF ELASTICITY AND OF RUPTURE BY TENSION OF THE METALS APPLICABLE TO THE CONSTRUCTION OF ORDNANCE.

Metal.	$\epsilon$ Extension per unit of length up to elastic limit.	T = P Strain per unit of section at elastic limit.	P Strain in tons.	*Te = $\frac{1}{2}$ Pi Value for unit of length and section.	Tr Value for unit of length and section.	$e$ Coefficient of elasticity for unit of section.
Cast steel (English), blue temper..	.00022†	47040	21.0	5.125	39650	42666750
Cast steel (German), soft.....	.00096	35392	15.8	16.988	103500	28866725
Wrought-iron bar, maximum ductility.....	.00090	17024	7.6	7.660	96000	25000000
Wrought-iron bar, strong and rigid.....	.00054	25760	11.5	6.955	38325	28444500
Cast iron, mean.....	.00085	14112	6.3	5.997	12287	17066700
Gun metal, cast, mean.....	.00104	10304	4.6	5.308	93252	9955575
Brass wire, drawn and softened..	.00135	21280	9.5	16.490	31680	9173190
Brass, cast, mean.....	.00076	6944	3.1	2.639	20900	8930000

As to the elastic limit of cast and wrought iron, Mr. Colburn states that two cast-iron beams, experimented upon by Mr. Hodgkinson, took each a permanent set with weights respectively equal to  $\frac{1}{57}$  and  $\frac{1}{86}$  of the breaking weight; and that "in a discussion at the Institution of Civil Engineers, a Mr. Dines mentioned that he had tested upwards of 8000 cast-iron girders for the late Thomas Cubitt, and that he found it hardly possible to apply a weight so small as not to produce some permanent set, one-twentieth of the breaking weight producing a perceptible set. \* \* \* In seven experiments by Professor Barlow, on wrought-iron bars 10 feet long, 2 of them retained their full elasticity under a strain of 11 tons per square inch; 3 bars bore 10 tons without injury, while one bore  $9\frac{1}{2}$  tons, and another, made from old furnace bars, did not retain its elasticity beyond a strain of  $8\frac{1}{4}$  tons per square inch. \* \* \* \* \*

\* Te = foot-pounds in reaching elastic limit of tension.

† In Table 51 Mr. Mallet puts this .00222, which is right according to other experimenters.

Mr. Edwin Clark, from the results of his experiments, considers that the limit of elasticity of wrought iron is 12 tons per square inch."

**343.** The following results (Table 54) of Mr. Mallet's experiments were stated by him to the Institution of Civil Engineers, in his paper of March 1, 1859, "On the Coefficients of Elasticity and Rupture in Massive Forgings:"

Mr. Anderson, Superintendent of the Armstrong Gun Factory at Woolwich, states\* that "from several hundred experiments that have been made with wrought iron cut from bars intended for the manufacture of Armstrong guns, the following result has been obtained: The point of yielding permanently gives an average resistance of 28000 lbs. per square inch, while the point of ultimate rupture gives an average of 57120 lbs., or rather more than double that of the point when permanent elongation commences." In heavy forgings, "the average point of yielding permanently was 23760 lbs.—average point of ultimate fracture being 48160 lbs. The forgings from which the specimens were cut were all of high quality."

**344. Ductility** (GAIN OF STRENGTH BY STRETCHING).—Beyond the limit of elasticity, some metals, especially soft wrought iron, may be considerably and permanently stretched without rupture. After stretching, they appear to assume a new arrangement of particles and a new limit of elasticity until close to the point of rupture, when they lose all elasticity and ductility, but gain ultimate cohesion,—that is to say, a bar that is a square inch in section after stretching, will stand a greater pull than an inch-square bar that has not been stretched. Wrought iron increases in tenacity when drawn into wire, or cold rolled or cold stretched, and especially when stretched after a little heating. Mr. Anderson states,\* as a result of many experiments on iron for Armstrong guns, that "after the first yielding, by the addition of extra weight, the wrought-iron specimen gradually stretches until it has been considerably reduced in diameter; and such parts as have been so reduced have a greater tenacity per square inch than

\* Journal of the Royal United Service Institution, Aug., 1862.



when in the previous normal condition. The iron has to a small extent assumed the character of wire, which, from the drawing process, is always stronger than the iron out of which the wire is made."

Mr. Colburn states that increasing the strength of iron by drawing it is probable, from the known results of drawing wire, and that "when heated moderately, or to less than a dull red, and then stretched, iron is strengthened throughout. This treatment is known as thermo-tension, and in an extensive course of experiments made about twenty years ago, by Professor Walter R. Johnson, for the United States Government, a total gain of nearly 30 per cent. in strength and length, taken together, was estimated to have been obtained with a variety of irons. \* \* \* Captain Blakely has lately proposed the same treatment of iron, and his experiments, it is understood, corroborate those of Professor Johnson."

Captain Palliser mentions the following experiment:\* "I constructed a tube-gun which was  $1\frac{1}{2}$  in. diameter of bore, and threw a  $1\frac{1}{2}$  lb. cylindro-conoidal shot. This tube is  $\frac{1}{2}$  in. thick and rifled. \* \* \* The tube was accurately fitted into the gun to within one inch from the bottom, and was screwed home with ease by means of the nut at the muzzle (332). I fired a series of charges, increasing in severity, from this gun, and after each discharge I took the tube out and examined it. After the last and most severe discharge, I found that there was some power required to unscrew the nut, owing to the tube having become slightly jammed. Thus this shot sufficed slightly to disturb the equilibrium of the tube. I then reinserted the tube and ground it back into its place as before, with fine emery and oil. On using the same charge in the gun as that which had previously enlarged the tube, I found that it produced no further effect on the latter, which can be taken out and reinserted with the same ease as at first."

**345.** But the addition of strength by stretching is not all gain, because, although the tenacity of a given area is increased,

\* "Treatise on Compound Ordnance," 1863.

TABLE LIV.—PROPERTIES OF LIGHT AND HEAVY WROUGHT-IRON FORGINGS.

*Mallet, Inst. Civil Engineers, March, 1859.*Unit of Section, 1 square inch  $\times$  1 foot in length.

No.	CHARACTER OF IRON.	Form of Fracture.
1	Fagoted forged slabs, drawn out under steam hammer to $11 \times 2\frac{1}{2}$ in.....	Fibrous.....
2	The same, drawn out under hammer.....	Fibrous.....
3	Rolled slabs of the same iron as No. 1, and same dimensions.....	Fibre and crystal.....
4	Rolled bar same as No. 3.....	Fibre and some crystal.....
5	Hammered slabs from best selected Scotch and North Wales pig. Rough bars hammered with slabs, and these piled and hammered to $5\frac{1}{2}$ ft. square $\times$ 12 in. thick. Bars cut parallel to broad surfaces.....	Crystal; traces of fibre.....
6	Crude pig same kind as No. 5, puddled, rolled into No. 1 bar iron, which was cut up, piled, and rolled into No. 2 bars to be piled for central forging of Horfball 13-inch gun.....	Fine crystal and traces of fibre
7	Bar cut longitudinally out of exterior of mass forged from pile of such bars as No. 6.....	Coarse crystal and trace of fibre
8	Similar bar from similar forging to No. 7.....	Coarse crystal.....
9	From a hoop (3 ft. diameter), cut out of circumference of similar forging to No. 7.....	Coarse crystal and some fibre..
10	From a hoop, cut from the mass that No. 7 longitudinal bar was obtained from.....	Coarse crystal.....
11	Bar cut parallel to diameter from muzzle end of gun-forging made from bars No. 6.....	Fine crystal.....
12	Bar fagoted in charcoal fire from the heavy "curled borings" from interior of gun forged from bars No. 6.....	Fine fibrous.....
25	Puddled steel.....	Fine steely fracture.....

TABLE LIV.—CONTINUED.

Specific gravity.	Tension at elastic limit.	Total extension at elastic limit.	Final value of Te.	Tension at rupture.	Total extension at rupture.	Value of Tr.	Ratio of final distortion at rupture.	Ratio of tension to extension at elastic limit.
	Tons.	Inches.		Tons.	Inches.			
7518	15.312	0.0143	20.579	24.062	2.2166	4978.1	100 : 140	100 : 1071
7546	14.219	0.0240	31.850	22.969	1.6333	3501.4	100 : 129	100 : 592
7457	10.937	0.0333	33.993	22.969	1.8290	3920.9	100 : 133	100 : 328
7537	10.937	0.0200	20.416	22.969	2.1667	4644.6	100 : 140	100 : 547
7610	8.750	0.0156	22.740	18.594	0.0924	160.4	100 : 101	100 : 561
7649	12.031	0.0292	32.789	21.875	0.6600	1347.5	100 : 111	100 : 412
7772	9.844	0.0240	22.050	19.688	1.0400	1911.0	100 : 118	100 : 410
7640	10.937	0.0110	11.229	17.900	0.5200	869.4	100 : 129	100 : 994
7632	6.562	0.0100	6.125	16.406	0.0772	118.2	100 : 101	100 : 656
7614	5.470	0.0152	7.758	16.716	0.1040	162.4	100 : 101	100 : 360
7673	3.281	0.0040	1.225	6.562	0.0424	31.9	100 : 101	100 : 820
7634	5.470	0.0800	40.833	22.321	0.9280	1928.2	100 : 116	100 : 68
7795	14.219	0.0288	38.220	42.3	0.6700	2693.1	100 : 112	100 : 494

the total area is diminished. And this property of ductile metals is not depended upon in the construction of engineering works. On the contrary, a load that will permanently change the figure of an iron or steel structure, is deemed unsafe. The importance of determining\* the elastic limit of metals, so that it may not be exceeded in practice, is just now discussed in Great Britain with unusual earnestness.

Mr. Colburn remarks, after mentioning instances of increased tenacity by stretching:—"But from what has been said, it is not to be supposed that iron is not injured by excessive strains, notwithstanding that the metal strained may, when tried immediately afterwards, still retain its full breaking strength. The injury will appear when a subsequent working strain is long continued; and even without waiting for this, it will be found that strained iron has been deprived of a large part, if not the whole, of its natural elasticity." The same writer mentions the following experiments: The late Mr. Vicat, from 1830 to 1833, investigated the strains on unannealed iron wire. "One wire was strained to  $\frac{1}{4}$  its breaking weight, but beyond the elongation which at once took place no additional stretching occurred in 33 months. A second wire was strained to  $\frac{1}{3}$  of its breaking weight, and in 33 months it stretched at the rate of  $2\frac{2}{3}$  parts in every 1000 parts of its length, this stretching being additional to that which took place as soon as the weight was applied, but which of itself was not sufficient to immediately produce any permanent set. Under a strain of  $\frac{1}{2}$  of the breaking weight, another wire stretched rather more than 4 parts in every 1000 parts of its length. Under a strain of  $\frac{3}{4}$  of the breaking weight, a fourth wire stretched, in 33 months, 6 parts in every 1000 parts of its length, and then broke, which circumstance terminated the experiment."

**346.** If, then, the limit of elasticity is not exceeded in other structures, why should it be in guns? Are the circumstances under which wrought iron does appear to gain strength by stretching, the same as those of cannon strained by gunpowder? In one particular they are certainly similar. Wire drawing and cold rolling involve the application of lateral pressure in addition to

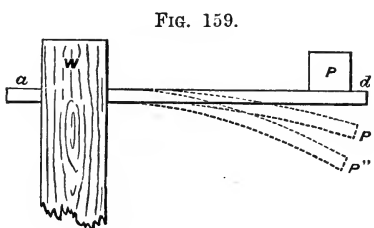
mere stretching. Gunpowder upsets or draws the iron as under a hammer. The testimony of Sir William Armstrong and Mr. John Anderson before the Defence Commissioners is very clear on this point (402). But does the suddenness of the strain brought upon a gun render its change of figure safe, when that of a uniformly loaded beam or chain would be dangerous? Experiments show that a sudden jar will cause the fracture of bars that had long remained whole under strains greatly exceeding their elastic limit, and approaching very near to their ultimate tenacity. In Mr. Farbairn's experiments of 1837 to 1842, columns loaded with  $\frac{1}{2}\%$  of their breaking weight could only be made to support it for a long period of time by preventing all vibration in and about them. In the experiments of Mr. Roebling, engineer of the Niagara Suspension Bridge, bars drawn down to  $\frac{3}{4}$  inch square at the centre, and having an ultimate tenacity of 33 tons per square inch, bore a strain of  $20\frac{1}{2}$  tons per square inch without visibly stretching, for a week, when no jar was given to them. Upon any vibration, they immediately took a permanent set. The above specimens, however, were *permanently* loaded and then jarred.

### 347. EFFECT OF DIFFERENT RATES OF APPLICATION OF FORCE.

—This is illustrated by Fig. 159.

Let the elastic body  $a b$  be firmly secured in the wall  $W$ , and the weight  $P$  slowly placed upon the end  $b$ , which will thus be depressed to  $P'$ , the point where the resistance will equal the weight. But if the weight

being placed in contact with  $b$  but not resting upon it, is suddenly let go, the weight will exceed the resistance until  $P''$  is reached, after which the momentum acquired by the total weight ( $P$  and  $b$ ) will depress  $b$  to  $P''$ , but with a constantly diminishing velocity, because the resistance will then exceed the weight. If the elasticity is perfect, and there is no atmospheric resistance,  $P''$  will be twice as low as  $P$ . From  $P''$ , the elastic force being in excess, the weight will again rise to  $b$ , and continue to vibrate, but, owing



to atmospheric resistance and imperfect elasticity, it will finally be brought to rest at  $P'$ , the point of statical equilibrium. So that, the more slowly a force is applied, the less the resisting body will be strained by being moved beyond the position of statical equilibrium.

Referring to this illustration, Captain Rodman says:\* "The excess of strain due to the rate of application of any force, above that due to its statical equilibrium, is caused by the momentum or living force developed in both the straining and resisting bodies, up to the time when they attain their position of statical equilibrium, or by the momentum at which they arrive at that position. To illustrate: suppose the sum of the masses of the resisting body  $a b$  and of the weight  $P$  to become infinitely small as compared with that assigned them in the discussion above referred to; and the force of gravity to be so increased as to cause their weight to remain constant, and the resisting power of  $a b$  to remain the same.

"These hypotheses would not change the position of statical equilibrium, and the moving and resisting bodies would reach that position with the same velocity as before; but their mass being, by hypothesis, infinitely small, their momentum at that position would also be infinitely small, as compared with its value under the former hypothesis, and they would consequently be carried by that momentum only an infinitely small distance beyond the position of statical equilibrium. The ultimate strain would, consequently, under this hypothesis, be independent of the rate of application of the straining force.

"The statical pressure exerted upon that portion of the surface of the bore, around the seat of the charge, in firing a 10-inch gun with service charges and solid shot, cannot be less than 50000 lbs. per square inch. The weight of a body that would produce this amount of statical pressure per square inch, on the area of a cross-section of the bore of that gun, would  $= 78.54 \times 50000 = 3927000$  lbs. This would be the weight of the moving or strain-

\* "Experiments on Metals for Cannon and Cannon Powder," 1861.

ing mass necessary to render the remarks, in the discussion above referred to, applicable to a 10-inch gun; whereas, in the discharge of cannon, the charge of powder is the moving mass, and that portion of the gun around the seat of the charge is the resisting mass.

“The extensibility of gun-iron is, at the highest estimate, not over  $\cdot 004$  in. per inch in length. The increase in diameter of the bore of a 10-inch gun would therefore be, at the moment of interior rupture,  $= \cdot 04$  in., and the extent of radial motion of the surface of the bore would  $= \cdot 02$  in. The surface of the bore would have a greater extent of motion than any other part; and if there were no other resistance to motion than the inertia of the mass of the metal around the seat of the charge, the velocity developed in that mass, in passing over a space of  $\cdot 02$  in., would be very trifling indeed, and the momentum correspondingly small.

“The sum of the moving and resisting masses in the case of a 10-inch gun, as compared with that of a body whose weight = 3927000 lbs., would be very small; nor can the radial velocity of the charge, at the moment when the bore attains the diameter due to the statical pressure exerted upon it, be so great as to render its momentum of any considerable magnitude; from which it follows that, in firing cannon, the excess in strain upon the gun, above that due to statical pressure, caused by the most rapid rate of application or development of that pressure, is a very small percentage of the total strain.

“This reasoning, and the conclusion to which it leads, must not, however, be construed into a disregard of the rate of combustion of the charge, for this is of primary importance; but from causes entirely different from that discussed above.” \* \* \*

“It is well known and understood, in architecture and practical mechanics, that a given beam of wood or bar of iron will sustain, for a limited time, a weight which would be certain, ultimately, to break it; and, in general terms, that the rupturing force is a decreasing function of the time required for it to produce rupture.

“It is believed, however, that we have not heretofore properly appreciated the effect of time on the resistance which a body can offer, where the *absolute* difference in the times of action is small, but where the *ratio* of the maximum to the minimum time of action is very great. For example: the time required to rupture a tensile specimen of cast iron on the testing machine is, say, five minutes. This is a small absolute space of time, and the difference between this and any smaller space must be still less; but as compared with the length of time during which the maximum pressure is exerted upon the bore of a gun at a single discharge it becomes very great; probably as great as the ratio of the time of existence of any known structure of either wood or iron to that required to test the strength of a single specimen of either material. And if so, why should not the resistance of a gun or shell, to a single discharge, be as much greater than indicated by the test specimen, as the permanent architectural load required of any material is less than that indicated by the test specimen?

“The results of different experiments which I have made, indicate that such is the fact. For example: in bursting cylinders with powder (see page 192, Report of 1860), set No. 1, with a thickness of metal of  $\cdot 5$  inches, gave a bursting pressure per square inch = 37842 lbs., and requiring a tensile strength of iron = 75684 lbs. per square inch, while the tensile strength of the iron by the testing machine was only 26866 lbs. And in set No. 4 (same page and report), with 2 inches thickness of metal, the bursting pressure was 80229 lbs. per square inch, while the most that it could have been by the testing machine would be twice the tensile strength, or 53732 lbs.

“These same results, as well as others, show the important differences in resistance due to differences in time of action, when the *greatest* duration was so small as to be entirely inappreciable to the senses. Take, for example, sets Nos. 1 and 2 of the same cylinders just referred to. These sets were both of the same interior capacity, same metal, near as could be, and were burst by equal charges of powder of the same quality. Set No. 1 was  $\cdot 5$



inch thick, and set No. 2 was 1 inch thick. The mean bursting pressure of set No. 1 was 37842 lbs. per square inch, while set No. 2 was only 38313 lbs. One cylinder of set No. 2 required two charges to burst it, the indication of pressure being something less for the second than for the first charge.\* Now the only true explanation of these results is believed to be, that 38,313 lbs. was the pressure due to the combustion of the charge of powder used, in the space in which it was burned; that it did not greatly exceed the resisting power of the cylinder of set No. 2, and required a greater, though still unappreciable length of time, to produce rupture (as is indicated by the fact of one cylinder forcing the whole products of combustion of one charge out through a hole one-tenth of an inch in diameter, without bursting), while it greatly exceeded the resisting power of set No. 1, and consequently burst that set in much less time, but not before almost the full pressure due to the charge of powder used had been developed. \* \* \*

“Now the difference in the times of action of the forces in all these examples was entirely inappreciable to the senses, yet the *ratio* of the greatest to the least must have been very considerable. And in the ordinary discharge of cannon the gun is subjected, at each discharge, to a force which would inevitably burst it, if permitted to act for any appreciable length of time; so that it may be said that cannon do not burst because they have not time to do so before the bursting pressure is relieved.”

**348.** The apparent increase of strength by stretching may be otherwise accounted for. Mr. Colburn says: “Mr. Thomas Lloyd, Engineer to the Admiralty, made a like series of experiments, a few years ago, on 10 bars of SC Crown iron,  $1\frac{3}{4}$  inch diameter and  $4\frac{1}{2}$  feet long. The mean breaking weight at the first breakage was 23·94 tons per square inch. At the second breakage, with pieces 3 feet long, the mean strength was 25·86 tons per square inch; at the third breakage, with pieces 2 feet long, 27·06 tons per

\* The pressures were determined by Captain Rodman's indenting apparatus.

square inch; and at the fourth breakage, with 15-inch lengths, 29·2 tons per square inch. Mr. Lloyd's experiments have been held to show that iron was actually strengthened by stretching it; or, in other words, that by destroying the cohesion at one point, the cohesion was everywhere else increased. A more obvious explanation is, that the bars first broke at the weakest part, then again at the next weakest part, and so on. A variation of from 23·94 tons to 29·2 tons in the strength of the same bar is undoubtedly large, the greater strength being 22 per cent. more than the lesser; a difference which appeared to exist in each of the 10 bars tried. It is well known, however, that hardly any two bars of iron have exactly the same strength, and Mr. William Roberts, manager of Messrs. Brown, Lenox, & Co.'s extensive chain-cable works at Millwall, has cast a 12-ft. bar of iron into 2-ft. lengths, and found, on testing, that there was a difference of strength of 20 per cent. between the strongest and the weakest of these pieces. In the experiments of the Railway Iron Commission upon the extension of cast iron, the strength of Low-Moor cast bars was 7·325 tons per square inch at the first, and 8·152 tons at the second breaking. Blaenavon iron broke with 6·551 tons per square inch at the first, and 6·738 tons at the second breakage. Gartsherrie broke with 7·567 tons per square inch at the first, and 8·475 tons at the second breakage. Other cast-iron bars of a certain mixture broke with 6·6125 tons per square inch at the first, and 6·777 tons at the second breakage, the latter being at an unsound place. Upon these results the commissioners remarked, that 'it would appear that iron repeatedly broken becomes more tenacious than it was originally. This erroneous conclusion may be obviated by considering that it would be very difficult, if not impracticable, to obtain cast-iron bars perfectly sound and 50 feet long. Fractures may be supposed to take place the first time at the largest defect, and subsequently at those smaller, until finally none remain.'"

The permanent stretching of the interior layers of a gun without initial strains would tend to put them into compression, and the exterior layers into tension, which is a condition of strength (405)

**349.** SAFETY OF DUCTILITY. WORK DONE IN STRETCHING.—Mr. Mallet considers soft wrought iron the proper cannon metal for another reason:—the work done in greatly stretching a bar of soft wrought iron beyond its elastic limit to the breaking point, considerably exceeds the work done in slightly stretching a less ductile but very much more tenacious metal, such as high cast steel, to the breaking point (352), (466). Mr. Mallet does not propose to load wrought iron above its elastic limit, but advocates its use because there is such a large margin of safety between the elastic limit and the breaking strain. If the former is accidentally, or through defects in the metal or the fabrication, exceeded, the gun will still be far from the bursting point, and may considerably stretch and give ample warning. But when the elastic limit of high steel and other slightly ductile metals is reached,—and it is at any time likely to be, through defective material or fabrication,—fracture occurs almost immediately. Very little “work done” is then required to reach the breaking point. Mr. Mallet admits, however, that high steel is perfectly safe, if this margin of work done is provided for by an excessive *quantity* of material. In other words, there must be provision for the expenditure of a great power between the working strain and the ultimate tenacity.

Wrought iron provides this by its ductility. High steel and cast iron, and all less ductile metals, provide it only by excessive quantity, so that the working strain shall never exceed the limit of elasticity.

**350.** But if wrought iron changes figure under the strain of gunpowder, although it may have a higher tenacity, it ultimately loses its ductility by stretching, and thus gradually approaches the position assigned by Mr. Mallet to high steel and cast iron—*without a margin of safety*. If any of the material is bad (it may even have been fractured in some unseen part), or if accidental overpressure occurs, there is then very little “work done” required to reach the breaking point. Nor is this the only defect of stretched wrought iron. As compared with steel, it has very little elasticity, which still more reduces the above margin of safety.

Thus, although the rupture of wrought iron may *at first* require of any force in motion vastly more effort than the rupture of steel, it would appear that if the wrought iron is stretched by gunpowder beyond its elastic limit, it gradually assumes the very defect ascribed by Mr. Mallet to steel, although it may gain in ultimate tenacity by stretching. So that a wrought-iron gun must originally have a greater excess of material—a greater thickness of wall—than steel, because the strain required to reach its limit of elasticity is less; or else, it must deteriorate with use, while steel will never deteriorate if the strains imposed upon it do not permanently change its figure.

**351.** So long as the pressure in a light wrought-iron gun is kept below the limit of elasticity, it may be as safe as a heavy steel gun. But the demand is for the highest possible pressure upon the shot, and hence upon the gun. The strain required to reach the limit of elasticity is much greater for steel than for iron, so that steel can endure the greater pressure, and propel a given shot with the higher velocity, without a permanent change of figure.

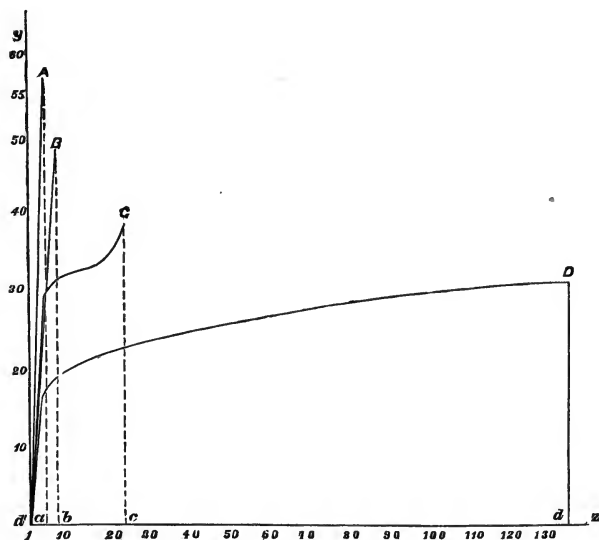
**352.** Mr. Mallet's reasoning and conclusions are as follows: \* "From these tables (51, 52, and 53) the succeeding diagram (Fig. 160) has been produced, in which the quadratures of the four curves indicate the values of  $T_e$  (foot-pounds in reaching the elastic limit of tension), and  $T_r$  (foot-pounds to produce rupture by tension, for cast steel, harsh strong iron, soft strong iron, and wrought iron of extreme ductility but of moderate strength). From  $d'$  the origin,  $d' y$  is the ordinate of strain in kilogrammes, and  $d' z$  the abscissa of extension in millimetres. The curve  $d' A$ , nearly a right line, is that for the extension of cast steel; the curve  $d' B$ , that for harsh, strong wrought iron;  $d' C$  the curve for soft strong iron; and  $d' D$  that for extremely ductile but not very strong iron.

"On the known principles of *vis viva*, the 'work done' in each case in producing these extensions will be equal to one-half the

\* "On the Construction of Artillery," 1856.

quadrature of each respective curve. It is obvious, then, to the eye, that although the strength of cast steel (its ultimate cohesion) is enormously greater than that of the very ductile iron, still, from

FIG. 160.



the greater range of extension of the latter, in the abscissa  $d'z$ , the 'work done' in producing its extension to final rupture, or even its extension within the elastic limit,\* is enormously in excess of that required to bring the cast steel up to the point of rupture. In fact, in round numbers, it will require of any force in motion above 50 times the effort to rupture a given section and length of ductile wrought iron, that will rupture the best and toughest cast steel; while again, for the very ductile wrought iron, its value for  $Tr$  is nearly 650 times that for  $Te$ , so great is the range or limit of work to be done between the elastic (safe) limit and that of rupture.

"Hence it follows, that a gun formed of cast steel or of harsh, strong wrought iron, provided it have an enormous surplus of

\* The statement as to the work done in producing the extension of iron and steel *within* the elastic limit should be compared with Mr. Mallet's tables (353).

strength above the highest strain to which it is to be exposed, will be very safe; but if its proportions be reduced within a narrower limit of balancing the final resistances with the bursting strain, or if the latter be brought up, accidentally or otherwise, so as to approach such balance, the cast steel or the harsh wrought iron will be the most unsafe gun possible, while in all cases the gun of ductile iron will be the safest. This might be popularly illustrated by saying that the former gun approximates to one of enormous strength, but made of glass; while the latter approximates to a gun made of sufficient strength,—if conceivable, of leather or india-rubber, or to the silk-wrapped guns of the Chinese.

“The highest possible ultimate cohesion is, no doubt, most desirable; but this quality *alone* will not answer for ordnance (or for any other purpose in which impulsive strains are concerned); it must be united with the largest possible amount of ductility within the elastic range\* to give security; or, otherwise, security must be purchased by the accumulation of an immense overplus of material.”

**353.** Mr. Mallet’s conclusions about the superiority of wrought iron to steel, when the amount of material used is proportioned to the ultimate cohesion of the respective metals, are obviously correct and useful. But he appears to have been so absorbed in his crusade against steel, that he allowed himself to found another theory against it, on an obvious inconsistency in his own tables. We find in the table on page 73 of his work, the following:

Nature of Metal, and Authority.	Elongation at limit of elasticity—Length of bar=10.	Corresponding strain, in pounds per square inch.	Ratio to the ultimate cohesion.	Value of coefficient of elasticity, in lbs. per square inch.
Cast steel (English), blue temper.....				
Ditto (Morin), mean.....	·00222	93,866	0·67	42666750

\* Mr. Mallet’s Tr = foot-pounds to give *rupture* by tension, the value of which does not appear, if “ductility within the elastic range” is all that must be united with the highest ultimate cohesion to produce a good cannon metal.

In the table on page 79 we find the following:

No.	Metal.	$i$ Extension per unit of length up to elastic limit.	$T = P$ Strain per unit of section at elastic limit.	$P$ Strain in tons.	$T_e = \frac{1}{2} P_i$ Value for unit of length and section.	$e$ Coefficient of elasticity for unit of section.
			Lbs.		Dynams.	Lbs.
1	Cast steel (English), blue temper ....	·00022	47040	21·0	5·175	42666750
3	Wrought-iron bar (maximum ductility)	·00090	17024	7·6	7·660	25000000

No. 1, from Morin's experiments on flexure of dynamometric springs.

It is obviously an error to say that of two steels described as the same, and having the same coefficient of elasticity, one should elongate within its elastic limit  $\cdot 00222$ , with a strain of 93866 lbs., while the other should elongate within its elastic limit  $\cdot 00022$ , with a strain of 47040 lbs.

Referring to the latter table, Mr. Mallet remarks: "In the case of tempered cast steel, although the resistance to a passive strain is taken as high as 21 tons per square inch, yet from the extremely small range of extension, the 'work done' to bring it to the limit of its safe load is found to be less than that required for the soft ductile wrought iron, that will only bear a passive load of about one-third as much as the steel, in the ratio of 5·175 : 7·660."

Now, instead of 5·175, the "value for a unit of length and section" will be 52·214, if the elongation at limit of elasticity is taken at  $\cdot 00222$  instead of  $\cdot 00022$ . And if, instead of taking the strain at elastic limit per unit of section at 47040 lbs., we take it at 93866 lbs., the value for unit of length and section will be 104·19, which compares rather more favorably and fairly with iron at 7·660.

It is proposed to consider the various properties of cast iron, wrought iron, steel, and bronze, and the effects of the various processes by which they are made into cannon, with reference to the conditions of greatest effect.

The relations of elasticity and ductility to the endurance of strain have already been considered. Since the ultimate tenacity of metals approximately indicates their safe working strain, their tensile strength will be compared in some detail.

## SECTION II. CAST IRON.

**354. WEAKNESS A SERIOUS OBJECTION.**—The chief argument against cast iron as a material for an entire gun made without regulated initial tension, is its comparative weakness. The first resort for strengthening a gun thus fabricated from a weak material, is to make it thicker. But it has been shown that mere increase of thickness, beyond a point nearly or quite attained in practice, does not practically strengthen a gun. No possible thickness will enable a cylinder to permanently bear an internal pressure greater per square inch than the tensile strength of a square inch of the material (282). Mr. Longridge says,\* with reference to this law, assuming the pressure of powder to be more than 8 tons per square inch (he assumes 17 tons), and the strength of iron to be 8 tons: "It does seem strange that the use of this material should be persisted in, and that experiment after experiment should be made in search of that which is as impossible to be found as the philosopher's stone, viz., a means to make cast iron alone endure more than its ultimate strength."

The diagram (Fig. 161) shows the advantage of using strong metal, and making guns (if homogeneous) and rings for hooping guns of moderate thickness, rather than to use weak metal, and attempt to compensate by quantity for its defect in quality. The inner circle represents the calibre of a gun; the outer arcs represent tubes for two, three, and four calibres in diameter. The full tensile strength of the metal being represented by the square A, its strength in a cylinder is represented by the areas B, C, D: and the weight of guns of one, two, and three calibres in diameter, is represented by the numbers 3, 8, and 15: and the addi-

\* "Construction of Artillery," Inst. C. E., 1860.



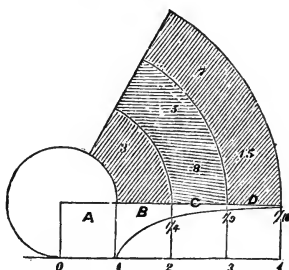
tional weight to give the additional strength corresponding to the area C, is represented by the middle part of a ring 5; and the additional weight to give the slight additional strength represented by the area D is represented by the outer part of a ring 7. The only other resort, then, if the principles of construction are not radically changed, is to add what strength can be got out of a better process of founding.

### 355. COMPARATIVE STRENGTH.—

An American cast iron, having a tensile strength of 49496 lbs. per square inch, has been quite recently applied to cannon-founding.\* Assuming a sufficient supply of such iron of uniform quality, and that its contraction when cooling and its elastic limit are favorable for cannon-making, it is still a weak material when compared with steel at 100000 to 150000 lbs.—twice to three times as much. But cast iron does not average 50000 nor even 40000 lbs. tensile strength. The average of five samples of the highest quality, mentioned by Captain Rodman,† is 31000 lbs. The system of inspection of gun-iron since 1841, is also stated to have resulted in an improvement of the quality of gun-iron used, from 23638 lbs. to 37774 lbs.‡ The highest tensile strength of the various gun-iron tested during a series of years, is stated by Major Wade to be 45970 lbs., and the average of the highest and the lowest is 27485 lbs.

356. Mr. Longridge gives the strength of English gun-iron at less than 20000 lbs., and states§ that in the Blue Book of 1858,

FIG. 161.



\* From the notes of Colonel Delafield (in charge of the defences of New York), it appears that this iron was taken from a 6-pounder of 1000 lbs. weight, cast by Mr. J. Johnson, Malleable Iron Works, Spuyten Duyvel, N. Y. The tensile strength varied from 30420 to 49496 lbs., as follows: 39364, 37340, 33590, 42660, 45575, 42660, 30420, 48672, 45044, 45044, 45044, 42336, 39040, 49496, 35520, 40090, 45632, 46078, 42748. The average of 19 specimens was 41913 lbs.

† "Experiments on Metals for Cannon, etc.," 1861, pp. 137-138.

‡ "Reports of Experiments on Metals for Cannon," 1856.

§ "Construction of Artillery," Inst. Civil Engineers, 1860.

containing the Woolwich experiments: "The maximum strength of cast iron there tried was 15 tons (33600 lbs.), the minimum strength  $4\frac{1}{2}$  tons (10080 lbs.), and the average strength 10 tons (22400 lbs.) Those experiments were made upon irons prepared and sent specially by the makers, and doubtless considered by them as the best for the purpose. The result of Mr. Hodgkinson's experiments, recorded in his edition of 'Tredgold,' showed an average tensile strength of 7 to  $7\frac{1}{2}$  tons (15680 to 16800 lbs.) per square inch; Low Moor iron being  $6\frac{1}{2}$  tons (14560 lbs.), and Carron iron  $6\frac{1}{2}$  to 7 tons. From the report of the 'Commissioners on the use of Iron in Railway Structures' (1849), it appeared that the tensile strength of Bowling iron was 6 to  $6\frac{3}{4}$  tons (13440 to 15120 lbs.), and that of Low-Moor, 7 tons (15680 lbs.) per square inch."

Mr. John Anderson (superintendent of the Royal Gun Factory at Woolwich) states,\* that "from several hundred experiments made with the higher qualities of cast iron, which were collected with a view to obtain the strongest iron for cast-iron guns, the ultimate tenacity was found to range from 10886 lbs. up to 31480 lbs., or an average of 21173 lbs. per square inch. This is considerably above the strength of the greater proportion of the cast iron of commerce. The average of the Nova Scotia iron, specimens of which have recently been tested, gave only 15821 lbs., and some of the Scotch pig-iron, selected at random, only gave 12912 lbs."

In the discussion on Artillery, before the Institution of Civil Engineers, before referred to, Mr. Bramwell said "he had a sample (of cast iron) which was broken at the testing machine at Woolwich, that bore  $19\frac{1}{2}$  tons (43680 lbs.) to the square inch of section before it gave way." Mr. Longridge replied that, "on inquiry, he found that in that instance Acadian charcoal iron was used. But in the same page of the pamphlet from which this high result was quoted, there were instances in which the tensile strength of the same iron was not quite 8 tons."

\* Journal Royal United Service Inst., August, 1862.

**357.** The construction from unstrengthened cast iron, of rifled guns, which require much greater strength than smooth-bores, has been generally abandoned on account of the weakness of the material. Mr. Wiard states\* that work on a number of  $7\frac{1}{2}$  inch cast-iron rifled guns (Fig. 83) was stopped because "various trials, at the West Point Foundry and elsewhere, demonstrated these guns to be entirely unreliable." He also states that the 80-pounders were equally unsuccessful, and that the liability of the 50-pounders to failure has induced the Department to withdraw them pretty generally from service. The shape of these guns was certainly good, but the material was not trustworthy. English experiments on the rifling of old and new cast-iron guns will be detailed under the head of Rifling and Projectiles.†

**358.** GREATER SHRINKAGE OF STRONG IRONS.—It is farther

\* "Great Guns," 1863.

† Colonel Eardley Wilmot, in the discussion on the Construction of Artillery, before the Institution of Civil Engineers, in 1860, gave the following facts about the endurance of certain cast-iron guns:

"At the present moment experiments were being made in Woolwich Arsenal, with a gun which had stood the following discharges: 10 rounds with a cylinder weighing 68 lbs.; 10 rounds with a cylinder weighing twice 68 lbs.; 10 rounds with a cylinder weighing three times 68 lbs.; and so on to four times, five times, six times, and seven times, so that the weight of the cylinder with the last 10 rounds was 476 lbs., the charge of powder being in all cases 16 lbs.; yet the gun was uninjured. Five rounds had since been fired, with the same charge of powder, and a cylinder weighing 544 lbs., which had the effect of destroying the carriage of the gun. This was repaired, and another round was fired of the same proportions of charge and weight of cylinder, when the gun burst.

"He had been furnished with the results of experiments made with a Spanish cast metal 32-pounder, 8 feet 9 inches long, and weighing 45 cwt. That gun was fired, first with 21 lbs. of powder, 2 shots, and 2 wads; then with 9 lbs. of powder, 2 shots, and 3 wads, at an elevation of 10 degrees. He need hardly say, that as the elevation was increased, the strain upon the gun became greater. It was then fired 827 times without injury, with 9 lbs. of powder, 2 shots, and 3 wads; next with 9 lbs. of powder, 3 shots, and 2 wads; then with 9 lbs. of powder, 4 shots, and 2 wads; continuing with the same charge of powder, and the same number of wads, up to 11 and 12 shots, when the gun was full to the muzzle. Subsequently, it was tried with 12 lbs. of powder and 10 shots; 15 lbs. of powder and 9 shots; 18 lbs. of powder and 8 shots; 21 lbs. of powder and 7 shots; 24 lbs. of powder and 6 shots; 27 lbs. of powder and 5 shots, when the gun was again filled to the muzzle, and then it burst. It thus took to burst that gun an aggregate of 3 tons 13 cwt. of powder, 25 tons 8 cwt. of shot, and 2 tons 19 cwt. of wads.

proved that the strongest iron does not always make the most enduring gun. Several examples mentioned by Captain Rodman\* illustrate the general experience in this direction.

“The very low endurance of the first pair (8-inch) of experi-

“An American shell-gun, 9 feet long, 9 inches diameter, and weighing  $81\frac{1}{4}$  cwt., had been fired with the results given in Table LV.

TABLE LV.

Number of Rounds.	Charge of Powder.	Number of Shot and Shell.	Weight of Shot and Shell.
	Lbs.		
2	15	1 shot	90
1500	10	1 shell	72
5	15	1 shot	90
5	15	2 shot	180
2	15	3 shot	270
3	15	4 shell	288
1	20	{ 3 shot }	342
		{ 1 shell }	
1	20	{ 2 shot }	468
		{ 4 shell }	
1	20	{ 2 shot }	612
		{ 6 shell }	
1	20	7 shot	630
1	20	8 shot	720
1	20	9 shot	810
1	20	10 shot	900

When the gun burst.

“He might also mention that a British 32-pounder was known to have fired, at the siege of Sevastopol, three thousand rounds; and though the vent was much enlarged, the bore was perfectly smooth, sound, and serviceable.

“It is stated, on the authority of Sir Richard Dacres, who commanded the artillery in the Crimea, that some 68-pounders, lent to the French, endured two thousand rounds.

“Colonel Wilford states that some of the siege-mortars, fired with 20 lbs. of powder, have stood two thousand rounds.—*Jour. Royal U. Service Inst.*, June, 1862.

“In the Great Exhibition of 1851 were several cast-iron guns, produced at the Liege Foundry, Belgium, which were certified to have withstood the following number of rounds respectively:

Size.	Weight—lbs.	Rounds.
80-pounder.....	6055	2000
24-pounder, short.....	1985	3649
6-pounder.....	1954	6002
6-inch howitzer.....	1147	2118

“Several of the siege-guns—24-pounders—used at St. Sebastian in 1813, are stated to have been fired six thousand rounds.”—MALLET. “*On the Construction of Artillery*,” 1856.

\* “Experiments on Metals for Cannon, etc.,” 1861, pp. 137-138.

mental guns which were cast in that year (1849), was attributed to the inferior quality of the iron of which they were made. Two years were spent in searching after a better quality of iron, which was undoubtedly found; and in 1851 another pair of 8-inch guns were cast. The iron in this pair of guns had a tenacity of near 38000 lbs.; while that of the iron in the first pair was only between 27000 and 28000 lbs. The solid-cast gun of the first pair burst at the 85th fire, and that of the second pair at the 73d fire; the superior iron giving the inferior solid-cast gun. These results, however, did not destroy the confidence in strong iron for solid-cast guns, and the first pair of 10-inch guns were made from the same lot of iron; and with a tenacity of 37000 lbs., the solid-cast gun burst at the 20th fire. This result weakened confidence in very strong iron, and the tenacity was reduced.

“In 1857, after guns of good tenacity had failed at the Fort Pitt, South Boston, and West Point foundries, four out of seven guns offered for inspection at the last-named foundry having burst in proof, Mr. Parrott, proprietor of the West Point Foundry, one of our most experienced gun-founders, cast his trial contract guns of iron having a tenacity of 30000 to 32000 lbs. One of these guns has endured 1000 service charges of 14 lbs. powder (800 rounds with shell, and 200 with shot).”

An 8-inch gun cast in 1844, of iron giving a tensile strength of 26376 lbs., stood 671 fires, while two guns of the same pattern, cast in 1851, from iron of 37814 lbs., gave a mean endurance of 46 fires.\*

**359.** This inferiority of the strongest iron for guns is attributed to its greater contraction in cooling, the effect of which will be further considered. Of the last guns mentioned, the best is stated to have been made of *low*, soft, gray iron, of moderate tenacity and small shrinkage. The poorest was made of high, hard, close-grained strong iron, having the greater contraction of .10 to .15 inch more in the diameter of a gun than lower irons. It was all melted and run into pigs once, and a part of it remelted before

\* “Reports of Experiments on Metals for Cannon,” 1856, p. 198.

being melted for casting the guns. The reduction of the carbon by this process appears to account for its greater shrinkage, as well as its greater strength.

**360.** Cast iron has perhaps reached its maximum strength. At least, *as* cast iron, without the aid of other ingredients or processes, it has only been improved by the discovery of better ores and better mixtures. Indeed, one authority\* states that "the quality of our pig-iron has deteriorated within the last half century. In an English gun, imported into America in 1845, the cast iron was of a density of 7.04, and tensile strength 18145 lbs. to the square inch; while other English guns, imported about thirty years previously, contained metal of a density of 7.202, and tensile strength corresponding to 28067 lbs. to the square inch." But the strength of steel and the size of the masses produced are increased every year.

**361.** WANT OF UNIFORMITY.—Cast iron is not uniform. Captain Rodman says:† "We do not *know*, for example, what qualities of iron are necessary to make the best gun; nor, if we did, do we know how, from any of its ores, *constantly* to produce iron which shall possess those qualities?" From the fact that high, strong iron makes a weaker gun than lower iron, there would appear to be some uniformity, at least, in the variation of iron. But other facts mentioned by Captain Rodman warrant the conclusion that "we are at present far from possessing a practical knowledge of the *properties* of cast iron in its application to gun-founding." A gun made by Captain Parrott having failed at the 169th fire, the iron, having a tenacity of 30000 to 32000 lbs., was condemned by him as too high—having too much contraction—for heavy guns. From this rejected iron two 10-inch guns were made, "which have been fired 2452 rounds each, the least charges being 14 lbs. of powder and one solid shot; and neither gun broke. These guns have since been fired 1000 rounds each, with 18 lbs. powder and solid shot, and neither gun yet broken."

*The same* iron is generally supposed to be uniform in contrac-

\* "The Useful Metals," p. 213.

† "Reports of Experiments on Metals for Cannon, etc.," 1861.

tion. A striking instance to the contrary is the attempt at Woolwich to shrink a gun over a wrought-iron tube (Fig. 153). Two guns were broken in the process, and the metal of the third shrunk so unequally, that the endurance was limited compared with that of a tube put without initial strain into a cast-iron gun (Table XIII. and 332).

In five specimens of the best American iron mentioned above, there was a maximum variation of 11000 lbs. per square inch—a variation equal to the total strength of other qualities. The difference in the strength of the highest and lowest American gun-iron, tested during a series of years, is stated at 36970 lbs.\* The difference in the strength of the lowest English iron mentioned by Mr. Anderson, and the highest American reported by Colonel Delafield, is 40000 lbs. per square inch—a number given by Haswell for the highest cast iron of commerce.

**362.** This want of uniformity must always be risked, because it cannot be remedied. Long experiment indeed enables founders to mix ores with some degree of certainty as to the intended product, but no two charges in the smelting furnace, nor pigs broken for remelting, are substantially alike. But steel and the more refined metals are, and obviously should be, more uniform. Cast iron is made from materials the number and proportion of which we do not know. Steel is made from materials the number and proportion of which are much more definitely known beforehand. This was unintentionally admitted by Mr. Abel, chemist to the British War Department, in the following statement:† “The chemical examination of a large number of samples of cast iron, from different sources, either as obtained from the blast furnace, or after repeated remeltings, had led him to the conclusion that the uniformity of this material was to a great extent under control. He had examined specimens obtained from some of the best iron-works, and on comparing with them samples made, at intervals of two or three years, at the same works, he found them, from

\* “Reports of Experiments on Metals for Cannon,” 1856, p. 274.

† “Construction of Artillery,” Inst. Civil Engineers, 1860.

a chemical point of view, almost identical in their nature. There might be a variation in the density, and other physical properties, resulting from the temperature at which the metal was cast, and from other circumstances, but the regulation of such differences was under the control of founders and engineers. If, therefore, it was found that cast iron might, with proper attention to its manufacture, be made almost perfectly uniform, some faith ought to be placed in that material. At the same time, the important results obtained by the further treatment of cast iron should not be lost sight of. By progressive decarbonization, it might be made to approach to perfect steel in its nature, or to acquire the characteristics of malleable iron. Such conversions could, a few years ago, only be carried out upon a small scale, or by most laborious process; now they could be effected upon a very large scale, so that masses of the products, of great size, could be produced. Amongst others, Mr. Bessemer had obtained results which should not be passed over. He thought they might prove most important, particularly when it was remembered what had already been done in this direction by Mr. Krupp, in Prussia."

That is to say, there may be a variation in density and *other physical properties* of cast iron, but it promises great results when improvements amounting to a new manufacture are introduced, especially a new manufacture of steel.

To this Mr. Longridge replied: "Many striking instances might be given to show, that identity of chemical composition might coexist with great variation of physical properties. For example, phosphorus was a deadly poison, and ignited with the least friction in its ordinary state; yet in another state, without any change chemically, it might be swallowed without causing any injury, and did not ignite by friction. He believed there were certain compounds, such as one of chlorine and naphthaline, which existed in the gaseous, the liquid, and the solid form, and yet no chemical difference could be detected. Therefore he did not think that chemical identity had much to do with the mechanical properties of iron. He was supported in that opinion by the Report of a Committee of Chemists appointed in the United



States, in 1849, to investigate this question. In 1851 their first report was made, which was of a hopeful character. In 1852, it was reported that a decided relation, it was believed, had been observed between the amount of uncombined carbon and the tensile strength of the metal. But in the final report, in 1855, all the former reports were withdrawn, and it was stated, that 'though at first largely appreciating the extent of our labors, the completion of them sensibly diminished that estimate of their usefulness.' Therefore, he thought, however desirable it might be to ascertain the chemical qualities of iron, practical men were yet very far from being in a position to accept them as indices of its tensile strength."

Mr. Bidder, President of the Institution, said in the same discussion: "Cast-iron guns had no doubt occasionally exhibited wonderful results. They had withstood an immense amount of firing and strain; but there was not any certainty of uniform results being obtained. In one case a cast-iron gun had sustained 1500 or 2000 rounds, whilst another gun, stated to have been cast from the same metal and under precisely the same conditions, had not resisted for a single day."

Mr. John Anderson, in a paper on materials for cannon,\* says: "There are many instances on record of cast iron having shown an amazing amount of strength, toughness, and general endurance, both as guns and in other constructions; still, at the best, it is uncertain, and, as will be seen hereafter, it is not strong, and is proverbially treacherous to depend upon, as it gives no warning before rupture; and hence the time has arrived when, for ordnance especially, it seems about to give place to a better material, either wrought iron or steel, or perhaps a combination of both."

**363.** It is indeed stated, that the endurance of cast-iron guns can be pretty certainly predicted upon an examination of the minute cracks and other appearances in the bore after a certain number of rounds; and that, in a general way, experience has settled the number of fires that a gun will stand. Without questioning

\* Journal Royal United Service Inst., August, 1862.

these statements, it is only necessary to consider that this information has not been, perhaps because it could not be, so far utilized as to prevent very serious losses of life, treasure, and discipline, from the bursting of cast-iron guns. And what is worse, it has failed to remove that constant looking for of disaster which prohibits high charges, high velocities, and the sharp and decisive warfare which a more trustworthy gun-metal of no greater strength would render safe and practicable. Cast and wrought iron will be further compared in this respect.

**364. DEFECTS IN FOUNDING.**—The actual strength of the interior of a thick casting is far less than that of the same iron in a small bar. The outside cools and contracts first, squeezing some part of the liquid or pasty iron within up into the riser-head. Taking the case of a solid cylinder: when the outside is firmly set, the inside begins to cool, and in contracting tends to do three things: 1st. It tends to pull the outside into a smaller diameter, but with only the weaker or tensile force reduced by heat, while the outside opposes the stronger or compressive resistance, in the best form to maintain it—the arch.\* The outside is then a little compressed. 2d. The contracting interior tends to break loose from the exterior; but as the metal is cooler and the section greater towards the periphery than at the centre, the iron is but little strained in this direction. 3d. As the inside meets with these two resistances in trying to get into a cylinder of less diameter, its last tendency is to separate in radial cracks. In every large casting this result would actually occur; otherwise the inside would be left in high tension. “The extent of contraction in a 10-inch gun, cooled as above supposed, with a maximum difference of temperature ( $2700^{\circ}$ ), would be about two inches in length and a half an inch in diameter, and  $\frac{1}{4}$  of the latter would be in a direction from the centre towards the exterior, tending to split open the gun. The

\* The American solid cast guns are slightly oval in section, so that the effects of an unyielding arch are modified. The Dahlgren guns are also cast much larger than the finished size, so that the metal can adjust itself to the strains, in some degree, when it is turned. Several of the 11-in. solid-cast guns have endured 1500 to 2000 rounds.

above supposes an extreme case, in which a maximum difference of temperature between the exterior and interior occurs, a condition which never exists in practice. But it serves, however, to explain the law which governs the contraction of iron.\* In any case, the interior is not compact and dense.

**365.** If, as some authorities state, the contraction of cast iron is greater when cooled rapidly than when cooled slowly, the greater contraction of the outer part of the gun would to that extent relieve the difficulty specified; but if the reverse is true—and upon this theory Captain Rodman proposes to put the exterior of a gun cooled from the inside into tension—the strains described above would be aggravated.

**366.** The sources of failure, then, are as follows: when the gun is cool, a considerable part of the tensile strength of the inside is already employed in preventing the inside from contracting, thus leaving only the residue to resist the powder, while the outside, being in compression, can at first oppose no resistance at all to the powder; on the contrary, its first tendency is to help the powder open the gun. But this does not fully state the case. The outer layer of any tube is but slightly stretched by elastic internal pressure, while the inner layer is greatly stretched—the amount being inversely as the squares of their diameters. Hence, if the outer layer is initially compressed, it may be so slightly elongated by the powder as never to come into tension until the inside is actually burst.

**367.** The tendency of the core of the gun to contract away from the outer portion, is compared by Mr. Conybeare† to building up a gun of a number of concentric wrought-iron rings, by heating the second ring and placing it within the exterior ring already shrunk; and, when the ring had cooled, repeating the operation with a third red-hot ring. Such a gun would be entirely destitute of coherence and strength; yet this “was precisely the mode of proceeding adopted in the construction of cast-iron ordnance cast solid and cooled from the exterior.”

\* Major Wade. “Reports of Experiments on Metals for Cannon,” 1856.

† Discussion on the “Construction of Artillery,” Inst. Civil Engineers, 1860.

**368.** The existence of strains from unequal cooling is proved by the superior endurance of guns that have been kept a long time after casting, thus giving the metal time to recover a condition of repose. Mr. Bramwell\* thus refers to the American experiments: "A gun which had been so kept for six years, endured eight hundred discharges before it burst; while another gun endured two thousand five hundred and eighty-two discharges, and did not burst. Guns of the same description, tried thirty days after casting, burst, one at the eighty-fourth, and the other at the seventy-second discharge. This result showed it was not impossible that the superior manner in which guns cast some years ago, but recently used, had stood their work, as compared with those of modern make, was not due, as was commonly supposed, to the better quality of metal in those days, as compared with the present, but to their having been cast a long time; and to the strains that existed in them, from unequal contraction, when originally cast, having ceased, while the strains in the new castings were still exerting a prejudicial effect. It was proved, in the case of the two guns to which he had alluded, that the gun which burst after eight hundred discharges had a tensile strength of 23000 lbs., and that which endured upwards of two thousand five hundred discharges without bursting, had a tensile strength of 29000 lbs. to the square inch. Of the guns which were tested thirty days after being cast, the one had a tensile strength of 27000 lbs., and the other a tensile strength of 37000 lbs. per square inch of section. Both these recently cast guns endured a less number of rounds than those which had been cast some years, although the metal of these latter was much weaker than that of the former."

**369.** The expansion of the inner layer of metal by the heat of firing is, in the case of guns cast solid, a direct and unqualified advantage. If carried far enough, it not only relieves the tension of the interior and the compression of the exterior, but reverses these strains, placing the various layers in the condition to be equally strained at the instant of the maximum elastic pressure. But this advantage can never be depended upon in practice. A

\* "Construction of Artillery," Inst. C. E., 1860.

gun may never attain the exact state of strain required ; and if it does, it instantly goes beyond it.

**370.** The next source of weakness due to casting guns solid is, the reduction of the tensile strength of the material. A bar of cast iron 1 inch square was cut out of a bar 3 inches square, and tested with a bar originally cast 1 inch square. The reduction in the resistance of the former bar to crushing was 43 per cent., and to transverse strain, 42 per cent.\* Mr. Longridge is of the opinion† that “in a mass of metal such as was required in a 68-pounder gun, the loss of strength would be at least 50 per cent.” In a solid gun mentioned by Captain Rodman, a sample cut out near the trunnion showed a tensile strength of 44000 lbs. for the outside and 31000 lbs. for the inside. So that a gun unequally cooled not only offers the resistance of but a part of its strength to the strain of the powder, but has less total strength than a gun uniformly cooled. These facts are fully competent to account for the weakness of solid cast-iron guns.

**371.** The want of density in the metal of guns thus cast is the source of another species of failure. Mr. Mallet thus describes its condition :‡ “In a casting of 2 or 3 feet or more in diameter, it is not unusual (with a founder’s best care) to find a central portion of from 6 to 8 inches in diameter, consisting of a spongy mass of scarcely coherent crystals of cast iron, usually in arborescent masses, made up of octohedral crystals ; the whole so loose, that upon a newly cut section dark cavities can be seen by the naked eye in all directions, out of which, often, single or grouped crystals can be picked with the hand, and so soft that a sharp pointed chisel of steel may be easily driven into the mass some inches, as if into lead or soft stone.” The poorest part of this core is bored out in the chase, but the chamber, where the greatest strain comes, is the worst part of the casting. Hardness and density of bore are necessary to prevent enlargement both from concussion and friction, especially in the case of rifled guns. Commander

\* “Report of Commission on Railway Structures,” 1849.

† “Construction of Artillery,” 1860.

‡ “On the Physical Conditions involved in the Construction of Artillery,” 1856.

Scott states,\* that "from being cast solid, guns were made with a degree of hardness which was injurious to tenacity, in order that the centre of the gun might not be worn away by the rubbing of the shot." He instances certain guns cast at Woolwich.

**372.** EFFECT OF AGE ON ENDURANCE.—The metal of a gun, thus placed by unequal cooling in an unnatural condition, tends to assume a natural position of repose. Three 8-inch columbiads of the same form and dimensions, and cast in the same way, from the same iron, were tried as follows:—One fired immediately after casting, failed at the 72d round; after 6 years, the others were fired; one of them stood 800 rounds, and the other 2582 (368).

**373.** IMPROVEMENT IN FOUNDED.† CAPTAIN RODMAN'S PROCESS.—The principal improvement in the fabrication of cast-iron guns, is Captain Rodman's process of cooling them as far as possible from the interior, and, for this purpose, casting them hollow. The fabrication and test of these guns have been described in a preceding chapter (154).

The design is to remedy the various defects of the old process; principally to obviate the tendency of solid castings to be burst by their own initial strains, by reversing the process of cooling and shrinking described above. Since there would then be no force opposed to the contraction of the inner layers of metal, except the trifling cohesion of the liquid or pasty mass that they shrunk away from, 1st, they would not be left in tension, and therefore, 2d, they could not exert any power to pull the exterior layers into compression.

**374.** But it is not proposed to leave the metal in a condition

\* "Construction of Artillery," Inst. Civil Engineers, 1860.

† The Dahlgren guns, up to 11-in. calibre, some of which have endured above 2000 rounds, were cast solid, but considerably larger in diameter than the finished size. The heavy Navy guns are now cast hollow. All the rifles are cast without trunnions.

In a discussion on guns, before the Franklin Institute (1862), Chief-Engineer Wood said that "Captain Dahlgren's method to obviate the evil (of strain due to unequal shrinkage) consisted in casting the gun more nearly in the form of a cylinder, then turning off the additional metal on the exterior which had caused the strain in unequal shrinkage, by having been first cooled in the mould. His guns were cast solid; then the interior part, supposed to be the weakest, is bored out."—*Scientific American*, Nov. 15, 1862.

of repose. The attempt is to remedy by the same process the defective strength of a hollow cylinder, already considered, viz., that the inside is more stretched than the outside by internal pressure. Captain Rodman quotes this law from Professor Barlow, and says, as to the greater endurance of his hollow-cast gun:\* “The object of my improvement was in part, if not fully attained, viz., to throw the gun upon a strain, such that under the action of the law of strain, as stated above, each one of the infinitely thin cylinders composing the thickness of the gun, shall be brought to the breaking strain *at the same instant.*”

**375.** The process of cooling would then have to occur as follows:—Taking any two of the infinitely thin cylinders referred to, the exterior of the inner one having set at a diameter of say 2 feet, the interior of the outer one would have to contract to a diameter somewhat *less* than two feet. In other words, a given length of metal would have to contract more in one cylinder than in the other, by the abstraction of a given amount of heat. Now if all parts of the iron were alike in their composition and structure, the cooling of all parts in a given time would of course leave the whole mass in repose. But certain experiments are said to show that “the contraction of the same iron is greater or less, according to the greater or less rapidity with which it is cooled. That which cools most rapidly contracts most.”† If this is true, when a gun is cooled from within, the inside is not only cooled first, but most rapidly, since the heat has a shorter distance to travel. Hence the outside contracts less than the inside, and the outer infinitely thin cylinder, in the case we have supposed, instead of shrinking to a diameter less than 2 feet, so as to compress the one within it, would tend to stretch it into a state of tension, and, in stretching it, to be itself compressed; and so on throughout the mass, which is just the opposite state of strain to that required. These results would be very minute, but Mr. Longridge has demonstrated that a deviation from the *proper* tension of  $\frac{1}{500}$  inch

\* “Reports of Experiments on Metals for Cannon,” 1856, p. 212.

† *Ibid.*, p. 195.

in a diameter of 17 inches, reduces the strength of a cylinder 40 per cent.

**376.** Other experiments indicate that a large mass of metal cooling last, will contract upon a smaller mass which, being thinner, cools first. Mr. Wiard cast a heavy ring with a thin bar extending across its diameter. The ring contracted upon the bar so tightly that it could not easily be broken out. When broken out, the bar was considerably longer than the space it had filled.

The results are at least so irregular, that it would be almost impossible to produce *theoretically* exact strains by this method.

**377.** Another source of error arises from the partial cooling of the outside of the casting, while the intermediate portions are still liquid. Major Wade's report on this subject states that\* "the fracture of the 10-inch gun, cast hollow, developed cavities or fissures in the face of the fractured surface, near the front of the chase. The fissures are irregular, presenting in some parts an open chasm, half an inch wide and 4 or 5 inches in length and depth; in other parts the metal has a sponge-like appearance; they are from 10 to 14 inches below the neck or narrowest part of the casting,† where the iron, in cooling, soonest becomes solid entirely through a cross-section of the gun. The position of the fissures marks the place where the iron remained longest liquid, in this section of the casting; for it is evident that they were formed by the liquid iron in this part descending, to supply the vacancies made by the shrinkage beneath. The mass of the metal below being greater, a portion of it continued liquid a longer period of time, and until after a cross-section at the neck had become solid; and this solid intercepting the descent of liquid metal from the sinking-head above, the shrinkage below could be replaced from no other part than that where the fissures are found, viz., directly beneath the cross-section at the neck, where the metal first becomes solid throughout."

"The area of that part of the cross-section which is outside of

\* "Reports of Experiments on Metals for Cannon," 1856, p. 198.

† The gun was of the old pattern; the place referred to is in the rear of the long muzzle-swell.



the fissure, is  $\frac{7}{10}$  of the area of the whole section; and the part within the fissures is  $\frac{3}{10}$  of the whole. This indicates that  $\frac{7}{10}$  of the heat contained in the liquid metal escaped by passing outward, through the exterior surface, to the mould, by which it was conducted off; the remaining  $\frac{3}{10}$  of the heat passed inward to the core, and was carried off by the water."

**378.** The strains would then be as follows:—The intermediate metal, still hot, after the exterior and interior had set, and after the surrounding parts had become so pasty that it could receive no supply of metal from the sinking-head, or elsewhere, would still continue to contract, thus pulling the parts within it into tension, and the parts outside of it into compression, and itself into extreme tension, or, in large castings, pulling itself apart. These strains in all parts of the  $16\frac{1}{2}$ -in. walls of a 15-in. gun, would be about equal to the strains in a solid-cast gun  $16\frac{1}{2}$  in. in external diameter, or about the size of the rifled siege-gun, Fig. 80, although very much less than in a solid-cast gun of equal size.

**379.** Some of the strains, then, in a hollow-cast gun, are in the opposite direction to that required by Professor Barlow's formula. And supposing that the layers of a gun will be drawn tightly over each other, proceeding outward from the centre, if the heat is abstracted exclusively from within, the absolute condition of such a result is, that the mould shall be kept at the temperature of molten iron ( $2700^{\circ}$ ) until the extreme outer layer of the gun begins to fall below that point by the abstraction of heat from within. When this occurs, the temperature of the mould must be made to fall with the same rapidity; for if it falls faster, the gun will begin to cool from the outside, and if it falls slower, the stress on the different layers of the gun will become irregular.

Surrounding the mould with a mass of molten iron thicker than the walls of the gun, so as to be always hotter than the gun, would obviously prevent cooling from without. The unequal contraction of the same mass of iron, by reason of its chemical differences, would in any case disturb the desired uniformity of strain.

**380.** So that, while the defect of rupturing strains in solid castings may be entirely avoided by means of a mould that can be

heated to 2700° before the iron is poured, it appears impracticable to put the outer layers of metal into tension regulated with theoretical nicety, by Captain Rodman's process. Even if this tension was attained, the gun would lose much of it in time, for it is well known that castings lose their other initial strains by age (368, 372). The results certainly show a vast improvement over solid-cast guns, but neither the endurance of the hollow-cast guns, nor the charges they are allowed to carry, warrant the belief that the iron in them can be "brought to the breaking strain at the same instant." In fact, the above extract from Major Wade's report, shows that  $\frac{1}{10}$  of the hollow casting, being cooled from without, was in the opposite condition of strain.

**381.** The expansion of the interior of the gun by the heat of firing, would of course disturb the initial strains, but no more than in the case of the hooped gun. If the tension of the exterior was insufficient, the first few rounds would increase it, and strengthen either gun. The intermediate spongy place in the wall of a gun cast hollow and cooled from both surfaces, would allow the inner layers of metal to expand more without straining the outer layer, than if the metal were solid throughout. But the longitudinal strain of expansion by the heat of firing, produces no compensating results. This strain is in a great degree avoided by strong steel guns, because the walls may be thin; and by hooped guns, because the inner tube may slide within the hoops; but the thick cast-iron wall must endure its greatest force. Even if hooped with steel, cast iron must be quite thick to have the necessary longitudinal strength. (304.)

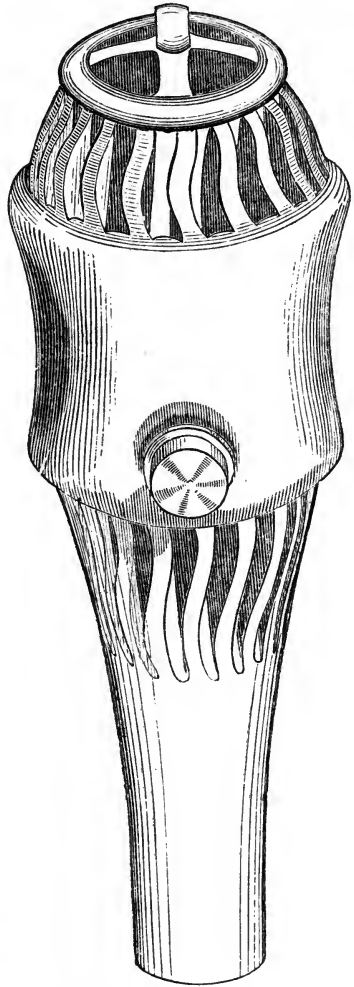
**382.** The other defects of solid-cast guns, are partially or entirely remedied by Captain Rodman's process. The surface of the bore is the hardest and densest part of the casting, and best calculated to resist pressure and abrasion. The tensile strength of the metal that receives the first shock of the exploding powder, is uninjured, because it is not drawn like the interior of a solid-cast gun. The intermediate metal is stronger or weaker, as the cooling is more or less carried on from the interior.

**383.** MR. WIARD'S PLAN.—Mr. Norman Wiard, whose ingeni-

ous and important speculations on the bursting of guns by the heat of the firing have been referred to in the foregoing chapter, has received a large order for heavy cannon, based upon the endurance of either one of two test-guns. The engravings illustrate the general features of his plan, but not the exact proportions; these are the subject of extended experiments and calculations not yet perfected.

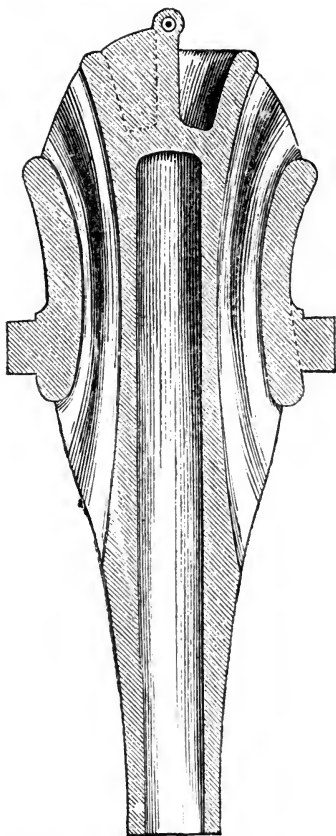
The gun is to have the same diameter and length of bore as the Navy 15-in.\*gun, and about 9 in. greater external diameter, and is to weigh 43000 lbs. The interior parts may be cooled uniformly by water passing through the cores between the ribs and in the bore, upon Captain Rodman's plan.—The exterior part or reinforce, being thicker than the other parts, will cool last after casting, and is by this means intended to compress the barrel with such force as to bring all parts of the metal into equal strain at the instant of firing, according to Professor Barlow's formula. The ribs are curved in both directions,—from front to rear, and from the inner barrel to the outer hoop or reinforce, so that they can spring enough to allow the inner barrel to expand both longitudinally, and the intention is, radially, by the heat of firing, without seriously straining the structure. The ribs also yield during the process of

FIG. 162.



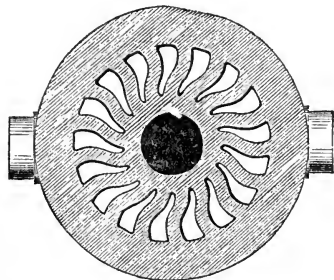
Wiard's cast-iron gun.

FIG. 163.



Longitudinal section of Wiard's cast-iron gun.

FIG. 164.



Cross-section of Wiard's cast-iron gun.

casting, under unequal contraction due either to unequal cooling or to chemical differences in the metal. They are proposed to be stiff enough to resist the pressure of the powder, and sufficiently flexible to bend under the greater force of expansion—a force limited only by the ultimate strength of the metal. The elasticity of the whole structure would be greater than that of guns without ribs.

**384.** *First.* This gun will undoubtedly cool without serious initial rupturing strains. The whole practice in founding, especially in founding car-wheels (which a cross-section of the gun resembles), warrants this conclusion. A plain disk wheel, not annealed,\* can only be stretched or compressed, and so broken or greatly strained, in cooling, and therefore goes to pieces under service. A gun when so corrugated as to bend in cooling at some thin part intended to be bent, instead of breaking or being severely strained at some part that cannot be bent, endures more hard service than would be ordinarily expected of cast-iron.

\* Messrs. A. Whitney & Sons, of Philadelphia, the most extensive car-wheel manufacturers in the world, cast plain disk wheels, which are afterwards annealed for

**385.** *Second.* For the foregoing reasons, the strongest iron may be employed. It has already been shown that a pure, high iron of great tenacity, shrinks too much to make a safe casting by other plans. But car-wheels are cast as sound from the highest and strongest iron as from a weaker iron, because ample provision is made for it to change its figure more or less, as required, without strain.

**386.** *Third.* Upon the proper tension and strength of the reinforce as modified by its large diameter, the heat of firing, and the elasticity of the parts within it, depends, after all, the chief strength of the gun.

Comparing the reinforce with an equal thickness of metal on the exterior of Captain Rodman's gun, the former is cooled on all sides to prevent, as far as possible, unequal shrinkage, and is curved in two directions to prevent unequal and injurious strain due to what unequal shrinkage there may be. The latter is cooled (in practice) only from the outside, so that its interior surface is strained and weakened. It appears, then, that the former would be in a better condition to stand the tension. In which can the tension be the better regulated?

The official report already quoted (375) is evidence that the outer part of the Rodman gun is drawn into *compression* by the subsequent shrinkage of the intermediate metal. It cannot be put into the desired tension except by cooling the gun exclusively from within; and this can only be done by keeping the mould at a temperature of  $2700^{\circ}$ —a process so difficult that it has not been realized in practice. But there is nothing to draw the corresponding part of the Wiard gun—the reinforce—into compression. All the parts enclosed by it have already cooled and set. In other words, the part that cools last, regulates the strain of the rest. The interior and the exterior parts of the walls of the Rodman gun cool independently, and without any great strain. Then the intermediate metal cools, and puts strains into them which are just opposite to those required. But the reinforce of the Wiard

some hours under the highest temperature that will not draw the chill of the tread. The strains which would otherwise destroy the wheels are thus removed.

gun cools last, and, if it shrinks most, must compress the inner tube, and be itself drawn into tension—the required condition.

**387.** As to the strain due to expansion by the heat of firing:—Suppose the reinforce and the barrel to be put under such respective initial tension and compression that the force of the powder would strain them equally, and as much as they would safely bear in service; if the ribs yield under the pressure of the powder, the barrel may be stretched to the breaking point before the reinforce is stretched to the same point. If the ribs do not yield under the pressure of the powder, then they will not yield under an equal pressure from the expansion of the barrel by heat. So that the expansion of the barrel by heat, up to a pressure equal to the pressure of the powder, will act directly to stretch the reinforce which had already been stretched as much as it will bear. Up to this point, the case is similar to that of a solid gun; beyond a pressure equal to that of the powder, the ribs may yield to the pressure by heat without straining the reinforce as much as it would be strained in a solid gun.

But the barrel will not be heated as much as the corresponding part of a solid gun, because it is exposed to the air on both sides, and presents a large radiating surface. Besides, the longitudinal expansion of the barrel is the source of the greatest strain, and this, in the Wiard gun, is provided for by the longitudinal corrugation of the ribs.

**388.** The larger diameter of the reinforce is a source of comparative weakness.

**389.** On the whole, it is probable that the barrel and ribs of Mr. Wiard's gun can be cast without serious strains; that the reinforce can be shrunk upon them with some degree of tension; that the strongest iron can be used; and that the gun will not be seriously strained by heat. The failure of the first guns, if they should fail, ought to be attributed to the improper carrying out of the principles; for the present knowledge on the subject of cast-iron, however imperfect it may be, defines these principles with much clearness.\*

\* Since the above was written, Mr. Wiard's first gun having been cast upon cores which it was difficult or impossible to remove, has not been bored or tested. His second gun burst at trial.

**390. SHAPE.**—With reference to sudden changes in the dimensions of a gun, Mr. Mallet's theory is, that the principal axes of the crystals arrange themselves in the direction of the flow of heat outwards, and that whenever re-entering angles or sudden changes of dimensions occur, planes of weakness are thereby produced.\* Mr. Longridge is of the opinion† that this explanation depends too much upon what appear to be arbitrary assumptions, to enable him to place much confidence in it. "He has examined carefully many cases of fracture of cast iron, but in no instance has he been able to satisfy himself that the crystals have that definite direction which would justify him in determining thereby a plane of weakness. They have always appeared to be a confused mass of more, or less, defined crystals, but certainly not so arranged that he could ascertain any uniform direction of what Mr. Mallet calls their principal axes." Mr. Longridge thinks, "that without having recourse to this theory, the law of cooling alone will fully account for the source of weakness in the cases in question. Whenever a variation in thickness occurs, a difference in the rate of cooling must also take place. This alone must give rise to a state of *varied* stress amongst the particles of the metal, which, without doubt, diminishes its efficiency as a resisting substance. \* \* \* Take, for instance, the accompanying sketch of a gun (Fig. 165) distorted in its proportions for the sake of illustration, and suppose it to have cooled down after casting. Although in the present state of knowledge on the subject, it would be impossible to determine the absolute position of the isothermal lines at any period of cooling, yet it is certain they must approximate to the dotted lines shown in the sketch; and following these lines according to some definite law, would be the lines of equal stress of the particles of the gun when cold. \* \* \* Whenever a change of dimensions occurs, the cooling will give rise to varying strains, which may account for fracture taking place at those particular places."

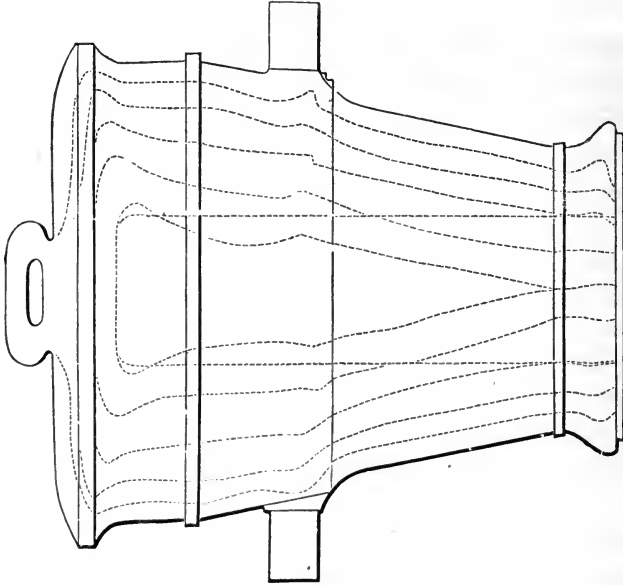
The shaping of guns so that each part shall bear only the

\* "On the Physical Conditions involved in the Construction of Artillery," 1856.

† "Construction of Artillery," Inst. Civil Engineers, 1860.

strain imposed upon it without waste of material, has been well considered by American designers (149). That it adds nothing to

FIG. 165.



Gun distorted to show the effects of irregular cooling.

the cost of a cast gun, is an obvious advantage of cast iron and bronze over wrought iron and steel.

**391. RESISTANCE TO CONCUSSION AND WEAR.**—The hardness of cast iron as compared with wrought iron and bronze, enables it to better resist change of shape by pressure and abrasion. The chambers of wrought-iron guns almost invariably enlarge under high charges, and rifled projectiles often cut away their rifling. The Parrott cast-iron 100-pounder has fired 1000 expanding (brass ring) projectiles without injurious enlargement or wear.

**392. WEIGHT.**—The great weight of cast-iron guns for a given strength, is not, in all cases, a serious objection. As far as preventing excessive recoil is concerned, the recent improvements in compressors will allow much of the present weight to be dispensed



with. On the other hand, the very light steel guns of Mr. Krupp have been set in heavy cast-iron jackets which add no strength, simply to relieve the recoil. This is chiefly a question of situation and cost. In a fort, a few thousand pounds increased weight at a few thousand dollars reduced cost per gun, would be desirable if the question could be considered independently of strength. On the other hand, an armament of 11-inch guns is said to impair the sea-going qualities of some of our lighter-gunboats and cruisers. Nor can such guns be handled on small vessels, in rough weather.

**393.** Cost.—The principal argument in favor of cast iron as a material for guns is its cheapness, compared with wrought iron or steel. To convert and shape the latter, at a great expenditure of fuel and labor, wear of machinery, and loss of material, costs in England, where prices are lowest, from 20 to 40 cents per pound; the cost of large guns increasing faster than their weight. Melting cast iron, preparing the moulds, and dressing the surfaces already shaped, can be done for from 7 to 13 cents per pound, which is about half the cost of wrought iron for a given calibre (Table 27). But calibre is not always a measure of work. If cast-iron guns will not stand the necessary powder, they are a waste of money, however cheap. But if a fixed sum to be invested in guns will not purchase enough of the best to defend every available point, it is undoubtedly better to have a part of them cheap, at the risk of their being weak. But it does not follow that they should all be weak because weak guns are cheap.

Cast iron may be utilized, however, without making weak guns. When reinforced with wrought iron or steel, and especially when *lined with steel* on the plans described, it is both cheap and strong. On the other hand, nothing but the best, at any price, should be placed in the better class of iron-clad ships, since here they not only are in a position to do the best work, but should make up in efficiency what they lack in numbers.

SECTION III. WROUGHT IRON.

**394. STRENGTH.**—Cast iron is in such a crude state that the number and proportion of its deteriorating ingredients are irregular, and in practice imperfectly known, while wrought iron, being comparatively refined, is not necessarily so various in quality, and it is very much stronger. “The conversion of cast into wrought iron by the removal of carbon and silicium completely changes the characteristics of the material. It has lost the brittle property; it now yields and stretches before it breaks; the permanent yielding point is now higher than the former breaking point, and the breaking point is double that of the yielding point.”\*

**395.** The average tensile strength of the best qualities of wrought iron, is about 60000 lbs. per square inch, or about double that of the best qualities of cast gun-iron. The range of good brands, according to Nystrom,† is from 56000 to 65000 lbs.; according to Haswell,‡ 60000 to 72000 lbs.; according to Templeton,§ 64000 lbs. for American, and 55872 lbs. for English. Whildin|| gives the table (56) of tensile strength:—

TABLE LVI.—TENSILE STRENGTH OF WROUGHT IRON.

Bar Iron.	{	Salisbury, Conn. ....	66000 lbs.	} Franklin Institute.
		Bellefonte, Pa. ....	58000 “	
		English. ....	56000 “	
		Pittsfield, Mass. ....	47000 “	
		Maramec, Mo. ....	43000 “	
	53000 “			

According to Mr. Kirkaldy, the highest mean for English rolled bars is—

	Lowest.	Highest.	Mean.
Govan B. Best, $\frac{3}{4}$ in. round.....	61864	66553	64795

\* Mr. Anderson (Superintendent Royal Gun Factory), Journal Royal United Service Inst., August, 1862.

† “Nystrom’s Mechanics,” 1862.

‡ “Engineers and Mechanics’ Pocket-Book,” 1860.

§ “Engineers and Mechanics’ Pocket Companion,” 1854.

|| “Experiments on Wrought Iron and Steel,” 1862.

The lowest mean for English rolled bars is—

	Lowest.	Highest.	Mean.
Ystalyfera puddled, $\frac{3}{4} \times 1$ in. flat.....	36979	40977	38526

TABLE LVII.—SUMMARY OF RESULTS OF KIRKALDY'S EXPERIMENTS\* FOR BRITISH HAMMERED IRON.

	Lowest.	Highest.	Mean.
Scrap iron, forged down.....	52665	54070	53420
Bushelled iron, do. do.....	54070	57526	55878
Crank shaft, scrap iron, cut out, length.....	46450	49671	47582
do. do. do. do. ....	43420	44561	43759
do. do. do. cross .....	44453	44703	44578
do. do. do. do. ....	32582	40467	38487
Armor plate, do. do. do. ....	36646	40745	38868
do. do. do. do. ....	34614	39213	36824

Mr. Kirkaldy says: "The breaking strain per square inch of wrought iron is generally stated to be about 25 tons for bars, and 20 tons for plates. This corresponds very nearly with the results of the writer's experiments." According to Mr. D. K. Clark,† the best Yorkshire boiler plates averaged 25 tons (56000 lbs.); the best Staffordshire, 20 tons (44800); the best American, 70000 lbs.; and ordinary American, 60000 lbs. Mr. Clark's authority as to the American plates is Mr. Zerah Colburn.

Mr. Anderson states‡ that the average strength of the coils of the Armstrong gun, in the direction of their circumference, is 55500 lbs. The specification to the makers of the iron prescribes a tenacity not to exceed 65000, nor to fall below 56000 lbs.

The foregoing figures are intended merely to give a general

\* "Experiments on Wrought Iron and Steel," 1862.

† "Recent Practice" in the Locomotive Engine, 1860.

‡ "Journal of the Royal United Service Institution," August, 1862.

view of the tenacity of wrought iron. Its elasticity and ductility under various treatment, and the qualities adapting it to particular uses, are not measured exclusively by tensile strength, and have been referred to.

**396. UNIFORMITY.**—Although there is a wide range of strength between the highest and lowest specimens of wrought iron, it is practically much more uniform than cast iron, that is to say, the iron for a given service can be selected with much more certainty. The armor-plate iron tested by Mr. Kirkaldy indeed averaged but about 37000 lbs.; but it has been found that softness and ductility are better indices of fitness for this particular service. The low strength of both the armor-plate and the crank-shaft (45670 lbs.) were in some measure due to the process of manufacture—forging a large mass solid. This, however, is an argument against the process only, if it can be shown that any other process can utilize the full strength of the material.

On the other hand, it appears, from Mr. Longridge's statement (356), that the cast iron sent to Woolwich for test—each maker undoubtedly supposing his own the best *for guns*—varied in strength all the way from 10080 to 33600 lbs. The mere fracture of wrought iron (including puddled steel, which is in this particular the same) affords such evidences of its quality, that, by this test, the most uniform products—such as Low-Moor tires, and Krupp's and Vickers' steels—are compounded. Mr. Anderson says\* on this point: Wrought iron "is never high, nor never low; on the contrary, wrought iron from any particular maker, who is careful in the manufacture, is found to be nearly uniform, and, being possessed of great toughness, and being without brittleness, it is exceedingly reliable so far as its strength will permit."

This, indeed, is a second advantage of a refined metal over a crude one. At each stage in its progress its character is better understood.

Another source of embarrassment in the use of cast iron—the unfitness of the finest and strongest varieties for guns (358)—

\* "Journal of the Royal United Service Institution," August, 1862.

applies only in a limited degree to wrought iron, and arises from other causes. In fact, the wide range of defects in *founding*, though not all serious defects in *fabrication*, are avoided by the use of wrought iron and steel.

**397.** What has been said of the average deterioration of cast iron, during the last half-century, appears to be true of wrought iron. Mr. Hughes remarks,\* that “writers on the strength of materials in the last century seldom assigned to bar-iron a less tensile strength than 30 tons per square inch as the weight which would tear asunder a bar of ordinary wrought iron 1 inch square. Thus, Emerson gives the tensile strength of bar-iron at 34 tons; Telford, 29·29; Drewry, 27 tons; while at the present day Templeton gives 25 tons; Beardmore, 26·8; Brown, 25 tons; and Eaton Hodgkinson, probably from more careful experiments than any other, at 23·817. The iron manufacture of this country (Great Britain) has attained an enormous development, which, unfortunately, has not been accompanied by a corresponding increase of quality. On the contrary, all the early experimenters on iron found a greater strength than is now possessed even by the best qualities.”

**398.** This deterioration is attributed to various causes, such as “cunning chemical secrets,” which enable manufacturers to work up inferior iron, and the “spirit of speculation,” which in some measure account for it. But so long as processes—smelting, puddling, piling, &c.—deal with ore and iron as if they were always uniform, irrespective of chemical differences, just as certain systems of medicine deal with human bodies, irrespective of constitutional and intellectual diversities, the means and opportunities of general improvement will be wanting, and any relaxation of care and faithfulness will necessarily lead to the deterioration of the product. The selection, compounding, and elimination of materials on account of their *chemical* relations to the desired result, is the new system of treatment, as yet but approximately developed in the Bessemer process, but destined to lead to much

\* “The Artisan,” February, 1858.

greater uniformity and certainty in the adaptation of iron to its various service.

**399.** DETECTION OF WEAKNESS.—Unmistakable evidence of failure, when it approaches, is obviously the function of gun-metal next in importance. As a matter of professional experiment, the detection of the coming fracture of cast-iron guns may undoubtedly be determined from minute cracks and other delicate tests. But from the fact that cast iron breaks in the testing machine at the instant of perceptible elongation, these evidences must be vague to the professional observer, and quite obscure to the persons throughout the fleets and fortresses of a country, who are in a position to decide the matter, however faithfully they may be looked after.

Wrought iron and low steel continue to stretch after the point of permanent elongation. Mr. Anderson states\* that “from several hundred experiments that have been made with wrought iron cut from bars intended for the manufacture of Armstrong guns, the following result has been obtained: The point of yielding permanently, gives an average resistance of 28000 lbs. per square inch, while the point of ultimate rupture gives an average of 57120 lbs., or rather more than double that of the point where permanent elongation commences; the margin that lies between these two amounts is of great importance as a condition of safety.” In heavy forgings, the yielding and breaking points, although both lower, were found to be in about the same proportion. Mr. Anderson says that “the average point of yielding permanently was 23760 lbs.—average point of ultimate fracture being 48160 lbs. The forgings from which the specimens were cut were all of high quality.”

The fact that out of some 3000 Armstrong wrought-iron guns, not one has burst explosively, or without giving warning, is completely satisfactory evidence on this point.† The bursting of several solid wrought-iron guns without warning—the *Princeton's*

\* “Journal of the Royal United Service Institution,” August, 1862.

† Two 40-pounders are said to have burst into small pieces under the extraordinary service of proving vent-pieces.

gun (426), for instance—is known to have been due to the degradation of the iron in the process of fabrication. The Committee of the Franklin Institute found by experiment that the iron of this gun had deteriorated 50 per cent. during its fabrication, from over-heating.

**400.** This refers to a gun made wholly of wrought iron. The authorities do not agree as to the use of wrought-iron hoops on cast-iron guns. Captain Blakely and others in England say that its limit of elasticity is too low to allow the necessary tension. If this limit is exceeded, or if, under constantly recurring strains, the particles readjust themselves, and acquire a new limit of elasticity, the rings will, after a time, cease to compress what is within them. Captain Parrott uses better iron, undoubtedly, and finds no sensible change of figure in a wrought-iron reinforce after the gun has been fired 1000 rounds. This, however, is under low pressures compared with those that will be required for punching modern armor.

**401. RESISTANCE TO COMPRESSION AND WEAR.**—One of the desiderata for gun-metal is thus specified by Mr. Anderson in the paper before quoted:—"That the material shall be sufficiently hard, so that the surface of the interior of the bore shall not in any way be indented or bruised, or otherwise acted upon by the powder or projectile, or even by the premature fracture or explosion of a cast-iron shell within the bore." He then gives the details of a series of important experiments made at Woolwich to determine the relative fitness of gun-metals in this particular. It is remarkable, that in resistance to compression, cast iron, wrought iron, and steel, are more nearly alike than in any of their other properties.

"The pressure per square inch which is required in either metal to produce a permanent, sensible indentation or shortening, about equal to  $\frac{3}{1000}$  inch in measurement, ranges from 30500 to 40700 lbs."

"Ten specimens, parts of guns of the highest quality, but which have been severally burst, gave 35000 lbs. per square inch; producing an average compression of  $\frac{3}{1000}$  of an inch; the softest being 30000 lbs., the hardest 40300 lbs."

“Ten specimens of rolled wrought-iron bars, made specially for guns, the specimens being selected at random and reduced from bars 3 inches square, all of the highest quality and suitable for guns, gave an average of 33000 lbs. per square inch, with an average compression of  $\frac{3}{1000}$  inch; the softest requiring 31000 lbs., the hardest 35000 lbs.”

“Ten specimens of wrought iron, cut from large forgings of superior quality, gave an average of 26900 lbs., producing an average compression of  $\frac{3}{1000}$  of an inch; the softest being 22800 lbs., the hardest 31000 lbs.”

“Ten specimens of soft cast steel of the finest quality, and that either withstood the proof-rounds, or which failed before the 7 proof-rounds were completed, gave an average of 35500 lbs. per square inch, with an average compression of  $\frac{3}{1000}$  inch; the softest being 25000 lbs., the hardest 46000 lbs.”

“Ten specimens of cast steel more highly converted than the former, and in quality almost fit for cutting-instruments, but which broke first round at proof, gave an average of 76000 lbs. per square inch, with an average compression of  $\frac{3}{1000}$  inch.”

“A specimen of cast steel, cut from a gun made by Mr. Krupp, of Essen, cut from a gun which failed at first proof,\* gave 25300 lbs. per square inch, with a compression of  $\frac{3}{1000}$  inch.”

“Four specimens of steel and iron, welded together like layers of sandwiches, gave in the direction of the fibre, that is, pressing the steel and iron upon the edge of the sandwich, an average of 26000 lbs. per square inch, with an average compression of  $\frac{3}{1000}$  inch.”

“Four specimens upon the flat of the sandwich, thus pressing the two metals closer together, gave an average of 25400 lbs. per square inch, with an average compression of  $\frac{3}{1000}$  inch.”

“It will thus be seen, according to these experiments, which were all made on carefully prepared specimens, exactly 1 inch in length and  $\frac{1}{2}$  inch in diameter, that the average resistance to  $\frac{3}{1000}$  inch compression, or shortening, was as follows:—

\* From causes (138) that Mr. Anderson does not mention.



TABLE LVIII.—RESISTANCE OF IRON AND STEEL TO COMPRESSION.

1. Cast steel.....	35500
2. Cast iron.....	35000
3. Wrought-iron bar.....	33000
4. Wrought-iron forgings.....	26900
5. Sandwich steel and iron on edge.....	26000
6. Sandwich steel and iron on flat.....	25400
7. Krupp's cast steel.....	25300

The low resistance of Krupp's steel to compression, is the test of a single specimen. The fact that the star-gauge showed no compression in a gun of this steel, after 3000 rounds and an unusually severe additional test (137), is evidence of at least sufficient hardness.

**402.** The chambers of wrought-iron guns have been permanently indented by the powder-gas. In the paper last quoted, Mr. Anderson says:—"In wrought-iron guns, which have resisted proof successfully, minor defects will sometimes appear after a number of ordinary service rounds; such defects have required a repetition of charges to bring them out into view for examination, each successive round acting like the blow of an enormous sledge-hammer, and gradually producing an alteration of form in the bore or in other parts of the structure."

Mr. Anderson testified before the Defence Commission,\* speaking of the Armstrong wrought-iron gun, that "the effect produced with high charges is very considerable in compressing the iron, altering the dimensions of it. \* \* \* In the larger guns that have yet been tried, there is more effect produced than in the smaller ones. \* \* \* We find the larger guns are affected to a small extent; they seldom come back from the proof the same size that they went away." In answer to various inquiries, Mr. Anderson stated that the 100-pounder was considerably enlarged in diameter by the first few rounds, and that the smaller guns also gave way to some extent.

**403.** On another occasion† Mr. Anderson said that he wished

\* "Report of the Defence Commissioners," 1862.

† "Report of the Select Committee on Ordnance," 1862.

to use a hard wrought iron to avoid indentation, but that "the harder we get it, so the greater is the liability to non-welding; now, the chances are, when the iron is hard, that some portion is unwelded, and then the powder acts upon that part of it, and very soon makes it appear worse, and renders it necessary to withdraw the interior of the gun, and put in another lining."

He also said that "the material which Sir William Armstrong is inclined to trust in is wrought iron, which has many defects, one of its greatest defects being its softness, or a liability to be indented; we are now using wrought iron with a capacity of resisting a pressure of 33000 lbs. on a square inch, but that is much too soft; the capacity of resisting pressure should be very nearly 50000 lbs. to the square inch, to produce a sensible compression; still wrought iron is very defective, for when the gun comes to be put together, if we make it of hard material, an effect which is produced from having carbon, which leads to blistering and to defects in the welding, so that when the gun comes to be proved the bore may be defective, and has to be taken out and another put in. In commencing the manufacture, we applied to seven or eight of the first houses for the kind of material which we required, but none of the iron we obtained was fit for our purpose; it was full of blisters, and did not weld properly, the consequence being that many of the guns had to be half made over again. By and by some of the makers having greater aptitude than others in seeing what we wanted, we obtained better iron, and our iron is now tolerably good, with a power of 33000 lbs. to the square inch of resisting compression inside, and an ultimate tenacity represented by 57120 lbs., as the strength of the iron in the outward direction, but the strength of the iron coils in the lateral direction are different."

Sir William Armstrong said before the Defence Commission, with reference to his own gun:—"With a long shot and such a charge as would give a high velocity there would be risk of injuring the gun. The gun would also have to be inconveniently long. If you fire a long shot with a very heavy charge, you attain a point at which the material begins to crush; the metal in the chamber yields to the

pressure, and is displaced; the gun begins to lose its form, and therefore it is desirable to keep your velocity moderately low.”

**404.** Table LIX. shows the permanent enlargement of a 40-pounder (4.75 in.) gun made by the Mersey Co., under 117 rounds with increasing charges. The celebrated Horsfall gun is enlarged at the seat of the charge.

Instances of the failure of Armstrong guns from this cause, are mentioned under another head. (See 444 and Table 64).

TABLE LIX.—EXPANSION OF 40-POUNDER RIFLE MADE BY THE MERSEY STEEL AND IRON COMPANY.

(From the Report of the Select Committee on Ordnance, 1863.)

Position of Enlargement.	Vertical Expansion.		Horizontal Expansion.	
	From Breech-end.	Increase in Diameter.	From Breech-end.	Increase in Diameter.
	Ins.	Ins.	Ins.	Ins.
In powder-chamber, original diameter, 4.96 in. {	2	.031	2	.025
	6 $\frac{3}{4}$	.046	6 $\frac{3}{4}$	.044
	12 $\frac{1}{2}$	.068	12 $\frac{1}{2}$	.064
In shot-chamber, original diameter, 4.825 in. {	14 $\frac{1}{2}$	.095	14 $\frac{1}{2}$	.087
	20 $\frac{1}{2}$	.374	20 $\frac{1}{2}$	.314

The gun was rifled like the Armstrong 40-pounder. It fired 100 rounds with the service charge of 5 lbs., and cylinders increasing in weight from 40 to 400 lbs.; also 17 double service charges of 10 lbs., and a 40-lb. shot.

The bore is also deeply fluted all round from 75 inches from the muzzle to the end of the powder-chamber.

**405.** This is the principal objection raised in England against wrought iron. It may become a serious defect under the high pressures which future guns will have to endure.

But this indentation of the iron decreases its thickness and increases its length, that is, draws it as under a hammer. As far as this is done, without reducing its strength, the result, in a solid-

forged gun, without initial strains, is undoubtedly beneficial, because it tends to put the interior metal into compression, and the exterior metal into tension, so that both will be more equally strained at the instant of firing (287). But if the proper initial strains have already been adjusted, as in a hooped gun, the enlargement of the interior metal by pressure or heat tends to derange them, and to weaken the gun. As to the compression, Mr. Anderson says\* that after a time the iron becomes set and does not farther enlarge, and that "it becomes very hard after a little." It therefore becomes more like steel, and is better able to resist the wear of the projectile.

**406.** The hardness of metals—their resistance to abrasion such as the wear of projectiles—approximates to their resistance to compression. The average hardness of steel is highest, and that of wrought iron lowest. Cast iron is so well adapted for this purpose, as to fire 1000 rifle projectiles without sensible injury (80). The wearing down of the grooving in wrought-iron guns is not of unfrequent occurrence. This result is aggravated by the comparative purity of the material and its greater corrosion by the powder-gas. In case of coils, the effects of this corrosion, and of oxidation when the gun is damp, are observed in the form of minute grooves running with the grain of the iron. The Armstrong multigroove rifling crosses these nearly at right angles, so that the bore, thus acted upon, would present a surface of minute ridges and spikes. But steel and cast iron are not grooved or furrowed by corrosion; they are smoothly and evenly reduced.

**407.** WANT OF HOMOGENEITY.—The grand defect of wrought iron is, that it is not homogeneous. The puddling process by which it is produced, the piling process by which large masses are aggregated, and the welding process by which all parts, large and small, are united, are all the means of interposing strata of impurities and planes of weakness.

**408.** WELDS.—Wrought iron cannot be produced from the pig-metal in larger masses than puddle-balls weighing from 200

\* "Journal of the Royal United Service Institution," August, 1862.

to 300 lbs. Before these can be brought together, to be welded into a bloom, the surfaces oxidize and prevent a perfect union. Large masses are formed by welding small pieces to the end of a bar; the entire surface of each piece being exposed to oxidation. It is also difficult to prevent the enclosing of cinder in some points instead of squeezing it out. Small welds, made under a hand-hammer, with a uniform heat, are, of course, much better; and these are weaker than the solid bar. Mr. Anderson\* found that two bars of the finest quality of iron, properly heated in a fire free from impurities, could be welded together in such a manner as to be as strong as the solid bar (56000 lbs.) only by scarfing them, and so increasing the surface that the welded area was much larger than the fractured area.

“With all other descriptions of welding,” says Mr. Anderson, “which I have yet tested, the result is lower than the above, down even to 12000 lbs. per square inch, the same care having been observed in every instance. Two pieces of the best quality of iron butted together, under the best conditions which I have been able to effect up to the present time, have only given an average ultimate tenacity of 32140 lbs. per square inch, which is only a little over the half of the iron bar.

“Iron butt welded to steel under the best conditions invariably breaks at the weld, and shows only an average tenacity of 26800 lbs. But even this depends entirely on the nature of the iron and steel; any increase of hardness, or of the steely property, either in the iron or in the steel, affects the strength of the weld in many cases down to 10000 lbs., and even still lower.

“In the construction of the Armstrong guns, the bar iron is first wound into a spiral coil, and then a welding heat is taken through the entire mass, and by means of a steam hammer it is welded into a homogeneous cylinder. With iron of the very best quality which we have as yet been able to obtain, the highest average tenacity of the welding of the coil has been 32140 lbs. per square inch, the iron being 55500 lbs.

\* “Journal of the Royal United Service Institution,” August, 1862.

“With other iron, also of a high quality and of a still greater tenacity, the welds have been lower down, even to 10000 lbs. per inch; hence such iron, however strong, is, from the steely property, unsuitable for being made into coils; the defect being due to the reluctance shown by harder and stronger iron to unite when raised to a temperature that will not otherwise injure the quality of the material, and cause it to blister.”

Mr. Kirkaldy concludes\* that “a great variation exists in the strength of iron bars which have been cut and welded; whilst some bear almost as much as the uncut bar, the strength of others is reduced fully a third.”

**409.** SHAPE.—A solid-forged gun may be turned down to the Dahlgren form (see Ames’s gun, 129), so as to have the greatest strength with the least weight. The cost of this operation, although considerable, is much less than that of turning the rings of a built-up gun, without and within.

**410.** The outline of a hooped gun is almost necessarily a series of sharp curves and right angles. The weakness already explained, of cast-iron guns with re-entering angles, is obviously due to the process of casting, and would not apply to a built-up gun. It is well known, however, especially in the case of railway axles, that a sharp shoulder turned in a bar of iron or steel subjected to continuous shocks, is a source of weakness, and the almost certain starting point of a fracture. So far as the fracture arises from the unequal vibration of the adjacent parts, there would appear to be no difference between forming these shoulders by turning a large bar down to different diameters, and building a small bar up to the same diameters by shrinking on rings. A railway axle is a beam, and the staves of which a cannon may be supposed to consist are beams, and therefore subject to the same sources of weakness. Still, the practice with wrought-iron guns does not yet appear to have demonstrated any particular tendency to fracture at the junction of a larger with a smaller cylinder. Perhaps the large guns thus constructed have shown a tendency to fail in other

\* “Experiments on Wrought Iron and Steel,” 1862.

places before there was time for this source of failure to develop itself. The reinforce of the Parrott 100-pounder is 6·4 inches larger in diameter than the cast-iron barrel within it, and hence vibrates much more slowly under a given shock; and it joins the barrel at a sharp angle. No fracture occurred at this junction or elsewhere, after 1000 rounds with service charges; and it is stated by Captain Parrott, that the few guns of his that have burst did not fail at this point. (See note in Appendix.)

**411. WEIGHT.**—The saving of weight by substituting wrought for cast iron, is theoretically about in proportion to the respective strength of the two materials. Wrought iron has the greater specific gravity; on the other hand, its tensile strength does not fully measure its resistance to internal pressure. Practically, large, solid wrought-iron guns are not proportioned by this rule, because the strength of a *bar* cannot be relied on in a gun—that is to say, the process of welding a strong metal is rather less trustworthy than that of casting a weaker one. The 13-inch Horsfall wrought-iron gun carries a 279 lb. shot with 74 lbs. of powder. The 15-inch Rodman cast-iron gun carries a 425 lb. shot with 60 lbs. of powder. So that the strains on these guns cannot differ in a very great degree. The former, with a tensile strength of 50000 lbs., weighs 53846 lbs., while the latter, with a tensile strength of say 30000 lbs., only weighs 49100 lbs. The Alfred 10-in. wrought-iron gun weighs 24094 lbs, and has been fired only with 20 and 30 pounds of powder, although it is undoubtedly competent to stand 50 lb. service charges. The new 10 inch cast-iron Dahlgren gun weighs less than 20000 lbs., and for some time stood 47 lb. service charges. The 10-inch Rodman army gun weighs 15059 lbs., and burns 18 lbs. of powder. In the built-up form, wrought iron is more trustworthy, and can be made lighter, although weight is not reduced in proportion to tensile strength in the smaller Armstrong guns.

This source of embarrassment is avoided by the use of cast steel, which is not only stronger than wrought iron, but homogeneous and without welds.

**412. COST.**—The cost of large wrought-iron cannon is about double that of cast-iron cannon of the same calibre, or of the same

power, when (because welds cannot be trusted) equal weights of material are used in both cases. (See Table 27 of Cost of Guns.)

In fabricating guns, the first necessity is the production of a large mass of material. While melted cast iron and steel run into castings of any size by their own gravity, wrought iron is not melted at a practicable heat, so that a new process must be resorted to. If the gun is forged solid, the process consists in adding a little at a time under the hammer, and trimming off a great deal of scrap. Seven weeks were occupied in forging the Horsfall gun. If the gun is built-up, small pieces are fitted together by tools, at a still greater cost. When all this is done, it is not homogeneous.

Refining and strengthening the material is substantially a separate operation. Steel is drawn and condensed after the mass has been formed; wrought iron, before. The inventions of Bessemer and others are constantly reducing the cost of forming steel masses from the pig-metal, by substituting chemical processes that require very little aid from hands or tools.\*

**413. Systems of Fabricating Wrought-Iron Guns. SOLID FORGING.**—The defects of this process have been alluded to. The first and most serious is the liability to imperfect welds between the great number of pieces. Were the pieces fitted to each other, uniformly heated, and sufficiently pressed together, the welds between *raw* iron, after a large amount of subsequent compression would be good. It has been found that large pieces of *refined* iron do not weld soundly by the rolling or forging process. Old railway rails of the finest quality when re-rolled into new rails without a large admixture of raw iron, are usually very unsound. There does not appear to be either cinder or pressure enough to insure a thorough union.† The blacksmith makes an artificial cinder to unite refined irons, and the compression from the blow of his hammer is greater in proportion to the mass, than that of

\* Low steel, formed by carbonizing wrought iron or by decarbonizing pig iron by the Bessemer process, is often called wrought iron, because it is not *hard* like high steel. But it much more closely resembles high steel than wrought iron. Low steel produced by the puddling process may be more reasonably called high wrought iron.

† "European Railways," Colburn & Holley, 1858.



the machinery employed for heavy work. He can also be very exact about his heats. Cast iron has the maximum amount of cinder; two pieces of it, heated to welding, that is, to the melting point, unite perfectly. Two raw puddle-balls weld soundly, although the mass would be weak throughout in the absence of farther drawing.

Mr. Roebling\* refers to the same subject, in stating his ingenious theory to account for the weakening of wrought-iron structures under vibration—viz.: the loosening of the iron threads and lammæ in their cinder envelopes.

**414.** The importance of forming the mass before the iron is purified and the cinder expelled, is therefore evident. Puddle-balls cannot well be handled if above 300 or 400 lbs. weight. If 100 of these could be forged at once into a mass, and afterwards worked into a gun in such a way as to expel the then superfluous cinder, the product would be more homogeneous and trustworthy.

**415.** The slabs or bars of which a large gun-forging is composed, are not fitted beforehand. The flat sides of two slabs may be soundly welded, but the irregular edges and ends do not always happen to be pressed together hard enough to make sound work; so that there are scarf-welds, butt-welds, and no welds, or, rather, seams between parts that either do not touch at all, or are only stuck together by cinder (426). The tendency of the drawing process under the hammer or the rolls is to squeeze out cinder. But if the edges of a slab happen to be united to the mass before the centre, an excess of cinder is shut in and prevents a farther union of the metal. Large cavities are sometimes left in such forgings. If the forgings are farther drawn, under the hammer or rolls, these cavities are not only flattened into long, wide seams, but the seams run in the direction of the grain, thus weakening a gun at the point most strained by internal pressure.

**416.** The welding temperature of various irons is not always the same. One part may be burned before another is sufficiently

\* "The Engineer," London, Jan. 25, 1861.

softened. Or, the small slabs may receive much more heat from the fire than the large mass. Mr. Clay, of the Mersey Steel and Iron Works, says on this point,\* speaking of scrap-iron, that various qualities of iron all have their own special welding points. "When worked together, one portion that is less refined is too much heated, and consequently deteriorated, before the more highly refined portions are at a welding heat, and we are thus placed in the awkward dilemma of either burning the one or of being unable to weld the other."

**417.** By the solid-forging process a great body of iron is kept red hot or white hot for weeks. The Committee of the Franklin Institute, in a report on the failure of the United States frigate *Princeton's* wrought-iron gun (426), mention this as a cause of weakness. Mr. Longridge, however, dissents from this view of the case,† inasmuch as he does not believe that long exposure to heat alone will deteriorate the iron, nor that any amount of hammering will restore its fibre." Mr. Kirkaldy's conclusion on this subject is, that "iron is injured by being brought to a white or welding heat, if not at the same time hammered or rolled."\* The finished part of a large forging is kept at a high heat without being again brought under the hammer.

The defect under consideration is admitted by Mr. Clay, who says:† "The change in the structure of a mass of iron, when it occurs during the process of heating, is usually produced from the furnace being urged to a much greater heat than is necessary for welding the iron; in fact, the outside first, and, if the heat be not checked, the whole of the mass is reduced to a pasty or partially fluid condition. The structure of the iron is thus entirely changed, and in the process of cooling the mass, crystallization takes place in the same manner as with other substances which crystallize in passing from the fluid to the solid state. Under these circumstances the iron may be injured—in other words, it may be burned; but we are not to suppose that such a result is either inevitable or

\* "Experiments on Wrought Iron and Steel," Kirkaldy, 1862.

† "Construction of Artillery," Inst. Civil Engineers, 1860.

by any means common; on the contrary, the heat necessary to produce the evil is with difficulty obtained in an ordinary furnace, under the most favorable circumstances."

**418.** The grain of the iron, in a solid-forged gun, runs in the wrong direction. The greatest strain acts in a radial direction. The greatest strength is in a longitudinal direction. The mean breaking strain of six pieces cut lengthways from a heavy crank-shaft\* was found by Mr. Kirkaldy to be 47582 lbs.; from another crank-shaft, 43579 lbs. The breaking strain of six pieces cut crossways from the first shaft was 44578 lbs.; from the other, 38487 lbs. The difference in favor of those cut lengthways was in the two shafts respectively, 3004 and 5272 lbs., or 6·7 and 13·7 per cent. Similar results were observed from iron cut lengthways and crossways from an armor-plate.

The experiments of Mr. Mallet on "The Coefficients of Elasticity and Rupture in Massive Forgings,"† show that "as regards relative resistance to tension in different directions within the same large mass of forged iron of *cylindrical* form, and within the elastic limits, the resistance end on, or in the line of the axis, is  $10\frac{1}{3}$  tons, tangential to the circumference, 6 tons, and transverse to the axis, or in any diameter,  $3\frac{1}{4}$  tons per square inch; while in heavy *rectangular* forged slabs of upward of 12 inches in thickness in the plane of the slab, it rises to  $8\frac{3}{4}$  tons per square inch for equal sections." Mr. Mallet attributes the difference in strength to the difference in molecular arrangement. "The integral crystals of the cylindrical masses are strained, distorted, and partially separated, by the effects of hammering in various directions, and by the peculiar constraining forces due to contraction in cooling. None of these forces act to the same extent upon rectangular masses, which are only hammered in two directions, and the constraining forces of cooling are all parallel to the faces of the parallelepiped, or in these directions also."

**419.** Another defect in the usual process of forging wrought-

\* "Experiments on Wrought Iron and Steel," 1862.

† Paper before the Institution of Civil Engineers, March, 1859.

iron guns is due to the light blows of small hammers, which compress only the shell of the mass, and are not felt at its centre. Steamboat shafts thus made prove defective; but the results are peculiarly bad in the case of guns.

*First.* Only the skin of the iron is soundly worked and condensed. It was ascertained by Mr. Kirkaldy\* that the difference in the breaking strain between specimens cut from the outside of a marine crank-shaft, and specimens cut from its centre, was, in one case, 3221 lbs., or 6·5 per cent.; in another case 1141 lbs., or 2·6 per cent.

*Second.* The outer part of the forging is sometimes expanded and thus drawn away from the centre, leaving the interior weakened, or actually cracked—the exact state of a solid-cast gun.

*Third.* The inner part of the gun is left in tension while the outer part is in compression, which is the opposite state of strain to that required. This defect, however, is the result of inadequate machinery, and does not necessarily follow the use of wrought iron, or even of solid-forged masses of wrought iron.

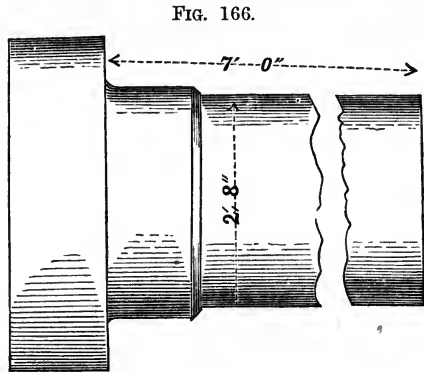
Mr. Clay testified as follows before the Defence Commissioners,† in answer to the inquiry if the limit of manufacture was not reached: “Certainly not with our present machinery. We made that 13-inch gun with machinery as inferior to our present machinery as the 68-pounder is less in size than the 13-inch gun. We have now machinery five or six times as powerful.”

**420.** The initial strains of large cylindrical forgings are to some extent deranged by a cause that operates so unfavorably in solid cast-iron guns—the cooling of the exterior first, and the consequent stretching of the interior (364). Mr. Clay acknowledged this difficulty before the Defence Commissioners, and stated that his new process—hollow forging—overcame it (429). Such a result actually occurred in the case of the Horsfall gun (113). A breech-plug or false bottom was placed in the chamber, to cover a crack arising from this cause.

\* “Experiments on Wrought Iron and Steel,” 1862.

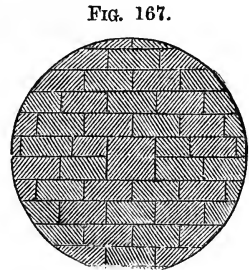
† “Report of the Defence Commissioners,” 1862.

Mr. Mallet, in the paper before referred to,\* gives the following facts and illustrations as to this cause of failure. Two masses, about  $2\frac{1}{2}$  ft. in diameter and 8 ft. long, were forged for two 36-inch mortars which Mr. Mallet was constructing for the British Government. They were slightly tapered, and at one end there was a collar projecting about 6 inches all round, and about 12 inches wide in the line of the axis, presenting laterally the general form shown in Fig. 166.



Forging for Mallet's mortar-chamber.

The masses were forged from puddled slabs of manageable size, "by slabbing up two or more large flat pieces (Fig. 167), laying these upon each other, and welding them together into a rude sort of square prism, which was afterwards partially rounded down, at the corners, under the hammer. These pieces were welded together, apparently, perfectly sound; but after they had become cold, they were invariably found, upon borings being made into the centre, to have large rents internally, with jagged, crystalline, irregular surfaces. \* \* \*



Pile for mortar-chamber.

At first it seemed probable that the rents due to cooling, now to be described, were formed in the direction of the broad planes of the slabs; but more careful and exact examination proved that in more than one case, at least, these rents had undoubtedly been formed across, or at right angles to those planes. \* \* \* The opposite faces of the rents were counterparts, and presented dis-

\* "The Coefficients of Elasticity and Rupture in Massive Forgings," Inst. Civil Engineers, March, 1859.

tinct evidence of having been torn asunder by contraction, from the centre towards the circumference, as the mass cooled." Two of these rents are shown by Figs. 168 and 169. "The limits of

FIG. 168.

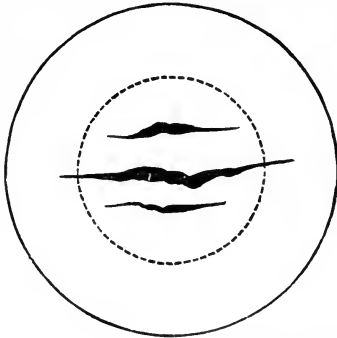
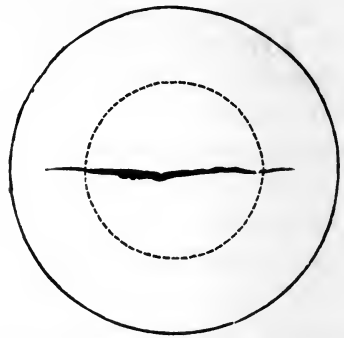


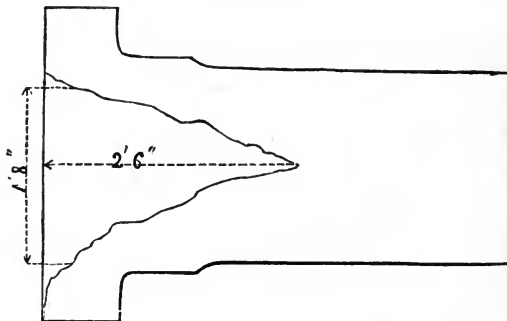
FIG. 169.



Rents in forged masses—from cooling.

the fractures, as seen perpendicularly to their plane, were found to be generally as shown by Fig. 170. The ascertainable extent

FIG. 170.



Section of rent—from cooling—in mortar-chamber.

was from two to three feet along the axis, and usually rather more than half the external diameter of the mass in breadth, measured across the large end. The cracks were from  $\frac{1}{2}$  to  $\frac{7}{8}$  inch open at the widest part, in the centre, and passed off, at each extremity,

to an indefinitely thin wedge. In no case was there a trace of bad welding or of defective workmanship. They were clean fissures, presenting opposite surfaces of solid, sound metal, though rough by being torn asunder. In this conclusion Mr. Clay coincided. On consideration, it appeared that the phenomenon was simply due to contraction on cooling."

**421.** Mr. Mallet reasons that this defect must occur in solid cylinders or conic frustra, "whenever the dimensions are such that the total amount of the contraction of the metal, in any one diameter, from its highest temperature down to that of the atmosphere, as fixed by the circumference of rigidity due to the outer cold shell, exceeds the limit of extension of the iron at rupture, due to the length of the diameter of the interior core, which cools last. This is the theoretic limit of the size of forging, beyond which internal rents must occur.

"If it were possible that a cylindrical mass of forged iron could be increased sufficiently in diameter so as to bring it into evidence, there can be no doubt that the following would be the phenomena resulting from the conjoint reactions of its originally soft condition and uniformly high temperature, its external cooling, contraction, and assumption of rigidity, and the final cooling, contraction, and rigidity of the internal portions: the external surface would rupture in several places, parallel to the axis, and directed to the centre, in the first instance. These fissures would afterwards all close, and the opposite and abutting surfaces would press against each other, like the voussoirs of a circular arch. The internal diametric fissure, or fissures, would then be rent; the external form of the mass would change from a circle to an oval, the minor axis being in the plane of the internal rent; and the whole mass would at length assume stable equilibrium as respects its molecular forces. The change to the oval figure would probably be accompanied with a reopening of some of the external fissures situated towards the ends of the major axis of the oval section."

One great cause of the low measure of strength of material in heavy forgings is, obviously, the drawing asunder of all the par-

ticles in both a tangential and a radial direction. Hence, as the foregoing authority expresses it, "increased distance in both directions between the integrant crystalline faces is produced, and diminished cohesive strength; the proof of this is to be found in the fact that the specific gravity of the material of these great forgings is lower than that of the iron from which they are formed, or than that of small portions of the same fagoted mass."

**422.** During the discussion of Mr. Mallet's paper, some attempt having been made to rebut the author's "assumptions," by a statement that large forgings were, after all, pretty sound and trustworthy, he produced a statement from the manager of the Peninsular and Oriental Steam Navigation Company, to the following effect: During ten years, an average of more than one serious accident had occurred from the breaking of large forgings, principally paddle and screw shafts, every three months, to one or the other of 41 ships. During the last five and a half years (down to 1859), there were 37 such accidents, or nearly one every two months, on the same number of ships. It was assumed that the cost of these accidents, due to the unsoundness of large forgings, would average \$10000 each.

**423.** The comparative strength of heavy and light forgings, according to the experiments of Mr. Kirkaldy,\* is as follows (Table 60):

TABLE LX.—STRENGTH OF HEAVY AND LIGHT FORGINGS.

	Lbs. per sq. inch.
English rolled bars, highest mean.....	64795
Scrap-iron, forged down, mean.....	53420
Crank-shaft, scrap, cut lengthwise, mean.....	47582
do. do do. do. ....	43759
do. do. cut crosswise, do. ....	44578
do. do. do. do. ....	38487
Armor-plate, scrap, mean .....	38868
do. do. do. ....	36824

According to Mr. Mallet's experiments† the tensile strength was as follows (Table 61):

\* "Experiments on Wrought Iron and Steel," 1862.

† "The Coefficients of Elasticity and Rupture in Massive Forgings."



TABLE LXI.—STRENGTH OF HEAVY FORGINGS.

	Tons.
Hammered slab or bar, 12 × 4 inches.....	24·062
Fagoted forged slab, 48 × 48 × 12 inches.....	18·594
Horsfall 13-inch gun, original fagot bars.....	19·688
do. do. longitudinal cut from gun.....	18·839
do. do. circumferential do. ....	16·561
do. do. transverse do. ....	16·562
do. do. charcoal-rolled bar, from borings of gun.....	22·321

**424.** On the other hand, the solid-forging process overcomes a grave objection to the plan of hooping—the fracture and relaxation of parts due to want of mass and continuity (299, 335).

**425.** Only a few large guns have been fabricated by the solid-forging process. Several of these have burst on trial. A wrought-iron 8-inch gun forged at the Gospel Iron Works, and proved at Woolwich on the 17th July, 1855, burst into several pieces at the first discharge, with 28 lbs. powder and 2 spherical shot. The gun is stated to have been of very nearly the same dimensions as the established cast-iron guns of the same calibre.

The thickness at the breech end was therefore about 9 inches. The metal appeared to the eye to be sound and perfect without and within.\*

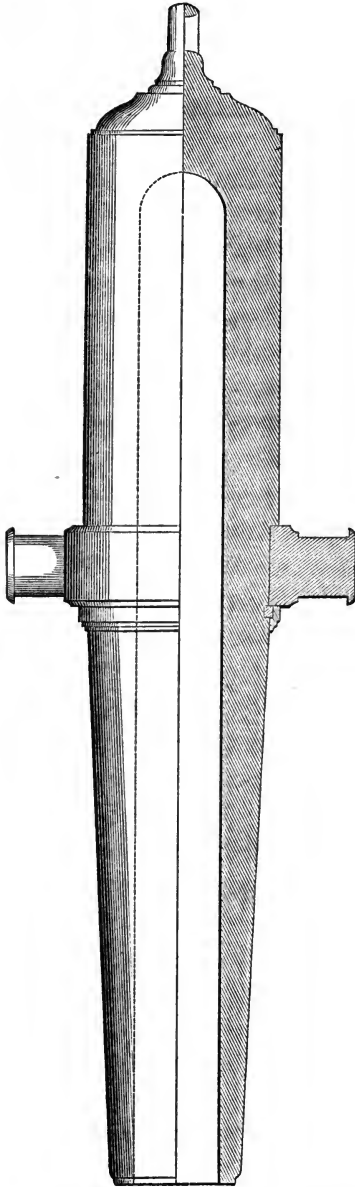
**426.** The most memorable case is that of the 12-inch solid-forged gun, Fig. 171, called the "Peacemaker," that burst on board the United States steamer *Princeton*. The gun was built by Messrs. Ward & Co., under the direction of Commodore Stockton. The 12-inch gun, Fig. 66, now in the Brooklyn navy yard, almost an exact copy, was built by the Mersey Steel and Iron Co., to replace it.

A committee of the Franklin Institute, of Philadelphia, made a detailed examination into the character of the "Peacemaker" gun; from their report† the following facts are compiled: The greater part of the iron of which the gun was composed, was in the shape of bars 4 in. square and about 8½ ft. long. Of these, 30 were laid up in a fagot, welded, and rounded up into a shaft 20 to 21

\* "On the Construction of Artillery," Mallet. Appendix.

† "Journal of the Franklin Institute," Vol. 8, p. 206 (1844).

FIG. 171.



The "Peacemaker" 12-inch wrought-iron gun.

in. in diameter. Iron in the form of segments, varying in weight from 200 to 800 lbs., and usually large enough to reach  $\frac{1}{3}$  round the gun, were then welded on, there being two strata of segments over the breech.

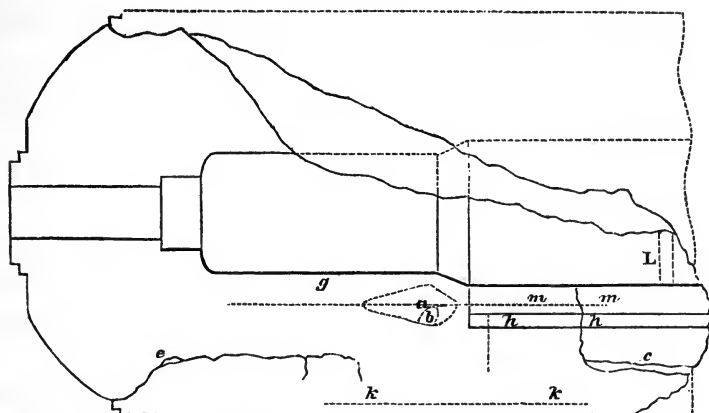
The hammer used weighed 15000 lbs.

The time occupied in the forging, during which the iron was kept more or less heated, was  $45\frac{1}{4}$  days.

The gun was broken across under the trunnion-bands, the chase remaining entire. The breech split into 3 principal pieces, the largest of which, 5 ft. long and embracing half the circumference of the gun, is shown at Fig. 172. A part of the fracture showed large crystals lying in various planes. *Traces of the original bars were observable*; also spots covered with scale. The relative size of one of these ( $10 \times 3$  in.) is shown at *a*. "Besides the spots indicating a want of continuity in the metal in the plane of the fracture, the edges of many others, in different places, were observed; also a wide solution of continuity was seen throughout a cylindrical surface, con-

centric with the bore, and extending, in one place at least, entirely around the fragment. This was evident from the

FIG. 172.



Fragment of the "Peacemaker."

fact that oil, poured in at the upper side, came out at *a*, after passing through a distance, within the fragment, of about 3 feet. Another opening in the prolongation of the cylindrical surface is shown at *c*. The sides of this were separated to a distance of a quarter of an inch, and, by inspecting these, it was evident that they had never been welded; into this opening a wire was thrust to a depth of 10 inches." Several other considerable fissures were observed.

TABLE LXII.—STRENGTH OF IRON IN THE "PEACEMAKER" GUN.

The mean tensile strength per square inch of the original bar was—

1st bar.....	46086 lbs.
2d " .....	38595 "
3d " .....	52521 "

Other experiments made from the same iron gave the following results :

1. The average tensile force with which the specimens from the interior of the gun broke, when strained in the direction of the fibre, is less than... 32100 lbs.
2. The specimen from the interior, strained in a direction across the fibre, gave ..... 23700 "
3. The specimens from the outside of the gun, across the fibre, gave an average of less than ..... 45333 "

4. Annealed specimens from the interior, strained lengthwise of the fibre, gave an average of.....	36067 “
5. The average of all the specimens from the gun, not hammered, is.....	33300 “
6. The average of the specimens, worked down under the hammer, is.....	63475 “

The general conclusions, from these results, are the same as those from the experiments made by the Committee in Boston, so far as the two series can be compared.

1. The average strength of the iron, as it existed in the gun, from both series, is .....	33586 lbs.
2. The average strength of the iron from the gun, after being drawn down with the hammer, from both series, is.....	59824 “
3. The average strength of the original bar from the experiments of the first series, is.....	46950 “

Consequently, taking the original strength as 100, that of the average of the iron, as existing in the gun, was 72, showing a deterioration of 28 per cent.; and if the tensile force of the interior be taken, when strained in a direction across the fibres, that being the actual direction of the strain in the gun, the proportion to the original bar is as 50 to 100, or a deterioration of 50 per cent.

The Committee state, in conclusion, their “opinion, that, in the present state of the arts (in 1844), the use of wrought-iron guns of large calibre, made on the same plan as the gun now under examination, ought to be abandoned, for the following reasons:—

1. The practical difficulty, if not impossibility, of welding such a large mass of iron, so as to insure a perfect soundness and uniformity throughout. 2. The uncertainty, that will always prevail, in regard to imperfections in the welding; and 3. From the fact that iron decreases very much in strength from the long exposure to the intense heat necessary in making a gun of this size, without a possibility, with the hammers at present in use in this country, of restoring the fibre by hammering.”

Experiments were made to determine the tensile strength, 1st, of the original bar; 2d, of a bar cut from the interior of the gun; 3d, of a bar made from a portion of the gun reworked under the hammer.

The mean strength of two large forgings—steamship crankshafts—was found by Mr. Kirkaldy to be 45670 lbs. in the direc-

tion of the grain. Among his "concluding observations" are the following which bear on the subject: "Inferior qualities show a much greater variation in the breaking strain than superior.

"Greater differences exist between small and large bars in coarse than in fine varieties."

From which it may be concluded that large forgings are not only weaker than smaller bars, but less uniform and trustworthy.

**427.** Speaking of wrought-iron guns, Mr. Mallett says:\* "The facts (which he has previously stated) are worthy of notice, as indicating the absolute uncertainty that ever must exist as to the trustworthiness of wrought-iron guns, forged in one great mass, although executed without regard to cost, and by parties anxious faithfully to produce a result of the highest excellence. Some of the evils incident to this gun might have been avoided by greater experience and judgment; but the main evil is inherent, and inseparable from every huge forging, and most so where the weldings are most numerous."†

On the other hand, Mr. Clay, of the Mersey Iron Works, differs from Mr. Mallett, and very justly observes, that "the several failures in the manufacture of wrought-iron guns should not be a matter of surprise; for it is hardly reasonable to expect immediate success in any new fabrication."

**428.** Mr. Clay gives an account‡ of experiments to determine the tensile strength of the iron from which the monster gun (110.)

\* "On the Construction of Artillery," 1856.

† Mr. Anderson says on this subject: "A few years ago it was believed that the proper gun would be obtained by forging. In 1854, when Mr. Nasmyth was at work, the country expected great results. The end of that gun might be said to have been a national disappointment. Since then, there had been the Liverpool guns—a monster mortar, which was referred to in the paper. It was a magnificent forging—the finest he had ever seen—yet it was not a perfect gun. The bore of that gun would never have passed the proof of the artillerist. There were defects in it, and that would always be more or less the case in the heart of all such large structures when forged. At the present moment there were at Woolwich some apparently very fine forgings, which were defective, owing to fissures at the core, and more especially in the chamber at the breech. Therefore he did not think the good gun which all were aiming at would be obtained by the system of forging."—"Construction of Artillery," *Inst. Civil Engineers*, 1860.

‡ "Orr's Circle of the Industrial Arts."

was made, and of the same iron, after manufacture into the gun. The results were as follow (Table 63):—

Taking the average of the first two experiments, and comparing it with that of the following three, there is a decrease of strength of about 13 per cent.; whilst on the other hand, as compared with the 6th, 7th, and 8th, there is a gain of 2 per cent.

Mr. Longridge is of the opinion\* that these experiments are not very conclusive, because “the iron was cut from the muzzle of the gun, and not from the interior at the breech, where the thickness is greatest and the deterioration is necessarily the most.” He sums up the question by saying that “the manufacture of large forged wrought-iron guns is an operation of great difficulty, expense, and uncertainty; and however the difficulty and expense may be decreased, the uncertainty must still remain. Moreover,

TABLE LXIII.—STRENGTH OF IRON IN THE HORSFALL GUN.

Experiment. No.	Description of Iron.	Breaking strain in lbs. per sq. in.	Average.	Sample bars $\frac{1}{4}$ in. long. Elongated in.
1	Original iron of which the gun was made..	48384	49504	$\frac{1}{2}$
2	Ditto ditto .....	50624		$\frac{1}{2}$
3	Cut across the grain from muzzle of gun...	41644	43390	$\frac{3}{8}$
4	Ditto ditto .....	43904		$\frac{3}{8}$
5	Ditto ditto .....	50624		$\frac{1}{2}$
6	Cut with the grain from muzzle of gun.....	48384	50624	$\frac{3}{8}$
7	Ditto ditto .....	50624		$\frac{3}{8}$
8	Ditto ditto .....	52864	61704	$\frac{1}{2}$
9	Borings from gun reworked with coal.....	60584		$\frac{1}{2}$
10	Ditto ditto .....	62824	$\frac{1}{2}$	
11	Borings from gun reworked with charcoal..	76584	76584	$\frac{9}{16}$
12	Swedish iron as imported, $\frac{3}{4}$ inch square.....	60584	60584	$\frac{1}{2}$

\* “Construction of Artillery,” Inst. Civil Eng., 1860.

at the best, it is but substituting for cast iron a material of a higher tensile strength; the radical defect of a homogeneous mass still remaining, viz., the unequal distribution of the strain, from the inner to the outer circumference."

**429. Hollow-Forging and Rolling.** The Alfred gun (115) was forged hollow—a process which, according to Mr. Clay, the maker of this and of the Horsfall gun, overcomes several defects of the system last discussed. He says:\* "We forge our guns hollow, which gets over a difficulty which we had experienced, namely, the tendency to contraction in the breech of the gun, where the metal is exposed to the cooling influence of the air on three sides instead of merely on the two sides, and where, the outside crust getting cool first, a contraction takes place. By forging them hollow, and leaving the breech screwed in, similar to the Armstrong 10½-inch gun, and similar to our Prince Alfred gun in the Exhibition, we get over the difficulty."

This process also gives the superfluous cinder more chance of escape, and may be conducted so as to make the heat more uniform throughout the mass. Still, the fundamental defects of the solid-forging process remain—the multiplication of welds between badly-fitted parts, and their liability, from various causes, to be unsound; overheating; the wrong direction of the seams and of the fibre; and the comparatively small reduction and purification of the mass after it is aggregated.

A number of field-guns, now in service, were rolled hollow at the Phoenix Iron Works of Pennsylvania, on the plan of Mr. Griffin. Rolled staves  $\frac{7}{8}$  in.  $\times$   $\frac{7}{8}$  in.  $\times$  4½ ft. long, were laid up in the form of a barrel, on an arbor which was placed in a lathe. A long bar  $\frac{3}{4}$   $\times$  4½ in.—a rhomboid in section—was wound spirally upon the barrel by the revolution of the lathe. Another bar was wound upon the first, the spirals running in an opposite direction, and so on until five layers had been applied. A thin layer of staves was then bound upon the outside, and a plug driven into the breech, to close it, and to form the cascable. The whole

\* Report of the Defence Commissioners," 1862.

was then heated to welding and upset endways two inches in a press, after which it was drawn out between the rolls from  $4\frac{1}{2}$  to 7 feet in length. The trunnions were then welded on, without removing the gun from the reverberatory furnace; the bore was dressed out, and the chase reduced to the proper size by turning, the mass being cylindrical when it left the rolls. These guns are well spoken of by Captain Benton,\* and appear to have been successful on a small scale.

**430.** But the Phoenix Iron Company have now abandoned this process, and substituted another, which produces a cheaper and sounder gun, and promises well for larger ordnance.† A

\* "Ordnance and Gunnery," 1862.

† The following is an abstract of the specification of Mr. D. T. Yeakel, of Lafayette, Indiana, for British patent, dated April 16, 1862:

"One of the improved modes of constructing cannon and other ordnance, which forms the subject of the present invention, consists in rolling or winding a plate, or sheet of iron or steel, or several (if more than one is required), around a central mandrel of wrought iron or steel; the whole mass is to be welded together as it is rolled up, or, after it is rolled up, the welding to be done by the pressure of rollers, or the impact of a hammer or hammers at welding heat. The mandrel should be of less diameter than the desired bore of the gun-barrel or shaft-cylinder, if the latter is intended to be hollow, so that the boring may remove all of the mandrel.

"Another mode of carrying out the invention consists in using a cold mandrel of wrought or cast metal, and rolling the sheets or plates of iron or steel around it till the desired size is produced. Sheets or plates are to be rolled around the mandrel at a welding heat and welded together as rolled, then removing the mandrel, and boring, reaming, and turning in the manner now pursued with cast guns or hollow shafts.

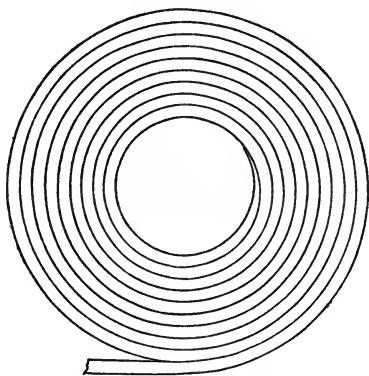
"Another mode consists in rolling up the sheets or plates in the same form, but without the mandrel, then inserting the mandrel and welding the whole mass together. The mandrel should always be less than the bore or hollow to be produced, if the mandrel is to be bored out or otherwise removed. The plate or sheet used should be of sufficient length, when used in one piece, to produce, when rolled and welded, the barrel or cylinder of the desired thickness or diameter before turning, and of a breadth several inches wider than the desired length of the barrel or cylinder. The sheet or plate of iron or steel may be used of a uniform thickness, or it may be tapered from one edge of its breadth to the other, so as to produce, when rolled or welded, the approximate shape of a barrel before turning; if used of a uniform thickness, the rolling must be continued till a sufficient diameter at the breech is obtained.

"By the improved process of making cannon or shafting, the most carefully consolidated plates of iron or steel are welded together in one continuous length, thereby producing a quality, viz., uniform consolidation of metal, and a form of barrel composed of concentric welded folds, capable of offering a resistance to the explosive force of gunpowder, which cannot be obtained in any other way."



sheet of iron is rolled around a mandrel into a cylinder, and drawn down into a tube with solid walls. The bore may be made entirely within the mandrel, which may be of steel. The seams in this case would not weaken the gun—indeed, the mere sticking of the iron together would prevent its uncoiling under fire. And the iron may be refined before it is made into a gun. But with all these advantages, the 7-inch gun made on this plan for Mr. Lynall Thomas, at Newcastle, burst at the second round (127), although the field-guns of the Phoenix Iron Company stand very well.

FIG. 173.



Gun made from a sheet of iron.

**431.** Mr. Ames's wrought-iron gun, of which the fabrication and test were mentioned (128), is forged hollow by welding a series of short, thick rings to the end of a bar, thus building out the gun from the breech to the muzzle. The rings are separately hooped before welding; any initial tension they may have is destroyed in the subsequent heating and hammering, and the gun is left without the desirable initial strains. At the same time, it is left without rupturing initial strains—the metal is substantially in a state of repose. As the rings are forged solid, no well-defined grain is developed in the direction of its circumference, as in the Armstrong or Phoenix Iron Company's guns. But there are no longitudinal *welds*. The principal strain of the powder is resisted by the unbroken strength of the solid ring. Overheating and the bad effects of imperfectly fitting pieces, welding in cinder, and light hammering, are more likely to be avoided, and the advantages of cooling the mass, to some extent, from within, are secured. The process appears to be in many respects an improvement on the plan of building upon the end of a bar with rough pieces and multiform welds.

**432. The Armstrong Gun.**—The process by which this gun is fabricated, and its charges, have been described in the first chapter.

The gun consists of several hoops (Fig. 174), welded up from

FIG. 174.

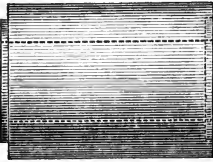
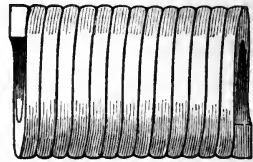


FIG. 175.



coils (Fig. 175), and shrunk together (Fig. 176). The breech-piece is forged so that its grain shall run longitudinally.

**433. LEADING FEATURES OF THE SYSTEM.**—These are—*First*. Placing the grain of the iron in the direction of the greatest strain, and opposing the tension of the welds to the least strain. That is to say—1st, the grain and the welds in the body of the gun run in the direction of its circumference. 2d. The grain of a sufficient portion of the breech to resist the longitudinal strain runs parallel with the bore.

*Second*. Placing the outer hoops in initial tension, so that all parts may be equally strained at the instant of firing (287). Sir William Armstrong has publicly stated\* that he did not carry out this plan with the nicety prescribed by Mr. Longridge (293), but that the rings were simply applied with a sufficient difference of diameter to secure effective shrinkage. Indeed, Sir William considers† the important principle of his gun to be, not merely building up a barrel, nor the placing of it under regulated initial strains, but welding coiled tubes end to end, and shrinking them together.

*Third*. The breech-loading, and,

*Fourth*. The system of rifling and projectiles, are the other leading features of the Armstrong Ordnance, and will be considered under their respective heads. Both tend, directly or indi-

\* "Construction of Artillery," Inst. Civil Engineers, 1860.

† Select Committee on Ordnance, 1863.

rectly, to weaken the gun, and are either modified or abandoned in the heavier guns.

#### 434. ADVANTAGES OF THE SYSTEM.

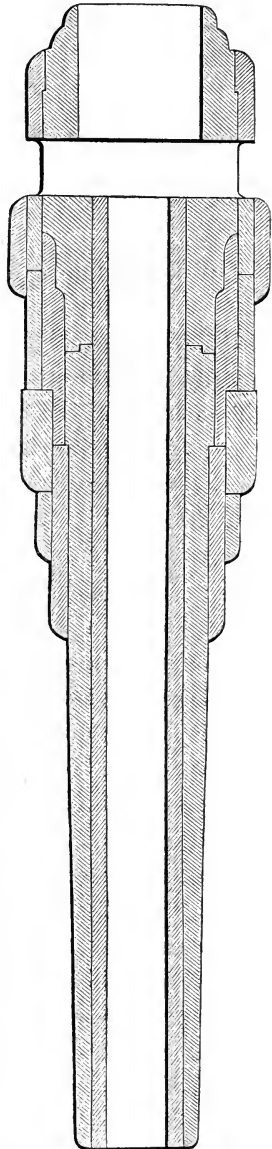
—The first grand advantage of wrought-iron tubes having the grain in the direction of the greatest, and the welds in the direction of the least strain, and having such initial strain that all the iron will do equal work at the instant of firing, is, obviously, *great strength to resist internal pressure*. The practice, also, warrants this conclusion.

Besides the wrong direction of welds and fibres, and possible flaws, and the want of proper initial tension, other defects of the solid-forged gun are modified or avoided in the Armstrong gun; among them, unequal shrinkage (420), and the various bad effects of light hammering (419).

Although the iron of the Armstrong gun is refined before welding (414), and although the pressure in welding the coil into a tube is not as uniform as it should be, the heat is so uniform, and the surfaces to be joined are so plain, that the union of the parts can be more certainly relied on than in case of the solid-forged gun. The iron *is* refined; in the other case, it may be crude after the forging is done.

Burning the iron may be avoided, but there is enough over-heating to weaken the material. Mr. Anderson says:\* “When rolled bars of the best

FIG. 176.



\* “Journal Royal United Service Inst.,” August, 1862.

quality are wound into coils, and then welded into cylinders for gun manufacture, the iron, as a general rule, is found to suffer to about 3481 lbs. per square inch on the average. The following shows the average results both in regard to yielding and breaking:

Yielding point.	{ Iron in bar.....	31100
	{ " cylinder.....	27852
Rupture point.	{ Iron in bar.....	58986
	{ " cylinder.....	55500

“The loss is due to the necessary heating being greater in proportion than the working.”

**435.** Another advantage of this system of fabrication, is thus stated by Mr. Anderson: “In building up guns of cylinders, this high tenacity afforded by the coil system circumferentially, and the opportunity which it gives of *knowing the soundness of the gun in every part*, and from the fact that every part of the gun is put under the full exercise of its duty from the commencement—this arrangement of building up guns will always have an immense advantage over guns made of a single solid forging, in point of strength and security against bursting of the whole structure; and even when the coiled cylinder is considered as a means of obtaining the inner lining or bore of a rifled gun, a purpose for which it is by no means so perfect, yet, even in that respect, it is superior to the bore which is formed within the heart of an immense forging, of dimensions suitable for a large gun, such a mass of forging being always more or less defective, even under the best and most careful workmanship.”

**436.** The comparative strength of the coil system and the solid-forging system, has been tested as follows: A 6½-in. wrought-iron gun, weighing 9282 lbs., made from a block forged at the Mersey Iron Works, was tested as follows, in 1862. Charge, 16 lbs.; 10 rounds with 68-lb. 10-oz. shot, 10 with 136-lb. 8-oz. shot, 10 with 204-lb. shot, 10 with 273-lb. shot, 10 with 340-lb. 8-oz. shot, 10 with 410-lb. shot, and 10 with 476-lb. shot. At the 70th round, the gun burst into eight pieces. Subsequent experi-

ments on the metal showed it to possess a tensile strength of 45359 lbs.

A 6½-in. Armstrong wrought-iron gun was tested in comparison with the above. The inner barrel was made from a solid forging; weight, 9474 lbs. The gun fired 100 rounds; charge, 16 lbs. The projectiles were cylinders, beginning at 68-lbs. 10-oz. weight, and increasing, every 10 rounds, the last rounds being 672 lbs. At the 60th round a cavity was found in the chamber, which gradually increased to 2·75 in. deep, with small fissures.

Afterwards, however, a 40-pounder and a 12-pounder Mersey solid-forged gun were tested (122), and the committee reported\* that “both these guns have shown an endurance, if not fully equal to guns made on the coil system, yet at least ample for the requirements of the service, if it is accompanied by the power of resisting a very great number of service charges.”

**437.** The following is an official account of the “endurance, under testing, of a 100-pounder Armstrong breech-loading gun :†

“My Lords Commissioners of the Admiralty desire that the following particulars as to the testing for endurance of an Armstrong 100-pounder breech-loading gun be communicated for the information of the officers and crews of Her Majesty’s ships.

“The proof of this gun, which was conducted in the usual manner, was commenced on the 20th June last, and was carried on until 100 rounds had been completed on the 10th September last. The charge of powder used was the service charge of the gun for shot of 100 lbs. as originally proposed by Sir William Armstrong, viz., 14 lbs. ; which will not be exceeded for shot of 110 lbs. For the first 10 rounds, cylinders of 100 lbs. were employed ; for the next 10, cylinders of 200 lbs. ; and so on, up to the last 10, for which cylinders of no less than 1000 lbs. were employed. These last were 8 ft. 8 in. long, and projected 2 feet beyond the muzzle. The gun was found to be uninjured. The powder-chamber and shot-chamber were found slightly seamed in the direction of the grain of the iron. The breech-screw worked freely throughout the

\* “Report of the Select Committee on Ordnance,” 1863.

† From an admiralty circular.

experiment. Two steel vent-pieces were broken in the course of this experiment, viz., at the 28th and 31st round respectively; one wrought-iron vent-piece, after being used from the 32d to the 81st round, was found so much worn on the face as to injure the cups; and a second wrought-iron vent-piece was used from the 82d to the 100th round. This vent-piece was observed, at the 91st round, to exhibit a number of fine cracks, which extended considerably in the course of the remaining 9 rounds; it broke at the 4th round of a subsequent experiment, with proof-charges of  $27\frac{1}{2}$  lbs. and a single proof-shot of 110 lbs. The breech-copper required refacing at the 30th round; after every 35th round it was removed and replaced. At the 85th round the new copper was refaced, and replaced after the 63d round; the copper then put in received no repairs during the rest of the experiments. Lubricating wads of the service pattern were used for the first 10 rounds, afterwards those of Captain Lyon's pattern. The powder-chamber was washed out after each round, to allow the expansion of the breech-copper to be measured. Cups of strong tinned plate were used for the first 35 rounds, but were too weak to resist the pressure exerted by the gas, with the cylinders of the weight then in use, and were replaced by copper cups, which answered well for the remainder of the trial, being seldom broken. The recoil, as the experiments advanced, became very violent; the suspending-rods, ultimately, were removed, and the gun was placed on a species of carriage, which recoiled up a steep inclined plane, checked by sand. It is stated, however, by the Inspector of Artillery, that great difficulty was found in completing the experiment even with this arrangement. The gun used in these experiments was of Elswick manufacture, made entirely on the coil principle, and weighed 81 cwt. 3 qrs. 16 lbs., and was of the usual external dimensions. The remarkable strength exhibited by this gun is very satisfactory, and would appear to leave nothing in that respect to be desired, except some improvement in the vent-pieces, which every endeavor is being made to effect."

**438.** It should be remarked, with reference to this experiment, as was suggested by Commander Scott before the Select

Committee on Ordnance (1863), 1st, that the great length of time occupied by the experiments prevented the possibility of heating the gun; 2d, that the lead was turned down off the cylinders, and did not close the bore of the gun; 3d, that the velocity of the heavy cylinders being lower than that of the service-shot, the destructive effect of jamming the shot through the rifling was modified; and 4th, that the gun was kept perfectly clean.

**439.** Sir William Armstrong stated, before the Select Committee on Ordnance (1863), that "with guns which had been previously fired 100 rounds with shot rising up to 100 lbs., one gun had stood 319 proof rounds, another 274 proof rounds, another 357 proof rounds, another 261 proof rounds, another 313 proof rounds, another 119 proof rounds, and one only 27 proof rounds." He also stated that one, previously cracked, stood 15 proof rounds, which showed the high ultimate strength of the gun.

As to the endurance of some of the 12-pounders, he says: "No. 7 has been fired 3263 rounds, and is perfectly good and serviceable. I have here another 12-pounder which has been fired 1453 rounds, another which has been fired 1515 rounds, another which has been fired 1911 rounds, and another which has been fired 1146 rounds, which may be taken as instances of the very great endurance possessed by these guns."

**440.** Table 64 gives a list of all the guns returned to Woolwich for repairs up to June 3, 1863.\* Sir William Armstrong makes the following statement† with reference to the guns mentioned in Table 65:

"Out of 66 9-pounders issued, only one had to be returned for repairs; of the 12-pounders, out of 392 land service and 178 sea service issued, 13 had to be returned. This is exclusive of 20 broken vent-pieces and 22 broken breech-screws. These guns had fired some 50000 rounds. Of the 40-pounders, 641 were issued and 9 returned. Of the 110-pounders, 799 were issued and 9 returned."

\* We have no means of knowing how many, if any, guns requiring repairs have not been returned; but we know (443) that many costly repairs are required *before* the guns are issued.

† "Report of Select Committee on Ordnance," 1863.

TABLE LXIV.—LIST OF ALL ARMSTRONG GUNS RETURNED TO WOOLWICH AND REQUIRING REPAIRS UP TO JUNE 3, 1863.

(From the Report of the Select Committee on Ordnance, 1863.)

Nature.	Where made.	Rounds fired.	Nature of Injury.	Remarks.	Cost or Repairs. \$
9-pdr...	R. G. F.	50	Exterior crack 3 in. from muzzle.	Not yet repaired.	.....
12-pdr...	"	Not reported.	Exterior crack in breech.	Repaired, and serviceable.	29.75
12-pdr...	"	227	Cracks in the chase.	Unserviceable. To be shortened.	.....
12-pdr...	"	26	Coil behind trunnion shifted, and inner tube broken.	Ditto	.....
12-pdr...	"	36	Lining shifted .15 in.	Not yet repaired.	.. ...
12-pdr...	"	17	Coil behind trunnion split longitudinally.	Unserviceable. To be converted.	.....
12-pdr...	"	200	Flaw in bore 21 in. from muzzle.	Filed, and serviceable.	1.50
12-pdr...	"	Not reported.	Flaw in bore at 37 $\frac{3}{4}$ to 39 in.	Ditto	1.37
12-pdr...	"	"	Bad flaw in bore at 57 in. (Bad weld.)	New inner tube. Serviceable.	105.48
12-pdr...	"	276	Inner tube cracked through at 6 in. from muzzle.	Unserviceable. To be converted.	.....
12-pdr...	"	993	Ditto ditto at 40 in.	{ New lining, which failed at proof. Lined again. } Serviceable.	165.93
12-pdr...	"	479	Lining shifted .15 in.	Repaired, and serviceable.	5.20
12-pdr...	"	Not reported.	{ Lining in powder-chamber cracked by 10 devel- } oping rounds.	Not yet repaired.	.....
12-pdr...	"	"	Lining in powder-chamber cracked.	Ditto	.....
20-pdr...	"	372	Lining split.	New coiled tube put in, in place of lining.	150.32



40-pdr...	E. O. C.	26	{ 22 ins. of muzzle blown off by carelessness in leaving in drill-shot.	New chase. Serviceable.	400.20
40-pdr...	"	Not reported.	Flaw in bore at 49½ in. from muzzle.	Filed, and serviceable.	2.81
40-pdr...	"	29	Ditto at 46 in.	Ditto ditto.	3.75
40-pdr...	"	17	Ditto at 17½ in.	Ditto ditto.	3.16
40-pdr...	"	137	Flaw in breech-end of bore.	Ditto ditto.	3.18
40-pdr...	"	Not reported.	Flaw in powder-chamber.	Repaired with short bouche. Serviceable.	26.50
40-pdr...	"	671	Coil in front of trunnions shifted .15 in.	New coil. Serviceable.	48.54
40-pdr...	"	244	Rifling damaged by shell.	Lined throughout, and serviceable.	197.93½
40-pdr...	"	5	Inner tube cracked.	Lined throughout. Used for proving vent-pieces.	188.50
110-pdr...	R. G. F.	294	{ Rifling damaged by shell and flaw in powder-chamber.	Repaired, and serviceable.	465.53
110-pdr...	"	81	Flaws in powder-chamber.	Repaired with coilbarrel. Serviceable.	202.18
110-pdr...	"	84	Ditto ditto.	Ditto ditto ditto.	224.50
110-pdr...	"	325	Crack at slot-hole.	Two new tubes put in.	217.73½
110-pdr...	"	57	Flaws in powder-chamber.	Not yet repaired.	.....
110-pdr...	"	128	Expansion of powder-chamber.	Ditto ditto.	.....
110-pdr...	"	388	Flaws in powder-chamber.	Ditto ditto.	.....
110-pdr...	"	200	Crack in breech-piece.	Not yet repaired. Used for proving vent-pieces.	.....
110-pdr...	"	81	Flaws in powder-chamber.	Ditto ditto ditto.	.....

TABLE LXV.—LIST OF ARMSTRONG GUNS RENDERED UNSERVICEABLE BY PROVING VENT-PIECES.

(From the Report of the Select Committee on Ordnance, 1863.)

Nature.	Where made.	No. of Gun.	Proof charge=2 service charges. Proof rounds fired.	Remarks.
6-pdr...	R. G. F.	36	9	
9-pdr...	"		None rendered unserviceable.	
12-pdr...	"		Ditto ditto.	
20-pdr...	"		Ditto ditto	
40-pdr...	E. O. C.	17	460	
40-pdr...	"	147	369	{ Cracked, after 200 rounds, on board her Majesty's ship <i>Hero</i> , and not repaired.
40-pdr...	"	166	1050	
40-pdr...	"	184	144	
40-pdr...	"	503	135	
110-pdr...	R. G. F.	17	15	
110-pdr...	"	135	309	
110-pdr...	"	657	247	
110-pdr...	"	663	357	
110-pdr...	"	683	261	
110-pdr...	E. O. C.	28	313	
110-pdr...	"	143	27	{ Previously tested with 100 rounds for endurance, with shot up to 1000 lbs.
110-pdr...	"	191	119	

**441.** Sir William Armstrong considers his system very superior to other systems\* of construction, because inventors of projectiles, rifling, etc., who want strong guns, always avail themselves of it by applying to have their guns made at Woolwich. The fact is, however, that no other system accessible to them has been *developed*. The following evidence of Mr. Whitworth\* touches this point very fairly:

\* Select Committee on Ordnance, 1863.

Q. "Do you think the system of manufacture under Sir William Armstrong's principle is right or wrong?"

A. "I believe it is utterly wrong."

Q. "Then why did you avail yourself of it?"

A. "Because I was desirous to show that I could—and I think that I could—send a shell through armor-plates, and there was no other way in which I could get the gun made with a 7-inch bore, weighing 7 tons, except at Woolwich. I am convinced that no large gun made of welded iron will stand. I utterly condemn welded iron in a gun at all, either for the inner tube or for the coil."

But the injury of that very gun, in the manner indicated by Mr. Whitworth, after less than 30 rounds, is more conclusive evidence against the system. The 9-inch gun made on the same plan at Woolwich, for Mr. Lynall Thomas (34), has fired but very few rounds. The first 10½-inch Armstrong muzzle-loader has burst twice after a short service (446).

**442.** It is mentioned, as an advantage of the Armstrong system, that injured guns can be taken apart and repaired in detail (see Table LXIV.), without sacrificing the whole structure, as in case of solid guns. But this feature only provides a remedy for a defect which it induces—this very want of integrity creates weakness and hastens failure.

**443.** DEFECTS OF THE SYSTEM.—All the guns mentioned in Table 64 failed after they were issued for service. That many costly failures occur before the guns are issued, is obvious from the facts elicited about the 40-pounders, by the Committee on Ordnance, during the session of 1863. Out of 192 guns, 153 had been lapped out and otherwise repaired at the cost of \$20270 (£4054); 21 of them were bouched throughout at the cost of \$3701.25 (£740—5); and 25 were bouched with tubes of various lengths. Sir William Armstrong said, indeed, that these "are questions of manufacture, and not of repair."

**444.** The most obvious defect in the Armstrong gun is in the material used—its softness and consequent yielding under the pressure of the powder-gas. Since no other material but wrought

iron could be welded up in this way, the defect may be fairly urged against the system.\*

The evidence of Mr. Anderson and Sir William Armstrong, admitting this defect, has already been quoted (402). Some instances will illustrate the character of the failure. A 6½-in. Armstrong gun, tested in comparison with a Mersey solid-forged gun, endured 100 rounds with increasing charges, while the Mersey gun burst at the 70th round; but at the 60th round the Armstrong gun had a cavity 2·75 in. deep in the chamber. The 200-pounder side breech-loader bulged at the 7th round. A 110-pounder that had fired 127 rounds with 27½ lbs. of powder, and 48 with 14 lbs., was indented and cracked in the chamber. Subsequently, 133 rounds, with 27½ lbs., parted it near the trunnions. One 110-pounder is reported to have become fractured in the chamber, and destroyed in the rifling, after 57 service rounds. The 9-in. gun made for Mr. Lynall Thomas on this plan, as well as the 7-in. gun made for Mr. Whitworth, have permanently changed figure—the latter is unfit for regular service after less than 30 rounds. The first 10½-in. gun was indented in the chamber with a 90-lb. charge (446), and a round 150-lb. ball.†

All the Armstrong guns are left smaller in the bore than the finished size, to allow for expansion in proof—and they all expand in proof, the 110-pounders in a considerable and irregular degree.

**445.** The small amount of “work done” in slightly stretching wrought iron—its great ductility—allows the hoops of the Armstrong gun to relax. In several instances the inner tubes have failed, while the outer ones have remained whole.

In view of the facility with which the outer hoops can stretch, their *fracture*, several instances of which are mentioned in the Report of the Select Committee on Ordnance (1863), must be traced to those effects of vibration which are due to want of continuity of substance (335). Table (LXIV.) has many examples of both kinds of failure. But they are sooner developed in the larger ordnance.

\* According to the evidence of Mr. Anderson (“Report of Committee on Ordnance,” 1862), the harder kinds of irons weld badly, so that the coils split.

† The chamber of the 600-pr. became oval, and the inner tube started after “a dozen or twenty rounds.”—*Capt. Fishbourne, Jour. R. U. Service Inst., May, 1864.*

**446.** The first 10½-in. smooth-bore (Fig. 177) burst after firing 264 spherical shot, with 40-lb. charges, in nearly all cases, there were several of 50 lbs., and as the gun had never been proved, one of 70, one of 80, and one of 90 lbs. The latter charge was not considered as excessive, but only equivalent, with a spherical shot, to 50 lbs. with the 300-lb. elongated shot that the gun was intended to carry when rifled. Other guns of this class have fired 300-lb. shot. At the discharge with 70 lbs. of powder, the inner coil split in the spiral weld; at the next round, with 80 lbs., this crack closed and another opened parallel and near to it. The next round, with the 90-lbs. charge, made a crack parallel to the bore, in the outer coil, behind the trunnions. After a few rounds more, the breech-piece pulled apart, as shown by the dotted lines *a c*, and blew out. Fig. 178 shows the condition of the gun after fracture. This result was undoubtedly hastened by the gas leaking past the movable bottom *F* of the chamber, and the copper disk *a a*, and pressing upon the larger area of the screw-plug *G*.\*

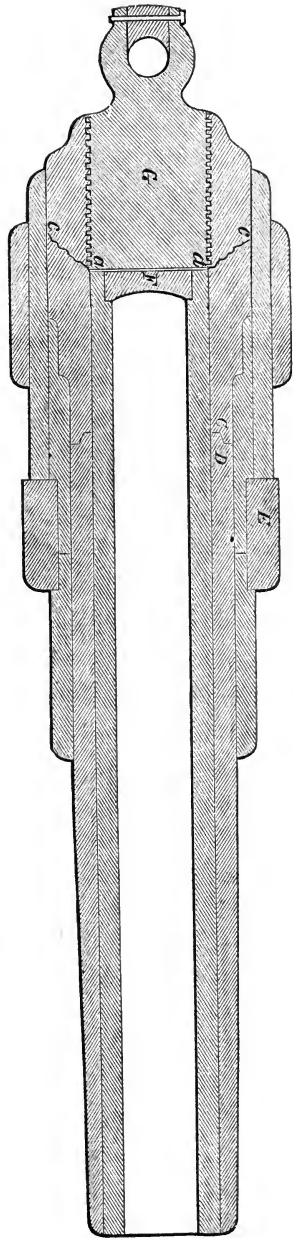
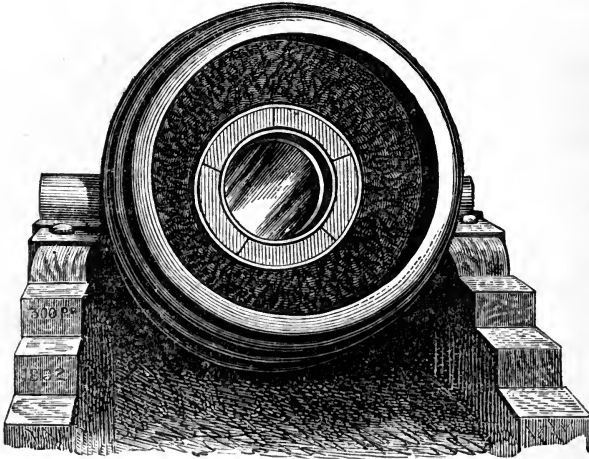


FIG. 177.—Armstrong 10½-in. muzzle-loader. Scale,  $\frac{1}{16}$  in. to 1 ft.

\* It is worthy of note that the same construction was adopted for the new guns made at Elswick. Mr. Anderson's were made with a solidly-closed inner tube (32).

This gun\* having been repaired, one of the outer tubes cracked again, rendering the gun unserviceable after a few rounds with

FIG. 178.



First Armstrong 10½-inch gun, after the breech blew out. From a photograph.

50 lbs. of powder and a round ball. And the new 10½-in. guns that have been rifled show such limited endurance that the charge with an elongated shot has been reduced from 50 to 45, and then to 35 lbs. One of them was fractured in the chase, at the 8th round, by the sudden nipping of the shunt-shot.

**447** The following is the report of the Ordnance Select Committee on the failure of the 120-pounder shunt gun:† “The Committee have the honor to report, for the information of the Secretary of State, that the 120-pounder muzzle-loading shunt gun, which they were authorized to fire with shot reduced to 100 lbs. weight, and a charge of one-fourth, gave way in the trunnion

\* With regard to the bursting of this gun, Mr. Anderson said, before the Select Committee on Ordnance, 1862, that “to provide for any escape of gas that there might be, an annular passage around the gun was left, and in the drawing it was shown with an opening to the outside. The workman, in making that opening, drilled a hole into another part of the gun, and not into the passage, and hence, when the leakage arose, the pressure was exerted over a very much larger surface; there being no vent through the solid part, hence the pressure came upon nearly a double area.”

† “Report of the Select Committee on Ordnance,” 1863.

coil at the second round, and is at present unserviceable. The actual weight of the shot fired was only 98 lbs., and the charge 24 lbs. The gun having been fired with impunity, by the Iron Plate Committee, with shot of 140 lbs., and a charge of 20 lbs., this accident cannot be attributed to the severity of the charge. It has fired, altogether, 103 rounds, and the present failure must either be traceable to a weakness originally stated by Sir William Armstrong to exist in it, or be the consequence of using the powder known as 2 A 4. The Committee do not apprehend the latter to be the case; and the reported position of the crack, which is far forward, tends to show that a flaw must have existed, because the force of the powder would be diminished by expansion to less than one-half its original amount before it could operate on that part of the structure."

Perhaps the sudden blow of the shunt-shot as it centred in that part of the bore, and the various effects of vibration, would account for this failure, since one of the 300-pounders gave way in a similar place.

**448.** Charges of 25 lbs. of powder are said to have rapidly destroyed 110-pounders. The service charge (for shot) for these guns has been reduced from 14 to 12 lbs.

The effect of multiplying parts is shown by the failure of bouched guns, about which much testimony was taken by the Select Committee on Ordnance, during the session of 1863.

Nearly all the old pattern 12-pounders were found too weak, and are being altered by having 12 in. cut off from the muzzle, and a heavier and longer coil placed in front of the trunnions.

The character of these failures—a general loosening and shaking to pieces of the gun after short service—although aggravated by the softness and extreme ductility of the metal, must be traced, in a great degree, to want of mass and continuity of parts.

**449.** Although the welds are in the direction of least strain, the splitting of the inner coil is admitted by Mr. Anderson and others, in the evidence before the Select Committee on Ordnance (1863), to be of frequent occurrence.\*

\* In discussing this subject in December, 1861, before the United Service Insti-

As to the welds, Mr. Anderson says :\* “ With iron of the very best quality which we have as yet been able to obtain, the highest average tenacity of the welding of the coil has been 32140 lbs. per square inch, the iron being 55500 lbs. \* \* \* It will thus be seen that the ultimate strength of a coil in the circumferential direction, is about 55000 lbs. per inch, while in that of its length it is only 32 140 lbs. per inch.”

**450.** The following defect is mentioned by Captain Fishbourne.† “ The coils are shrunk on hot ; the metal of course contracts in every direction, consequently the joints open ; it were impossible they should be close ; the *overlapping* pieces at the joints indicate the knowledge of this defect. All these are points of weakness, and the whole of the great vibration which takes place every time the gun is fired, must be thrown in turn on these separate parts, and not distributed, owing to the continuity being broken, which must lead early to the disintegration of the gun.”

**451.** Another possible disaster, serious, perhaps, but not very likely to occur in case of guns wholly inclosed in turrets or casemates, is damage from the blows of shot or flying pieces of armor. “ This was shown,” says Commander Scott,‡ “ in the experiment of firing with a 9-pounder smooth-bore brass field-piece, at a rifled 12-pounder coiled gun, and also at a 9-pounder brass gun. The charges were very much reduced, so as to resemble the effect of distant firing.” In this trial the 12-pounder was broken to pieces in 3 rounds, each blow being alone sufficient to disable it ; while the

tution, Commander Scott said :—“ The coils of which the gun is made, though exceedingly strong to resist direct internal pressure, often show flaws after firing ; \* \* the coils are also liable to separate. This was shown by the 100-pounder which was returned from Shoeburyness, badly cracked in the inner tube of the breech, and in another gun, also sent back on account of a similar flaw in a similar part. It was also equally apparent in the 12-pounder which failed and became wholly disabled in ordinary practice at Shoeburyness. \* \* \* The separation of coils has frequently happened ‘ in proof ’ with both 40 and 100-pounders, and also took place with one 120-pounder shunt, and may be expected to happen on service from the concussion and friction resulting from the jar before the *leaded shot* starts, and the strain of driving it through a hole of smaller diameter than itself.”

\* Jour. Royal U. Service Inst., Aug., 1862.

† Jour. Royal U. Service Inst., June, 1862.

‡ Jour. Royal U. Service Inst., Dec., 1861.



9-pounder, after receiving the same number of shots on one side, sustained a similar discharge against the other, and remained still serviceable for discharging grape, case, or 6-lb. round balls. In fact, but for one blow on the thinnest part of the chase, the gun could have continued to fire its usual ammunition; and while the broken breech-loader would have perhaps not been worth removal from the field of battle, the brass gun could have been made as serviceable as ever in a couple of hours."

**452.** With reference to the necessity of employing this system for very large guns, Mr. Anderson said, before the Defence Commission in 1862, that "building the gun up with portions of the iron one above the other," appeared to be "the only ready way of constructing enormous guns, and getting them absolutely perfect when made;" and that upon consultation with others, he had determined that 24-inch guns could be made, but at a very considerable expense. He said that the great difficulty of manufacture was in handling such enormous masses, but that he had been devising arrangements "to make men into giants, as it were. \* \* \* You want an arrangement that would enable a man or two to manipulate those great things readily without going near them."

**453.** The success of the system certainly depends upon the use of costly machinery; and its development from the beginning has been chiefly a matter of money. The difficulties to be overcome were numerous and formidable. The proper joining of the rings at their ends, the proportioning of the breech-piece to the requisite longitudinal strength, the adjustment of the hoops to give the necessary initial tension, and the general elasticity of the whole structure under fire, involved so much costly experiment, that access to the Government purse was an important, if not an essential condition, of the final production of the present Armstrong gun. If the still larger sums which have been expended on a bad system of rifling, and an unnecessary system of breech-loading, had been devoted to the adaptation of low steel, from which Mr. Anderson, with all his preferences for iron, evidently expects great results—the Armstrong gun would probably have been far more formidable.

**454.** WELDING.—The hardest and toughest wrought iron—such as that used by Captain Parrott for reinforcing cast-iron guns—may indeed be indented and stretched by the heaviest charges; but its chief defect, when welded into masses of sufficient size to avoid the destructive effects of vibration (335), is in the imperfect adhesion of necessarily small pieces (415).

Nor is the objection to *welds*—that is to say, to the uniting of parts that once were separate. Indeed, the ultimate atoms of matter are not supposed to be in absolute contact with each other. They are kept at a certain distance apart by heat, and held from further separation by the attraction of cohesion. When they are violently separated, beyond the range of cohesion, they cannot be again perfectly united until they are brought within their original distances from each other. When so brought together, hot or cold, the old antagonism of forces will ensue. Heat is only a convenient means of restoring the distance between the atoms, because it allows them to move among themselves, and to adjust themselves by gravity, when a melting heat is reached, and by slight pressure when only a softening heat is attained. Cast iron, cast steel, and bronze, may be welded at a melting heat; but although wrought iron cannot be melted at a practicable heat, every iron-worker knows that it *can* be treated so as to have as much strength at the weld as elsewhere, and sometimes more strength, because the iron at this point is better worked.

**455.** Hence it appears that, although in the general practice, welds are treated as weak points, and a still further allowance is made, especially in large forgings for actual seams or flaws, there is no physical law against sound welding, if iron and iron are brought together at the proper heat, and under the proper pressure. A certain amount of cinder is necessary to the process, but this already exists in the iron, or may be artificially supplied. The risk, as far as cinder is concerned, is, that too much of it will be enclosed by joining the edges of the iron, and thus preventing a union at the centre (Fig. 179). To remedy this defect, it has long since been proposed to shape the parts so that the centre or one edge will be first joined, thus allowing the superfluous cinder

to be squeezed out at one or both edges, as the parts are brought together. (Figs. 180 and 181.) This improvement, which special

Fig. 179.

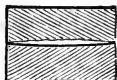


Fig. 180.

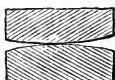
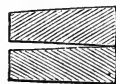


Fig. 181.



provision is made to avoid in the Armstrong gun, by bringing the coils (slightly upset on their edges by the coiling process) flatly together (Fig. 179), is adopted in the welding of the reinforce of the Parrott gun, by bringing the edges together first (Fig. 181).

**456.** The next condition of a perfect weld is, that no substance that will impair it shall be interposed between the parts. Oxide of iron, in the form of scales, which form very rapidly when a heated bar is exposed to the air, undoubtedly prevents a perfect union. The blacksmith joins his two bars in the fire, or as quickly as possible after they are removed; or, if much time is lost, he brushes away the scale, and then instantly closes up the joint by heavy blows; and so makes a good weld. But several minutes must elapse before large parts can be brought together. Meanwhile, thick scales are forming in places where they cannot be removed. The rapidity with which iron at a welding heat becomes oxydized is strikingly illustrated in the operation of "patting" the Armstrong tubes after they are welded end to end (8). The scales that form on the inside of the tube are jarred off at every stroke of the hammer upon the outside, thus exposing fresh surfaces to oxidation. At the end of the process, the scales form a pile in the tube several inches in depth.

**457.** To upset the Armstrong coil (432), it must be taken from the furnace by a crane, swung round to the hammer, and located on the anvil. By the time this is done, a thick scale, which cannot be got at and removed, has covered the entire surface to be welded. The first few blows of the hammer jar off this scale, exposing fresh surfaces to oxidation, before the seam is sufficiently closed to exclude air. If the surfaces were bevelled so as to close up at one edge, or in the centre, first, the outflowing cinder might

carry off some of the scale. As they are, both cinder and scale must be shut in. This would appear to explain the reason why Mr. Anderson gets only the highest average tenacity of 32140 lbs. at the welds between bars having 55500 lbs.


**458.** Since oxidation cannot be prevented by any practicable rapidity of operation, the only remedy appears to be the exclusion of oxygen, that is to say, *making the weld in an atmosphere which contains no oxygen*, or, at most, but a trace of oxygen. The gaseous products of combustion constitute such an atmosphere. The parts are already in it when raised to the welding heat, and require only proper contact before they are removed from it, to avoid the interposition of scale.

Gas-welding was long since proposed by Mr. W. Bridges Adams, of London, and referred to by him during the discussion on "The Construction of Artillery," already quoted,\* as follows: "As regarded the question between built guns and solid forgings, the present practical condition of the art of forging made the former mode preferable; but it was probable that ultimately a mode of welding by jets of intense gas-flame, instead of by furnace-heat, would enable the manufacturer to pile any mass of iron together in perfect welds, without any oxidation of the surfaces internally."

**459.** This system has been applied to the construction of steam-boilers with great success, considering the crudity of the machinery and processes employed, by Mr. William Bertram, of Woolwich.† The edges to be welded are placed in contact between jets of flame issuing from two furnaces attached to cranes or cars, one on each side, after which the furnaces are removed, and the compression is done (not much is required when the surfaces are clean and fit well) by hand-hammers or steam-hammers, so fixed to the same or other cranes or cars that they can be instantly brought into service. Government experiments at Woolwich show the following percentage of strength, that of the plate being 100:

\* "Construction of Artillery," Inst. Civil Engineers, 1860.

† Patent, Dec. 21, 1854. No. 2692.

Flush		joint, $\frac{1}{2}$ -in. plate.....	82 $\frac{1}{2}$
Do.		do. $\frac{7}{16}$ -in. do. ....	101
Do.		do. $\frac{3}{8}$ -in. do. ....	105.7

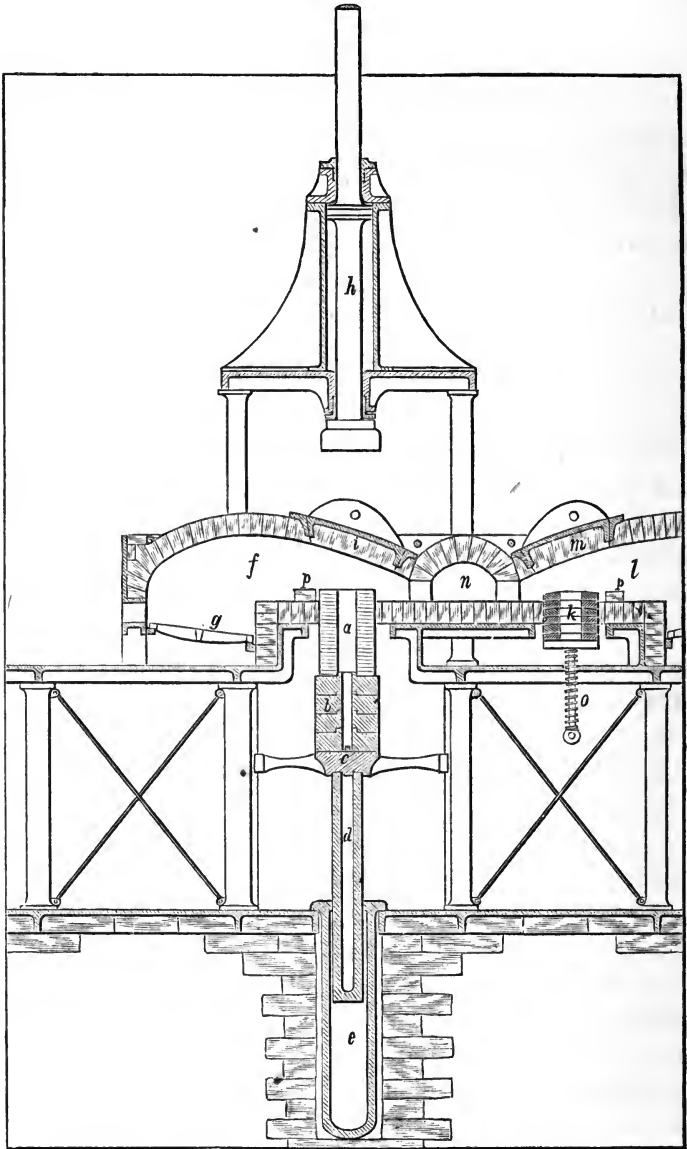
Bertram's process is successfully employed by the Butterly Iron Company in the manufacture of heavy beams. The sulphur in coal is another cause of imperfect welds. The bad effects of this mineral are so formidable, that Mr. Bessemer melts the pig-iron, for conversion by his process, in a reverberatory furnace, rather than to risk its contact with sulphur in a cupola.

Adequate heat and pressure are the remaining obvious conditions of sound welding. Although little pressure may be required, an excessive amount can do no harm, but, on the contrary, improves the iron.

**460. HITCHCOCK'S SYSTEM.**—To carry out, in the fabrication of large cannon, the principles of sound welding considered above, Mr. Alonzo Hitchcock, of New York, proposes the system illustrated by Fig. 182. The iron is heated in a reverberatory furnace, to avoid its contact with sulphur and other impurities of coal. The gun is formed of rings of wrought iron, or low steel made without welds (68), and upset or butted together, as by Ames's process (128). The rings are so formed as to be united first in the centre (455), that the superfluous cinder may be squeezed out. The anvil (*b*) is seated on the piston of a hydrostatic press (*e*), so as to be lowered as the successive rings (*a*) are added. The furnace (*f*) is situated between the anvil and the steam-hammer (*h*), and so arranged that the rings project into it from below, and the hammer drops into it from above.

The ring to form the muzzle of the gun is laid upon the movable anvil and projected sufficiently into the furnace to allow the flame to raise it to the welding heat. Meanwhile, in another part of the furnace, the rings (*k*) are heated to welding in the same time, by proportioning the heat, by means of dampers, to the relative bulks of the two parts. Without removing the parts from an atmosphere in which there is very little if any oxygen, they are laid together and instantly welded by a few strokes of

Fig. 182.



Hitchcock's system of forging cannon.

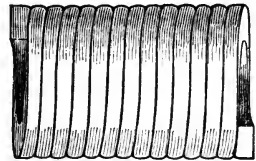
the steam-hammer. The anvil is then lowered by the thickness of another ring, and the same process is repeated.

Although the *gun* may be of any size, the parts actually united at one operation may be made so light by reducing their thickness, that the pressure of a hammer of moderate weight will be adequate.

And when the whole operation of upsetting is confined to one joint, exactly the requisite pressure for that joint can be applied; and there is no fear of injuring other parts by setting it up soundly, because the mass of the gun below it is cold, and forms a rigid pillar—practically a continuation of the anvil.

**461.** The blows upon the end of the Armstrong coil (Fig. 183) have to weld a great number of joints; those next the anvil and those that, from bad fitting, require the most pressure, are not always set up until other parts of the tube, which is a long column softened by heat, are bulged and disfigured. To avoid destroying the tubes in this way, they are made in short lengths, which have to be joined by a subsequent process, at a considerable cost. Even these are bulged, and have to be restored to the cylindrical shape by “patting” (8).

FIG. 183.



**462.** It would appear that all the conditions of sound welding may thus be attained, if the process can be practically carried out. The objection raised by some iron-workers, that the single ring will be burned before the larger mass is heated to welding, is not well founded. Certainly the heat in what are substantially, or may be actually, two different furnaces, can be regulated with the utmost nicety. Besides, the mass is already hot before the ring to be added to it is put into the flame. Locating an anvil upon water is simply a question of the strength of what holds the water. A screw would answer the purpose, and would not be liable to derangement, since an accurate fit is not important, and the adjustment does not take place at the instant of the blow. Or, the screw might be employed simply to elevate and depress the anvil—the force of the blow being received by blocks of varying thickness, placed between the anvil and its bed.

**463.** The mechanical difficulties do not appear to be serious; and a considerable cost of apparatus is warranted by the certainty of sound work. The expense of dressing the ends of short tubes by the Armstrong process, and of making colossal furnaces and hammers to heat and condense a 30 or 40-ton forging to the core, is dispensed with. Indeed, the furnace may be little larger than that employed for gas-welding the Armstrong tubes (8).

**464.** Mr. Hitchcock's process was intended especially for fabricating guns of low steel—the rings to be made without welds, by being originally cast in the form of small thick rings, and then rolled, in a modification of the tire-rolling machine, to a larger diameter and a smaller section. This treatment would develop an endless grain in the rings, in the direction of the circumference (68).

**465.** Wrought iron may be formed into rings without seams parallel to the bore, by Ames's process (128)—flattening a mass under the hammer, and then punching or boring a hole in it. Rings (tires) are made without welds, by Mr. Krupp, by boring holes in the ends of a bar (Fig. 184), slotting between these holes, and then opening out the sides. Mr. Bessemer has patented\* a plan of making hoops—flattening low steel masses into large washers, and then boring or punching them. The material thus

treated would be very sound, and the grain would run both radially and circumferentially; that is to say, the crystals would be upset into lammæ instead of being drawn into fibres. Or Mr. Ames's rings could be rolled in the tire-machine so as to develop an endless circular grain. Again, very short Armstrong coils could be welded together by Hitchcock's process,

thus avoiding the embarrassments of Armstrong's present process.

FIG. 184.



Krupp's method of making solid rings.

#### SECTION IV. STEEL.

**466.** HIGH AND LOW STEEL.—By high steel is meant that which contains a large amount of carbon, and a consequently low

\* Jan. 26, 1861.



specific gravity. Its distinguishing properties are extreme ultimate tenacity, hardness, and capability of extension without permanent change of figure; but its extensibility beyond the elastic limit is small, and it is therefore brittle under concussion. It will harden when heated and immersed in water; it is with difficulty welded, because it deteriorates under high heat, and because its welding heat is so very near its melting point; and it is melted at a low temperature as compared with wrought iron.

Its obvious defect for guns is its brittleness; but if so large a mass is used that its elastic limit will never be exceeded, or if it is jacketed with a less extensible metal (320), this defect is remedied or modified. Low steel, however, is a more suitable metal for cannon, according to present tests.

Low steel, also called "mild steel," "soft steel," "homogeneous metal," and "homogeneous iron," contains less carbon, and has a higher specific gravity; it can be welded without difficulty, although overheating deteriorates it, and it more nearly resembles wrought iron in all its properties, although it has much greater hardness and ultimate tenacity, and a lower range of ductility, depending on its proportion of carbon. It has less extensibility within the elastic limit than high steel, but greater extensibility beyond it; that is to say, greater ductility.

The grand advantage of low steel over wrought iron, for nearly all purposes, is, that it can be melted at a practicable heat and run into large masses; thus avoiding the serious defect of wrought iron in large masses—want of soundness and homogeneity. Its other important advantages for cannon are, greater elasticity, tenacity, and hardness.

**467. ELASTICITY AND DUCTILITY.**—Mr. Anderson, Sir William Armstrong, Mr. Mallet, and others, complain, in various public statements, that most of the steel they have experimented with for guns is too brittle—that it gives way under *sudden* strains, which wrought iron will stand. Hence steel, especially high steel, has been condemned as a cannon-metal.

In answering this objection, let us briefly review what has been said under the head of "Ductility" (344). Suppose two thin tubes

of equal size, one of high steel, and the other of wrought iron, to be subjected to the violent and sudden strains of gunpowder. The elastic limit of the steel is overcome, and it soon breaks, because it has but a small reserve of ductility to draw upon, to eke out its integrity. The elastic limit of the wrought-iron tube is overcome much sooner, but it has an immense capital of ductility to expend, and so it stretches and stretches for a long time without fracture.

Now suppose the quantity—thickness of steel to be increased just so much that the pressure—proof charges, for instance—will never overcome its elastic limit, that is to say, so that its particles will return to their original position after the pressure ceases. Its original resistance to the next strain is then unimpaired, and there is no evidence that it will ever become impaired; for elasticity is simply the antagonism between two tireless and changeless forces—repulsion by heat, and the attraction of cohesion.

But in order to bear the same pressure (and the demand is for the highest possible pressure of powder), the iron, equally increased in quantity, will stretch beyond its elastic limit, and therefore must depend upon a new arrangement of particles and a new limit of elasticity, for continued cohesion. Its great ductility allows this rearrangement to continue for some time; but although it may stretch to a less distance at each renewed application of the pressure, its ability to stretch and its range of elasticity are constantly diminishing, until it at last arrives at a point where it can stretch no further without fracture. It has exhausted its reserved ductility. If it were not so, iron would never be broken at all by stretching. In addition to this, although a given area of stretched iron may sustain more than the same area of the original metal, the total area is constantly diminishing. It is, to a great extent, a substitution of a little strong iron for much weak iron. In order to endure *as long* as the steel, the iron must be still greater in quantity, because the “work done” to raise it to its limit of elasticity is less than that required to raise steel to its limit of elasticity (349, 352, 353).

**468.** This explains the failure, after short service, of thin tubes made of the moderately high steel heretofore used, while thin

iron tubes *appear* to be unimpaired by elongation, although they certainly are impaired from another cause—compression. It is simply a question of excess of metal and, practically, endless endurance, on the one hand, and ultimate failure on the other hand.

The serious mistake in the use of the steel heretofore obtained, for extreme charges of powder, appears to have arisen from the neglect of the whole subject of the elastic and the ductile limits. Because the *ultimate strength* of steel was higher than that of iron, the quantity of the material has been proportionately reduced, when its quantity should have been proportioned to the work done in overcoming its resistance to extension.

If steel, or any metal requiring the highest attainable effort of force in motion to stretch it *within* its elastic limit, could also be made to have a great range of ductility beyond it, the safest and most perfect cannon-metal would be obtained. But unfortunately, as the one property increases, the other decreases. (Table 69.) Low steel, the amounts of metal being the same in each case, would stand more pressure than iron within the elastic range, and would stand sudden strains longer than high steel; but its elastic limit once exceeded, from any cause, it would fail sooner than wrought iron. As a compromise between high steel and wrought iron, it has this advantage: that a small increase of weight of material will bear a considerable increase of pressure, within the limits of safety.

**469.** But according to Mr. Kirkaldy's experiments,\* the lower steels have a considerable degree of extensibility before fracture, (Table 66), and so much tenacity that the work done in stretching them to rupture actually exceeds that required to rupture the best wrought iron. In the table, several of the best specimens of both iron and steel mentioned by Mr. Kirkaldy, are compared in this regard. The average of the steel not specially treated, is higher than that of the iron.

\* It is to be regretted that Mr. Kirkaldy has not given the limit of elasticity; so that we cannot form a diagram like that given by Mr. Mallet (Fig. 160), to show where the elasticity ends and the ductility begins. Were this done, both the iron and the steel would show much more work done before rupture. The result would probably be slightly favorable to the iron, as far as ductility is concerned.

TABLE LXVI.—THE "WORK DONE" IN STRETCHING TO RUPTURE, SEVERAL OF THE BEST SPECIMENS OF IRON AND STEEL, AS TESTED BY KIRKALDY.

Names of Makers or Works.	Condition and Treatment.	Breaking.		Work done in lbs. lifted 1 foot in stretching to rupture a bar 1 foot long and 1 in. square.
		Ext'n	Strain.	
IRON.				
Lowmoor .....	Bar .....	.249	60364	7315
Farnley.....	Plate.....	.1645	62544	5144
Govan .....	Do. ....	.1379	55546	3830
Bradley.....	Do. ....	.1571	58534	4098
CAST STEEL.				
Turton's, Tool.....	Highly heated and cooled in oil.....	.033	215400	3554
Jowitt's do. ....	Low heat, cooled in tallow.....	.18	112750	10147
do. do. ....	Cooled in ashes .....	.07	121711	4260
do. do. ....	Cooled slowly.....	.10	125978	6298
Shortridge & Howell's Homogeneous Metal.....	Highly heated, cooled slowly.....	.22	86166	9038
Krupp's Bolt Steel .....	Soft.....	.1673	94838	7933
Moss & Gamble.....	Plates, soft .....	.1964	79937	7850

**470.** Mr. Anderson concludes, from experiments upon Krupp's steel, as follows :\*

"This material is so soft as to admit of being flattened down to any extent; indeed, the same remark applies to most of the good qualities of steel which are under 40000 lbs.; they continually yield more and more by the increase of pressure, and the structure of the steel shows a wonderful adaptation for keeping together without cracking at the edges, unlike almost any of the other descriptions of material. This property is greatly in its favor, both for guns and armor-plates; and if it could be made to resist

\* Jour. Royal U. Service Institution, Aug., 1862.

a sudden shock as well as it does the effect of mere pressure, it would be exceedingly valuable.”

**471.** It will, however, be said that steel armor-plates do not practically resist shot as well as iron armor-plates, and that “work done,” as computed in this table, and in the tables of Mr. Mallet, is not a correct measure of the effect of a *sudden blow* (346).

To which it may be answered:—*First.* Steel plates are certainly cracked and fractured for some distance around the point of impact, by shot that only locally bulge, indent, and mutilate iron plates. But this does not prove a difference in the work done. The tenacity of the steel is sufficient to distribute the blow—to overcome the inertia of the surrounding parts—and its hardness prevents much expenditure of power in local indentation. The iron yields very much more at the point struck, because it is not hard enough to resist indentation, nor tenacious enough to overcome the inertia of the surrounding metal. The damage to the steel, considered as an *armor-plate*, however, is much the greater, because it is rendered more liable to be thrown off. The iron, considered as an armor-plate, is not materially injured, if it is not actually punched.

*Second.* There is no evidence that the armor-plates tried had the same relation of tenacity and ductility as the steel and iron specimens tested by Mr. Kirkaldy. It is known, on the contrary, that the Bessemer and other plates tried, were not sufficiently worked. The Mersey puddled steel plates failed; but Table 68 shows them to have much less ductility than iron.

*Third.* The pressure in a cannon is not exerted upon one point, but over the whole inner surface of a cylinder.

*Fourth.* The blow of a cannon-shot is obviously very different from the blow of a perfectly elastic gas, lighter than air.

*Fifth.* The actual extension of some of the steel specimens was greater than that of some of the iron specimens, not to speak of the greater resistance to that extension. So that the rule of “work done” is equally applicable to steel and to iron.

**472.** Mr. Mallet, in one of his tables,\* gives “Tr. value for

\* “On the Construction of Artillery.” Table on page 79.

unit of length and section" for "cast-steel (German), soft," at 103·500, and for "wrought-iron bar (maximum ductility)," at 96·000.

The ductility of Messrs. Naylor, Vickers & Co's. steel, and of low steel as compared with high steel, is shown by Tables 68 and 69.

The extreme ductility of the Bessemer low steel was shown by various specimens in the Great Exhibition of 1862. The *London Engineer*\* says of one them—a rail—that it was "twisted *cold* into a spiral like a ribbon, and does not show a single flaw after this severe treatment. All idea of the 'brittleness of steel' vanishes with the inspection of this example." The same authority says of other specimens: "There are also some close bends of rails, one of which is deserving special notice. Mr. Ramsbottom, the able engineer of the railway works at Crewe, had this piece taken up while covered with sharp frost and placed under the large steam-hammer, when it stood the blows necessary to double both ends together, without showing the smallest indication of fracture. \* \* \* There are also some extraordinary examples of the toughness of the Bessemer steel, made from British coke pig-iron, among which may be enumerated two deep vessels of 1 foot in diameter, with flattened bottoms and vertical sides. At the top edge, one of them is  $\frac{5}{8}$  in. and the other  $\frac{7}{8}$  in. in thickness. \* \* \* A 4-in. square bar has been so twisted, while hot, that its angles have approached within less than half an inch of each other, so that what was originally 1 ft. length of surface, has now become 26 feet, while the central portion of the bar still preserves its original length of 1 foot."†

**473. STEEL HOOPS.**—Elasticity is an indispensable quality in hoops, especially when the inner barrel is of cast iron or a slightly ductile metal. If hoops change their figure permanently, their

\* May 2, 1862.

† The author is aware, from personal inspection and measurement, that the specimens are correctly described, although he did not see them put into these shapes. From tests that he has seen and made, however, at Mr. Bessemer's works in Sheffield, he does not believe that the excellence of the steel is overstated by the editor of the *Engineer*.

usefulness is in a great degree destroyed. With the high charges necessary to punch the best armor, wrought iron is likely to fail in this particular (445). For a given elongation without permanent change of figure, high steel requires more "work done" than any other metal (Fig. 160).

But the substitution of very low steel for wrought iron involves another important principle. The want of homogeneity—the numerous strata of impurities and planes of weakness introduced into wrought iron, especially in large masses, all the way from the puddle-ball to the finished gun, have already been explained (413 to 416). Its grand defect, by the present processes of manufacture, is imperfect welds. The casting of low steel into masses of any size overcomes this whole difficulty.

**474. COST; WEIGHT; QUALITY.**—By the present processes, excepting Bessemer's (486), although the number of operations is reduced, by casting steel in large masses, its cost, as compared with that of wrought iron, is somewhat increased. (Table 27.) Still, it compares favorably, considering its greater strength.

The present causes of the costliness of steel are principally these: Melting the metal is expensive. Such a high temperature is required, that the pots for very low steel only stand one or two meltings. The subsequent heating of immense ingots (one of Krupp's, in the Great Exhibition, was 44 inches in diameter and 8 feet long) requires time and skill; drawing them under ordinary hammers, not to speak of its injurious effects (419, 421), is a very long operation. The careful preparation and selection of the material adds considerably to the cost.

Again, the business is now monopolized by a few manufacturers. Standard qualities of low steel bring a price much more disproportionate than that of wrought iron, to the cost of production. Some of the processes are secret—others are covered by patents; but the chief difficulty is, that very few establishments, out of the whole number, have undertaken the manufacture. The remedy is fast developing itself, especially in England. Many of the large British establishments have introduced the Bessemer process. In this country, several iron-masters, to-day, pronounce this process a

failure, and propose to stick to puddling and piling. At the same time, others are doing all they can to develop this and similar improvements (490), but are indifferently encouraged.

There is no doubt, however, that within a few years low steel will be produced at a cheap rate all over the world. The great increase in the use of Krupp's, and of the Bochum Prussian steel, and of Naylor, Vickers & Co's. equally good cast steel, and of the steel of Firth, Howell, and other English makers, and, above all, the wonderful success and spread of the Bessemer process, in England, France, Prussia, Belgium, Sweden, and even in India—all within three or four years, prove that great talent and capital are already concentrated on this subject, and promise the most favorable results. The processes are certainly dissimilar; but that only shows the determination to find the right way, and indicates the increasing demand for the right product.

It has already been remarked that the advantage of steel over iron in its more crude forms is, that the number and quantity of its ingredients are better known at each stage of its refinement.

Then, the growing improvements in treating steel, after it is produced, promise further reduction in the cost of manufactured articles. In an establishment about to be erected in London, and another in Staffordshire, for the production of Bessemer metal, 50-ton hammers will be used. Messrs. John Brown & Co., of Sheffield, have recently erected a 40-ton hammer and two 10-ton Bessemer converting-vessels, for the manufacture of steel cannon; and it is said that Mr. Krupp's 40-ton hammer is to be rivalled in his own works. In some of the larger establishments, hydraulic presses are to be substituted for hammers; and other heavy machinery, for working large masses, is rapidly coming into use. The largest cast-steel ingot ever made, up to 1851, was sent by Mr. Krupp to the Great Exhibition of that year; it weighed 4500 lbs. One of his ingots, in the Exhibition of 1862, weighed 44800 lbs.—about ten times as much.

Meanwhile, wrought iron must be puddled and piled. The means of improving and cheapening its manufacture do not seem to be capable of much further development.



The secret of the whole matter is this: The New Treatment of iron is based on chemical laws. The old treatment was a matter of tradition, trial, failure, and guess-work. The Bessemer process is a chemical process—suggested by the study of chemical laws, conducted on chemical principles, and prosecuted, modified, and improved, according to the results of chemical analyses. The old process was suggested by accident, is liable to be disorganized by accidental and unexpected causes, and has been brought to the present, which is perhaps the ultimate degree of perfection, after generations of groping in the dark. Instead of first *finding* the right course, and then pursuing it, every course has been taken, or an old and wrong course has been persisted in. There is nothing but blundering into truth in its whole history, if we except the part of Henry Cort. Now that this method of proceeding is likely to be superseded, we may look for rapid improvement.

475. But it is said that the new products are not always uniform and trustworthy. Mr. Anderson remarks :\*

“Cast steel is the most expensive of all cannon-metals, yet, from its soundness in the bore, if it could be made as trustworthy as wrought iron, and if, at the same time, it could be depended upon for the certain possession of toughness, it would be perfection, notwithstanding the cost; but the uncertainty of manufacture which now exists must first be completely removed before it can be compared with wrought iron as an instrument for men to fire and stand alongside with perfect assurance of safety; and, as wrought iron is so reliable and the cost moderate, there is no particular want felt for steel to constitute the entire body of the gun.”

It is, however, due to Mr. Anderson and to the subject to say, that in his more recent practice at Woolwich, steel hardened in oil has quite superseded wrought iron, especially coils, as a material for the inner barrels of guns. Indeed, Mr. Anderson admits in the same lecture, speaking of the 8-inch Krupp gun tested at Woolwich (138), that “such a mass of homogeneous steel, after having been cast into an ingot, all its impurities floated to

\* Journal of the United Service Institution, August, 1862.

the surface, then well worked under the hammer, and afterwards properly annealed, has a degree of perfection in the bore, in regard to entire freedom from specks, seams, or flaws, superior to any wrought-iron structure, coiled or forged; and some remarkably fine guns have been constructed with such steel linings, having the main structure of the gun built up with wrought-iron hoops, to give the requisite strength to the steel lining. Such a combination gives the perfect bore and the strong gun, but there is not yet sufficient experience to enable me to assert positively, that the steel will not give way under long-continued firing."

The failure of steel, as *used* in guns, has already been accounted for, and the remedy specified (467 and 468). Other authorities\* do not entertain so high an opinion of the trustworthiness of wrought iron as not to particularly want something better. Of course, new things will be avoided as long as possible, by old practitioners, as a rule. The steam-engine, the war-steamer, the rifled cannon, the iron-clad—all had to fight their way into notice and adoption. But, even when men are willing to adopt an improvement, they are apt to be over-cautious and too easily frightened.

\*In the discussion before referred to, in the Institution of Civil Engineers, on "The National Defences," 1861, after Sir William Armstrong and others had talked pretty freely against steel (which is *now* adopted in all the new Armstrong guns for inner tubes, because wrought iron fails), Mr. Bidder, president, said:

"Sir William had expressed an entire want of confidence in homogeneous iron. The president could not concur in that view; he did not think that, at present, they would be justified in saying that homogeneous iron had ever yet had a fair trial and had been found wanting. He had received a letter from Mr. Krupp, of Essen, accompanied by a communication from Colonel Petiet, of the Artillery Commission of France, stating, as the results of his experience with 12-pounder guns, constructed of homogeneous iron, that they had been completely successful. Mr. Krupp stated that, in Prussia, they had made guns of 8-inches bore, which had successfully resisted all the proofs to which they had been submitted. There could be no doubt that, in this country, there had been some disappointment attending the manufacture of guns of large calibre, of homogeneous iron. This, however, might be fairly attributed to the mode of manufacture. The machinery for working the iron in the large masses necessary for guns, was not suitable for the purpose; and, until hammers of thirty or forty tons were applied, it would not be fair to pronounce the condemnation of homogeneous iron as a material for artillery; indeed, they were not justified in rejecting homogeneous iron for guns, until the same experience had been gained, and the same attention had been bestowed upon that metal, as had been given, under Sir William Armstrong's superintendence, to his own peculiar mode of construction."

If they would devote the same energy in trying to perfect and develop steel, for instance, that they now expended in trying to get more out of wrought iron than there is in it, there would be less cause of complaint. Besides, a perfect result cannot be at once expected from a new manufacture, however well founded its principles may be.

**476. STRENGTH.** (See Tables 67, 68, and 69). The strength of the low steel, adapted to gun-making, averages about 90000 lbs., or three times that of cast gun-iron, and 50 per cent. more than that of the best wrought iron. Kirkaldy's summary of results for the lower steels will be found in Table 67.

The strength of Krupp's steel, according to the report of the Prussian Minister of War, as quoted by Mallet, is 107516 to 117212 lbs. In Mr. Krupp's gun-circular (134 note), it is taken at 120000 lbs.

The strength of the lowest and softest Bessemer steel is 72000 lbs. per square inch. That of the highest Bessemer tool-steel (remelted in crucibles and drawn under the hammer) is 170000 lbs. That of the average metal is about 90000 lbs. Plates tested at Woolwich are said to have endured 68314 to 73166 lbs.

Messrs. Cornings & Winslow's (American) puddled steel, of the highest quality, averages about 90000 lbs. tensile strength.

High steel, hardened in oil, was found by Mr. Kirkaldy to have a tenacity of 215400 lbs.

**477. UNIFORMITY.**—Want of uniformity is, in one sense, fairly urged against steel, when certain qualities, supposed to be uniform, are less so than certain qualities of wrought iron. But, to condemn steel, as some authorities seriously do, because it ranges all the way from 50000 to 200000 lbs. tensile strength, is as absurd as it would be to condemn timber, because it ranges all the way from 6000 lbs. (cypress) to 23000 (lancewood), tensile strength. The causes of improvement already considered—proceeding in accordance with chemical laws, instead of groping among traditions and expedients, liable at any time to accidental confusion—are certain to lead also to *uniformity* in the product.

TABLE LXVII.—TENSILE STRENGTH OF LOW STEEL. KIRKALDY.

Names of the Makers, or Works.	Condition.	Breaking weight per square inch of original area.		
		Lowest.	Highest.	Mean.
	Bars.			
Krupp's Steel for Bolts.....	Rolled.	86054	96208	92015
Shortridge & Co.'s Homogeneous Metal	Rolled.	82218	99570	90647
Ditto           ditto       ...	Forged.	84794	94752	89724
Mersey Co.'s Puddled Steel.....	Forged.	67065	75304	71486
Blochairn       ditto       .....	Rolled.	55006	57114	70168
Ditto       ditto       .....	Forged.	42564	71501	65255
Ditto       ditto       .....	Forged.	45931	70341	62769
	Plates Lengthwise.			
	In. thick.			
Shortridge & Co.'s Cast Steel.....	$\frac{3}{16}$	85650	108900	96280
Naylor, Vickers & Co.'s ditto....	$\frac{1}{2}$	76772	87972	81719
Morse & Gambles's ditto.....	$\frac{3}{16}$ and $\frac{1}{4}$	67977	81588	75594
Mersey Co.'s Puddled.....	$\frac{2}{16}$ and $\frac{3}{16}$	92676	108906	101450
Ditto ditto Hard.....	$\frac{1}{2}$	95946	106110	102593
Ditto ditto Mild.....	$\frac{1}{2}$	67184	86908	77046

But, according to Mr. Kirkaldy's late experiments,\* steel compares very favorably with iron, as to uniformity of strength, and of ultimate elongation. The table (68) is compiled from the tables of Mr. Kirkaldy.

**478. SHAPE.**—What has been said, under this head, of wrought iron (409), applies also to steel.

**479. TEMPER.**—The specific gravity of steel has been found to affect the qualities we have considered—tenacity, elasticity,

\* "Experiments on Wrought Iron and Steel," 1862.

TABLE LXVIII.—THE UNIFORMITY AND EXTENSIBILITY OF WROUGHT IRON AND STEEL COMPARED.

Names of the Makers, or Works.	Description.	Breaking weight per square inch of original area.		Percentage of Elongation before fracture.	
		Highest.	Lowest.	Highest.	Lowest.
<b>IRON BARS.</b>					
Low Moor.....	{ Rolled 1 in. square.	62635	58228	24.9	20.5
Bowling .....	{ Rolled 1 in. round.	65701	58687	26.0	24.4
J. Bradley & Co. ....	{ Rolled 1 in. and $\frac{3}{4}$ in. round.	63604	54575	30.2	22.2
Govan Ex. B. Best.....	{ Rolled $\frac{3}{4}$ to $1\frac{1}{8}$ in. round.	59820	53266	23.8	17.3
Farmley .....	{ Plates (lengthwise).	62544	51541	14.5	10.85
Dundyvan (Common).....	Bars.	62429	45611	11.1	6.3
Heavy Forgings.....	{ Armor-Plate and crank shaft.	44561	32528	20.5	6.4
<b>STEEL.</b>					
Turton's and Jowitt's Cast Steel } for Tools.....	Bars	148229	112224	7.1	5.2
Krupp's Steel for Bolts, and Howell's Homogeneous Metal.. }	Bars.	99570	82218	18.0	11.9
Blochairn Puddled.....	{ Rolled and forged bars.	75114	45931	11.3	9.1
Turton's Cast Steel.....	{ Plates (lengthwise).	95360	92858	*9.64	5.71
Naylor, Vickers & Co.'s Cast Steel..	Do.	87972	81588	17.32	17.50
Moss & Gamble's Cast Steel.....	Do.	81588	67977	19.82	19.64
Shortridge, Howell & Co.'s Homogeneous Metal.....	{ Do.	108900	85650	8.93	8.61
Ditto ditto .....	{ Highly heated and cooled slowly }	82166	.....	22.00	.....
Mersey Puddled (Ship Plates).....	Do.	108906	92676	Average. 2.79	
Ditto "Hard".....	.....	106110	95946	4.86	
Ditto "Mild".....	Do.	86908	67184	6.16	
Blochairn ditto.....	.....	106394	93327	3.60	

\* Average, crosswise and lengthwise.

and ductility—very materially. It may be stated, generally, as follows:

1. High steel has a low specific gravity.
2. Low steel has a high specific gravity.
3. Decreasing specific gravity increases tenacity.
4. Decreasing specific gravity increases the capability of elongation within the elastic limit.
5. Decreasing specific gravity diminishes the capability of elongation between the limit of elasticity and the point of rupture.

The 1st, 2d, 3d, and 5th propositions, are proved by the experiments of Mr. T. E. Vickers (of Naylor, Vickers & Co., Sheffield). The soft, mild steel (Table 69), which stood 17 blows of the drop, and bent  $58\frac{1}{8}$  inches, endured but  $30\frac{3}{4}$  tons tensile pull, and had a specific gravity of 7.871. The high, hard steel, which stood but 10 blows, and bent only  $61\frac{1}{8}$  inches, endured 69 tons tensile pull, and had a specific gravity of 7.823.

Table 70, compiled from Mr. Kirkaldy's experiments, shows the remarkable gain in ultimate tenacity by decreasing the specific gravity of steel in another way—hardening in oil.\* At the same time, the "work done" in overcoming this tenacity, is less than for the same steel cooled slowly, because its elongation before rupture is so much less.

\* The process of hardening steel in oil, as practised at Woolwich, has been described (35).

The following is the provisional specification of Mr. George W. Rendel (one of the Elswick Ordnance Co.), dated November 13th, 1863, which sufficiently describes the very simple process:

"I, GEORGE WIGHTWICK RENDEL, Newcastle-on-Tyne, in the County of Northumberland, Civil Engineer, do hereby declare the nature of the said invention for 'An Improved Method of Strengthening and Hardening Cannon made wholly or partially of Carbonized Iron or Steel, or the Barrels, or other parts thereof,' to be as follows:

"I bring the cannon or parts of cannon to a suitable heat in an oven, or any convenient furnace, and I then plunge them into a bath of oil or other liquid; or instead of plunging the cannon or parts of cannon, I pour the liquid over them and to keep down the temperature of the liquid, which is raised in the act of cooling the cannon or parts thereof, I employ pipes winding through the liquid, in which pipes a current of cold water circulates, or the liquid may be cooled by any other suitable arrangement; but any arrangement for cooling is not essential to the process of strengthening, being only a matter of convenience, as having the effect of reducing the volume of liquid necessary for cooling large masses of metal."

TABLE LXIX.—SHOWING THAT DECREASING THE SPECIFIC GRAVITY OF STEEL INCREASES ITS ULTIMATE TENACITY, AND DIMINISHES ITS DUCTILITY.  
(Compiled from the Experiments of T. E. Vickers, Esq.)

NOTE.—The material, in the form of an axle of  $3\frac{1}{8}$  in. diameter, was laid on bearings 3 feet apart, and subjected to the blows of a drop weighing 1547 lbs., falling 1, 2, 3, 4, 5,  $7\frac{1}{2}$ , 10,  $12\frac{1}{2}$ , 15, 20, 25, 30, and 36 feet, up to the 13th blow, and 36 feet at the remaining blows. The material subjected to tensile test was a bar 14 in. long and  $1\frac{1}{32}$  in. in diameter

Specific Gravity.	No. of Blows endured.	Total Bend under Blows.	Elongation before breaking.	Ultimate Tenacity per square in.
		Ins.	Ins.	Tons.
7.871	17	$58\frac{1}{8}$	$1\frac{3}{8}$	$30\frac{3}{8}$
7.867	18	$56\frac{1}{8}$	$1\frac{3}{8}$	34
7.855	18	$53\frac{9}{16}$	$1\frac{1}{4}$	$37\frac{1}{2}$
7.855	15	$35\frac{1}{8}$	$1\frac{1}{8}$	$42\frac{1}{2}$
7.852	16	$38\frac{1}{8}$	$1\frac{3}{8}$	$41\frac{1}{2}$
7.848*	18	46	1	45
7.847	16	$40\frac{5}{8}$	$1\frac{1}{8}$	$45\frac{1}{2}$
7.840	10	$6\frac{9}{16}$	$1\frac{1}{8}$	55
7.836	8	$4\frac{5}{8}$	1	60
7.823	10	$6\frac{1}{8}$	$\frac{5}{8}$	69

\*This is considered the proper temper for cannon.

Neither of these experimenters has determined the amount of elongation within the elastic limit, nor the "work done" to reach it; but we know from experiments, and practice generally, that the higher the steel, the greater the safe elongation, and the greater the power required to produce that elongation.

Hardening steel in water or in oil, or by cold hammering, decreases its specific gravity, by combining the free carbon chemically, and so fixes the crystals of steel in their expanded state. Annealing steel increases its specific gravity; a part of the carbon is set free, and the crystals are allowed to assume their closest and natural form.

TABLE LXX.—SHOWING THE EFFECTS OF TREATMENT ON STEEL.

Names of the Maker or Works.			How treated.	Breaking weight per square inch.	Elongation per cent.
1 BAR.	Jowitt's Cast Steel for Chisels,		Highly heated and cooled in oil,	215400	3.3
	Do.	do. do.	Do. do. cooled in water,	90094	0.0
	Do.	do. do.	Do. do. cooled in ashes, slowly,	121716	7.0
1 BAR.	Bessemer's	do. Tools,	Heated and cooled in oil,	211072	0.1
	Do.	do. do.	Do. do. slowly,	123165	5.9
1 BAR.	Shortridge & Howell's Homogeneous Metal,		Highly heated, cooled in oil,	130237	2.5
	Do.	do. do.	Do. do. do. water,	66953	0.0
	Do.	do. do.	Do. do. do. slowly,	82166	22.0

The proper temper of steel for guns may be generally determined on these principles, although more careful and comprehensive experiments and analyses are of the highest importance, and should be undertaken by governments, if not by steel and gun makers, for the purpose of avoiding uncertainty and occasional or partial failure.

**480.** RESISTANCE TO COMPRESSION AND WEAR.—The superiority of steel in this regard—hardness—is too evident to require comment. Mr. Anderson, and authorities generally, pronounce even the low steels to be quite satisfactory. Considering the friction of rifled projectiles, and the enormous pressure that modern guns are required to stand, this is by no means an unimportant quality. The permanent indentation of the chambers of the Armstrong and other wrought-iron guns, by the pressure of the powder-gas, is admitted by Sir William Armstrong and Mr. Anderson (402. Tables 71 and 72).

**481.** In another particular steel has a great advantage over wrought iron. A piece of cast steel, that has been immersed for a time in acid, will be found to present a smooth surface. A thin



TABLE LXXI.—HARDNESS OF CANNON-METALS.  
Major Wade.—1856.

Metal.		Hardness.
Cast Iron .....	{ Least .....	4·57
	{ Greatest.....	33·51
Wrought Iron .....	{ Least .....	10·45
	{ Greatest.....	12·14
Bronze .....	{ Least . . . . .	4·57
	{ Greatest .....	5·94

TABLE LXXII.—VARIOUS QUALITIES OF CANNON-METAL.  
(Compiled from the Tables of Mr. Mallet—"Construction of Artillery.")

Metal.	Ultimate tenacity.	Relative hardness.	Relative resistance to abrasion.	Te.-Value for amt. of length and section. Dynams.	Tr.-Value for amt. of length and section.
Bronze, mean.....	32704	5 (?)	10·5	5·308	93·525
Cast Iron .....	19341	10 (?)	39·4	5·997	12·287
Wrought Iron, Maximum Ductility.....	64323	20 (?)	322·6	7·660	96·000
Steel, Soft German ...	110393	40	968·4	16·988	103·500

film of equal thickness will have been dissolved. But a piece of puddled iron, similarly treated, will be eaten away in irregular furrows. Iron, being more nearly pure, is the more corroded by the gases of gunpowder, and is therefore roughened, and thus more rapidly worn by the projectile, besides increasing its friction and the strain on the gun.

**482. STRAINS ON A HOMOGENEOUS TUBE.**—A solid steel gun, or any solid tube, as left by the forging or annealing process, is obviously deprived of one element of strength possessed by built-up guns—the increased tension or the decreased elasticity of its external layers (287, 320). But this defect becomes less serious as the tenacity of the material increases (Fig. 161), and Mr. Krupp considers that with his material, built-up guns lose more by vibration

than they gain in resistance to internal pressure. On the other hand, Blakely, Whitworth, Anderson, &c., make equally strong guns by reinforcing steel tubes with steel in a cheaper form, or with a cheaper material than steel.

There are also various schemes for putting the layers, of which a solid gun may be supposed to consist, into the required state of initial strain or elasticity. That of Mr. Thomas E. Vickers\* (Messrs. Naylor, Vickers & Co., Sheffield) is about to be tried, and promises the best results. Initial tension obtained on Captain Rodman's plan, by casting the gun hollow and cooling it from within, would obviously be destroyed by the annealing process, which should always follow the casting or forging of a steel gun. (See Table 70.)

**483. Methods of producing Steel.—PUDDLED STEEL.**—As this product is made in the puddling-furnace, by a modification of the puddling process; and as large solid masses are aggregated only by piling and welding, the grand defect of wrought iron—want of

\* Extracts from T. E. Vicker's Patent of Dec. 11, 1862. "Improvements in the Construction of Ordnance. \* \* \* The object of my invention is to cool the block of metal in such a manner as to cause that portion of its section which is nearest to the inside of the bore to contract first, the other portions of the section being allowed to cool upon it in the order of their respective distances from the axis of the piece.

"In carrying out my invention, I first roll, hammer, or otherwise form a solid block of steel or iron, or other suitable metal or alloy, of the required form, in any convenient manner, and I then bore out the solid block of steel, iron, or other suitable metal or alloy, to about the required size for the calibre of the piece. When bored out, the block of steel, iron, or other metal or alloy, is to be subjected to heat in a reheating or annealing furnace, and when brought to a heat sufficient to expand the crystals in the mass, and while the block of metal is still in the furnace, I introduce into the hollow portion of the gun a stream or jet of water, which is continued until the gun shall have cooled down entirely. I do not, however, confine myself to the use of water alone, but employ other fluids or air, or any material which is capable of being passed through the bore of the gun, and which possesses a sufficiently low temperature to cool the metal.

"I also subject to the above process of reheating and cooling from the centre, guns that have been cast of steel in a mould made of fire-proof material, and with a hollow core. \* \* \*

"The essential feature of novelty in the present invention, in contradistinction to that of cooling molten metal from the inside of the block, as now practised, consists in boring, reheating from the inside, metal gun-blocks, made either by casting, rolling, or forging the same, or of reheating and cooling from the inside, gun-blocks that have been made with a hollow core."

homogeneity—is not avoided. It is, however, a much stronger material than wrought iron. The tensile strength of the best averages about 90000 lbs. per square inch, the best iron averaging about 60000 lbs. In small masses, it is now produced by Messrs. Cornings & Winslow, Troy, N. Y., and at the Mersey Iron Works, Liverpool, of a very uniform quality, especially in its lower or mild form. But it has considerably less ductility than the low cast steels. (Table 68.)

The process of making puddled steel may be described, in a general way, as follows: Cast iron contains from 3 to 5 per cent. of carbon; ordinary steel contains from  $\frac{3}{4}$  to 1 per cent. of carbon; while wrought iron contains but a trace. In changing from cast to wrought iron, in a puddling-furnace, the pig-metal passes through the state of steel—that is to say, it is steel before it is wrought iron. Now, making puddled steel is simply stopping the common puddling process just at the moment when the decarbonizing mass under treatment is in the state of steel. Several modifications in furnaces and processes have been patented. Usually, a higher heat than that necessary for iron making is employed, in what is termed a boiling-furnace. Various fluxes, especially manganese, are differently used by different manufacturers.

**484.** LOW CRUCIBLE STEEL OR HOMOGENEOUS METAL.\*—In its general features, the process of making low cast steel is the same as that employed for making ordinary cast steel. The chief object is to obtain, as the name indicates, a *homogeneous* iron, which can only be done by casting it. Since wrought iron, which has but a trace of carbon, cannot be melted at a practicable heat, just enough carbon is introduced to render it fluid under the highest temperature that the crucibles will stand for one melting. The wrought iron is broken into small pieces and put in the pots along with 5 oz. or 6 oz. of charcoal to every 40 lbs. of metal.† The great

\* The latter name was first introduced because consumers did not believe in any thing that went by the name of steel, for guns and large masses.

† London *Engineer*, May 2, 1862.

secret of the manufacture is in the selection and mixture of irons, and in the pouring of sound ingots.

Large castings are made by emptying a sufficient number of 50-lb. crucibles into an immense ladle placed over the mould; the ladle is then tapped from the bottom. The largest (7 tons) and best castings made in England by this process, are produced by Messrs. Naylor, Vickers & Co. In their new works, now erecting, they will be able to cast ingots of 15 tons weight. These ingots will be worked by hydraulic presses as well as by hammers.

The treatment of the solid and hollow ingots has already been described (62, 68, 69).

**485. KRUPP'S STEEL.**—This celebrated material is also produced by a modification of the ordinary process of making cast steel. It is understood that a superior quality of puddled steel is broken up, and pieces of similar fracture are selected for melting. Four hundred clay crucibles, holding 100 Prussian pounds each, are required to make a 20-ton casting.\* Mr. Krupp has recently introduced the Bessemer process—but to what extent the Bessemer metal is used for guns, is not known to the public. It has been suggested that it is broken up instead of puddled steel for remelting. Considering the character of the Bessemer metal as it is first produced, especially under the skilful treatment of Mr. Krupp, this process would hardly be necessary.

It is known that the manganesian iron (Spiegeleisen) of the country, resembling the Franklinite of New Jersey, is of especial value. Great skill in melting and pouring the metal, and particularly in heating such masses to the centre without burning them on the outside, and heavy hammers to condense them to the core, are features of obvious importance. Indeed, to this skill, and the proper use of manganese, may be traced, to a great extent, the success of the manufacture.

So long as crucibles are employed, the metal can never be very cheaply produced. The adoption of Mr. Bessemer's invention, however, would indicate that the process will be gradually changed.

\* Practical Mechanics' Journal, Record of the Great Exhibition.

Among the specimens of Krupp's steel in the Exhibition of 1862, were the following :

A 9-in. gun, weighing, finished, 18000 lbs., forged from a single ingot weighing 50000 lbs. ; a crank-shaft 15 ft. long and 24 in. in diameter, weighing  $15\frac{1}{2}$  tons (34720 lbs.), forged from a 25-ton ingot ; a double-crank propeller-shaft, 24 ft. long and 15 in. in diameter, weighing 11 tons (24640 lbs.); and a screw propeller 9 ft. in diameter, weighing only 800 lbs. A forging of 15 tons weight, 30 in. wide and 17 in. thick, was broken at four places to show its quality. A square ingot 8 ft. long and weighing about 8 tons, was forged down at one end, and broken longitudinally to show the fracture of the cast and the hammered metal. An ingot 8 ft. long and 44 in. in diameter, weighing 20 tons (44800 lbs.) was cut around in the middle and broken under the 40-ton hammer, presenting just as it was cast, without hammering, an area of above 1500 square inches of uniform, fine-grained, homogeneous fracture, without seams or cracks. It is proper to mention here, that above 40000 railway tires of this material were at that time in service all over the world. Some of them have run above 90000 miles without requiring to be turned. One of the engine tires exhibited had run 67000 miles on the Eastern Counties Railway, without being turned. It had worn down about  $\frac{1}{4}$  in., equally over its whole circumference. The extent to which Mr. Krupp's cannon have been employed, and the severe tests of some of them, have already been mentioned (135).

A similar kind of steel is made at the Bochum works, in Prussia.

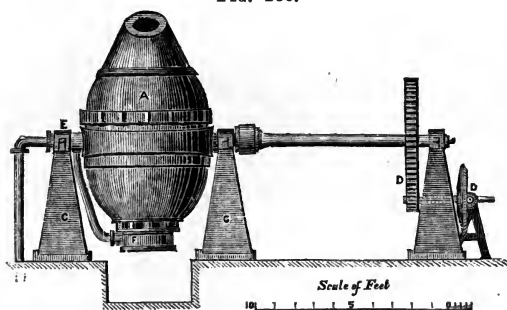
**486. BESSEMER STEEL.\***—The great value of the Bessemer process is, that it produces steel direct from the ore or from the pig-iron, in masses of any size, at about the cost of wrought iron.

The "converting-vessel" (Fig. 185), when large enough to convert 5 tons at a heat, is about 11 feet high and 7 feet in diameter. It is made of plate-iron, and lined with a silicious stone called "ganister." In the bottom of the vessel are about 50 small

\* The following account of the Bessemer *process* is taken from the Practical Mechanics' Journal, Record of the Great Exhibition of 1862.

tuyeres, communicating, through the trunnions, with a blower. Most of the establishments where this process is employed, are

FIG. 185.



Front of Bessemer converting-vessel.

not connected with smelting furnaces; so that pig-iron is melted for conversion in a reverberatory furnace, instead of a cupola, to avoid contact with any sulphur there may be in the coal. The iron originally must

be as free as possible from sulphur and especially from phosphorus.

After the converting-vessel is heated, the melted iron is let into it, and the blast turned on at a pressure of about 14 lbs. per square inch. The oxygen thus forced in, first unites with the silicium in the iron, forming silicic acid. As this burns away, and the heat is increased, the oxygen begins to unite with the carbon in the iron, which soon increases the heat and rate of combustion until the mass rises in a frothy state, presenting a great surface to the contact of the air; then the combustion becomes excessively intense, producing a series of harmless explosions, and throws out liquid slag and a column of white flame. In Sweden, and at some of the British establishments, the process is stopped here—the required decarbonization being determined by the time of its duration. In Sheffield, it is usually continued until from the sudden dropping of the flame, the iron is known to be quite decarbonized; after which a small amount of pig-iron of known quality, already melted in another compartment of the reverberatory furnace, is put into the converting-vessel. In a few seconds more the blast is shut off; the whole process lasting from 15 to 20 minutes.

The vessel is then turned on its trunnions so that the metal will run out into the ladle G (Fig. 186), on the lever H, which is elevated, lowered, and turned round upon the hydraulic cylinder P.

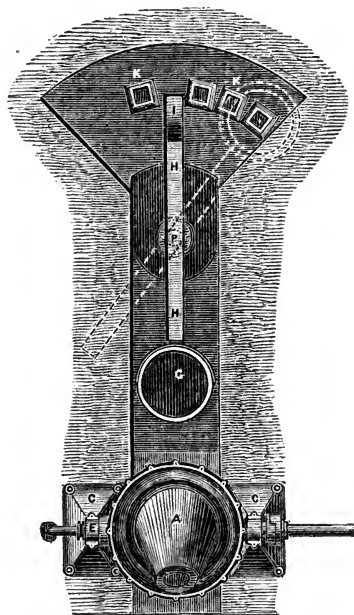
By removing a fire-clay plug in the bottom of the ladle, the respective cast-iron moulds (K) ranged around it are filled. To pour a heavy ingot, several converting-vessels are thus emptied into one mould.

The whole of the silicium is not burned out. Some 5 to 6 ounces of it, per ton, are required in all steel, to insure solid casting. While the carbon and silicium are uniting with the oxygen, some of the iron also unites with it, but is not absolutely lost, although the product is of little value. In working English iron in small quantities, from 14 to 18 per cent. of the iron is thus lost; with the purer Swedish irons, tapped from the blast-furnace, the loss is said to be but  $8\frac{3}{4}$  per cent.

After the ingots are heated some 15 minutes, to soften the outside, which has been chilled by the mould, the inside still being pasty, they are hammered into cannon or other shapes. This steel does not fly to pieces like some other cast steel, under this treatment. The interior of the ingot is certain to be thoroughly heated—an important feature—and much fuel is saved.

**487.** Among the specimens of Bessemer metal in the Exhibition of 1862, were a 14-in. octagonal ingot broken at one end and turned at the other end, to show that the metal was perfectly solid. The turned end looked like forged steel. An 18-inch ingot, weighing 3136 lbs., was the 6410th "direct steel" ingot made at the works of Messrs. Henry Bessemer & Co. There were also exhibited, a double-headed rail, 40 feet long; a 24-pounder and a 32-pounder cannon; a 250 H. P. crank-shaft, and several

FIG. 186.



Plan of Bessemer converting apparatus.

tires without welds. The specimens, showing the wonderful ductility of the metal, have been referred to (472).

The Bessemer process has been adopted, during the last two or three years, since its early embarrassments were overcome, with such great success, and by so many leading manufacturers in England, France, Sweden, Belgium, and other European states, that its general substitution for all processes of making either fine wrought iron or cheap low steel is now considered certain. At one establishment in Sheffield—the Atlas Works, Messrs. John Brown & Co.—two 3-ton vessels have been at work above two years, and a pair of 10-ton vessels are now completed, which will make the total product of Bessemer metal at these works alone over 400 tons per week.

Messrs. Winslow & Griswold, of Troy, New York, are now erecting apparatus for the production of Bessemer steel, under the direction of Mr. Bessemer.

**488. ABOUKOFF'S STEEL.**—The steel now made for guns at several establishments in Russia,\* on Aboukoff's system, is thus described in the patent :

White cast iron.....	540 lbs.
Magnetic ore.....	108 “
Arsenic .....	1 “
	649 lbs.

\* “In Russia (the Ural Works) they are producing about twenty guns per month (up to 6-in. bore) of cast steel. Mr. Povteeloff, at his large works in Finland, and in his smaller works in Petersburg, is also producing smaller guns rapidly; and that gentleman, associated with Colonel Aboukoff and Mr. Kondraftzoff, have a very extensive factory, close to Petersburg, nearly ready for producing solid guns of the very largest calibre, of steel, made on Aboukoff's system. This factory Mr. Povteeloff hopes to start in November. There will be sufficient crucible furnaces in it to enable him to cast a block of 15 tons; and the hammer-power intended to be used for reducing these masses to shape is a 35-ton one, ordered from Morrison's, of Newcastle, but which, from accidents in castings, &c., will not be delivered till the spring of 1864. The Government, therefore, are giving Mr. Povteeloff every assistance in their establishment at Colpino, to enable him to produce, by January 1st next, a 25-ton hammer, on Nasymth's plan, which, with a 15-ton hammer from England, will enable them to make 9-in. guns rapidly. The works are on a very large scale, and calculated, in a year or so, to produce ten large guns per week. \* \* \*

“By June, 1864, the Russian Government will have sunk at least a million and a half sterling on this system, or rather quality, of steel guns, that is to say, on home-made cast-steel guns.”—*Correspondence of the London Engineer, Nov. 20, 1863.*



In the specification of the patent the manipulation is thus described:—First melt in the crucible the pig-iron, then add the magnetic ore (previously reduced to the size of peas by crushing), and then the arsenic. If it is desirable to improve the quality of the steel, iron chippings are added, and the proportions are varied as may be required. Thus hard steel is made:—White iron, 14 lbs. ; chippings, 18 lbs. ; magnetic ore, 3 lbs. ; arsenic, 1 oz. Soft steel:—White iron, 10 lbs. ; chippings, 22 lbs. ; magnetic ore, 3 lbs. ; arsenic, 1 oz.

“Mr. Povteeloff, as also Colonel Aboukoff, no doubt possesses some secret beyond what is thus given, for they maintain that they can cast a portion of a block of steel, and ten hours after pour the remainder into the mould, and have a perfectly united mass. Our Sheffield manufacturers would do well to ponder on this. The steel produced is really very good ; but whether or not the uniformity claimed is to be had in making on a large scale remains to be seen.”\*

**489.** In France, the Government is understood to be developing, at great expense, another method of producing cheap steel, viz., in a reverberatory furnace, resembling a puddling furnace ; the wrought iron, or puddled steel, is protected from oxygen, sulphur, and other destructive agents, by a covering or bath of cinder, and thus melted and run into moulds without the aid of crucibles and of the costly processes usually employed.

**490.** AMERICAN CAST STEEL.—It has been remarked that Messrs. Winslow & Griswold, of Troy, New York, are erecting works for the production of Bessemer steel, under the direction of Mr. Bessemer. Other manufacturers in the United States are experimenting with various processes of making steel direct from the ore, and of improving and cheapening the manufacture generally. Such success has attended many of these latter efforts, that they deserve more than a passing notice ; but, inasmuch as large masses have not yet been produced, and as the products have not yet attained to celebrity as cannon-metals, a further reference to them would be outside of the scope of this work.

\* Correspondence of *The London Engineer*, Nov. 20, 1863.

It should be remarked, however—1st. That the Government and the old established iron-firms, with a very few exceptions, have not rendered the encouragement to these improvements which is warranted by the notorious success of similar improvements in Europe, and by the importance of the subject. 2d. That the Franklinite ores of New Jersey possess, in the greatest abundance, and in the most remarkable variety of combination, the very materials—manganese and zinc—upon which the success of Bessemer, Krupp, and the European steel-makers, so greatly depends.

**491. Systems of Fabrication.**—**SOLID FORGING.**—The grand advantage of steel is, that very large masses may be forged without welds, and so left homogeneous throughout. And to whatever extent hoops may be employed, the inner barrel, or the main piece which gives the gun longitudinal strength, must be a large and heavy mass of metal.

The serious defects of the solid-forging process for wrought iron have been specified (413 to 421). With one exception, they apply to wrought iron only. The use of light hammers would be more injurious to steel than to iron. But this is not a fault of either material. Good work necessarily implies good and adequate tools.

The drawing down of a heavy ingot—for instance, Krupp's ingot in the Exhibition, which was 8 feet long and 44 in. in diameter—requires, *first*, a uniform heat throughout the mass. To soften the centre of such a casting through 22 inches of solid metal, without burning the outside, requires a moderate and steady temperature, maintained for several days. *Second*. The effect of the hammer must be felt at the centre of the mass, instead of being confined to the outside. The *vis viva* of a light blow is absorbed in changing the figure of the surface metal. Nor would a very rapid stroke from a light hammer answer the purpose. Its effect would be local, because the surrounding metal would not have time to distribute it. The "grain" of the metal would also be broken and distorted, just as a light cannon-shot at high velocity shears a hole for itself, in the side of an iron-clad, while a very

heavy and slow shot racks and drives in the whole structure. A great weight, falling from a moderate height, is resisted by the whole mass of the forging below and around the place where it strikes. For this reason, Mr. Krupp employs a 40-ton hammer, which is said to have a fall of 12 feet. The ascertained defects of heavy forgings, due to light hammering, are—1st, the interior of the metal is not condensed; 2d, the outer part of the forging is expanded, and thus drawn away from the centre of the mass, sometimes cracking and always weakening it; 3d, the interior of a gun thus forged is left in tension, while the exterior is in compression, which is the opposite state of strain to that required.

**492. FORGING HOLLOW.**—The manner in which Naylor, Vickers & Co.'s steel jackets are forged hollow for Blakely guns has been referred to under the latter head (22, 68, 69).

Mr. Whitworth and his partner, Mr. Hulse, in a subsequent patent for constructing steel or homogeneous metal ordnance, thus specify the method of hollow forging: They "cast an ingot with a hole through it, and afterwards hammer it between an angular-shaped anvil-block and a hammer-head of a similar or flat shape. A mandrel of a taper form is inserted through the hole cast in the ingot, and the operation of hammering or forging proceeds till the mandrel becomes too hot from its contact with the heated metal of the ingot; it is then withdrawn, and a cold mandrel is inserted in the place of the heated one, and the hammering or forging is continued until it is made of the desired size and shape. If preferred, a hollow mandrel may be used and cooled internally. The hammered tubular ingot is subsequently annealed. If necessary, the interior surface of the tubular ingot may be 'converted' to the required depth."

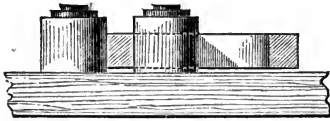
**493. COMPRESSING BY HYDRAULIC MACHINERY.**—The heaviest hammers, however, are found to produce too much local and exterior, and too little distributed and interior compression upon large masses of steel. And heavy hammers are inconvenient, especially when the forging is irregular in shape. Therefore steel-makers are beginning to use hydraulic presses for drawing and shaping their ingots. At the new works of Messrs. Naylor, Vickers & Co.,

now erecting at Sheffield, this machinery will be substituted for the heaviest hammers. Mr. Bessemer has also patented some alterations especially adapting hydraulic apparatus to the drawing of his ingots.

It is obvious that the slow and uniform pressure of water pumped through a small aperture into a large cylinder, will not strike a blow, but that it will allow each particle of matter acted upon, however thick the mass, time to distribute the pressure to the next particle. In the case of ingots compressed while hot from the moulds, and, therefore, softer within than without, the interior metal would be better worked and more condensed than the exterior metal.

**494. ROLLING AND JOINING HOOPS.**—Another, perhaps equally important advantage due to the casting of steel, is the cheap fabrication of hoops with endless grain. The machinery used is a

FIG. 187.



Machine for rolling hoops.

modification of the ordinary rolling-mill; the rolls are short, overhanging their journals, so that a ring can be slipped over them (Fig. 187). A ring of, say, half the diameter and double the thickness of the finished ring, is cast as any other ingot is cast.\*

This is put between and drawn round by the rolls, which are made to gradually approach each other until its diameter is properly increased, and a continuous grain is developed in the direction of its circumference. Messrs. Naylor, Vickers & Co. cast a great many ingots in this shape for tires, and for Blakely and other hooped guns.

There would be no difficulty, if the springing of the necessarily small inner roll is not serious, in making tubes two or three feet long in this way. Long rolls would require support at both ends, but one of them might have a movable pillow-block at one end, so that a ring could be readily put in or removed.

\* Messrs. Naylor Vickers and Co. cast these ingots on a yielding core, and have patented their process.

Mr. Krupp makes rings with endless grain, by forging an ingot into the shape shown at Fig. 188, having holes in its ends, and uniting them by a slot, opening it out into a ring, and then rolling it in the manner described.\* With his present machinery, he can make hoops of any diameter, but not of a width exceeding 6 inches.

FIG. 188.



Krupp's method of making solid rings.

To avoid the necessity of immense hammers and furnaces, and the costly experiments, by which alone a manufacture like Mr. Krupp's can be established in another country, with different materials and unskilled workmen, Mr. Hitchcock, of New York, proposes the process already discussed and illustrated (460), of fabricating solid guns from small masses of low steel or wrought iron. In any case, Mr. Hitchcock's process would be valuable for the fabrication of long hoops from rings.

**495. Solid Cast-Steel Guns.**—The soundness of steel castings, especially those produced by Messrs. Naylor, Vickers & Co., and by the Bochum Company, Prussia, have induced Captain Blakely to construct parts of some of his guns, such as outer jackets to embrace inner tubes, of hollow ingots not forged, but only annealed; and there is a growing impression in England that the heaviest ordnance will be cast solid from steel. As such guns would have about three times the tenacity of cast iron per square inch, the walls could be so much thinner, that the defects due to unequal cooling (364) would not be very serious. Besides, the advantages of hollow casting (373) and cooling from the interior could be as well realized in steel as in iron. On the other hand, it is contended that the gain in strength will *always* pay the cost of hammering steel.

The outer jackets of built-up guns, upon which must be formed or secured the trunnions and cascable, and which, for the sake of longitudinal strength, should be solid at the breech end, can only be *forged* at a very great cost. And, if cast hollow, they could be so little compressed or drawn by forging, that very little

\* Mr. Krupp's Circular—Great Exhibition, 1862.

strength would be added to them by that process. Therefore the simple casting and annealing of such parts, in the manner adopted by Captain Blakely, would seem to be a very valuable improvement in gun-making.

It has already been remarked that tubes for hydraulic presses, railway tires and wheels, cranked axles and bells of every size, are cast sound and homogeneous throughout, from low steel, by the two establishments mentioned. These castings are always annealed, which increases their specific gravity and toughness.

#### SECTION V. BRONZE.

**496.** An alloy of about 90 parts of copper and 10 parts of tin, commonly known as "gun-metal" in Europe, is popularly called "brass" in America, when used for cannon, and named "bronze" by recent American writers. A strong cast iron is also known in America as "gun-metal."

Referring to Table 72, it will be observed that the "work done" in stretching to the elastic limit and to the point of fracture, is less for ordinary bronze than for wrought iron of maximum ductility, and for low steel. This defect, added to the costliness\* of bronze, to the various embarrassments experienced in the casting of large masses, to its softness, and consequently rapid wear and compression, and to its injury by heat, has not warranted its employment for large calibres and high charges. The increase of cost, with increase of weight, would probably be greater for bronze than for cast iron, and much greater than for steel fabricated by Bessemer's, or wrought iron fabricated by Ames's or Hitchcock's process, because bronze must be cast under great pressure, to be sound and tenacious. So that, were it the proper metal in other particulars, an unnecessarily large and actually immense non-paying capital would be tied up in a national bronze armament. The high value of the old material would not offset this

\* The price of bronze field-pieces, according to Benton's "Ordnance and Gunnery," 1862, was about 45 cents per pound.

cost to the extent that it does in railway matters, for obvious reasons.

The mean ultimate cohesion of gun-metal, according to European authorities and the experiments of the United States Government, is about 33000 lbs. per square inch. In one of his tables, Mr. Mallet states it from 32334 lbs. to 43536 lbs.\* Major Wade states it from 17698 to 56786 lbs.†

Captain Benton says,‡ that "the density and tenacity of bronze, when cast into the form of cannon, are found to depend upon the pressure and mode of cooling. This is exhibited by the means of observations made on five guns cast at the Chicopee Foundry, viz. :

DENSITY.			TENACITY PER SQUARE INCH.	
Breech square.	Gun-head.	Finished gun.	Breech square.	Gun-head.
8.765	8.444	8.740	46509	27415

"The guns were cast in a vertical position, with the breech square at the bottom. In consequence of the difference in the fusibility of tin and copper, the perfection of the alloy depends much on the nature of the furnace and the treatment of the melted metal. By these means alone, the tenacity of bronze has been carried, at the Washington Navy Yard Foundry, as high as 60000 lbs."

The fabrication of bronze ordnance appears to be far better understood in Spain, and more especially in Turkey, than in America or England. Some bronze guns of 20 tons weight have been cast in Spain, but they cannot be rapidly fired.

**497.** According to American and British authorities, the want of uniformity, even in different parts of the same gun, is a striking defect. For instance: "For light pieces, especially for

\* "On the Construction of Artillery," Mallet, 1856, p. 78.

† "Reports of Experiments on Metals for Cannon," 1856.

‡ "Ordnance and Gunnery," 1862.

field-cannon, bronze is much used, but there are many objections even to this alloy. As the tin is much more fusible than the copper, and must be introduced when the latter is in fusion, it is difficult to seize the precise moment when the alloy can be properly formed; part of the tin is frequently burned and converted into scoria.”\*

Major Wade, after calculating the results of experiments on a lot of bronze guns, cast at Chicopee,† says: “The most remarkable feature of the above table is the irregular and heterogeneous character of the results which it exhibits, in samples taken from different parts of the same guns. \* \* \* By an examination of the results obtained from the heads of all the guns cast, it will appear that the density varies from 8·308 to 8·756, a difference equal to 28 lbs. in the cubic foot; and that the tenacity varies from 23529 to 35484, a difference in the ratio of 2 to 3. These differences occur in samples taken from the same part of different castings, the gun-head; the part which, in iron cannon, gives a correct measure of the quality of the metal in all parts of the gun. \* \* \* The materials used in all these castings were of the same quality; they were melted, cast, and cooled in the same manner, and were designed to be similarly treated in all respects. The causes why such irregular and unequal results were produced, when the materials used and the treatment of them were apparently equal, are yet to be ascertained.” Speaking of another lot of bronze howitzers, made at the South Boston Foundry, the same authority says: “On a general resurvey of the results obtained from all the samples tested, the most striking feature exhibited is that of their great diversity in density and strength, and for which no obvious or satisfactory cause is seen or can be assigned.”

**498.** The authorities generally agree that the tin in bronze guns is gradually melted by the heat of successive explosions. If this is the case with field-guns, the heavy charges and pro-

\* “Ordnance and Naval Gunnery,” Simpson, 1862.

† “Reports of Experiments on Metals for Cannon,” 1856.



jectiles, and the quick firing demanded in iron-clad warfare, would soon destroy this material. Colonel Wilford stated, at a meeting of the United Service Institution,\* that iron mortars were introduced because holes were burned in the chambers of bronze mortars by the immense heat of the powder-gas. Heat also causes the drooping of the parts of a bronze gun that overhang the trunnions.

As to decomposition, Captain Benton says :† “Bronze is but slightly corroded by the action of the gases evolved from gunpowder, or by atmospheric causes ;” but Captain Simpson remarks‡ that the gases produced by the combustion of gunpowder also produce an injurious effect upon this kind of piece, by acting chemically on the bronze.

**499.** Both abrasion and compression are due to softness. The hardness of bronze, as compared with cast and wrought iron, is tabulated by Major Wade. (Table 71.)§

All these defects of bronze for the bore of a gun, irrespective of strength, viz., the melting of the tin, the change of figure, the conversion, abrasion, and compression—obviously aggravate each other ; and, when taken in connection with rifling and excessive pressures, are conclusive evidence as to the unfitness of the material to meet the conditions of greatest effect under consideration.

The average ultimate tenacity of bronze is so low—in fact, little above that of the best average cast gun-iron—that the loss of strength, due to want of regulated initial tension and compression, becomes a very serious defect, when calibres are large and pressure high. To remedy it by hooping bronze with steel or iron, would not avoid the defective surface of the bore, just considered.

**500.** The Dutch, however, have lined cast-iron guns with bronze, and Captain Blakely has constructed some experimental guns in the same way, for another reason : bronze can safely elongate more than cast iron, without permanent change of figure ;

\* “Journal of the United Service Institution,” June, 1862.

† “Ordnance and Gunnery,” 1862.

‡ “Ordnance and Naval Gunnery,” 1862.

§ “Reports of Experiments on Metals for Cannon,” 1856.

and when it is put in a position where it must be more elongated by internal pressure, the strength of the whole structure is thus brought into service—the principle of varying elasticity, already considered, is approximately realized (320).

**501.** Bronze hoops upon steel or iron barrels (106) would avoid the defect of a soft bore, but it would increase the defect just considered, due to the unequal stretching of the layers of a tube by internal pressure. A principal advantage of bronze hoops mentioned by Mr. Wiard (338) is, that with the little heat they would get from the powder, they would expand to the same extent, approximately, as the more highly-heated iron barrel, thus reducing the danger of bursting by rapid firing.

#### SECTION VI. OTHER ALLOYS.

**502.** PHOSPHORUS is known to improve the strength of copper, and to make it cast soundly. Mr. Abel, chemist to the British War Department, stated before the Institution of Civil Engineers,\* that he had made some experiments upon the combinations of phosphorus with copper, and “had found that by the introduction of a small proportion of that substance, say from 2 to 4 per cent., of phosphorus into copper, a metal was produced, remarkable for its density and tenacity, and superior in every respect to ordinary gun-metal (the alloy of copper and tin known by that name). He believed the average strain borne by gun-metal might be represented by 31000 lbs. upon the square inch; whilst the material obtained by adding phosphorus to copper bore a strain of from 48000 to 50000 lbs. But the increased tenacity was not the only beneficial result obtained by this treatment of copper. The material was more uniform throughout, which was scarcely ever the case with gun-metal. The experiments alluded to were merely preliminary, and had been, to a certain extent, checked by the improvements since introduced in the construction of field-guns, which had led to a discontinuance of the employment of gun-

\* Construction of Artillery, Inst. Civil Engineers, 1860.

metal." The improvements alluded to were wrought iron and steel, and the Armstrong and Whitworth processes of fabrication.

**503.** ALUMINIUM is found to add great strength to copper. The compound thus formed is called Aluminium Bronze. Mr. Anderson, Superintendent of the Royal Gun-Factories, Woolwich, has found the tensile strength of an alloy of 90 per cent. of copper and 10 per cent. of aluminium, to be 73181 lbs. per square inch, or twice that of gun-metal; and its resistance to crushing, 132146 lbs., that of gun-metal being 120000 lbs. The aluminium bronze did not begin to change figure until the pressure exceeded 20384 lbs. In transverse strength or rigidity, it was also found superior to gun-metal, in the ratio of 44 to 1. Its tenacity and elasticity depend on a particular number of meltings: at the first melting it is very brittle, a state to which it again returns after fusion.\*

"The first melting appears to produce internal mechanical mixture, rather than chemical combination of the metals; as, in the proportion of 10 of aluminium and 90 of copper, an alloy of a very brittle character is produced by the first melting; but renewed opportunity of uniting into a definite chemical compound being afforded by repeated melting, a more uniform combination seems to take place, and a metal is produced free from brittleness, and having about the same hardness as iron. The alloy, containing rather less than 10 per cent. of aluminium, is said to possess the most uniform composition and the best degree of hardness; but it is not always an easy thing to produce this desirable uniformity of texture, as patches of extreme hardness sometimes occur, which resist the tools, and are altogether unamenable to the action of the rollers."†

Aluminium bronze, composed of 9 parts by weight of copper and 1 of aluminium, was found by Mr. Anderson to have a tensile strength of about 43 tons (96320 lbs.); but two other specimens, which were not quite sound, had only a mean tensile strength of

\* Philosophical Magazine.

† Newton's Journal of Arts.

about  $22\frac{1}{2}$  tons\* (50400 lbs.). So that the metal is liable to great variations in strength.

The cost of this alloy, 6s. 6d., or \$1.62 per pound, would of course prevent its extensive introduction as a cannon-metal.

**504.** STERRO-METAL, a recent invention of Baron de Rosthorn, of Vienna, is described by a correspondent of the *London Times*,† in an article that contains so many accurate statements on other points, as to merit consideration: “The mechanical properties of the alloy have been carefully examined at the Polytechnic Institution, Vienna, in the presence of competent observers; and I now have before me a duly attested copy of the tabulated results of not fewer than 30 experiments, from which I select the following. The tensile strength per square inch is estimated in English tons:

TABLE LXXIII.—TENSILE STRENGTH OF STERRO-METAL.—EXPERIMENTS OF POLYTECHNIC INSTITUTION, VIENNA.

	Tensile Strength in Tons.	Reduced to Pounds.
STERRO-METAL.		
After simple Fusion... ..	27	60480
After Forging Red-hot .....	34	76160
After Drawn Cold.....	38	85120
GUN-METAL—BRONZE.		
After Simple Fusion .....	18	40320

“The same copper, from Boston, U. S., was used in making both the sterro-metal and the gun-metal, and for the latter the best English tin was employed. Both alloys were cast under precisely similar conditions, and run into the same mould. Similar tests were made at the Arsenal, Vienna, and the results are as follow :

\* Correspondence of the *London Times*.

† *London Times*, Feb. 3d, 1863. Also quoted by the *London Engineer*, Feb. 6, 1863.

TABLE LXXIV.—TENSILE STRENGTH OF STERRO-METAL.—EXPERIMENTS AT THE ARSENAL, VIENNA.

	Tensile strength in Tons.	Reduced to Pounds.
STERRO-METAL.		
After Simple Fusion .....	28	62720
After Forging Red-hot .....	32	71680
Drawn Cold and reduced from 100 to 77 of transverse Sectional Area.. }	37	82880

“The specimens of metal operated on in the preceding experiments were analyzed at the Austrian mint. The results are as under:

TABLE LXXV.—ANALYSIS OF AUSTRIAN STERRO-METAL.

	Polytechnic Metal.	Arsenal Metal.
Copper .....	55.04	57.63
Spelter .....	42.36	40.22
Iron .....	1.77	1.86
Tin.....	0.83	0.15
	100.00	99.86

“Experience has shown that the proportion of spelter may vary from 38 to 42 per cent., without materially affecting the quality of the alloy. \* \* \* The specific gravity of the forged metal is 8.37, and that of the same metal, drawn cold into wire, 8.40. \* \* \* But sterro-metal possesses another quality which, in reference to its application for guns, is regarded as more important than its high tenacity, viz., great elasticity. It is not permanently elongated until stretched beyond  $\frac{1}{600}$  of its length. \* \* \* Sterro-metal, it should be stated, is from 30 to 40 per cent. cheaper than gun-metal. Field-guns, from 4 to 12-pounders, have been made of single pieces of metal, worked by the

action of a hydraulic press, whereby expense in forging is avoided; but reliable experiments have demonstrated that the metal thus treated has precisely the same properties and the same tensile strength as bars of it drawn out under the steam-hammer. \* \* \*

“It remains to be seen whether the tremendous concussions occasioned by firing will not seriously injure this new alloy, and whether the surface of a metal containing so large a proportion of spelter will not be seriously corroded.”

EXPERIMENTS AT THE ROYAL GUN-FACORIES, WOOLWICH, WITH STERRO-METAL.—The following is the official report of experiments made by Mr. John Anderson, upon this metal, variously compounded and treated :

“Composition of this alloy, as made in the arsenal at Vienna, is—copper, 60; zinc, 41·88; iron, 1·94; tin, ·156. And, as made at the Polytechnic, Vienna, its composition is: copper, 60; zinc, 46·18; iron, 1·93; tin, ·905.

“Alloys of similar composition to that of the Austrian metal have been prepared in the Royal Gun-Factories, from which a better result has been obtained than from mixtures of the Austrian metals, also prepared in the Royal Gun-Factories. The subjoined table shows the results of the experiments with these different specimens.

“This alloy is said to be the invention of Baron de Rosthorn, of Vienna. It derives its name from a Greek word signifying ‘firm.’ It consists of copper and spelter, with small portions of iron and tin; and to these latter its peculiar properties are attributed.

“It has a brass-yellow color, is close in grain, is free from porosity, and has considerable hardness, whereby it is well adapted to bearing-metal, or other purposes, where resistance to friction is needed.

“Sterro-metal possesses another quality, which, in reference to its application for guns, is regarded as more important than its high tenacity, namely, great elasticity.

“The inventor proposes that, in heavy ordnance, the interior

TABLE LXXVI.—COMPOSITION AND STRENGTH OF STERRO-METAL, WOOLWICH.

Composition.	Treatment.	Strain at permanent elongation of .002 per inch.	Breaking weight.	Ultimate elongation per in.
		Tons.	Tons.	Inches.
Austrian Mixture.....	As received .....	6.75	26.75	.1
R. G. Factories Mixture of copper, 60; zinc, 39; iron, 3; tin, 1.5 .....	Cast in sand.....	11.	21.5	.05
Do. do. of copper, 60; zinc, 44; iron, 4; tin 2.....	Cast in sand.....	13.75	19.25	.015
Do. do. do.	Cast in iron .....	17.25	24.25	.016
Do. do. do.	Cast in iron and annealed.....	15.25	23.25	.02
Do. do. do.	Forged red-hot.....	17.	28.	.045

should consist of a tube of sterro-metal, and, over this, wrought or cast iron should be shrunk, from the breech to beyond the trunnions.”

**505.** An alloy of copper, made by the Ames Manufacturing Company, at Chicopee, Mass., is said to have a tensile strength of 80000 lbs. per square inch. The particulars of the composition are not made public.

**506.** In the discussion before the Institution of Civil Engineers, before referred to, \* Mr. Charles Fox said that “he believed it would eventually be found that the best gun could be constructed with some extremely dense and homogeneous alloy, cast and used without being drawn under the hammer. If a gun was made of an alloy possessing very great density, the detonating force of the powder would be resisted by a greater quantity of the metal employed than it could be by making use of one with greater elasticity. He thought, therefore, the best guns would be made of iron, mixed with some other metals, such as wolfram and titanium, so as to insure the greatest strength and density. Mr.

\* “Construction of Artillery,” Inst. Civil Engineers, 1860.

Mushet had obtained great density, by mixing with iron a small percentage of wolfram, and great strength by the use of titanium. Therefore, he was inclined to believe, that guns cast of the densest alloys would have greater effect, in proportion to their thickness, than could be obtained by any complicated and expensive mode of construction."

**507.** It is obviously impossible, in the absence of further experiments, to predict either great success or failure for the alloys considered, as compared with steel. The field for discovery and improvement is certainly broad and promising; but no more so than in the case of steel. Although the alloying of copper, especially for cannon, has been practised for more than five hundred years, and should, therefore, be in advance of steel-making, which, for the purposes of artillery, is the work of the last decade, both metals—in fact, all metals—are undeveloped, because their chemical relations, and especially their elongation, within and beyond the elastic limit, and the corresponding pressures, have not been properly investigated.

While certain alloys, of both iron and copper, have one important feature in common—homogeneity, due to fusibility, at practicable temperatures—the alloys of iron have this grand advantage: iron is everywhere cheap and abundant; and the other necessary ingredients and fluxes—carbon, manganese, zinc, and silicium—are equally abundant, and, in some localities, already mixed, which would appear to be, on the whole, advantageous, although the mixtures are not found in proper proportions.

**508. Conclusions.**—1. The fitness of metals for cannon depends chiefly on the amount of their elongation within the elastic limit, and the amount of pressure required to produce this elongation; that is to say, upon their elasticity.

It also depends, if the least possible weight is to be combined with the greatest possible preventive against explosive bursting, upon the amount of elongation and the corresponding pressure, beyond the elastic limit; that is to say, upon the ductility of the metal.

Hardness, to resist compression and wear, is the other most important quality.



2. Cast iron has the least ultimate tenacity, elasticity, and ductility; but it is harder than bronze and wrought iron, and more uniform and trustworthy than wrought iron, because it is homogeneous.

The unequal cooling of solid castings leaves them under initial rupturing strains; but hollow casting, and cooling from within, remedies this defect, and other minor defects.

3. Wrought iron has the advantage of a considerable amount of elasticity, a high degree of ductility, and a greater ultimate tenacity, than cast iron; but, as large masses must be welded up from small pieces, this tenacity cannot be depended upon: this defect, however, is more in the process of fabrication than in the material, and may be modified by improved processes. Another serious defect of wrought iron is its softness, and consequent yielding, under pressure and friction.

4. Low cast steel has the greatest ultimate tenacity and hardness; and, what is more important, with an equal degree of ductility, it has the highest elasticity.

It has the great advantage over wrought iron, of homogeneity, in masses of any size.

It is, unlike the other metals, capable of great variation in density, by the simple processes of hardening and annealing, and, therefore, of being adapted to the different degrees of elongation that it is subjected to, in either solid or built-up guns.

5. Bronze has greater ultimate tenacity than cast iron, but it has little more elasticity, and less homogeneity; it has a high degree of ductility, but it is the softest of cannon-metals, and is injuriously affected by the heat of high charges.

The other alloys of copper are very costly, and their endurance, under high charges, is not determined.

6. In view of the duty demanded of modern guns, simple cast iron is too weak, although it can be used to advantage for jackets over steel tubes—a position where mass, small extensibility, and the cheap application of the trunnions and other projections, are the chief requirements. And, although cast-iron barrels, hooped with the best high wrought iron, and with low steel, cannot fulfil

all the theoretical conditions of strength, and do not endure the highest charges, they have thus far proved trustworthy and efficient.

Wrought iron, in large masses, cannot be trusted, and is, in all cases, too soft.

Bronze is impracticably soft and destructible by heat.

Low steel is, therefore (possibly in connection with cast iron, as stated above), by reason of the associated qualities which may be called strength and toughness, the only material from which we can hope to maintain resistance to the high pressures demanded in modern warfare.

## CHAPTER V.

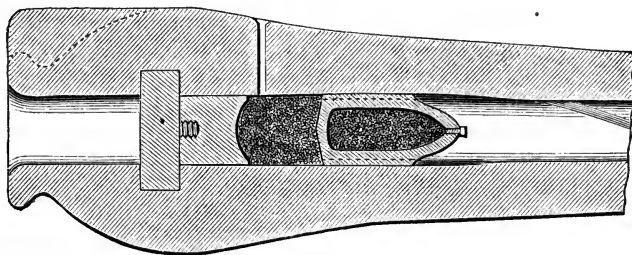
## RIFLING AND PROJECTILES.

## STANDARD FORMS AND PRACTICE DESCRIBED.\*

**509.** THE first comprehensive experiment with rifled cannon appears to have been made in Russia, about 1836, and consisted in firing 1800 rounds from a 12-pounder, 262 shots in one day from an 18-pounder, and 100 shots continuously, on successive days, from both an 18-pounder and a 24-pounder, without either wads or grease. The gun was the invention of Montigny, of Belgium, and was rejected by his own Government, and finally by the Russian and the British Governments.

**510.** Major (now General) Cavalli, a Sardinian officer, experimented, in 1845, with a breech-loading gun (Fig. 189) which was rifled with two grooves for a plain iron shot (Fig. 190). In 1847,

Fig. 189.



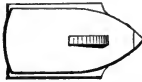
Cavalli rifled breech-loader.

he obtained good results with an 8-in. gun, until the breech-loading apparatus gave way.

\* Many of the following historical and descriptive facts about European projectiles are compiled from papers read by Commander R. A. E. Scott, R. N., before the Royal United Service Institution.

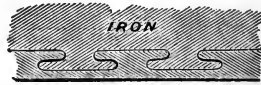
**511.** In 1846, Baron Wahrendorf, of Sweden, affixed lead to the sides of elongated projectiles by means of grooves (Fig. 191).

FIG. 190.



Cavalli projectile.

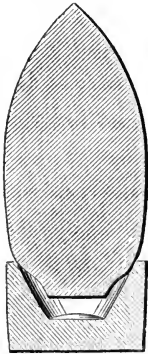
FIG. 191.



Wahrendorf's lead-coating.

The plan was tried at Berlin in 1851, in a 6-grooved 12-pounder with a slow twist; and afterwards in both Sweden and Prussia; and in 1857 in France, but without remarkable success. In 1856, General Timmerhaus, of Belgium, invented an expanding (Fig. 192) sabot, which was forced into the rifling, and thus gave rotation to the projectile. His gun had two, four, and six grooves, with one turn in 18 feet.

FIG. 192.



Timmerhaus's expanding shot.

**512.** In these plans we find the germs of the three leading systems of the present day—the solid projectile, fitted to enter the grooves of the gun; the compression of a soft covering on the shot by the lands of the gun (the Armstrong system); and the expansion of the rear of the shot by the pressure of the powder, to fill the grooves of the gun.

**513. The Centering System.**—The solid projectile, fitted to the rifling of the gun so as to centre itself, has been improved by Commander Scott, R. N., in what he calls the “central” system, which will be further mentioned (535). The centering system may embody the compressing or expanding system in any required degree. While the shot is rotated by the solid projections formed upon it and fitting into the grooves of the gun, the exterior of these projections, or of the whole shot (521), may be covered with a soft substance, which may, in the case of a breech-loader, be larger than the bore, and thus be compressed while passing out of the gun; or which may, like the Sawyer projectile

(540), he expanded by the pressure of the powder to fill the gun.

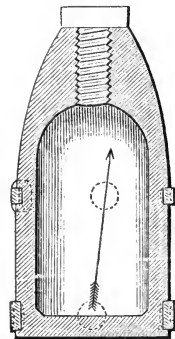
Usually, the hard surface of the projectile is dressed to bear directly upon the surface of the bore, leaving a little windage. Whitworth's (531) and Scott's (535) projectiles are examples of this practice.

**514.** Projectiles, having wings fitted for certain grooves, can only be used, each with its own bore; while compressed or expanded shot will adapt themselves to any form of rifling. In a *gun* grooved for winged shot, however, any expanding shot can be employed; while, if the enemy has no guns fitted for winged shot, he cannot fire such shot back, when any are captured or recovered.

**515.** FRENCH.—The first successful adoption of rifled cannon in warfare was by the French against the Austrians, in 1859.\* The plan (Fig. 193), brought forward as early as 1842 by Colonel (now General) Treuille de Beaulieu, and twice ignored by the French Artillery Committee, was finally appreciated by the Emperor, after the before-mentioned trials of Wahrendorf's and several other rifled projectiles. It consisted of 12 zinc studs, or buttons, placed on the shot in pairs, so as to project into the 6 rounded grooves of the gun. One stud, or projection on the gun, was arranged to push the bearings of the shot tight against those sides of the groove on which it would press in going out, so as to decrease jarring and play.

For larger ordnance, the French commenced by making two shallow elliptical grooves (Fig. 194). The projectiles were of solid iron; those having short studs or bearings were used with the "gaining twist," and those having long bearings with the uniform twist.

FIG. 193.

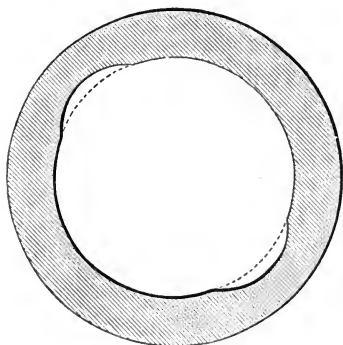


Beaulieu's, or first French service rifle shot.

\* The present French centering system was introduced in Dec., 1860, after Commander Scott's centering system, which was offered to the British Government in August, 1859.

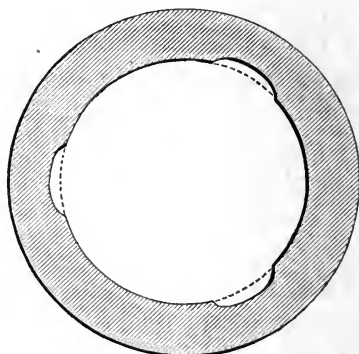
But as the projectile could not accurately centre itself on two points, three points were provided, and in December, 1860, the three-grooved gun (Fig. 195), with the gaining twist, was intro-

FIG. 194.



Early French rifling for ordnance.

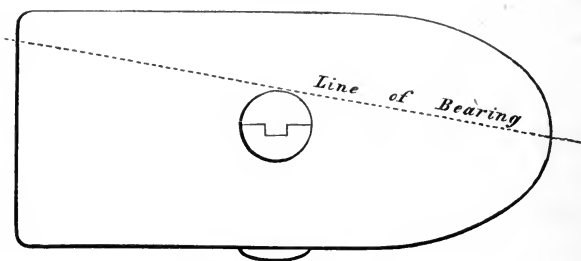
FIG. 195.



French rifling, 1860.

duced. Studs faced with white metal were cast on the bearing side of the projectile (Fig. 196). The ordnance thus treated were cast-iron 30-pounders and 50-pounders, strengthened by hoops over the breech.

FIG. 196.



French projectile, 1860.

**516.** The following are the particulars of the French rifling and projectile (Fig. 197) used with a cast-iron 32-pounder gun, charge, 5·5 lbs., in the English competitive trials of 1861:—In-

creasing twist, from 0 to 4·652 in 88·548; number of grooves, 3; width, 1·919 in.; depth, 0·2363 in.; weight of shot, 59·5 lbs.; length, 14·05 in.; diameter, 6·36 in.; diameter of powder-chamber, 4·66 in.; bursting charge, 5 lbs. 5 oz. (592).

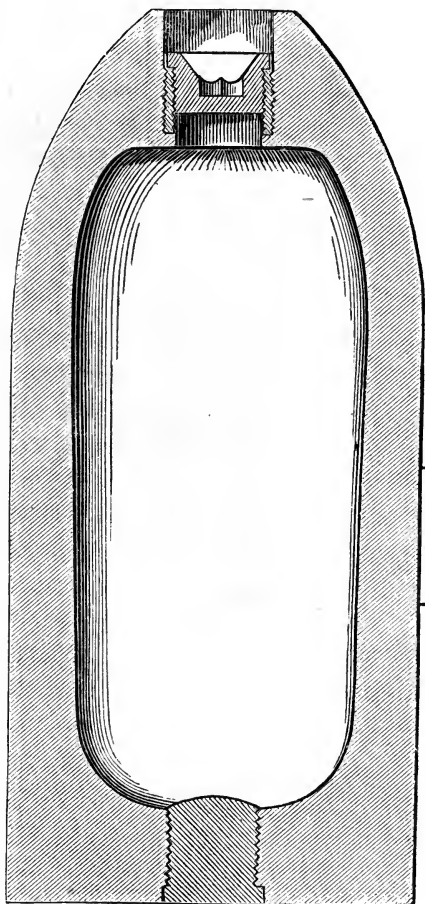
**517.** The old 6-in. 24 pounder, of 4400 lbs. weight, is rifled to carry 53-lb. projectiles with a 5-lb. 2-oz. charge.

**518.** The old 30-pounder,\* of 6·5-in. bore and 8239 lbs. weight, is hooped with steel, and rifled to carry 99-lb. projectiles, with charges of  $7\frac{3}{4}$  lbs. to 26 lbs. The rifling and the present stud of this gun are shown, full size, by Fig. 199. The hooped *Canon de 30* is the standard French naval gun.

**519.** It will be observed that a considerable windage is allowed in French guns. The object of this practice, which is directly opposed to the Armstrong practice, will be considered in another section. (647, note).

**520.** The regular French bronze field-gun, Fig. 198, has the calibre of the old 4-pounder—3·4 inches; it weighs 730 lbs., and fires an 8·8-lb. projectile, with a charge of 1 lb. 3 oz.; bursting

Fig. 197.



French shell.

\* This gun is minutely described in Chapter I. (84.)

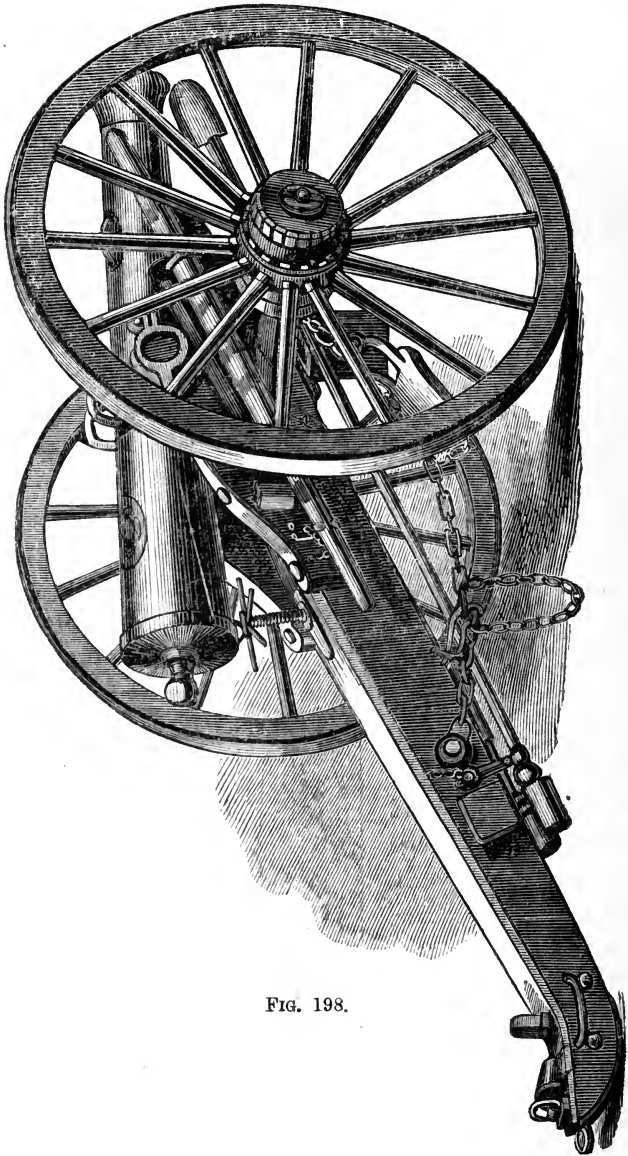


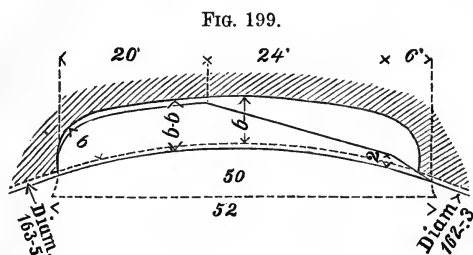
FIG. 198.

French field-gun, mounted. (From a photograph.)



charge of shell, 7 oz. The mountain howitzer, a shorter gun, uses the same ammunition.

The old 12-pounder, when rifled, is called a gun of *reserve*. Its



Present French groove and stud, *Canon de 30*, full size.

particulars are:—Bore,  $4\frac{3}{4}$  in. ; weight, 1350 lbs. ; charge, 2.2 lbs. ; weight of shell, 25.3 lbs.

**521. AUSTRIAN.**—The Austrians, having experimented with both the compressive system and the centering system, decided on the latter, substantially in the form used by the French. More recently they have introduced the system illustrated by Figs. 200 to 203, as specially adapted to gun-cotton, a material now entirely substituted for gunpowder in the Austrian service. (See Appendix.) Fig. 203 is a cross-section of the 3-in. field-gun. The bore is spiral in section, increasing in diameter from the point *a*. The land *a c* is the bearing side going in, and all the rest of the bore is the bearing side which rotates the shot coming out. The cast-iron projectile *d d*, Fig. 200 (longitudinal section), and Fig. 201 (cross-section), is covered with the soft metal coating *e e*, which enters the gun freely when the projection *h* bears against the land *a c*, but which, as the shot comes out, is compressed by the spiral bore and shuts off the windage. To prevent the shot jamming in the bore, three grooves, *k m n*, are introduced to receive corresponding ribs on the shot. But the shot is centred and rotated coming out, by the whole circumference of the bore as well as by these three grooves. Fig. 202 represents the fuse used with the shell.

**522. THE RUSSIANS** have adopted the French rifling for heavy

FIG. 200.

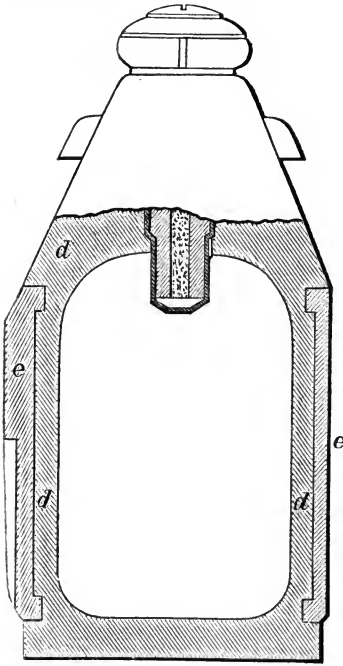


FIG. 201.

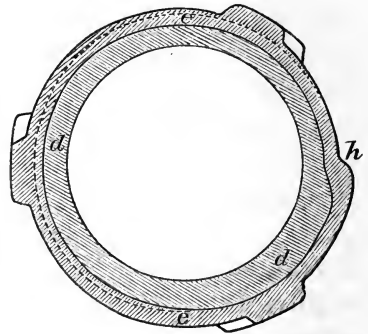


FIG. 203.

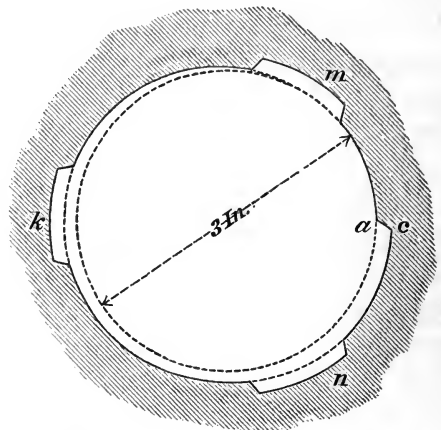
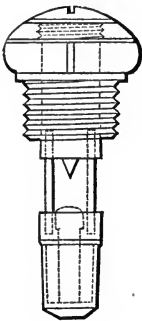


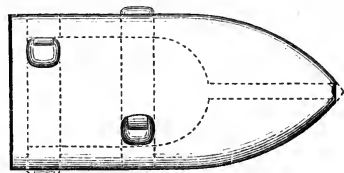
FIG. 202.



Austrian rifling, shell and fuse for gun-cotton.

ordnance, and have provided themselves with machinery for grooving guns without dismounting them. It is stated that their cast-iron 56-pounders and 120-pounders are to be hooped and rifled with three grooves. "The Russians had rifled several of their smaller fortress-guns (30-pounders and 24-pounders) with six grooves, and their field-pieces have been mostly rifled in a similar manner; but, instead of placing the studs in pairs, and having twelve of them, they use only six placed alternately. Their rifling has an equal twist, and the grooves are slightly narrowed at the bottom. In the field-piece they are sloped off on one side to allow the projectile, the bearings of which are also sloped off, to wedge itself tightly; but these slight modifications, which have been also tried in France, possess no advantage over the fittings adopted for the French service."\*

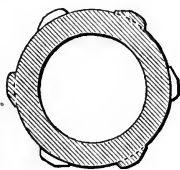
FIG. 204.



Russian studded rifle-shell.

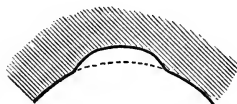
**523.** More recently, the Russians have adopted the Armstrong shunt system of rifling with their steel ordnance. This will be

FIG. 205.



Section of Fig. 204.

FIG. 206.



Russian rifle-groove.

illustrated, as used in England and in Russia, in another section (552).

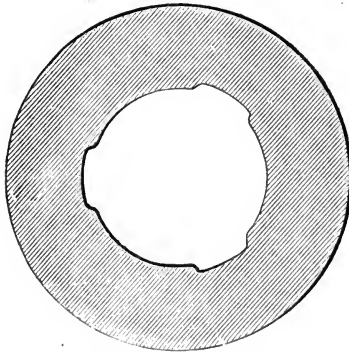
**524.** THE SPANIARDS have modified the French system by adopting a uniform twist, and placing the studs upon the projectile in pairs (Figs. 207 and 209). Three grooves are used; the

\* Com. Scott. Journal Royal U. Service Inst., April, 1862.

cast-iron guns are reinforced with hoops having definite initial tension.

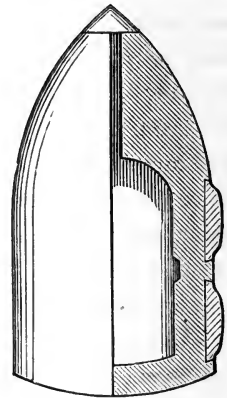
**525.** The failure of the Cavalli and Wahrendorf breech-loading apparatus for heavy guns, in Sardinia, led to the abandon-

FIG. 207.



Section of Spanish gun.

FIG. 209.



Spanish shell.

ment of the compression system, and the adoption of the French rifling and projectiles. A similar failure of the Armstrong breech-loader is anticipated, if not quite realized, in England. In that event, the compression system, which depends upon loading at the rear end of the bore, would of course be abandoned.

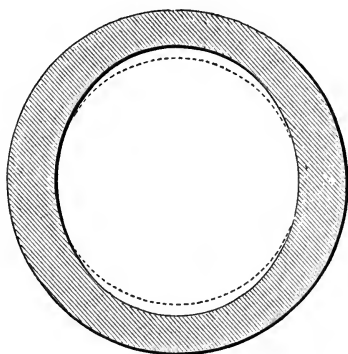
**526.** In Sweden, Holland, and Portugal—in fact, on the Continent generally, excepting in Prussia and Belgium, centering the projectile, on the French plan, has been adopted for rifled ordnance. It has also been adopted in England, with a little modification (see shunt-rifling), for the Armstrong 10½ and 13-in. rifles, for experimental 70 and 12-pounders, and for other experimental guns.

**527.** LANCASTER.—Another plan of centering the shot is that of Mr. Charles Lancaster (Fig. 210), used, with partial success, by the English in the Crimea, and since made the subject of many costly experiments. The gun is rifled with two rounded grooves, each half the circumference in width, so that the cross-section of the bore is oval. Only a trace of the original bore is left at its

minor axis. The major axis in the 32-pounder is 6·97 in., and the minor axis 6·37 in., so that, considered as a two-grooved rifle, the grooves are  $\cdot 3$  inch deep at their centres. The pitch of the rifling is one turn in 30 feet. The earlier projectiles, viz., those sent to the Crimea, were made of wrought iron, simply oval, but without any rifle-twist upon them; but more recently the shot have been bent to the shape of the bore; some of these had a wrought-iron casing put over a cast-iron projectile, and this, projecting  $\frac{1}{2}$  inches to the rear, carried a lubricant which the wooden wedges at the bottom sent out while expanding the casing so as to fill the bore. The weight of this projectile was 44 lbs., and its capacity for bursting charge,  $4\frac{1}{2}$  lbs. It was thick in the rear, and thin in the front, tapering to a point.

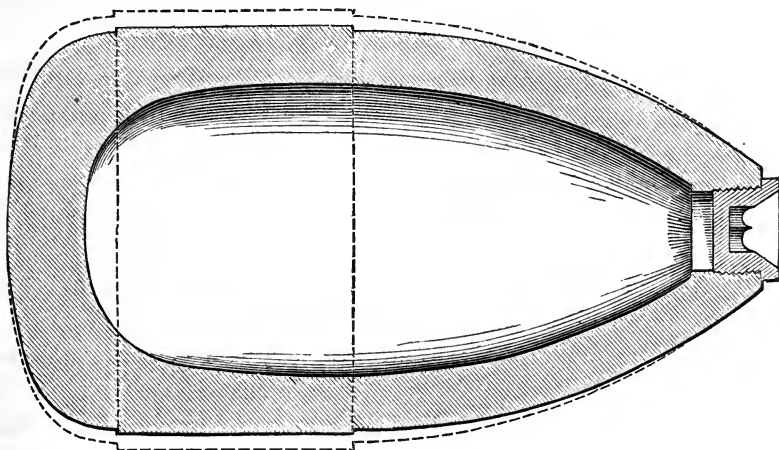
**528.** The Lancaster shell (Fig. 211), fired in the competitive

FIG. 210.



Lancaster's rifling.

FIG. 211.



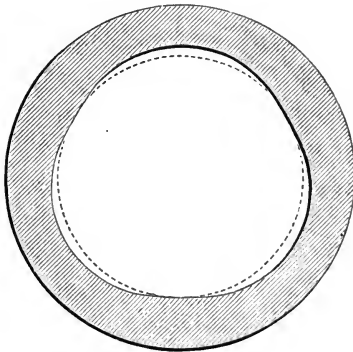
Lancaster cast-iron shell.

trials of 1861, with 6 lbs. of powder, from a cast-iron 32-pounder, was in length, 11·9 in. ; diameter (major), 6·90 in., (minor) 6·32 in. ; weight, 46·5 lbs. ; diameter of powder-chamber 4·59 in. The bursting charge is 4 lbs. 7 oz. (592). The rifling of the earlier guns had an increasing pitch. The present guns have a regular twist.

**529.** The wrought-iron Lancaster gun, recently making at Woolwich for trial, with other 7-inch guns rifled on different plans, has a major axis of 7·6 and a minor axis of 7 inches.

**530.** HADDAN.—Mr. Haddan's plan of centering against the bore is illustrated by Figs. 212 to 214. The rifling consists

FIG. 212.



Haddan's rifling.

of 3 large and shallow elliptical grooves, which in the earlier forms were about  $\frac{1}{4}$  in. deep and took away nearly two-thirds of the surface of the bore. In the competitive trials of 1861, Mr. Haddan's grooves were 0·15 in. deep, and 3·4 in. wide. The twist was 1 turn in 25 feet.

The projectile is rotated by 3 wings formed upon the front of the shot, straight with its axis.

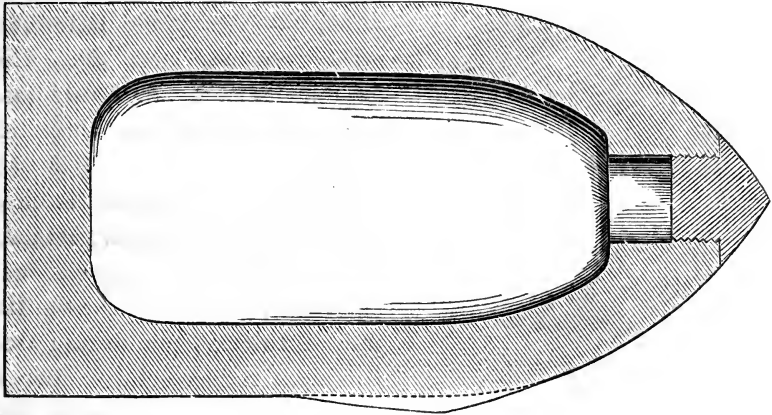
In the earlier projectiles (Fig. 214) the rear tapered, and had a shoulder for the ring-wad *a a* to stop the windage. The later projectiles have merely a wooden sabot. As the wings are on the front part of the projectile, the rifling is carried only to within one calibre of the powder-chamber, and hence is not a source of weakness at that point.

The projectile (Fig. 213) for a 32-pounder bore, as used in the trial of 1861, was 11·95 in. long, and 6·20 in. in diameter ; weight, 51 lbs. ; diameter of powder-chamber, 4 in. ; bursting charge, 3 lbs. 6 oz. ; charge, 7 lbs. from a cast-iron gun (592).

**531.** WHITWORTH.—Mr. Whitworth's system of rifling (Figs. 215 to 219) is known, in the smaller ordnance, as the hexagonal system. A larger number of sides have been experimented with in various ways (664). Fig. 219 is a full-sized section of part of a

Whitworth bore and 70-pounder projectile, showing that what is called a "flat" of the gun is not a plane surface, but a double

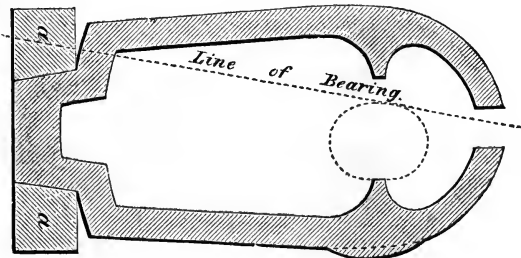
FIG. 213.



Haddan's projectile.

incline with the apex inward. This formation facilitates loading, but its principal and very important use is to give the shot so much

FIG. 214.

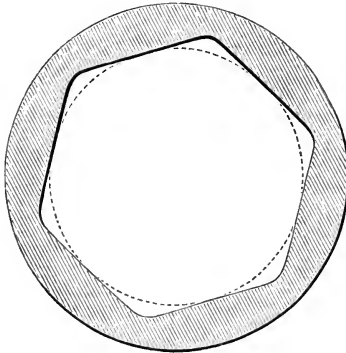


Haddan's projectile for wood sabot.

bearing that it will not cut into the gun. A hexagonal bolt revolved on its axis within a slightly larger hexagonal orifice, would not bear upon its sides, but only upon its six corners. The points of contact would be mere lines. The bore must be slightly larger than the projectile, to allow easy loading when the gun is

foul.\* In Fig. 219, while the face  $ae$  of the shot is flat, the face  $de$  of the gun is so inclined that the shot, in coming out, will bear

FIG. 215.



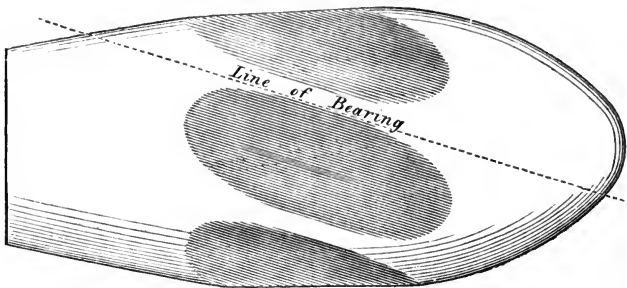
Whitworth's rifling.

upon the whole of it, as shown. If the face  $ae$  of the bore was also plain, the shot would bear only on the corners  $e$ ,  $b$ , &c. The gaining twist is obviously impracticable with this form of rifling.

**532.** The projectile is first turned truly cylindrical; its flats are then planed by a special machine-tool, at the cost, for the 12-prs., of 10 cents per dozen; this is to be reduced to 6 cents.†

For range, Mr. Whitworth uses a projectile 3 calibres in diameter; for punching, a shorter shot, to save weight, and thus secure a high velocity.

FIG. 216.



Whitworth's short round-fronted shot.

The cartridge for the breech-loader is made of tinned iron, shaped to fit the rifled bore; the powder is retained in it by the

\* In his patent of April 23, 1855, for projectiles, Mr. Whitworth specifies that they are cut so as to *exactly fit* the bore of the gun.

† The value of the self-acting machinery for shaping the rifled-cannon projectiles, would be about £500, to enable a workman to produce the shot at such a rate, as that the cost should not exceed one penny per shot, for wages only.—*Mr. Whitworth, "Construction of Artillery," Inst. Civil Engineers, 1860.*



lubricating wad, which is placed in the open end. This wad is composed of wax and tallow, and when the explosion takes place it is melted and driven through the gun, lubricating the bore so thoroughly that, with a good quality of powder, the gun may be fired for a long time without sponging.

**533.** The Whitworth shell, fired with 25 lbs. powder through the *Warrior* target at 800 yards, Sept. 25, 1862, was 17 inches long, 6.4 in. across the flats, and 7 in. across the corners. It weighed 130 lbs. and

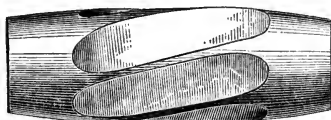
FIG. 217.



Whitworth's long round-fronted shot.

held a bursting charge of 3 lbs. 8 oz. The shell fired with 27 lbs. of powder, through the *Minotaur* 5½-inch plate, and burst in the backing of the target, at 800 yards range, Nov. 13th, 1862, was 20½ in.

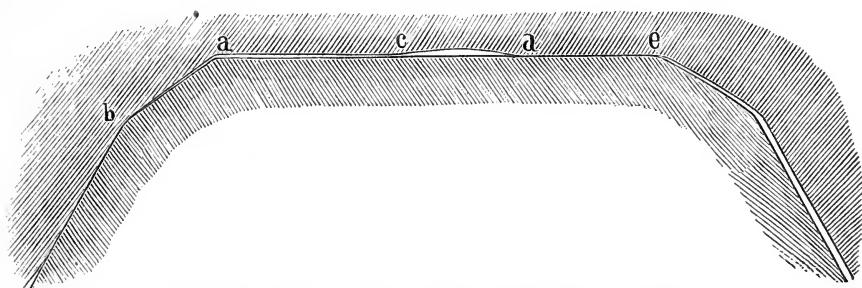
FIG. 218.



Whitworth's flat-fronted projectile.

long, 6.4 in. across the flats, and 7 in. across the corners. It weighed 151 lbs. and held a 5-lb. bursting charge. The 70-lb.

FIG. 219.



Full-sized section of Whitworth's 70-lb. shot and rifling.

cast-iron shell is 15½ in. long, 5 in. in diameter in the middle, 4 in. at the rear, and 1¾ in. at the front. Its thickness, in the middle, is 1 in. The powder-chamber is 12 in. long, and 3 in. in diameter.

TABLE LXXVII.—EXPERIMENTAL PRACTICE. WHITWORTH BREECH-LOADING 80-POUNDER. SOUTHPORT, JULY 25 AND 26, 1860.

Weight of gun.....	80 cwt 20 lbs.	Axis of gun above plane.....	3 ft. 2½ in.
Length.....	10 feet.	Gun mounted on heavy ship-carriage; platform partly horizontal and partly inclined.....	1 in 6.
Diameter of bore.....	5 in. and 5.4 in.	No difficulty in loading.	
No. of grooves .....	6.	No escape of gas perceptible.	
Twist .....	1 turn in 8 ft. 4 in.		
Charge.....	12 lbs.		

No. of rounds fired.	Elevation.	Recoil, average.	Projectile.		Greatest time of flight.	Least time of flight.	Mean range, 1st graze.	Mean deflection.	Mean deflection.
			Nature.	Weight.					
	degrees.	in.		lbs.	seconds.	seconds.	yards.	feet.	feet.
5	1	101	shot	70	2.	1.6	760	2.6	
5	1	104.6	shell	55	2.25	1.9	967	2	3
5	2	133.5	shot	70	3.75	3.	1297	1	1
5	2	116.4	shell	55	3.75	3.	1494	5	4.2
5	3	110.2	shot	70	4.6	4.	1786	2.4	3.4

TABLE LXXVIII.—RANGES OF WHITWORTH RIFLED GUNS.\*

Weight of projectile.	Diam. across the flats.	Length of barrel.	Twist 1 turn in inches.	Charge of powder.	Initial velocity.	Number of revolutions per second.	Elevation.	Actual range.	Parabolic range.
lbs.	in.	in.			ft. per sec.		degrees.	feet.	feet.
3	1½	72	40	8 oz.	1300	400	3	4707	5550
							10	12567	18300
							20	20970	34500
							35	28740	49200
12	3¼	93	60	28 oz.	1300	260	2	3756	3780
							5	6960	9210
							10	11739	18300
80	5	118	100	12 lbs.	1300	156	5	7722	9200
							7	10476	12900
							10	13665	18300

\* "Construction of Artillery," Inst. Civil Engineers, 1860.

**534.** The particulars and charges of the Whitworth guns and projectiles have been given in Table 8. The practice for range and accuracy is given in Tables 77, 78, and 81. A competitive trial of Armstrong and Whitworth 12-pounders and 70-pounders is now in progress. In Mr. Whitworth's guns for this trial, the outer bearing edges of the rifling have been so modified as to more nearly resemble 6 rounded grooves.\*

**535.** SCOTT.—The "central" system of Commander Scott,

FIG. 220.

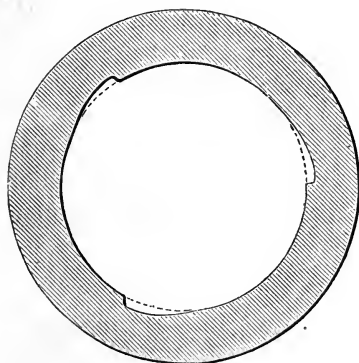
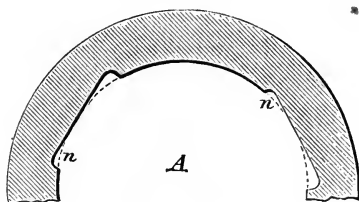


FIG. 221.



Scott's rifling.

illustrated by Figs. 220 to 223, was laid before the British War Department in 1849. "The rifling is called 'central' from the

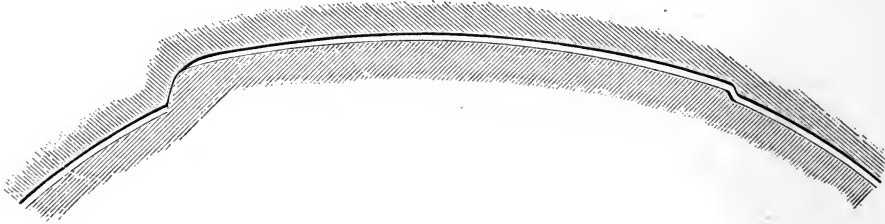
\* No official report has been made as to the trials lately in progress, at Shoeburyness, of the 12-pounder and 70-pounder Whitworth muzzle-loading guns, and the Armstrong breech-loading and shunt 12-pounder and 70-pounder guns.

The *Army and Navy Gazette* of April 9th, 1864, states that up to 900 yards range the Whitworth 12-pounder had a slight advantage in range, and that it put every shot into a bull's eye one foot in diameter, at 300 yards. At 1300 yards the Whitworth still had a slight advantage. The breech-loading Armstrong gun was inferior in all respects to the other guns. The *Engineer* of April 22d, 1864, says that each gun had fired 600 of the 3000 rounds assigned, and that at 1600 yards the Whitworth gun fired 10 shots with a lateral deviation of only 5 inches, but that the shots fell short or went over a wall 8½ feet high at 1100 yards. The Armstrong projectiles were more accurate in this particular. "The Armstrong shell shows a superiority in cutting up abatis or earthworks." All the guns are constructed of mild steel. The Whitworth rifling has been considerably altered from the original hexagonal form. The Armstrong shunt rifling has also been changed, and now resembles the French. The rifling of both these guns is thus on the centering system.

The 70-pounders are ready for trial, but their test had not commenced.

peculiar mode of centering its simple iron projectile, which, instead of inclining towards the bottom of the bore in its passage

Fig. 222.



Full-sized section Scott's rifling; projectile leaving the gun.

out, is centered on its rounded bearings, without jar by the first pressure of the elastic fluid. This is effected by the peculiar curves of the shoulders of the 3 grooves (Fig. 223), which incline towards the centre of the bore, and thus form 3 rails for the projectiles to slide out upon without being compressed or strained."

**536.** In case of large calibres with heavy projectiles, a shallow shoulder (Figs. 221 and 222) is taken out for the shot to turn against in loading.

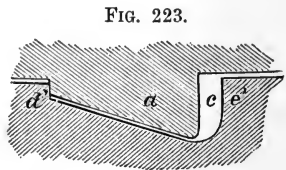


Fig. 223.

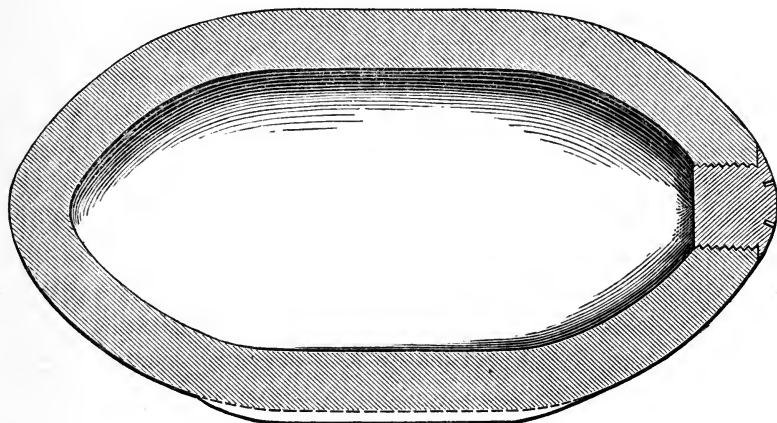
Scott's groove and rib.

**537.** The following are the particulars of the rifling and shell (Fig. 224) used in a 32-pounder cast-iron gun, with 5·5 lbs. and 6 lbs. of powder, in the trials of 1861:—Twist, 1 in 48 ft.; number of grooves, 3; width 1·7 in.; depth, 0·20 in.; weight of shell 39 lbs.; length, 11·88 in.; diameter, 6·28 in.; diameter of powder-chamber, 4·42 in.; bursting charge, 4 lbs. 13 oz. (592.)

**538.** LYNALL THOMAS.—Mr. Thomas's first system resembled the Hotchkiss expansion system (566). His present rifling consists merely in leaving three or more very narrow lands and the same number of very wide grooves in the gun. Projections are planed in the shot to correspond with the lands. At first sight, the system closely resembles Commander Scott's (535), ex-

cept that the grooves are made in the shot and the projections in the gun. But it will be observed that Commander Scott's grooves are so rounded as to *gradually* lift the shot and hold it in the

FIG. 224.



Scott's shell.

centre of the bore, and that spherical shot cannot be fired from Mr. Thomas's gun without injuring the three narrow lands, and without some very strong and cumbrous arrangement to stop the excessive windage. The lands are also in the way of loading the powder easily and rapidly.

**539.** A 9-in. gun, fabricated on the Armstrong plan, was tried at Shoeburyness on the 20th of November, 1863, with results given in Table 79.

Mr. Thomas attributes the comparative inaccuracy of the firing\* to the stripping of the zinc bearings with which the grooves of the shot were surfaced.

**540.** SAWYER.—The Sawyer projectile, considerably used in the United States Army (Figs. 225 and 226), is cast with projections corresponding with and slightly smaller than the grooves in the gun. Instead of being dressed, like Scott's and Whitworth's, to bear upon the lands, the whole cylindrical part of the projec-

\* Letter to *Army and Navy Gazette*, Dec. 5th, 1863.

TABLE LXXIX.—RANGE AND DEFLECTION OF LYNALL THOMAS'S 9-INCH GUN.  
SHOEBURYNNESS, NOV. 20, 1863.Weight of shot (3 calibres), 300 lbs.; Charge, 40 lbs.; Windage,  $\frac{1}{10}$  in.

Round.	Elevation.	1st graze, yds.	Deflection, yds.		Round.	Elevation.	1st graze, yds.	Deflection, yds.	
			Left.	Right.				Left.	Right.
1	2°	948	1.6	.....	16	5°	2042	.....	3.4
2	"	928	.....	1.2	17	"	2123	.....	4.0
3	"	955	1.0	.....	18	"	1945	.....	6.4
4	"	1029	.....	1.4	19	"	2161	.....	1.2
5	"	999	.....	.8	20	"	2095	.....	6.0
6	"	958	1.2	.....	21	10°	3635	.....	33.0
7	"	928	2.2	.....	22	"	3768	.....	18.4
8	"	939	.....	2.6	23	"	3775	.....	14.0
9	"	971	.....	4.0	24	"	3795	.....	7.8
10	"	1092	.....	1.0	25	"	3921	.....	19.0
11	5°	2107	.....	8.0	26	"	4007	.....	19.2
12	"	1883	.....	1.0	27	"	3569	.....	27.0
13	"	2073	.....	9.4	28	"	3863	.....	21.0
14	"	1958	.....	2.4	29	"	3680	.....	13.0
15	"	2082	.....	3.0	30	"	3731	.....	13.6

tile is then covered with a composition of lead and tin, cast on. The soft metal extends  $\frac{1}{8}$  inch below the base of the cast iron

Fig. 225.

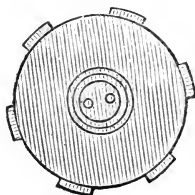
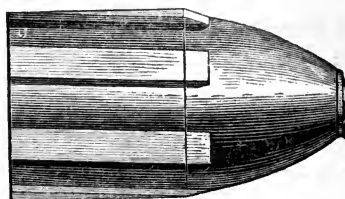


Fig. 226.



The Sawyer Shell.

(which is slightly chamfered), so as to be sufficiently compressed by the powder-gas to stop the windage.

This principle of construction is of course applicable to any form of rifling, but has only been applied to the standard American groove (560).

**541.** Pattison's projectile (Figs. 227 and 228) has projections

FIG. 227.

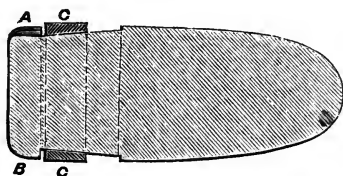


FIG. 228.



Pattison's projectile. Leather band.

cast upon it to fit the rounded grooves of the gun. The windage is stopped by a simple leather band, c c, which is driven upon the conical base of the shot by the powder-gas. This projectile has been used with some success experimentally, but has not been adopted in the service.

**542.** The Armstrong "Shunt" rifling is a modification of both the centering and the compressing systems, and will be considered under the latter head.\*

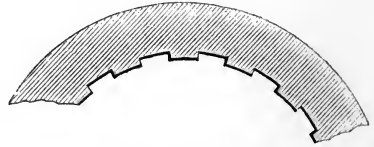
**543. The Compressing System.**—With this system the shot is larger than the bore, and is squeezed or planed to fit the bore by the lands of the rifling. The shot must therefore be entered at the breech, into a chamber larger than the rest of the bore; and whatever escape of gas there may be around the breech-closing apparatus reduces its range and velocity.

**544.** This plan was early adopted and perfected by the Prussians, who obtained great accuracy and range with charges of  $\frac{1}{16}$  the weight of the projectile. The rifling consisted of numerous shallow rectangular grooves (Fig. 229). The shot was encircled by 4 rounded lead bands or hoops (Fig. 230), held in place by grooves in the shot.

\* As most recently modified, this is a centering projectile, with little or no compression.

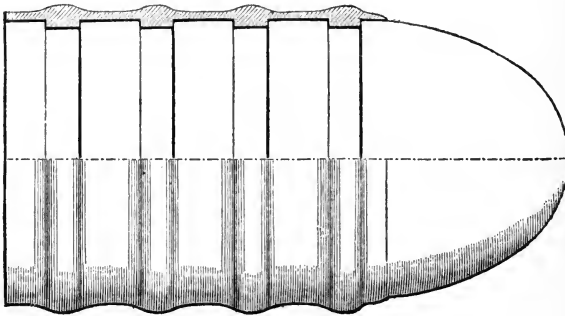
**545. ARMSTRONG.**—The Armstrong system of rifling for breech-loaders does not differ in principle from, and was subsequent to, the Prussian compression system last mentioned. The rifling consists of a great number of shallow, narrow grooves—the 7-in. 110-pounder has 76—see tables 1 and 2—the object being to give the soft metal covering of the shot a very large bearing on the driving side of the grooves, and thus prevent stripping, and make up for want of depth. The different forms of grooves that

FIG. 229.



Early Prussian rifling.

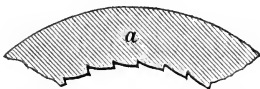
FIG. 230.



Early Prussian lead-coated shot.

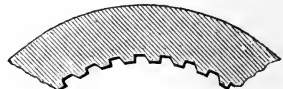
have been tried are shown by Figs. 231 to 233. The grooves of the 6-pounder and 12-pounder are shown, 4 times enlarged, by Figs. 234 and 235.

FIG. 231.



Original Armstrong rifling.

FIG. 232.



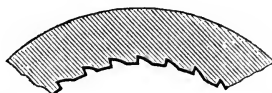
Adopted Armstrong groove.

**546.** The shot-chamber of the gun is about  $\frac{1}{8}$  in. larger in diameter than the adjacent part of the bore, so that the shot can



be easily entered from the rear. This is illustrated by Fig. 236. The actual diameters for the 110-pounder are—opening through the breech-screw, 7.12 in.; powder-chamber, 7.2 in.; shot-chamber, 7.075 in.; bore, 7 in. From a point a few inches in front of the shot-chamber to a point near the muzzle, the bore is enlarged to 7.005; the object being, 1st, to mould the lead covering of the shot at the first instant of motion, and to give it freedom in passing through the remainder of the bore; 2d, to centre the shot as it is leaving the muzzle.

FIG. 233.



Armstrong groove of 1861.

FIG. 234.

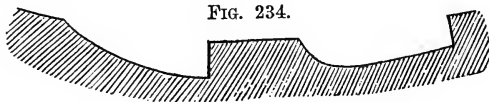
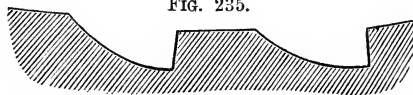


FIG. 235.



FIGS. 234 and 235.—Armstrong 6 and 12-Pr. rifling, 4 times enlarged.

**547.** The particulars of the Armstrong rifling and projectiles have been given in Tables 1 and 2, and in the descriptions of different guns, Chapter I.\* The ranges of several guns are given in following Tables.

\*For heavy guns, this system of rifling and projectiles seems to be going out of use. No new Armstrong guns, with this rifling, have been fabricated since the beginning of 1863. The *Army and Navy Gazette*, of June 4, 1864, speaking of operations at Woolwich, says: "In the laboratory, the workmen are preparing button-shot (the centering system) for the 70-pounders and 100-lb. projectiles, which are to be substituted for those of 110-lb. weight, now in the service. In the gun-factories, the men are busily employed in converting the breech-loading coil 70-pounders into muzzle-loaders. \* \* \* They are also preparing solid breech-pieces for the 110-pounders, which are intended to take the place of the prevent vent-pieces." The 70-pounders and the 100-pounders, will thus be converted into muzzle-loaders, which will prevent the continuance of the compressing system.

On the 13th of August, the same authority says: "We understand that the further manufacture of 100-lb. lead-coated shot for the Armstrong breech-loaders has been stopped, as it is in contemplation to convert the guns into muzzle-loaders, firing non-loaded shot, so soon as the 70-pounders now in process of conversion from breech-loaders are finished."

**548.** The practice with the Armstrong 110-pounder rifle gives the following averages:

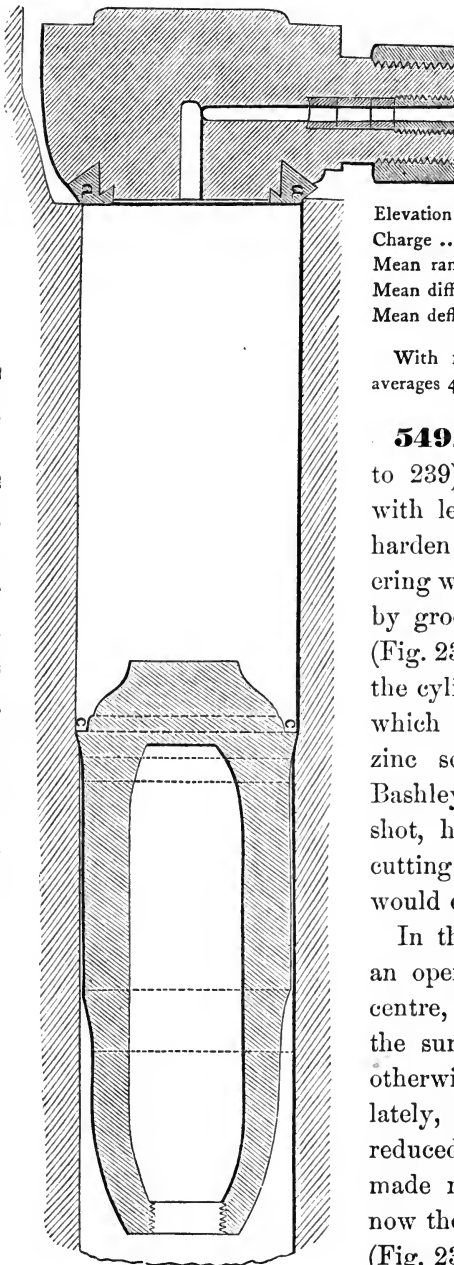
Elevation.....	10°
Charge .....	12 lbs.
Mean range (yards).....	3387
Mean difference of range.....	61.48
Mean deflection.....	4.18

With 16 lbs. charge, at 10°, the range averages 4139 yards.

**549.** The projectile (Figs. 236 to 239) is of cast iron, coated with lead alloyed with tin, to harden it. This soft metal covering was formerly kept in place by grooves, encircling the shot (Fig. 237). It is now soldered to the cylindrical part of the shot, which is turned smooth, by a zinc solder, invented by Mr. Bashley Britten (581). The steel shot, however, requires undercutting; the heat of the zinc would draw its temper.

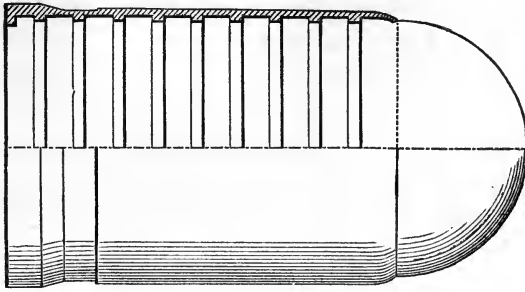
In the earlier shot there was an opening, or score, near the centre, for the lead to strip into, the surfaces of the lead being otherwise nearly straight; but, lately, the soft metal has been reduced in front, and the score made nearer the base; which is now the largest part of the shot (Fig. 237).

FIG. 236.—Chamber and projectile of 12-pounder.  $\frac{1}{2}$  size.



**550.** The segmental shell (Figs. 238 and 239) is intended to answer the purposes of the common shell, the canister-shot, and,

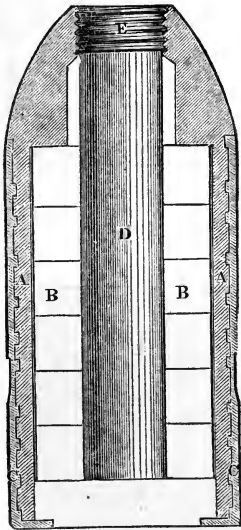
FIG. 237.



Armstrong lead-coated shot.

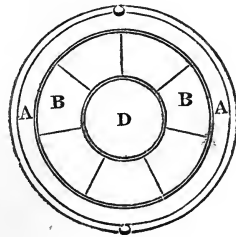
if the fuse is adjusted so as to prevent the ignition of the bursting charge, of the solid shot; thus preventing the risk of running short of either kind of ammunition.\* (717.)

FIG. 238.



Armstrong segmental shell.

FIG. 239.



**551.** The cartridges for the Armstrong 110-pounder are shown by Figs. 240 to 242. As the cartridge must fill the powder-cham-

\* This shell was first patented by a Mr. Holland, in 1854.

FIG. 242.

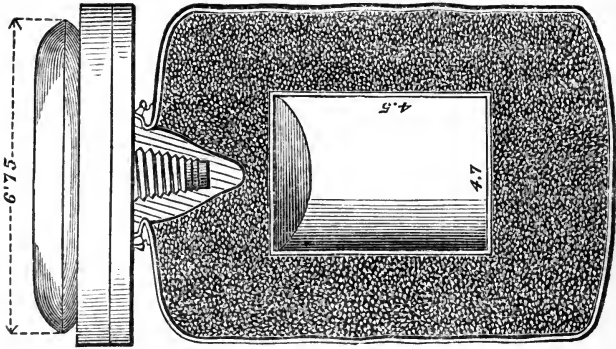
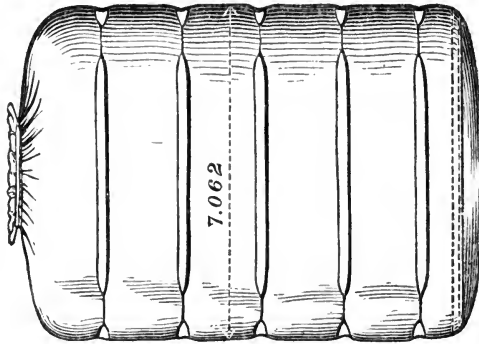


FIG. 241.



Cartridges and Boxer's Lubricator for  
Armstrong 110-pounder.

FIG. 240.

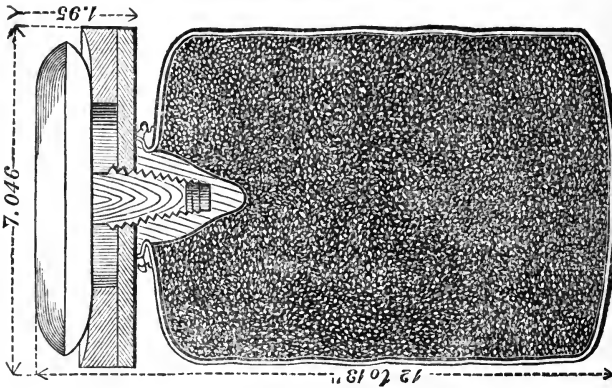


TABLE LXXX.—RANGE AND DEFLECTION OF WHITWORTH AND ARMSTRONG GUNS.

(Report of Ordnance Select Committee, April 2, 1861.)

Armstrong's Breech-loading 12-pounder Gun *versus* Whitworth's Breech-loading 12-pounder Gun.  
 OBJECT.—To ascertain Range and Deflection of Whitworth's Breech-loading 12-pounder Gun in comparison with Armstrong's Gun.

No. of Rounds.	Charge.	Elevation.	ARMSTRONG'S 12-pdr. B. L. No. 6.						WHITWORTH'S 12-pdr. B. L. No. 1.									
			Range.			Mean diff. of Range	Deflection.		Mean Time of Flight.	Range.			Mean diff. of Range	Deflection.		Mean Time of Flight.		
			lbs.	deg.	yd.	yd.	yd.	yd.	yd.	yd.	sec.	yd.	yd.	yd.	yd.	yd.	sec.	
5	1.50	2 1108	1150	1130	12	4.2	1.04	3.42	1159	1223	1198	19	1.38	0.75	3.50	40.88	2.74	110
"	1.75	"	1226	1307	1256	5.2	1.48	3.62	1250	1344	1290	28	1.50	1.08	3.46	86.24	2.98	257
"	1.50	5 2128	2165	2146	11	9.2	1.48	6.78	2072	2486	2368	119	1.40	1.72	6.96	36.92	3.90	144
"	1.75	"	2331	2399	2360	18	0.80	7.28	2335	2644	2471	97	1.79	0.64	7.06	59.86	2.11	126
"	1.50	10 3512	3597	3568	24	12.6	2.14	12.30	4137	4318	4223	68	3.00	0.85	12.62	80.97	5.64	457
"	1.75	"	3866	3961	3908	35	6.17	12.92	4348	4449	4400	25	6.90	2.92	13.08	118.25	16.27	1875
			Area expressing Error.			Rectangle.			Area expressing Error.			Rectangle.			Area expressing Error.			
			yds.			yds.			yds.			yds.			yds.			
			64.61 × 1.98			104.70 × 2.85			388.97 × 4.54			313.81 × 1.69			226.80 × 2.24			
			128			298			1766			530			508			
			128			298			1766			530			508			

SUMMARY.

The general average of range is as 2658 to 2394 in favor of the Whitworth Gun.  
 The general average of accuracy is as 647 to 495 in favor of the Armstrong Gun.  
 The Whitworth 12-pdr. is heavier than the Armstrong 12-pdr., in the proportion of 1092 to 963, and 20 in. longer.

(Signed) J. H. LEFROY.

TABLE LXXXI.—EXPERIMENTAL PRACTICE. ARMSTRONG BREECH-LOADING  
12-POUNDER. SHOEBURYNESS, APRIL 2, 1861.

Height of axis of Gun above plane,  $8\frac{1}{2}$  feet.

Ordnance.....	{	Nature, ARMSTRONG'S B. L. 12-Pdr. Gun, No. 6.	Barometer, 29·7.
		Weight..... 8	Wind, South—3.
		Length..... $7\frac{1}{4}$ feet.	Direction } of Wind. }
		Diameter of Bore.... 3 inches.	
		Spiral, if rifled, 1 turn in 38 calibres.	
Grooves, Number 38. Width, 0·15 inches. Depth, 0·05 inches.			

Nature and object of the Experiment—To ascertain the Range, &c., of Armstrong's Breech-loading  
12-Pdr. Iron Gun, in comparison with Whitworth's Breech-loading 12-Pdr.

Programme received, 28th March. Stores received, 2d April, 1861. Minute No. 8625.

No. of Round.	Charge.	Elevation.	Recoil.	Projectile, Weight and Mean Weight.	Times and Mean Time of Flight.	Range, 1st graze.	Mean Range, 1st graze.	Deflection.		Remarks.	
								Left.	Right.		
	lbs.	deg.	feet.	lbs. mean.	seconds.	yds.	yds.	yds.	yds.		
1	1·75	2	8·0	12	3·5	1239	...	4 $\frac{3}{8}$	...	3d April.	
2	...	...	7·10	...	3·7	1271	...	6 $\frac{3}{8}$	...		
3	...	...	8·0	...	3·6	1238	...	6	...		
4	...	...	8·0	...	3·7	1307	...	4	...		
5	...	...	8·0	...	3·6	1226	1256	4 $\frac{3}{8}$	...		
6	1·5	...	7·0	...	3·4	1108	...	5 $\frac{1}{8}$	...		
7	...	...	7·0	...	3·4	1133	...	5	...		
8	...	...	7·0	...	3·6	1150	...	4 $\frac{1}{8}$	...		
9	...	...	7·0	...	3·4	1121	...	3	...		
10	...	...	7·0	...	3·3	1137	1130	3 $\frac{1}{8}$	...		
11	1·5	5	6·9	...	6·8	2134	...	11	...	2d April.	
12	...	...	6·8	...	6·9	2165	...	9	...		
13	...	...	6·6	...	6·6	2157	...	8 $\frac{3}{8}$	...		
14	...	...	6·6	...	6·8	2146	...	10 $\frac{1}{8}$	...		
15	...	...	6·6	...	6·8	2128	2146	7	...		
16	1·75	...	7·9	...	7·2	2357	...	13	...		Wind increased to 4.
17	...	...	8·0	...	7·3	2331	...	11 $\frac{1}{8}$	...		
18	...	...	7·10	...	7·2	2356	...	11	...		
19	...	...	8·0	...	7·4	2351	...	11 $\frac{3}{8}$	...		
20	...	...	8·0	...	7·3	2399	2360	11	...		
21	1·5	10	4·6	12	12·2	3512	...	12	...	Wind changed and increased. Squally.	
22	...	...	4·8	...	12·4	3576	...	11	...		
23	...	...	4·6	...	...	3593	...	17	...		
24	...	...	4·6	...	12·4	3597	...	12	...		Wind increased to 6, and continued squally.
25	...	...	4·5	...	12·2	3563	3568	11	...		
26	1·75	...	5·0	...	12·8	3943	...	8	...		
27	...	...	5·0	...	12·8	3898	...	23	...		
28	...	...	5·0	...	13·0	3961	...	14	...		
29	...	...	5·1	...	13·0	3866	...	19	...		
30	...	...	5·1	...	13·0	3873	3908	21	...		

Elevation throughout by Quadrant.

The Gun was mounted on a Travelling Carriage, and placed on one of Lieut.-Colonel Clerk's Platforms, on the level.

Wads, choked in the Cartridge, were used throughout the Practice.

The Secretary,  
Ordnance Select Committee.

(Signed)

A. J. TAYLOR, Colonel R. A.,  
Commandant and Superintendent.

TABLE LXXXII.—EXPERIMENTAL PRACTICE. WHITWORTH BREECH-LOADING 12-POUNDER. SHOEBOURNESS, APRIL 2, 1861.

Height of axis of Gun above plane,  $3\frac{1}{2}$  feet.

Ordnance..... Nature, WHITWORTH'S B. L. 12-Pdr. Gun, No. 1. Barometer, 29·7.  
 Weight..... cwt. qrs. lbs. Wind, South—3.  
 Length..... 8 8-12 feet. Direction }  
 Diameter of Bore, Major axis 3 in., Minor, 2·75 in. of Wind. {  
 Spiral, if Rifled, 1 turn in 55 inches.  
 Grooves, No. —, Width, —, Depth, —.

Nature and object of the Experiment—To ascertain the Range, &c., of Whitworth's Breech-loading 12-Pdr. Iron Gun, in comparison with Armstrong's Breech-loading 12-Pdr. Programme received, 28th March. Stores received, 2d April. Minute No. 8625.

No. of Rounds.	Charge.	Elevation.	Recoil.	Projectile, Weight and Mean Weight.	Times and Mean Time of Flight.	Range, 1st graze.	Mean Range 1st graze.	Deflection.		Remarks.	
								Left.	Right.		
	lbs.	deg.	feet.	lbs. mean.	seconds.	yds.	yds.	yds.	yds.		
1	1·75	2	7·0	12·094	3·5	1266	...	$\frac{1}{8}$	...	3d April.	
2	...	...	7·3	...	3·6	1344	...	...	3		
3	...	...	7·6	...	3·4	1250	...	...	2		
4	...	...	7·3	...	3·4	1280	...	...	1		
5	...	...	7·6	...	3·4	1306	1290	...	$1\frac{1}{8}$		
6	1·5	...	6·6	...	3·6	1223	...	...	$2\frac{1}{8}$		
7	...	...	6·6	...	3·6	1211	...	...	$1\frac{1}{8}$		
8	...	...	6·6	...	3·4	1188	...	...	2		
9	...	...	6·6	...	3·5	1209	...	0	0		
10	...	...	6·6	...	3·4	1159	1198	...	$1\frac{1}{8}$		
11	1·5	5	6·0	...	7·2	2442	...	$1\frac{3}{8}$	...	2d April.	
12	...	...	6·0	...	6·2	2072	...	...	2		
13	...	...	6·0	...	6·8	2389	...	...	$\frac{1}{8}$		
14	...	...	5·10	...	7·2	2449	...	...	2		
15	...	...	6·0	...	7·2	2486	2368	1	...		
16	1·75	...	7·0	...	7·0	2475	...	$2\frac{1}{8}$	...		Wind increased to 4.
17	...	...	7·0	...	7·2	2644	...	1	...		
18	...	...	6·9	...	6·9	2335	...	2	...		
19	...	...	7·0	...	7·0	2370	...	$1\frac{1}{8}$	...		
20	...	...	7·0	...	7·2	2533	2471	$2\frac{1}{8}$	...		
21	1·75	10	6·9	...	13·2	4409	...	4	...	Wind changed and increased. Squally.	
22	...	...	6·8	...	13·0	4348	...	10	...		
23	...	...	6·8	...	12·8	4387	...	$7\frac{3}{8}$	...		
24	...	...	6·9	...	13·0	4405	...	$8\frac{3}{8}$	...	Wind increased to 6, and continued squally.	
25	...	...	6·9	...	13·4	4449	4400	4	...		
26	1·5	...	5·0	...	12·6	4137	...	4	...		
27	...	...	5·6	...	12·9	4299	...	3	...		
28	...	...	5·0	...	1·0	4139	...	$2\frac{1}{8}$	...		
29	...	...	5·0	...	12·8	4318	...	$3\frac{3}{8}$	...		
30	...	...	5·0	...	12·8	4220	4223	2	...		

Elevation throughout by Quadrant.  
 The Gun was mounted on a Travelling Carriage, and placed on one of Lieut.-Colonel Clerk's Platforms, on the level.  
 The Powder and Wad were contained in the usual Tin Cases.  
 The rounds marked \* were fired with Tin Cases that had been used previously, there being no more in store, and they were simply well cleaned, and answered quite as well as when new.  
 The Wad weighs about 2 oz. 4 drs., and the empty Tin Case about 8 oz. 5 drs.  
 The Secretary, (Signed) A. J. TAYLOR, Colonel R. A.,  
 Ordnance Select Committee. Commandant and Superintendent.

ber, whatever the amount of powder, the necessary reduction of powder-space is made by placing a paper cylinder inside the cartridge, as in the 10-lb. charge (Fig. 242). The lubricator consists of a hollow disk, of thin copper, filled with tallow, and resting upon a paper sabot and felt, in layers. The whole is secured by a wooden screw, to a wooden plug, tied into the mouth of the cartridge-bag.

TABLE LXXXIII.—RANGE AND ACCURACY OF LONG AND SHORT ARMSTRONG 12-POUNDERS. H. M. SHIP "EXCELLENT," MAY 22, 1861.

Charge, 1 lb. 8 oz.; Projectile, 10.75 lbs.; Elevation, 7° 5'; fired at target, 2550 yards distant and 14 feet square.

LONG 12-POUNDER.				SHORT 12-POUNDER.			
Length of bore..... 84.125 in.				Length of bore..... 53 in.			
Diameter " ..... 3 "				Diameter " ..... 3 "			
Weight ..... 8 cwt. 2 qrs.				Weight ..... 8 cwt.			
No. of rounds.	Actual range, yds.	Beyond or short of target, yds.	Deflection, yds.	No. of rounds.	Actual range, yds.	Beyond or short of target, yds.	Deflection, yds.
1	2580	30 beyond	1 right.	1	2570	20 beyond	3 left.
2	2550	0 "	1 "	2	2565	15 "	3 "
3	2570	20 "	Through.	3	2570	20 "	Direct.
4	2570	20 "	"	4	2570	20 "	Through.
5	2550	0 "	1 left.	5	2545	5 short	1 right.
6	2575	25 "	1 right	6	2545	5 "	5 left.
7	2580	30 "	1 "	7	2550	0 "	Direct.
8	2565	15 "	Through.	8	2545	5 "	"
9	2570	20 "	Direct.	9	2550	0 "	Through.
10	2558	8 "	1 right.				

NOTE.—The discrepancy is attributed, in the official report, to error in laying the gun.

**552. SHUNT.**—The Armstrong shunt rifling, for muzzle-loaders, combines both the centering and compressing systems. As the



TABLE LXXXIV.—RANGE AND DEFLECTION.—ARMSTRONG SIDE BREECH-LOADING AND SERVICE 40-POUNDERS.

*(Ordnance Select Committee's Report, Oct. 17, 1862.)*

	Elevation.	Mean range.	Mean difference of range.
		yds.	yds.
Side Breech-Loader, 40-pounder	5°	2147	25.0
	10°	3688	45.3
Land Service 40-pounder	5°	2150	26.5
	10°	3660	25.0

TABLE LXXXV.—RANGE AND DEFLECTION OF THE ARMSTRONG SIDE BREECH-LOADING 70-POUNDER.

Height of Gun, above plane, 20 feet; Shells, filled, 25 lbs.; Charge, 9 lbs.; Burster, 5 lbs.; Tin Cup; Boxer's Lubricators.

*(Ordnance Select Committee's Report, Jan. 13, 1862.)*

No. of rounds.	Elevation.	Mean reduced time of flight.	Ranges.			Mean difference of range.	Mean observed deflection.	Mean reduced deflection.
			Min.	Max.	Mean.			
		sec.	yds.	yds.	yds.	yds.	yds.	yds.
10	2°	3.50	1104	1259	1168	39.1	1.88	0.71
10	5°	6.95	2144	2255	2193	23.9	4.30	2.10
10	10°	12.38	3547	3729	3594	68.5	22.32	3.60

inventor deemed it important to prevent the shot from moving laterally, by direct pressure on its sides, instead of by allowing it to centre itself, like Commander Scott's (535); and, as the expansion system did not meet his views, his ingenious resort was to arrange the rifling so that the shot runs home easily, and is then shunted, or switched off, or turned a little in the gun, so that, when it comes out, a shallower portion of the groove will nip it, and prevent its lateral movement.

The projectile (Fig. 243, the dotted lines show the outline of

TABLE LXXXVI.—RANGE AND DEVIATION OF THE ARMSTRONG 600-POUNDER.  
*Shoeburyness, Nov. 18th, 1863.*

No. of Round.	Projectile.					Charge, in lbs.	Range, in yards.		Elevation.	Deviation, in feet.		Recoil, ft.	Time of flight.	Velocity at 120 ft.	Remarks.
	Nature.	Length.	Diameter.	Weight.	Form.		Actual.	Mean.		Right.	Left.				
1	Cast-Iron Shot	25.1	13.25	509.0	A	70	740		1	3	8.5	1.8	1220	Compressor hard over except as otherwise stated.	
2	"	"	"	511.25	"	"	785	771	"	1	9.25	1.9	1266		
3	"	"	"	509.0	"	"	789		"	...	9.2	2.0	1257		
4	"	"	"	513.0	"	"	1160		2	4	10.7	3.2	1255	No compressor.	
5	"	"	"	512.5	"	"	1148	1164	"	1	8.75	"	1258		
6	"	"	"	516.5	"	"	1184		"	...	9.0	"	1247		
7	"	"	"	516.75	"	"	2400		5	...	"	6.7	.....	Shot jammed from fouling; after this washed out at every round.	
8	"	"	"	509.5	"	"	2338	2349	"	1	9.9	6.6	.....	No compressor.	
9	"	"	"	511.5	"	"	2308		"	...	9.7	"	.....	No compressor.	

10	Cast-Iron Shot	25.1	13.25	510.25	A	70	4080	10	6	...	7.6	12.5	.....	No ricochet.
11	"	"	"	513.25	"	"	4176	4148	line	...	8.0	12.6	.....	
12	"	"	"	507.25	"	"	4187	"	...	12	8.25	"	.....	
13	Cast-Iron Shell	30.5	"	595.81	C	60	1880	1889	...	6	8.5	6.0	.....	Ricocheted to right.
14	"	"	"	601.31	"	"	1898	"	...	11	8.75	6.1	.....	Ricocheted to left.
15	"	"	"	599.31	"	"	.....	.....	...	...	11.2	6.3	.....	
16	Cast-Iron Shot	.....	13.2	304.75	S	70	960	1	...	..	6.25	2.2	1576	Loss of velocity in 300 feet=110 feet; of rifle projectile, .25 feet.

A. Cast-iron Solid Shot with hollow conoidal head.

C. Cast-iron Shell with hollow conoidal head.

S. Spherical Cast-iron Shot.

In publishing a part of this Table, the Elswick Ordnance Co. append the following note :

The rising tide prevented the range and deviation of Rounds 15 and 16 being ascertained.

It will be seen that at the mean ranges of 771 yards, 1164 yards, 2349 yards, and 4148 yards, or 2½ miles, targets of 3 ft., 4 ft., 13 ft., and 18 ft. respectively, in width, would have received all the shot

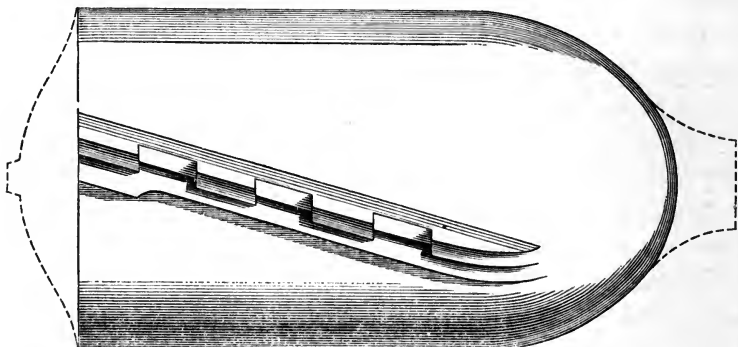
The velocity of the rifled shot at 120 ft. from the gun was 1265 ft. per second.

The velocity of the round shot at the same distance was 1565 ft. per second, being rather more than that of the 68-pounder shot fired with the service charge of 16 lbs.

In order to ascertain the relative loss of velocity of the round and the rifled shot, the velocities were taken at two points of the trajectory—viz. : at 120 ft. and at 420 ft. from the gun's muzzle. The loss of velocity of the round shot between these two points was three times as great as that of the rifled shot.

the shell) is fitted with three bars of zinc, abutting against and projecting above iron ribs cast on the shot. The tops of the

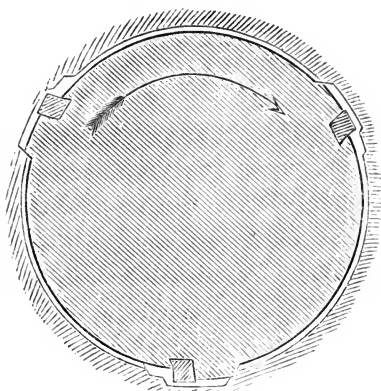
FIG. 243.



Elevation of shunt shot.

zinc bars are sometimes notched, as shown, to facilitate compression. The outsides of the zinc bars bear against the lands of the gun, and rotate the projectile.

FIG. 244.



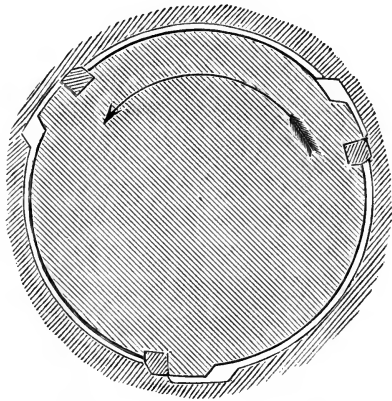
Shunt; section at muzzle; shot going in.

**553.** The development of one of the grooves is shown by Fig. 246; a section at the muzzle, with the shot going in, by Fig. 244; and the same section, with the shot coming out, by Fig. 245. The grooves at the muzzle are slightly wider than they are lower down, and are stepped, or have two levels, the lower level corresponding in width with the entire rib, and the higher level being narrower,

so that the projectile will only enter by the low level, or deeper portion of the groove. The high level runs into the muzzle, parallel, for eight inches (in the 7-in. gun), where an incline commences running off to the low-level 14 inches lower down the

bore. Supposing the spiral direction of the groove to be such that the shot, in going down, would hug the right side of the groove, as viewed from the muzzle, then, in coming out, it would hug the left side, because the rotation would be in a contrary direction. As the shot goes down, on the right side, it runs against a curve, or switch, which deflects it to the side upon which the high level is situated. But, at this point, the high level has become extinct, so that the shot runs easily, without compression, all the way down.

FIG. 245.



Shunt; section at muzzle; shot coming out.

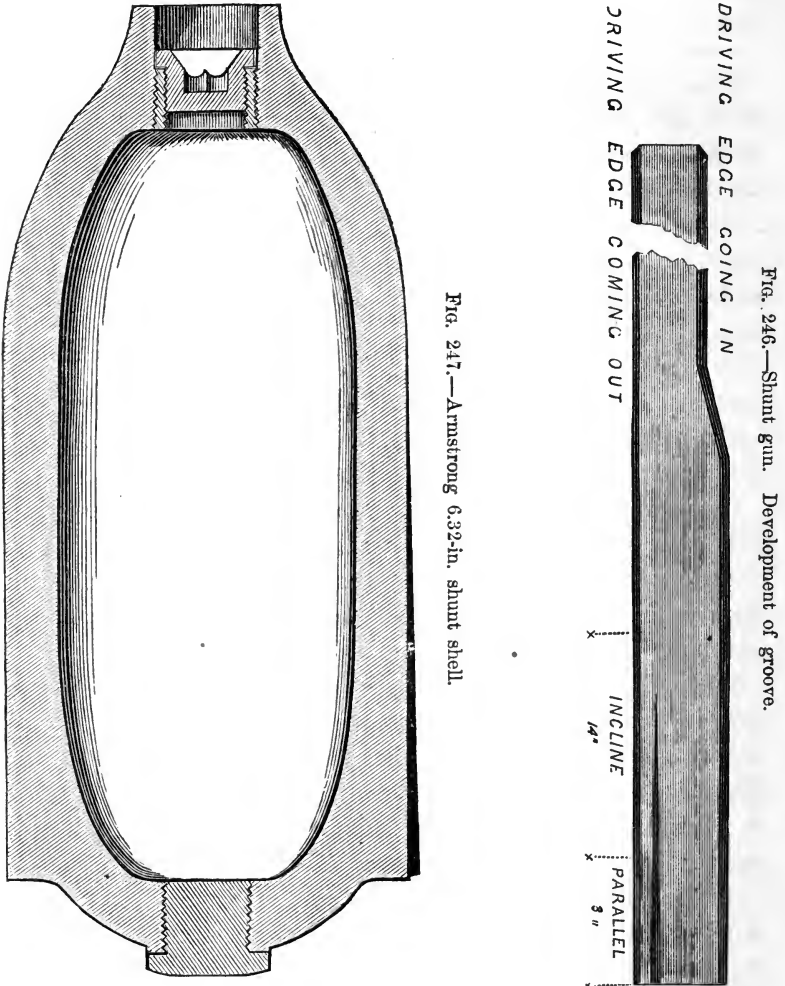
In coming out, the shot is regularly revolved by the straight side of the groove, but slides along the bottom of the bore until it reaches the incline, when the compression, commencing gradually, squeezes it up into the middle of the bore, so that it leaves centered and tightly nipped.\*

**554.** The Armstrong shunt shot (Fig. 247), fired with 5·5 lbs. powder, from a cast-iron 32-pounder, in the trials of 1861 (592), was, in total length, 15·22 in. ; diameter, 6·32 in. ; weight, 50·5 lbs. ; diameter of powder-chamber, 4·8 in. ; bursting-charge, 5 lbs. 13 oz. ; twist of rifling, 1 in 28 in. ; number of grooves, 3 ; width of grooves, 1·25 in. ; depth of grooves, 0·18 in.

**555.** Brass studs, in rows, and a greater number of rows, are now generally used instead of zinc strips. The particulars of the 10½-in., 13-in., and other shunt guns and projectiles, have been given in a foregoing chapter (22 to 30). Upon some of the heavier

\* "The modification of the shunt system, consisting in reversing the grooves and projections by making the former in the shot and placing the latter upon the bore, was unsuccessful, one of the ribs of a wrought-iron gun giving way after about 100 rounds."—*Commander Scott. Jour. Royal U. Service Inst., Dec., 1861.*

shunt shots there are three kinds of projections for three different purposes. A circular row of studs on the base guides the shot as



it enters; a shorter row rests on the bottoms of the grooves, and allows the shot to run home easily, without damaging the grooves; a row of long strips bears against the sides of the grooves to rotate the shot.

TABLE LXXXVII.—RANGE AND DEFLECTION OF THE ARMSTRONG 70-POUNDER MUZZLE-LOADING 6-GROOVED SHUNT-GUN.

Diameter of Bore.....	6.4 in.	Charge .....	11 lbs.
Length of Bore .....	109 in.	No. of Grooves .....	6
Weight.....	60 cwt.	Width of do. ....	0.94 in.
Mean weight of Projectile	71.7 lbs.	Depth of do. ....	0.15 in.
Bursting Charge.....	5 lbs. 6 oz.	Twist, 1 turn in.....	45 cal.

Gun 17½ feet above plane. Result from 119 rounds.

(Abstract of Report of Ordnance Select Committee, Feb. 6, 1863.)

Elevation.	Mean range.	Mean difference of range.	Mean deflection.
	yds.	yds.	yds.
2°	1138	37.97	0.95
5°	2316	40.92	2.50
10°	3959	60.	3.15

**556.** Table 86 is an account of the practice with the 13.3-in. gun or 600-pounder,\* at Shoeburyness, November 19, 1863.

The gun is served by 1 officer and 20 men. The shot is placed in a cradle hooked on to the muzzle, and provided with grooves corresponding with the grooves of the gun. One man lifted up the cartridge and four men lifted the shot. When sponging out dry, 4 men rammed home the cartridge—after washing, 6 men. Four men rammed the shot home. The gun was mounted on a garrison carriage of 54 cwt., with a platform of 75 cwt., having an incline of 3½°. The gun was traversed on a raised iron racer with a treble and double block-tackle, by 6 men on a side.

The shot ricocheted straight. The time between the shots was toward the end of the firing, 10 minutes.

**557.** The shunt rifling adopted in Russia, as used in the 9-in. steel gun (134), is illustrated by Figs. 248 to 251. The projectiles

\* A minute description of this gun and its rifling has been given in Chapter I. (30.) See also note in Appendix.

TABLE LXXXVIII.—RANGE AND DEVIATION OF 70-POUNDER SIDE BREECH-LOADING ARMSTRONG GUN.

Calibre, 6.4 in.; length, 110 in.; weight, 6903 lbs.; 70 grooves, 1 turn in 45 calibres. Gun 17 feet above plane.

No. of rounds.	Elevation as to point of impact.	Charge.	Weight and kind of projectile.	Mean reduced time of flight.	Ranges.			Mean difference of range.	Mean observed deflection.	Mean reduced deflection.
					Min.	Max.	Mean.			
10	1° 28'	9	77.875 seg. shell.	2.25	682	728	710	14.1	0.98	0.38
10	2° 18'	10	79.812 solid shot.	3.47	1105	1176	1134	20.7	1.24	0.68
10	2° 18'	9	68.562 com. shell	3.40	1068	1111	1096	7.7	0.94	0.68
10	5° 9'	10	79.812 solid shot.	6.90	2132	2266	2183	31.5	2.98	3.22
10	5° 9'	9	68.562 com. shell	7.01	2016	2236	2156	51.1	3.42	0.88
10	10° 6'	9	77.875 seg. shell.	12.13	3448	3710	3578	79.8	5.24	1.96
10	10° 5'	9	68.562 com. shell	12.68	3586	3760	3704	30.9	15.60	2.80

are fitted with "composition-metal" rectangular studs. Most of the projectiles are 2½ diameters long, so that the 9-in. gun fires a shell 22½ in. in length. Figs. 252 and 253 show the different forms of steel shells recently used in experiments against armor (235).

**558.** The following are the dimensions of the rifling in the steel 24-pounder (6.03) and the 8-in. guns:—The rifling is from left to right, looking from behind. It commences 6 in. from end of bore. The bore must be cylindrical, and the difference between the diameter at different sections should not be greater than 0.01 in. The bore must be between 6.03 in. and 6.05 in. The diameter of discharging-grooves should be from 6.29 in. to 6.31 in. at the muzzle, and at 36 in. from muzzle, from 6.31 to 6.32 in. Diameter of loading-grooves from 6.38 in. to 6.40 in. Breadth



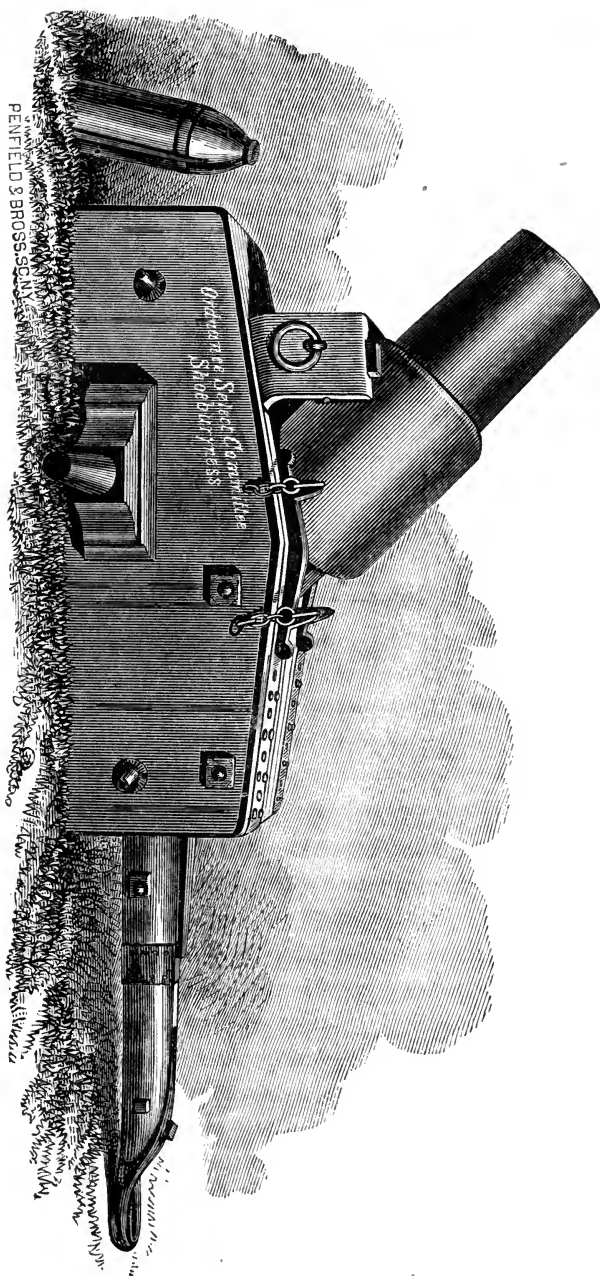


FIG. 247 A.—Armstrong shunt-rifled mortar. From a photograph.

TABLE LXXXIX.—PRACTICE WITH ARMSTRONG'S 7-INCH SHUNT-RIFLED MORTAR. SHELLS WITH COPPER AND ZINC RIBS.

No. of Rounds.	Charge, lbs	Elevation.	Weight of Shell, lbs.	Mean reduced time of flight, Seconds.	Mean range, Yards.	Mean observed deflection.	Mean reduced deflection.	Unsteady.
10	1	42°	87.812	10.6	601	21.7	2.7	2
10	1.25	"	"	11.8	765	24.5	3.7	...
5	2	45°	87.562	17.1	1332	78.2	11.8	1
5	3	"	"	21.7	2028	108.	7.2	2
5	3.5	"	"	23.0	2072	145.	13.8	4
5	4.	"	"	23.9	2268	124.	37.0	4
5	5.	"	"	26.2	2627	183.	43.2	4.

Burfting charge, 6.625 lbs.

of discharging-grooves, from a point 6 ft. 9 in. from end of chamber to muzzle, and from a point 3 ft. 9½ in. from end of chamber to breech, from 0.70 to 0.72 in. ; and discharging-grooves from a point 6 ft. 9 in. from end of chamber to muzzle, from 0.77 to 0.83 in.

**559. The Expansion System.**—This system is carried out on the most extensive scale in the United States ; in England it is experimental, and has not been adopted in the service. On the Continent it is hardly recognized.

**560.** The plan of rifling almost universally adopted in America (Fig. 254), is lands and grooves of the same or nearly equal width, viz. :— $\frac{3}{8}$  to  $\frac{3}{4}$  in. wide and  $\frac{1}{16}$  to  $\frac{1}{8}$  in. deep in the smaller guns, and  $\frac{3}{4}$  to  $1\frac{1}{4}$  in. wide and  $\frac{1}{16}$  in. deep in the larger guns.

**561.** As all the standard Army and Navy projectiles (except Sawyer's, Figs. 225 and 226), viz., James's, Hotchkiss's, Schenkl's, Parrott's, and Stafford's, are expanding projectiles ; they may all be used in any gun of proper calibre, irrespective of the width or depth of the grooves.

**562.** The ranges of these projectiles from field guns (bore from

2.9 to 3.80 in.), with 12° or 13° elevation (the greatest elevation the carriages will admit of), is from 3000 to 3500 yards, or about 1¾ to 2 miles. With higher elevations 6000 yards are easily attained.

FIG. 248.

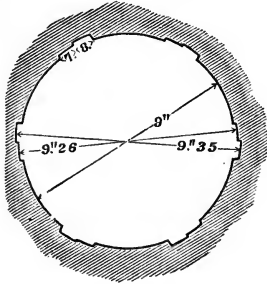


FIG. 249.

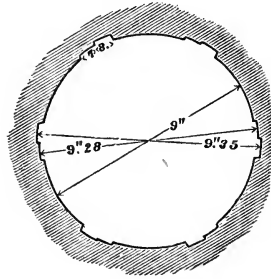


FIG. 250.

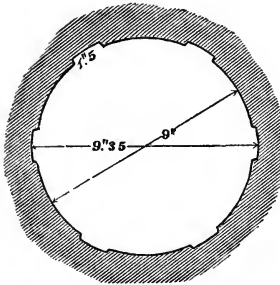
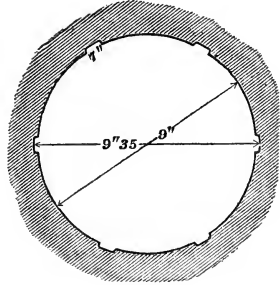


FIG. 251.



FIGS. 248 to 251.—Shunt rifling of Russian 9-in. gun. Scale, 1½ in. to 1 ft.

Fig. 248 .....	Section at muzzle.
" 249 .....	36 in. from muzzle.
" 250 .....	92 in. from muzzle.
" 251 .....	124 in. from muzzle.

**563.** The gaining twist is not employed to any considerable extent except in the Parrott guns; and Parrott's projectile (573) is particularly adapted to this twist, by having a very short bearing. The long bearing of the Armstrong shot (459) would evidently be stripped by lands with increasing pitch.

**564. JAMES.**—The James (American) projectile is illustrated by Figs. 255 to 258, and is cast with 8 or 10 longitudinal recesses or slits

leading from the periphery to a central orifice in the base. These are filled with soft metal, which is pressed out into the grooves of the gun by the powder-gas acting through the orifice *e*, Fig. 255. Fig. 257 is a section through one of these recesses, *d*; *m m* are the entrances to other recesses, from the central cavity. The projectile retains its full diameter for  $\frac{3}{4}$  in. of its length at each end of the cylindrical part. The intermediate space is  $\frac{1}{2}$  in. less in diam-

FIG. 252.

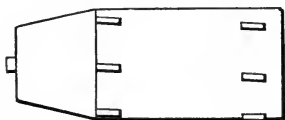
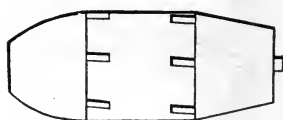


FIG. 253.



Russian shunt steel shells.

FIG. 254.



Rifling of 4.2-in. United States siege gun. Full size.

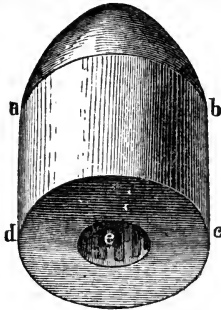
eter, forming a recess, in which is wrapped a plate of tin, covered by a piece of canvas, secured to the tin by being folded under it and cross sewed. The space inside of the tin wrapper is filled with melted lead, which adheres to the tin and prevents its revolving on the shot. The outer canvas wrapper is well greased, to insure an easy entrance, and to clean and lubricate the gun.

**565.** The average weight of the projectile for a 42-pr. (old) gun is, if solid,  $81\frac{1}{4}$  lbs.; if a shell,  $64\frac{1}{4}$  lbs. Its length is 13 in., of which  $6\frac{3}{4}$  in. is cylindrical. The James projectiles used in the breaching of Fort Pulaski were fired from 42, 32, and 24-pounder guns, and weighed, respectively, 84, 64, and 48 lbs. The charges were, respectively, 8, 6, and 5 lbs. of powder.

**566. HOTCHKISS.**—The Hotchkiss (American) projectile (Fig. 259) consists of a cast-iron body, which may be a shot or a shell, with a cylindrical base of diminished diameter, over which a cast-iron cap is fitted. These parts are slightly less in diameter than

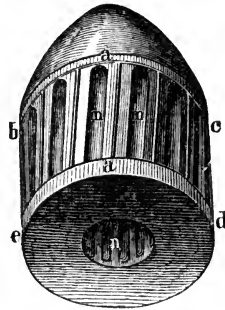
the bore of the gun. The groove between the body and the cap is cast full of lead, so that the first power of the powder, before the

FIG. 255.



James shot.

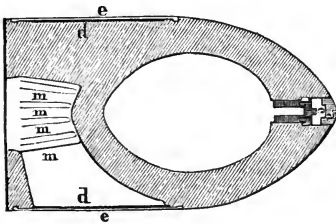
FIG. 256.



James shot, without packing.

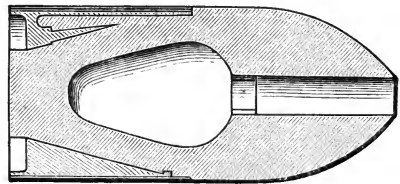
inertia of the whole projectile is overcome, is devoted to driving the cap farther upon the body, thus squeezing out the intermediate

FIG. 257.



Section of James shell.

FIG. 258.



New James shell.

lead into the grooves of the gun, and at the same time holding the lead, as in a vice, so that it cannot revolve on the projectile. As in the James shot, the lead is covered by a greased canvas band.

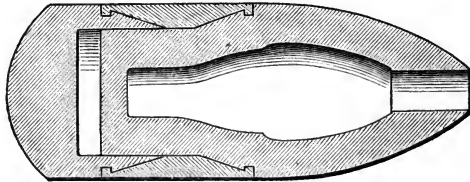
The lengths and weights of projectiles of different calibres are varied according to circumstances.\*

**567. THOMAS.**—Mr. Lynall Thomas's (English) projectile (Fig. 260), as used with little success in the competitive trials of 1861,

\* In a letter to the *Army and Navy Journal*, of Nov. 14, 1863, Mr. Hotchkiss states that he is furnishing his projectiles to the U. S. Government at the rate of 3000 per day; and that he has made, since the rebellion commenced, over 1600000 projectiles.

closely resembles the Hotchkiss projectile. The lead is forced into the grooves by a sliding ring instead of a cap. The particulars of the rifling and projectile are as follows: Pitch of rifling, 1 turn in 18 feet; No. of grooves (flat, square-cornered), 7; width of grooves,

FIG. 259.

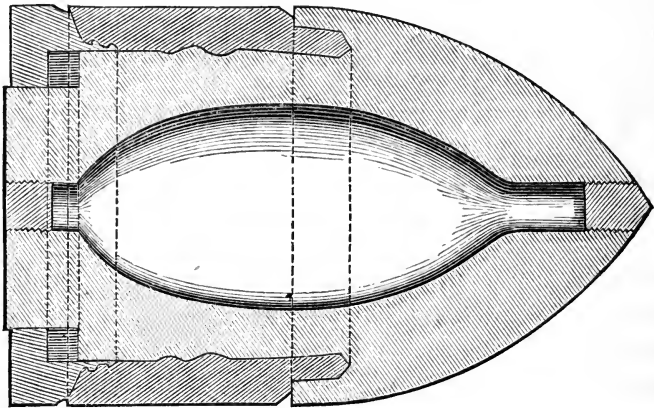


Section of the Hotchkiss shell

1·8 in. ; depth of grooves, 0·1 in. ; weight of shell, 55 lbs. ; length, 10·2 in. ; diameter, 6·3 in. ; diameter of powder-chamber, 3·2 in. ; bursting charge, 1 lb. 5½ oz. ; charge, 7 lbs.

**568.** With a 7-in., 7-grooved, puddled-steel gun, of 7 tons

FIG. 260.



Lynall Thomas's early projectile.

weight, forged solid at the Mersey Iron works, and a 175-lb. shot, charge, 27 lbs., elevation, 35°, Mr. Thomas has obtained the longest range on record—10070 yards, or nearly 6 miles. The gun burst after a few discharges.

The rifling lately adopted by Mr. Thomas has been described under the centering system.

**569. SCHENKL.**—The Schenkl (American) projectile (Figs. 261 and 262) is a casting, having its greatest diameter a little more

FIG. 261

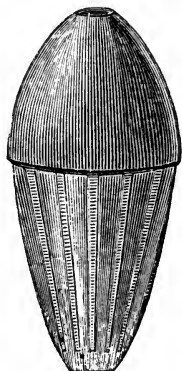
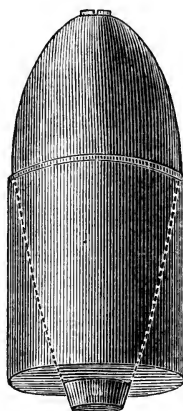
Schenkl projectile,  
without patch.

FIG. 262.

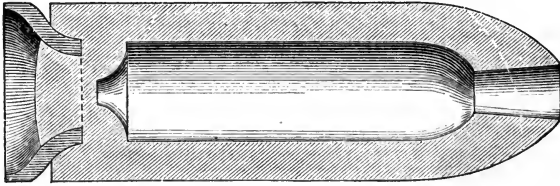
Schenkl projectile, with *papier*  
*mâché* patch.

than  $\frac{1}{3}$  of its length from the forward end; from which point, to the rear end, it presents the form of a truncated cone, with straight projections cast upon it. Around this rear portion is placed a ring of *papier mâché*, the interior of which is made conical and grooved to fit the projections on the casting, so that there shall be no lateral slipping: the exterior is cylindrical, and slightly smaller than the bore, so as to run home easily. The powder-gas drives the *papier-mâché* packing forward upon the cone, whence it is jammed into the grooves of the gun, and made so compact as to rotate the projectile without stripping. Upon leaving the gun, the *papier mâché* flies off in the shape of a harmless powder. The weights and lengths are varied for different service.

**570. REED.**—The Reed (American) system (Fig. 263) is not largely adopted in the form shown, but illustrates the principle of several projectiles extensively used in both the Northern and Southern States. In the latter, the projectiles are usually of Eng-

lish make, and have a brass disk, or a brass cup, bolted to the base of the shot. Fig. 263 shows a corrugated ring of wrought iron

FIG. 263.

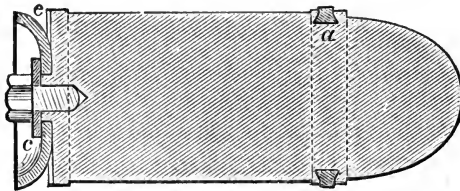


The Reed projectile.

cast into the base of the shot. The pressure of the powder expands and mashes the ring into the grooves of the gun.

**571. BLAKELY.**—The projectile manufactured by the Blakely Ordnance Co., and elsewhere in England, to be used with the Blakely guns and Brooke's guns, is illustrated by Fig. 264. The

FIG. 264.



Captain Blakely's projectile.

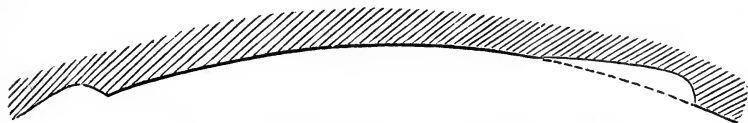
expanding copper cup *e* is secured to the base of the shot, whatever its size, by a single tap-bolt, and is prevented from revolving on the shot by being compressed by the powder-gas against projections cast (or in case of steel shot, planed) on the base of the shot. The space *e* is filled with tallow, to lubricate the gun. The small soft metal studs *a* are greater in number than the grooves of the gun; so that however the shot is put in, some of the studs will bear upon the lands, and hold up or centre the point of the shot. The engraving shows a 21-lb. shot for an "18-pounder,"  $\frac{1}{4}$  size.

**572.** The rifling of Captain Blakely's 9-in. gun is shown by Fig. 265, and of Brooke's (Confederate) 7-in. gun by Fig. 266 (104). The groove of Captain Blakely's 12 $\frac{3}{4}$  in., or 900-pounder gun (66),



is shown by Fig. 267. The grooves are 4 in number, and are used with a modification of Commander Scott's projectile (535).

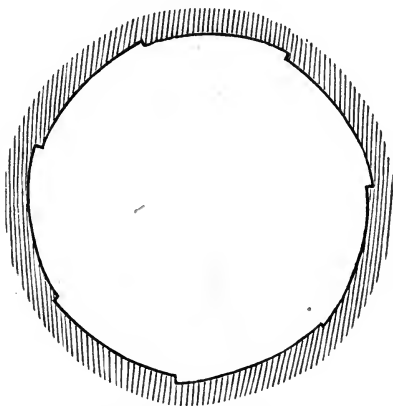
FIG. 265.



Rifling of Blakely 9-in. gun. Full size.

**573. PARROTT.**—The Parrott projectile (Figs. 268 and 269) consists of a cast-iron body, recessed around the corner of the base to receive a brass ring from 1 in. to  $1\frac{1}{2}$  in. in width, and about 1 in. in maximum depth, which is mashed into the grooves of the gun by the explosion of the powder. The recess in which the brass ring is cast, is provided with numerous projections, parallel to its length, like the teeth of gearing, by which the ring is prevented from revolving on the shot. The diameter of the recess is greatest at the extreme rear of the shot, so that the brass ring cannot fly off without breaking. The entire shot is slightly smaller than the bore, so as to be easily rammed home.

FIG. 266.



Rifling of Brooke's 7-in. gun.

**574.** The weight of the 6.4-in. (32-pounder) Parrott shot and shell is from 70 to 100 lbs. The 8-in. projectile weighs from 132 to 175 lbs., and the 10-in. averages about 250 lbs. The Parrott projectiles used in the breaching of Fort Pulaski were 30-pounders—charge,  $3\frac{1}{4}$  lbs.

In the rifling of the Parrott guns, the grooves and lands are of equal width, and  $\frac{1}{16}$  in. deep. The bottom corners of the grooves

TABLE XC.—RANGE OF AND PRESSURE IN THE PARROTT 6·4-INCH 100-POUNDER RIFLE. WEST POINT,  
JULY 22 TO 28, 1862.

Charge, 10 lbs. of powder in all cases.

Number.	Elevation.	Powder.	Projectile.	Range, in yards.	Time of Flight.	Drift to Right.	Pressure per sq. in., as indicated by Rodman's pres- sure-gauge.	REMARKS.
1	5°	Dupont, 7 .....	lbs. Shot, 99½	yds. 2078	" ...	yds. 4	lbs. 38000	} Drift as nearly as could be observed.
2	"	"	"	2180	"	4	45300	
3	"	Hazard, 7 .....	"	2251	"	4	80000	
4	"	"	"	2308	"	4	86000	
5	"	Bennington, 5 .....	"	2221	"	4	27500	
6	"	Doremus cake, Hazard, 2....	"	2370	"	4	114000	
7	40°	Dupont, 7 .....	"	3820	13	8·5	55000	
8	"	"	"	3792	12½	8·5	46000	
9	"	Hazard, 7 .....	"	3810	12	3·5	76000	
10	"	"	"	3802	12½	3·5	49500	
11	"	Bennington, 5 .....	Shell, 100	3370	...	1·0	24750	
12	"	Doremus cake, Hazard, 2....	"	3662	12½	1·0	103000	

13	15°	Dupont, 7.....	Shell, 100	4830	18	30.0	32630
14	"	"	Shell, 82	5190	19	24.5	40000
15	"	Hazard, 7.....	Shell, 101	4911	...	30.0	48700
16	"	"	Shell, 82	5247	...	30.0	51240
17	"	Dupont, 7.....	Shell, 101	4796	...	42.0	60350
18	"	"	Shot, 99½	5030	18½	52.5	64000
19	"	"	Shot, 82	5190	19	52.5	66000
20	"	Hazard, 7.....	Shell, 101	4735	18½	35.0	99002
21	"	"	Shot, 99½	5045	18½	45.5	102980
22	"	"	Shot, 82	5254	18½	56.0	89000
23	"	Bennington, 5.....	Shell, 101	4868	18½	38.5	61750
24	"	"	Shot, 99½	4796	17¾	...	40200
25	"	"	Shot, 82	5038	18	63.0	41600
26	"	Dupont, 7.....	Round shot, 32	3701	16½	63.0	27250
27	"	Hazard, 7.....	"	3352	...	7.0	39300
28	"	Bennington, 5.....	"	3195	15½	7.0	20000
29	20°	Dupont, 7.....	Shell, 101	5853	21¾	56.0	65800
30	"	"	Shot, 99½	6125	22½	56.0	48650

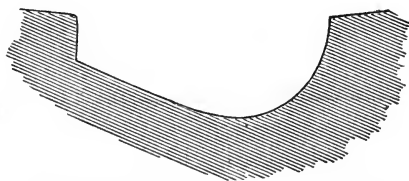
TABLE XC.—(CONTINUED.)

Number.	Elevation.	Powder.	Projectile.	Range, in yards.	Time of Flight.	Drift to Right	Pressure per sq. in., as indicated by Rodman's pressure-gauge.	REMARKS
31	20°	Dupont, 7.....	lbs. Shot, 82	yds. 6338	" 23	yds. 59.5	lbs. 81000	
32	"	Hazard, 7.....	Shell, 101	5762	22½	55.0	102900	
33	"	"	Shot, 99½	5972	22½	49.0	102000	
34	"	"	Shot, 82	6273	23	96.0	98000	
35	"	Bennington, 5.....	Shell, 101	5698	22½	54.0	50000	
36	"	"	Shot, 99½	6240	23½	66.5	91500	
37	"	"	Shot, 82	5991	23	71.0	39300	
38	25°	Dupont, 7.....	Shell, 101	6431	28½	96.0	66400	
39	"	"	Shot, 99½	6910	28½	106.0	69300	
40	"	"	Shot, 82	7180	27½	116.0	70200	
41	"	Hazard, 7.....	Shell, 101	6820	28	81.0	87000	The gun with the pressure-gauge attached would not admit of higher elevation.
42	"	"	Shot, 99½	6840	29	101.0	...	

43	25°	Hazard, 7.....	Shot, 82	7190	29½	116.0	...
44	"	Bennington, 5.....	Shell, 101	6892	28¾	43.5	...
45	"	"	Shot, 99½	6899	28½	42.5	...
46	"	"	Shot, 82	7090	29	44.0	...
47	30°	Dupont, 7.....	"	7800	32½	156.0	...
48	"	"	Shell, 80	7810	32½	156.0	...
49	"	Hazard, 7.....	Shot, 82	7988	32½	146.0	...
50	"	"	Shell, 80	7951	32½	151.0	...
51	"	Bennington, 5.....	Shot, 82	8190	32¾	171.0	...
52	"	"	Shell, 80	7842	32½	141.0	...
53	35°	Dupont, 7.....	Shot, 82	8453	36¾	191.0	...
54	"	"	"	8439	36¾	197.0	...
55	"	Hazard, 7.....	"	8548	36¾	206.0	...
56	"	"	"	8450	...	...	...
57	"	Bennington, 5.....	"	8845	37	211.0	5 miles, 45 yards.
58	"	"	"	8222	36¾	226.0	...
59	"	Dupont, 7.....	Shell, 80	8301	36½	186.0	...
60	"	"	"	8428	36¾	191.0	...

are rounded. The twist of the grooves in the 100-pounder commences at 0 and ends at 1 revolution in 18 feet. The bore is 130

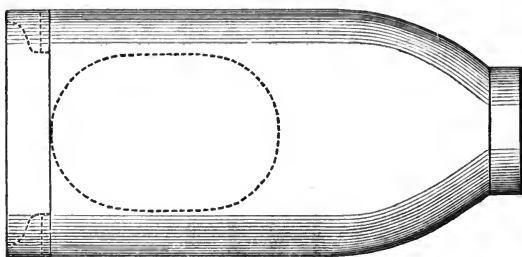
FIG. 267.

Groove of Blakely 12 $\frac{3}{4}$ -in. gun. Full size.

in. long. The 8-in. rifle has 11 grooves; the twist commences at 0, and ends at 1 turn in 23 feet. The bore is 136 in. long. The 10-in. rifle has 15 grooves; the twist commences at 0, and ends at 1 turn in 30 feet. The bore is 144 in. long.

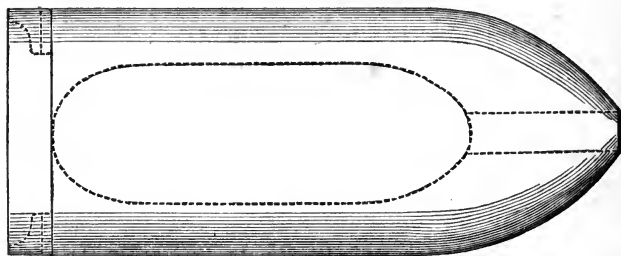
**575.** Figs. 270 and 271 show the accuracy of the Parrott 100-pounder shells in practice which was much like service, having

FIG. 268.



Parrott's hollow shot.

FIG. 269.



Parrott 100-pounder shell.

TABLE XCI.—TRIAL OF PARROTT 6·4-INCH 100-POUNDER RIFLE, BY FIRING IT 1000 TIMES WITH 100-LB. PROJECTILE AND 10 LBS. CHARGE. WEST POINT, JULY 1 TO JULY 19, 1862.

GUN, FOUNDRY, No. 339; CAST MAY 22, 1862.

	lbs.
Greenwood Iron, No. 1.....	4480
Greenwood do., No. 2.....	3360
Salisbury do.....	2352
Scotch do.....	336
Gun-Heads do.....	2240
	12768

The metal was 2½ hours in fusion.

DENSITY.		TENSILE STRENGTH.
	BAR.	
7·3750		29897
	HEAD.	
7·2848		34975

Wrought-iron reinforce, 27 in. long and 3·2 in. thick, was made from a bar 4 × 4 in. and 76 ft. long, and weighed, finished, 1725 lbs.

DIMENSIONS.

	Inches.
Length, extreme .....	154·25
Do. Bore .....	130
Do. Trunnions.....	5
Diameter of Bore.....	6·4
Do. Trunnions .....	8·
Do. at Muzzle .....	13·038

Grooves square, with rounded corners. Increasing twist commenced at 0, and ended at muzzle with 1 revolution in 18 ft.

	Inches.
Diameter reinforce .....	25·9
Length from face to end of Grooves.....	124
Width of Grooves .....	0·711
Depth do. ....	0·1
Weight .....	9812 lbs.
Preponderance .....	20 "

Copper bushing in vent, ⅞ in. diameter; vent vertical, entering the bore, at 3·75 in. from the bottom.

The powder was furnished by the Navy Department, and consisted of Dupont's No. 7 grain.

Initial velocity, mean of 3 fires, 1151 ft.; pressure per sq. in., 8226 lbs. The cartridges were 5·7 in. diameter. The gun was fired by a friction tube.

PARROTT'S PROJECTILE, WITH BRASS RINGS AT THE BASE.—Shot flat-headed, averaging  $98\frac{1}{2}$  lbs. Shells loaded with sand, averaging  $101\frac{1}{2}$  lbs. The projectiles used averaged 100 lbs. The gun is yet in good condition. The elevations varied from  $3\frac{1}{4}^{\circ}$  to  $15^{\circ}$ , the majority being at  $4\frac{7}{8}^{\circ}$  and  $5^{\circ}$ . Four were fired at  $10^{\circ}$ , 34 at  $10\frac{1}{4}^{\circ}$ , 6 at  $14^{\circ}$ , and 18 at  $15^{\circ}$ .

Of the projectiles, 927 took the grooves perfectly and performed well. Of the remainder—

Wobbled, range good.....	12
Do. do. bad.....	8
Ring broken, good.....	48
Do. do. bad.....	2
Sound angular, good.....	2
Unloaded shell, broken.....	1
	<hr/>
	73
	927
	<hr/>
	1000

At the 300th round 3 incipient cracks appeared round the vent-piece, but were not much increased by constant firing.

The effect of firing on the grooves was only to polish them. Their edges were sharp and well defined, and the accuracy of firing was not diminished at the end of the trial.

STAR-GAUGE.—The bore was gauged at the termination of every 25 rounds. The greatest enlargement was .023 inches, near the seat of the brass ring, and opposite where the reinforce terminates. The gun often became very much heated from the rapid firing—as fast as one round in less than two minutes—and the consequent expansion of the metal gave large results. The temperature of the gun, when heated by firing, was  $130^{\circ}$ ; when cold,  $81^{\circ}$ .



TABLE XCII.—TRIAL OF PARROTT 8-INCH 200-POUNDER RIFLE. WEST POINT: COMMENCED MAY 28, AND ENDED APRIL 2, 1862.

Bore, 8 in.; weight, 16000 lbs.; rifled with 11 grooves; increasing twist, 23 ft. at muzzle; specific gravity of metal, 7.3025; tenacity, 34059.

Projectiles, prepared with brass rings, 1½ in. wide.

Hollow shot, truncated .....	15 in. long.	Weight.....	150 lbs.
Solid shot, truncated.....	15 " "	Weight.....	176 "
Short shell, conoidal .....	17½ " "	Weight.....	155 "
Long shell, truncated.....	19 " "	Weight.....	200 "

The cartridges fitted the bore with just windage enough to render loading easy.

No. of Rounds.	Powder.	Charge.	Projectile.	Weight of Projectile.	Elevation.
		lbs.		lbs.	°
12	Dupont, No. 5.....	15	Hollow shot.	150	5½
16	"	15	Short shell.	155	5½ to 5½
8	"	16	"	155	5
2	"	16	Long shell.	200	5½
13	Dupont, No. 7.....	15	Short shell.	155	5 to 5½
2	"	16	Solid shot.	177	5½
2	"	15	Short shell.	155	10
2	"	15	"	155	15
2	"	15	"	155	20
5	Smith & Rand's, No. 5.....	15	"	150 to 155	5 to 6
4	"	15	Solid shot.	176 to 186	6½ to 6¾
18	"	16	Shell and shot.	155 to 176	5¾ to 6
1	"	15	Short shell.	155	15
1	"	15	Solid shot.	177	20
6	Hazard, No. 2.....	16	Shell and shot.	155 to 176	5 to 5¾
4	"	16	Long shell.	200	5½
2	"	15	Short shell.	155	15

TABLE XCII.—(CONTINUED.)

100 shot fired into a bank 2100 yards distant. Time of flight,  $6\frac{1}{2}$  to  $6\frac{1}{4}$  seconds. Accuracy very great. Of the first 26, 20 struck within 10 sq. ft. Drift not to exceed 5 feet.

All the projectiles took the grooves without failure, which was remarkable, as the gun had not been fired before, and was the first gun made of this calibre. The greatest enlargement was 12 in. from the bottom of the bore, at the position of the expanding brass rings, and was :

At 90th round..... .004 in.  
At 100th " ..... .006 "

JUNE 2.—Initial velocity of the same gun by means of Benton's Electric Ballistic Pendulum :

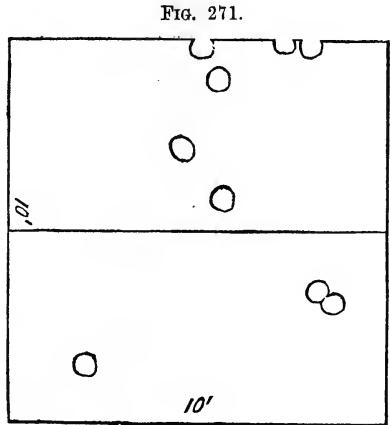
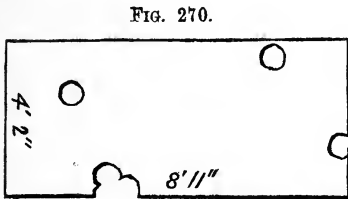
No. of Rounds.	Powder.	Charge.	Projectile.	Weight of Projectile.	Elevation.	Initial Velocity.
		lbs.		lbs.	°	ft.
1	Bennington, No. 5...	16	Shell.	152	$4\frac{7}{8}$	1197
2	"	16	"	152	$4\frac{7}{8}$	1215
3	Dupont, No. 5.....	16	"	152	$4\frac{7}{8}$	1234
4	Hazard, No. 5.....	16	"	152	$4\frac{7}{8}$	1197
5	Bennington, No. 5...	16	"	155	5	1182
6	Hazard, No. 1.....	16	"	152	$4\frac{7}{8}$	1244
7	Dupont, No. 1.....	16	"	155	5	1179
8	{ Hazard, No. 7 } { Dupont, No. 10 } ...	16	{ Spherical shell filled with earth..... { Papier maché sabot...	$52\frac{1}{2}$	$5\frac{1}{8}$	1809
9	Bennington, No. 5...	16	Shot.	175	$5\frac{1}{2}$	1161

been made at the 501st and 601st rounds, respectively, while firing the gun 1000 rounds. The targets were made of boiler-plate, and set at 2000 yards from the gun. The smaller target, 8 ft. 11 in. by 4 ft. 2 in., was hit, as shown, 6 times in 14 consecutive rounds. The other target, 10 ft. square, was hit 9 times in 17 consecutive rounds.

**576. STAFFORD.**—The projectile shown by Fig. 272 has recently been introduced in the United States Army. A brass cup is forced upon the conical base of the shot (590).

**577. BUCKLE.**—The projectile, Fig. 273, has also been recently employed in the United States Army. The cup of lead at the base of the shot is held in place by a thin brass sleeve which is forced into the grooves of the gun.

**578. JEFFERY.** Mr. Jeffery's projectile and rifling are illustrated by Figs. 274 and 275. The lead is affixed to the rear of the projectile by dovetails, into which it is cast; a hollow, resem-



bling that of the Minié bullet, is left at the bottom, for the purpose of causing the lead to be driven into the rifling. A wad or covering, consisting of flannel coated with soft soap, is wrapped around the rear of the projectile, to facilitate loading, decrease windage, and lubricate the bore.

**579.** The following are the particulars of the rifling and projectile (Fig. 274) used in the competitive trial of 1861, with a 5½-

TABLE XCIII.—TRIAL OF PARROTT 10-INCH 300-POUNDER RIFLE. WEST POINT, MARCH, 1863.

The target was 600 feet above the level of the gun.

No. of Rounds fired.	Powder, 25 lbs.	Shell, lbs.	Elevation, deg.	Range, yards.	All shot struck within a space		REMARKS.
					Feet high.	Feet broad.	
20	Dupont's Mammoth.....	252	10½	2500	45	30	Shell empty and plugged; two irregular; recoil, 39 to 51 in.
15	"	254	"	"	32	20	Shells loaded; time fuze; one irregular, and struck low—ring flew off.
10	"	"	5½	2200	25	10	Shell loaded; ignition of 3 doubtful.
1	Oriental, No. 5.....	252	"	"	...	...	Shell empty; good line shot, 30 ft. high; recoil, 60 in.
4	"	"	4½	"	25	5	Shell empty; ring flew off one, but went well and struck high.
21	Mammoth.....	245½	10½	2500	40	25	Loaded shell; percussion fuze; all burst.

TABLE XCIII.—(CONTINUED.)

5	Oriental, 5 .....	24½	10½	2500	20	25	Loaded shell; percussion fuze; all burst.
4	Mammoth.....	254	"	"	20	10	Loaded shells; 3 with percussion and 1 with time fuze.
5	Oriental, 5 .....	254½	"	"	25	20	2 with percussion fuzes; 3 plugged.
15	Mammoth.....	252	"	"	...	...	Fired during snow-storm; 1 wobbled; recoil over 40 in.

Of the 100 projectiles fired, 96 took the grooves perfectly. The star-gauge and impressions showed the gun to be in perfect order at the close of the trials. 15 rounds were fired in 56 minutes.

PRESSURES.

Elevation, 10½°. Range, 2500 yards.

Mammoth powder.....	27340 lbs. pressure.
"	"
Oriental, No. 5.....	25670 "
"	"
"	25280 "
"	22350 "
Hazard.....	85590 } estimated.
"	85000 }

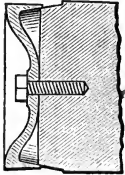
10-in. Rifle .....

25 lbs. Charge .....

252-lb. Shell.....

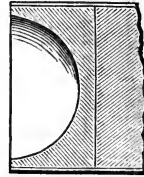
lb. charge in a 32-pounder cast-iron gun:—Pitch of rifling, 1 turn in 64 feet; No. of grooves, 7; depth of grooves, 0·12 in.; width of grooves, 1·65 in.; weight of shot, 45 lbs.; length, 9·68 in.; diam-

FIG. 272.



Stafford's new projectile.

FIG. 273.



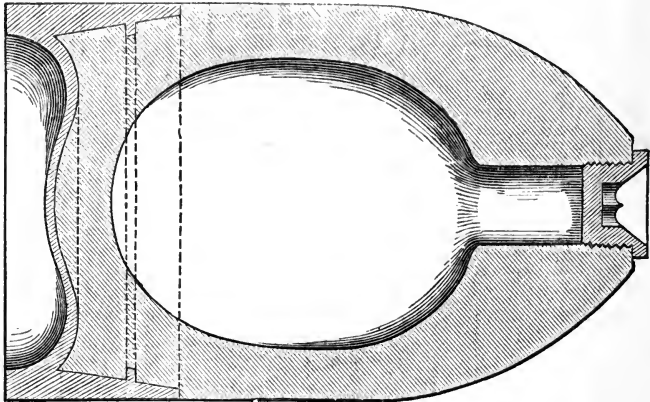
Buckle's projectile.

eter, 6·2 in.; diameter of powder-chamber, 4·6 in.; bursting charge, 2 lbs. 8 oz.

The range of the Jeffery, as compared with the Armstrong 100-pounder projectiles, is shown by table 108.

**580. BRITTEN.**—The system of Mr. Bashley Britten, shown

FIG. 274.



Jeffery's shell.

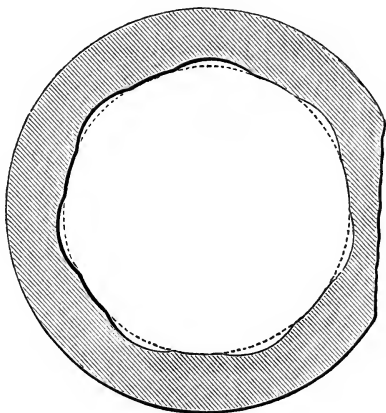
by Figs. 276 and 277, is at present in considerable favor in England, and resembles the American system, both in the shape of the grooves and in the expanding lead base. The groove shown by Fig. 278 has been employed by Captain Blakely for this pro-

jectile, and is largely used by the Confederates for other expanding projectiles.

**581.** The most novel and valuable part of Mr. Britten's invention is the fastening of a lead ring to an iron shot, by zinc solder, so firmly that the explosion will not strip it off. This process is now used for coating the Armstrong projectiles (549). The process, as practised at Woolwich, is as follows:—The iron projectile is heated to a dull-red heat, dipped in sal-ammoniac, which thoroughly cleans the surface, held for about 2 minutes in a bath of melted zinc alloyed with antimony, and then placed in a bath of melted lead, hardened with zinc or tin, for 3 or 4 minutes. It is finally placed in an iron mould, and lead from the last bath is poured around it. The projectile, thus coated, is squeezed out of the mould by a screw.

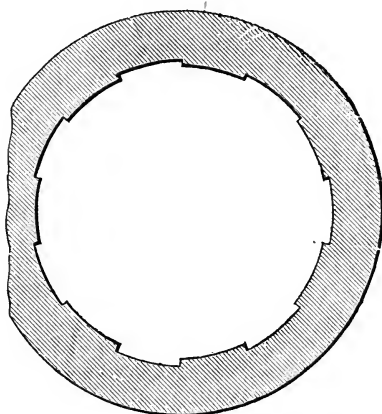
A wooden plug, usually screwed to the bottom of Britten's projectile, is driven against the lead, and causes it to expand into the grooves. The amount of projection on the ring *ff*, Fig. 279, as the projectile was formerly constructed, regulated the pressure of the lead against the bore, and was adjusted so as

FIG. 275.



Jeffery's rifling.

FIG. 276.

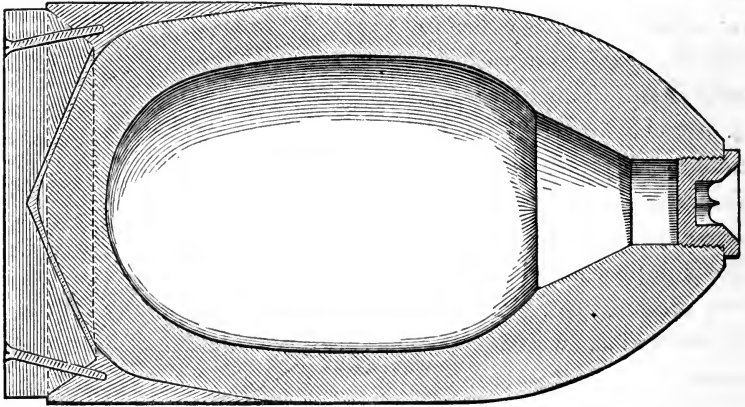


Britten's rifling.

to just stop the windage without wasting power or straining the gun.

**582.** The following are the particulars of the rifling and pro-

FIG. 277.



Britten's projectile.

jectile used in the trials of 1861, with 5 lbs. of powder, and a cast-iron 32-pounder gun:—Twist, 1 in 48 feet; No. of grooves, 5; width of grooves, 2 in.; depth of grooves, 0·10 in.; weight of shot, 47 lbs.; length, 10·7 in.; diameter, 6·25 in.; diameter of powder-chamber, 4·7 in.; bursting charge, 3 lbs. 7 oz. (592).

FIG. 278.



**583.** The ranges of the Britten 100-lb. projectile at 10° elevation, charge 10 lbs., are from 3400 to 3500 yards.

**584. Armor-Punching Projectiles.**—Whitworth's armor-punching shells,\* lately fired through the *Warrior* target (231), is thus described by the inventor in his patent specification:†

\* Speaking of armor-punching shells, the Ordnance Select Committee say (November, 1862,) that "there is great reason to expect similar results from the guns of the service when the same material (for shells) is employed. To Mr. Whitworth, however, will always be due the great distinction of having first effected it."—*Report of the Select Committee on Ordnance*, 1863.

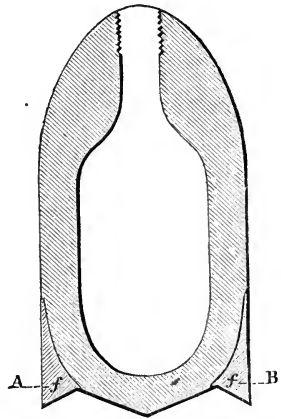
† No. 1663. June 2d, 1862.



“Now it has been found, that one cause of the inefficiency of shells heretofore employed against armor-plates has been, that the concussion, on a shell striking armor-plates of any considerable thickness, and with velocity sufficient to penetrate, generates so much heat as to explode the bursting charge in the shell, thus fracturing it before it has had time to pass through the armor-plating. Another cause of the inefficiency of shells heretofore employed against armor-plates has been, that the shells have been so weak that the force of the blow has been sufficient to fracture them mechanically; this weakness has arisen usually from the material of which shells have been formed being soft, or brittle, or both, and in many cases also from the form given to the shell.

\* \* \* According to my invention, shells are made of metal

FIG. 279.



Britten's early projectile.

FIG. 280.

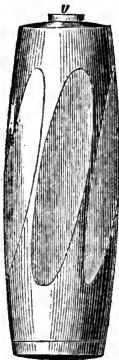


FIG. 281.

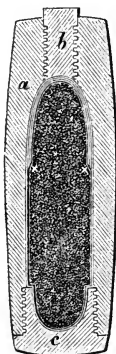


FIG. 282.

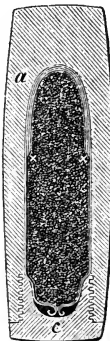
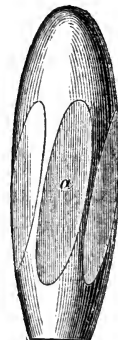


FIG. 283.



Whitworth's armor-punching projectiles.

properly hardened. They are solid for a sufficient length in front of the internal cavity to give the requisite strength for penetration.

“The fuse usually employed for igniting the bursting charge is dispensed with, as the heat generated by the impact of the shell is sufficient to ignite the bursting charge. To prevent the heat generated by impact from acting prematurely, and to regulate the time of ignition, the bursting charge is surrounded with a proper thickness of flannel, or other material which is a non-conductor of heat.”

**585.** Mr. Whitworth then states that he converts or highly carbonizes a forged bar of homogeneous iron (or very mild, lowly-carbonized steel),  $\frac{1}{4}$  to  $\frac{1}{2}$  in. deep, which then, being dressed and bored, is put into the ordinary case-hardening material, heated to redness, and cooled by jets of water or brine. He then tempers it by placing its base on a block of metal heated to a dull-red heat, until a straw-color at the point and a blue color at the base indicate that it is properly tempered. The front plug, *b*, also hardened and tempered, is sometimes used to enable the shell to be more thoroughly hardened.

**586.** The time of bursting is regulated by the thickness of the flannel layers, *x x*.

“I have found practically,” the specification continues, “that a shell, such as shown, having a maximum diameter of 7 inches, and propelled by 27 lbs. of powder, will, at a range of 800 yards, penetrate with facility a 5-in. wrought-iron plate supported by a heavy backing of timber and iron skin.”\*

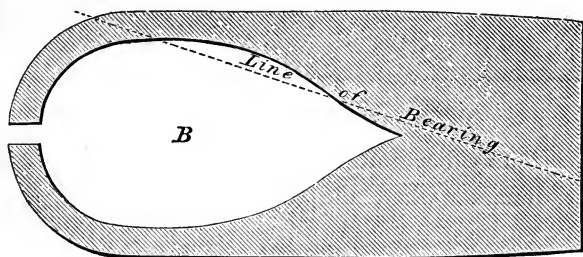
**587.** Mr. Whitworth uses the flat front for punching armor, because, as it is generally impossible to make a shot strike at exactly the right angle, a round end will glance. The shot is made largest in the middle, because the hole made by the head is always larger than the head, thus leaving room for the body to

\* “In the year 1824, Captain Norton completed an elongated rifle-shot and shell, and in 1826, we find him using them at Dublin, Woolwich, Addiscombe, and Sandherst, as well as at various other places, with complete success. \* \* \* In 1832, we find Captain Norton at Windsor, firing a *flat-fronted steel* punch-formed rifle-shot from an air-gun through a Life Guard’s cuirass, and exploding powder placed on the other side. This steel punch-fronted rifle-shot was tested at Woolwich, in 1828, and Captain Norton stated that it might ‘also be converted into a shell, by drilling a hollow tube into its front.’”—*Cor. Mechanics’ Magazine*, Jan. 30, 1863.

pass through without much resistance and better flight. The best compromise results in the form shown.

**588.** The shell proposed by Commander Scott for punching armor, with a percussion fuse in the rear, is shown by Fig. 284.

FIG. 284.



Scott's steel shell.

**589.** Captain Parrott's shot for iron-clad fighting (Fig. 285) is entirely of cast iron, but is reduced and chilled at the end, which prevents its mashing like strong soft cast iron.\*

**590.** The sub-calibre shot and shell proposed by Mr. Stafford (249) for punching armor, are shown by Figs. 286 and 287. The steel projectile, covered with wood, simply to centre it, is attached in the rear to a piston the full size of the bore, so that its weight is very small compared with the full-calibre projectile of equal length, while the area upon which the powder acts is the same for both.

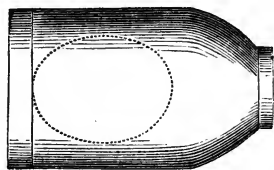
The projectile is rotated by a brass disk attached to the rear—a modification of the Reed system (570).

**590 A.** The sub-calibre projectile of Messrs. Bates & Macy, of New York, is illustrated by Figs. 287 A to 287 E. The following considerations and facts are quoted from the inventor's circular:—

“The engraving shows the shaft projectile (P) before and after

\* Cast-iron spherical shot have been more recently cast with a chill in England, by Captain Palliser.

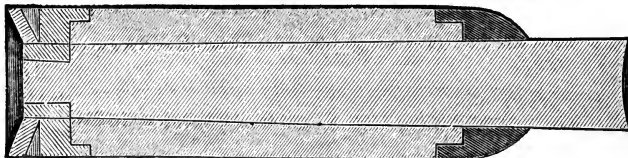
FIG. 285.



Parrott's shot, with chilled end.

loading. It occupies about *one-eighth* of the space in the bore of the piece, and is of equal weight with a ball (B) of the calibre of

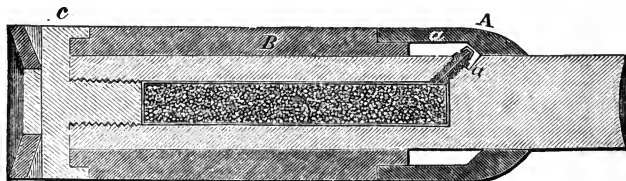
FIG. 286.



Stafford's sub-calibre punching shot.

the gun. It may be, however, of greater or lesser weight, and of greater diameter when adapted for a shell. The form of the

FIG. 287.

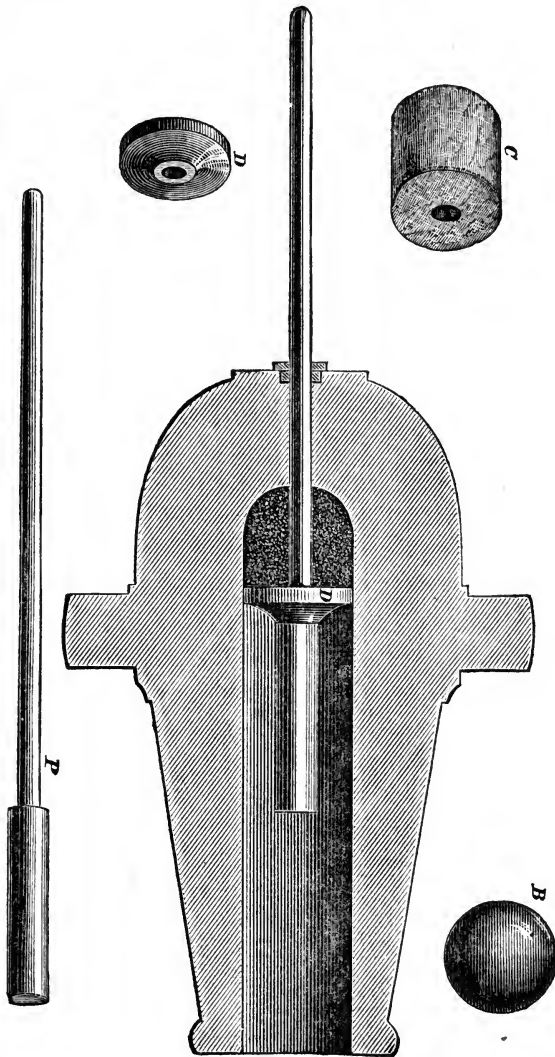


Stafford's sub-calibre punching-shell.

end of the head may be square, for perforating iron armor, or conical, for entering masonry or earthworks, or for piercing ships under water. By a proper device in the breech of the gun, this projectile can be rotated during its discharge, but the true direction of its flight does not depend upon rotation. The principle of its projection is the same as that of the *arrow*. The centre of gravity is placed forward of the centre of bulk and lateral resistance, whilst the impulse of the discharge is communicated to the shoulder of the head, by an annular disk (D), at a point before the centre of gravity; the tail being guided in the minor bore of the breech. A right line motion is thus secured in the direction of the axis of the projectile, and any tendency towards tumbling is entirely prevented.

“The force of a projectile, or its impact, may be expressed by multiplying its weight by the square of its velocity; but projectiles of equal weight and velocity, but of unequal resistant areas,

will differ in penetrative powers, as the square root of the ratio of resistant areas, in favor of the one of least area. Hence the im-



FIGS. 287 A to 287 E.—Bates and Macy's ordnance and projectiles.

portance of a high degree of velocity, and the great advantage of reducing the section of penetration. \* \* \*

“ The force of the gas being exerted in every direction, the long,

narrow charge acts with proportionate power against the sides of the gun, thereby straining it far more than the shorter charge in a bore of commensurate diameter. In the latter, the projectile absorbs a given force more rapidly, and the piece is the sooner relieved of strain. Influenced by these facts, a large diameter of cartridge has been deemed essential in the system under consideration. The charge is contained in an annular cartridge (c). Through the space in the middle the tail of the projectile passes in loading.

“The force is applied to the base of the head of the projectile by means of the disk (d), as shown in the engraving. It fits loosely on the tail, and occupies the bore when loaded, and guides the head in passing from the gun. The windage is stopped by a leaden flange inserted in the rear edge. When freed from the gun, the disk is stripped from the projectile, and comes to the ground within range at command. This is done by the resistance of the atmosphere, being about eight times greater on the large surface of the disk than on the head of the projectile. The disk may be fitted with a *vent* for discharging the piece, thus dispensing with the usual vent in the gun, and thereby increasing its durability.

“The invention described requires a muzzle-loading, smooth-bore piece, fitted with a small bore through the breech for the insertion of the tail of the shaft projectile; or the piece may be adapted to contain the entire projectile, in which case it must have a differential bore; or a jacket can be fitted to cover the protruding tail of the shaft, in pieces which are fitted in the manner shown in the engraving, should it prove desirable.

“The advantage of the rifle motion can be gained without the expensive and weakening process of grooving the bore of the gun, by means of a rifle-box inserted in the breech, which shall act upon the rifled tail of the projectile. This arrangement leaves the gun smooth-bored for the discharge of round shot or shell. It is effected by stopping the bore in the breech with a close-fitting bolt, which is secured in place with a screw.

“This ordnance will fire the following classes of projectiles:—

1st. Round shot and shell, or other smooth-bore missiles. 2d. Shaft shot and shell with smooth-bore motion. 3d. Shaft shot and shell with rifle motion. The easy application of this improvement to ordnance already in service is an advantage which is very great. All smooth-bore cannon can be fitted readily according to this system, thus vastly improving their efficiency. \* \* \*

“The shaft projectile will strike with its END, no matter at what elevation it may be fired, or to what distance it reaches. Along the entire path of its flight its axis is maintained in a tangent to the trajectory. \* \* \* It will not *ricochet* or glance like a round ball or rifle-shot, but will pursue the original direction, as in the air. Whether it be discharged into the water from above or below the surface, its motion is governed by the same principle. This theory has been proved in practice.

“The first trial of this system of shooting was made with a model cannon about sixteen inches in length and of two-inch bore. The bore of the breech was half an inch in diameter. The projectile weighed seventeen ounces, and was fired with three ounces of powder. The target was a white-oak butt, twelve inches thick. Round balls were fired first; their penetration was about three and a half inches—the shaft projectiles went entirely through.

“The second trials were with a larger piece. A 12-pounder cast-iron gun was fitted by boring the breech for the tail of the projectile. The length of the bore was 40 inches; diameter, 4.62 inches. The length of projectile was 52 inches; diameter of the head, one inch and five-eighths—of the tail, nine-eighths. The chief object was to discover the proper proportions in the distribution of weight and form. The projectiles differed in weight from 14 to 16½ lbs.; some of them were rotated in their flight, and others were not—but when fired they all served to prove the theory of the system, and to show its entire feasibility in practice. The charge was from 1½ to 2 lbs. of powder—the disks weighed from 2½ to 3 lbs.

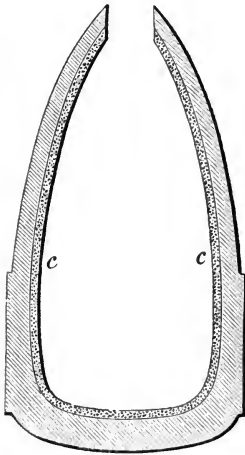
“At a distance of 250 yards from the gun, the fired projectile can plainly be seen sailing like an arrow through the air. The

disk invariably comes to the ground before the projectile; following it at an ever-increasing distance, it makes a trajectory of less elevation.

“These experiments have been regarded as valuable chiefly for preliminary objects, and to test any seeming objections which might arise to the theory and practice of the system.”

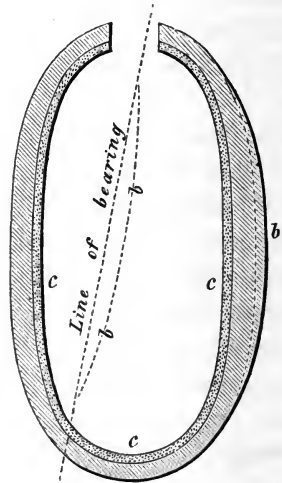
**591. Shells for Molten Metal.**—Figs. 288 and 289 show Lan-

FIG. 288.



Lancaster shell for molten metal.

FIG. 289.



Scott's shell for molten metal.

caster's and Scott's shells for firing molten iron. They are lined with loam, to prevent the excessive escape of heat from either expanding the shell and sticking it fast in the gun, or from igniting the charge, in case of delay in firing. Lead-coated projectiles would, of course, be destroyed by the heat of molten metal.

**592. Competitive Trial of Rifled Guns.**—In 1861, a comprehensive experiment on six different systems of rifling and projectiles was made by the British Government. The whole of the guns were new Lowmoor 32-pounders, of 58 cwt. The mean of 42 samples of the iron gave a tensile strength of 28501 lbs. per square inch.

The systems were as follow :—



Britten's. (The projectile used on this occasion is shown by Fig. 277.) Expanding projectile; lead attached by zinc; weight, 47 lbs. Five grooves, 2 in. wide and .062 in. deep; one turn in 48 feet.

Thomas's (Fig. 260). Expanding projectile; lead mechanically attached; weight, 55 lbs. Seven grooves, 1.8 in. wide and .1 in. deep; one turn in 18 feet.

Jeffery's (Fig. 274). Expanding projectile; lead mechanically attached; weight, 45½ lbs. Seven circular grooves, 1.65 in. wide and .12 in. deep; one turn in 64 feet.

Haddan's (Fig. 213). Centering system; projections cast on the shot; weight, 51 lbs. An expanding wad or a wooden sabot were used. Three circular grooves, 3.4 in. wide and .15 in. deep; one turn in 25 feet.

Lancaster's (Fig. 211). Centering system; oval bore, with .6 in. difference of axis. Projectile planed to fit the twist of the rifling; weight, 45¾ lbs.; one turn in 20 feet.

Scott's (Fig. 224). Centering system; wings set to the angle of the rifling, cast on the projectile; edges planed, and faced with zinc; weight, 38¾ lbs. Three grooves, 1.875 in. wide and .225 in. deep; one turn in 48 feet.

**593.** The estimated cost per thousand of these projectiles was—

Scott.....	40 lbs.....	\$922.25
Haddan .....	47½ lbs.....	967.25
Lancaster .....	49½ lbs.....	971.
Jeffery.....	49 lbs.....	1476.25
Britten.....	47½ lbs.....	1527.
Thomas .....	54½ lbs.....	2420.50
Smooth-bore, 32-lb. shell... ..	22 lbs.....	438.50
Do. do. shot.....	32 lbs.....	429.25

The estimated cost of the rifling was \$1.87 to \$2.50 per gun.

**594.** In order to perfect the various systems for final trial, some preliminary experiments were undertaken during 1859 to 1861, the order of merit being as follows:—Haddan, Britten, Jeffery, Scott, Lancaster, Thomas. The results are shown by Table 100.

**595.** In the subsequent trial, the following systems were also introduced; weight and character of guns the same.

The French plan (Fig. 197); centering system, 3 studs faced with zinc; weight, 59·5 lbs. Three grooves, 1·919 in. wide, and 2363 in. deep; increasing pitch from 0 to 4·652 in 88·548 calibres.

Armstrong's shunt (Fig. 247); centering and compressing system; zinc ribs; weight, 50·5 lbs. Three grooves, 1·25 in. wide and ·18 in. deep; 1 turn in 28 calibres; and

The smooth bore 32-pounder.

The results of this trial are given in Table 102.

To obtain a direct comparison of range, it was then determined to make a new trial of the best systems, with *equal relative charges* of  $\frac{1}{16}$  the weight of the shot.

The Armstrong 40-pounder was here introduced. Weight of shot, 41·06 lbs.; compression system; 56 grooves; one turn in 36½ calibres.

The results are shown in Table 99.

The velocities of the various projectiles are given in Table 101.

**596.** ENDURANCE.—The endurance of the guns is shown in Table 94.

TABLE XCIV.—ENDURANCE OF COMPETITIVE RIFLED GUNS.

Gun.	No. of rounds in experiment.	No. of rounds fired at proof butt.	Charge. lbs. oz.	Weight of projectile.	Total endurance.
Britten .....	363	1123	5 0	50·	1486*
Jeffery .....	113	250	5 8	47·	363
Lancaster ...	200	1800	6 0	50·	2000*
Haddan .....	125	90	7 0	54·12	215
Scott.....	309	.....	.....	.....	309
Shunt.....	327	.....	.....	.....	327
French .....	107	.....	.....	.....	107

\* Not burst.

The Committee report that Mr. Britten's system obviously strains the gun least, and that the high endurance of some of the others was out of all proportion to the strain imposed, and may be accounted for, especially in Mr. Lancaster's case, by the accidental superiority of the iron.

The following mechanical considerations favor this view of the case, but the Committee's opinion is chiefly based on the great endurance of several other guns rifled on Mr. Britten's system, as shown in Table 95.

**597.** The Committee believe that the liability of the projectiles to jam in the bore, is in the following order: Lancaster (most liable), Scott,\* Haddan, French, Shunt, Thomas, Jeffery, Britten.

**598.** The Committee believe that the liability of the gun to be burst, from the direct strain of rotating the shot, is as the sine of the angle of the rifling, which for the guns mentioned is shown in Table 96.

**599.** The cup at the base of Mr. Jeffery's shot, and the sliding ring at the base of Mr. Lynall Thomas's, appeared to upset the lead with unnecessary friction. It was assumed that the French shot got through the bore with the least friction.

**600.** The driving side of the grooves, especially of Mr. Britten's gun, was somewhat worn by the lead.

The grooves of Commander Scott's gun were not perceptibly worn by the projectile.

**601.** ACCURACY.—The order of accuracy in the two trials was as follows :

<i>First Trial.</i>	<i>Second Trial.</i>
Haddan,	French,
Britten,	Shunt,
Jeffery,	Jeffery,
Scott,	Haddan,
Lancaster,	Britten,
Thomas.	Lancaster.

\* Reference to Commander Scott's rifling (535) will justify a difference of opinion. The inertia of the shot simply tends to rotate the gun in the opposite direction; not to open it by the radial strain, due to wedging in the bore, as in the case of Whitworth, Lancaster, and Haddan (See experiments at Woolwich—644).

TABLE XCV.—ENDURANCE OF CAST-IRON GUNS RIFLED ON MR. BRITTEN'S SYSTEM.

GUNS.	Charge.	Shot.	No. of Rounds.	Remarks.
	lbs.	lbs.		
56 cwt. 32-pdr. No. 24.....	5.5	48	10	
“ “ .....	“	72	10	
“ “ .....	“	96	10	
“ “ .....	“	115	10	
“ “ .....	“	140	10	
“ “ .....	“	165	4	{ Burst at 55th round, March, 1862.
56 cwt. 32-pdr. No. 2339.....	“	48	10	
“ “ .....	“	72	10	
“ “ .....	“	96	10	
“ “ .....	“	120	10	
“ “ .....	“	144	10	
“ “ .....	“	163	7	{ Burst at 58th round, June, 1862.
95 cwt. 68-pdr. No. 6095.....	7.5	90	10	
“ “ .....	“	135	10	
“ “ .....	“	180	10	
“ “ .....	“	225	10	
“ “ .....	“	270	10	
“ “ .....	“	315	10	{ Burst at 61st round, April, 1862
95 cwt. 68-pdr. No. 6439.....	7.5	Same order	60	Not burst.
68-pdr. No. 8282 .....	7.5	87	300	Uninjured.
68-pdr. bored to 32-pdr.....	Service.	Service.	110	Not burst.

The Committee state that the comparative inaccuracy of Commander Scott's system was attributed by him to bad boring and rifling. The superior straightness of ricochet on land and water, also claimed for this projectile, the Committee do not consider of much importance.

TABLE XCVI.—PARTICULARS OF RIFLING OF COMPETITIVE GUNS.

Name of system.	One turn in calibres.	Angle.	Sine of angle.	Bearing.	Approximate area of	
					Bearing surface.	Guiding edges.
		°			sq. in.	sq. in.
Jeffery.....	120	1 30	.0262	Lead	26.2	2.1
Britten .....	90	2	.0349	"	20.	1.
Scott.....	90	2	.0349	Zinc	19.5	3.9
French .....	.....	{ at muzzle } 2 53	.....	"	4.7	0.6
Lancaster ...	56	3 13	.0561	Iron	3.75	0.
Haddan .....	47	3 49	.0666	"	8 4	1.
Thomas .....	32	5 17	.0921	Lead	34.6	1.9
Shunt.....	28	6 24	.1115	Zinc	7.7	2.4

**602. ADAPTATION FOR ROUND SHOT.**—That rifling which left the largest part of the original bore untouched, was most effective with, and least injured by, round shot. Lancaster's system was most inaccurate; beyond 1000 yards it was impracticable.

The rifled gun, with shallow grooves and broad lands, fired spherical shot more accurately than the smooth-bored gun,\* as shown by Table 103.

**603.** The windage added by the grooving, in the various systems, is shown in Table 97.

**604.** Commander Scott's system has the advantage in this particular. But windage is not necessarily a disadvantage. It may be stopped by a sabot, or the charge may be increased without increasing the strain on the gun (649 note).

**605. EFFICIENCY OF PROJECTILE.**—This involves initial velocity and capacity for bursting charge. Mr. Britten's shot had the highest initial velocity of those tried with  $\frac{1}{16}$  charges. The velo-

\* The round shot, especially when fired with a sabot, undoubtedly received a spinning motion from the rifling.

TABLE XCVII.—WINDAGE OF COMPETITIVE RIFLED GUNS.

Lancaster.....	2.955 square inch	Jeffery.....	1.14 square inch.
Haddan.....	1.37 “	Britten.....	1.00 “
French.....	1.36 “	Shunt.....	0.67 “
Thomas.....	1.26 “	Scott.....	0.53 “

city of Commander Scott's projectile was not ascertained, but its superior powder capacity, for a given weight,\* is shown by Table 98.

TABLE XCVIII.—BURSTING CHARGES OF SHELLS. TRIAL OF 1861.

Name of system.	Weight of shell empty.	Bursting charge.		Relative weight of bursting charge of shell.
	lbs.	lbs.	oz.	
Scott.....	38.8	4	13	0.124
Shunt.....	50.5	5	13	0.115
French.....	59.4	5	5	0.090
Lancaster.....	45.8	4	7	0.076
Britten.....	46.9	3	7	0.073
Haddan.....	51.1	3	6	0.065
Jeffery.....	45.4	2	8	0.055
Thomas.....	55.3	1	5	0.025

**606. LIABILITY TO INJURY.**—In this particular, Commander Scott's and Mr. Haddan's projectiles have a very great advantage over those coated or studded with soft metal. The former have the further merit of a shape easy to handle and to pile. A fall, or any rough handling, would obviously mutilate the lead cup of Mr. Jeffery's shot.

**607. CONCLUSIONS OF THE COMMITTEE.**—Mr. Lynall Thomas's system, of which the disadvantages are obvious, from the fore-

\* It should be observed that the ribs on Commander Scott's shell strengthen it materially, and allow the use of somewhat thinner walls and a higher bursting charge.

going tables, is not even mentioned in the Committee's conclusions.\* Indeed, Mr. Lynall Thomas has subsequently adopted the centering system (538).

The first place is awarded to Mr. Bashley Britten, on account of the small strain upon his gun, with high initial velocities.

Mr. Jeffery's plan is rejected, because several guns thus rifled have showed a low endurance; and because the lead on the projectile is greater in quantity, more easily injured, less simply attached, and productive of greater friction, as compared with Mr. Britten's.

Mr. Haddan's system was rejected on account of the weight of the projectile, and the heavy wood sabot (1 lb. 5 oz.) placed behind it. His rifling was also calculated to burst the gun.

Commander Scott's system was rejected on account of inferior practice, and the low endurance of the gun. But this rejection was qualified by the explanations already mentioned.

Mr. Lancaster's system was rejected for irregular practice, with elongated as well as spherical shot.

Finally, the committee avow a considerable distrust of cast iron, of the quality turned out by English foundries, as a material for rifled cannon, except with such restrictions as to charge as would limit them to the use of howitzers.

The systems of Commander Scott, Mr. Lancaster, and Messrs. Britten and Jeffery (the two latter in one gun, with Britten's grooving), also the French system, are to be tried again, on a larger scale, and with the improvements suggested by previous practice. The guns (7-inch bore and  $7\frac{1}{2}$  tons weight) are in process of completion at Woolwich. The inner tube is cast steel, hardened in oil. In other particulars, the guns are similar in construction to the Armstrong muzzle-loading 110-pounder, and in capacity to the Whitworth 7-inch rifle.†

\* Mr. Thomas declined firing the eighty-two remaining rounds allotted to him.

† Since the above was written, the trial of these guns has commenced. See Appendix.

TABLE XCIX.—PRACTICE WITH RIFLED 32-POUNDER CAST-IRON GUNS WITH IMPROVED PROJECTILES AND  
 $\frac{1}{16}$  CHARGES: 1861-'62.

NAME OF SYSTEM.	Date.	Direction and force of wind.	No. of Rounds.	Charge.	Mean weight of projectile.	Elevation.	Mean reduced time of flight.	RANGES.			Mean difference of range.	Mean observed deflection.	Mean reduced deflection.
								Min.	Max.	Mean.			
40-pdr. Armstrong. B. L....	Oct. 11, 1861.	↙ 5-6	5	4.106	41.06	2	3.40	yds. 955	yds. 1073	yds. 1033	32.8	yds. 2.4	yds. 1.2
" .....	"	"	5	"	"	5	6.24	1831	1950	1886	41.2	2.1	0.7
" .....	"	"	5	"	"	10	11.38	3222	3354	3262	37.0	3.0	1.9
Britten .....	Aug. 6, 1861..	↗ 3-4	5	5.038	50.38	2	3.18	1083	1125	1103	13.8	1.7	1.5
" .....	"	"	5	"	"	5	6.44	2045	2197	2123	41.6	6.8	3.2
" .....	"	"	5	"	"	10	11.52	3425	3523	3465	24.4	11.5	6.5
Jeffery .....	"	"	5	4.791	47.91	2	2.94	945	1067	1018	29.6	2.3	2.1
" .....	"	"	5	"	"	5	6.14	1958	2053	1991	25.2	7.8	3.3
" .....	"	"	5	"	"	10	11.62	2896	3440	3282	154.4	24.0	12.8
Haddan .....	"	"	5	5.450	54.5	2	2.70	837	944	905	31.8	2.4	1.3
" .....	"	"	5	"	"	5	5.70	1618	1888	1752	104.4	6.2	5.1
" .....	"	"	5	"	"	10	10.78	3037	3250	3109	56.4	22.9	4.8



Shunt.....	Oct. 11, 1861.	5—6	1	5·635	56·35	2	.....	.....	1093	.....	5·3	.....
Lancaster.....	"	"	5	5·078	50·78	2	3·04	967	1087	41·8	2·4	2·6
"	"	"	5	"	"	5	6·44	1961	2097	34·2	11·6	11·3
"	"	"	5	"	"	10	11·48	3113	3464	126·2	12·2	10·9
French.....	Mar. 9, 1862..	"	5	6·554	65·54	2	2·76	822	909	861	32·0	0·4
"	"	"	5	"	"	5	6·20	1817	1877	1839	19·5	1·2
"	"	"	5	"	"	10	12·07	3233	3308	3274	27·7	0·3
Service 32-pdr. Smooth-bore	Oct. 11, 1862.	5—6	5	3·125	31·25	2	2·80	653	770	721	34·8	1·1
"	"	"	5	"	"	5	5·32	1186	1351	1302	68·4	3·7
"	"	"	5	"	"	10	8·88	1770	2160	2029	107·0	12·4

TABLE C.—PRACTICE WITH RIFLED 32-POUNDER CAST-IRON GUNS WITH IMPROVED PROJECTILES, 1859-61












NAME OF SYSTEM.	Date.	Direction and force of wind.	No. of Rounds.	Charge.	Mean weight of projectile.	Elevation.	Mean reduced time of flight.	RANGES.			Mean difference of range.	Mean observed deflection.	Mean reduced deflection.	Area of rectangle.
								Min.	Max.	Mean.				
Britten .....	Nov. 16, 1859	3	23	5.	51.2	5	{ not obs. }	yds.	yds.	yds.	2.7	2.2	yds.	724
" .....	"		19	"	"	10	"	1735	1918	1850	5.9	4.6	2864	1860
Jeffery .....	May 18, 1861		18	5.5	47.362	5	6.23	1706	1969	1886	10.2	3.0	1706	1358
" .....	"	"	15	"	"	10	11.30	2985	3237	3129	31.6	6.1	2985	2640
Haddan .....	July 24, 1860		20	7.	53.991	5	6.48	1970	2123	2034	7.8	3.9	1970	991
" .....	July 25, 1860	"	14	"	"	10	11.57	3117	3301	3228	22.6	5.1	3117	1428
Scott.....	Oct. 23, 1860		11	6.	40.641	5	6.32	1880	2031	1975	7.5	2.8	1880	891
" .....	"	"	8	"	"	10	11.48	2967	3221	3136	7.4	7.6	2967	5598
Lancaster .....	Jan. 21, 1861		20	6.	48.016	5	{ not obs. }	1964	2233	2096	9.9	7.3	1964	3749
" .....	Feb. 4, 1861		20	"	"	10	12.02	3239	3540	3410	20.6	10.5	3239	5811
Thomas.....	Feb. 23, 1860		20	7.	56.606	5	5.73	1655	2140	1916	7.8	6.8	1655	5941
" .....	Feb. 24, 1860	"	5	"	"	5	6.18	1758	2031	1933	12.2	3.1	1758	2331
" .....	April 13, 1860		15	"	"	10	12.21	3160	3608	3375	72.8	15.8	3160	13345










TABLE CII.—VELOCITIES OF PROJECTILES. TRIAL OF RIFLED CAST-IRON GUNS, 1861-2.\*

NAME OF SYSTEM.	No. Rounds.	Charge.	Projectile.		Velocity at 90 ft. from Muzzle.	Velocity at Muzzle.		Relative strength of Powder.
			Weight.	Diameter		Service Charge.	1-10th Charge.	
		lbs. oz.	lbs.	in.	ft.	ft.	ft.	ft. per sec. of 12-pdr.
Britten .....	5	5 0	50.36	6.24	1199.7	1209.2	1213.5	1170
Jeffery .....	5	5 8	48.06	6.26	1253.	1263.6	1181.2	1170
Haddan.....	5	7 0	54.20	6.19	1267.9	1277.1	1123.7	1170
Lancaster .....	5	6 0	51.	{ 6.88 } { 6.32 }	1234.4	1246.	1149.	1170
Thomas .....	5	7 0	56.92	6.25	1384.	1395.	1277.	1248
French .....	5	5 8	64.68	6.36	1052.4	1059.	1148.4	1248
Shunt .....	6	5 8	55.25	6.32	1161.9	1170.1	1172.7	1248
32-pounder Smooth-bore.....	10	10 0	Shot, 31.60	6.166	1653.7	1690.	.....	.....
“	5	3 2	Shell, 31.37	6.166	977.5	.....	993.7	1195
“	5	2 7	Shell, 24.31	6.164	968.0	.....	988.8	1195
Armstrong 40-pounder.....	5	5 0	Shot, 41.25	4.75	1190.3	1197.5	.....	1248
“	5	5 0	Shell, 40.5	4.75	1219.7	1227.3	.....	1248
“	5	4 0	Shell, 40.5	4.75	1076.2	.....	1081.4	1248
“	5	5 0	Shot, 41.0	4.75	1168.5	1174.8	1050.7	1248

\* Commander Scott's gun burst before this experiment.

TABLE CII.—PRACTICE WITH RIFLED 32-POUNDER CAST-IRON GUNS, WITH IMPROVED PROJECTILES, AND PROPOSED SERVICE CHARGES, 1861.

NAME OF SYSTEM.	Date.	Direction and force of wind.	No. of Rounds.	Charge.	Mean weight of projectile.	Elevation.	Mean reduced time of flight.	RANGES.			Mean difference of range.*	Mean observed deflection.†	Mean reduced deflection.‡	Area of rectangle.§
								Min.	Max.	Mean.				
				lbs.	lbs.	°	"	yds.	yds.	yds.	yds.	yds.	yds.	yds.
Britten .....	Aug. 2, 1861	 5	15	5	50.37	2	2.84	738	1064	912	76.4	2.6	4795	
"	Aug. 3, 1861	 6	15	"	"	5	6.06	1725	2084	1898	73.1	3.5	6059	
"	Aug. 5, 1861	 4.5	12	"	"	10	11.56	3268	3467	3396	52.8	7.6	9869	
Jeffery .....	Aug. 2, 1861	"	15	5.5	47.95	2	2.97	1036	1124	1072	26.7	1.8	1131	
"	Aug. 3, 1861	"	15	"	"	5	6.43	2051	2238	2155	38.5	2.9	2668	
"	Aug. 5, 1861	"	12	"	"	10	11.95	3524	3666	3624	31.3	8.9	5899	
Haddan .....	Aug. 2, 1861	"	15	7	54.46	2	2.70	742	1093	980	51.1	3.0	1338	
"	Aug. 3, 1861	"	14	"	"	5	6.49	1821	2248	2137	65.9	7.0	4015	
"	Aug. 5, 1861	"	12	"	"	10	11.66	3377	3673	3593	67.7	35.7	6018	
Scott   .....	Aug. 2, 1861	"	9	6.125	43.76	2	3.26	1094	1151	1129	19.7	7.2	1252	

Lancaster .....	Sept. 24, 1861		6	6.	50.78	2	3.40	1023	1242	1175	62.4	6.7	4.9	2568
"	Sept. 25, 1861		6	"	"	2	3.36	1017	1238	1137	61.3	2.6	2.6	1261
"	"		3	"	"	5	6.78	2059	2213	2136	51.2	6.8	6.8	3481
"	Sept. 26, 1861		9	"	"	5	6.68	1970	2265	2128	57.2	22.2	4.1	2043
"	"		7	"	"	10	12.14	3350	3566	3466	65.9	61.5	9.5	5913
"	Sept. 27, 1861		3	"	"	10	11.80	3103	3583	3333	172.6	31.8	15.2	28326
French Gun	Sept. 24, 1861		7	5.5	64.69	2	2.83	848	916	876	17.9	2.0	1.4	225
"	Sept. 25, 1861		8	"	"	2	2.81	828	916	873	19.0	3.5	2.4	355
"	"		6	"	"	5	5.87	1641	1818	1721	50.8	7.8	5.0	2542

\* *Mean difference of range* is the arithmetical mean of the quantities by which each individual shot differs, in point of range, from the mean of the whole.

† *Mean observed deflection* is the mean of all the deviations from the line of fire, whether right or left.

‡ *Mean reduced deflection* is the mean of the deviations, referred, not to the line of fire, but to the mean direction of all the shots; thus eliminating derivation or drift, and wind.

§ *Area of rectangle* is the area of the rectangle into which, by calculation of probabilities, one-half the shot at each distance may be expected to fall.

|| This gun burst at the 10th round of this trial, having previously fired 800 rounds.

¶ These projectiles had been made for a gun with right-handed twist. In the present trial, the iron sides of the studs bore against the lauds of the gun.

TABLE CII.—(CONTINUED.)

NAME OF SYSTEM.	Date.	Direction and force of wind.	No. of Rounds.	Charge.	Mean weight of projectile.	Elevation.	Mean reduced time of flight.	RANGES.			Mean difference of range.*	Mean observed deflection.+	Mean reduced deflection.+	Area of rectangle.§
								Min.	Max.	Mean.				
French Gun  ..	Sept. 26, 1861	↗ 3	9	5.5	64.69	5	6.01	1664	1779	1730	28.9	4.9	3.2	540
"	"	"	7	"	"	10	10.99	2949	3082	3014	51.7	8.3	6.1	2965
"	Sept. 27, 1861	"	5	"	"	10	11.02	2888	3040	2963	39.0	25.8	5.3	1066
"	March 9, 1862	"	15	"	65.54	2	2.82	768	882	827	24.2	2.03	1.55	218
"	"	"	15	"	"	5	5.89	1584	1772	1672	45.6	6.19	2.33	849
"	"	"	15	"	"	10	11.02	2742	3019	2891	84.6	19.9	4.40	2962
Shunt Gun.....	Sept. 24, 1861	"	7	"	56.351	2	2.93	917	1006	972	25.9	3.3	1.1	263
"	Sept. 25, 1861	"	8	"	"	2	2.91	898	974	934	16.2	2.8	1.4	199
"	"	"	6	"	"	5	6.27	1832	2002	1940	63.0	8.2	2.5	1595
"	Sept. 26, 1861	"	9	"	"	5	6.31	1883	2009	1952	38.7	20.0	2.7	918

TABLE CII.—(CONTINUED.)

Shunt Gun.....	Sept. 26, 1861	↑	3	7	5.5	56.351	10	11.79	3238	3402	3331	50.3	55.8	7.5	3560
"	Sept. 27, 1861	"	"	5	"	"	10	11.50	3158	3317	3222	42.0	38.3	4.3	1953
Service 32-pdr.	Sept. 24, 1861	"	"	7	10.	31.25	2	3.76	1267	1373	1300	38.0	1.5	1.4	514
"	Sept. 25, 1861	"	"	7	"	"	2	3.41	1118	1311	1154	20.0	4.7	2.3	443
"	"	"	"	6	"	"	5	7.05	1964	2174	2033	55.2	24.2	9.6	5296
"	Sept. 26, 1861	"	"	9	"	"	5	7.12	1945	2281	2038	84.0	11.4	8.9	6571
"	"	"	"	7	"	"	10	12.10	2814	3126	2957	103.6	51.5	50.7	49644
"	Sept. 27, 1861	"	"	5	"	"	10	11.54	2734	3079	2848	92.8	33.5	36.2	36494

\* *Mean difference of range* is the arithmetical mean of the quantities by which each individual shot differs, in point of range, from the mean of the whole.

† *Mean observed deflection* is the mean of all the deviations from the line of fire, whether right or left.

‡ *Mean reduced deflection* is the mean of the deviations, referred, not to the line of fire, but to the mean direction of all the shots; thus eliminating derivation or drift, and wind.

§ *Area of rectangle* is the area of the rectangle into which, by calculation of probabilities, one-half the shot at each distance may be expected to fall.

¶ These projectiles had been made for a gun with right-handed twist. In the present trial, the iron sides of the studs bore against the lands of the gun

TABLE CIII.—SHOWING THAT THE RIFLE IS MORE ACCURATE THAN THE SMOOTH-BORE, WITH SPHERICAL SHOT.

GUN.	No. of rounds.	Elevation.	Time of flight.	RANGES.			Mean dif. of range.	Mean obs. deflection.	Mean reduced deflection.
				Min.	Max.	Mean.			
		°	"	yds.	yds.	yds.	yds.	yds.	yds.
Smooth-bored 32-pounder .....	20	2	3.40	1027	1329	1146	51.7	8.1	2.6
		5	not obs.	1823	2222	1994	70.8	9.8	8.9
32-pounder rifled on Britten's plan;.... shallow Grooves...	20	2	3.59	1063	1260	1172	32.6	7.8	2.7
		5	6.59	1821	1988	1882	24.9	5.8	5.8

Charge, in all cases, 10 lbs. ; shot, 32 lbs.

#### DUTY OF RIFLED GUNS.

**608.** The possibility of making very long ranges useful in land service, where the gun-platform is fixed; the immense superiority of rifled projectiles for breaching masonry\* (273); the advantage of

\* "An account of some experiments carried on in this country, to test the respective powers of rifled and smooth-bored guns, in breaching masonry at a long range, viz., 1032 yards, is given in the Proceedings of the Royal Artillery Institution (272). With regard to these experiments, the Ordnance Select Committee made, in their Report, the following remarks: 'It appears that, irrespectively of the superior concentration of the fire of the rifled guns, and its consequently greater effect, they actually performed half as much work again as the smooth-bored guns, with the diminished expenditure of iron and gunpowder noticed in a previous paragraph.' Again: 'The precision with which the guns could be directed upon any point it was intended to strike, gave them advantages with which no smooth-bored ordnance, firing from such a distance, could compete; and the same circumstances would have rendered it almost impossible to retrench or defend the breach, for the fire might have been continued, with perfect safety to the assaulting columns, until they were within a very few yards of it, sweeping away all obstacles as fast as they could be laid, and without the slightest interruption from the musketry of the defenders, the battery being quite out of their range.'

"An abstract of the Prussian experiments at Julich, in 1860, is given in the 'Professional Papers' of the corps of Royal Engineers. The conclusions drawn from these experiments were: 'That rifled ordnance can be employed advantageously for firing at a covered object, not visible from the battery, at longer ranges than smooth-bored pieces; that reduced charges may be used successfully with projectiles from rifled guns; that the effect of the shells from these pieces is so great that no other



rifled guns on shipboard, for supporting troops and shelling\* distant works† and encampments, and their occasional excellence in operating against armor (250), warrant every effort that can be made to improve this new and (considering both land and sea service) most useful branch of ordnance.‡

kinds of ordnance are required for breaching; that 13-lb. shells, fired from rifled guns, are sufficient to breach quickly a good wall, of moderate strength; that 27-lb. shells, from the same pieces, can destroy, in a short time, embrasures in the strongest masonry; and that 57-lb. shells, from rifled guns, can breach, with a comparatively small expenditure of ammunition, the strongest masonry.'—*Maj. C. H. Owen, Jour. Royal U. Service Inst.*, Aug., 1862.

\*The bursting charge of the 110-pounder Armstrong 7-in. shell is 8 lbs.; that of the 68-pounder 8-in. shell is only 2½ lbs.

†“The practical object of attaining exceedingly long ranges must be for attacking any fortified place, or for bombarding a naval arsenal, so as to be able to fire all day and night, still keeping out of the reach of the enemy; and to drop shots and shells with impunity into apparently inaccessible places, so as to cause, if not absolute ruin, at least very considerable annoyance, to any naval arsenal or maritime establishment. It was a very material element to be able to lower the elevation, as, by that means, the accuracy of the firing was increased, or a longer range with the same elevation. Thus, for instance, with 2° of elevation, the range, with a velocity of 1000 feet per second, would be 730 yards; with 1300 feet per second, it would be 1230 yards; with 1500 feet per second, it would be 1620 yards: the latter velocity giving the same accuracy, at double the range, which the initial velocity of 1000 feet could command.”—*Mr. Bidder, Prest.*, “*Construction of Artillery*,” *Inst. Civil Engineers*, 1860.

“A 32-lb. shot, fired from an Armstrong gun, at 33° of elevation, ranged 9153 yards.

“A 3-lb. shot, fired from a Whitworth gun, at 35° of elevation, ranged 9688 yards.

“A 175-lb. shot, fired from a gun of Mr. L. Thomas, at 37½° of elevation, ranged 10075 yards.

“All these ranges being obtained at very high angles—over 30°—the ‘angles of descent’ of the projectiles must have been very great, so that the chance of striking an object in this manner would not certainly be worth the powder expended. The difficulty of judging the distance, of laying a gun upon an object at a long range, and of observing the effect of the fire, also the disturbing influence of the wind, during a long time of flight, will confine the ranges of projectiles used for military purposes within 2000 yards; or, perhaps, in special cases, when firing at masses of troops, ships, buildings, etc., to 3000 yards.”—*Maj. Owen, Jour. Royal U. Service Inst.*, Aug., 1862.

‡ Mr. Benjamin Robins made the following often-quoted prediction, one hundred years ago:

“I shall, therefore, close this paper with predicting, that whatever state shall thoroughly comprehend the nature of rifled-barrelled pieces, and, having facilitated and completed their construction, shall introduce into their armies their general use, with a dexterity in the management of them, they will by this means acquire a superiority which will almost equal any thing that has been done at any time by the particular

While certain conditions of success are common to all rifled ordnance, the kinds of work to be done are so various, that some special provisions would appear to be required for each. It is proposed to consider briefly the principles of rifling, the requirements of each service, and especially the features of the most generally useful rifled gun and projectiles for small casemates and turrets, where the armament will certainly be limited, if the protection is adequate.\*

As far as iron-clad warfare is concerned, *velocity* is obviously the most important consideration; 1st, because the penetration—(smashing is better done by spherical balls. (See 193)—is as the weight of the shot into the square of the velocity; 2d, because, at the necessarily short ranges of iron-clad warfare (253), the small increase of accuracy due to improved balance of shot can hardly compensate for the inaccuracy due to an unstable platform; 3d, because a high velocity gives a low trajectory (640).

**609. OBJECT OF RIFLING.**—The object of rifling is to diminish, as far as possible, the deviations of ordinary shot, due to the following causes:

1st. Want of uniformity in figure and weight around the longitudinal axis of the shot passing through the centre of gravity.

2d. Position of the centre of gravity before or behind the centre of figure.

3d. Resistance of the air.

excellence of any one kind of arms; and will fall but little short of the wonderful effects which histories relate to have been formerly produced by the first inventors of fire-arms."

\* Commander Scott specifies the following requirements of naval guns (*Jour. Royal U. Service Inst.*, Dec., 1861):—

"A naval gun then should,

- 1st. Be simple in its construction.
- 2d. Be not liable to injury from blows or weather.
- 3d. Fire a shot of large diameter (from 8 to 10 inches or more).
- 4th. Be able to use the smashing round ball at close quarters.
- 5th. Give a flat trajectory.
- 6th. Have projectiles which deflect little, and ricochet straight and evenly.
- 7th. Fire elongated molten iron shells.
- 8th. Fire elongated powder shells, near or across ships, &c., with safety.
- 9th. Fire shrapnell or built-up shells over boats with safety.
- 10th. Fire canister."

In addition to these causes of inaccuracy, the following are common to all projectiles, and cannot be modified by rifling:—The action of wind, the rotation of the earth, and the want of horizontality of the axis of the trunnions.\*

**610.** I. By rotating the projectile around its longitudinal axis, the direction of these deviations is so rapidly shifted from side to side, that the shot has no time to go far out of its course either way.

II. As an elongated bolt can be steadied by this rotation, a given weight of projectile can be put into such a form as to oppose the least practicable cross-sectional area to the air, and thus to receive the least practicable retardation of velocity. The cross-sectional area of a 100-lb. spherical shot is 67·1; that of the Parrott or Armstrong 100-lb. rifled projectile is from 32 to 38·5 square inches.

**611.** The resistance of the air is assumed to be as the squares of the diameters of the projectiles,† or, in this case, nearly as 4

\* “We have no levels for adjusting the trunnions, and therefore, when a piece is elevated for a long range, there is no certainty that the axis is in the vertical plane of the point aimed at.

“Our sights for cannon are of the most clumsy construction. There is no difficulty in applying a telescope and quadrant to our guns, intended for a long range, with such adjustments for collimation, that at the distance of 4 or 5 miles the chance would be in favor of hitting a target of 50 feet square every time. If any one will look at the impression made by the shot from Parrott guns on the Crow’s Nest, the only opinion he will have will be, that the sighting for the direction in altitude is better than that for azimuth. Telescopes for this purpose should have semi-object glasses and lenses.”  
—*G. W. Blunt.*

† “If an elongated shot and a ball of equal weight be fired with the same initial velocity and angle of elevation, the former will be less retarded, and will consequently range farther than the ball, for the diameter of the elongated projectile being smaller than that of the ball, the elongated shot will not oppose so great a surface to the resistance of the air as the ball. For instance, if a 12-lb. Armstrong projectile and a 12-lb. ball be moving with the same velocity, the resistance of the air being assumed to vary as the squares of their diameters,

The diameter of the 12-lb. Armstrong shot=3 inches.

“ “ “ ball=4·5 inches.

Therefore the resistances will be as 9 : 20·25, or 1 : 2·25.

From which it appears, that the resistance opposed to the ball is more than twice that which acts against the Armstrong projectile; and this comparison, though rough (for

to 1. At a velocity of 1200 feet a second, which is about the initial velocity of rifled cannon projectiles,

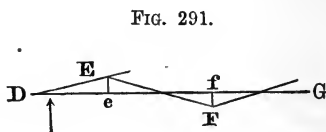
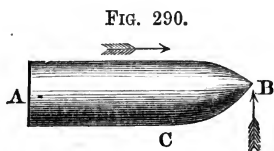
An Armstrong 100-lb. shot will be resisted by a force of	432 lbs.
“ 40-lb. “ “	203 lbs.
“ 20-lb. “ “	127 lbs.
“ 12-lb. “ “	79 lbs.

Therefore range as well as accuracy are greatly promoted by rifling.

**612. Accuracy.\***—The specific effect of rotating the shot is thus stated by Mr. Longridge:†

**613. WANT OF SYMMETRY.**—“If the material of the shot be not homogeneous, or its form be not symmetrical, the resistance of the air causes the projectile to deviate from the true line of flight. Again, if the centre of gravity be behind the centre of the figure, the shot will turn over. Lastly, if the shot leaves the gun with a rotation arising from striking or rubbing against the inside of the chase, and is not determined by any specific direction, it will fly off to one side, or the other, according to the accidental circumstances under which it leaves the gun.

“In Fig. 290, let A B be a shot projected in the direction of the arrow. Now, if the front end be not symmetrical, but be formed as shown at B C, it is evident that the resistance of the



air will cause the shot to deflect in the direction D E (Fig. 291), and that its path, as projected on a horizontal plane, would be a curve to the left of D G. If, however, the shot rotates on its

the obliquity of the axis and the form of the point of the elongated shot are not considered), is sufficiently accurate to account for the results obtained in practice.”—*Maj. Owen, Prof. of Artillery, Woolwich. Jour. Royal U. Service Inst., Aug., 1862.*

\* See also Competitive Trials of 1861 (592).

† Appendix to “Construction of Artillery.” *Inst. Civil Engineers, 1860.*

axis, the extent of lateral deviation is limited, and the shot is brought back from *E* towards the axis *D G*. Now, it is generally stated and believed, that this retrograde motion goes on, until the shot reaches a point *F*, as far to the right of *D G* as *E* was to the left, and that, in fact, the shot travels in a spiral around the axis *D G*, its greatest deviation, at any part of its path, being the distance *E e* or *F f*. This, however, is not the case. The path of the projectile is of a much more complex form, and results in a deviation, increasing uniformly with the distance from the gun, and depending as to its direction on the direction of the deflecting force, at the moment of its first application. If *A* be the gun (Fig. 292) seen projected on a horizontal plane, and the deflecting force acts on the shot as it leaves the muzzle, in a vertical direction downwards, the general projection of the line of flight will be a line *A B*, deviating to the right, or to the left of *A C*, according as the twist is left, or right handed. If the deflecting force acts in the opposite direction, the shot will be deflected to the right of *A C*, and whatever be the direction of the deflecting force at the first exit of the shot, the deviation will be a uniformly increasing one at right angles to it. But the line *A B* is not absolutely a straight line; it is a curve of double curvature, and if projected on a vertical plane at right angles to the axis *A C*, would consist of a series of cycloidal curves (Fig. 293), increasing the distance

FIG. 292.

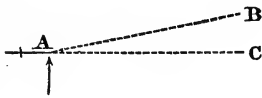


FIG. 293.



of the shot from *A C* by the length *A a* of one of these cycloidal curves at each revolution. The length of each of these cycloidal curves depends upon the amount of the deflecting force, and the number of them is equal to the number of revolutions made by the shot in its flight. The formula for calculating these curves is given in the note before referred to, and Table 104 gives the results as calculated for the several guns therein mentioned, and the aggregate deviation from the line of axis of the gun, at a distance

of 1000 yards, and for a deflecting force, which would have given a deviation of 10 yards to a non-rifled shot, projected under the same circumstances.”

TABLE CIV.—TWIST AND DEVIATION.

Name of Gun.	Amount of Twist.	Number of Turns in 1000 yards.	Breadth of Cycloid.	Length of Cycloid.	Total Deviation in 1000 yards.
Haddan.....	1 in 50 ft.	60	$\frac{1}{90}$ th of an inch	$\frac{1}{30}$ th of an inch	2. inches.
Armstrong .....	1 in 10 ft.	300	$\frac{1}{2250}$ th of an inch	$\frac{1}{750}$ th of an inch	0.4 inch.
Whitworth.....	1 in 5 ft.	600	$\frac{1}{9000}$ th of an inch	$\frac{1}{3000}$ th of an inch	0.2 inch.

**614.** “The aggregate amount of deviation, even with the very slow twist of Mr. Haddan’s gun, is very small, and this teaches, that as far as the correction of the deviation, due to want of symmetry, is concerned, the more rapid twists of Mr. Whitworth’s and Sir W. Armstrong’s are unnecessary.

“It is, however, necessary that the rotative momentum be sufficient to keep up the spinning motion to the end of the flight of the shot, and this may require a greater degree of twist than would be required simply for the purpose of correcting the deviation due to the deflecting force. Experiments are wanting, to show the decrease of rotation due to the friction of the projectile in the air. In Mr. Haddan’s projectile, with an initial velocity of 1300 feet per second, the number of revolutions would be twenty-six per second; and it does not appear likely that this would be much reduced in the few seconds of the projectile’s flight, even to its most distant range. Therefore, in this respect also, the rapid twist adopted by Mr. Whitworth and Sir W. Armstrong appears unnecessary (619).

**615.** CENTRE OF GRAVITY.—“The next point for consideration is the influence of the position of the centre of gravity before or behind the centre of figure of the shot.\* The gyroscope affords

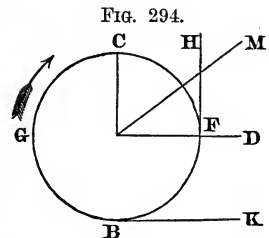
\* “It was also found, in the experiments tried by the French Commission, that when the centre of gravity of an elongated projectile was near the front, the point of

an excellent means of illustrating this. If a weight be attached to the axis of this instrument, when in rotation, the axis will deviate in the same direction as the rotation, if the weight be behind the revolving disk, and *vice versa*.

“The velocity of this horizontal deviation of the axis is smaller as the rotative velocity is greater. If, then, in a rifled shot, the centre of gravity be behind the centre of the figure, the shot will deviate to the right, with a right-handed twist. If, on the other hand, the centre of gravity be forward, the deviation will be to the left; and these deviations will be greater as the velocity of rotation is less; that is to say, as the twist is slower. Here, then, the advantages of a rapid twist are manifest, but it must be borne in mind that the deviation here sought to be counteracted is solely due to the centre of gravity being placed before or behind the centre of the figure; and if these centres coincide, no tendency to deviate exists (243).

**616. FRICTION AGAINST THE AIR.**—“The next cause of deviation is from the friction of the shot against the air. If a body be revolving rapidly in any fluid pressing equally against it in every direction, it is obvious that the only effect of the fluid is to diminish, and finally to destroy the velocity, without changing the position of the axis A (Fig. 294). But if the fluid press with a greater force on the side B, for instance, than on C, the axis will move in the direction D. Again, if the velocity of motion be greater at F than at G, the tendency is to move the axis in the direction 'A C.

**617.** Now in the case of an elongated rifled shot both these actions take place. The pressure of the air is always greatest



such projectile drooped below the trajectory, in its flight; that when the centre of gravity was near the rear, the tail drooped; but that when the centre of gravity was in the centre of the length of the projectile, the axis of such projectile remained coincident with the line of trajectory throughout its flight. It was obvious that the resistance of the air would be at a minimum in the last case, and this explained the improvement that was effected in the range of the Whitworth projectiles, by tapering them in the rear as well as in the front.”—*Mr. Conybeare, "Construction of Artillery."* *Inst. C. E.*, 1860.

on the under side, and consequently the axis is moved in the direction of the twist. Moreover, the side F is always meeting the air, with the velocity due to the sum of the velocity of rotation and the falling velocity of the shot; whereas the opposite side is meeting the air, with the velocity due to the difference of these two; consequently, the effect is to roll the shot upwards, in the direction F H, and sideways in the direction B K; the actual result being a deviation in some intermediate direction A M.

**618.** “The deviation above considered, which is unavoidable in all rifled shot, is greater as the twist is greater, and may possibly vary as the square of the velocity of rotation.—*i. e.*, as the square of the rate of twist. It will probably, also, be a good deal affected by the nature of the rifling, being, of course, greatest with a rough rifled surface.

“The deviation due to the friction, as last described, is always in the direction of the twist. It may therefore be, to some extent, counteracted by the gyroscopic deviation of the shot, if the centre of gravity be placed in advance of the centre of the figure. This gives a deviation to the side opposite to the direction of twist, so that the actual deviation is, in one case, the sum, and in the other, the difference of the two deviations.”

**619.** As to the rate of twist, Captain Blakely says:\*

“Many experiments have been made, with a view to determine the exact length of bullet each degree of twist can steady. Amongst others, I may mention those of Mr. Dove, of Glasgow, who had a set of steel barrels rifled, of precisely the same length, weight, diameter of bore, and shape of groove; the only difference being in degree of twist. He found that, with one turn in 50 diameters, he could fire a bullet three-and-a-quarter diameters in length; with one turn in 60 diameters he could use a bullet  $2\frac{3}{4}$  diameters in length; with one turn in 75 calibres the bullet might be a little more than  $1\frac{3}{4}$  diameters in length.

**620.** “The Swiss Government about the same time made similar experiments, and determined on the use of a military rifle,

\* Journal Royal United Service Inst., March, 1861.



$\frac{11}{16}$  in. in bore, throwing a bullet 2.44 calibres long, with only one turn in 80 calibres. The apparent discrepancy of these results is explained by the very great charge of gunpowder used by the Swiss. Their bullets weighing less than half as much as the Enfield or Mr. Whitworth's bullets, a man can use a charge of powder which would disable him if he attempted to use it with a heavier bullet; he consequently obtains much greater initial velocity.

**621.** "General Jacob made, perhaps, the most extensive series of experiments ever undertaken by an individual. He found that a bullet  $2\frac{1}{2}$  calibres in length could be kept point foremost by firing it from a barrel with a twist of one in 57 calibres, even when the point was lighter than the base. While General Jacob and Mr. Dove were making experiments at their own expense, Mr. Whitworth was making some at that of the country. As he has taken out patents for any improvements he has made, they can be accurately ascertained from his published specifications, so I need only briefly refer to them. The bullet he wishes to introduce into the military service of this country is 3 calibres in length, and weighs 520 grains. With 80 grains of powder he can project this bullet from a rifle-barrel, having one turn in 46 diameters, to a distance of upwards of a mile with astonishing accuracy. The initial velocity is, however, not great, and the rifle is very expensive, depending for its accuracy on workmanship only, not on the development of any new principle. We may fairly consider it proved by General Jacob, by Mr. Dove, and by Mr. Whitworth, that, with a moderate initial velocity of bullet, one turn in 45 or 50 calibres is ample to give rotation to the longest rifle bullet required. We may also accept the theory acted upon by the Swiss, viz., that with greater initial velocity less turn will suffice, and the converse as proved by the Sardinians, who use a small charge of gunpowder, but the extremely short twist of one turn in 26 calibres. All the bullets I have referred to were solid, and some tapering at both ends."\*

\* "As regarded the rate of twist, measured in terms of the calibre, according to Major Croquillet, of the Belgian artillery, the turn of the grooves should be to each other, in all

**622.** With reference to the rates of twist to length of bore, Mr. Whitworth mentions the following facts:\*

“The rifle-twist in the 80-pounder gun was one turn in 100 inches; in the 12-pounder it was one turn in 60 inches; and in the small 3-pounder, it was one turn in 40 inches. With respect to the degree of rifling adopted in the Whitworth guns, enabling the powder to be consumed more effectually, the following experiment was mentioned: Two barrels, alike in diameter and bore, were prepared; all the conditions were identical, except the dif-

rifled arms, as their calibres, provided the projectiles were similar. Colonel Theroux, of the French artillery, gave a similar formula, for determining the proper twist of grooves, for firing elongated balls.  $H$  (the helix or twist) =  $56.8 D$ ;  $D$  being the diameter or calibre. This rate of twist was also found to be the best in General Jacob's experiments, and was adopted in his pattern rifle. The ratio of twist to calibre, ranged from 1 turn in 20 calibres to 1 turn in 136 calibres. In the case of each particular gun, or rifle, all four ratios,—weight of powder to that of projectile—weight of projectile to cross-section—rate of twist—and length of bore—must be considered, together, and in connection with each other. For there were different means for effecting the same ends; and in many cases a deficiency in one of the four ratios might be made up by an excess in another. Thus, in the case of the twist, its object was to give a certain amount of rotation to the ball, as it left the muzzle. This requisite amount of rotation might be obtained—either by means of a rapid twist combined with a low initial velocity, or by a slower twist, combined with a high initial velocity. The first mode was adopted in the Sardinia Bersaglierin rifle, where, with a projectile 0.65 in diameter, not a diameter and a half in length, and weighing 530 grains, the charge was only 54 grains, or little more than one-tenth. The initial velocity was, consequently, exceptionally low—and a very rapid twist was required to establish the necessary rotation in the balls. The twist was, accordingly, 1 turn in 17 inches, or in 26 calibres. The second method was adopted in the Swiss Federation rifle. In this, instead of one-tenth, the charge of powder was one-fourth the weight of the ball. This produced so high an initial velocity, that 1 turn in 77 calibres sufficed to establish the requisite amount of rotation in the ball. Each of these two methods would secure equal accuracy, in firing at a mark, at a known distance; but the Sardinian rifle-ball would have a much higher trajectory, and much less penetration, than the Swiss. Rapid rotation could not be combined, beyond a certain extent, with a high initial velocity, unless the projectile was made with projections to fit the grooves. Without such projections, at high initial velocities, the ball would ‘strip,’ or be driven out without taking the rifling. Hence, those experimenters who, like General Jacob and Mr. Whitworth, had obtained the greatest results, by discerning clearly the advantage of combining the accuracy of rapid rotation with high initial velocity, and its consequence, a flat trajectory and great penetration, had adopted projectiles made with projections to fit the grooves; and he believed such projectiles were destined to supersede those which were forced into the guns by the explosion of the powder.”—*Mr. Conybeare, “Construction of Artillery.” Inst. Civil Engineers, 1860.*

\* “Construction of Artillery.” Inst. Civil Engineers, 1860.

ference of twist in the rifling. One barrel had two turns, and the other had four turns. It was found, on placing them both at an elevation of  $1^{\circ} 20'$ , and firing them with 50 grains of powder, that they each carried the shot to about the same height on the target. Mr. Whitworth then fired them with an increased charge of powder, and the barrel with two turns sent the shot considerably higher upon the target, while the barrel with four turns sent its shot but very little higher than with the small charge. A length of 10 inches was then cut off the latter barrel, leaving only three turns, and it was fired again with the increased charge. The result was, that, the elevation remaining the same, it threw its shot higher on the target than the other barrel. This showed that rotation must bear a due proportion to the length of the barrel. It was desirable to have as much rotation as possible, taking into consideration the length of the gun. With a very long gun it was not advisable to have very rapid rotation, as the quick turn of the projectile was most felt at the muzzle."

**623.** The greater the specific gravity of a shot, the less velocity of rotation it will require, for this velocity will be less diminished during flight by the friction of the air. The inaccuracies of weight and figure are also likely to be less in proportion to the mass. The extraordinary accuracy of the 13·3-in. (600-pounder) Armstrong shot (556), is undoubtedly due, in some degree to its great size and weight.

**624.** Since elongated projectiles tend to turn over in the air—to rotate round their shortest axis—from the greater pressure of the air below than above their points, in proportion to their lengths, the velocity of rotation should increase with the length of the projectile. To accomplish this, the twist of the rifling must be increased.

**625.** CHARACTER OF PROJECTILE—ITS INFLUENCE ON ACCURACY.—In order to secure accuracy of fire, it is essential that the axis of the projectile should correspond with that of the bore of the piece, for otherwise the axis of rotation will be variable, and the deflection of the projectile uncertain. Major Owen, Professor of Artil-

lery at Woolwich, says upon this subject :\*—“ Should the axis of the shot on leaving the bore be unsteady, the projectile will have the ‘wabbling’ motion so frequently observed in experimental practice. It is therefore indispensable that the bearings of the projectile should extend along the cylindrical part, or should be very near the centre of the shot, for if they be either too far forward or behind, unsteady motion must result from the axis of the projectile being inclined to that of the bore.

**626.** “ When the whole length of the cylindrical part of the shot bears against the grooves, the projectile fitting the bore tightly, as is the case with almost all rifled small arms having leaden bullets, with breech-loading ordnance, like the Armstrong or Prussian guns, or with the Armstrong ‘shunt’ gun, L. Thomas’s rifled gun, &c., the axis of the bore and shot must coincide.

“ When there is any windage, as in the case of all muzzle-loading rifled pieces with hard projectiles having projections or buttons, there must be a slightly oblique movement of the axis of the projectile ; but still, if the bearings are over the centre of the shot, or there are two sets, one round the fore part, and the other round the hind part, as in the French elongated shot, the axis of the projectile will, no doubt, on leaving the bore, be tolerably steady. With the Whitworth rifled cannon, the projectile being made to fit the bore so accurately, and there being such a very trifling amount of windage, the axis of the shot is practically stable on leaving the bore.

“ Other cases might be stated, and the results of practice shown, to prove that the above principle is correct, and that a violation of it, by placing the bearings at random and in the wrong position, only results in giving an unsteady motion to the shot, thereby causing inaccurate shooting.”

**627.** Commander Scott says upon this subject,† with reference to expanding shot :—“ The difficulty experienced in the expansion plans is that of keeping the axis of the projectile coincident with the long axis of the piece. At low elevations, the friction along

\* Journal Royal United Service Inst., August, 1862.

† Jour. Royal United Service Inst., December, 1861.

the bore tends to raise the rear of the shot, and facilitate the equal expansion of the lead; but, if the lead at the rear expands equally, it is clear that the iron forepart of the shot, having nothing to raise it, must continue to rub along the bottom of the bore. At high elevations, however, the shell keeps more fairly along the bottom of the bore, the lead on its upper surface expanding the most. An illustration of this is found in the greater accuracy obtained at high as compared with that obtained at low elevation with the same gun."

**628.** The compressed lead-coated shot is also likely to be thrown out of line by the greater compression of the lead at one point than at another.

**629.** A further disadvantage of the expanding-shot is, the position of the centre of gravity behind the centre of figure (615). Commander Scott says\* that "the Southern Confederacy has purchased very many of its heavy guns from England, which, with few exceptions, fire lead-coated shell. At the cannonading against Fort Pickens, these leaded projectiles struck on their base, which was heavier than the front, and did not explode." He also instances the following†:—"In breaching the tower at Eastbourne, at 1032 yards, it was observed that, while some of the rifle projectiles penetrated from 7 to 8 feet into the brickwork, others did not pass through more than from  $1\frac{1}{2}$  to 2 feet. This difference was probably owing to some of the shot striking less fairly than the others. A familiar illustration of a somewhat similar effect is afforded by the difference between hitting a straight and a bent nail; for, while the former easily penetrates hard wood, the latter will make but comparatively small impression."

The James shot, however, which are particularly heavy at the base, were found to have struck point foremost, in the breaching of Fort Pulaski.‡ But these projectiles were comparatively short.

**630.** The stripping of soft-coated projectiles, with high charges, is another source of inaccuracy (691).

\* Jour. Royal United Service Inst., April, 1862.

† Jour. Royal United Service Inst., December, 1861.

‡ Report of General Gillmore.

**631.** The lateral motion of a rifle shot due to the resistance of the atmosphere (616) depends upon the smoothness of its surface. The projections formed on the shot to fit the rifling, act like the floats of a paddle-wheel; and these must be most numerous and deep, in a lead-coated shot, in case of a high rotation, to prevent stripping. And these numerous ridges not only increase drift, but rapidly decrease the rate of rotation. So that the mechanically fitted shot with few grooves would appear to be indispensable to the highest accuracy at long range. Commander Scott thus refers to this subject.\* In making his shot (535), he "had endeavored to obtain the form for permitting the greatest velocity through the air, and at the same time for keeping up the rotation as perfectly as possible. His shot were cast so as to bear on three grooves in the gun, and were so shaped as to carry round little or no air. In this respect they had a great advantage over polygonal and lead-coated shot, with which a large quantity of air must be carried round in rotating. This defect he had endeavored to avoid by deviating as little as possible from a cylindrical form. When that or a circular form was not adopted, as, for example, if the shot was polygonal, a greater amount of initial rotation was required than if the shot were of a figure adapted to keep up the rotatory movement. Hence, those who had tried the polygonal form, or who had fired a lead-coated shot out of a many-grooved gun, had been obliged to give a greater amount of rotation to the shot than would have been necessary with fewer projections."

**632. Range.**—Long range is due, 1st, to a high initial velocity; and, 2d, to a great weight of projectile in proportion to the resistance of the atmosphere—in other words, to great length and small cross-sectional area. At the same time, the large area in proportion to the weight, presented by the long projectile to the air below it, prolongs the time of its elevation, and in this way also contributes to long range. †

\* "Construction of Artillery." Inst. Civil Eng., 1860.

† As to "the question of diameter of bore, it would be seen, that although a solid cylinder of small diameter, had a decided advantage, as regarded penetration of the air, over a hollow cylinder of large diameter, yet the hollow cylinder had the advantage in flotation, and the consequence was, that the difference in range was not

**633.** But, 1st, to insure steadiness, such a projectile must have a high velocity of rotation by means of a rapid twist, which brings a considerable strain upon the gun in addition to that due to the mere translation of the shot. 2d, the greater the proportion of weight to cross-sectional area of shot, the greater the pressure imposed upon the gun for a given velocity of translation. And the friction of a very long projectile in a foul gun is very great. So that the length of the projectile cannot be excessively increased. The length of about 3 calibres has been found to give the best ranges.\*

**634.** In the discussion of this subject before the Institution of Civil Engineers, Mr. Britten "considered there was a great deal of misconception, as to the advantages to be obtained by the employment of small bore guns and projectiles of great length. At very high elevations, such projectiles undoubtedly had longer range, because from their greater weight and smaller area of transverse section, they were less impeded by the air, and maintained their velocity during a longer time of flight. But it was a mistake to suppose, that at low elevations they had any advantage, in point of range, over the larger projectiles which he had fired from rifled service guns. In order that this important point should be fully understood, he had prepared a Table (105), giving the results of his experiments, and he had added the results, as published in the newspapers, obtained with the Armstrong and the Whitworth guns :

**635.** "It would be seen from these figures, that up to about  $10^\circ$  elevation, the rifled cast-iron guns had at least as long a range as the wrought-iron breech-loaders with equal charges; and that at less than  $5^\circ$  elevation, the rifled service guns had a positive

nearly so considerable as might otherwise be supposed."—*Sir W. Armstrong, "Construction of Artillery." Inst. C. E., 1860.*

\* "By increasing the twist it became practicable to increase the elongation of the projectile to the extent of 7 diameters if such a projectile was similarly grooved. But the elongation of the projectile was limited by other considerations; and it was now established that from  $2\frac{1}{2}$  to 3 diameters would be the utmost amount of elongation adopted, save in exceptional cases."—*Mr. Conybeare, "Construction of Artillery." Inst. Civil Engineers, 1860.*

TABLE CV.—RANGES OF LARGE AND SMALL RIFLED PROJECTILES.

GUN.	Bore.		Charge of Powder.	Projectile.		Elevation.	Range.	Mean Velocity per second.
	Diam.	Area.		Weight.	Capacity.			
	In.	In.	lbs.	lbs.	lbs.	Degrees.	Yards.	Feet.
Rifled 9-pounder Service Gun, Cast Iron, 17 cwt.....	4.2	13.1	1 $\frac{3}{4}$	14	6 oz.	5	2000	} Not observed.
	"	"	"	"	"	10	3200	
Rifled 32-pounder Service Gun, Cast Iron, 56 cwt.....	6.41	32.2	6	49	3 $\frac{3}{4}$	3	1600	1122
	"	"	"	"	"	4 $\frac{1}{2}$	2100	1016
	"	"	"	"	"	8 $\frac{1}{4}$	3100	930
Similar Gun.....	6.57	31.9	5	41	solid*	10	3600	900
Rifled 68-pounder Service Gun, Cast Iron, 95 cwt.....	8.12	51.7	6 $\frac{1}{2}$	90	7 $\frac{1}{2}$	"	3700	740
	"	"	8	"	"	10	3150	850
Rifled 32-pounder, Cast Iron, 95 cwt.....	6.37	31.9	7	56	2	"	3560	920
Rifled 18-pounder, Cast Iron, 58 cwt.....	5.29	22	6 $\frac{1}{2}$	34	1 $\frac{1}{4}$	"	3700	955
Smooth-Bore 68-pounder Service Gun, Cast Iron, 95 cwt.....	8.12	51.7	16	68	solid	0.30'	3900	948
	"	"	"	"	"	1	340	2040
	"	"	"	"	"	5	640	1280
Armstrong Breech-loader, Field-Gun†...	"	"	"	"	"	14	1960	939
	3	7	1.6 oz.	12	8 oz.	3	3480	714
	"	"	"	"	...	5	1200	923
Ditto, Large Gun.....	"	"	"	"	...	10	1820	900
	6	28.2	9	80	solid	10	3030	826
Whitworth Breech-loader, Field-Gun.....	3	7	1 $\frac{3}{4}$	12	solid	2	3900	...
	"	"	"	"	"	5	1250	} Initial velocity about 1300 feet per second.
	"	"	"	"	"	10	2300	
5.2	21	12	80	"	5	3780		
Ditto, Large Gun, Weight, 80 cwt.....	"	"	"	"	"	7	2600	}
	"	"	"	"	"	10	3490	
						10	4400	

\* Service round shot, prepared by Mr. Britten to suit rifled guns.

† Range Tables in Horse Guards Manual, published by authority.



superiority in this respect. Nor was this all. The velocity with which the rifled service guns projected their shot, even with smaller charges of powder, was much greater than was the case with the breech-loaders. In the official reports of Mr. Britten's experiments, the time of flight of each shot was carefully recorded, so that there was no difficulty in ascertaining the mean velocities at the different ranges. The mean velocity of his 49-lb. shells, fired from the 32-pounder rifled service gun, was thus shown to be 1120 feet per second, in a range of 1600 yards; the 56-lb. shell, with 7 lbs. of powder, had a mean velocity of 955 feet per second, in a range of 3700 yards; and the 90-lb. shell, of 8 inches diameter, with only 8 lbs. of powder, or  $\frac{1}{11}$ th the weight of the projectile, had a mean velocity of 920 feet per second, in a range of 3560 yards. When, therefore, it was stated, that the velocity of the Armstrong projectiles, on leaving the gun, with charges of  $\frac{1}{8}$ th the weight of the shot, was only 1080 feet per second, and that of the Whitworth shot, with a charge of  $\frac{1}{7}$ th, was under 1300 feet per second, he thought it might safely be asserted, that the muzzle-loaders did more work with the power applied than the breech-loaders.

“In order to show the great effect of the resistance of the air in diminishing the velocity of large bodies during flight, the mean velocities, at different ranges, of the 68-pounder service solid shot, with full service charges, were given in the table. These figures were officially determined, from practice on board the ‘Excellent’ gunnery ship. It would be seen, that at 340 yards, the mean velocity of the service solid 68-pounder shot was 2040 feet per second; but this mean speed fell off to 714 feet per second at the range of 3480 yards. The same gun, when rifled, threw a 90-lb. shell, 3560 yards, with a mean velocity of 920 feet; it was therefore probable, that the initial velocity, in this case, must be very much more than was obtained by the breech-loaders. This was remarkable, when it was remembered, that the 8-inch shells had the resistance of the air upon 51 square inches, the sectional area of the shell; while the Armstrong and the Whitworth projectiles had a sectional area of only 28 and 21

square inches respectively, and were fired with much heavier charges. From these facts he inferred, that for horizontal fire up to 2000 yards range, which was the service most required, his large-bore guns were in no respect inferior to the new small bores, while in many points they were far more serviceable."

**636.** The shape of the projectile has an important influence upon its remaining velocity and range. But as the shapes required for range and for armor punching are different (713), and as iron-clad fighting must be done at so short a range that little velocity will be lost whatever the shape of the projectile, this consideration is of limited importance in the present inquiry.\*

The following tables and diagrams,† however, are of special interest.

**637.** EFFECT OF FORM UPON RANGE.—“The retardation of a projectile is influenced by the form of both its fore and hind part, but especially by the shape of the former. The following table ‡ (106) of resistances to bodies of different forms, moving with low velocities of 10 feet per second, is constructed from the results of Dr. Hutton’s experiments with the ‘whirling machine’ invented by Robins.

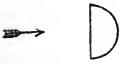
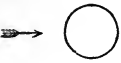
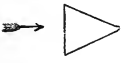
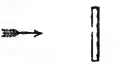
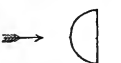
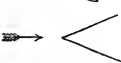
“The experimental resistances to 2 and 3 are about the same,

\* “As to practical results, Mr. Whitworth did not now propose to carry out the comparison. But something ought to be said as to range, which he was surprised to hear undervalued. Without attaching too great importance to mere range, it must be admitted to be a very good measure of what the gun could do. If at an elevation of  $7^{\circ}$ , the range of the fluted gun was 2495 yards, and the range of the hexagonal gun was 3107 yards, the trajectory of the latter was flatter, and the errors in judging distance were of less importance, as during a greater portion of its flight the hexagonal projectile was nearer the ground. This perhaps would appear more plainly, by comparing the range of the fluted 12-pounder gun at  $9^{\circ}$ , which was stated on good authority to be 3000 yards and upwards, with the range of the hexagonal 12-pounder at  $7^{\circ}$ , which was 3100 yards and upwards; now considering the ranges as about equal at these different elevations, the advantage of firing the hexagonal gun at  $7^{\circ}$ , as compared with another gun, which to attain a like range required to be elevated to  $9^{\circ}$ , was obvious. The gun which had the longer range and the flatter trajectory was more likely to hit a distant object, than another gun which had one-fifth less range, for the same elevation.”—“*Construction of Artillery*” *Inst.*, C. E., 1860.

† Major C. H. Owen, R. A. Jour. Royal U. Service Inst., Aug., 1862.

‡ Extracted from Capt. (now Lieut.-Col.) Boxer’s Treatise on Artillery, page 152, art. 299.

TABLE CVI.—RESISTANCE OF BODIES TO THE ATMOSPHERE.

FORM OF THE BODIES.		Experimental Resistance.	Theoretical Resistance.
	1. Hemisphere, convex side foremost.....	119	144
	2. Sphere.....	124	144
	3. Cone, angle with the axis 25° 42' .....	126	53
	4. Disk.....	285	288
	5. Hemisphere, flat side foremost.....	288	288
	6. Cone, base foremost .....	291	288

notwithstanding the sharp point of the latter. The resistances to the three last, which theoretically ought to be double of the two first resistances, are experimentally much more, in fact  $2\frac{1}{2}$  times as much.\*

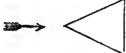
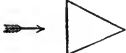


“The next table (107) is taken from Piobert’s ‘Cours d’Artillerie,’ and contains the results of experiments made by Borda in the last century, with velocities of 3 to 25 feet a second.

**638.** “From this table it appears that the ogival form experienced the least resistance. With high velocities the results might perhaps differ considerably from the above, and experiments carefully executed can alone enable us to determine the form of projectile which will attain the greatest range with a given initial velocity.

“One of three different forms is generally employed for the head of an elongated projectile. The figures represent sections of these three forms. Fig. 305 is the section of a “cone.” Fig. 306 is the section of a “conoid,” or a figure generated by the revolution of a conic section about its axis. Fig. 307 is the section of a

\* Dr. Hutton’s remarks on these experiments will be found in his 36th Tract, page 190, vol. iii.

TABLE CVII.—RESISTANCE OF BODIES TO THE ATMOSPHERE.

FORM OF THE BASE OF PRISMS.		Experimental Resistance.	Theoretical Resistance.
	1. Triangle, base foremost.....	100	100
	2. Triangle, apex foremost.....	52	25
	3. Demi-ellipse.....	43	50
	4. Ogival.....	39	41

pointed arch, which is termed by the French “ogival.” The last is most probably the best form, as the one which experiences the

FIGS. 305.



306.

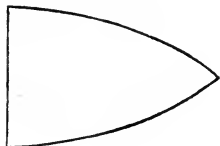


307.



least resistance from the air. Sir Isaac Newton in his Principia gives a form of body (Fig. 308) which would, in passing through

FIG. 308.



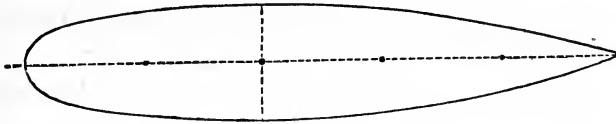
a fluid, experience less resistance than a body of any other shape. This form, it will be seen, is very similar to the ogival. Piobert says that the form Fig. 309 will experience the least resistance from the air. Its length is five times its greatest diameter, and its largest section is placed at  $\frac{2}{3}$  of the

length from the hind part. The shape of some of Mr. Whitworth’s projectiles approach more nearly to this form than those of any elongated projectiles hitherto used.”

**639. Velocity.**—Although the elongated bolt, with 400 to 500 feet less velocity at starting, overtakes the round shot at 800 to 1000 yards, yet the necessity of a high *initial* velocity is obvious.

It is absolutely necessary to penetration, even at short range, when, for instance, the rifled gun is called upon to send shells through

FIG. 309.



armor. It is necessary to accuracy at long range, for reasons already considered; and without extraordinary provisions for accuracy, long range is of little advantage.

**640.** Captain Fishbourne, R. N., says upon this subject:\*

“Greater accuracy with the same guns, &c., at known distances, with heavier charges; arising from the greater velocity of projectile, is so well known and admitted, as not to need proof or explanation; but, great as are the other advantages of high charges, they are small as compared with those of a flat trajectory, where the distances are unknown.” Supposing two trajectories, “one, that of a ball with such a velocity that it travels the distance in one second, and subject only to the fall of 16 feet; the other, of a ball that requires two seconds, therefore subject to a fall by gravity of 64 feet. If no disturbing cause arises, a ship that is but 12 feet high, and there are few so low, will be struck at any point in the trajectory of the ball, with high velocity; whereas a ship 48 feet high or more, will be passed over by the ball having the lower velocity, and only within narrow limits of distance would a ship 30 feet high be struck by it in *its* trajectory.”

**641.** The first condition of high velocity is a light projectile. This does not necessarily mean a short projectile; the proper length for the greatest stability may be preserved by hollowing the projectile in such a way as not to displace the centre of gravity, or better, by some modification of the principle adopted by Mr. Stafford (590 and 590 A).

**642.** The second condition of high velocity is that the least

\* Journal Royal United Service Inst., June, 1862.

possible power shall be expended in overcoming friction and changing the figure of the shot, while getting it out of the gun. Power thus wasted is worse than lost, because it strains the gun so much as to require reduced charges, thus decreasing the velocity in another way. The service charge of the Armstrong 110-pounder has been reduced from 14 to 12 lbs., for this reason.\*

So much power is expended in planing 76 grooves in a hardened lead-coated projectile, that even 14 lbs. of powder pressing on the 7-in. 111-lb. Armstrong shot, gives less velocity than 10 lbs. of powder pressing on the Parrott 6·4-in. 100-lb. shot. The initial velocities are, respectively, 1211 and 1244 feet, and the areas of the shot pressed by the powder are, 38·5 and 32·1 sq. in. The range of an Armstrong 7-in. 110-lb. shot with 12 lbs. of powder, was 3387 yards against 3981 yards for the Jeffrey 100-lb. shot—same bore, charge, and elevation. (See Table 108.)

**643.** Sir William Armstrong attempted to justify this retardation of his projectile in the gun as follows:—"By holding back the projectile until the powder is thoroughly converted into gas, you will get a higher pressure upon the projectile, and impress a greater quantity of work upon it. \* \* \* Experiments have been made with lead-coated shot, having the lead considerably reduced in diameter so as to facilitate the passage of shot through the bore; and it was found that, instead of reduced friction increasing the initial velocity, the result was rather the contrary."†

**644.** It by no means follows that a shot moves more slowly *because* the impediments in its way are removed. The reduction of the lead covering might have so increased the windage that the full pressure of the powder was not exercised upon the shot.

\* "The pressure of forcing a 25-lb. Armstrong shot slowly through the bore, by mechanical means, is said to have exceeded forty tons."—*Capt. Fishbourne, Journal Royal U. Service Inst., May, 1864.*

"Another evil arising from rifling is, in case of lead-covered projectiles of one class, such as are used with the Armstrong gun, that the rifle-grooves have to be cut by the explosive force of the powder, and this is done with immense velocity, and in the space of a few inches, the power required must be very great. The leading of the gun and the stripping of the shot show how great this strain must be, and in order to meet the difficulty and prevent such effects, recourse has been had to slow burning powder, and as a consequence a low initial velocity has been obtained."—*Mr. Michael Scott, on Projectiles and Rifled Guns.*

† *Jour. Royal United Service Inst., June, 1862.*

TABLE CVIII.—COMPARATIVE RANGES OF JEFFERY AND ARMSTRONG PROJECTILES.

## JEFFERY.

Average range, with 12 lbs. of powder, 3981. Average range, with 16 lbs. of powder, 4139.

Charge.	Elevation.	Weight.	Range. 1st graze.	Deviation. Right, yards.
lbs.	Degrees.	lbs.		
12	10°	100	4050	26
12	10°	100	4001	22
16	10°	100	4032	11
12	10°	100	3988	4.2
12	10°	100	3949	19
16	10°	100	4185	14
12	10°	100	3998	14
12	10°	100	3942	30.4
12	10°	100	3974	11.6
12	10°	100	3953	7
16	10°	100	4259	20
16	10°	100	4083	11.2

## ARMSTRONG.

12	10°	110	3400	32
12	10°	110	3411	21
12	10°	110	3434	24
12	10°	110	3328	23
12	10°	110	3324	29.4
12	10°	110	3368	33
12	10°	110	3364	23
12	10°	110	3496	22
12	10°	110	3350	22
12	10°	110	3395	26

Average range, with 12 lbs. of powder, 3387.

NOTE.—Only 2 rounds, with this proportionate charge and elevation, were fired from Mr. Britten's gun. The ranges were 3500 and 3400 yards.

Guns of the same calibre, length, and weight.

Jeffery's gun was rifled with 15 grooves  $\frac{1}{10}$  inch deep. The base of the projectiles was coated with lead hardened by tin.

And if it is important to increase the pressure upon a shot, the use of more powder would appear to be a simpler and safer means than straining and abrading the gun by jamming a hard wedge through it. Besides, continuing to retard the shot by the friction of many grooves, and by an additional nip at the muzzle, after the pressure of the gas has been reduced by expansion, simply wastes power and reduces velocity without any compensation. If the shot must be retarded, it would be better, as Mr. Whitworth has suggested,\* to expend the power in increasing its rotation. This *must* be done in the gun; grooving the shot may be done elsewhere.

**645.** A mechanical fit offers the least friction and retardation to the shot. There would not appear to be much difficulty in obtaining all the *pressure* that a rifled gun can stand, by the use of plenty of powder, however smoothly the projectile may fit. It is, however, a defect of the Armstrong gun, that the length of cartridge and projectile must always be the same; if longer, they will not enter the chamber; if shorter, an air space is left in the powder-chamber (551).

**646.** This subject is thus referred to by the Ordnance Select Committee, July 30, 1862:† “Under strictly comparable conditions, that is to say, equal weight of shot, equal charge, and equal length of gun, the Whitworth 12-pounder appears to give an initial velocity below that of the Armstrong gun. This is probably due to the retardation experienced by the Armstrong shot in passing through the contracted part of the bore immediately in front of it, which permits a steady accumulation of pressure behind it, and is instantly followed by a decrease of friction when the shot emerges into the wider part of the bore. The friction of the Whitworth shot, arising from the very rapid twist of the rifling, concurs to produce the same relative effect. In the Armstrong 12-pounder the angle of rifling is  $4^{\circ} 44'$ , and in the Whitworth 12-pounder is  $8^{\circ} 55'$ .” But the Committee discuss neither the retardation of the Whitworth shot by its *wedging*

\* “Construction of Artillery.” Inst. Civil Engineers, 1860.

† Report of the Select Committee on Ordnance, 1863.



in the grooves, nor the philosophy of increasing the pressure (as in the Armstrong gun) at the very place where large guns fail, even when slow powder and accelerating charges are applied to reduce the initial pressure.

**647. WINDAGE.**—Windage is the principal objection raised against mechanically fitted projectiles. Supposing it impracticable to prevent windage, Mr. Whitworth's experiments show that it is not disadvantageous. He fired, "from the same gun, an iron shot, rifled on his plan (in which a small amount of windage was purposely allowed), and leaden shot of the same shape and size. The leaden shot was necessarily expanded by the explosion, until it filled the bore; and was propelled without there being any windage at all. But, although its specific gravity was greater than that of the iron shot, and it had no windage, its range was not nearly so good as that of the iron shot."\*

**648.** The entire stoppage of windage appears to prevent the certain action of time-fuzes, as they have to be lighted after the shell leaves the gun; and in case of the Armstrong gun this has led to costly and nearly fruitless experiments with percussion-fuzes. The rush of the gas past the projectile also tends to relieve fouling—to blow out the dirt that would otherwise accumulate.

**649.** The windage may be stopped in any required degree by the use of wads. Mr. Whitworth and Commander Scott have used them without inconvenience, but what is more important, have abandoned them (at least for the purpose of stopping windage), without impairing range or velocity. In fact, increasing the charge with windage, strains the gun less for a given velocity, than reducing the charge and the windage. More time is allowed the powder to overcome the inertia of the shot.† (652).

\* "Construction of Artillery," Inst. Civil Engineers, 1860.

† The following statement of French experiments and practice regarding windage is compiled from an article entitled "Rifled Ordnance in England and France," in the *Edinburgh Review*, April, 1864: "The result of the more recent experience of the French artillerists proves that the suppression of windage diminishes the accuracy of fire. \* \* \* When the projectile is driven forwards to the muzzle of the piece, by the expansion of gas generated by the explosion, the point of time at which it

**650.** Mr. Whitworth's lubricating wad\* has other advantages, and is thus described by him :†

“The metallic cartridge was made of tin plate, and had a rifled shape to fit the bore. When it was inserted in the gun, it formed

leaves the gun decides its direction, and the slightest variation of pressure from within or without at that instant causes deviation in its subsequent flight. The absence of windage is now thought by the French to increase the probability of some such accidental variation of pressure; but when a portion of the gas generated by the explosion is allowed to escape by windage, as this gas travels four or five times faster than the projectile, it serves as it were to prepare the atmosphere for the ball, and to launch it on the straight line to its trajectory. \* \* \*

“A heavy gun of fifty French measure (corresponding to our 70-pounder), which had already fired 280 shots at iron plates  $4\frac{1}{2}$  inches thick, and pierced them at a distance of 1093 yards, was treated in the following manner: The gun was bored, like a flute, with 36 holes, each of 6 centimetres in diameter. In that state it was again fired, and it turned out that the initial velocity of the projectile was diminished scarcely 2 per cent. But on the other hand, the accuracy of fire of the piece was greatly augmented, and the recoil, which had averaged about seven metres before the operation, was reduced to 1 metre 40'. It is, therefore, now asserted by some of the highest French authorities, that windage, without really diminishing the power of guns, improves their accuracy, and greatly reduces the stress of the explosion on the piece. \* \* \*

“Provided the projectile leaves the gun with its axis in line with that of the piece, the inaccuracy caused by windage ceases; and this is precisely what is obtained both in the French and in the Whitworth guns.”

Another advantage of windage—that the gun can be fired rapidly and often without sponging—is thus illustrated by the same writer: “At the battle of Solferino, when the corps of General Benedek, having driven in the Piedmontese army for a distance of two or three miles, threatened to turn the left of the French position, it was fortunate for the French army that they had guns not requiring to be sponged out after every round; for it was the extraordinary rapidity of the fire of the rifled batteries of the French Guards which arrested the Austrian advance at a range which then appeared incredibly great, and enabled the Piedmontese to recover their ground. \* \* \*

“On a recent occasion at Rennes, the experiment has been tried on the new French artillery in a still more striking manner. A gun, taken at random from one of the batteries of troops quartered in that town, was fired consecutively 1000 times without being washed or sponged out, and without even once washing, clearing, or scraping the touch-hole. After this extraordinary trial, we learn from the report of the officers in command, that the gun had lost only  $\frac{1}{8}$  of a degree of precision required by the regulations of the French service. It is proper to add, that this experiment was made with compressed gunpowder; but the result is mainly due to the windage of the piece, which is now freely admitted by French artillerists to be not only no evil, but an essential condition of accurate and rapid firing.”

\* “Mr. Whitworth, in his specification, claimed the original arrangement of a tallow-box in front of the powder. Sir William Armstrong, after experience of the disadvantages of washing out the gun, enclosed the tallow in a ball of hemp.”—*Mr. W. B. Adams, “Construction of Artillery,” Inst. C. E., 1860.*

† “Construction of Artillery,” *Inst. C. E., 1860.*

a lining within which the charge was fired. The powder, therefore, instead of acting against the sides of the gun, acted against the inside of the cartridge. This saved the gun; and moreover, when the cartridge was withdrawn after the discharge, it brought away with it the fouling deposit. A small hole was made in the rear of the cartridge case, through which the fire from the friction fuze was flashed to the powder. The case was filled with powder to within about half an inch of the open end. It was then closed by a wad, of lubricating material, which, when the charge was fired, was distributed over the interior of the gun. This obviated the necessity of sponging out, which had always been a great inconvenience in working guns. He believed this plan of obviating the necessity of sponging, by the use of the wad of lubricating material, had not been used previously to his adopting it."

**651.** Projectiles are retarded and their velocity is reduced by other causes, which also strain the gun, viz.: rapid twist of the rifling, the wedging of the projectile due to a bad form of rifling (656), sudden starting and compression of the shot, and fouling due to lead coating. These causes are further considered in the following paragraphs. The shape of the projectile also affects the maintenance of its velocity (637); but cleaving the air and punching armor require different shapes, and since the latter must be done at short range, little velocity will be lost, whatever the shape of the projectile.

**652.** Mr. J. B. Atwater, of Chicago, has arrived at some singular results, by largely increasing the windage of the gun after the shot has started. The experiments are not yet complete enough, however, to warrant an extended inquiry. A 5.85-inch (80-pounder) cast-iron hooped gun, constructed after preliminary experiments, for this rifling, has 12 grooves  $\frac{1}{8}$  inch deep, and 12 lands of equal width at the breech (Fig. 310). At 12 calibres from the bottom of the chamber the lands are cut away in alternate pairs to  $\frac{1}{8}$  inch below the bottom of the original grooves (Fig. 311). Other conditions remaining the same, the range of projectiles from this bore is considerably increased. This result is

ascribed to various causes. Decrease of friction would be better promoted by cutting off the chase altogether. The more perfect

FIG. 310.

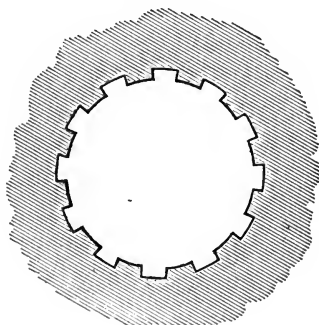
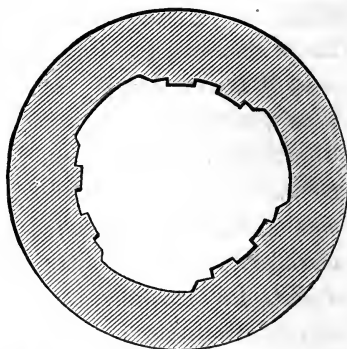


FIG. 311.



Atwater's rifling.

combustion of the powder by the air entering at the side of the shot would also follow, leaving an air space in the chamber of the gun ; in fact, to the sudden and perfect combustion thus promoted some authorities attribute the bursting of guns. Mr. Atwater reasons from the experiments of Captain Rodman, that the air pressure in front of the shot is greater than the gas pressure behind it, at the point where he cuts the lands away. (649, note.)

**653. Strain.**—The failure of unstrengthened cast-iron guns generally, even of the Dahlgren  $7\frac{1}{2}$ -inch rifles, with all their advantages of superior iron, figures and founding, is evidence of the increased strains due to rifling. Mr. Bashley Britten has certainly obtained very good range and accuracy, and tolerable endurance from old unstrengthened cast iron guns, rifled. But the charges were reduced from 10 lbs. for a 32-lb. ball to 6 lbs. for a 50-lb. shell fired from the same gun, and the grooves, only 5 in number and  $\frac{1}{8}$  inch deep, had a very low twist (1 turn in 48 feet), all of which is unsuitable for the heavy projectiles and high velocities required in iron-clad warfare.

The strains imposed upon a gun in firing an elongated rifle-shot, in addition to the strain due to the mere translation of the shot are various.\*

\* "The argument that the smallness of the recoil of rifle-guns, establishes that

**654. WEIGHT OF PROJECTILE.**—First, the pressure on a gun is nearly in proportion to the weights of the projectiles (240). A rifled shot, to be accurate, to be conveniently laid hold of by the rifling, and to range farther than the round ball, must be somewhat elongated: it is therefore two or three times the weight of the round ball, unless it can be hollowed without disturbing the centre of gravity, or arranged on the sub-calibre principle (590), without otherwise impairing its efficiency. The heavy shot is displaced more slowly, and the pressure behind it is greatly increased. This source of strain has nothing to do with the grooving, or with the method of taking the grooves.

**655. TWIST OF RIFLING.**—The next source of strain is the twist of the rifling, irrespective of the bursting strain due to the wedging of the projectile in such grooves as Whitworth's and Lancaster's. The inertia of the shot tends to tear away the land or to split the gun along the groove, which is the thinnest and weakest place. The Ordnance Committee, in their report on the experiments of 1861 (598), are of the opinion that the liability of the gun to be burst from this cause is directly as the sine of the angle of the rifling, although, by calculation, Mr. Longridge finds\* that "even with the rapid twist employed by Mr. Whitworth (1 in 5), the amount of force expended on the rifling scarcely exceeds 2 per cent. of the total force of the powder. Taking Mr. Whitworth's large gun (80-pounder), the following will be, approximately, the forces required to give translation and rotation, when the shot weighs 80 lbs., and the velocity on leaving the gun is 1300 feet per second:—

there is little friction, and therefore little tension on the gun, is a fallacy, for it is the intensity of the friction that prevents the gun from recoiling; so great is it, that it could not fail, with higher charges than those used for *them* now, in time to disintegrate such guns, by separating the chase from the breech, or more properly the inner cylinder from the outer; indeed, I believe this has already, in many cases, taken place."—*Captain Fishbourne. Jour. Royal U. Service Inst.*, June, 1862.

\* "Construction of Artillery," *Inst. Civil Engineers*, 1860. Mr. Longridge's obvious meaning having been misapprehended, he afterwards explained, in some remarks at the United Service Institution (*Journal*, March, 1861), that the wedging of the Whitworth shot was a source of great strain, but that the friction *necessary* to give rotation was as stated above.

		lbs.
Mean force, to give translation.....		306900
Force, to give rotation .....	3784	
Friction of shot in grooves, taken at $\frac{1}{8}$ th pressure.....	3012	
	—————	
		6796
Total force.....		313696

Or taking the total force at 100, the force to give rotation is 2.16.”

**656.** WEDGING OF THE PROJECTILE.—Another most serious, although remediable, source of strain from rifling is due to the wedging of the projectile in all grooves of which the bearing sides do not lie in the plane of the diameter of the gun. For instance: the inertia of a projectile rotated by the groove C D, Fig. 314,

FIG. 312.

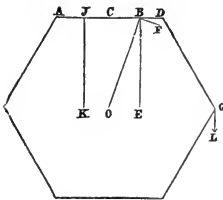


FIG. 313.

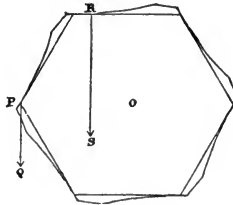
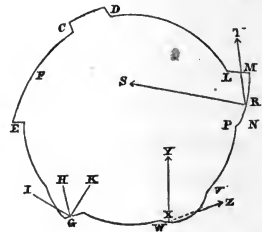


FIG. 314.



Illustrating the strain of rifling.

tends only to rotate the gun in the opposite direction; but the greater part of the pressure imposed by the shot in Fig. 313, assists the powder in enlarging the diameter of the gun.

**657.** In addition to this direct rupturing strain, the friction of the projectile is increased by the same cause. The accompanying illustrations are given by Captain Blakely, who remarks: \*—If, in Fig. 312 “the shot is meant to revolve in the direction G L, all the pressure on the half-side C D will assist this motion, all on the half-side C A will resist it and cause enormous friction and waste of power. \* \* \* Mr. Whitworth, after the bursting of his second gun, in 1857, abandoned this idea of a mechanical fit, and, while retaining an almost hexagonal form for his bullet, planed away that part of the bore whose pressure would be mischievous. The

\* Jour. Royal United Service Inst., March, 1861.

bore of his latest gun is 24-sided in section, six of these sides only being bearing surfaces (Fig. 313). If from  $R$ , the centre of one of these bearing surfaces, a line,  $RS$ , be drawn perpendicular to the surface, it will represent the force tending to make the shot rotate. A glance will show how much less force would effect the same object if applied at  $P$  in a parallel direction. \* \* \* The worst of all conditions would be the mechanical fit (Fig. 312), where not only part of the pressure  $JK$  would prevent the bullet from rotating, but where the force which we may suppose to act at  $B$ , and to be represented by  $BE$ , would be so disadvantageously applied that, if we resolve it into two forces,  $BO$  and  $BF$ , the former, which can only cause useless friction, will be found four times as great as the latter, which alone is useful. \* \* \* In the very common form shown at  $CD$  (Fig. 314), one of the surfaces,  $C$  or  $D$  must be useless, and it surely simplifies the form to cut off the shoulder as at  $EF$ . The bearing surfaces must be truly radial. The slightest inclination causes increased friction, as at  $G$ , where the pressure, acting in the line  $GI$ , can be resolved into two forces,  $GI$ , useful, and  $GK$ , the reverse. The form of groove adopted by the French,  $LMNP$ , Fig. 314, has all the disadvantages of the hexagonal bore, for the force is applied to the bullet by the surface  $MN$  in the direction  $RS$ , whereas motion is intended to be given in the direction  $RT$ . All curled grooves, as at  $VXW$ , have the same defect; force is applied in a direction  $XY$ , quite different from that  $XZ$ , in which it should be given."

**658.** The Lancaster oval shot is obviously calculated to jam in the bore.\* Mr. Bashley Britten makes the following important statement:† "The repeated failures of the Lancaster gun, involving sacrifice of the enormous sums of public money which were lavished on that system, induced the belief that cast-iron guns were not strong enough to be rifled; but the fact that whenever the Lancaster guns burst, it was always in front of the trunnions,

\* In October, 1862, the Ordnance Select Committee reported against Mr. Lancaster's system, but in December they thought it might be so improved as to utilize the old brass guns for field use.

† Journal Royal U. Service Inst., March, 1861.

while guns which burst under proof charges always go in rear of them, was a clear proof to my mind that the cause of bursting was not the charge of powder, or the weight of the projectile, but was connected with the method of rifling, and the employment of a rigid shot, at any time liable to get jammed in the gun." (671.)

**659.** The Government Report on Rifled Cannon in 1858, states that "three out of eight Lancaster guns employed against Sebastopol burst, all, however, of the lighter natures; they were nearly all 8-in. guns of 65 cwt. bored up. Two also of the heavy Lancaster guns, bored up from the 68-pounder gun of 95 cwt., have burst at Shoeburyness. These accidents have led to some doubt whether they can be used with safety with full charges, viz.: 8 lbs. and 12 lbs." The report also states that there are "remarkable irregularities in the ranges, which it is difficult at present to explain, but which, however accurate the gun may prove in direction, are a most serious evil." To the increasing twist formerly used in these guns, however, in connection with the long bearing of the projectile, much of the extraordinary strain is attributed.

**660.** The testimony before the Select Committee on Ordnance, 1863, was rather more favorable on the whole, to the Armstrong, than to the Whitworth system of rifling and projectiles.

**661.** The friction of the Whitworth projectile\* in comparison with that of the shunt shot is shown by their relative velocities. The Whitworth 68 lb. 9 oz. shot from a 70-pounder,—charge, 9 lbs.,—had a velocity of 1132·5 feet. The Armstrong 3-grooved shunt shot of 68 lbs. 6½ oz. weight,—charge 9 lbs.,—had a velocity of 1283·8 feet. The Whitworth 68 lb. 9 oz. shot,—charge 10 lbs.,—had a velocity of 1199·4 feet. The Armstrong 6-grooved shunt

\* Mr Whitworth was informed by General Peel in December, 1858, "that as all three of his cast-iron polygonally bored guns had burst at an early stage of the experiments, he had decided on discontinuing experiments with this form of rifled cannon."—*Report of the Select Committee on Ordnance*, 1863.

Captain Blakely said before the above Committee, that the Whitworth gun had been tried and rejected in France; that at 5°, out of 10 shots, some went 570 yards further than others; that the gun was also tried without success at Copenhagen, and that one tested at St. Petersburg, burst at the 149th round with 5 lbs. of powder and a 35-lb. shot.



shots of 74 lbs. 6½ oz. and 76 lbs. 8 oz., had a mean velocity of 1314·3 feet. The same result followed all trials of the two systems of rifling.

**662.** In July, 1861, the Ordnance Select Committee reported unfavorably upon Mr. Whitworth's system of rifling, for the following reasons: 1. If the projectiles are accurately fitted, they are likely to rust, and give trouble in loading without frequent painting and cleaning. If not accurately fitted, the gun forfeits one of its principal claims to superiority.

2. The comparatively small calibre and long projectile greatly increase the strain on the gun, and the shape of the projectile is unfavorable for shrapnel, although favorable for the penetration of solid shot.

3. The rapid pitch of the rifling, although necessary to the accuracy of long projectiles, is another source of strain upon the gun.

4. The Committee think the finish and fitting of the Armstrong guns and projectiles to be equal to those of the Whitworth guns and projectiles, and that these features would not in any case render the polygonal system preferable to other systems.

**663.** The following experiments, recently made at Woolwich, to test the strain due to various forms of rifling, are obviously decisive as far as bursting pressure is concerned. But they do not show the additional weakness of the Lancaster and Whitworth systems due to increased friction, because the experimental shot were not moved longitudinally in the rifling, but only revolved. And although the sides of the grooves in the 10-grooved shunt gun are not quite in the plane of the diameter, its superior endurance is obviously due only to the larger number of grooves and the greater amount of metal thus called into service.

**664.** RESULTS OF EXPERIMENTS MADE TO TEST THE STRAIN ON THE GUN DUE TO VARIOUS FORMS OF RIFLING, BY MR. JOHN ANDERSON.\*—"The power required to give the rotatory motion to the projectile, through the agency of ribs or grooves in

\* The following is quoted from British Artillery records.

the gun, must necessarily cause an opposite straining in the gun tending to open it, or else to break the metal without actually splitting. We can easily perceive that an inclined surface is more apt to split the structure than a flat or perpendicular surface, but there were no precise data in regard to the position in which different plans stood with respect to each other.

“In order to ascertain this point, experiments have been made in the Royal Gun Factories, by preparing cylinders of cast-iron, all of equal strength and area; these cylinders were bored and rifled on the several plans shown on the accompanying table, and to prevent the risk of error from any exceptional defect of any description, several of each sort have been experimented with.

“Into these rifled cylinders there were correctly fitted corresponding plugs of steel representing the projectile; these plugs were made to fit the part representing the gun, and being of steel, which is a stronger metal than the cast-iron cylinders, it was resolved to continue the experiments until a form of rifling was arrived at, in which the steel plug would be broken before the cylinder was split open.

“The experiment consisted in fixing one end of the plug representing the projectile in a frame which was immovable, its other end being within the cylinder. The cylinder was fixed in the centre of a lever fulcrum, and capable of having a torsional motion given to it, by the application of weights on the extremity of a lever. The accompanying table shows the weight required to produce fracture on the several plans of rifling, and the diagrams will explain the exact form of the arrangement of rifling in the several systems.” (See Table 109.)

**665.** CHARACTER OF THE GROOVES.—The depth of the grooves has an obvious influence upon the strain brought upon the gun. Mr. Britten attributes his success in rifling old cast-iron guns, in part, to shallow grooves\* (5 grooves  $\frac{1}{16}$ -in. deep, for the old 32-pounder). But Mr. Britten uses a very low twist (1 turn in 48 feet in the competitive experiments of 1861), and therefore requires but

\* “Construction of Artillery,” Inst. of Civil Engineers, 1860.

TABLE CIX.—STRAIN DUE TO VARIOUS KINDS OF RIFLING.

No. of Figure.	KIND OF RIFLING.	Nature of rifling.	Breaking weight in tons at circumference.
315	Lancaster's .....	Oval.....	7.02
316	Experimental .....	Decagon .....	23.29
317	Armstrong's .....	Three-grooved shunt.....	25.65
318	Commander Scott's.....	Three grooves, but only } two ribs bearing..... }	27.95
319	Whitworth.....	Hexagon.....	28.07
320	Commander Scott's .....	Two grooves, opposite to } each other..... }	29.00
321	Experimental .....	Two grooves, opposite to } each other .....	29.18
322	Lynall Thomas's .....	Three ribs .....	35.09
323	Commander Scott's.....	Three grooves .....	35.30
324	Armstrong's .....	Ten-grooved shunt .....	46.50*

\* At this weight the plug broke and the cylinder showed a slight crack.

FIG. 315.

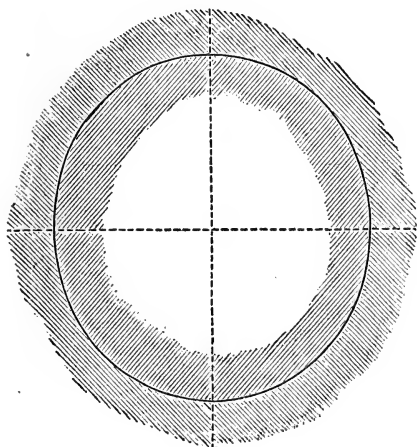
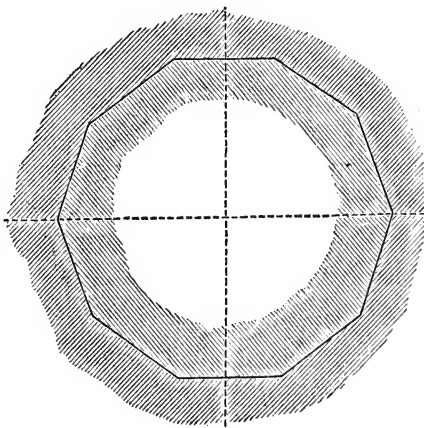


FIG. 316.



a small bearing surface to rotate his shot. But with either a high velocity or a sharp twist, shallow grooves would strip a soft metal

FIG. 317.

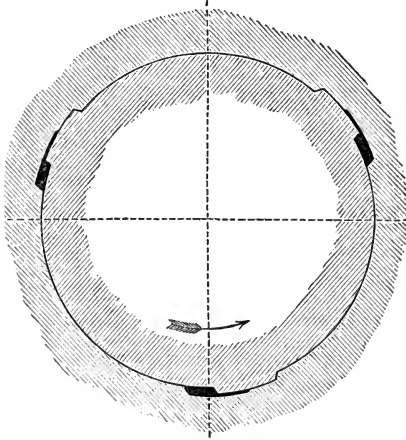
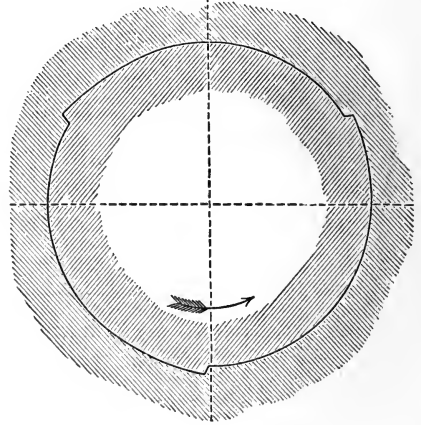


FIG. 318.



shot, or cut a hard bearing ; even the Armstrong 110-pounder shot, with 76 grooves and a long lead covering, shows evidences of slip.† So that the necessity for a considerable bearing surface, either by

FIG. 319.

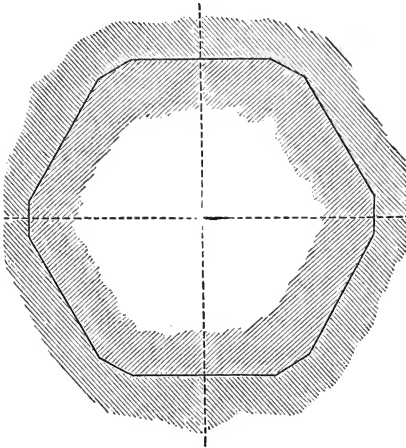
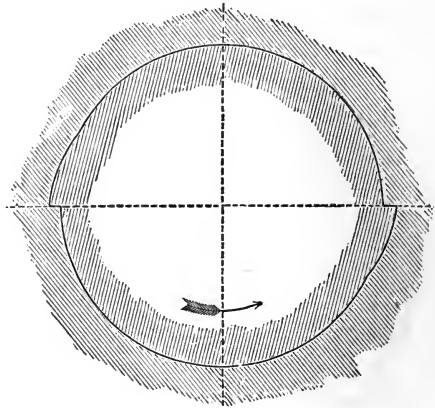


FIG. 320.



† Recovered shot observed at Woolwich.

a great number of grooves or by very deep grooves, is obvious.

**666.** Studs in the middle of the shot instead of wings or ex-

FIG. 321.

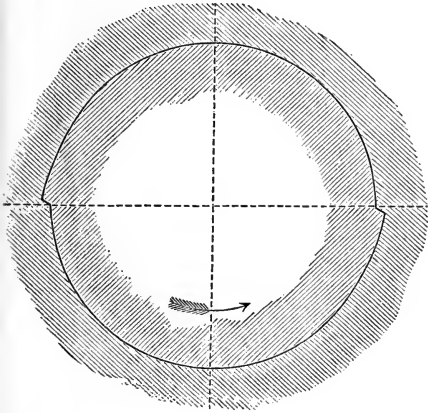
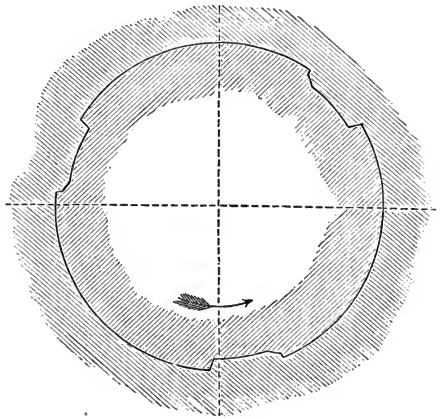


FIG. 322.



panding material at the base, allow the rifling to stop farther away from the chamber, so that the gun is not weakened by it at the point of greatest powder pressure. This feature is specially

FIG. 323.

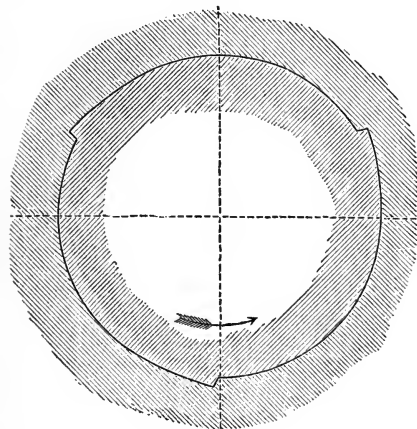
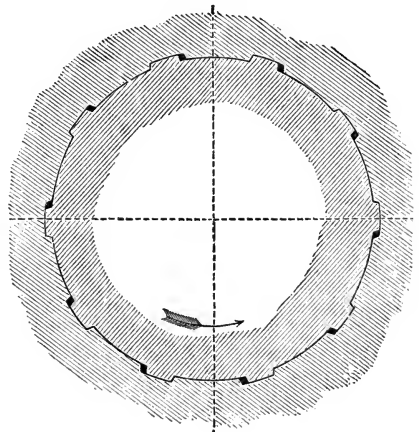


FIG. 324.

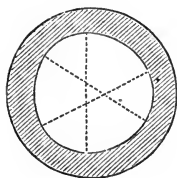


mentioned by Mr. Haddan, and is realized in the French system.

**667.** The angle of the side of the land with the bottom of the groove\* has the usual relation to strength, generally observed in mechanical construction. A sharp angle in a part subjected to strain and vibration is, in railway and machine practice, considered the beginning of a fracture. For this reason Captain Parrott, and others who understand the advantages of a radial bearing side, nevertheless round the angles of their grooves. In Commander Scott's rifling, the grooves are considerably rounded for an additional reason (669).

**668.** But this practice involves a more serious defect if carried too far. Mr. Conybeare recommends† the form of rifling shown in Fig. 325, because "the rifling should be free from re-entering

FIG. 325.



angles, which were a source of weakness in cast iron, and it should be such as to weaken the cylinder in the least possible degree. The form that would best answer these conditions, would be one that would bear the same relation to the three-grooved rifle, that the Lancaster oval did to the two-grooved rifle." And Mr. Hadden

specifies ‡ "three very broad, shallow grooves with little or no shoulder." These plans would certainly equalize the vibration, but they would greatly increase the wedging of the projectile—a known and serious cause of failure (656).

**669.** Another reason for rounding the groove, especially in case of the centering system, is to prevent the violent shock of the projectile when its bearing edges strike the rifling. Figures 326 and 327 are exaggerated to illustrate this. The stud or projection *a* bears and remains upon the side *d* of the groove, going in, and so leaves the windage *c* on the other side. In going out, the stud will have acquired a considerable velocity before it strikes

\*The rounded groove is obviously better for firing wads and expanding sabots, than the square groove.

† "Construction of Artillery," Inst. Civil Engineers, 1860.

‡ Jour. Royal U. Service Inst., Mar., 1861.

the side *e*, so that the blow will be violent and the commencement of the rotation instantaneous. But the stud, Fig. 327, not only

Fig. 226.

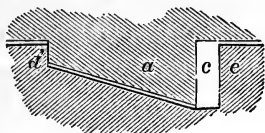
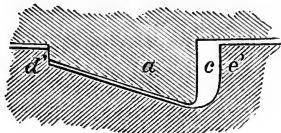


Fig. 227.



slides up the rounded groove without a blow, but lifts the shot into the centre of the gun—centres it. This is one of the special features of Commander Scott's system (535).

**670.** A still more violent blow is given by the shunt shot when the studs or bars strike the shallower part of the groove near the muzzle (552). One of the 300-pounders is said to have been seriously strained from this cause after five rounds. This result was predicted by Captain Fishbourne:\* “For greater accuracy, the rifling diminishes in diameter towards the muzzle, to nip the ribs; this necessarily increases the tension on the gun, to which it must prematurely yield.”

**671.** A 9-pounder brass gun, rifled on Lancaster's system, was grazed along the minor axis by the bearing of a 16-lb. shot and considerably indented 10 in. from the bottom of the bore in front of the seat of the shot, the evident cause being the sudden taking of the rifling. A similar smooth-bore after the same service (200 rounds) was indented 0·025 in., 58 inches down, and lightly grazed.

**672.** INCREASING TWIST.—A projectile is usually started forward before it begins to take the rifling, and usually commences its rotation at an infinitely low velocity, whatever the pitch of the rifling. Hence, the increasing twist is sometimes considered unnecessary. But it is equally true that a ball *begins* to move at an infinitely low velocity, whatever the quickness of the powder, but this does not prove that quick powders do not strain a gun unnecessarily. The experiments of Captain Rodman and others show

\* Jour. Royal U. Service Inst., June, 1862.

that the maximum pressure in a gun is not when the projectile starts, but when it has moved several inches forward. Then it begins to decline rapidly. Now if the projectile can reach this point of maximum pressure without being revolved at all, it may afterwards begin to acquire rotation, and to increase it up to any required velocity, without increasing the pressure of the powder-gas. But with the regular twist, the maximum strain due to rotating the projectile, including friction, is suffered by the gun at the time of its maximum strain due to translating the projectile.

The parabolic groove does not begin to rotate the shot, to an appreciable degree, until after the shot passes this point of maximum pressure. Then, as the strain due to translation falls, that due to rotation rises more gradually, and, if the shot is properly centred, without any shock or blow, whatever the final angle of the rifling. It would be practicable to make the rifling quite parallel with the bore until the maximum strain due to translation was over.

**673.** The greatest objection to the increasing twist is that it cannot be used with a long bearing of projectile. Indeed, the theoretical bearing, whether it is a soft metal ring, a strip or a stud, is infinitely short—a mere line—and practically, length of bearing is only obtained by a constant moulding of the projectile to the new angle of rifling. So that, 1st, the portion of the shot intended to take the grooves must be short: the Whitworth shot would wedge in grooves with increasing twist, and the Armstrong shot would strip at both ends. 2d, This portion of the shot must be soft as well as short, for if it cannot obtain, by changing its figure, more bearing on the grooves than a mere line, it will undoubtedly cut the grooves, thus increasing friction and soon ruining the bore.

**674.** In the absence of further experiments, it would hardly be safe to conclude that long bearings will not prove indispensable to the heavy projectiles and high velocities that will soon be required in iron-clad warfare. At the same time, projectiles made on the French plan, with only three zinc or brass studs, and Parrott and Blakely projectiles up to 300 lbs. weight, with narrow brass or



copper rings or disks, are rotated without being stripped, without abrading the grooves, and without the use of the fine grooving that would be injured by spherical shot.

**675. CHARACTER OF THE PROJECTILE.**—As to the direct influence of *lead-coated* shot upon straining the gun, various facts and opinions are given by the advocates of the respective systems.

The first result of a soft coating, whether it is expanded or compressed into the grooves, is stopping the windage. Gas which cannot escape without moving the shot, may accumulate to a bursting pressure before the shot moves at all, whereas a safety-valve, in the shape of a thin annular space around the shot, allows its inertia to be overcome before the pressure reaches the maximum. A heavier charge—the burning of more powder after the shot has begun to move—will of course make up the loss of velocity with a less strain upon the gun, because it has more time to act. Thus, all the advantages of slow-burning powder are realized.

**676.** A large windage in the case of spherical shot injures the bore and wastes power, in lodgments. But a shot like that of Commander Scott's (535) or the French shot (516), centred upon three points, may have any amount of windage without bounding in the bore; the windage has no more to do with the straight passage of the shot, than the size of a tunnel has to do with the straight passage of a train on the rails within it.

**677.** French artillerists have been convinced by various experiments, that windage not only prevents strain and delay from fouling, but increases accuracy. At the battle of Solferino, the French army was, in one instance, enabled to hold its position only by such rapid firing that there was no time to sponge out the guns. More recently, 1000 consecutive rounds have been fired from a French field-gun without sponging. Undoubtedly the escape of gas around the projectile prevented fouling in these cases. (649, note.)

**678.** But, if it is necessary, windage may be entirely stopped without excessive friction, by wads, or it may be sufficiently reduced in the original fitting up of the projectiles. A greased

wad, like that used in the Armstrong gun (551), or like Mr. Whitworth's, formed with the cartridge, is loaded without loss of time, and so thoroughly cleans the gun that a close-fitting *hard* projectile, not liable to be mutilated in handling, will always run home with ease. As the gun expands, the windage certainly increases; but the gun is weakened by the same expansion, and needs the extra relief.

**679.** It is the soft-coated shot, expanded or compressed into the groove of the gun, that cuts off windage suddenly and not without unnecessary friction.

**680.** The "leading" of the gun and other fouling due to soft-coated projectiles,\* is avoided by the mechanical fit of Commander Scott's, without the wedging and strain due to the shape of the Whitworth and Lancaster mechanically fitting projectiles.

**681.** The following objection to expanding projectiles is mentioned:† "The expansion of the lead at the rear of the projectile increases as the combustion of the powder becomes more perfect from the bore's warming; and hence, when the gun is weakened by being heated, an increased strain is thrown upon it by the sharper driving out of the lead into the rifling and more instantaneous closing of the windage. An iron shot, on the contrary, does not expand by the explosion, and hence gets more windage as the bore warms, so that its safety-valve gets larger as the gun expands and becomes weaker."

**682.** On the other hand, Mr. Bashley Britten, who has been more successful than any one else in England, with lead-coated, expanding projectiles, says of his system:‡—"All the hold of the rifling was on the five thin projections of soft lead,  $\frac{1}{16}$  of an inch thick. It was impossible they could offer sufficient opposition to the egress of the shell to cause the gun to burst. Some of these shells had been fired with such heavy charges of powder, that the lead had been entirely sheared away by the rifling, but this was

\* In experiments on board H. M. ship "Excellent" (1860) with the 110-pounder Armstrong gun, the wet sponge appeared to be more efficient than any other plan for removing the hard scale in the chamber.

† Jour. Royal U. Service Inst., December, 1861.

‡ "Construction of Artillery," Inst. Civil Engineers, 1860.

all that could happen. The shot could never get locked in the bore."

**683.** On the subject of soft-coated *vs.* mechanically-fitted projectiles, Sir William Armstrong says, in his evidence before the Select Committee on Ordnance, 1863:—"I very greatly prefer using a soft metal or a projectile which shall most probably be self-adjusting, so that if any part of it be at all too prominent, that prominent part shall bring all the other parts up to their proper bearing, causing every groove to take its proper share of strain; that plan has also the obvious advantage of saving the bore from any possible injury from friction; and I think, also, that it has the advantage of avoiding the possibility of there being any choke or jam, if I may so say, from fouling, or any other material lying in the bore. It obviates, also, the necessity of accurate workmanship, and has all the facility of construction which can be obtained from a tight-fitting projectile."

**684.** But the chief strain due to lead coating is confined to the compressing system—the Armstrong service system.\* Forcing a projectile coated with hardened lead through a bore of smaller diameter, not to speak of impressing 76 grooves in it at the same operation, produces the following results:†

1st. A direct bursting pressure by the projectile itself. And, compressing a lead covering soldered upon an iron shot, and very thin so that it cannot expand longitudinally, is quite different from upsetting a leaden bullet which simply changes figure in the same bulk.

2d. An increased powder pressure due to the detention of the shot by this stricture in the bore.

**685.** Soft brass is probably the best material for the bearing of a shot, whether made on the centering or the expanding principle. It does not stick to nor perceptibly wear the grooves of

\* The testimony before the Select Committee on Ordnance, 1863, was, however, on the whole, more favorable to the Armstrong than to the Whitworth system of Rifling and Projectiles.

† "The pressure of forcing a 25-lb. Armstrong shot slowly through the bore, by mechanical means, is said to have exceeded forty tons."—*Capt. Fishbourne, Journal Royal U. Service Inst.*, May, 1864.

the cast-iron Parrott gun after 1000 rounds (Table 91), and it is hard enough to revolve a projectile without fine grooving. It has been adopted for studs by Sir William Armstrong in his later shunt guns, and by other imitators of the French system of projectiles. Coating a hard projectile like Scott's or Whitworth's with brass, by modern chemical processes, would not be more difficult than coating them with zinc or lead.

**686. Liability of the Projectile to Injury.**—The advantage of the mechanically fitted, hard projectile in this regard is too obvious to require discussion. The heavy projectiles required in naval and sea-coast warfare are constantly liable to such falls and rough handling as would be quite sufficient to upset a soft coating and to prevent its entrance into either a breech-loading or a muzzle-loading gun. It should be stated, however, that the result of experiments on board the *Excellent*, to ascertain whether shot which had been dented by several months' exercise would *strip*, were quite satisfactory. The shots were fired at the 2600 yards target with good results.

**687.** The Ordnance Select Committee have objected even to the shunt gun with 6 grooves because it requires, according to Sir William Armstrong's system, 24 zinc studs of three different sizes on the projectile, some of which would probably be so injured by the falling or rough handling of the projectile that they would not enter their respective grooves. Sir William's alleged reason for so many studs is to prevent the injury of the bore by the contact of a rough cast-iron shot.

**688.** Lead-coated projectiles are liable to other kinds of injury. It has been remarked\* that "they will decay from damp, and those in store are decaying and the lead exfoliating. Many of you are aware that Lord Clyde sent home some bullets which could not be got down into the rifles at all. The lead had exfoliated, and the bullets were too large, and at Delhi several of our men were shot down while trying to force the bullets down the bore of their rifles."

**689.** Mr. Lancaster states that if the lead "is put on evenly

\* Jour. Royal U. Service Inst., 1862.

as in some projectiles in a thin form, and you pass one-eighth of the weight of projectile as a charge, the lead is given off from the projectile on the discharge of the gun in the shape of an amber-colored cloud, called lead fumes," and that "if you exceed a charge of one-eighth, and go to the charge of one-fourth, you are then exposed to another source of inconvenience, the positive melting and remaining of the lead in the bore of the gun; that is the result of the experiment at Shoeburyness alluded to by Colonel Lefroy."

**690.** The lead-coated projectile is also liable to injury in the gun. One of the requirements of modern shells is to fire molten metal.\* Even if the heat of the molten metal does not loosen the lead the expansion of the shell vastly increases the strain in forcing an Armstrong shell through the bore.

**691.** As to the stripping of soft-coated projectiles, Captain Fishbourne gives a table† to show that at moderate velocities, and with small increments of powder, the Armstrong projectile becomes less accurate just in proportion to its increase of velocity. This is attributed to the slipping of the lead. Commander Scott says,‡ "it has been found in practice by Sir William Armstrong—although he has the lead so closely confined, as already mentioned, that it cannot well escape—that, if he uses a larger charge than about one-eighth the weight of the shot, he loses accuracy; and that, if a stronger powder be used, the shot cuts its way out across the grooves. Expanding projectiles also, which answer well with a small charge from a weak gun, if put into a strong

\* "One of the most important things that has been very much overlooked is that of molten iron. The molten iron will fill up the shell and make it almost solid, so that you will at first have the full blow of the molten iron, and, unlike powder, the molten iron, if you can pitch it against any thing, will stream over it; it may stream into the port. This will be found, I believe, a very fearfully destructive weapon. The Armstrong gun will not throw it, that is, practically it will not do it. The small round shell contains too small a quantity to be effective. What we want is a large quantity; but even the less quantity sufficed to set a vessel on fire; and when it was tried, although they had the engines and every thing ready, as is well known to Admiral Halsted, they could not put the fire out.—*Com. Scott, Jour. Royal U. Service Inst.*, June, 1862."

† *Jour. Royal U. Service Inst.*, June, 1862.

‡ *Jour. Royal U. Service Inst.*, April, 1862.

gun and fired with a greater charge, are expanded irregularly.”

**692. Firing Spherical Shot from Rifled Guns.**—The importance of obtaining as many kinds of service as possible from one gun, is especially obvious in the case of iron-clads, since, with a given displacement, the guns must be few if the protection is adequate. Spherical shot are, for reasons already considered, more useful than rifle-bolts, in iron-clad warfare\* (267–269).

**693.** The bounding of spherical balls along the bore, is a well-known cause of injury to the gun; and the more the original surface of the bore is cut away by the rifling, the greater is the injury. The amount of this reduction of surface, in various British guns, is thus illustrated by Captain Fishbourne:† “Suppose the rectangle (Fig. 328) to represent the whole of the inner circle of the cylinder of the gun, then the smaller rectangles (Figs. 329 to 335) represent the quantities of this circle required to be left untouched in rifling, according to the respective plans named. The total amount of windage occasioned by the different systems of rifling, when the present round shot are fired, is given in Table 110. (See also Table 97.)

**694.** In the American rifled guns, generally, about half the surface of the bore is cut away by the rifling. The lands and grooves are of nearly or exactly equal width. The Parrott rifled gun fires spherical shot without difficulty. The windage is stopped by a *papier-maché* sabot.

\* “The comparison so often made between round balls and rifled shot, is seldom if ever made as respects their comparative cost and their value at close quarters, but only as respects their effect at distances too great to be correctly measured, or to produce any decisive result in actual warfare. The question, as regards naval ordnance, is not, however, between the round ball and the elongated shell, for the round ball is the most effective, and is far more easily handled and loaded at close quarters, and the rifle-shell is the best for bombardment; but between a mode of rifling that *will* admit of the use of the round ball at close quarters, and one that *will not* admit of its use. By adopting the former plan, good broadside guns throughout would be obtained for the decisive struggle; and this is the first and the main point to secure, and the cost of ammunition would be kept at its old rate; by the latter plan, the broadside power would be lessened, a mixture of different sorts of weapons rendered necessary, and the simplicity essential in naval warfare entirely lost.”—*Com. Scott, U. Service Inst.*, April, 1862.

† *Jour. Royal U. Service Inst.*, June 1862.

TABLE CX.—WINDAGE OF ROUND SHOT IN RIFLED GUNS.

Diameter of bore .....	6.375
Diameter of round shot.....	6.177
Windage .....	.198

	Area of Bore.	Area of Round Shot.	Area of Windage.
Original bore .....	31.92	29.97	1.95
Scott's .....	32.24	"	2.27
Britten's.....	32.55	"	2.58
Armstrong's shunt.....	32.97	"	3.00
Jeffery's.....	33.07	"	3.10
Lynall Thomas's.....	33.34	"	3.37
Whitworth's .....	34.62	"	4.65
Lancaster's.....	34.73	"	4.76

The above results have been obtained by measurements from the guns.

FIG. 328.

FIG. 332.

Original bore ..... 1.000



FIG. 329.

Jeffery's ..... .433



FIG. 333.

Scott's..... .855



FIG. 330.

Lynall Thomas's † .388



FIG. 334.

Shunt\* ..... .763



FIG. 331.

Whitworth's ..... .169



FIG. 335.

Blakely's..... .500



Lancaster's ‡..... .010



\* Cast-iron and steel balls are now fired in target practice, at Shoeburyness, from the 10½-in and 13-in shunt-rifled guns.

† This is for Mr. Thomas's expanding shot. His present system—3 narrow bands with all the rest of the bore cut away—would be nearly as defective as Lancaster's for the purpose under consideration.

‡ Mr. Lancaster's system has been considered well adapted to firing round shot, but upon special trial, the smooth bore 9-pounder was far more accurate than the oval bore when firing spherical shot. —British Artillery Records.

**695.** The rotation of heavy lead-coated bolts, fired with high charges, is only accomplished by a great number of grooves. Even 76 grooves do not always prevent the slipping of the hardened lead covering of the Armstrong 110-lb. shot. Sir William Armstrong admits that spherical balls would injure his multi-groove rifling, and suggests coating the balls with lead as a remedy.\* It may then be generally stated that the use of lead-coated projectiles, with high charges, would demand grooving the gun too finely to fire spherical shot without injury.

**696.** The rifled gun was found by Captain Parrott, and in the competitive trials of 1861 (Table 103), to increase the accuracy of smooth projectiles, especially when a wad or sabot was used to stop the windage. The sabot takes the grooving, and its friction upon the shot gives the latter a low rotation.

**697. Material for Armor-Punching Projectiles.**—A wrought-iron shot, a cast-iron shot, and a steel shot, of equal size and practically equal weight, fired at a given velocity, carry equal amounts of power, and must expend equal amounts of power before they come to rest. But upon striking armor, the steel shot produces the greatest local effect, and the wrought-iron shot the least. It has therefore been commonly said that the wrought-iron shot absorbs so much more power than the steel shot in changing its own figure, that it has less power left for destroying the armor. This explanation, however, does not appear to satisfy the conditions of the case.

**698.** 1st. “Action and reaction are equal.” Whatever power is employed in bringing either of the shots to a state of rest, is expended on the armor—no more, and no less, provided that neither shot breaks up. When a shot breaks up, a part of its power is employed in changing the direction of some of the pieces, and in sending them through space after they have glanced off from the armor.

**699.** 2d. The steel shot, the wrought-iron shot, and a shot of lead—the weights and striking velocities being the same—would

\* Jour. Royal U. Service Inst., June, 1862.



absorb equal amounts of power in changing their own figures, supposing the target to be perfectly rigid, and the shots to be only flattened,—not broken to pieces. Since power is force acting through space, a given power may be the result of a small force acting through a large space, or of a large force acting through a small space. Now the resistance of the steel shot to change of figure is so great, that *very small space and time* are required to absorb the whole power stored in the shot. But the wrought-iron shot will be flattened, and the lead shot will be mashed into a disk; that is to say, their resistance to change of figure is so small, that the force must be resisted through a *considerable space and time*.

**700.** 3d. If the steel shot were compressed only within its elastic limit, and the target could be supposed to be both rigid and immovable, so as to absorb no power, the shot would rebound with sufficient force to compress the powder gases into powder again, within the chamber of the gun, minus the resistance of the atmosphere; but no more nor less power would be required to compress the shot, in consequence of this rebounding, than would be required to flatten the lead shot into a disk that would not rebound at all. This is a question of the elasticity of metals.

**701.** 4th. Supposing the target incapable of change of figure, but capable of change of place: all the shots would move it equally.

**702.** 5th. But supposing the target to be capable of change of figure: the effects of shot upon the point of impact would not be as their power, but as the rate of applying their force. A small force acting through a large space and a large force acting through a small space, if the momenta ( $W \times V$ ) were the same, would move the rigid target equally, but they would not produce the same *local* effects on a target that was not rigid. This we know from all the results of iron target practice. The local effect of shots are not to be compared by their weight multiplied into their velocity, but by their weight multiplied into the square of their velocity. Now this would appear to be one of the reasons why the steel shot punches the target while a wrought-iron shot of equal velocity and weight does not punch it. The space through which the steel shot is compressed is so small that *the time occu-*

*plied in its compression is insufficient to allow the elasticity and ductility of the armor, around the point of impact, to come into service. The point struck is carried away before it has time to communicate the shock to the adjacent matter.*

**703.** 6th. Another reason why the wrought-iron shot produces less local effect is that its diameter, due to its flattening, is so much greater than that of the steel shot,—not at the moment of impact, but during the time of compression. And the resistance to punching is directly as the diameter of the punch.

**704.** 7th. The *cast*-iron shot has the same power to expend, but after devoting what is necessary to overcome its own elasticity and ductility, *i. e.*, after its fracture, a considerable amount of its remaining power is devoted to changing the direction of its own fragments and in carrying these fragments through space after they have glanced off from the target. So that a shot broken at impact delivers less power to the target than a shot that is only compressed.

**705.** 8th. But although the cast-iron shot communicates less power to the target than the wrought-iron shot, it communicates what it can, in so much less time than the wrought-iron shot requires for a given work, that the local—punching—effect is in favor of the cast iron.

**706.** Therefore, if moving the target bodily, if driving in the side of a vessel is the object, then the softer the shot, the greater the time that it can be made to occupy in coming to rest without fracture, the less power will it waste in local effect, and the more power will it reserve for the purpose intended.

**707.** But if the object is to punch the armor, then the harder the shot—the less the space and time required to compress it, the less will be the power wasted on the metal surrounding the point struck, and the greater will be the power devoted to punching.

**708.** These results are always observable in armor-plate experiments, but were very well defined in the following experiments at Shoeburyness:—A 150-lb. cast-iron ball fired with 35 lbs. of powder at the *Bellerophon* target (6-in. plate; 10-in. backing; 1½-in. skin) struck at the edge of a plate, indenting it 3½ in.,

making a crack 10 in. long, driving the bottom in  $3\frac{1}{2}$  in., and slightly bulging the skin. A 150-lb. steel ball—same gun and charge—struck the junction of two plates smashing an 11-in. hole through them, embedding itself in the backing, breaking one rib, bending another, and bulging and slightly cracking the skin. The cast-iron ball was smashed to pieces; the steel ball remained in the hole, a little upset and chipped, but nearly entire.

**709.** Two 150-lb. cast-iron balls fired at the *Minotaur* target ( $5\frac{1}{2}$ -in. plate, 9-in. backing,  $\frac{3}{8}$ -in. skin), with 50 lbs. of powder, made clean holes through the whole structure. A wrought-iron ball fired from the same gun, with the same charge, made a hole in the plate and stuck in it, but did not go through the backing. The local effect was very much less, although the distributed effect was greater than that produced by the cast-iron ball.

**710.** A wrought-iron ball, fired at Mr. Scott Russell's target with 50 lbs. of powder, was upset from 10.372 in. diameter to 12.969 in. major and 8.2 minor diameter. A 9-in. wrought-iron bolt,  $18\frac{1}{2}$  in. long, fired at  $7\frac{1}{2}$  and  $6\frac{1}{2}$  in. plates, with 50 lbs. powder, was upset  $5\frac{1}{2}$  in. A 7-in. wrought-iron bolt,  $16\frac{1}{2}$  in. long, fired at the Inglis 13-in. target, with 25 lbs. of powder, was upset  $6\frac{1}{2}$  in. A wrought-iron  $10\frac{1}{2}$ -in. ball, fired at a  $7\frac{1}{2}$ -in. plate with 45 lbs. of powder, was upset to 13 in. major diameter.

**711.** Low steel, either crucible steel or Bessemer steel (which is the cheapest), compressed under the hammer into balls, appears to be the best material for punching armor. The results of recent experiments in this direction are mentioned in a following chapter. A 68-pounder cast-iron ball, fired with 16 lbs. of powder at 200 yards range, does not indent a good  $4\frac{1}{2}$ -in. plate backed with 18 in. teak, more than  $2\frac{1}{2}$  inches. A steel shot of proper temper breaks through the plate under the same circumstances.\*

Mr. Whitworth's fabrication of steel shot and shells has been described.

**712.** The cast-iron shot used in armor-plate experiments and provided for iron-clad warfare by the U. S. Navy Department,

\* It is stated that the British Government has recently ordered 200 tons of steel shot.

are cast from a very superior metal melted in crucibles. They are often fired through  $4\frac{1}{2}$ -inch plates without breaking up, although they are always cracked and often flattened.

**713. Shape of Armor-Punching Projectiles.**—The shape of projectiles for range—the sharp point and the tapering rear—has been considered. (637.) The shape best adapted to penetrating armor is quite different in most particulars. But adaptation to long range is of minor importance in iron-clad warfare.

The following results of experiments on crushing shot of different materials and shapes are mentioned by Mr. Fairbairn :\*

Shots with cast iron flat ends crushed with...	55·32	tons per sq. inch.
“ “ Cast iron round ends crushed with	26·86	“
“ “ Wrought iron flat ends distorted		
by compression.....	74·00	“
“ “ Wrought iron round ends.....	49·89	“
“ “ Steel flat ends slightly compressed,		
but not crushed.....	120·27	“
“ “ Steel round ends crushed with.....	90·46	“

“From the foregoing we may conclude that the steel shot with flat ends would have followed the same law as the cast-iron, provided the apparatus had been sufficiently strong to crush the specimen, which was not the case.”

**714.** As to the effect produced upon armor by flat-ended and round-ended shot, Mr. Fairbairn says: “In order to ascertain the difference between flat-ended and round-ended shot, a series of experiments was undertaken with an instrument or punch exactly similar in size and diameter, and precisely corresponding with the steel shot of the wall-piece ( $\cdot 85$  inch. diameter), employed in the experiments at Shoeburyness. The result on the plates marked A, B, C, D, is given in Table 111.

**715.** “These figures show, that the statical resistance to punching is about the same, whether the punch be flat-ended or round-ended, the mean being in the ratio of 1000 ; 1085, or  $8\frac{1}{2}$  per cent. greater in the round-ended punch. It is, however, widely different when we consider the depth of indentation of the flat-ended

\* Proceedings Inst., Naval Architects, March 26th, 1863.

TABLE CXI.—RESISTANCE OF PLATES TO FLAT AND ROUND PUNCHES.

Character of plates.		Resistance in lbs.	
		Punch, flat-ended.	Punch, round-ended.
½-inch thick	A plates.....	57956	61886
	B plates.....	57060	48788
	C plates.....	71035	85524
	D plates.....	49080	43337
¾-inch thick	B plates.....	84587	98420
	D plates.....	82381	98571
Mean.....		67017	72754

punch, and compare it with that produced by the round-ended one, which is 3½ times greater. Hence we derive this remarkable deduction, that while the statical resistance of plates to punching is nearly the same, whatever may be the form of the punch, yet the dynamic resistance or work done in punching is twice as great with a round-ended punch as with a flat-ended one. This, of course, only approximately expresses the true law; but it exhibits a remarkable coincidence with the results obtained by ordnance at Shoeburyness, and explains the difference which has been observed in these experiments, more particularly in those instances where round shot was discharged from smooth-bore guns at high velocities.”

**716. Capacity and Destructiveness of Shells.**—In capacity for bursting charge, Commander Scott’s shell was found superior to all the others, in the competitive trial of 1861. (592.) Expanding projectiles are inferior to those mechanically fitted, in this regard; 1st, because the lead or other soft metal occupies so much space that the shell must be increased in weight and length (thus decreasing range and stability), to hold a given bursting charge; 2d, because the centre of gravity is thrown back, causing still more instability. The advantage of the centering shell—Scott’s,

the shunt, and the French shells—is obvious. In the Parrott shell, however, the expanding brass ring is so small that it adds little weight and practically occupies no space wanted for the bursting charge. The same is true of the shell used by Captain Blakely (571), and of other shells rotated by brass disks or rings.

In projectiles having much lead or soft metal on the base, the bursting charge is mostly in the front, instead of being in the rear, where it would allow a strong thick head for punching, and then throw the fragments forward.

**717.** The advantages claimed for the Armstrong segmental shell (550); which is a common shell filled with one or more concentric layers of small iron segments, are as follows: 1st, upon the explosion of the bursting charge, the segments, as well as the fragments of the shell are scattered in every direction; 2d, one kind of ammunition answers the purpose of solid shot, shell and shrapnel. It is stated, however, that the segments sometimes rust together and produce little more effect than common shells; and it is obvious that a shot already in pieces will be inefficient against armor or masonry. For field purposes, however, the segmental shell is, on the whole, successful.

**718.** There is no doubt that gun-cotton (see Appendix) will be exclusively employed for bursting charges; 1st, because it is so much stronger than powder, for a given weight and bulk; 2d, and chiefly, because the stronger the wall of the shell—the greater the resistance opposed to the bursting charge, the more violent the explosion, and the greater the number of fragments. Hence the tenacity that enables a steel shell to penetrate armor, is the very quality that makes the shell destructive when it explodes.

**719. Elongated Shot from Smooth-Bores.**—Upon this subject Mr. Michael Scott says\* that the chase near the muzzle determines the direction of the shot, that this may be made perfectly straight, and that the projectile may be made to fit the gun perfectly, and without any difficulty in case of breech-loading, but

\* "On Projectiles and Guns," 1862.

that "the real difficulties consist in adjusting the centre of gravity, and correcting the want of symmetry in the shot." The first defect Mr. Scott proposes to overcome by making the shot in two or three unbalanced parts united by a longitudinal through-bolt upon which they are turned round till the whole is in balance. Longitudinally, the centre of gravity is to be adjusted by simply placing it in advance of the centre of figure. The form of the shot is to be made symmetrical in the lathe.

**720.** It is probable that short shot fired from smooth-bored guns could be prevented from turning over by these means within the short ranges required for effective iron-clad warfare, and that the weakening of the gun by rifle-grooves and the strain due to rotating the projectile could thus be avoided. Such projectiles, however, if effective, would not require a special armament. Either the ordinary smooth-bore or a rifle adapted to firing round shot would fire these balanced projectiles; and the rifle would have the same advantage that it has over the smooth-bore in firing round balls—the friction of the wad or sabot (which must take the grooves), against the shot, would give the latter a little rotation and proportionately increase its accuracy.

**721.** Various schemes have been devised for rotating smooth projectiles. When this is done by wings, or their equivalents, acting against the air after the shot leaves the gun, the velocity of rotation has been found insufficient; more than this, the accuracy of such projectiles has appeared to be more impaired by the resistance of the air than that of ordinary projectiles which received their spinning motion before leaving the gun.

**722.** But it is possible that projectiles may be made to spin with sufficient velocity to insure accuracy by the action of the powder-gas, *before* they leave the gun; if such projectiles are centred, they should move with as much accuracy as others of similar shape *after* leaving it.

**723.** Among the plans proposed for this purpose, Mr. Bessemer's is illustrated by Figs. 336 and 337. Channels, *m*, formed in the exterior of the projectile, conduct the powder-gas to the front, *b*. The forward end of these channels is sharply inclined so

that the gas escapes nearly at right angles with the bore, and thus causes the shot to *recoil* in an opposite direction. No adequate test has been made of this plan; in some preliminary experiments, Mr. Bessemer found that an elongated shot fired from a 12-pounder smooth-bore did not turn over in going 900 yards, and that its accuracy was much greater than that of spherical shot from the same gun. The shot made  $2\frac{1}{2}$  revolutions in the gun (8 feet length of bore), charge, 2 lbs.

**724.** The Mackay projectile operates on a similar principle. The inventor's patent specification states that "the improvements consist in the application and use of diagonal grooves formed in the interior surface of the gun at a greater angle than hitherto

FIG. 336.

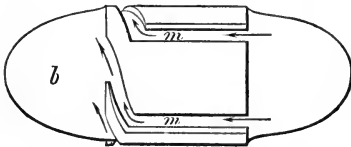
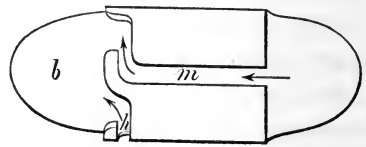


FIG. 337.



Bessemer's shot for smooth-bores.

employed, which are to act as windage grooves, so that the powder and gas passing down such grooves encircling the projectile shall have a longer distance to travel than the projectile, and also cause the projectile to revolve round its longest axis at a high rotation as it passes down the gun. The projectiles are not allowed to enter or fit these grooves as in rifles, but simply to pass down the smooth surface in which the grooves are formed." The inventor also specifies means of balancing the projectile.

This system has some notoriety in England, and is understood to have given good results.

**725. Conclusions.**—Guns for naval and sea-coast warfare are required to punch and smash armor, to breach masonry, often at long ranges, to shell distant works and encampments, and vessels that are not iron-clad. But since vessels having practicable size and draught, and adequate protection, can only carry a limited number of the large, strong guns required for these purposes, each



gun, or the greater part of a ship's guns, should be capable of every kind of service.

Therefore, 1st, the rifling should leave so much of the original bore untouched, that it will not be injured by spherical shot; 2d, it should have a tolerably rapid twist for the purpose of sustaining and giving accuracy to long projectiles; 3d, it should oppose the least possible resistance of wedging and friction to the projectile, so that the highest possible velocity may be attained.

The rifling decides, to a certain extent, the character of the projectile. A small number of grooves (to fire spherical shot well) and a rapid twist, are likely to strip both the compressed projectile, for that must be soft-coated, and the expanded projectile, for the part of that which takes the rifling must be tolerably soft and quite short. But the centering system admits of a hard-metal bearing, as well as a soft-metal bearing, in cases when the latter is at hand or is from any cause desirable.

So that as far as the number and the twist of the grooves are concerned, the centering system would appear to be the best. Wedging and friction due to the shape of the grooves may be equally well avoided in all the systems.

But the best kind of projectile is to be further determined by other considerations, independent of the rifling.

The compressing system has three principal defects:—1st. It unduly strains the gun by suddenly stopping the windage, by fouling, and by forcing the shot into a bore of smaller diameter. 2d. It reduces the velocity of the shot by the compression and the fouling. 3d. The increasing twist is impracticable, from the great length of the soft-metal coating. 4th. The soft-coated projectile is liable to injury in handling and in store. 5th. The windage is entirely stopped, thus increasing strain, possibly decreasing accuracy, and rendering the use of time-fuzes uncertain. 6th. Soft coatings are likely to be so much loosened by the heat of molten metal that shells could not be charged with it. 7th. The compressed shot must be fired from a breech-loading gun.

The advantage of the compressing system over the expanding

system, but not over the centring system, is, that it holds both ends of the shot in the centre of the bore during its passage. If a soft-bearing surface saves the bore, it is equally applicable to the expanding and the centering systems.

The chief defects of the expanding system are:—1st. The centre of gravity is almost necessarily behind the centre of figure; and, 2d, the bearing of the projectile is behind the centre of gravity; both of which features tend to cause inaccuracy. 3d. The sudden stopping of the windage unduly strains the gun. 4th. Fouling and the violent wedging out of the soft metal to fill the grooves, are obvious sources of strain. 5th. The shot is liable to injury, and the disadvantages in firing time-shells and shells filled with molten metal, are the same as in the case of compressed projectiles.

The expanding system allows the use of brass or copper bearings which will take the increasing twist very well with moderate charges, and which appear to injure the grooves less than pure or hardened lead.

The centering system, as practised by Mr. Whitworth, Mr. Lancaster, and others, who use grooves that the shot can wedge in, strains the gun unduly, and decreases the velocity of the projectile. But the French system, and particularly the system of Commander Scott, bring the minimum wedging strain and friction upon the gun, place and hold the projectile in the centre of the bore without shock, allow its centre of gravity to be in the centre of figure, and support the projectile at or on both sides of its centre of gravity, thus promoting velocity and accuracy. The centering system may further decrease the strain upon the gun by allowing windage and the increasing twist. The hard projectile is not liable to injury in transportation or in store, and it can carry molten metal with safety and light time-fuzes with certainty.

For field-guns, various expanding projectiles are successful, and for heavy guns, the Parrott projectiles and those used by Captain Blakely have done good service. But the obvious mechanical advantages of the centering system, as well as the good results of the shunt guns, the guns rifled upon Commander Scott's plan, and especially the results of the French guns, indicate that this system

will be adopted for heavy ordnance. The best results, including the firing of spherical shot, that have been attained with heavy rifles, are those of the 10·5 in. and 13·3 in. guns constructed on this plan. In these guns the projectile is centred by brass studs substantially on the French plan. The distinctive feature of the Armstrong shunt system—compressing the shot at the muzzle—is being gradually abandoned.

TABLE CXII.—VELOCITIES OF PROJECTILES,  
As determined by the Electro-Ballistic Pendulum; and Particulars of Guns. Compiled from British and U. S. Artillery Records.

GUN.	Rifling, Turns.	Length of Bore.	Diameter of Bore.	Diameter of Shot.	Weight of Charge.	Character of Projectile.	Weight of Shot.	Velocity.
RIFLES								
Armstrong 600-pdr.....	...	...	...	...	...	.....	lbs.	feet per second.
Armstrong 300-pdr.....	1 in 65	11.81	10.5	...	75	Round end; zinc studs and ribs.	300	1715 initial.
"	"	"	"	...	45	"	301	1293.1 at 200 yards.
"	"	"	"	...	"	"	288	1318.4 at 200 yards.
"	"	"	"	10.337	"	Solid sphere.	163	1627 at 508 feet.
"	"	"	"	...	"	Round end hollow.	230	1400.6 at 563 feet.
"	"	"	"	...	"	Round end solid.	307	1228.4 at 563 feet.
Armstrong 150-pdr.....	...	19.	7.52	7.50	40	Round end shot.	150	{ 1770 initial; 1485 at 1000 yds.
Whitworth 150-pdr. 7-in.	1 in 18.57	19.5	6.4 & 7	.06*	27	Flat-fronted shot; no soft metal.	151	1170 at 780 yards.
"	"	"	"	"	25	"	150	1241 at 563 feet.
"	"	"	"	"	25	"	131.3	1268 at 780 yards.
"	"	"	"	"	27	"	130	1227 at 780 yards.
"	"	"	"	"	25	"	130	1268 at 580 yards.
"	"	"	"	"	27	"	129.5	1204 at 780 feet.
"	"	"	"	"	23	"	129	1278.5 at 580 yards.

\* Windage on half sides.

Armstrong 110-pdr.....	14.2	7.	No windage.	11	{ Round end shot; lead coating } compressed.	174	892 initial; 890 at 30 yds.; 885 at 100; 877 at 200. 780 initial.
"	"	"	"	10		200	
"	"	"	"	12		150	995 in 1; 992 at 30 yds.; 983 at 100; 974 at 200.
"	"	"	"	16		111	1307 initial; 1300 at 30 yards; 1287 at 100; 1271 at 200.
"	"	"	"	14		111	1211 initial; 1205 at 30 yards; 1193 at 100; 1178 at 200.
"	"	"	"	12		111	1125 initial; 1120 at 30 yards; 1109 at 100; 1094, 200; 980, 1000.
"	"	"	"	12		103	1166 initial; 1160 at 30 yards; 1149 at 100; 1133 at 200.
"	"	"	"	16		68	1433 initial.
"	"	"	"	18		60	1581 initial.
Parrott 100-pdr.....	10.3	6.4	"	10		100	2154 initial.
"	"	"	"	10		80	1374 initial.
"	"	"	"	11		80	1405 initial.
"	"	"	"	10		32	1829 initial.

TABLE CXII.—(CONTINUED.)

GUN.	Rifling-Turns.	Length of Bore.	Diameter of Bore.	Diameter of Shot.	Weight of Charge.	Character of Projectile.	Weight of Shot.	Velocity.
RIFLES.	calibres.	calibres.	in.	in.	lbs.		lbs.	feet per second.
Armstrong 70-pdr. Shunt	1 in 45	14.8	6.4	6.25	11	Round end shell.	74.6	1318.7 initial; 1311.7 at 90 feet.
"	"	"	"	"	10	"	74.4	1259 initial.
Whitworth 70-pdr.....	1 in 18.18	11.8	5 & 5.5	0.35*	12	Flat-fronted shell; no soft metal.	68.5	1275.8 initial.
"	"	"	"	"	13	"	81	1107 at 580 yards.
"	"	"	"	"	13	"	72.31	1148 at 580 yards.
Armstrong 40-pdr.....	1 in 36.5	17.2	4.75	No windage.	5	Round end; lead coat'g compressed.	41	1174.8 initial; 756 at 2000 yards.
Parrott 30-pdr.....	1 in 34.04	28.5	4.2	"	3.75	Conical end shell; brass ring.	28	1215 initial.
"	"	"	"	"	4	"	"	1436 initial.
Armstrong 12-pdr.....	1 in 38	24.5	3.	3.07†	1.5	Round end shell; lead compressed.	11.75	1238.7 initial.
"	"	"	"	3.01†	2.92	"	11.69	1740 initial.
SMOOTH-BORES.								
Rodman 15-in. Army...	None.	11.	15.	14.74	50 cake.	Spherical shell.	330	1118 initial.
"	"	"	"	"	40	"	315	1250 initial; 1210 at 100 yards; 1160 at 200; 1080, 400; 890, 1000.
U. S. Navy 15-in. Gun..	"	8.66	15.	14.80	60	Spherical cored shot.	400	1480 initial.
Horsfall 13-in. Gun.....	"	12.2	13.014	12.614	74.40	Spherical shot.	279.50	1631 initial.

\* Windage on half sides.

† No windage.

Horsfall 13-in. Gun.....	None.	12.2	13.014	12.883	74.40	Spherical shot.	284.8	1299.2 at 800 yards.
Armstrong 150-pdr.....	"	11.9	10.48	10.41	40	"	150	1726 initial; 1710 at 30 yds.; 1645, 100; 1586, 200; 1168.3, 1000.
"	"	"	"	"	90	"	150	2010 initial.
U. S. 10-in. Columbiad..	"	10.55	10.	9.87	18	Spherical shot.	127	1315 initial; 1270 at 100 yd.; 1217, 200; 1150, 400; 957, 1000.
"	"	"	"	"	18	Spherical shell.	101	1475 initial.
British 87 cwt. 10-in. Gun	"	10.9	10.	9.84	12	Spherical hollow shot.	88.31	1292 initial.
Armstrong 100-pdr.....	"	...	9.21	9.08	25	Spherical shot.	113	1461.8 at 563 feet.
British 95 cwt. 68-pdr...	"	14.	8.12	9.84	16	"	66.25	1292 initial.
"	"	"	"	"	16	"	66	1579 at 30 yards.
"	"	"	"	"	16	"	66	1488 at 100 yards
"	"	"	"	"	16	"	66	1422 at 200 yards.
"	"	"	"	"	16	"	66	988 at 1000 yards.
"	"	"	"	"	16	"	66	341 at 2000 yards.
British 65 cwt. 8-in. Gun	"	13.	8.05	7.85	10	Spherical shell.	46	1487 initial.
U. S. 8-in. Columbiad...	"	11.	8.00	7.88	10	Spherical shot.	65	1375 initial.
"	"	"	"	"	10	Spherical shell.	50	1570 initial.

## CHAPTER VI.

## BREECH-LOADING.

**726. Advantages and Defects of the System.**—This subject can hardly be considered of the most immediate and paramount importance, for various reasons :

**727.** *First*, the practice: No efficient breech-loading cannon of large calibre has been introduced into any service. In the United States there is not even breech-loading field-artillery in service, and no experiments have been made in this direction with heavy guns, either for the army or for the navy.

In Russia, the solid-steel and the hooped guns constructing for naval, garrison, and siege purposes, are exclusively muzzle-loaders, as were the old cast-iron guns which they are intended to replace.

**728.** In France, one of the best systems of breech-loading has been applied to naval ordnance, but not to calibres exceeding 6·5 inches; and these guns can hardly be called formidable when compared with the British steel-lined 9-inch and 10·5-inch guns, the American hollow-cast 10-inch Parrotts, and 10, 11, and 15 inch Rodmans and Dahlgrens, or the 8, 9, and 11 inch Russian steel cannon, all of which are muzzle-loaders.

**729.** In England, the largest service breech-loader is the 110-pounder Armstrong, a 7-inch gun which burns only 12 lbs. of powder, which cannot fire round shot, and which is far inferior, when measured by penetration in armor, to the old cast-iron 68-pounder. The 110-pounder is no longer considered by the Armstrong *party* as a proper gun for iron-clad warfare. No service breech-loading guns are constructing in England, either for the army or for the navy.

**730.** The practice in other countries than those mentioned is of less importance, for obvious reasons. In England and in America, the subject of ordnance has received more aid from



mechanical engineers, and from ample appropriations, than in all other countries; and neither in England nor in America has breech-loading been attempted with the heaviest ordnance. In one or two European States the Wahrendorff and Cavalli breech-loading guns are employed to some extent; but these are generally cast-iron guns of limited power. Mr. Krupp has made a few very good steel breech-loaders on his own plan (767) for European governments. The guns furnished to these, and to other governments, by Captain Blakely, and the larger hooped guns generally, as in Spain, for instance, are muzzle-loaders. Breech-loaders are almost exclusively field-guns. So that the best practice is clearly unfavorable to the system.

**731.** The opinion of those who have had the most experience, although it must be admitted that the experience was chiefly with a very troublesome apparatus, is thus expressed by the Select Committee on Ordnance, in 1863: "The preponderance of opinion seems to be against any breech-loading system for the larger guns."

**732.** *Second.* The grand defect of the best breech-loading guns has been inadequate material. Although Mr. Krupp's steel breech-loaders up to 7 inches calibre have shown extraordinary endurance, it by no means follows that this best material would stand proportionate charges in guns having twice the calibre, and burning four times the powder. And even if the material were adequate, the cost of a durable breech-loading apparatus would buy another muzzle-loading gun of the same material. To add as much strength to the reinforce as a transverse mortise would take away; to construct and fit up interchangeable hollow screws or sliding stoppers; to fit and renew gas-checks; to apply opening and closing apparatus, which cannot be very simple, but which must be very strong and durable; to fabricate, keep clean, and maintain all these parts on such a plan that two or three men can manipulate them with ease and certainty, and without unusual risk of disaster from excitement or carelessness, and of such size and strength that projectiles of 300 to 500 lbs. weight can be fired with 50 to 70 pounds of powder, must necessarily

involve an outlay which is only to be justified by greatly increased efficiency, if, indeed, it can be accomplished at all with the present materials.

**733.** *Third.* An objection to very rapid firing from large guns is straining the gun from the heat of the inflamed gases. (336.) "The tendency of all guns to absorb the heat developed during explosion puts a limit to all extreme rapidity of fire. During the late Russian war, at Sweaborg, it was found necessary to allow an interval of five minutes between each discharge of a mortar, and yet the whole of them burst after an average of 120 shots."\*

It is practicable to cool the gun after each discharge by a large quantity of water injected by machinery (748). But the same machinery that injects water may ram home the ammunition, however bulky, in less time than that required to adjust the simplest breech-loading apparatus *by hand*.

**734.** Other objections, which may not be serious in all cases, and which do not outweigh any substantial advantages, are as follows: There are more parts to be damaged. Captain Coles said before the Select Committee on Ordnance, in 1863: "In muzzle-loading there is the simple chance of bursting; whereas, in the Armstrong there are five different parts, upon any one of which getting out of order, your gun is *hors de combat*." The accumulation of dirt, and the necessity of constant lubrication, are at least embarrassments in action. The increased weight of the breech-loader is thus mentioned by Sir William Armstrong himself:† "Breech-loading guns of any given power would be heavier than muzzle-loading guns; and now that we are so limited for weight, in order to get the necessary power to produce the required effect upon armor-plates, its increase of weight becomes a very formidable objection." Want of safety is very fairly urged against breech-loaders, of which the vent-pieces and other parts blow out in service; but it cannot be fairly urged against the system.

\* "Ordnance and Naval Gunnery," Simpson, 1862.

† "Report of the Select Committee on Ordnance," 1863.

**735.** *Fourth.* The grand advantage claimed for the breech-loader is, that it fires faster. More shots can, undoubtedly, be got out of it. But in cases where the aim is of any importance, it is not the loading, but the sighting of the gun that takes time.\*

All guns used in iron-clad warfare, afloat or ashore, and all naval guns, must fire either from an unstable platform, or at a moving object, or both, which requires a readjustment of the line, or the elevation at every round. There are, indeed, likely to be cases of a siege-gun recoiling on a chassis so firm that its position would not require alteration, or an iron-clad battle at such close quarters that all projectiles would strike the enemy. In such cases, every thing might depend on mere rapidity of fire.

**736.** But there is neither practice nor experiment to prove that very heavy guns can be loaded by hand, more quickly from the breech than from the muzzle. Even in the smaller pieces, the breech-loader is admitted to possess no practical advantage in this regard. Before the Select Committee on Ordnance, in 1862, Mr. Whitworth said that he was not a partisan of the breech-loader, "the muzzle-loading gun being so much more simple, and equally rapid for loading." Sir William Armstrong said before the same Committee in 1862, and said again in 1863, that "a rifled gun loaded at the breech may be more rapidly fired than a rifled gun loaded at the muzzle, because the fouling of the bore presents no impediment to the insertion of the bullet when introduced from behind; but as compared with smooth-bored ordnance, of the ordinary description, there is probably nothing to gain in point of quickness of firing." The practice with nearly all the rifled projectiles used in the present war, and with many experimental projectiles abroad, would indicate that Sir William's objection to muzzle-loading rifles is unfounded. The advantages of smooth-bores for iron-clad warfare have been considered; as to

\* "The facility of loading, and rapidity with which a breech-loading piece can be fired, are spoken of as advantages of great importance, but these amount to nothing; for the gun, after every discharge, must be relayed in order to obtain accuracy of aim, and it is the pointing of a gun, not the loading, that consumes time."—"*Ordnance and Naval Gunnery*," *Simpson*, 1862.

smooth-bored, Sir William thinks nothing is to be gained by breech-loading.

**737.** Two batteries of 9-pounder Armstrong breech-loaders, of the most approved form, fired 100 rounds per gun in about 100 minutes, in experiments at Dublin. This included the time occupied in moving the batteries six times and in putting up the targets twice. On one occasion 17 consecutive rounds were fired in  $8\frac{1}{2}$  minutes, or at the rate of 2 rounds per minute. On another occasion, at Southsea, with old Armstrong breech-loading 9-pounders, and old ammunition, 123 rounds were fired in 138 minutes, including 30 minutes' delay, or at the rate of 1 round in .87 minutes. Another 9-pounder was fired 40 rounds in 31 minutes, or at the rate of 1 round in .77 minutes.\*

**738.** Muzzle-loading field-cannon are fired more rapidly. "Field-cannon can be discharged, *with careful aim*, about twice per minute; in case of emergency, when closely pressed by the enemy, canister-shot may be discharged about 4 times per minute. The 12-pounder boat-howitzer of the navy, with experienced gunners, can be discharged at the rate of 16 times per minute."†

**739.** The most rapid firing that is recorded, from the heaviest breech-loader, is 50 rounds from a 110-pounder wedge-gun (760), which is obviously more quickly manipulated than the service 110-pounder, in 21 minutes, or at the rate of 1 round in .42 minutes.

The heaviest service ordnance in the world,—the U. S. 15-inch columbiad,—is loaded and fired by hand when mounted on the wrought-iron barbette carriage, in 1 minute 10 seconds. Traversing the chassis  $45^\circ$  requires an equal amount of time.

The *Monitor* 15-inch guns have been fired, mounted as they are in small turrets, with but 30 inches space between the muzzle and the muzzle-box, in 3 minutes. The 400 to 425 lb. balls had to be raised by a fall, and the rammer was jointed and run out through a hole in the port-stopper. Training and aiming the

\* "Report of Select Committee on Ordnance," 1863.

† "Ordnance and Gunnery," Benton. 1862.

*Monitor* guns is a much longer operation. The 600-pounder Armstrong was fired during the first experiments, once in 10 minutes; the 8-in. Columbiad, experimentally, once in 2 minutes.

**740.** It is probable that a very heavy gun can be the more quickly loaded from the *muzzle* for various reasons. In either case the ammunition must be lifted to the height of the bore; in either case it must be inserted into the bore. So far, the slight advantage of the breech-loader is that the ammunition has to be moved laterally but two or three feet, while the muzzle-loaded ammunition has to be moved the whole length of the bore. But in manual operations especially, it is not so much the continuance of effort already commenced, as it is changing the direction and means of effort, that consumes time. Ramming a charge a few feet farther, when the apparatus is adjusted, is not a serious disadvantage of the muzzle-loading system. Again, the gun would be almost constantly elevated, so that gravity would help the movement of the muzzle-loaded ammunition, and retard that of the other. Were the gun depressed, or were the ship rolling, the breech-loaded spherical shot, at least, would *also require a wad to be loaded from the muzzle*. Fixed ammunition, with a sabot tight enough to retain the projectile in its place, would be too heavy and too tight for hand-loading. Again, a breech-loading gun, in a small turret or a narrow-waisted vessel or casement, would have to be run partially out to be loaded, while the recoil drives the muzzle-loader to the proper position for loading.

**741.** But the grand disadvantage of the breech-loader is yet to be mentioned. There is always a hole open in the muzzle-loader, for the insertion of the charge. No time is wasted in taking the gun apart and putting it together again, for that purpose. But the removal and insertion, or even the double movement of vent-pieces, screws, or wedges, which are at least as heavy as the ammunition, and which will occasionally stick fast for many minutes, is just so much labor *in addition to* raising and inserting the charge. When all the parts are so light that few enough men to keep out of each other's way, can handle them as fast as they would naturally move their arms, the case is entirely changed.

**742.** *Fifth.* As to the convenience of loading from the breech in narrow turrets and casements: the *Monitor* guns recoil but four feet, bringing the muzzle but 30 inches out of the muzzle-box. Although the operation of loading and firing has been experimentally performed in three minutes, by means of a jointed ramrod run out of a hole in the port stopper, the two men who have room to work it, can hardly be expected to send the 50-lb. cartridge and 400-lb. shot home at that rate, throughout an action, especially if there is any rolling. The breech-loader offers no better facilities for hoisting and entering the ammunition, and saves but little time in the ramming home (740) when the muzzle does not project through the port, as in the *Monitors*. When the gun is run out of the port, ample room is of course left behind it, but the muzzle is then exposed to the enemy's fire. In casemates only as wide as the length of the gun, the piece may be loaded at the breech, but obviously cannot be loaded at the muzzle. And there is perhaps greater safety in loading at the breech. This whole subject, however, is relieved by the use of machinery for working heavy guns, and will be further referred to. Captain Coles, who is certainly an advocate of whatever will advance the turret system, uses muzzle-loaders in his vessels, and testified before the Select Committee on Ordnance in 1863, that he preferred and had asked for muzzle-loaders to arm the *Royal Sovereign*. Captain Ericsson has recently constructed muzzle-loaders (127) for his best turret-ships—the *Puritan* and the *Dictator*.

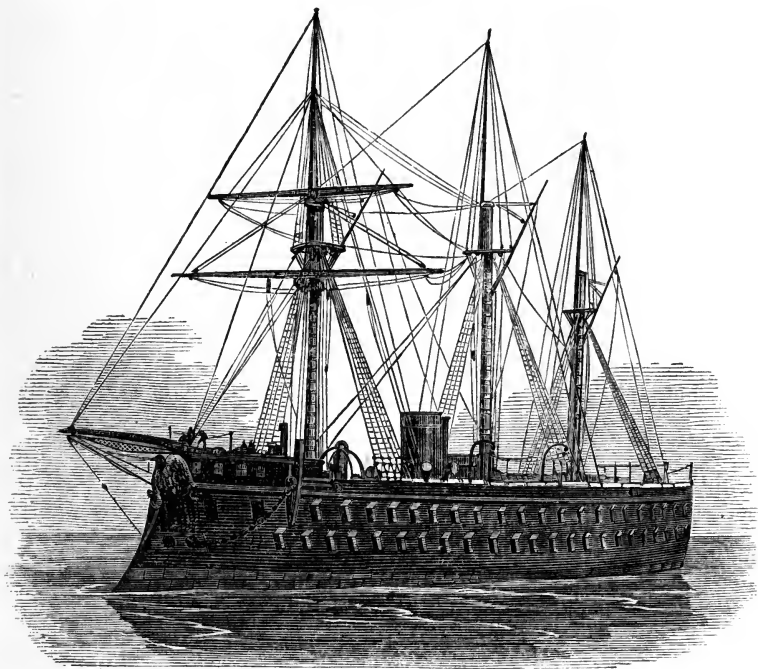
**743.** On the whole, the heavy breech-loader cannot answer, it should seem, the grand purpose of the small breech-loading arm—rapidity of fire. Its other advantage—convenience of loading in close quarters, may not be of great importance. But its grand, and in the present state of the art, remediless defect—weakness—is likely to outweigh all its advantages.

**744.** It will be suggested that machinery be applied to the movement of heavy breech-loading apparatus and to the ammunition. But less machinery will produce the same result in the case of the muzzle-loader, for there, the ammunition only, has to

be moved. And if the machinery to load the muzzle-loader is disabled, the gun can still be loaded by hand, while if the breech-loading machinery is disabled the chances are that the breech cannot be made tight again—certainly not without clearing away the wreck and adjusting new parts.

**745. RAPID FIRING BY MACHINERY.**—The advantages of rapid firing are too obvious to require explanation. The gun-carrying parts of manageable ships must be small in extent if they are thick

FIG. 337 A.

French iron-clad two-decker, *Solferino*.

enough to be invulnerable; so that a few guns must do the work of a broadside. The inadequate offensive power of such vessels in which the guns are worked by hand, in the *Monitors* for instance, is not due to a small number of guns but to a small number of *projectiles fired*. If a ship carrying six 20-ton guns can fire each piece once a minute, while a ship of the same size and dis-

placement, carrying thirty similar guns, can only fire each piece once in five minutes, then, other things being equal, the latter ship must have 480 tons less armor over five times the area to be protected.

**746.** The practice in some quarters would seem to indicate that a greater number of *guns* is the only consideration in naval warfare. The French, for instance, have sacrificed armor-carrying power, increased top-weight, enlarged the space to be fired at and otherwise impaired the defensive qualities of their recent frigates, all for the purpose of piling up two stories of little 30-pounders. These 30-pounders, fired in rapid salvos, are not indeed to be despised, especially by ships that can fire but two guns in a quarter of an hour. But it is strange that when so many millions have been spent in the widest departures from the old systems of ship-building, ordnance and projectiles, not a single adequate experiment has been attempted, for the purpose of increasing the rapidity of fire from heavy guns, and thus vastly increasing the protection of vessels without decreasing their offensive qualities. Doubling the rate of discharge, other things being equal, would quadruple the resistance of armor, because it would reduce the number of guns and the length of battery one-half, thus doubling the thickness of the remainder; and the resistance of armor is as the square of its thickness.

**747.** But the heating of the gun, urged against breech-loading, on the supposition that breech-loading would increase the rapidity of firing, may be as well urged against any means of promoting the rapid discharge of cannon. Indeed, this is the only serious objection, for it has been admitted that accurate *aim*, which takes more time than hand-loading even, is of small importance at very close quarters; and the faster of two opposing vessels has the power to make the fighting as close as possible.

**748.** The heating of a gun, however, can be prevented by the most certain means—the introduction of water by machinery. So long as it is done by machinery, any necessary quantity of water can be injected; and flooding the gun at the instant the charge has left it, must, of course, abstract the heat before it has penetrated much beyond the interior surface. Thus the proper initial



strains of the gun will not be disturbed, and the bore will be thoroughly cleaned.

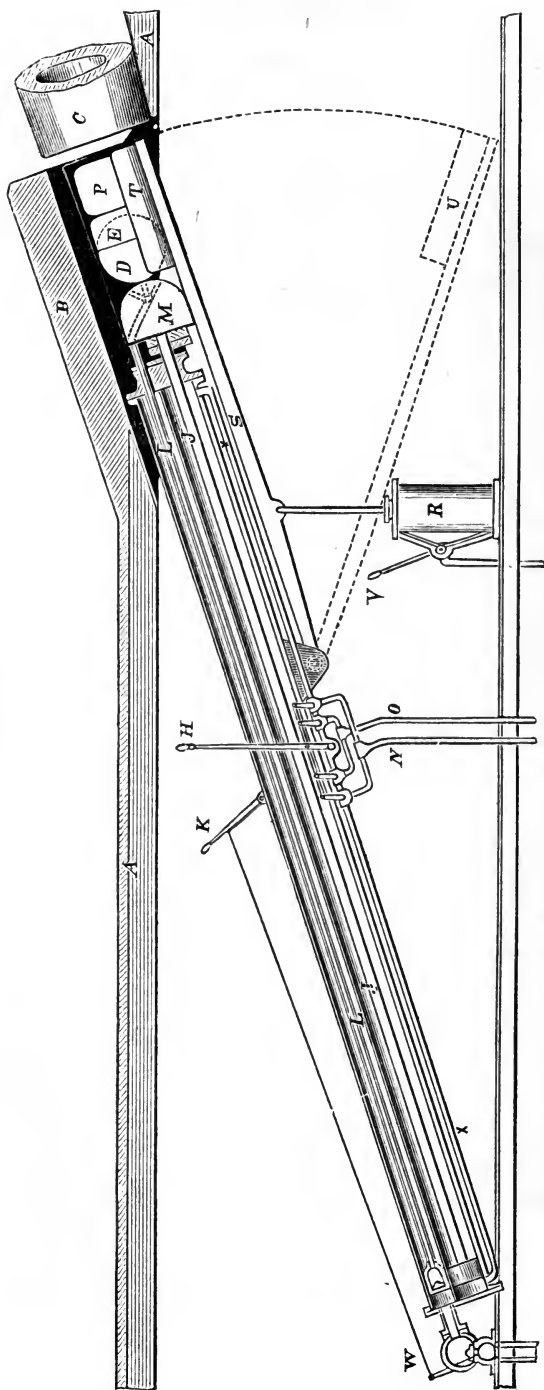
**749.** Mr. Edwin A. Stevens, of Hoboken, has devised a very simple arrangement for cooling guns with water, to be applied in connection with his steam-loading apparatus.\* This will be further referred to.

**750.** Loading by steam with great rapidity, has been actually practised by Mr. Stevens. The apparatus was rudely constructed, but this only shows that delicate parts and nice adjustment are unnecessary.

Fig. 338 illustrates the machinery as designed for the 15-in. guns of the *Stevens Battery*. The experimental apparatus (to be further considered) consisted of the same parts, excepting the water-cylinder and the steam-cylinder, *R*, for hoisting the ammunition. The muzzle, *C*, of the gun being depressed to receive the charge, the cartridge, *P*, and the ball, *D*, connected together by the wooden sabot, *E* (which also prevents the ammunition slipping back) are rolled (not lifted) upon the scoop, *T*, when the latter is in the position *U*. The scoop is then raised to the position shown, by means of the lever, *S*, and the steam-cylinder, *R*. By moving the handle, *H*, steam is then admitted to the long inclined cylinder of which the piston-rod, *J*, is the ramrod of the gun; the charge is thus shoved out of the scoop into the gun, and home. *N* and *O* are the steam and exhaust pipes leading to a boiler and to a condenser or into the atmosphere. The gun is then elevated (by machinery, in the design for the battery), fired, and depressed. The cock, *K*, is then turned so as to admit water from any convenient vessel into the pump, of which *L* is the hollow plunger. The rammer, *M*, also a swab, is then run into the gun by moving the handle, *H*, carrying up with it the pump-piston, *L*. As the rammer is withdrawn, the pump-full of water is forced, by the automatic operation of the common pump-valves, through the pipe *L*, and out of numerous orifices in the rammer-head, *M*, upon the whole surface of the bore,

\* It is proper to state that, although the steam-loading was devised and the cooling by water suggested by Mr. Stevens, the details of the plan as shown, were proposed by the author.

FIG. 338.



Stevens's steam loading and cooling apparatus.

from the chamber to the muzzle. This operation may be repeated in a few seconds, or a limited quantity of water may be let in by adjusting the valve *W*, as the case may require. The valve *K* is then shut, the ammunition having, in the mean time, been rolled upon the scoop *U*, and the loading proceeds as before. The whole operation of sponging, cooling, and loading, may be performed as quickly as a man can make eight passes with levers within his reach. The water from the gun will not injure cartridges in metallic cases, and may be conducted to any convenient place of discharge.

The whole apparatus, if disabled, may be removed by knocking out a few keys, thus leaving the gun free for hand-loading.

**751.** The gun used by Mr. Stevens was mounted on a fixed carriage (Fig. 339) like the *Naugatuck's* (Fig. 339 A), the trunnion-slide, *A*, being simply backed with eighteen 8-in. disks of India-rubber 1-in. thick each, to take up the recoil. In front of the trunnions, half the thickness of rubber took up the counter recoil; the gun almost instantly stopped in the position from which it started.

The *Naugatuck's* gun, shown by Fig. 339, was a Parrott 100-pounder. The gun is trained with great precision by turning the vessel (Figs. 339 A and B) on her keel, by means of twin screws. The gun is loaded from below deck, by apparatus resembling that shown in Fig. 338, except that it is operated by hand. The vessel is lowered, in action, to the deck, by filling the compartments *m m* with water.

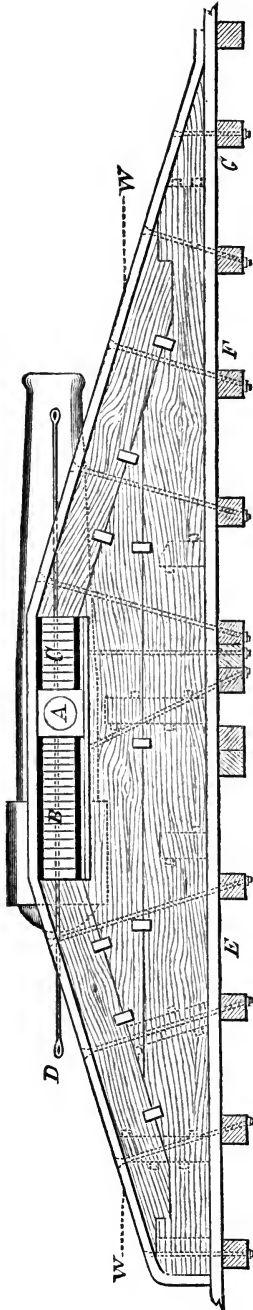
**752.** But the gun is not necessarily depressed for loading. In a casemate, afloat or ashore, the gun may be wheeled round and steam-loaded horizontally. A patented plan for doing this in a small space is shown by Fig. 339 C,\* and another by Fig. 339 D.†

A turret may be turned, after each discharge, to a small shot-proof loading-house on deck. Rough machinery, situated within armor or below water, to revolve a gun or its carriage, is as

\* James Hyde, patented Dec. 23, 1862.

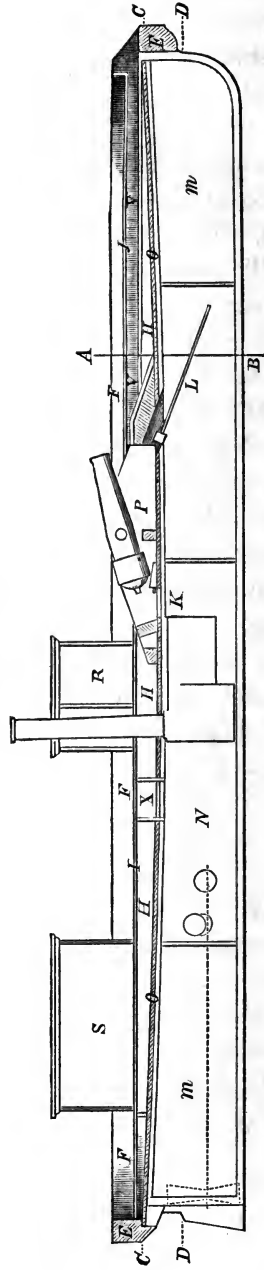
† C. F. Brown, patented June 19, 1862.

FIG. 339.



Stevens's gun-carriage on the *Naugatuck*.

FIG. 339 A.



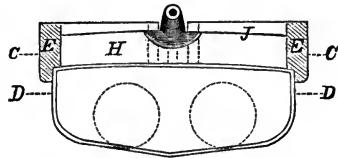
Longitudinal section of steamer *Naugatuck*.

practicable as the delicate and complex mechanism of a frigate's steam-engine.

A gun recoiling to various distances by the old apparatus, may be readily placed, by machinery, at the proper distance for loading; and Mr. Stevens's experiments have shown that the axis of the gun need not be exactly coincident with that of the loading cylinder, nor the gun always placed for loading at a fixed distance from the cylinder.

**753.** Mr. Stevens's experiments are thus described in the official report.\* Experiments of January 4th, 1862. "A 10-inch gun, procured from the Navy Department, weighing 9883 lbs.,

FIG. 339 B.



Cross section of the *Naugatuck*.

FIG. 339 C.

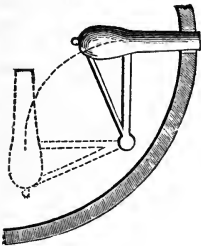
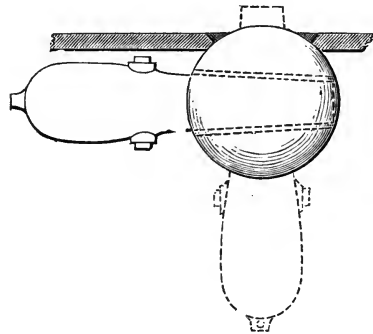


FIG. 339 D.



was mounted with India-rubber buffers behind the trunnions. This gun was loaded with the full service charge of 11 lbs. of powder, and a solid spherical ball weighing 124 lbs. \* \* \* This gun was loaded by steam power, the muzzle being depressed so as to bring the bore parallel with a steam cylinder situated below a platform made to represent the deck of the battery. \* \* \* The piston-rod of this steam cylinder was the ramrod of the gun. Upon the upper end of this ramrod was a swab which also answered the purpose of a rammer. The cartridge and ball were

\* "The Stevens Battery—Memorial to Congress," 1862.

attached to a sabot and placed on a scoop arranged so as to lift the ball to its proper position between the rammer and the muzzle of the gun, when steam being admitted to the cylinder, the ball was forced home. The gun was then elevated and fired."

Experiments of January 11th, 1862. "The 10-inch gun, mounted as before described, was loaded by steam with 11 lbs. of powder and a 124-lb. ball, and fired four times with the same charge. The entire time occupied by the four shots being 139 consecutive seconds, and the average time being  $34\frac{3}{4}$  seconds. The quickest time was 25 seconds. The average was increased by the failure of a friction-primer to go off. A 225-pound elongated shot was afterward fired with 4 lbs. of powder, having been loaded with the same rapidity as the 124-pound shots, and the recoil being less." It should also be recollected that the ammunition was raised to the muzzle, and that the gun was elevated and depressed by hand.

**754.** Mr. Eads, of St. Louis, builder of most of the Western iron-clads, has put in operation a plan (the idea having been also suggested by Mr. Stevens and others) of raising the gun and carriage bodily by steam from below the water-level, at the moment of firing, and then dropping it for loading and for safety when not in actual use. Steam-loading is obviously practicable and convenient in case of guns thus mounted either in vessels or forts.

Mr. Cunningham, the inventor of the reefing apparatus bearing his name and extensively used on every sea, has introduced a very simple method of running guns in and out by steam power.

Mr. Norman Scott Russell has devised a practicable plan of moving heavy guns and taking up their recoil, by hydraulic machinery.

Mr. Mallet has invented hydraulic machinery for the elevation, running out, and training of heavy guns.

Various other schemes for performing one or all of these operations by steam-power have been put forward. Many of them are obviously practicable and applicable to steam-loading. In fact, working heavy guns *better by steam than by hand labor* is not a

very difficult problem. Of course, the subject demands, and is worthy of the highest engineering talent.

**755. Standard Breech-Loaders described.**—ARMSTRONG.—Two forms of loading at the breech are employed in the Armstrong guns—the screw and the wedge or side breech-loader. The screw, which is used in most of the service guns, is generally illustrated by Figs. 340 to 346. The breech-piece D, Fig. 344, which forms a continuation of the second tube J, receives in its rear a hollow screw, A, of about the diameter of the inner tube, so that the bore of the screw forms a continuation of the bore of the gun, except that it is a little larger in diameter to allow of the easy insertion of the projectile. At the forward end of this screw, a vertical mortise, G, is cut in the breech-piece for the movable vent-piece E. The vent-piece, when inserted, forms the bottom of the bore, and when removed, opens the bore from end to end of the gun. To hold the vent-piece firmly during the explosion, the hollow screw is turned hard against it. The explosion of the powder reacts through the vent-piece upon the forward end of the screw, and through the screw-threads upon the breech-piece, whence it is transferred by the tenacity of the longitudinal fibres of the breech-piece and the friction of the rings which embrace it, to the trunnions.

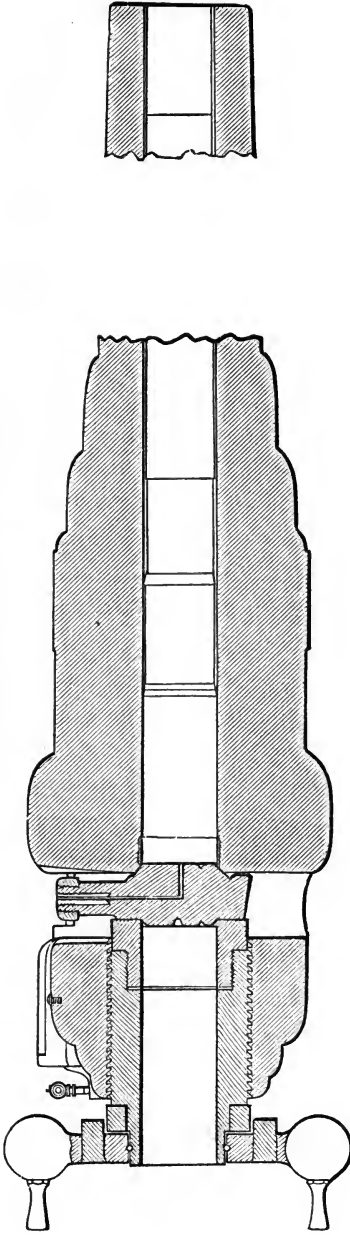
To load the gun, the revolving hammer B attached to handles at the rear of the gun, is struck upon projections on the screw, (C, Fig. 345), thus starting it back, when it is easily unscrewed enough to allow the vent-piece to be lifted out. The bore of the gun is then open from end to end and may be sponged\* and loaded from the rear.

**756.** The breech-screws for the smaller guns are solid forgings of steel. For the 40-pounders, 70-pounders and 110-pounders,† they

\* The army gun is always not sponged, but is cleaned by a greased wad. See "Rifling and Projectiles."

† It is worthy of remark that, in 1862, some steel forgings for 110-pounder vent-pieces were returned from Woolwich to the makers as being unsound and unfit for use. These forgings were afterwards put to the most severe tests, displayed in the Great Exhibition of 1862, and noticed by experts as very fine specimens of tough steel.

Fig. 340.—Section of breech of 110-pounder.



Cross section behind vent-piece.

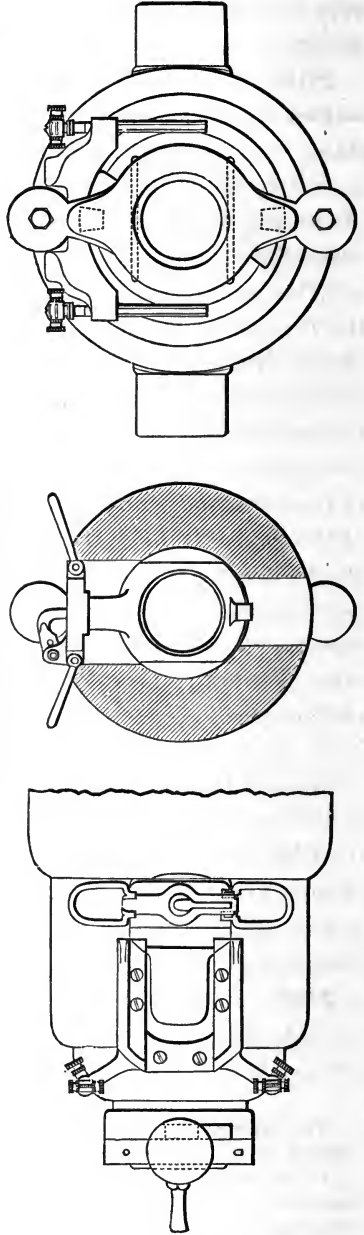


Fig. 341.—Plan of breech.

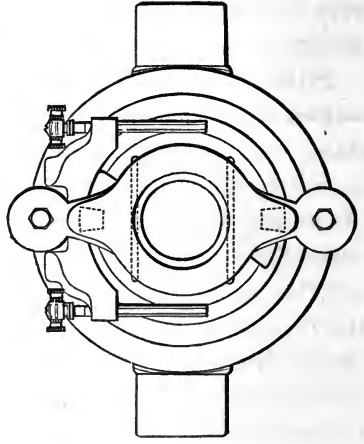


Fig. 342.

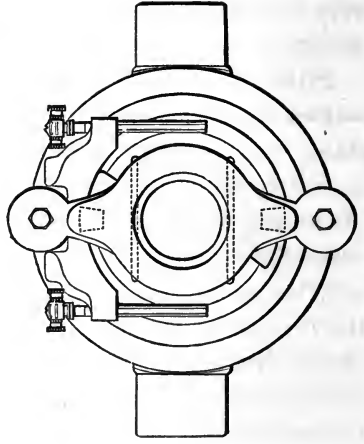


Fig. 343.—Rear view.



are of wrought-iron, with steel ends to bear against the vent-pieces.

**757.** The vent-pieces have been made of wrought iron, hard steel\* and sandwiched iron and steel, which respectively mashed, cracked, and split. Steel toughened in oil is now employed.

**758.** The gas-check for the smaller guns consists simply of a ring of copper let into the face of the vent-piece and jammed against the end of the powder-chamber (Fig. 16, page 9) by the screw. A bushing of iron is sometimes employed in the larger guns. In the 110-pounder, it has been found necessary to attach a tin cup, similar in position to the steel cup in Krupp's gun (Fig. 348), to the face of the vent-piece; this cup projects into the powder-chamber, and forms, by its expansion, a tolerably good gas-check, although it stands but one round. But with this form of gas-check, the screw and the vent-piece are unnecessary. The required accuracy of workmanship and liability to derangement may however be inferred from the following instructions taken from British Artillery records: "The allowance between the nose of the vent-piece and powder-chamber should be exactly  $\frac{2}{1000}$  of an inch or  $\frac{4}{1000}$  difference in diameter. If less than this is allowed, any burr or upsetting of the vent-piece nose will cause it to jam in the gun, and if a greater allowance is given, the edges of the cup will be split open and blown by the gas into the space, and the faces will be destroyed."

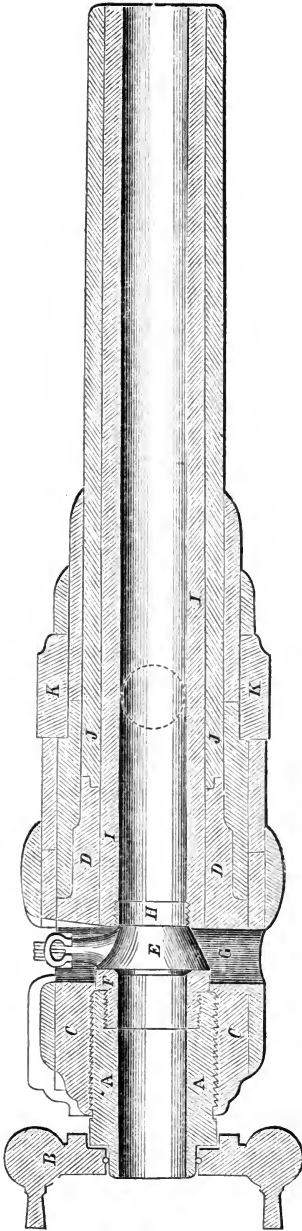
**759.** Sir William Armstrong stated in his evidence before the Select Committee on Ordnance, 1863, that 300 rounds was a very good endurance for a vent-piece, theoretically; and that practically, but 117 had failed during the firing of 30,000 rounds. This would give 256 rounds as the average endurance.

The vent is made in the vent-piece so that it can be readily renewed in case of undue enlargement.†

\*It is stated that 484 vent-pieces of unsuitably tempered steel were made at Woolwich at the cost of £10,000 to £12,000, and then abandoned without trial.

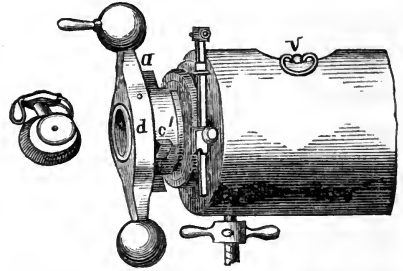
† "The present 110-pounder service rifled gun has a movable breech-piece, which requires two primings—that is, the lower part of the vent-piece is first primed, and when this vent-piece is placed in the gun a tube has to be put in on its top, and thus on discharge the gun hangs fire from two ignitions, and the shot is afterwards detained

Fig. 344.—Longitudinal section of Armstrong 110-pounder. Scale,  $\frac{1}{16}$  in. to 1 ft.



**760.** Another method of closing the breech has been considerably employed in the later experimental Armstrong ordnance. It is called

FIG. 345.

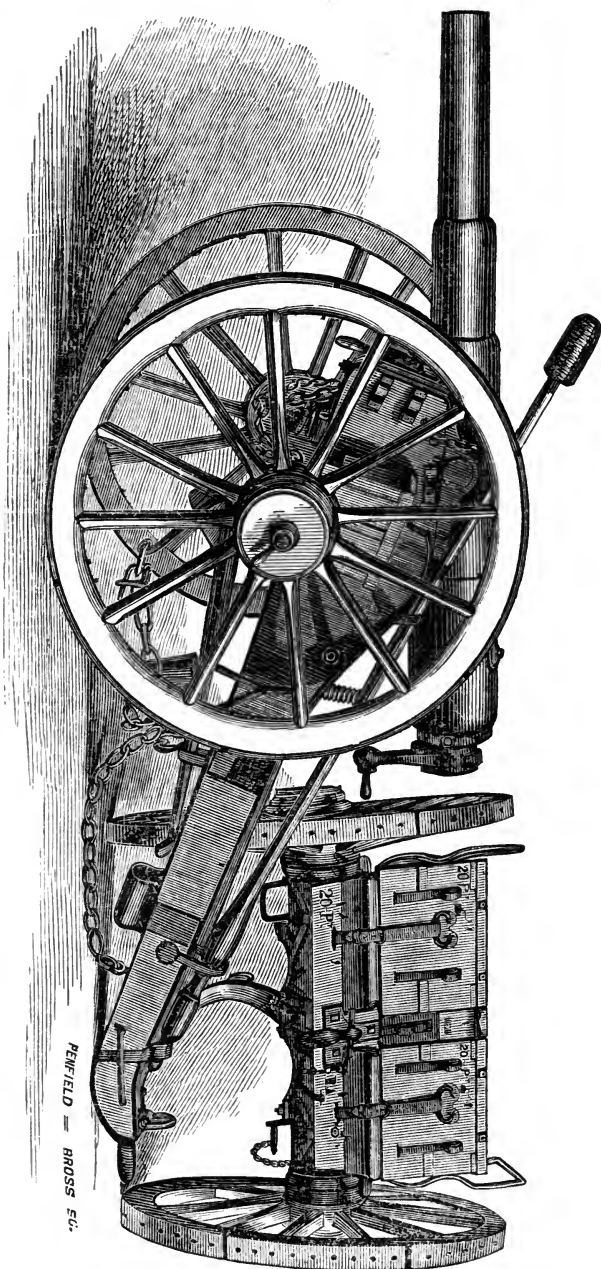


Breech of 40-pounder. From a photograph.

the side or wedge breech-loader, and may be generally described as a cross-piece or sliding-block inserted in a horizontal mortise which intersects the bore at right angles. This block is fitted with a sliding hammer, and has on its face, which forms the bottom of the bore, a thin iron or tin cup (similar to *c*, Fig. 348) to stop the gas. The sliding-block is similar to that of the Cavalli gun, Fig. 364, and the block and hammer together are situated somewhat like the two wedges in the Prussian gun, Figs. 370 and 371.

until it cuts its way through the grooves in the gun. The difference between this gun and the smooth-bore is therefore somewhat similar to that between the old flint-lock and the new percussion-musket, and this hanging fire is a very material disadvantage in naval warfare." —*Captain Fishbourne, Jour. Royal United Service Inst.*, 1862.

FIG. 346.—The Armstrong 20-pounder gun and limber. From a photograph.



**761.** The arrangement is thus described by Sir William Armstrong :\* “In the ordinary construction of the gun, the slot or chamber which received the vent-piece was cut through the gun in a vertical direction, whereas in the model, it passed through horizontally. This slot or chamber contains a stopper, corresponding in its function to the vent-piece ; but in this case called a stopper, because the vent was in the gun and not in the stopper. It also contains a sliding-block, slightly wedge-shaped at the back, and which performed the part of a screw, in the other arrangement. Where the prevention of the escape of gas depended upon the mere pressure of well-fitting surfaces, the application of a screw was requisite, to render the contact of those surfaces sufficiently close, but when the prevention of escape was effected by a cup (a thin iron expanding cup behind the charge) it was only necessary to give support to the stopper, and hence the screw was dispensed with. The sliding-block was fitted with a running handle which acted as a hammer in overcoming the friction of the block against the stopper. By first using the handle as a hammer, and then applying a gentle pressure, the block was thrust back against a stop which prevented its going too far. The stopper was then drawn forward by which means the breech was opened, and the shot and charge inserted. The iron cup was then applied to the projecting face of the stopper, and by means of a button upon the face of the cup, was rendered a fixture, by giving it a portion of a turn.” The face of the stopper enters half an inch into the bore. The chief object of this apparatus is to prevent the necessity of lifting out a heavy vent-piece.

**762.** The wedge-block of the 40-pounder weighs 118 lbs., and the stopper 27 lbs. The weights of these pieces for the 70-pounder are 201 and 56 lbs. respectively. Several 110-pounders have been constructed on this plan. The largest breech-loader made by Sir William Armstrong is an 8·5 in. wedge gun. It was injured by a small number of rounds.

**763.** The rapidity of fire by Armstrong breech-loaders has

\* Discussion on “The National Defences,” Inst. Civil Engineers, 1861.

been referred to. With 9-pounders of the old pattern, and the old ammunition, 132 rounds were fired at the rate of one round in  $\cdot 87$  minute, and 40 rounds at the rate of one round in  $\cdot 77$  minute. With new 9-pounders and approved ammunition, 17 consecutive rounds were fired at the rate of one round in  $\cdot 5$  minute. The above guns had the breech-screw and vent-piece. With the side breech-loader the following practice has been made:—With the 40-pounder, at  $5^{\circ}$  elevation, 25 rounds at the rate of one round in  $\cdot 62$  minute; at  $10^{\circ}$  elevation, 25 rounds at the rate of one round in  $\cdot 63$  minute. With the 70-pounder, at  $5^{\circ}$  and  $10^{\circ}$  elevation, 50 rounds at the rate of one round in  $\cdot 65$  minute. With the 110-pounder, 50 rounds at the rate of one round in  $\cdot 42$  minute.

**764.** An immense mass of information relative to the advantages, disadvantages, and failures of the Armstrong breech-loaders, was elicited by the Select Committee on Ordnance in 1862 and 1863. It is perhaps unnecessary to refer to this evidence or to the merits of this system, further than to quote

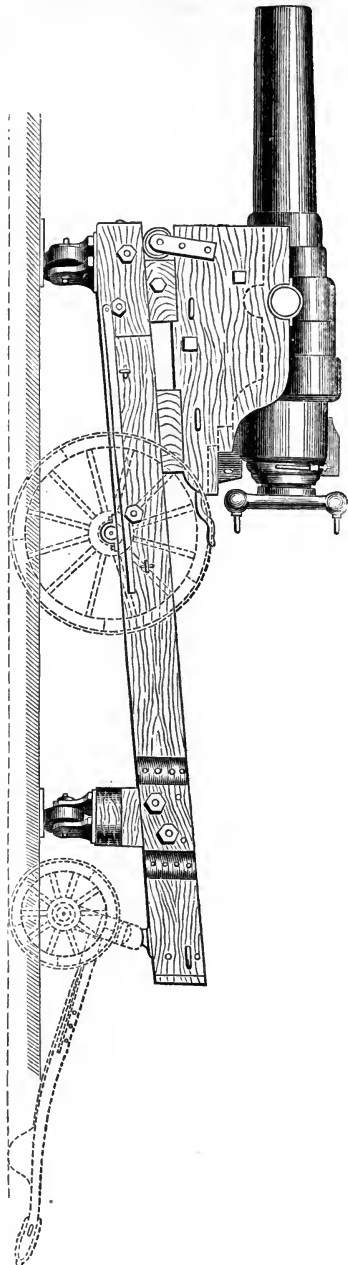
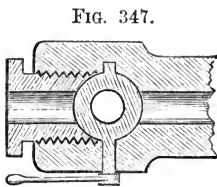


FIG. 346 A.—Armstrong 110-pounder on barbette carriage.

the opinion of the Committee, that "the preponderance of opinion seems to be against any breech-loading system for the *larger guns*," and the remark of Captain Blakely before the same Committee—a remark which would appear to dispose of the screw system:—"My objection has been to the *Armstrong* breech-loader. My objection to that is, that the breech-plug is only a valve; and the first principle of every valve, whether the vessel contain water or oil, or gas, is that the pressure of that fluid should press the valve tighter. Now Sir William Armstrong's breech-loader is on a diametrically opposite system; nothing there confines the gas but the actual amount of labor expended in the screwing up of the breech. If the gas is stronger than the man, aided by the screw, the gas will escape; if the man, aided by the screw, is stronger than the gas, it will be kept in."\*

**765.** It should be stated that several 110-pounder screw breech-loaders have endured 100 rounds with projectiles increasing in weight from 100 lbs. to 1000 lbs., not however without requiring a renewal of a part of the apparatus (437).

**766.** A substitute for the Armstrong vent-piece, which must be lifted out of its seat, is illustrated, in horizontal section, by Fig. 347, and was patented by Mr. Alger, of Boston, Dec. 24, 1861. The



Alger's breech-loader.

cross-plug forms a continuation of the bore when the handle is vertical, and closes the bore, being set up firmly by the screw, when the handle is horizontal. A suitable gas-check might be placed through the hollow screw, in a recess in the cross-plug, by revolving the latter through half a circle.

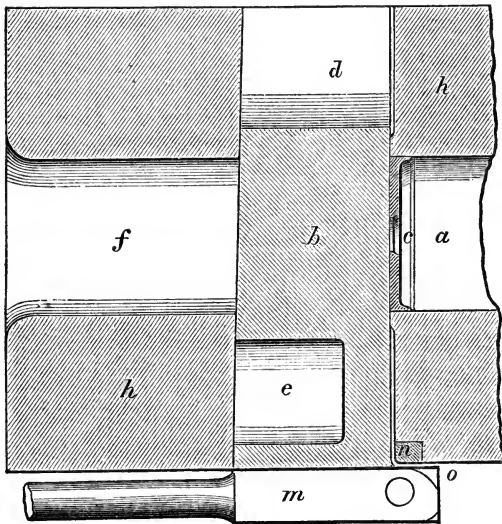
**767.** KRUPP. —This is generally pronounced in England the most simple, strong, and trustworthy breech-loader that has been subjected to extreme proof. It consists of a block, sliding in a

\* "We understand that the farther manufacture of 100-lb. lead-coated shot for the Armstrong breech-loaders has been stopped, as it is in contemplation to convert the guns into muzzle-loaders, firing non-leaded shot, so soon as the 70-pounders now in process of conversion from breech-loaders are finished."—*Army and Navy Gazette*, August 13, 1864.

horizontal mortise crossing the bore of the gun. The gas-check is a steel ring L-shaped in cross-section.

Fig. 348 is a horizontal section of the breech, copied from Mr. Krupp's English patent, of Oct. 29, 1862: No. 2910. The bore  $a$   $f$  is continued throughout the length of the gun. The sliding-block  $b$  is lightened by the removal of metal at  $e$  and  $d$  (see also Fig. 352), and is started out by the lever  $m$ , secured to the hinge  $o$ , and bearing against the piece  $n$ , which may be renewed. The

FIG. 348.



Horizontal section of Krupp's breech-loader.

steel ring  $c$ , detachable when required, from the sliding-block, effectually prevents the escape of gas, by expanding both against the bore and against the block when under pressure.

**768.** A more convenient situation of the gas-check is shown by Fig. 349, where the ring  $c$ , being let into the sliding-block  $b$ , is withdrawn with it, and may be inspected or renewed during the loading. This form is employed in the guns put to extreme test at Woolwich; the breech of the 110-pounder is shown, with the sliding-block in place, by Fig. 350, and with the block re-

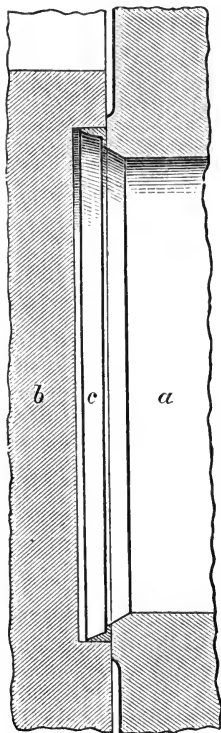
moved, by Fig. 351. Fig. 352 shows the sliding-block in perspective.

In loading, after the block is started out by the lever, it is easily drawn out, being guided by proper grooves, until the charge will pass through the opening *d*, Fig. 348, into the chamber.

Other metals than steel may be used for stopping the gas. Cups of pasteboard, even, were used in the first 6-pounder tried at Woolwich. One of them stood 7 rounds.

**769.** In 1862, three of Mr. Krupp's breech-loading steel guns were tested at Woolwich—a 20-pounder, a 40-pounder, and a 110-pounder, of 3.75-in., 4.75-in., and 7-in. bore respectively, rifled upon the Armstrong plan with 44, 56, and 76 grooves respectively. The projectiles were lead-coated. The 20-pounder fired one round with 3 lbs. 10 oz. charge; 2 with 5 lbs. charge; 3 with 3 lbs. 10 oz. charge; 100 with 2½ lbs. (service) charge, and a projectile increased by the weight of 1 shot every 10 rounds, from 20 to 200 lbs.; and 30 rounds with 5 lbs. charge, and projectiles increased by the weight of one shot every 3 rounds from 20 to 200 lbs. During the first 100 rounds, three gas-rings were used. One of these was spoiled by the blowing out of the sliding-block at the 73d round, with a 140-lb. projectile. The 40-pounder fired 7 "developing" and "proof" rounds, and 100 rounds with projectiles increasing in weight from 40 to 400 lbs. The 110-pounder fired 7 "developing" and "proof" rounds, and 100 rounds with projectiles increasing in weight from 100 to 1000 lbs. The 1000-lb. projectile was

FIG. 349.



Krupp's gas-check.

7 in. in diameter, and 8 ft. 9½ in. long. (See Tables 19 to 21, pages 98 to 100.)

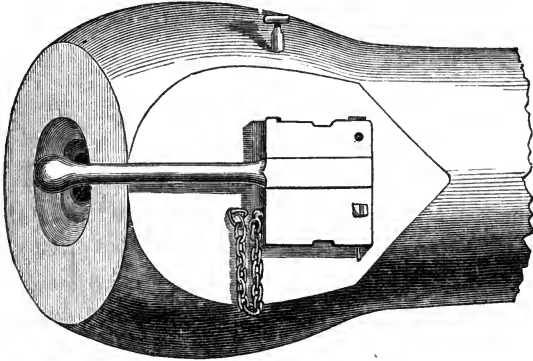
The sliding-blocks of these guns worked with ease throughout



these experiments. A block was occasionally blown out under the enormous pressure, and the gas-checks were occasionally renewed, without delay. The guns are apparently as serviceable as ever.

**770. BROADWELL.**—Another form of gas-check, patented in

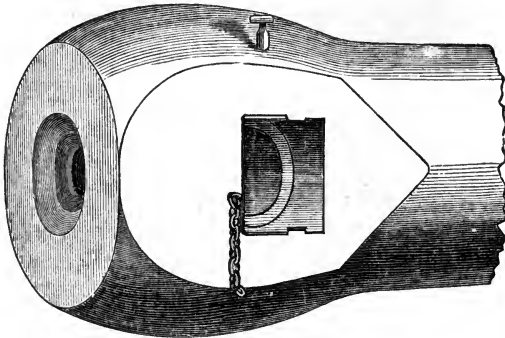
FIG. 350.



Breech of Krupp 110-pounder.

England by Mr. Broadwell, is shown by Fig. 353. As in Krupp's gun, the sliding-block is started out by the lever *a*, and a steel ring is placed in the end of the bore. But an undercut copper

FIG. 351.



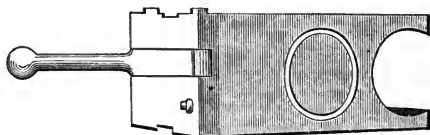
Breech of Krupp 110-pounder, with sliding-block removed.

ring is also placed in a recess in the sliding-block, and the two rings are forced together by the gases.

**771. STORM.**—The gas-check, and the means of fastening it,

used by Mr. Storm, of New York, are illustrated by Figs. 354 and 355. Substantially the same arrangement has been applied, with great success, to small arms, both here and in England.

FIG. 352.

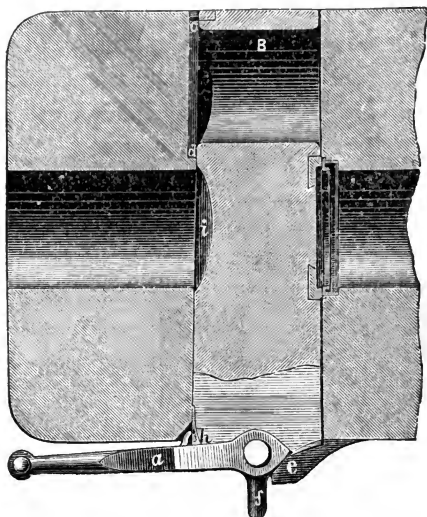


Sliding-block of Krupp 110-pounder.

The engravings are thus described in the patent specification :

“The main object of this part of the invention is the application of the gas-check, or valve, which consists of a loose tubular lining, which fits into the barrel of the weapon, and covers the junction between the barrel proper and the breech-piece ; and

FIG. 353.

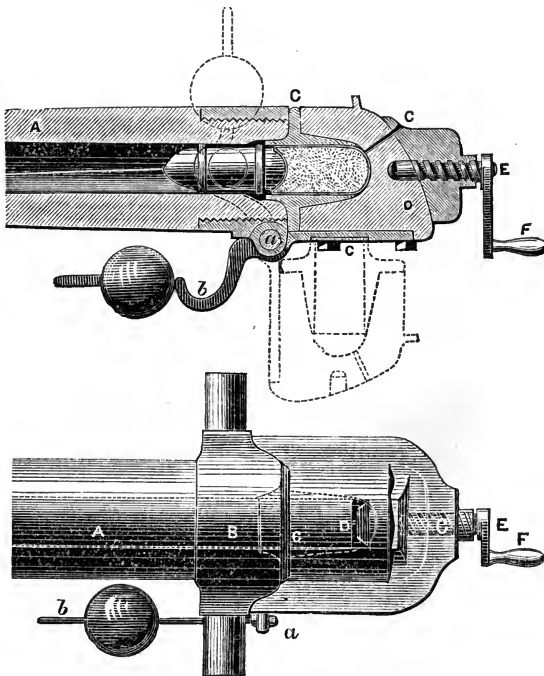


Broadwell's breech-loader.

being capable of an endway movement, by reason of the expansive force of the ignited powder, will completely seal the joint between the breech and barrel. \* \* \*

“A is a barrel of the cannon, provided at its inner or rear end with a screw-thread, which takes into a hollow screw tapped in the breech-frame B. This hollow screw or ring carries the trunnions, and forms the forward end of the breech-frame. On the under side of the trunnion ring two lugs are formed to receive a transverse axle *a*, which passes through a similar lug formed on a hinge-piece C, attached to the movable breech D. Keyed to this axle is a weighted lever *b*, which serves to counterbalance the breech, and thereby facilitates the working of the gun. The rear

FIGS. 354 and 355.



Storm's breech-loader.

end of the breech-frame B is tapped to receive a quick screw E, which is operated by a winch handle F, and enters a hole bored in the rear end of the breech, for the purpose of securing it in position when the cannon has been charged. A recess is made in the breech-chamber to receive the gas-check or valve G, the front

end of which projects into the barrel. The vent *c*, for firing the cannon, is carried through the breech-frame to give access for priming, so that if by any chance it is attempted to fire the charge before the breech is brought "home," or to its proper position, the vent will be closed by the hole in the breech-frame not being in coincidence with that of the breech. To charge the cannon, withdraw the screw-bolt *E*, by means of the winch handle *F*, and let the breech fall into the dotted position, when the valve *G* will come away with it. In the breech-chamber, contracted by the insertion of the valve *G*, which forms a lining thereto, the cartridge is placed, and the shot or shell is inserted in the barrel of the cannon through the now open rear end; then, by means of the weighted lever *b*, raise the breech into position, as shown at Fig. 2, and secure it there by the screw-bolt *E*. The cannon is then ready for firing. For adjusting the cannon to the proper angle for firing, the elevating screw, or analogous device, is provided in advance of the trunnions, instead of in rear thereof, as heretofore.

**772.** "It will be understood that the barrel of the cannon may have a smooth bore, or be rifled, as thought most desirable, and that shots or shells of any suitable construction may be employed therewith. The part of the gas-check or valve *G*, which overlaps the rear end of the barrel, is, by preference, formed with a curved face, the curve being struck from the axis of the supporting hinge."

**773.** FRENCH. This is adapted from an American plan illustrated by Figs. 356 and 357.\* Six of these guns were fabricated at Boston for the British Government in 1855, but owing to the clumsiness with which the principle was carried out they have never been mounted for service. A screw is cut in the enlarged end of the bore at *b*. A corresponding screw is cut upon the breech-plug *a*. Three longitudinal grooves are then planed out of the screw cut in the bore, and similar grooves are planed across the threads of the breech-piece. In other words, the screw-threads are "stripped" at three places in the gun and at three

\* A plan similar to this was patented in the United States, by John P. Schenkl and Adolph S. Saroni, August 16, 1853.

places in the plug. The plug may then be slipped into the gun, the threads of the former entering the grooves of the latter. By turning the plug one-sixth of a revolution the sections of threads left on the plug enter those left in the gun, and hold the two

Castmann's American breech-loader.

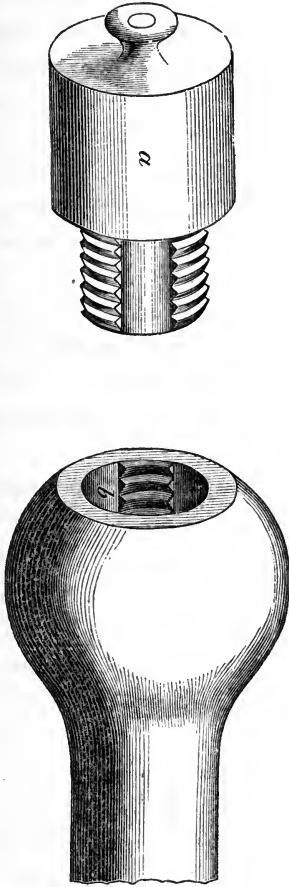


FIG. 357.

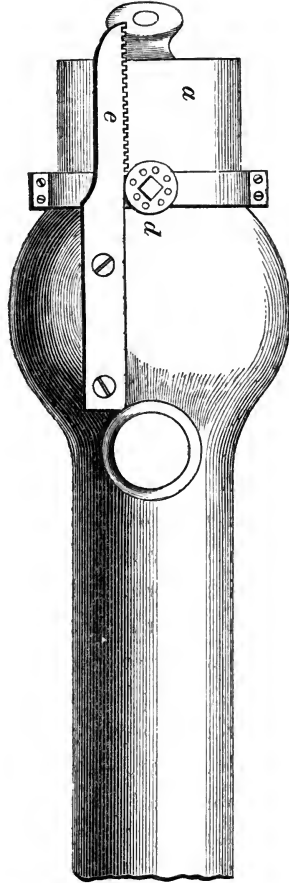


FIG. 356.

together just as if they had been screwed in. Or the threads may form independent circular ridges instead of being helical, the object being to save the time necessary to screw in the plug, which would require 20 or 30 revolutions. The plug *a* turns in the collar *e*, to which is attached the pinion *d*, by means of which the plug is withdrawn and supported on the rack *e*.

**774.** In place of this clumsy withdrawing apparatus, the plug of the French gun is secured to a simple slide upon which it is supported and turned far enough to one side to leave room in the rear for the insertion of the charge. A suitable gas-check is fastened to the end of the plug.

**775.** In some of these guns (6.4-in. bore) recently fabricated in England, Krupp's steel cup (Fig. 349) is used for this purpose. The guns consist of steel or wrought-iron barrels, placed within old cast-iron guns, upon the plan employed by Captain Palliser (331). They are rifled for the French projectiles, with the increasing twist.

**776.** The French guns are generally of cast iron, hooped with steel. A large number of them have been mounted in iron-clads, and it is understood that many more are being constructed of steel.

This breech-loading apparatus obviously weakens the gun less than the side mortise in any form. Half the screw-threads are cut off, but solid guns, or those made of thick tubes, are not likely to fail longitudinally. Increasing the length of the plug remedies this defect, and also increases the resistance to bursting.\*

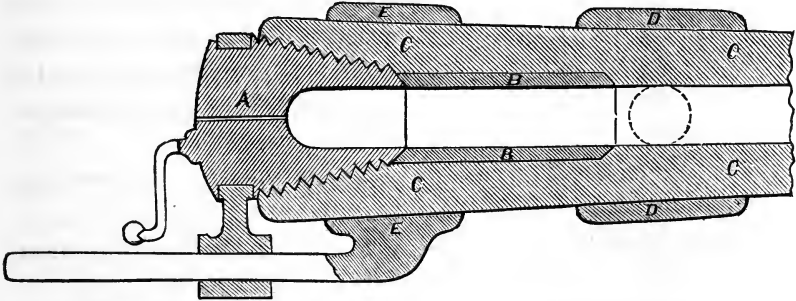
**777.** As to facility of loading, it would not appear to possess any advantages over Krupp's plan, the bore of which is opened by two movements. The plug of the French gun has to be turned, withdrawn, and then moved to one side. The 6.5 in. gun (the largest to which this apparatus has been applied) is said to be loaded six or seven times as rapidly from the breech as from the muzzle; the plan is highly approved in France, and has been thought worth copying in England.

**778. BLAKELY.**—To realize the advantages of a plug parallel with the bore, and yet to withdraw the plug without unscrewing its whole length, Captain Blakely devised the taper screw shown by Fig. 358. This is described in an addition, dated April 4, 1860, to his French Patent of June 28, 1855 (333). After the plug A is unscrewed two or three turns it may be withdrawn longitudinally on the slide E without further turning. The thin end of the screw forms a kind of gas-check.

\* In some of the French guns the end of the breech-plug is hollowed out to receive the charge and to form a gas-check.

**779. NASMYTH.**—The failure of the ordinary screw, even with a slight taper, is illustrated by the following account, from official sources, of the structure and test at Woolwich of a plan proposed by Mr. James Nasmyth. In 1859, an ordinary cast-iron 32-pounder was converted into a breech-loader at Woolwich under the direction of Mr. Nasmyth. A wrought-iron plug, 12 in. long, was screwed for 9½ in. with a V-thread rounded at the top and bottom; pitch,  $\frac{7}{8}$  in.; angle of side of thread, 60°. A corresponding thread in the breech of the gun—a continuation of the bore—received this plug, which was slightly tapered, being 8.1 in. dia-

FIG. 358.



Blakely's breech-loading gun, with internal strengthening tube.

meter at the back end, and 8 in. next the chamber. The point of the plug was cylindrical, terminating in the frustum of a cone, and fitting a corresponding recess in the bore. The plug was turned by a 5-ft. lever.

**780.** After 2 proof rounds with 21½ lbs. powder, 32-lb. shot, and 2-lb. wads, the gun was fired, 10 rounds with 10 lbs. powder, 32-lb. ball and wad. No escape of gas was observable without, but the threads of the screw were discolored from 6 to 10 in. The plug showed no indication of displacement, but worked very stiff, although cleaned and oiled at each round, and, at the 10th round, became immovable by the force at hand. After 4 hours' labor with sledges, &c., the breech was opened and 10 rounds more were fired with 10 lbs. powder, a 64-lb. cylinder, and a wad. After 2 rounds without cleaning, unscrewing the plug required the force of six instead of two men. At the 14th round

fissures began to appear at the joint in the bottom of the bore, but no escape of gas was visible. With a 96-lb. cylinder and wad—charge, 10 lbs.—7 rounds more were fired, when the gun burst. The lever worked easily, and the time of loading was reduced.

**781. WHITWORTH.**—The screw breech-stopper adopted by Mr.

Whitworth in his early guns, is shown by Fig. 359. A cap, revolving in a ring hinged to the gun, is screwed over the end of the bore. The largest gun made in this way was an 80-pounder, which was disabled after a short experimental service. Mr. Whitworth's later ordnance, even the smallest field artillery, is muzzle-loading.

**782.** Another similar form of breech-screw, employed to some extent on the Continent, is shown by Figs. 360 and 361.

**783. CLAY.**—Fig. 362 shows the apparatus patented by Lieutenant-Colonel Clay, of the Mersey Steel and Iron Co., Liverpool. One side of the breech is enlarged to receive a screw-plug, *A*, a little over twice the diameter of the bore. A hole, *C*, in the plug, forms, when the latter is unscrewed half a turn, a continuation of the bore, *D*, through which the charge is loaded. By screwing

up the plug half a turn, the solid part of it covers the end of the bore and sets closely against it. The breech is thus opened by one movement, and the parts, though large, are simple; but the obvious defect is the difficulty of applying a suitable gas-check.

**784. CAVALLI.**—This breech-loader, for some time noted on the

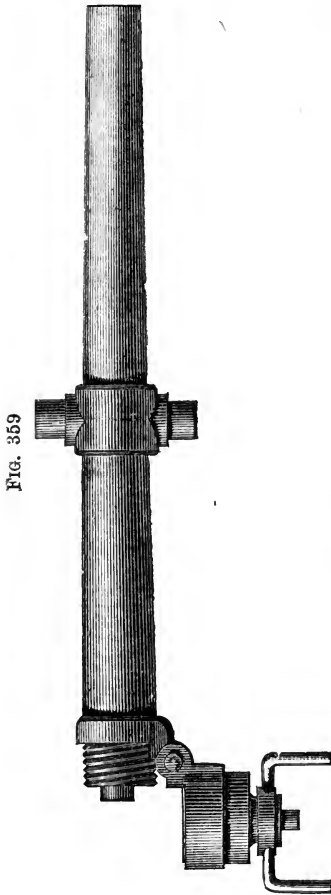
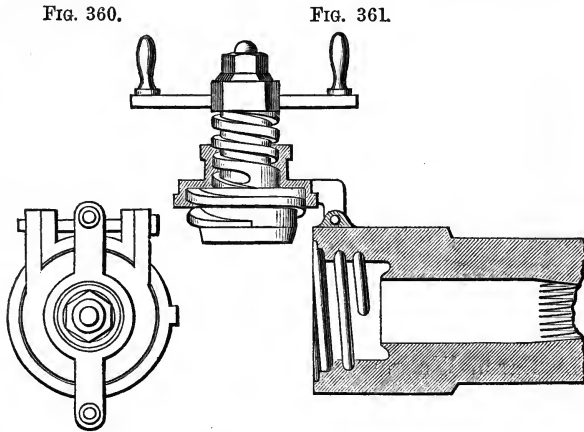


FIG. 359

Whitworth's breech-loader.

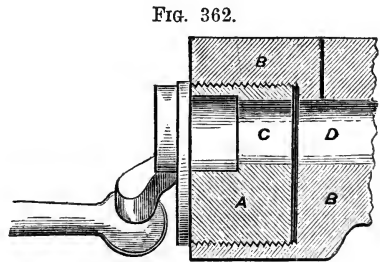


Continent as the best, was invented in 1846, by Colonel (now General) Cavalli, of the Sardinian service. Fig. 363 is a horizontal section of the gun; Fig. 364, a plan of the breech; Fig. 365,



Screw breech-loader.

a horizontal section, and Fig. 366, a rear elevation of the sliding wedge. The horizontal mortise, for the 32-pounder, is 9·4 in. deep, and 3·4 and 3·7 in. wide. The wedge has two handles; the charge is passed through the larger one, the chain preventing too great a movement. The wedge slides on three steel pins, to prevent excessive friction. In case it is stuck by fouling, it may be pried to one side by inserting a handspike in the mortise shown. "The breech-piece is found, after firing, to be



Clay's breech-loader.

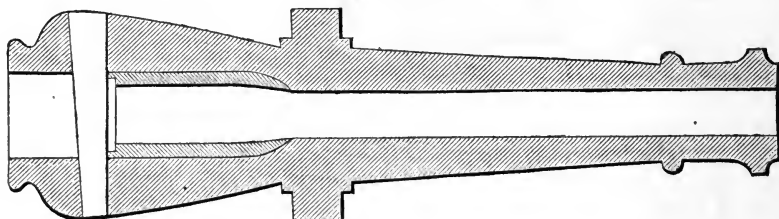
more or less moved at the same time that there is no danger of its being pushed too far or thrown out of its place."\* Seeing that the Armstrong vent-piece and the Krupp sliding stopper, which are not wedge-shaped, are sometimes thrown out of place, it is

\* "Artillerists' Manual." Gibbon, 1863.

not probable that this wedge would remain tight under high charges. The apparatus, however, is very simple, and is adapted to the use of a cup or ring gas-check.

**785. WAHRENDORF.**—This plan, Figs. 367 and 368, was invented

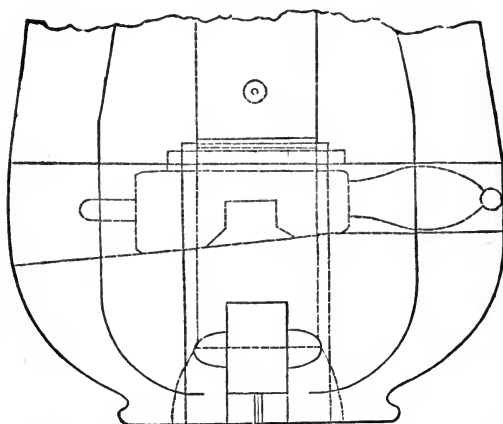
FIG. 363.



Cavalli breech-loader.

in 1846, by Baron Wahrendorf, of Sweden, in connection with a new system of rifling and projectiles (511). The breech-plug is held in by a horizontal bolt passing through the breech. It is obvious that these parts cannot be handled with great rapidity.

FIG. 364.

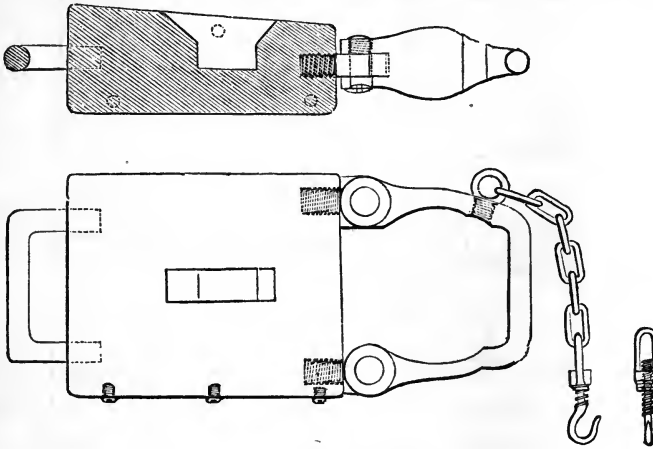


Cavalli breech-loader.

**786. PRUSSIAN.**—The early Prussian breech-loader (Fig. 369) is similar to that last mentioned. The leakage of gas is stopped by a valve and a papier-maché cup.

The Prussian breech-loader of 1861, is shown by Figs. 370 and 371. The sliding-block is set up by a wedge tightened by a screw.

FIGS. 365 and 366.



Cavalli breech-loader.

**787. ADAMS.**—A plan of loading and cooling guns *from* the breech (Fig. 372) has been patented in the United States by Mr. Joseph Adams,\* and is thus described in his claims: “I claim, the use and application of a piston, for the purpose of loading, cleaning, and cooling a cannon, the stem or end G, which passes through the breech or rear end of the gun and is attached to a head or metallic piston, the circumference of which is equal to the bore of the cannon, and is made to fit the same exactly, and which piston-head, when drawn back, rests upon the main shoulder or substance of the breech at the point where the rod G connects therewith, and is of sufficient length to cover and serve as a valve to close the lateral opening at the breech end of the cannon, through which water is admitted to fill the bore of the gun when said piston is forced forward towards the muzzle, and which piston plays forward and backward the entire length of the bore of the gun, so as to protrude sufficiently at the muzzle

\* October 25th, 1859

when forced forward, thus carrying out any substance of the exhausted cartridge after firing, and to which piston-head or

FIG. 368.

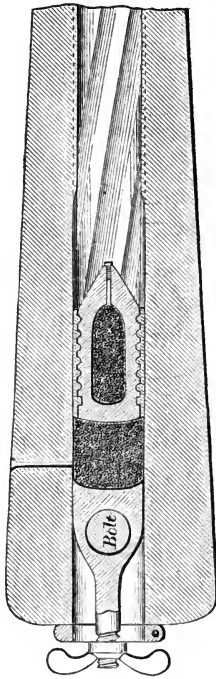


FIG. 367.

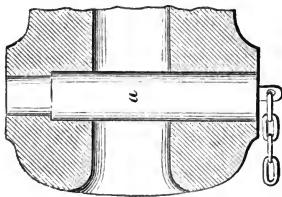
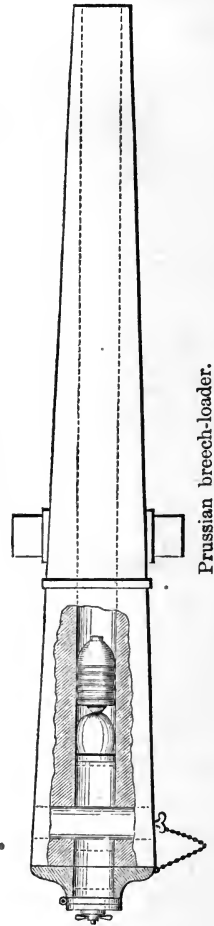


FIG. 367 and 368.—The Währendorf breech-loader.

FIG. 369.



bulb, the new cartridge is attached and drawn back to the breech or butt of the gun by the force applied to said rod, and in which condition the gun is loaded and ready to be again discharged. "Second. I claim the construction and employment of a lateral opening from the main chamber or bore of the gun, either passing through the breech-pin or otherwise at or near the rear end

thereof, and where the same will be closed and covered by the piston-head, when the same is fully drawn back into (or by means of a tube or pipe connecting with a water-sack or vessel), and by

FIG. 370.

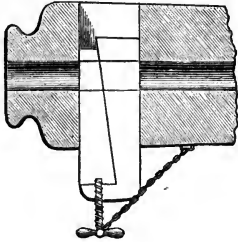
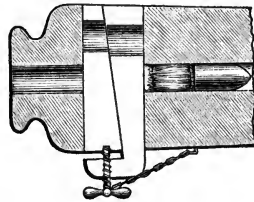


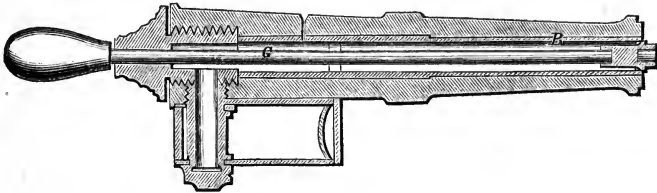
FIG. 371.



Prussian.

means of which arrangement water is admitted and drawn into the gun by the same force which carried the piston forward to receive the charge at the muzzle, and is returned to the vessel

FIG. 372.



Adams's loading and cooling from the breech.

again by the same force which carries in the charge, thus washing and cooling the gun at every discharge, without any other movement than that necessarily employed in the act of loading alone."\*

**788.** Many other devices for breech-loading, some of them ingenious, have been the subject of experiments more or less satisfactory in their results. The foregoing pages are simply intended to give a general view of the subject. Only such guns and practice have been described in detail, as appear to promise

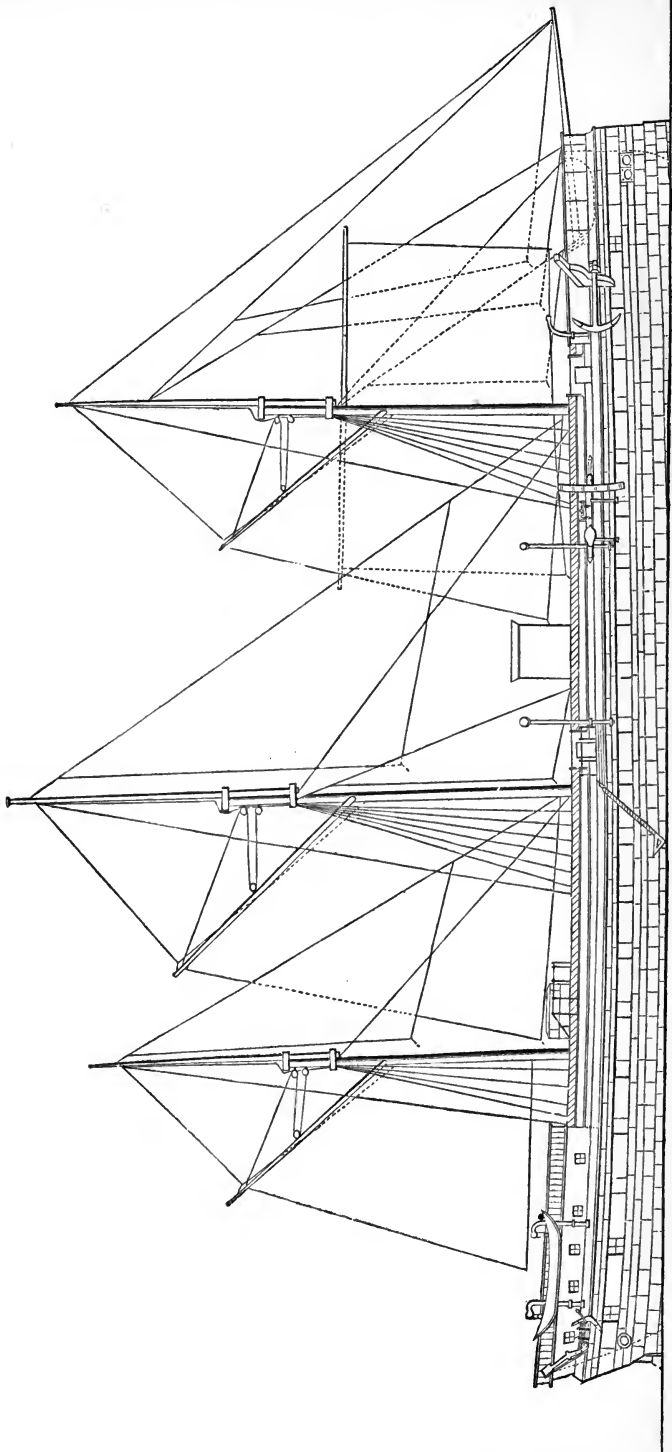
\* In a recent patent (see *Engineer*, July 29, 1864), Captain Blakely has specified a mode of hauling in the charge by a rod running through a hole in the rear of the gun.

a reasonable degree of durability and efficiency in iron-clad warfare.

**789.** The grand feature of any successful breech-loader of *large calibre*, is the removable gas-check. The simplest and best form of gas-check that has been severely tested, is that of Mr. Krupp. The French plan of closing the bore weakens the gun least, but it can hardly be as quickly handled as Krupp's.

PART II.

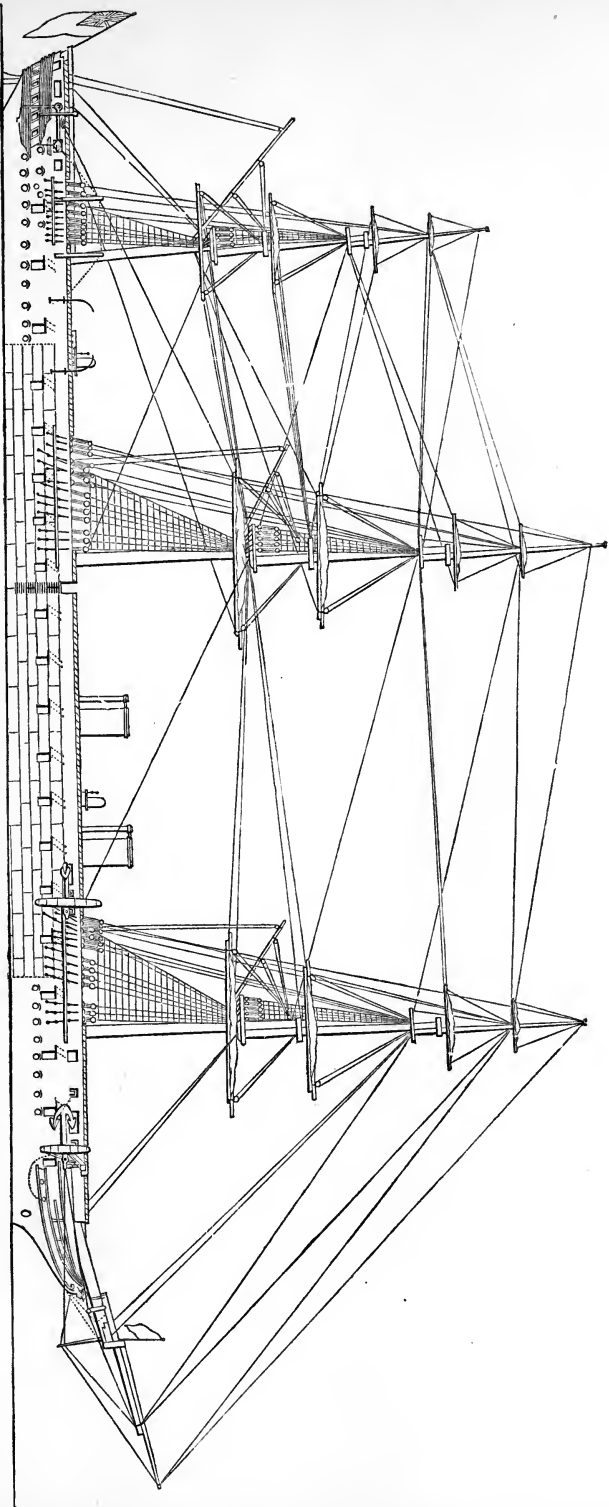
EXPERIMENTS AGAINST ARMOR.



“LA GLOIRE.”



THE "WARRIOR."





## PART SECOND.

---

### EXPERIMENTS AGAINST ARMOR.\*

**790.** THE first authenticated experiments with Artillery upon Iron Armor, were made by John Stevens, Esq., at Hoboken, U. S., during the war of 1812. Mr. Stevens then proposed, for the defence of New York, a vessel to be propelled and rotated (to train the guns) by steam, and to be clad with inclined iron armor. From that time to the present, his sons, Robert L. Stevens, Esq., projector of the *Stevens Battery*, and Edwin A. Stevens, Esq., have conducted a great number of experiments upon various kinds of armor, and have anticipated many of the results of modern naval construction and warfare.

**791.** Iron armor for the protection of batteries was recommended by Colonel Paixhans, in 1821.

**792.** "In 1827, the first recorded experiment that I have as yet found," says Captain Inglis, R. E.,† "took place at Woolwich, when Major-General Ford, R. E., proposed to ascertain the resistance to cannon-shot of a piece of masonry covered with iron. This iron-cased wall, 5 feet high and 7 feet thick, was built of Aberdeen granite blocks, cased with two layers of iron bars, the under layer being horizontal, of  $1\frac{1}{4}$  in. square, and the other vertical,  $1\frac{1}{2}$  in. square, each layer being strongly cramped into the granite. This wall was fired at with round-shot from three 24-pounders, at 634 yards distance, when the effect of twenty round shot was, that nineteen of the front layer and five of the inner layer were

\* This account of experiments against armor, is compiled from the official records.

† "The Application of Iron to Defensive Works." R. E. Papers, 1862.

broken, four being entirely broken off and the stone under them completely pulverized.\*

**793.** "In 1835, extensive experiments were conducted at Mentz, on plates of forged and rolled iron."†

**794. Stevens's Experiments.**—In a letter dated August 13, 1841, written by the Messrs. Stevens, of Hoboken, to a Government committee on coast and harbor defences, a series of experiments is mentioned, and the following conclusions are given:—"The thickness (of iron) necessary to resist balls of the largest size would require to be determined by experiments. This could be easily and quickly done, but we suppose a thickness of one-half or two-thirds the diameter of the ball (set at an angle of 45°) would be sufficient to resist or glance it off. If so, it would require only 4½ or 6 inches to resist a 9-in. shell." Experiments are then mentioned, and the letter continues:—"From the above experiments it would appear that it takes wood 16 times the thickness of iron to offer the same resistance to a ball fired with a full charge. Four inches of wrought iron, therefore, would be equal to 5 feet 4 inches of oak, which we suppose sufficient to stop the horizontal ball at point-blank distance."‡

On this letter was based the contract for the construction of the *Stevens Battery*, an iron vessel, which has been lying in dry dock, nearly completed, for nine years, and which embodies a greater part of the best features of modern construction.

**795. Thin Plates at Woolwich.**—The next recorded experiments (from 1846 to 1856) are mentioned by Captain Inglis,

\* Captain Dyer, R. A. (Remarks on Iron Defences, R. A. Inst.) says of this experiment that "after 20 rounds had struck, 19 of the front bars and 5 of the horizontal course were broken and 4 bars were detached. The result of this experiment was considered so unsatisfactory that all idea of using iron as a means of defence was for the time abandoned; it was again revived about the year 1850, by Lord Ross and others, but apparently the time had not yet arrived for these sweeping changes in old-established notions, and it was reserved for the Emperor Napoleon III. to bring the question to a practical issue."

† "Armor-Plates." Thos. W. Rumble, C. E. Society of Engineers, Oct., 1861.

‡ In the same letter (August 13, 1841), the Messrs. Stevens propose the submerged screw propeller, a small battery of the largest guns, wrought-iron breech-loading guns, rifled, and lead or pewter-coated shot.

R. E.\* The first were carried on "under the direction of Colonel Colquhoun and Colonel Sandham, upon thin wrought-iron plates placed obliquely to the line of fire, at angles varying from  $10^{\circ}$  to  $30^{\circ}$ . The plates were  $\frac{3}{8}$  of an inch thick, and placed, in the first instance, against a ship gun-carriage, loaded with pig-iron; afterwards attached to granite; and lastly, to a mass of oak. They were fired at by an 8-in. iron gun, throwing a 56-pounder hollow shot, and afterwards by a 32-pounder of 56 cwt., at 100 yards. The principal thing to observe in this experiment is, that the shot were almost always broken on striking the plate, and a quantity of splinters deflected, and that a 32-pounder shot, striking at an angle of  $30^{\circ}$ , where a former shot had been, passed through the plate and all the 4 feet of oak. Another 32-pounder shot, fired with a higher charge, broke up, and some pieces penetrated 3 feet into the oak backing; otherwise not much is to be learned from this experiment.

**796.** "In 1850, the Navy made an experiment at Portsmouth, to try the effect of shot on  $\frac{5}{8}$ -in. plates of iron, placed 35 feet apart, with ribs representing a section of the *Simoom*. This was fired at with 32-pounders and 8-in. hollow and solid shot, and 10-in. hollow shot, and, of course, offered little resistance. Both shot and shell split and broke up into innumerable splinters, which caused great havoc. This experiment was continued with 32-pounders, 68-pounders, 8-in. and 10-in. hollow shot, the same year; the  $\frac{5}{8}$ -in. iron being backed between the ribs with oak and fir planking of different thicknesses, with ribs on the inside similar to the *Simoom*; the iron, wood, ribs, and all, were of course easily torn away, and the effect of splinters, of both shot and iron, were very destructive.

**797. 4½-Inch Plates.**—"This was followed by experiments, also by the Navy, at Portsmouth, in 1854. Here there was a target composed of 4½-in. best scrap wrought-iron plates backed with 4 inches of fir planking, the whole bolted by heavy iron screw-bolts to a strong timber frame-work, well braced and strutted. Ten 32-pounder shot from a 58-cwt. gun, charge 10 lbs., at 360 yards,

\* "The Application of Iron to Defensive Works." R. E. Papers, 1862.

struck the plates; a single shot indented 2 inches; two in nearly the same spot, indented  $2\frac{1}{4}$  inches, and slightly cracked a plate; four shot cracked a plate in four places, and bulged it  $3\frac{1}{2}$  inches; all the shot broke up. Two 68-pounder shot, charge 16 lbs., at 1250 yards, indented about  $1\frac{1}{2}$  inches, and cracked the plate, and were supposed to break up. Ten from same gun, charge 13 lbs., at 400 yards, struck the plates—indentation caused by one shot,  $2\frac{1}{2}$  inches; each shot more or less cracked the plates, and several near the same spot injured them very much. Subsequently, 68-pounder shot, charge 16 lbs., at 400 yards, nearly destroyed the target and backing.

**798.** “About the same time, plates of  $\frac{1}{4}$ ,  $\frac{3}{8}$ , and  $\frac{1}{2}$ -in. thicknesses were fired at, and it was found that solid and hollow shot would pass through  $\frac{1}{4}$  and  $\frac{3}{8}$ -in. iron, without breaking; that hollow shot break up in passing through  $\frac{1}{2}$ -in. iron, and that both solid and hollow break up in passing through  $\frac{3}{4}$ th iron.”

**799. Gen. Totten's Experiments.**—“From 1853 to 1855 General Totten, of the United States Army, carried on some interesting experiments in some degree involving the question of iron defences. In his first target, containing six embrasures, a variety of materials was tried, namely, granite, hydraulic cement concrete, asphaltic concrete, and lead concrete, and brickwork. In one of these embrasures the throat was composed of wrought-iron, 8 in. thick, made up of sixteen  $\frac{1}{2}$ -in. thicknesses, set partly in cement concrete and partly in brickwork. In one lead and cement concrete was notched, and protected by wrought-iron plates 2 in. thick and 6 in. wide. And in one these two plans were combined with asphaltic cement. His second target contained three embrasures. One had its throat or jambs composed of wrought iron, 4 in. thick, 10 in. wide, made up of eight thicknesses of boiler-plates riveted (rivets countersunk and flush) together, backed by a small mass of tough cast iron. This embrasure was built of granite, and had shutters in two leaves of three thicknesses of  $\frac{1}{2}$ -in. boiler plate. I believe there was thin sheet lead between the wrought and cast iron. Another embrasure in the second target was of similar construc-

tion to the last, only in brickwork instead of granite; there were no shutters, but a projecting portion of brickwork was protected by  $\frac{1}{2}$ -in. wrought plate. The last embrasure was of similar form to the other two, but of cement concrete; it had the 8-in. wrought-iron throat used in the former target, and a projection covered by  $\frac{1}{2}$ -in. plate. The general result of the experiments was, so far as iron is concerned, that grape-shot passed through, or entirely carried away  $\frac{1}{2}$ -in. boiler-plate, but that canister shot produced no injurious effects; that shutters,  $1\frac{1}{2}$  in. thick, of boiler-plate stopped grape-shot, but were bent by it, and were quite disabled by heavier shot; that the 2-in. offset plates of wrought iron did not stand against a 42-pounder; that throat-plates of 4 in. wrought iron, in  $\frac{1}{2}$ -in. thicknesses, backed by cast iron, being struck two or three times by a 68-pounder solid shot, were carried away, the cast-iron backing being cracked and broken; and that 8-in. wrought gorge plates, in sixteen thicknesses, were bent and finally torn from their fastenings by 42-lb. solid shot, and even were considerably injured when struck several times by a 24-pounder at 95 yards. The great advantage of a single mass of wrought iron over one composed of several thinner plates was noticed; that the brittleness of cast iron unfits it for use as a means of directly resisting heavy shot; and that a cast-iron block, protected by a 4-in. compound plate, was always broken up, splintered, and badly cracked. It is almost unnecessary here to notice the performance of the other materials; but it is interesting to remember that, next to wrought iron, lead concrete proved the best material. It is of course less resisting and more costly than wrought iron, but it will not crack and splinter. Heavy shot at high velocities mould for themselves a symmetrical bed in which they are found crushed; in fact, the effect is quite local, and even shells exploding in it produced no cracks."

**800. Floating Batteries.**—In 1855 floating batteries, covered with  $4\frac{1}{2}$ -in. plates, 3 ft. long  $\times$  20 in. wide, secured to the wooden hull by  $1\frac{1}{4}$ -in. screw-bolts, received the fire of the Russian batteries at Kinburn. The following particulars are from Commander Dahlgren's account of the action:—"The French floating batte-

ries *Devastation*, *Lave* and *Tonnante* steamed in to make their first essay, anchoring some 600 or 700 yards off the S. E. bastion of Fort Kinburn. \* \* \* The Russians could only reply with 81 cannon and mortars, and no guns of heavier calibre than 32-pounders, while many were lower. \* \* \* This was the sole occasion in which the floating batteries had an opportunity of proving their endurance. \* \* \* They were hulled repeatedly by shot; one of them (the *Devastation*), it is said, 67 times, without any other effect on the stout iron plates than to dent them, at the most,  $1\frac{1}{2}$  in.—still there were 10 men killed and wounded in this battery by shot and shell which entered the ports.”

**801.** In March, 1856, the Messrs. Stevens made the following experiment at Hoboken. The target (vertical), 3 ft. 2 in.  $\times$  4 ft. 4 in. face was composed of four 1-in. plates, two  $\frac{1}{2}$ -in. plates, one  $\frac{5}{8}$ -in. plate, and lastly two  $\frac{1}{2}$ -in. plates, in all  $6\frac{5}{8}$  inches of wrought iron. The bolts, 48 in number, were in 8 vertical and 6 horizontal rows. The target was set up against, but not fastened to, a mass of pine timber. A 125-lb. (10-in.) ball with 10 lbs. of powder, range 24 feet, cracked the three first plates around the bolt holes, a disk being nearly broken out of the outer one. No other plates were cracked. The back was indented about three inches.

**802.** “In the middle of 1856,\* Sir John Burgoyne collected what little had been done in the matter of applying iron to parapets of batteries, both floating and on shore, and moved the Government to consider the important question of giving better cover to guns, and by the use of iron to reduce the external openings of embrasures. Several high authorities were consulted, and some good opinions given. From what had then been done, it appeared that  $4\frac{1}{2}$ -in. wrought iron on a ship’s side was penetrated to a depth of  $2\frac{3}{4}$  in., by a 68-lb. shot, at 400 yards; that  $4\frac{1}{2}$  in. of wrought iron completely protected a ship’s side against 68-pounders, at 1200 yards; that they gave considerable protection against the same gun, at 600 yards, and but little, at 400 yards; that they gave considerable protection against 32-pound-

\* Captain Inglis’s account continued.



ers solid, and 8-in. 56-lb. hollow shot, at 400 yards; a 32-pounder shot penetrated only  $1\frac{1}{2}$  or  $1\frac{3}{4}$  in., and the hollow shot only one in.; but three or four shot of the same kind striking near together will break up the plates.

“From some experiments in France, iron plates, 3.94 in. in thickness, were found to resist about fourteen shots per square metre ( $10\frac{3}{4}$  square feet, English) from a French 30-pounder (English 32.4 lbs.), at 300 metres distance; and  $5\frac{1}{2}$ -in. plates gave a resistance of eighteen shots per square metre.”

**803. Cast-Iron Blocks.**\*—“Many suggestions were made, and amongst them, that cast-iron blocks should be tried; and in consequence, in 1857, experiments were carried on at Woolwich against large 8-ton cast-iron blocks, 8 feet by 2 feet,  $2\frac{1}{2}$  feet thick, tongued and grooved together, and partially backed by heavy blocks of granite. They were first fired at with a 68-pounder, 95-cwt. gun, at 400 yards, charge 16 lbs., solid cast-iron shot; these shot made indentations of from 1.3 in. to 1.6 in., and cracked, displaced, and broke up the blocks very much. Some wrought-iron shot (the same gun) indented from 1.6 in. to 1.9 in., and broke off large fragments and scattered the iron in pieces of from 10 lbs. to 80 lbs. Subsequently a cast-iron block, 6 ft.  $\times$  4 ft. and 2 ft. thick, weighing 9 tons 13 cwt., was fired at with the same gun, at same range, with wrought and cast shot, by which it was cracked all through. Cast-iron shot broke

\* A correspondent of the London *Engineer* gives the following account of experiments against cast iron in Russia, 1863:

“Another interesting experiment was tried with cast-iron armor-plates, proposed for forts, in blocks 4 ft. thick, 2 ft. high. This block was fired at with round-shot from 68-pounders, at 700 ft. distance. The first shot took off a mass of 100 lbs. weight from the lower corner; the second shot struck low, and only carried away a few pounds; the third shot struck fair, and cracked the plate every way; the fourth and fifth shots hit fair, and shivered the whole mass.

“The reason for trying cast iron was simply this—it can be produced in Russia. At present armor-plates come from abroad. General Todleben, who was present, suggested trying combined cast and wrought iron—around the embrasure wrought iron, and between them filled up with cast iron; and targets are now being constructed of this description for the purpose of testing the principle.

“The result on cast iron alone—where, as in this experiment, the block was 4 ft. thick—was, that a few round shots, at point-blank distance, destroyed the mass.”

up; wrought-iron shot recoiled considerably, and were much flattened."

**804. 4-Inch Iron.—Steel.\***—"After this, in 1856, wrought plates, furnished by different makers, 4 in. thick, backed by 2 feet of woodwork, were fired at by 68-pounders, at Woolwich. The cast-iron shot, at 600 yards, indented from 1 in. to 2·3 and 3 in., and cracked and bent the plates; wrought-iron shot, at 600 yards, indented from 2·2 to 2·8 in., and carried away pieces; cast-iron shot, at 400 yards, indented 2·2 in., and cracked the plates, drove in bolts, and shattered bulkhead; wrought-iron shot, at 400 yards, indented 3 in., and went right through a plate without cracking it. This large bulkhead, weighing more than 30 tons, was driven back by the blows it received, 3 or 4 feet.

**805.** "After this, in 1857, more wrought plates by different makers, 4 in. thick, and steel 2 in. thick, secured by bolts to 2 feet of oak, were fired at with 68-pounders, at 600 and 400 yards at Woolwich, the general result of which was that wrought-iron shot at 600 yards passed through, and cast-iron shot at 600 yards were resisted, but they crushed the iron, and by a repetition of blows would ultimately destroy the plates. At 400 yards, the plates were quite broken up by both cast and wrought shot. Mr. Begbie's 2-in. steel did not stand."

**806. Firing Through Water.**—In December, 1857, Mr. Whitworth's 24-pounder howitzer,—4 and 4½ in. bore; twist, 1 turn in 40 inches; charge, 2½ lbs.; shell, flat headed, of 24 lbs. weight,—was fired through water at various angles, at a 4-in. (8-in. after the 3d round) oak butt. The gun was 15 feet above a horizontal

\* A correspondent of the London *Engineer* thus mentions late Russian experiments against steel armor.

"The plates of Petin, Gaudet, and Co., the Thames Company, John Brown and Co., the Parkgate Company, have all been tried, with results similar to those obtained in England. One hammered steel armor-plate, 4½ in. thick, was fired at by the ordinary 68-lb. naval gun, and the plate was hit in three places, on a line about the centre of the width, and at pretty equal distance. The penetration was not quite so deep as in the iron; but, on removing the plate from the target, it was found that the back of the plate, behind where the shots struck, was broken into fragments, and the plate was cracked its whole length."

TABLE CXIII.—PENETRATION OF WATER AND WOOD. WHITWORTH 24-POUNDER RIFLED HOWITZER.

H. M. S. "Excellent," December 22, 1857.

Round.	Depression.	Height above plane.	Height of water above part aimed at.	Height of water above part struck.	Shell entered water distant from butt.	Penetration through water.	Total penetration, water, mud, and wood.	Remarks.
	° ' "	ft. in.	ft. in.	ft. in.	ft.	ft.	ft.	
1	8 0	9 6	4 0	5 6	28	28	31	Missed butt.
2	7 0	10 0	2 0	3 0	15	29	47	Through butt.
3	7 45	8 6	4 9	6 0	34	36	39	Ditto.
4	7 30	7 8	5 4	7 4	37	39	49	Missed butt; shell preserved angle of fire throughout its trajectory. Deflection L 6 ft.
5	7 30	7 8	5 4	7 4	37	37	45	Missed butt.
6	7 0	7 8	4 4	5 4	34	34	...	Could not penetrate wood.
7	7 0	7 8	4 4	5 2	34	34	...	Ditto.
8	6 30	9 0	2 0	2 6	17	35	53	Through butt; preserved angle of fire.
9	7 0	9 6	2 6	4 0	19	20	...	Half through butt.
10	6 45	9 9	1 9	2 9	14	21	33	Through butt.
11	7 0	9 0	3 0	1 8	23	23	...	Could not go through butt.
12	7 30	10 3	2 9	3 9	18	18	...	Indented butt 4 ins.
13	6 45	8 6	3 0	3 6	24	25	...	Lodged in butt.
14	7 0	9 6	2 6	3 0	19	36	52	Through; butt broken before.
15	6 45	9 0	2 6	4 0	21	21	...	Indent, 2 ins.; butt shattered.
16	6 45	9 0	2 6	3 0	21	41	...	Through butt; shell fell in mud 20 ft. beyond.

plane passing through the foot of the butt. The results are given in Table 113, and are thus summed up in the report of the Select Committee on Ordnance, 1863: "Firing with  $5\frac{1}{2}^\circ$  depression it penetrated through 13 feet of water and then 13 in. of oak; but after penetrating 20 feet of water, the velocity became so much reduced that when it struck the target it only grazed. Distance of target, 100 feet." At the same time, and in March, 1858, similar experiments were continued with the Whitworth 24-pounder howitzer. The results are given in Tables 114 and 115.

TABLE CXIV.—PENETRATION OF WATER AND WOOD. WHITWORTH 24-POUNDER RIFLED HOWITZER.

(From the Launch at the "Serpent" Brig, Dec. 22, 1857.)

No. of Round.	Depression.	Height above plane.		Height of water above part struck.	Shell entered water distant from ship.	Wood penetrated.	Water penetrated.	Remarks.
		ft.	in.					
1	7 0	4 0	2 2	21	7	21	4 in. fir and 3 in. oak, and grazed timber.	
2	7 0	4 0	2 0	21	7	22	4 in. fir and 3 in. oak.	
3	7 30	4 0	3 4	21	7	21	4 in. fir and 3 in. oak. Dropped in hold.	
4	7 30	4 0	5 0	21	...	22	Grazed angular side 1 in. deep.	
5	7 30	4 0	3 6	21	4	21	Penetrated to rib and dropped in the mud.	
6	7 30	4 0	4 0	21	3	22	Penetrated to rib. Side very angular.	

### 807. Comparison of 68-Pounders and 32-Pounders.—

"In 1858,\* the effect of 68-pounders and 32-pounders, at 100 yards, against iron plates, was compared at Portsmouth, when one 68-lb. shot was found to do as much damage to a plate and more to the woodwork frame of a ship than 5 32-pounders striking close together, and at 20 yards some 4-in. wrought plates on a ship's side were not penetrated by a 68-pounder cast-shot with full service charge; but a wrought shot, of 72 lbs. from

\* Captain Inglis's account continued.

TABLE CXV.—PENETRATION OF WATER AND WOOD. WHITWORTH 24-POUNDER RIFLED HOWITZER.

*From Mooring Lighter at "Serpent" Brig, March 16, 1858.*

No. of Round.	Depression.	Height above plane.	Height of water above part struck.	Shell entered water distant from ship.	Penetration in wood.	Remarks.*
	° '	ft. in.	ft. in.	ft.	in.	
						The first 8 shots were above water.
9	5 15	6 6	...	28	...	Did not hit the vessel.
10	"	"	3 0	28	...	Hit sternpost, knocking off a piece 3 in. thick.
11	"	"	3 9	28	$\frac{1}{2}$	Fell into the mud.
12	"	"	3 3	28	$\frac{1}{2}$	Grazed and fell into the mud.
13	"	"	7 3	28	$\frac{1}{2}$	Buried in mud.
14	4 15	"	3 3 to 4 3	15	$\frac{1}{2}$	Grazed and buried in mud.
15	6 30	"	3 6	22	$1\frac{1}{2}$	Ditto ditto.
16	"	"	"	22	$1\frac{1}{2}$	Grazed and buried 6 feet in mud.
17	6 0	"	1 6	18	4	Also passed through a rib, tearing off $\frac{3}{4}$ ths of it.
18	6 30	"	3 0	22	$1\frac{1}{2}$	Buried $4\frac{1}{2}$ ft. in mud.
19	"	"	3 3	22	$4\frac{1}{4}$	Lodged between 4-in. side and lining.
20	6 0	"	2 6	18	4	Lodged in side.
21	5 30	"	1 0	13	4	Knocked away part of bulkhead of magazine, glanced up knocking away 5 in. combing, and fell overboard 20 yards beyond.
22	5 45	"	2 0	16	2	Fell in mud.
23	5 30	"	1 8	13	13	Through side and a rib, and lodged in store-room.

\* Percussion fuzes were used in the shells, but did not burst; the plugs having acted, but the fire being put out by the water.

same gun, did just penetrate them. Also, it was found, that hollow shot, red-hot shot, and shell, made little impression on 4-in. plates at either 200 or 400 yards; that, at 200 yards, the effects were much increased. At 100 yards 2 or 3 hollow shot, red-hot shot, and shell, striking at same spot, would penetrate a 4-in. plate, but a single 32-pounder cast shot at that range would sink deep into a 4-in. plate, but not get through. At 20 yards, cast shot did very little more damage than at 100 yards. It was also important to observe that if a shot does get through iron it does far more damage than if it had only gone through timber.

**808. Whitworth 68-Pounder 4-Inch Plates.**—"In the autumn of 1858, a Whitworth 68-pounder fired solid cast and wrought shot against 4-in. wrought plates on ship's side at Portsmouth, at ranges from 350 and 450 yards. A cast shot, at 350 yards, dented a plate  $\frac{5}{8}$  in., bulged it  $1\frac{3}{8}$  in., cracked it, and started 12 bolts, and at 400 yards much the same. A wrought shot at 450 yards went right through 4-in. plate and 7-in. of oak in ship's side. After this the gun burst." The details of this experiment are given in Table 116.

**809. 4-Inch Plates; 68 and 32-Pounders.**—"In November, 1858,\* the *Erebus* and *Meteor* floating batteries were fired at at Portsmouth. The former ship's side had a  $\frac{5}{8}$  inside skin on iron ribs, outside this 5 or 6-in. oak plank, and 4-in. wrought plates outside all. The *Meteor's* side was made up of an inner planking of oak from 4 to 9 in. thick, then 10-in. oak timbers 4 in. apart, then 6-in. outside oak planking with wrought 4-in. plates outside all. 32 and 68-pounders at 400 yards did no serious damage in-board to the *Meteor*, but 68-pounders penetrated the *Erebus*, and did as much damage as a volley of grape-shot. The *Meteor* also resisted a wrought 68 shot at 400 yards, and sustained only trifling injury in-board at 300 yards. A 68-pounder shell, with weight of sand=to bursting charge, indented a plate  $\frac{7}{8}$  in., but did not crack it.

**810. 8-Inch Plate; 68-Pounders.**—"In 1858, a large

\* Captain Inglis's account continued.

TABLE CXVI.—WHITWORTH 68-POUNDER AGAINST 4-INCH PLATES. H. M. S.  
 "EXCELLENT," OCT. 8, 1858.

GUN.—68-Pounder Block; Diameter of Bore, 5 in. and  $5\frac{1}{2}$  in.; Rifling, 1 turn in 100 inches.

PROJECTILES.—Weight, 68 lbs.; Cast Iron, 12.7 in. long; Wrought Iron, 11.7 in. long. Some of these were hardened.

TARGET.—Plates 13 ft. long  $\times$  1 ft. 9 in. high  $\times$  4 in. thick; Target, 13  $\times$  10 ft., fastened to the side of the *Alfred* frigate.

Round.	Projectile.	Charge.		Range.		Indent.	Remarks.
		lbs.	yds.	in.	in.		
1	Cast I.	10	350	$\frac{5}{8}$			Hit obliquely; 12 bolts started out $\frac{1}{4}$ to $1\frac{3}{4}$ in.; 2 cracks, 1 across the plate $7\frac{1}{2}$ ft. to R. of indent; woodwork on lower deck slightly shaken and a few treenails started; shot broke up.
2	Wt. I.	10	350	...			D d not strike the plates.
3	Wt. I.	10	350	...			Shot jammed in loading; $1\frac{1}{2}$ hours spent in clearing the gun.
4	Cast I.	10	400	1			Hit obliquely at lower edge of a plate; 4 bolts started out $\frac{1}{2}$ in.; crack 8 in. R. of indent 7 in. long.
5	Wt. I.	12	450	...			Through plate and ship's side; 6-in. hole; pieces of plate (badly welded) through ship's side; shot passed through 4-in. iron and 7-in. oak.
6	Cast I.	12	400	$1\frac{1}{8}$			Hit end on; 4 bolts started out $\frac{1}{2}$ in.; 4 cracks, 2 across the plate 2 ft. 1 in. R. and 2 ft. 4 in. L. of indent; no injury in board; shot broke up.
7	Cast I.	...	...	...			Gun burst cutting away fore and mainmasts; greater part blown overboard.

wrought plate 6 ft.  $\times$  6 ft. and 8 in. thick, weighing 5 tons, leaning back about  $10^\circ$ , and supported by large fragments of cast iron used in some former experiments, these again backed with heavy blocks of granite, were fired at with 68-pounders, solid, cast, and wrought shot, at Woolwich, at 600 and 400 yards,—charge, 16 lbs. At 600 yards, a cast shot indented 1.25 in., cracked the plate slightly on its face, bulged it in with a wide crack behind, which was afterwards increased. At 400 yards, a cast shot indented 1.4 in., and extended the cracks very much. At 600 yards, a

wrought shot broke off large fragments, and in fact quite broke it up. The report adds that when this plate began to break up its destruction was as rapid as that of the cast blocks in 1857.

**S11. 14-Inch Thorneycroft Shield.**—“In 1859, Messrs. Thorneycroft, of Wolverhampton, proposed to Captain Wrottesley the use of rolled iron tongued and grooved bars in horizontal layers, as an inexpensive method of applying iron to resist heavy shot. The great advantage offered was that of producing a mass of wrought iron at about £15 per ton, whereas in other forms it had not been previously put together under thrice that cost. Sir John Burgoyne strongly advocated the principle, and a shield measuring 10 ft. × 4 ft. 6 in. high and 14 in. thick, with an embrasure opening in it, was tried at Portsmouth. On the first day's trial seven 68-pounders shot at 400 yards range, striking fairly, made a very trifling impression, except in those parts where large vertical bolts passing through the heart of the bars had weakened them. This iron mantelet showed such powers of resistance on this occasion, that subsequently it underwent further trial with a 68-pounder at 400 yards; 6 cast-iron shot struck the target, were of course broken up, but indented 1 in. and cracked it slightly; one of these shot on an old shot mark, carried away a piece of the target. 8 wrought-iron shot struck it, 1 chipped off a piece, 2 carried away parts of the top sill of port, 5 indented and cracked slightly. Greatest depth of indent, 2 inches. Altogether, except for an error in construction, the result was considered very favorable to rolled-iron bars in layers, and further trials hereafter described were soon determined upon.

**S12. Special Committee; 1½-Inch, 2-Inch, 2½-Inch, 3-Inch Plates.**—“During 1859, a Special Committee carried on a series of experiments\* on iron plates of various thickness of which the

\* Captain Dyer, R. A., says as to the experiments made by this Committee (“Remarks on Iron Defences,” R. A. Inst.), that “the result, arrived at, was, that a good wrought-iron plate 4½ in. in thickness, backed with 18 in. of teak, is considered for all practical purposes proof against any ordnance not exceeding the 68-pounder or 100-pounder Armstrong, at a range of 400 yards.



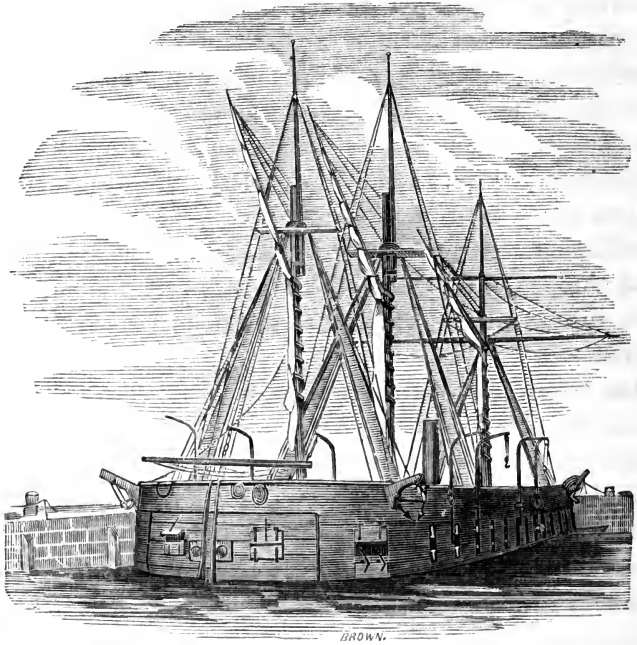
following is an outline: "They commenced upon plates respectively  $1\frac{1}{2}$ , 2,  $2\frac{1}{2}$ , 3 in. in thickness, bolted to a timber target representing the side of a 50-gun frigate, of oak from 18 in. to 24 in. thick. A shell weighing 78 lbs. when filled with sand,—charge, 10 lbs.,—thickened at the head, fired from one of Sir W. Armstrong's guns at 400 yards, passed readily through the  $1\frac{1}{2}$  and 2-in. plates, and of 4 shells fired against 3-in. plates, 2 were resisted, although they injured the plate and timber a good deal, and 2 passed through the plates, but not through the timber. An 8-in. shell (68-pounder) 16 lbs. charge, made a circular crack in a  $2\frac{1}{2}$  plate, but did not drive any of the plate into the timber. All these shells were of course broken. Puddled steel and cast-iron solid shot from Sir W. Armstrong's 80-pounder (11 lbs. charge) passed through the  $2\frac{1}{2}$  and 3-in. plates and timber, the steel entire, the cast iron in fragments, doing much damage by splinters.

**813. "Trusty," 4-Inch Plates.**—"The 'Trusty' was next fired at; her side consisted of wrought 4-in. plates on 2 feet 1 in. solid oak. At 400 yards, 72 lbs. cast flat-headed shot from Sir W. Armstrong's 80-pounder gun, broke the plates but did not pierce; shot broke up of course. The puddled steel shot broke in a large portion of a plate. A homogeneous iron fairly penetrated both plate and timber. At 200 yards the cast-iron conical-headed shot 100 lbs. did a good deal of injury but did not pene-

"During these experiments it was found that although, except in rare cases, ships of this construction were impenetrable, still, that penetration was at last obtained coupled with most terrible destruction if struck several times with heavy projectiles near the same spot. The shot on impact is broken in pieces, and carried through with the fragments of the iron and wood; the plate in this case not only not affording any protection, but materially increasing the destructive effect of the shot; on one occasion the number of pieces produced by a single shot were carefully collected, and it was found that there were over 700 pieces of wood and iron each of sufficient size to be formidable. The possibility of such destructive and alarming effects have led many to question the advantages of iron defences; but I think few except those whose sympathies are wedded to the romantic notion of 'the wooden walls of England,' would hesitate to prefer defence capable of resisting all missiles under ordinary circumstances,—defective only in the improbable event of several shot striking the same spot, to being exposed to the fire of Armstrong 100-pounder shell with  $8\frac{1}{2}$  lbs. of power, or Martin's liquid iron shell."

trate. A homogeneous iron 78-lb. shot punched a hole through plate and penetrated 10 in. into the timber, and a homogeneous shot of 100 lbs. at a lower velocity, did not punch a hole, but made a large fracture; oblique shots at an angle of  $50^\circ$  to the

FIG. 373.

The floating battery *Trusty*.

side of the vessel, caused less injury than direct shots. The bolts holding the *Trusty's* plates rarely yielded except when directly hit.

**814.  $4\frac{1}{2}$ -Inch Plates.**—After this the same Committee fired at some  $4\frac{1}{2}$  rolled plates from Messrs. Palmer's and some 2-in. plates from the Mersey Company, bolted to a section of a 50-gun frigate, with homogenous iron bolts double nutted. The 2-in. plates could not resist Sir W. Armstrong's 80-pounder shell at 400; the shell broke up, but always passed through the plate. A 68-pounder shell at same range, 16 lbs. charge, broke the 2-in. plate, but did not penetrate deep into timber. The  $4\frac{1}{2}$  plates had

a hole punched in them by a homogeneous flat-headed shot, and the plate was forced 3 in. into timber, and several shot striking together, some of the plate was driven in 20 in. Altogether these  $4\frac{1}{2}$ -in. plates were considered to stand well.

**815.**—“Some experiments were also about the same time carried on at Portsmouth, tending to show that three 68-lb. shot, striking close to the same point, will, at 200 yards, break up and drive in  $4\frac{1}{2}$ -in. wrought-iron plates attached to a timber ship's side. This Committee came to the conclusion that although thin wrought plates will break up cast-iron shell, little advantage will be gained by the use of iron, unless it be strong enough to resist both the fragments of shell and of cast-iron shot; that ships with  $4\frac{1}{2}$  in. of rolled plates were invulnerable by any projectile then in use, and that plates should be strongly backed and secured by strong wrought-iron bolts with double nuts.

**816. Jones's Inclined Target.**—“In August, 1860, Jones's (miscalled) angular butt was tried at Portsmouth. It consisted of a series of ribs of  $\frac{1}{2}$ -in. iron plates, 21 in. deep, spaced 14 in. apart, connected together at outside and top and bottom with  $\frac{1}{2}$ -in. iron pieces, screwed and nutted to the ribs, outside this was laid  $13\frac{1}{2}$  in. of stout fir planking, and outside this the armor-plates, the whole structure measuring 39 in. through, and being placed at an angle of  $52^\circ$  with the perpendicular. The armor-plates were  $4\frac{1}{2}$ -in. and  $3\frac{1}{2}$ -in. steel, and  $4\frac{1}{2}$ -in. wrought-iron from the Mersey Works, and  $4\frac{1}{2}$ -in. of Derbyshire iron. The butt, with a strong and solid foundation, and well supported by stanchions, was placed on the upper deck of an old vessel and fired at by a 68-pounder solid cast-iron shot, 16 lbs. charge, range 200 yards. The result of 35 rounds was reported to be that the penetration was less than half that on perpendicular plates, and that the effect on the woodwork backing was very slight, compared with that when the plates are on a ship's side. The Derbyshire wrought iron was extremely brittle; that by Mersey Company was far better; the steel plates useless. One  $4\frac{1}{2}$  Mersey wrought-iron plate, 7 ft.  $\times$  3 ft., took 17 blows in an area of 13 square feet before any part of it was removed, and then,

TABLE CXVII.—EXPERIMENTS AGAINST JONES'S INCLINED TARGET. AUG. 21, 1861.

The numbers in brackets (Fig. 374) show the numbers of these rounds.

GUN.—Armstrong 100-pdr. of 81 cwt.

SHOT.—Elongated solid cast iron, with spherical head. Charge, 14 lbs.

RANGE—200 yards.

TARGET.—The plates Nos. 1 and 2 were  $4\frac{1}{2}$  in.; Nos. 3 and 4 were  $5\frac{1}{2}$  in. thick, and each one  $7 \times 3$  feet, showing a vertical height of  $4\frac{1}{2}$  ft. They were secured to 1 ft. square balks of pine by screw-bolts with conical countersunk heads,  $1\frac{3}{8}$ -in. bolts. These plates rested on plates 15 in. wide by  $1\frac{3}{4}$  in. thick let into the backing of timber. Angle of inclination,  $50^{\circ} 53'$  from the perpendicular.

No. of Round.	Diameter of Indent.	Depth of Indent.	Remarks.
	in.	in.	
1	6	1	No fracture; 2 bolts broken, and 3 shaken.
2	...	...	Missed.
4	...	...	Struck wood framing.
5	6	1	Plate slightly bulged and started up $\frac{3}{4}$ in.; crack, 7 in. long.
6	6	$\frac{5}{8}$	3 bolts broken out.
7	6	$1\frac{1}{16}$	Plate bulged $\frac{1}{2}$ in.
8	6	1	
9	...	...	Missed.
10	...	$1\frac{1}{2}$	Bolt driven in $1\frac{1}{2}$ in.
11	6	$1\frac{5}{16}$	4 cracks 5 to 8 in. long.
12	6	$\frac{7}{8}$	Crack 11 in. long $\times$ 1 in. deep to edge of plate.
13	6	$1\frac{1}{4}$	
14	6	$1\frac{1}{2}$	
15	...	...	Broke a piece of plate out $8 \times 6\frac{1}{2}$ in.; 5 shot now in space $12 \times 21$ in.; upper edge of No. 2 plate started up 1 to 2 in.
16	...	...	Missed.
17	6	$\frac{3}{4}$	
18	6	$2\frac{1}{8}$	Crack 7 in. long, and 4 small cracks.
19	...	...	Missed.
20	6	$\frac{7}{8}$	
21	6	$\frac{3}{4}$	
22	...	...	Six shot now in a space $12 \times 21$ in.; breaking out 2 ft. $\times$ 1 ft. 4 in. of No. 2 plate, and bulging framework to a depth of 4 in.; pulverizing the wood.

All the shot appeared to break, upon striking, into numerous fragments, which generally fell between 500 and 1500 yards beyond.

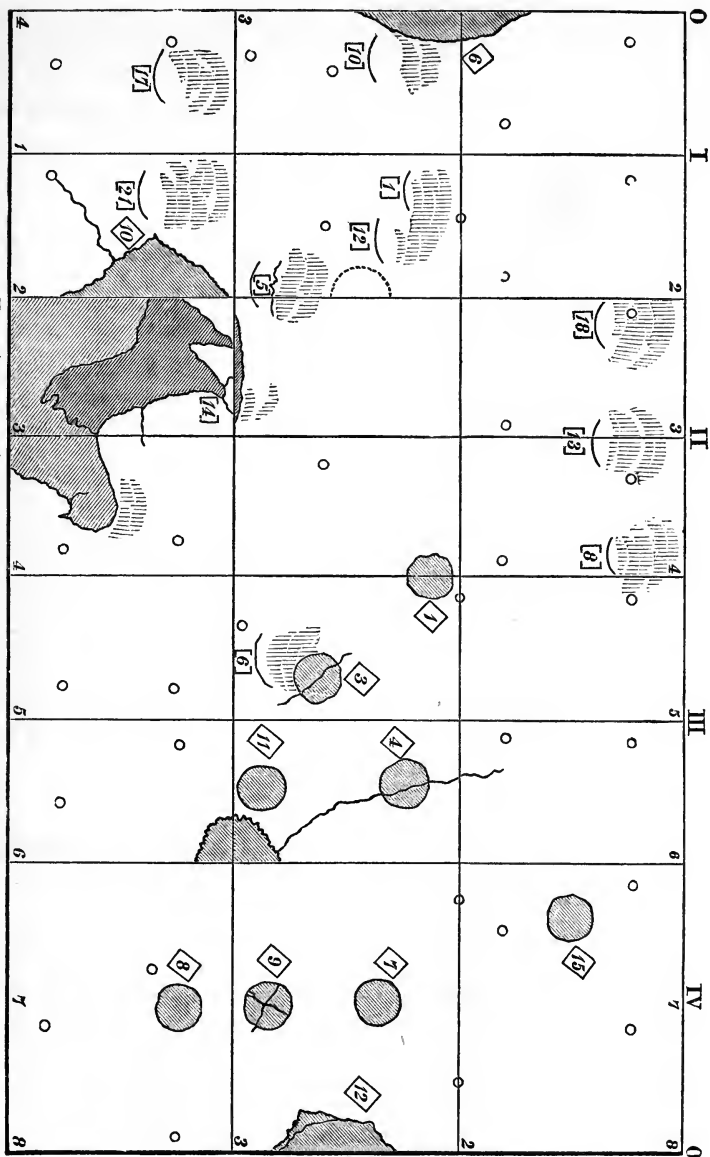


FIG. 374.—Jones's inclined target. See Tables 117 and 118.

TABLE CXVIII.—EXPERIMENTS AGAINST JONES'S TARGET PLACED VERTICALLY.  
SEPT. 18, 1861.

The plates had not been disturbed since the experiments recorded in the foregoing table. The target was merely raised to a vertical position and secured by heavy balks of timber.

GUN.—Armstrong 100-Pounder; Charge, 14 lbs.; Shot, cast iron, conical headed; Range, 200 yards. The numbers in diamonds (Fig. 374) show the numbers of these rounds.

No. of Round.	Diam. of Indent.	Depth of Indent.	Remarks.
	in.	in.	
1	6	$1\frac{3}{8}$ and $1\frac{3}{8}$	4 securing bolts broken and a number of bolts started.
2	...	...	Securing bolts all broken; plate fell to the deck.
3	6	$1\frac{1}{4}$	Shot broke up; bulge, $\frac{3}{8}$ in.; crack, 8 in. long; upper edge started from backing $1\frac{3}{8}$ in.; plate badly welded.
4	7	$1\frac{1}{4}$	Crack 14 in. long, and 2 short cracks.
5	7	$1\frac{3}{8}$	2 bolts broken and several started.
6	...	...	Drove fragment of plate 18 × 20 in. into backing 12 in.
7	7	$1\frac{1}{4}$	2 bolts broken and more started.
8	6	$1\frac{1}{8}$	1 small crack; bulge, $1\frac{1}{8}$ in.; outer edge started 2 to 3 in. from backing.
9	6	$1\frac{1}{8}$	
10	...	...	Drove piece of plate 17 × 24 in. into backing 10 in.; 1 crack 14 in. long.
11	...	...	Drove piece of plate 12 × 9 into backing 8 in.
12	...	...	Drove piece of plate 17 × 7 into backing 7 in.; opened former cracks; plate ready to fall, and secured by a rope.
13	...	...	Plate detached, and fell overboard.

even, the iron was not penetrated nor the woodwork much injured." The official account of these experiments is given in Tables 117 and 118.

**§17. Comparison of Elongated and Spherical Projectiles.**\*—“A general comparison was also made about this time

\* Captain Inglis's account continued.

between the effects of elongated and spherical shot upon iron plates at 200 yards, which went to show that an elongated shot penetrated more than a spherical one, striking with the same momentum, but the blow of the elongated was less spread and the smashing effect less. Also, that a flat-headed elongated shot penetrated deeper than a spherical, because the latter spreads out on striking, and thus has a larger surface opposed, while the elongated shot punches a hole out for itself.

**§18. Thorneycroft 10-Inch Shield.\***—“In the autumn of

\* Captain Dyer, in his paper before quoted (“Remarks on Iron Defences”), thus refers to the history and objects of the “Thorneycroft” bars:—“As it was considered desirable that some further experiments should be carried on to determine the best quality of iron for defensive purposes, a committee was formed at the beginning of last year to ascertain whether it might not be possible, by some improvement in the manufacture of armor-plates, to lessen the thickness of  $4\frac{1}{2}$  in., and also to devise some mode of attachment that would obviate the necessity of bolt-holes, and the tongue and groove. The question of employing iron for land defences was also submitted for their consideration, as the Defence Commission had some idea of employing iron very largely in constructing the works at Spithead, Portland, &c. This idea gave rise to the experiments that were carried on with the Thorneycroft bars. As greater resistance to shot was obtained by these bars than by any other means, and as they are now being employed in the defences of Antwerp, the following history of their origin may be interesting:—

“In the early stage of the inquiry relative to iron defences, it was found exceedingly difficult and expensive to obtain large forgings sufficiently sound to resist shot, until Mr. Hartley, of the Shrubbery Iron Works, Wolverhampton, proposed to try the effect of rolled bars of iron tongued and grooved together; this proposal was agreed to, and Mr. Hartley was desired to prepare a target with as little outlay as possible; he therefore adapted a pair of rolls he had in stock, and produced bars with a sectional area of  $15 \times 5$  in., the size of the rolls, or rather the chance selection of the pair used, determined the size of the first bars, which obtained the name of Thorneycroft’s bars, simply because they were made at the Shrubbery Iron Works, which were formerly more generally known by the name of Thorneycroft’s. A target formed of these bars, secured together (in addition to the tongue and groove) by a bolt passing through them, was found to offer such resistance to shot as to warrant the belief that if reduced to  $10 \times 4\frac{3}{4}$  in., the defence would still be found sufficient. An embrasure was therefore constructed of bars  $10 \times 4\frac{3}{4}$  in., having several feet of masonry above them; on this occasion, the bolt used in the former experiment to secure the bars together was dispensed with, as it was considered that sufficient solidity would be obtained by the weight of the masonry above. This embrasure stood the most severe tests without showing any signs of weakness; salvos from 68, 80, 40, and 32-pounder guns were fired against it, apparently without damaging the structure, and it was, with reason, thought that an embrasure of this construction was invulnerable. Indeed, so confident were all in this method of applying iron for defence, that it was proposed still further to reduce the sectional area of the bars, and to substitute wrought-iron supports for the masonry. Two embrasures were therefore constructed for experi-

1860, a further trial was made at Shoeburyness, of the Thorneycroft principle, on a shield 12 ft.  $\times$  5 ft. 4 in., with an embrasure opening of 23 in.  $\times$  39 in., composed of rolled bars 10 in. wide and 4 in. thick, with tongues and grooves. There were thus 6 long bars and 10 short bars; the shield was applied to the front of a masonry casemate, and a 68-pounder gun was mounted in the casemate, on a traversing platform. It will thus be seen that this shield was but 10 in. thick, or 4 in. less than that tried at Portsmouth, and before described. The principal points in which it differed from the Portsmouth shield was, that instead of the several bars being held down by bolts passing through them, they were in this case clamped together by strong vertical tie-bolts at their back at each end, and these passed through bonding-irons at the top and bottom; the whole was well bedded in the masonry, and tied through the whole thickness of the parapet by strong tie-rods; the shield was, moreover, backed by masonry over its whole surface. This shield was first fired at with grape and segment

ment; one of bars  $10 \times 4\frac{1}{2}$  in., supported by wrought-iron uprights  $2\frac{1}{2}$  ft. apart, and every fourth bar secured by a dovetail at the back to the upright. The other embrasure was composed of bars  $8 \times 3\frac{1}{2}$  in., supported at the ends by masonry, and in the centre by wrought-iron uprights  $2\frac{1}{2}$  ft. apart, similar to the other. At this experiment, Sir W. Armstrong's 120-pounder shunt gun was used, and the effect of this formidable piece of ordnance against the embrasures was such as to put an end at once to all idea of their impenetrability and the strength anticipated by the wrought-iron supports. It was found that the tongue on the bars was readily stripped off, and the uprights broken in the vicinity of the blow, leaving, as it were, each bar singly to resist the impact of the shot without deriving any support from the others. In the bars used at this experiment sufficient care had not been taken in the 'piling' to obtain the greatest amount of strength; but independently of this defect in manufacture, the very small comparative resistance offered to the shot caused all idea of using these bars to be most reluctantly abandoned. Bars of this description possess many advantages over wrought-iron plates, if it were possible to hold them securely together, and make each one derive its proper share of support from the others. The advantages alluded to are as follows:—

“1. The rapidity with which they can be manufactured.

“2. The facility of transporting them from the forge to the work.

“3. The great thickness of metal obtained sound, at a comparatively small cost per ton, for it must be remembered that the price per ton of wrought iron increases very rapidly in proportion to the weight. For example: while £19 per ton was paid for Thorneycroft's bars, with a prospect of a very considerable reduction, the armor-plates were costing from £32 to £40 per ton, and the stern-port of the 'Warrior' cost no less than £150 per ton.”



Armstrong shell, at 400 and 600 yards, from 68-pounder, 32-pounder, and a 25-pounder Armstrong gun, and, from the diminished size of the embrasure, the effect upon the inside of the casemate was favorable. After this, a number of rounds (about 21), with wrought and cast shot, were fired from 68-pounder, and 80-pounder, and 40-pounder Armstrong guns, at 600 yards, and without any serious injury.

	in.	in.
The 68-pounder indented about.....	1½	to 1½
“ 80-pounder “ “ .....	1	
“ 40-pounder “ “ .....	¾	
“ grape “ “ .....	¼	

“The masonry of the parapet was struck several times and fearfully injured.”

#### **§19. 10-Inch Thorneycroft Shield without Backing.—**

“After this, another experiment was made upon the same shield, without masonry backing, the masonry only giving it support at its two ends. In this trial it received 29 blows from 68-pounder, and 80-pounder, and 40-pounder, at 600 yards, with wrought and cast shot, and stood very nearly as well as with the stone backing. It will thus be seen that the shield received 50 shots in all. One bar had a piece knocked out of it; one or two slid laterally a few inches; a few had cracks in them; but altogether the shield was but little injured. No indentation exceeded 1½ inch.”\*

**§20. Iron Embrasure Flaring Checks.—**“Together with the trial of this 10-inch Thorneycroft embrasure, a trial of another wrought-iron embrasure of special construction was made. This consisted of four massive pieces, two cheeks or side-pieces about 8 inches thick, set splayed, to allow a lateral traverse of 60°, with a sill and head-piece 4 inches thick; the whole was very firmly bolted and dovetailed together, and proved very strong; but the defect of

\* “EFFECT OF SOUND.—A short time after this, an opinion gained ground that the effect of the sound arising from heavy guns, fired out of an iron embrasure of this construction, would be an obstacle to its use; and, to test this, a number of shots were fired from a 68-pounder, at every possible degree of lateral range, and no inconvenience whatever was felt by any person in the casemate.”—*Captain Inglis.*

the flaring cheeks was so apparent, in comparison with the small opening of the Thorneycroft embrasure, and the effect of the splinters and grape let in by these sloping cheeks so destructive upon the interior of the casemate, that the principle, although possessing some advantage as to strength, was soon given up. It is right, perhaps, that I should here mention that, on a subsequent occasion, the 10-inch Thorneycroft shield (which I have been describing as about proof against an 80-lb. shot) was found to be unequal to a blow from a 120-lb. shot thrown from Sir W. Armstrong's shunt muzzle-loading gun.

**821. Special Iron Committee, 1861.**—"Early in 1861, the special committee on iron was appointed, and during the whole of the past year (1861) they have been fully occupied with a vast number of very important investigations. The more important and immediate and difficult object of inquiry of this committee, has been that of giving the most effective armor to our navy; but the question of iron, as used for defence generally, has also occupied much of their attention, and the greater part of their experiments are as useful and instructive to the designers of fortification as to naval architects.

**822. Thorneycroft 10-Inch and 8-Inch Shields.**—"The 10-in. Thorneycroft shield, fired at by the Ordnance Iron Committee, having given great promise of success, and the principle appearing to give greater strength for the same money than by any other plan, it was determined to prosecute the inquiry further, and to erect two new shields.\* The 10-in. shield was made on the

\* Captain Inglis says, in the same paper:—"I think that a false step was taken in fixing the thickness of these two shields. When the original Portsmouth 14-inch shield had been tried, and, except for a certain defect in construction, found very good, instead of cautiously taking off little by little, so as to find a safe minimum, 4 in. in thickness, or 28 per cent., was taken off at one step, just at the time when projectiles were getting larger and flying faster, and a 10-in. shield tried at Shoebury. This proved, as I have said, equal to a certain gun, but quite unequal to resist the heavier projectiles coming into the service.

"Instead, therefore, of putting on some strength, such as making up 12 inches in thickness, another 10-in. shield of much larger dimensions, and under considerably less advantageous circumstances, and of very questionable and ill-contrived construction, was brought out; and, to make matters worse, another shield of only 8 inches

independent principle—that is to say, it was to be self-supporting, without any aid from the rest of the fort, or other work of which it might form an embrasure. It presented a front of 12 ft.  $\times$  8 ft., with an opening or port for gun. It consisted of bars in section, 10 in.  $\times$   $4\frac{1}{2}$  in., tongued and grooved as before, but five of the bars, viz., 1st, 8th, 12th, 19th, and 21st, had dovetails on the whole length of their back, on which upright backing pieces fitted, which were intended to bind the mass from top to bottom; the shield was supported at the back by massive rolled-iron struts footed down into sill-pieces of the same material. The 8-in. shield was composed of bars 8 in.  $\times$   $3\frac{3}{4}$  in., with similar backing pieces, but supported at either end by masonry piers to which it was bolted. On the first day's firing at the 10-in. shield, the backing pieces gave way at the dovetails, and the mass not being tied together, the bars got displaced and broken, and ultimately, the whole shield being driven off its solid bed, it fell over and buried its face in the sand. On the second day, strong vertical iron shackles had been prepared in order, as a temporary measure, to supply the place of the backing pieces that had failed; these made the shield offer considerably greater resistance, but when they ultimately gave way, the shield could not stand against the 120 or 100-pounder guns. The 8-in. shield could not even stand two 68-pounder shot, striking near the same spot, and the 100-pounder destroyed the target; shackles, as before, were afterwards added, but, although they had some effect, the shield was quite unequal to the gun brought against it."

Table 119 is the official report of the firing against these targets. Figs. 375 and 376 represent, respectively, the front and end of the 8-in. target, and Fig. 377 is a section of the 8-in. bar.

RESULTS.—THORNEYCROFT 10-INCH TARGET. The 2d shot (Table 119) hit the right face just at the mouth of the embrasure on the 4th bar above the sill; made an indent 7 in. in diameter. Three

was ordered. The trial of these two against such blows as the 100-pounder service and 120-lb. shunt gun can give, at 400 yards, led to what might have been easily foreseen, and the two targets completely broke down."

of the bars driven back 3 in., two more bars 2 in. The tongues of the bars where struck sheared off.

3. Passed through the embrasure.
4. Struck the lower bar on its lower edge; scooped out a hemi-

FIG. 375.

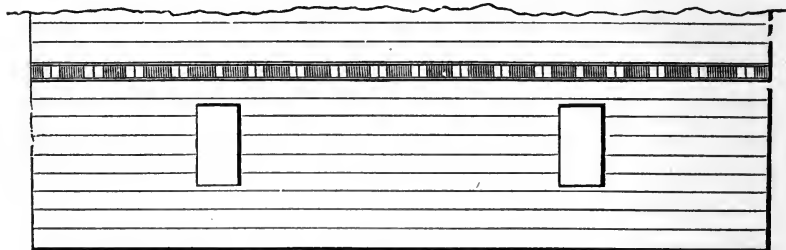
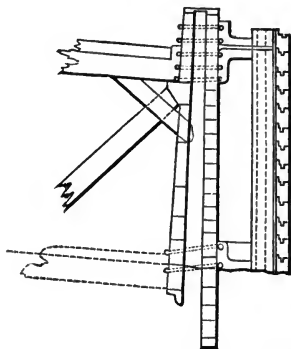
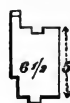


FIG. 376.



Thorneycroft 8-in. target.

FIG. 377.



spherical piece  $2\frac{1}{2}$  in. in depth, 7 in. in diameter; tore away some of the wooden foundation.

5. Struck 20 in. to the left of the last round. Exactly the same effect.

6. Hit the left top of the target on the 7th and 8th bar from the top; diameter of indent,  $9\frac{1}{2}$  in.; depth,  $1\frac{3}{4}$  in. The back of the 8th bar which, owing to the dovetail on the back was  $12\frac{1}{2}$  in. thickness, was cracked. The bars did not appear to be displaced.

7. Through the embrasure.

8. To the right and 13 in. from the mouth of the embrasure

TABLE CXIX.—EXPERIMENTS AGAINST THE THORNEYCROFT 8-INCH AND 10-INCH TARGETS. JUNE 6, 1861.

The 1st target was formed of Thorneycroft bars, secured by dovetails to the iron uprights; the dovetails were rolled on the back of the 1st, 8th, 12, 19th, and 21st bars. The bars were 10 in. by 4 in., and 12 ft. long; the iron uprights were 2½ ft. apart.

The 2d target was formed of similar bars, 8 in. by 3¾ in., supported in a similar manner with iron uprights, the end ones being supported by masonry.

Nos. 14-20 give the results of experiments against the Thorneycroft 10-in. target.

No. of Round.	Nature of Ordnance.	Charge, lbs.	Weight of Projectile, lbs.	Nature of Projectile.	Range, yds.	Elevation.	Deflection.
2	68-pdr..... 95 cwt.	16	66½	Cast-iron round shot.	400	½°	...
3	“	“	“	“	“	“	...
4	“	“	“	“	“	“	...
5	“	“	“	“	“	“	...
6	“	“	“	“	“	“	...
7	“	“	“	“	“	“	...
8	“	“	“	“	“	“	...
9	100-pdr. Armstrong	14	110	Cast-iron solid shot, hemispherical head.	400	30'	6' R
10	“	“	“	“	“	38'	...
11	“	“	“	“	“	46'	...
12	“	“	“	“	“	“	...
13	120-pdr..... shunt gun, muzzle- loader.	18	126	Cast-iron solid shot, hemispherical head.	400	33'	...
14	68-pdr.....	16	66½	Cast solid.	400	½°	...
15	“	“	“	“	“	“	...
16	“	“	“	“	“	“	...
17	100-pdr.....	14	110	Cast solid.	400	46'	6' R
18	“	“	“	“	“	“	...
19	“	“	“	“	“	“	6' R
20	120-pdr.....	18	126	Cast solid.	“	“	...

TABLE CXIX.—(CONTINUED.)

The experiments continued against the Independent Shield of Thorneycroft bars, 10-in. by 4-in., and against the Embrasure formed of Thorneycroft bars, 8 in. by  $3\frac{3}{4}$  in., were resumed June 13, 1861. Range, 400 yards; cast-iron solid shot.

*Both the bars were secured by strong iron braces, and strongly supported by timber beams, but no backing was used.*

Nos. 27-30 give the results of experiments against the 8-in. target.

No. of Round.	Nature of Ordnance.	Charge, lbs.	Weight of Shot, in lbs.	Elevation.	Deflection.
21	100-pdr. ....	14	110	47'	3' R
22	120-pdr. ....	14	125 $\frac{1}{2}$	40'	2' L
23	120-pdr. ....	18	125 $\frac{1}{2}$	30'	5' R
24	100-pdr. ....	14	110 $\frac{1}{2}$	47'	5' R
25	120-pdr. breech-loading shunt gun.....	14	125 $\frac{1}{2}$	42'	2' L
26	120-pdr. ....	18	125 $\frac{1}{2}$	32'	5' R
27	100-pdr. ....	14	110	47'	5' R
28	120-pdr. breech-loading shunt gun.....	14	125 $\frac{1}{2}$	42'	2' R
29	{ 120-pdr. ....	14	125 $\frac{1}{2}$	42'	2' R
	{ 100-pdr. ....	14	110	47'	2' R
30	{ 120-pdr. ....	14	125 $\frac{1}{2}$	42'	3' R
	{ 120-pdr. ....	18	125 $\frac{1}{2}$	31'	3' L
	{ 100-pdr. ....	14	110	47'	5' R
	{ 68 pdr., 95 cwt. ....	16	67	$\frac{1}{2}$ °	...

on the 13th and 14th bars; diameter of indent, 9 in.; depth, 1.64 inch.

9. Through the embrasure.

10. Hit the foot of the second upright below the bars; broke away  $3\frac{1}{2}$  feet of the bar, tore away the part that formed the dove-tail between 19th and 21st bars, and drove the top of the target 6 in. forward.

11. Struck the 5th bar from the top; diameter of indent  $8\frac{1}{4}$  in., depth 1.68 in.; cracked the bar.

12. Hit the 10th bar from the top; opened a crack right through the bar one inch wide. The left upright was cracked right through at the second dovetail from the top. The tongue of the bar where struck was sheared off for several inches. Indent, 2.12 in.

13. Hit the 3d bar from the top; broke away 2 ft. 9 in. of the bar, and drove it ten yards to the rear of the target; opened the three top bars  $1\frac{1}{2}$  in. each, stripped off the top part of the first dovetail on the second upright; opened the crack on the first upright  $2\frac{1}{2}$  in. wide. Indent, 2.20 in. The target fell on its face.

THORNEYCROFT 8-INCH TARGET.—14. Hit on the 3d and 4th bar below the sill of the embrasure; drove a piece  $7\frac{1}{2}$  by  $4\frac{1}{4}$  by  $2\frac{1}{2}$  in. from the back of the 3d bar; diameter of indent on the face, 9 in.; depth, 2 in.

15. Hit on the left of the embrasure on 17th, 18th, and 19th bars; made an indent 9 in. in diameter,  $1\frac{3}{4}$  in. deep, and cracked the bar.

16. Hit almost exactly on the same spot as No. 2, made a crack across all three of the bars  $2\frac{1}{2}$  in. wide; the bars were driven  $2\frac{3}{4}$  in. into the mouth of the embrasure. The masonry was much shaken.

17. Hit just over one of the iron upright supports, which it drove away, breaking it into three pieces and tearing away the slots made to receive the dovetails on the back of the bars; cracked the bar where it struck; crack, 2 in. wide. Indent, 2.8 in.

18. Drove a piece of the bar, 80 lbs. in weight, thirty yards to the rear of the target; hit just below on the next bar to No. 4; opened a crack 8 in. wide through both bars; drove the ends of the bars  $5\frac{1}{2}$  in. across the mouth of embrasure; knocked down the four top bars and cracked the masonry. Indent, 3.1 in.

19. Hit the bar which formed the top of the mouth of the embrasure at its extreme end, just over the wood backing, which it crushed in, made a small indent, and brought down six more bars.

THORNEYCROFT 10-INCH TARGET.—The 8-in. target was now so destroyed that the firing was discontinued, and the 120-pounder shunt gun was laid on the old 10-in. Thorneycroft embrasure.

20. Hit to the right and below the mouth of the embrasure; cracked three bars through in five places, opened the bars  $1\frac{1}{2}$  in.; the bars were much bulged and distorted in rear. Indent, 3·3 in.

21. Hit the top bar of the mouth of the embrasure, and passed through, scooping out a very small piece.

22. Breech-loading shunt gun.—Hit on the 7th and 8th bars; depth of the indent, 1·65 in.; diameter of indent,  $9\frac{1}{2}$ -in. The bar slightly bent behind: the tongue of the 6th bar sheared. The bars were separated  $\frac{1}{4}$  in. in rear.

23. The muzzle-loading shunt gun.—Hit on the 18th and 19th bars; depth of indent, 1·9 in. No crack or bulge in rear; the bars did not separate; the upper dovetail on the left upright started  $\frac{1}{4}$  in.

24. Hit on the 18th and 19th bars; depth of indent, 1·3 in. No bulge behind, damage being slight indeed in rear.

25. Hit on the 10th bar; opened a crack 1 in. wide, broke off 13 in. of the bar and drove the bar 3 in. to the rear; sheared off the tongue. Struck over the 3d upright from the left; knocked it off, tearing off the dovetails, broke the upright into two pieces; opened the bars, bulged them 3 in. to the rear, cracked the 13th bar lengthways.

26. Struck over the left brace which was  $1\frac{3}{4}$  in. in thickness; cut it in two; started the dovetail at the back of the left upright to  $1\frac{1}{4}$  in.; broke the upright; cracked the bar across the back.

THORNEYCROFT 8-INCH TARGET.—27. Hit on the 6th and 7th bars; drove them 2 in. to the rear, cracked them through and drove away the two uprights; broke one into two pieces; tore away the dovetails from each.

28. Hit on right wood support; passed through 6 in. of wood, indented iron 1·75 in.; broke iron upright in rear in two places.

29. Tore away  $\frac{1}{2}$  feet of 4 bars; sheared off tongues; made a hole 4 ft.  $\times$   $2\frac{1}{2}$  ft.  $\times$   $1\frac{1}{4}$  ft. beside embrasure; drove several



pieces to rear. These 2 shots hit at the same time and struck near together.

30. These 4 guns were fired together; the 68-pounder passed through embrasure, and the 100-pounder struck the masonry. The 7th and 8th bars cracked through; broke 6th, 8th, and 9th bars across in two places, and bulged them all inwards. The two shots that struck the embrasure were  $5\frac{1}{2}$  feet apart.

**§23. Different Qualities of Iron and Steel.**\*—“At the commencement of their proceedings the Iron Committee, besides consulting all practical and scientific men of experience in the manufacture of iron in this and in other countries, invited all the principal manufacturers to send in plates for experiment.† The plates were tried at Shoebury, fixed vertically without backing against strong timber frames.

“Plates of homogeneous iron, of hammered and rolled iron of various qualities and make, steel, and steel and iron combined, and even copper have been tried. The plates of more than twelve different firms underwent trial and test of every possible descrip-

\* Captain Inglis's account continued.

† Captain Dyer remarks in the paper before quoted: “The Committee appointed at the beginning of last year to continue the inquiry on the subject of iron defences, obtained the opinion of most of the principal iron manufacturers in the country as to the best quality and manufacture of iron to resist shot. The great diversity of opinion among so many practical men could only be accounted for by the fact that none of these gentlemen had ever had an opportunity of witnessing the effect of a shot on an iron plate, and this in some measure explains the very small progress that had, up to a recent period, been made in their manufacture. In consequence, plates of various qualities and manufactures were ordered for experiment, and the makers were requested either to be present themselves at the experiment, or to send some one in whom they placed confidence. They all most gladly availed themselves of this permission, and at the conclusion of the experiment they expressed themselves confident of being able to overcome all difficulties of manufacture, and of producing plates capable of resisting shot. Practical knowledge of great value was by this means afforded to those manufacturers who proposed to devote themselves to this branch of the iron trade; and a spirit of emulation raised among the different iron-masters which cannot fail to have a most beneficial effect in bringing the question (as far as qualities and manufacture are concerned) to a satisfactory solution.

“The advantage of having allowed the iron manufacturers to be present at the different experiments is already becoming apparent in the improvement of the plates supplied for trial; and the time is not far distant when the more general use of mechanical means, to move the large masses while being forged, will reduce the price per ton to more reasonable limits.”

tion, from the very rough and ready and most unerring one of artillery practice, to the delicate and less conclusive test of the chemical analysis, and all the laborious mechanical tests and examination as to specific gravity, tensile strength, resistance to compression, punching, shearing, torsion, &c.

“A breech-loading wall piece, throwing a  $5\frac{1}{2}$ -oz. ball, with initial velocity of about 1100 feet, was used upon plates up to one in. thick, at range 25 yards; roughly speaking, a steel, lead-coated, cylindrical flat-headed bullet punched a clean hole through the  $\frac{1}{2}$ -in. rolled, hammered, or homogeneous plates, but did not always get through  $\frac{3}{4}$ -in. plates, and stuck in an inch plate, making a hole about  $\frac{1}{4}$  in. deep.

“A 6-pounder Armstrong gun, throwing solid cylindrical cast-iron shot, with hemispherical head, at 1125 in velocity,—range, 50 yards,—did not get through  $1\frac{1}{2}$ -in. plates; a 12-pounder Armstrong, throwing cast-iron shot, in velocity 1150, at 100 yards, did not get through 2-in. plates; and a 25-pounder Armstrong cast-iron shot, at 100 yards, did not get through  $2\frac{1}{2}$ -in. plates; a 40-pounder Armstrong, at 100, did not get through a 3-in. plate.

“The wall piece, at 25 yards, did not get through 3-in. copper. The 6-pounder Armstrong, did not get through 3-in. copper, but the 12-pounder Armstrong did.”

**824. Armor on Brickwork.**—“In May, 1861, a very interesting experiment was instituted to ascertain what protection would be afforded to brickwork by iron plates of 2-in.,  $2\frac{1}{2}$ -in., 3-in. and  $3\frac{1}{2}$ -in. thicknesses. The plates were of rolled iron 2 ft. 6 in. wide, and 4 ft. 6 in. and 5 ft. 6 in. long. Each plate was secured by six 2-in. bolts, with countersunk heads; an existing wall about 8 feet thick was used for the trial, and its face was first taken down to a depth of 4 feet; at that depth rolled iron bars were placed vertically in the work (the common railway rail was used for cheapness and expedition), their lower ends being firmly driven down into the foundations, their upper ends held back by a horizontal bar, which was secured at intervals of about two feet by bolts to the rear of the work. The bolts were

bolted to the vertical bars and secured by double nuts, and the brickwork built up solid in cement around them. \* \* \* The result of this experiment may be set down in a few words—viz. : that a brick wall covered by  $3\frac{1}{2}$  in. of iron in this manner would be quite proof against the battering guns at present in the service, but that if it has to resist guns about equal to our 100-pounders, it should be covered with about 5 in. of armor, and that the mode of securing in this experiment was satisfactory.”

The following is the official account of these experiments :

MASONRY PROTECTED BY IRON, MAY 9TH, 1861.—The object of the experiment was to ascertain what protection would be afforded to masonry by iron plates, 2,  $2\frac{1}{2}$ , 3, and  $3\frac{1}{2}$  in. in thickness.

The experiment was commenced by firing a 12-pounder Armstrong cast-iron solid shot at a range of 600 yards. The projectile did not penetrate any of the plates nor cause any damage to the brickwork.

The 25-pounder land service Armstrong gun was next used, with cast-iron solid shot, at the same range. The projectile from the gun penetrated the 2-in. plates, but caused little damage to the other plates, and none to the masonry behind.

The 40-pounder Armstrong was next used, with cast-iron solid shot. The projectile penetrated all the plates, with the exception of the  $3\frac{1}{2}$ -in. plate, on which it had hardly any effect at all; even when it penetrated the plates it did but very little damage to the masonry behind.

A 68-pounder 95-cwt. gun was next used, with a charge of 16 lbs. and cast-iron solid shot, at a range of 500 yards. The shot penetrated all the plates and damaged them a great deal; still the plates were not displaced, neither were the bolts started; it was remarkable that the bolts stood exceedingly well and prevented the plates buckling; the bolt-holes were evidently a cause of weakness, as cracks almost invariably commenced there.

The number of shot of different rounds fired at these plates is as follows :—

12-pdr. Armstrong .....	5
25-pdr. " .....	16
40-pdr. " .....	11
68-pdr. " .....	10
Total .....	<u>42</u>

But the plates are still firm and in good order; and the wall is in as complete a state for defensive purposes as before the firing commenced.

MAY 16TH.—The experiment was continued with a 100-pounder Armstrong gun, firing for the first 10 rounds shells filled with sand: weight, empty, 95½ lbs.; full, 104 lbs.; charge, 12 lbs.; then 4 rounds solid cast-iron shot from 68-pounder 95 cwt., with a charge of 16 lbs.; then 21 rounds, alternately 8-in. shell and 100-pounder Armstrong shell. With the 8-in. shell Pittman's naval fuze was used; with the Armstrong shell, the Pillar fuze. Every shell burst on striking. Range, 400 yards.

The 100-pounder shell filled with sand penetrated all the plates, except the 3½-in. The first shell that struck this plate did apparently no damage at all; it broke up, making a small indent on the plate; another, however, on striking near the same place, broke half the plate away and exposed the masonry.

After 10 rounds of 100-pounder blind shell and 4 rounds solid 68-pounder shot had been fired, the plates were so damaged that live shell were used.

The live shell did very little damage when they struck the iron plate, not nearly as much as the blind shell, owing probably to its bursting before the whole of its force was expended on the plate; but when the live shell struck where the masonry was exposed they caused great damage, and soon brought the wall and surrounding masonry to such a state that a few more shell would entirely have destroyed it and the casemate next to it.

This experiment shows that masonry covered with 2-in. iron plates will effectually resist a 12-pounder Armstrong shot at 600 yards.

Covered with 2½-in. plates it will effectually resist a 25-pounder Armstrong shot at 600 yards.

Covered with 3-in. plates it will effectually resist a 40-pounder Armstrong shot at 600 yards.

But the  $3\frac{1}{2}$ -in. plates are not sufficient to resist the heavier nature of projectiles.

The iron plates were manufactured of rolled iron by Messrs. Brown, Hughes & Co., Newport.

5 feet 6 inches by 2 feet 6 inches, }  
4 feet 6 inches by 2 feet 6 inches, } 2,  $2\frac{1}{2}$ , 3,  $3\frac{1}{2}$  inches in thickness.

Each plate was secured to the masonry by six 2-in. bolts which passed through the plate and were secured by double nuts to railway bars buried vertically four feet in the masonry; the tops of these bars were again secured by bolts to the rear of the work. (See Table 120.)

RESULTS.—MASONRY PROTECTED BY IRON. (TABLE 120.)—1. Hit right-hand corner of masonry; buried itself in the brickwork.

2. Hit centre of  $2\frac{1}{2}$ -in. plate; very slight indent; no cracks; shot broke.

3. Missed.

4. Hit left-hand top corner of 3-in. plate just over the bolt; one very small crack from the bolt-hole; indent, very small; plate not hurt.

5. Hit centre of 3-in. plate; very small indent; plate not damaged.

6. Short and ricochet. Hit 3-in. plate to left of left-centre bolt, half on plate, half on masonry; bolt slightly drawn out; plate bent a little but no damage done.

7. Short and ricochet. Hit 2-in. plate with side of shot, just leaving the mark of its shape on the plate.

8. Struck on the edge of the 3-in. plate near right-centre bolt; made a circular crack through bolt-hole; diameter of the cracked part, 7 inches.

9. Hit close to No. 8; very small indent; no cracks.

10. Hit  $3\frac{1}{2}$ -in. plate near the centre; no damage to plate.

11. Hit 4 in. from top of lower  $2\frac{1}{2}$ -in. plate; no damage done.

TABLE CXX.—EXPERIMENTS AGAINST MASONRY PROTECTED BY IRON. MAY 9, 1861.

No. of Round.	Nature of Ordnance.	Projectile.		Change in lbs.	Elevation.	Range in yards.	Deflection.	Initial Velocity.	Effects.		Bursting charge of Shell in lbs.
		Weight.	Form.						Depth of Incident in ins.	Area of Incident in ins.	
		lbs. oz.			° /		/				
1	12-pdr. shot..	11·9	...	1½	1 4	600	4 R	...	¼	...	...
2	"	"	...	"	1 2	"	2 R	...	¼	...	...
3	"	"	...	"	1 0	"	2 L	...	...	...	...
4	"	"	...	"	1 0	"	2 L	...	¼	...	...
5	"	"	...	"	0 57	"	2 R	...	¼	...	...
6	25-pdr. shot..	24 $\frac{11}{16}$	...	3 $\frac{2}{16}$	0 56	"	2 R	...	$\frac{3}{4}$	...	...
7	"	"	...	"	1 0	"	4 R	...	...	...	...
8	"	"	...	"	0 58	"	6 R	...	½	...	...
9	"	"	...	"	0 56	"	8 R	...	½	...	...
10	"	"	...	"	0 57	"	8 R	...	½	...	...
11	"	"	...	"	0 57	"	8 R	...	½	...	...
12	40-pdr. shot..	40	...	5	0 58	"	4 R	...	$\frac{3}{4}$	...	...
13	"	"	...	"	0 58	"	4 R	...	6	...	...
14	"	"	...	"	0 58	"	4 R	...	...	...	...
15	25-pdr. shot..	24 $\frac{11}{16}$	...	3 $\frac{2}{16}$	0 57	"	8 R	...	½	...	...
16	"	"	...	"	0 57	"	8 R	...	$\frac{3}{4}$	...	...
17	"	"	...	"	0 57	"	8 R	...	½	...	...
18	"	"	...	"	...	"	...	...	½	...	...
19	"	"	...	"	...	"	...	...	$\frac{15}{16}$	...	...
20	"	"	...	"	...	"	...	...	2 $\frac{1}{16}$	...	...
21	"	"	...	"	...	"	...	...	2	...	...
22	"	"	...	"	...	"	...	...	3	...	...
23	"	"	...	"	0 58	"	8 R	...	...	...	...
24	"	"	...	"	...	"	...	...	3½	...	...

TABLE CXX.—(CONTINUED.)

No. of Round.	Nature of Ordnance.	Projectile.		Charge in lbs.	Elevation.	Range in yards.	Deflection.	Initial Velocity.	Effects.		Bursting charge of Shell in lbs.
		Weight.	Form.						Depth of In- dent in ins.	Area of In- dent in ins.	
25	40-pdr. shot..	40	...	5	0 58	600	4 R	...	...	...	...
26	"	"	...	"	...	"	...	...	3	...	...
27	"	"	...	"	1 0	"	4 R	...	...	...	...
28	"	"	...	"	1 0	"	4 R	...	...	...	...
29	"	"	...	"	1 3	"	4 R	...	...	...	...
30	"	"	...	"	1 5	"	4 R	...	1/4	...	...
31	"	"	...	"	1 5	"	4 R	...	1/4	...	...
32	"	"	...	"	1 5	"	...	...	1/4	...	...
33	68-pdr. shot..	68	...	16	...	500	...	...	4	...	...
34	"	"	...	"	...	"	...	...	8	7 by 11	...
35	"	"	...	"	...	"	...	...	...	...	...
36	"	"	...	"	...	"	...	...	5 1/2	20 by 9	...
37	"	"	...	"	...	"	...	...	6	12 x 12	...
38	"	"	...	"	...	"	...	...	7	10 x 10	...
39	"	"	...	"	...	"	...	...	...	...	...
40	"	"	...	"	...	"	...	...	6	12 x 12	...
41	"	"	...	"	...	"	...	...	...	...	...
42	"	"	...	"	...	"	...	...	...	11 x 13	...
43	100-pdr. shell	104	...	12	40'	400	7' R	...	...	...	Filled with 8 1/2
44	"	"	...	"	48	"	10' R	...	...	...	lbs. of
45	"	"	...	"	...	"	8' R	...	...	...	sand.
46	"	"	...	"	...	"	...	...	...	...	"
47	"	"	...	"	...	"	...	...	...	...	"
48	"	"	...	"	...	"	9' R	...	...	...	"

TABLE CXX.—(CONTINUED.)

No. of Round.	Nature of Ordnance.	Projectile.		Charge in lbs.	Elevation.	Range in yards.	Deflection.	Initial Velocity.	Effects.		Bursting charge of Shell in lbs.
		Weight.	Form.						Depth of In- dent in ins.	Area of In- dent in ins.	
		lbs.			° /		'				
49	100-pdr. shell	104	...	12	...	400	...	...	...	...	Filled with 8½ lbs. of sand. “ “ “
50	“	“	...	“	...	“	...	...	...	...	
51	“	“	...	“	...	“	...	...	...	...	
52	“	“	...	“	...	“	...	...	...	...	
53	68-pdr. shot..	68	S.*	16	½°	400	...	1557	...	...	...
54	“	68	“	16	½°	400	...	1557	...	...	...
55	“	68	“	16	½°	400	...	1557	...	...	...
56	“	...	...	...	...	400	...	...	...	...	...
57	100-pdr. shell	104	A.	12	48'	400	8' R	...	...	...	8½
58	68-pdr. shell	49½	Sc.	16	½°	400	...	1746	...	...	1½
59	100-pdr. shell	104	A.	12	48'	400	8' R	...	...	...	8½
60	68-pdr. shell	49½	Sc.	16	½°	400	...	1746	...	...	1½
61	100-pdr. shell	104	A.	12	48'	400	9' R	...	...	...	8½
62	68-pdr. shell	49½	Sc.	16	½°	400	...	1746	...	...	1½
63	100-pdr. shell	104	A.	12	48'	400	9' R	...	...	...	8½
64	68-pdr. shell	49½	Sc.	16	½°	400	...	1746	...	...	1½
65	100-pdr. shell	104	A.	12	48'	400	9' R	...	...	...	8½
66	68-pdr. shell	49½	Sc.	16	½°	400	...	1746	...	...	1½
67	100-pdr. shell	104	A.	12	48'	400	9' R	...	...	...	8½
68	68-pdr. shell	49½	Sc.	16	½°	400	...	1746	...	...	1½
69	100-pdr. shell	104	A.	12	48'	400	9' R	...	...	...	8½
70	68-pdr. shell	49½	Sc.	16	½°	400	...	1746	...	...	1½
71	100-pdr. shell	104	A.	12	48'	400	9' R	...	...	...	8½

\* S. denotes Spherical; A., Armstrong; Sc., Spherical common.



TABLE CXX.—(CONTINUED.)

No. of Round.	Nature of Ordnance.	Projectile.		Charge in lbs.	Elevation.	Range in yards.	Deflection.	Initial Velocity.	Effects.		Bursting charge of shell in lbs.
		Weight.	Form.						Depth of Indent in ins.	Area of Indent in ins.	
72	68-pdr. shell	49½	Sc.*	16	½°	400	...	1746	....	....	1½
73	100-pdr. shell	104	A.	12	48'	400	9' R	...	....	....	8½
74	68-pdr. shell	49½	Sc.	16	½°	400	...	1746	....	....	1½
75	100-pdr. shell	104	A.	12	48'	400	9' R	...	....	....	8½
76	68-pdr. shell	49½	S.	16	½°	400	...	1746	....	....	1½
77	100-pdr. shell	104	A.	12	48'	400	9' R	...	....	....	8½

\* S. denotes Spherical; A., Armstrong; Sc., Spherical common.

12. Hit at the joint of the 3-in. plates; the left bolt slightly drawn, and the plate bent ¼ in., but not damaged.

13. Hit left top corner of the lower 2-in. plate; broke the plate; a piece 8 in. by 8 in. driven 6 in. into masonry; the bolts were not drawn, nor the plate shaken nor cracked.

14. Hit at junction of 2-in. and 2½-in. plates; a piece 6 in. by 7 in. nearly broken out, driven 4 in. into masonry; the edge of 2½-in. plate slightly bulged.

15. Hit centre of 3½-in. plate; no damage.

16. Hit centre of 2½-in. plate; no damage done.

17. Hit near centre of 3½-in. plate; no damage.

18. Hit at junction of 2½-in. and 3½-in. plates; 2½-in. plate driven in ¼ in.

19. Hit centre of 2½-in. plate; no damage done.

20. Hit lower 2-in. plate; made a large circular crack round the indent.

21. Hit lower 2-in. plate near bolt-hole; two large cracks, one on each side of bolt-hole, extending from it 6 in.

22. Large crack passing through the bolt-hole near the indent

and extending round it in diameter 12 in., plate much bent; the bolt-hole evidently weakened the plate.

23. Hit top of granite.

24. Hit  $2\frac{1}{2}$ -in. plate 4 in. from the edge; the plate much cracked within and round the indent, in area 8 by 10 in.

25. Miss, short, and ricochet on to bottom of plate.

26. Hit lower left plate ( $2\frac{1}{2}$ -in.) near left-centre bolt, bulged the plate into masonry in area 6 in. by 7 in.; two cracks from the bolt-hole.

27. Hit close to No. 25 at bottom of 3-in. plate, 2 in. from a bolt; drove a piece 12 in. by 5 in. into the masonry 4 in. deep.

28. Struck 300 yds. short and over target.

29. Miss; short.

30, 31, 32. Hit lower  $3\frac{1}{2}$ -in. plate; damage very slight.

33. Struck 300 yds. short; hit top of 2-in. plate over top right-hand bolt; diameter of indent, 9 in.; the corner of the plate buckled up  $1\frac{1}{2}$  in.; masonry started and cracked a little.

34. Hit at junction of 2-in. and 3-in. plates; depth of indent, 8 in.; area, 7 in. by 11 in.; started masonry  $\frac{1}{4}$  in. and cracked the granite block on the top; a crack from the bolt-hole of 3-in. plate.

35. Missed the target and hit Thorneycroft's embrasure close to its left edge, on the 5th bar from top; broke the bar and drove it 5 in. into the opening of the embrasure.

36. Hit  $2\frac{1}{2}$ -in. plate, crack extending from a bolt-hole; a piece of the plate 20 in. by 9 in. driven into the masonry, which was much shaken.

37. Hit at junction of  $2\frac{1}{2}$ -in. and 2-in. plates, which separated  $\frac{1}{4}$  in.

38. Hit top of lower  $3\frac{1}{2}$ -in. plate; crack through left upper bolt-hole; it struck over No 11.

39. Hit top of stonework.

40. Hit at the junction of the two  $3\frac{1}{2}$ -in. plates; the plates separated  $\frac{3}{4}$  in., crack extending from bolt-hole to No. 32 shot-hole; the bolts not a bit started.

41. Hit corner of the granite and brought down a large piece.

42. Hit lower edge of 2-in. plate; shot broke up and remained in the hole 5 in. in masonry.

MAY 16, 1861.

43. Struck bottom corner of 2-in. plate on the top of the bolt, broke away a piece 15 in. by 9 in., and drove it, broken up with the pieces of the shell, 2 ft. into masonry; struck over No. 42.

44. Struck at the joint of 2½-in. plates, broke away an irregular hole 14 in. by 11 in., and forced the pieces with the shell 1 ft. into masonry; lower bolt very much damaged and bolt bent.

45. Hit junction of 2-in. plates; shell broke up and driven into the masonry about 15 in. deep; broke away the left corner of lower 2½-in. plate near last round; broke off 5 in. of the bolt where hit.

46. Struck joint of 3-in. plates; hole, 9 in. by 12 in.; drove pieces, with pieces of shell, 10 in. into masonry; plate not cracked, very slightly bent; the plates slightly separated.

47. Struck 2½-in. plate near left edge over No. 24, broke away a piece 2 ft. by 9 in., and drove it in pieces, with pieces of shell, 1 ft. into masonry; plate much bent, no cracks.

48. Hit joint of 3½-in. plates over the 68-pounder No. 38; two large cracks extending through bolt-holes in a circular direction right across the plate; another circular crack on lower plate through the port-hole; did not penetrate.

49. Hit centre of lower 3½-in. plate; started a bolt 1 in; plate very slightly bent; depth of indent very small indeed; plate not damaged at all; a great deal of masonry shaken down from top.

50. Hit near the same place; plate a very little buckled, and cracked across; the bolts stood well, the plate being forced back on them; the crack passed through a bolt-hole.

51. Hit centre of 3-in. plate; depth, 3¼ in.; large circular crack round indent; diameter of crack, 14 in.

52. Struck lower 3½-in. plate, broke away the upper half of the lower plate, except a small corner near left top bolt; right top bolt broken; the piece cracked through, and much buckled.

53. Hit on the exposed part of masonry, on the place where the

piece of plate fell off. Penetration  $2\frac{1}{2}$  ft. to shot; masonry much broken; shot not broken.

54. Hit just at edge of hole made by No. 5; shot broke up; increased the hole by a circle 9 in. in diameter.

55. Hit  $3\frac{1}{2}$ -in. plate at edge of hole made by No. 5, increasing hole by a circular hole 9 in. in diameter; plates much separated; brickwork powdered to a depth of 14 in.; bolts near a little bent.

56. Hit Thorneycroft embrasure; depth of indent,  $1\frac{3}{4}$  in.; no damage done; diameter of indent, 9 in.; no cracks at all visible.

57. Hit near No. 3; passed through the plate, and burst behind the plate, breaking away a large piece, making 3 and 2 into one hole; masonry much damaged behind.

58. Shell struck near top of  $3\frac{1}{2}$ -in. plate; broke away a piece 9 in. in diameter.

59. Hit at junction of 2-in. and  $2\frac{1}{2}$ -in. plates between Nos. 2 and 3, and near No. 15; damaged the masonry very much; the effect on the plate could not be seen, as it was so damaged by previous shot.

60. Struck where the  $3\frac{1}{2}$ -in. plate was broken away; broke off one bolt, and crumbled away the brickwork to a depth of 3 ft.

61. Hit lower 3-in. plate about the middle; blew away half the plate, starting and bending all the bolts near, and undermining the whole centre of the plates.

62. Hit at top of  $2\frac{1}{2}$ -in. plate; broke away a large piece; undermined the plate.

63. Hit in the hole made by the destruction of the upper part of  $2\frac{1}{2}$ -in. and  $3\frac{1}{2}$ -in. lower plates; increased the depth of the hole in the masonry; the plates were so damaged round here that the effect could not be ascertained.

64. Hit nearly in the same place as last, increasing the breach in the masonry to a depth of 4 ft.; broke and bent the bolts all around.

65. Hit nearly in the same place as the former shot; the plates and masonry were so damaged that the effects cannot be recorded.

66. Hit left lower corner of upper 3-in. plate; bulged in the piece  $2\frac{1}{4}$  in.; plate started forward  $\frac{1}{4}$  in.

67. Hit centre of target; broke away a piece of plate 2 ft. square, with a bolt 4 ft. long attached to it; increased the hole in brickwork.

68. Hit the granite to the left; split the granite block, but did little other damage.

69. Hit 3-in. plate, upper, near the centre; broke away the lower half, leaving the piece supported by one bolt; broke away and started the masonry round, and started the plates and brought down some more masonry.

70. Hit the same place as last shot; increased the hole; cracked the masonry behind.

71. Hit centre of 2-in. plate; knocked the whole iron face to pieces; the few pieces of plates remaining were merely hanging by the bolts; the railway bars and masonry behind them perfectly secure.

72. Hit the left on the granite; did not do much damage.

73. Hit bottom of 2-in. plate; passed through it and 1 ft. 8 in. into the masonry.

74. Hit at the bottom among the debris of the masonry, and did not much increase the damage.

75. Hit near centre of target; broke away some more masonry.

76. Short 20 yds.; hit 3-in. lower plate; broke away a piece 9 in. by 11 in.

77. Hit against the railway bars, broke one of them, and broke through the masonry, driving out a solid piece of brickwork 2 ft. square; the masonry much shaken and cracked behind; the arch of embrasure cracked nearly across in two places; some of the bricks driven 20 yds. in rear; the upper part of masonry cracked and started.

**825. Inclined Plates.**\*—“About this time the question of the relative increase of resistance given to iron plates, when inclined at various angles, was again brought up; and in apparent contradiction to the experiments at Portsmouth, on Jones's butt, in 1860, there was found to be no apparent difference in the powers

\* Captain Inglis's account, continued.

of resistance of  $\frac{3}{4}$ -in.,  $1\frac{1}{2}$ -in., and 3-in. plates, whether they were placed at angles of  $30^\circ$ ,  $45^\circ$ ,  $60^\circ$ , or vertical. The plates were without backing, merely held on to a skeleton framework of wood. They were fired at by the wall piece, 6-pounder Armstrong, 12-pounder, and 40-pounder, at ranges of 25, 50, and 100 yards; the bullets of wall piece were of steel, flat-headed cylindrical, and the other shot of wrought and cast iron.

“Subsequently, in continuation of this experiment, two plates of wrought iron, placed respectively in a vertical position, and at an angle of  $45^\circ$ , were tried, each having a 12-inch oak backing, and there being in them equal weight of iron for the same vertical height—

The inclined one was.....	$3\frac{1}{4}$ -inch thick.
The vertical .....	$4\frac{1}{2}$ -inch thick.

“They were fired at by a 40-pounder, at 100 yards, and there was scarcely any difference; in each case a dent of about  $\frac{8}{16}$  inch was caused.

“Afterwards, a 100-pounder, at 200 yards, sent a hemispherical-headed shot through the inclined plate, but it did not get through the vertical; and a square-headed 100-lb. shot did not penetrate the inclined plate so much as the hemispherical-headed shot; and, altogether, the vertical plate may be said to have stood best. Whether the apparent discrepancies between these results, and those at Portsmouth are to be accounted for by spherical shot having been used in one case and elongated in another, or whether they may not be reconciled in some other way, I am not prepared to say; but, at any rate, the effects are worth considering, and I think the experiments should be carried further, until the differences are accounted for.

**826. Plates of  $6\frac{1}{2}$  and  $4\frac{1}{2}$  Inches.**—“In July, 1861, two plates of 7 ft.  $\times$  3 ft., of hammered scrap, unbacked, respectively  $6\frac{1}{2}$  and  $4\frac{1}{2}$  inches thick, standing vertical, were fired at, at 400 yards range. A cast-iron shot, 126 lbs., from Armstrong’s muzzle-loading shunt gun, struck a  $6\frac{1}{2}$ -in. plate, made an indent of 1.9-in., and cracks were shown behind; and another shot of same kind

struck a  $4\frac{1}{2}$ -in. plate, and cracked and bulged it very much; another of them, and two 110-lb. cast-iron shots, quite destroyed this  $4\frac{1}{2}$  plate; while the  $6\frac{1}{2}$ -in. plate, after receiving three fair shots from the 126-pounder, was also broken up."

**827. Roberts's Target.**—In 1861, a target of special construction, provided by a Mr. Roberts, was tried. "This consisted of a mass of timber and T-plates, protected by armor-plates 3 and 4 inches thick, of malleable scrap-iron, about 2 feet wide, hammered and rolled to such form as to present a series of angular projections, ridges, and furrows; the apices of the angles were pointed with steel.

"It was altogether of too complicated and costly construction; and, although the armor-plates were of very good iron, it was separated and opened out, and the fittings damaged, and ultimately all destroyed by a few 68-pounder and 100-pounder shot.\*

**828. Fairbairn's 1st Target.**—"Another target, of a construction proposed by Mr. Fairbairn, was tried about this time. It consisted of rolled plates 5 in. thick, attached by a number of  $1\frac{3}{8}$ -in. screws to a  $\frac{3}{4}$ -in. sheathing, supported by wrought-iron built-up ribs of  $\frac{1}{2}$ -in. plate, 12 in. deep and 18 in. apart; the screws were  $7\frac{1}{2}$  in. apart, and tapped for a depth of 2 in. only into the back of the plate. The plates themselves stood remarkably well, but the tap-screws broke off so easily that the armor became completely separated from the rest of the target, and so became useless; 4-in. elm on face decreased effect."

**829. Captain Coles's Cupola.**—The revolving cupola tried at Sheerness, in 1861, was a truncated cone in form, and was composed of "massive timber, about 18 in. thick, covered with armor-plates  $4\frac{1}{2}$  in. thick; the internal diameter of the cupola is about 12 feet, and the height about 8 feet, inside; the sides are inclined to the horizon at an angle of  $40^\circ$ . The gun is mounted on a special carriage, and extends some feet outside the port; the chase of the gun just in front of the trunnions rests on the sill of the

\* Two 68-pounders cracked the plate and broke two bolts. A salvo of three 100-pounders made a hole  $18 \times 9$  in., and cracked the plate across.

port. The whole cupola revolves by means of winches on a sort of turntable, so that the training of the gun is effected by turning the whole apparatus; and the porthole, therefore, is only a narrow slot long enough to permit the gun to be elevated and depressed.

“On the day of trial, the cupola, as erected on the ‘Trusty,’ was subjected to very severe tests, not only to try its endurance under fire, but also to test the working of the machinery under all circumstances; and it was proved that, even after heavy battering, and with the vessel heeled over several degrees, there was no difficulty or obstacle whatever in working the apparatus; on the contrary, it afforded very great facilities for rapid and accurate firing, and for keeping a moving object in sight, and this with a very small complement of men. A great number of shot (nearly 100) were fired from the 40-pounder Armstrong gun in it, and then it received a few shots from a 40-pounder, and a great many blows (26) from a 100-pounder at 200 yards.

“Four 100-pounder shot, striking very near the same spot, broke through into the cupola, but the machinery worked as well as before.

“The muzzle of a cast-iron gun, mounted in the cupola, was struck by a shot; the gun broke off a short distance in front of the trunnion, and a portion went overboard.

“After this, a 68-pounder was laid upon it, at 200 yards, and had much the same effect as the 100-pounder, but the cupola was never thrown out of gear; there was no difficulty from smoke, and only a little from concussion; and altogether, its performance was considered highly satisfactory.

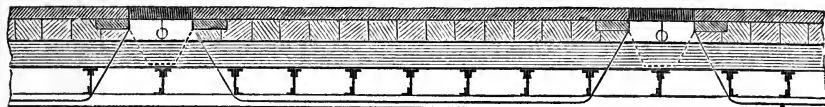
**§30. Various Backings to Iron Plates.**—“After this, in order to test the various effects of different sorts of backing, some 2½-in. wrought-iron plates were fastened respectively to blocks of cast iron 3 feet thick, to solid granite, to a mass of oak made up of timbers 10 in. by 10 in., and to a mass made of alternate layers of fir and cork and bitumen cork.

“The results proved the immense superiority of a massive rigid over an elastic backing, both as regards the plates themselves



and also as regards the fastenings.\* The 40-pounder service shot, at 200 yards, did little or no damage to the plates backed by

FIG. 378.

Section of the *Warrior's* side.

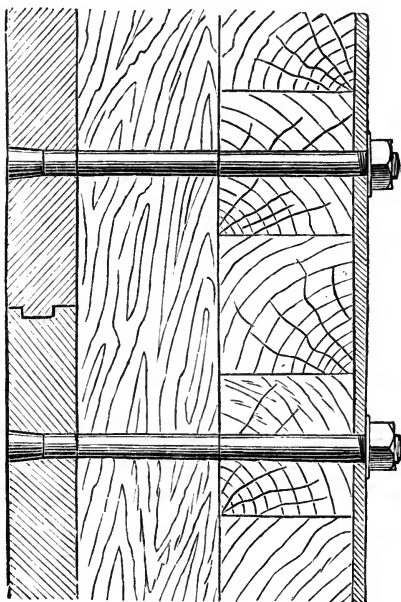
granite and cast iron, but went clean through the plates backed by oak and fir, and did great damage to it.

“A 100-pounder cracked a plate backed by cast iron, and the cast iron also, but did little damage.”

### 831. *Warrior* Target.—

“Later in the year (1861), a target, representing a piece of the ‘*Warrior's*’ side, was fired at by 68-pounder, 100-pounder, and 120-pounder. It measured 20 feet by 10 feet, and had a porthole in the centre, and was struck by 13 solid shot, besides 6 experimental 200-lb. shot, thrown with a reduced charge from a 100-pounder gun, and by 10 shells.

FIG. 379.

Section of the *Warrior* target.

\* In this experiment there were four plates,  $4 \times 2$  ft.  $\times$   $2\frac{1}{2}$  in.

The backing of the first was cork and kamptulicon. The plate was smashed like glass. The backing of the second plate was oak. The plate was badly broken, and the shot lodged in the oak.

The third plate was backed by granite. The indentation of the shot was  $\frac{3}{4}$  in., and the plate was not cracked.

The fourth plate was backed by a block of cast iron, and no injury was done by the shot, except a small indentation.

The other advantages of wood backing, for naval purposes especially, have been mentioned. (199, note.)

“The result was, that although the armor-plates were more or less cracked and indented, and deflected especially where 12 shots (of which one was a steel 100-lb. shot) struck a plate within an area of  $4\frac{1}{2}$  square feet, the back of the target, agreeing with the ribs and sheathing of the ship, were not at all injured.” (Table 121.)

Table 121 is the official account of this experiment.

The target was “exactly similar” to a midship section of the *Warrior*: length, 20 ft.; height, 10 ft.; with a porthole in the centre.

This target was strongly supported by timber, at the same angle as the side of the ship, and was fired at with the following guns. Range, 200 yards:—

One 120-pdr. muzzle-loading shunt gun.		One 68-pdr. 95 cwt. gun.
Three 100-pdr. breech-loading Armstrong guns.		One 68-pdr. 112 cwt. gun.

The following shot and shell struck the target:—

From 120-pounder gun,

Solid shot..... 2; weight, 140 lbs. each.

From 100-pounder guns,

Solid shot..... 6; weight, 110 lbs. each.		Solid shot..... 6; weight, 200 lbs. each.
Shell ..... 6; weight, 104 lbs. each.		Solid shot..... 1; steel.

From 68-pounder guns,

Solid shot..... 4; weight,  $66\frac{1}{2}$  lbs. each. | Shells..... 4; weight,  $49\frac{1}{2}$  lbs. each.

RESULTS.—WARRIOR TARGET. (Table 121.)—1. Hit on upper plate; made very slight indent; opened the plate  $\frac{1}{8}$  in.

2, 3. Hit close together on the centre left plate; made a small crack 5 in. in length.

4. Hit on upper plate, 7 in. from the edge; opened the plates  $\frac{1}{4}$  in., and started two bolts very slightly.

5. Hit centre of left-middle plate,  $3\frac{1}{2}$  ft. from port, 7 in. from a bolt, which it drew  $\frac{1}{4}$  in.; broke the two bolts close to the port, and buckled the plate  $\frac{3}{4}$  in.

6. Hit on junction of lower and centre plate; did no damage.

TABLE CXXI.—EXPERIMENTS AGAINST THE "WARRIOR" TARGET. OCT. 21, 1861.

No. of Round.	Nature of Ordnance.	Charge, lbs.	Nature of Projectile.	Weight, lbs.	Indent in ins.
1	100-pounder.....	12	shell filled with sand.	104	...
2	“	“	“	“	...
3	“	“	“	“	...
4	68-pounder.....	16	“	49½	1.5
5	“	“	“	“	“
6	100-pounder.....	12	shell filled with powder.	104	...
7	“	“	“	“	...
8	“	“	“	“	...
9	68-pounder.....	16	“	49½	1.8
10	“	“	“	“	...
11	120-pounder.....	20	solid cast-iron shot.	140	3.1
12	100-pounder.....	14	“	110	1.6
13	“	“	“	“	1.9
14	“	“	“	“	1.3
15	68-pounder.....	16	“	66½	2.7
16	100-pounder.....	10	“	200	...
17	“	“	“	“	...
18	“	“	“	“	...
19	“	“	“	“	...
20	“	“	“	“	...
21	“	“	“	“	...
22	68-pounder.....	16	solid shot.	66½	2.25
23	120-pounder.....	20	“	140	...
24	100-pounder.....	14	“	110	...

TABLE CXXI.—(CONTINUED.)

No. of Round.	Nature of Ordnance.	Charge, lbs.	Nature of Projectile.	Weight, lbs.	Indent in ins.
25	100-pounder.....	14	solid shot.	110	...
26	“	“	“	“	...
27	68-pounder.....	16	“	66 $\frac{1}{4}$	...
28	“	“	“	“	...
29	100-pounder.....	“	steel jacket-shot, flat headed.	...	3·3

7. Hit upper plate; did no damage.

8. Hit centre plate; did no damage.

9. Hit on upper plate over No. 1; tore up 4 ft. of tongue and groove, and cracked the plate in two places; cracks 7 in. long; drew the bolt  $\frac{3}{4}$  in.

10. Hit on centre plate; cracked it in four places; the cracks very small.

11. Hit on right-hand corner of the top plate; plate deflected  $1\frac{3}{4}$  in.; the bolt, however, only stretched, and did not break. The right rib was very slightly bent.

12, 13, 14. Hit close together; made a small crack across one indent; the plate driven back on a bolt 1 in. The plate now deflects nearly 2 in.

15. Hit 18 in. from the three 100-pounders; one crack 7 in. long near the indent; two bolts broken near the porthole. The centre right plate deflected 1·2 in.

16, 17, 18. Indent too small to be measured; no damage apparent. The three shots hit close together.

19, 20, 21. These three shots were fired in salvo. Struck close together on the right-centre plate; the indent on plate very slight indeed. The plate buckled forward  $\frac{3}{4}$  in. more. The tongue and groove broken for  $2\frac{1}{2}$  ft.

22. Hit near the porthole, and buckled the plate  $\frac{1}{4}$  in.

23, 24, 25, 26, 27, 28. Fired in salvo three 100-pounders. Hit

close together  $2\frac{1}{2}$  ft. from the porthole; broke a hole  $1\frac{1}{2}$  ft. by 9 in.; one large crack extended across the plate, two other smaller ones near it; 120-pounder hit on the junction of the centre and lower plates; made an indent  $4\frac{1}{4}$  in. deep,  $9\frac{3}{4}$  in. diameter; broke the tongue and groove, and buckled the plate  $1\frac{1}{4}$  in. forward. One 68-pounder missed the target; the other struck the lower plate on the left; made an indent 2 in. deep,  $8\frac{1}{2}$  in. in diameter. The back of the target was not at all damaged; not a bolt or rivet displaced.

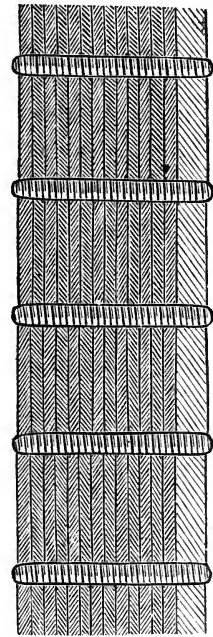
29. Hit the middle of the left-centre plate on top of a bolt; drove it nearly out at the back; the bolt was bent, but the nuts did not move; eleven shots had previously struck the plate in a space 3 ft. by  $1\frac{1}{2}$  ft., viz.:—

Three 200-lb. solid shots; three 100-lb. solid shots; three 100-lb. shells; two 68-lb. shells.

**832. Hawkshaw's 6-Inch and 10-Inch Laminated Shields.\***—"Since this (in 1861), two targets, proposed by Mr. Hawkshaw, have been tried; the one was 6 in. thick, composed of a number of thicknesses; the front layer was  $1\frac{1}{2}$  in., and the rest made up of seven  $\frac{5}{8}$ -in. boiler-plates, held together by alternate rivets and screws,  $8\frac{1}{2}$  in. from centre to centre, all over the target; the rivets had counter-sunk heads in the front.

"The other was 10 in. (Fig. 380), made up of one 2-in. and thirteen  $\frac{5}{8}$ -in. plates, held together much as before. The weakness of a number of thin plates, as compared with a solid mass, was here very apparent; the 6-in. target was deeply dented by a 40-pounder, at 100 yards, and both 68-pounder and 100-pounder, at 200 yards, went clean through, breaking off many of the rivet heads.

FIG. 380.



The Hawkshaw 10-inch target.

\* Captain Inglis's account, continued.

“The 10-in. target was bulged in very much by the 100-pounder and 68-pounder, and broke several thicknesses of the  $\frac{5}{8}$ -in. plates at the back; the 68-pounder had rather more effect than the 100-pounder.”

**833. Warrior Target; 10-Inch “Alfred” Gun.**—In November, 1861, at Liverpool, a 140-lb. spherical shot was fired with 20 lbs. of powder at a target representing the side of the *Warrior*—range, 210 yards. This shot neither punched nor smashed the target, but indented the plate 3 in., and drove the whole target out of place and overturned it. A similar shot with 30 lbs. of powder broke the plate and indented it 6 in., splintering the teak.

**834. Conclusions up to 1862.**—The summary of experiments, and the conclusions drawn therefrom, are thus stated by Captain Inglis in the paper quoted:—

“I shall now, as briefly as I can, sum up the resistance offered by each thickness of plate experimented on.

$\frac{1}{4}$  and  $\frac{3}{8}$ -inch.—Both hollow and solid shot pass through without breaking.

$\frac{1}{2}$ -inch.—Hollow shot pass through, but are generally broken up. Grape pass through, but not canister.

$\frac{5}{8}$ -inch.—Solid shot break up in passing through.

$\frac{3}{4}$ -inch.—Wall piece, throwing  $5\frac{1}{2}$ -oz. ball, with charge of 10 drams, at 25 yards, not always through.

1-inch.—Proof against same wall piece; indent,  $\frac{1}{4}$  in.

$1\frac{1}{2}$ -inch.—6-pounder Armstrong, at 50 yards, not through.

2-inch.—12-pounder Armstrong, at 100 yards, not through; indent 1 in. to  $1\frac{1}{2}$  in.

2-inch (oak backing).—80-pounder shell, filled with sand, passed through, at 400 yards.

2-inch (brick backing).—12-pounder Armstrong, at 600 yards, resisted.

Ditto.—25-pounder Armstrong, at 600 yards, just penetrated.

$2\frac{1}{2}$ -inch.—25-pounder Armstrong, at 100 yards, not through.

$2\frac{1}{2}$ -inch (oak backing).—8-in. shell, at 400 yards, not through.

Ditto.—80-pounder steel and cast-iron shot, through.

2½-inch (brick backing).—25-pounder Armstrong, at 600 yards, not through.

2½-inch (cast-iron backing)	}	12-pounder	at 200	indent,
		Armstrong,	yards,	·5 inches.
Ditto,		40-pounder,	"	·9 "
Ditto,		100-pounder,	"	1·75 "
2½-inch (granite backing)	}	12-pounder	}	"
		Armstrong		
Ditto,		"	"	·6 "
2½-inch (oak backing)	}	12-pounder	"	·65 "
Ditto,		40-pounder	"	through.
2½-inch (fir and cork backing)	}	12-pounder	"	·6 "
Ditto,		40-pounder	"	through.

3-inch.—40-pounder Armstrong, 100 yards, not through.

3-inch.—Two 78-pounder shell filled with sand, at 400 yards, passed through.

3-inch.—Two 78-pounder shell filled with sand, at 400 yards, just resisted.

3-inch (brick backing).—40-pounder Armstrong, 600 yards, passed through.

Ditto.—68-pounder, penetrated.

Ditto.—100-pounder shell, at 600 yards, penetrated.

3½-inch (brick backing).—40-pounder Armstrong, at 600 yards, no effect.

3·94-inch.—Resisted 14 shots of 30 lbs. (English 32·4 lbs.), at 300 metres in a square metre, or 10¾ square feet English.

4-inch.—68-pounder, did not penetrate.

4-inch.—72-lb. shot, just penetrated.

4-inch.—Hollow and red hot shot, little impression.

4-inch.—32-pounder, at 100 yards, sunk deep, but not through.

4-inch, on *Alfred*.—Whitworth 68-pounder, at 350 to 450 yards, indent, ⅝ in.; bulge, 1⅜ in.

Ditto.—Same gun, wrought-iron shot, through, and penetrated 7 in. in oak.

4-inch (+6 inches oak and  $\frac{5}{8}$  iron, *Erebus*).—68-pounder, at 400 yards, penetrated, and did great execution inboard.

4-inch (on oak ship *Meteor*).—32-pounder and 68-pounder, at 400 yards and 300 yards, no damage inboard.

4-inch (24 } inches oak). }	68-pounder, {	at 600 } yards, {	indented with cast-iron 1" to 2'3" shot.
Ditto,	"	"	2'2" to 2'8" " wrought do.
Ditto,	"	400 "	2'2" " cast do.
Ditto,	"	"	3" " wrought do.
Ditto,	"	600 "	would ultimately destroy.

One 68-pounder does as much damage as five 32-pounders.

4-inch (2 feet 1 inch oak, *Trusty*).—72-pounder cast-iron shot, at 400 yards, broke plate but not scantling.

Ditto.—72-pounder, homogeneous iron, fairly through.

Ditto.—100-pounder cast-iron shot, at 200 yards, did not penetrate.

Ditto.—78-pounder homogeneous shot, through, and 10 in. oak.

Ditto.—100-pounder homogeneous shot, at lower velocity, large fracture.

4½-inch } 32-pounder, at 360 yards; indent, 2 in.

+ } 68-pounder, at 1250 yards; indent, 1½ in.

4-in. fir } " " 400 yards; indent, 2½ in.

Several shot together injured the plates very much.

4½-inch, on timber.—80-pounder homogeneous flat-headed shot punched a hole, and 3 in. into timber.

4½-inch, on timber.—Three 68-pounder shot close together, broke up a plate.

4½-inch, Jones's angular butt.—Took 17 blows from a 68-pounder, at 200 yards, and then the iron was not penetrated.

4½-inch.—126-pounder, at 400 yards, cracked and bulged much.

4½-inch.—Two 110 lb. cast-iron and two 126 lb., at 400 yards, quite destroyed.

4½-inch, on *Warrior*.—More or less cracked by 68, 100, and 120-pounders, but ribs and inner skin uninjured.



	68-pounder, indented	1·5
	“	“ 1·8
100	“	“ 1·3 to 1·9
120	“	“ 3·1

4½-inch, on timber.—Considered protection against 68-pounders, at 1200 yards; but 68-pounders, at 400 yards, indented 2·75 in.

Ditto.—Considered protection against 32-pounders and 8-in. hollow shot, at 400 yards; 32-pounder indented 1½ to 1¾ in.

Ditto.—Three 32-pounders striking near each other will break it up.

5-inch plate, on iron sheathing & ribs.	}	68-pounder shell, at 200 yards, indented	1·25.
		68-pounder shot, “	“ 2·00.
		100 “	“ 1·75.
		120 “	“ 2·25.

5½-inch.—Resisted 18 shot of 30 pounds (English, 32·4) in a square metre (10¾ feet square), at 300 metres range.

6½-inch.—126-pounder cast-iron shot, at 400 yards, indented 1·9.

“ “ “ a few shots broke it up.

8-inch, supported by cast-iron and granite.	}	68-pr. cast-iron shot, at 600 yds., indented	1·25
		“ “ “ 400 “	“ 1·4
		“ wrought-iron shot 600 “	broke it up.

“As, without knowing the velocity of the several shot here mentioned at the time of impact, it will be impossible to make a comparison of the resistance offered in these experiments, I have drawn up a brief abstract of the initial velocities of all the guns in the service.\*

**835.** “Now I do not know whether it is possible to draw from all this any universal rules. I have not done so myself, but others may; but, at any rate, some general practical laws may be laid down from them, such as:

“1st. Good tough wrought iron of high elasticity, but not necessarily of the highest ultimate tensile strength, is the best material for use in iron defences.

\* See Table 112, of initial velocities, which embraces the one given by Captain Inglis.

“2d. Rolled iron, although not perhaps equal in resistance to the best hammered iron, has such great advantages as to cost, if used in simple forms, as to justify its use where lightness is not of extreme importance.

“3d. Cast iron and steel, as at present manufactured, are too brittle; the former can only be thought of as backing, or where weight is wanted.

“4th. In plates or bars of ordinary dimensions the resistances to cannon-shot vary in a proportion approximating that of the squares of the thicknesses of the plates or bars.

“5th. Rigid backing is immensely superior to elastic backing, so far as the endurance of the front facing is concerned, but the elastic backing deadens the effect of a blow upon any structure behind.

“6th. The larger the masses and the fewer the joints the stronger the structure, so long as the limits of uniform and perfect manufacture are observed.

“The slight advantages gained by inclining the surfaces do not compensate for the extra difficulty and expense in construction involved, except in a few instances.

“7th. That revolving iron shields are practicable and safe.”

**836.** Captain Dyer, in his paper before quoted, thus sums up the same experiments.

“These preliminary experiments determined the following points:

“1. That steely iron, commonly known as homogeneous iron, puddled steel, &c., when in large masses, is inapplicable for defensive purposes; although in the thinner plates this metal offered great comparative resistance, it became brittle when in large masses, and readily cracked when struck by a shot.

“2. That plates of a hard crystalline structure are inferior to those of a soft fibrous nature.

“3. That the great fault and primary cause of weakness in all forged plates is unsoundness in welding the different piles of which the plate is composed. This defect was invariable in all (except the homogeneous iron plates); it was more apparent in

the rolled than in the hammered plates, but this was compensated for by the hammered plates being harder and more crystalline than those forged under the rolls ; and this led to the conclusion that there is but little choice between the two processes, if both are properly worked out with efficient machinery.

“4. That the qualities necessary in an armor-plate are softness combined with toughness, or better expressed by the word ductility. Apparently, the purer and better the iron is, the more this quality is perceptible ; any impurity or alloy appears to harden the metal and produce brittleness. The presence of either sulphur or phosphorus in the fuel is specially to be guarded against, as productive of red shortness and cold shortness in the iron. The presence of more than 0·2 per cent. of carbon in armor-plates also appears highly prejudicial.”

**837. Stevens's Inclined Laminated Armor.**—On the 4th of January, 1862, Mr. Stevens, of Hoboken, fired at a section of the armor at that time proposed for the *Stevens Battery*. The following is the official report of the experiment:—“A 10-in. gun, procured from the Navy Department, weighing 9883 lbs., was mounted with India-rubber buffers behind the trunnions. The gun was loaded with a full service charge, 11 lbs. of powder, and a solid spherical ball weighing 124 lbs., and was fired at a target exactly representing a section of the armor of the *Battery*, and anchored in the river, 220 yards from the gun.

“The target was composed of layers of plate-iron, from  $\frac{5}{8}$  to 2 in. thick, making  $6\frac{3}{4}$  in. in all. It was 4 ft. broad, 8 ft. long, and set at an angle of  $27\frac{1}{2}^{\circ}$  with the horizon. The iron was backed with two layers of locust timber 7 in. thick each. In the lower layer were imbedded wrought-iron beams 6 in. high, 4 ft. apart and 2 ft. apart, weighing 46 lbs. to the yard. Beneath the wood was a  $\frac{1}{2}$ -in. iron plate ; making the entire thickness  $21\frac{1}{4}$  in.\* The upper and lower plates were fastened to the wood by wood screws 15 in. apart, and the side edges of the upper plates were battened by iron 1 in. thick and 3 in. wide, and riveted together. This

\* This backing somewhat resembles that of the Chalmers and Bellerophon targets—the best English backing.

target rested on a raft, so as to have no support except at the edges; the lower part of it was 18 in. under water.

“After a few experimental shots the gun was pointed at the target, and the 1st shot struck it 21 in. above the water and within 9 in. of the right edge of the target. Its effect was to make an indentation and depression, which together were  $1\frac{1}{8}$  in. deep in the deepest place, and which ran out to the surface or diminished to nothing in a distance of 13 in., measured on the line of flight, without cracking any of the plates. The 2d shot passed to the right of the target, and the 3d went over it. The 4th shot struck the target on the left side, 13 in. from the edge and 11 in. above the water, with the same effect as that of the 1st shot, except that the depression was  $1\frac{3}{4}$  in. deep. The figure of this indentation was similar to that of the first. The recoil of the gun was  $7\frac{1}{2}$  in., and did no injury to the carriage or buffers.\*

“A Parrott rifled gun, having a 6.4 in. bore, and weighing about 9300 lbs., was then fired at the target, with 10 lbs. of powder, and an elongated shot weighing 100 lbs. Several of these shots were fired, and one struck the target 4 ft. 6 in. from the water, and 6 in. from the right side, making a depression 1 in. deep, and running out to the surface at a distance of 8 in., without doing other injury to the plates. This shot grazed the edge of the batten, upsetting the corner to the depth of  $\frac{1}{2}$  in.”

**338. Experiments against the “Committee Target,”**  
**March 4, 1862.**—(See Tables 122 and 124.)—This target ( $20 \times 10$  ft.) was composed of two plates  $20 \text{ ft.} \times 3 \text{ ft.} 4 \text{ in.} \times 4\frac{1}{2} \text{ in.}$ , and two plates of  $9 \text{ ft.} \times 3 \text{ ft.} 4 \text{ in.} \times 4\frac{1}{2} \text{ in.}$ , the upper and lower of which

\* “This gun was loaded by steam power, the muzzle being depressed so as to bring the bore parallel with a steam-cylinder situated below a platform made to represent the deck of the *Battery*. The platform was composed of white-pine planks  $2\frac{1}{4}$  in. thick, resting on pine beams 5 in. square and 2 ft. apart, from centre to centre, and calked and pitched in the usual manner. The piston-rod of this steam-cylinder was the ramrod of the gun. Upon the upper end of this ramrod was a swab, which also answered the purpose of a rammer. The cartridge and ball were attached to a *sabot* and placed on a scoop arranged so as to lift the ball up to its proper position between the rammer and the muzzle of the gun, when, steam being admitted to the cylinder, the ball was forced home. The gun was then elevated and fired.” (See chapter on “Breech-Loading.”)

were secured by fifteen 2-in. bolts, and the two centre by eight 2-in. bolts each. The plates were fastened to 1-in. plates, which latter formed the skin of the ship, which was supported by ribs 18 in. deep and 18 in. apart, made of  $\frac{7}{8}$ -in. plates, secured by angle-irons 4 in.  $\times$  4 in.  $\times$   $\frac{3}{4}$  in.; the backs of the ribs were secured by four strips of plate 12 in.  $\times$   $\frac{1}{2}$  in.; strips 10 ft.  $\times$  9 in.  $\times$   $\frac{3}{4}$  in. were placed behind the skin along each line of bolts. The plates were rolled by Messrs. John Brown & Co., Sheffield.

The object of the experiment was to determine whether wooden backing can be dispensed with. The "Committee target" was, therefore, constructed with the view of comparison with the *Warrior* target.

- "Committee target:" area, 200 square feet; weight, 31 tons.
- "*Warrior* target:" area, 200 square feet; weight, 32 tons 9 cwt. 3 qrs.

The guns used were the same as against the *Warrior* target, viz. :—

- |   |  |   |
|---|--|---|
| One 120-pdr. muzzle-loading shunt gun.<br>Three 100-pdr. breech-loading Armstrong guns. |  | One 68-pdr. 95 cwt. gun.<br>One 68-pdr. 112 cwt. gun. |
|---|--|---|

Range, 200 yards.

The following shot and shell struck the target :—

From 120-pounder gun,

Solid shot..... 1; weight, 140 lbs

From 100-pounder guns,

- |  |  |                                      |
|--|--|--------------------------------------|
| Solid shot..... 3; weight, 110 lbs. each.<br>Solid shot..... 3; weight, 200 lbs. each. |  | Shell..... 6; weight, 104 lbs. each. |
|--|--|--------------------------------------|

From 68-pounder guns,

- |  |  |  |
|--|--|--|
| Solid shot..... 1; weight, 66 $\frac{1}{4}$ lbs. each. |  | Shell..... 4; weight, 49 $\frac{1}{2}$ lbs. each |
|--|--|--|

RESULTS.—"COMMITTEE TARGET." (Table 122.)—1. Hit centre plate to the left of porthole, about 9 in. from bottom of the plate; very slight indent. Diameter of bulge, 5 in.

2. Hit left-centre plate 18 in. from bottom and about 5 ft. from left; indent very slight.

3. Hit left-centre plate about 12 in. from top; slight indent. Diameter of bulge, 3 in.

TABLE CXXII.—EXPERIMENTS AGAINST THE "COMMITTEE TARGET." MARCH 4, 1862.

No. of Round.	Nature of Ordnance.	Charge, lbs.	Nature of Projectile.	Weight, lbs.	Indent in ins.
1	100-pounder.....	12	shell filled with sand.	104	...
2	“	“	“	“	...
3	“	“	“	“	...
4	68-pounder.....	16	“	49½	1.4
5	“	“	“	“	1.5
6	100-pounder.....	12	shell filled with powder.	104	...
7	“	“	“	“	...
8	“	“	“	“	...
9	68-pounder.....	16	“	49½	1.14
10	“	“	“	“	1.26
11	120-pounder.....	20	solid cast-iron shot.	140	...
12	100-pounder.....	14	“	110	...
13	“	“	“	“	1.9
14	“	“	“	“	...
15	68-pounder.....	16	“	66½	1.8
16	100-pounder.....	10	“	200	0.4
17	“	“	“	“	0.5
18	“	“	“	“	0.7

4. Struck left-centre plate 17 in. from bottom, and close to No. 2 round. Diameter of bulge, 8 in.

5. Hit left-centre plate about 18 in. from bottom, and close to the 4th round. Diameter of bulge, 9½ in.

At the conclusion of the 5th round, the target was inspected. The left-centre plate had buckled  $\frac{3}{4}$  of an in.; two bolts in bottom plate, and two in centre plate, and one in top plate, started. Eight

bolt-heads were broken off; one rib broken through, and two rivets of angle-irons knocked out. Two angle-irons broken. The bolts were slackened after this round.

6. Struck on junction of middle and upper plate, 2 ft. 2 in. from left edge of target. The middle plate started forward.

7. Struck 2 ft. 5 in. from left edge of target, making an indent 7 in. in diameter.

8. Struck about 6 in. from top edge of the target near the bolt over porthole.

9. Struck middle plate on left of port, and 2 ft. from it. Diameter of indent, 10 in. Bolt just above indent started.

10. Struck on junction of middle and upper plate, 16 in. from port. Diameter of indent,  $9\frac{1}{2}$ .

The target was carefully examined after the 10th round, and it was found that all the bolts in the middle plate on the left of the target were broken, except the two nearest the port. The buckling was 1·7 in. at the left edge of the plate. The top plate had also started forward 0·4 in. at edge of target. At the back, the inner angle-iron by port on left side and one rib were broken, two rivets driven out, and several started. The skin bulged. No cracks visible on any of the indents.

11. Struck junction of right-centre plate with top plate, at about 3 ft. 10 in. from port.

12. Struck the bottom of upper plate close to No. 11 round.

13. Struck centre of right-centre plate.

14. Hit target close to 12 and 13 shots, and went clean through the target, carrying a large piece of the plate, part of the rib (on which the shot struck), and pieces of angle-iron 10 or 12 yards to the rear. The fracture measured in front of the target 1 ft. by 7 in. on the middle plate, and 5 in. by 3 in. on the upper plate. There was also a curved crack, 14 in. long, round the edge of the bulge, and through a bolt-hole.

15. This shot struck within 5 in. (from centre to centre of indent) of the 13th round. The middle plate was bent back 1·6 in. at its lower edge. One bolt was knocked out and two started. Middle plate started forward at right edge of target 0·65 in., and

the upper plate similarly 0·2 in. At the back of the target seven bolt-heads broken and one rivet. Two ribs broken through, and several rivets of angle-irons started.

16, 17, 18. These three shot struck the left-middle plate of target in a line, measuring only 16 in. from centre to centre of outside indents. The shot nearest to the port was 8 in., and the one furthest from, 15 in. from the lower edge of plate; the former 2 ft. 4 in. from port, and the latter only about 4 in. (centre to centre) from No. 4 round.

The plate bent back 1·2 in. at its lower edge, at a point 2 ft. 9 in. from the port, and had started forward at left edge 6 in. from skin.

Another angle-iron broken, and only three bolt-heads remaining on left side.

At the conclusion of this round, the target was considered so much injured that the experiment was ordered to cease.

**839. Experiments against the Warrior and Committee Targets, April 18, 1862; Range, 200 Yards.**—Alterations made on Committee target since the experiments of March 4th, 1862.

**UPPER PLATE.**—On the left half of this plate, rivets having conical heads, had been substituted for bolts, and vulcanized india-rubber washers inserted behind the bolt-heads on the right half of the plate; there being no intervening substance between the plate and the skin. This part of the target therefore remained as iron on iron.

**LOWER PLATE.**—One quarter in. thickness of felt, dipped in tar, had been inserted between the skin and half the length of the plate on the left side, the fastenings being rivets. On the right half of the plate,  $\frac{1}{4}$  in. thickness of vulcanized india-rubber had been inserted between the skin and plate; bolts having nuts and india-rubber washers were used for fastenings. A few of the bolts had spun-yarn instead of india-rubber washers.

**CENTRE PLATES.**—These plates had suffered most from the firing at the late experiment, and had been refastened with bolts having four washers (three of lead and one of iron) under the bolt-heads; they were not fired at on the present occasion.



TABLE CXXIII.—EXPERIMENTS AGAINST THE "WARRIOR" TARGET. APRIL 18, 1862.

No. of Round.	Nature of Ordnance.	Charge, lbs.	Nature of Projectile.
1	10½-in. Smooth-bore .....	40	150-lb. spherical cast iron.
2	10½-in. Smooth-bore .....	40	150-lb. spherical cast iron.
3	10½-in. Smooth-bore .....	50	150-lb. spherical cast iron.
4	10½-in. Smooth-bore .....	50	150-lb. spherical cast iron.

## EFFECTS. (Table 123.)

1. FRONT.—Hit on the junction of the lower and centre plates to the left of the porthole. Smashed in the plates, making a hole 1 ft. high  $\times$  14 in. The bulge was 3 ft. 1 in. long  $\times$  1 ft. 8 in. high. A crack 2 ft. 7 in. long across top of the bulge, and a huge zigzag crack across the plate and through its thickness. The tongue and groove broken only at the actual hole.

BACK.—Inner skin fractured and bulged in; strong iron ribs broken in two; two nuts of bolts broken off.

2. FRONT.—Hit the target a little to the right of the previous shot; 3 ft. 2 in. of the plate smashed, and the wood exposed. A piece of the plate 2 ft. 3 in.  $\times$  11 in. broken away.

BACK.—Skin broken up; a second rib broken. The former broken rib driven clean out and bent back at a considerable angle and smashed. Portions of shot, wooden backing, &c., driven right through. Large irregular *hole*. The square timbers forming the backing to the plates were shattered, and the fibre of the wood seemed to be drawn through the entire length of the beams, by the passage of the shot at the place of fracture and penetration.

3. FRONT.—Struck the lower plate on the right side of the porthole. Made a clean hole 11 in. diameter. Centre of the hole 1 ft. 3 in. from the bottom of the plate. Two cracks extended to the bottom of the plate, but independent of the shot-hole.

BACK.—Nothing perceptible but a few splinters of wood raised

up from the foot of the target, and a few nuts loosened. One broken off.

4. FRONT.—Hit the top plate in the centre of the right side. Made a hole 11·5 in. diameter, and the shot broke up in it. Depth of hole, 13 in.

BACK.—Struck where the inside skin was supported at top by two beams, with a total of about 2 ft. square solid timber, which was cracked through. The heavy beams also giving support (at right angles to the target) were started, and the solid granite blocks in the rear were shaken. Upon taking the target to pieces, it was found that the inside skin was cracked, and that the shot had penetrated 13 in. into the wood backing, leaving 5 in. of wood into which no fragment of the shot had penetrated.

#### EFFECTS. (Table 124.)

1. FRONT.—Struck on junction of middle and lower plates 4 ft. 4 in. from the left side of the target, half the indent being on each plate. Depth of indent, 1·8 in. ; diameter, 10 in.

BACK (see below \*).

2. FRONT.—Struck the target 2 ft. 3·75 in. from the left side, and 2 ft. 5 in. from the bottom of the lower plate. Made a slight indent. A bolt started.

BACK (see below \*).

3. FRONT.—Hit lower plate 3 ft. 11 in. from the left side, and 2 ft. 7 in. from the bottom, making a slight indent.

BACK (see below \*).

Struck on the centre plate.

4. FRONT.—Hit on the lower edge of the porthole 7 in. from the left side. A piece of the plate 9·5 in. long and 2 in. wide broken off, and a crack 6 in. long extended from a bolt-hole in the lower plate. Indent, 1·7 in. ; diameter, 9·5 in.

BACK (see below \*).

\* At the back, a few small rivets, merely uniting the angle-iron to the skin of the ship, were broken off. A very slight crack on one of the angle-irons, where it joined one of the iron supporting ribs. Some of the lead washers of the through-bolts (in the neighborhood of the blows) drawn thinner and worked loose; india-rubber washer much compressed.

TABLE CXXIV.—EXPERIMENTS AGAINST THE “COMMITTEE TARGET.” APRIL 18, 1862.  
Five rounds were fired at the *left* side of the lower plate.

No. of Rounds.	Nature of Ordnance.	Charge, in lbs.	Nature of Projectile.	
1	68-pounder.....	16	Shell filled with sand.	
2	110-pounder.....	12	“	
3	“	“	“	
4	“	“	“	
5	68-pounder.....	16	“	
6*	110-pounder.....	12	Shell filled with powder.	
7	68-pounder.....	16	“	
8	110-pounder.....	12	“	
9	“	“	“	
10	68-pounder.....	16	“	
11	110-pounder.....	14	Solid shot.	
12	68-pounder.....	16	“	
13	110-pounder.....	14	“	
14	“	“	“	
15	120-pounder.....	20	140-lb. shot.	
16	110-pounder.....	10	Flat-headed bolt, 200 lbs.	
Salvo. {	19	“	“	
	20	“	“	
	21	“	“	
Salvo. {	22	120-pounder.....	20	140-lb. shot.
	23	110-pounder.....	14	Solid shot.
	24	“	“	“
	25	“	“	“
	26	68-pounder.....	16	“

\* The following rounds were fired at the *right* side of the lower plate.

TABLE CXXIV.—(CONTINUED.)

No. of Rounds.	Nature of Ordnance.	Charge, in lbs.	Nature of Projectile.	
27	68-pounder.....	16	Solid shot.	
Salvo. {	28	“	“	
	29	“	“	
	30	110-pounder.....	14	“
	31	“	“	“
	32	“	“	“
	33	120-pounder.....	20	140-lb. shot.
Salvo. {	34	110-pounder.....	14	Solid shot.
	35	“	“	“
	36	“	“	“
	37	68-pounder.....	16	“
	38	“	“	“
	39	120-pounder.....	20	140-lb. shot.

6. Struck the centre plate.

7. FRONT.—Hit on the junction of centre and lower plates, and 1 ft. 5 in. from the port. Depth of indent, 1.2 in.; diameter on lower plate, 4 in.

8. FRONT.—Hit the plate 7 in. from the top, and 2 ft. from the port. Slight indent.

9. FRONT.—Hit the plate 14 in. from the top, and 1 ft. 7 in. from the right side of the target. Slight indent.

10. FRONT.—Hit the plate 8.5 in. from the top, and 1 ft. 9.5 in. from the right side. The 2d and 3d bolts from the right in the top row started, the latter 5 in. Indent, 1.25 in.; diameter, 9 in.

BACK.—*After rounds 6 to 10 inclusive.*—Two bolt-heads broken

off, but none gone in the bottom plate, where a sheet of vulcanized india-rubber intervenes. No other trace of injury.

11. FRONT.—Hit the lower plate on the right side 1 ft. 11·5 in. from the port, and 8·5 in. from the top. Indent, 2·05 in. A crack 16 in. long across the centre of the bulge.

12. FRONT.—Hit the plate 3 in. from the top, and 2 ft. 11 in. from the port. Indent, 2·3 in.; diameter, 8 in. A crack 10·25 in. long across the bulge.

13. Struck the centre plate.

14. FRONT.—Hit the plate 9 in. from the top, and 3 ft. 5 in. from the port on the top of a bolt which had previously been started. The bolt was drawn. Indent, 2·55 in.; diameter, 6·5 in. A crack 7·5 in. long extended from the bulge.

15. FRONT.—Hit the plate 1 ft. 5 in. from the top, and 1 ft. 11 in. from the right side. Indent, 2·9 in.; diameter, 8 in. Slight crack across the centre of the bulge.

BACK.—*After rounds 11 to 15 inclusive.*—Two ribs broken clean through. Five angle-irons broken. Skin fractured and forced out in pieces behind, along with parts of the india-rubber sheeting. One of the through-bolts had the head broken off.

16. FRONT.—Did no apparent damage.

BACK.—Slight bulging of skin merely.

19, 20, 21. FRONT.—Fired at left side of lower plate. Did no apparent damage.

BACK.—Did not fire together. Had no visible effect.

22, 23. FRONT.—Hit left side of lower plate 1 ft. 9·5 in. from the bottom, and 3 ft. 10·5 in. from the left side. Depth of indent, 2·25 in.; diameter, 7 in. A crack across the bulge.

One 110-pounder of this number struck the centre plate.

24, 25, 26. FRONT.—These shot made a hole (triangular) with a base 1 ft. 7 in. long, and sides 1 ft. 10 in. long, on left side of lower plate. A wide crack extended from the bottom of the hole through some old shot marks to the bottom of the plate.

27. FRONT.—Hit just below the hole made as above. Indent, 2 in.; diameter, 9 in.

BACK.—*After rounds 22 to 27 inclusive.*—Huge fracture with hole. A large piece of solid plate driven through with other debris. Two ribs broken across. Skin bulged out, torn and bent up nearly at right angles. A through-bolt driven out with the rest. Solid timber support at foot of target cracked through.

28. FRONT.—Hit on a rivet which was forced out. Indent, 2·3 in. ; diameter, 9 in.

29. FRONT.—Hit the plate 1 ft. 4 in. from the top, and 5 ft. 1 in. from the left side. Indent, 2·1 in. ; diameter, 9 in.

30. FRONT.—Hit 6 in. from the top. Indent, 2·35 in. A crack extended from a bolt-hole to the top of the target.

31. FRONT.—Hit 1 ft. 3 in. from the top. Indent, 2·05 in.

32. FRONT.—Hit 1 ft. 8 in. from the top. Indent, 1·8. Two cracks across the bulge.

33. Missed the plate.

BACK.—*After rounds 28 to 33 inclusive.*—One rivet was driven out but not broken. 14 in. of the backing of the skin broken off. One bolt with spun-yarn washer driven back and part of the washer destroyed, but the bolt apparently uninjured.

*Fired at right half of top plate.*

34. FRONT.—Made an indent 2·5 in.

35, 36, 37, 38. FRONT.—Two shot struck on a rivet 6 in. from the bottom and drove it out. A huge crack extended to the bottom of the plate.

39. FRONT.—Hit 1 ft. 5 in. from the bottom of the plate. Made an indent 2·1 in. ; diameter, 7 in. Huge crack across the bulge.

The lower plate had now buckled 1 in. on the right side, but the bolts were uninjured. The left side was buckled 1·25 in., but the rivets were uninjured.

BACK.—*After rounds 34 to 39 inclusive.*—18 in. of the backing of the skin was destroyed. One rib broken across, and 2 angle-irons.

**840. Experiments against 2-Inch, 2·35-Inch, 3-Inch, and 4·5-Inch Plates with 12-Pounder and 40-Pounder, and against Mr. Scott Russell's and Mr Samuda's Targets with 40-Pounder, 100-Pounder, and 150-Pounder, June 26, 1862.**  
—(See Table 125.)

Plate A, 4 ft. 6 in.  $\times$  2 ft. 6 in.  $\times$  2 in. (Inferior iron badly rolled.)

“ B, 5 ft.  $\times$  3 ft.  $\times$  2.35 in.

“ C, 5 ft. 5 in.  $\times$  3 ft.  $\times$  3 in. (Badly rolled.)

“ D, 6 ft.  $\times$  3 ft.  $\times$  4.5 in.

The plates rested against strong upright timbers, with sloping supports to the rear. Four powerful rivets, bolted through to the upright timbers, overlapped the edge of each plate. The plates were without backing of any kind.

Service charges for the respective guns were used throughout the practice. The 150-pounder was fired with 2A<sub>1</sub> powder.

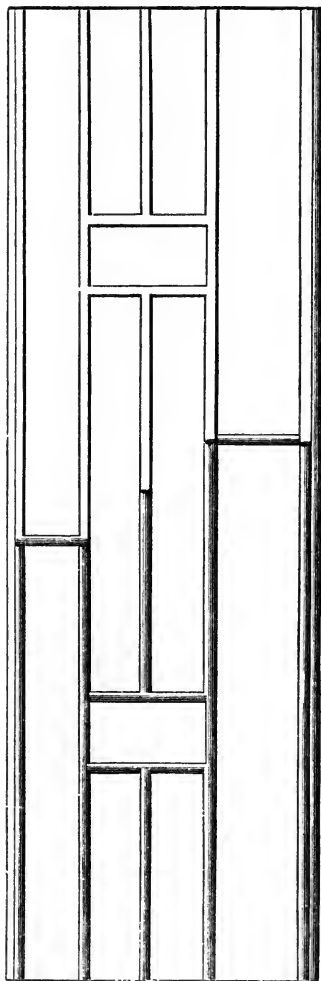
**841.** MR. SCOTT RUSSELL'S TARGET, Figs. 381, 382 and 383 (29 ft. 10 in.  $\times$  9 ft. 9 in.) was composed of four rows of plates of the following widths, viz.:—upper row, 1 ft. 10 $\frac{3}{4}$  in.; second row, 1 ft. 9 $\frac{1}{4}$  in.; third row, 1 ft. 8 $\frac{3}{4}$  in.; and bottom row, 2 ft. 10 $\frac{1}{2}$  in.

The plates (all of hammered iron) 4 $\frac{3}{8}$  in. thick, were supplied by the Admiralty, and had originally been made for the *Warrior* by the Thames Iron Company.

The total thickness of the target was 8 $\frac{1}{8}$  in., made up as follows:—a 4 $\frac{3}{8}$ -in. plate, a filling-in piece of 1 in., two 1-in. plates for backing, and two  $\frac{3}{8}$ -in. plates forming the skin.

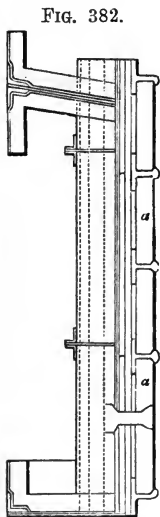
The construction of the target at the rear consisted of two longitudinal stringers 5.5 in. deep, one above, and the other below the port; also two iron water-ways, representing the

FIG. 381.



Mr. Scott Russell's target. Front view,  $\frac{1}{8}$  in to 1 ft.

upper and main decks. The vertical ribs were 10.5 in. deep and 21.25 in. apart; and, in order to represent the mode of construction with iron backing, as proposed by Mr. Scott Russell, a lining of iron  $\frac{1}{2}$  in. thick was placed on the upper part of the target (instead of 3 in. of teak lining of the *Warrior* target), the remainder of the target being left open, in order to allow of the examination of the skin.



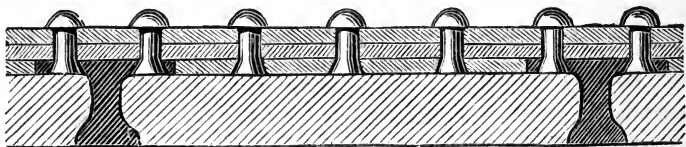
Section of Mr. Scott Russell's target. Scale,  $\frac{1}{4}$  in. to 1 ft.

The object of the original experiment was to test Mr. Scott Russell's system of continuous riveting, combined with iron backing instead of wood.

Projecting riveting was used on one-half the target, and flush riveting on the other half. There were neither bolts nor rivets in any of the armor-plates, with the exception of the bottom one on the right side of the target, which had four rivets through its centre. The target had two portholes.

**842.** Mr. SAMUDA'S TARGET, (20 × 10 ft.), was composed of two plates, 20 × 3 ft. 4 in. × 5 in., and two centre plates, the one to the left of the porthole being 11 ft. 6 in. × 3 ft. 4 in. × 5 in., and the one to the right of the porthole, 6 ft. 8 in. × 3 ft. 4 in. × 5 in. The skin was 1 in. thick, and longitudinal ribs,  $2\frac{1}{2}$  in. thick, were

FIG. 383.



Section of Mr. Scott Russell's armor.

placed at the junction of the plates, by which means the whole target was supposed to be of uniform strength. The upper and lower plates were secured by bolts, 14 in. apart, and the middle plates by alternate bolts and rivets. A thin layer of india-rubber was placed between the armor-plate and the skin and leather under the bolt-heads.



The target was supported by a framework of 14-in. timbers, 3 ft. 6 in. apart, strutted to the rear; the feet of the struts being secured to timber piles. The total weight of the target (exclusive of the beams of the ship) was 27 tons 19 cwt.

The armor-plates were rolled by Messrs. John Brown & Co., of Sheffield.

#### EFFECTS. (Table 125.)

1. Ragged hole through plate, 2·3 in.  $\times$  2·5 in.; diameter at back, 5·5 in.; large crack 6 in. long in front below hole. Bend of plate 1·8 in. in length of 13 in.; shot broke up small.

2. Clean hole through diameter, 3·8 in.  $\times$  3·6 in. No bend in plate; shot broke up in large pieces.

3. Indent, ·55 in. in length of 6 in. A 4-starred crack at the back.

4. Ricocheted and hit low broadside. Shot broke up.

5. Indent, ·875 in. in length of 11 in. Back starred with cracks and piece in centre of star cracked round.

6. Hole through diameter, in front, 5·6 in.; at back, 11 in. Bulge of plate, ·45 in. in 1 ft. 7 in. Doubtful whether shot did not hit on old bolt-hole.

7. Struck above a bolt-hole. Indent, 1·6 in. in 1 ft. 6 in. At back, slight bulge and three cracks.

8. Struck top to the right near last shot.

9. Hit target 3 ft. 1 in. from right and 6 in. from top of lower plate. Hole through 12·75 in. in diameter, and plate broken away to the extent of 4 ft. 2·75 in.  $\times$  2 ft. 7·5 in. A crack 1 in. wide from top to bottom of plate, also a crack from a bolt-hole 1 ft. 8 in. from point struck, 2 ft. of rivet (or uniting railway iron) broken off. The plate above the one struck cracked right through. At the back, 1 vertical rib broken through; pieces of skin driven into wooden hulk 38 in. to the rear; horizontal stringer also bent out 1·1 in. and cracked through. The shot fell back 5 yds. from the target. The "work done" upon the shot itself was considerable. The sphere was altered in figure so that the front and hind hemispheres were flattened (so to speak), and "set up" together, forming a sharp circular flange or rim.

TABLE CXXV.—EXPERIMENTS AGAINST 2-IN., 2·35-IN., 3-IN., AND 4·5-IN. PLATES WITH 12-POUNDER AND 40-POUNDER, AND AGAINST MR. SCOTT RUSSELL'S TARGET AND MR. SAMUDA'S TARGET. JUNE 26, 1862.

No. of Round.	Nature of Target.	Nature of Ordnance.	Projectile.				Charge, lbs.	Range, yards.	Elevation.	Deflection.	Indent.
			Nature.	Weight.	Length,*	Form.					
				lbs. oz.	in.			° '		in.	
1	A. 2-in.....	12-pdr.	cast iron.	11 9	7	Service.	1·5	200	nil.	10 R ...	
2	“	“	steel.	13 2	6·5	“	“	“	“	“ ...	
3	B. 2·35-in.....	“	cast iron.	11 9	7	“	“	“	“	·55	
4	“	“	steel.	13 2	6·5	“	“	“	“	“ ...	
5	“	“	wt. iron.	12 9	6·5	flat head.	“	“	0 3	“ ·875	
6	C. 3-in.....	40-pdr.	cast iron.	41 8	10·25	“	5	“	0 10	“ ...	
7	D. 4·5-in.....	40-pdr.	“	“	“	Service.	“	“	“	7 R 1·6	
8	“	“	steel.	45 4	“	round headed.	“	“	0 13	10 R ...	
9	Scott Russell's	10½-in.	wt. iron	162 8	10·372	sphere.	50	“	nil.	nil. ...	
10	C. 3-in.....	40-pdr.	steel.	45 4	10·25	round head.	5	“	0 10	5 R ...	
11	“	“	wt. iron.	43 0	9·25	flat head.	“	“	“	“ 5·75	
12	C. 3-in.....	“	cast iron.	41 8	10·25	Service.	“	“	“	“ 8·5	
13	B. 2·35 .....	12-pdr.	“	11 9	7	“	1·8	400	0 30	12 R 7·0	
14	“	“	wt. iron.	12 9	6·5	flatheaded	“	“	0 32	10 R 1·05	
15	“	“	“	“	“	“	“	“	0 33	18 R ...	
16	D. 4·5-in.....	40-pdr.	cast iron.	41 8	10·25	Service.	5	“	0 38	10 R ...	
17	“	“	“	“	“	“	“	“	0 35	3 R ...	
18	“	“	steel.	“	9·25	flat headed	“	“	0 38	9 R ...	
19	“	“	“	“	“	“	“	“	0 39	1 R ...	
20	“	“	“	45 4	10·25	round headed.	“	“	0 35	3 R 1·85	
21	“	“	“	43 0	9·25	flatheaded	“	“	0 38	“ 1·15	
22	Samuda's .....	“	steel.	45 4	10·25	round head.	“	600	1 0	4 R 2·2	
23	“	“	cast iron.	41 8	“	Service.	“	“	1 3	8 R ·65	

TABLE CXXV.—(CONTINUED.)

No. of Round.	Nature of Target.	Nature of Ordnance.	Projectile.				Charge, lbs.	Range, yards.	Elevation.	Deflection.	Indent.
			Nature.	Weight.	Length.	Form					
24	Samuda's .....	40-pdr.	steel.	lbs. oz. 45 4	in. 10.25	round headed.	5	600	1 3	12 R	2.45
25	"	"	wt. iron.	43 0	9.25	flat headed	"	"	"	"	.65
26	Scott Russell's	110-pr.	cast iron.	110 8	12.25	Service.	14	200	0 24	10 R	2.15
27	"	"	wt. iron.	116 8	11.25	flat headed	"	"	"	12 R	2.3
28	"	"	cast iron.	110 8	12.25	Service.	"	400	0 42	8 R	...
29	"	"	"	"	"	"	"	"	"	10 R	1.7
30	"	"	wt. iron.	117 1	11.25	flat headed	"	"	0 44	13 R	2
31	"	"	cast iron.	110 8	12.25	Service.	"	600	1 6	8 R	...
32	"	"	"	"	10.25	"	"	"	1 12	"	1.65
33	"	"	wt. iron.	117 11	11.25	flat headed	"	"	1 13	12 R	2

Diameter of shot before firing..... 10.372 in.

Major diameter of shot after firing..... 12.969 "

Minor diameter of shot after firing..... 8.2 "

Weight of shot before firing..... 162 lbs. 3 oz.

Weight of shot after firing..... 161 " 12 "

The shock of this blow was transmitted to a heavy structure of timber, in rear of the target, of 16 paces in depth, so as to move the whole mass about  $\frac{1}{4}$  in., as shown by the displacement of the surrounding sand.

10. Hole clean through; diameter in front, 5 × 5.5 in.; at back (inner), 5.5 in.; (outer), 10 in. No indent or curvature of plate.

11. Bulge of plate extending over a surface 2 ft. 5 in. × 3 ft. Four 1-in. wide starring cracks from centre of blow. Bulge at back over space, 1 ft. 7 in. × 1 ft. 6 in. Plate opened out in wide rent. Much more damage from wrought-iron shot. More injury to plate on the whole, though steel shot punches a fair hole clean through. Shot set up 1.75 in.

12. Indent, 8.5 in. in length of 1 ft. 8 in.; diameter of hole, 6 in. Struck on margin of No. 10. Ragged irregular hole at the back.

13. Hit centre of plate nearly; slight indent, .7 in. No bend of plate. Very slight star of three branches at back. Indent, 1.05 in. in 1 ft. 2 in.

14. Effect more of a *bend* in the whole plate. Bulge and 7-starred cracks at the back. More "work done" still with the wrought iron. Shot set up 1.5 in.

15, 16. Missed.

17. Indent, .625 in.; diameter, 3.1 in. No breaking of plate. Back, slight crack from bolt-hole.

18. Missed. } Flat-headed projectiles gave very uncertain prac-  
19. Missed. } tice.

20. Indent, 1.85 in.; diameter, 5.5 in. No bend in plate. Back crack, 1 ft. 8 in. laterally; opening of crack, .65 in.; two small upward cracks from it. Shot broke up.

21. Indent, 1.15 in. in 1 ft. 6.5 in.; diameter, 4.2 in. A certain amount of work lost in knocking down the plate from its fixtures, accounting for small effect. Bulge at back and 4-starred cracks, one of them 1 ft. 10 in. in length, gaping  $\frac{3}{8}$  in. in widest part.

22. Indent, 2.2 in.; area of indent, 7.7 in  $\times$  5.8 in. Struck on junction of two plates.

23. Indent, .65 in.; diameter, 3 in.

24. Indent, 2.45 in.; diameter, 5.55 in. Worked up the rim of plate at top of target half an inch.

25. Indent, .65 in.; diameter, 3.9 in.  $\times$  4.8 in.

26. Struck at bottom of second plate from the top, grazing lower riveting. A semi-circular crack extended for an area of 12  $\times$  22 in. The plate was driven in .7 in. in a length of 1 ft. 8 in.; diameter of indent, 6.5 in. At the back, one rib with its angle-iron was cracked in two places, and a through-bolt (not covered by armor-plate) was broken.

27. Hit third plate 5.5 in. from top. A crack extended from the bulge nearly to the bottom of the plate. Indent, 5.7  $\times$  6.6 in.

The riveting was cracked across in two places and forced up for a length of 2 ft. 6 in., and the plate was driven in 1 in. At the back a rib was broken, and the one referred to last round was broken in a fresh place. The skin was broken for a short distance, and a joint-strip was forced out. The shot set up 3·25 in.

28. Missed.

29. Hit lower plate 1 ft. from top. The riveting started 5 in. in a length of 3 ft. and cracked along its centre for a length of 2 ft. 7 in. The plate was cracked at the back through half its thickness, as seen at the outer end. At the back one of the ribs was broken from its outer rivet-hole to the outside, and two angle-irons were cracked. The skin slightly bulged out.

30. Struck on projecting riveting between lower and third plates. The riveting was cracked across in two places and compressed at point of impact. A semi-circular crack at a distance of 1 ft. from point of impact. At the back a rib and two angle-irons cracked through, one rivet in angle-iron broken, and skin cracked across from rib to rib. Shot broke up into several pieces.

31. Missed.

32. A crack 1 ft. long from point of impact; 1 ft. of riveting under the bulge damaged, 2·5 in. being broken off. The riveting was cracked across at 2 ft. from the point of impact. At the back, one rib and angle-iron cracked, and the skin slightly bulged.

33. Hit broken plate; a crack 15 in. long at 13 in. from point of impact; also, another crack from a bolt-hole to the top of the plate at a point 2 ft. 1·5 in. from impact. At the back, two rivets of the lower stringer were broken, an angle-iron and rib broken, and the skin cracked around a rivet-hole. Shot set up 3·75 in.

**843. Experiments against the Minotaur Target, July 7, 1862.**—The target consisted of three plates. The top one (12 ft. 6 in. × 3 ft. 4 in. × 5·5 in.) was made by Messrs. John Brown & Co., of Sheffield.

The centre one (9 ft. × 3 ft. 7 in. × 5·45 in.) was made at the Thames Iron Works.

The bottom one (12 ft. 6 in.  $\times$  3 ft. 4 in.  $\times$  5.5 in.) was made by Messrs. Beale & Co.

The backing consisted of 9 in. of teak and the same skin as in the *Warrior* target.

Each plate was fastened with three rows of through-bolts, the upper and lower rows being  $1\frac{3}{4}$  in. diameter, and the centre row  $1\frac{1}{2}$  in. A strip of iron  $1\frac{1}{4}$  in. thick was placed in rear, at the junction of the plates, the upper strip being 16 in. wide, and the bolts passing through it; the lower one was only 10 in. wide, and was not bolted through. The support in rear was similar to that of the *Warrior* target.

The range was 200 yards, and the guns used were the 12-ton gun (10 $\frac{1}{2}$ -in. smooth-bore Armstrong) and the 68-pounder smooth-bore.

From the results of the experiments, "it is plain that the powers of resistance of a structure such as the *Warrior* are far superior to those of a vessel constructed on the plan proposed for the *Minotaur*."

"An additional inch of iron in the thickness of the plate, is clearly no compensation for the reduction of 9 in., or half the thickness of teak backing."

#### EFFECTS. (Table 126.)

No. 1 (150-pounder). Hit the centre plate 2 ft. from the bottom and made a hole through the plate 12.5 in.  $\times$  12.2 in., and about 13 in. deep. The plate was driven in 1.1 in. at the bottom, and 1.5 in. at the top, and buckled forward .45 in. at the end of the porthole, and .25 in. at the outer end. The lower strip at the junction of the plates also started .3 in. from the backing. Two bolts in the bottom row of the upper plate started  $\frac{7}{8}$  in., and one in the centre row  $\frac{5}{8}$  in. The top and bottom bolt of the porthole of the centre plate started .2 in., and those in the top row of the lower plate started respectively 1 in.,  $\frac{5}{8}$  in., and  $\frac{1}{4}$  in.; also one in the centre row of the same plate  $\frac{1}{4}$  in. The shot broke up, and parts of the plate and shot were driven into the wood backing. No cracks on the plate; iron good; at the back, 2 vertical iron ribs

TABLE CXXVI.—EXPERIMENTS AGAINST THE MINOTAUR TARGET. JULY 7, 1862.

No. of Round.	Nature of Ordnance.	Nature of Projectile.	Projectile.		Charge in lbs.	Elevation.	Deflection.	Indent in ins.
			Weight.	Diameter.				
1	10½-in. Smooth-bore 150-pdr.....	Cast-iron sphere.	150	10.35	2 A4 50	Nil.	Nil.	Nil.
2	“	“	“	“	“	“	“	“
3	“	“	“	“	“	“	“	“
4	“	Wrought iron.	162	10.364	“	“	“	“
5	68-pdr. Smooth-bore .....	“	71	....	W A 16 lbs.	20'	“	2.4
6	“	Cast iron.	67	....	“	“	“	3

cracked (one on each side of point struck); one of these ribs broken clean in two. Four bolt-heads broken off; 2 in centre plate, one in corner below the seat of injury, and one to right of lower plate, 3 ft. 5 in. from the point struck; a rivet-head gone near the same place. Two angle-irons cracked. Iron shelf-piece carried away. Eleven rivet-heads broken off. Skin much bulged, and a 3-starred crack from the bolt-hole where struck. Serious *bulge* of skin over a space 1 ft. 6 in. × 1 ft. 6 in. General *bend* of inner surface over a space of 3 ft 6 in. × 3 ft. 6 in.

No. 2 (150-pounder). Hit the top plate 17 in. from the bottom, and made a hole through the target; 13 in. × 12.5 in., being the diameter, in the armor-plate. One edge of the hole was on a bolt which was driven out, and a crack extended from the bolt-hole parallel to and 1.3 in. from the edge of the shot-hole, for a quarter of its circumference. Eight bolts in this plate were now started, viz.:—3 in the upper row, 3 in the lower, and 2 in the centre. There were no radiating cracks on the plate, but the quality of the iron was unequal, the exterior of the plate being good, but large crystals visible on the centre. Fracture laminated. The plate buckled .3 in. at its outer end, and the centre

plate had now buckled 1·1 in. at the end by the porthole, but was set back into its place at the other end, where it had buckled ·25 in. the last round. At the top of the target 1 ft. of the backing was forced up 4·2 in., and a filling-in piece 1 ft. 10 in. long was forced up 8 in.; also a horizontal wooden balk 1 ft. 7 in. to the rear was quite cracked through. At the back, 2 bolt-heads broken off in centre plate, one in lower; large irregular hole; skin doubled back; pieces of shot clean through along with teak backing and fragments of plate. Hole and breakage, 18 in. × 14 in. Solid timbers supporting the top of the target in rear (total thickness, 1 ft. 8 in.) cracked and splintered; upright balks of timber, 4 ft. 6 in. in rear, penetrated by splinters of iron; bolt-heads and rivet-heads picked up 36 ft. in rear. Front portion of plate struck (bearing impression of blow), found 15 ft. in rear of target. Effect partially concealed by the supporting beams at top, which suffered in being rent by the blow.

No. 3 (150-pounder). Struck the lower plate 5 in. from the top, and made a hole through the target, the diameter in front being 13 in. The plate buckled ·5 in. at the outer end. Three cracks, each about 2·5 in. long from the edge of the hole, one extending to the top of the plate. Two bolts in the centre row had started respectively ·8 in. and ·9 in., and one in upper row (3 ft. 4 in. from the point of impact) started ·5 in.; also one in the lower row, under the shot-hole, started ·3 in. Plate very badly welded and much laminated. The shot broken up. At the back, large hole; daylight through; vertical rib broken clean through, and bent back 2 ft. 6 in. from target; large portions of skin, bolt-heads, and rivets broken away; cone of shot found lying 15 ft. in rear; other fragments of shot and plate driven through; shreds and splinters of teak backing protruding. The hole and rent 16 in. × 2 ft. 6 in. Entire bulge, 3 ft. 6 in. wide.

No. 4 (150-pounder). Struck the centre plate 2 ft. 3 in. from the bottom, 1 ft. 6 in. from the right side of the plate, and 3 ft. 11 in. from the hole made by No. 1 shot. The shot remained in the plate. The target was tremendously shaken. The centre plate had now buckled forward 3·3 in. at the end by the porthole,



and was driven 6.5 in. at the outer end. The whole of the backing of the target, on the right side, was driven back, the space being 6 in. at the top, and 9.25 in. at the bottom of the upper plate. The upper plate was unsupported for a length of 6 ft. from the right side. The teak backing through which the bolts passed, was cracked quite through. The diameter of the hole made was 13.5 in., and the bulge on the plate was 2.5 in. in an area of 3 ft., whereas, in No. 1 round the bulge in the plate was only .5 in. in a smaller area. A narrow crack extended from the top of the hole made by No. 1 round to the top of the plate. At the back, 2 vertical ribs and angle-irons broken, 1 on each side of blow; bolt started and driven out 1 ft. 2 in.; skin, 2 small cracks at bolt-hole; three bolt-heads off, 2 in centre plate, 1 in top. Iron shelf-piece loosened and partly bent out. Bulge of plate, 4 × 2 ft. Interior damage less than No. 1, but distributed over a block of masonry several feet in rear, on which leaned the intervening beams between it and the top of target.

The entire breech of the 12-ton gun (10½-in. Armstrong smooth-bore) was blown out at this round, and fell 12 yards to the rear, rebounding 21 yards farther to the rear, where it remained. A 14-in. balk of timber in front of the platform, to which the tackle for checking recoil was secured, was broken through. In considering the damage done to the target by this round, the accident here recorded must be taken into account, as the loss of *work* must have been considerable.

No. 5 (68-pounder). Struck the lower plate 10 in. from the bottom and under porthole. Diameter of indent, 9.5 in. Area of bulge in plate, 19 × 18 in.; depth in area, .5 in. One small crack on indent. At the back, one rivet-head off. No other damage visible.

No. 6 (68-pounder). Struck the lower plate just above the last round. The indent of last round now measures 3.2 in., and the diameter of the two indents is 1 ft. 3 in. × 9 in. The area of the bulge, 21 in. No radiating cracks, and no other damage to the fastenings; but the plate had very slightly started at the top by the porthole. At the back, no damage visible.

**844. Experiments against 4-Inch and 6-Inch Lumina-  
ted Target, Stafford Sub-Calibre and Parrott Projectiles.  
West Point, August 26th, 1862.**—Target 5 ft. | 5 ft., made  
of 1-in. wrought-iron plates, half the target being four plates thick,  
and half six plates thick. The iron was fastened by 21 bolts to  
oak backing 6 in. thick, and propped by logs. The plates were  
said to be of the quality used for the *Monitors*.

1. AUG. 14, 1862.—Semi-steel 50-pounder rifle, 5.1-in. bore,  
laid at the 4-in. part of the target, at 108 ft. range. Target, verti-  
cal. A cylindrical steel sub-calibre shot, with a brass-cup to fill  
the grooves. Weight, 41 lbs.; charge, 10 lbs. Penetrated three  
plates and was embedded in the fourth, which it dished, breaking  
the back timbers. Indentation,  $6\frac{1}{2}$  in. in diameter. Shot, much  
broomed and crushed up.

2. Shot and charge the same as above. Shot did not take the  
grooves well, and did not strike square. Result not so favorable  
as above.

SEPT. 17, 1862.—The same target, backed also by a block of  
granite and heavy logs, and set at  $3\frac{1}{2}^{\circ}$  from the vertical.

1. A cylindrical sub-calibre 36-lb. shot with a brass cup to  
take the grooves; fired with 10 lbs. of mortar-powder from a  
5.1-in. gun, made a clear breech 7 in. in diameter, through the  
4-in. part of the target and the backing.

2. Shot and result the same as above.

3. Same shot and charge as above, fired at the 6-in. part of the  
target, made  $3\frac{1}{2}$  in. indentation  $6\frac{1}{2}$  in. in diameter. Shot found at  
the foot of the target.

4, 5. 100-pounder Parrott rifle-gun, 6.4 in. bore; charge, 12 lbs.  
Hazard, No. 7 grain powder. Cylindrical shot; failed to take  
the grooves and struck sideways.

1. SEPT. 5.—100-pounder Parrott rifle. Target, vertical;  
range, 135 ft; charge, 14 lbs. Hazard, No. 7 grain powder.  
Projectile, 70 lb. sub-calibre shot, consisting of a steel bolt  $4\frac{3}{4}$  in.  
in diameter, enclosed in wood, with a brass cup to take the rifling.  
Struck the edge of the target, penetrating the 6 plates and  
backing.

2. The gun, shot, and charge, the same as above. Struck fairly, penetrating the 6-in. iron and backing, and breaking the granite block to pieces; made 7-in. hole. Some of the wood round the shot was found crushed into the sides of the orifice, and the brass cup went through.

Oct. 6.—The same gun; shot and charge, as above; range, 130 ft.; target at 43°. Shot penetrated the 6-in. iron and backing, making an orifice 5 × 12 in. as it turned in its passage through.

After the experiments of August 14th, the backing was much broken, offering little resistance to the shot, and did not hold the plates so close to each other as before.

It was concluded that this shot would penetrate a 6-in. laminated target at 45° with a  $\frac{1}{3}$ th charge from a 100-pounder.

After this a 70-lb. Parrott cast iron flat-fronted full-calibre shot, with a chilled head, 14 lbs. Hazard No. 7 grain powder, struck the edge of the 5th and 6th plates, tearing both off and going through the 4 others.

The target was set at 38°. This shot was considered as effective as any during the experiment.

**845. Experiments with the Whitworth 12-Pounder, 70-Pounder, and 120-Pounder, against the Warrior Target. Opinions of the Committee.**—(See Table 127).—“The experiments with the Whitworth guns were extremely satisfactory. The 12 lbs. solid shot, fired with a charge of 1 lb. 14 oz., at a range of 200 yards, penetrated a 2½-in. wrought-iron plate, and remained unbroken.

“A shell, with a bursting charge of 6 oz. was next fired from the 12-pounder gun, with the same charge, and at the same range, at 2 in. of wrought-iron backed by 12 in. of wood; it passed completely through the target, buried itself in the sand-hill in the rear, and has since been dug up, when it was found not to have burst. The charge was then reduced to 1 lb. 12 oz., and one fold of the flannel covering the bursting charge taken off, and the second shell passed through the target and burst in the rear.

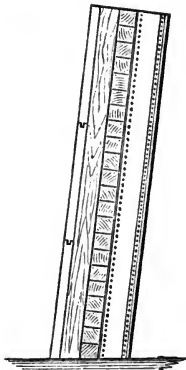
“The 70-lb. Whitworth gun was next fired, at 200 yards range.

A shell from this gun weighing 68 lbs. 7 oz., with a bursting charge of 2 lbs. 6 oz., was fired with 12 lbs. of powder at an iron case, presenting a front of  $7 \times 4$  ft., covered with a 4-in. wrought-iron plate on a backing of 9 in. of wood, the rear of the box consisting of 4 in. of wood covering a 2-in. iron plate. The shell passed unbroken through the 4-in. plate, the 9 in. of wood, and the 4 in. of wood, indented and cracked the 2-in. plate, and then burst, shattering the box into fragments.

“The 120-pounder Whitworth gun was fired from a 600 yards range, at a target representing the side of the *Warrior*. A solid shot weighing 129 lbs., and fired with a charge of 23 lbs. of powder, penetrated the armor-plate and wood backing, and fractured, but did not pass through the skin. A shell weighing 130 lbs., with a bursting charge of 3 lbs. 8 oz., was fired with a 25-lb. charge, at the same target. It penetrated the armor-plate, and burst while passing through the wood backing, injuring and penetrating the skin in a line with the axis of the shell.

“It must be remarked, also, that these projectiles, though flat-ended, were fired with great accuracy, and were much truer in their flight than any flat-ended projectile which the Committee have hitherto seen fired.

FIG. 384.



The *Warrior* target.  
Scale,  $\frac{1}{2}$  in. to 1 ft.

“The results above recorded were obtained here partly by using a larger charge of powder in proportion to the weight of the projectile, than has hitherto been used in any rifled ordnance; but the great merit due to Mr. Whitworth on this occasion, seems to be in the successful manufacture of a metal possessing such hardness and temper as to be capable of penetrating wrought-iron plates, yet, at the same time, so tough as not to crush or break on striking the target. On no previous occasion have the Committee seen a shell of any description

penetrate more than 1 in. of iron without breaking up on impact, nor have they seen cast-iron or steel shot fired through more than 2 in. of iron without the shot itself being broken by

the blow; wrought-iron shot have been fired through plates as thick, but though unbroken, they have been crushed and distorted by the impact.

“The Committee cannot conclude this report without commenting on the very inferior character of the  $4\frac{1}{2}$ -in. plates of which this *Warrior* target was composed. They were from Parkhead forge, near Glasgow, and are said to be of the number of those made for the *Black Prince*. They were very brittle and not sufficiently worked; and the measure of their inferiority may be recorded by stating that with the service smooth-bore 68-pounder, at 200 yards, and 16 lbs. of powder, the effect upon the old *Warrior* target, and upon other good  $4\frac{1}{2}$ -in. plates, was an indentation of about 2·5 in.; whereas, the same test upon this target produced an indentation of 4·05 in. with considerable damage in the vicinity of the blow. The Committee deem it right to state that they believe the experiment with the Whitworth gun here recorded should be repeated, with as little delay as possible, on a target constructed of more satisfactory material. The Committee would further recommend that the Whitworth solid shot and shell should be tried at an angular target, in order to ascertain the effect of homogeneous projectiles on plates placed at different angles to the horizon.”

#### RESULTS. (Table 127.)

No. 0. To obtain range.

No. 1. (12-pounder). Shot and shell of “homogeneous metal,” hardened and tempered. The plate was secured to a wooden frame, without backing. Its dimensions were 4 ft. 3 in.  $\times$  3 ft.  $\times$  2·5 in. Shot passed through the plate and fell 20 yards to the rear. A clean hole in front 3·2 in.  $\times$  3·1 in., and at the back the diameter of the hole was 6·5 in.  $\times$  6 in., the plate being broken for about 1 in. round the edge of the hole, and piped out about 1·5 in. in the centre. The shot set up ·5 in.

No. 2. Clean hole through plate and backing 3·1 in.  $\times$  3 in. No trace of shell having burst.

No. 3. Clean hole through plate and backing 3·4 in.  $\times$  3·1 in.

TABLE CXXVII.—EXPERIMENTS WITH WHITWORTH 12-POUNDER, 70-POUNDER, AND 120-POUNDER AGAINST THE "WARRIOR" TARGET, &c. SEPT. 16 AND 25, 1862.

No. of Round.	Nature and Weight of Ordnance.	Projectile.					Diameter of Bore.	Windage on going in half sides.	Turn of Rifling.	Range in yards.	Thickness of Plate.	Elevation.	Deflection.	Initial velocity in feet.
		Nature.	Weight.	Bursting charge of Shells.	Form.	Length.								
0	12-pdr. Breech-loader, 9½ cwt.	...	lbs. oz. 12 1	...	...	in. 7	...	2.733	.02365	in 55	200	...	...	...
1	"	Solid shot.	lbs. oz. 12 1	...	Cylinder flat ended.	...	1.14	"	...	"	2.5	...	...	...
2	"	Shell.	lbs. oz. 12 2½	0 6	...	...	1.14	"	...	"	2.	...	...	...
3	"	"	...	...	...	...	1.12	"	...	"	2.	...	...	...
1	70-pdr. Whitworth Muzzle-loading Rifle, 76 cwt. 2 qrs. 14 lbs. ....	"	lbs. oz. 68 8	2 6	...	16	12.5	5.5	.035	1 in 100	4. & 2.	...	...	1275.8
1	120-pdr. Muzzle-loading Rifle, 148 cwt. 3 qrs.	Solid shot.	lbs. oz. 120 6	...	Round ended.	14	20.	6.4	.06	1 in 130	600	45	0	Velocity at 580 yards.
2	"	"	lbs. oz. 131 10	...	Flat ended.	"	20.	"	"	"	"	55	0	...
3	"	"	"	...	"	"	23.	"	"	"	"	5 R	"	...
4	"	Homo. metal.	lbs. oz. 129 0	...	"	"	23.	"	"	"	"	47	6 R	1278.5
5	"	Shell, hom. metal	lbs. oz. 130 0	3 8	"	17	25.	"	"	"	4.5	45	"	1268

Burst after passing through backing. Plate 5 ft. 6 in.  $\times$  2 ft. 6 in.  $\times$  2 in., and 12 in. backing.

No. 1. (70-pounder). This gun was fired at a box-target made of 4 in. wood, with a 4-in. armor-plate (made at the Thames Iron Works) in front, backed by 9 in. of wood, and a 2-in. armor-plate in the rear (made at Portsmouth Dockyard) as a guard-plate, the interior space of the box being 36  $\times$  40 in. One round with solid cast-iron shot was fired, in order to get the range; it passed through a thin wooden target, and struck a damaged 5.5 in. plate (one belonging to the *Minotaur* target) and broke it in two. The first shell fired penetrated into the box-target, making a hole in the 4-in. armor-plate 5.6  $\times$  5.4 in., and exploded on the rear plate, blowing out the sides of the box, and forcing the front and rear plates outwards. The rear plate was deeply indented (viz.: 2.6 in.), but not penetrated. The shell broke into large pieces.

No. 1, 2, 3. (120-pounder). SEPR. 25.—Trial shot for range at wood-target 9  $\times$  9 ft., indicating great precision in No. 1 and 2.

No. 4. Fired at the *Warrior* target; struck the centre plate 2.5 ft. from the left, and 1.5 ft. from the top; made a clean hole in the plate 8 in.  $\times$  8.5 in., the edge of the hole being 1 ft. 8 in. from the one made by the first shot from the Horsfall gun; a narrow crack from one hole to the other; the shot remained in the hole, having struck on a rib, the depth of the hole to the bottom of the shot being 13.5 in.; no bulge on the plate; one bolt in the centre plate started .4 in., and 2 bolts started in the upper plate. The centre plate had started out .3 in. at the top, and .1 in. at the bottom on the left side. At the back, one rib, which had been cracked by a shot from the Horsfall gun, was broken through, bulged out, and a length of 1 ft. 6 in. of it nearly detached; the wood backing splintered and broken; the skin opened about 1.5 in. at the joint, and some additional bolt-heads broken off.

No. 5. (120-pounder). Struck the centre plate 1 ft. from the bottom, and 1 ft. 4.5 in. from the right side; penetrated the target, making a hole 8.5 in.  $\times$  7.5 in. in the plate, and burst in passing through the backing; two cracks on the plate, viz.: one

from the bottom of the hole to the bottom of the plate, and the other from a bolt-hole (1 ft. from impact) to the bottom of the plate; two bolts in the centre plate started  $\cdot 5$  in., and one in the lower plate  $\cdot 2$  in. At the back, the diameter of the hole was 13 in., and portions of the shell, and the piece of iron punched out of the plate, were picked up inside the target; some old oakum on the ground was on fire; three bolt-heads and one rivet-head broken off just above the hole; the skin not injured except where penetrated; the outer rib was broken through for a length of 4.5 in. The timber backing much shattered, and driven out at the side 7 in. The shell burst into about 14 pieces.

**846. Experiments with the Whitworth 120-Pounder, and 70-Pounder, against  $4\frac{1}{2}$  and  $5\frac{1}{2}$ -Inch Plates, and the 12-Pounder against  $2\frac{1}{2}$ -Inch Plates, November 13, 1862.**—A box-target measuring 12 ft.  $\times$  9 ft. 6 in., and having an interior space of 10  $\times$  6 ft., was constructed for the experiment, and was composed of 3 armor-plates; the upper one, which was 4.5 in. thick, had been used in the original *Warrior* target, and the centre one and lower one (each 5 in. thick) were taken from Mr. Samuda's target. The thickness of the backing and skin was the same as in the *Warrior* target.

#### RESULTS. (Table 128.)

No. 1. (120-pounder steel shell). Struck the middle plate 4 ft. 4.5 in. from the right side and 5.5 in. from the bottom, punched a hole in the plate 7.5 in.  $\times$  6 in.; started 3 bolts in the lower row 1 in. each, and narrow cracks extended from 2 of these bolt-holes to the bottom of the plate; one bolt in the top row of the lower plate was also slightly started. The plate was driven in below the hole  $\frac{3}{8}$  in. for a length of 12 in. At the top of the target, 3 of the filling-in pieces were blown out. The damage on the inside was as follows, viz.: a large irregular hole, inner diameter 10 in.; skin of ship bent out with ragged rent, sticking out 10 in.; general bulge, distributed over a surface of 3 ft. 5 in.  $\times$  3 ft. 5 in.

The shell evidently burst between the front plate and the skin



TABLE CXXVIII.—EXPERIMENTS WITH THE WHITWORTH 120-POUNDER AND 70-POUNDER AGAINST 4½ AND 5-INCH PLATES, AND THE 12-POUNDER AGAINST 2½-INCH PLATES. NOV. 13, 1862.

No. of Rounds.	Nature of Ordnance.	Projectile.				Charge, lbs.	Bursting Charge of Shells.	Elevation.	Range in yards.	Deflection.	Depth of Indent.	Diam. of Indent.	Length Cartridge.	Velocity at 730 yards.
		Nature.	Weight.	Form.	Length.									
1	7-in. 120-pdr. Muzzle-loading Rifle.....	Homo. metal Shell...	151	Cylind. flat end	20.5	27 A4	5 0	1 14	800	2 L	...	28	1170	
2	"	"	"	"	"	"	"	"	"	"	...	"	1180	
3	"	Hollow cast-iron Shot	130	"	17	"	...	1 5	"	Nil.	2.3	"	1227	
4	"	Homo. metal Shell.....	"	"	"	"	3 8	"	"	"	...	"	1245	
5	"	Homo. metal solid Shot	129.5	"	14	"	...	1 3	"	"	...	"	1204	
6	5½-in. 70-pdr. Muzzle-loading Rifle.....	Homo. metal Shell...	81	"	19	13	3 12	1 7	600	"	...	9	Vel. at 580 1107	
7	"	"	"	"	"	"	"	"	"	"	...	"	1104	
8	"	"	72.5	"	16	"	2 10	1	"	"	...	"	1148	
9	"	"	69.14	"	"	"	Blind.	59	"	"	1.55	...	1146	
10	{ 3-in. 12-pdr. Breech-loading Rifle.....	Solid cast-iron Shot...	12.	"	7.5	1½	...	5	200	"	.85	...	...	
11	"	"	"	"	"	"	...	8	"	"	.5	...	...	
12	"	Homo. metal Shell...	12.4	"	8½	"	Blind.	9	"	"	...	...	...	
13	"	Homo. metal solid Shot	21.1	"	7.1	"	"	8	"	"	...	...	...	
14	"	"	12.2	"	"	"	"	"	"	"	...	...	...	

*i. e.*, in the wooden backing; the base and some pieces of the shell blown out in front of the target. Injury by fragments of the burst shell or splinters in the chamber (or interior of the target), not serious. A vertical rib was broken right through, and bent back. One of the bolt-heads broken off was 4 ft. 5 in. from point struck.

The shell broke into 14 large and 9 small pieces: the following fragments of iron were picked up inside the target, viz.: 8 large and 10 small bolt-heads, eight rivets, 3 pieces of angle-iron and 8 pieces of plate, including one large piece punched out.

No. 2 (120-pounder shell). Struck the top plate 2 ft. from the right side, and 7.5 in. from the bottom, nearly in line with one of the ribs, punching out a piece of plate 7.75 in. diameter; the hole was stopped up with splinters of the backing; three bolts in the lower row, one in the centre and two in the upper row of this plate were started from .75 to 1 in. (one of the bolts which had started in the lower row was at a distance of 4 ft. 5 in. from the point of impact), and the plate had started out from the backing 1.25 in. on the right side; at the top the front balk of the timber backing was blown out for a length of 2 ft., and the skin was driven back .875 in. for the same length. At the back, a large irregular breakage of inner skin; a piece of shell sticking in the hole shutting out daylight till removed. Inner diameter of hole about 10 in.; wood backing closed up considerably on path of shot; one rib broken and driven out, together with rent skin, about 1 in.; general bulge on a surface of 4 × 4 ft.

The shell exploded farther forward this time, blackening the side of the chamber and roof (corresponding to "upper deck") with bursting charge, and had evidently been diverted by striking in the line of the rib. Many (46) pieces of shell and inner skin of ship scattered about the interior. One piece of the former sticking in "upper deck," fragments had struck in every direction, in this instance, as far laterally as they could go (about 5 ft. 6 in.) The butt of the shell remained in the hole and was taken out from the front.

The shell broke into 13 large and 6 small pieces; fragments

picked up inside: 6 large and 6 small bolt-heads, 7 rivets, 3 washers, and 5 pieces of plate and skin, including the large piece punched out.

No. 3 (120-pounder hollow cast-iron shot). Struck the centre plate 5 ft. from the right side, and 6 in. from the top, partly on a bolt, making an indent of 2·3 in., and forcing in the plate at the top side for a length of 5 ft., to a depth of 3 in. at the deepest point; a crack 11 in. long extended from the top of the plate through a bolt-hole at a point 1 ft. 2 in. from impact, also a crack 8 in. long from the top of the plate through a bolt-hole, at a distance of 1 ft. 4 in. from impact; the plate buckled 6 in. at the right side; the shot broke up. At the back, one vertical rib broken, and one angle-iron cracked. Six bolt and rivet-heads broken off, at distances from point struck varying from 6 in. to 4 ft. The shell broke into 7 large pieces and a great many very small ones; fragments: 3 large and 3 small bolt-heads, 1 rivet, 2 pieces of skin, and 1 piece of rib.

No. 4 (120-pounder steel shell). Struck the centre plate and punched a hole 8 in.  $\times$  7·5 in.; the hole was stopped up with portions of plate and splinters of wood backing. No damage at top of the target; at the back a large irregular hole 14 in. in diameter; skin forced out 9 in. to rear.

The whole shell, apparently, front and base, passed through in fragments, and, apparently, burst just as it broke the skin, as the hole itself was scarcely charred, and the "upper deck," above where the shell entered the ship's side, was blackened with powder. The shell broke into 9 large and 10 small pieces; fragments: 2 large and 10 small bolt-heads, 7 rivets, 5 pieces of skin, a large piece of plate punched out (broken in half), and a great many small pieces of plate.

No. 5 (120-pounder solid steel shot). Struck the middle plate near round No. 1, penetrated the target, making a clean hole 8 in.  $\times$  8·3 in. in the plate; the hole filled with broken pieces of plate; at the back, the shot had penetrated close to the hole made by round No. 1, and the skin was now broken away for a space of 1 ft. 4 in.  $\times$  1 ft. 5 in.; two former broken ribs driven

out and bent back at considerable angle; and fibres of wooden backing and skin protruding 1 ft. 5 in. Shot set up 2 in.

The following fragments of iron were picked up inside the target, viz.: one large and 3 small bolt-heads, 3 rivets, 3 pieces of skin, one washer, and 24 pieces of plate, including a large piece punched out.

No. 6 (70-pounder steel shell). Struck the upper plate 13 in. from the top and 3 ft. from the side; made a hole 6 in.  $\times$  5.5 in., and burst in the backing; a crack extended from the top of the hole to the top of the plate; one through-bolt in the top row broken; at the top, the front balks of the wood backing were blown out for a length of 1 ft., and a depth of 13 in. from the top, and the rear balks were blown out for a length of 5 ft., and a depth of 10 in. The lower half of the shell, and the piece of plate punched out were resting against the skin which was not penetrated; on the inside, only 1 bolt-head broken off. The shell broke into 10 pieces.

No. 7 (70-pounder steel shell). Struck the target at the junction of the lower and centre plates; burst outside the target, punching a hole in the plate 4.35 in. deep; 2 bolts, one on each side of the hole, started .5 in.; a crack extended from a bolt-hole in the centre plate to the bottom of the plate, also a crack 6 in. long, parallel to the circumference of the hole, and 1.5 in. below it. No damage visible on the inside of the target. The shell broke into 2 pieces.

No. 8 (70-pounder steel shell). Struck the top plate 5 in. from the side and 6 ft. 5 in. from the bottom, and burst in the backing, which it penetrated to a depth of 11 in.; a large part of the shell remained in the rear balk of the backing; a length of 3 ft. of the front balks very much damaged, 1 ft. of it being blown out for a depth of 2 ft. from the top, and 3 in. in thickness of the remaining 2 ft. blown out for the same depth; the rear balk was forced up 3 in. for a length of 2 ft. 6 in.; two bolts in the lower row, started respectively 1 in. and 5 in.; a crack from a bolt-hole to the bottom of the plate at 10 in. from the point of impact, also a crack 2 in. long immediately under the hole made by round No.

·5: plate started out 1·25 in. on the right side, being now 2·5 in. from the backing. The butt of the shell was picked up 190 yards in front of the target. No damage visible on the inside. The shell broke into 15 pieces; fragments: 2 pieces of plate (1 punched out).

No. 9 (70-pounder steel shell). Struck the centre plate 6 in. from the top and 2 ft. 8·5 in. from the right side; the top of the plate driven in 4 in. for a length of 8 in.; a crack 8 in. long extended from the top of the plate through a bolt-hole; no damage visible inside. The shot broke into 7 large and 24 small pieces.

No. 10 (12-pounder solid cast-iron shot). Fired at 2·5-in. plates (unbacked), at an angle of 45°. Plate starred at the rear with 3 narrow cracks about 1 in. long; the shot broke up.

No. 11 No damage at rear; shot broke up.

No. 12 (12-pounder steel shell). Struck the target 2·5 in. from the side where the plate was supported on a frame-work of wood 8 in. thick; broke a hole in the plate, and remained in it, projecting 7·5 in. on its upper and 4 in. on its under side. The timber balk was smashed through for a length of 2 ft. The shell set up ·2 in.

No. 13 (12-pounder solid steel shot). Struck the plate 1 ft. 5 in. from the side, and made a hole measuring 5·3 in.  $\times$  3·3 in. in front and 7·5 in.  $\times$  8 in. in the rear. The shot bounded back, and was picked up 25 yards in front of the target. Set up ·2 in.

No. 14 (12-pounder solid steel shot). Struck near the last round and made a hole 4·9 in.  $\times$  3·1 in., and at the back the fracture had joined into that of last round, the hole now measuring 12 in.  $\times$  6·5 in. The shot penetrated and fell at the foot of the target, and was set up ·1 in.

**847. Experiments with the Horsfall 13-Inch Smooth-Bore Gun against the Warrior Target, Sept. 16 and 25, 1862.**—The target (10  $\times$  12 ft.) was of the *Warrior* construction, without a port-hole. The plates, which were tongued and grooved, and which had been manufactured at the Parkhead forge, were of the following dimensions, viz.:—Upper one, 12 ft.  $\times$  3 ft.  $\times$  4·5 in.; centre one, 12 ft.  $\times$  3 ft. 8 in.  $\times$  4·5 in.; lower one, 12 ft.  $\times$  3 ft. 4 in.  $\times$  4·5 in.

SEPT. 16.—Range, 200 yards. Charge, 74·40 lbs. Solid cast-iron shot, weight, 279·50 lbs. Initial velocity, 1631.

Struck the centre plate about 1 ft. from the top and 5 ft. from the left side. The shot completely penetrated the target, making an irregular hole in the armor-plate 2 ft. 1·5 in. × 2 ft. 4 in., and breaking off 1 ft. of the tongue at the top of the plate; a large crack, 7 in. wide, extended from the bottom of the hole to the bottom of the plate; also 3 narrow cracks, one 8 in. long, running from the large one, parallel to the circumference of the hole; the other two radiating from the hole, at a distance of 1 ft. and 1·5 ft. from the large one, the latter being 15 in. long, and running into a bolt-hole. Three bolts had started in the centre plate, two of them 6 in. and one 2 in. Four bolts in the upper plate and one in the lower plate also started. The upper plate was forced up 4 in. for a quarter of its length from the left side. There was *no buckling* of the plate. At the back, portions of the shot and plate were buried deeply in a timber bulkhead 3 ft. in the rear; five bolt-heads broken off; two ribs broken completely through, one being driven out, and 2 ft. 4 in. of the other detached; and a third rib was cracked through a rivet-hole for a length of 4 in. About 3 sq. ft. of the interior skin driven in, more than 20 bolts broken, and the skin much shaken, bulged, and opened at the joints. Two of the front balks of the timber backing forced up at the top 1 in. and 5 in. respectively.

On the gun being thoroughly cleaned and examined, it was found that one of the flaws which existed in the bore of the gun previous to this experiment, had slightly increased.

SEPT. 25.—Range, 800 yards. Charge, 74·40 lbs. Solid cast-iron shot, annealed and very tough; mean weight, 284 lbs. 13 oz. Velocity, at 800 yards, 1299·2 ft. The same target was used as on the 16th of September. The windage of the shot was reduced to 1305 in.

1st Round.—Missed the target; the shot struck the masonry some yards to the left. Elevation, 57'.

2d Round.—Elevation, 1°. The shot grazed 17 yds. 1 ft. in front of the target, which it struck at the junction of the middle and

lower plates, 3 ft. from the right side, making an irregular hole 2 ft.  $\times$  1 ft. 11 in. in the armor-plate; the shot broke up and was buried in the backing, the depth from the surface of the plate to the broken shot being 1 ft.; the lower plate was forced down 1.3 in. from the hole to the right side, and the centre plate had started to the front 1.2 in. at the bottom, between the hole now made and the one made at the last experiment; cracks already on the plate much opened, and several new ones (one being 1 ft. 9 in. long) made on the centre plate. At the back, two ribs broken completely through, one being driven in 4 in., and a length of 2 ft. of the other doubled back, and resting on the ground; the skin considerably bulged out and opened at the joint, but not cracked; four bolts and one rivet driven out some inches, and 3 bolt-heads broken off. No buckling of the plate.

3d Round.—Elevation,  $1^{\circ} 5'$ . Missed the target and penetrated the backing of the old *Warrior* target some yards to the right; did great havoc on brickwork, wood supports, &c., in the rear, some large pieces of wood being picked up 60 yards in the rear.

4th Round.—Elevation,  $1^{\circ} 2'$ . The shot struck the left top corner of the upper plate, and broke off a piece of plate measuring 2 ft. horizontally  $\times$  1 ft. 6 in. vertically; no cracks on the plate; one bolt driven out, and one started 2.5 in. The backing and skin at the top of the target very much shaken. The skin forced back 8 in. (in the greatest depth) for a length of 4 ft., and the damage extended down the target for 5 ft. from the top; the front balks of the backing forced out for a depth of 2 ft. 1 in. from the top, and three of the rear balks much splintered. The outer rib broken through vertically for a length of 2 ft. 6 in. from the top, and doubled up 4 in., only now measuring 6 in. in depth.

No increase in the flaws in the gun after this day's firing.

One round of solid cast-iron shot was fired from a 68-pounder 95 cwt. gun, at 200 yards range, at the left side of the lower plate, to test the quality of the metal, and made an indent of 4.05 in.; two large, and two small cracks on the face of the indent, and 5 in. below it, extending upwards for 1 ft. on each side. The

iron was very brittle, irregular, and largely crystalline, and seemed unfit for armor-plates.

**848. OPINIONS OF THE COMMITTEE.**—"The experiment with the Horsfall gun, which was to test the endurance of this piece of ordnance, shows that solid wrought-iron guns of great size may be manufactured capable of bearing large charges of gunpowder; although this gun had several flaws in the breech, one 13 in. deep, as before described, yet these flaws have been very slightly altered by the firing.

"The smashing effect of a spherical shot of 280 lbs. weight, fired with a charge of 74 lbs. of powder, was what might have been anticipated, and the accuracy of the gun was as good as that of any well-made smooth-bore piece of ordnance."

**849. Experiments on Armor with 110-Pounder Fired under Water. H. M. S. "Excellent," October 7, 1862.**—A target, 4 ft. square, composed of 4 half-inch boiler-plates bolted together (making a total thickness of 2 in.), was secured to the side of the *Griper*, nearly amidships, where the side fell in considerably, making an angle with the vertical of 3°. The gun was placed 20 ft. from this target, measuring from the muzzle, laid horizontal, with its axis pointed exactly for the centre of the target, loaded with a flat-headed solid projectile and 14 lbs. charge, and fired when the water had attained a height of 6 ft. above the axis.

The shot struck the target about 3 in. to the right of the spot on which the axis was directed, penetrated the plate and 14 in. of backing, and lodged in a shelf-piece immediately in rear of the target; shelf-piece much shattered and ship's side a round fracture greatly shaken. Fracture in plate, a clean circular hole 8 in. in diameter, 2 small cracks radiating from the fracture.

Nov. 10.—A target 8 ft. × 4 ft. composed of 6 half-inch boiler-plates bolted together, making a total thickness of 3 in., was secured to the side of the *Griper* nearly amidships, where the angle of the side from the vertical was about 3°.

No. 1. The gun (110-pounder), range, charge, and immersion as before, was loaded with a wrought-iron flat-headed shot, which



struck the target about on the spot aimed at. It broke in the 2 outer  $\frac{1}{2}$ -in. plates, making a round fracture of 7 in. diameter, and drove the remaining plates back into the wood  $2\frac{1}{2}$  in., but without breaking them. The projectile fell back. The shelf-piece (new) in rear of the point struck was badly broken; lining shattered.

No. 2. Gun and conditions the same as above. The shot, solid cast iron, struck the target 8 in. to the right of point aimed at, and broke up and fell back, but broke all the plates, driving the fragments into the side 12 in., and making an irregular fracture  $14 \times 10$  in. Right edge of plate started from side  $2\frac{1}{2}$  in. Shelf-piece broken and lining shattered.

No. 3. Gun and conditions same as above. The shot, cast iron, struck where aimed and broke all the plates, driving the fragments through the side into the ship, and making an irregular fracture in the target  $9 \mid 12$  in. Shelf-piece broken and ship's side destroyed for a considerable extent.

**850. Experiments against Captain Inglis's Shield, December 29, 1862.**—This target was composed of two thicknesses of iron planks crossing each other, and bound together by an iron frame, and supported by iron brackets. The structure was 11 ft. wide  $\times$   $8\frac{1}{2}$  ft. high, with an embrasure 3 ft. 6 in. high  $\times$  2 ft. 4 in. wide. The outer vertical planks were respectively 1 ft. 11 in. wide  $\times$  8 in. high; 1 ft. 11 in.  $\times$  7 in.; 1 ft.  $7\frac{1}{4}$  in.  $\times$  8 in.; 1 ft.  $7\frac{1}{4}$  in.  $\times$  7 in., and 1 ft.  $7\frac{1}{4}$  in.  $\times$  6 in. These were backed by horizontal planks of rolled iron 14 in. wide, and 5 in. thick. The measured thicknesses of the target were  $11\frac{1}{8}$  in., 12 in., 13 in., and  $12\frac{1}{2}$  in. Where the cross-framing supported the rear, the maximum thickness was 17 in. The frame consisted of 4 vertical pieces 14 in.  $\times$  4 in., and 2 horizontal pieces 14 in.  $\times$  5 in. The brackets at the ends were of 1-in. plate, and 8 in.  $\times$  5 in.  $\times$  1 in., and 5 in.  $\times$  5 in.  $\times$  1 in. angle-irons; base, 3 ft. They were riveted to sill-pieces 14 in.  $\times$  4 in., and the sill-pieces were riveted to a cross-beam 18 ft. long  $\times$  11 in. wide  $\times$  3 in. deep, and placed 6 ft. behind the shield. The cross-beam was weighted

and held in place by masonry. Between the surfaces of the front and rear planks were placed sheets of lead, weighing 6 lbs. per foot. The planks were held together by 3-in. bolts and 3-in. rivets, with rubber, wire-rope, lead, and millboard washers.

**851.** Captain Inglis, in the paper before quoted, anticipates the following advantages for this plan of construction: "The advantages I claim for it are simplicity and capability of universal application, facility of repair, and adding strength either to the whole, or to any part at any future time, and a large share of strength for the money. It will be composed of heavy masses, \* \* \* and, as I propose to use them just as they come from the rolls, without any machine-work upon them, except the bolt-holes, I hope a shield put together in any part of the kingdom will not cost more than £20 per ton."

**852.** The guns fired on this occasion were the 68-pounder smooth-bore, and the 110-pounder Armstrong, and the 120-pounder Whitworth rifles. Range, 200 yards.

No. 1. Solid 67-lb. ball; charge, 16 lbs. Struck 12-in. part, 2 ft. 9½ in. from top; indent, 1·65 in. × 9·4 in. diameter. Bulged ·5 in. in 1 ft. length; lead much squeezed out at embrasure. Some washers mashed and 1 nut loosened.

No. 2. Solid 67-lb. ball; charge, 16 lbs. Struck 13-in. part, 1 ft. 5½ in. from top; indent, 1·65 in. × 9·5 in. Plank driven in 1·25 in. at top, and out ·6 in. at side; narrow crack from right edge of plank to indent; indent, ·5 in. on next plank; 1 small rivet-head broken; washers squeezed; angle-iron of right bracket bent.

No. 3. Solid 67-lb. ball; charge, 16 lbs. Struck 12-in. part, 4 in. from left side, and 2·5 in. from top, and partly on next plank; indent, 1·65 in. × 9 in.; plank started out ·5 in.; two 3-in. rivets broken; lead squeezed out on left side.

No. 4. Solid 67-lb. ball; charge, 16 lbs. Struck 13-in. part, partly on plate over embrasure; indent, 1·1 in. × 10·5 in. Several small cracks from edge of plank, and one in indent. No damage at back.

No. 5. Solid 67-lb. ball; charge, 16 lbs. Struck 11-in. part,

4 in. from top, and  $3\frac{1}{2}$  in. from left; indent, 1·1 in.  $\times$  8·6 in.; plank driven in 5 in. at top for 6 in. length, and crack 6 in. long; 1 lead washer broken; adjacent plank bulged.

No. 6. 110-lb. bolt; charge, 14 lbs. Struck 13-in. part, 3 ft. 5 in. from bottom; indent, 1·1 in.  $\times$  7 in.; plank cracked on side and bulged  $\frac{1}{4}$  in. in 8 in. One bolt started 2 in.; 6 small rivets broken on angle-irons.

No 7. 110-lb. bolt; charge, 14 lbs. Struck 12-in. part, 4 ft. 1 in. from top; indent, 1·15 in.  $\times$  7·5 in.; 1 nut started 1 in. at back.

No. 8. 110-lb. bolt; charge, 14 lbs. Struck 13 in. part, 2·9 from top, partly on a bolt-head; indent, 1·2 in.  $\times$   $7\frac{1}{4}$  in.; 1 bolt driven in  $\frac{1}{4}$  in., and lead more pressed out.

No. 9. 68-lb. bolt from 110-pounder; 16 lb. charge. Struck edge of 13-in. part, 3 ft.  $4\frac{1}{2}$  in. from top,  $6\frac{1}{2}$ -in. of indent being on plank; indent, 2·45 in.  $\times$  8·25 in. Plank cracked inside for 5 in. in 2 places. At back, angle-iron and backing-piece cracked through.

No. 10. 68-lb. bolt, 16 lb. charge. Struck junction of 12 and 13-in. parts, 2 ft. 11 in. from bottom; indent, 2 in.  $\times$  8·8 in.; 3 washers mashed.

No. 11. 129·5-lb. steel-headed bolt, 20 lbs. charge. Struck 13-in. part, 3·75 in. from side, and 7 in. above last round. Indent, 1·8 in.  $\times$  7 in. No other damage.

No. 12. 130-lb. flat-ended steel-headed bolt; charge, 25 lbs. Struck 12-in. part; indent, 2 in.  $\times$  9·5 in.; left edge bulged out 2 in.; shot broke up. At back, 2 rivet-heads broken, and a brace detached. Brackets shaken, and slight widening between adjacent parts of planks about the blow.

**853.** EXPERIMENTS OF DEC. 29, 1862, CONTINUED ON CAPTAIN INGLIS'S SECOND SHIELD, AT SHOEBOURNE, MARCH 3, 1863.—(See Table 129.)—Guns used in the experiments: One 300-pounder Armstrong muzzle-loading shunt gun; calibre, 9·20 in.; weight, 11 tons, 15 cwt., 2 qrs. One 100-pounder Armstrong muzzle-loading smooth-bore gun. One 130-pounder (hitherto recorded as 120-pounder) rifled gun. One 7-in. Lynall Thomas's gun, rifled with 3 ribs; weight, 149 cwt., 3 qrs., 14 lbs.

TABLE CXXIX.—EXPERIMENTS AGAINST CAPTAIN INGLIS'S SECOND SHIELD, MARCH 3, 1863.

No. of Round.	Nature of Gun.	Projectile.				Charge in lbs.	Length of charge in in.	Elevation.	Range in yds.	Deflection.	Depth of Indent in in.	Diameter of Indent in in.	Velocity at 563 ft.
		Nature.	Weight in lbs.	Form.	Length in in.								
1	Whitworth 7-in. rifle.....	Solid wrought iron	148	F. E.	17.3	.....	25	15'	200	Nil.	9.5	1239.9	
2	100-pounder smooth-bore	Do. Do.	113	Spherical.	.....	9.16	25	16'	Do.	Do.	11.3	1461.8	
3	300-pounder rifle.....	Hollow cast iron...	230	C.	19	.....	45	20'	Do	2'R	10.0	1400.6	
4	Thomas's 7-in. rifle.....	Solid wrought iron	150	Cyl. R. E.	16.5	.....	25	20'	Do.	Nil.	8 × 7.5	1217.9	
5	Whitworth 7-in. rifle.....	Solid steel (Firth's)	150	F. E.	17.5	.....	25	15'	Do.	Do.	13 × 11	1241.0	
6	300-pounder rifle.....	Solid cast iron.....	307	Cyl. R. E.	18.5	.....	45	25'	Do.	4'R	12.5 × 12	1228.4	
7	Thomas's 7-in. rifle.....	Solid steel.....	138	R. E.	14.5	.....	27.5	18'	Do.	Do.	.....	.....	

## EFFECTS (Table 129.)

No 1 (Whitworth 7-in. rifle). Struck 3 and 4 planks, 3 ft. 4 in. from the bottom; 2 in. of indent was on plank No 3; the bulge on plank No. 3 measured 1.3 in. in depth, but the depth of indent on No. 4 could not be taken, as part of the shot remained in the indent; the edge of plank No. 3 was cracked in the bulge for a length of 1.5 in.; a narrow crack on plank No. 4, at 1 ft. 5 in. from the point of impact, extending from a bolt-hole to the edge of the plank. At the back, slight bulge of 4 in. of horizontal plank at seat of blow; lead sheeting at left side of embrasure pressed out; plank below the one struck gaping .5 in. from front plank at side of embrasure; vertical frame-piece, to left of embrasure, slightly curved back.

No. 2 (100-pounder smooth-bore). Struck at 2 ft. 2 in. from bottom of target, and 5.5 in. from the side of the plank; a bolt 8.5 in. from the point of impact started .3 in.; the edge of No. 4 plank was bulged 2 in.  $\times$  1.5 in., and the edge of the plank was cracked on the bulge for a length of 5 in. At the back, the second through-bolt from the top of the left row, distant about 3 ft. from the point of impact, was broken; the lead washers of No. 4 through-bolt, from the top of the same row, squeezed and broken, and angle-iron bulged out .5 in.; the lower horizontal plank, about 1 ft. beneath the blow, was cracked through vertically; the left vertical frame-piece was slightly curved, and angle-iron at top set back from it. Major diameter of shot after firing 12.2 in.

No 3 (300-pounder rifle). Struck No. 3 plank, 1 ft. 9 in. from the bottom; the plank was cracked across its width through the indent; the crack made by round No. 1 extended to a bolt-hole, and the plank was cracked completely through its width and thickness at 1 ft. 5.5 in. from the top, the crack being .4 in. wide on the front, and having extended from an old crack 4 in. long made by the previous day's firing; the plank was driven in 1.8 in. for 3 ft. 6 in. from the bottom; the bottom bolt of the plank started .2 in. and the two bolts next above were driven in .2 in. and .4 in. At the back, a through-bolt, just below embrasure,

broken off; vertical frame-piece, or "upright of frame," bent considerably at seat of blow; gaping of horizontal planks from front planks at left side of embrasure, increased now to an inch; horizontal frame-piece or cross-stay, at bottom curved back considerably; a through-bolt (mashed by the above frame-piece) broken, and its head brought up pressing against the frame-piece; washers of No. 2 through-bolt from the top of right row squeezed up; bottom through-bolt, right side, loose, being broken in front; vertical frame-piece, right of all, slightly curved; and a partial crack (former day's practice) now continued through the thickness of iron.

No. 4 (7-in. rifle). Struck No. 1 plank, 4 ft. 7 in. from the bottom, and 5 in. from the side; plank driven in 1·8 in. at point of impact, and the edge of plank No. 2 bulged 1 in. in a length of 10 in.; the plank cracked diagonally across its width through a bolt-hole at 1 ft. 2 in. above the point of impact; also from a bolt-hole to right side of the plank at 1 ft. 5·5 in. below the point of impact; a crack 15 in. long also extended from the left side of the plank at 2 ft. 7 in. below the point of impact. The shot set up 6·5 in.

No. 5 (Whitworth 7-in. rifle). Struck the plate below embrasure, 1 ft. 8 in. from the top, and 10 in. from the left side, which was driven in ·8 in. on the right side, and 1·1 in. on left side; the shot broke up and a portion remained in indent, the depth of which could therefore not be taken; the bottom bolt started 1 in., and a crack, made by previous firing on plank No. 2, opened to ·3 in. At the back, a through-bolt 2 ft. 6 in. from the point of impact, driven out; whole of bottom of embrasure set back, opening between front and rear planks ·5 in.; a slight irregular-starred crack on lower horizontal plank; lower horizontal frame-piece rather more bulged back.

No. 6 (300-pounder rifle). Struck at the junction of planks 3 and 4, 3 ft. 2 in. from the top of the target; a portion of the shot remained in plank 3; the cracks at the top and bottom of this plank made by round No. 3 much enlarged, and now measure ·6 in. and ·9 in. in width. At the back, a through-bolt (second from the top of the third row from the left) broken; through-bolt, top

of second row from left, much squeezed up; vertical frame-piece considerably bulged (now 1·2 in.); horizontal planks 2, 3, and 4 from top also bulged; 3 and 4 horizontal planks opening out from front planks 1 in. at left side of embrasure.

No. 7 (L. Thomas's 7-in. rifle). The gun burst and the shot did not strike the target.

**854. Experiments on Millboard as a Backing to Armor-Plates. Sept. 8, 1862.**—A piece of millboard 1 ft. 3 in.  $\times$  1 ft. 8·5 in.  $\times$  8 in., was secured in rear of an iron plate ·9 thick, the millboard resting against a 2½ in. plate backed by granite.

The gun used was a 6-pounder Armstrong rifled gun, with solid cast-iron shot and service charge, at 50 yards range.

No. 1 Round.—Struck the ·9-in. plate at a spot above where it was backed by the millboard, made a clean hole 2·9 in. diameter through the plate, and the shot broke up.

No. 2 Round.—Struck the plate where backed; shot penetrated 3·9 in., and remained in the hole unbroken. The millboard was slightly forced out at the side, owing to its small area.

No. 3 Round.—Hit the plate at a spot 1 in. below the top of the millboard; 2 in. of the rear of the shot broken off, the remainder stuck in the hole, having penetrated 2·5 in. into the millboard.

(A piece of teak 7·9 in. thick was now put in rear of the ·9-in. plate just above the millboard, and resting against the 2½-in. plate and granite backing. The 6-pounder Armstrong gun was used at the same range.)

No. 4 Round.—The shot struck fair on the plate and wood, passed clean through both and remained whole in the wood, which was split in half. The shot penetrated to the 2½-in. plate.

The penetration into the millboard of a flat-fronted shot, weighing 5½ oz., fired from a wall-piece at 25 yards, with a charge of 10 drs., was 2·76 in.

Nov. 14.—A block of millboard\* measuring 4 ft. ·75 in.  $\times$  3 ft.

\* This block of millboard was supplied by Mr. Morris, of Glasgow, on his own proposal, but was not at all suited for the purpose intended, consisting merely of sheets

1·5 in. × 1 ft. 2·5 in., and weighing 6 cwt.,  $12\frac{1}{2}$  lbs., was tested in comparison with teak of the same weight, and measuring 4 ft. ·75 in. × 3 ft. 1·25 in. × 1 ft. 2 in. Each block was faced with a 1-in. iron plate, the whole being secured at the sides; by means of clamps, to avoid through-bolting.

The guns used were:

One 6-pounder Armstrong gun at 50 yards.

One 12-pounder do. at 100 yards.

No. 1 Round.—6-pounder solid shot at millboard. Struck 1 ft. 4 in. from the top, and 1 ft. 6 in. from the side; penetrated 3 in. into the millboard, the shot remaining unbroken. The plate buckled ·95 in. over a space measuring 17 in. × 6 in.

No. 2 Round.—6-pounder solid shot at teak. Struck 1 ft. 3 in. from the top. Shot penetrated completely and broke up. The balk of timber on which it struck was cracked through its thickness; very slight buckle of plate.

No. 3 Round.—12-pounder solid shot at millboard. Struck the plate at 1 ft. 2 in. from the top, and penetrated to a depth of 1 ft. 7 in., being 3 in. into some wood in rear. Left a clean hole through the millboard of 3·1 in.

No. 4 Round.—12-pounder solid shot at teak. Struck at 1 ft. 3 in. from the top of the plate, made a hole 3·3 in. diameter, and penetrated the wood, which it split through its thickness at the top; the hole closed up.

No. 5 Round.—6-pounder solid shot at millboard. Struck at 6·5 in. from the top, and penetrated the millboard to a depth of 2·65 in., the fore-part of the shot remained in the hole, the remainder being broken off. The plate buckled ·9 in. for a space of 14 in. × 12 in.

No. 6 Round.—6-pounder solid shot at teak. Struck at 1 ft. from the top, and penetrated 6 in. into the teak. The wood was split through as in previous rounds; very slight buckling of plate. The shot did not break up.

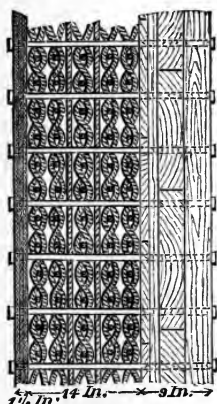
### **855. Experiments against Hodge's Wire Target, May 7,**

of brown paper laid together and bound by hoops of iron, and when these latter were removed, the sheets of paper were found to be quite disconnected.



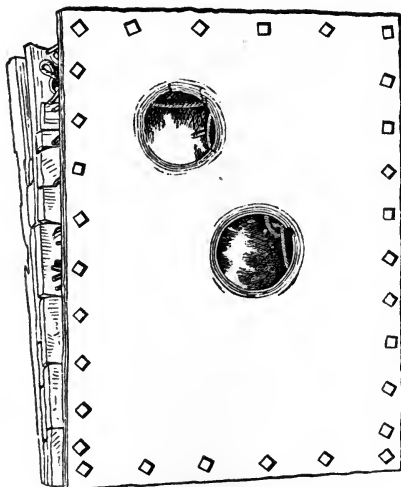
1862.—(See Table 130.)—"The front of the target consists of three thicknesses of  $\frac{1}{2}$ -in. plate iron; then comes a tissue of wire ropes 14 in. thick. The target is mounted on timber 9 in. thick, con-

FIG. 385.



Section of wire target.

FIG. 386.



Front of wire target after two 11-in. shot.

sisting, 1st, of two 1-in. boards (one horizontal and one vertical), and then of two layers of timber  $3\frac{1}{2}$  in. thick, disposed vertically and horizontally.

TABLE CXXX.—EXPERIMENTS AGAINST WIRE TARGET.

No. of Gun.	No. To-day.	Charge, lbs.	Weight of Shot, lbs.	Insertion, inches.	Recoil, feet.	Time fired.		Distance to Target, feet.
						H.	M.	
10	1	25	156	106	7	11	28	83
102	200	15	165	108	6	11	39	83

"Dimensions of target: Length,  $67\frac{1}{2}$  in.; width,  $50\frac{1}{2}$  in.; iron, thickness,  $15\frac{1}{2}$  in.; timber, 9 in.

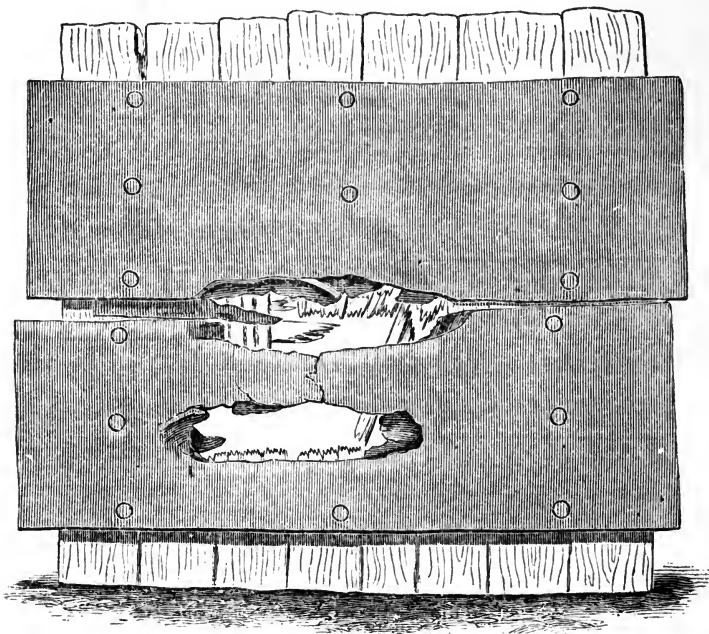
“Gun, 11 in., No. 214, C. A. & Co., mounted on a wooden pivot-carriage, in front of battery. Charges: cannon powder, 1862. Projectiles: 1st, one wrought-iron, and 2d, one cast-iron solid shot. Friction primers.

“1st shot hit direct, passing clean through the target into the bank; penetration not determined.

“2d shot hit direct, passing clean through the plates, and penetrating the bank a distance of 9 ft. 6 in.”\*

**856. Experiments against Laminated Iron inclined 15° from Line of Fire and backed by India-Rubber and Timber, Sept. 4, 1862.**—(See Table 131.)—“This target was made of two

FIG. 387.



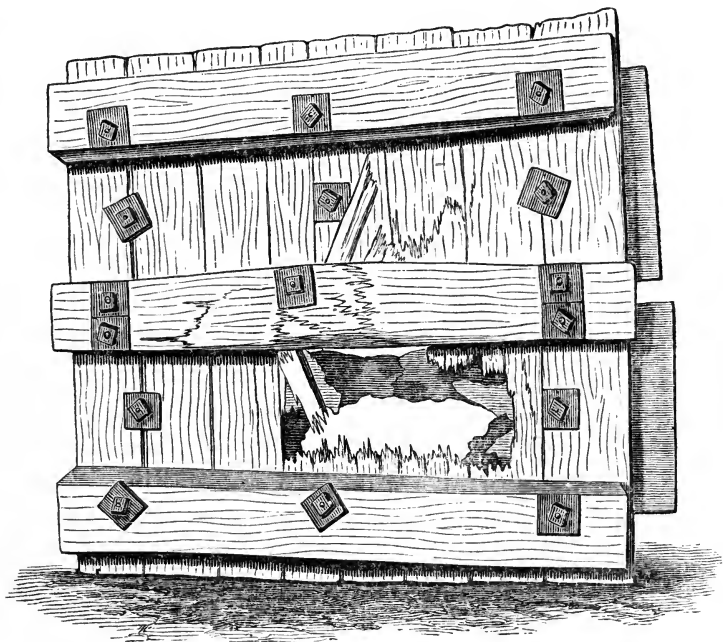
Front of laminated target, after two 11-in. shot.

thicknesses of  $\frac{1}{2}$ -in. boiler-iron put on in 4 plates, backed by 1 in. rubber and 7 in. yellow pine and 3 beams, running lengthwise of

\* Official: From *Scientific American*, Dec. 19, 1863.

the target. The rubber was placed between the plates and timber ; all bolted together with eighteen  $1\frac{1}{4}$  in. bolts, and the target set up firmly against a bank of clay, at an angle of  $15^\circ$ .

FIG. 388



Back view of Fig. 387.

“Dimensions of target: Iron plates, 8 ft. long, 6 ft. 8 in. wide, and 1 in. thick; rubber, 1 in. thick; timber, 7 in. thick; beams, 1 ft. square. Gun 11 in., No. 214. Charges of cannon powder, 1862. Projectiles, Cloverdale cast-iron solid shot. Primers, friction tubes.

“The 1st shot struck the plates 3 ft. 3 in. from the right-hand edge, and 12 in. from the lower edge, tearing through the plates, rubber, and timber, making a hole 3 ft. 8 in. long, and mean width  $8\frac{3}{4}$  in.; the shot passed off and penetrated the bank  $11\frac{1}{4}$  ft. from the outer surface. Angle of shot after leaving the target was  $9^\circ$ . The plate is indented at the right edge of shot-hole,  $\frac{1}{2}$  in.; at left edge, 1 in.; at top edge,  $\frac{3}{8}$  in.; at lower edge, 1 in.

TABLE CXXXI.—EXPERIMENTS AGAINST LAMINATED TARGET.

No. of Gun.	No. to-day.	Charge, lbs.	Weight of Shot, lbs.	Insertion, inches.	Recoil, feet.	Distance to Target, feet.	Time fired.	
							h.	m.
149	1	30	168	106	Taut breeching.	74	3	15
150	2	30	169	106		74	3	31

“The 2d shot struck the plates on the crack between the plates and  $2\frac{1}{2}$  feet from the right edge, tearing through the plates, rubber, timber, and a portion of the beam, making a hole 4 ft. long, and mean width 10 in. This shot forced the lower plates from the upper ones  $3\frac{1}{2}$  in. on the left edge, and over  $1\frac{1}{2}$  in. on the right edge of the shot-hole. The shot passed off and penetrated the bank 15 ft. Angle of shot, after leaving the target,  $9^\circ$ . The plate is indented on the right edge of the hole  $1\frac{1}{2}$  in.; on the left edge, 1 in.; on the top edge,  $\frac{3}{4}$  in.; on the lower edge,  $1\frac{3}{4}$  in. The plates are cracked from the lower edge of the shot-hole No. 2 to the lower edge of shot-hole No. 1. The bolts appear to be in good condition on the face of the target, but it is impossible to ascertain if any are broken in the rear until the target is taken down.\*

**857. Experiments against Laminated Iron inclined  $15^\circ$  from Line of Fire and backed by India-Rubber and Pine, Sept. 16, 1862.**—(See Table 132.)—“This target was made of two thicknesses of 1-in. wrought-iron plates, backed by  $1\frac{3}{4}$  in. of rubber, 7 in. of yellow pine, and 3 beams, 12 in. square, running lengthwise of the target. The outer layer of plate consisted of three plates placed horizontally, and the inner layer of two plates placed perpendicularly. The rubber was placed between the plates and timber. It not being as large as the plates, a margin of about 1 ft. was left which was filled in with pine planks, the

\* Official: From *Scientific American*, Dec. 26, 1863.

whole being joined together with thirty-two  $1\frac{1}{4}$ -in. bolts. The target was placed against a solid bank of clay, with planks in its rear to keep the clay clear of the timber. *Angle of incidence, 15°.*

“Dimensions: Plates, 8 ft. long, 6 ft. 8 in. wide, 2 in. thick. Rubber,  $1\frac{3}{4}$  in. thick. Timber, 7 in. Beams, 12 in. square. Gun, 11 in., No. 214. Charges of cannon powder, 1862. Projectiles, Cloverdale cast-iron solid shot. Primers, friction tubes.

TABLE CXXXII.—EXPERIMENTS AGAINST INCLINED IRON AND RUBBER TARGET.

No. from Gun.	No. to-day.	Charge, lbs.	Weight of Projectile, lbs.	Insertion, inches.	Recoil, feet.	Time fired.		Distance to Target, feet.
						H.	M.	
54	I	30	169	107	Taut breeching.	3	00	74

“The shot struck the target 24 in. from the right edge of centre plate, tearing through the plate and rubber, and breaking the timber and beam, making a hole 2 ft.  $8\frac{1}{2}$  in. in length, and  $7\frac{1}{8}$  in. mean width. Extreme depth of hole, 9 in. The shot passed off and penetrated the bank 15 ft. Angle of shot, after leaving the target, 9°. The plates are indented at top edge of shot-hole 4 in.; at lower edge, 3 in.; at right-hand edge,  $1\frac{3}{4}$  in.; at left-hand edge,  $1\frac{1}{2}$  in. The shot has a small piece broken out.”\*

**858. Experiments against Laminated Iron inclined 15° from Line of Fire and backed by India-Rubber and Pine, Nov. 5, 1862.**—(See Table 133).—“The target was made of two 1-in. plates (wrought-iron), backed by two 1-in. plates of rubber, 7 in. of yellow pine, and 3 beams running lengthwise the target. The rubber was placed between the plates and timber; and the whole joined together with ten  $1\frac{1}{4}$ -in. bolts. The target was placed against a solid bank of clay, with timbers in its rear to keep the earth clear of the target. Angle of incidence, 15°.

\* Official: From *Scientific American*, Jan. 9, 1864.

“Dimensions: Plates, 8 ft. long, 4 ft. wide, 2 in. thick. Rubber, 2 in. thick. Beams, 12 in. square. Timber, 7 in. thick. Gun, 11 in., No. 214. Charges of cannon-powder, 1862. Projectile, solid Cloverdale cast-iron shot.

TABLE CXXXIII.—EXPERIMENTS AGAINST INCLINED IRON AND RUBBER TARGET.

No. from Gun.	No. to-day.	Charge, lbs.	Weight of Shot, lbs.	Insertion, inches.	Recoil, feet.	Time fired.		Distance to Tar- get, feet.
						H.	M.	
155	1	30	164	107	11	9	51	74·9
156	2	30	168	...	Taut breeching.	10	12	74·9

“The first shot struck the target 11 in. from lower edge and 30 in. from top edge of plates, tearing through the plates, rubber, and timber, and breaking the lower beam, making a hole 28 in. long and 6·8 in. mean width. Shot passed off and penetrated the bank 16 ft. Angle of shot, after leaving the target, 10°. The plate is indented at top edge of shot-hole,  $\frac{3}{4}$  in.; at lower edge,  $1\frac{1}{4}$  in.; at right edge,  $1\frac{3}{4}$  in.; at left edge,  $1\frac{1}{4}$  in. The shot broke into pieces, one of which was found in the bank (weight, 52 lbs.)

“The second shot struck the target on the right edge of the plates, and 12 in. from the top, tearing through the plates, rubber, and timber, making a hole  $31\frac{1}{2}$  in. in length and 10·7 in. mean width. The shot passed off and penetrated the bank 18 ft. Angle of shot after leaving the target, 15°. The plates are very much bent on the right-hand side, and the timber badly shattered. The cause of this shot striking the edge was occasioned by an error being made in sighting the gun from a point on the timber and not allowing 4 in. for thickness of plates and rubber.”\*

**859. Experiments against 4½-Inch Solid Plate backed by India-Rubber and Oak, July 26, 1862.**—(See Table 134.)—  
“This target was made in the Washington Navy Yard, of scrap-

\* Official: From *Scientific American*, Jan. 9, 1864.

iron,  $4\frac{1}{2}$  in. thick, backed by 1 in. rubber, 20 in. oak, and a 1-in. wrought-iron plate, all joined together by six  $1\frac{1}{4}$ -in. bolts, and clamped on the top and bottom with wrought-iron clamps, and set up firmly against a clay-bank, with timber in the rear to prevent it from being forced into the bank.

“Dimensions of plates: 8 ft. 3 in. long, 4 ft. 2 in. wide,  $4\frac{1}{2}$  in. thick. Gun, 11 in.; charges, cannon powder, 1862. Projectiles, Cloverdale cast-iron solid shot. Primers, friction tubes.

TABLE CXXXIV.—EXPERIMENTS AGAINST SOLID  $4\frac{1}{2}$ -INCH PLATE WITH RUBBER AND OAK BACKING.

No. from Gun.	No. to-day.	Charge, lbs.	Weight of Shot, lbs.	Insertion, inches.	Recoil, feet.	Distance to bank, feet.	Time fired.	
							H.	M.
9	1	30	167	...	3	88.3	11	45
140	2	30	168	...	...	“	1	23

“First shot at plate struck the plate 20 in. from the left side of the target, and 18 in. from the right side, throwing the target forward on its face. After a delay of about  $1\frac{1}{2}$  hours, the target was placed in its former position. The ball entered the plate and passed through the rubber, and lies embedded in the plate and first course of timber, with its rear level with the outer surface of the plate. The plate is indented on the right side of the hole,  $1\frac{1}{4}$  in.; on the left edge,  $\frac{3}{4}$  in.; top edge,  $1\frac{1}{4}$  in.; lower edge,  $1\frac{1}{4}$  in.; The plate is not bent on the right edge of the target; on left edge,  $\frac{1}{4}$  in. The plate is not cracked excepting directly around the shot-hole, which is cracked very slightly. The bolts are all broken in the rear of the target, but on the face of the plate they appear to be good. The last two courses of timber are broken at the centre from right to left edges of the target, and have sprung back from the first course 3 in. on the right edge and  $2\frac{1}{2}$  in. on the left edge. The first course of timber is somewhat shattered and thrown out on both sides of the target: right side,  $2\frac{1}{4}$  in.; left side, 5 in. Diameter of shot-hole, 12 in.

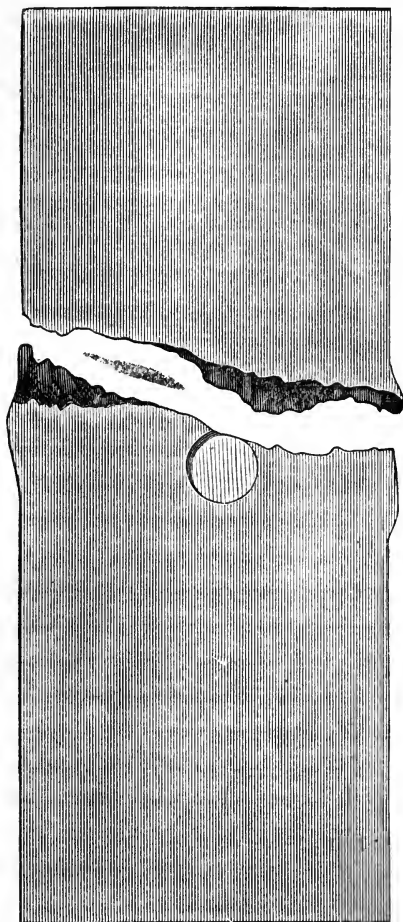
“The 2d shot struck the plate  $17\frac{1}{2}$  in. from right and left edges, and  $10\frac{1}{2}$  in. from shot-hole No. 1. The shot threw the plate on its face as before, which occasioned a delay of two hours before it was placed in its proper position. The shot broke into pieces, which fell out when the target was thrown down, excepting a small portion which remained in the hole. This shot passed through the plate, rubber, and first course of timber, and entered the second course, making a hole  $16 \times 30\frac{1}{2}$  in. in diameter. The extreme depth of hole is 14 in. The plate is indented on the right edge of the hole, 1 in.; on the left edge,  $\frac{3}{4}$  in.; on the top edge, 1 in.; on the lower edge, 1 in. The plate is bent on the right side of the target,  $\frac{1}{2}$  in.; on the left side,  $\frac{3}{8}$  in. Opposite the centre of the shot-hole No. 2, the timber (first course) has sprung out on the right side 5 in.; on the left side, 6 in. The back plate is forced back from the timber 3 in. at the centre. The top clamp was broken in two places. No cracks are visible about the plate, excepting those already mentioned. The rubber-plate was furnished by Mr. Bennett, of New York, last May, for trial, as above. Dimensions, as follows: 8 ft. long, 4 ft. wide, 1 in. thick.”

**860.** CONTINUATION OF EXPERIMENTS AGAINST  $4\frac{1}{2}$ -INCH PLATE BACKED WITH RUBBER AND TIMBER, JULY 28, 1862.—SAME GUN AND CHARGE.—“Third shot at target struck the plate  $18\frac{3}{8}$  in. from right side of target, and  $10\frac{1}{2}$  in. from the left side, and  $5\frac{1}{2}$  in. from lower edge of shot-hole No. 1, passing through the plate, rubber, and first course of timber. The shot broke into pieces, several of which were thrown in the rear of the battery, and several were lying in front of the target. The main body of the shot remains in the hole, with its rear  $9\frac{1}{8}$  in. from the outer surface of the plate. The plate is indented on the top edge of the shot-hole,  $\frac{7}{8}$  in.; on the lower edge,  $\frac{1}{2}$  in.; on the right edge,  $1\frac{1}{6}$  in.; on the left edge,  $\frac{3}{4}$  in. The plate is bent on the right side  $1\frac{1}{2}$  in.; on the left side,  $1\frac{5}{8}$  in. In the right side of the shot-hole No. 2, the plate is cracked from the edge of the hole, 13 in.; on the left side there is also one, extending 10 in. from the edge of the hole. Between the shot-holes No. 1 and No. 2, there is a crack from edge to edge of the



holes; and between shot-holes No. 1 and No. 3, there is a piece broken out measuring  $2\frac{7}{8}$  in. at the top and  $5\frac{7}{8}$  in. at the bottom. On the right edge of the plate is also a small crack. The lower

FIG. 389.



8-in. solid plate—Parrott 10-in. rifle.

clamp is broken. The first course of timber is completely broken up and thrown out at the sides; the second course is somewhat broken. The target was forced out 7 in. from its position; it being secured by a rope, leading from a tree in the rear, prevented its falling on its face as before.”\*

**861. Experiments against 8-Inch Plate and Target of Bars; Parrott 10-Inch Rifle, Feb. 9, 1863.**—In this experiment, conducted at the West Point Foundry, the plate was made of soft hammered scrap-iron, 6 ft. 4 in. long, 2 ft.  $6\frac{1}{4}$  in. wide, and 8 in. thick, well supported at the rear, but without backing. At 100 yards range, a 232-lb. cast-iron shot, with chilled head (589), fired with 28 lbs. of powder, broke the plate as shown at Fig. 389, and indented it 1 in., and bulged it 1 in., as shown at Fig. 390.

**862.** The same gun was then fired at a target  $5\frac{1}{2}$  ft.

square (Fig. 391), composed of 3 layers of bars,  $7\frac{3}{16}$  in. in aggregate thickness, backed and bolted to  $15\frac{1}{4}$  in. of oak. Weight of shot, 232 lbs.; charge, 28 lbs.; range, 100 yards. The result is shown by Fig.

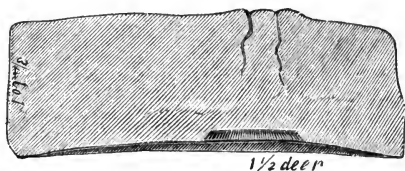
\* Official: From *Scientific American*, Dec. 26, 1863.

392. Of the 25 bolts, 23 were broken out. The indentation was  $11\frac{3}{4}$  in.

**863. Iron-Clad Atlanta; 15-Inch Ball.**—In 1863, a 15-in. ball from the "Monitor" *Weehawken* smashed in, at about 300 yards range, the armor of the Confederate iron-clad *Atlanta* (Fig. 393), and completely disabled her. An 11-in. 169-lb. ball, with 20 lbs. of powder, did not break through the same armor. The casemate of the *Atlanta* was inclined  $35^\circ$  from the horizon, and was composed of laminated armor of the aggregate thickness of  $4\frac{1}{2}$  in., backed by  $2\frac{1}{2}$  ft. of yellow pine, as shown.

**864. Experiments against 10-Inch Solid and Laminated Target; 15 and 11-Inch Guns, 1863.**—In the Spring of 1863,

FIG. 390.



Section of Fig. 389 at point of impact.

at the Washington Navy Yard, a 15-in. spherical shot, weighing 400 lbs., was fired, at 200 yards range, with 40 lbs. of powder, at a target (Figs. 394, 395, and 396), composed of a  $4\frac{1}{2}$ -in. plate  $3\frac{1}{2}$  ft. wide, and 15 ft. high, backed with  $5\frac{1}{2}$  in. of 1·1-in. plates (10 in. of iron in all), and 20 in. of oak.

A disk was broken out of the  $4\frac{1}{2}$ -in. plate (*a*, Fig. 395), and the thin plates were indented, but not broken. The wood was a little crushed; but the shock was so great that nearly all the bolts were jerked out or broken, and the plate was ready to be dislodged and thrown off by a slight additional vibration.

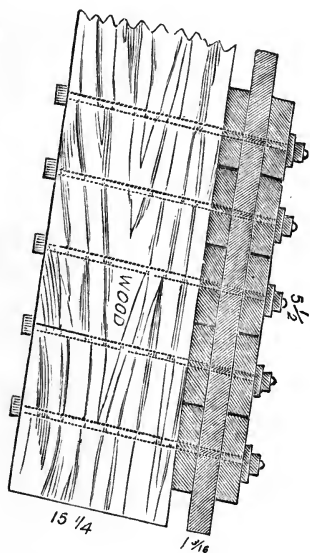
**865.** In 1863, an 11-in. spherical cast-iron 169-lb. shot was fired at the foregoing target, at 200 yards range, with 30 lbs. of powder.

A disk (Fig. 397) was broken out of the  $4\frac{1}{2}$ -in. plate (*c*, Fig. 395), leaving an indentation  $3\frac{1}{2}$  in. deep; and about half the bolts were broken, and some of them were thrown out.

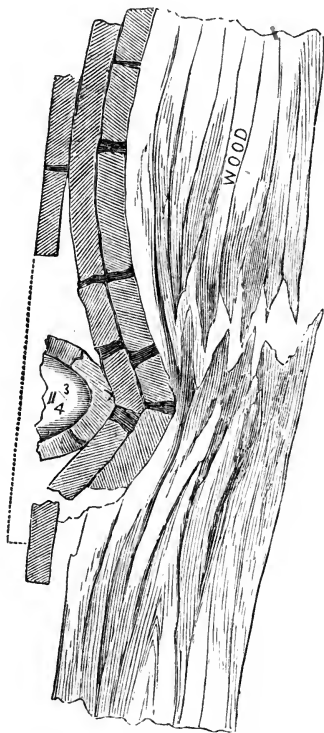
**866. Experiments against 14-Inch Target; 11-Inch Gun,**

**1863.**—Early in 1863, an 11-in. 169-lb. spherical cast-iron shot was fired, at about 50 yards range, with 30 lbs. of powder, at a target (Fig. 398) 14 in. thick, and about 7 ft. square, composed, where the shot struck it, of six 1-in. plates, one 4-in. plate, and four 1-in. plates without wood backing. The target was planted against a heavy timber frame-work, which abutted against the cap-stones of a sea-wall.

FIG. 391.



Target of bars. Parrott 10-in. rifle.

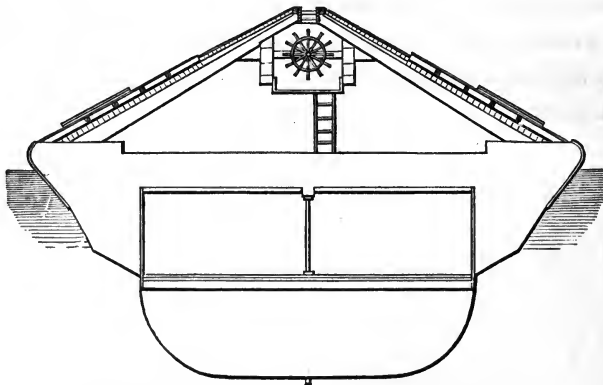


Section of Fig. 391 after firing.

The blow of the shot produced a small local effect. The indentation was about 5 in. ; the outer 1-in. plate was cracked across, and the back plates were bulged 2 or 3 in. ; but the whole target and frame-work, and the earth and the sea-wall behind it, were shoved bodily backwards several inches. Nearly all the through-bolts, some 40 in number, were loosened, and some of them were broken off in the thread of the screw at the rear.

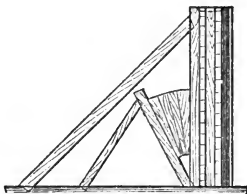
**867. Experiments against Laminated Armor; 10-Inch Gun, 1863.**—At the Washington Navy Yard, in the spring of

FIG. 393.

Cross-section of the Confederate iron-clad *Atlanta*.

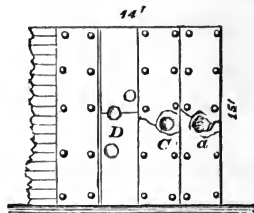
1863, a 10-in. 130-lb. cast-iron spherical shot was fired with 43 lbs. of powder; range, 200 yards; through a target composed of 6 plates, making an aggregate thickness of  $6\frac{1}{2}$  in., backed by 18 in. of oak. The target was the same as that used with the 15-in. shot

FIG. 394.



Side of 10-in. target for 15-in. gun.  
Scale,  $\frac{1}{16}$  in to 1 ft.

FIG. 395.



Front of 10-in. target.

(864), except that the outer  $4\frac{1}{2}$ -in. plate was removed. The shot made a clean breach (Fig. 399), and passed some 100 yards to the rear.

**868. Experiments against 4½-Inch Plate, 1863.**—A  $4\frac{1}{2}$ -in. plate 98½ in. long, and 48 in. wide, backed with 20 in. of white-oak, and a 1-in. skin, was set against a bank of earth, and knocked to pieces (as shown Fig. 400) by the following shot, viz. :

1 cored cast-iron spherical 11-in. 163-lb. shot, 30 lbs. powder.

- 1 steel flat-fronted 40·7-lb. shot, 8 lbs. powder.
- 1 spherical wrought-iron 53-lb. shot, 17 lbs. powder.
- 1 solid cast-iron spherical 11-in. 169-lb. shot, 30 lbs. powder.

**869. Experiments against Nashua 4½-Inch Plate; 11-Inch Guns, 1863.**—The Nashua Iron Works forged plate (Fig. 401), upon which this experiment was made, was 40 in. wide, 4½ in. thick, and 16 ft. long. It was backed with 20 in. of oak, and a

1-in. iron skin. At the range of 30 yards, three 11-in. 169-lb. spherical cast-iron balls, and three 186-lb. wrought-iron balls were fired in the order marked on the engraving, with 30 lbs. of powder.

The plate was considerably bulged and cracked, and was broken to pieces at one end by the 5th shot. No breach was made through the entire target.

**870. Experiments on 5½, 6½, and 7½-Inch Plates Rolled by Messrs. John Brown & Co., March 17, 1863.**—The plates were of the following dimensions and weights:

	cwt.	qrs.	lbs.
No. 1. 13 ft. 4 in. × 3 ft. 6¾ in. × 5½ in.	93	1	6
No. 2. 12 ft. 2¼ in. × 3 ft. 7¾ in. × 6½ in.	103	2	0
No. 3. 11 ft. 9¼ in. × 3 ft. 8¾ in. × 7½ in.	116	2	10

FIG. 397.

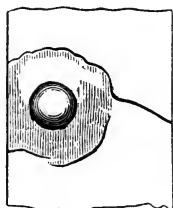
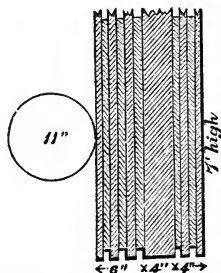


FIG. 398.



14-in. target—11-in. ball.

They were secured by  $2\frac{1}{2}$  in. conical-headed bolts, with double nuts, to the frame of Mr. Samuda's target ( $2\frac{1}{2}$  in. thick), and were backed by timber for one-half their length. The  $5\frac{1}{2}$ -in. plate by 9 in., the  $6\frac{1}{2}$ -in. plate by 8 in., and the  $7\frac{1}{2}$ -in. plate by 7 in., so that the front of the target presented a plane surface; India-rubber washers were placed under the bolt-heads.

The plates were divided into compartments by seven vertical lines numbered from 1 to 7, and by three horizontal lines; the backed portion of the plate extending from 1 to 4, and the unbacked portion from 4 to 7.

The guns used in the experiment were:

One 300-pounder Armstrong muzzle-loading shunt gun.

One Lynall Thomas's 9-in. gun.

One Whitworth 130-pounder muzzle-loading rifled gun.

One 110-pounder Armstrong breech-loading rifled gun.

One 68-pounder smooth-bore, 95 cwt.

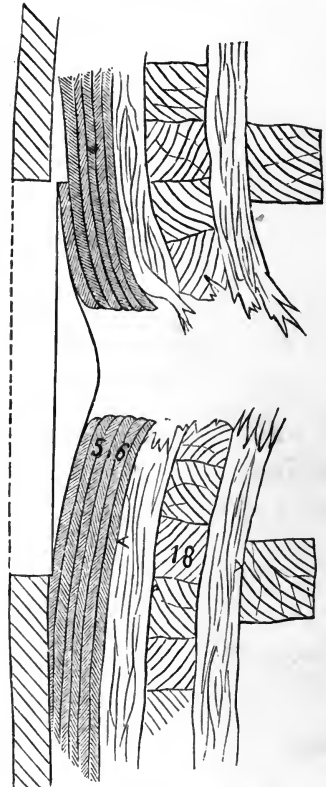
REMARKS.—(See Table 135.)

No. 1 (68-pounder). Struck the 5.5-in. plate, 9 in. to the right of 3 vertical and 11 in. below 2 horizontal; the plate driven in at the bottom .4 in. in a length of 2 ft.

No. 2 (68-pounder). Struck the 7.5-in. plate, 3 in. to the left of 5 vertical and 8 in. below 2 horizontal.

No. 3 (68-pounder). Struck the 6.5-in. plate, 6 in. to the left of 4 vertical and 3 in. below 2 horizontal. At the back, after these three rounds, one nut-head off the top right of target, and the lead and India-rubber washers of two through-bolts squeezed up.

FIG. 399.



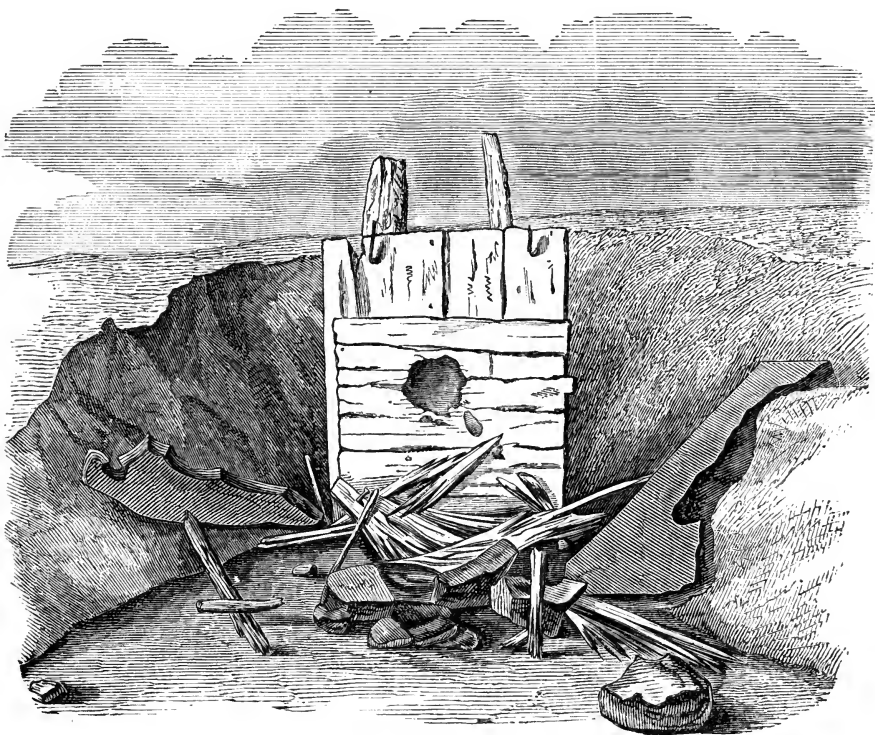
Section of  $6\frac{1}{2}$ -in. laminated target.

No. 4 (110-pounder). Struck the 5·5-in. plate, 4 in. to the right of 6 vertical and 3·5 in. above 2 horizontal; a bolt, 14 in. from impact, started 3 in., and a narrow crack, 8 in. long, on indent.

No. 5 (110-pounder). Struck the 6·5-in. plate, 3 in. to the right of 6 vertical and 5 in. above 2 horizontal.

No. 6 (110-pounder). Struck the 7·5-in. plate, 6 in. to the left of 6 vertical and 8 in. above 2 horizontal. At the back, after

FIG. 400.



4½-in. Dahlgren target. No. 5.

rounds 4, 5, and 6, two rivet-heads off; a bulge and lateral crack across it on the 5·5-in. plate; the backs of the 6·5-in. and 7·5-in. plates, where struck, could not be seen.

No. 7 (300-pounder). Struck the 7·5-in. plate, 8 in. to the left of 4 vertical and 7·5 in. above 2 horizontal, on a rib; the top of the plate was driven in 1·3 in. in a length of 7 ft.; bolt above

TABLE CXXXV.—EXPERIMENTS AGAINST 5½, 6½, AND 7½-IN. PLATES, ROLLED BY MESSRS. JOHN BROWN & Co.

No. of Round.	Nature of Gun.	Projectile.				Bursting charge of Shells.	Charge in lbs.	Elevation.	Range in yards.	Deflection.	Depth of Indent in inches.	Diameter of Indent in inches.	Remaining Velocity.
		Nature.	Weight.	Form.	Length.								
1	68-pounder.....	Cast iron, solid.	lbs. oz. 64 14	Sphere.	...	...	16	23	200	Nil.	9.7	...	
2	"	"	"	"	...	...	"	"	"	"	9.5 × 9	...	
3	"	"	"	"	...	...	"	"	"	"	9.7	...	
4	110-pdr. Arm- strong Rifle...	"	65 15	Cylindrical.	...	...	"	15	"	9 R	8.	...	
5	"	"	"	"	...	...	"	"	"	"	8.5 × 9.5	...	
6	"	"	"	"	...	...	"	"	"	"	9.	...	
7	300-pounder Rifle	Steel, solid.	301	"	14.	...	45	27	"	4 R	12.9	1293.1	
8	"	Steel, shell.	288	Cylindrical, with cast-iron head.	20.	11.	"	25	"	"	...	1318.4	



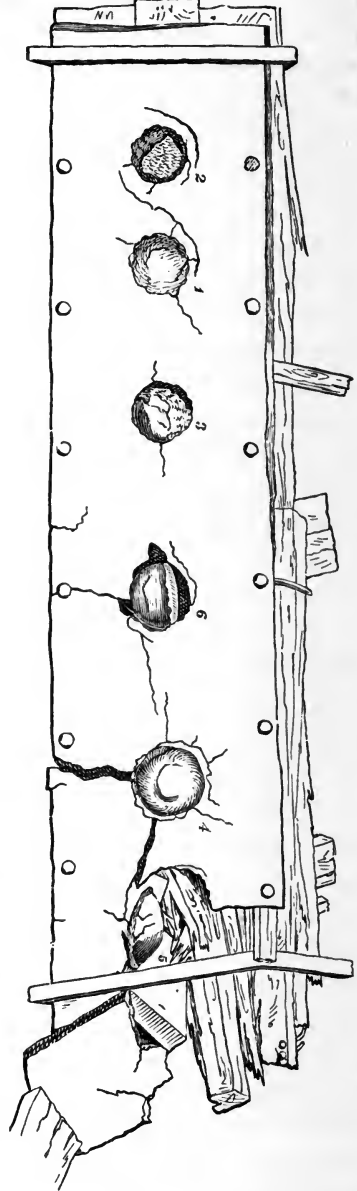
TABLE CXXXV.—(CONTINUED.)

9	7-in. Whitworth Rifle .....	Shell, homogeneous metal.	148	Cylinder, flat head.	21.	5.12	25	15	200	2 R	...	...	{ at 524' 1267.8
10	Thomas's 9-in. Rifle .....	Steel, solid.	327	Cylindrical, round end.	21.5	...	50	20	"	Nil.	...	...	{ at 546' 1222.0
11	"	Wrought-iron solid shot.	302	Flat end.	18.5	...	50	30	"	15 R	...	8.5	{ 995.4 doubtful.
12	"	Hardened steel solid shot.	330	Round end.	21.5	...	"	"	"	10 R	...	...	1222.0
13	300-pdr. Shunt..	Wrought-iron solid.	163	Spherical 10.337 in. diameter.	...	...	45	20	"	Nil.	3.7	13.	{ at 508' 1627.

the hole made by this shot started .9 in. ; a narrow crack 4 in. long from the top of the plate ; the right side of the plate started out from the backing .7 in. at top and .8 in. at bottom ; the left side started out .5 in. at top and .7 in. at bottom ; the shot set up 2.25 in., and was cracked at the side through the "aillette" holes, and also across the rear. At the back, twenty rivets broken ; no nuts off the through bolts, but many washers much compressed and altered in form, and two iron tires, for resisting the spread of the washers, driven off, and one broken ; angle-iron on vertical rib cracked through and bent out ; horizontal angle-iron cracked and started considerably ; fastenings of heavy iron shelf-piece broken and shelf-piece ready to give way. This plate exhibited a considerable amount of fibre in the hole made by the shot to a depth of 3 in. from the front of the plate.

No. 8 (300-pounder). Struck the 5.5-in. plate, 1 ft. to the right of 2 vertical and 7 in. below 2 horizontal ; the shell completely penetrated the plate and burst in the backing, the hole being filled with portions of the shell. The diameter of the hole was

FIG. 401.



Nashua 4½-in. plate, after six 11-in. shot.

14 in.  $\times$  14.3 in. ; the plate was driven in 1.8 in. in a length of 4 ft., and cracked from the bottom of the hole to the bottom of the plate, and was forced up from the centre plate .5 in. in a length of 4 ft. ; started from backing .7 in. at left side ; bolt in top row of centre plate started 3 in. ; outside balk of timber backing driven out at the side 1.7 in. and split through its thickness at the top, and the backing at point of explosion completely destroyed and fired. At the back, one vertical rib and angle-iron broken ; inner skin and additional iron plates (riveted to back of skin) rent and bulged ; depth of fracture and bulge 14 in. over an area of 3  $\times$  3 ft. ; horizontal angle-iron along the top cracked and thrust out ; washers more squeezed, and more rivets off.

No. 9 (Whitworth 7-in. rifle). Struck the 5.5-in. plate 5.5 in. (measuring from circumference to circumference of the holes) to the right of the last round, and 6 in. below 2 horizontal, penetrated the plate, and burst in the backing ; the timber backing from the hole to the top of the target was completely blown out at the top ; diameter of hole, 9.5 in.  $\times$  9 in., a narrow crack uniting the two holes. At the back, a slight increase of breakage of rib and thrusting out of fragments of skin and its support ; wooden fibre of backing more protruding.

No. 10 missed the target.

No. 11 (L. Thomas's 9-in. rifle). Struck at the junction of the 6.5-in. and 7½-in. plates on unbacked portion of plates ; the greatest depth on 7.5 in. was 5.95 in., and on 6.5 in. was 4 in., the total length of plate driven in was 7 ft. 6 in. ; the 6.5-in. plate was much cracked for a semicircle of 9 in. from the top ; a crack .6 in. wide extended from the right from the semicircle for a length of 1 ft. 5 in., passing through a bolt-hole ; a crack 2.5 in. long from the left of semicircle, and a crack from the top of the plate to a bolt-hole at 1 ft. 9 in. from impact. On the 7.5-in. plate a crack .7 in. wide extended from the bottom of the plate to a bolt-hole at 11 in. from point of impact, and the plate cracked round parallel to the indent and 11 in. above it. At the back, the 6.5 in. plate was cracked through and opened. Four rivet-heads off ; vertical rib and angle-iron cracked through. The shot set up 5.5 in.

No. 12 (L. Thomas's 9-in. rifle). Struck the lower edge of the 7·5-in. plate on a bolt, made a semicircular hole, measuring 1 ft. 9 in.  $\times$  12·5 in. and 7·5 in deep. At the back, one rib and angle-irons broken; two other ribs much bent, and their angle-irons broken; inner skin and supporting plate bulged and fractured; extent of damage over a surface of  $4 \times 2$  ft.; bulge of skin about 6 in.; old loosened shelf-piece wholly detached and fallen; two through-bolts broken; one driven out. The shot broke in half, longitudinally.

No. 13 (300-pounder). Struck the 7·5-in. plate on 5 vertical and 8 in. above 2 horizontal; plate driven in 3·75 in., and slight crack across indent. Back of plate showed a large 7-starred crack; fissures of cracks  $\cdot 2$  in.; considerable bulge of plate; adjoining rivets off. Major diameter of shot, after firing, 13 in.

**871. Experiments against  $4\frac{1}{2}$ -Inch Solid Plate, Faced with 4 Inches of Rubber, and backed with 20 Inches of Oak, May 18, 1863.**—“This target was made of one  $4\frac{1}{2}$ -in. scrap-

FIG. 402.



$4\frac{1}{2}$ -in. plate, faced with 4-in. rubber, after three 11-inch shot.

iron plate, backed by 20 in. of solid oak. On the face of the plate were placed 4 thicknesses of 1-in. rubber plates, the whole

being fastened together with 8 nut-bolts, with square heads. The target was placed against a bank of solid clay.

Dimensions: Plates 8 ft. long, 4 ft. wide; rubber, 4 in. thick; plate,  $4\frac{1}{2}$  in. thick; timber, 20 in. thick. Gun 11 in., No. 214 (A. F.); charge, 30 lbs. of cannon powder. Projectiles, cast-iron solid shot  $\frac{2}{3}$  Cloverdale iron, and  $\frac{1}{3}$  Hopkins's iron.

TABLE CXXXVI.—EXPERIMENTS AGAINST  $4\frac{1}{2}$ -IN. PLATE BACKED WITH RUBBER.

No. from Gun.	No. to-day.	Charge, lbs.	Weight of Projectile, lbs.	Insertion, inches.	Recoil, feet.	Distance to Target, feet.	Time fired.
164	1	30	169.5	106	...	87	P. M. 2.58
165	2	30	168	106	...	87	3.10
166	3	30	168	106	Taut breeching.	87	3.25

“The first shot struck near the centre, and  $17\frac{1}{4}$  in. from the right edge, and  $16\frac{3}{4}$  in. from the left edge of the plate, passing through the rubber and plate, and embedding itself in the 2d course of timber, with its rear  $9\frac{3}{4}$  in. from the outer surface of the plate. All the rubber was forced off and fell about 15 ft. in front, and a little to the left of the target. The rubber plate nearest to the iron was the only piece that was separated in two parts. Diameter of shot-hole in the iron, 14 in.;  $7\frac{1}{2}$  in. above the shot-hole, there is a crack in the plate 21 in. long, extending cross-wise the target, and  $5\frac{1}{4}$  in. below the shot-hole is also a crack extending downward 20 in. Three timbers in the last course are broken, and 2 driven back  $3\frac{1}{2}$  in. on the right side, and  $2\frac{1}{2}$  on the left side.

**872.** SAME TARGET WITHOUT RUBBER.—“The second shot struck 17 in. from the right edge, 16 in. from the left edge, and 21 in. below the first shot-hole, passing through the plate and embedding itself in the third course of timber, with its rear 17 in.

from the outer surface of the plate. The plate is cracked across from the right to the left edge of the plate, and from this shot to shot-hole No. 1. The lower edge of the plate was started forward from the timber  $2\frac{1}{2}$  in. The timber in the rear is somewhat shattered.

“The third shot struck the plate in the middle, near the top edge, splitting the plate from the top to the bottom, separating it at the top 5 ft., and breaking the plate into 6 pieces. One piece of shot, weighing 86 lbs., was found 52 ft. in the rear of the target. Some of the fragments of the plate were thrown 45 ft. to the rear of the target. One large piece of timber was thrown to the rear, passing through a fence, carrying away 8 palings, and lodging against a stump 165 ft. from the target. Another piece was found lying 80 ft. from the target. The timber backing is shattered to pieces. None of the bolts were broken.

“The damage to the target by the first shot was quite as great as all other first shot (11-in.) at similar targets.”\*

**873. Experiments against the Chalmers Target constructed at the Millwall Iron Works, April 27, 1863.**—The target (Fig. 403, 13 ft. 4 in. long by 10 ft. high), was composed of 3  $\frac{3}{4}$ -in. armor-plates backed by alternate layers of timber and iron  $10\frac{3}{4}$  in. thick, placed horizontally, and bolted together; then a second armor-plate  $1\frac{1}{4}$  in. thick, with a cushion of timber  $3\frac{3}{4}$  in. thick between it and the  $\frac{5}{8}$ -in. plate forming the skin of the ship; the iron plates used in the backing, between the 1st and 2d armor-plates, were  $\frac{3}{8}$  in. thick and 5 in. apart from centre to centre. The armor-plates were secured to the skin by through-bolts  $2\frac{1}{4}$  in. in diameter, having stepped conical necks and a square thread, with double nuts and India-rubber washers. An iron plate,  $\frac{3}{4}$  in. thick, was riveted on each end of the target, and a  $\frac{5}{8}$ -in. plate on the top. The target was supported against one of the Hawkshaw targets.

Weight, per superficial foot, Chalmers target.....	371 lbs.
Do. do. Warrior do. ....	341 “
Range, 200 yards.	

\* Official: *Scientific American*, Jan. 16, 1864.

*Guns* used in the experiment:

- One 10½-in. (300-pounder) Armstrong muzzle-loading rifle.  
 Three 7-in. (110-pounder) " breech-loading rifle.  
 Two 8-in. 68-pounder smooth-bores.

TABLE CXXXVII.—SHOT AND SHELL THAT STRUCK THE CHALMERS TARGET.

From 300-pdr.	No. of Shot.	Total weight in lbs.
Steel solid shot.....	1.....	301
Spherical cast iron.....	2.....	299
From 110-pdr.		
Solid shot, cast iron.....	6.....	662
Do. do. (197 lbs. each).....	6.....	1182
Shell, cast iron.....	6.....	624
From 68-pdr.		
Solid shot, cast iron.....	3.....	198
Shell, cast iron.....	4.....	198
		Total.....3464 lbs.

## EFFECTS (Table 138).

**874.** No. 1 (110-pounder). Struck centre plate 1 ft. 6 in. from bottom, and 4 ft. 4 in. from left side.

No. 2 (110-pounder). Struck centre plate 6 in. from top, and 1 ft. 5 in. from right side; plate driven in 1.5 in. in a length of 3 ft.

No. 3 (110-pounder). Struck lower plate 6 in. from top, and 7 ft. 3.5 in. from right side. Bolt, 1 ft. 2 in. from indent, started .4 in.; and a crack 19 in. long extended through a bolt-hole at 1 ft. 4.5 in. from impact. At back, after these 3 rounds, 5 rivet-heads were gone.

No. 4 (68-pounder). Struck centre plate 1 ft. 4.5 in. from top, and 5 ft. 1.75 in. from right side. At the back, 2 rivet-heads gone.

No. 5 (68-pounder). Struck the lower plate 7.5 in. from the top and 6 ft. 8.5 in. from the right side; a crack 8 in. long, parallel to the circumference of the indent, and 9 in. below it; a crack 6 in. long, from the top of the plate, at 9 in. from the indent; 3 small cracks below indent, and parallel to its circumference; also a narrow crack 9 in. long from a bolt-hole 1 ft. from impact. This round struck near No. 3, and the plate is now driven in 1.25 in. One rivet-head off at the back of the target, and several India-rubber washers compressed.

No. 6 (110-pounder). Hit at junction of upper and centre plates 4 ft. from right side. Centre plate started .25 in. at right side.

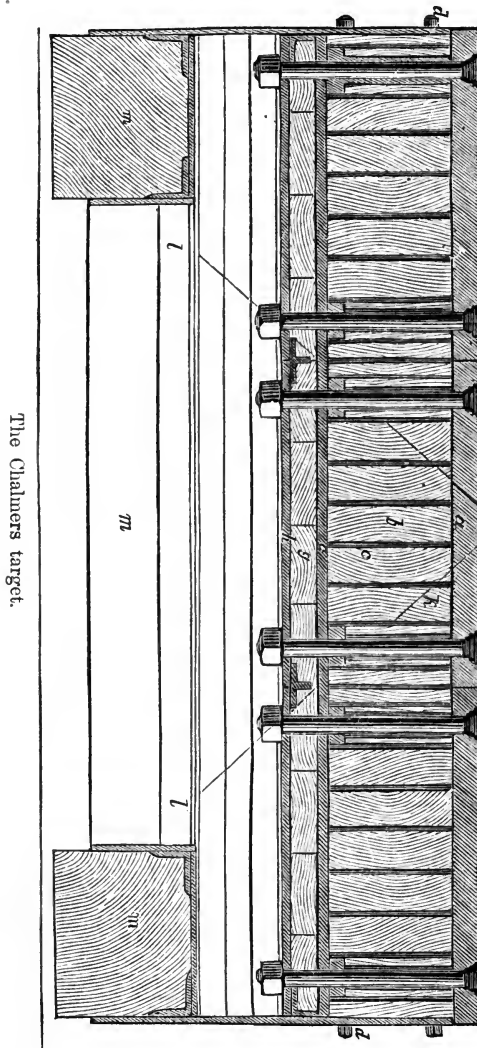


FIG. 403.

No. 7 (110-pounder). Hit upper plate 1 ft. 3 in. from bottom, and 6 ft. 6 in. from right side.

No. 8 (110-pounder). Hit upper plate 1 ft. 6 in. from bottom,





TABLE CXXXVIII.—(CONTINUED.)

No. of Round.	Kind of Ordnance.	Projectile.		Charge.	Elevation.	Deflection.	Depth of Indent.	Diam. of Indent.	Bulge of Plate.
		Nature.	Weight.						
			lbs. oz.	lbs.	'	'	in.	in.	in.
24	110-pdr.....	Solid cast-iron shot.	...	...	...	...	...	...	...
25	68-pdr.....	"	...	...	...	...	...	...	...
26	"	"	...	...	...	...	...	...	...
27	300-pdr.....	Steel solid shot.	301	45	20	4 R	Through	...	...
28	"	Spherical cast-iron shot, 10.369 in. diameter.	149 10	50	18	Nil.	...	...	...
29	"	"	"	"	5	7½	...	...	...

and 4 ft. 5 in. from left side. At back of target, after rounds 6, 7, and 8, one rivet-head was off, and a slight curvature of one side of a double rib.

No 9. (68-pounder). Struck lower plate 6 in. from bottom, and 4 ft. 3 in. from right side.

No. 10 (68-pounder). Struck lower plate 1 ft. 3.5 in. from bottom, and 4 ft. 5 in. from left side. The crack from bolt-hole made by round No. 5 much widened, and now extends to bottom of plate; three small cracks on the indent of round No. 5.

No. 11 (110-pounder). Struck the top plate 1 ft. 2 in. from left side, and 1 ft. 6 in. from the bottom. A wide crack on face of indent. The plate was forced up .5 in. from the centre one, and started 1.6 in. at the bottom, and 1.3 in. at top, on left side, and had started from the backing for a length of 3 ft. from the left side. Three rivets broken in the ¾-in. plate on left side of the target.

No. 12 (110-pounder). Struck the centre plate 1 ft. 4 in. from the top, and 2 ft. 2.5 in. from left side. Plate cracked slightly in indent, and a narrow crack, 2 ft. long, 6 in. above indent. Plate started 1.4 in. at top, and 1.3 in. at bottom, on left side.

No. 13 (110-pounder). Struck the lower plate 1 ft. 4·5 in. from the left side, and 1 ft. 3·5 in. from bottom. A crack 7·5 in. long, 8 in. to left of indent; lower left-hand bolt started ·5 in.; the plate started 2 in. at bottom, and 1·3 in. at top, on the left side. Seven rivet-heads were broken off by the last three rounds.

No. 14 (68-pounder). Struck the centre plate 8 in. below round No. 4 (from centre to centre). The indents of the 2 rounds measure 16 in. in length; a crack 3·5 in. long on indent, and 5 cracks on indent of round No. 4; plate started ·1 in. on right side. No damage to rear of target.

No. 15 (110-pounder). Struck top plate 9 in. from bottom, and 5 ft. 5 in. from left side.

No. 16 (110-pounder). Hit centre plate 9 in. from bottom, and 5 ft. 11 in. from left side.

No. 17 (110-pounder). Hit lower plate 6 in. from round No. 10; indent, very slight. At the back, three inner armor-plate bolts broken.

Nos. 18, 19, and 20 (salvo of 110-pounders). Struck centre plate in a space 1 ft. 3 in. square. Round 18 struck at 1 ft. 2 in. from bottom of plate; round 19, at 1 ft.; and round 20, at edge of plate. At the back, 3 rivet-heads off and 2 ribs slightly buckled.

No. 21 (68-pounder). Struck 3 yards short; passed under the target, grazing lower plate.

Nos. 22, 23, 24 (110-pounder), 25, 26 (68-pounder). Salvo. Struck on the right end of the upper plate. Two 68-pounder shot and one 110-pounder struck in a space measuring 2 ft. 7 in.  $\times$  1 ft., the 110-pounder at the junction of the centre and upper plates, and the two 68-pounders on a bolt, the two indents of the latter measuring 14 in. in length; the upper plate driven in 4 in. at the bottom, below the 68-pounder indents; wide cracks on each side of 68-pounder indents. Indents of 110-pounder, 2·5 in. and 2 in. respectively; cone (remains of shot) stuck in one indent; wide crack across right 68-pounder indent, extending to a bolt-hole; crack, 5 in. long, from top of centre plate below 68-pounder indents. Upper plate forced up ·75 in. At the back, one through-bolt broken and driven out (fracture not in thread of screw, but in

shank); one rib buckled. Two small bolts (bolting the wood backing to the skin) started  $\cdot 2$  in. and  $\cdot 5$  in.

No. 27 (300-pounder elongated steel bolt). Struck at the junction of the centre and upper plates, at 4 ft. 4 in. from the left edge of the target, and on a bolt; penetrated the target, and made a hole  $14\cdot 5 \times 13$  in. At the back, fragments of plate, backing, &c., driven through; large irregular hole, 2 ft.  $\times$  1 ft. 6 in.; general bulge of skin over 4 ft. 6 in.  $\times$  3 ft. 6 in.; one rib smashed and driven back 1 ft. 6 in., ragged inner skin sticking out 1 ft.; many adjoining rivet-heads off. The shot set up 1.93 in.

No. 28 (300-pounder spherical cast-iron shot). Struck at the junction of the upper and centre plates, at 3 ft. 6 in. from right side of the target; penetrated to a depth of 11 in., and made a hole in front of the target measuring 14 in.  $\times$  11 in.; two through-bolts broken—one at 15 in. from point of impact; five inner armor-plates broken, and one driven in 3 in.; five rivets broken; a rib bulged out 2 in. in a length of 4 ft., and another rib bent  $\cdot 5$  in. in a length of 3 ft.; considerable bulge of skin over a space of  $3 \times 2$  ft., and the skin opened  $\cdot 5$  in. at the junction of the plates; one angle-iron of rib broken. When the front armor-plate was removed; the backing was found to have been affected for about 3 ft. 6 in. on each side of the hole, being 2 in. out of the plane at the greatest depth.

No. 29 (300-pounder spherical cast-iron shot). Struck the lower plate 10 in. from the right side, and 8 in. from the top, touching a bolt; made a hole in the target 12 in. in diameter, and penetrated to the depth of 12 in.; shot broke up in the hole; the upper right-hand corner of the plate, the sides measuring  $11 \times 9$  in., was detached, and forced 4 in. into the backing at the side next the hole; two inner armor-plate bolts and three rivets were broken; the skin was slightly bulged over a space of 2 ft.  $\times$  1 ft. 6 in., and was cracked for a length of 12 in., the crack being  $\cdot 6$  in. wide in the widest part; one angle-iron of rib broken, and the India-rubber washers of the through-bolts much compressed.

**875. Experiments on Mr. George Clark's Target, July 7, 1863.**—Length of target, 13 ft. 6 in.; height, 10 ft. The face

consisted of seven Millwall Iron Works plates, each about 7 × 3 ft. × 3 to 5½ in., and numbered from 1 to 7. The backing consisted of horizontal cells, 5 in. wide × 7 in. deep, formed of angle-irons 1⅝ in. thick, dovetailed into the plates, and also fastened by ten 2½ and 3-in. bolts. Under plates 1, 3, and 5, these cells were filled with millboard; under the rest, with end-grain teak, the fastening being modified and complicated. In fact, the target consisted of seven distinct targets, all, however, constructed on the principle of cellular backing. The target received nine shots from 68-pounders, two from 110-pounders, and a salvo from three 110-pounders and two 68-pounders, the result of which was the knock-

TABLE CXXXIX.—EXPERIMENTS AGAINST 4½-IN. PLATE FACED WITH 12-IN. OAK.

No. from Gun.	No. to-day.	Charge, lbs.	Weight of Shot, lbs.	Insertion, inches.	Recoil, feet.	Distance to Target, feet.	Time fired.
167	1	30	168	105	Taut breech.	90.2	P. M. 4.8

ing off of many rivets and through-bolts, and the breaking through of the plates when struck on their edges. A 150-lb. shot, with 50 lbs. powder, from the 10½-in. gun, and a 300-lb. live steel shell, loaded with 15 lbs. bursting charge, and fired with 35 lbs. of powder, went entirely through and beyond the thickest part of the target.

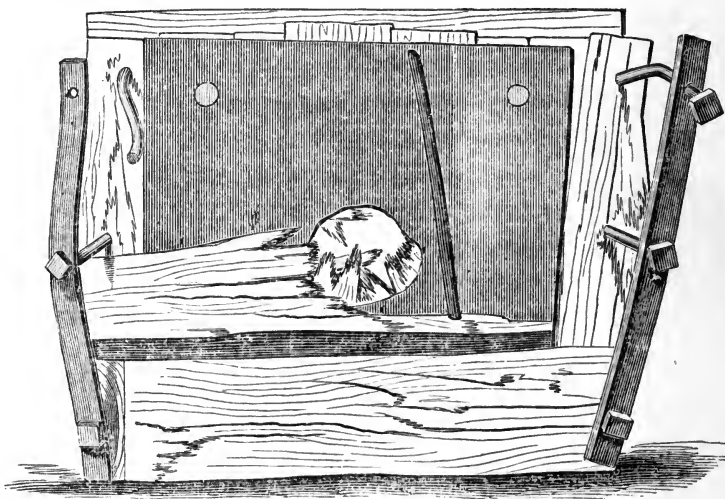
**876. Experiments against 4½-Inch Solid Plate faced with 12 Inches of Oak and backed with 20 Inches of Oak, May 28, 1863.**—“This target was made of one 4½-in. scrap-iron plate, backed by 20 in. of solid oak, and faced with 12 in. oak, on the plan of Mr. Heaton. The plate was joined to the rear timber with four wood screw-bolts, and the facing timber was secured to the rear timbers with six square-headed bolts with nuts. The target was placed against a bank of solid clay.

“Dimensions of target: Plate, 4 ft. long, 4 ft. wide, 4½ in. thick. Rear timber, 20 in.; facing timber, 12 in. thick. Gun, No. 214,

A. F. Charges, cannon powder. Projectiles, solid cast-iron shot —  $\frac{2}{3}$  Cloverdale iron and  $\frac{1}{3}$  Hopkins's iron.

“Shot struck 16 in. from top edge, 17 in. from lower edge, and  $16\frac{1}{2}$  in. from right and left edges of target, passing clear through the facing timber, plate, and rear timber, and embedding itself 3 ft. 6 in. in the bank in rear of target. Diameter of hole in iron,  $15\frac{1}{2}$  in.

FIG. 404.



Front of  $4\frac{1}{2}$ -in. plate, with 12-in. oak facing, after one 11-inch shot.

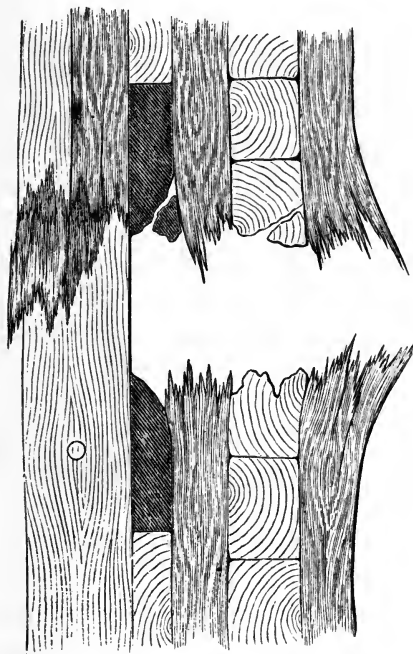
“The top and middle courses of facing timber were completely shattered, and the whole top course and a portion of the middle course carried away; the bottom course was somewhat fractured; two of the timbers were thrown forward, and fell 30 ft. in front of target. One piece of iron plate was found 102 ft. in front of target.

“One bolt on the top left side of target had its head broken off, and the top right bolt had its nut broken off in rear and was forced out in front. None of the wood screw-bolts were broken nor started from the surface of the plate. Indentation of plate on top edge of shot-hole,  $\frac{7}{8}$  in.; on lower edge,  $\frac{3}{4}$  in.; on right edge,

$\frac{5}{8}$  in.; and on left edge,  $\frac{7}{8}$  in. The shot was considerably fractured and flattened on its forward face, but retained its spherical form until it was taken from the bank.”\*

**S77. Experiments against Target of Sandwiched Iron and Rubber as compared with same Plates of Sandwiched Iron without Rubber, Oct. 3, 1863.**—“This target was made of four 1-in. wrought-iron plates and four sheets of rubber 1 in.

FIG. 405.



Section of Fig. 404.

thick, backed by 20 in. of solid oak and joined with six  $1\frac{1}{4}$ -in. wrought-iron bolts and nuts. The plates, rubber, and bolts were furnished by Mr. G. L. Jones, of St. Louis, Mo. The first 4 in. nearest the timber were composed of alternate layers of rubber and iron, and then two sheets of 1-in. rubber and two 1-in. wrought-iron plates, the latter being on the outer surface of the target. The target was placed against a bank of solid clay.

“Dimensions of target: Length, 96 in.; width, 42 in.; thickness of rubber and plates, 8 in.; thickness of timber, 20 in. Gun, 11 in. No. 214 C. A. & Co., mounted on wooden pivot carriage in

front of the battery. Charge, cannon-powder; projectiles, Cloverdale cast iron; primers, friction.”

Range, 84 ft.; weight of ball, 169 lbs.; charge, 30 lbs.

“This shot struck 20 in. from the right edge, and 28 in. from the lower edge of the target, passing entirely through the plates,

\* Official: *Scientific American*, Jan. 30, 1864.

rubber, and timber, and penetrating the bank a distance of 12 ft. Diameter of shot-hole,  $11\frac{1}{4}$  in. The timber in rear of the target, around the shot-hole, is much broken. The plates are sprung outward directly around the shot-hole 1 in. All the bolts were slightly started, but none broken."

"On the 6th inst., the target having been placed on its longest edge, at an angle of  $45^\circ$  with the line of fire, another shot was fired at it from the same gun, and under the same conditions, and with results as follows: This shot struck 15 in. from the top and bottom edges and 37 in. from the left edge of the target, passing entirely through plates, rubber, and timber, and penetrating the bank a distance of 6 ft. The shot appears to have been broken in its passage through the target, as several small pieces were taken out of the shot-hole, and one small piece was found in the rear of the target on the bank. Horizontal diameter of shot-hole,  $18\frac{1}{4}$  in.; vertical,  $12\frac{1}{2}$  in. The plates were sprung inward on the right edge of the shot-hole,  $\frac{1}{2}$  in.; and on the left edge,  $\frac{3}{4}$  in. The plates have sprung forward on the right and left edges of the target  $\frac{1}{2}$  in. The timber in the rear of the target is completely shattered. No bolts were broken, but all were more or less started from the surface of the plates."

**878.** LAMINATED TARGET WITHOUT RUBBER IN COMPARISON WITH THE ABOVE.—"This target was made of four 1-in. wrought-iron plates (Abbott's) backed by 20 in. of solid oak and joined together with ten wood screw-bolts. The target was placed against a bank of solid clay.

"Dimensions of target: Length, 96 in.; width, 48 in.; thickness of plates, 4 in.; thickness of timber, 20 in. Gun 11 in., No. 214 C. A. & Co., mounted on wooden pivot carriage in front of battery; charges of cannon powder; projectiles of Cloverdale cast-iron—solid shot; primers, friction."

Range, 84 ft.; weight of ball, 168 lbs.; charge, 30 lbs.

"This shot struck 23 in. from the right edge and 21 in. from the lower edge of the target, passing entirely through plates and timber, and penetrating the bank a distance of 5 ft. Diameter of shot-hole,  $12 \times 14$  in. The plate is sprung inward on the left



edge of the shot-hole  $1\frac{1}{2}$  in. The timber in the rear around the shot-hole is much broken. One bolt was started forward  $1\frac{1}{8}$  in. and five others slightly started, but none were broken.

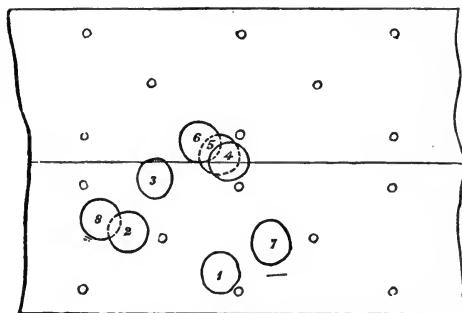
“On the 6th inst., the target having been placed on its longest edge at an angle of  $45^\circ$  with the line of fire, another shot was fired at it from the same gun, under the same conditions, with results as follows:—The shot struck 19 in. from the top,  $14\frac{1}{2}$  in. from the lower edge, and  $56\frac{1}{2}$  in. from the left edge of target, tearing through the plates, and the shot breaking into pieces, part of which glanced off at an angle of  $45^\circ$  and penetrated the bank on the right of the target; the remaining portion (43 lbs.) remained in the shot-hole. Horizontal diameter of shot-hole,  $16\frac{1}{2}$  in.; vertical,  $14\frac{3}{4}$  in. The plate is sprung inward on the right edge of the shot-hole, 3 in.; top edge,  $2\frac{1}{2}$  in.; lower edge,  $2\frac{1}{2}$  in. The plates have sprung forward on the top edge  $2\frac{1}{2}$  in. One bolt was started forward  $\frac{3}{4}$  in. None are broken excepting the one in the centre of the shot-hole. The plates are cracked around the shot-hole, one crack extending 8 in. The timber is all completely shattered.

**879.** “The experiment with this target was for comparison with Mr. J. L. Jones’s target (composed of four 1-in. iron plates and four 1-in. sheets of india-rubber), to obtain the relative resistance. The conditions of the two experiments were identical. The penetration of the projectile fired at this target was five feet from the face, while the penetration of that fired at the iron and India-rubber targets was 12 feet. In the second experiment, oblique firing,  $45^\circ$ , the shot at this target did not penetrate entirely through, and 126 lbs. of it were thrown out, at an angle of about  $45^\circ$ , into the bank of earth, while the corresponding shot at the iron rubber target passed entirely through it and penetrated the bank of earth a total distance of 6 ft. from its face.\*

**880. Experiments at the Warrior Target with 9-Inch Steel Shells, at St. Petersburg, Oct. 17, 1863.**—“The object in view was to see the effect on a target representing nearly a section of

the *Warrior* comparatively with steel and with cast iron. Two  $4\frac{1}{2}$ -in. plates from Messrs. John Brown & Co.'s works were fixed on the teak. That portion of the plate hit by the shells is shown on the drawing (Fig. 406); the holes are numbered in the order in which the shots were fired. The steel shells were of two

FIG. 406.



Warrior target—9-in. shells.

qualities, one from Krupp, cast and hammered, the other made by Povteeloff, in Finland, from small ingots, and welded together. All the shots weighed about the same, 270 lbs., and were charged either with 8 lbs. sand or powder, and were all fired at 700 ft. distance with 50 lbs. of powder.

“Now, although it was evident that the resisting powers of  $4\frac{1}{2}$ -in. plates were not equal to such shells, still one object was answered in respect to the plates by the experiment. It showed that when the plates were made of really good material, the concentration of fire, even on so small a surface, will not break up the plates, but merely punch holes, which may easily be plugged in action.

“The shell numbered Nos. 1, 2, and 3 made each a hole  $10\frac{1}{2}$  in.  $\times$   $9\frac{1}{2}$  in., or thereabouts. No. 1 had a flat nose 4 in. diameter, and Nos. 2 and 3,  $6\frac{1}{2}$  in. These three shells Krupp classified, Nos. 1 and 3 as hard, and No. 2 as mild steel. All three, however, although only charged with sand, went to pieces on passing through the plates, proving that, had the plate been  $5\frac{1}{2}$  or 6 in. thick, they would have been harmless as respects penetration.

The shells Nos. 4 and 5 were those from Povteeloff, of puddled steel, hit very close together. No. 4, however, made a larger hole than the preceding three, and showed its penetrating power, by not only destroying a large portion of the teak backing, but by passing through another target of teak behind the other. It was found to be only slightly bulged up, without any cracks, not a single piece being taken out of it. The next shell, also of Povteeloff's, not having met with full resistance on the plate, went off through a second target standing behind the one fired at, some two miles, quite uninjured.

"The Russians present were highly delighted with the favorable results of these latter shots—their own production—and Mr. Povteeloff engaged to produce better when the works were fully in operation. In fact, unless Krupp brings forward a better quality every way than those yet tried, the Russians will drive him out of their market. The general opinion was that the penetrative power of the Povteeloff shot, compared with Krupp's, was as 5 to 3.

"Shells Nos. 6 and 7 were Krupp's, and were charged with powder. The result on the plate was a slightly larger hole. No. 7 burst in the plate, but did not injure it.

"A cast-iron shell was then fired, and went through the plate similarly to Krupp's shells—being crushed by the concussion. The conclusion arrived at was, that the cast-iron shell was, as against armor-plates, equal to Krupp's steel shells in penetrative power, but not equal to Povteeloff's—cost being one-fourth.

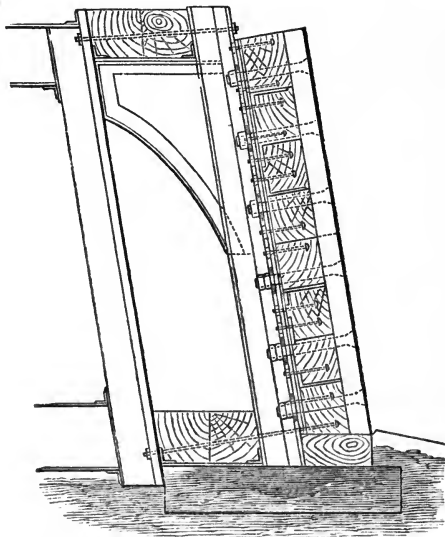
"Further trials will be made on thicker plates, when other shells of Russian make will be tried. We may remark, in passing, that these shells were of steel, made by Povteeloff, from Finnish lake ore, and the shells used were made from small 2-lb. ingots, welded up, bored, and turned. With proper apparatus, now nearly ready, the shots will be cast in proper-sized ingots, and be hammered near to form, and be much better in every respect."\*

\* Correspondence of the London *Engineer*.

The London *Times* has the following account of these experiments:

**881. Experiments against the Bellerophon Target, Dec. 8, 1863.**—“This target has been constructed to represent as

FIG. 407.

The *Bellerophon* target. Scale,  $\frac{1}{4}$  in. to 1 ft.

nearly as possible a portion of the proposed side of the *Bellerophon* iron-cased frigate, ordered to be built at Chatham Yard.

“First, a series of cast-iron shells, 300 lbs. each, were fired at different ranges, and then shells made by Krupp were fired at the  $4\frac{1}{2}$ -inch armor-plates. The first shell, of hard cast steel, was  $22\frac{1}{2}$  in. long (two and a half diameters), with a flat end 4 in. in diameter. Fired with 50 lbs. of powder, at 700 ft. distance, it passed through the plate, oak and teak backing, and broke into many pieces, although filled with sand only. The second and third shells were also of Krupp’s steel, the same length, but with  $6\frac{1}{2}$ -in. ends. These shells pierced plates, wood, etc., and also went to pieces, although only filled with sand. The fourth shell was made by M. Popteeloff, of puddled steel, on Aboukoff’s system, the same dimensions as the second and third, and went through iron, teak, etc., but was only bulged up from 9 in. to 12 in., and the end flattened, not a single crack being visible in the shell. The fifth shell, the same as the fourth, passed through iron, teak, and the second target, and went at least a mile beyond. The sixth and seventh were from Krupp, and were charged with powder; they were quite flat-ended, 9 in. diameter. One exploded in the plate, the other in the wood. The eighth and ninth shells were of cast iron, and, although they passed through the plates, were of course destroyed. Evening prevented further trials, which will yet be made on the same plate.

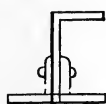
“The results on the plate were highly satisfactory. In a space of 4 ft. 6 in. by 3 ft. 6 in. eight holes were made without any crack of the slightest description.”

The part of the ship which is to be tested by the target is that situated between the main and lower decks, and not in the line of ports, the object being to test the strength of the general side of the ship.

“Special arrangements will be made to strengthen the side in the vicinity of the ports, which will be few in number, as the *Bellerophon* is to carry a small number of very large guns. These few ports can be strengthened by the introduction of additional iron to an extent which would not be practicable if the number of ports were large.

“Each frame of the target is made of an angle-iron  $10'' \times 3\frac{1}{2}'' \times \frac{1}{2}''$ , and two angle irons  $3\frac{1}{2}'' \times 3\frac{1}{2}'' \times \frac{5}{8}''$ , riveted together thus (Fig. 408). To the double angle-irons of this frame the skin, which is composed of two thicknesses of  $\frac{3}{4}''$  plating, making together  $1\frac{1}{2}''$ , with a layer of painted canvas between, is riveted.

FIG. 408.



“On the outside of the skin plating four horizontal angle-iron stringers are attached, two under the upper armor-plate,  $9\frac{1}{2}'' \times 3\frac{1}{2}'' \times \frac{1}{2}''$ , the broad flange being square to the skin, and not reaching out to the armor by half an inch. The other two are placed behind the lower plate,  $10'' \times 3\frac{1}{2}'' \times \frac{1}{2}''$ . The breadth of the broader flange being the same as the thickness of the backing, it reaches out to, and comes in contact with, the armor.

“Wood backing, 10'' thick, is worked longitudinally on the skin plating, and between the angle-iron stringers, bolted with nut and screw-bolts through the skin plating.

“The armor consists of two rolled plates, 6 in. thick, weighing upwards of 9 tons each. The upper armor-plate is bolted with bolts  $2\frac{1}{2}''$  diameter, and the lower plate with bolts  $2\frac{3}{4}''$  diameter. In one-half of the target, divided vertically, the armor-bolts have elastic washers, and are clenched on single nuts. In the other half the bolts have common washers with double nuts, and the bolts *not* clenched.

“In constructing this target, the mere capability of resisting shot and shell has not alone been considered; regard has also been had in arranging its details, to the satisfactory and econom-

ical construction of an actual ship upon the same plan. In erecting the target, care has been taken to support it behind with beam ends, etc., so that the actual condition of the proposed ship's side may be approximated to as closely as possible.

"All the portions of this target have been carefully weighed, and the weight, as reported by the Admiralty Overseer, is 389 lbs. per square foot."\*

**882.** The range was in all cases 200 yards. The 1st shot, a 66½-lb. cast-iron ball from the 68-pounder; charge, 16 lbs.; struck the top plate, 9 in. from the upper edge, and midway between the fourth and fifth bolts. The indentation was 1·5 in. deep. About half the bolts in the plate were just perceptibly started, but not strained.

The 2d, a 66½-lb. cast-iron shot, with a false, hemispherical, hollow head, fired from the 110-pounder Armstrong gun, with 16 lbs. of powder, struck between the next two bolts, 9 in. from the top of the plate, over a rib; indent, 1·45 in. deep. The bolts were hardly more started by this shot.

The next round was a salvo of four 66½-lb. shot, fired at the top plate, two from the 68-pounder, and two from the 110-pounder; charges as above. A third 110-pounder was fired, but missed. One 66½-lb. ball struck 8 in. from the bottom of the plate, partially on the fourth bolt from the right; indent, 1·75 in; bulge, 2·1 in. One rifle-bolt struck partially on the same bolt, a little to the right; indent, 1·25 in.; bulge, 1·45 in. The bolt was started out ¼ in. The other ball struck 1 ft. 9 in. below the top of the plate, and 6 ft. from the right edge; indent, 1·75 in.; bulge, 1·85 in. The other rifle-shot hit the top edge of the plate, chipping out a piece. The condition of the other bolts was not changed. Up to this time the inner skin of the target showed no evidences whatever of the firing.

The 7th shot, weighing 66½ lbs., circumstances as above, struck the lower plate 12 in. from the top, and 10 in. to the left of the fifth bolt from the right; the bolt started ¼ in.; indent, 1·8 in.;

\* Admiralty circular.

bulge, 1.95 in. A small backing bolt-head was broken off inside the skin, and nine through bolts were slightly started, but not strained.

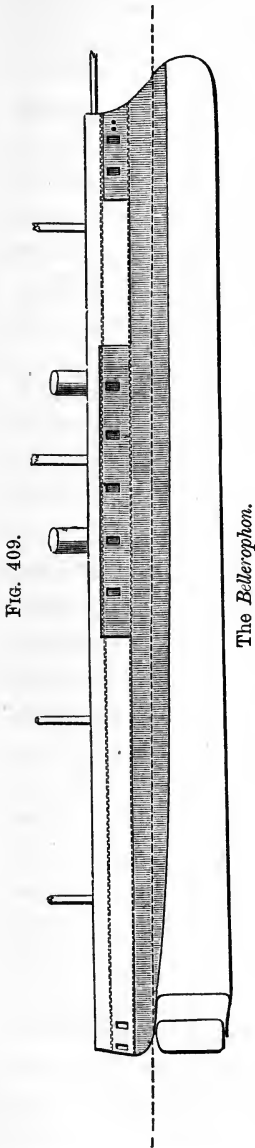
The 8th, a 70-lb. steel shell—bursting charge 2 lbs. 6 oz.—was fired, with 21 lbs. of powder, from the Whitworth 70-pounder, and struck 5 ft. from the right edge and 8 in. from the top of the bottom plate, partially on the third bolt from the right. Indent, 1.3 in.; narrow crack on the face of indent; the bolt was driven in  $\frac{1}{8}$  in., and afterwards screwed up tight. The plate was bulged  $\frac{1}{4}$  in. below the edge of the upper plate. The shell broke up. The ends of the plates had not buckled outwards at this time.

The 9th, a 117-lb. steel shell—bursting charge 2 lbs.—fired from the 7.1-in. "Committee" modified shunt gun with a 16-lb. charge, struck the lower plate 13 in. from the bottom and 7 in. from the right of the fourth bolt from the right. Indent, 1 in. A general bulge of the plate left the bolt nearest to the indent protruding  $\frac{1}{2}$  in., and the next (fifth)  $\frac{1}{8}$  in. The plate started out  $\frac{1}{8}$  in. at the right end. The greater part of the shell was thrown back over 200 yards, and buried in the earth in the rear of the guns.

The local effect of this shot was less than that of the preceding shots, and its distributed effect much greater.

The 10th, a 150-lb. cast-iron ball, fired with 35 lbs. of powder, from the 10 $\frac{1}{2}$ -in. shunt rifle, struck the third bolt from the left, in the upper plate; indent, 3.52 in.;

crack 5 in. to right of impact, 10 in. long; crack 9 in. long on face



of indent; no other cracks; plate driven in  $3\frac{1}{2}$  in. at bottom, in a length of 3 ft. The left top end of the plate was thrown out  $\frac{3}{8}$  in., and the backing  $\frac{1}{8}$  and  $\frac{1}{4}$  in. The backing was also driven out slightly endways. Inside, the skin was bulged slightly, and the bolt struck was driven in 2 in. No injury was done.

The 11th, a hammered cast-steel ball from the same gun—charge 35 lbs.—struck exactly at the joint of the upper and lower plates, 3 ft. to the right of the preceding shot, with a velocity of 1520 ft. It punched a  $11.5 \times 11.2$ -in. hole in the 6-in. plate, embedded itself to 1 in. below the face of the target, and stuck in the hole, much cracked and considerably flattened on its striking side. On the inside, the rib over which the shot struck was broken and bulged  $2\frac{1}{2}$  in.; the next rib was bent 1 in.; the skin was bulged 2 in., and had a small crack 8 in. long. Two through bolt-heads and two backing bolt-heads were broken off. The bulge of the target was not perceptibly increased, because the power of the shot had been employed locally.

The 12th was a 300-lb. cast-iron solid shot, with a false hemispherical head; charge, 35 lbs. It struck exactly on the third bolt from the right of the lower row in the lower plate, 10 in. from the bottom; the indent was only 2.8 in., but the distributed effect was more than that of the preceding shot, viz., the plate was driven in at the bottom 2.1 in. in a length of 5 ft.; a crack 1 ft. 6 in. long was made through a bolt-hole 2 ft. from the point of impact; the top of the plate was started out .4 in. for 2 ft. at the right, and the backing was a little split and driven out endways. At the back the skin was slightly bulged; the through-bolt struck (which was driven in 1 in. beyond the bottom of the indent) was driven out 2 in. at the back, and two backing bolts were broken.

The 13th, a 151-lb. steel shell—bursting charge, 5 lbs.—fired with 27 lbs. of powder, from the 7-in. Whitworth gun, penetrated the lower plate equally distant from the top, bottom, and left end. The rear of the shell was fired outwards, and the head lodged in the front of the backing. The inner-skin plate was bulged a little at a joint, and one through-bolt and two backing bolts were broken. The skin was practically uninjured.



The cast-iron shots and the steel ball were of excellent quality. The plates were also very tough.

The target, considered as the side of a ship, was, at the close of the experiments, practically uninjured.

**883. 13-Inch 610-lb. Steel Shell; 4½-Inch Plate; 18-Inch Backing.\***—On December 11, 1863, a 610-lb. steel shell was fired from the Armstrong 13-in. gun, with 70 lbs. of powder, at the *Warrior* target (Fig. 98); range, 1000 yards. This projectile smashed a 20 by 24-in. hole entirely through the target, splintering the backing and supports, starting all the plates, breaking nearly all the bolts, and slung round the entire structure. The shell contained a 24-lb. bursting charge, and exploded at the instant of its passage through the plate. This, however, should be considered a punching rather than a racking shot, so great was the disparity between the power of the projectile and the resistance of the target.

**884. 13-Inch 344½-lb. Steel Shot; 11-Inch Plate.**—On the 10th of March, 1864, a 344½-lb. spherical steel ball was fired from the same gun with 90 lbs. of powder—striking velocity, 1680 feet per second; range, 200 yards—at an 11-in. plate 3 ft. 5 in. × 2 ft. face, supported at the rear by two 12-in. oak posts. The ball struck the centre of the plate, breaking it in two, indenting it 4·9 in., and dislodging and splintering the supports. But the shot was flattened to 15·2 in. maximum and 10 in. minimum diameter, and thrown back towards the gun.

**885. 13-Inch 603-lb. Bolt; 6½-Inch Plate; 18-Inch Backing; 4000 Yards Range.\***—In July, 1864, the Armstrong 13-in. gun was fired, at 200 yards range, with 40 lbs. of powder and 860 ft. initial velocity. This charge was calculated to give the striking velocity (840 ft.) which the ordinary 70-lb. charge would give at 4000 yards. The target, resembling the *Bellerophon* target (881), was composed of a 6-inch plate, 18 in. of teak backing supported by horizontal stringers, 1¼-in. double skin, and heavy iron ribs. The shot smashed entirely through the plate and backing.

\* The account of these experiments was not obtained from official sources.

**886. 15-Inch and 11-Inch Balls and Parrott 150-lb. Bolt; Various Plates; Late Experiments.**—Some important experiments with the above projectiles have very recently been made at the Washington Navy Yard. The Department has determined not to make public the details of these experiments at present. The general results are as follows:

A target composed of 30-in. oak backing and a solid 6-in. French plate, made by Messrs. Petin, Gaudet & Co., was cracked, smashed, and completely penetrated by a 15-in. 400-lb. cast-iron ball, fired at about 50 yards range, with 60 lbs. of powder, at an initial velocity of 1480 feet per second. A target composed of six 1-in. plates, backed by 10 × 10-in. iron beams, was torn in two and thrown down by similar projectiles. Laminated targets, composed of 1-in. plates, up to 13 in. aggregate thickness, and backed by 24 to 30 in. of oak, have been ruptured and shattered through and through, though not completely penetrated, by the same shot and charges. The 15-in. ball has also knocked down, displaced, and shattered various targets of considerable thickness but not of large size, and therefore not exactly representing the mass and continuity of a ship's side. The 15-in. gun has not been fired at the *Warrior* target or at any 4½-in. target.

The 11-in. gun has recently been fired at various targets with 30-lb. charges and 169-lb. cast-iron balls. At 50 to 100 yards range, this gun completely penetrates 4½-in. solid plates of ordinary quality, but does not make a clean breach through the best plates (215).

The Parrott 8-in. rifle, with 150-lb. bolts, and 16 lbs. of powder, breaks through but does not punch the best 4½-in. plates, and does not seriously injure the backing.

These late experiments have also shown that the convex target representing the *Monitor* turret, offers very much greater resistance to both punching and racking than the flat target, composed of the same materials.

**887. Experiments with Steel Shot against Armor.\***—The

\* The author has not yet had access to the *official* reports of the later experiments in this direction; therefore only an abstract of the results will be attempted at present. The authorities are the *London Times*, and *Army and Navy Gazette*.

experiments with Mr. Whitworth's steel shells, recorded in foregoing tables, demonstrated the first important improvement in the *material* of projectiles, although the United States Navy Department had previously made a remarkably tough mixture of cast iron for balls, and had demonstrated its superiority to wrought iron.\*

But the improvement in the material of projectiles did not assume a revolutionary character—it had hardly been imagined that steel would so soon be acknowledged as the only proper shot-material for effective iron-clad warfare, until early in 1864, when spherical steel balls were fired through the *Warrior* class of armor by guns and charges which would neither punch nor crack it when the balls were of cast iron.

**888.** In January, 1864, the 4½-in. plates of the *Warrior* target were broken through by steel balls from the 68-pounder gun with 16-lb. charges. The average penetration of the cast-iron ball, gun and charge the same, is 2½ in., and the best plates are not cracked.

**889.** Shortly afterwards, at Portsmouth, the 9·22-in. "100-pounder" smooth-bore fired a 113-lb. and a 114-lb. Bessemer steel ball, with 25 lbs. of powder at 200 yards range, entirely through the *Minotaur* target of 5½-in. plates and 9 in. of teak backing, smashing a 2-ft. hole in the rear and driving fragments all over the ship and into the opposite timbers. A third shot, conditions the same, passed entirely through the centre of the plate, making a 10-in. hole through the face, driving large masses of the back of the plate into the wood backing, and smashing the ship's timbers (the wooden target-ship *Monarch*) over a space of 2 × 4 ft., and bulging them 12 in.

The 4th shot of Firth's steel, struck over a wooden knee; it did not shatter inside of the ship, although it penetrated the plate.

**890.** Speaking of similar experiments against the *America* target ship, the *Army and Navy Gazette* of March 12, 1864, says: "This old ship received, in two days' firing, 78 heavy knocks against her sides from heavy iron shots. She was none the worse, but floated quietly at her moorings. Not so after *one steel*

\* Captain Palliser has recently increased the effectiveness of cast-iron shot, in a great degree, by chilling the exterior of the metal when it is cast.

*shot* was brought to bear against her. This penetrated the armor-plate, which vainly strove to keep the subtle and destructive missile outside; and gradually, but surely, did the strongly-built craft fill with water, and settle down on the mud."

**891.** On the 24th of March, 1864, at Shoeburyness, the 110-pounder Armstrong gun was fired at various  $5\frac{1}{2}$ -in. plates without backing. The average penetration in backed  $4\frac{1}{2}$ -in. plates of 111-lb. cast-iron shot from this gun, with 14-lb. charges, is 1.6 in. The plates are not usually cracked, but the projectiles are completely smashed. In this experiment, two Bessemer steel projectiles, made at the Atlas Works, and fired with 12-lb. charges, passed entirely through the plates. Other steel projectiles indented the plates from 2 to  $4\frac{1}{2}$  in. In all cases the rear of the plates were bulged and cracked, and in several cases pieces of iron were knocked out.

**892.** About the same time, two steel 100-lb. balls were fired from the Armstrong 9.22-in. smooth bore at a 6-in. solid Millwall plate, bolted to the side of a target ship at Portsmouth; charge, 30 lbs.; range, 200 yards. Both balls were buried partly in the plate and partly in the ship's side. The whole inner part of the plate about the shot-holes was broken up. A section of the ship's side,  $4 \times 16$  feet, was bulged inwards from 4 to 7 in., and the whole was violently shaken. Two other steel balls, from the same gun, just broke through two other similar plates and lodged at the front of the backing, without injuring the interior of the ship.

**893.** In May, 1864, experiments with steel shot were made against  $5\frac{1}{2}$ -in. plates, bolted to the sides of the *America*, wooden target ship at Portsmouth. The guns were the 9.22-in. smooth-bore and a 7-in. shunt-rifled gun; charges, 30 and 25 lbs. respectively; range, 200 yards. All the shot broke through the plates; one of them passed through the ship's side; and in all cases the ship's side was more or less shattered.

A 6-in. plate was also broken through by both the 115-lb. ball and the 98-lb. bolt; the *débris* of the plate was driven into the backing.

The projectiles used in these experiments were prepared at

Woolwich; they were all considerably flattened and mutilated upon striking the plates.

**894.** In June, 1864, the following experiment was made at Shoeburyness: The target represented the side of the *Lord Warden* iron-clad (building), and consisted of 12½-in. oak frame timbers, supported by deck beams and iron knees, and connected by 6-in. × 1¼-in. diagonal iron braces; the inner 8-in. planking; a casing of 1½-in. iron plate; 10 in. of oak; and, finally, the 4½-in. armor-plate, held by 2-in. bolts—in all, 30½ in. of oak and 6 in. of iron. The target presented a 20 × 9 ft. face. Range, 200 yards.

A 9·22-in. rifle, made for a 10½-in. "300-pounder," fired a 220-lb. steel bolt, with 44 lbs. of powder, at 1460 ft. striking velocity, entirely through the target and the bank beyond and a mile out to sea. The splinters of the backing and an iron knee were hurled to the rear in every direction.

Two steel 120-lb. shells—bursting charge, 7 lbs.—fired with 20-lb. charges from a 6½-ton 9·22-in. rifle, passed through the armor-plate and burst in the backing. The second shell tore the back of the target into splinters, which were thrown violently to the rear.

A 300-lb. bolt, from the 10½-in. gun, was then fired entirely through the target, with a 45-lb. charge.

The plate, although pierced by every shot, was not cracked.

**895.** Several experiments have also lately been tried in St. Petersburg with round steel shot and ordinary cast-iron shot, both 9 in. in diameter. The round steel shot are also the production of Mr. Povteeloff. The steel is made from Finnish lake ore—puddled, and made into octagonal blooms, which are then again heated, and gradually hammered into a globular form, in swages, under the steam-hammer; and when fired from the ordinary naval gun, at 4½-in. plates, the penetration of the steel shot was found to be nearly double that of the cast iron, and the injury done to the plates much greater. Round steel shot have also been tried from Germany.

**896.** The following experiments, partly with steel shot, also show the quality of the standard British armor-plates:

EXPERIMENTS OF FEB. 24 AND 25, 1864.\*—“The plates were bolted to the side of the target-ship *America*, and were fired at on the 24th from the 68-pounder smooth-bore gun, with the service charge of 16 lbs. of powder; and on the 25th with spherical cast-steel and wrought-iron case-hardened shot from the 100-pounder Armstrong, with 25 lbs. of powder. The range of both occasions was 200 yards.”

The following is the list of the plates selected for test (Table 140):

“*Lord Warden*, 5½-in. plate (J. Brown & Co.)—Eleven shots were fired at this plate, three overlapping each other. Diameter, 9 in.; depth of indentation, 1⅞ in. With the exception of the third and eighth shot, which showed a minute separation of the

TABLE CXL.—COMPETITIVE TEST OF ARMOR-PLATES. PORTSMOUTH, FEB., 1864.

Manufacturers' Names.	Ship.	Descriptions.	Admiralty Order of Merit.
John Brown & Co.....	<i>Lord Warden</i> .	5½-in. rolled.	A 1.
“	“	4½-in. “	A 1.
“	<i>Royal Alfred</i> .	4½-in. “	A 1.
“	<i>Prince Albert</i> , cupola ship.	5½-in. bent plate.	A 2.
Mersey Co.....	<i>Agincourt</i> .	5½-in. hammered.	A 3, infer.
“	“	5½-in. rolled.	A 1
Charles Cammell & Co...	<i>Lord Clyde</i> .	5½-in. “	A 1.
Millwall Co.....	<i>Bellerophon</i> .	6-in. “	A 3.
Beale & Co. ....	<i>Pallas</i> .	4½-in. “	B 1.

surface layer of the metal within the indent, there were no cracks upon this plate, and it was reported upon as being ‘remarkably good.’ Injury to backing, *nil*.

“*Lord Warden*, 4½ in. (J. Brown & Co.)—Fourteen shots were

\* This account is quoted from the correspondence of the *Army and Navy Gazette* of March 12, 1864.

fired at this plate, several overlapping each other. Plate was started  $\frac{1}{2}$  in. from backing. After twelve shots were fired from the 68-pounder gun, with 16-lb. charge, producing only slight indentations varying from 2.9 to 2.1 in., two shots were fired from the 100-pounder gun with 25-lb. charge. The first was made of cast iron at Woolwich laboratory. It broke up after penetrating the plate 6 in. The second was made of Dr. Price's crucible iron. The shot was again destroyed after a penetration of  $\frac{3}{4}$  of its diameter into the plate. Backing sound.

"*Royal Alfred*,  $4\frac{1}{2}$  in. thick (J. Brown & Co.)—This plate received five severe blows near its edge from the 68-pounder cast-iron shot without showing material injury. A wrought-iron shot, case-hardened, was subsequently fired at it, producing an indent  $2\frac{1}{2}$  in. deep and 9 in. diameter. A Bessemer cast-steel shot followed, embedding itself nearly half its diameter in the plate. No cracks appeared around the part struck. Another cast-steel (crucible) shot was then fired, and struck 4 in. distant from the preceding one, shaking it out of its place. This shot stuck in the plate, projecting 3.7 in. above the plate's outer surface. Although the shot preserved its spherical form, it was much broken up. Injury to backing, *nil*.

"*Prince Albert*,  $5\frac{1}{2}$  in. thick (J. Brown & Co.)—This plate was 6 ft. long and had been reheated and bent. It was severely tried on the lower edge by three overlapping shot which made two cracks downwards. It received a fourth shot near the centre without showing any crack.

"*Agincourt*,  $5\frac{1}{2}$ -in. hammered plate (Mersey Company).—The first two blows from the 68-pounder inflicted no apparent injury upon this plate. The third brought out a crack 2 ft. in length. The fourth shot cracked the plate through to within an inch of the surface. Shot 6 broke out a piece 2 ft. 6 in.  $\times$  12 in. It received seven shots in all.

"*Agincourt*,  $5\frac{1}{2}$ -in. rolled plate (Mersey Company) was an excellent plate. The indentations were slight; and, though some of the shots touched each other, no cracks were apparent except in the 5th indent. It received nine shots.

“*Lord Clyde*, 5½ in. rolled plate (Cammell & Co.)—First shot showed a crack 4 in. long. Another shot, striking near the former, broke out a piece of plate 19 in. × 8 in. The plate subsequently received eight additional blows without material injury. It was also fired at with two Bessemer steel shot which embedded themselves in the plate.

“*Bellerophon*, 6-in. rolled plate (Millwall Company), received four shots in two pairs, shots slightly overlapping. No cracks. The fifth and sixth shots opened the lamina of the plate, and the seventh and eighth manifested a large number of severe cracks in and about the indentations. It received two steel shots from the 100-pounder, with 25-lb. charge, and showed considerable resistance. The backing was somewhat injured.

“*Pallas*, 4½ in. (Beale & Co.)—The first two shots broke out a piece of the plate 24 × 10 in., and the eighth shot carried away another large portion 2 × 1 ft. Numerous cracks appeared from the other blows, with the exception of shot 3, the indentation of which was 2·1 in. deep. No steel shot was fired at this plate. \* \* \*

“P. S. I have at the moment of closing my letter discovered that I have omitted two shots which struck the 4½-in. plate \* \* \* the upper shot was supplied from the arsenal, and the lower one by Messrs. Price.”

**897. Experiments at Shoeburyness against Compressed Wool on Mr. Nasmyth's Plan, March 18th, 1864.**—“A large iron boiler, about 10 ft. in diameter, was filled with wool to form, to borrow Mr. Nasmyth's own words, a cone of obstruction. The wool was pressed down by men trampling on it. \* \* \* A slight frame of woodwork was placed at the mouth of the caisson to keep its contents from springing back after having been exposed to pressure, and when all was pronounced to be ready the guns (a 68-pounder and a 110-pounder breech-loading Armstrong) with the ordinary service charges at a range of 100 yards were fired. The shot, on examination, were found to have passed through the 11 ft. of wool, the bottom of the iron caisson, and buried themselves in 12 ft. of solid earth.”\*

\* *Army and Navy Gazette*, March 19th, 1864.



TABLE CXL A.—EXPERIMENTS WITH STEEL SHOT, ON GUNNERY SHIP "EXCELLENT,"  
FEB. 24 AND 25, 1864.\*

GUN.	Charge, lbs.	Weight of Shot, lbs.	Nature of Shot.	Thickness of Plate, ins.	Diameter of Indent, ins.	Depth of Indent, ins.
68-pounder.....	16	68	Cast iron Service.†	4½—6	...	1½
100-pdr. Smooth-bore...	25	100	Laboratory cast iron.†	4½	10	6½
"	25	100	Price's crucible iron.†	4½	10	7
"	25	100	Steel.	6	...	7·12
"	25	100	Steel.	5½	...	4·62
"	25	100	Steel.	5½	...	6·42
"	25	100	Steel.	6	...	6·32
68-pounder.....	16	68	Wt. iron, case-hardened.	4½	9	2½
"	16	68	Steel.	4½	8	4½
"	16	68	Steel.	4½	...	4·1

\* This table is compiled from a table given by Captain Selwyn, R. N., in a paper before the Royal United Service Institution.—See *Journal, of May, 1864.*

† These cast-iron shot all broke up.

**898. Experiments against a Hog's-Hair Target, on Mr. Brady's Plan, Washington Navy Yard, Sept. 1, 1863.**—"This target was made of 5 bales of hog's-hair, faced and backed with pine plank, 4 in. thick, and fastened with 28 wrought-iron bolts. Two of the bales had been subjected to one and the same amount of compression, and two others were compressed alike, but differing in degree from the former; and the remaining bale, as stated by the inventor, was but slightly compressed. The bales were bound with iron hoops. The target was backed with 4 ft. of solid clay.

"Dimensions of target: 11 ft. 3 in. long; 4 ft. wide; 3 ft. 3½ in. thick. Gun, rifle 50-pounder, No. 30, mounted on wooden carriage, on Pencote Battery. Charges, 3¼ lbs. Schagticoke cannon powder. Projectile, J. A. D. shell. Primers, friction." Weight of projectiles, 36·25 to 38 lbs.

“1st shot struck the right-hand bale in the centre, passing entirely through the bale and 4 ft. of clay, entering the bank at a distance of 18 ft. 3 in. back of the target, and embedding itself.

“2d shot struck the 2d bale, from the right edge of the target, in the centre, passing entirely through bale and 4 ft. of clay, entering the bank at a distance of 10 ft. back of target, and embedding itself.

“3d shot struck 3d bale, from right edge of target, in the centre, passing entirely through bale and 4 ft. of clay, entering the bank at a distance of 12 ft. back of target, and embedding itself.

“4th shot struck 2d bale, from left edge, in the centre, passing entirely through bale and 4 ft. of clay, entering the bank at a distance of 11 ft. back of target, embedding itself.

“The 5th bale was not fired at, at the request of the inventor. It will be perceived that all the bales were pierced, and the projectiles not having been found, it was not possible to ascertain which offered the greatest resistance.”\*

#### EFFECTS (Table 141).

1. Three shots passed through at 50 yds.; and at 75 yds. it was considerably indented.

2. No bullets through at 50 yds., but plate indented and cracked considerably.

3. One shot passed through at 25 yds.; at 50 yds., the plates were considerably indented and cracked, and the bullets passed between the joints.

4. None of the bullets passed through at 50, 25, or 10 yds.; the plates were considerably indented; the bullets passed between the joints.

5, 6, 7. None of these plates bullet-proof at 50 yds. Nos. 5 and 7 plates placed together; bullet passed through 1st and

\* Official: *Scientific American*, Oct. 10, 1863.

TABLE CXXI.—ORDNANCE COMMITTEE'S EXPERIMENTS SINCE OCTOBER, 1859, ON MANTELETS FOR EMBRASURES TO PROTECT GUNNERS AGAINST THE ENEMIES' RIFLEMEN.

Number.	DESCRIPTION	Thickness.	Total Weight.		Weight per square foot.
		in.	lbs.	oz.	lbs. oz.
1	Thornycroft's rolled iron, 4 × 2 ft.....	$\frac{1}{4}$	87	0	10 14
2	Thornycroft's steel iron, 4 × 2 ft.....	$\frac{1}{4}$	84	0	10 8
3	Rolled steel plain plates, 2½ ft. × 3 in., riveted on cowhide.....	$\frac{1}{8}$	52	0	6 15
4	Ditto.....	$\frac{1}{4}$	91	0	12 2 $\frac{3}{8}$
5	Tempered steel.....	$\frac{1}{10}$	36	0	4 8
6	Ditto.....	$\frac{1}{10}$	29	0	4 10
7	Ditto.....	$\frac{1}{10}$	28	0	3 8
8	Annealed steel.....	$\frac{1}{8}$	38	0	4 12
9	Ditto.....	$\frac{1}{8}$	33	0	4 2
10	Ditto.....	$\frac{1}{20}$	29	0	3 10
11	Ditto.....	$\frac{1}{10}$	38	8	4 13
12	Ditto.....	$\frac{1}{2}$	27	4	3 6½
13	Tempered steel.....	$\frac{1}{10}$	32	14	4 1½
14	Ditto, 4 × 2 ft. each.....	$\frac{1}{8}$	39	12	4 15½
15	13 homogeneous iron plates, 2½ ft. × 3 in., riveted to cowhide, and overlapping ½ in.....	$\frac{1}{2}$	41	12	5 9
16	14 ditto.....	$\frac{1}{10}$	41	8	5 8 $\frac{8}{16}$
17	Thornycroft's iron in 2 plates, 2 × 2 ft. each, bound in the centre to a piece of wood.....	$\frac{3}{16}$	85	10	10 11½
18	Ditto, screwed together in centre.....	$\frac{3}{16}$	85	13	10 11½
19	3 homogeneous iron plates, ogee, 1 ft. 6½ in. × 3 in., hinged on jalousie fashion, overlapping.....	$\frac{1}{8}$	6	13	6 0
20	20 homogeneous iron plates, ogee, 2½ ft. × 3 in., overlapping ½ in., hinged on jalousie fashion....	$\frac{1}{8}$	73	6	7 10

TABLE CXLI.—(CONTINUED.)

Number.	DESCRIPTION.	Thickness.	Total Weight.		Weight per square foot.	
		in.	lbs.	oz.	lbs.	oz.
21	Homogeneous iron, in 2 plates, 4 ft. $\times$ 2½ ft., and ¼ in. apart.....	½	105	12	10	9 <sup>8</sup> / <sub>10</sub>
22	Homogeneous iron.....	¼	100	6	10	0 <sup>6</sup> / <sub>10</sub>
23	Ditto.....	⅜	71	12	7	2 <sup>8</sup> / <sub>10</sub>
24	Homogeneous iron, 2 plates, 4 ft. $\times$ 2½ in., and ¼ in. apart.....	½	105	12	10	9 <sup>3</sup> / <sub>10</sub>
25	Case-hardened wrought iron, 2 $\times$ 2½ ft.....	½	81	0	16	3½
26	Homogeneous iron, 2 plates, 2¼ in. apart, with iron bar in centre of plates.....	1½ <sup>2</sup> / <sub>1½</sub>	105	6	10	8 <sup>6</sup> / <sub>10</sub>
27	Ditto.....	1½ <sup>2</sup> / <sub>1½</sub>	130	2	13	0 <sup>2</sup> / <sub>10</sub>
28	Iron wire rope, 1½ in. circumference, stretched across a frame front and rear, one side horizontally and the other vertically, pressed close and screwed with iron staples to the frame, 2 ft. 6 in. $\times$ 25 in.....	2½ from front to rear; diam of rope, ½	102	5	25	8
29	9 homogeneous iron plates, 4 ogee and 5 plain, 2 ft. 2 in. $\times$ 4½ in., riveted on 2 strips of cowhide, overlapping.....	½	38	6	5	10

dented 2d, and one hit an old shot-mark, and passed through both plates.

8, 9, 10. Nos. 8 and 9 placed so as to overlap No. 10; bullets passed through 1st and dented 2d; and same result at 25 yds.

11, 12. No. 11 placed in front of No. 12, gradually separating downwards; bullets passed through 1st and dented 2d.

13, 14. No. 13 plate placed behind No. 14, leaving an interval of about an inch; bullets passed through 1st and slightly dented 2d.

15. Not bullet-proof at 50 yds.; the metal too highly tempered, and only successfully resisted the bullet when the overlapping joints were fairly hit.

16. Not bullet-proof at 50 yds.; 2 shots passed through, and 2 hit the overlapping, which did not penetrate.

17. Not bullet-proof at 25 yds.; one shot passed through, and one hit an old mark and passed through with great force; the plate was considerably cracked and indented; at 10 yds., 4 shot passed through.

18. Not bullet-proof at 25 yds.; 3 shots passed through, and 3 nearly through; plate indented and cracked considerably. At 10 yds., 6 shot passed though out of 10.

19. Bullet-proof from 75 yds. down to 10 yds.; not one passed through; the plates were considerably indented; the jalousie part was a failure; the hinges gave way.

20. Not bullet-proof at 75 yds.; resisted when hit fair on the flaps, but when near the joint, forced its way through. The hinges gave way after 20 rounds.

21. Bullet passed through 1st plate and slightly indented 2d. This mantelet is shot-proof, and would, in all probability, admit of thinner plates without impairing its efficiency.

22. Bullet proof at all distances.

23. Not bullet proof.

24. Bullets penetrated and would have passed through 1st plate, as before, only they were prevented by the closeness of the 2d; the indentations on the 2d plate were much greater than when the interval was  $1\frac{1}{4}$  in.

25. Bullet-proof from 75 yds. down to 10; not one penetrated; slight cracks perceptible in rear of plate.

26. Consider them bullet proof at the shortest range.

27. Bullet-proof at the shortest distance.

28. Not bullet-proof at 50 yds.; 10 shots penetrated, cutting and displacing the strands.

29. Not bullet-proof; one shot passed through at 75 yds., and 6 shot passed through at 50 yds.; several passed through the joints.

**899.** The Committee then fired at the best of these mantelets with 12-pounder segmental shells, which broke up, and 32-pounder solid shot, which caused many splinters, and came to the conclu-

sion that thin iron mantelets of the qualities tried are not adapted for closing the embrasures of guns liable to be attacked directly or replied to by artillery. They may, perhaps, be advantageously applied to embrasures in elevated situations, or others where, from the nature of the ground in their front, guns are little likely to be brought against them; and in such case shutters of homogeneous iron,  $\frac{1}{4}$  in. thick, would appear on the whole preferable to the double-plate mantelet in simplicity and durability, the weight being nearly the same, about 10 lbs. per square foot. Their size, form, and mode of suspension must vary with the form of the embrasure or opening; but, in any case, they should be so attached as not to permit that entry of splinters observed at Chatham.

“Should any tougher quality of iron be hereafter made, that will resist bullets but permit the passage of cannon shot and shells without splintering itself or breaking up the shells, the problem will have been completely solved.

“For siege-works and other situations under artillery fire, the Committee incline to the belief that a non-resisting screen or curtain, which simply hides the interior of the work, is preferable to the mantelet.”

**900. Experiments with Steel and Cast-iron Shot against La Flandre Target, August, 1864.\***—“The target was composed of 4 layers of plates, the two upper being of  $4\frac{3}{4}$  in. thickness, and the two lower plates of  $5\frac{9}{16}$  in. thickness. Those plates were bolted on by screws of  $1\frac{1}{2}$  in. diameter, with a coarse thread at their points to hold fast in the wood. The screws in the upper plates were 19 in. long, and placed at intervals of  $10\frac{1}{4}$  in. from centre to centre; and the screws in the lower plates were 21 in. long and 14 in. apart from centre to centre. Immediately behind the plates was placed 10 in. of teak laid horizontally, and behind that 11 in. of oak placed vertically, inside which was an oak planking of 6 in. thickness, making a total of 27 in. of wood behind the iron plates. This structure was strengthened on the upper part

\* This account is from a corrected report of the experiments, published in the *Army and Navy Gazette*, Aug. 13, 1864.

by a shelf-piece 20 in. deep and  $4\frac{1}{2}$  in. thick, supported by wooden knees 14 in. wide, held by rather slight knee-irons insufficiently bolted. These knees were 5 in number, and had about 2 ft. 10 in. space between them. The lower part of the structure was supported by the water-way and deck laid of the proper thickness, the whole mass being securely fastened in front of Mr. Scott Russell's target."

The first cast-iron ball, from a 68-pounder, struck a corner of a plate, broke up and indented the plate 5 in.

"No. 2 round was fired from the 110-pounder breech-loader, with 12 lbs. of powder and a cast-iron projectile of 110 lbs., and made an indent of 1.7 in.

"No. 3 round was from the 68-pounder, with a steel ball, and made an indentation of 5.7 in., laying bare the wood.

"No. 4 round was from the 110-pounder, with a steel projectile, which penetrated about 5 in. and stuck.

"No. 5 round was from the  $12\frac{1}{2}$ -ton shunt-rifled gun of 9.22-in. bore, and was fired with 30 lbs. of powder and a steel shot of about 225 lbs. weight. This went clean through the target, penetrating the shelf-piece and cutting some of the supports. It was stopped by the Scott Russell target, which it indented and cracked.

"No. 6 round was fired from the same gun. One of Captain Palliser's chilled, hollow shots, weighing 258 lbs., was fired with 44 lbs. of powder, and went through the target, tearing off one of the knees, and hurling it a dozen or more feet behind. This shot broke up into a great number of pieces.

"No. 7 round was fired from the  $10\frac{1}{2}$ -in. 12-ton gun, which is also shunt-rifled; but in this case a steel ball, weighing 168 lbs., was fired with 50 lbs. of powder, going through the target with plenty of force to spare.

"No. 8 round was with a steel ball from the 68-pounder, which made an indent of 3.9 in. in the lower plate.

"No. 9 round was with a steel projectile from the 110-pounder breech-loader; it made an indent of 2.8 in.

"No. 10 round was from the  $10\frac{1}{2}$ -in. gun, which again fired a

steel round ball of 168 lbs., with only  $22\frac{1}{2}$  lbs. of powder. This, to the surprise of those few who knew the fact of the low charge, went clean through.

“No. 11 round was from the 9·22-in. gun, with 30 lbs. of powder and 225-lb. steel shot, and went through, like the previous 5th round from the same gun.

“No. 12 round was from the  $10\frac{1}{2}$ -in. gun, and this time a 301-lb. shot was fired with 35 lbs. of powder. This shot proved to be of cast iron instead of steel, and it broke up after deeply indenting the plate and seriously shaking the target.

“No. 13 round was from the 9·22-in. gun, with 30 lbs. of powder and a 220-lb. steel shot, which went through the target.

“No. 14 round, from the  $10\frac{1}{2}$ -in. gun, with 35 lbs. of powder and a steel shot of 301 lbs., also passed through.

“No. 15 round was from the 9·22-in. gun, with 30 lbs. of powder. This time a steel shell, containing 11 lbs. of powder, was used. The shell burst in the centre of the middle lower plate, which it split, thrusting out the plate below, which was also split, as well as all the woodwork.

“This round completed the shattering of the target behind, and in front some of the plates were just hanging, others were pushed out of place, and the whole a wreck.

“Captain Palliser now had 2 rounds from the 9·22-in. gun, which sent his chilled projectiles through one of the upper plates, with 30-lb. charge each round.”



APPENDIX.



# APPENDIX.

---

## GUN-COTTON.

**901. Report on the Application of Gun-Cotton to Warlike Purposes.** (From the Report of the British Association, 1863.)\*—Since the invention of gun-cotton by Professor Schönbein of Basle, the thoughts of many have been directed to its application to warlike purposes. Many trials and experiments have been made, especially by the French Government; but such serious difficulties and objections presented themselves, that the idea seemed to be abandoned in every country, but one. That country was Austria. From time to time accounts reached England of its partial adoption in the Austrian service—though no explanation was afforded of the mode in which the difficulties had been overcome, or the extent to which these attempts had been successful.

This was the state of the case when the present Committee was appointed.

During the year your Committee have been put in possession of the fullest information on the subject, mainly from two sources, F. A. Abel, Esq., F. R. S., the Chemist to the War Department, and Baron William von Lenk, Major-General of the Austrian Artillery, who is the inventor of the system by which gun-cotton is made practically available for warlike purposes.

Mr. Abel, by permission of the Secretary of State for War, has communicated the information given by the Austrian Govern-

\* This Committee consisted of J. H. Gladstone, Ph. D., F. R. S., Prof. W. A. Miller, M. D., F. R. S., and Prof. E. Frankland, Ph. D., F. R. S., from Section B.; and W. Fairbairn, LL. D., F. R. S., Joseph Whitworth, F. R. S., James Nasmyth, C. E., F. R. A. S., J. Scott Russell, C. E., F. R. S., John Anderson, C. E., and Sir W. G. Armstrong, C. B., LL. D., F. R. S., from Section G.

ment to the Government of this country, and the results which he has himself arrived at during the course of an elaborate series of experiments.

General von Lenk, on the invitation of your Committee, and by permission of the Emperor of Austria, paid a visit to this country, with the object of answering any inquiries the Committee might make, and explaining his system thoroughly; and for this purpose he brought over drawings and samples from the Imperial factory.\*

In addition to these principal sources of information, your Committee would mention the services rendered by two of their own number. Professor Frankland was able to corroborate by his own experiments most of the statements made in the earlier communications of Mr. Abel. Mr. Whitworth has made experiments on the application of gun-cotton in mines, and has sent over to Austria rifles and ammunition, to be experimented with by Baron von Lenk, with a view of obtaining results, which he has promised to communicate to the Committee.

The following documents form part of this Report, and contain the information received.

I. Report by Mr. Abel, received February, 1863, on the system of manufacture of gun-cotton, as carried on in the Imperial Austrian Establishment.

II. Report by Mr. Abel, dated February 10th, 1863, on the composition, and some properties, of specimens of gun-cotton prepared at the Austrian Government Works.

III. Memorandum by Mr. Abel, with reference to experiments

\* It would appear that the British Government at first attempted to get at the secret of the Austrian success without the aid of General Lenk. Failing in this, they formally applied to the Austrian Government, which granted their request for political reasons, but gave as little and as unsatisfactory information as possible to the British Commissioners. Mr. Abel, however, from the inadequate report of the Commissioners, and what additional information he could gather, made some tolerably good, but not perfect, gun-cotton. Meanwhile, General Lenk, naturally anxious to have the British Government use his invention successfully, if at all, was induced to come to England, and to communicate the necessary information. This practical result was chiefly due to the exertions of Mr. Scott Russell.

General Lenk's gun-cotton is patented in England and in the United States.

in progress bearing upon the manufacture of gun-cotton. Received August 27th, 1863.

IV. General von Lenk's replies to the questions put to him at the Meetings of June 22 and July 14.

V. Extracts from a report on Baron Lenk's gun-cotton by Professors Redtenbacher, Schrötter, and Schneider. Dated June, 1863.

On the data afforded by these documents, and other information communicated personally by Baron Lenk, your Committee have founded their present Report. It must therefore be regarded in the light of a preliminary inquiry. Should the Committee be reappointed, they will be happy to undertake some experiments with the view of clearing up those points which are still more or less obscure.

These communications are broken into paragraphs, which are numbered for convenience of reference; those of Mr. Abel are indicated by the letter A., those of Baron Lenk are distinguished by the letter L., whilst the extracts from the Austrian chemists are marked C.

The following is a summary of the more important matters referred to in this evidence, with the main conclusions which your Committee have drawn from them. The subject may naturally be divided into two parts, the chemical and the mechanical.

#### 1. CHEMICAL CONSIDERATIONS.

**902.** Under this head are included the manufacture of the gun-cotton itself, and the answers to such inquiries as those which refer to its liability, or non-liability, to deterioration by keeping, the possibility of its spontaneous decomposition, and the nature and effects of the products into which it is resolved on explosion.

As to the chemical nature of the material itself, Baron Lenk's gun-cotton differs from the gun-cotton generally made, in its complete conversion into a uniform chemical compound. It is well known to chemists that, when cotton is treated with mixtures of strong nitric and sulphuric acids, compounds may be obtained varying considerably in composition, though they all contain the

elements of the nitric acid, and are all explosive. The most complete combination, or product of substitution, is that described by Mr. Hadow as  $C_{36}H_{21}(9NO_4)O_{30}$ , which is identical with that termed by the Austrian chemists Trinitrocellulose,  $C_{12}H_7(3NO_4)O_{10}$ . (C. 2). This is of no use whatever for making colloidion, but it is Baron Lenk's gun-cotton, and he secures its production by several precautions. Of these the most important are—

1st. The cleansing and perfect desiccation of the cotton, as a preliminary to its immersion in the acids.

2d. The employment of the strongest acids attainable in commerce.

3d. The steeping of the cotton in a fresh strong mixture of acids, after its first immersion and partial conversion into gun-cotton.

4th. The continuance of the steeping for forty-eight hours.

5th. The thorough purification of the gun-cotton so produced, from every trace of free acid. This is secured by its being washed in a stream of water for several weeks. Subsequently a weak solution of potash may be used, but this is not essential.

The prolonged continuance of these processes appears at first sight superfluous, but it is really essential; for each cotton-fibre is a long narrow tube, often twisted and even doubled up, and the acid has first to penetrate into the very furthest depths of these tubes, and afterwards has to be soaked out of them. Hence the necessity of time. It seems to have been mainly from want of these precautions that the gun-cotton experimented on by the French Commission gave irregular and unsatisfactory results. (C. 1.)

From the evidence before the Committee, it appears that this highest nitro-compound, when thoroughly free from acid, is not liable to some of the objections which have been urged against that mixture of compounds which has been usually employed for experiments on gun-cotton.

These advantages may be classed as follows:—

1st. It is of uniform composition, and thus the force of the gases generated on explosion may be accurately estimated. (C. 2.)

2d. It will not ignite till raised to a temperature of at least  $136^{\circ}C.$  ( $277^{\circ}F.$ ), a heat which does not occur unless artificially

produced by means which would render gunpowder itself liable to ignition. (C. 5.)

3d. It is almost absolutely free from ash when exploded in a confined space.

4th. It has a very marked superiority in stability over other forms of gun-cotton. It has been kept unaltered for fifteen years, and is not liable to that spontaneous slow decomposition which is known to render lower products worthless after a short time. (C. 4, 6.) Yet there are still some reasons for suspecting that even the gun-cotton produced at the Imperial works suffers some gradual deterioration, especially when exposed to the sunlight. (A. 20; C. 3).

The details of the process of manufacture at Hirtenberg are given at length in Mr. Abel's first report, in General von Lenk's replies (L. 21), and in a patent (No. 1090) taken out by Mr. Thomas Wood Grey, and sealed Oct. 10, 1862.

The course of proceeding recently adopted at the Royal Gunpowder Works, Waltham Abbey, is fully described in Mr. Abel's third memorandum. (A. 10-16.)

There is one part of the process not yet alluded to, and the value of which is more open to doubt, namely, the treatment of the gun-cotton with a solution of silicate of potash, commonly called water-glass. Mr. Abel (A. 15) and the Austrian chemists think lightly of it; but Baron Lenk considers that the amount of silica set free on the cotton by the carbonic acid of the atmosphere is really of service in retarding the combustion. He adds that some of the gun-cotton made at the Austrian Imperial Works has not been silicated at all, and some but imperfectly; but when the process has been thoroughly performed, he finds that the gun-cotton has increased permanently about 3 per cent. in weight. A piece of one of the samples left by the General was indeed found to contain 2.33 per cent. of mineral matter, consisting chiefly of silica.\*

\* Two combustions of it, made by Dr. Gladstone, gave respectively 2.27 and 2.4 per cent. of ash. It was mainly insoluble silica in a state of very fine division; but acids dissolved out of it an appreciable amount of lime.

Much apprehension has been felt about the effect of the gases produced by the explosion of gun-cotton. It has been stated that both nitrous fumes and prussic acid are among these gases, and that the one would corrode the gun, and the other poison the artillerymen. Now, though it is true that from some kinds of gun-cotton, or by some methods of decomposition, one or both of these gases may be produced, the results of the explosion of the Austrian gun-cotton, without access of air, are found by Karolyi to contain neither of these, but to consist of nitrogen, carbonic acid, carbonic oxide, water, and a little hydrogen, and light carburetted hydrogen. (C. 7.) These are comparatively innocuous; and it is distinctly in evidence that practically the gun is less injured by repeated charges of gun-cotton than of gunpowder, and that the men in casemates suffer less from its fumes. (L. 13.) The importance of this latter property in a fortress, or a ship, will be at once apparent.

It seems a disadvantage of this material as compared with gunpowder that it explodes at a lower temperature, possibly at  $136^{\circ}$  C. ( $277^{\circ}$  F.); but against the greater liability to accident arising from this cause may be set the greatly diminished risk of explosion during the process of manufacture, since the gun-cotton is always immersed in liquid, except in the final drying; and that may be performed, if desirable, at the ordinary temperature of the air. Again, if it should be considered advisable at any time, it may be stored in water, and only dried in small quantities when required for use.

The fact that gun-cotton is not injured by damp like gunpowder, is indeed one of its recommendations. It is not even so liable to absorb moisture from the atmosphere, 2 per cent. being the usual amount of hygroscopic moisture found in it; and should that quantity be increased through any extraordinary conditions of the air, the gun-cotton speedily parts with its excess of moisture when the air returns to its ordinary state of dryness. (A. 5 and 8.)

But a still more important chemical advantage which gun-cotton possesses, arises from its being perfectly resolved into gases



on explosion, so that there is no smoke to obscure the sight of the soldier who is firing, or to point out his position to the enemy; and no residue left in the gun to be got rid of before another charge can be introduced.

## 2. MECHANICAL CONSIDERATIONS.

**903.** At the outset of this inquiry the Mechanical Members of the Committee found it difficult to believe that greater effects are produced by a given volume of gases generated from gun-cotton than by an equal volume of gases generated from gunpowder; nevertheless, from the facts as brought before the Committee, such contradiction would at first sight appear to exist.

The great waste of force in gunpowder constitutes an important difference between it and gun-cotton, in which there is no waste. According to the experiments of Bunsen and Schischkoff,\* the waste in gunpowder is 68 per cent. of its own weight, and only 32 per cent. is useful. This 68 per cent. is not only waste in itself, but it wastes the power of the remaining 32 per cent. It wastes it mechanically, by using up a large portion of the mechanical force of the useful gases. The waste of gunpowder issues from the gun with much higher velocity than the projectile; and if it be remembered that in 100 lbs. of useful gunpowder this is 68 lbs., it will appear that a portion of the 32 lbs. of useful gunpowder gas must be employed in impelling a 68-lb. shot composed of the refuse of gunpowder itself.

There is yet another peculiar feature of gun-cotton: it can be exploded in any quantity instantaneously. This was once considered its great fault; but it was only a fault when we were ignorant of the means to make that velocity any thing we pleased. General von Lenk has discovered the mean of giving gun-cotton any velocity of explosion that is required, by merely varying the mechanical arrangements under which it is used. Gun-cotton in his hands has any speed of explosion, from 1 foot per second to 1 foot in  $\frac{1}{1000}$  of a second, or to instantaneity. The instantaneous explosion of a large quantity of gun-cotton is made use of when it is

† Pogg. Annal., 4th Series, vol. xii. p. 131.

required to produce destructive effects on the surrounding material. The slow combustion is made use of when it is required to produce manageable power, as in the case of gunnery. It is plain, therefore, that if we can explode a large mass instantaneously, we get out of the gases so exploded the greatest possible power, because all the gas is generated before motion commences, and this is the condition of maximum effect. It is found that the condition necessary to produce instantaneous and complete explosion is the absolute perfection of closeness of the chamber containing the gun-cotton. The reason of this is, that the first ignited gases must penetrate the whole mass of the cotton; and this they do (and create complete ignition throughout) only under pressure. This pressure need not be great. For example, a barrel-load of gun-cotton will produce little effect and very slow combustion when out of the barrel, but instantaneous and powerful explosion when shut up within it.

On the other hand, if we desire gun-cotton to produce mechanical work and not destruction of materials, we must provide for its slower combustion. It must be distributed and opened out mechanically, so as to occupy a larger space, and in this state it can be made to act even more slowly than gunpowder; and the exact limit for purposes of artillery General von Lenk has found by critical experiments. In general it is found that the proportion of 11 lbs. of gun-cotton, occupying 1 cubic foot of space, produces a greater force than gunpowder (of which from 50 to 60 lbs. occupy the same space), and a force of the nature required for ordinary artillery. But each gun and each kind of projectile requires a certain density of cartridge. Practically gun-cotton is most effective in guns when used as  $\frac{1}{4}$  to  $\frac{1}{3}$  weight of powder, and occupying a space of  $\frac{1}{16}$ th of the length of the powder cartridge, and of such density that 11 lbs. occupy a cubic foot.

The mechanical structure of the cartridge is of high importance, as affecting its ignition. The cartridge is formed of a mechanical arrangement of spun cords; and the distribution of these, the place and manner of ignition, the form and proportion of the cartridge, all affect the time of complete ignition. (A. 19.; L. 22.)

It is by the complete mastery he has gained over all these minute points that General Lenk is enabled to give to the action of gun-cotton on the projectile any law of force he pleases.

Even at the present high price of cotton, its cost of production is said to be less than that of gunpowder, the price of quantities being compared which will produce equal effects. (L. 20.)

#### PRACTICAL APPLICATIONS.

**904.** Gun-cotton is used for artillery in the form of thread or spun yarn. In this simple form it will conduct combustion slowly in the open air at a rate of not more than 1 foot per second. This thread is woven into a texture or circular web. These webs are made of various diameters; and it is out of these webs that common rifle-cartridges are made, merely by cutting them into the proper lengths, and enclosing them in stiff cylinders of paste-board, which form the cartridge. In this shape its combustion in the open air takes place at a speed of 10 feet per second. In these cylindrical webs it is also used to fill explosive shells, as it can be conveniently employed in this shape to pass in through the neck of the shell. Gun-cotton thread is spun into ropes in the usual way, up to 2 inches diameter, hollow in the centre. This is the form used for blasting and mining purposes; it combines great density with speedy explosion, and in this form it is conveniently coiled in casks and stowed in boxes. The gun-cotton yarn is used directly to form cartridges for large guns, by being wound round a bobbin, so as to form a spindle like that used in spinning-mills. The bobbin is a hollow tube of paper or wood. The object of the wooden rod is to secure in all cases the necessary length of chamber in the gun required for the most effective explosion. The gun-cotton circular web is enclosed in tubes of India-rubber cloth to form a match-line, in which form it is most convenient, and travels with speed and certainty.

**905.** *Conveyance and Storage of Gun-Cotton.*—It results from the foregoing facts that 1 lb. of gun-cotton produces the effect of more than 3 lbs. of gunpowder in artillery. This is a material advantage, whether it be carried by men, by horses, or in wagons.

It may be placed in store and preserved with great safety. (L. 7 and 16.) The danger from explosion does not arise until it is confined, as it simply burns intensely in the open air. It may become damp and even perfectly wet without injury, and may be dried by mere exposure to the air. This is of great value in ships of war; and in case of danger from fire, the magazine may be submerged without injury.

**906.** *Practical use in Artillery.*—It is easy to gather from the foregoing general facts how gun-cotton keeps the gun clean, and requires less windage, and therefore performs much better in continuous firing. In gunpowder there is 68 per cent. of refuse, or the matter of fouling. In gun-cotton there is no residuum, and therefore no fouling.

Experiments made by the Austrian Committee proved that 100 rounds could be fired with gun-cotton against 30 rounds of gunpowder.

In firing ordnance with gun-cotton, the gun does not heat to any important extent. Experiments showed that 100 rounds were fired with a 6-pounder in 34 minutes, and the gun was raised by gun-cotton to only 122° Fahrenheit, whilst 100 rounds with gunpowder took 100 minutes, and raised the temperature to such a degree that water was instantly evaporated. The firing with the gunpowder was therefore discontinued; but the rapid firing with the gun-cotton was continued up to 180 rounds without any inconvenience. (L. 9.) The absence of fouling allows all the mechanism of a gun to have more exactness than where allowance is made for fouling. The absence of smoke promotes rapid firing and exact aim.

**907.** *The fact of smaller recoil* from a gun charged with gun-cotton is established by direct experiment; its value is two-thirds of the recoil from gunpowder—the projectile effect being equal. (L. 5.) To understand this may not be easy. The waste of the solids of gunpowder accounts for one part of the saving, as in 100 lbs. of gunpowder 68 lbs. have to be projected in addition to the shot, and at much higher speed. The remainder General von Lenk attributes to the different law of combustion; but the fact is established.

The comparative advantage of gun-cotton and gunpowder for producing high velocities is shown in the following experiment with a Krupp's cast-steel gun, 6-pounder. An ordinary charge, 30 oz. powder, produced 1338 feet per second. A charge of 13½ oz. gun-cotton produced 1563 feet.

The comparative advantage in shortness of gun is shown in the following experiments with a 12-pounder:—

	Charge.	Length of gun.	Velocity.
Gunpowder.....	49·0 oz.*	13½ calibres.	1400
Gun-cotton.....	15·9 “	10 “	1426
“ .....	17·0 “	9 “	1402

*Advantage in Weight of Gun.*—The fact of the recoil being less, in the ratio of 2:3, enables a less weight of gun to be employed as well as a shorter gun, without the disadvantage to practice arising from lightness of gun. (L. 5.)

**908.** *Endurance of Gun.*—Bronze and cast-iron guns have been fired 1000 rounds without in the least affecting the endurance of the gun.

**909.** *Application to destructive Explosions.*†—*Explosion of Shells.*—From some unexplained difference in the action of gun-cotton, there is an extraordinary difference of result as compared with gunpowder; namely, the same shell is exploded by the same quantity of gas into more than double the number of pieces. This is partly to be accounted for by the greater velocity of explosion when the gun-cotton is confined very closely in very small spaces. It is also a peculiarity, that the stronger the shell the smaller the fragments into which it is broken. (L. 17.)

**910.** *Mining Uses.*—The fact that the action of gun-cotton is violent and rapid in exact proportion to the resistance it encounters, tells us the secret of its far higher efficacy in mining than gunpowder. The stronger the rock the less gun-cotton comparatively with gunpowder is necessary for the effect; so much so that, while gun-cotton is stronger than powder as 3 to 1 in artillery, it is stronger in the proportion of 6·274 : 1 in a

\* Ordinary charge of powder.

† See also results of recent experiments (967).

strong and solid rock, weight for weight. It is the hollow rope form which is used for blasting. Its power of splitting up the material can be regulated at will.

**911.** *Against the Gates of a City.*—It is a well-known fact that a bag of gunpowder nailed on the gates of a city will blow them open. In this case gun-cotton would fail; a bag of gun-

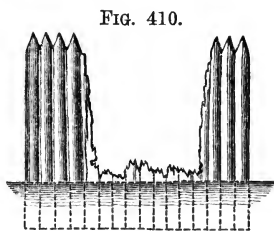


FIG. 410.

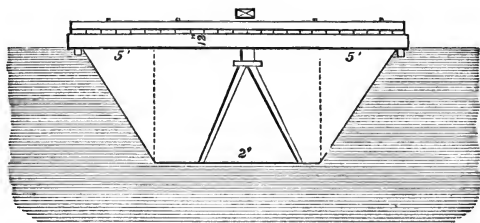
12 and 8-in. palisade cut down by 25 lbs. of gun-cotton.

cotton exploded in the same way is powerless. If 1 ounce of gunpowder is exploded in scales the balance is thrown down; with an equal force of gun-cotton the scale-pan is not depressed. To blow up the gates of a city, a very few pounds of gun-cotton carried in the hand of a single man will be sufficient; only he must know its nature. In a bag it is

harmless; exploded in a box it will shatter the gates to atoms.

**912.** *Against the Palisades of a Fortification.*—A small square box containing 25 lbs. merely flung down close to them, will open a passage for troops. In an actual experiment on palisades a foot diameter and 8 feet high, driven 3 feet into the ground, backed by

FIG. 411.



Bridge of oak, 12 inches scantling, 24 feet span.

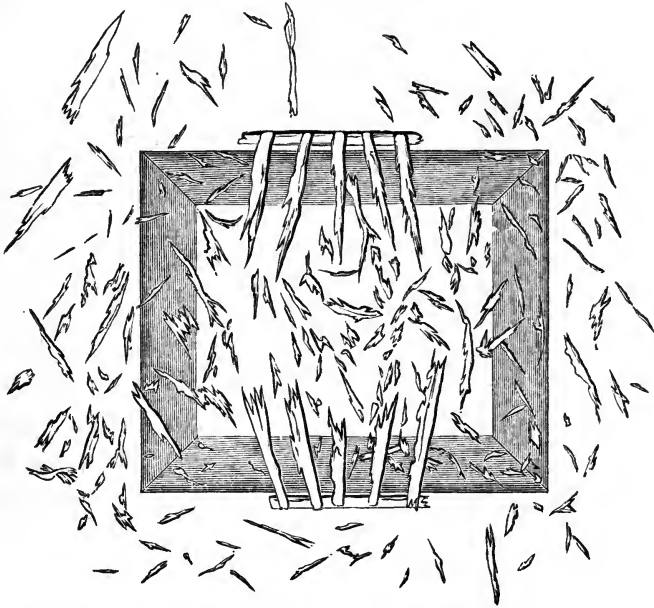
a second row of 8 inches diameter, a box of 25 lbs. cut a clean opening 9 feet wide (Fig. 410). On this three times the weight of gunpowder produced no effect whatever, except to blacken the piles.

**913.** *Against Bridges.*—A strong bridge of oak (Fig. 411), 12 inches scantling, 24 feet span, was shattered to atoms (Fig. 412)

by a small box of 25 lbs. laid on its centre: the bridge was not broken, it was shivered.

**914.** *Under Water.*—Two tiers of piles 10 inches thick, in water 13 feet deep, with stones between them, were blown up by

FIG. 412.



Bridge of oak, shattered to atoms by a box of 25 lbs. of gun-cotton.

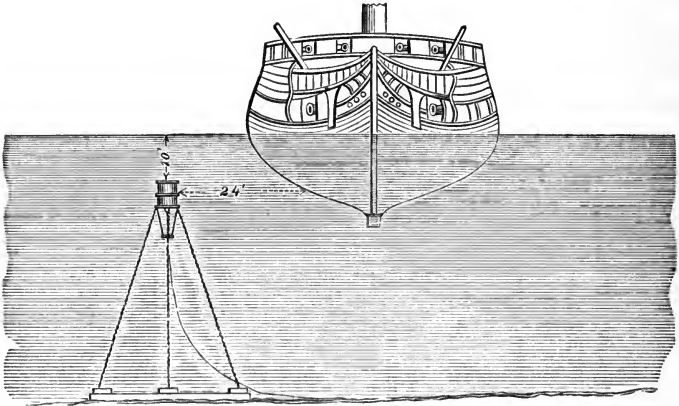
a barrel of 100 lbs. gun-cotton placed 3 feet from the face, and 8 feet under water. It made a clean sweep through a radius of 15 feet, and raised the water 200 feet. In Venice, a barrel of 400 lbs. placed near a sloop in 10 feet water at 18 feet\* distance, shattered it to pieces and threw the fragments to a height of 400 feet (Fig. 413).

All experiments made by the Austrian Artillery Committee were conducted on a grand scale—36 batteries of 6 and 12-pounders having been constructed for gun-cotton, and practised

\* The official record from which the author has copied these illustrations states this distance to have been 24 feet. The *local* effect of gun-cotton is shown by Figs. 414 and 415—a 25-lb. box laid on the side of a bridge.

with that material. The reports of the Commissioners are all based on trials with ordnance from 6-pounders to 48-pounders smooth-bore and rifled cannon. The trials with small fire-arms

FIG. 413.



400-lb. gun-cotton torpedo, 24 feet from a ship. Ship blown to pieces.

have been comparatively few, and are not reported on. The trials for blasting and mining purposes were also made on a large scale by the Imperial Engineers Committee, and several reports have been made on the subject.

FIG. 414.

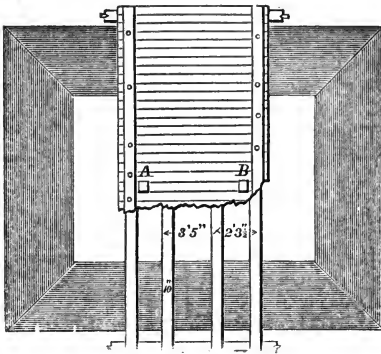
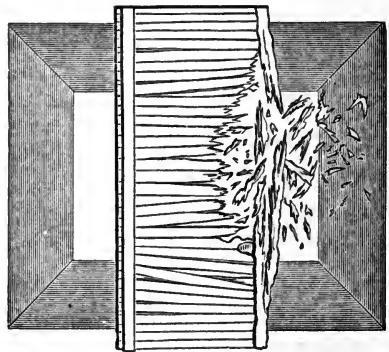


FIG. 415.



Effect of a 25-lb. box of gun-cotton, laid on the side of a bridge.

The Committee desire to put upon record their conviction that the subject has neither chemically nor mechanically received the



thorough investigation which it deserves. There remain many exact measures still to be made, and many important data to be obtained. The phenomena attending the explosion of both gun-cotton and gunpowder have to be investigated, both as to the temperatures generated in the act of explosion, and the nature of the compounds which result from them under circumstances strictly analogous to those which occur in artillery practice; and until these are accurately ascertained, it is impossible to reconcile the apparent contradictions between the mechanical phenomena which result from the employment of gun-cotton gases and gunpowder gases, when employed to do the same kind of mechanical work.

---

#### APPENDIX TO THE FOREGOING REPORT.

##### **915. I. System of Manufacture of Gun-Cotton as carried on in the Imperial Austrian Establishment. By F. A. Abel, F. R. S.**

(1) The cotton employed is of superior quality, tolerably free from seed; it is carded loosely, twisted, and made up into skeins before conversion. The strands of the cotton composing the skeins are of two sizes—the larger being intended for cannon-cartridges, and the other for small-arm cartridges and bursters.

**916.** (2) *Preparatory Preparation of the Cotton.*—The cotton, made up into skeins weighing about 3 ounces each, is washed in a solution of pure carbonate of potassa of the specific gravity 1.02, being immersed in the boiling solution for a short time. Upon removal from the alkaline liquid, the skeins are placed in a centrifugal machine, by which the greater portion of the liquid is separated. The skeins are now washed in clear running water, either by allowing them to remain in it for three or four hours, or else by washing each skein by hand for a few minutes. They are then again worked in a centrifugal machine and afterwards dried—in summer by the rays of the sun, but during winter in a

drying-house heated by air-pipes to between 30° and 38° C.; the latter plan usually takes four or five days.

**917.** (3) *Production of the Gun-Cotton.*—The nitric acid employed has a specific gravity of 1.53, and the sulphuric acid a specific gravity of 1.82. They are mixed in the proportion of three parts by weight of sulphuric acid and one part of nitric acid.

Two skeins (about 6 ounces) of the cotton are immersed at one time in the mixed acids, and moved about for a few moments with iron paddles. They are then raised upon a grating above the level of the acids and submitted to gentle pressure; thence they are transferred to covered stone jars, each of which receives six skeins of known weight. The jars are then weighed, some of the mixed acids being added if necessary, to bring the proportion of acids up to 10½ lbs. to 1 lb. of cotton.

The jars are set aside for forty-eight hours in a cool place; in summer they should be placed in cold water. When that period has elapsed, the acid is separated from the cotton, as far as possible, by means of a centrifugal machine, as before described. The men working the machine are protected from the fumes of the acids by a wooden partition. The acids removed from the cotton are not used again in the preparation of gun-cotton.

The skeins of gun-cotton are at once removed from the centrifugal machine to perforated receptacles, which are immersed in a stream, where they are allowed to remain at least three weeks. Each skein is afterwards separately rinsed in the stream to remove mechanical impurities, and the water is then separated by the centrifugal machine.

The gun-cotton is next submitted to treatment with a solution of carbonate of potassa, as in the preliminary process, and again washed after the alkaline liquid has been expressed. When the skeins have been allowed to dry tolerably by simple exposure to air, they are placed in a large wooden tub containing a solution of silicate of soda, the temperature of which is about 15° C. This solution should have a specific gravity of 1.072, and is prepared as required from a solution of spec. grav. 1.216. The cotton remains

one hour in the solution of silicate of soda, which is supposed to exercise two functions:—

(a) That of protecting the cotton by acting as a varnish upon the fibres.

(b) That of retarding its combustion.

Upon removal of the gun-cotton from the bath of water-glass, the liquid is partly expressed by hand, and afterwards more fully by means of the centrifugal machine. The skeins must then be thoroughly dried. They are afterwards immersed in running water for five or six hours, and each skein subsequently washed by hand. The water having been extracted by the centrifugal machine, the gun-cotton is removed to the drying-house, where it remains eight or ten days. Its manufacture is then completed.

The gun-cotton is packed in ordinary deal boxes lined with paper, and kept in dry magazines until required to be made into cartridges, &c.

Well-organized arrangements are employed for mixing the sulphuric and nitric acids, immersing the cotton, and for conducting the various other operations connected with the manufacture.

**918. II. On the Composition, and some Properties, of Specimens of Gun-Cotton prepared at the Austrian Government Works. By F. A. Abel, F. R. S.**—(4) Several specimens of gun-cotton prepared at the Imperial Factory at Hirtenberg, near Vienna,\* being the descriptions manufactured for cannon, for shells, and for small arms, were submitted to chemical examination, to determine the following points:—

(a) The proportion of hygroscopic moisture existing in them, under normal conditions.

(b) The composition of the different specimens of gun-cotton.

(c) The proportion and nature of their mineral constituents.

(5) I. The proportion of moisture expelled from the samples of gun-cotton, by exposure to desiccation *in vacuo* over sulphuric

\* Several of these specimens were taken from ammunition, &c., which were being used at the time, for experimental practice, by the Austrian authorities.

acid, was very uniform. The specimens were examined both in the condition in which they were found on opening the parcel containing them, and after their exposure for some time to a temperate and moderately dry atmosphere. The mean proportion of hygroscopic moisture found in the gun-cotton was 2 per cent. Further experiments, relating to the hygroscopic properties of the gun-cotton, will be described hereafter.

**919.** (6) II. The composition of the specimens of Austrian gun-cotton, *i. e.*, the proportion of hydrogen-atoms which had been replaced, in the original cotton, by hyponitric acid, was determined by the synthetical method first employed by Mr. Hadow, in his examination of the substitution products obtained by the action of nitric acid upon cotton.\* The dried specimens of gun-cotton were digested in the cold, for twenty-four hours, in an alcoholic solution of sulphhydryde of potassium (KS, HS), prepared as prescribed by Mr. Hadow; and the reduced cotton thus obtained in each case was thoroughly washed and dried. These products, after weighing, were proved to be free from nitrogen-compounds, by the ignition of portions with hydrate of potassa, when no indications of the existence of nitrogen in the specimens were obtained.

The percentage of cotton obtained by this synthetical method from four specimens of the gun-cotton were as follows:—

I.....	55·20	per cent.
II.....	55·07	“
III.....	55·13	“
IV.....	54·97	“

These results show, as might have been predicted from the method of treatment of the cotton adopted, that the products obtained at the Austrian works consist, very uniformly, of the most highly explosive variety of gun-cotton, represented by the formula  $C_{36}H_{21}O_{30}, 9NO_4$ , as is shown by a comparison of the above numbers with Mr. Hadow's results, and with the theoretical percentage number:—

\* “Quart. Journ. Chem. Society,” vol. vii., p. 201.

By synthesis.				
Cotton found in Austrian samples.	Hadow.	By analysis. Hadow.		By calculation.
55.20				
55.07	55.13	54.6	55.19	54.54
55.13				
54.97				

**920.** (7) III. The proportions of non-volatile matter or ash contained in the specimens of gun-cotton were determined in the following manner. The weighed gun-cotton was thoroughly moistened with distilled water; it was then cut into small fragments, and these were projected from time to time into a deep platinum vessel heated to dull redness. In this manner the gun-cotton was decomposed very gradually, the expulsion of the volatile portions being placed under such complete control as to exclude the possibility of any mechanical dispersion of portions of the ash. The heat was finally raised sufficiently to burn off any small quantity of residual carbon. From the ash thus obtained, the proportion was calculated upon the dry gun-cotton. Results obtained by this method from several determinations, with the same specimen of gun-cotton, were closely concordant; but those furnished by different specimens varied slightly.

The following were the main percentage results obtained:—

- (a) From a specimen of gun-cotton prepared for cannon.....1.14 per cent.  
 (b) From a specimen of gun-cotton prepared for small arms and shells.. .....0.42 “  
 (c) From a specimen of gun-cotton prepared for blasting purposes.....1.90 “

(This specimen was slightly discolored, made from a lower quality of cotton, and not so perfectly washed as (a) and (b).)

The analysis of the ash furnished by the gun-cotton in these experiments demonstrated the existence of some differences in the proportions of the several mineral constituents of the different specimens. The ash from (a) consisted of

Silicic acid.....	0.71	per cent in the cotton..
Lime .....	0.13	“ “
Magnesia.....	trace.	
Oxide of iron.....	trace.	
Alkalies.....	0.25	“ “
Sulphuric acid.....	trace.	

That furnished by specimen (*b*) consisted principally of lime; it contained besides traces of magnesia, oxide of iron, and alkalis, and only a small trace of silicic acid.

The ash from (*c*) consisted of

Sand and clay.....	0.75	per cent. in the cotton.
Silicic acid, soluble.....	0.53	“ “
Lime.....	0.27	“ “
Alkalis.....	0.30	“ “
Magnesia.....	} traces.	
Oxide of iron.....		
Sulphuric acid. ....		

The ash was determined for comparison in a specimen of cotton obtained from the Austrian Works which had been submitted to the preparatory purifying processes (treatment with carbonate of potassa and long-continued washing). The results obtained furnished a mean of 0.63 per cent. of ash, which consisted principally of lime and magnesia, and contained a small proportion of insoluble matter (clay and sand), traces of soluble silicic acid, and of alkalis.

The above determinations and analyses of the ash in the gun-cotton and in the unconverted cotton show that no result of the slightest practical importance, in the direction supposed to be aimed at, is obtained by the treatment with solution of soluble glass, to which the purified gun-cotton is submitted, according to the Austrian system of manufacture.

It is evident that, by the washing in running water for five or six hours, and subsequent rinsing of each skein, *after* the treatment with silicate of soda, the proportion of the latter which had in the first instance been introduced into the cotton is again extracted, only traces being retained by the cotton, besides a very small proportion of silica in the form of pulverulent silicate of lime, resulting from the decomposition of the soluble glass by the lime-salts in the spring or river water. It will be observed that, in specimen (*b*) of gun-cotton, the proportion of non-volatile constituents is actually even less than that found in the purified but unconverted cotton—a fact which is evidently due to the solvent action of the acids upon portions of the mineral matter in the

cotton. In the place of the comparatively large proportions of lime and magnesia in the *original* cotton, the product which, after separation from the acids by very long-continued washing, &c., has been submitted to treatment with soluble glass and again washed, contains some small quantities (necessarily variable in a product of manufacture) of impurities (clay and sand) derived from the water used, and of silicic acid in combination with lime and also with soda, minute quantities of the soluble glass having escaped removal or decomposition in the final washing process. Supposing that the maximum proportion of silicates (1 per cent.) found in the above determinations existed entirely in the form of soluble glass in the finished gun-cotton, a piece of twist 12 ft. 10 in. in length, and of the size used for artillery purposes ( $\frac{1}{4}$  inch thick), would contain only one grain of soluble glass. It is evident, therefore, that no protective effect nor retardation in the explosion of the gun-cotton can result from the treatment with soluble glass to which it is submitted.

**921. Experiments on the Hygroscopic Properties of the Austrian Gun-Cotton.**—(8) It has already been stated that the proportion of moisture contained, under normal conditions, in the specimens of Austrian gun-cotton was found to be very uniform, the main proportion being fixed at 2 per cent. by the results of several experiments.

Some gun-cotton prepared from ordinary cotton-wool, and having the same composition as the Austrian samples—but not having been submitted to the preparatory or subsequent treatment with alkali, nor to the very long-continued washing—was examined with regard to its hygroscopic properties in comparison with the Austrian gun-cotton. The proportion of moisture existing in the former, under ordinary conditions, was found to be almost identical with the average proportion in the Austrian samples.

Some experiments were instituted to ascertain the rate at which the Austrian gun-cotton would absorb moisture on exposure to a damp atmosphere.

The specimens experimented with were first thoroughly dried

*in vacuo* over sulphuric acid, and then exposed for successive periods, together with a shallow vessel containing water, under a capacious bell-jar placed in a moderately warm room. The following results were obtained:—

Specimen.	Period of exposure to a damp atmosphere.					
	1 hr.	2 hrs.	4 hrs.	20 hrs.	80 hrs.	72 hrs.
No. 1.....	1·35	...	...	3·15	...	3·87
" 2.....	1·60	...	...	3·21	...	3·65
" 3.....	...	1·89	2·15	...	3·55	...
" 4.....	...	1·73	2·00	...	3·21	...
" 5.....	1·77	2·21	...	...	...	3·90

These results show that the rate of absorption of moisture by the gun-cotton is uniformly rapid up to the point where 2 per cent. (the normal proportion of hygroscopic moisture) have been absorbed, and that, when this point has been attained, the absorption of further moisture proceeds comparatively very slowly.\* Several experiments were made to determine, as far as possible, the *maximum* amount of moisture which the gun-cotton would absorb from a damp confined atmosphere. The great rapidity with which the specimens operated upon parted with the water absorbed, on exposure to the ordinary atmosphere, after the experiments had been proceeded with for some days, rendered the attainment of accurate numbers very difficult. The results, however, showed very definitely that no important increase in the amount of water absorbed took place when it had reached from 5·5 to 6 per cent. When these specimens had ceased to absorb moisture, they were, after the last weighing, exposed to the atmosphere at the ordinary temperature for one hour, and again weighed, when they were found to have parted with very nearly one-half of the total proportion of water absorbed. After further exposure to air for about four hours, the proportion of moisture retained had fallen to the average normal percentage (2 per cent.), and afterwards evinced no further tendency to decrease.

\* Several determinations of the moisture in cotton rovings, both before and after treatment with alkali (and repeated washing), show that the proportion of hygroscopic moisture in the cotton amounts to between 6 and 7 per cent., this amount being reabsorbed by the dried cotton, within twenty-four hours, on exposure to air.



Two specimens were kept confined as described, together with a vessel of water, for several weeks in a moderately warm room. The water had then condensed, in numerous minute globules, upon the projecting filaments of the gun-cotton; the specimens were therefore very highly charged with moisture. In this condition they were exposed to the air at the ordinary temperature; within one hour and a half they contained only about 4·5 per cent. of moisture. After the lapse of a second similar period, the moisture had decreased to about 3 per cent (3·16 in one specimen and 2·78 in the other). When again weighed, after a lapse of about four hours, the percentage of water had fallen, in both, to the average proportion.

Experiments corresponding to the above were made with the specimen of gun-cotton referred to above as having been prepared from common cotton-wool. The rate of absorption of moisture of this specimen was found to be decidedly more rapid than that of the Austrian gun-cotton; but they very closely resembled each other as regarded the rapidity with which they again parted, spontaneously, with the moisture absorbed from a damp atmosphere, and the average proportion ultimately retained. The differences noted in the rate of absorption of moisture between the two varieties of gun-cotton, is most probably due to the difference in their mechanical condition. Some of the specimens of Austrian gun-cotton used in these experiments were picked asunder, as loosely as possible, instead of being exposed in the form of twists; the difference thus established in the mechanical condition of the specimens did not affect, to any great extent, their relative hygroscopic properties. It was found impracticable, however, to reduce the gun-cotton rovings to the same mechanical condition as the gun-cotton prepared from finely carded wool.

**922.** It appears from the results above described, that—

(a) The proportion of moisture absorbed and retained, under ordinary circumstances, by the gun-cotton is about double that contained under similar conditions in good gunpowder (which averages one per cent.).

(b) Gun-cotton possesses no tendency to absorb moisture beyond that proportion, unless in very damp situations; and even under those circumstances the proportion of moisture absorbed is limited. Moreover its capacity for retaining water (beyond the normal proportion) is so feeble that, however highly it may have accidentally become impregnated with moisture, it will return spontaneously to its original condition of dryness by simple exposure to the open air for a few hours. In these respects it possesses important advantages over gunpowder; for although the latter contains, under normal conditions, less moisture than gun-cotton, it exhibits great tendency to absorb water from a moist atmosphere, which it continues to exert until it actually becomes pasty. Moreover gunpowder, when once damp, cannot be restored to a serviceable condition without being again submitted to the incorporating and subsequent processes. \* \* \*

**923. IV. Information given by Baron Lenk on June 22 and July 14, 1863.**—1. *What weight of gun-cotton and gunpowder give equal effects?*—In accordance with experience, gun-cotton produces the same effect as three times its weight of gunpowder; which proportion, under certain circumstances, may be increased to six times its weight of gunpowder; for the effect of gun-cotton in proportion to gunpowder is the greater the more resistance is offered to the charge by the sides which enclose it, and the less gas can escape at the beginning of the explosion.

**924.** 2. *What bulks of each give equal effect?*—The space required for a gun-cotton cartridge, to produce an equal effect, is scarcely half as large as that of a gunpowder cartridge; and it is only made equally large or slightly larger, if secondary circumstances should demand it.

**925.** 3. *Is the effect more constant with gun-cotton or with gunpowder?*—The effect of small fire-arms and of artillery in general is considerably more uniform and constant with the use of gun-cotton than with gunpowder, provided the proper charge and cartridge has been taken.

That superiority gun-cotton partly owes to the chemical process by which I have produced it, and partly to the uniform forma-

tion of the cartridge, which can only be attained by its regular texture, using it in the shape of cotton-yarn.

**926.** 4. *Which admits of more precise aim?*—On account of the more constant effect of gun-cotton, and because its use prevents fouling of the gun, which further admits to reduce the space between shot and barrel, and on account of less heating of the gun, as well as by the uniform position of the cartridge, there must be a more precise aim of shot with gun-cotton—which, moreover, has been fully proved by experience.

**927.** 5. *Which occasions least recoil?*—Chiefly on account of the smaller space of time the projectile requires to pass through the barrel of a gun to attain a certain initial velocity, the recoil of the gun is less than with the use of gunpowder. It may be stated that, by the official trials of the Commissioners in the year 1860, the recoil of the gun with gun-cotton was found to be 0.68 of that with gunpowder.

**928.** 6. *What is the relative effect as to fouling?*—Except an extremely small residuum of carbon, there is no deposit with the use of gun-cotton. The barrel of a gun requires no cleaning out; there is no chemical effect upon cast and wrought iron, steel, or bronze barrels by using gun-cotton cartridges.

**929.** 7. *Is gun-cotton liable to decay when stored?*—Gun-cotton has been stored like gunpowder for twelve years, usually packed in wooden boxes: and no trace of alteration has been discovered. My own experiments go back as far as 1846, and have given most favorable results in this respect.

**930.** 8. *How is it affected by water or damp?*—Gun-cotton placed under water is unalterable. By the transformation of ordinary cotton into gun-cotton, it loses the greater part of its hygroscopic property, so that gun-cotton, properly manufactured, resists the influence of damp much better than gunpowder: and moreover it cannot, like gunpowder, get permanently spoiled thereby. Gun-cotton, if dried in the open air, contains 2 per cent. moisture; ordinary cotton, about 6 per cent. Gun-cotton, placed in a room completely saturated with moisture, after thirty-three days of exposure contained 8 per cent. moisture, whilst under the

same circumstances gunpowder was saturated with 79·9 per cent. of water; some weeks afterwards the whole saltpetre of the gunpowder was converted into a concentrated solution of saltpetre, whilst gun-cotton took no more than 8 per cent. of water as a maximum saturation.

**931.** 9. *Which admits of most rapid firing?*—The gun being heated considerably less by using cotton cartridges, the absence of a noteworthy residuum and smoke admits of a more easy manipulation and sighting of the gun, and thereby secures a more continuous and rapid fire.

It may be stated that 100 rounds with gun-cotton were fired in thirty-four minutes, and the barrel was heated to fifty degrees Cent.; whilst 100 rounds with gunpowder cartridge in 100 minutes heated the gun so much that water dropped on the barrel immediately evaporated with noise, though three times as much time was required with the powder charges. The Commissioners continued the trials with gun-cotton up to 180 rounds without any danger from heating being apprehended, whilst the Commissioners thought it advisable, for the sake of safety, not to continue firing with powder charges under the above circumstances.

**932.** 10. *What effect has gun-cotton on the coolness and cleanliness of the gun?*—It has been already mentioned that, with the use of gun-cotton, fire-arms remain considerably cooler than with gunpowder: and the slight residuum has no influence upon the effect of the gun.

**933.** 11. *How far is it adapted for breech-loading?*—There being no fouling of the gun, it follows that with the use of breech-loaders the construction of the breech may be kept quite tight.

**934.** 12. *How is it for precision of aim?*—Under all circumstances the aim is not disturbed or interrupted, there being no smoke attending the discharge of the gun.

**935.** 13. *Has it any special advantages in forts, ships, and casemates?*—From many experiments, but especially from the official trials made in the casemates of the fortress of Comorn in the year 1853, it results that under circumstances which would render the firing with powder difficult, or even impossible, there

was no trouble or molestation in any way to those serving the guns with the use of gun-cotton cartridges.

The trials in the fortress of Comorn were made in casemates, ventilation being intentionally obviated. After fifteen rounds with powder cartridges, further sighting of the gun was impossible; after forty-six rounds, one of the men serving the gun fell into convulsions of suffocation; a second man being ordered in the place of the first disabled man, got immediately sick on entering the casemate; the rest of the men were more or less stupefied; it was necessary to stop firing after fifty rounds given in eighty minutes. By using gun-cotton cartridges, on the contrary, after fifty rounds the men serving the gun felt not the least molestation, and the aim was always clearly visible.

**936.** 14. *How is it adapted for mining?*—The more accelerated effect of gun-cotton, and the possibility of enclosing in the same space more than double the quantity of gases, especially direct us to employ gun-cotton where it is desired to attain an energetic effect for mining purposes, for example, to secure harbors by means of sea-mines.

**937.** 15. *What is the relative danger of manufacture?*—In the manufacture of gun-cotton every manipulation, up to its final accomplishment, is without any danger whatever, whilst with the manufacture of gunpowder danger of explosion exists from the beginning of the operation.

**938.** 16. *What is the comparative risk in conveyance?*—The smaller weight of gun-cotton, as well as the smaller volume of it for an equal effect, favors the conveyance of gun-cotton considerably; and it may be taken moreover into consideration that the dangerous “getting to dust” of powder cannot take place with gun-cotton.

The transport of gun-cotton to the most distant parts of the empire of Austria under intentionally difficult circumstances, has always been effected without difficulty.

**939.** 17. *How is it adapted for shells?*—Shells filled with gun-cotton hold a considerably larger quantity of material for the production of gases; at the same time, it is in the nature of both

compounds that gun-cotton develops far quicker the gases of combustion than gunpowder; for this reason, shells filled with gun-cotton burst into at least double the number of pieces.

**940.** 18. *Is it liable to spontaneous explosion?*—From the last Report, dated June, 1863, of the Professors of Chemistry appointed by the Minister for War to report on that subject, and to give their opinion, and which is submitted to you, the apprehension of self-explosion has in no way any foundation whatever.

Without direct ignition, gun-cotton may detonate between iron and iron if a heavy blow be struck; but it is known that only that part explodes which was hit, without communicating ignition to the surrounding particles. If, however, even with an iron hammer, gun-cotton be struck a heavy blow upon bronze or other soft metals, or upon stone, no detonation can take place. In every report of the Austrian Empire Commissioners, that subject was considered and disposed of as not impairing the safety of manipulation.

**941.** 19. *How far is it possible to regulate its explosive power?*—It has been established by experience that it is possible to moderate the force of gun-cotton within very extensive limits, and thereby to suit it to the different purposes without having ground for apprehension that variable effects would be the consequence; that valuable property of gun-cotton, however, requires that the trials be made under the superintendence of an expert, which will secure the desired effects to a certainty.

**942.** 20. *What is its cost of manufacture?*—Supposing quantities which would produce equal effects, then its cost is considerably less than that of gunpowder; under ordinary circumstances and normal prices of cotton, the cost of manufacture of gun-cotton is under fourteen pence per pound, but at the present high price of raw cotton its cost will be under twenty pence per pound weight.\*

**943.** 21. *Give us what, in your opinion, are the essential points in the manufacture of gun-cotton?*

a. *Cotton.*—Any sort of cotton may be used for the production

\* Baron Lenk subsequently reduced this estimate.

of gun-cotton, provided it be tolerably free from seed-capsules and oleaginous matter. Absence of the latter is indeed imperative; hence factory cotton, as ordinarily obtained, must be digested in a weak alkaline solution, as is usual in such cases.

Other forms of lignine can be substituted for cotton to produce an explosive material—viz., flax, hemp, bog-grass, maize, straw, rags, sawdust, &c. I have given rules so as to meet the case of either of these; however, it is only in some extraordinary cases that any of these materials are to be preferred to cotton; further, ulterior applications of the explosive material are much facilitated by the device of *spinning* into threads.

**944. b. Nitric Acid.**—The nitric acid employed must be in the highest possible degree of concentration; and here the remark should be made, that an impurity of hyponitric acid imparted to the acid by concentration, and which is difficult to eliminate, does not prejudice the acid for this special application.

**945. c. Sulphuric Acid.**—The ordinary commercial sulphuric acid of spec. grav. 1.84 answers perfectly.

**946. d. Mixture of the Acids.**—This consists of *one part by weight of nitric acid, and three parts (weight) sulphuric acid,*—assuming the nitric acid employed to possess an average specific gravity of 1.485. If, however, the specific gravity should differ from the above, then cognizance of the amount of anhydrous acid supplies the data necessary for regulating the mixture.

The mixture is effected by means of an apparatus represented by Fig. 1.\* The vessel C is filled with the predetermined quantity (equivalent to the required weight) of nitric acid; B and D with sulphuric acid. This being done, the acids from the three vessels are allowed to run very slowly into F, in which is an agitator T, set in motion by the handle L. As soon as a portion of the two acids has been mingled in this manner, the mixture is allowed to run from F to G, and the operation resumed as before.

The reservoir G being completely filled, its contents must be set aside in closed vessels. It is advantageous to preserve the

\* This refers to a drawing exhibited at the time.

mixed acids a considerable time in the above vessels; in no case must the mixture be used until it has become quite cold.

**947. e. Process of Steeping.**—Cotton-wool ordinarily absorbs about 6 per cent. of atmospheric moisture, which must be dissipated in a drying-room heated to 95° F. previous to dipping the cotton.

Steeping is effected in an apparatus represented by Figs. 2, 2*a*, and 2*b*.\* The apparatus, during the process, is kept *cool* by a constant change of cold water poured into the vessel F. The chamber A contains a store of acid, B sixty pounds of the acid mixture, D represents the vessel in which the cotton is stored after dipping is accomplished. Two skeins (about three ounces) of dried cotton are dipped at one operation in the mixture contained in B, the spatula G being used to effect, by pressure, complete incorporation between acid and cotton; in the next place, the cotton is to be removed from the bath, laid upon the rack C, and pressed to such extent that the amount of mixed acids left absorbed by the cotton be in the ratio of 10½ *lbs. of the former to 1 lb. of the latter*. The cotton being now lifted into the vessel D, this is to be filled with mixed acids, and the portion of acid absorbed made good by means of the tarred spoon E, in such manner that the surface in B may always maintain the same level for every additional portion of cotton dipped.

The vessel D filled in the manner prescribed, is at length set aside, the due proportion of its contents being regulated, if necessary: the regulation is easily accomplished after a little practice, but it is seldom requisite. The cotton is next compressed by the handle H in such manner that it is wholly covered by acid, to the further action of which it is left exposed for the space of forty-eight hours; it must be cooled during that exposure, thus guarding against the violent action of the acids resulting in decomposition.

**948. f. Removal of Acid from the Gun-Cotton.**—This is performed by means of a centrifugal machine, the drum of which is

\* This refers to a drawing exhibited at the time.



of copper, a material which lasts a considerable time; after this manipulation, there still remain 3 lbs. of acid in the gun-cotton manufactured from 1 lb. of ordinary cotton. This must be got rid of by rapid water affusion applied in some convenient manner.

Mere affusion, however, does not suffice to get rid of all the adherent acid, hence the cotton must remain for a yet *longer* period in a stream of water, natural or artificial.

**949. g.** *Impregnation of Gun-Cotton with soluble Glass.*—The object of this process is to close the pores of the gun-cotton fibre by silica precipitated within them, by which the velocity of explosion of gun-cotton is hereafter retarded; moreover any lingering traces of acid that may remain are neutralized by combination with soda liberated from the soluble glass. This operation is performed by means of a centrifugal machine, into which a central tube passes for supplying the glass solution. By this arrangement the liquid is driven in very minute division through the gun-cotton; the glass solution employed has a density of 12° Baumé. The material having been treated as described, has next to be dried by atmospheric exposure: as drying proceeds, decomposition of the soluble glass goes on. Atmospheric carbonic acid uniting with soda, forms carbonate of soda, whilst silica is precipitated.

The carbonate of soda thus produced being soluble in water, can be got rid of hereafter by washing, whereas the precipitated silicic acid not being soluble, remains attached to the cotton fibres, protecting them from decomposition under atmospheric influences, however high the temperature may be.

**950. h.** *Treatment with Soap.*—For many purposes it is desirable to retain the fibres of gun-cotton soft, in order to guard against the contingency of explosion from very violent friction, gun-cotton being somewhat harsh to the touch.

This is readily effected by dipping the material, already treated with soluble glass and washed, previous to final drying, into a soap ley, the excess of which is to be hereafter squeezed out, and the gun-cotton finally dried.

**951. 22.** *Have you any special information to give the Committee respecting the practical applications of gun-cotton?*

a. *In general.*—The proper utilization of gun-cotton presupposes a thorough knowledge of the nature of its energy and the bearing of its mechanical advantages, in order that the object proposed may be gained through a favorable choice of circumstances. These influences are more perceptible with gun-cotton than with gunpowder, inasmuch as gun-cotton admits of variation from a point of *inefficiency* to one of *highest energy*.

Ignited in an open space (*i. e.* not under pressure), the explosive effect of gun-cotton is trifling, very much less than that of gunpowder. Ignited in spaces more or less closed, then in proportion as the closure is perfect does the explosion assimilate itself to that of gunpowder, the force of which under certain circumstances it considerably surpasses; *i. e.*, it is dependent on the resistance met with. The maximum of the explosive effect of gun-cotton is attained when the charge is so regulated, as to dimensions and form, that the whole of it becomes ignited before the yielding of any side of a vessel in which it is enclosed.

The products of combustion of gun-cotton are wholly gaseous, whereas gunpowder by combustion yields only 31 per cent. of gas, whence it would seem that the energy of a charge of gun-

TABLE CXLII.—EXPERIMENTS WITH GUN-COTTON, INITIAL VELOCITIES, ETC., IN 12-POUNDER GUN.

Result.	Gun.		Cartridges.		Initial Velocity.	General Observations.
	No.	Length of Bore.	Material of Charge.	Length.		
I.		13½ calibres.	Powder, 3 lbs. 1 oz.	7.5	1400	Normal.
II.	2	11½ "	Gun-cotton, 13.6oz.	5.1	1375	
III.	"	11½ "	" 14.8	"	1407	Cartridges slightly compressed, filling the whole space.
IV.	3	10½ "	" 13.6	"	1358	
V.	1	11½ "	" 14.8	8.3	1400	
VI.	1	10 "	" 15.9	"	1426	Hollow cartridges represented by Fig. 416.
VII.	1	9 "	" 17.0	"	1402	

powder should be nearly equalled by a charge of gun-cotton only one-third of its weight. The available power of one part of gun-cotton by weight, may, under certain circumstances, be raised to the effect of six parts by weight of gunpowder.

**952. b.** *Application of Gun-Cotton as a charge for Smooth-bore Guns.*—The standard of reference was furnished by experiments conducted with a 12-pounder bronze field-piece, which gave results as follows :

The weight of shot, solid round, used was 12 lbs.

Diameter of shot 4·5 inches. (English weight and measure.)

Diameter of bore for gun-cotton 4·56 inches.

Diameter of bore for gunpowder 4·67 inches.

The normal performance of ordinary powder-guns gives result I., as compared with gun-cotton. With gun-cotton, when compressed charges were used, each of 13·6 oz., result II., gun 2; the gun was not injured; while with 14·8 oz. of charge, after a few rounds, a considerable enlargement of the bore, where the shot lies, took place. A similar result happened to a second gun, No. 3, even with a charge of 13·6 oz., after the first few shots.

When one of the enlarged cartridges, represented at Figs. 416 and 417 was used, occupying 1·1 of the powder-space, the gun's endurance was perfect, and no loss of effect was sustained, and its practice remained good, as proved by results set forth at III. and V., since *equal charges in very different spaces* (*i. e.*, in the ratio of 5 to 8) still produced equal results.

In proportion as the tube is shorter, an increased charge is required (shown by results V., VI., VII.); yet the effect of a normal powder-gun and charge may be attained by a tube shortened from 13½ to 9 calibres: it follows that guns to be used with gun-cotton may be constructed much shorter than if intended to be charged with gunpowder\*.

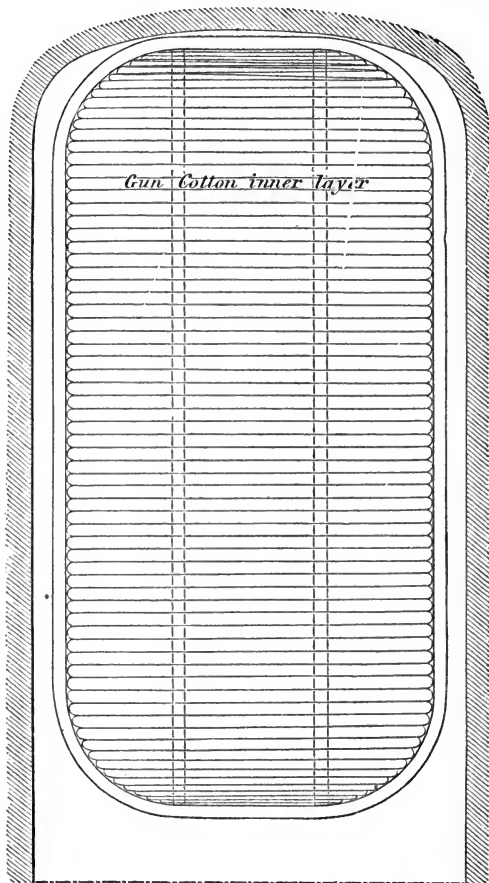
With the largest charge used, *i. e.*, 17 ounces, about 1000 shots were fired from the same gun, without affecting the piece in the

\* No details are given as to precision.

slightest—an endurance very satisfactory, and considerably greater than has been experienced with gunpowder.

This experiment was further continued for arriving at results by empirical means as to the strength of metal in various parts of the tube.

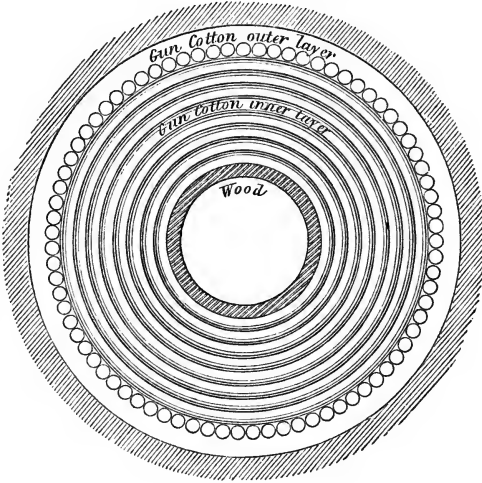
FIG. 416.



The original tube, formed as depicted at Fig. 418, was gradually turned off until it assumed the shape figured in broken lines, but without any disadvantageous effect. The metallic strength of 3·7 inches close behind the seat of the ball, where, according to ex-

perience, the greatest strain takes place, and 1''·6 at the muzzle, were so moderate that for practical uses no further diminution was desirable; hence the experiments in this respect were discontinued.

FIG. 417.



Finally, I turned my attention to the object of flattening the trajectory of projectiles with this gun, and succeeded to such an extent that a projectile fired from the gun horizontally pointed at targets set up at 100 yards from each other as far as 1200 yards struck at an *even height* at 3 feet from the ground, and fell *without ricochet* at about 3200 yards.

An experiment made with a Krupp cast-steel 6-pounder, demonstrated that with harder and more resisting metal than bronze, the great power of gun-cotton might unhesitatingly be made use of to obtain a more energetic projectile force than would have been compatible with the use of gunpowder.

The results are as follows :

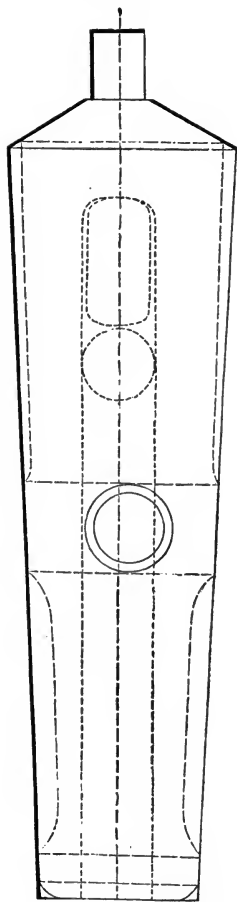
A Krupp 6-pounder, cast steel, charged with } 1388 feet per second initial
30 oz. of normal powder..... } velocity of shot.
A Krupp 6-pounder, cast steel, charged with } 1563 feet per second initial
13½ oz. of gun-cotton..... } velocity of shot.

In practice it is necessary with the use of gun-cotton to reduce

the "windage" to a minimum; otherwise larger charges must be used, and with no corresponding advantage.

**953. c. Application of Gun-Cotton to rifled Ordnance.**—The time may have arrived for breech-loaders, which have lately come into use under such good auspices, to be set aside in favor of muzzle-loaders, for the service of which gun-cotton offers such facilities, because of its leaving no solid residue after combustion, and because windage admits of reduction to a minimum.

FIG. 418.



The method of determining the condition of charge differs from the data given for smooth bores, in so far that the vehemence of explosion may be decreased by mechanical means—such as variation of length of chamber, regulating the mode of ignition so as to attain a sufficiently favorable condition of starting of the projectile from rest. This result was easily achieved (as demonstrated by experiments conducted in Austria) within the degrees of velocity hitherto deemed sufficient, as by the gun shown by Figs. 419 and 420 (521).

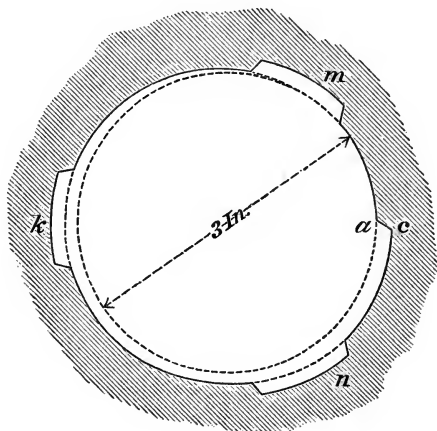
To what extent these deductions may hold good at higher velocities, must be determined by further experiments, which may be expected, judging from present data, to give favorable results.

The Austrian breech-loading guns (cast-iron) of three service calibres (6, 12, and 24-pounders charged with 13, 30, and 60 lbs. weight projectiles respectively) answer perfectly

when charged with gun-cotton, provided the chambers are enlarged to 1.1 of the original capacity for powder. For larger charges, cartridges made in the form of a hollow rope, similar to those used for blasting, would answer; however, I have to remark

that it is more necessary in rifled than in smooth-bore guns to reduce the windage to a minimum; this, on account of the surprising exactness of work in English factories, would be easy of accomplishment,

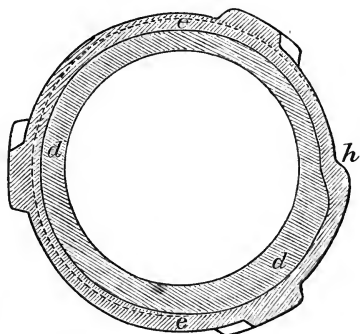
FIG. 419.



and would raise the effect of gun-cotton. Experiments performed with a cast-steel gun of 3 in. diameter, weighing only 50 lbs., firing hollow projectiles with effect to 3000 yards, demonstrate that, on account of the short length of tube necessary and the slight recoil, very light pieces can be made; the carriage was about 40 lbs. weight.

**954. d.** *Application of Gun-Cotton to Small Arms.*—In this respect it is important to observe that the plasters used with the old round-ball rifles were completely torn so long as short cartridges were used. When I elongated the cartridges the plasters resisted perfectly, and practice was very accurate; hence it is demonstrated that *length* is a very important element in the construction of small-arm cartridges. Experiment only can determine the *proper* length.

FIG. 420.



One circumstance is not to be lost sight of—that with a *very* long cartridge the *ignition* of it in proper time may be difficult to achieve. Practice in the application of mechanical means is requisite to secure the proper explosion of long cartridges by igniting them well in front. Lastly, experience proves that in small-arm cartridges *separation* of the cotton into several layers, by the interposition of paper, influences the result. Small-arm cartridges which have answered best are composed of three layers of flat woven gun-cotton with paper interposed. For the small-bore long range rifles used in England, the cartridges most suitable may be those represented at Figs. 421 and 422, the precise dimen-

FIG. 421.

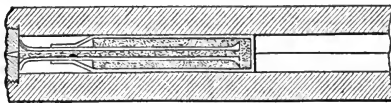
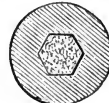


FIG. 422.



sions of them being fixed experimentally. On the 4th and 5th of July, 1863, there was a preliminary trial at Manchester, during which it was found that no distortion of the projectiles ensued even when the proper conditions of charge were departed from by using too heavy charges.

**955. e.** *Application of Gun-Cotton to purposes of Mining.*—Gun-cotton is more appropriate to this use than gunpowder, which it surpasses in proportion as the mass to be blasted is more compact. Assuming a solid rock to be blasted, and that the proper condition of charge together with the proper distribution of holes have both been heeded, the relative proportions of gun-cotton and of gunpowder for producing an equal effect are 1 gun-cotton to 6·274 gunpowder (weight by weight), whilst the relative proportions for wall-blasting (masonry) are 1 gun-cotton to 2·25 gunpowder; however, here the point must be noted, that when these experiments were performed the *best shape* of charge had not been determined. According to experiments more recently conducted, the form of charge for blasting which best answers is that of a *hollow twisted rope*, according to sample; the operation of charging is rendered thus very easy and safe—wooden tamping-



rods being used until the charge is covered. According to repeated experiments, the strongest friction of gun-cotton between stone is unattended by the slightest danger. For large charges, it is to be remembered that *complete* ignition is more difficult than the complete ignition of large powder charges; to accomplish this result satisfactorily for mining purposes, it is indispensable to fasten up the gun-cotton in *tightly closed vessels*—which afford the necessary resistance, *not yielding until the whole mass of gun-cotton has become ignited*. Experiments have proved that little barrels with strong hoops answer best. The proper construction of these restraining cases can be learned experimentally from models, when it will be remarked that *no smoke* results from explosion, and *very little fire* is seen.

As a charge for hollow projectiles, gun-cotton substituted for gunpowder will produce similar effects; but then the space of shell is only *partly* filled, even when the bursting powder charge is raised to its maximum. An increased charge of gun-cotton may be employed with advantage, which thus, in comparison with gunpowder, will give an additional effect, partly referable to additional material used, and partly to the occurrence of a more rapid explosion.

With projectiles having very small holes for filling, the accompanying samples were used, because of the ease with which filling could be conducted. When projectiles with cylindrical bore, capable of being thrown open, have to be filled, it would be advisable to insert cylindrical charges of gun-cotton previously compressed. A soft layer of felt is recommended to be laid interiorly against the base of the projectile—though this precaution does not seem to be imperative, no premature bursting having taken place in the course of any experiments.

**956. f.** *Application to Fuze Purposes.*—For fuzes gun-cotton is woven (according to pattern given), then steeped in saltpetre and covered with a jacket of India-rubber. In this manner the progress of combustion is rapid (over 30 feet per second): the line will bear considerable pressure, and may even be folded crossways without fear of the fire leaping from one fold to the other.

If ordinary gun-cotton thread be fired in a train loosely, ignition is very slow, about 1 foot per second.

**957. V. Extracts from a Report on Baron Lenk's Gun-Cotton, by Professors Dr. Redtenbacher, Dr. Schrotter, and Dr. Schneider, to HIS EXCELLENCY FIELD-MARSHAL JOHANN FREIHERR KEMPEN VON FICHTENSTAMM, PRESIDENT OF THE ROYAL IMPERIAL COMMISSION ON GUN-COTTON, JUNE, 1863.**—(1) “*Difference between the French Gun-Cotton and Baron Lenk's.*—According to the method pursued by the French Commission, the raw cotton was immersed in the acid mixture for one hour. Baron Lenk leaves his cotton forty-eight hours in the acid bath. The French cotton was afterwards dipped in running water for an hour or an hour and a half. Baron Lenk's gun-cotton lies four, six, or eight weeks in a stream. The French cotton had, after washing, so much free acid left, that wood-ash lye (a solution of carbonate of potash, therefore) was neutralized by contact with it, and after long use became sour. Baron Lenk's cotton is so freed from acid by long immersion, that a two per cent. solution of potash, in which two cwt. of gun-cotton had been boiled, has lost none of its alkaline properties—that is to say, that the cotton was completely free from acids, as experiments wholly accordant with those of the Imperial (Austrian) Engineers' Committee fully demonstrated. The French gun-cotton having been prepared in a manner so different, it must necessarily have had a different composition to that of Baron Lenk's; hence it is clear that the French experimental results cannot, without considerable reserve, be accepted as precedents.”

**958.** “If this analysis (Tables 143 and 144) differs somewhat from the theoretical formula of the trinitro-cellulose, the circumstance must be remembered that cotton is not pure cellulose, but that it consists of long-extended vegetable celluloses, in which there is always a little albuminous substance containing over 50 per cent. carbon, and 7 per cent. hydrogen, the presence of which even in such quantities easily increases the percentage of carbon and hydrogen. The treatment of soluble glass has no influence on Baron Lenk's gun-cotton, it being previously free from acids.

TABLE CXLIII.—ANALYSIS OF AUSTRIAN GUN-COTTON. LABORATORY OF ENGINEERS' COMMITTEE, 1861.

In 100 parts.	Trinitro-cellulose, calculated.	No. 4.
Carbon .....	24.3	25.1
Hydrogen .....	2.3	3.0

## UNIVERSITY LABORATORY, 1863.

In 100 parts.	No. 8. 1856.		No. 6. 1860.		No. 14. 1862.			Dinitro-cellulose, calculated.
	1.	2.	1.	2.	1.	2.	3.	
Carbon .....	24.4	24.5	24.6	24.2	23.6	23.9	24.1	28.6
Hydrogen .....	2.7	2.8	2.6	2.7	2.6	2.4	2.4	3.2

Gun-cotton is always put into comparison as an explosive compound with gunpowder; but it must be remembered that one of the component parts of gunpowder (charcoal) is most irregular in quality, especially where the primitive method of preparing it is followed. Still, in theoretical disquisitions upon gunpowder, charcoal is taken into account as pure carbon."

**959.** (3) "In the magazines of gun-cotton at the Neustadter Haide, there are stores of various years. In the laboratory of the University there are samples of Hirtenberg gun-cotton of three several years, which have been examined by the above-named artillery officers, and they have been found not to differ materially in their composition from trinitro-cellulose. (See Table 144.)

**960.**—"If these results (Table 144) are compared with each other, there can be no right to say that Hirtenberg gun-cotton alters by keeping. They agree as far with each other as analyses of the same material usually do. It is to be regretted, on this as on many other accounts, that during the last twelve years such analyses were not frequently repeated. If the opponents of gun-

TABLE CXLIV.—ANALYSIS OF GUN-COTTON OF VARIOUS YEARS.

In 100 parts.	Trinitro cellulose, calculated.	No. 3 1856.		No. 6 1860.		No. 14 1862.		1862.
		1.	2.	1.	2.	1.	2.	3.
Carbon .....	24.3	24.4	24.5	24.6	24.2	23.6	23.9	24.1
Hydrogen .....	2.3	2.7	2.8	2.6	2.7	2.6	2.4	2.4

cotton, in performing an adverse experiment, heat the substance in a test-tube up to 100° C., and holding litmus-paper over it, deduce from redness of the latter that gun-cotton changes after long keeping, they merely prove thereby that gun-cotton changes at 100° C. Of an explosive compound, it can only be required that *it shall not deteriorate within certain limits of temperature, —a requisition amply fulfilled by Lenk's gun-cotton.*

“Some varieties of gun-cotton, if enclosed together with litmus paper in a tube, often manifest an acid reaction at ordinary temperature. This may arise from various causes. There may exist, for example, free acids. These acids may be the result of nitrogen partially oxidized, and may result from imperfectly worked cotton. This assumption granted, the phenomenon is explained, and the cause easily avoided. It may arise from decomposition of the gun-cotton, atmospheric dampness having brought about a partial reconstitution of the cellulose.”

**961.** (4) “But some specimens of Lenk's cotton do not even yield traces of decomposition. A parcel of Hirtenberg cotton was laid for six weeks in a pond, and not subsequently treated with potash. It was then deposited in a running stream, afterwards exposed for one month to the air, being subjected to all the various influences of dew, rain, and sun, day and night continuously. It retains all its original explosive qualities, and fails to redden litmus-paper, even though the latter be wrapped in a mass of this cotton and allowed to remain for many days. The results of an analysis of this cotton were almost identical with the cal-

culated elements of trinitro-cellulose, as the following table makes apparent:—

	Calculated.	Found.
Carbon.....	24·2	24·4
Hydrogen .....	2·3	2·8

**962.** (5) “*Temperature at which Gun-Cotton ignites.*—The rejection of gun-cotton, in consequence of the changeable nature, or explosive quality of the material at low temperatures, is so thoroughly and decidedly contradicted in the Report of Baron von Ebner, that it would be superfluous to go any further into this question—the lowest explosive temperature of the Hirtenberg gun-cotton being therein fixed at 136° C., a temperature which, practically, cannot raise any doubts against the use of gun-cotton.”

**963.** (6) “*Experimental Proofs demonstrate that Lenk’s Gun-Cotton is not spontaneously combustible.*—The history of gun-cotton, as chronicled by chemists and artillerists, short though the history be, is so full of records of explosion under unexpected circumstances, that an unbiased mind can hardly fail to be impressed with the belief that, amongst the ordinary conditions of military practice, there may be some competent to induce the spontaneous combustion of this material. Nevertheless, the experience of Baron Lenk, acquired during a period extending over more than ten years, is more pregnant with reliable testimony than can be found in the entire remaining history of this material.

“*The manufacture of gun-cotton in Hirtenberg consists of a number of perfectly harmless operations; and it is remarkable that, contrary to what happens with gunpowder, if fire be not actually applied, explosion is impossible. All operations are so arranged that the material acted upon is in a moist or wet condition—hence not explosive. Drying takes place in a capacious building, on every side open to the air. The last process of drying is carried out in the drying-chamber, where it is effected by a stove situated on the outside, distributing its heat to the building by earthenware pipes—drying being thus insured through a gentle warmth. The gun-cotton next goes either into a magazine to be packed away in chests, or is at once prepared for ammunition.*

In this magazine, Hirtenberg cotton has been stored for a period of twelve years, and not a single instance of explosion has taken place. How many powder-mills have exploded in that time? In Prussia, however, a drying-chamber has lately blown up. Your Excellency has officially been informed, that in Prussia they have worked for eight years with gun-cotton, and not a single explosion has occurred except the last-named. In the Prussian drying-chamber referred to, a stove with iron smoke-pipe was used—a sufficient explanation of the misfortune.

“During twelve years we have prepared gun-cotton at Hirtenberg for ammunition—that is, for yarns, spun ropes, and threads twisted and woven. One single case of explosion has occurred in the course of Baron Lenk’s manufacture, the result of improper speed of working the spinning machinery. Now, the circumstance hardly need be insisted on, that gunpowder as well as gun-cotton can be exploded by friction. Gun-cotton has been used for military purposes now more than twelve years; it has also been employed for mining and blasting. It has been subjected to every variety of transport. Packed in black wooden chests, it has been exposed to sunshine for months together—all this without one single accident. In the face of such testimony, it cannot be said that gun-cotton manifests any tendency to explode spontaneously.”

**964.** (7) “Lieutenant von Karolyi’s analysis of the gases of combustion of Lenk’s gun-cotton, which he made in the Chemical Laboratory of the Engineers’ Corps Committee, may be seen in the ‘Report of the Imperial Academy of Science,’ vol. xlvii., Mathematical and Physical Part, p. 59, and is given in Table 145, in which the gases of combustion of powder according to Bunsen (*vide* Poggendorff, 4th series, vol. xii., p. 131) are cited in comparison with those of gun-cotton.

“If we compare the gases of gunpowder with those of gun-cotton, we easily see that the chemical action of the product of combustion of gun-cotton on the sides of the barrel, if there exists any action at all, must be smaller than with the use of gunpowder, because they are less oxidizing gases than those of gunpowder.

TABLE CXLV.—ANALYSIS OF THE GASES OF GUNPOWDER AND GUN-COTTON.

Gases of Combustion. Volume per cent.		Bunsen.	Karolyi.		
		Sporting powder.	Rifle powder.	Ordnance powder	Gun-cotton.
Nitrogen	N .....	41·1	35·3	37·6	12·7
Carbonic acid	CO <sub>2</sub> ...	52·7	48·9	42·7	20·8
Carbonic oxide	CO .....	3·9	5·2	10·2	29·0
Hydrogen	H .....	1·2	6·9	5·9	3·2
Sulphuretted hydrogen	HS .....	0·6	0·67	0·86	Carbon 1·8
Oxygen	O .....	0·52	.....	.....	Water 25·37
Light carburetted hydrogen.....	.....	.....	3·02	2·7	7·2

Should, therefore, bronze barrels be ‘burnt out’ by the use of gun-cotton, cast steel may be then used instead of bronze, which, in fact, has been successfully done. Moreover, bronze gun-barrels have withstood a sufficient number of rounds by using an adequate charge of gun-cotton with elongated cartridges. In this way no alteration of the bore prejudicial to the correctness of aim has taken place. From the steel barrel of a rifle, forty rounds have been fired with gun-cotton cartridges, which have hit the target 300 yards distant in an unexceptionable manner. After the said number of rounds, the barrel was internally as clean and polished as a mirror. It appears, then, that this problem is solved in a general and satisfactory manner.”

**965.** (8) “*Application of Gun-cotton to Mining Warfare.*—Gun-cotton is also used for mining purposes and mining warfare. On this subject nothing but what is favorable has been reported by the Imperial Engineers (*vide* Communications of the R. I. Engineers’ Committee, 1861, vol. i., by Moritz Baron von Ebner, Colonel of the Engineers). However, it is said that the gases of gun-cotton were more poisonous in mines than those of gunpowder, and therefore the use of gun-cotton for mining warfare is not to be recommended. If we compare the result of Lieutenant Karolyi’s

analysis of the combustion-gases of gun-cotton with those of gun-powder as above given, we observe that both of them contain irrespirable gases; further, that they contain qualitatively the same sort of irrespirable gases; and although the relative quantities of some of the gases from powder and gun-cotton are different, the effect of those gases leads to the same practical result, viz., that, after blowing up a mine, one cannot without danger approach the spot of the explosion before renewing the air by ventilation. In this respect, we may say that the gases of gun-cotton will be more quickly removed by ventilation than those of gun-powder, because the first-named contain a greater quantity of gases easily dissipated, since 100 pounds of gunpowder contains 68 pounds of fixed solid matter, which alone suffices to make respiration almost impossible. It is not probable that an explosive compound will be found which will produce any other but irrespirable gases. It is one and the same in practice, whether a cellar contains 40 per cent. of carbonic acid and 10 per cent. carbonic oxide, or 30 per cent. carbonic oxide and 20 per cent. carbonic acid, inasmuch as no one could, without danger of suffocation, enter such a cellar. Both the gases of gun-cotton and of gunpowder, according to Karolyi, may be ignited by a match."

**966. Gun-Cotton—Manufacture and Experiments in England.**—Soon after the meeting of the British Association, in 1863, where the facts embodied in the foregoing report were first made public, the manufacture of gun-cotton was commenced at Stowmarket by Messrs. Prentiss, under the direction of Mr. Revy, the partner of General Lenk.

The first order for gun-cotton was given to Messrs. Prentiss by the author, on behalf of the United States Navy Department, which has long been aware of the value of this material, and anxious to make a thorough test of its qualities. The trial of this gun-cotton has not yet been completed.

**967.** The first gun-cotton made at Stowmarket was subjected (Feb. 19, 1864) to the following trial, which was witnessed by the writer; its results were not made public at the time:



A palisade was formed of 12 piles of green English poplar, set in a trench 3 ft. deep, and rammed up with earth. The piles were 18 to 20 in. diameter, and averaged 7 ft. high. A 12-in. elm log, 14 ft. long, was laid at the foot of the palisade, and a 21-in. poplar log, of the same length, was laid against the elm log.

A 12-in. cylinder, made of  $\frac{1}{4}$ -in. wrought-iron, with flat heads, bolted on, and containing 24 lbs. of gun-cotton, was laid on the elm log, 3 in. removed from the largest (20-in.) pile, and 30 in. from the ground.

A gun-cotton fuze (a gun-cotton yarn, enclosed in a rubber tube), was laid over the snow, from the box to a ditch 150 yards off, and lighted. There was no smoke, and no visible sign of work, except the disappearance of the central portion of the palisade; but the report was like that of a heavy rifled gun.

FIG. 423.



Palisade opened by 25 lbs. of gun-cotton. From a photograph.

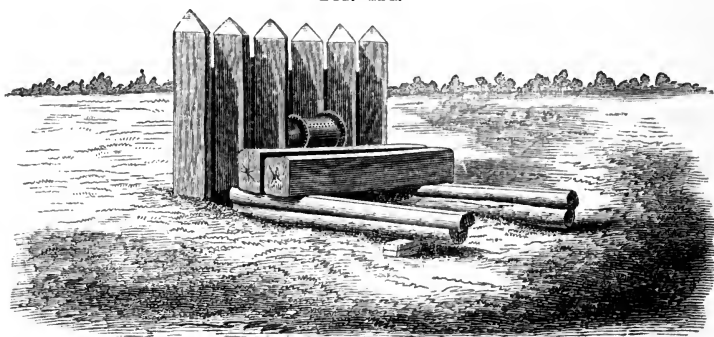
The opening made in the palisade was 3 ft. 2 in. at the bottom, and 4 ft. 11 in. at the top. The 20-in. pile was not torn down nor broken down, nor shattered from end to end; the central portion of it *disappeared altogether*; the top end was thrown twenty feet to the rear; the stump was bent back to an angle of  $45^\circ$ . The part of the elm log upon which the box lay also disappeared. The ends were moved a few feet; the inner ends looked as if they had been *chewed off*. The 21-in. horizontal log was thrown 25 ft. forward, and appeared to have been gnawed half in two in the

middle. The earth was broken and driven down for 6 feet around the point of the explosion. The piles next to the one carried away were shattered and bent back and sideways to an angle of about  $20^{\circ}$ .

**968.** The peculiar action of gun-cotton, as illustrated by this experiment, is: 1st. The intensity of its local effect. 2d. The small range of its action. Another well-established fact is, that the stronger the chamber in which it is confined, the more violent is its local effect. The box of  $\frac{1}{2}$ -in. iron, with flat heads, offered such a slight resistance to increase of volume, that the effect on the palisade, complete as it was, afforded no measure of the actual expansive force of the material.

**969.** On July 23, a similar experiment was made at Newcastle-on-Tyne, in presence of many military men and other spectators. The results are shown by a comparison of Figs. 424 and

FIG. 424.



Palisade before the explosion of a 25-lb. box of gun-cotton. From a photograph.

425. The stockade was constructed of a double row of timber, the first consisting of 6 balks, each 10 ft. long by 12 to 14 in. square; the timber backing being formed of 5 balks, 9 to 10 in. square. These balks were sunk about 4 ft. into the ground and firmly bedded. Two logs, 7 ft. long and 14 in. square, were laid in front of the stockade. The timber was the best Memel. The box, or shell, was 16 in. long and 12 in. in diameter, made of  $\frac{1}{2}$ -in. iron, and containing 25 lbs. of gun-cotton. The shell was lighted by electricity. The four upright timbers nearest it were blown

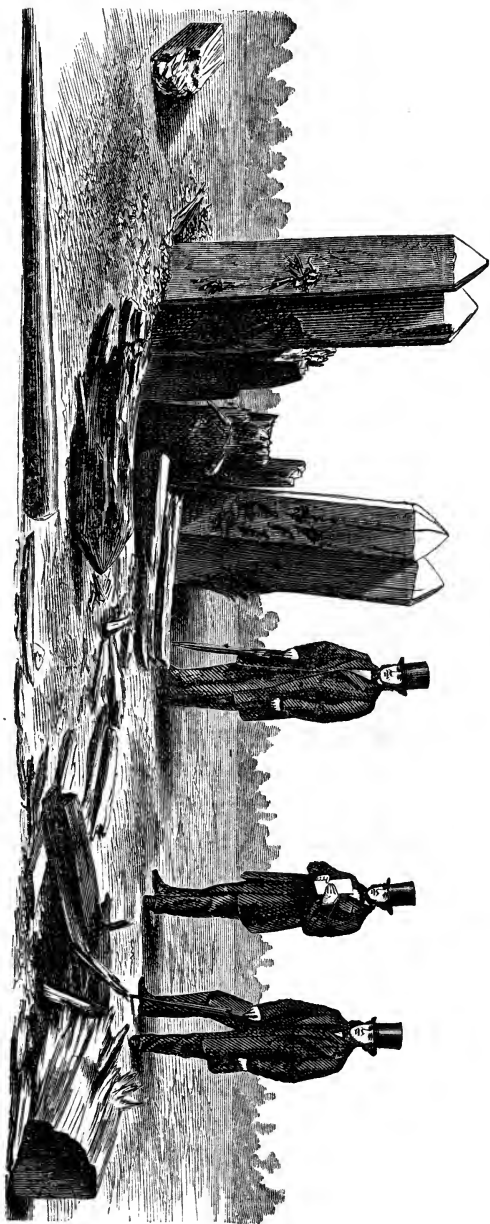


FIG. 425.

Palisade after the explosion of a 25-lb. box of gun-cotton. From a photograph.

away nearly level with the ground, one fragment having been thrown 130 yards. One of the horizontal timbers was torn to pieces; the other was thrown about 40 yards. The ground under the shell was sunk about 6 inches. The fence of the adjacent railway was broken, but no part of it was removed; a few windows in a building 500 to 600 yards off were broken.

**970.** Gun-cotton is now regularly employed in England for mining purposes, and is largely ordered by various governments.

**971. Nature and Mechanical Application of Gun-Cotton.**

In a recent paper before the Royal Institution, Mr. Scott Russell thus clearly set forth the nature and action of gun-cotton, under various treatment, and the manner of adapting it to experimental and to mining uses, and to ordnance:

\* \* \* “The first form which General Lenk bestowed on gun-cotton was that of a continuous yarn or spun thread. Gunpowder is carefully made into round grains of a specific size. Gun-cotton is simply a long thread of cotton fibre, systematically spun into a yarn of given weight per yard, of given tension, of given specific weight. A hank of a given length is reeled, just like a hank of cotton yarn to be made into cloth, and in this state gun-cotton yarn is bought and sold like any other article of commerce.

**972.** “This cotton yarn, converted into gun-cotton, may be called, therefore, the raw material of commerce. In this form it is not at all explosive, in the common sense of the word. You may set fire to a hank of it, and it will burn rapidly, with a large flame; but if you yourself keep out of reach of the flame, and keep other combustibles beyond reach, no harm will happen, and no explosion or concussion will result. If you lay a long thread of it round your garden walk at night, disposing it in a waving line, with large balls of gun-cotton thread at intervals, and light one end of the thread, it will form a beautiful firework, the slow lambent flame creeping along with a will-o'-th'-wisp-looking light, only with a measured speed of 6 in. per second, or 30 ft. a minute; the wind hastening or retarding it, as it blows with or against the line of the thread. This is the best way to commence an acquaintance with this interesting agent. \* \* \*

**973.** “The second form of gun-cotton is an arrangement compounded out of the elementary yarn. It resembles the plaited cover of a riding-whip: it is plaited round a core or centre, which is hollow. In this form it is match-line, and, although formed merely of the yarn plaited into a round hollow cord, this mechanical arrangement has at once conferred on it the quality of speed. Instead of travelling as before only 6 inches a second, it now travels 6 feet a second.

**974.** “The third step in mechanical arrangement is to enclose this cord in a close outer skin or coating, made generally of India-rubber cloth, and in this shape it forms a kind of match-line, that will carry fire at a speed of from 20 to 30 feet per second. \* \* \*

**974 A.** “The cartridge of a common rifle in gun-cotton is nothing more than a piece of match-line in the second form, enclosed in a stout paper tube, to prevent it being rammed down like powder. The ramming down, which is essential to the effective action of gunpowder, is fatal to that of gun-cotton. To get useful work out of a gun-cotton rifle, the shot must on no account be rammed down, but simply transferred to its place. Air left in a gunpowder barrel is often supposed to burst the gun; in a gun-cotton barrel it only mitigates the effect of the charge. The object of enclosing the gun-cotton charge in a hard strong paste-board cartridge is to keep the cotton from compression and give it room to do its work.

**975.** “It is a fourth discovery of General Lenk, that to enable gun-cotton to perform its work in artillery practice, the one thing to be done is to ‘give it room.’ Don’t press it together—don’t cram it into small bulk! Give it as least as much room as gunpowder in the gun, even though there be only one-third or one-fourth of the quantity (measured by weight). One pound of gun-cotton will carry a shot as far as 3 or 4 pounds of gunpowder; but that pound should have at least a space of 160 cubic inches in which to work.

“This law rules the practical application of gun-cotton to artillery. A cartridge must not be compact, it must be spread out

or expanded to the full room it requires. For this purpose, a hollow space is preserved in the centre of the cartridge by some means or other. The best means is to use a hollow thin wooden tube to form a core; this tube should be as long as to leave a sufficient space behind the shot for the gun-cotton. On this long core the simple cotton yarn is wound round like thread on a bobbin, and sufficiently thick to fill the chamber of the gun; indeed, a lady's bobbin of cotton thread is the innocent type of the most destructive power of modern times—only the wood in the bobbin must be small in quantity in proportion to the gun-cotton in charge. There is no other precaution requisite except to close the whole in the usual flannel bag.

“The artillerist who uses gun-cotton has therefore a tolerably simple task to perform if he merely wants gun-cotton to do the duty of gunpowder. He has only to occupy the same space as the gunpowder with one-fourth of the weight of gun-cotton made up in the bobbin as described, and he will fire the same shot at the same speed. This is speaking in a general way, for it may require in some guns as much as one-third of the weight of gunpowder and eleven-tenths the bulk of charge to do the same work; a little experience will set the exact point, and greater experience may enable the gun-cotton to exceed the performance of the gunpowder in every way.

**976.** “The fifth principle in the use of gun-cotton is that involved in its application to bursting uses. The miner wants the stratum of coal torn from its bed, or the fragment of ore riven from its lair; the civil engineer wishes to remove a mountain of stone out of the way of a locomotive engine; and the military engineer to drive his way into the fortress of an enemy, or to destroy the obstacles purposely laid in his way. This is a new phase of duty for gun-cotton—it is the work of direct destruction. In artillery you do not want to destroy directly, but indirectly. You don't want to burst your gun, nor even to injure it: and, we have seen, in order to secure this, you have only to give it room.

“The fifth principle, therefore, is, to make it destructive—to cause it to shatter every thing to pieces which it touches, and for

this purpose you have only to deprive it of room. Give it room, and it is obedient; imprison it and it rebels. Shut up without room, there is nothing tough enough or strong enough to stand against it.

“To carry this into effect, the densest kind of gun-cotton must be used. It must no longer consist of fine threads or hollow textures wound on roomy cores. All you have to do is to make it dense, solid, hard. Twist it, squeeze it, ram it, compress it: and insert this hard, dense cotton rope or cylinder or cake in a hole in a rock, or the drift of a tunnel, or the bore of a mine; close it up and it will shatter it to pieces. In a recent experiment, 6 oz. of this material, set to work in a tunnel, not only brought down masses which powder had failed to work, but shook the ground under the feet of the engineers in a way never done by the heaviest charges of powder. \* \* \*

“To carry out this principle successfully, you have to carry it even to the extreme. Ask gun-cotton to separate a rock already half-separated, it will refuse to comply with your request. Give it a light burden of earth and open rock to lift, it will fail. If you want it to do the work, you must invent a ruse—you must make believe that the work is hard, and it will be done. Invent a difficulty and put it between the cotton and its too easy work, and it will do it. The device is amazingly successful. If the cotton have work to do that is light and easy, you provide it with a strong box, which is hard to burst, a box of iron for example; enclose a small charge, that would be harmless, in a little iron box, and then place the box in the hole where formerly the charge exploded harmless, and in the effort it makes to burst that box, the whole of the light work will disappear before it. \* \* \*

**977.** “It is, therefore, the nature of gun-cotton to rise to the occasion and to exert force exactly in proportion to the obstacle it encounters. For destructive shells this quality is of the highest value. You can make your shell so strong that nothing can resist its entrance, and when arrived at its destination no shell can prevent its gun-cotton charge from shivering it to fragments.

**978. Mr. Scott Russell's Theory of the Explosion of**

**Gun-Cotton.**—"In conclusion, I may be asked to say as a mechanic what I think can be the nature and source of this amazing power of gun-cotton. In reply let me ask, who shall say what takes place in that pregnant instant of time when a spark of fire enters the charge, and one hundredth part of a second of time suffices to set millions of material atoms loose from fast ties of former affinity, and leaves them free every one to elect his mate, and uniting in a new bond of affinity, to come out of that chamber a series of new-born substances? Who shall tell me all that happens then? I will not dare to describe the phenomena of that pregnant instant. But I will say this, that it is an instant of intense heat—one of its new-born children is a large volume of steam and water. When that intense heat and that red-hot steam were united in the chamber of that gun and that mine, two powers were met, whose union no matter yet contrived has been strong enough to compress and confine. When I say that a gun-cotton gun is a steam-gun, and when I say that at that instant of intense heat the atoms of water and the atoms of fire are in contact, atom to atom, it is hard to believe that it should not give rise to an explosion infinitely stronger than any case of the generation of steam by filtering the heat leisurely through the metal skins of any high-pressure boiler."

**1799.** The same subject was thus referred to by Mr. Scott Russell before the British Association in 1863:—"How was it that in gunpowder and in gun-cotton where there were equal quantities of gas put in, the gas in the case of gunpowder was raised to an enormously high temperature, and came out at an enormously high pressure, showing that they had gas enormously expanded by heat; whereas in the case of gun-cotton the gas came out quite cool, so that you might put your hand upon it, and the gun itself was quite cool? He (Mr. Russell) had a theory. Steam was a gas, and steam expanded just by the same laws as other gases did. A great deal of the gas of gun-cotton happened to be steam. Let them conceive 100 lbs. of gun-cotton shut up in a chamber that just held it. They had got there all the gases that had been spoken of, but they had also got 25 lbs. of solid water—about one-



third of a cubic foot of water—in that chamber. What did they do with it? They put fuel, they put fire to it. They heated the whole remaining pounds of patent fuel. If, then, they considered the gun-cotton gun as the steam-gun, they got rid of two difficulties. They would have, first, the enormous elasticity of steam; and secondly, they would get the coolness of it. They all knew that if they put their hand to expanded high-pressure steam, it had swallowed up all the heat and came out quite cool. He believed that the gun-cotton gun was neither more nor less than Perkins's old steam-gun with only this difference, that you bottled up the fuel and water, and let them fight it out with each other. They did their work and came out quite cool. He hoped, however, that it was understood that he did not dogmatize. He put all he had said with a note of interrogation upon it."

---

## GUNS HOOPED WITH INITIAL TENSION.

THIÉRY, 1834.

TRANSLATION OF PAGES 153 TO 163, PUBLISHED IN 1834.\*

**980. "Cannons of Cast Iron, with Envelope of Wrought Iron.**—What we have called to mind, shows sufficiently how satisfactory the employment of cannons of cast iron would be for the service of land artillery, if in addition to the considerable economy which would result from it, and the extreme resistance which these pieces of ordnance would offer to the blows of bullets, one could render them perfectly sure in firing.

"But as long as this last condition shall not be fulfilled; as long as cannons of cast iron shall be subject to burst unexpectedly into fragments, considerations of humanity joined to military considerations, impose the law of rejecting from our *matériel* engines exposing the life of our own soldiers to constant dangers,

\* "Application of Iron to Artillery Constructions," by A. Thiéry, Chief of Squadron. Paris, 1834 and 1840.

and the explosions of which, at the decisive moments of combats, would compromise the success of our arms.

“However, the insufficiency of the duration of bronze cannons for the service of the attack and defence of places, demands equally artillery to seek, by all means possible, to put itself in possession of pieces of ordnance less imperfect than those which it is reduced to make use of.

“To attain the solution of this problem, we have thought that the combination of wrought iron, and cast iron, which has contributed so much to the power of steam-engines, could also present happy results in the construction of cannon.

**981.** “It is in this view that we have proposed the trial of a cannon of cast iron, with envelope of wrought iron, adding to the resistance of the piece of ordnance, and preserving in explosions from the danger of fragments.

“We have seen that the opinion of Monge was pronounced in favor of wrought iron, and that the difficulty of execution was in the eyes of this celebrated scholar the only cause which should cause the rejection of the employment of this metal in the manufacture of ordnance. The progress made since the time of Monge, in the art of forging iron, has, without doubt, diminished these difficulties, but they are not sufficiently removed by any practice in this kind of construction. Nevertheless, while admitting the possibility of success, one should bear in mind that cannons of wrought iron, superior in tenacity to those in bronze, would, in respect of durability, be very inferior to cannons of cast iron, much more costly, and much more subject than these last to be damaged by oxidation and the blows of bullets.

“Since cast iron is perfectly satisfactory against the blows of projectiles; against the effects of oxidation; and that it has, in addition, the advantage of being easily produced, and at a cheap rate, in all the forms desirable, it is natural to form of it the bore of cannons, and to make this metal enter into the composition of pieces of ordnance in as great a proportion as can comport with security in firing.

**982.** “A peremptory reason imposes, on another account, the

necessity of forming of cast iron the greater part of the thickness of a piece of ordnance of which it constitutes the interior. This metal having but very little elasticity, resists the explosion of the powder principally by virtue of its resistance to extension; this resistance once overcome, the cast iron would not evidently find any assistance against rupture in a surrounding body more elastic, and which yields beyond the limit at which its cohesion is destroyed. All that one can hope for from an elastic envelope compressing the cast iron, is that it augments by the compression the resistance to extension of this hard, rigid, brittle metal, but not that it should cause it to participate in elastic properties which are not in its nature.

“These considerations appear to us to have been lost from view in the trial, made in 1829, of the cannon of bronze with a body of cast iron. The body of cast iron consisted of a sleeve of a thickness so small that one could not expect from it any resistance against the expansive force of the powder. It should then have been necessary, to sustain the stress of firing, that this frail tube of cast iron should receive from the surrounding bronze an extraordinary power, and one does not see how this phenomenon would possibly have been effected, as the cast iron, immersed in the melted bronze, should have followed the expansion (by heat); and that the operation of cooling should annul the effect of the compression which should have resulted from the difference in the contractions of these two metals.\*

“Thus it was not necessary to wait long for the rupture of these tubes of cast iron. After some shots, they split, and did not permit further firing without danger.

**983.** “By employing for the envelope, wrought iron, in place of bronze, the chances of success are altogether otherwise; not only because the wrought iron has a tenacity double that of

\* “The linear dilatation of cast iron, wrought iron, and copper, for an interval of 100 degrees, follows the following progression:

Cast iron .....	0.00112
Wrought iron .....	0.00122
Red copper.....	0.00171

bronze, but because the hooping of wrought iron can be effected mechanically in such manner as to consolidate the system much more than the causing of the metals to adhere only by the operation of fusion.

**984.** “The means which naturally first offer for hooping a cannon of cast iron with wrought iron, would be to cover it with a series of hoops placed upon it while hot, side by side, and which would thus adhere to this piece of ordnance with the whole force of the contraction—a force which might become excessive by carrying the temperature of the hoop of wrought iron to a very high degree. But on the one part, this process would not permit the clothing of the cannon at the space of the trunnions; and on the other, would not secure completely against the dangers of fragments, even in the hooped parts.

**985.** “The examination of a great number of fragments of guns of cast iron burst in the proof at the Royal Foundry at Nevers, has convinced us that these guns could explode in the whole extent of their bore, and that a series of hoops placed side by side, which were not bound to each other by any thing, would only present incomplete pledges of security in firing.

“The greater portion of guns break at the position of the charge. In this case, the rupture takes place generally following two or three planes, passing through the vent, forming with the axis an angle approaching a right angle. The fragments, then, are composed of the breech, projected behind to the right or to the left according to the inclination of the planes of rupture, and of some fragments of the first reinforce thrown out laterally.

“In this circumstance, it is evident that hoops placed side by side would be of little preservative effect. The breech, torn off from the body of the cannon, would not the less be projected in the rear, and the hoops, detached by reason of this violent rupture, would add probably to the number of fragments.

“Although the ruptures generally take place at the position of the charge, there are not the less examples of their being seen to take effect upon every other part of the bore chamber. The successive burning of the powder carries the most violent explosion of

the charge in advance of the bottom of the bore. The adhesion of the projectiles to the sides of the bore, an adhesion which can occur from the distortion of these projectiles or the presence of a foreign body—in fine, the defects of manufacture, are causes which explain sufficiently the possibility of these ruptures.

“After these facts, it has appeared to us that in order that an envelope of wrought iron should accomplish efficaciously the end which we principally propose, that of becoming a preservative against fragments, it is necessary that it shall extend throughout the entire length of the pieces of ordnance, that it shall adhere perfectly to them, and shall itself form but a single and one body, all the parts of which become solid from the resistance.

**986.** “In consequence,\* we have conceived the idea of composing our envelope of wrought iron immediately upon an armature of longitudinal bars of the length of the cannon, and having spaces between them of about twenty centimetres. It is in this armature that we have cast the truncated cone of cast iron in which the bore has been bored.

“By previously raising the temperature of the armature of wrought iron, and by means of some very simple arrangements for executing the matter, the operation of casting the cast iron within the longitudinal bars of wrought iron, has been accomplished without any difficulty. The truncated cone of cast and wrought iron which resulted from it, has not shown any blow holes; the bars, kept in place by some hoops of wrought iron, have been immersed in the cast iron; the fusible portions contained in these bars have become united to the cast iron, and the welding has been intimately effected between all the parts constituting this base of the cannon of wrought and cast iron.

“The bars of wrought iron have become steeled at their surfaces, but have preserved their fibre in the interior. The cast iron compressed in the wrought iron is solidified into fine compact homogeneous grains, presenting the appearance of the hard rolls cast in chills. We hope that its resistance has been increased.

**987.** “It is upon this truncated cone of cast and wrought iron

\* See Fig. 426.

that we have effected the hooping by hoops placed over it at a welding red. Nicks made at various distances in the longitudinal bars, and in the cast iron, have secured the connection of the system.

“The hoop carrying the trunnions has been formed of two parts, in each of which the trunnions have been previously raised. This piece has been executed at an ordinary forge, without presenting great difficulties. The trunnions were turned before placing the hoop. In a manufacture on a large scale, the ring carrying the trunnions would not require a costly labor. It cannot be considered an obstacle to the production of a complete envelope of wrought iron.

“The hoop of the trunnions having been put in place, the hooping of the chase has been continued, taking care to bind the hoops always to the longitudinal bars by the nicks.

“By means of these arrangements, one should believe there should be no more danger of dreading fragments of such a gun when exploding.

**988.** “In fact, if it be at the position of the charge that the rupture takes place, in order that the breech may be projected in the rear it is necessary that the bars forming the longitudinal armature should break all at a time, or should be torn from the cast iron in which they are welded and maintained by the pressure of the series of hoops placed when hot.

“In order that the gun should open at any part of the bore, it would be necessary, first, that many rings should be broken; and in order that fragments should be projected through the opening, it would be necessary for the longitudinal bars to break at the same time.

“The effort necessary to produce, suddenly, similar tearings away of the wrought iron at the same time as the explosion of the cast-iron, is beyond calculation.\* There is no doubt that long

\* “In our 8-pound cannon there are twelve longitudinal bars of 50-15 millimetres, (about two in.) the combined resistance of which may be estimated at 300000 kilogrammes (about 600000 pounds). The rings are 36 in number, of 50-30 millimetres, (about two in.). Reducing, by reason of the welding, their resistance to 20 kilogrammes per square millimetre of transverse section, one finds for each of them a power of 30000 kilogrammes (about 60000 pounds).”

before this effect should be produced, the distension of the hoops would precede the explosion.

“We would, in addition, remark that everywhere where the fracture should seek to take effect, whether longitudinally or transversely, it would always meet with the wrought iron opposing its resistance in the direction of its length.

“With such a combination, it is difficult for one to be exposed to projections of fragments by reason of an explosion. It is probable that the portion of the cast iron happening to burst, the envelope of wrought iron would contain its fragments, would let them issue forward, and would hinder their dispersion in the enclosure of the battery.

**989.** “We have, up to the present time, considered the envelope of wrought iron as the sole preservative against fragments; we look forward to more from it. The examples which we have stated of the extraordinary resistance acquired by pieces of cast iron compressed in wrought iron, permit us to hope for a similar result from the series of hoops placed while hot upon the truncated cone of cast or wrought iron in which the bore is bored. The strong compression, exerted by the hoops adhering with the whole force of the contraction upon this portion of cast iron, should of necessity increase its resistance to extension.

“It is in conformity with this increase of strength that the thicknesses of the body of cast iron and the envelope of wrought iron should be regulated, and that all the rules for the construction of pieces of ordnance of wrought and cast iron should proceed. Experience alone can guide one to the estimation of these thicknesses, but the specific gravities of bronze and cast iron being in the ratio of 7·80 to 7·20, one would believe that one will be able to construct cannon of wrought and cast iron of the same length within the weights of bronze cannon of large calibres.

**990.** “We have not pretended to fulfil this condition in our first trial. The fear of not succeeding and of incurring uselessly heavy expenditures, has compelled us to make choice of an eight-pound cannon.

“To keep within the weight of a field-piece of this calibre, we

would have to reduce the cast iron and the wrought iron to proportions so low, that, giving way in the firing, one would not be able to come to any conclusion as to the application to large calibres which it is, above all, necessary to improve.

“If the proofs made upon our eight-pound cannon, having the thickness of bronze in cast iron and overlaid with wrought iron, succeed, one could conclude upon the possibility of manufacturing in this way without a notable increase of weight, cannons of large calibres having the same dimensions and length as those of bronze.

**991.** “If, after a prolonged firing, one should recognize in this eight-pound cannon an excess of strength, it should be bored to a 12-pounder, and if it resisted sufficiently after this reduction of weight, the system would be applicable to field artillery.

“The piece for the trunnions, of wrought iron, should not, we repeat, be the subject of an objection to the adoption of cannon of cast iron with an envelope of wrought iron, because nothing hinders the limitation of this envelope to the first reinforce, leaving the trunnions and forward part, in which explosions are rare and less formidable, of cast iron; this forward portion might, on the other hand, be equally hooped.

**992.** “This system would be to our eyes less complete, and it appears to us that the difficulty of manufacturing the trunnions of wrought iron being once removed, the adoption of a ring carrying these trunnions presents a very positive advantage. With this ring, the existence of the piece of ordnance is no longer dependent upon the feeblest part of it; a trunnion of wrought iron would probably never break; but admitting that it should be broken, one could replace it with another by detaching the hoops of the chase.

**993.** “The manufacture of pieces of ordnance of cast iron, with an envelope of wrought iron, although less economical than that of cannons of cast iron, would be infinitely less costly than that of guns of bronze. One could estimate that in a manufacture on a large scale they would amount to one-fourth of the value of these last.



“The production of these cannons would be at the same time easy and rapid, because it would reduce the moulding to some very simple operations.”

### THIÉRY.

**994. Cannons of Cast Iron with Envelope of Wrought Iron.**—(Pages 137 to 146, published in 1840.)—After mentioning the armament needed for France, M. Thiéry says: “If the experiments which we have stated, should have for their consequence the rejection of cannons of cast iron from all the services, one perceives to what enormous sacrifices the treasury would be condemned, since the expense of the wanting (21136176) would be increased from the difference between the price of bronze and that of cast iron, for all the pieces of ordnance which we have thus far permitted to be of iron.

“But, as we have proposed, we think that we should not yet despair of the solution of the question of cannons of iron, and that this solution would be easily obtained, if, in place of limiting ourselves to the exclusive employment of cast iron, we should have recourse to the combination of cast iron and wrought iron.

**995.** “Already we have constructed in 1833, with complete success as to execution, a trial cannon upon the basis of this proposition.

“Putting to a profitable use the rigidity of cast iron to constitute the bore of the piece of ordnance, the elasticity of wrought iron to surround it with an envelope as a preservative against explosions, we have cast the interior of the gun of cast iron immediately within a longitudinal armature of wrought iron, binding together all the parts in the direction of the length; then we have afterwards hooped it transversely with hoops of wrought iron, put in place while hot, and adhering by the contraction.

“We have set forth in the FIRST PART of the APPLICATIONS OF IRON TO THE CONSTRUCTION OF ARTILLERY, the facts of experience

which brought us to test this trial; we will here mention some of them :

**996.** “Some pipes for carrying water, put up in the foundry of Fourchambault, not having borne the receiving proof at the hydraulic press, they conceived the idea, in order to make them useful, of hooping them with hoops of wrought iron placed while hot over their fissures and compressing them by the contraction. The results surpassed their expectations. These pipes showed a resistance to every proof, and when they wished to destroy them in order to remelt them, the means used in parallel cases were not sufficiently powerful; they had to have recourse to powerful sledge-hammers, and the rings of wrought iron adhered so strongly to the cast iron, that it was necessary to break them to withdraw the metal from them.

“A hoop of cast iron, constructed for iron wheels, having been covered with a hoop of wrought iron, placed while hot and adhering by the contraction, showed an analogous resistance. Before this juncture, a few blows of hammers were sufficient to cause the hoop of cast iron to fly into fragments; compressed in the hoop of wrought iron, it was necessary to make long exertions with a heavy sledge-hammer; the two hoops changed shape together before the cast iron broke, and the fragments of cast iron remained contained in the envelope of wrought iron.

**997.** “These examples, and some others which it would take too long to enumerate, conducted us to seeking whether a hooping of wrought iron would not add to the resistance of cylinders of cast iron against the explosion of powder; we consequently covered with hoops of a thickness of ten millimetres, (about  $\frac{4}{16}$  of an inch), wheel-boxes, the sides of which had been thinned an equal amount. The boxes which burst into fragments before this operation under a charge of 0 K. 75 (1.65 pounds), showed themselves, with the assistance of the hooping of wrought iron, inexplodable under the strongest charges which they could contain, 1 K. 35 (2.97 pounds), and whatever was the mode of wadding employed to effect their rupture.

**998.** “We will add to these facts the one, not the less stri-

king, of the body of cast iron hooped with wrought iron, adopted recently in the ballistic pendulum at Metz. The bodies made simply of cast iron broke under the first blows; those of bronze cost 10000 francs; they conceived the idea of hooping with wrought iron, bodies of cast iron, and they showed themselves indestructible against the repeated shocks of bullet fired with the strongest charges.

**999.** “Finally, in Belgium, the mortars of  $O^m$  .60 (24 inches), designed to project bombs weighing 500 kil. (about 1100 pounds), having exploded after a small number of shots, before thickening their walls and thus augmenting beyond measure their already very considerable weight, they tried if they could not consolidate them sufficiently by enveloping them with some hoops of wrought iron; the success was so complete that three hoops sufficed; they limited themselves to placing one at the muzzle, the other at the middle, and the third at the position of the charge.

**1000.** “Upon examining the circumstances which had accompanied the bursting of cannons proved in 1837 at Lafère, we perceived, as we had already done while studying the fragments of a great number of guns burst at the naval foundry at Nevers, that the rupture commonly takes place following planes passing through the vent, and that the fragments are projected in the rear and laterally, following the inclination of these planes with respect to the axis of the piece of ordnance.

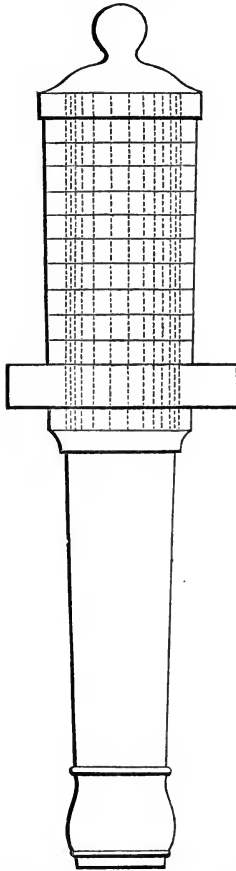
“Hoops of wrought iron placed transversely upon the reinforce would prevent lateral explosions; but it happens sufficiently often that the rupture taking effect through many planes, cutting through the vent, the breech is found separated and projected in the rear.

“In this case it should be feared that the transverse hoops, torn away with the breech, would be dispersed, and would add themselves to the number of fragments.

**1001.** “In order to obviate this defect, in order that under all circumstances the fragments of the burst gun should remain together and contained in the envelope of wrought iron, it is

evidently necessary that all the parts of this envelope should be bound together with sufficient strength to resist rupture in the longitudinal direction. In consequence, we have conceived the plan of composing the wrought-iron envelope:

FIG. 426.



Thiéry's hooped gun. 1833.

“1st. Of a longitudinal armature extending from the platband of the breech to  $O^m$ .12 centimetres (about 4·8 inches), beyond the trunnions.

“2d. Of transverse hoops, placed side by side, from the trunnions to the platband of the breech formed by the last of them.

**1002. “1st. Longitudinal Armature.**—Plate VI.—This armature is composed of twelve bars of wrought iron A, A, A, etc. (Fig. 1), having  $O^m$ .66 (almost 1·2 inches) in breadth  $O^m$ .03 (about 1·2 inches) in thickness.\*

“The bars have the length necessary to extend from the extremity of the breech to 12 centimetres (about 4·8 inches) beyond the trunnions, with the exception of the two bars placed below the trunnions, which are shortened in such manner as to permit the cast iron to pass which should form them.

“The bars are arranged parallel to each other  $O^m$ .06 (about 2·4 in.) apart, in such manner as to form the bars of a cylinder, presenting at its exterior surface as many solid parts as spaces, and having for the 24-pound cannon  $O^m$ .48 (about 9·2 in.) exterior diameter. The exterior part of the bars is rounded, so as to coincide with the exterior surface of the cylinder of which they make part. The bars are secured in their

\* Fig. 426 is reduced from one of M. Thiéry's drawings, and sufficiently illustrates his plan.

position by means of straps B B, B' B', B'' B'', B''' B''', B'''' B'''', spaced apart 0<sup>m</sup>.25 (about 10 in.). The bars are held against the straps by draw-screws c, c, c, etc. (Fig. 2).

“These arrangements being made, the apertures of the cylinder at the openings presented by the longitudinal armature, are closed by means of bars of wood and wax, in such manner as to have at the exterior a solid surface, and the cylinder thus obtained serves itself as the pattern for the lower part of the cannon. This pattern is placed in the flask designed to contain it; the sand is rammed around it; then the wax is melted by means of a chafing-dish; the bars are removed. The longitudinal armature thus remains placed in the mould, in order to form one body with the cast iron.

“The other parts of the cannon are moulded by the ordinary processes, and when we are ready to cast it, we lower chafing-dishes into the mould so as to raise as much as possible the temperature of the bars of wrought iron which are to be immersed in the cast iron, and to avoid thereby the blow-holes which would result from the contact of these bars at the ordinary temperature with the iron in a melted state.\* By means of these precautions, we have obtained, in 1833, in the foundry of Fourchambault, a cylinder of wrought iron and cast iron perfectly well formed. The bars sustained by the wrought-iron straps, a, have been fitted into the cast iron, their exterior portions entering into fusion, have effected a welding, uniting intimately together all the parts constituting the exterior surface of the cylinder. Upon cutting one extremity of the cylinder, we have perceived that the bars of wrought iron were steeled at their surfaces, but for a depth which did not exceed one millimetre.

“At the interior the iron was altered in no respect; it had preserved all its fibre and its quality. A bar extricated from the

\* “The process of founding, the muzzle below and the breech above, described in the first part of the *Applications of Iron to Construction of Artillery*, p. 149 and following, would be applied with advantage to this system of pieces of ordnance; by casting in this manner the piece of ordnance, the longitudinal armature would be raised to the necessary temperature to weld itself to the cast iron.”

cast iron, then submitted to rupture, has not shown a sensible diminution of its resistance to extension.

**1003. "2d. Envelope of Transverse Hoops.**—Plate VI. (Fig. 3).\*—The 24-pounder cannon cast in the longitudinal armature, presents, from the breech to the trunnions, a cylindrical portion having  $O^m .48$  (about 9 in.) in diameter.

"It is upon this portion that we have placed the series of hoops placed side by side, represented at Fig. 3.\*

"These hoops have  $O^m .10$  (about 4 in., breadth); their thickness is variable in such manner as to give the lower part of the cannon the truncated conical form which pieces of ordnance should present. The hoop against the trunnions presents  $O .05$  (about 2 in.) for the minimum thickness; that forming the platband of the breech has one of  $O .10$  (about 4 in.); the last but one, placed upon the vent,  $O .08$  (about 3.2 in.). Before placing the hoops, nicks are made from distance to distance upon the exterior surface of the cannon, to cause the hoops, which are placed afterwards after having heated them to the temperature found to be necessary to obtain a suitable dilatation, to adhere strongly to it. The hoops, in cooling, exert, by the contraction upon the cannon, a powerful compression, which cannot fail to add to the strength of resistance of the cast iron, and guarantees the connection of the system of the envelope of wrought iron. Afterwards, a hoop of wrought iron, having likewise,  $O^m .10$  (about 4 in.) of breadth, by  $O^m .05$  (about 2 in.) of thickness, was introduced from the side of the chase and which rests in front against the trunnions, to secure the longitudinal bars which extend up to this point, and upon which one must be careful to make nicks to bind to them the hoop which is heated in order to obtain a strong contraction.

"A last hoop, designed to unite the preceding against the trunnions with the chase of cast iron, terminates the envelope of wrought iron.

"The cannon is afterwards bored and turned on the exterior by the ordinary processes. All these operations are very simple;

\* See Fig. 426, which sufficiently illustrates all the drawings mentioned.

we have said that they did not present any difficulty in execution for the trial cannon constructed in 1833 at the foundry of Fourchambault with very imperfect means.

**1004.** "We strongly regret not having been able to obtain the proof of the rupture of this cannon, and of having, in addition, in place of the results of experience, only conjectures to present in support of our system.

"However, if, notwithstanding the facts cited, one may still call in question, until new proofs, the increase in resistance which we claim to give to cast iron by means of the hooping of wrought iron, one should not the less contest its effectiveness for containing the fragments in case of rupture, and for preventing the dispersion of the fragments.

"In fact, the envelope of wrought iron, such as we there propose, has some analogy to the pieces of ordnance of wrought iron constructed at the origin of artillery, and by means of which they fired the enormous bullets of which history makes mention. These gigantic culverins were composed of longitudinal bars of wrought iron placed in the manner of staves, and secured together by transverse hoops of wrought iron.

"Since this system sufficed to constitute, by itself, pieces of ordnance, it will evidently satisfy, without difficulty, the auxiliary part which we impose upon it here. Experience will give the limit of the resistance necessary to contain the fragments in all directions; we think that it will be shown below smaller dimensions than those we have proposed."\*

\* "The resistance of wrought iron to rupture in the direction of the fibres, is estimated at 40 kil. (about 48 lbs.) for the square millimetre (about  $\frac{1}{100}$  of an inch square, or  $\frac{1}{10000}$  of a square inch), of the transverse section; let us reduce it to 20 (44 lbs., about), on account of the welding of the hoops and of the immersion of the longitudinal armature in the cast iron. In order to burst at the same time the twelve bars composing this latter, an effort of 432,000 kil. (950,400 lbs.), time would be necessary; but the resistance of cast iron being only 13 kil. (about 28.6 lbs.) for each square millimetre of section, the trunnions of a 24-lb. cannon would break under an effort of 250,000 kil. (about 550,000 lbs.). The rupture of the trunnions will then always precede the complete tearing away of our armature, and we have seen, by the preceding proofs, that the trunnions have uniformly withstood."

## CHAMBERS, 1849.

**1005. Benjamin Chambers's Specification of United States Patent, dated July 31st, 1849.\***—"Be it known that I, Benjamin Chambers, of the city and county of Washington, in the District of Columbia, have invented a new and useful Improved Cannon, and I do hereby declare that the following is a full, clear, and exact description thereof, reference being had to the accompanying drawings, which make part of this specification.

"My improvements have reference as well to the construction as to the mode of using cannon, the object being to produce such an improvement in fire-arms as will secure all the strength necessary, together with suitable weight of metal, and a prompt, safe, and easy mode of charging and discharging the piece.

"The material of my cannon is wrought iron. I am aware that this material has been already employed in various ways for the purpose of constructing heavy ordnance; that staves of iron and hoops of the same material have been put together in alternate layers until a cylindrical or conical mass of suitable magnitude had been produced; that solid masses have been forged and subsequently bored out to the required interior size; that series of rings have been piled up and held together with bolts passing through them lengthwise of the gun, and fastened at each end by screw-nuts, or with straps running fore and aft on the outside; also, that flat rings have been made separately and welded together into a pile of sufficient height to constitute the length of the gun.

"I am aware that serious objections have in practice been found to exist against all these modes of forming wrought-iron cannon, and I have devised the following, which I consider decidedly preferable to any hitherto in use.

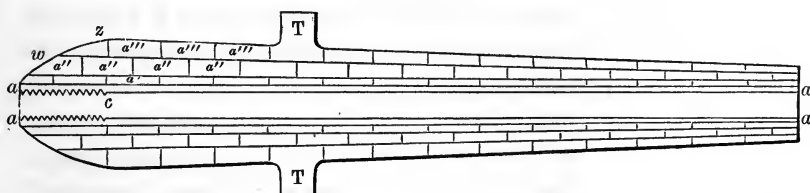
**1006.** "To obviate the danger of crystallizing the iron by

\* Fig. 427, reduced from the patentee's drawings, sufficiently explains all that part of the specification referring to the mode of construction under consideration. The description of the breech-loading has been omitted.



welding it in large masses, I form my cannon of pieces of a moderate thickness only, commencing with the tube  $a, a$ , as seen in section at Fig. 427, the interior of which tube is the bore of the gun, and the outside is turned to receive a series of rings  $a', a'$ , etc., which have an interior diameter, such that they will not, when cold, pass on to the tube  $a$ , but, when heated, will readily slip on, and come to the required position. I avoid too great a heat, for the purpose of preventing oxidation of the rings, and determine the diameter of the interior of the rings, as compared with that of the exterior of the tube, on the principle of the law of expansion of wrought iron, which I compute at about seven-millionths parts of its dimensions for every degree Fahrenheit to which it is heated above the freezing point of water.

FIG. 427.



Chambers's hooped gun, patented in 1849.

**1007.** "Having shrunk the rings  $a', a'$ , upon the barrel  $a$ , I place in a similar manner, by heating and shrinking on, the rings  $a'', a''$ , so as to break joints with the rings  $a', a'$ , and when a greater number of courses of rings is necessary, they are placed on the preceding series in the same manner as the second series is placed upon the first, that is, so as to break joints with each other. The rings may all be prepared separately and finished ready to be put together, or when one set has been placed upon the barrel  $a$ , throughout its length, the piece thus formed may be placed in a lathe, and the exteriors of the rings turned all together, so as to receive the next tier of rings.

**1008.** "Instead of turning the barrel  $a$  of a cylindrical

form, and shrinking on the rings  $a'$ ,  $a''$ , etc., with so much tension as to make them adhere firmly by the mere friction thereby created, I shall, in some cases, either in whole or in part, turn the barrel  $a$ , having alternately elevated and depressed portions. To fit these elevations and depressions, the rings  $a'$ ,  $a''$ , will be formed on their inner sides with reverse depressions and elevations answering to the ridges and cavities turned on  $a$ . The edge of the ring  $a'$ , is of such interior diameter that it will not, when cold, pass over the ridge on the barrel  $a$ ; but when heated to the proper temperature, it will come into place, and then the contraction of metal brings the ridges into firm contact with the depressions, leaving the barrel at all parts firmly gripped by the rings, but not so straining the latter as to diminish essentially the tenacity of the ring when cold. In deciding how high the elevations may be made consistently with ease in getting on the rings, and with due adhesion after they are cooled, I calculate the expansion at the temperature used in putting on the rings, and ascertain and give to the diameters of the ridges the same relations as the ring  $a'$  will have at the edges, in its hot and its cold state respectively. But in turning the rings  $a'$ , I leave their interior diameters in the respective parts, slightly less than that of the barrel at the parts on which they are severally to be set. This is for the purpose of having every part of the ring, when cold, brought into a moderate tension, but not overstrained.

**1009.** “By means of the rate above stated for the expansion of iron by heat, and assuming the temperature of 1000 degrees above the freezing point at which the rings might be able to pass on to the barrel, I find that if the ring have at its edge a diameter of 6 in. when cold, its larger diameter (as well as that of the barrel), may be made  $\frac{7}{1000} \times 1000 \times 6 = \frac{42}{100}$  of an inch more than its lesser diameter; or it may be 6.042 in. in diameter. As successive rings are put on, the relative diameters at the depressed and at the elevated parts of the interior and of the exterior rings, will remain the same as above, but the abso-

lute heights of the ridges, over which the edges of the rings must pass, will increase in proportion as the diameter increases. The exterior peripheries of all the series of rings, except the last, have depressions turned on their middle parts, which depressions are to receive the ends of the next series of rings ( $a''$ ).

**1010.** “The last series ( $a'''$ ) will be turned off to the regular conical form of the finished cannon.

“The trunnions TT are forged with one of the outside rings, which, for the purpose of strengthening the connection, may be made thicker than the other exterior rings.

“It is not necessary that all the rings composing a cannon should be made of the same diameter for the same series, but they may increase gradually from the muzzle towards the breech end of the cannon, as represented in Fig. 427.

“The portion of my cannon near the breech is tapered to a greater extent than has been generally customary, this part being represented by the curved line  $z, w$ . The firing of the cartridge is made to take place at  $c$ , about opposite to the point  $z$ , and where the diameter of the gun is greatest.”\*

**1011.** In a reissue of this patent, dated April 19th, 1853, the inventor describes the parts under consideration, in the same language, but makes no reference to them in his general description of the invention, nor in his claims.

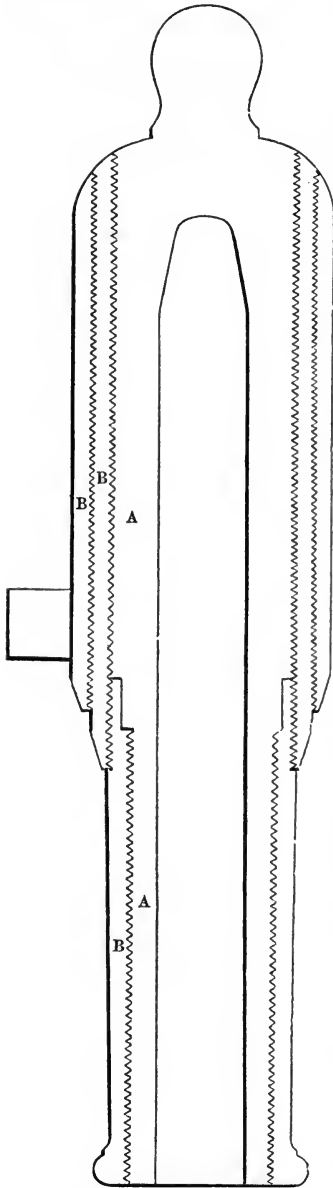
### TREADWELL, 1855.

**1012. Daniel Treadwell's Specification of United States Patent dated December 11th, 1855.**—“Know all men by these presents, that I, Daniel Treadwell, Engineer, a citizen of the United States of America, but now resident in London, have invented a new and useful improvement in making cannon; and I hereby declare the following to be a true description and specification of my said improvement, to wit:

\* See Fig. 427.

† The remainder of the specification and the claims refer exclusively to the patentee's method of breech-loading.

FIG. 428.



Treadwell's hooped gun, patented in 1855.

**1013.** "I first cast a cannon in the usual manner, but having in its largest part a diameter only about twice as great as the calibre intended to be bored in it. I then bored it and turn the outside, making two or three cylinders, as represented at A, A, in the drawing hereto annexed, one of these cylinders, extending from the breech to a little beyond the trunnions, being somewhat larger than the others that extend from near the trunnions to the muzzle. Upon these cylinders I cut a screw formed of about eight threads, each thread taking about an eighth of an inch space, so that one turn advances each thread about an inch. I then form several hoops or rings of wrought iron, represented at B, B, B, etc., in section. These hoops are turned upon the inside, and have a female screw cut upon their inner surface, to fit the threads before described as cut upon the cast-iron cylinders forming the gun body. They are to be finished, however, about one *one-thousandth* ( $\frac{1}{1000}$ ) part of their internal diameter less in diameter than the male screw that they are to encircle. They are then heated, to expand them sufficiently to turn them on to their place or places, as shown in the drawing. It will be seen that the hoop marked B<sup>1</sup> must be first put in its place, and a

portion of its outer side turned, and have the threads formed upon it, before the hoop B<sup>2</sup>, that partly covers it, can be put in its place.

**1014.** "When one cover of hoops (B, B, B, etc.) are arranged as herein described and shown, I place the gun again in the lathe and turn the outside of these first series of hoops, and cut thereon a screw formed of several threads, as was before done upon the cast-iron body. (This may be done upon all, or only, as shown in the figure, upon those from the breech to the trunnions inclusive.) I then form another set of hoops, c, c, c, etc., with female screws corresponding to the male screws upon the first series, and, the diameter being one one-thousandth part less than the screw they are to cover, I expand them by heat, as was practised with the first set, and let them shrink on in place, as they are shown in the drawing. One of these hoops has the trunnions forged upon it, as shown at D, D. It will be noticed that the series c, c, *break joint* over B, B. The drawing is a section of the cannon made through its axis, and the several parts cannot fail to be at once known and understood. The proportions in this drawing are intended for a cannon of 12 in. calibre.

**1015.** "I do not claim a patent for using hoops generally in making cannon, as the earliest cannon known were formed in part by hoops brazed upon them. But my invention consists in constructing cannon with hoops screwed and shrunk upon a body in which the calibre is formed in the manner herein described.

**1016.** "In witness of all which I have hereto set my name, this 19th day of June, 1855, at London.

"DANIEL TREADWELL."

**1017.** A reissue of this patent was granted on February 4th, 1862. The patentee first repeats the entire specification as contained in the foregoing paragraphs 1013 and 1014, and then proceeds as follows:

**1018.** "Having thus stated with sufficient minuteness the method of manufacturing a cannon according to my improved method, I now proceed to describe the principle or principles to

which a cannon thus formed owes its great superiority over those constructed in the ordinary way.

**1019.** “About thirty years ago, Mr. Peter Barlow, of Woolwich, published a paper in the Transactions of the Society of Civil Engineers, on the hydrostatic press, in which he showed that hollow cylinders of the same materials do not increase in strength in the ratio of increase in thickness, but that the ratio of increase of strength is such that where they become of considerable thickness, the strength falls enormously below that given by the ratio of thickness. The law of the diminution in the power of resistance may be stated as follows: Suppose such a cylinder to be made up of a great number of thin rings or hoops placed one within another and exactly fitting, so that the particles of each hoop shall be in equilibrium with each other. Then the resistance of these rings, compared one with another, to any distending force, will be inversely as the squares of their diameters.

“With these incontrovertible laws of resistance before us, we cannot fail to perceive how impossible it must be to increase the strength of cast-iron cannon in any useful degree by an increase of their thickness beyond that now given to them.

**1020.** “Now, to obviate the great cause of weakness arising from the conditions before recited, and to obtain, as far as may be, the strength of wrought iron instead of that of cast iron, for cannon, I have invented the following mode of instruction: I form a body for the gun containing the calibre and breech, as now formed, of cast iron, but with walls of only about half the thickness of the diameter of the bore. Upon this body I place rings or hoops of wrought iron in one, two, or more layers. Every hoop is formed with a screw or thread upon its inside, to fit a corresponding screw or thread formed upon the body of the gun first, and afterwards upon each layer that is embraced by another layer. These hoops are made a little, say one one-thousandth part of their diameters, less upon their insides than the parts they enclose. They are then expanded by heat, and being turned into their places, suffered to cool, when they shrink and compress,

first the body of the gun, and, afterwards, each successive layer all that it encloses. This compression must be made such that when the gun is subjected to the greatest force, the body of the gun and the several layers of rings will be distended to the fracturing point at the same time, and thus all take a portion of the strain up to its bearing capacity.

**1021.** "There may, at the first view, seem to be a great practical difficulty in making the hoops of the exact size required to produce the necessary compression. This would be true if the hoops were made of cast iron or any body which fractures when extended in the least degree beyond the limit of its elasticity. But wrought iron, and all malleable bodies, are capable of being extended, without fracture, much beyond their power of elasticity. They may therefore be greatly elongated without being weakened. Hence we have only to form the hoops small in excess, and they will accommodate themselves under the strain without the least injury. It will be found best in practice, therefore, to make the difference between the diameter of the hoops and the parts which they surround, considerably more than one one-thousandth part of a diameter.

**1022.** "It will be seen that with a gun made in this way, we must depend upon the cast-iron body to resist the strain tending to produce cross-fracture, though this resistance will be in some degree supported by the outer rings breaking joint over the inner rings. It will moreover be advantageous to make the threads of the female screw sensibly finer than those of the male, to draw, by the shrink, the inner rings together endwise.

"By this means (as herein set forth) a gun may be made nearly four times as strong as a cast-iron gun of the same weight, wrought iron being taken at only twice the strength of cast iron.

**1023.** "I do not claim a patent for using hoops generally in making cannon, as the earliest cannon known were formed, in part, by hoops brazed upon them. But my invention, for which I claim letters patent, consists :

"1st. In making a cannon consisting of a body (in which the calibre is formed), the walls of which are of one piece, surrounded

by rings, hoops, or tubes, in one or more layers, placed upon said body under great strain, by which said body is compressed, and the natural equilibrium of the molecules or particles of which it is composed disturbed by their being brought nearer together; and this is accomplished in the manner herein set forth, namely, by making the hoops smaller than the part which they are to surround, and then expanding them by heat, and then suffering them to shrink or contract after having been put in their places.

“2dly. I also claim the method of securing the hoops to the body of the gun, and the several layers of hoops to each other by screw-threads, when they shrink to their places, as above described.

DANIEL TREADWELL.”

BLAKELY, 1855.

**1024. Alexander Theophilus Blakely's Specification of British Patent, dated February 27th, 1855.\***—“The improvements relate first to *a method of forming guns with an internal tube or cylinder of cast iron or steel, enclosed in a casing of wrought iron or steel.* I sometimes form the outer surface of the inner tube somewhat conical, the greatest diameter being just in front of the trunnions, and tapering both ways, and apply the outer casing in the form of collars or rings driven thereon. And in some cases I apply two or more layers of such rings, according to the strength sought to be obtained, the trunnions being of one piece with one of the rings. The outer casing may, however, be applied in the form of collars or rings, heated and shrunk upon the cylindrical surface of the inner cylinder or tube; *but I do not claim as my invention the method of forming guns or cannon by the application of collars or rings, heated and shrunk upon a cylindrical inner tube, save and except when the internal diameters of such collars or rings are, previously to being heated, so*

\* This is Captain Blakely's specification as altered March 5th, 1859. The words printed in *italics* were then added to the original specification. The parts of the original specification that have been omitted, do not refer to the method of construction under consideration.



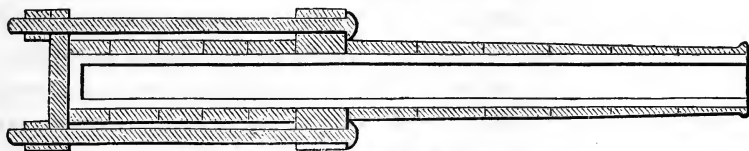
*much smaller than the external diameter of the inner tube on which they are shrunk, that after being cooled, the outer casing formed by the rings or collars is in a state of tension or permanent strain, similar to that produced when the rings or collars are forced upon a conical surface, as before described, and the inner tube is in both cases similarly compressed;\* a like effect may be produced by forming heavy ordnance, especially rifled guns or sea-service mortars, with an internal tube or cylinder (formed by casting and boring in the usual manner) upon which are cast rings of cast iron in one or more layers. When in several layers, the joints of the rings should 'break band.'*

**1025.** "*Secondly, the improvements relate to strengthening old guns or guns made according to other arrangements, by the application of external metal rings or coils of iron, as referred to under the first head of the improvements.*

"But that my said invention may be fully understood and readily carried into effect, I will proceed to describe the drawings annexed.†

"Fig. 1 shows a sectional view, and Fig. 2, an external view of a gun arranged according to the first part of my improvements; Fig. 3 shows the internal core separately; Fig. 4 shows two

FIG. 429.



Blakely's hooped gun, patented 1855.

views of one of the rings; and Fig. 5, two views of the rings upon which the trunnions are formed; *a a* is the internal tube or cylinder of cast iron or steel which receives the charge; *b b* are a series of collars or rings, which are shrunk or driven upon the

\* After the word "compressed," the words "Secondly, the improvements consist in," were written in the original specification.

† Figure 429, Blakely's original 18-Pounder (72), sufficiently explains the drawings referred to, the only difference being that the gun shown in the patent has two courses or layers of hoops.

outer surface of the inner cylinder. There may be one or several series of such collars or rings, but when there are several layers, they should be applied so as to break joint as shown: and when applied they, with the internal cylinder, form one combined mass of metal, to resist the force of the charge when firing. The trunnions are formed on or affixed to one of the collars or rings as shown by Fig. 5; *c c* are rods formed with screws at their ends for nuts, by which the parts are retained in position, *but to which I make no claim*; guns thus formed of several parts may be either put together and transported as a whole, or they may be transported in separate pieces, and put together as required, by which great facility will be obtained for transport, especially with heavy guns. In these figures I have shown the end, *a'* of the cylinder or tube\* formed as part of that cylinder. I do not, however, confine myself to that arrangement, and in some cases I form that part separately, as shown in Fig. 6; *to do so, however, forms no part of my invention to which I lay claim*. In place of forming the outer casing of separate collars or rings, I sometimes form such outer casing of wire or rod wound spirally in one or more layers around the inner cylinder or tube. When the guns are formed in several parts to be put together separately, then the internal cylinder may for the time be shrunk somewhat by the application thereto of any suitable freezing mixture, or the external rings may be caused to expand by heat, previous to being applied to the internal cylinder, and then shrunk thereon.

**1026.** “I have not thought it necessary to give any specific direction for casting metal upon the surface of internal cylinders or cores for the purpose of strengthening them, as I proceed by simply forming a mould of the figure of such ring, and then having applied the internal cylinder therein as a core, I pour the fluid metal into the space around, as is well understood by persons accustomed to casting in metal.

**1027.** “Old guns or guns made according to other arrangements, may be strengthened by the application of external rings

\* The breech-plug

or coils of wire, or bars of iron or steel, as described in respect to the first part of the invention.

**1028.** "Having thus described the nature of my said invention, I would have it understood that I do not confine myself to the precise details shown and described, so long as the peculiar character of any part of the improvements be retained."

### ARMSTRONG—BLAKELY—TREADWELL.

**1029.** The patents of Sir William Armstrong are not made public. (¶ 1.) The following relates to the originality of the Armstrong gun—1st, as regards the use of hoops with initial tension. Captain Blakely testified as follows before the Select Committee on Ordnance, in 1863 :

**1030.** "The manager of the Butterly Company in Derbyshire, which made my guns in 1855, who accompanied me to Woolwich Arsenal last year, or the year before last, said, in my presence, that the system on which they were making the guns there was identically the same on which they had made guns for me in 1855.

**1031.** "I had taken out a patent on the 27th of February, 1855, and Sir William Armstrong made his experiments with his first field-gun, or his second field-gun, with my permission. There was no doubt about the identity of the thing. I gave him permission to make those experiments; and on the condition that I allowed him to continue those experiments, he promised to negotiate with me before using the gun commercially. I will read his own letter :

" 21st January, 1857.

"MY DEAR SIR:—Your letter of the 19th has reached me here. At present I am making no guns, except for experimental purposes. If you have a valid patent for any method of construction which I may adopt, I shall, of course, on being satisfied of that, negotiate with you before I use it commercially; until then the question may fairly stand over. You will observe that I make no claim to the exclusive invention of any thing in my letter to "The Times," but have confined myself to a simple description of what I have done.

"I am, dear sir, yours truly,  
(Signed)

" W. G. ARMSTRONG.

"Captain BLAKELY."

“ When Sir William Armstrong’s gun was introduced into service, I wrote him to remind him of his promise, and his reply was this :

“ ‘ NEWCASTLE-ON-TYNE, 9th January, 1859.’

[So that he had had plenty of time.]

“ DEAR SIR:—I have received your note of yesterday, and assure you that I have no intention of doing you any injustice. At the same time I must inform you that the guns which are being made under my direction have no interior lining of steel, and are not in any way affected by your patent.’

**1032.** “ Sir William Armstrong had then introduced a modification which I suppose he conceived to be a great improvement, viz. : making the entire gun of wrought iron, instead of the method which he had first used, of a steel barrel covered with wrought-iron coils, which is clearly within the words of my patent. My specification says :

“ ‘ The improvements relate, first, to a method of forming guns with an internal tube or cylinder of cast iron or steel, enclosed in a case of wrought iron or steel. I sometimes form the outer surface of the inner tube somewhat conical; the greatest diameter being just in front of the trunnions, and tapering both ways, and apply the outer casing in the form of collars or rings, driven thereon; and in some cases I apply two or more layers of such rings, according to the strength sought to be obtained, the trunnions being of one piece with one of the rings. The outer casing may, however, be applied in the form of collars or rings heated and shrunk upon the cylinder or tube; but I do not claim as my invention the method of forming guns or cannon by the application of collars or rings heated and shrunk upon a cylindrical inner tube, save and except when the internal diameters of such collars or rings are, previously to being heated, so much smaller than the external diameter of the inner tube on which they are shrunk, that, after being cooled, the outer casing formed by the rings or collars is in a state of tension or permanent strain, similar to that produced when the rings or collars are forced upon a conical surface, as before described. \* \* \* In place of forming the outer casing of separate collars or rings, I sometimes form such outer

easing of wire or rod, wound spirally in one or more layers, around the inner cylinder or tube.'

**1033.** \* \* \* "The real essence of Sir William Armstrong's gun and of my gun does not lie in the use of those coils, but in the manner in which the outer coils are made to compress the inner ones, so as to make the two layers act in unison in resisting the strain. This is very clearly explained by Sir William Armstrong in his letter of the 14th of July, 1855, in the blue book of last year

**1034.** "It is also to be observed, in reference to the strength of steel or wrought-iron cannon, that the resistance of a cylinder to internal pressure does not increase in the ratio of its thickness. If the cylinder be regarded as made up of a number of concentric layers, each capable of sustaining without injury a degree of extension proportionate to its length, it is obvious that the greater the circumference of each layer, the less will it be stretched by a given distention of the bore, and, consequently, the less will it contribute to the general strength of the cylinder. The ratio of this decrease is very rapid, being as the square of the circumference, or distance from the centre inversely;\* and, consequently, when the cylinder is thick, the deficiency of strength from this cause becomes very great.

"Now this defect can only be remedied by giving to the external portion of the cylinder a certain initial tension, gradually decreasing, and finally passing into compression towards the centre; and although this condition cannot be effected by any known process of forging or casting, yet where wrought iron or steel is the material used, it may in a great measure be attained by shrinking an outer cylinder upon an inner one, and in like manner superadding others until the requisite thickness has been acquired."

**1035.** Captain Blakely then refers to the fact that Sir William Armstrong subsequently ignored this principle, for instance, before the Institution of Civil Engineers in 1860. Sir William says:

"The outer layers and rings of metal are not put on with any

\* Sir William here gives the calculation at length.

calculated degree of tension ; they are simply applied with a sufficient difference of diameter to secure effective shrinkage."

**1036.** As to the use of a steel barrel hooped with wrought iron, the examination before the same Committee (1863) elicited the following statements from Sir William Armstrong :

"Q. You mentioned on the last day of your examination that one of the results which had been obtained by the country had been a system of construction of guns ; will you kindly say whether you mean by that the system of strengthening the guns by hoops of wrought-iron, or whether you include the system of constructing the barrel ?" A. "I referred to the coil system." Q. "You referred to both the barrel and the external hoops?" A. "It is applicable to the barrel and to the hoops." Q. "Then what do you mean by the coil system as applicable to the barrel and hoops ?" A. "The gun with the barrel of steel as exemplified in my first gun." Q. "What is the system of construction which you say the country has gained?" A. "The coil system ; but I have made the internal tubes of the gun of both steel and coils. *I use the coil as alternative when steel is not to be obtained.*" Q. "Then how do you define the system of construction which you referred to?" A. "The construction of the gun by a coiled tube, and it may either be applied to the barrel or not. I have already stated that *the system which I most approve is to use steel for the barrel*, provided I can get the proper metal ; but if it cannot be got, then the alternative is to use coils for the barrel."

**1037.** It appears then, first, that Sir William Armstrong infringes Captain Blakely's patent for hooping a steel barrel when he uses the most approved system, and second, that he is at least not original in the use of hoops having definite initial tension.

Again, Sir William Armstrong says in the same testimony : "From the very first I saw and I still feel that steel is the proper metal for the barrel of a gun, if it can be obtained, and my only reason for not persevering in the use of steel was the difficulty of getting it of suitable quality. There can be no question that

wrought iron is too soft, and that brass is still more objectionable than wrought iron, and if we can only obtain with certainty and uniformity, steel of the proper quality, there can be no question as to the expediency of using it. Now *no one has any right to appropriate to himself the merit of applying steel to this particular purpose*; the merit of its application must rest with the manufacturer who produces a satisfactory article."

**1038.** Considering the foregoing letter of Sir William to Captain Blakely, disclaiming the use of steel, and the fact that Sir William, during an expenditure of twelve and a half million dollars on his plant and gun, failed, if he did not neglect to develop the use of steel while other manufacturers did use steel successfully,\* and the fact that he has on several occasions disclaimed the use of hoops with definite initial tension, might lead to the impression that he may have wasted some public money on the less approved system, for the purpose of protecting *himself* against Captain Blakely and other prior inventors.

**1039.** What Sir William Armstrong more specifically claims as his improvement (his patents, by special orders of the Government have never been made public) is thus stated by him before the same committee (1863): "Now the peculiarity of that gun was not its being merely a built-up gun, because built-up guns are of very ancient date. In fact, I have no doubt that the original construction of all guns was by building up. It was not merely a hooped gun, that is to say, a gun strengthened by rings, because rings give only circumferential strength, and no longitudinal strength; *but that gun was peculiar in being mainly composed of tubes, or pipes, or cylinders, formed by coiling spirally long bars of iron into tubes, and welding them upon the edges as is done in gun-barrels.* Now, whether any one had conceived that idea before is beyond my power to say, but I feel assured that no gun up to that time had been actually made upon that principle, *the whole difficulty lying in the making.* It is very easy now, with all our knowledge and experience, to define how

\* Commander Scott stated before the Ordnance Committee of 1863, that Krupp's steel had never been tried for inner tubes.

such coils are to be made; but at that period (1855) it was very difficult to accomplish, and it was not until I had made very many unsuccessful attempts, that I succeeded in satisfactorily carrying it out.”

**1040.** As to the originality of this part of Sir William Armstrong's gun, it is only necessary to quote Professor Treadwell's account, published in 1845, of the construction of guns proposed by him in 1840, twelve years before Sir William's experiments began.\*

**1041.** Professor Treadwell says:† \* \* \* “I determined, between four and five years ago, to attempt to apply it [the principle of constructing cannon by directing the fibres—the greatest strength of the metal—round the bore], practically, to the fabrication of cannon. My first attempt was to make a 4-pounder

\* In a note on page 7 of a pamphlet entitled, “On the Construction of Improved Ordnance,” 1862, Professor Treadwell says:—“When I first read an account of the method followed by Armstrong in constructing his gun, although I saw at once the exact resemblance of it to the method invented by me in 1840–44, yet not being aware of the fact that the specification of my English patent had been published *in extenso*, I thought it might be that Armstrong had reinvented my form of gun, and the machinery required to produce it. But since writing this letter I have looked into that great work. “The English Printed Specifications,” a copy of which is in the Burton Library, and I there find that the specification of my English patent, enrolled July 5th, 1844, No. 10013, was printed in 1854. This patent was taken out in the name of Thomas Aspinwall, then American Consul at London, who acted as my attorney. The specification was written by me and transmitted complete to him. It occupies twenty-one large printed pages, with full references to elaborate drawings, which occupy a large folio plate, of the machinery used by me in constructing the cannon. Any one acquainted with what Armstrong calls his gun, and the mode of constructing it, will find here every thing relating to it so far as its structure *without rifling and breech-loading apparatus* is concerned. There is no difference whatever in the form of the construction, the mode of putting the rings together within the furnace, or the tools and enginery required for the work, except the substitution by Armstrong, of a steam-hammer for the hydrostatic press used by me. [Professor Treadwell of course refers here to the method of making a single tube.]

“Now, Armstrong has shown, by his denunciation of patents, to the British Association, that he is well read in the record of them; is it then probable that this has been overlooked by him? And will the high-minded and honorable men, the English engineers, especially those who constitute the Institution of Civil Engineers, suffer this plagiarism or piracy, taking whichever of these ugly words may best describe the act, to pass unchallenged in England?”

† “A short Account of an Improved Cannon, and of the Processes and Machinery employed in its Manufacture, by Daniel Treadwell,” 1845.



cannon, by the best means then at my command, of rings, or short hollow cylinders joined together end to end by welding. Each ring was made of several thinner rings, placed one over the other and welded. It will be seen, that, in this case, as the bars of which the several rings were formed were curved round the calibre, the direction of the fibres herein shown to be so essential, was fully preserved. I may remark here, that this method was subsequently changed in some degree, by first making a single thin ring of steel, and upon the outside of this, winding a bar of iron spirally, as a ribbon is wound upon a block. This gun, although imperfectly made, withstood the action of enormous charges of powder, and was only burst by using very superior powder, and shot without windage. The fracture was made lengthwise of the gun, or across the fibres of the iron; and although the welds (technically called jumps), which united the rings to each other endwise, were most imperfect, they yet held together completely against the action of the powder. Two other cannon of similar kind were subsequently made, one of which yet remains uninjured, after having withstood many most severe tests. Having this experimental proof of the strength of cannon made in this form, my attention was next directed to devising machinery which should enable me to produce guns of large size, with expedition and certainty. The result was, the construction of a hydrostatic press, of 14-inch piston, having a power calculated at 1000 tons, and adapting to it a variety of machinery by which the rings can be formed, and afterwards united together, with an ease and expedition, and with a perfection in form and freedom from flaw or blemish, altogether unattainable by any other means; at the same time preserving, in the iron, all its strength and toughness.

**1042.** "A description of this elaborate machinery, and the use of it, would not be intelligible, in detail, without drawings. Nor is it necessary to my present purpose—which is to show the superiority of the cannon when made—to say more than that a number of rings or short hollow cylinders are first formed, by means of various moulds, dies, and sets connected with the powerful press before alluded to. The rings are upon their inner

sides, and to about one-third of their thickness, of steel; the outer portion being of iron, wound about the inner steel ring, and the whole welded together. They are then joined together, end to end, successively, by welding, thus forming a frustum of a hollow cone, the hollow being cylindrical. In giving form to the cone, in the press, its size is determined by a mould of great thickness and strength, which encloses the heated portion of the cone, while a solid mandrel occupies the hollow cylinder, the force of the press being applied to sets upon its ends. The pores of the metal are therefore closed, and the metal condensed to a degree not to be attained by the hammer. By turning and boring, this frustum of a cone is formed into the cannon, the breech being closed by a screw-plug, and the trunnions fixed upon a band, which is likewise screwed upon the outside of the gun. The trunnion-band and trunnions are formed, like the cannon, by machinery moved by the hydrostatic press.”

**1043.** Professor Treadwell then gives an account of the trial and remarkable endurance of several of his guns ordered by the Navy Department.

#### PARROTT, 1861.

**1044. Robert P. Parrott's Specification of United States Patent, dated Oct. 1, 1861.**—“To all whom it may concern: Be it known, that I, Robert P. Parrott, of Cold Spring, in the county of Putnam, and State of New York, have invented a new and useful improvement in the manufacture of Ordnance; and I do hereby declare, that the following is a full, clear, and exact description of the same, reference being had to the accompanying drawings forming part of the specification, in which Fig. 1\* is a central longitudinal section of a cannon, and Fig. 2 a transverse section of the same. Similar letters of reference indicate corresponding parts in both figures.

**1045.** “This invention relates to the application of a wrought-

\* Fig. 430 only differs from this drawing in having a differently shaped cascabel and no muzzle-swell.

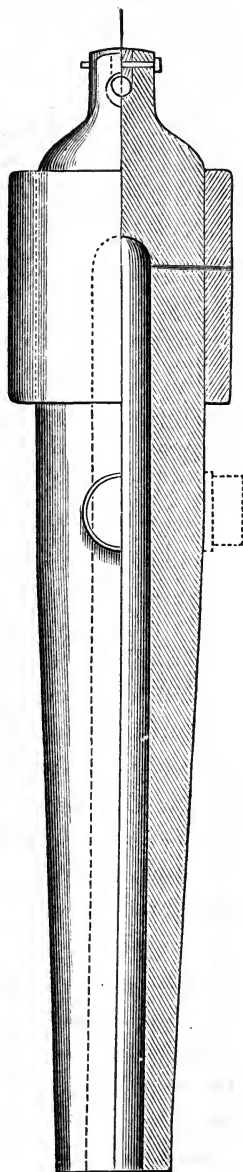
iron reinforce to a gun having its body or main portion of cast iron; and it consists in a peculiar mode of shrinking the reinforce on the body, whereby the heating and expansion of the body, in a very high degree, by heat communicated to it from the reinforce, is prevented, and the reinforce is caused to be drawn equally close all round the body.

“To enable others skilled in the art to apply my invention to practice, I will proceed to explain the manner in which it is performed.

**1046.** “The cast-iron main portion or body, A, is or may be made like any cast-iron gun, either with its breech a part of the same casting, like a gun of the ordinary kind, or with a breech made of a separate piece or pieces of metal, either permanently secured to the body, for loading at the muzzle, or movable, to provide for loading at the breech; or, what I have called the body, to distinguish it from the reinforce, may be a cast-iron gun which has been already finished for use, but requires strengthening to enable it to carry heavier projectiles than those for which it was originally intended; or a cast-iron gun, which, not having been originally intended for a rifled gun, has been weakened by rifling.

**1047.** “The wrought-iron reinforce, B, may be made in various ways, but that which I consider the best, is to take a bar of square iron of proper dimensions, coil it spirally upon a mandrel, then heat it to a welding heat, and place it in a strong cast-iron cylin-

FIG. 430.



Parrott 6.4 inch "100-pounder" rifle,  $\frac{7}{8}$  in. to 1 ft.

der and hammer it endwise till the coils are welded together and a round hollow wrought-iron cylinder is formed. The cylinder thus forged is to be bored, and turned in a lathe to the proper size and thickness.

“The body A having been previously bored, has that portion of its exterior which is to receive the reinforce turned to a cylindrical form, and of a diameter about one-sixteenth of an inch to the foot larger than the diameter which the interior of the reinforce has in a cold state. It is then placed in a horizontal or nearly horizontal position, upon suitable supports or bearings, which permit it to be rotated on its axis or rolled, and which will permit the reinforce to be put on when sufficiently expanded by heating it; and a pipe is introduced through the muzzle for the purpose of conveying a constant and copious stream of cold water to the bottom of the bore. When the reinforce has been properly heated, and so expanded, to enable it to pass loosely on to the body, it is placed in its proper position thereon, and cold water is introduced into the bore by the aforesaid pipe, and the body is rotated on its axis. By this rotary movement the reinforce, while hanging loosely on the body, is prevented from remaining in contact therewith at one point, and so prevented from cooling first at one part, which would be the case if I let it remain hanging with one part only in contact with the body, and which would set the reinforce at that part and prevent it from being drawn equally close at all points round the body. By the introduction of the stream of water, which runs out at the muzzle of the gun, the heat imparted to the body from the reinforce is carried off and the body prevented from being thereby materially expanded, and so lessening the pinch or force with which the reinforce binds finally upon it. As soon as the reinforce is found to bind upon the body, I cover it with sand or other material which is a good non-conductor of heat, continuing the flow of water through the body until the entire gun is cold. The object of so covering up the reinforce, is to prevent the outer portion from cooling and contracting quicker than the inner portion, and to cause it to be cooled from the interior, by which it is made to bind more firmly on the body.

**1048.** "What I claim as my invention, and desire to secure by letters patent, is:

"The within-described mode of shrinking the wrought-iron reinforce, upon the cast-iron body, of a piece of ordnance, that is to say, by rotating the body while water is introduced into the bore.

"ROBERT P. PARROTT."

**1049.** PARROTT'S PATENT OF 1862.—On the 6th of May, 1862, Captain Parrott obtained another patent for "Improvement in Hooped Ordnance," in which he specifies the above-described manner of putting on the hoops, and certain other proportions and parts, as follows: \* \* \* "I make the thickness of this reinforce, when finished, by boring the interior and turning the exterior, about equal to from  $\frac{4}{16}$  to  $\frac{5}{16}$  of the calibre of the gun, and its length sufficient to cover the usual charge of powder, and make it extend a distance about equal to one calibre in rear of the bottom of the bore, that is to say, the inner face of the breech, and a distance about equal to one calibre in front of the charge of powder."

**1050.** The inventor then mentions a number of pins screwed through the hoop into the gun, to hold the former in place, and describes a breech-plug having two diameters, the larger diameter screwed into an enlargement of the rear of the bore, and the smaller diameter extending forward into the bore, but not screwed.

The reason assigned for this practice is as follows: "I believe that owing to the rigid connection made between the bottom and sides, or cylindrical portion of the bore, in such guns, great strain is thrown upon the centre of the bottom, and at the junction of the bottom and sides."\*

**1051.** The inventor does "not claim, broadly, the reinforcement of a cast-iron gun with a band of wrought-iron, when such band and the body of the gun are not proportioned to each other, and the reinforce does not occupy a position on the body substantially, as herein set forth.

\* Captain Parrott has not, as yet, used this breech-plug for service guns.

“Nor do I claim fitting a gun with a screw-plug, when such plug is movable for breech-loading, and used without a wrought-iron reinforce.

“But what I claim as my invention, and desire to secure by letters patent, is:

“A gun made as herein shown and described:

“The arrangement of the screw-plug C, constructed as shown, with the said gun, as herein set forth.”

## HOW GUNS BURST.

BY NORMAN WIARD, ESQ.\*

**1052.** “When gunpowder is fired from a gun, two prominent phenomena are to be observed; the wonderful expansive force which ejects the shot, and the heat which results from the combustion of the powder.

“Let us exhibit the effect of heat on metals by a familiar ex-

FIG. 431.

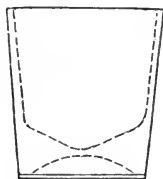
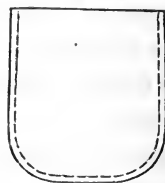


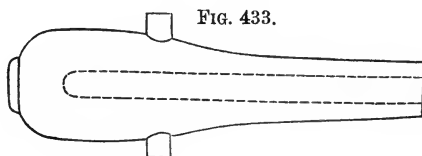
FIG. 432.



periment. Pour boiling water into a glass tumbler; the heat, communicating more quickly to the thin sides than to the thick bottom, breaks the glass from unequal expansion. If we wish the tumbler to withstand the sudden communication of heat, we must make it everywhere thin alike, so that the heat may pass through it uniformly and quickly. Hot water may then be poured into it with impunity. \* \* \*

\* “Great Guns; the cause of their failure, and the true method of constructing them.”—Norman Wiard, 1863.

**1053.** "Now, this unequal communication of heat, has a similar effect upon large guns. This may, also, be illustrated by a glass model of a gun (Fig. 433), which, although strong enough



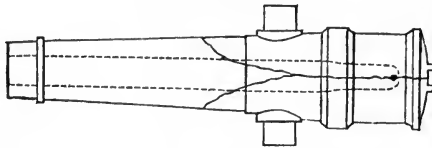
to withstand a pressure on the inner surface of 400 pounds to the inch, would be broken by the insertion of a heated rod of iron of smaller diameter than the bore, even though so inserted, as not to come in contact with its sides, and not accompanied by any pressure against the surface. \* \* \* If, however, after waiting a time *for the model to be slowly heated throughout its whole mass*, the outer surface of the gun be touched by the wetted finger, the evaporation of the moisture will make the heat sufficiently unequal, and the model will break. This example may exhibit the direct cause of the bursting of the 100-pounder Parrott gun, on the steamer Naugatuck, on the James River, before Fort Darling, when other guns of the same kind on the steamer Galena, though fired with great rapidity, and oftener, did not burst; all of which may be accounted for, by the fact that it was raining at the time, and that the gun of the Naugatuck being on the upper deck and exposed to the rain, was subjected to a more unequal heating, than the guns of the Galena, which were between decks. I have stated that guns are more *likely to burst* when fired on *cold* or *rainy* days, and offer the following examples in corroboration: first, two large steel guns, of my fabrication, burst under such circumstances, then this example of the gun on the Naugatuck, and two guns, referred to in the Table,\* are among many other similar cases I have noticed.

\* Mr. Wiard constructs a table from experiments recorded by Captain Rodman, showing a much greater endurance of guns with proof rounds, in fair than in rainy weather.

**1054.** “There being two forces acting upon the guns which burst, one the direct pressure of the gases evolved from the powder, and the other resulting from the expansion of the inner metal of the gun, both forces acting in the same direction, and nearly at the same time, it would seem difficult to show one to be pre-eminently the cause of the fracture. \* \* \*

**1055.** “The fractures of large guns upon improved models, with a light chase and heavy reinforce, that have burst with the service charges, are curiously alike in their direction, running through the centre of the breech and reinforce, to a point usually forward of the trunnions, and branching off at either side, generally breaking the gun into three great pieces. This direction of fracture holds, whether the gun has the outlines of the army Columbiad (Fig. 434), of the Dahlgren gun (Fig. 435), or of the Parrott gun with its strong wrought-iron reinforce, and whether the gun be made of steel or of cast iron. It would scarcely be expected, when the Dahlgren guns burst, with this great thickness of metal about the breech, that the fracture would occur through the cascabel, where the metal has more than twice the thickness exhibited in the army Columbiad, but this principal direction is usually the result.

FIG. 434.

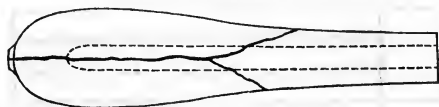


**1056.** “Guns sometimes exhibit additional fractures to those represented above, and this occurs when the thickness of metal is continued further forward towards the muzzle (Fig. 436), having the same effect as if a tire, or strong band, were placed upon the gun at the place where the fracture usually branches off to either side, thus delaying the longitudinal fracture until the expansion lengthwise of the inner metal is greater than the *elasticity* and *ductility* of the reinforce, when the cross fracture occurs. It may be said, then, in brief, that the fractures at right angles to



the plane of the bore are caused by the lengthening of the inner metal about the bore by heat, while the outer metal remains the same length, or with less expansion of length, until ruptured, and that longitudinal fractures are due *principally* to the enlarge-

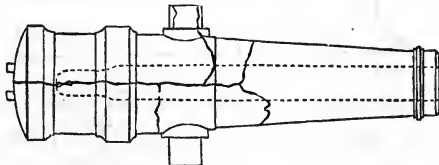
FIG. 435.



ment of the inner metal by *heat* in the direction of the diameter, or *radially*. If the gun be parallel all the way to the muzzle the cross fractures will occur more frequently along the reinforce, because in that part it is exposed to the highest temperature, and, consequently, the greatest expansion of length. \* \* \*

“It is a corroboration of this theory that the guns of the Dahlgren model, with more than double the thickness of metal behind the chamber, though made of the strongest material, should break in the same direction, forward of the trunnions, but sometimes exhibit only cross fractures (when made of cast iron) to the rear of the

FIG. 436.

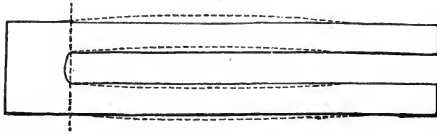


trunnions. It is evident that the model is best in which the direction of the fracture is least uniform, but a properly constructed gun should not burst at all.

**1057.** “The gun, however, is usually broken through the breech—the strongest part of the gun—and beyond the range of the pressure, which is, of course, limited to the bottom of the bore or chamber. The diagram (Fig. 437) in Captain Rodman’s book, p. 43, exhibiting the various kinds of strain to which a gun is subjected at each discharge, considers the gun as if made up of staves, and really exhibits only the strain from the expansive force

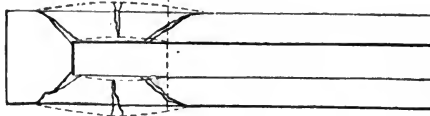
or direct pressure of the powder, bending the staves outward; and page 47 of the same book, by diagram (Fig. 438), the direction of fracture due to such strain, not through the breech, but running at an angle to the plane of the bore.

FIG. 437.



**1058.** “To show that it is improbable that the direct pressure of the powder should be the cause of fracture, as exhibited by the gun actually broken by firing, prepare three plates of metal, say 4 inches thick, 12 inches wide, and 60 inches long, with plane surfaces; the middle one, on being heated to  $1600^{\circ}$ , will be found expanded one-sixtieth part of its length, or will be 61 inches long. On placing it between the other two (Fig. 439), a part of its heat is immediately communicated to their contiguous surfaces only. The expansion of one surface of the out-

FIG. 438.



side plates, while the other surfaces remain cold, warps the latter to the form of a segment of a circle. Now, supposing them placed upon the diagram of a burst gun (Fig. 440), the centre

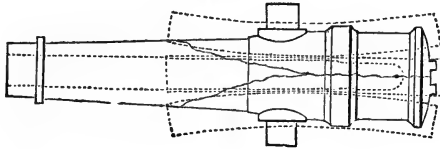
FIG. 439.



metal of which has been heated by the combustion of powder, it is evident that the fracture in the particular direction exhibited must have resulted from the unequal expansion of the gun by heat, and a diagram exhibiting these curves, the result of this expansion, will be exactly the opposite of the curves on the diagram by Rodman, and will account for the breaking of the gun through the breech, beyond the range of the pressure made by the powder (Fig. 441).

“The following diagrams (Figs. 442 and 443) exhibit the effects of expansion of the inner metal by wedges, the drawing exhibits a section of the metal of a gun, with dovetail notches cut along the surface of the bore. Upon driving wedges into

FIG. 440.



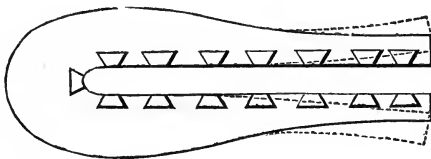
the notches the muzzle would be expanded, as shown by the dotted lines. If a band were put upon the muzzle, the fracture nearest the muzzle and the one through the cascabel would be most likely to occur first. If the band were placed over the first-

FIG. 441.



mentioned fracture, and the wedges along the reinforce and at the bottom of the bore driven most, as the heat is most intense at the bottom of the bore, cross fractures of the reinforce would be the result, as shown in the diagram. As the heat expands

FIG. 442.

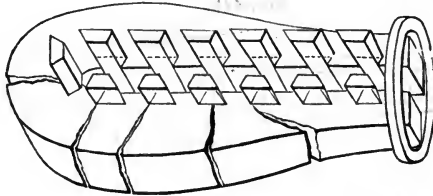


the metal in the direction of the diameter also, its effect in this direction also must be considered. The expansion of length, however, is of most consequence in considering the probable direction of fracture.

**1059.** “That the fracture almost always intersects the vent has been heretofore referred to the weakness resulting from

drilling away part of the metal, but on page 355, Major Wade's Reports on Metals for Guns, we find that after a gun had been put to extreme proof, and exhibited signs of fracture, a hole was

FIG. 443.



drilled one inch forward of the base-ring, and four inches from the line of the vent, to a depth of four inches, and of the diameter of one and a quarter inches. The gun was then fired with double charges of powder, and with a bore full of balls and wads, eleven times, to bursting. Although the piece burst into

FIG. 444.

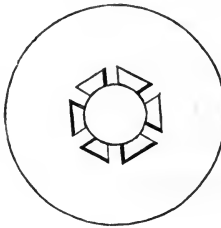
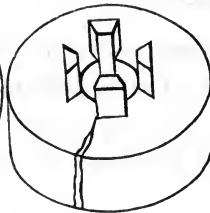


FIG. 445.

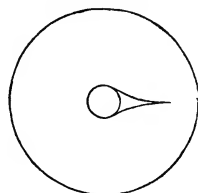


more than twelve fragments, one of the fractures intersecting the vent, it did not split through the large hole, showing that the gun had strength to resist the pressure of the powder, but burst, notwithstanding the drilling away of so large a part of the metal, from the communication of heat. The true cause, probably, of the intersection of the vent by the fracture, was the communication of heat to the surface of the vent, thereby expanding a column of metal about it, for it should be recollected that the passage of a large quantity of gases through the vent would communicate more heat to its surface than would be communicated if there were no current, but the capacity of the vent

only filled; in that case not much heat would be supplied to the surface, because the quantity contained within the vent would be small.

**1060.** "But in this example, as in all others, as is well known to ordnance inspectors, the fracture began to exhibit itself on the interior surface of the bore. This would seem to prove that guns burst by pressure rather than by expansion of the inner metal—as if the inner metal were expanded by the communication of heat before the outer metal gave way—a *strain of compression* resisted by the strength of the outer metal would rest upon the inner metal of the gun that would prevent fracture; and, undoubtedly, if it ever occurred to an ordnance officer to inquire whether the communication of heat to the inner metal of guns was the cause of their failure, the beginning of fracture on the inside would appear to him an argument against the theory. This I consider a critical point, but one directly favoring the theory. \* \* \* The accompanying diagram (Fig. 446) exhibits a cross-section of a gun at the point of greatest pressure, and, consequently, highest temperature; the surface of the bore is supposed, in this example, to be *continuously* exposed to the high temperature evolved from the combustion of powder when its expansive force is resisted by the inertia of a heavy projectile, or, *as if a fire were constantly burning within the gun.* The space between the curved lines represents the place and quantity of heat thus communicated to the metal, showing the greatest expansion immediately at the surface of the bore.\* But we are to recollect that, in the most rapid firing, the surface of the bore is exposed to this high temperature only about one-hundredth part of the time, while during the other ninety-nine-hundredths the heat of the surface of the bore

FIG. 146.



\* "To represent a reduction of temperature by lines converging toward each other I know is not philosophical, although as no conventional lines have been adopted to represent intensity of heat by their direction, and as I have confidence, my meaning will be understood. I have chosen to use them in this manner."

is radiating away. If the diagram represented a gun of six inches diameter of bore, and eight inches thickness of metal about the bore, the range to which the heat would penetrate the metal at the first discharge would be about four inches; for heat enters metal with a velocity depending on the difference in temperature of the source from which it flows and the metal into which it is flowing. The heat is communicated to the *small* surface of the bore, while it is radiated from the *large* outside surface of the gun; from this cause, if from no other, the temperature would be much higher within the mass than on the outside.

“The penetration from the first discharge being four inches, it might be supposed that the range of the heat from the next discharge would be greater; but heat having been communicated by the first discharge, the range of the second is less, from the reduced difference of temperature. Although, of course, the heat flows onward, its motion is very slow. If, then, the penetration be four inches, at the distance of four inches from the surface of the bore the temperature will be comparatively low, but little higher than that of the metal at four and a half inches from the surface of the bore. The heat, therefore, is conducted from the point of four to that of four and a half inches slowly; more slowly from that of four and a half to five, and with a continually reduced and very slow rate of motion to the outside. As the heat is communicated from one inner stratum to the stratum surrounding it, for each inch of the increasing distance it travels, the mass of which the temperature has to be raised is greater in circumference also; this is another cause of the retardation to its motion outward. Although for ninety-nine hundredths of the whole time the heat is radiating from the surface of the bore, the velocity with which it leaves is much less than the velocity with which it is received, because the difference in the temperature of the gun and the atmosphere occupying the bore is much less than the difference of temperature between the metal of the gun and the gases ejecting the shot by their pressure. The atmosphere occupying the bore

receives the heat by radiation, in the intervals between firing quickly, from the immediate surface, and less quickly a little distance beyond; and so again the heat flows from the metal of the gun with reduced velocity as the distance increases from the bore, leaving the point of highest temperature in the mass of metal, but not far from the surface of the bore. (See Fig. 447.) Its effect towards causing rupture may be illustrated by taking a cylinder of pine wood a few inches in length and a cross-section like the diagram, and providing a wedge similar in form to a bayonet (Fig. 448), but truly tapered to a point from a

FIG. 447.

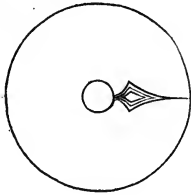


FIG. 449.

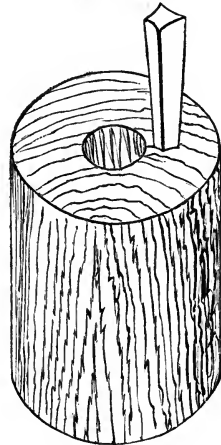


FIG. 448.

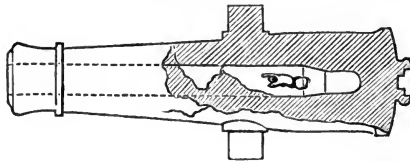



cross-section at the head, the same as the lines representing the place and quantity of heat on the diagram, showing its effects by *intermittent communication* of heat. (Fig. 447.) If the point of this wedge be set upon the end of the wooden cylinder at the point supposed to be the point of greatest heat, according to the theory above, and by a blow driven into the end-wood, it will penetrate so as to make an impression like the inner line of the diagram. A second blow, driving it further into the wood, penetrating as if to the second line of the diagram, and expanding the wood, will cause a fracture inward toward the surface of the bore first; a third or fourth blow will split it to the

outside. And thus guns burst, *the first fracture occurring on the inside, and afterward opening to the outer surface.*

**1061.** “It is often noticed as a curious phenomenon when large guns burst, that notwithstanding the chase or forward part of the gun, several feet in length, may be thrown many feet end over end, the shot passes through the chase the length of the bore without being diverted from the direction of its aim. This fact corroborates the theory under consideration, as it is evident that the shot is not projected by the same force that bursts the gun—the communication of heat to the inner metal of the gun requiring a longer interval of time, and gun metals being comparatively non-conductors of heat. In Rodman, Plate II., Fig. 2, is shown the interior line of fracture of a 10-inch Columbiad. (Fig. 450.) Here a thin bit of metal, indicated by

FIG. 450.



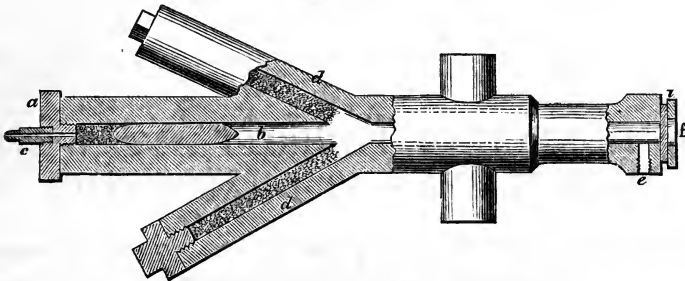
the line marked , is shown, which seems nearly to envelop the bore. Nearly one-half the reinforce was broken off this gun in the same manner as chips break off a stone door-cap when a building is burning, but in this example the outside of the stone is first heated while the inside remains colder. The outward *pressure* of the powder at the time of this fracture would surely have carried away so thin a piece of metal; but it remains standing *to show that the pressure had been reduced before the gun broke—a remarkable evidence of the true cause of the bursting of the gun.* \* \* \*



LYMAN'S ACCELERATING GUN.

**1062.** Extract from the patent specification of Azel S. Lyman, New York, for accelerating fire-arms (No. 16568), Feb. 3, 1857: "As soon as the gun has been fired and the ball has passed the chamber, *d* (Fig. 451), the fire in the bore, *b*, ignites the charges

FIG. 451.



Lyman's accelerating gun. (From the patent.)

in the chambers, *d*, thereby giving the ball additional force. Before the gun is to be fired, the muzzle is to be covered with some elastic material, *i*, and the air to be exhausted by applying an air-pump to the opening, *e*. \* \* \*

*Claim.*—The employment of the accelerators or additional charge-chambers in the manner and for the purpose substantially as described. I also claim covering the muzzle and exhausting the air through an appropriate aperture, whereby the atmospheric resistance is removed from the front of the projectile while passing along the bore, as set forth."

**1063.** A small gun on this plan, tested at New York and elsewhere, was composed of three heavy  $\frac{1}{2}$ -in. rifle-barrels screwed into chambers so as to form a continuous tube about 9 feet long. At the breech, there was a small chamber holding 50 grains of powder to start the projectile. Around this was an annular chamber containing 400 grains; 34 in. farther forward there was a chamber containing 900 grains; and 34 in. farther another containing 750 grains; the muzzle was 37 in. beyond this last chamber.

This gun fired a sharp-pointed steel bolt 8 in. long and  $\frac{1}{2}$  in. in diameter—weight,  $6\frac{1}{2}$  oz.—entirely through 4 in. of  $\frac{1}{2}$ -in. plates, with the above charge— $4\frac{1}{3}$  oz. The average penetration in laminated armor composed of  $\frac{1}{2}$ -in. boiler plates, was  $4\frac{7}{8}$  in.; and  $4\frac{1}{4}$  in. in solid iron.

A gun on this system, with a  $2\frac{7}{8}$ -in. bore, rifled with one turn in 36 in., has been recently constructed. But the system has not been adequately tested, and government officers have objected to it as dangerous.

---

## ENDURANCE OF PARROTT AND WHITWORTH GUNS AT CHARLESTON.

**1064.** As to the endurance of the Parrott guns at the siege of Fort Sumter (276 A), General Gillmore states that one 20-pounder was fired 4606 times at an elevation of  $40^\circ$ , without bursting. The shells were fired nearly five miles from the Federal works into the city of Charleston, which accounts for the great elevation of the piece.

General Gillmore also states, that out of six 200-pounders and seventeen 100-pounders, which were expended by bursting, on Morris Island, four of the former and two of the latter broke, after great service, square off under the wrought-iron hoop. One 200-pounder and seven 100-pounders burst by blowing out just in front of the hoop. As a rule, the guns had sufficient resistance to bursting, only three of the hoops having split—one into three pieces and the other into two.

The obvious defects of the gun are, therefore, insufficient length of hoop and insufficient longitudinal strength. Both are easily remedied. The resistance to bursting appears to be adequate to the charges.

**1065.** General Gillmore states, that at the siege of Fort Sumter (276 A) two 80-pounder (called 70-pounder in England) Whitworth guns had less mean endurance than the Parrott guns, but

that their failure was due to the slipping to the rear of the inner tubes, thus closing the vent. Reference to Fig. 28 will explain the cause of this failure, and Fig. 25 will illustrate Mr. Anderson's means of preventing it—hooking the tubes over one another so that they cannot slip.

---

## HOOPING OLD UNITED STATES CAST-IRON GUNS.

**1066.** In September, 1863, it was recommended by the United States Army Ordnance Board, that “in order to make the 24, 32, and 42-pounders of the old pattern reliable rifled guns, the 42-pounder guns be banded, bushed, and rifled; and as experiments\* show that the 32 and 24-pounder guns are reliable when rifled, up to at least 500 rounds, it is recommended that they be rifled and bushed for immediate service.”

This work was then ordered to proceed at once by the Secretary of War, and an officer was instructed to inspect all such guns in certain forts and batteries, the examination being specially directed to the following points:

“1st. To ascertain, from the records of the post, or other data, how many times each gun has been fired with service charges.

“2d. To see if the bore is a true cylinder.

“3d. To see if the vent is unduly enlarged.

“4th. To see if there are any other defects which will unfit them for the service required.

“All the guns which have been fired over 500 rounds; all those in which the variations in the bore from a true cylinder are .05 or more; all in which the greatest internal diameter of the vent is .7 in., or in which there are other radical defects, which, in your judgment, unfit them for the service required, will be laid aside and specially reported on.”†

\* These experiments were chiefly conducted at the West Point Foundry, with old guns hooped by Captain Parrott.

† Ordnance Memoranda, No. 5.

## ENDURANCE AND ACCURACY OF THE ARMSTRONG 600-POUNDER.

**1067.** “The 600-pounder has now fired about 50 rounds altogether, with charges from 60 to 70 lbs., and one charge of 40 and one of 90 lbs., which last was used with a steel round ball, weighing 340 lbs. The weight of the cast-iron shot fired for range is about 510 lbs., and the initial velocity obtained with 70 lbs. of powder is 1250 feet per second. With 610 lbs. steel projectiles of which few have been fired, the velocity has been nearly 100 feet less. The accuracy of this powerful weapon has been very good, its mean lateral diameter deviations being only  $1\frac{2}{3}$  yds. at 1500 yds.,  $8\frac{1}{10}$  (?) yds. at 2300 yds., and 3 yds. at 4000 yds. range. With an elevation of  $23^{\circ} 9'$  the gun ranged 7300 yds., and the time of flight of the shot was 26 seconds.

“After firing, the gun was carefully examined and found to have suffered most in the upper side of the powder-chamber, which was covered with small cracks or openings, but, as far as could be ascertained, there is no flaw of any magnitude. The gun is expected to stand at least 100 discharges (!) and may go on to 300 or even 500 before rupturing. It is generally supposed that, had the inner tube been of soft steel instead of coiled iron, it would have withstood the action of the powder gases better.”\*

\* \* \* “Beyond all doubt, however, the coils may be said to be gradually opening, and it is only a question whether or not the inner coil will stand a large number of rounds before it gives way. Once the inner coil yields, all the others on the outside become useless until the place of the defective coil is supplied with a tube of steel, as all the modern Armstrongs are now built with.” †

\* *Army and Navy Gazette*, July 23d, 1864.

† *London Times*, quoted by the *Engineer*, July 22d, 1864.

## COMPETITIVE TRIALS WITH 7-INCH GUNS.

**1068.** The trials of these guns (607, last paragraph) is not yet completed. The *Army and Navy Gazette* of July 23d, 1864, says:—"As far as the trial has yet gone, the contest seems to lie between the Scott and Lancaster guns, the lead coating of the Jeffery and Britten projectiles having proved unequal to withstand the 25-lb. charges. This quantity of powder appears also to have blown off portions of the studs upon the French shot, and to have considerably increased the difficulty of loading the Lancaster gun. The loading of the French gun has been generally easy, that of the Scott gun, invariably so.

The accuracy of the Lancaster with 25-lb. charges was very good at 10° of elevation, the mean difference in the range of the shot being about 27 yards, with a mean deviation of 7 yards; Scott, 30, with a mean deviation of 9 yards. But, on the other hand, Scott's range was nearly 4800 yards to Lancaster's 4600 yards. At 2° of elevation, Scott's range of 1600 yards was 20 yards more than Lancaster's, and his mean difference of range and deflection, 16 and 1½ yards to Lancaster's 29 and 2 yards respectively."

TABLE CXLVI.—COMPARISON OF PRESSURES AND VELOCITIES WITH LOOSE AND COMPRESSED POWDER. (DOREMUS AND BUDD'S COMPRESSED POWDER.) WEST POINT, AUG. 29, 1861.

Cartridges cylindrical, and fitted the chamber accurately. Diameter,  $\frac{1}{10}$  in. less than the calibre. Weight,  $1\frac{1}{4}$  lbs. The usual charge.

Powder No. 1, compressed to 10 tons on the entire surface of the specimens.

Powder No. 7, compressed to 30 tons on the entire surface of the specimens.

Powder Nos. 3 and 6, to intermediate pressure.

Powder.	Initial Velocity.	Pressure per sq. in. on Chamber.	Range, yards.
	ft.	lbs.	yds.
Hazard B, Loose.....	1433	42330	368
“ 1.....	1499	68090	452
“ 3.....	1514	70000	316
“ 6.....	1507	70000	330
“ 7.....	1477	57170	239
“ 7, Loose.....	1274	19490	287
“ 1.....	1452	68090	303
“ 3.....	1425	50000	252
“ 6.....	1382	45000	204
Dupont P, Loose.....	1452	50000	281
“ 1.....	1482	68090	299
“ 3.....	1489	50000	284
“ 6.....	1393	40000	267
“ Glazed Shel-lac.....	1492	67800	368
“ Not Glazed.....	1409	67800	403

The initial velocity and pressure on the chamber of the compressed powder were greater than that of the loose in every case but one; and they increased with the amount of compression to a certain point, and then decreased as the pressure increased, so that, with a

certain pressure, the cake and the loose powder are alike in results. The only advantages of the cake powder seem to be as follows :

1. Dispensing with the cartridge-bag, and accidents from fire remaining in the gun
2. Reducing the bulk of ammunition to three-fourths the size.
3. Preventing dusting in transportation.
4. Rendering the powder impervious to moisture.

The glazed and unglazed cartridges were nearly alike in results.

It having been suggested by Captain Benét, of the Ordnance Department, to make the cartridges smaller than the bore, so as to give greater space for the gases to expand, and lessen the first shock on the gun, this was tried, November 30, 1861, with the following results :

Powder.	No. of Rounds.	Initial Velocity.	Pressure.
		ft.	lbs.
Hazard No. 7 Powder.....	2	1344	13500
	3	1348	13500
	4	1357	13500
	5	1359	13500
Hazard No. 7 Powder, in Grains.....		1274	19490

The cakes, therefore, gave an initial velocity greater by 78 feet, or  $\frac{1}{7}$ , and a pressure on the bore less by 6000 lbs., or  $\frac{1}{3}$ ; *i. e.*, a greater initial velocity with a diminished strain on the gun.

Comparing these results with Hazard's No. 7, tried in 1860 :

Hazard No. 7 grain, Initial Velocity .....1473 feet. Pressure.....55530 lbs.  
 Cakes, average Initial Velocity.....1352 " Pressure.....13500 "

That is, the initial velocity of cakes is less by 121 feet, but the pressure is less by 41830 lbs., or three-fourths. Hazard powder is now made less quick than formerly, which accounts for the discrepancy in the above results.

TABLE CXLVII.—BRITISH CANNON POWDER.

Velocities obtained with 32-pounder proof gun: Weight of shot, 33·506 lbs.; Diameter of shot, 6·312 in.; Diameter of gun, 6·375 in.  
Charge, 8 lbs.

Brand of Powder.	Velocity at 30 yards. Feet.	Initial Velocity. Feet.	Range in yards.	Relative Strength.	Measure of Percussion	Composition.					No. of grains in 10 grains, in weight.
						Nitre.	Charcoal.	Sulphur.	Moisture.	Total.	
L. G. 1859 .....	1663·6	1698·3	629	1000·0	1000·0	74·26	14·68	9·98	1·08	100·00	59
W. A. ....											
L. G. 1862 .....	1624·0	1657·5	584	976·0	913·7	74·88	14·49	9·73	0·90	100·00	109
W. A. ....											
L. G. Curtis & Harvey.....	1660·5	1695·2	581·6	998·2	545·0	74·06	14·95	9·93	1·06	100·00	64
L. G. Hall & Son.....	1632·9	1666·7	569	981·4	585·7	74·88	13·80	10·44	0·88	100·00	92



# I N D E X.

[The References are to the Paragraphs.]

ACCELERATING GUN, LYMAN'S, 1062, 1063.

Alloys for gun-metal, see Bronze, 506.

Aluminum bronze, 503.

Ames's wrought-iron guns, 128, 129, 431.

Anderson, John, Esq., on Armstrong system, 452.

On elasticity and ductility of cannon metals, see Elasticity; Ductility.

On qualities of guns, 271.

On welds, 449.

On wrought iron, 395, 401, 427.

Annealing steel, see Steel.

Armor, see Chapter II. and Part II.

American systems (see Armor Experiments, American), 191, 195, 204, 256, 262, 263.

British systems (see Armor Experiments, British), 191, 192, 195, 834.

Backing, 199 note, 830, 854, 856-859.

Best quality, 202, 212-216, 226, 236, 262, 834.

Combined, 204, 263.

Convex surface stronger, 181 A.

Destruction of, not the aim, 210.

Ductility, 203, 211, 212-216, 256.

Effect of shot going through, 262, 264.

Fastenings, 192, 194, 204.

Gun to operate against, see Guns.

Light targets, 206, 235 B.

Laminated, 191, 194, 197, 198.

Easily punched, 181 A, 195, 196-202.

Advantages, 194, 263.

Strengthens the ship, 194, 204.

Projectiles for punching, 857; material for, see Rifling and Projectiles.

Resistance to projectiles, see Velocity of Projectiles; Armor, Solid; Armor, Laminated.

Shells fired through (see Rifling and Projectiles), 226, 231-235, Table XXXL

Solid, weakens the ship, 194.

Punching, 202.

Advantages, 202, 203, 220.

Steel, 213, 236, 471.

Why necessary, 171, 210.

Work of, compared with cannon, 471.

Experiments against

Floating batteries, 800.

Russian, 580.

American, Chapter II., also Part II., Tables XXVIII. and XXXL; sub-calibre shot, 844; 15-in. ball, 179, 181 A, 181 B, 863, 864, 886; 11-in. ball, 179, 180, 181 B, 214, 235 B, 855-859, 864, 866-869, 871, 876, 877, 886; 10-in. ball, 200, 801, 837; Parrott 10-in. bolt, 181 A, 861, 862; Parrott 8-in., 886; Parrott 100-pounder, 837, 844; lead shot, Table XXXV; 14-in. iron, 181, 866; 10-in. iron, 179, 180, 200, 864; 8-in. iron, 861; 6-in. iron, 181 A, 844, 886; 6 $\frac{1}{2}$ -in. iron, 867; 4 $\frac{1}{2}$ -in. iron, 181 A, 214, 235 B, 859, 863, 869, 871, 876, 886; 4-in.

iron, 844; early experiments, 790; Stevens's, 790, 794, 801, 837; masonry protected by iron, 799; wire target, 855; inclined armor, 856-858; backing, 856-859; rubber, 856-859, 871, 877; target of bars, 862; *Atlanta*, 863; oak facing, 876; Hog's-hair target, 898.

British, see Tables XXVIII. and XXXL, Part II., and Chapter II.; early experiments, 792, 795, 796, 798, 802; masonry protected by iron, 190, 792, 820, 824; *Warrior* target, 183, 184, 201, 227, 229, 231, 232, 831, 833, 839, 845, 847; backing, 830, 854; Cole's cupola, 829; Fairbairn's target, 828; Roberts's target, 827; inclined plates, 816, 825; different qualities of iron, 823; Special Committee, 1861, 821; cast-iron blocks, 803; steel armor, 804, 823; firing through water, 265, 806, 849; thin plates, 793, 812, 840, 846; *Trusty*, 813; conclusions up to 1862, 834; "Committee" target, 833, 839; Scott Russell's target, 187, 840; Samuda's target, 840; *Minotaur* target, 183, 223, 843; Ingllis's target, 185, 850-853; Chalmers target, 189, 230, 873; Clark's target, 875; *Bellerophon* target, 189 A, 831, 832; compressed wool armor, 897; mantlets for embrasures, Table CXXI.; *La Flandre* target, 900; 4-in. plates, 804, 807-809, 813, 833, 839; 4 $\frac{1}{2}$ -in. plates, 797, 814, 815, 826, 831, 833, 838, 839, 845-847, 833, 888; 6 $\frac{1}{2}$ -in. plates, 293, 843, 846, 870; 6 in. targets, 832, 881, 882; 6 $\frac{1}{2}$ -in. plates, 826, 870, 885; 7 $\frac{1}{2}$ -in. plate, 186, 870; 8-in. targets, 810, 822; 10-in. targets, 813, 819, 822, 832; 11-in. plate, 181 D, 835; 14-in. target, 811; 65-pounders and 32-pounders compared, 807-809; Whitworth projectiles, 183, 185, 231, 232, 234, 806, 845, 846, 852, 853, 870, 881; elongated and spherical shot compared, 817; 10 $\frac{1}{2}$ -in. Armstrong gun, 184, 185-188, 189 A, 201, 227, 223, 230, 233, 839, 840, 843, 853, 870, 874, 875, 881, 900; 13-in. gun, 181 C and D, 182, 183, 229, 847, 883-896; Thomas's 9-in. gun, 870; steel shot, 887-896.

Armstrong gun.

Where and by whom made, 1, Table III., Table III. A.

Discontinance of manufacture—causes, 2, 3, 41.

Number made, 1, Table III.

Improvements probable, 3, 41. See Armstrong Gun, Defects.

Workmanship, facilities for, 3.

- Armstrong gun.**  
 Material, quality, make (see also Steel), 4, 6, 403.  
 History and originality, 1, 2, 5, 35; 1029-1043.  
 Principle of construction, 44, 433, 434, 452.  
 Description, Tables, I., III. A, 5-34, 44, 432, 433.  
 Fabrication, 5-12, 33, 44, 432. See Welds.  
 Strength and endurance (see also Armstrong Gun, Defects, Welds), 9, 10, 39-41, 309, 311, 434-439, 444-447, 1067.  
 Proof, 16.  
 Safety, 40, 301.  
 Advantages of system, 434, 435, 442.  
 Defects of gun and system, 2, 39, 402, 403, 440-457, 1067. See also Rifling and Projectiles.  
 Breech-loading, see Breech-loading.  
 Rifling and projectiles, see Rifling and Projectiles.  
 Ammunition, Table II., 545, 551.  
 Initial tension, 12.  
 Cast-iron gun hooped, 91, 309  
 Cost, see Cost of Guns.  
 Plant for manufacture, Table IV., 453.  
 New British gun, 41.  
 110-pounder, 21, 38, 36; Tables V., VII. See also Rifling and Projectiles.  
 150-pounder smooth-bore, 29, 32, 444, 446.  
 300-pounder rifle, 29, 32.  
 600-pounder rifle, 30, 252, 1067.  
 7-inch gun for Mr. Whitworth, 33, 44, 441, 444.  
 9-inch gun for Mr. Thomas, 34, 444.
- Armstrong, Sir William.**  
 Position under Government, 1.  
 On strains in guns, 238.  
 On guns for long range warfare, 252.  
 On strength of his guns, 440, 441.  
 On rifling and projectiles, 632, 643, 638.
- Atlanta, iron-clad, disabled by 15-in. ball, 181 B.**
- Attick's bronze hoop, 106.**
- Atwater gun, 107.**  
 Rifling, 652.
- BACKING, see Armor, 199 note.**
- Barlow, Peter, Esq., on strength of cylinders, 231.**
- Bertram's gas welding, 459.**
- Bessemer steel, 63, 393, 474, 486.**  
 Guns, 141-144.  
 Process, 142, 486.  
 In the Exhibition of 1862, 143, 487.
- Bidder, Mr., on rifled guns, 603.**
- Blakely gun, 55.**  
 Principles, 55, 59, 61.  
 Patent, 1024.  
 Early experiments, 72, Table XI.  
 Number made and makers, 56.  
 Structure, 57-73, Table X.  
 Fabrication, 60, 61, 68-70.  
 Varying elasticity, 59, 60. See Varying Elasticity.  
 Initial tension, 59, 60.  
 Material, 59-62, 63.  
 Steels and cast iron combined, 58, 60.  
 Endurance, 66, 71.  
 Rifling, 67, Table X. See Rifling and Projectiles.  
 Ammunition, 67, Table X.  
 Prices, Tables X., XXVII.  
 Guns for Massachusetts, 64.  
 Guns for Confederates, 56, 58, 66, 73.  
 12 $\frac{1}{2}$ -in. rifle, 66.
- Blakely, Captain T. A.**  
 Connection with improved ordnance, 55, 1029-1039.
- Blakely, Captain T. A.**  
 Treatment by British Government, 71, 1029-1039.  
 On strains in large guns, 221.  
 On strength of guns and cylinders, 279.  
 On longitudinal strength of guns, 307.  
 On wire-wound guns, 316.  
 On elasticity, see Varying Elasticity.  
 On rifling and projectiles, 619, 657.  
 On the originality of the Armstrong gun, 1029-1039.
- Blunt, G. W., Esq., on rifled guns, 609.**  
 Breaching, see Masonry.
- Breech-loading, Chapter VI.**  
 Advantages and defects of the system, 726-743.  
 The practice against it for heavy guns, 727-731.  
 Opinions of Select Committee on Ordnance, 731.  
 Material inadequate, 732.  
 Fast firing, 735-741.  
 Convenience in turrets, etc., 742.  
 Standard forms described, 755.  
 Krupp, 767-769.  
 Endurance, 769.  
 Broadwell, 770.  
 Storm, 771.  
 Alger, 766.  
 Armstrong, 13, 25, 737, 739, 755-764.  
 Vent-pieces, 755, 753, 759.  
 Side breech-loader, 760-762.  
 Rapidity of fire, 735-741, 763.  
 Conclusions, 764.
- French, 773.**  
 American origin, 773.  
 Used in England, 775.
- Blakely, 773.**  
 Nasmyth, 779.  
 Whitworth, 52, 781.  
 Cavalli, 784.  
 Clay, 783.  
 Wahrenndorf, 785.  
 Prussian, 786.  
 Adams, 787.  
 Rapid firing by machinery, 745-754.  
 Cooling guns by machinery, 748, 749, 753.  
 Loading by steam, 750-753.  
 Gas-checks, 758, 760, 767, 768, 770, 771, 789.  
 Screw breech-loaders, 755, 766, 773, 778, 779, 783.  
 Wedge breech-loaders, 760, 767, 770, 784-786.  
 Cap breech-loaders, 771, 751.
- Breech-plug, 32, 44, 50.**
- Breech-screw, Armstrong, see Rifling and Projectiles.**
- Breech-strap, Dahlgren, 305.**
- British gun, new, 41. See Armstrong Gun, Cast-iron Guns.**
- Britten, Bashley, Esq.**  
 On rifled cannon, see Rifling and Projectiles.  
 On strains in guns, 238.  
 On rifling and projectiles, 634.
- Bronze, 496.**  
 Properties, 496.  
 Want of uniformity, 497.  
 Strength, 496.  
 Difficulties of manufacture, 496, 497.  
 Resistance to compression and wear, 499.  
 Resistance to heat, 498.  
 Cost, 496.  
 Ames Manufacturing Company's, 106.  
 Phosphorus and copper, 502.  
 Aluminium, 503.  
 Sterro-metal, 504.  
 New alloys proposed, 506.  
 Hoops for guns, 106, 501, Table XIII.  
 Linings for guns, 500.  
 Conclusions, 507, 508.

- Brooke's hooped guns, 104, 105.  
Bumford 12-in. gun, 108.
- CAST IRON, 354.** See also Cast-iron Guns.  
Weakness a serious defect, 354.  
Strength of, 77, 355, 356.  
Quality, 150, 164, 355, 356, 360-362.  
Deterioration, 360.  
Fatigue of, 290.  
Elasticity, see Elasticity.  
Ductility, see Ductility.  
Resistance to compression and wear, 371, 391.  
Want of uniformity, 361, 362.  
Detection of weakness, 363.  
Shrinkage of strong irons, the greatest, 353, 359.  
For Parrott guns, 77.  
Transmitting strain by, 99.  
Solid cast guns, 364.  
    American, 364 note, 373 note.  
    Unequal contraction, 364.  
    Initial strains, 364, 368.  
    Loss of tensile strength, 370.  
    Density of metal, 371.  
    Weakness to resist pressure, 366.  
    Fast and slow cooling, 365.  
    Heat of firing, 369.  
    Shape, effect of, 390.  
Hollow-cast guns, see Hollow-cast Guns.  
Conclusions, 503.
- Cast-iron guns, 91, 92, 149, Tables XIII. and XXII. to XXVI. See also Cast Iron, Initial Tension, Hooped Guns.  
Solid cast, see Cast Iron.  
Hollow cast, see Hollow-cast Guns.  
Rodman's and Dahlgren's shapes, 149, 390.  
Quality of iron, 150, 163, 355-363.  
Endurance, 163, 357 note, 372, 391.  
Lined, see Varying Elasticity.  
Rifled, 357, 391, 592. See Rifling and Projectiles.  
French, 55.  
Russian, 169.  
British, 167.  
    Endurance, 168, Table XXIV.  
    Particulars and charges, Table XXV.  
United States, 149-166; Tables XXII. XXIII.  
    Columbiads, 164, 165.  
    New, 164-166; test of, 163.  
    Shape, 149, 165, 390.  
    Dahlgren, 373 note, 236.  
    Quality of iron, 150, 163.  
    Hollow casting, see Hollow-cast Guns.  
    10-inch navy, 166.  
    11-inch navy, 166.  
    15-inch navy, 163.  
    20-inch navy, 166.
- Chambers's hooped gun, 1005.  
Charges, Tables XXVIII., XXXII. See Spanish Gun; French Gun.  
    Armstrong gun, 25, 29, 32, Table II.  
    Whitworth, Table VIII.  
    Blakely, Table X.  
    Parrott, Table XII.  
    U. S. cast-iron, Tables XXII., XXIII.  
    British cast-iron, Table XXV.
- Clark, Edwin, Esq., 341.  
Clay, Lieutenant-Colonel, on the shrinkage of hoops, 269 note.  
    On forgings and wrought-iron guns, 416-419, 429.
- Clerk, Lieutenant-Colonel, on change of figure due to heating and cooling metals, 298.  
Coils, Armstrong (see Armstrong Gun), 7, 449, 450, 455, 457; Parrott, 74, 455.
- Colburn, Zerah, Esq., on the elasticity of metals, 341, 342.  
Columbiads, 164.  
Competitive trials of rifled guns, see Rifling and Projectiles.  
Confederate guns, 56, 58, 64, 66, 73, 104. See also Blakely Gun.  
Conybeare, Mr., on rifling and projectiles, 615, 622, 633, 668.  
Cooling guns from within, see Hollow-cast Guns.  
Cooling guns by machinery, see Breech-loading.  
Cost of guns, 37, 38, 74, 393, 412, 453, 474, Tables IV., V., VI., VII., XXVII.  
Cylinders, strains by internal pressure, see Strains in Guns.  
Conclusions, 270, 339, 503, 725, 759.
- DAHLGREN GUNS, see Cast-iron Guns.**  
Ductility of metals, 344, 467, Tables LI. to LIII. LXIX.  
    Wrought iron, 343, 349-352, 399.  
    Steel, 344, 349-352, 399, 467, 472, 479, Tables LI. to LIII., LXVI., LXVIII., LXIX.  
    Comparison with iron, 469, 479.  
    Bessemer, 472.  
    Safety of, in guns, 349-352.  
    Gain of strength by stretching, 344, 345, 348.  
    Mallet on, 341, 349, 352, 353.  
    Anderson on, 343, 344, 399.  
    Metal for hoops of guns, see Initial Tension.  
Duty of guns, see Guns, and Rifling and Projectiles.
- ELASTICITY OF METALS, 340, 467.**  
Limit of, 341, 342, 346, Table LIII.  
Should not be exceeded in guns, 346, 347, 350, 351.  
Relation to extension in metals, Tables LI. to LIII.  
Principles of Varying, see Varying Elasticity.  
Hoops of, see Initial Tension.  
Coefficients of, Tables LI. to LIV.  
Mallet on, 342, 349, 352, 353.  
Clark, Edwin, on, 341.  
Colburn on, 341, 342.  
Wrought iron, 341-343.  
Steel, 467, 479, Table LII.
- Ericsson, 13-in. guns, 127.  
Experiments against targets, see Armor.
- FAIRBAIRN, MR.,** experiments on armor-punching projectiles, 713.  
Firth's steel, 45, 68.  
Fishbourne, Captain, on spherical shot for naval warfare, 239.  
    On Armstrong gun, 450.  
    On rifling and projectiles, 653, 670, 691, 693.
- Force, effect of, in guns, see Strains in Guns.  
    Effect of different rates of application, 347, 697.
- Forging, see Wrought Iron, and Welds and Welding.  
Forts, see Masonry.  
French guns, 84-90.  
    Material and calibre, reason of, 90, note.  
    Canon de 30, 84.  
    Unhooped guns, 85.  
    Charges, 88.  
    Strength and endurance, 89, 90.  
    Rifling, see Rifling and Projectiles.  
    Breech-loading, see Breech-loading.

GALENA, armor of the, 262, 265.

Guns.

Description of, Chapter I.  
Requirements of, Chapter II., 27C.  
Work to be done by, Chapter II., 270.  
Strains and structure, Chapter III., 339.  
Materials and processes of fabrication, Chapter IV., 508.

Cast iron, see Cast-iron Guns and Cast Iron.  
Wrought iron, see Wrought Iron Guns and Wrought Iron.

Steel, see Steel Guns and Steel.

Bronze, see Bronze.

"Work done" by different, Table XXXVI.  
Shell, uses of, 174. See Rifling and Projectiles.

For breaching masonry, 273-276 B, Tables LXV. and LXXVII.

Working by machinery, see Breech-loading.

Hooped, see Hooped Guns and Initial Tension.

Varying elasticity, principle for, see Varying Elasticity.

To operate against armor, Chapter II. and Part II.

Unsettled state of the question, 175.

Best class, 271.

Two classes important, 267-269, 271.

Popular notions, 186, 207-210.

Two systems, 176, 191, 193 (see Velocity of Projectiles); illustrations, 179, 183; combination of systems by same gun, 178, 187, 207-210; combination of systems by different guns, 267; one helps the other, 268; objections, 269; advantages, 267-269.

Armor smashing and dislocating, Table XXVIII., 177, 181, 191-193, 205-209, 211, 212; not illustrated by light targets, 206, 235 C; defects of the system, 185, 193 A, 208-211, 221, 225, 261, 267, 268; great distributed and small local effect, 193, 206, 208-211; advantage of large balls, 193, 222, 242; difficulty of adapting the system, 218; time wasted, 219; recapitulation, 224, 225.

Armor-punching, Table XXXI., 176, 178, 181, 193, 200, 202, 207, 226, 236, 244, 252, 265; defects of the system, 261, 267; advantages of the system, 193 A, 211, 218, 261-266; American guns for, 236; large diameter of shot wanted, 257, 258, 260; below water, 265.

Conclusions, 270, 271, 339.

Gun-Cotton, 901.

Report on, British Association, 901.

Chemical considerations, 902, 918-922, 957-965.

Mechanical considerations, 903, 923-957, 971-979.

Practical applications, 904-914, 923-957, 967-969.

Palisades destroyed by, 912, 967, 969.

Bridges destroyed by, 913.

Ships destroyed by, 914.

Manufacture in Austria, 915.

Composition, 918-920.

Properties, 918-922, 971-979.

Information given by Baron Lenk on all features of gun-cotton, 923-957.

Report of Austrian chemists, 957-965.

Safety, 957-965.

Manufacture and experiments in England, 966-970.

Mr. Scott Russell on, 971-979.

Theory of explosion, 973, 979.

HARDENING IN OIL, 35. See Steel.

Hart, Dr., on the strength of guns, 232, 300.

Heating and cooling—effect on metals, 298.

Heat of firing—effect on guns, 336. See Cast Iron.

Theory, 336, 1052-1061.

Remedy, 333. See Breech-loading.

Danger in iron-clad warfare, 337.

Heavy shot at low velocities, Table XXVIII.

Hitchcock's process of forging guns, 460-464.

Hollow-cast guns, 151, 153, 373, 482.

Rodman's plan, 373.

Fabrication, 154-162, 166.

Test, 154, 159-163.

Object, 373.

Cooling, 155, 160, 166, 376-378.

Condition and strength of the metal, 382.

Regulated initial tension, 374-380; state of strains, 375, 376, 378; error from exterior cooling, 377, 378; requirements for, 379; removed by age, 380; heat of firing, effect on, 381.

Wiard's plan, 383.

Object and structure, 383.

Probable result, 384, 388.

Strongest iron may be used, 385.

Effect of heat of firing, 387.

Homogeneous metal, see Steel.

Hoops, see Initial Tension by Hoops and Description of Guns, Chapter I.

Wrought iron, 91, 92, 300-302, 400, 445, Table XIII.

Steel, 43, 65, 310, 465, 473, 482, 494.

Bronze, 106, 501, Table XIII.

With varying elasticity, see Varying Elasticity.

Strength,

Tension,

Putting on, } see Initial Tension by Hoops.

Size,

Hooped Guns (see Initial Tension, Armstrong Gun, Whitworth Gun, Blakely Gun, Parrott Gun, Spanish Gun, French Gun), Table XIII., 91, 92, 104, 109, 127, 152, 980-1051.

Defects, see Initial Tension by Hoops.

British cast-iron experimental, Table XIII.

Shape, effect on strength, 410.

History, 980-1051.

Horsfall wrought-iron gun, 110, 111.

Fabrication, 110, 112.

Endurance, condition, material, 113, 428.

Cost, 114, Table XXVII.

History, 114.

Experiments on armor, Tables XXVIII., XXXI.

Hydraulic forging machinery, 493.

INITIAL TENSION BY HOOPS, 287. See Chapters I. and III.; Hollow-cast Guns, Wire-wound Tubes.

History of, 980-1051.

Combined with Varying Elasticity, see Varying Elasticity.

Object of, 287, 290, 292.

Law of, 289, 293, 307.

Illustration of effects, 292.

Theoretical accuracy of, 293-293.

Professor Treadwell's plan, 288, 289, 1012-1016.

Safety of ductile outer hoop, 301.

Forcing on hoops, 44, 50, 295.

Shrinking on hoops, 11, 60, 61, 75, 296, 297.

Want of continuity, 291, 292, 299, 300.

Vibration, 299, 319, 335, 445, 448.

Elasticity of metal, 300, 302.

Ductility of metal, 91, 300-303, 445.

Loosening of hoops, 76, 91, 300, 302, 445.

- Initial tension by hoops.  
 Dimensions of hoops, 76, 92, 312.  
 Jackets, 310.  
 Transverse strength diminished, 313.  
 Conclusions, 339.
- Initial strains, see Strains on Guns.  
 Iron-clads, systems of destroying, see Guns, and Chapter II.
- KIRKALDY** on the strength of wrought iron and steel, 395, 403, 417, 423, 469, 476, 479.  
 Krupp's steel guns, see Steel.  
 History, 130, 140.  
 Principle of construction, 134 note.  
 Description, 133-134.  
 Fabrication, 131, 140.  
 Markets for, 133, 134.  
 Amount produced, 131 note.  
 Cost, 134 note, Table XXVII.  
 Weight, 134 note.  
 9-in., in Exhibition of 1862, 132.  
 For Russia, 134, 136.  
 Endurance, 135-139, 401, 475, 485, Tables XIX., XX., XXI.
- LANCASTER GUNS**, 309.  
 Rifling, see Rifling and Projectiles.  
**Lancaster, Charles, Esq.**, on Rifling and Projectiles, 689.  
 On the longitudinal strength of guns, 309.  
 Lead shot, Table XXXV.  
 Lined guns, see Varying Elasticity.  
 Loading guns by machinery, see Breech-loading.  
 Longitudinal strength of guns, 9, 10, 32, 90, 91, 227, 304-311.  
 Remedies for weakness, 305-310.  
 Dahlgren breech-strap, 305.
- Longridge, Mr. J. A.**, experiments on wire-wound guns, see Wire-wound Guns.  
 On unequal strain in the layers of a cylinder, 286.  
 On hooping guns, 292-296, 299.  
 On cast iron as a cannon metal, 354, 370.  
 On rifling and projectiles, 312.
- Lyman's** accelerating gun, 1062.
- MALLET, ROBERT, Esq.**, on the effect of heat in guns, 337.  
 On the elasticity of metals for cannon, 341, 349, 352.  
 On the ductility of metals for cannon, 341, 349, 352, 353.  
 On cast iron as a cannon metal, 371.  
 On heavy forgings, 418, 420, 421, 427.  
 86-in. mortar by, 109.
- Mantelets for embrasures, Table CXXI.  
 Martello towers, breaching, see Masonry.  
 Masonry, breaching, 171, 272-276 B.  
 Martello towers by rifles and smooth-bores, 273, 274, Tables XXXVIII. to XLV.  
 Fort Pulaski, 275, 276, Tables XLVI., XLVII.  
 Fort Sumter, 276 A, Table XLVII. A.  
 Fort Wagner, 276 B.  
 Protected by iron, see Armor.
- Metals for cannon, see Chapter IV.  
 Conclusions, 503.
- Mersey Steel and Iron Co.'s** guns (see Horsfall Gun, Prince Alfred Gun), 115-120, 429.  
 Test of, 121-123.
- Miscellaneous hooped guns, 81-92.  
 Mortars, 109, 170.  
 Mallet's 36-inch, 109.  
 British, 170, Table XXVI.  
 United States, 170.  
 Armstrong rifled, Table LXXXIX.
- NAUGATUCK, STEAMER**, 751.  
 Naval warfare, Chapter II., 219, 255, 261.  
 New, 171, 172.  
 Range of actions, 242, 251-254.
- Naylor, Vickers & Co.'s** 20-pounder gun, 146, 452, 484.  
 Steel, 63, 69, 145, 310.  
 New British gun, 41.  
 Noble, Captain, on long range warfare, 253.  
 On effect of velocities of projectiles, 177.
- OIL**, hardening in, see Hardening in Oil.  
 Oregon gun, 125.  
 Owen, Major C. H., on rifling and projectiles, 603, 611.
- PALLISER, CAPTAIN WILLIAM**, on guns with varying elasticity, see Varying Elasticity.  
 On the gain of strength in wrought iron by stretching, 344.
- Parrott gun**, 74.  
 Patents, 1044-1051.  
 Description, 74, 78, Table XII.  
 Fabrication, 74, 75, 455.  
 Material, 74, 77.  
 Principles, 76, 78.  
 Strength and endurance, 79, 80, 311, 1064.  
 Cost, Tables XII., XXVII.  
 Ammunition, Table XII.  
 Rifling and projectiles, see Rifling and Projectiles.  
 100-pounder, 78, }  
 8-inch, 73, 79, } Table XII.  
 10-inch, 73, }
- Parsons, P. W., Esq.**, on guns with varying elasticity, see Varying Elasticity.  
 On the longitudinal strength of guns, 308.
- Peacemaker**, 126, 426.  
 Phosphorus in copper, for guns, 502.  
 Plant in manufacture of Armstrong guns, 37, Table IV.
- Pressure in guns, see Strains in Guns.  
 Prince Alfred gun, 115-117.  
 Projectiles, see Rifling and Projectiles; Velocity of Projectiles; Armor.  
 Armor-punching (see Part II.), 231, 246, 247, 387.  
 Experiments, see Armor; Guns.  
 Whitworth, 584-587; manufacture, 584-586; bursting, 586.  
 Stafford, 249, 590  
 Scott, 588.  
 Parrott, 589.  
 Bates & Macy, 590.  
 Material, 697-712, 887-899.  
 Shape, 713-715.  
 Rifling necessary to, 250.  
 Results considered, 266.
- Light**, 243, 249, 256, 641.  
 Breaching masonry, for, 274-276 B, Tables XLV. to XLVII. A.  
 Steel (see Rifling and Projectiles), 697-711; Tables XXVIII., XXXIII., 887-896.  
 Lead, Table XXXV.  
 Wrought iron (see Rifling and Projectiles), 697-711.
- Spherical**:  
 Higher initial velocity, 239, 241.  
 Loss of velocity, 251.  
 Large, advantages of, 222, 224, 257-260, 293.  
 Firing from rifled guns, see Rifling and Projectiles.  
 Defects and remedies, 241-245, 248.  
 Self-destruction against armor, 246, 247.  
 Rifled, see Rifling and Projectiles, Chapter V.

- Projectiles, rifled.  
 Effect of, after punching armor, 262, 263, 265.
- Pulaski, Fort. breaching of, 275.
- Punching armor, see Guns and Projectiles.
- RAM, 211, 254.
- Ranges, see Rifling and Projectiles.
- Rapid firing, 735-741, 745-754.
- Requirements of guns, see Guns, Chapter II.
- Rifled guns, see Rifling and Projectiles; Armstrong Gun; Whitworth Gun; Blakely Gun; Parrott Gun.  
 Uses of, 245, 250, 251, 255, 273.  
 Competitive trial in 1861, 592.
- Rifling and projectiles, 509. See Projectiles, Chapter V.  
 Early, 509, 512, 543.  
 Germs of present systems, 512.  
 Competitive trials of cast-iron rifled guns, 1861, 592.  
 Guns, 592-595.  
 Cost of projectiles, 593.  
 Endurance, 596.  
 Accuracy, 601.  
 Adaptation for round shot, 602.  
 Efficiency of projectile, 605.  
 Liability to injury, 606.  
 Conclusion, 607.
- Steel projectiles, see Projectiles, Armor-punching, 887.
- Sub-calibre projectiles, see Projectiles, Armor-punching.
- Light, 248, 249, 256, 641.
- Masonry breaching projectiles, see Projectiles.
- Shells for molten metal, 591.  
 Windage, 647-652, 676-678.  
 Increasing twist, 672.  
 Elongated shot from smooth-bores, 719-724.  
 Spherical shot from rifled guns, 79, 245, 246, Table CIII., 692.  
 Liability of projectile to injury, 656.  
 Capacity and destructiveness of shells, 716-718.  
 Russian, 509, 522, 557, 558.  
 Cavalli, 510.  
 Wahrenndorf, 511.  
 Timmerhaus, 511.  
 Austrian, 521; for gun-cotton, 521.  
 Continental, 526.  
 Brooke's, 105.  
 Atwater's, 652.
- Centering system, 510, 513, 514, 625-631, 665-696.  
 Scott, 535-537, 558, 592; trial, 1861, 537, 1065; advantages, 669.  
 Lancaster, 527-529, 592, 1068; in the Crimea, 527; trials, 1861, 528; defects, 655, 659.  
 Haddan, 530, 592.  
 Thomas, 538, 539.  
 French, 84, 87, 515-520, 592, 1068; English experiments with, 516, 592; 30-pounder, 518; windage, see Windage; field-gun, 529.  
 Spanish, 524, 525.  
 Whitworth, Table VIII., 51, 52, 531-534, 584-587, 645-650; shape of bore, 531, cost, 532; cartridges, 532; projectile, 533, 584-587; practice, 534; defects, 656, 661, 663, 664.  
 Sawyer, 540.  
 Pattison, 541.
- Compressing system, 511, 543, 625-631, 665-669.  
 Early Prussian, 544.
- Rifling and projectiles, compressing system.  
 Armstrong, 14-16, 25, 29, 30, Table I., 545; defects, 625-631, 642-644; particulars, 546, 549; practice, 547, Tables LXXX. to LXXXIX.; segmental shell, 550; cartridges, 551; mortar, Table LXXXIX.; shunt, 14, 552, 592; particulars, 553-555; Russian, 557, 558.
- Expanding system, 511, 559, 625-631, 665-669.  
 Thomas, 567, 568, 592.  
 Blakely, 67, 571.  
 Jeffery, 578, 579, 592, 1068.  
 Britten, 580-583, 592, 1068; zinc attachment, 581.  
 American, 569; James, 564, 565; Hotchkiss, 566; Schenkl, 569; Reed, 570; Parrott, 79, 573, 574, 589, Tables XII., XC. to XCIII.; accuracy, 575; Stafford, 576, 590; Buckle, 577.
- Object of rifling, 609-611.  
 Duty of rifled guns, 608.
- Range and causes affecting, 241, 258, 608, 692, Table XXXIV. See Armstrong, Whitworth, Parrott, Competitive Trials of 1861, under Rifling and Projectiles.  
 Mr. Britten's conclusions, 634, 635.  
 Effect of form, 637, 638.  
 Of iron-clad warfare, see Naval Warfare.  
 Of large balls, 258.
- Accuracy and causes affecting, 241, 612.  
 Want of symmetry in shot, 613.  
 Velocity of rotation, 614.  
 Centre of gravity, 615, 619-623.  
 Friction against the air, 616.  
 Character of projectile, 625-631.
- Velocity and causes affecting, 639, 238-249, see Velocity of Projectiles; Tables, XXVIII., XXXII., CXII.  
 Importance of high velocity, 639, 640.  
 Conditions of high velocity, 641-652.  
 Windage, 647.
- Strain and causes affecting, 653.  
 Weight of projectile, 654.  
 Twist of rifling, 655.  
 Wedging of projectile, 656.  
 Experiments on, 664.  
 Character of grooves, 665.  
 Increasing twist, 672.  
 Character of projectile, 672.  
 Conclusions, 725.
- Robins, Benjamin, on rifled cannon, 608.
- Rohman guns, see Cast-iron Guns; Hollow-cast Guns.
- Rohman, Captain, on the effects of different rates of applying force, 347
- Russian guns.  
 Blakely, 65.  
 Wrought-iron, 119.  
 Krupp's, 134, 136.  
 Cast-iron, 169.  
 Armor plate experiments, 255.
- SALVOS, 222, 223.
- Scott, Commander, on hooping guns, 290, 312.  
 On the Armstrong gun, 438, 449, 451.  
 On rifling and projectiles, 608, 627, 629, 631, 688, 691, 692.
- Sebastopol, British guns at, 168, Table XXIV.
- Scott, Michael, Esq., on strains in guns, 221, 238.
- Shape of guns, 149, 165, 170, 390, 410.
- Shot, } see Projectiles, and Rifling and Projectiles.  
 Shells, } tiles.
- Shrinking tubes together, see Initial Tension.
- Shrinkage of guns in cooling, see Hollow-cast Guns.

- Smashing armor, see Guns.  
 Spanish hooped guns, 81.  
 Endurance, 81-83.  
 Stevens's, steam-loading and cooling guns, see Breech-loading.  
 Static pressure, resistance to, 277.  
 Steel, 466. See Bessemer Steel; Krupp's Steel Guns; Naylor, Vickers & Co.'s Steel.  
 Bochum, 810.  
 Puddled, 148, 488.  
 Mushet & Clare's, 147.  
 Russian, 134, 488.  
 Crucible, 484.  
 American, 490.  
 French, 489, 487.  
 High and low, 466.  
 Strength of, 476.  
 Specific gravity, test by, 479.  
 Elasticity, see Elasticity.  
 Ductility, see Ductility.  
 Safety of, for cannon, 350, 351, 467, 469.  
 Failure of, in guns explained, 468, 475.  
 Refinement compared with iron, advantages, 362, 398, 474.  
 Resistance to compression, 401, 480, 481.  
 Uniformity, 477, 481.  
 Cost, 474, Table XXVII.  
 Weight, 474.  
 Manufacture and improvements, 474, 488.  
 Annealing, 46, 69, 70, 479.  
 Hardening in oil, 35, 36, 41, 479.  
 Armstrong gun, 13, 41, 403.  
 Blakely gun, 62, 68.  
 Whitworth gun, see Whitworth Gun.  
 Wire-wound guns, see Wire-wound Guns.  
 Combined with cast iron, 58, 60.  
 Anderson on, 470, 475.  
 Initial tension on solid guns, 482.  
 Hoops, see Initial Tension.  
 Shells and shot (see Projectiles; Armor), 887.  
 Armor, 213.  
 Systems of fabrication,  
 Hollow forging, 69, 310, 492.  
 Solid forging, 69, 491, 482.  
 Rolling hoops of, 68, 494.  
 Solid casting, 495.  
 Temper, } results, 35, 46, 48, 68-70,  
 Treatment, } 479.  
 Conclusions, 339.  
 Steel guns, see Steel; Whitworth Gun; Blakely Gun; Krupp's Gun; Bessemer Guns; Naylor, Vickers & Co.'s Guns.  
 Endurance, Table XIX., XX., XXI., 135-148, 475, 485.  
 Fabrication, 491.  
 Sterro-metal, 504.  
 Stockton guns, see Wrought-iron Guns.  
 Strains in guns, see Initial Tension; see Chapter III.  
 Initial, 151. See Cast iron and Hollow-cast Guns.  
 Four kinds, 134, 277, 313.  
 Relations of, 277.  
 Greater in large, 221, 238, 259.  
 Velocity of shot, effect of, 238, 240.  
 Weight of shot, effect of, 237, 259.  
 Increased charges, effect of, 259.  
 Sudden, effect of, 346.  
 Different rate of applying, effect of, 347.  
 Unequal stretching and strain, by internal pressure, 278-286.  
 Illustrations, 279, 280, 286.  
 Law of, 279, 281, 282, 285, 286.  
 Experiments, 283, 284, 240.  
 Thickness of walls, influence upon, 278-286.  
 Hoops with initial tension, influence upon, see Initial Tension.  
 Strains in guns.  
 Hoops with varying elasticity, influence upon, see Varying Elasticity.  
 Sub-calibre shot, see Rifling and Projectiles.  
 TARGETS, guns against, see Armor.  
 Tension, initial, of hoops, see Initial Tension.  
 Tensile strength, see Cast Iron; Wrought Iron; Steel; Bronze. Not a true indication of safe load, 340.  
 Thiery's hooped gun, 980.  
 Thomas's, Lynnall, guns, 34, 127.  
 Time, effect of, on strain of guns, 347.  
 " " on cast-iron guns, 386, 372.  
 Tredegar Works, Va., 104.  
 Treadwell, Prof. Daniel, on strains in guns, 259, 285.  
 On hooping guns, 288, 289, 1012.  
 Patent for hooped guns, 1012.  
 On the originality of the Armstrong gun, 1040.  
 Early wrought-iron gun, 1041.  
 Turrets, effect of shot in, 262, 263.  
 Resistance to shot due to shape, 181 A.  
 UNITED STATES, guns of, 74-80, 149-166, Tables XII., XXII., XXIII.  
 VARYING ELASTICITY, principle of, for guns, 59, 320.  
 Theory, 320, 324, 327, 328, 333.  
 Materials, 321, 324, 500.  
 Safety, 322 note.  
 Advantages, 322.  
 History, 322 note.  
 Combined with initial tension, 59, 60, 302, 329, 330, 334.  
 In solid guns, 322 note.  
 Experiments, 323, 332.  
 Blakely's plan, 322 note, 59, 60, 333, 334.  
 Parsons's plan, 322 note, 324-327.  
 Palliser's plan, 322 note, 328-332.  
 Experiments, 332.  
 Babcock's plan, 322 note.  
 Conclusions, 339.  
 Velocity of projectiles (see Rifling and Projectiles), 259 note, Tables XXVIII., XXXI., XXXII., CXII.  
 Loss of, 251, Table CXII.  
 Work done by, 181, Table XXXVI.  
 Large balls, 259.  
 Effect on armor (see Armor), Tables XXVIII., XXXII., 181, 193, 202, 206-211, 237, 261.  
 Illustration of effect, 179, 183, 261.  
 Cause of phenomena, 180, 182, 207, 208.  
 Vibration, effect on hooped guns, 299, 319, 355, 445, 448, 450.  
 WEIGHT OF GUNS, 354, 329, 411, Tables I., VIII., X., XII., XVII., XXII., XXIII., XXV. to XXVII.  
 Welds and welding, 408, 413-416, 454-463.  
 Armstrong coils and tubes, 7, 8, 434, 449, 455-457, 461.  
 Hitchcock's process, 460-464.  
 Bertram's process, 459.  
 West Point Foundry, 74.  
 Whitworth guns, 42, 1065.  
 Principles of construction, 44, 54 note.  
 Description, 33, 42, 44, 47, 53, 229 note, Table VIII., 1065.  
 Material, 45, 46, 48.  
 Fabrication, 45-50.  
 Proof, 51, 52.

- Whitworth guns.  
 History, 54.  
 Initial tension, 49.  
 Breech-plug, 44, 51, 806.  
 Ammunition, 51, Table VIII.  
 7-inch, on Armstrong plan, 33, 43, 44.  
 7-inch, on Whitworth plan, 43, 44.  
 Breech-loading, 52, 781.  
 Rifling, see Rifling and Projectiles.  
 Armor-punching, see Armor; Projectiles.  
 Cost of experiments on, 54 note, Table IX.
- Whitworth, Jos., Esq., inventions in ordnance, 42.  
 On rifling and projectiles, 636, 647.
- Wiard, Norman, Esq., on the effects of the heat of firing guns (see Heat of Firing), 1052-1061.
- Windage, 519, 241, Tables XXII., XXIII., XXV.
- Wire-rope bolt for armor, 204.
- Wire-wound guns and cylinders, 93.  
 Principles, 93, 291, 292, 315, 316.  
 Strength of brass cylinders, 93, 95, Table XIV.  
 Strength of cast-iron cylinders, 99-101, Tables XV., XVI.  
 Strength of wire, 94, 98, 315.  
 Method of constructing, 314, 317.  
 Transmitting pressure through cast iron, 99-101, Tables XV., XVI.  
 3-pounder gun, 96, 97.  
 296-in. gun, 102, 103, Table XVII.  
 Defects, 317-319.
- Working guns by machinery, see Breech-loading.
- Work to be done by guns, see Guns; see Chapter II.
- Work done by projectiles, see Velocity of Projectiles.
- Work done by stretching metals, 349, 352.
- Wrought iron, 394. See Armstrong Gun; Wrought-iron Guns  
 Tensile strength, 394, 397, 413, 423.  
 Uniformity, 396.  
 Deterioration, 397, 398.  
 Detection of weakness, 399.  
 Want of homogeneity, 407, 413-416.  
 Resistance to abrasion, 406.
- Wrought iron.  
 Chemical action on, 406.  
 Elasticity, see Elasticity.  
 Ductility, see Ductility.  
 Strengthened by stretching, 330. See Ductility.  
 Effects of heat, 417, 434.  
 Anderson on, 396, 401, 427.  
 Advantage over cast iron, 394, 396.  
 Defect for hoops, see Initial Tension.  
 Resistance to compression, 113, 119, 350, 351, 402-405, 444.  
 Softness, 113, 119, 350, 351, 402-405, 444.  
 Processes of fabrication discussed, 413.  
 Solid forging, 413-423, 343, 399, Table LIV.; light hammering, 419, 421; unequal cooling, 420, 421; ant of homogeneity, 413-416; examples of unsoundness, 420, 422, 425, 426; Stockton gun, 426; professional opinions, 427.  
 Hollow forging and rolling, 120, 429.  
 Rolling from plates, 430.  
 Ames's, 123, 129, 431.  
 Armstrong's, see Armstrong Gun.  
 Hitchcock's, 460, 461.  
 Hoops, see Hoops.
- Wrought-iron guns, see Armstrong Gun; Horsfall Gun; Prince Alfred Gun; Wrought Iron.  
 Processes of fabrication, see Wrought Iron.  
 Compression by gas, see Wrought Iron.  
 Endurance, 121, 122, 437.  
 Shape, 409.  
 Weight, 411.  
 Cost, 412, Table XXVII.  
 Ames's, 123, 129, 431.  
 Brooklyn Navy Yard gun, 118.  
 Ericsson, 127.  
 Mallet's mortar, 109.  
 Stockton guns, 124-126, 426. See Wrought Iron.  
 Griffen, 429.  
 Lynall Thomas's, 127, 430.  
 Yeakel, 430.



*D. Van Nostrand's Publications.*

---

## Rhymed Tactics, by "Gov."

1 vol. 18mo, paper. With portraits. 25 cents.

"It will strike the military man, familiar with the tedious routine of drill, by theory, practice, and memory, as a most unique and valuable method of strengthening the latter, with the least mental exertion. The author is a thorough soldier, and his ability as a rhymester will be conceded by any intelligent reader."—*New York Leader*.

"Our author deserves great credit for the ingenuity he has displayed in putting into verse a Manual which would at first glance seem to defy the most persistent efforts of the rhymers. The book contains a number of illustrations representing some of the more difficult positions, in the figures of which portraits of several prominent officers of the New York Volunteers may be recognized."—*New York Times*.

---

## Maxims and Instructions on the Art of War.

Maxims, Advice, and Instructions on the Art of War; or, A Practical Military Guide for the use of Soldiers of all Arms and of all Countries. Translated from the French by Captain LENDY, Director of the Practical Military College, late of the French Staff, etc., etc. 1 vol. 18mo, cloth. 75 cents.

---

## Nolan's Treatise on the Training of Cavalry Horses.

By Capt. KENNER GARRARD, U. S. A. 1 vol. 12mo, cloth, with twenty-four lithographed plates. \$2.00.

---

## Military Bridges,

For the Passage of Infantry, Artillery, and Baggage-Trains; with suggestions of many new expedients and constructions for crossing streams and chasms; designed to utilize the resources ordinarily at command and reduce the amount and cost of army transportation. Including also designs for Trestle and Truss Bridges for Military Railroads, adapted especially to the wants of the Service of the United States. By HERMAN HAUPT, Brig.-Gen. in charge of the construction and operation of the U. S. Military Railways, Author of "General Theory of Bridge Construction, &c." With 300 Plates and Illustrations. Octavo, cloth, \$6.50.

## Viele's Hand-Book.

Hand-Book for Active Service, containing Practical Instructions in Campaign Duties. For the use of Volunteers. By Brig.-Gen. EGBERT L. VIELE, U. S. A. 12mo, cloth. \$1.

## Monroe's Company Drill.

The Company Drill of the Infantry of the Line, together with the Skirmishing Drill of the Company and Battalion, after the method of Gen. LE LOUTEREL. And Bayonet Fencing. By Col. J. MONROE, 22d Regiment N. Y. S. M. 24mo, cloth. 75 cents.

## A System of Target Practice.

For the use of Troops when armed with the Musket, Rifle-Musket, Rifle, or Carbine. Prepared, principally from the French, by Captain HENRY HETH, 10th Infantry, U. S. A. 75 cents.

"WAR DEPARTMENT, Washington, March 1st, 1858.  
"The 'System of Target Practice,' prepared under direction of the War Department, by Captain Henry Heth, 10th Infantry, having been approved, is adopted for the instruction of troops when armed with the musket, rifle-musket, rifle, or carbine."

## Hints to Company Officers.

By Lieut.-Colonel C. C. ANDREWS, 3d Regiment Minnesota Volunteers. 1 vol. 18mo, cloth. 60 cents.

## Systems of Military Bridges,

In Use by the United States Army; those adopted by the Great European Powers; and such as are employed in British India. With Directions for the Preservation, Destruction, and Re-establishment of Bridges. By Brig.-Gen. GEORGE W. CULLUM, Lieut.-Col. Corps of Engineers, United States Army. 1 vol., octavo. With numerous illustrations. \$3.50.

## Holley's Railway Practice.

American and European Railway Practice, in the Economical Generation of Steam, including the materials and construction of Coal-burning Boilers, Combustion, the Variable Blast, Vaporization, Circulation, Superheating, Supplying and Heating Feed-water, &c., and the adaptation of Wood and Coke-burning Engines to Coal-burning; and in Permanent Way, including Road-bed, Sleepers, Rails, Joint Fastenings, Street Railways, &c., &c. By ALEXANDER L. HOLLEY, B. P. With seventy-seven lithographed plates. 1 vol. folio, cloth. \$12.

*D. Van Nostrand's Publications.*

---

## The Political and Military History of the Campaign of Waterloo.

Translated from the French of General BARON DE JOMINI. By  
Capt. S. V. BENET, U. S. Ordnance. 1 vol. 12mo, cloth, third  
edition. \$1.25

"Baron Jomini has the reputation of being one of the greatest military historians and critics of the century. His merits have been recognized by the highest military authorities in Europe, and were rewarded in a conspicuous manner by the greatest military power in Christendom. He learned the art of war in the school of experience, the best and only finishing school of the soldier. He served with distinction in nearly all the campaigns of Napoleon, and it was mainly from the gigantic military operations of this matchless master of the art that he was enabled to discover its true principles, and to ascertain the best means of their application in the infinity of combinations which actual war presents. Jomini criticizes the details of Waterloo with great science, and yet in a manner that interests the general reader as well as the professional."—*New York World*.

"This book by Jomini, though forming the twenty-second chapter of his 'Life of Napoleon,' is really a unit in itself, and forms a complete summary of the campaign. It is an interesting volume, and deserves a place in the affections of all who would be accomplished military men."—*New York Times*.

"The present volume is the concluding portion of his great work, 'Vie Politique et Militaire de Napoleon,' published in 1826. Capt. Benet's translation of it has been for some time before the public, and has now reached a second edition; it is very ably executed, and forms a work which will always be interesting, and especially so at a time when military affairs are uppermost in the public mind."—*Philadelphia North American*.

---

## A Treatise on the Camp and March.

With which is connected the Construction of Field Works and Military Bridges; with an Appendix of Artillery Ranges, &c. For the use of Volunteers and Militia in the United States. By Capt. HENRY D. GRAFTON, U. S. A. 1 vol. 12mo, cloth, 75 cents.

---

## Manual for Engineer Troops,

Comprising Drill and Practice for Ponton Bridges, and PASLEY'S Rules for Conducting Operations for a Siege. The Sap, Military Mining and Construction of Batteries. By Capt. J. C. DUANE, U. S. Engineers. Plates and woodcuts. 12mo, cloth. Hf. mor. \$2.50

---

## New Manual of Sword and Sabre Exercife.

By Captain J. C. KELTON, U. S. A. Thirty plates. *In Press*.

*D. Van Nostrand's Publications.*

---

## Nautical Routine and Stowage,

With Short Rules in Navigation. By JOHN MCLEOD MURPHY, and  
WM. N. JEFFERS, Jr., U. S. N. 1 vol. 8vo, cloth. \$2 50.

---

## Union Foundations.

A Study of American Nationality, as a Fact of Science. By Major  
E. B. HUNT, Corps of Engineers, U. S. A. 1 vol. 8vo, paper.  
30 cents.

---

## Standing Orders of the Seventh Reg- iment, National Guard.

For the Regulation and Government of the Regiment in the Field or  
in Quarters. By A. DURYEE, Colonel. New edition. Flexible  
cloth. 50 cents.

"This, which is a new edition of a popular work, cannot fail to be eagerly  
sought after, as presenting clearly and succinctly the principles of organization  
and discipline of a most favorite corps. An appropriate index facilitates refer-  
ence to the matter of the volume."—*New Yorker*.

---

## The Automaton Regiment;

Or, Infantry Soldiers' Practical Instructor. For all Regimental Move-  
ments in the Field. By G. DOUGLAS BREWERTON, U. S. A.  
Neatly put up in boxes, price \$1; when sent by mail, \$1 40.

The "Automaton Regiment" is a simple combination of blocks and counters,  
so arranged and designated by a carefully considered contrast of colors, that it  
supplies the student with a perfect miniature regiment, in which the position in  
the battalion of each company, and of every officer and man in each division, com-  
pany, platoon, and section is clearly indicated. It supplies the studious soldier  
with the means whereby he can consult his "tactics," and at the same time join  
practice to theory by manœuvring a mimic regiment.

---

## The Automaton Company;

Or, Infantry Soldiers' Practical Instructor. For all Company Move-  
ments in the Field. By G. DOUGLAS BREWERTON, U. S. A.  
Price in boxes, \$1 25; when sent by mail, \$1 95.

---

## The Automaton Battery;

Or, Artillerists' Practical Instructor. For all Mounted Artillery Ma-  
nœuvres in the Field. By G. DOUGLAS BREWERTON, U. S. A.  
Price in boxes, \$1; when sent by mail, \$1 40.

## Rifles and Rifle Practice.

An Elementary Treatise on the Theory of Rifle Firing; explaining the causes of Inaccuracy of Fire and the manner of correcting it; with descriptions of the Infantry Rifles of Europe and the United States, their Balls and Cartridges. By Capt. C. M. WILCOX, U. S. A. New edition, with engravings and cuts. Green cloth. \$2.00

"Although eminently a scientific work, special care seems to have been taken to avoid the use of technical terms, and to make the whole subject readily comprehensible to the practical enquirer. It was designed chiefly for the use of Volunteers and Militia; but the War Department has evinced its approval of its merits by ordering from the publisher one thousand copies, for the use of the United States Army."—*Louisville Journal*.

"The book will be found intensely interesting to all who are watching the changes in the art of war arising from the introduction of the new rifled arms. We recommend to our readers to buy the book."—*Military Gazette*.

"A most valuable treatise."—*New York Herald*.

"This book is quite original in its character. That character is completeness. It renders a study of most of the works on the rifle that have been published quite unnecessary. We cordially recommend the book."—*United Service Gazette, London*.

"The work being in all its parts derived from the best sources, is of the highest authority, and will be accepted as the standard on the subject of which it treats."—*New Yorker*.

---

## Army Officer's Pocket Companion.

Principally designed for Staff Officers in the Field. Partly translated from the French of M. DE ROUVRE, Lieutenant-Colonel of the French Staff Corps, with Additions from Standard American, French, and English Authorities. By WM. P. CRAIGHILL, First Lieutenant U. S. Corps of Engineers, Assist. Prof. of Engineering at the U. S. Military Academy, West Point. 1 vol. 18mo. Full roan. \$2.00.

"I have carefully examined Capt. CRAIGHILL'S Pocket Companion. I find it one of the very best works of the kind I have ever seen. Any Army or Volunteer officer who will make himself acquainted with the contents of this little book, will seldom be ignorant of his duties in camp or field."

H. W. HALLECK,  
Major-General U. S. A.

"I have carefully examined the 'Manual for Staff Officers in the Field.' It is a most invaluable work, admirable in arrangement, perspicuously written, abounding in most useful matters, and such a book as should be the constant pocket companion of every army officer, Regular and Volunteer."

G. W. CULLUM,  
Brigadier-General U. S. A.  
Chief of General Halleck's Staff,  
Chief Engineer Department Mississippi.

"This little volume contains a large amount of indispensable information relating to officers' duties in the siege, camp, and field, and will prove to them a most valuable pocket companion. It is illustrated with plans and drawings."  
—*Boston Com. Bulletin*.

## Sword-Play.

**THE MILITIAMAN'S MANUAL AND SWORD-PLAY WITHOUT A MASTER.**—Rapier and Broad-Sword Exercises copiously Explained and Illustrated; Small-Arm Light Infantry Drill of the United States Army; Infantry Manual of Percussion Muskets; Company Drill of the United States Cavalry. By Major M. W. BERRIMAN, engaged for the last thirty years in the practical instruction of Military Students. Second edition. 1 vol. 12mo, red cloth. \$1.

"Captain Berriman has had thirty years' experience in teaching military students, and his work is written in a simple, clear, and soldierly style. It is illustrated with twelve plates, and is one of the cheapest and most complete works of the kind published in this country."—*New York World*.

"This work will be found very valuable to all persons seeking military instruction; but it recommends itself most especially to officers, and those who have to use the sword or sabre. We believe it is the only work on the use of the sword published in this country."—*New York Tablet*.

"It is a work of obvious merit and value."—*Boston Traveller*.

---

## Military Law and Courts Martial,

By Capt. S. V. BENET, U. S. Ordnance, Asst. Prof. of Ethics in the United States Military Academy. 1 vol. 8vo. Law sheep, \$4.00.

---

## The Artillerist's Manual :

Compiled from various Sources, and adapted to the Service of the United States. Profusely illustrated with woodcuts and engravings on stone. Second edition, revised and corrected, with valuable additions, By Capt. JOHN GIBBON, U. S. Army. 1 vol. 8vo, half roan, \$6.

This book is now considered the standard authority for that particular branch of the Service in the United States Army. The War Department, at Washington, has exhibited its thorough appreciation of the merits of this volume, the want of which has been hitherto much felt in the service, by subscribing for 700 copies.

"It is with great pleasure that we welcome the appearance of a new work on this subject, entitled 'The Artillerist's Manual,' by Capt. John Gibbon, a highly scientific and meritorious officer of artillery in our regular service. The work, an octavo volume of 500 pages, in large, clear type, appears to be well adapted to supply just what has been heretofore needed to fill the gap between the simple Manual and the more abstruse demonstrations of the science of gunnery. The whole work is profusely illustrated with woodcuts and engravings on stone, tending to give a more complete and exact idea of the various matters described in the text. The book may well be considered as a valuable and important addition to the military science of the country."—*New York Herald*.

## School of the Guides.

Designed for the use of the Militia of the United States. Flexible cloth. 60 cents.

"This excellent compilation condenses into a compass of less than sixty pages all the instruction necessary for the guides, and the information being disconnected with other matters, is more readily referred to and more easily acquired."—*Louisville Journal*.

"The work is carefully got up, and is illustrated by numerous figures, which make the positions of the guides plain to the commonest understanding. Those of our sergeants who wish to be 'posted' in their duties should procure a copy."—*Sunday Mercury, Philadelphia*.

"It has received high praise, and will prove of great service in perfecting the drill of our Militia."—*N. American and U. S. Gazette, Phil.*

"This neat hand-book of the elementary movements on which the art of the tactician is based, reflects great credit on Col. LE GAL, whose reputation is deservedly high among military men. No soldier should be without the School of the Guides."—*New York Daily News*.

---

## Gunnery in 1858 :

A Treatise on Rifles, Cannon, and Sporting Arms. By WM. GREENER, C. E. 1 vol. 8vo, cloth. \$4.

---

## Gunnery Catechism,

As Applied to the Service of Naval Ordnance, adapted to the latest Official Regulations, and approved by the Bureau of Ordnance, Navy Department. By J. D. BRANDT, formerly of the U. S. Navy. 1 vol., 18mo, cloth. \$1.50

BUREAU OF ORDNANCE—NAVY DEPARTMENT,  
WASHINGTON CITY, May 26, 1864. }

Mr. J. D. BRANDT.—*Sir*: Your "Catechism of Gunnery, as Applied to the Service of Naval Ordnance," having been submitted to the examination of ordnance officers, and favorably recommended by them, is approved by this Bureau.

H. A. WISE, CHIEF OF BUREAU, *ad interim*.

---

## Austrian Infantry Tactics.

Evolutions of the Line as practised by the Austrian Infantry, and adopted in 1853. Translated by Capt. C. M. WILCOX, Seventh Regiment U. S. Infantry. 1 vol. 12mo. Three large plates, cloth. \$1.

"The movements of armies engaged in battle have often been compared to those of the chess-board, and we cannot doubt that there are certain principles of tactics in actual war as in that game, which may determine the result independently, in a great measure, of the personal strength and courage of the men engaged. The difference between these principles as applied in the American Army and in the Austrian, is so wide as to have suggested the translation of the work before us, which contains the whole result of the famous Field-Marshal RADEZKY's experience for twenty-five years, while in supreme command in Italy."—*New York Century*.

*D. Van Nostrand's Publications.*

---

## Gunnery Instructions.

Simplified for the Volunteer Officers of the U. S. Navy, with hints to Executive and other Officers. By Lieut.-Commander EDWARD BARRETT, U. S. N., Instructor in Gunnery, Navy Yard, Brooklyn. Third edition, revised and enlarged. 1 vol. 12mo, cloth. \$1 25.

"It is a thorough work, treating plainly on its subject, and contains also some valuable hints to executive officers. No officer in the volunteer navy should be without a copy."—*Boston Evening Traveller*.

"This work contains detailed and specific instructions on all points connected with the use and management of guns of every kind in the naval service. It has full illustrations, and many of these of the most elementary character, especially designed for the use of volunteers in the navy. The duties of executive officers and of the division officers are so clearly set forth, that 'he who runs may read' and understand. The manual exercise is explicit, and rendered simple by diagrams. Forms of watch and quarter bills are given; and at the close there is a table of ranges according to the kind and calibre of gun, the weight of the ball, and the charge of powder. A valuable little hand-book."—*Philadelphia Inquirer*.

"I have looked through Lieut. Barrett's book, and think it will be very valuable to the volunteer officers who are now in the naval service.

"C. R. P. RODGERS,  
*Commanding U. S. Steam Frigate Wabash.*"

---

## The "C. S. A." and the Battle of Bull Run.

(A Letter to an English Friend.) By J. G. BARNARD, Major of Engineers, U. S. A., Brigadier-General, and Chief Engineer, Army of the Potomac. With five maps. 1 vol. 8vo, cloth. \$2 00.

"This book was begun by the author as a letter to a friend in England, but as he proceeded and his MSS. increased in magnitude, he changed his original plan, and the book is the result. General Barnard gives by far the best, most comprehensible and complete account of the Battle of Bull Run we have seen. It is illustrated by some beautifully drawn maps, prepared for the War Department by the topographical engineers. He demonstrates to a certainty that but for the causeless panic the day might not have been lost. The author writes with vigor and earnestness, and has contributed one of the most valuable records yet published of the history of the war."—*Boston Commercial Bulletin*.

---

## Models of Fortifications.

Vauban's First System—One Front and two Bastions; Scale, 20 yards to an inch. The Modern System—One Front; Scale, 20 yards to an inch. Field-Works—The Square Redoubt; Scale, 5 yards to an inch. Mr. Kimber's three volumes, viz.: Vauban's First System, The Modern System, and Field-Works, will accompany the Models. Price for the Set of Three, with books, \$100.



## Siege of Bomarfund (1854).

Journals of Operations of the Artillery and Engineers. Published by permission of the Minister of War. Illustrated by maps and plans. Translated from the French by an Army Officer. 1 vol. 12mo, cloth. \$1.00

"To military men this little volume is of special interest. It contains a translation by an officer of the United States Army, of the journal of operations by the artillery and engineers at the siege of Bomarsund in 1854, published by permission of the French Minister of War in the *Journal des Armées spéciales et de l'Etat Major*. The account of the same successful attack, given by Sir Howard Douglas in the new edition of his work on Gunnery, is appended; and the narrative is illustrated by elaborate maps and plans."—*New York Paper*.

## Lessons and Practical Notes on Steam,

The Steam-Engine, Propellers, &c., &c., for Young Marine Engineers, Students, and others. By the late W. R. KING, U. S. N. Revised by Chief-Engineer J. W. KING, U. S. Navy. Fifth edition, enlarged. 8vo, cloth. \$2.00

"This is the second edition of a valuable work of the late W. R. KING, U. S. N. It contains lessons and practical notes on Steam and the Steam-Engine, Propellers, &c. It is calculated to be of great use to young marine engineers, students, and others. The text is illustrated and explained by numerous diagrams and representations of machinery. This new edition has been revised and enlarged by Chief Engineer J. W. KING, U. S. N., brother to the deceased author of the work."—*Boston Daily Advertiser*.

"This is one of the best, because eminently plain and practical, treatises on the Steam-Engine ever published."—*Philadelphia Press*.

"Its re-publication at this time, when so many young men are entering the service as naval engineers, is most opportune. Each of them ought to have a copy."—*Philadelphia Evening Bulletin*.

## Manual of Internal Rules and Regulations for Men-of-War.

By Commodore U. P. LEVY, U. S. N., late Flag-officer commanding U. S. Naval Force in the Mediterranean, &c. Flexible blue cloth. Second edition, revised and enlarged. 50 cents.

"Among the professional publications for which we are indebted to the war, we willingly give a prominent place to this useful little Manual of Rules and Regulations to be observed on board of ships of war. Its authorship is a sufficient guarantee for its accuracy and practical value; and as a guide to young officers in providing for the discipline, police, and sanitary government of the vessels under their command, we know of nothing superior."—*N. Y. Herald*.

"Should be in the hands of every Naval officer, of whatever grade, and will not come amiss to any intelligent mariner."—*Boston Traveller*.

"A work which will prove of great utility, in both the Naval service and the mercantile marine."—*Baltimore American*.

*D. Van Nostrand's Publications.*

---

## Notes on Sea-Coast Defence :

Consisting of Sea-Coast Fortification ; the Fifteen-Inch Gun ; and Casemate Embrasures. By Gen. J. G. BARNARD, Corps of Engineers, U. S. Army. 1 vol. 8vo, cloth, plates. \$2 00.

"This small volume by one of the most accomplished officers in the United States service is especially valuable at this time. Concisely and thoroughly Major Barnard discusses the subjects included in this volume, and gives information that will be read with great profit by military men, and by all interested in the art of war as a defensive force."—*New York Commercial*.

"It is no light compliment when we say that Major Barnard's book does no discredit to the corps to which he belongs. He writes concisely, and with a thorough knowledge of his subject."—*Russell's Army and Navy Gazette*.

---

## Instructions for Naval Light Artillery,

Afloat and Ashore. By Lieut. S. B. LUCE, U. S. N. 1 vol. 8vo, with 22 lithographic plates. Cloth. \$3.00,

---

## Steam for the Million.

A Popular Treatise on Steam and its Application to the Useful Arts, especially to Navigation. By J. H. WARD, Commander U. S. Navy. New and revised edition. 1 vol. 8vo, cloth. \$1.

"A most excellent work for the young engineer and general reader. Many facts relating to the management of the boiler and engine are set forth with a simplicity of language, and perfection of detail, that brings the subject home to the reader. Mr. Ward is also peculiarly happy in his illustrations."—*American Engineer*.

---

## Screw Propulsion.

Notes on Screw Propulsion, its Rise and History. By Capt. W. H. WALKER, U. S. Navy. 1 vol. 8vo., cloth. 75 cents.

"Some interesting notes on screw propulsion, its rise and progress, have just been issued by Commander W. H. WALKER, U. S. N., from which all that is likely to be desired on the subject may be readily acquired. \* \* \* \* After thoroughly demonstrating the efficiency of the screw, Mr. Walker proceeds to point out the various other points to be attended to in order to secure an efficient man-of-war, and eulogizes throughout the readiness of the British Admiralty to test every novelty calculated to give satisfactory results. \* \* \* \* Commander Walker's book contains an immense amount of concise practical data, and every item of information recorded fully proves that the various points bearing upon it have been well considered previously to expressing an opinion."—*London Mining Journal*.

"Every engineer should have it in his library."—*American Engineer*.

*D. Van Nostrand's Publications.*

---

## Evolutions of Field Batteries of Artillery.

Translated from the French, and arranged for the Army and Militia of the United States. By Gen. ROBERT ANDERSON, U. S. Army. Published by order of the War Department. 1 vol. cloth, 32 plates. \$1.

WAR DEPARTMENT, *Nov. 2d, 1859.*

The System of "Evolutions of Field Batteries," translated from the French, and arranged for the service of the United States, by Major Robert Anderson, of the 1st Regiment of Artillery, having been approved by the President, is published for the information and government of the army.

All Evolutions of Field Batteries not embraced in this system are prohibited, and those herein prescribed will be strictly observed.

J. B. FLOYD, *Secretary of War.*

"This system having been adopted by the War Department, is to the artilleryist what Hardee's Tactics is to the infantry soldier; the want of a work like this has been seriously felt, and will be eagerly welcomed."—*Louisville Journal.*

---

## History of the United States Naval Academy

With Biographical Sketches, and the names of all the Superintendents, Professors and Graduates, to which is added a Record of some of the earliest Votes by Congress, of Thanks, Medals and Swords to Naval Officers. By EDWARD CHAUNCEY MARSHALL, A. M., formerly Instructor in Captain Kinsley's Military School at West Point, Assistant Professor in the N. Y. University, etc. \$1.

---

## Ordnance and Gunnery.

A Course of Instruction in Ordnance and Gunnery. Compiled for the Use of the Cadets of the United States Military Academy. By Captain J. G. BENTON, Ordnance Department U. S. A., late Instructor of Ordnance and the Science of Gunnery, U. S. Military Academy, West Point, and First Assistant to the Chief of Ordnance, U. S. A. Second edition, revised and enlarged. 1 vol. 8vo, half morocco, \$5.

Capt. Benton has carefully revised and corrected this valuable work on Ordnance and Gunnery, the first edition of which was published only about a year ago. The many important improvements introduced in this branch of the service have rendered such a revision necessary. The present edition will be invaluable, not only to the student, but as a standard book of reference on the subject of which it treats.

## Scott's Military Dictionary.

Comprising Technical Definitions; Information on Raising and Keeping Troops; Actual Service, including makeshifts and improved materiel, and Law, Government, Regulation, and Administration relating to Land Forces. By Colonel H. L. Scott, Inspector-General U. S. A. 1 vol., large octavo, fully illustrated, half morocco. \$6.

"It is a complete Encyclopædia of Military Science."—*Philadelphia Evening Bulletin.*

"We cannot speak too much in legitimate praise of this work."—*National Intelligencer.*

"It should be made a Text-book for the study of every Volunteer."—*Harper's Magazine.*

"We cordially commend it to public favor."—*Washington Globe.*

"This comprehensive and skilfully prepared work supplies a want that has long been felt, and will be peculiarly valuable at this time as a book of reference."—*Boston Commercial Bulletin.*

"The Military Dictionary is splendidly got up in every way, and reflects credit on the publisher. The officers of every company in the service should possess it."—*N. Y. Tablet.*

"The work is more properly a Military Encyclopædia, and is profusely illustrated with engravings. It appears to contain every thing that can be wanted in the shape of information by officers of all grades."—*Philadelphia North American.*

"This book is really an Encyclopædia, both elementary and technical, and as such occupies a gap in military literature which has long been most inconveniently vacant. This book meets a present popular want, and will be secured not only by those embarking in the profession but by a great number of civilians, who are determined to follow the descriptions and to understand the philosophy of the various movements of the campaign. Indeed, no tolerably good library would be complete without the work."—*New York Times.*

"The work has evidently been compiled from a careful consultation of the best authorities, enriched with the results of the experience and personal knowledge of the author."—*N. Y. Daily Tribune.*

"Works like the present are invaluable. The officers of our Volunteer service would all do well to possess themselves of the volume."—*N. Y. Herald.*

## New Bayonet Exercise.

A New Manual of the Bayonet, for the Army and Militia of the United States. By Colonel J. C. KELTON, U. S. A. With thirty beautifully-engraved plates. Red cloth. \$2.00

This Manual was prepared for the use of the Corps of Cadets, and has been introduced at the Military Academy with satisfactory results. It is simply the theory of the attack and defence of the sword applied to the bayonet, on the authority of men skilled in the use of arms.

The Manual contains practical lessons in Fencing, and prescribes the defence against Cavalry and the manner of conducting a contest with a Swordsman.

"This work merits a favorable reception at the hands of all military men. It contains all the instruction necessary to enable an officer to drill his men in the use of this weapon. The introduction of the Sabre Bayonet in our Army renders a knowledge of the exercise more imperative."—*New York Times.*

## Hand-Book of Artillery,

For the Service of the United States Army and Militia. New and revised edition. By Maj. JOSEPH ROBERTS, U. S. A. 1 vol. 18mo, cloth, New and enlarged edition. \$1 25.

"A complete catechism of gun practice, covering the whole ground of this branch of military science, and adapted to militia and volunteer drill, as well as to the regular army. It has the merit of precise detail, even to the technical names of all parts of a gun, and how the smallest operations connected with its use can be best performed. It has evidently been prepared with great care, and with strict scientific accuracy. By the recommendation of a committee appointed by the commanding officer of the Artillery School at Fort Monroe, Va., it has been substituted for 'Burns' Questions and Answers,' an English work which has heretofore been the text-book of instruction in this country."—*New York Century*.

---

## New Infantry Tactics,

For the Instruction, Exercise, and Manœuvres of the Soldier, a Company, Line of Skirmishers, Battalion, Brigade, or Corps d'Armée. By Brig.-Gen. SILAS CASEY, U. S. A. 3 vols. 24mo. Half roan, lithographed plates. \$2.50.

VOL. I.—School of the Soldier; School of the Company; Instruction for Skirmishers.

VOL. II.—School of the Battalion.

VOL. III.—Evolutions of a Brigade; Evolutions of a Corps d'Armée.

The manuscript of this new system of Infantry Tactics was carefully examined by General McCLELLAN, and met with his unqualified approval, which he has since manifested by authorizing General CASEY to adopt it for his entire division. The author has retained much that is valuable contained in the systems of SCOTT and HARDEE, but has made many important changes and additions which experience and the exigencies of the service require. General CASEY's reputation as an accomplished soldier and skilful tactician is a guarantee that the work he has undertaken has been thoroughly performed.

"These volumes are based on the French *ordonnances* of 1831 and 1845 for the manœuvres of heavy infantry and *chasseurs à pied*; both of these systems have been in use in our service for some years, the former having been translated by Gen. Scott, and the latter by Col. Hardee. After the introduction of the latter drill in our service, in connection with Gen. Scott's Tactics, there arose the necessity of a uniform system for the manœuvres of all the infantry arm of the service. These volumes are the result of the author's endeavor to communicate the instruction, now used and adopted in the army, to achieve this result."—*Boston Journal*.

"Based on the best precedents, adapted to the novel requirements of the art of war, and very full in its instructions, Casey's Tactics will be received as the most useful and most comprehensive work of its kind in our language. From the drill and discipline of the individual soldier, or through all the various combinations, to the manœuvres of a brigade and the evolutions of a Corps D'Armée, the student is advanced by a clear method and steady progress. Numerous cuts, plans, and diagrams illustrate positions and movements, and demonstrate to the eye the exact working out of the individual position, brigading, order of battle, &c., &c. The work is a model of publishing success, being in three neat pocket volumes."—*New Yorker*.

*D. Van Nostrand's Publications.*

## A Treatise on Ordnance and Naval Gunnery.

Compiled and arranged as a Text-Book for the U. S. Naval Academy, by Lieutenant EDWARD SIMPSON, U. S. N. Second edition, revised and enlarged. 1 vol. 8vo, plates and cuts, half morocco. \$5.

"As the compiler has charge of the instruction in Naval Gunnery at the Naval Academy, his work, in the compilation of which he has consulted a large number of eminent authorities, is probably well suited for the purpose designed by it—namely, the circulation of information which many officers, owing to constant service afloat, may not have been able to collect. In simple and plain language it gives instruction as to cannon, gun carriages, gun powder, projectiles, fuzes, locks, and primers; the theory of pointing guns, rifles, the practice of gunnery, and a great variety of other similar matters, interesting to fighting men on sea and land."—*Washington Daily Globe*.

"A vast amount of information is conveyed in a readable and familiar form. The illustrations are excellent, and many of them unique, being colored or bronzed so as to represent various military arms, &c., with more than photographic literalness."—*Washington Star*.

"It is scarcely necessary for us to say that a work prepared by a writer so practically conversant with all the subjects of which he treats, and who has such a reputation for scientific ability, cannot fail to take at once a high place among the text-books of our naval service. It has been approved by the Secretary of the Navy, and will henceforth be one of the standard authorities on all matters connected with Naval Gunnery."—*New York Herald*.

"The book itself is admirably arranged, characterized by great simplicity and clearness, and certainly at this time will be a most valuable one to officers of the Navy."—*Boston Commercial Bulletin*.

"Originally designed as a text-book, it is now enlarged, and so far modified in its plan as to make it an invaluable hand-book for the naval officer. It is comprehensive—preserving the cream of many of the best books on ordnance and naval gunnery, and is printed and illustrated in the most admirable manner."—*New York World*.

## Elementary Instruction in Naval Ordnance and Gunnery.

By JAMES H. WARD, Commander U. S. Navy, Author of "Naval Tactics," and "Steam for the Million." New edition, revised and enlarged. 8vo. Cloth, \$2.

"It conveys an amount of information in the same space to be found nowhere else, and given with a clearness which renders it useful as well to the general as the professional inquirer."—*N. Y. Evening Post*.

"This volume is a standard treatise upon the subject to which it is devoted. It abounds in valuable information upon all the points bearing upon Naval Gunnery."—*N. Y. Commercial Advertiser*.

"The work is an exceedingly valuable one, and is opportunely issued."—*Boston Journal*.

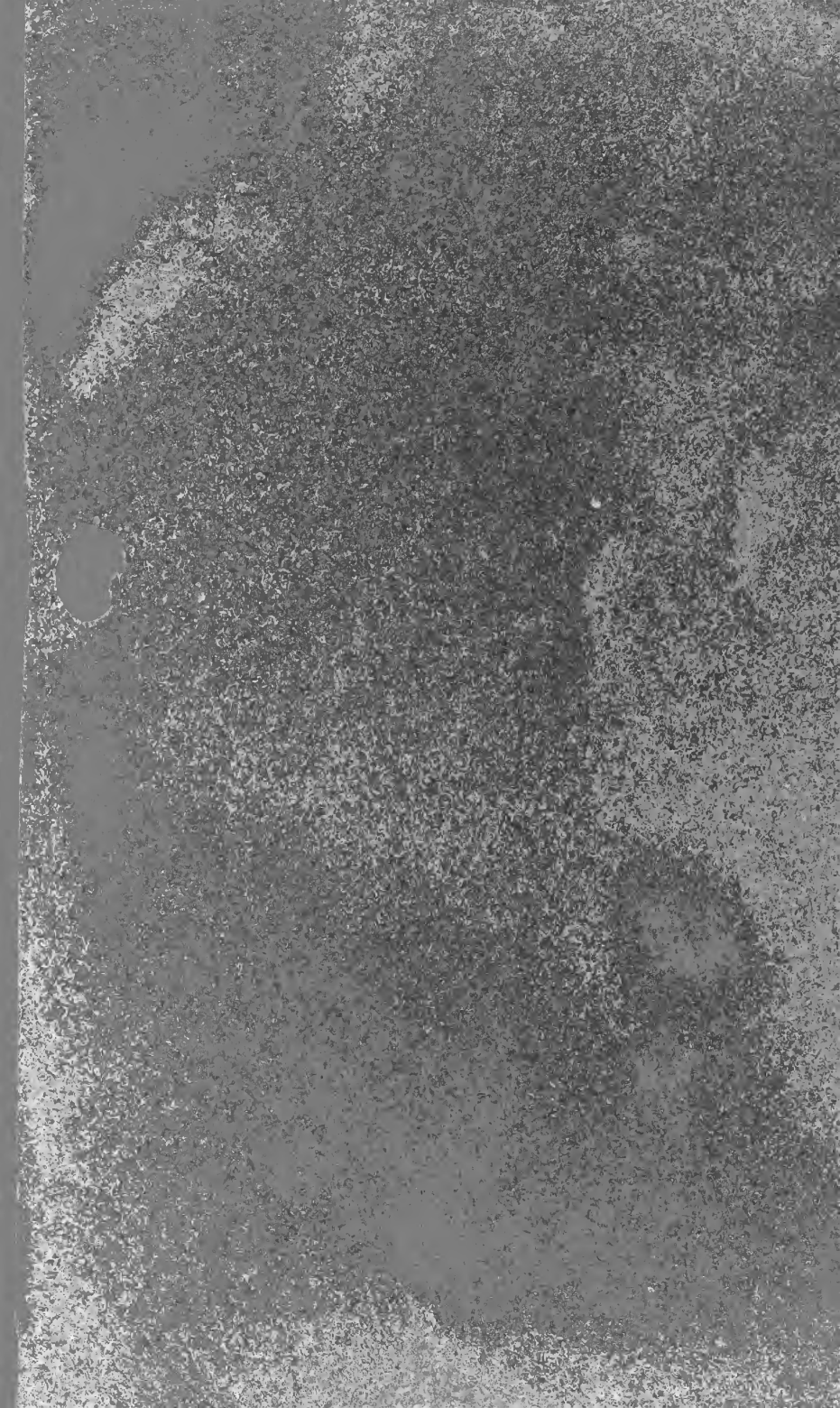












**RETURN TO: CIRCULATION DEPARTMENT  
198 Main Stacks**

LOAN PERIOD Home Use	1	2	3
	4	5	6

**ALL BOOKS MAY BE RECALLED AFTER 7 DAYS.**  
Renewals and Recharges may be made 4 days prior to the due date.  
Books may be renewed by calling 642-3405.

**DUE AS STAMPED BELOW.**

AUG 02 2003		
SENT ON ILL		
JUL 08 2005		
U.C. BERKELEY		

FORM NO. DD6  
50M 5-02

UNIVERSITY OF CALIFORNIA, BERKELEY  
Berkeley, California 94720-6000

U.C. BERKELEY LIBRARIES



8001024721

