

ZOOLOGY LIBRARY  
UNIVERSITY OF TORONTO



3 1761 03659263 2

Digitized by the Internet Archive  
in 2010 with funding from  
University of Toronto





I

A TREATISE ON ZOOLOGY

# A TREATISE ON ZOOLOGY

*Demy Seo, Cloth, price 15s. net each; or in Paper  
Covers, price 12s. 6d. net each.*

## VOLUMES READY

**Part I. (First Fascicle) INTRODUCTION AND PROTOZOA.** By Sir RAY LANKESTER, K.C.B., F.R.S.; Prof. S. J. HICKSON, M.A., F.R.S.; F. W. GAMBLE, D.Sc., F.R.S.; A. WILLEY, M.A., D.Sc., F.R.S.; J. J. LISTER, F.R.S.; H. M. WOODCOCK, D.Sc.; and the late Prof. WELDON.

**Part I. (Second Fascicle) INTRODUCTION AND PROTOZOA.** By J. B. FARMER, D.Sc., M.A., F.R.S.; J. J. LISTER, F.R.S.; E. A. MINCHIN, M.A.; and S. J. HICKSON, F.R.S.

**Part II. THE PORIFERA AND COELENTERA.** By Sir RAY LANKESTER, K.C.B., F.R.S.; E. A. MINCHIN, M.A.; G. HERBERT FOWLER, B.A., Ph.D.; and GILBERT C. BOURNE, M.A.

**Part III. THE ECHINODERMA.** By F. A. BATHER, M.A., assisted by J. W. GREGORY, D.Sc., and E. S. GOODRICH, M.A.

**Part IV. THE PLATYHELMIA, THE MESOZOA, and THE NEMERTINI.** By Prof. BENHAM, D.Sc.

**Part V. MOLLUSCA.** By Dr. PAUL PELSENER.

**Part VII. APPENDICULATA (Third Fascicle: CRUSTACEA).** By W. T. CALMAN, D.Sc.

*Demy Seo, Cloth, price 20s. net; Paper Covers, 15s. net.*

**Part IX. VERTEBRATA CRANIATA (First Fascicle: CYCLOSTOMES AND FISHES).** By E. S. GOODRICH, M.A., F.R.S.

## AGENTS

AMERICA . . .	THE MACMILLAN COMPANY 64 & 66 FIFTH AVENUE, NEW YORK
AUSTRALASIA	THE OXFORD UNIVERSITY PRESS 205 FLINDERS LANE, MELBOURNE
CANADA . . .	THE MACMILLAN COMPANY OF CANADA, LTD. 27 RICHMOND STREET WEST, TORONTO
INDIA . . . .	MACMILLAN & COMPANY, LTD. MACMILLAN BUILDING, BOMBAY 309 BOW BAZAAR STREET, CALCUTTA

Zool.  
L

A

# TREATISE ON ZOOLOGY

EDITED BY

SIR RAY LANKESTER

K.C.B., M.A., LL.D., F.R.S.

HONORARY FELLOW OF EXETER COLLEGE, OXFORD; CORRESPONDENT OF THE INSTITUTE OF FRANCE; LATELY DIRECTOR OF THE NATURAL HISTORY DEPARTMENTS OF THE BRITISH MUSEUM

PART IX

VERTEBRATA CRANIATA

(FIRST FASCICLE: CYCLOSTOMES AND FISHES)

BY

E. S. GOODRICH, M.A., F.R.S.

FELLOW OF MERTON COLLEGE, AND ALDRICHIAN DEMONSTRATOR OF COMPARATIVE ANATOMY IN THE UNIVERSITY OF OXFORD

94  
45  
L  
Part 9  
Zool.

LONDON

ADAM AND CHARLES BLACK

1909

126610  
5/3/13





## AUTHOR'S PREFACE

THIS first fascicle of the Ninth Part of the Treatise deals with the general characters of the Craniate Vertebrates and the two Classes, Cyclostomes and Fishes. I wish here to express my gratitude to Sir Ray Lankester, Dr. G. A. Boulenger, Dr. A. S. Woodward, and especially to Dr. R. H. Traquair, for the help they have given me in its preparation.

For those illustrations which are new I am directly responsible, but for a large number of figures I am indebted to the published works of other writers. My thanks, for allowing me to use their blocks, are due to several authors, publishers, and institutions. Among these may be mentioned Dr. A. S. Woodward, Dr. B. Dean, the Trustees of the British Museum, the India Office, the Smithsonian Institution, the Royal Society of Edinburgh, the Zoological Society, the Geologists' Association, the University Press of Cambridge, Messrs. J. and A. Churchill, Messrs. Longmans, Green and Co., Messrs. Swan Sonnenschein and Co., Messrs. Cassell and Co., Messrs. Engelmann of Leipzig, and Messrs. Fischer of Jená.

EDWIN S. GOODRICH.

20th January 1909.



# CONTENTS

## PHYLUM VERTEBRATA

	PAGE
<b>Subphylum VERTEBRATA CRANIATA</b> . . . . .	1
Cephalisation, 2 ; Skull, 11 ; Brain, 13 ; Visceral arches, 18 ; Mouth, 18 ; Lateral line, 19 ; Nerve components, 21 ; Sense-organs, 23 ; Pineal eyes, 24 ; Alimentary canal, 26 ; Vascular system, 26 ; Kidneys, 27 ; Gonads, 28.	

### DIAGRAM OF PHYLOGENY, 29.

<b>Branch I. and Class CYCLOSTOMATA</b> . . . . .	30
Skeleton, teeth, 30 ; Somites and nerves, 37 ; Branchial basket, 38 ; Nostril, 39 ; Brain, 41 ; Gills, 41 ; Viscera, 43 ; Vascular system, 43 ; Kidneys, 43 ; Gonads, 46.	

<b>Sub-Class 1. MYXINOIDEA</b> . . . . .	46
Fam. Myxinidae, 51.	

<b>Sub-Class 2. PETROMYZONTIA</b> . . . . .	51
Fam. Petromyzontidae, 54.	
Affinities, 54.	
INCERTAE SEDIS. Fam. Palaeospondylidae, 56.	

<b>Branch II. GNATHOSTOMATA</b> . . . . .	58
Cartilage and bone, 58 ; Skull, 67 ; Vertebral column, 68 ; Median fins, 69 ; Concentration, etc., 71 ; Paired fins, 73 ; Muscle and nerve, 77 ; Nasal sacs, 82 ; Viscera, 82 ; Sense-organs, 82 ; Urinogenitals, 83 ; Chief characters, 92.	

<b>Grade I. Class PISCES</b> . . . . .	93
Gills, 63 ; Jaws, 95 ; Vertebral column, 97 ; Axial and appendicular skeleton, 101 ; Caudal fin, 101 ; Skeleton of paired fins, 106 ; Dermal rays, 109 ; Vascular system, 109 ; Yolk-sac circulation, 114 ; Alimentary canal, 114 ; Classification, 117.	

	PAGE
<b>Sub-Grade 1. CHONDRICHTHYES</b> . . . . .	118
Placoid scale, 119 ; Dentine, 119 ; Ceratotrichia, 122 ; Gill slits and rays, 123 ; Classification, 123.	
DIAGRAM OF PHYLOGENY, 124	
<b>Sub-Class 1. ELASMOBRANCHII</b> . . . . .	125
Nostrils, 125 ; Lateral line, 125 ; Brain, 126 ; Pectoral fin-skeleton and archipterygium, 127 ; Pelvic fin, 128 ; Claspers, 129 ; Urinogenitals, 131 ; Viviparity, 134.	
<b>Order 1. SELACHII</b> . . . . .	135
Centra, 135 ; Skeleton, 137	
<b>Group 1.</b>	
<b>Sub-Order 1. NOTIDANI</b> . . . . .	139
Fam. 1. Chlamydoselachidae, 142 ; Fam. 2. Notidanidae, 143.	
<b>Group 2.</b>	
<b>Division A</b> . . . . .	143
<b>Sub-Order 1. HETERODONTI</b> . . . . .	143
Fam. 1. Cestraciontidae, 145 ; Fam. 2. Cochlodontidae, 146 ; Fam. 3. Edestidae, 147.	
<b>Division B</b> . . . . .	148
<b>Subdivision 1.</b>	
<b>Sub-Order SCYLLIOIDEI</b> . . . . .	148
Fam. 1. Scylliidae, 149 ; Fam. 2. Lamnidae, 149 ; Fam. 3. Carchariidae, 150.	
<b>Subdivision 2.</b>	
<b>Sub-Order 1. SQUALIFORMES</b> . . . . .	151
Fam. 1. Spinacidae, 151 ; Fam. 2. Pristiophoridae, 152.	
<b>Sub-Order 2. RAJIFORMES</b> . . . . .	153
Tribe 1, 155. Fam. Squatinidae, 156.	
Tribe 2, 158. Group A. <i>Rhinoraji</i> , 159. Fam. 1. Rhinobatidae, 159 ; Fam. 2. Pristidae, 160 ; Fam. 3. Rajidae, 160.	
Group B, Torpedinoidei, 161. Fam. Torpedinidae, 161.	
Group C. <i>Centrobatoidei</i> , 163. Fam. 1. Trygonidae, 164 ; Fam. 2. Ptychodontidae, 165 ; Fam. 3. Myliobatidae, 165 ; Fam. 4. Psammodontidae, 167. INCERTAE SEDIS. Fam. 5. Petalodontidae, 167.	

	PAGE
<b>Order 2. HOLOCEPHALI</b> . . . . .	168
<b>Group A</b> . . . . .	176
Fam. 1. Squalorajidae, 176 ; Fam. 2. Myriacanthidae, 176.	
<b>Group B</b> . . . . .	176
Fam. 1. Callorhynchidae, 176 ; Fam. 2. Chimaeridae, 176 ;	
Fam. 3. Rhinochimaeridae, 178.	
INCERTAE SEDIS. Fam. 1. Ptyctodontidae, 179 ; Fam. 2. Menaspidae, 180.	
<b>Sub-Class 2. PLEURACANTHODII</b> . . . . .	180
Fam. 1. Pleuracanthidae, 183 ; Fam. 2. Cladodontidae, 183 ;	
Fam. 3. Chondrenchelyidae, 183.	
<b>Sub-Class 3. CLADOSELACHII</b> . . . . .	184
Fam. Cladoselachidae, 187.	
<b>Sub-Class 4. ACANTHODII</b> . . . . .	187
Fam. 1. Diplacanthidae, 192 ; Fam. 2. Acanthodidae, 192.	
INCERTAE SEDIS. Fam. Gyraacanthidae, 192.	
<b>Sub-Grade 2. OSTRACODERMI</b> . . . . .	194
<b>Order 1. PTERASPIDOMORPHI</b> . . . . .	195
Fam. 1. Coelolepidae, 196 ; Fam. 2. Drepanaspidae, 197 ;	
Fam. 3. Psammosteidae, 198 ; Fam. 4. Pteraspidae, 198.	
<b>Order 2. CEPHALASPIDOMORPHI</b> . . . . .	200
Fam. 1. Ateleaspidae, 203 ; Fam. 2. Cephalaspidae, 203 ;	
Fam. 3. Tremataspidae, 204.	
<b>Order 3. ANASPIDA</b> . . . . .	204
Fam. 1. Birkeniidae, 205 ; Fam. 2. Lasaniidae, 205 ; Fam. 3.	
Euphaneropidae, 206.	
<b>Order 4. PTERICHTHYOMORPHI</b> . . . . .	206
Fam. Asterolepidae, 209.	
<b>Sub-Grade 3. OSTEICHTHYES</b> . . . . .	210
Scales, 210 ; Lepidotrichia, 212 ; Cranial bones, 213 ; Ganoid	
scale, 214 ; Lateral line, 219 ; Air-bladder, 223 ; Nostrils, 227 ;	
Chief characters, 227.	
DIAGRAM OF PHYLOGENY, 228.	
<b>Group A</b> . . . . .	230
<b>Sub-Class 1. DIPNOI</b> . . . . .	230
Scales, 230 ; Dermal rays, 232 ; Vertebral column, 233 ; Skull,	
236 ; Girdles and fins, 242 ; Brain, 245 ; Gills, 247 ; Blood-	
vascular system, 248 ; Urinogenitals, 253 ; Chief characters, 254.	

**Sub-Class 1. DIPNOI**—*continued*

Tribe 1: Fam. 1. Phaneropleuridae, 255; Fam. 2. Urone-  
midae, 255; Fam. 3. Dipteridae, 256. Tribe 2: Fam. 1.  
Ctenodontidae, 257; Fam. 2. Ceratodidae, 257; Fam. 3.  
Lepidosirenidae, 258.

Affinities, 258.

	PAGE
<b>Sub-Class 2. COCCOSTEOMORPHI</b> . . . . .	258
<b>Order 1. ANARTHRODIRA</b> . . . . .	262
Fam. Macropetalichthyidae, 262.	
<b>Order 2. ARTHRODIRA</b> . . . . .	262
<b>Sub-Order 1. ARTHROTHORACI</b> . . . . .	262
Fam. 1. Coccosteidae, 263; Fam. 2. Selenosteidae, 263; Fam. 3. Dinichthyidae, 263; Fam. 4. Titanichthyidae, 263; Fam. 5. Mylostomidae, 263.	
<b>Sub-Order 2. TEMNOTHORACI</b> . . . . .	263
Fam. Homosteidae, 263.	
<b>Group B</b> . . . . .	266
<b>Sub-Class TELEOSTOMI</b> . . . . .	266
Skull, 266; Seventh nerve, 271; Teeth, 272; Vertebral column, 273; Actinotrichia, 273; Limb-girdles, 276; Classification, 277; Characters, 279.	

**Division 1.**

<b>Order OSTEOLEPIDOTI</b> . . . . .	280
<b>Sub-Order 1. HAPLISTIA</b> . . . . .	283
Fam. Tarrasiidae, 284.	
<b>Sub-Order 2. RHIPIDISTIA</b> . . . . .	284
Fam. 1. Holoptychiidae, 284; Fam. 2. Glyptopomidae, 285; Fam. 3. Osteolepidae, 285; Fam. 4. Rhizodontidae, 285; Fam. 5. Onychodontidae, 286.	

**Division 2.**

<b>Order COELACANTHINI</b> . . . . .	287
Fam. Coelacanthidae, 290.	

**Division 3.**

<b>Order POLYPTERINI</b> . . . . .	290
Fam. Polypteridae, 300.	

**Division 4. ACTINOPTERYGII** . . . . . 302

Paired fins, 302; Fulcra, 304; Gular plates, 304.

**Subdivision 1.**

<b>Order CHONDROSTEI</b> . . . . .	307
<b>Sub-Order 1. PALAEONISCOIDEI</b> . . . . .	309
Fam. 1. Palaeoniscidae, 309; Fam. 2. Platysomidae, 312; Fam. 3. Catopteridae, 313.	

	PAGE
<b>Sub-Order 2. ACIPENSEROIDEI</b> . . . . .	315
Fam. 1. Chondrosteidae, 316 ; Fam. 2. Polyodontidae, 317 ; Fam. 3. Acipenseridae, 318.	
INCERTAE SEDIS. Fam. Belonorrhynchidae, 320.	
<b>Subdivision 2. HOLOSTEI</b> . . . . .	321
Tail, 322 ; Otoliths, 324 ; Interorbital septum, 324 ; Myodome, 326 ; Supraoccipital, 326.	
<b>Order 1. AMIOIDEI</b> . . . . .	327
Vertebral column, 327.	
Fam. 1. Eugnathidae, 330 ; Fam. 2. Pachycormidae, 331 ; Fam. 3. Amiidae, 333 ; Fam. 4. Semionotidae, 334 ; Fam. 5. Macrosemiidae, 336 ; Fam. 6. Pholidophoridae, 336 ; Fam. 7. Archaeonemidae, 337 ; Fam. 8. Oligopleuridae, 337 ; Fam. 9. Pycnodontidae, 337.	
<b>Order 2. LEPIDOSTEOIDEI</b> . . . . .	340
Fam. 1. Lepidosteidae, 344.	
INCERTAE SEDIS. Fam. Aspidorrhynchidae, 344.	
<b>Order 3. TELEOSTEI</b> . . . . .	344
Chief characters, 344 ; Skull, 345 ; Vertebral column, 352 ; Bone, 355 ; Scales, 356 ; Phosphorescent organs, 357 ; Lateral line, 358 ; Gills, 358 ; Air-bladder, 359 ; Urinogenitals, 364.	
<b>DIAGRAM OF THE PHYLOGENY OF THE TELEOSTEI</b> , 370	
<b>Division A</b> . . . . .	371
Fam. Leptolepidae, 371.	
<b>Division B</b> . . . . .	371
<b>Group A</b> . . . . .	371
<b>Sub-Order CYPRINIFORMES</b> . . . . .	371
Weber's apparatus, 373.	
Tribe A. <i>Characinoidei</i> , 374.	
Fam. 1. Characinidae, 374 ; Fam. 2. Cyprinidae, 375 ; Fam. 3. Gynnotidae, 376.	
Tribe B. <i>Siluroidei</i> , 377.	
Fam. 1. Siluridae, 379 ; Fam. 2. Callichthyidae, 384 ; Fam. 3. Loricariidae, 384 ; Fam. 4. Aspredinidae, 384.	
<b>Group B</b> . . . . .	386
<b>Sub-Group 1</b> . . . . .	386
<b>Sub-Order CLUPEIFORMES</b> . . . . .	386
Fam. 1. Elopidae, 387 ; Fam. 2. Albulidae, 387 ; Fam. 3. Mormyridae, 388 ; Fam. 4. Hyodontidae, 389 ; Fam. 5. Notopteridae, 389 ; Fam. 6. Osteoglossidae, 390 ; Fam. 7. Saurodontidae, 390 ; Fam. 8. Chirocentridae, 390 ; Fam. 9. Phractolaemidae, 391 ; Fam. 10. Clupeidae, 391 ; Fam. 11. Crossognathidae, 393 ; Fam. 12. Salmonidae, 393 ; Fam. 13. Alepocephalidae, 394 ; Fam. 14. Stomiidae, 394 ; Fam. 15. Gonorrhynchidae, 395 ; Fam. 16. Cromeriidae, 396 ; Fam. 17. Pantodontidae, 396 ; Fam. 18. Ctenothrissidae, 396.	

	PAGE
<b>Sub-Group 2</b> . . . . .	397
<b>Series 1.</b>	
<b>Sub-Order 1. ESOCIFORMES</b> . . . . .	397
Tribe 1, 397.	
Fam. 1. Galaxiidae, 398 ; Fam. 2. Haplochitonidae, 398.	
Tribe 2, 398.	
Sub-Tribe A. Fam. 1. Enchodontidae, 398 ; Fam. 2. Esocidae, 398 ; Fam. 3. Dalliidae, 398.	
Sub-Tribe B. Fam. 1. Scopelidae, 399 ; Fam. 2. Alepidosauridae, 399 ; Fam. 3. Cetomimidae, 399.	
Sub-Tribe C. Fam. 1. Kneriidae, 399 ; Fam. 2. Chirothricidae, 400 ; Fam. 3. Cyprinodontidae, 400 ; Fam. 4. Amblyopsidae, 401.	
Sub-Tribe D. Fam. Scombresocidae, 402.	
INCERTAE SEDIS. Fam. Ammodytidae, 403.	
<b>Series 2.</b>	
<b>Sub-Order 2. ANGUILLIFORMES</b> . . . . .	403
Division 1. <i>Archencheli</i> , 404.	
Fam. Urenchelidae, 404.	
Division 2. <i>Neencheli</i> , 405.	
Group A. <i>Enchelicephali</i> , 405.	
Fam. 1. Anguillidae, 405 ; Fam. 2. Nemichthyidae, 406 ;	
Fam. 3. Derichthyidae, 406 ; Fam. 4. Synphobranchidae, 407 ; Fam. 5. Saccopharyngidae, 407.	
Group B. <i>Colocephali</i> , 407.	
Fam. Muraenidae, 408.	
<b>Series 3.</b>	
<b>Sub-Order 3. SYMBRANCHIFORMES</b> . . . . .	408
Fam. 1. Symbbranchidae, 409 ; Fam. 2. Amphipnoidae, 409.	
<b>Series 4.</b>	
<b>Sub-Order 4. GASTEROSTEIFORMES</b> . . . . .	410
Tribe 1. <i>Gasterosteoides</i> , 411.	
Fam. 1. Gasterosteidae, 412 ; Fam. 2. Aulorhynchidae, 412.	
Tribe 2. <i>Hemibranchii</i> , 412.	
Sub-Tribe A. <i>Protosyngnathoides</i> , 412. Fam. Protosyngnathidae, 412.	
Sub-Tribe B. <i>Aulostomoidei</i> , 412. Fam. 1. Aulostomatidae, 413 ; Fam. 2. Fistulariidae, 413.	
Sub-Tribe C. <i>Centriscoidei</i> , 413. Fam. 1. Centriscidae, 413 ; Fam. 2. Amphisilidae, 413.	
Tribe 3. <i>Lophobranchii</i> , 414.	
Sub-Tribe A. Fam. Solenostomidae, 414.	
Sub-Tribe B. Fam. 1. Syngnathidae, 415 ; Fam. 2. Hippocampidae, 415.	
Tribe 4. <i>Hypostomides</i> , 416.	
Fam. Pegasidae, 416.	



	PAGE
<b>Series 5.</b>	
<b>Sub-Order 5. NOTACANTHIFORMES . . . . .</b>	416
Division 1. Fam. Dercetidae, 417.	
Division 2. Tribe 1, 417.	
Fam. 1. Halosauridae, 417 ; Fam. 2. Lipogenyidae, 417 ;	
Fam. 3. Notacanthidae, 418.	
Tribe 2. Fam. Fierasferidae, 419.	
<b>Series 6.</b>	
<b>Sub-Order 6. MUGILIFORMES . . . . .</b>	419
Tribe 1, 419.	
Sub-Tribe A. Fam. Sphyraenidae, 419.	
Sub-Tribe B. Fam. Atherinidae, 419.	
Sub-Tribe C. Fam. 1. Mugilidae, 420 ; Fam. 2. Polynemidae, 420.	
Tribe 2, 421.	
Sub-Tribe A. Fam. 1. Tetragonuridae, 421 ; Fam. 2. Stromateidae, 421.	
Sub-Tribe B. Fam. Icosteidae, 421.	
Tribe 3, 421.	
Sub-Tribe A. Fam. Ophiocephalidae, 422.	
Sub-Tribe B. <i>Labyrinthici</i> , 422. Fam. 1. Anabantidae, 422 ;	
Fam. 2. Osphromenidae, 422.	
Tribe 4, 423.	
Fam. Chiasmodontidae, 423.	
Tribe 5, 423.	
Fam. Stephanoberycidae, 423.	
<b>Sub-Order 7. ACANTHOPTERYGII . . . . .</b>	424
Division 1. <i>Salmopercae</i> , 425.	
Fam. Percopsidae, 425.	
Division 2, 426.	
Subdivision 1.	
Tribe 1. <i>Beryciformes</i> , 426.	
Fam. 1. Berycidae, 426 ; Fam. 2. Aphredoderidae, 427 ;	
Fam. 3. Pempheridae, 428 ; Fam. 4. Monocentridae, 428.	
Subdivision 2.	
Tribe 1. <i>Perciformes</i> , 428.	
Sub-Tribe A : Superfamily I.	
Fam. 1. Sparidae, 428 ; Fam. 2. Mullidae, 429 ; Fam. 3. Serranidae, 430 ;	
Fam. 4. Sciaenidae, 431 ; Fam. 5. Pseudochromiidae, 431 ;	
Fam. 6. Cepolidae, 431 ; Fam. 7. Hoplognathidae, 431 ;	
Fam. 8. Sillaginidae, 432.	
INCERTAE SEDIS : Fam. Anomalopidae, 432.	

**Sub-Order 7. ACANTHOPTERYGII—continued**

Superfamily II. Fam. 1. Scorpididae, 432 ; Fam. 2. Caproidae, 432.

Sub-Tribe B. *Chaetodontiformes*, 433.

Division A. *Squammiptennes*, 434.

Fam. 1. Chaetodontidae, 434 ; Fam. 2. Drepanidae, 434.

Division B. *Plectognathi*, 435.

Subdivision A.

Fam. 1. Teuthididae, 435 ; Fam. 2. Siganidae, 435 ; Fam. 3. Acanthuridae, 435.

Subdivision B.

Branch 1. *Sclerodermi*, 436.

Series 1, 436.

A. Fam. Triacanthidae, 437. B. Fam. 1. Balistidae, 437 ; Fam. 2. Monacanthidae, 437.

Series 2, 437.

Fam. Ostraciontidae, 439.

Branch 2. *Triodontes*, 439.

Fam. Triodontidae, 439.

Branch 3. *Gymnodontes*, 439.

A. Fam. 1. Tetrodontidae, 441 ; Fam. 2. Diodontidae, 441. B. Fam. Molidae, 442.

Sub-Tribe C, 442.

Fam. 1. Acropomatidae, 442 ; Fam. 2. Percidae, 442 ; Fam. 3. Centrarchidae, 443 ; Fam. 4. Cyphosidae, 443 ; Fam. 5. Lobotidae, 444 ; Fam. 6. Nandidae, 445 ; Fam. 7. Gerridae, 445 ; Fam. 8. Pristipomatidae, 445 ; Fam. 9. Trichodontidae, 445 ; Fam. 10. Lactariidae, 445 ; Fam. 11. Latrididae, 445 ; Fam. 12. Haplodactylidae, 445.

Sub-Tribe D, 445.

Branch 1. Fam. 1. Pomacentridae, 446 ; Fam. 2. Cichlidae, 446.

Branch 2. Fam. Embiotocidae, 446.

Branch 3. Fam. 1. Labridae, 446 ; Fam. 2. Scaridae, 447.

Tribe 2. *Gobiiformes*, 447.

Fam. Gobiidae, 448.

Tribe 3. *Echeneidiformes*, 448.

Fam. Echeneididae, 449.

**Sub-Order 7. ACANTHOPTERYGII—continued**Tribe 4. *Scorpaeniformes*, 449.

Sub-Tribe A. A. Fam. 1. Scorpaenidae, 449 ; Fam. 2. Triglidae, 450. B. Fam. Agonidae, 450 ; Fam. 3. Dactylopteridae, 451 ; Fam. 4. Hexagrammidae, 453 ; Fam. 5. Comephoridae, 453 ; Fam. 6. Rhamphocottidae, 453.

Sub-Tribe B. Fam. 1. Cottidae, 453 ; Fam. 2. Cyclopteridae, 454.

Sub-Tribe C. Fam. 1. Platycephalidae, 454 ; Fam. 2. Hoplichthyidae, 454.

Tribe 5. *Blenniiformes*, 454.

Sub-Tribe A. Fam. 1. Trachinidae, 455 ; Fam. 2. Percophiidae, 455 ; Fam. 3. Leptoscopidae, 456 ; Fam. 4. Nototheniidae, 456 ; Fam. 5. Uranoscopidae, 456.

Sub-Tribe B. Fam. 1. Callionymidae, 456 ; Fam. 2. Gobiesocidae, 456 ; Fam. 3. Trichonotidae, 457.

Sub-Tribe C, 457 ; Fam. 1. Blenniidae, 458 ; Fam. 2. Pholididae, 458 ; Fam. 3. Zoarcidae, 458 ; Fam. 4. Congrogadidae, 460 ; Fam. 5. Ophidiidae, 460 ; Fam. 6. Podatelidae, 460.

## Sub-Tribe D.

Division 1. *Batrachi*, 460.

Fam. Batrachidae, 460.

Division 2. *Pediculati*, 461.

1. Fam. Lophiidae, 462 ; Fam. Ceratiidae, 462 ;  
Fam. Antennariidae, 462. 2. Fam. Gigantactinidae,  
462. 3. Fam. Malthidae, 462.

Tribe 6. *Scombriformes*, 462.

1. Fam. Bramidae, 464. 2. Fam. Carangidae, 464 ;  
Fam. Rhachicentridae, 464. 3. Fam. Scombridae, 465 ;  
Fam. Trichiuridae, 466 ; Fam. Coryphaenidae, 466 ; Fam.  
Luvaridae, 467. 4. Fam. Palaeorhynchidae, 467 ; Fam.  
Histiophoridae, 467 ; Fam. Xiphiidae, 468.

Tribe 7. *Kurtiformes*, 468.

Fam. Kurtidae, 468.

Subdivision 3. *Zeorhombiformes*, 468.

## Branch A.

Fam. Zeidae, 469.

## Branch B.

Fam. 1. Amphistiidae, 469 ; Fam. 2. Pleuronectidae, 469.

Division 3. *Lampridiformes*, 475.Subdivision 1. *Selenichthyes*, 475.

Fam. Lamprididae, 475.

---

<b>Sub-Order 7. ACANTHOPTERYGII—continued</b>	
Subdivision 2, 475.	
Tribe 1. <i>Histichthyes</i> , 476.	
Fam. Veliferidae, 476.	
Tribe 2. <i>Taeniosomi</i> , 476.	
Fam. 1. Lophotidae, 476 ; Fam. 2. Trachypteridae, 476 ;	
Fam. 3. Stylephoridae, 477.	
Division 4. <i>Mastacembeliformes</i> , 477.	
Fam. Mastacembelidae, 478.	
<b>Series 7.</b>	
	PAGE
<b>Sub-Order 8. GADIFORMES</b>	<b>478</b>
Division 1.	
Fam. Macruridae, 480.	
Division 2.	
Fam. 1. Gadidae, 482 ; Fam. 2. Muraenolepidae, 483.	
<b>INDEX</b>	<b>505</b>

# A TREATISE ON ZOOLOGY

## PART IX

### VERTEBRATA CRANIATA

#### FIRST FASCICLE—CYCLOSTOMES AND FISHES

By E. S. GOODRICH.

#### LIST OF ERRATA AND CORRIGENDA

- Page. 40. Legend of Fig. 25, for '*ol.l.*, olfactory lobe,' read '*ol.l.*, olfactory bulb, below which is the olfactory lobe.'
- „ 50. Bottom paragraph—the Myxinoids are probably not hermaphrodite.
- „ 65. 3rd paragraph, 4th line, for '*Amphidia*' read '*Amphibia*.'
- „ 75. 8th line from top, for '*ergion*' read '*region*.'
- „ 99. Legend of Fig. 60, '*A*' should be before Transverse section, and '*B* and *C*' should take the place of '*A* and *B*.'
- „ 133. Legend of Fig. 91, first line, for '*pale*' read '*pole*.'
- „ 134. 2nd line, fertilisation in *Laemargus* is internal.
- „ 135. 10th line from bottom, for '*Fig. 52*' read '*Fig. 52, C*.'
- „ 136. 1st line, for '*Raja*' read '*Mustelus*.'
- „ 136. 2nd and 3rd lines, p. 156, 2nd line from bottom, and p. 159, 3rd line from top, for '*Division*' read '*Tribe*.'
- „ 170. Legend of Fig. 134, '*BH*' and '*HB*' should be transposed; for '*hyomandibular*' read '*hyomandibular?*'
- „ 201. Legend of Fig. 173, add '*p.f.*, pectoral fin.'
- „ 247. 11th line from bottom, after '*Dipnoi*' add '*except in Ceratodus*.'
- „ 278. Last line, omit '*Dipnoi*.'
- „ 305. Legend of Fig. 281, add '*ep.*, epithelial roof; *b.g.*, basal ganglia; *c.w.*, cut wall of hemisphere; *est.*, epistriatum; *v.*, ventricle.'
- „ 307. 2nd paragraph, 7th line, for '*Catopterydae*' read '*Catopteridae*.'
- „ 331. 5th line from top, for '*Lophrostomus*' read '*Lophiostomus*.' 2nd line from bottom, for '*Hypsicormus*' read '*Hypsocormus*.'
- „ 357. Legend of Fig. 343, add '*D*, section of developing lepidotrichia near edge of fin.'
- „ 358. Legend of Fig. 344, for '*Scopelius*' read '*Scopelus*.'
- „ 360. Legend of Fig. 346, for '*B* and *C*' read '*C* and *D*,' in the first line.
- „ 364. Fig. 353, *A*, '*fb*' points to the epiphysis.
- „ 373. Legend of Fig. 359, add '*sa.*, sinus endolymphaticus.'
- „ 377. The first two lines apply not to *Gymnotus*, but to *Malapterurus* on p. 383.
- „ 404. For '*Gymnotus*' in 8th line read '*Malapterurus*.'



## Subphylum VERTEBRATA CRANIATA

THE present work deals with the Vertebrata Craniata, that highest branch of the Phylum Vertebrata, or Chordata, which comprises the classes Cyclostomata, Pisces, Amphibia, Reptilia, Aves, and Mammalia.

Besides the Subphylum Craniata, there are included in the Phylum Vertebrata the Cephalochorda, represented by *Amphioxus* and a few allied genera, the degenerate Tunicata, and the Enteropneusta. The latter group is an aberrant one, whose right to a position in the Phylum is less thoroughly established.

That the six Classes of Craniata mentioned above belong to a single branch derived from some common ancestral form, which had acquired many new characters, and had advanced very considerably beyond the grade of structure found in their nearest allies the Cephalochorda, cannot be doubted when we study their anatomy.

Not only do the Craniata differ from the Cephalochorda in the possession of a large brain more or less completely enclosed in a cartilaginous cranium, to which character they owe their name; but they have made a great advance in almost every detail of their organisation. The comparison given below shows clearly the great gap which separates the lowest known Craniate from *Amphioxus*. In making this comparison it must, of course, be remembered that *Amphioxus* is itself a highly specialised animal, differing in all probability very considerably from the early vertebrate ancestor from which both these surviving branches have diverged.

The Craniata have in common with the Cephalochorda the fundamental characters of the Vertebrata (Chordata), such as: the bilateral symmetry; the pronounced metameric segmentation of the mesoblast; the gut opening by an anterior mouth and a posterior anus, and provided with paired lateral gill-slits; the dorsal tubular central nervous system; the supporting notochord of endodermal origin, unsegmented and underlying the central nervous system; the prolongation of the body beyond the anus in the form of a metamericly segmented tail, containing tissues derived from the three germ-layers; the well-developed coelom, and the separate blood-vascular system.

Among the chief features which denote the great advance in structure of the Craniate vertebrate should first be mentioned the pronounced cephalisation of the anterior segments. Now a typical trunk segment of *Amphioxus*, besides a portion of the nerve-cord, of the notochord, and of the gut, contains a paired coelomic cavity, and a right and left myotome or muscle segment. Motor fibres are supplied to these muscles direct from the nerve-cord by the ventral 'nerve-root' (Fig. 1). The separate dorsal 'nerve-root' passes out from the nerve-cord between the myotomes to the surface, supplying sensory fibres to the skin, and probably both sensory and motor fibres to the viscera (Hatschek [202], Heymans and van

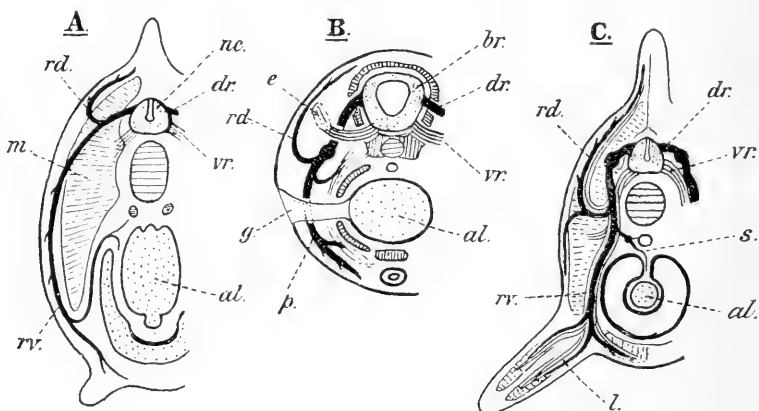

FIG. 1.

Diagrams to show the relations of the dorsal and ventral nerve-roots in (A) the trunk of *Amphioxus* (modified from Hatschek), in (B) the gill-region of a Gnathostome (cranial nerve), and in (C) the trunk-region of a Gnathostome. *al*, alimentary canal; *br*, brain; *dr*, dorsal root; *e*, eye-muscle; *g*, gill-slit; *l*, mixed nerve to paired limb; *m*, myotome; *nc*, nerve-cord; *p*, ventral branch to skin and visceral muscles; *rd*, ramus dorsalis; *rv*, ramus ventralis; *s*, sympathetic; *vr*, ventral root. Fibres from the dorsal root are black.

der Stricht [213], Johnston [248]). But whereas in *Amphioxus* the mesoblast is clearly segmented to the very tip of the head, and the myotomes, developed from the second segment backwards, persist with their corresponding nerves throughout the anterior region, in the Craniate the segments at the anterior end of the body are so highly modified, and their limits so obscured, that they can only be made out with difficulty in the embryo, and are unrecognisable as such in the adult. Two of the chief factors in the specialisation of the head-region have no doubt been the presence of the mouth and gill-slits, and the development of the paired organs of sense.

The 'Vertebral' theory of the skull, as upheld by Goethe and Oken, and further elaborated by Owen, was upset by Huxley in



his famous Cronian Lecture in 1858 [225]. It received its final blow from Gegenbaur (1872), and has been gradually replaced by a 'Segmental' theory of the Craniate head founded on sound anatomical and embryological evidence (Gegenbaur [153, 161], Fürbringer [143], Froriep, Balfour [27], Marshall [292-3], van Wijhe [495], von Kupffer [275], and others).

It is now recognised that the remote ancestor of the Craniata must, like *Amphioxus*, have been fully segmented to its anterior extremity; that the great differences in structure between the head and the trunk must be considered as due to the divergent specialisation of two regions of the body, which primitively resembled each other closely; and that there is no hard and fast line between the two, the distinction having been gradually established, and being more pronounced in the higher than in the lower forms. The limit of the head-region varies according as we adopt the skeleton, the nerves, or the gill-slits as our criterion.

To unravel the complex structure of the head, to enumerate and identify the segments of which it is composed, is one of the most interesting and difficult problems of the morphology of the Craniata.

For this purpose three chief sets of structures must be studied: the nervous system and sense-organs; the mesoblastic somites; and the gill arches and slits. Of these it is the second, perhaps, which affords the most trustworthy evidence. It is well known that in the trunk-region the mesoblast becomes differentiated in ontogeny into two main divisions: the segmental dorsal somites and the ventral unsegmented 'lateral plate.' The former may contain segmental transient coelomic cavities (myocoel), the latter the unsegmented coelom or permanent body-cavities. Indeed, it is one of the main characteristics of all Craniata, as distinguished from the Cephalochorda, that the ventral mesoblast is continuous and has lost its segmentation, though traces of it may be seen in the development of the trunk segments of Cyclostomes (Hatta [202a]), and in the head region of all Craniates. The dorsal somites become further differentiated into an outer 'cutis layer' yielding connective tissue, an inner muscular layer forming the true myotomes from which are derived all the segmental muscles of the body, and a ventral inner outgrowth, the sclerotome, the chief source of the connective tissues. From the lateral plate are derived the coelomic epithelium and the splanchnic or visceral muscles. Now it is important to notice that, while the myotomes and the muscles derived from them (such as the limb-muscles) receive their motor nerves exclusively from the ventral roots of the spinal nerves, the splanchnic muscles, the skin, the mucous membranes, and their sense-organs are supplied from the mixed dorsal roots (Fig. 1).

In both the Cephalochorda and the Craniata the trunk segments are provided with corresponding segmental spinal nerves. Originally, these were perhaps restricted in distribution to definite segmental areas. The ventral motor root is probably from the very first in ontogeny continuous with the myotome of its own segment; if not by means of nerve-fibres, at all events by protoplasmic strands along which the fibres may grow. There is reason to believe that they remain for ever faithful to that segment both in individual development and in phylogeny. The fate of the root depends on that of the muscle it supplies; if the latter enlarges, the motor root acquires many fibres and becomes thick; if, on the contrary, it dwindles, the nerve diminishes also, and may finally vanish (Fürbringer [142]). Anastomoses between neighbouring motor nerves, plexus formation, can presumably only follow on the fusion of muscle segments, a phenomenon of frequent occurrence.

The distribution of the nerve-fibres of the dorsal mixed root is less rigidly confined. Possibly the sensory fibres remain always faithful to the sensory cells and organs they supply; but these may multiply and spread over the skin from one region to another. Obvious traces of an originally metameric distribution of the sensory nerves are still visible in the highest vertebrates (Bolk). The nerve-fibres of the dorsal root which supply structures derived from the lateral unsegmented plate are free to form an anastomosing plexus (vagus nerve, sympathetic system).

The ventral roots are never and the dorsal roots are always provided with a ganglion in the Craniata. Originally (*Amphioxus*) the two roots were independent. But in all Craniates, with the exception of the Petromyzontia (p. 38), the ventral root joins the dorsal root near the ganglion to form a mixed nerve (Fig. 1). Typically, the mixed nerve gives off four main branches: a dorsal, a median, a ventral, and a visceral. In some fish (Selachians) the mixing of the two sets of fibres is not very complete, and in the tail region it may scarcely take place at all (Goodrich [176]). The spinal ganglia and sensory nerves, originally derived from the surface, sink inwards between the somites, and come to occupy a position internal to the myotomes. In ontogeny the dorsal roots and ganglia are all derived from a longitudinal neural crest, which develops on each side of the ectodermal neural plate or thickening (the rudiment of the central nervous system). The crest is discontinuous in the head, but continuous at first in the trunk and tail.

Now, it is obvious that most valuable evidence with regard to the segmentation of the head might be expected from a study of the development of its muscles and nerves. It has been found that in the lower Craniata there is no abrupt division between the trunk and the head; that as we pass forwards the segments become

on the whole less and less typically developed, more and more specialised; that this process of cephalisation has proceeded farther in the higher than in the lower forms; and finally, that it is less pronounced in the embryo than in the adult. Observers differ as to the exact number of somites in front of the segment corresponding to the vagus nerve. The head behind that region includes a very variable number of segments. The hind limit of the head in fish not only may be quite indefinite, there being a gradual transition from one region to the other, but also it does not occupy a fixed position, and the process of cephalisation, or assimilation of trunk segments, has gone much further in some groups than in others.

Without attempting to give a history of the study of the segmentation of the head, it may be mentioned that Balfour, Marshall [292-3], Dohrn [118], van Wijhe [495], Hoffmann [216], Braus [47], Platt [331], Koltzoff [272-3], Johnston [248a], and numerous others, have worked at this difficult problem. It has been fairly well established that there are 3 mesoblastic segments in front of the auditory capsule (prootic somites), and a varying number behind (metaotic somites); 9 in *Pristiurus*, 10 in *Acanthias*, 11 in *Spinax*. The fourth somite may extend below the auditory capsule. These somites, first clearly identified by van Wijhe [495] in Elasmobranchs, have been found in the Cyclostomes (Koltzoff [272]), the Amphibia (Platt [331a]), and the Amniota. They appear to be strictly comparable throughout the Craniata (Fig. 3). A more anterior evanescent somite has sometimes been seen in front of the first of van Wijhe; it is the so-called 'anterior head-cavity' of Elasmobranchs (Platt [331]).

In all the Craniate vertebrates the myotomes of the first three prootic somites are entirely subordinated to the use of the optic capsule, and become converted into the 'eye-muscles.' Although there are slight discrepancies between the arrangement of the six eye-muscles of the Cyclostomes and Gnathostomes, yet their form and innervation are remarkably constant throughout (Figs. 3 and 4). With regard to the more posterior segments, the Cyclostomes seem to be in a much more primitive condition than the Gnathostomes. For, whereas in the former all the metaotic somites (from the fourth backwards) appear to be represented in the adult by myotomes forming a continuous series with ordinary trunk-muscles (Koltzoff [272], Hatschek [202]), in the Gnathostomes the myotomes of the first two or more metaotic somites vanish during ontogeny, and the 4th somite (1st metaotic)<sup>1</sup> never forms muscle even in the embryo (Figs. 2 and 3).

<sup>1</sup> Many authors, Dohrn, Kilian, Platt, Sewertzoff, etc., consider that there are here two or more fused somites; but the evidence, especially of the nerves, seems to be against this view.

A varying number of somites behind the 6th grow downwards and inwards to form the epibranchial and hypobranchial muscles, the dorsal myotome dwindling away. A normal muscular segment, serial with the trunk-myotomes, is generally not developed at all in the head-region of a Gnathostome.

The anterior mesoblastic somites extend downwards to form the lateral plate, which passes between or is pierced by the gill-slits. From this plate are developed the muscles of the visceral skeleton

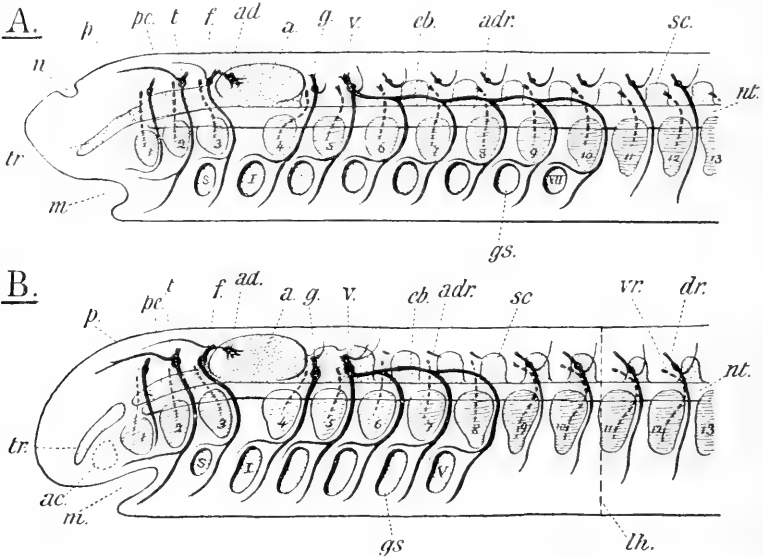

FIG. 2.

Diagrams of the segmentation of the anterior region of a Cyclostome, A, and a Gnathostome, B. The skeleton is dotted; the myotomes, 1-13, are shaded with lines (broken when vestigial); the gill-slits (dotted) are shown below; the dorsal root-nerves are black; the ventral root-nerves are represented by dotted lines. *a*, auditory capsule; *ad*, auditory nerve; *adr*, dorsal root of anterior spinal nerve; *dr*, dorsal root; *cb*, epibranchial nerve; *f*, facial nerve; *g*, glossopharyngeal nerve; *gs*, branchial slit, I-VII; *lh*, limit between head and trunk; *m*, mouth; *n*, nostril; *nt*, notochord; *p*, profundus nerve; *pc*, parachordal; *s*, spiracular slit; *sc*, skeletal segment or scleromere; *t*, trigeminal nerve; *tr*, trabecula cranii; *v*, vagus nerve; *vr*, ventral root.

and alimentary canal, and the trapezius muscle passing to the scapula.

The cranial nerves, which used to be considered as radically different from the spinal nerves, have now been recognised as, for the most part, merely modified segmental nerves, some having dorsal and others ventral roots. The old numbering of the cranial nerves, founded on human anatomy, is often retained for convenience, but has been replaced by an enumeration referring to their true metameric order. Those characters which distinguish them from the spinal nerves are partly primitive and partly secondary.

Among the former may be reckoned the separate course of the ventral motor roots (for these do not mix with the dorsal roots), and the more superficial course of the dorsal ganglionated roots. The cranial nerves of the Craniate, in fact, more closely resemble the segmental nerves of *Amphioxus* than do the spinal nerves (Fig. 1). The existence of a large number of motor fibres in the dorsal nerves is correlated with the great development of the visceral muscles in the head. This, the chief difference between the two types of nerves, is one of degree. Likewise with regard to the

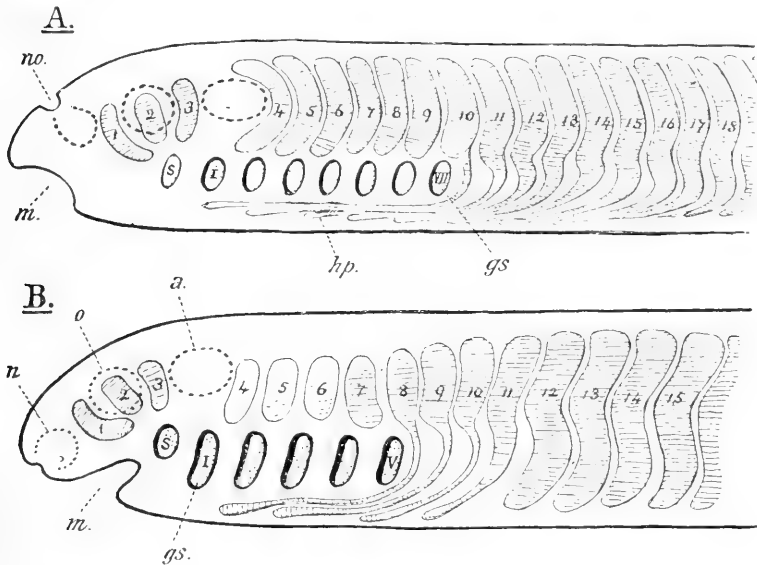

FIG. 3.

Diagrams of the anterior region of a Cyclostome, A, and of a Gnathostome, B, showing the position and development of the myotomes (numbered 1-18). In the Gnathostome the first few metaotic myotomes (4-6) are more or less vestigial. The sense-capsules are indicated by dotted lines. *a*, auditory, *n*, nasal, and *o*, optic capsule; *g.s.* I-VII, gill-slits; *h.p.*, hypoglossal processes of myotomes; *m*, mouth; *s*, spiracular slit.

position they occupy, the cranial nerves seem to lie outside the muscles, while the spinal nerves lie mostly on the inner side of the muscles; this is explained by the fact that the myotomes are well developed in the trunk and tail, but scarcely at all in the head of Gnathostomes (Fig. 1). The position of the post-auditory cranial nerves is normal in the Cyclostomes, where the myotomes are present.

Setting aside the special olfactory and optic nerves, we find that the 5th cranial nerve consists of a pair of segmental nerves (Fig. 2). The ventral root of the first (IIIrd nerve or motor oculi) supplies eye-muscles derived from the first or premandibular somite

(rectus internus or anterior, rectus superior, rectus inferior, and obliquus inferior). Its dorsal root is the nervus ophthalmicus profundus passing to the quite anterior region of the head. The ventral root of the second segment (IVth nerve or patheticus) passes to the superior oblique muscle, developed from the second or mandibular somite. Its dorsal root is the trigeminus nerve (Vth in part) supplying the front region of the head and the jaws. The myotome of the third and last prootic somite (rectus posterior or externus) is innervated by a ventral root (VIth nerve or abduccens); and the corresponding dorsal root is the VIIth nerve or facialis, which has an epibranchial branch forking over the first gill-slit or spiracle, and passing down the hyoid arch. The VIIIth or auditory nerve also represents a portion of the dorsal root of this segment. The 4th somite, first metaotic, disappears together with its ventral root in all except the Cyclostomes. The glossopharyngeal (IXth) nerve is the corresponding dorsal root, and supplies the second gill-slit and first branchial arch. The dorsal root of the fifth segment is the vagus (pneumogastric) or Xth nerve sending a branch to the third gill-slit and second branchial arch. All the remaining gill-slits and arches have similar epibranchial nerves which all come from the vagus. Gegenbaur supposed the vagus to be a compound nerve formed by the gathering together of segmental nerves equal in number to the gill-slits they supply [156]. But this view, that the vagus root is formed by the fusion of the dorsal roots of several segments which have become incorporated into the hinder region of the head, has been shown not to be in agreement with embryology; for there is no evidence of so complete a disappearance of segments behind the first vagus root. Nor is it reconcilable with the evidence of comparative anatomy. Not only are transitory vestigial dorsal roots and ganglia found in the segments of the gill-bearing region in Gnathostomes, but in the Cyclostomes (Ammocoete larva of *Petromyzon* (Hatschek [202], Koltzoff [272])), each of these segments is provided with a dorsal root, a ganglion, and a dorsal branch passing to the skin between consecutive myotomes. Nevertheless, it is possible that in the Cyclostome one dorsal root (Hatschek [202]) and in the Gnathostome one or more (van Wijhe) may coalesce with the vagus root.

Nor do the known facts of development and anatomy support the view that the distribution of the branchial nerves of the vagus is due to the branching of an originally single segmental nerve. There remains, as the most probable explanation, the theory of the partial polymerisation of the vagus (Hatschek [202]), according to which the original segmental dorsal branchial nerves have been joined together by a longitudinal commissural epibranchial nerve coextensive with the gill-bearing region, and have lost their original connections with the spinal ganglia. In *Petromyzon*, indeed, the

dorsal roots of the gill-region join the epibranchial nerve. Metamereric epibranchial placodes, or proliferations of the epidermis (Beard [32], Koltzoff [272]), are found above each gill-slit; from these are derived the ganglia on the branchial nerves which become joined together by the longitudinal connection. Similar longitudinal nerves also unite the trigeminal with the facial nerve, and

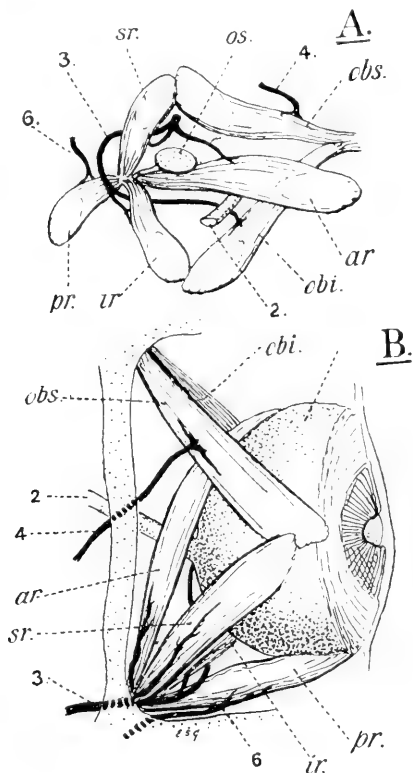

FIG. 4.

*Acanthias vulgaris*, Risso. A, outer view of muscles and nerves of right orbit, from which the eye has been removed. B, dorsal view of right eye. *ar*, anterior, *ir*, inferior, *pr*, posterior, and *sr*, superior rectus muscle; *obi*, inferior, and *obs*, superior oblique muscle; *os*, cartilaginous optic stalk; 2, optic, 3, oculomotor, 4, pathetic, and 6, abducens nerve.

the latter with the glossopharyngeal in *Petromyzon* and most Gnathostomes. The exact composition and mode of formation of the vagus root is still far from thoroughly understood, and it is possible that it may have been formed by a gathering together not of whole posterior dorsal roots as Gegenbaur suggested, but of only those components of each root which supplied the gills and alimentary canal; this supposition (of a slipping forward, so to speak, of

certain portions) would avoid the assumption that new central connections have been established with the brain (Johnston [248a]). The intestinal branch of the vagus may perhaps have developed in somewhat the same manner from the visceral branches of the more posterior nerves. The sympathetic system of nerves, scarcely recognisable as such in the Cyclostomes, would appear to be a specialisation in the general plexus supplying the unsegmented splanchnic structures, and is developed from the dorsal roots and ganglia in the main. The 'dorsal' cranial nerves are provided

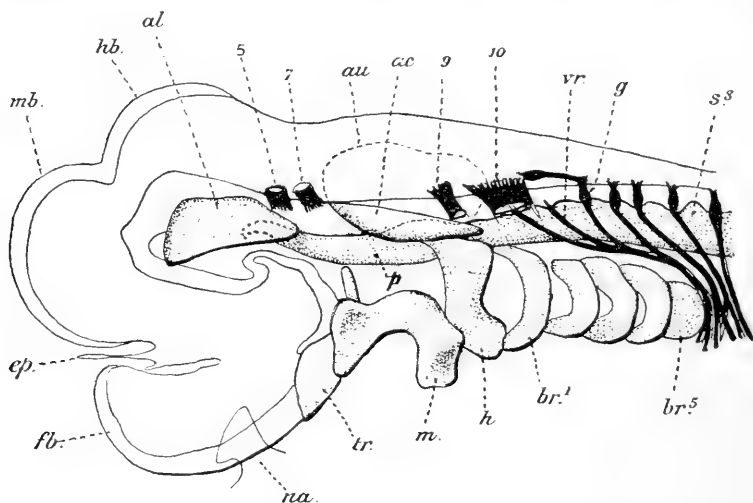

FIG. 5.

Reconstruction of the head of an embryo of *Acanthias*, enlarged. (After Sewertzoff.) *a.c.*, cartilage of auditory capsule; *al.*, alisphenoid cartilage; *au.*, auditory capsule; *br*<sup>1-5</sup>, first to fifth branchial arches; *ep.*, epiphysis; *fb.*, fore-brain; *g.*, spinal ganglion; *h.*, hyoid arch; *h.b.*, hind-brain; *m.*, mandibular arch; *m.b.*, mid-brain; *na.*, nasal pit; *p.*, parachordal plate; *s*<sup>8</sup>, eighth scleromere; *tr.*, trabecula; *vr.*, ventral spinal root; 5, 7, 9, 10, roots of the trigeminal, facial, glossopharyngeal, and vagus nerves.

with ganglia; these generally sink deep down, and may even enter the cranial cavity.

The ventral roots of the segments in the branchial region are variously affected by the fate of their corresponding myotomes. In the Cyclostomes (*Petromyzon*) they are normally developed (p. 5). Since the myotomes behind the vagus root have a tendency to disappear from before backwards in the Gnathostomes (p. 5), the ventral roots dwindle also. They survive, however, in so far as they supply the epibranchial and hypobranchial muscles (Fig. 5). These are developed, as already mentioned, as ventral downgrowths from somites of the posterior branchial segments and of a varying number of segments farther back (from about the 8th to the 12th



metaotic somite in Elasmobranchs (van Wijhe [495], Neal [308a]); from the 7th to the 14th in *Petromyzon* (Koltzoff [272]); from the 3rd to the 5th in *Necturus* (Platt [331a]). The processes from these somites grow down behind the last gill-slit, and then pass forwards again below to form the hypoglossal musculature, and it is the ventral nerve-roots corresponding to them which form the spino-occipital nerves of fish, representing the compound hypoglossal nerve (XIIth cranial nerve) of higher forms (Fürbringer [143]). Thus we get a very variable number of hypoglossal constituents in the different groups of Craniate vertebrates (Figs. 3, 44).

After Huxley's brilliant attack on the Vertebral theory of the skull, came Gegenbaur's epoch-making work on the Elasmobranch skeleton (1872). He showed that though the chondrocranium of the adult Selachian forms a continuous box, yet it exhibits many signs of an original segmental structure, at all events behind the infundibulum and the exit of the oculo-motor nerve. This part of the skull, including the occipital, auditory, and part of the orbital regions, is traversed below by the notochord, gives exit to segmental nerves, and is connected with segmental gill-arches. It was therefore called the 'vertebral' region as distinct from the more anterior part of the skull, including a part of the orbital and the ethmoid regions. The latter was called the 'prevertebral' region; it is chiefly formed by a forward growth round the nasal organs (Gaupp [150-3]).

Following Rathke, Huxley had pointed out that the basis cranii of all Craniata arises in the embryo as a basal or parachordal plate embracing the extremity of the notochord, below the brain, and two trabeculae cranii in front, one on either side of the infundibulum. Stöhr [426a] showed that, in the Urodela, the 'vertebral region' is developed from three distinct centres—the parachordal, the mesotic cartilage of the auditory capsule, and an occipital segment resembling a vertebra. Subsequently Frioriep found, in the occipital region of birds and mammals, some three metameres with distinct somites, skeletal segments, and nerves (hypoglossal). Rosenberg [374a], Sagemehl [379], and Gegenbaur [160] also studied the process of assimilation of vertebral segments (Fig. 6). This gradual inclusion of skeletal segments, scleromeres, in the occipital region of the skull of fish has lately been followed in great detail from embryo to adult by Sewertzoff [407], Hoffmann, Braus [47], and Schreiner [390a]. It has now been conclusively shown that in the Gnathostomes skeletal segments of vertebral nature do, in the course of ontogeny, and doubtless also in that of phylogeny, become attached to, fused with, and finally completely embodied in the occipital region, carrying with them their corresponding nerves. Originally spinal nerves thus

come to pass through the cranial wall—so-called spino-occipitals. The more anterior ventral roots only represent the hypoglossal nerve, already described, p. 11, but more posterior and normally developed spinal nerves may also be included, the ‘occipito-spinals,’ which supply the anterior trunk, myotomes, etc. (Jackson and Clarke [236], Gegenbaur [160], and especially Fürbringer’s admirable monograph [143]).

The exact early history of the skull is sunk in the obscurity of the past, and may perhaps never be reconstructed from embryo-

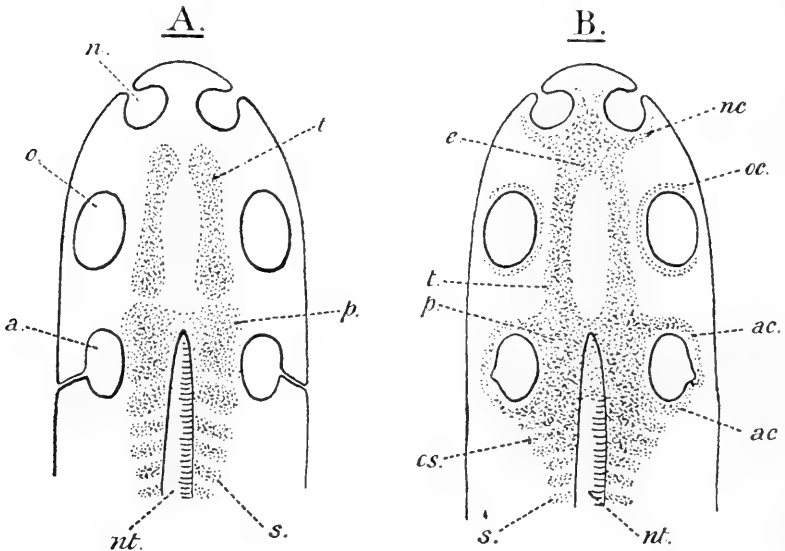

FIG. 6.

Diagrams illustrating the development of the skull in the Craniata. A, early stage; B, later stage. *a*, auditory vesicle; *a.c.*, auditory capsule; *e*, ethmoid region; *n*, nasal sac; *n.c.*, nasal capsule; *nt*, notochord; *o*, optic vesicle; *o.c.*, optic capsule; *o.s.*, occipital segment or sclerotome; *p*, parachordal region; *s*, vertebral sclerotome; *t*, trabecular region. The dotted areas represent cartilage and procartilage.

logical data. That the occipital region is segmental is clear. The parachordals themselves show but slight indications of subdivision (Platt, in Urodela [331*a*]); the trabeculae show none whatever. How far segments in the prechordal and even in the parachordal region of the head may have been modified and obliterated before cartilage developed—how far, in other words, the anterior region was ‘cephalised’ before the skull arose—in the ancestors of modern Craniates remains an unsolved problem.

But it must be remembered that the infundibulum, to which the notochord always reaches in Craniates, probably lies at or near the

morphological anterior limit of the head;<sup>1</sup> and as far as this the mesoblast is segmented. The great extension forwards beyond this point of both the nervous system and the skull is doubtless related to the great development of the special organs of sense, and of the brain. Indeed, the position of the olfactory, optic, and auditory organs must have been one of the chief factors in influencing not only the growth of the brain, but also of the cartilaginous skull, with its three pairs of protective capsules (Figs. 5 and 6). The nasal capsules develop in front of the trabeculae, with which they generally become continuous, if they are not so from the first. The optic capsules arise independently and remain separate, partially enclosing the optic vesicles. The auditory capsules either from the first or very soon are continuous with the parachordal plates. Chondrification extends up the sides and over the roof of the cranial brain-cavity more or less completely. The skull acquires further strength and rigidity for the support of the visceral skeleton and the attachment of its muscles.

To protect and support the brain is one of the chief functions of the cranium. The brain in even the lowest known Craniate has made vast advances over that of *Amphioxus*. Into its minute histological structure it is not possible to enter in this book; some day, however, the results of a more complete knowledge of the disposition of its cells and fibres will doubtless be of the greatest importance in the study of phylogeny. The gross subdivisions into which the brain becomes differentiated are of no segmental significance. But attempts have been made to interpret local aggregations of cells, and certain transverse swellings and constrictions of the neural tube, which appear at a very early stage in ontogeny, as true neural segments or neuromeres (Hoffmann [216], Orr, McClure, Locy [284], von Kupffer [275], Neal [308a], Johnston [248a], and others). The observations are somewhat uncertain and contradictory, and these neuromeres do not appear to correspond exactly with the other evidences of segmentation. The subject is too unripe for treatment here; but it may be stated that if the evidence of the neuromeres is to be trusted, there would appear to be three segments in front of the segmented mesoblast, of which all other trace has been lost.

The embryonic brain of the Craniate is subdivided into primary fore-brain, mid-brain, and hind-brain.

Later on the hind-brain forms a posterior myelencephalon or medulla oblongata, and an anterior metencephalon, giving rise above to the cerebellum (Figs. 7, 8, 9, and 10). The hind-brain is

<sup>1</sup> Authors differ on this debatable point. Some place the anterior end of the brain at the infundibulum, others at the edge of the neuropore. Johnston [248a] believes it to lie at a point just behind the anterior commissure, and in front of the optic recess and chiasma.

the least modified part; it resembles the spinal cord most closely in histological structure, and from it emerge all the cranial nerves to which a segmental value is usually attached, except the oculomotor and pathetic. It always retains a considerable cavity, metacoele or 4th ventricle. Its roof is never entirely nervous, and forms a vascular membrane, the choroid plexus. The roof of the metencephalon becomes thickened as the cerebellum, which acquires a

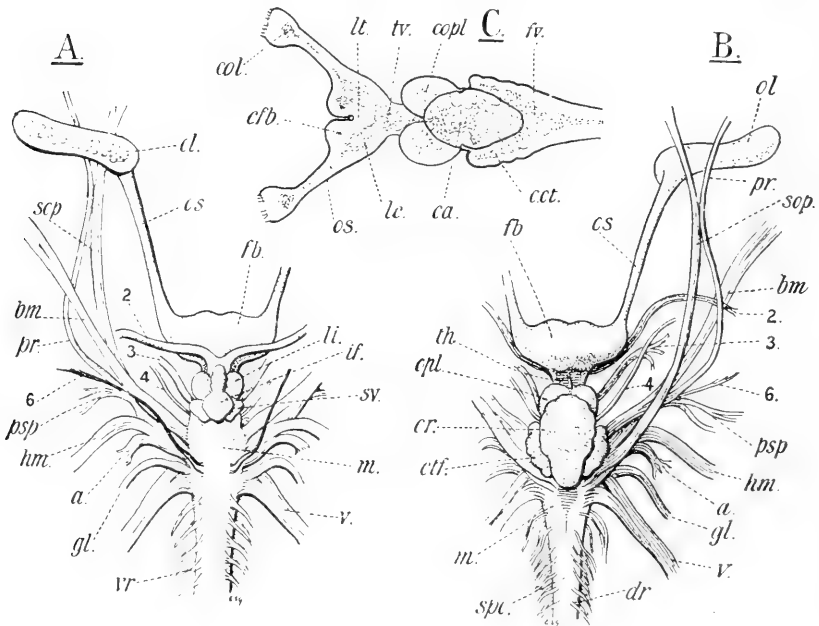

FIG. 7.

Ventral view (A) and dorsal view (B) of the brain of *Raju batis*. Dorsal view (C) of the brain of *Acanthias vulgaris*, showing the internal cavities shaded. *a*, auditory nerve; *bm*, buccal nerve; *ca*, cavity of mid-brain; *cet*, lateral cavity of corpus restiforme; *c.fb*, cavity of fore-brain, "cerebral hemisphere"; *c.ol*, cavity of olfactory lobe; *c.op.l*, cavity of optic lobe; *cr*, cerebellum; *ctf*, corpora restiformia; *d.r*, dorsal root of spinal nerve; *f.b*, fore-brain (prosencephalon); *f.v*, fourth ventricle; *gl*, glossopharyngeal nerve; *hm*, hyomandibular nerve; *if*, infundibulum; *l.c*, lateral cavity; *os*, olfactory tract; *op.l*, optic lobe; *pr*, profundus nerve; *psp*, prespiracular branches of facial; *s.op*, superior ophthalmic branches of facial and trigeminal; *sp.c*, spinal cord; *s.v*, saccus vasculosus; *th*, diencephalon (thalamencephalon); *t.v*, third ventricle; *v*, vagus nerve; *v.r*, ventral root of spinal nerve.

large size and complicated structure in the higher Pisces and higher Tetrapoda. The mid-brain remains undivided. The cavity it encloses is known as the aqueductus of Sylvius, or mesocoele. Above and at the sides the wall thickens into the prominent optic lobes, from which pass fibres to the optic tract. Below, a bundle of fibres develops into the crura cerebri. From this mesencephalon issue the oculomotor and pathetic nerves.

From the primitive fore-brain are differentiated a posterior diencephalon (thalamencephalon) and an anterior secondary fore-

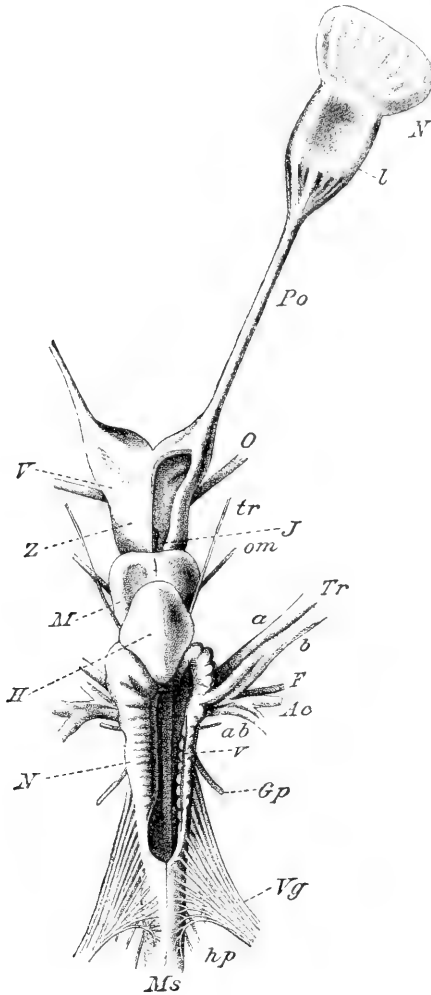

FIG. 8.

Dorsal view of the brain of *Heptanchus cinereus*. (From Gegenbaur, *Vergl. Anat. Wirbeltiere*.)  
*Ac*, auditory nerve; *F*, facial; *Gp*, glossopharyngeal; *H*, cerebellum; *M*, optic lobe; *Ms*, spinal cord; *N*, medulla, also nasal sac; *O*, optic nerve; *Po*, olfactory tract; *Tr*, trigeminal nerve; *V*, fore-brain; *Vg*, vagus nerve; *Z*, diencephalon; *a* and *b*, branches of facial and trigeminal; *ab*, abducens; *hp*, (hypoglossal) occipito-spinals; *l*, olfactory lobe; *om*, oculomotor; *v*, origin of vagus roots.

brain, the telencephalon. The diencephalon, bounded behind by the posterior commissure, is crossed above by the superior commissure

(habenular). Between these two tracts of fibres are the epiphysial outgrowths. At the anterior limit the thin non-nervous portions of the roof form a choroid plexus, sinking down behind the paraphysis, and projecting into the large 3rd ventricle as a velum transversum (permanent in the lower and transient in the higher forms). At the sides arise the optic thalami; above the ganglia habenulae. Below is the large infundibular downgrowth, with the optic chiasma and nerves immediately in front. The foremost division of the brain is that which undergoes the most conspicuous change in phylogenetic differentiation. Its hind limit above is marked by the commissura habenularis, and below by the recessus

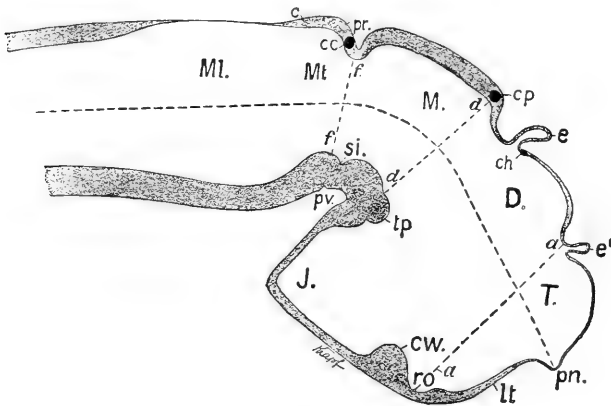

FIG. 9.

Diagram of the divisions of the brain. (After von Kupffer, from Hertwig's *Handbuch*.) *a, a, d, d, f, f,* limits between the regions; *Ml.*, myelencephalon; *Mt.*, metencephalon; *M.*, mesencephalon; *D.*, diencephalon; *T.*, telencephalon; *c.c.*, commissura cerebellaris; *c.h.*, commissura habenularis; *p.u.*, processus neuroporicus; *p.r.*, plica rhombo-mesencephalica; *p.v.*, plica encephali ventrali. Other letters as in Fig. 10.

opticus, marking the region from which develop the paired optic vesicles at a very early stage. In the middle line in front the wall forms the lamina terminalis, across which pass the anterior dorsal and ventral commissures. The thin roof projects upwards as the paraphysis (p. 25). This region between the recessus opticus and the lamina terminalis is the telencephalon. But the bulk of the secondary fore-brain becomes differentiated into large paired outgrowths, into which extends the 3rd ventricle. These are the cerebrum (prosencephalon) and the olfactory lobe (rhinencephalon). In the higher forms the thick-walled hollow outgrowths become very distinctly paired cerebral hemispheres passing far in front of the lamina terminalis. The corpus striatum is a thickening on their outer ventral wall. The communication of their cavities on either side with the median 3rd ventricle (prosocoele) narrows into

the foramen of Monro. The roof of the prosencephala becomes the pallium which acquires such an enormous development in the cerebral hemispheres of the highest Vertebrates. From the olfactory lobes issue the nerves to the olfactory epithelium. The great modifications in the shape and relative size of the different parts of the brain in the Craniata are, of course, the outward manifestations of the differentiation and orderly arrangement of the ganglion cells and nerve-fibres into an elaborate system of 'tracts' and 'nuclei,' which cannot be described in this volume. (Brain of Fishes: Burne [76], Burckhardt [70], Studnička [429], Johnston [249].)

A new paired cranial nerve of doubtful significance has recently

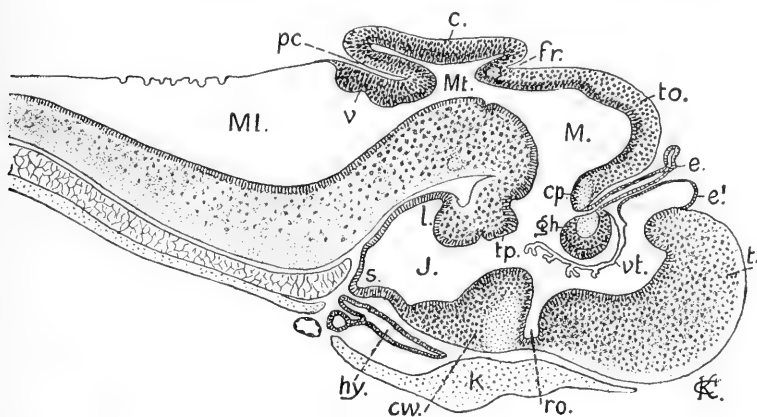

FIG. 10.

Longitudinal median section through the brain of an embryo *Spinax niger*. (After von Kuppfer, from Hertwig's *Handbuch*.) *C*, cerebellum; *c.p.*, posterior commissure; *cw.*, optic chiasma; *e.*, epiphysis; *e'*, paraphysis; *fr.*, rhombo-mesencephalic fissure; *sh.*, habenular ganglion and commissure; *hy.*, hypophysis; *K*, cartilaginous basis cranii; *J*, infundibulum; *l.*, lobus posterior; *M.*, mesencephalon; *Mt.*, myelencephalon; *Mt.*, metencephalon; *pc.*, plicæ cerebelli posterior; *ro.*, recessus opticus; *s.*, saccus infundibuli; *t.*, telencephalon; *to.*, tectum opticum; *tp.*, tuberculum posterius; *v.*, valvula cerebelli posterior; *vt.*, velum transversum.

been described in Elasmobranchs, *Amia*, and *Protopterus*: it is the nervus terminalis, which issues from the fore-brain near the olfactory nerve, bears a ganglion, and supplies the epithelium of the nasal sac (Pinkus [329], Allis [10], Locy [284a], Johnston [248a]). It may represent the dorsal root of the most anterior cephalic segment.

Further evidence concerning the segmentation of the head in Craniates may be gained from a study of the gill-slits and visceral arches (Gegenbaur, Koltzoff, etc.). The slits were probably primarily intersegmental; but their relation to the somites is not very close. They pierce the lateral plate of mesoderm to reach the exterior, and as they enlarge they are pushed backwards so as to

crush the segments behind. At the same time, the correspondence between myomery and branchiomery is to a great extent lost, though evident in the nerve-supply. As the row of slits bars the way to the downward growth of the myotomes, the latter have to pass round the hinder edge of the series to form the ventral hypoglossal musculature (Fig. 3). A cartilaginous visceral arch develops in front of the first or spiracular cleft, and behind this and each succeeding cleft. Related to each arch and cleft is a segmental branchial nerve and a blood-vascular arch.

The first or mandibular and the second or hyoid arch become closely connected with the skull in Gnathostomes; the mandibular arch bends over the mouth, and becomes subdivided into the primitive upper and lower jaws (Fig. 5). In the lips, in front and at the sides of the mouth, labial cartilages are often present in fish, which Gegenbaur considered to be remnants of preoral gill-arches. Huxley suggested that the trabeculae cranii represent gill-arches. But there is really no definite evidence that preoral gill-slits have ever existed, and it is difficult to see how they could have been functional. Gegenbaur subsequently abandoned this view [163], and inclined towards that of Pollard [333]. This author considered the labial cartilages to be remnants of a primitive system of cirrhi, such as are found in the Myxinoids, and which he compared with those of *Amphioxus*.

The nature of the mouth of Vertebrates is by no means easy to determine. Dohrn (1882) believed it to be a new mouth derived from a pair of anterior coalesced gill-slits [114]. Traces of the original mouth, the palaeostome, homologous with that of invertebrates, passing through the brain to open dorsally, were supposed by Kölliker to be represented by the hypophysis and the epiphysis. A less phantastic theory (Beard [33a] and von Kupffer [275]) is that the hypophysis represents the original mouth or palaeostome, which opened into the alimentary canal as it still does in Myxinoids (p. 46). This connection, however, appears to be secondary, and at present the most reasonable view seems to be that the ancestral vertebrate mouth has been retained, although it may have shifted its position backwards. It is possible that during this process of shifting some anterior gill-slits may have been obliterated, or combined with the mouth; but convincing evidence of this is missing.

The upper lip is formed in fish by the junction in the middle line below the snout of two upper-jaw processes (Fig. 117, p. 154); in the Tetrapoda these lateral processes combine with the median fronto-nasal process to complete the upper margin of the mouth.

We have briefly discussed above the subject of the segmentation of the head in the Craniates; but there is yet to be mentioned



another important method of describing the nervous system, taking account not so much of the segmental value of the nerves as of their peripheral destination and central connections. For this purpose, the sense-organs must first of all be considered.

Scattered sensory cells alone are found in the skin of *Amphioxus*, and small simple sense-organs on the buccal cirrhi. The Craniate vertebrates, on the other hand, especially the Gnathostomes, are provided on the outer surface of the body and on the inner surface of the alimentary canal with a network of free nerve-endings, and a variety of sense-organs the structure, distribution, and nerve-supply of which have been admirably worked out in the lower vertebrates by numerous anatomists, whose results are of considerable interest for the study of phylogeny (Schulze [391-2], Leydig [283], Strong [428], Allis [9, 10], Johnston [247-9], Herrick [210], Ewart [133, 134], Cole [82], and many others).

In all the lower aquatic Craniata we find an important series of sense-organs on the head and trunk constituting the 'lateral-line system' (Figs. 11, 85). Possibly they were primitively strictly metameric, as they are now in some fish; at all events, these sense-organs (neuromasts) have a definite distribution and nerve-supply, and become of great taxonomic value in the Gnathostomes. The less regularly arranged 'pit-organs,' ampullae, etc., of fish appear to be related to the lateral-line system. All the nerve-fibres derived from these lateral-line organs on the head enter the brain by the facial, glosso-pharyngeal, and vagus nerves (and probably the profundus also in *Petromyzon*). The lateral line of the trunk is supplied exclusively by the ramus lateralis vagi. Moreover, it has been shown to be extremely probable (Beard [31], Ayers [22]) that the ear and the auditory nerve represent a highly differentiated portion of the same system. The whole forms the 'acustico-lateral system,' whose nerve-fibres terminate centrally in the tuberculum acusticum of the medulla and associated centres.

That a cranial nerve, the vagus, should supply a series of sense-organs reaching to the tip of the tail strongly suggests that the lateral-line nerve is a collector, similar to the epibranchial nerve. Moreover, it has been observed (Alcock [7]) that in the branchial region of the larva of *Petromyzon* there are a series of lateral metameric groups of such organs, each supplied by a twig from the branchial nerve of its own segment (this needs confirmation). Evidence of a segmental origin may also be found in the development of the lateral-line organs in *Petromyzon*. The nervus lateralis vagi arises from a longitudinal thickening of the epiblast above the dorsal ganglia, which is continued on the head as a series of dorso-lateral 'placodes' contributing to the formation of the ganglia of the 9th, 7th, 5th, and profundus. Similar placodes occur in the lower Gnathostomes. On the other hand, the independence of the



ramus lateralis vagi (in the adult) from the spinal nerves, and the fact that in fish (Beard, Coilson) and in Amphibia (Harrison) the lateral-line rudiment grows from the head backwards in a most independent manner, have led most observers to believe that the organs have phylogenetically been derived from the head. It is a point still unsettled. The chief functions of the organs of the lateral-line system are probably equilibration and orientation.

The sensory free nerve-endings scattered over the skin are supplied by fibres belonging to the 'general cutaneous sensory system,' and entering the central nervous system by the 5th, 7th, 9th, and 10th cranial nerves, and by the succeeding dorsal roots of the spinal nerves. The fibres are related to the dorsal tracts of the spinal cord, and their prolongations in the medulla, including the tuberculum acusticum. It is conjectured that the acustico-lateral system is a specialised portion of this general cutaneous system.

The nerve-fibres of a similar 'general splanchnic sensory, or communis, system,' in the wall of the alimentary canal, enter the brain by the 7th, 9th, and 10th cranial nerves and by the sympathetic fibres in the dorsal spinal nerves, and terminate in Clarke's column, the fasciculus communis, the lobus vagi, and associated centres. To the same centres in the brain come the fibres from a system of gustatory 'end-bud organs,' or 'taste-buds,' distributed over the buccal and pharyngeal cavities, and also, in some fishes, spreading over the outer surface of the head and body. The nerves from this 'special splanchnic or end-bud sensory system' reach the brain by the 7th, the 9th, and the 10th cranial nerves. The end-bud system is supposed to have been differentiated from the splanchnic general sensory system. The taste-buds situated on the surface of the body on fins (Teleostei) would appear to have migrated from the endoderm; but the reverse may possibly have occurred.

To these four sensory systems must be added the 'somatic motor system,' communicating with their centres by the ventral roots; and the 'splanchnic motor system,' receiving fibres through the dorsal roots of the cranial and spinal nerves, and the sympathetic nerves, also from special central regions.

Thus, it has been shown that the nervous system of the Craniates can be subdivided into several distinct components, four sensory and two motor, each with its own type of 'end-organ,' its own set of nerve-fibres, and its own special nerve-centres (Strong [428], Herrick [210], Johnston [249]). It is further conjectured that the 'general cutaneous' and 'splanchnic' sensory systems, with their more specialised derivatives, and the motor systems, may each have originally been represented in every segment of the body.

The size of nerve components in a given region is proportional

to the development of the 'end-organs' they supply. Some systems may increase in importance; others may dwindle or disappear altogether. Thus, the splanchnic components, so small in the spinal nerves, are much developed in the head-region; the acustico-lateral system, so extensive in the fish, survives only in the ear of the land vertebrate.

We may now briefly analyse the nerves of a fish into their chief components (Fig. 12). A typical spinal nerve is formed by the junction of a dorsal ganglionated root, containing a large general

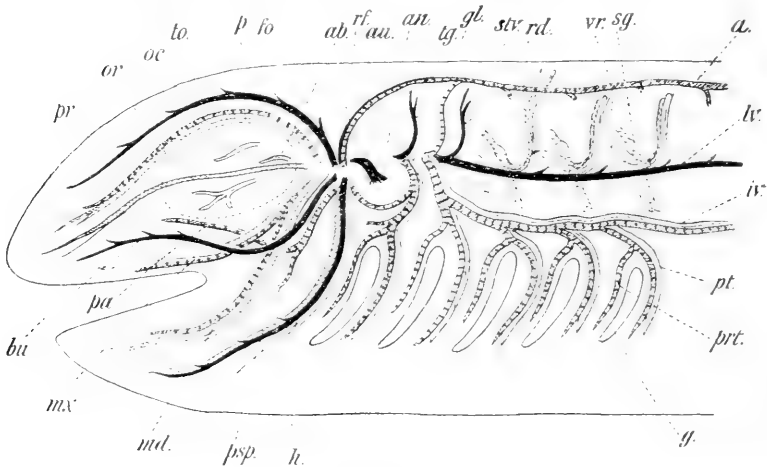

FIG. 12.

Diagram of the nerve-components in the head-region of a fish (chiefly after the figures of Herrick). *a*, ramus lateralis accessorius (r. recurrens facialis, *r*, acc. vagi); *ab*, abducens (6); *an*, anastomosis between facial and glossopharyngeal; *av*, auditorius (8); *ba*, r. buccalis (7); *fo*, r. ophthalmicus superficialis (7); *g*, branchial slit; *gl*, glossopharyngeus (9); *h*, r. hyomandibularis (7); *iv*, r. intestinalis (10); *lv*, r. lateralis (10); *md*, r. mandibularis (5); *ma*, r. maxillaris (5); *or*, motor oculi (3); *oc*, outline of orbit; *p*, patheticus (4); *pa*, r. palatinus (7); *ps*, profundus; *prt*, r. pretrematicus (10); *psp*, r. pretrematicus (7); *pt*, r. post-trematicus (10); *rd*, r. dorsalis; *rf*, r. recurrens (7); *sg*, spinal ganglion; *str*, r. supratemporalis (10); *to*, r. supratemporalis (9); *to*, r. ophthalmicus superficialis (5); *vr*, ventral root of spinal nerve. Between the vagus and the first spinal nerve are some spino-occipital nerves (ventral roots). The numbers refer to the cranial nerves. For the explanation of the components see Fig. 106, p. 222.

cutaneous component and a small splanchnic motor and sensory component, with a ventral root of somatic motor fibres. The mixed nerve branches, so that the general cutaneous and the somatic motor nerve-fibres are distributed along three main trunks, the ramus dorsalis, ramus medius, and ramus ventralis, to the dorsal fin muscles, dorsal somatic and ventral somatic muscles respectively, and to the corresponding regions of the skin. The paired fins are supplied from branches of the rami ventrales. The splanchnic components pass into the sympathetic system by the ventral ramus communicans.

In the vagus nerve the general cutaneous fibres compose the rami cutanei dorsales passing upwards behind the skull; the large acustico-lateralis component forms the ramus lateralis vagi, and a small ramus supratemporalis. The branchial nerves are chiefly formed by the splanchnic or visceral sensory component, and some splanchnic motor fibres, which pass into the post-trematic branches to innervate the branchial muscles; an intestinal and several pharyngeal mixed branches, with splanchnic sensory and motor components, pass inwards to the alimentary canal. The pharyngeal taste-buds are also supplied by the branchial nerves.

The glossopharyngeal nerve has a complete set of components distributed in much the same way. The lateralis branch, however, is small or absent.

The facialis nerve, which is very intimately connected with the trigeminus, has a dorsal ramus oticus, a supraorbital ramus ophthalmicus superior, and an infraorbital ramus buccalis composed of general cutaneous and acustico-lateralis elements distributed in the skin. A large mixed ventral hyomandibular trunk gives off cutaneous acustico-lateralis and splanchnic motor fibres passing behind the spiracular cleft to the hyoid region and lower jaw; and an internal branch, ramus palatinus, carries most of the splanchnic sensory component to the roof of the mouth. Jacobson's anastomosis of splanchnic sensory fibres generally unites the facial (geniculate) ganglion with the jugular ganglion of the glossopharyngeal. The auditory nerve represents a specialised portion of the acustico-lateralis component.

The trigeminus nerve divides into a supraorbital branch, the ramus ophthalmicus superior, and an infraorbital ramus maxillaris, both composed of general cutaneous fibres; and a mixed ramus mandibularis with a splanchnic motor component as well. The ophthalmicus profundus nerve belongs, as a rule, to the general cutaneous system.

The three nerves to the eye-muscles represent the somatic motor components corresponding to the three last nerves.

It is unnecessary here to enter into a detailed description of the paired organs of sense. In front are found the olfactory sacs: invaginations of the ectoderm which retain their opening to the exterior, the primitive nostrils. Next come the lateral eyes, organs of very complex structure, derived partly from an outgrowth of the fore-brain (p. 16), partly from an ingrowth of the outer ectoderm (lens). Lastly, the auditory organ (concerned with equilibration as well as hearing) is developed from a more posterior invagination of the ectoderm (Fig. 13) forming a deep sac, which remains in communication with the exterior by a narrow ductus endolymphaticus in the adult in the case of some Elasmobranch fish only. By a

complicated folding of this sac are elaborated a sacculus and utriculus, from which spring two vertical and one horizontal semicircular canals in all Craniata excepting the Cyclostomes.

The relation these organs of special sense bear to their respective cartilaginous capsules, and their influence on the process of

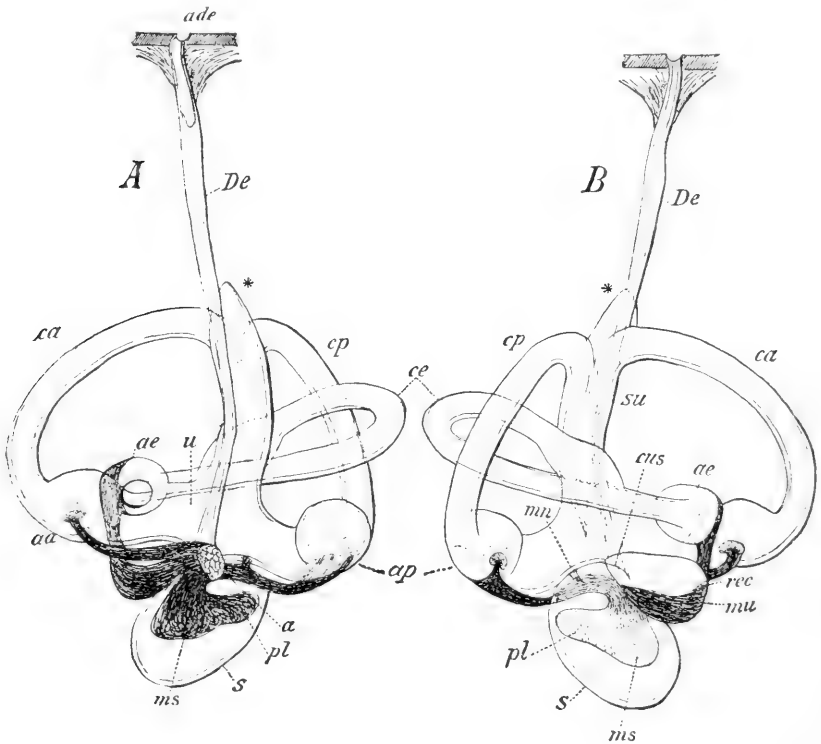

FIG. 13.

Auditory labyrinth of *Chimæra monstrosa*, L. A, inner view; B, outer view. (After Retzius, from Gegenbaur, *Vergl. Anat. Wirbeltiere*.) *a*, auditory nerve; *aa*, *ap*, *ae*, ampullae; *ade*, opening of ductus; *ca*, *cp*, *ce*, anterior, posterior, and horizontal semicircular canal; *c.u.s.*, canalis utriculo-sacculus; *De*, ductus endolymphaticus; *m.n.*, macula neglecta; *m.s.*, macula sacculi; *m.n.*, macula utriculi; *pl*, process of macula sacculi; *rec*, recessus utriculi; *s*, sacculus; *su*, sinus utriculi; *u*, utriculus.

cephalisation, has already been alluded to above (p. 2). No homologues of these organs have been found in the Cephalochorda.

Yet another organ of sense remains to be noticed—the pineal eye. Although it may not have a claim to the all-important function attributed to it by Descartes, the pineal eye, or epiphysis, is of considerable interest. Leydig in 1874 described it as a sense-organ; but De Graaf and Spencer, in 1886, were the first to demon-

strate its real significance as an eye, with both retina and lens, in the Reptilia.

It has now been ascertained that there are two organs developed on the roof of the diencephalon (thalamencephalon); they take up a median position: the pineal behind, the parapineal or parietal in front. In *Petromyzon* both are present, growing out as hollow processes expanding into an eye-like vesicle distally, the pineal, however, being more fully differentiated than the parapineal. The stalk of the former contains nerve-fibres passing to the posterior and habenular commissure, that of the latter fibres going to the habenular commissure (Fig. 14). In all other living Craniata the pineal organ is in a more or less degenerate condition and the

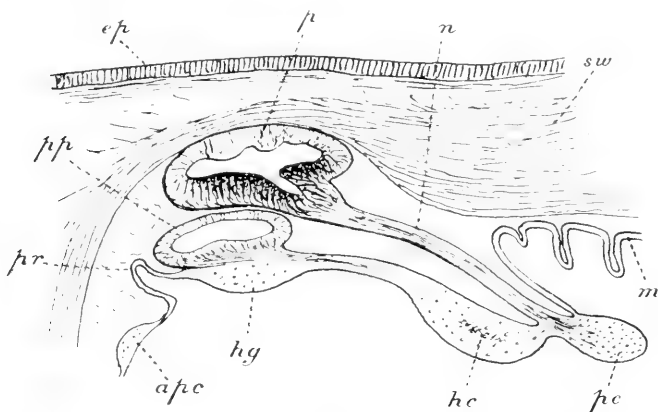

FIG. 14.

Longitudinal section of the pineal and parapineal organs of the larva of *Petromyzon*, enlarged (from the figures of Studnička). *ap.c.*: anterior dorsal commissure; *ep*, epidermis; *h.c.*, habenular commissure; *h.g.*, habenular ganglion; *m*, roof of mid-brain; *n*, nerve; *p*, pineal eye; *pp*, parapineal eye; *pr*, paraphysis.

parapineal is quite vestigial, with the exception of the Reptilia, in which it is occasionally found in a highly developed state, with lens and retina (De Graaf [181], Spencer [412], Béraneck [35*a*], Studnička [430]).

According to Hill and Dendy, there is reason to believe that the dorsal eyes are of paired origin—the parapineal being the left, and the pineal the right, each connected with the habenular ganglion of its own side—a conclusion which is supported by embryological evidence (Dendy [112], Cameron [77], Hill [213*a*]).

The epidermis of the Craniates, unlike that of *Amphioxus*, is formed of many layers of cells continually being renewed from the lowermost Malpighian stratum.

The alimentary canal behind the pharynx becomes differentiated

into an oesophagus, a stomach, and an intestine opening to the exterior by the anus. From the front end of the intestinal region develop glandular outgrowths, the pancreas and the liver. The latter is always a much more complicated structure than the hepatic diverticulum in the Cephalochorda, the lumen of the gland being much subdivided by the formation of an elaborate and compact system of tubules. A specialised sacculation of the duct, the gall-bladder, is present for storing the bile.

The ventral mesentery is always incomplete, remnants persisting in front and behind. A dorsal mesentery (also generally incomplete) supports the alimentary canal, which hangs in the body-cavity. This cavity is continuous, all trace of segmentation having disappeared in the abdominal coelom. In the embryo it is in open communication with the coelom of the branchial segments; but later a septum is developed cutting off, completely as a rule, an anterior cavity surrounding the heart—the pericardium. Abdominal pores, opening from the coelom to the exterior near the anus, are often found in fish, and occasionally in reptiles (Bridge [53], Bles [36]).

A ventral subintestinal vein in which the blood flows forward; an anterior prolongation of this vessel in the gill-region (the ventral aorta); a dorsal aorta, below the notochord, in which the blood flows backward; a system of aortic arches carrying the blood from the ventral to the dorsal aorta through the gill-arches; a longitudinal latero-dorsal cardinal vein on each side in which the blood converges towards a transverse ductus Cuvieri joining the subintestinal vein—these are the chief trunks found in the vascular system of *Amphioxus* (Legros [279a], Zarnick [511]), and the embryo of all Craniates. In the structure of their blood-vascular system the Craniata have again advanced far beyond the condition found in the Cephalochorda. Not only are the arterial and venous systems much more elaborately developed, especially the capillary networks in the gills, liver, and kidneys; but also the heart makes its appearance as a special chambered muscular pumping organ propelling venous blood through the ventral aorta into the gills. It develops as an enlargement of the ventral vein immediately in front of the junction of the ductus Cuvieri with the subintestinal vein.

The blood-vascular system may communicate, but only indirectly, with the coelom by means of the lymph-holding channels of the lymphatic system, which branch throughout the mesoblastic tissues. Fluid may pass into them through minute stomata in the coelomic epithelium, and be discharged into the blood-vascular system by a few special openings.

The blood itself consists of a colourless plasma, in which float leucocytes and red haemoglobinous cells or corpuscles.



Much more radical has been the change in the excretory system. No trace whatever of true nephridia, such as occur in *Amphioxus* (Weiss, Boveri, Goodrich [174]), have yet been discovered in any Craniate.

The kidney tubes of the Craniates are generally somewhat loosely compared to the nephridia or segmental organs of the Annelids (Gegenbaur, Semper [404], Hatschek, etc.). Now this comparison was first made at a time when the development of the renal organs of the vertebrates was incompletely known, and when both the structure and the ontogeny of the nephridia of Annelids were very imperfectly understood. Moreover, the theory was to some extent founded on observations which have since been shown to be erroneous. The question now wears a very different aspect (Goodrich [172]). Since then it has been ascertained that nephridia are found in almost all the invertebrate Coelomata, but that they may, or may not, be connected with the coelom; it has been shown that there occurs in these animals a second series of organs opening to the exterior—the genital funnels or coelomostomes, which develop from the wall of the genital or coelomic sacs; further, the excretory organs of *Amphioxus* are now known to be certainly homologous with the nephridia of Annelids [174]. It is therefore quite clear that if the kidney tubes of the Craniata are to be compared to any organ in the Invertebrata, it is with the coelomostomes, and not with the nephridia, that they must be homologised. Should Boveri's suggestion, that the genital pouches of *Amphioxus* represent the kidney tubes of the Craniates, prove to be true, it will be a striking confirmation of this conclusion.

The excretory system of the Craniates is founded on a series of paired segmental funnels and tubules derived, directly or indirectly, from the coelomic epithelium, and leading into a longitudinal connecting duct which opens to the exterior behind the anus. No Craniate is known in which these tubules open independently to the exterior, but it is reasonably conjectured that such must have been the original state of things. The renal tubes develop from before backwards. The earlier and more anterior become first functional, and are succeeded by the more posterior. Thus, the earliest set of tubes to appear occupy the pericardial region immediately behind the gill-slits, and form the pronephros. These subsequently become functionally replaced by the more posterior mesonephros of the abdominal region. Finally, in the Amniota, a separate and more posterior set of tubes, the metanephros, alone persist as the adult kidney. A more detailed account of the structure and development of these organs will be given later (p. 83).

There can be little doubt that originally some or all of these tubes carried the genital products to the exterior, and this function is still retained by the mesonephric tubes in the male sex of all

Craniata, excepting the Cyclostomes. In the female sex are generally found opening into the coelom a pair of oviducts, the homology of which is still uncertain. They appear to be as a rule connected with, if not derived from, the pronephric tubules in development (p. 89).

As for the gonads themselves, they are originally paired organs extending along the dorsal wall of the abdominal coelom into which they hang, and from the epithelium of which they develop. They form, in the embryo, two longitudinal genital ridges situated near the base of the mesentery; when the gonad is single in the adult, this is due to the fusion of the two rudiments, or to the suppression of one. Only doubtful traces of metamerism have been described in the gonads of the Craniata.

From what has been mentioned above it is obvious that many important characters, such as the possession of the paired sense-organs, the extreme cephalisation of the head segments, the structure of the skeleton, brain, heart, liver, kidneys, and gonads, distinguish the Craniata from the Cephalochorda. They appear to have been fully developed in the early common ancestor of the Craniata (there is perhaps some doubt about the paired olfactory organ, see p. 39), and these characters clearly demonstrate that the Craniata must have travelled a long way from their common starting-point with the Cephalochorda, and must have passed through a long series of intermediate forms of which we have now no trace, before they began to diverge into the various groups included in our modern classifications of the subphylum.

Two diverging branches from the Craniate stock are represented at the present day, the Cyclostomata and the Gnathostomata.

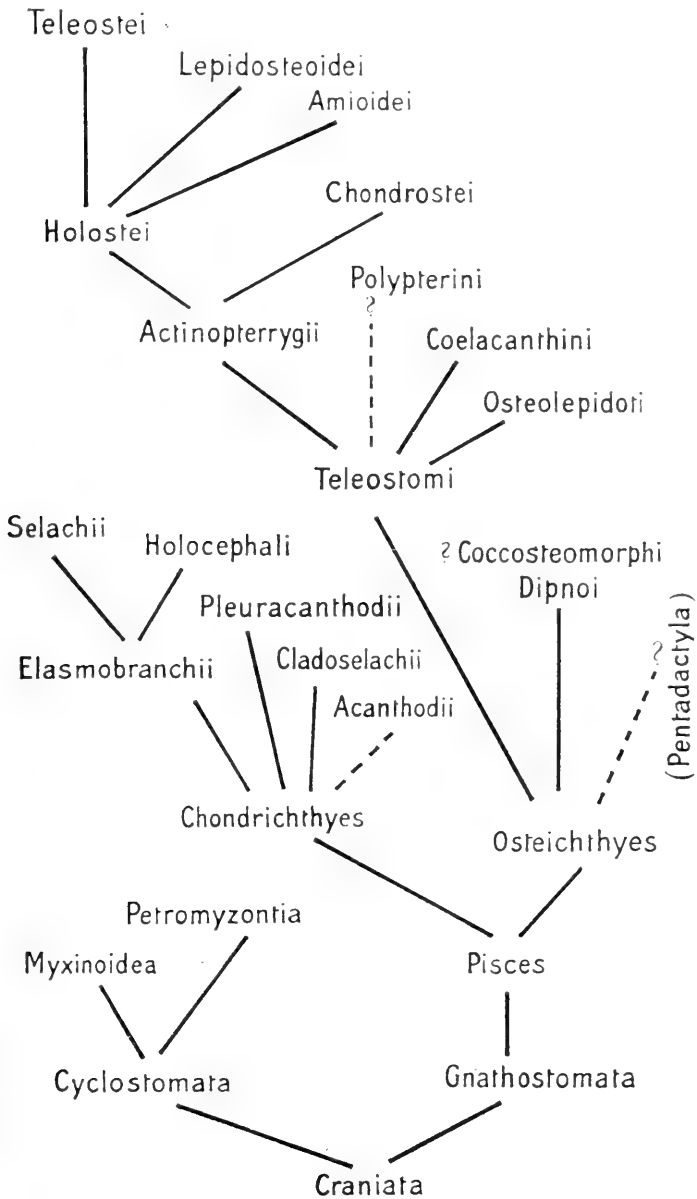

DIAGRAM I.—PHYLOGENY OF THE VERTEBRATA CRANIATA.  
The Ostracodermi have been omitted from this diagram.

## Branch I. and Class CYCLOSTOMATA.

THE Cyclostomes are the lowest of existing Craniates. They form a small group of marine and freshwater animals, widely distributed, but containing comparatively few genera and species. Like most isolated remnants of ancient stocks, the surviving members are very specialised, and they appear to be also somewhat degenerate. This, together with the absence of palaeontological evidence, renders the interpretation of their structure very difficult.

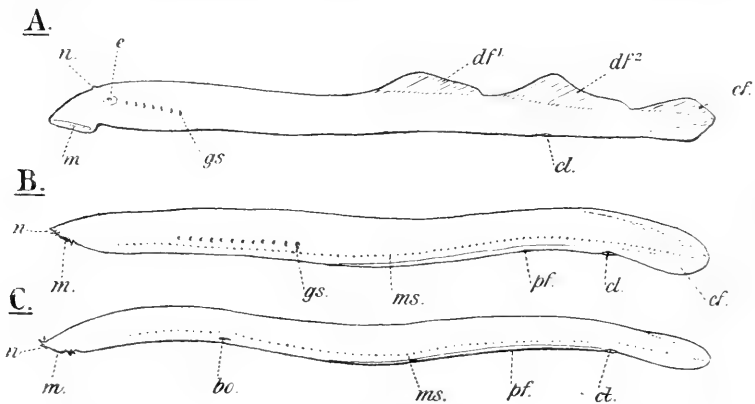

FIG. 15.

A, *Petromyzon fluviatilis*, L., the river Lamprey or Lampern. B, *Bdellostoma Dombeyi*, Lac. C, *Myxine glutinosa*, L., the Hag-fish. *b.o.*, branchial opening; *cf.*, caudal fin; *cl.*, cloacal aperture; *df<sup>1</sup>* and *df<sup>2</sup>*, first and second dorsal fin; *e.*, eye; *gs.*, gill-slit; *m.*, mouth; *ms.*, mucous sac; *n.*, nostril; *pf.*, preanal fin.

To Johannes Müller we are indebted for an excellent account of the anatomy of the Cyclostomes [306]; many important additions have been made by Fürbringer [144], Parker [322], Schneider [389], Dohrn [114*a*, 116, 117], Cole [83], and numerous other authors.

The body is elongated and eel-like in shape, with an anterior, almost terminal, mouth, and a median dorsal and ventral fin-fold continuous round the tip of the tail (Fig. 15). No biting jaws are present; but from the floor of the buccal cavity protrudes a so-called tongue, which is worked backwards and forwards so as to rasp the

flesh of the prey, and draw it into the alimentary canal. There are no paired fins or girdles. The skin is very slimy.

No dermal skeleton whatever is present; but the mouth and

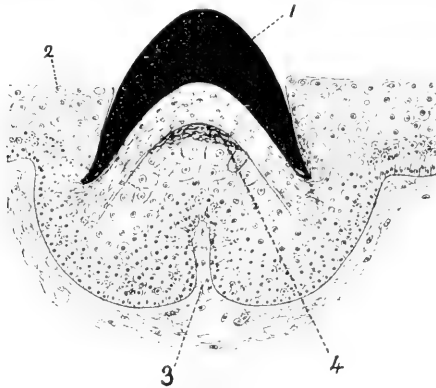

FIG. 16.

Section of developing teeth of *Petromyzon marinus*, L. (After Warren, *Q.J.M.S.*) 1, functional epidermal tooth; 2, epidermis; 3, dermal nutritive papilla; 4, successional tooth beginning to cornify.

'tongue' are provided with large horny teeth of cornified epidermis. The conical horny teeth when worn out are replaced by new cones from below (Warren [480*a*], Beard [34] (Figs. 16 and 17)). The lateral-line organs lie superficially exposed, on the head and trunk, not sunk in a canal. A continuous, persistent, and unstricted notochord extends from the infundibular region to near the end of the tail. It secretes two sheaths: an outer thin elastica externa, and an inner thick fibrous sheath without cells (Fig. 36).

The purely cartilaginous mesoblastic skeleton is in a very rudimentary condition, and is more developed in the lampreys than in the hag-fishes. The cartilage is of peculiar and variable structure, with relatively little matrix, Schaffer [382]. The axial skeleton in the Petromyzontia (not in Myxinoids) consists of a dorsal series of paired neural arches, and of somewhat irregularly developed interneural arches. These cartilages do not meet over the neural canal in the trunk-region, and alternate with the nerve-roots. Schauinsland [384] considers that the anterior cartilage corresponds to the intercalary (interneural or interdorsal) of higher

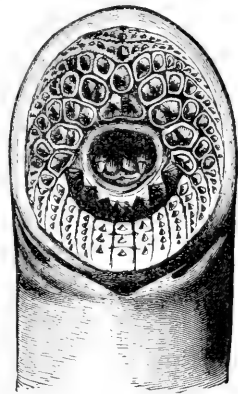

FIG. 17.

*Petromyzon marinus*. View of the oral sucker, horny teeth, and mouth. (After Heckel and Kner, from Gegenbaur, *Vergl. Anat.*)

forms, and the posterior cartilage to the neural arch (basidorsal) (Fig. 18). In the tail-region the arches are very irregular and small, and finally disappear. In Myxinoids, where there are no such arches, a continuous plate encloses both the notochord and the nerve-chord posteriorly (Fig. 19). The median fin is continuous, or in lampreys an anterior fin becomes separated off. In all Cyclostomes the fin-web is supported by slender median rods of cartilage (Figs. 19 and 28), separate from each other in front, but fusing at their base behind, and then towards the tip of the tail with the plate mentioned above in the Myxinoids. These rods or 'spines' may branch, are several times as numerous as the segments they

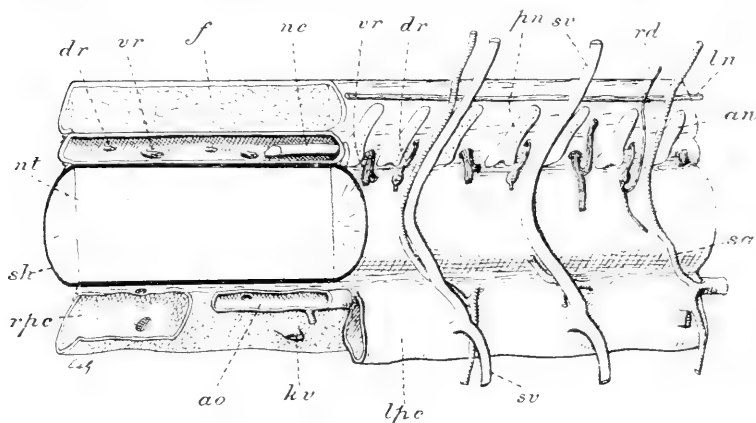

FIG. 18.

*Petromyzon marinus*, L. Left-side view of a portion of the notochord and neighbouring organs; the left half has been removed by a median longitudinal section in the anterior region. *an*, anterior arch (interdorsal?); *ao*, dorsal aorta; *d.r.*, dorsal nerve-root; *f*, fatty tissue; *k.v.*, kidney vein; *l.n.*, lateral-line nerve; *l.p.c.*, left posterior cardinal vein; *n.c.*, nerve-chord; *nt*, notochord; *pn*, posterior arch (basidorsal?); *r.d.*, ramus dorsalis; *r.p.c.*, right posterior cardinal; *s.a.*, segmental artery; *sh*, notochordal sheath; *s.v.*, segmental vein; *v.r.*, ventral nerve-root.

occupy, and are continued round the end of the tail to the ventral region, where they develop in the same way and support the ventral fin. Since the dorsal rods reach proximally to the connective-tissue tube surrounding the nerve-cord, and even join together at their bases and (in Myxinoids) with the axial plate, they should probably be considered as forming part of the axial skeleton, as, in fact, prolonged neural spines. If this view be correct, there is no special appendicular or fin-skeleton in the Cyclostomes (see p. 69).

In the Petromyzontia the brain-case is partly membranous, especially above, being bridged over dorsally only between the auditory capsules (Fig. 20). These capsules alone are firmly fused to the cranium; the optic capsules are, of course, free, and the nasal capsules are attached by connective tissue. The floor of the skull is formed by the united parachordals. This plate is continuous

with the trabeculae, which surround a basicranial fontanelle. It is through this aperture that the large pituitary sac passes downwards and backwards from above to expand below the brain-case. The trabeculae fuse in front below the pituitary sac, expand into a wide plate, and become continuous with a lateral subocular arch passing downwards on either side and joining the parachordals behind. At the side, the arch sends down a styloid process ending below in a longitudinal cornual cartilage. In front, the trabecular plate is connected with a large median posterior dorsal plate, overhanging an anterior dorsal plate. These, together with lateral plates, cover and support the anterior buccal region in front of the nostril. The sucker surrounding the mouth, and armed

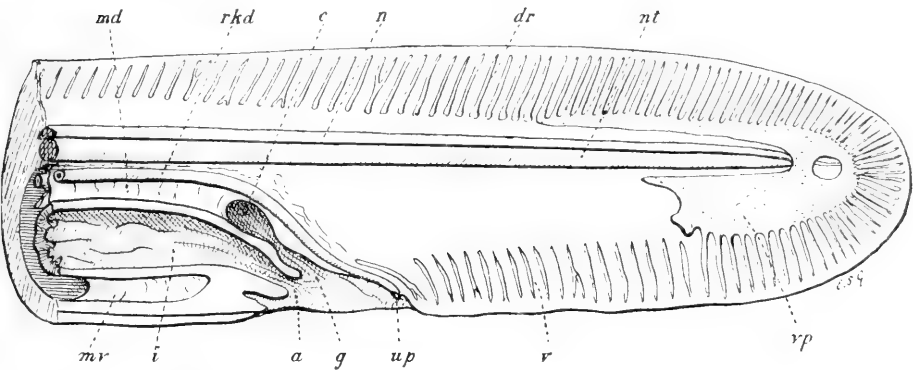

FIG. 19.

Tail of *Myxine glutinosa*, L., cut so as to show the skeleton and the opening of the intestine, etc.; left-side view. *a*, anus; *c*, gap behind mesentery leading from right to left coelomic cavities; *d.r.*, cartilage radials of dorsal median fin; *g*, median opening through which the genital cells escape; *i*, intestine; *m.d.*, dorsal mesentery; *m.v.*, ventral mesentery; *n*, notochord; *nt*, notochord; *r.k.d.*, left kidney duct; *u.p.*, urinary papilla; *r*, cartilage radials of ventral median fin; *v.p.*, cartilaginous plate.

with epidermal teeth, is strengthened with an annular cartilage, near which are placed a median ventral cartilage and a styloform cartilage on either side (Figs. 17, 20). The rasping 'tongue' itself is supported by large cartilages.

Behind the auditory capsule, the basal region of the cranium and the styloid processes are continuous with a complex network of cartilaginous bars situated in the wall of the pharynx, surrounding the gill-slits, and enclosing the pericardium itself. This is the 'branchial basket' (Fig. 20).

In the Myxinoidea, both the roof and the side-walls of the brain-case are membranous (Figs. 21, 22, 23). The nasal organ is surrounded by an apparently median cartilaginous capsule, attached by two strips to the trabeculae. Cartilaginous rings, mostly incomplete, surround the long nasal tube. Between the





three paired bars in the wall of the pharynx behind the skull, two of which are continued above into that part of the lateral plate which corresponds to the styloid process of the lamprey, and one

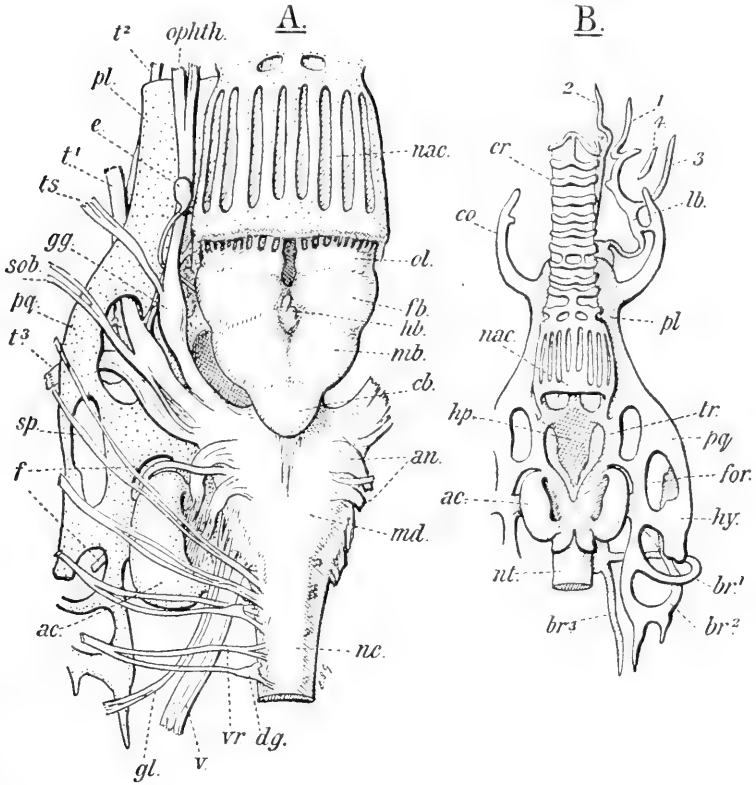

FIG. 21.

*Myxine glutinosa*, L. A, brain, nerves, and portion of the head skeleton (dotted). B, skeleton of the head, complete only on the right side. *a.c.*, auditory capsule; *a.n.*, auditory nerve; *br*<sup>1-3</sup>, branchial arches; *cb.*, cerebellum; *co.*, cornual cartilage; *cr.*, nasal ring cart.; *d.g.*, dorsal spinal ganglion; *e.*, eye; *f.*, facial nerve; *fb.*, forebrain; *for.*, foramen; *hb.*, habenular ganglion; *hp.*, hypophysial plate; *hy.*, 'hyoid' region; *g.g.*, gasserian ganglion; *gl.*, glossopharyngeal; *lb.*, labial cartilage; *mb.*, midbrain; *md.*, medulla; *na.c.*, nasal capsule; *n.c.*, nerve-cord; *nt.*, notochord; *ol.*, olfactory lobe; *ophth.*, ophthalmic branch of trigeminal nerve; *pl.*, 'palatine' and *pq.*, 'quadrate' regions; *sob.*, suborbital nerve; *sp.*, spinal nerve; *t*<sup>1-3</sup>, branches of trigeminal; *tr.*, trabecula cranii; *ts.*, preorbital sensory branch; *v.*, vagus nerve; *v.r.*, ventral root of spinal nerve; 1, 2, 3, 4, cartilages of the tentacles. For the nerves compare Figs. 22 and 25.

of which joins the cartilage of the 'tongue' below. Vestigial cartilages are also found near the branchial external openings, whether these are separate as in *Bdellostoma* or united as in *Myxine* (Figs. 23, 27).

The huge rasping organ is provided with a set of large anterior

and two small posterior cartilages, while a special plate supports the rows of horny teeth (Fig. 23).

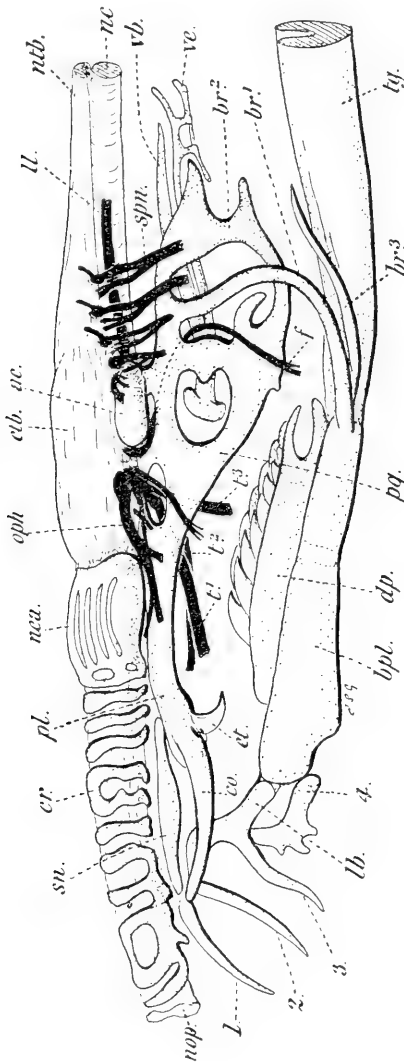

FIG. 22.

Left-side view of the skeleton of the head of *Thelostoma Fuscivittii*, M. (After Parker, and with the nerves added in.) *nc*, auditory capsule; *bpl*, basal plate of rasping 'tongue'; *br.1-3*, cartilages, probably representing three branchial arches; *cr*, cranial; *op*, nasal ring; *cb*, membranous brain-case; *dp*, plate bearing horny teeth; *et*, median 'ethmoid' tooth; *f*, facial nerve; *lb*, labial; *ll*, lacrimal; *nc*, notochord; *nca*, nasal capsule; *nop*, median nostril; *oatb*, neural tube; *oph*, superior ophthalmic branch of facial and trigeminal; *pl*, 'palatine' region, and *pqb*, 'quadrate' region of main subocular arch; *spm*, subbasal; *sp.1,2*, spinal nerve; *pl.1,2,3*, three branches of trigeminal nerve; *ty*, 'trigeminal' nerve; *ty*, 'tongue' cartilage cut short behind; *c.1,2,3,4*, cartilages of cirrhi. The cartilages are dotted.

Many attempts have been made to compare the skull and visceral skeleton of the Cyclostome with those of the Gnathostome; but none of these has proved very successful in detail. The com-

parison of the lateral cranial bars with the trabeculae, originally made by Agassiz [4], is doubtless well founded. Whilst Müller saw the mandibular arch represented in the subocular bar, and the hyoid in the styloid process, cornual, and median ventral styloid form cartilages, Huxley [229] considered the latter to be mandibular, and the lingual to belong to the hyoid arch. The annular and corresponding cartilages in *Myxine* are generally compared to the labials, and the subocular arch to the pterygo-quadrate. But branches of the trigeminal nerve pass below the subocular arch, not above as they should if this arch were homologous with the pterygo-quadrate bar (Figs. 20, 21, 22). It must be confessed that the exact homology of these cartilages is at present impossible to determine, and that many of them may be new formations in the Cyclostome head.

To understand the character of the head skeleton other systems must be taken into consideration. It has already been shown that in *Petromyzon* the first meta-otic somite, corresponding to the glossopharyngeal nerve, develops the first permanent myotome of the adult (p. 5). The muscles of the head are therefore less specialised than in other Craniates. Moreover, not only does the notochord extend fully into the base of the cranium, but there is no sort of articulation between the hind part of the skull and the anterior region of the vertebral column. More important still: whereas in all other

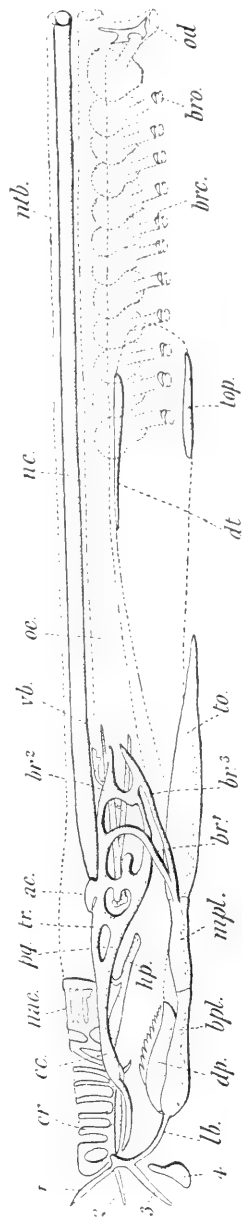

FIG. 23.

Skeleton of the anterior region of *Ichthyostoma Donabeyi*, Lac. (After Ayers and Jackson.) *ac*, auditory capsule; *b<sub>1</sub>pl*, basal-plate of resting organ; *br<sup>1,2,3</sup>*, first three branchial arches; *br<sup>c</sup>*, branchial cartilage; *br<sup>o</sup>*, cornual; *cc*, cranial; *cr*, cranial; *cp*, dental plate; *dd*, dorsal tongue; *dt*, cartilage; *dp*, hypophyseal plate; *lb*, labial; *m<sub>1</sub>pl*, middle plate; *nac*, nasal capsule; *nc*, notochord; *ntb*, notochord; *oc*, opening of first gill-pouch and of oesophageal duct; *oc*, oesophagus; *pb*, suborbital arch; *to*, tongue cartilage; *top*, posterior ventral tongue cartilage; *tr*, trabecular arch; *vb*, vetar skeleton; 1-4, cirrhi.

Craniata apertures for the 9th and 10th cranial nerves are included in the occipital region of the skull, in the Cyclostomata both these nerves pass out freely behind the auditory capsule, beyond which the cranium does not extend backwards. There is a considerable gap, in *Petromyzon*, between the auditory capsule and the large compound first neural arch through which also pass the combined ventral roots of the first three spinal nerves (Fig. 25).

Considerable controversy has taken place concerning the character of the branchial basket. It is often alleged that it is not homologous with the branchial arches of the Gnathostomes, since it lies in too superficial a position with regard to the muscles, nerves, and blood-vessels, and pharyngeal wall. For this reason also it is sometimes compared to the extrabranchials of Elasmobranchs. This objection is, however, unconvincing, for, although it is true that the ventral aorta lies internal to the basket, yet the relation of the cartilage to the vagus and spinal nerves, to the dorsal aorta, to the myotomes, and to some of the visceral muscles, is quite similar to that of a branchial arch. The proximity of the basket to the integument at the sides may be, to some extent, due to the peculiar development of the large sac-like gill-pouches (Fig. 35). Moreover, in Myxinoids the relative position of the three anterior deeply-set gill-bars is normal (Ayers and Jackson [25], Allis [17]). The branchial arches in both Cyclostomes and Gnathostomes are probably derived from the same structures (Dohrn [114<sup>a</sup>], Gaupp [152]).

The myotomes stretch uniformly from head to tail, bent in  $\Sigma$  shape (Fig. 28), and are not subdivided into dorsal and ventral halves by a horizontal septum as in Gnathostomes (Maurer [296]). They are interrupted by the row of gill-openings in the lamprey and are prolonged forward over the face above and below the eye.

An elaborate system of large muscles works the rasping 'tongue.' Since they are supplied by branches of the 5th cranial nerve (Fig. 20), it may be concluded that they represent the visceral muscles of the mandibular region, and that the cartilages to which they are attached correspond to the lower part of the mandibular arch (Meckel's cartilage), and perhaps to the hyoid arch as well (Ayers and Jackson). Development supports the view that the 'tongue' cartilages correspond to the mandibular arch (Stockard).

Some of the more interesting points in the development of the muscles and nerves of the Cyclostomes have already been dealt with above (p. 5, etc.). The permanent separation of the ventral from the dorsal roots of the spinal nerves in the *Petromyzontia*, and their junction in *Myxinoidea*, is very difficult to explain ([341], Figs. 18, 20, 22). On the whole, it seems probable that the fusion of

the roots is secondary in the latter (Koltzoff [273]), and has taken place independently in the Gnathostomes. *Petromyzon*, where they are both separate and alternate, would then retain the primitive condition found in *Amphioxus*.

All the Cyclostomes differ fundamentally from the Gnathostomes in possessing a single median nostril. Probably the nasal organ of

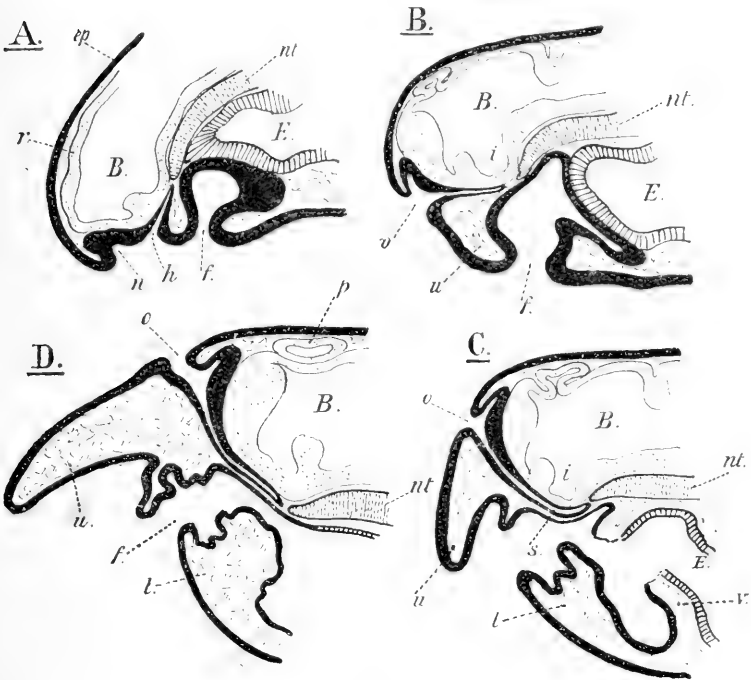

FIG. 24.

Median longitudinal sections of the head of four stages in the development of *Petromyzon*. A, the youngest, and D, the oldest stage. (After Dohrn.) *f*, opening leading to mouth; *h*, hypophysis; *i*, infundibulum; *l*, lower lip; *u*, nasal pit; *nt*, notochord; *o*, opening of nasal pit and hypophysis, future median nostril; *p*, pineal eye; *r*, roof of brain; *s*, hypophysial sac; *u*, upper lip; *v*, velum; *B*, cavity of brain; *E*, enteron.

the former was also originally paired (Scott), since the olfactory lobes and nerves are paired, and pierce the capsule by paired openings (Fig. 25). In the early embryo there is said to develop a single terminal olfactory (*l*) plate (von Kupffer [275]); this later becomes bilobed, probably incorporating two placodes, and gives rise to the olfactory epithelium. The olfactory pit becomes involved in the hypophysial invagination, is carried some distance back, and finally opens dorsally into the hypophysial or nasal canal (Fig. 24).

The external opening of the hypophysial sac is single and median, it forms the adult nostril, and it is perhaps chiefly owing to this confluence of the hypophysis with the nasal pits that the

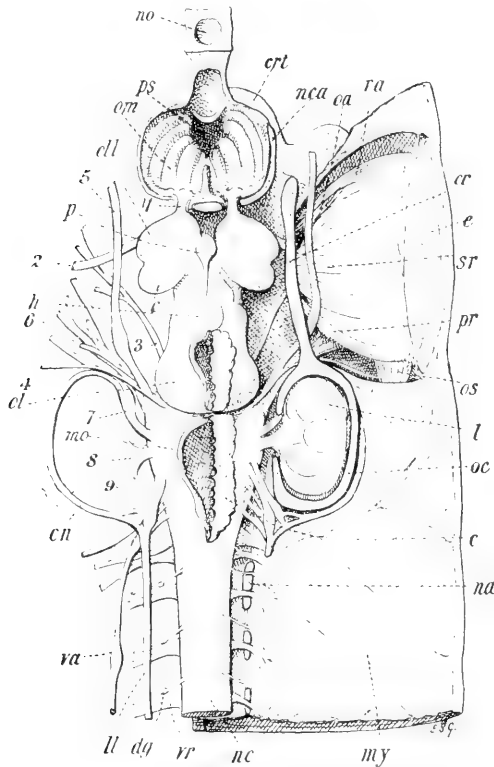

FIG. 25.

Head of *Petromyzon fluviatilis*, L., dissected; dorsal view. The brain and nerves have been exposed entirely on the left and partially on the right side; the eye, part of the skull, and muscles are retained on the right; and the nasal capsule has been opened in front. *c*, choroid plexus on roof of 4th ventricle; *ca*, connection between facial and glossopharyngeal and vagus nerves; *cr*, cranium; *crt*, anterior region of trabecula; *d.g.*, ganglion on dorsal spinal root; *e*, eye; *h*, habenular ganglia; *l*, labyrinth of ear exposed; *ll*, lateral-line nerve; *m.o.*, medulla oblongata; *my*, myotome; *na*, neural arch cut through; *nc*, spinal cord; *n.ca*, nasal capsule; *no*, nostril; *oa*, anterior oblique muscle; *oc*, auditory capsule; *ol*, optic lobe; *ol1*, olfactory lobe; *om*, olfactory fold; *os*, posterior oblique muscle; *p*, pineal eye; *pr*, posterior rectus; *ps*, opening to hypophysial sac; *ra*, anterior rectus; *sr*, superior rectus; *va*, vagus epibranchial nerve lifted up above the spinals; *vr*, ventral spinal root. 1-9 the first nine cranial nerves.

latter have come to acquire the appearance of a single median organ.

The hypophysial sac of the Cyclostomes is unique in that it persists in the adult opening separately and dorsally to the

mouth (Fig. 24). In the *Petromyzontia* it enlarges into a sac below the brain (Fig. 34); and in the *Myxinoidea* it actually opens backwards into the pharynx (Fig. 30), passing down between the trabeculae—thus piercing the basal plate from above.

The brain is very lowly organised (Ahlborn [5], Retzius [356], Johnston [247]). In *Petromyzon* the secondary-, fore-, mid-, and hind-brain all have large cavities and non-nervous roofs (Fig. 25), and do not overlap each other. The olfactory lobes are large, and closely applied to the remarkably small cerebral hemispheres, and the cerebellum is rudimentary. The mid-brain, on the contrary, is unusually large. There is but a rudiment of the saccus vasculosus. The epiphysial outgrowths consist of a pigmented pineal eye of elaborate structure in connection with the commissura habenularis, and of a smaller and simpler sac of the same nature below it, the parapineal organ, connected also with the posterior commissure (p. 24). In the larger superior vesicle not only does the outer wall become thickened into a clear cellular lens, but the inner wall develops into a pigmented retina of more perfect structure than that of the smaller inferior parapineal vesicle (Beard [33], Dendy [112], Studnička [430]). The skull wall thins out above these organs, which are separated from the exterior by a transparent corneal area (Fig. 14). In the *Myxinoidea* the pineal organs are less developed, and the brain is remarkable for the thickness of its walls, and reduction of the internal cavities (Fig. 141).

The first gill-cleft, the spiracular slit between the 3rd and 4th somites, is obliterated in the adult *Cyclostome* (Dohrn [114a], Dean [106]). The remaining branchial slits on each side are seven in number in the *Petromyzontia*, and from six to fourteen in number among the *Myxinoidea*. Since, in the *Gnathostomes*, the pairs of branchial slits rarely reach and never surpass the number seven, the question arises as to whether the *Cyclostomes* are more primitive in having a larger supply. At present, no definite answer can be given; but, as the number of slits in *Amphioxus* is very large, it seems probable that it may have been gradually reduced in the higher forms (p. 95).

The gills are distinguished by their spherical shape, being sac-like organs, lying to a great extent surrounded by a blood-sinus, and with gill-lamellae set all round the internal wall, scarcely interrupted above and below (Figs. 26, 27). The lining of the gill-sac is derived entirely from an endodermal outgrowth (Goette [169]). The gill-sac communicates externally by a narrow ectodermal duct, produced into a tube of considerable length in the Hag-fishes. A narrow internal aperture opens either directly into the pharynx, as in the *Myxinoidea* (Fig. 30), or into a sub-oesophageal tube in the *Petromyzontia* (Fig. 34). This branchial





tube in the lampreys. It is supported by a special cartilaginous skeleton, elaborately developed in the Myxinoïds (Figs. 30, 34).

The alimentary canal passes backwards in a straight course to the anus. The stomach is scarcely marked, and the long intestine has a slightly spiral "valve" in the *Petromyzontia*.

The liver is a large bilobed organ, provided with a gall-bladder. A pancreas, on the contrary, is scarcely differentiated, being apparently represented by small glandular tubes embedded in the liver.

The vascular system has advanced far beyond the condition found in the Cephalochorda, but still shows primitive characters (Müller [306], Goette [168], Klinckowström [267], Jackson [235], Vialleton [474]). Although large, asymmetrical, and three-chambered, the heart is not as completely twisted as in the higher vertebrates (Figs. 32, 34). The sinus venosus, passing across the pericardium from the dorsal to the ventral side, opens by a narrow neck into the large thin-walled atrium lying on the left side. This chamber opens into the more ventral ventricle by an aperture protected by two valves. Two valves are also placed at the entrance of the thick-walled ventricle into the swollen base of the ventral aorta, lying outside the pericardium.

Afferent vessels carry blood to the gills, and it is collected again into efferent vessels, which join a longitudinal dorsal aorta beginning very far forwards. Segmental somatic arteries are regularly supplied to the myotomes from the dorsal aorta; and a corresponding series of somatic veins empty into the cardinals. There is no renal-portal system. The kidneys are supplied with veins from the posterior cardinals and with arteries from the aorta (Figs. 18, 32).

In the early larva of *Petromyzon* we find paired anterior and posterior cardinals joining to paired ductus Cuvieri, paired inferior jugular veins outside the branchial basket, and a complete sub-intestinal vein (Goette [168], Cori [93], Julin, Dohrn). Soon this latter vein breaks up in the liver into the hepatic portal capillary system, its anterior portion forming the hepatic veins. The inferior jugulars are replaced by a median inferior jugular below the ventral aorta. This vein, and a ventral hepatic vein, are peculiar to the Cyclostomes (Fig. 18). The two anterior and also the posterior cardinals join above the oesophagus to large trunks, which open to the right into the dorsal limb of the sinus venosus. The ductus Cuvieri on the left side thus disappears, and all the venous blood pours into the heart on the right side. In the Myxinoïdea, strangely enough, it is the left ductus which persists, and the right ductus which is suppressed (Figs. 32, 34).

The pronephros nearly disappears in the adult Lamprey, but persists as an organ of considerable size in Myxinoïds (Fig. 27). It is, however, degenerate (Weldon [483], Semon [400], Kirkaldy [263a]), consisting of a few branching tubules, one of which is the one



hand into the pericardial coelom, and on the other into discontinuous remains of a longitudinal duct lying in a venous sinus. There is no communication with the kidney duct. Degenerate as this organ is, it is better developed in the Cyclostomes than in any known adult Craniate, excepting perhaps some aberrant Teleostei (p. 364).

The permanent functional kidney, or mesonephros, is represented by a single longitudinal duct on each side, into which open a number of tubules leading from closed renal capsules with glomeruli (Fig. 32). In all cases the tubules have lost their primitive openings into the abdominal coelom; in *Petromyzon* they do

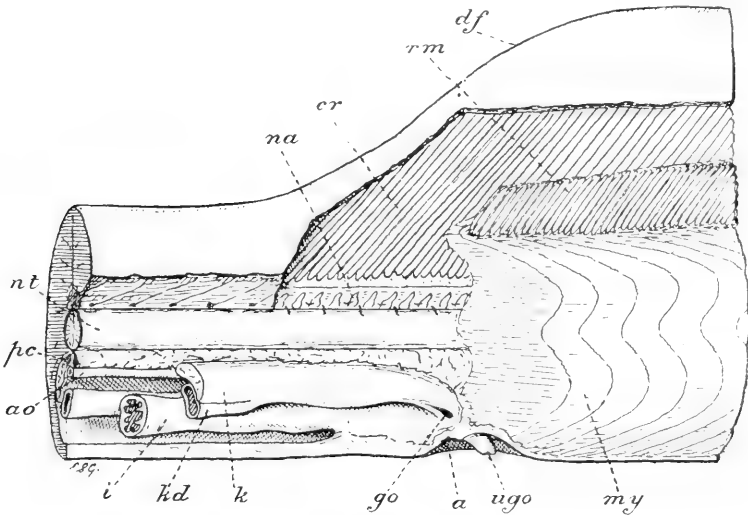

FIG. 28.

*Petromyzon marinus*, L. Left-side view of the trunk region near the base of the dorsal fin; the skin and muscles have been partially removed. *a*, anus; *ao*, dorsal aorta; *cr*, cartilage rays supporting fin; *df*, dorsal fin; *go*, left genital aperture into urinogenital sinus; *i*, intestine; *k*, mesonephros, and *kd*, its duct; *my*, myotome; *na*, neural arch; *nt*, notochord; *pc*, posterior cardinal vein; *rm*, radial muscles of fin; *ugo*, urinogenital opening on papilla.

not appear even during development (Wheeler [486]). While in the Lampreys the elongated kidney consists of crowded coiled tubules much more numerous than the segments of the body they occupy, in the Myxinoidea the tubules preserve their original metameric order (Müller [306]). In this character the Myxinoids appear to be more primitive than any other known Craniate (p. 82, where the morphology of the excretory organs is dealt with).

The right and left kidney ducts of the adult end behind in a common urinary sinus, which opens by a median papilla, placed in a narrow cloacal depression at the front end of which is the anus (Figs. 19, 28).

In *Petromyzon* the anterior wall of the sinus is pierced by a pair of genital apertures communicating with the abdominal coelom (Fig. 28). In the Myxinoidea, similar genital pores combine to open between the anus and the kidney opening (Fig. 19). The genital products in both sexes are shed into the coelom, and pass out through these pores (Burne [74]); there are no other special ducts, nor is there any communication between the testis and the kidney, as in the Gnathostomes. The exact morphological significance of the genital pores is unknown; since, however, the genital ducts may be occasionally reduced to very similar pores in the Teleostei (p. 365), it is not impossible that these pores in the Cyclostomes may be homologous with the Müllerian ducts of the Gnathostomes.

The Cyclostomata are classed in two very clearly differentiated Sub-Classes. No certain traces of fossil Cyclostomes have yet been found.

#### Sub-Class 1. MYXINOIDEA.

The Hag-fishes, Myxinoidea, are distinguished from the Petromyzontia by the following chief characters:—The single median nostril (Fig. 29) is terminal, or slightly ventral, and the nasal canal, strengthened by cartilaginous rings, is continued backwards below the brain into a pituitary sac, which opens into the pharynx by a secondary aperture pierced through in the late embryo (von Kupffer [275]). On either side of the nostril and mouth are four tentacles, supported by cartilages (Figs. 22, 23). They have plausibly been compared to the oral tentacles of *Amphioxus* (Pollard [333]). There is no toothed oral sucker, but a single large epidermal 'tooth' is placed below the 'ethmoid cartilage,' on the roof of the buccal cavity (Fig. 22). The 'tongue' is more highly developed. No neural arches are present in the trunk, the skull is more membranous, and the visceral skeleton, except in front near the skull, is reduced to mere vestiges near the external gill-openings (Figs. 23, 27). Owing, apparently, to the excessive size of the 'tongue,' the gills and heart are pushed very far back (Fig. 31). This migration of the branchial pouches behind the first three, which disappear *in situ*, occurs somewhat late in development (Dean [106]). Consequently the gill-openings are pierced between the dorsal and ventral somatic muscles, irrespective of their metameric order, when the gills reach their final position (the branchial nerves, of course, follow the gills). There is always on the left side a simple tube leading from the pharynx to the exterior, and opening in common with the last gill-pouch—it is the oesophageo-cutaneous duct, probably a modified gill-slit (Figs. 23, 27). The gills, in *Bdellostoma*, open independently to the outside, and there may be as many as fourteen pairs. But in *Myxine*, where there

are, as a rule, only six pairs, the elongated external ducts pass backwards, and open by a common pore on each side. The genus *Paramyxine* (Fig. 31) shows an admirably intermediate stage in the evolution of this secondary arrangement (Dean [110]).

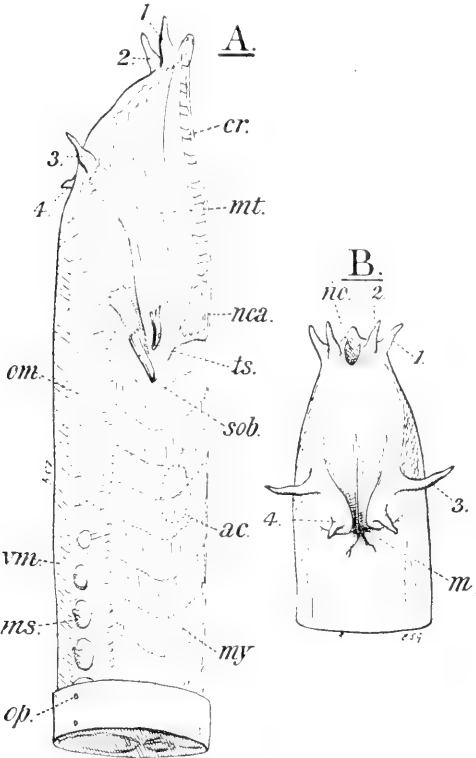

FIG. 29.

*Myxine glutinosa*, L. A, left-side view of the anterior end, from which the skin has been removed. B, ventral view of the head. *a.c.*, dotted line indicating position of auditory capsule; *c.r.*, cartilage ring of nasal tube; *m.*, mouth; *m.s.*, mucus sac; *m.t.*, muscles to tentacles and lip; *my*, myotome; *n.ca.*, nasal capsule; *no.*, median nostril; *a.m.*, oblique muscles; *op.*, opening of mucus sac; *sob.*, suborbital branch, and *ts.*, preorbital sensory branch of trigeminal nerve; *v.m.*, ventral muscles; 1, 2, 3, 4, tentacles.

The adult Myxinoids differ strangely from the Lampreys and the embryos of all other Craniates in that the afferent vessels pass to the gill-sacs themselves, and not between successive pairs to the gill-arches (Fig. 32).

The myomeres give rise to dorso-lateral and ventral longitudinal muscles, outside which extends a sheet of obliquely circular muscles (Fig. 29). The myotomes alternate from side to side as in *Amphioxus*.

The anterior region of the subintestinal vein seems to persist to

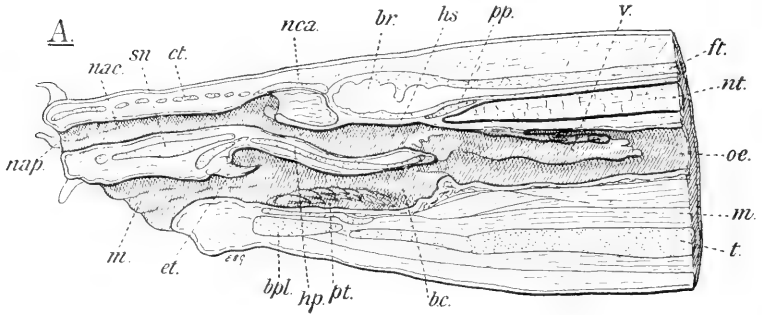

FIG. 30.

Median longitudinal section of the anterior region of *Bdellostoma Forsterii*, M. (Modified from Parker.) *b.c.*, buccal cavity; *b.pl.*, basal plate of 'tongue'; *br.*, brain; *ct.*, cartilage ring of nasal tube; *ct.*, median horny tooth; *ft.*, fatty tissue; *h.p.*, hypophysial plate; *h.s.*, hypophysial sac opening behind into pharynx; *m.*, mouth; *nac.*, nasal tube; *nap.*, median nostril; *n.ca.*, nasal capsule, with cavity divided by median septum; *nt.*, notochord; *oe.*, pharynx; *p.p.*, parachordal plate; *pt.*, rasping organ with horny teeth; *sn.*, subnasal cartilage; *t.*, cartilage of 'tongue'; *v.*, velum. The cartilages are dotted.

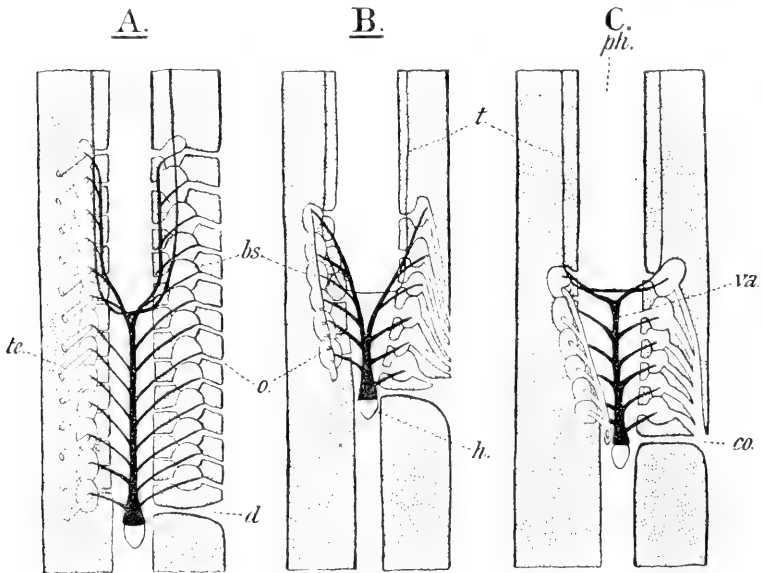

FIG. 31.

Diagram of the gills and their afferent blood system in A, *Bdellostoma (Homea stouti)*; B, *Paramyxine*; and C, *Myxine* (after Dean). Ventral view. *c.o.*, common opening of six gill-sacs and oesophageal duct; *b.s.*, gill-sac; *d.*, oesophageal duct; *h.*, heart; *o.*, external opening of gill-sac; *ph.*, pharynx; *t.*, outline of rasping 'tongue'; *t.c.*, tube leading to exterior; *v.a.*, ventral aorta.

a considerable extent in the adult as a vessel carrying blood from the intestine through the liver direct to the sinus venosus (Fig. 32).

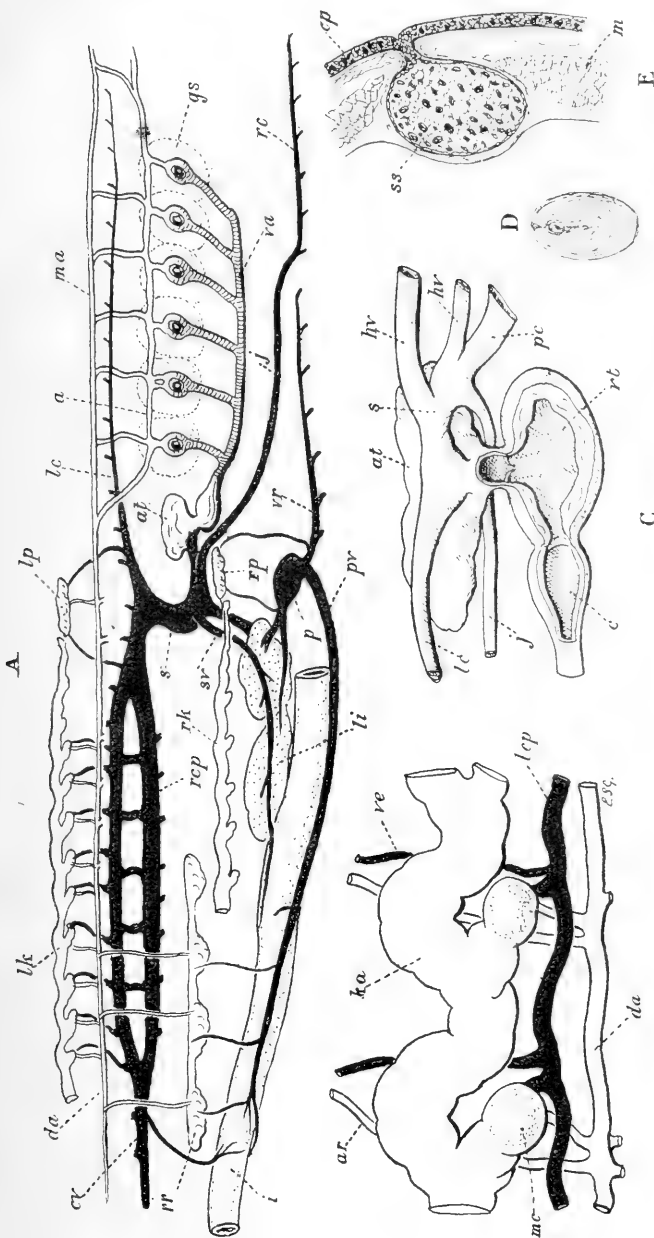

FIG. 32. A, diagram of the vascular system of *Bidulastoma* (from the figures of J. Muller, Jackson, and Klinekronström). B, piece of the kidney, and its blood supply, of *Bidulastoma donabekii*. Lac. C, heart of the same; the ventricle and conus have been opened (left-side view). D, thread-cell from mucous sac. E, transverse section of body-wall and mucous sac of *B. donabekii*. aa, paired anterior aorta; at, atrium; c, conus, separated by two valves from ventricle; cp, epidermis; ca, caudal vein; da, dorsal aorta; gs, gill-sac; hv, hepatic vein; i, intestine; j, jugular vein; kd, kidney duct; lc, left anterior cardinal; lc-p, left posterior cardinal; li, liver; lk, left kidney; lp, left pronephros; m, muscle; ma, median anterior aorta; mc, Mauthnerian capsule; p, portal heart; p-a, posterior cardinal; p-v, portal vein; r, right ovary; r-c, front end of right anterior cardinal; r-c-p, right posterior cardinal; r-k, right kidney; r-p, right pronephros; r-v, cavity of ventricle, separated by two valves from atrium; s, sinus venosus; ss, mucous sac; s-v, subintestinal vein; v-a, ventral aorta; v-r, hinder end of right anterior cardinal.

In addition, there is a supra-intestinal vein, which, joining an anterior vein derived from the right cardinal, swells into a pulsatile portal heart used for pumping blood into the liver (Figs. 27, 32). The liver is subdivided into two, separate lobes. The intestine shows no spiral valve.

The spacious pericardium surrounds the oesophagus, and remains in open communication with the abdominal coelom on the right side (Fig. 27). The tubules of the kidney are segmentally arranged (p. 87, Fig. 32).

The brain differs considerably in shape, and its ventricles are much reduced (Holm [217], Worthington [507a]). The vagus root has apparently fused with the glosso-pharyngeal. The dorsal roots of the spinal nerves join the ventral roots. The small degenerate eyes are sunk far below the skin; both the eye-muscles and their nerves disappear (Figs. 21, 22). Only one semicircular canal is present in the ear, probably representing the two vertical canals fused together, since there are two ampullae (Fig. 33).

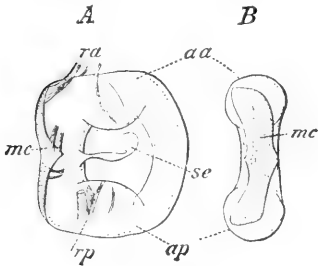

FIG. 33.

Auditory labyrinth of *Myxine glutinosa*, L. A, inner dorsal view; B, inner ventral view. (After Retzius, from Gegenbaur, *Verh. Anat. Wirbeltiere.*) *aa*, anterior ampulla; *a.p.*, posterior ampulla; *m.c.*, macula communis; *r.a.* and *r.p.*, ramus anterior and posterior of auditory nerve; *s.e.*, sinus endolymphaticus.

Quite recently the lateral-line system of *Bdellostoma* has been described by Ayers and Worthington [26]; it is in a very undeveloped condition, and consists of groups of sensory cells lodged in the epidermis of the head. The cavities which overlie the sense-organs are closed, and only shallow grooves indicate their presence on the outside.

The extraordinary sliminess of the skin is principally due to the activity of two longitudinal rows of large glandular sacs. These are segmental, paired, lateral invaginations of the skin (Figs. 29, 32), in which are stored mucous cells (Blomfield [37a]). They are of two kinds: granular mucous cells, and thread cells of very remarkable structure, which may perhaps be homologous with the club-cells in the skin of the Lamprey (Fig. 36).

The median fin is not subdivided, and is not provided with special muscles.

Alone among Craniate vertebrates the Myxinoids are normally hermaphrodite. They lay eggs of large size, richly provided with yolk, and enclosed in elaborately finished shells of horny consistency (Fig. 91). These shells are secreted in the ovary itself, and are not homologous with the very similar egg-cases of Elasmobranchs.

Cleavage is meroblastic; but, unfortunately, the development of



the Myxinoids is as yet but very incompletely known (Dean [106], Price [335]).

The Myxinoids are all marine, and are unknown as fossils.

Family MYXINIDAE. *Bdellostoma*, J. Müller (*Homea*, Flem.), Fig. 15 ; Pacific. *Paramyxine*, Dean ; Pacific (Fig. 31). *Myxine*, L. ; Atlantic, North Sea, Pacific (Fig. 15).

### Sub-Class 2. PETROMYZONTIA.

The Lampreys possess the following chief distinguishing features in their structure:—

A wide 'tooth'-bearing sucker surrounds the mouth. Since, dorsally, it develops between the stomodeum and the hypophysis, the nostril (hypophysial aperture) is carried up and far back on the dorsal surface of the head (Fig. 24), and is not terminal. The cartilaginous skull and neural arches are well developed ; but it is in the presence of an elaborate branchial basket, surrounding the gills and 'tongue,' and even enclosing the pericardium, that they differ most from the hag-fish (Fig. 20).

The gill-pouches are seven in number on each side, open separately to the exterior, and communicate internally with a suboesophageal tube (p. 34). In the larva, however, the gill-pouches open, as in all vertebrates, directly into the pharynx (Figs. 35 and 37). During the metamorphosis this region becomes nipped off behind ; whilst the oesophagus grows forward and above, so as to open into the buccal cavity in front of the gill-slits.

Other characters, such as the blind hypophysial sac, the simpler and hollow structure of the brain, the separate course of the dorsal and ventral roots of the spinal nerves, the normal structure of the eyes, the presence of two semicircular canals in the ear and of a well-developed lateral-line system of sense-organs, the closure of the pericardium, the more complex structure of the kidney, the spiral valve in the intestine, the subdivision of the dorsal fin, etc., have been mentioned above.

It is in the Ammocoete larva of *Petromyzon* that some of the strongest evidence of the primitive character of the Cyclostomes is found to occur (Balfour [29], Scott [393], Dohrn [116], von Kupffer [275], Koltzoff [273], Schneider [389], etc.).

The eggs are thin-shelled, small, with comparatively little yolk, and undergo holoblastic cleavage. The blastopore becomes the anus. The first three mesoblastic somites develop as outgrowths of the archenteric wall, and contain a coelomic cavity which for a time is in communication with the archenteron as in *Amphioxus*. The embryo develops into a larva differing very considerably in structure from the adult, and undergoes a pronounced metamorphosis to reach the perfect state. In this Ammocoete many

remarkable features bridge over the gulf between the Craniata and the Cephalochorda.

The mouth is bounded by lips (Fig. 37); there is neither sucker

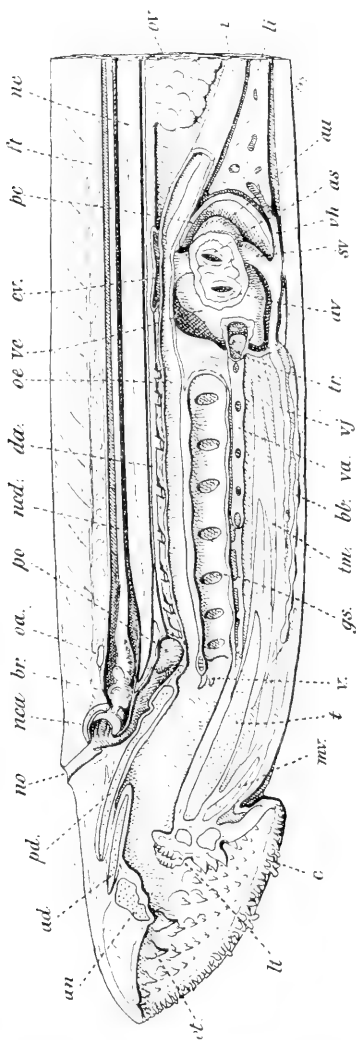

FIG. 34.

Longitudinal section of the anterior region of *Petromyzon marinus*, L. *a.d.*, anterior dorsal cartilage; *au*, annular; *as*, sino-atrial opening and valves; *av*, atrioventricular opening and valves; *b.b.*, branchial basket; *br*, brain; *c*, marginal cirri; *c.v.*, entrance of cardinal veins into sinus venosus; *d.a.*, dorsal aorta; *f.t.*, fatty tissue; *g.s.*, gill-slit; *i.*, intestine-opened to show spiral valve; *li*, liver; *lt*, teeth on rasping 'tongue'; *m.v.*, median ventral cartilage; *m.t.*, notochord; *n.c.a.*, nasal capsule; *nod*, nodal cord; *no*, median nostril; *o.a.*, oesophageus; *oa*, occipital arch; *oe*, oesophagus; *ot*, horny tooth; *ov*, ovary; *pc*, pericardium; *p.d.*, posterior dorsal cartilage; *p.o.*, hypophysial sac; *s.v.*, sinus venosus; *t.*, 'tongue' cartilage; *t.m.*, 'tongue' muscle; *tr*, bulbus arteriosus opened to show valve; *v.*, veal tentacles; *v.a.*, ventral aorta, median behind the 4th afferent gill-artery; *ve*, ventricle; *v.h.*, ventral hepatic vein; *v.j.*, ventral jugular vein. The cartilages are dotted.

nor horny armature, nor yet any rasping 'tongue.' The buccal cavity is separated by a velum from the pharynx, and this is limited in front by an encircling ciliated groove (like that of *Amphioxus*), which is at the level formerly occupied by the transitory first gill-

slit. The groove is carried back along the floor of the pharynx into the opening of the thyroid gland. This gland develops as a mid-ventral outgrowth of the pharynx, acquires a lumen of considerable size, and along its folded walls become differentiated four rows of mucous cells (Fig. 36). In fact, the whole structure bears a striking and unmistakable resemblance to the endostyle of the

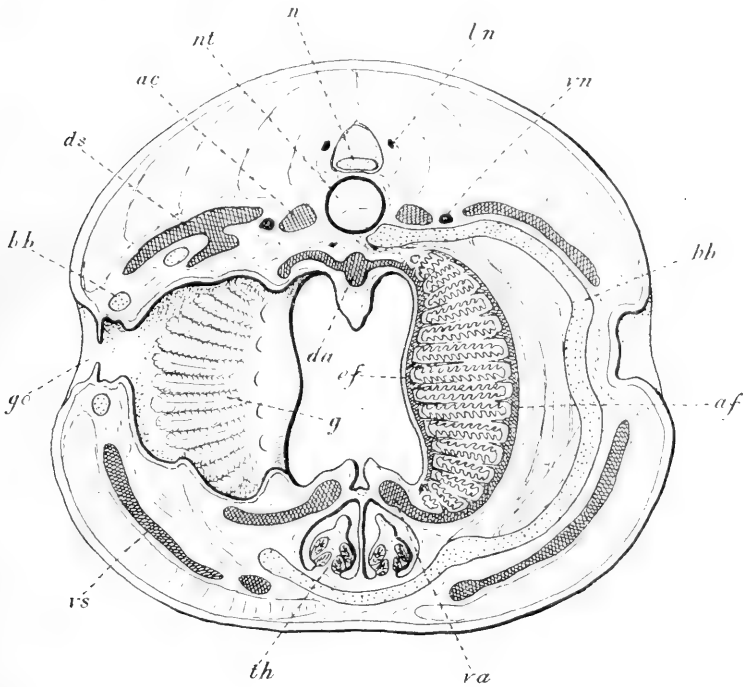

FIG. 35.

Transverse section of the gill-region of an Ammocoete larva, somewhat diagrammatic. (Partly after Alcock.) *a.c.*, anterior cardinal vein; *af.*, afferent artery; *b.b.*, branchial basket; *d.a.*, dorsal aorta; *d.s.*, dorsal blood-sinus; *ef.*, efferent artery; *g.*, gill-lamella; *g.o.*, gill-opening; *l.n.*, lateral-line nerve; *n.*, nerve-cord; *nt.*, notochord; *th.*, thyroid gland; *v.a.*, ventral aorta; *v.n.*, vagus nerve; *v.s.*, ventral blood-sinus.

Tunicata and Cephalochorda, with which it is no doubt homologous (W. Müller [307a]). It may also be mentioned that the liver is composed of a mass of branching tubules, much more distinct than in the compact liver of higher vertebrates; in the adult it undergoes fatty degeneration, and the gall-bladder is lost. The paired eyes lie hidden deep beneath the skin. The pericardium opens widely into the abdominal coelom (Fig. 37, C); on its dorsal wall lies the pronephros. The median fin is continuous.

Both marine and freshwater Lampreys are known, but no fossil forms have yet been discovered.

Family PETROMYZONTIDAE. *Petromyzon*, Art.; rivers and seas of Europe, Asia, and America (Fig. 16). *Mordacia*, Gray, and *Geotria*, Gray; S. America and Tasmania.

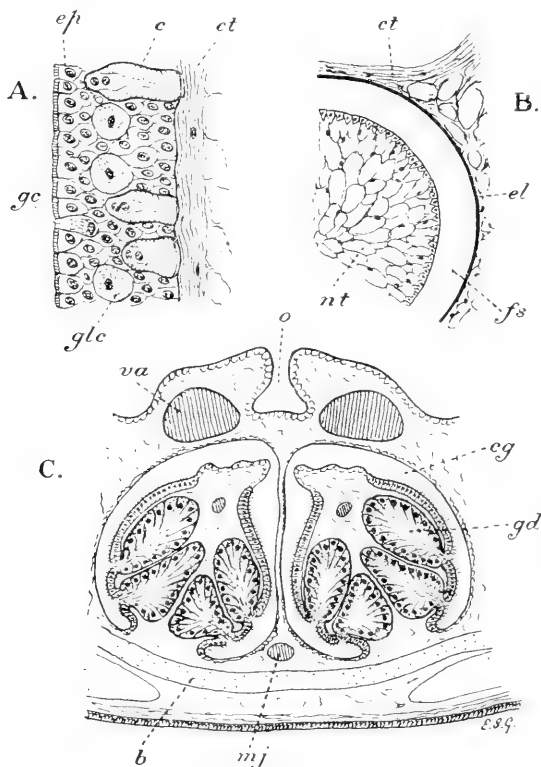

FIG. 35.

Ammocoete larva of *Petromyzon fluviatilis*, L. A, transverse section of skin, much enlarged. B, portion of a transverse section of the notochord, enlarged. C, transverse section of the thyroid gland, enlarged. *b*, branchial basket; *c*, striated club-cells; *cg*, lumen of thyroid gland, which communicates with the pharynx; *ct*, connective tissue; *el*, elastica externa; *ep*, outer layer of epidermis; *fs*, fibrous sheath; *glc*, gland-cell; *gd*, row of glandular cells of thyroid; *glc*, glandular cell; *mj*, median jugular vein; *nt*, notochord; *o*, opening of thyroid gland; *va*, ventral aorta.

AFFINITIES.—The Cyclostomes, united to the cartilaginous fish by Cuvier, were separated from the true fish by Agassiz (1857). That they should be definitely placed apart from the Gnathostomes the facts mentioned above leave no doubt. Such special characters as the rasping 'tongue,' the large sub-cerebral hypophysial sac, etc., prove that they form a single divergent group; on the other



(Dohrn) to show that the Cyclostomes are degenerate fish, derived from some member of the class Pisces. The facts we have just cited sufficiently dispose of this view; *these* characters, at all events (hypophysial sac, fully developed anterior myotomes, larval thyroid gland, rasping 'tongue,' etc.), cannot be due to degeneration! Nevertheless, it can hardly be doubted that the Myxinoids, if not the Petromyzontia as well, show some signs of degeneration. In the former group the vestigial eyes, for instance, and perhaps the absence of median fin muscles and many characters of the skeleton, may safely be attributed to degeneration. The total absence of paired limbs and girdles is, of course, a very important feature; there is no satisfactory evidence that the Cyclostomes ever had any, in spite of Dohrn's suggestion that the small folds at the sides of the cloaca represent vestiges of pelvic fins. Whether the ancestral Craniate, from which both the Gnathostome and the Cyclostome groups diverged, possessed biting jaws or not, is a question we can scarcely hope to solve without palaeontological evidence (Howes [221]).

#### INCERTAE SEDIS.

Family PALAEOSPONDYLIDAE. This family contains only the very interesting extinct fishlike creature from the Middle Old Red Sandstone of Scotland, named *Palaeospondylus Gunni* by Traquair, who first described it and considered it to be possibly a fossil Cyclostome. Unfortunately *Palaeospondylus* is very small, its skeleton is ill-preserved, and its structure still very imperfectly understood, in spite of the careful researches of Traquair [463], Dean [107], and Sollas [411].

The elongated body appears to have been naked; no trace of teeth has been found (Fig. 38). The skull is relatively large; it has an extensive brain-cavity with side walls, a continuous floor marked with an infundibular depression, but probably an incomplete roof. Behind the large orbits are the auditory capsules continuous with the cranial wall, and in front are ill-defined structures which probably represent paired olfactory capsules. From the extreme anterior end of the skull project some eleven slender processes attached in a circle to a basal ring; they seem to represent tentacles surrounding a median aperture, which might be the nostril or the hypophysis, but much more probably the mouth. Below the anterior region of the skull is a T-shaped element of doubtful nature, but probably belonging to the visceral skeleton, of which distinct traces have been described by Sollas. About four branchial arches can be made out, and in front of them indications of an upper and lower jaw. Attached to the hindermost arch are a pair of large plates projecting backwards behind the skull. The vertebral column has a large number of ring-like centra with neural arches. The tail is diphyccercal, bears a caudal fin supported by median prolongations of both the neural and the haemal arches, forming delicate rays sometimes branched, and strikingly like those of the Cyclostomes. There are no ribs, nor have any certain traces of paired fins been found, though it

has been suggested that the pectoral fins are represented by the large postbranchial plates mentioned above. The histological character of the skeleton is quite unknown, but it was probably cartilaginous.

Many views have been put forward with regard to the affinities of *Palaeospondylus* (Traquair, Gill [166], etc.). That it is not a larval form seems to be proved by the presence of well-marked centra. This fact is

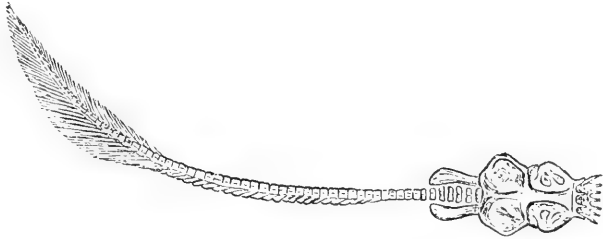

FIG. 38.

*Palaeospondylus Gunnii*, Traq. ; from the Middle Old Red Sandstone of Caithness ; restored.  
(After R. H. Traquair, from *Brit. Mus. Guide*.)

also a very serious objection to its close association with the Cyclostomes. While the fin-rays and the apparent absence of paired fins recall the latter, the structure of the vertebral column, the skull, and the visceral arches approaches that of the Gnathostomes. To which of these two Branches *Palaeospondylus* belongs it is not yet possible to determine ; it may have arisen from an extinct intermediate group.

*Palaeospondylus*, Traquair ; Middle Old Red Sandstone, Caithness.

## Branch II. GNATHOSTOMATA.

AMONG the many important new characters which distinguish the Gnathostomata from the Cyclostomata, and bear witness to the higher grade of development of the former, may first of all be mentioned the possession of a dermal exoskeleton. This superficial skeleton first appears in the form of small tooth-like structures, or denticles, scattered all over the skin. Since the skin grows inwards at the mouth and gill-slits, denticles may be found also inside the buccal cavity, and on the inner surface of the gill-bars. Along the inner edge of the jaws they become specialised into true teeth (Fig. 39).

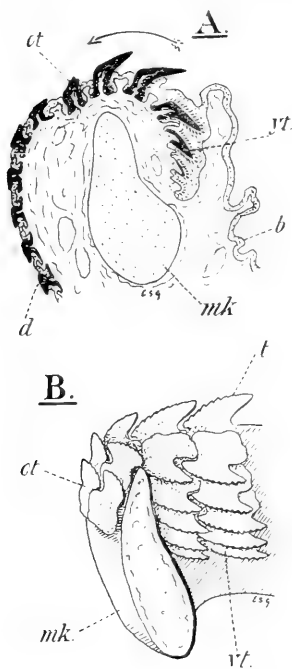

FIG. 39.

A, diagram of a transverse section of the lower jaw of *Scyllium canicula*, L., showing the development and succession of the teeth. B, anterior portion of the right mandible of *Acanthias vulgaris*, Risso, cut through at the symphysis (enlarged). *b*, mucous membrane lining the buccal cavity; *d*, denticles in skin on outer surface; *mk*, Meckel's cartilage; *o.t.*, old worn tooth; *t*, functional tooth at biting edge; *y.t.*, young tooth which will succeed the older teeth in the direction indicated by the arrow.

The Gnathostomes as a whole are characterised by the great and diverse development of the supporting tissues, whether endoskeletal or exoskeletal; and the skeleton is of such great importance in their anatomy that we may digress at once to briefly investigate the whole question of the relation borne by the original cartilaginous endoskeleton to the dermal denticles and bone.

Cartilage and bone may be looked upon as specialisations of the general scaffolding of connective tissue, which pervades, so to speak, the entire body of a Craniate, affording support to and binding together the various parts of the organism. It is really in connection with the muscular system that the connective tissues have reached their highest degree of differentiation. The Craniata are elongated



segmental animals, and correlated with this structure is the segmentation of their muscular system. In the lower forms, and in the embryos of the higher, the segmental character of the somatic muscles is most distinctly shown. Now the connective tissues are found to surround the myotomes, forming not only closed boxes in which these lie, but also a lining to the body-wall outside and to the body-cavity within, and a sheath surrounding the notochord and central nervous system. Thus a system of transverse septa (myocommata), intersegmental in position, and of

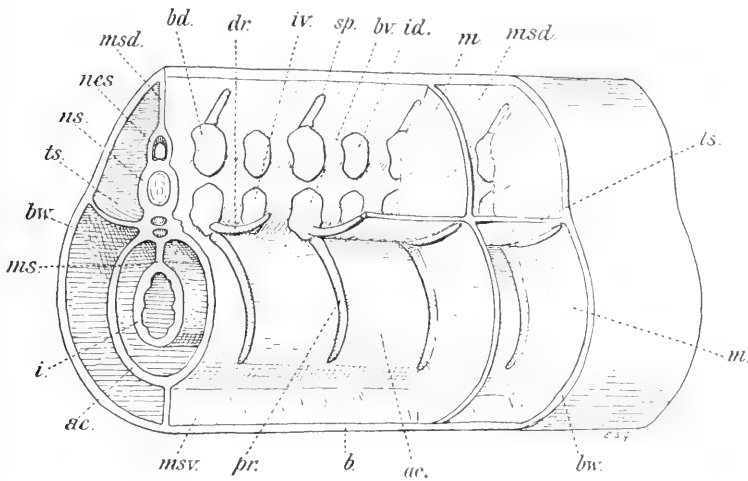

FIG. 40.

Diagram of the connective-tissue system in the trunk of a Craniate Vertebrate, showing the relation borne by the axial skeleton to the transverse and longitudinal septa. *ac.* wall of abdominal coelom; *bd.* basidorsal; *bv.* basiventral; *b.w.* cut body-wall; *d.r.* dorsal rib; *i.* intestine hanging in the coelom; *iv.* interventral; *m.* transverse septum (myocomma); *ms.* mesentery; *m.s.d.* median dorsal septum; *m.s.v.* median ventral septum; *nes*, neural tube; *n.s.* notochordal sheath; *p.r.* ventral or pleural rib; *s.p.* neural spine; *ts.* horizontal septum. Oblique view of left side, from which the septa have been partially removed.

longitudinal, more or less tubular coverings, is formed. To these may be added a longitudinal vertical median septum, a longitudinal horizontal septum (in Gnathostomes), and others of minor importance, completing the system of membranes in which the various parts of the skeleton arise (Fig. 40).

The true endoskeleton, in fact, is only the local strengthening of certain regions of the connective tissue, chiefly for the sake of affording a firmer hold and greater mechanical advantage to the muscular system enclosed in it. Since the musculature is segmented, we find that the skeletal system is also, as a rule, of a segmental character. As the lateral paired limbs become differentiated, and as the head becomes more and more 'cephalised'

(p. 2), the primitive arrangement of both septa and muscles becomes modified and obscured.

The skeleton of the trunk first develops in connection with the main notochordal axis and transverse septa: vertebrae are formed between the myotomes, where the septa meet the covering of the notochord and neural canal; and ribs are added where the same septa intersect the horizontal septum and the coelomic wall (Fig. 40).

Passing now to the origin and finer structure of the endoskeleton, we find that it arises in the mesoblastic tissue, and takes the form of cartilage. Cartilage is a tissue in which the cells secrete a firm, compact elastic matrix, more or less homogeneous and free from fibres, the chemical basis of which yields chondrin (Fig. 41). The cells, which are generally oval and provided with fine com-

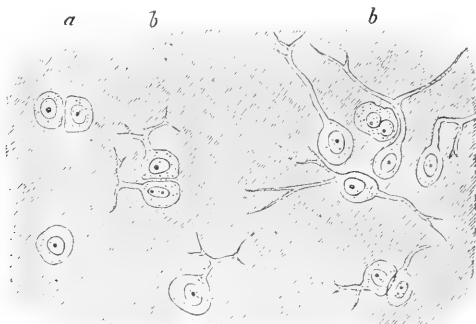

FIG. 41.

Section of articular cartilage of Man, showing transition of cartilage-cells, *a*, to branching connective-tissue cells, *b*. (From Quain's *Anatomy*, by permission of the Publishers.)

municating branches, are distributed throughout the matrix, and multiply by division. The matrix not being rigid, cartilage can grow equally in all directions, *i.e.* in the three dimensions of space. This is its most characteristic feature. Intermediate forms of tissue are found between such typical 'hyaline' cartilage and fibrous connective tissue.

Bone is a form of connective tissue which develops in relation to the endoskeleton later than cartilage. This is the case in both phylogeny and ontogeny. In the higher vertebrates bone gradually increases in importance as a skeletal tissue, and eventually almost entirely supplants the cartilaginous framework on which it has been moulded. There has been, so to speak, a struggle between cartilage and bone, in which the latter has triumphed.

In the majority of cases, then, bone has replaced cartilage, and, as a matter of fact, we find that in ontogeny the bony skeleton is, for the most part, actually preformed in cartilage. The advantage,

for mechanical reasons, of the retention of a cartilaginous stage of growth in the young is obvious. In some regions, however, true bone is developed in connective tissue without being preceded by cartilage. This is always the case in the exoskeleton. To such ossifications the terms 'dermal' and 'membrane' bone have been given.

It was a London physician, Clopton Havers, who first began the serious study of the structure of bone. Towards the end of the seventeenth century he described those small canals which have since borne his name. The Haversian canals are minute branching channels running throughout the substance of bone, and containing

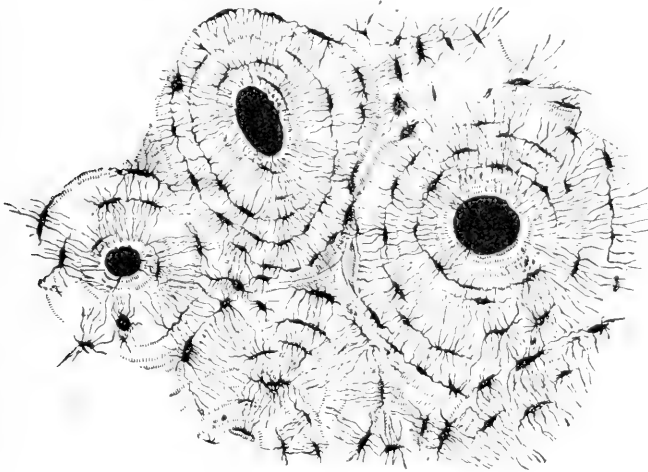

FIG. 42.

Transverse section of a human humerus showing the structure of bone, with lacunae for bone-cells set in concentric rings round three Haversian canals. (From Quain's *Anatomy*, by permission of the Publishers.)

blood-vessels, lymph-spaces, and nerves. To Purkinje is due the discovery of the microscopic cavities in which, as Virchow afterwards showed, the cells or so-called bone-corpuscles are situated. Among the numerous observers who have since completed our knowledge of this complex tissue may be mentioned Tomes, Todd and Bowman, Sharpey, and Kölliker.

Bone is constituted by lamellae formed of an organic basis, ossein, which yields gelatine; it is impregnated with phosphate and carbonate of lime. Distributed throughout the matrix, between the lamellae they have secreted, are the bone-cells (Fig. 42). These are provided with a multitude of fine ramifications reaching from one to the other, and ultimately to the nearest Haversian canal, or to the surface of the bone. The lamellae are arranged concentrically

round the canals, or parallel to the bone's outer surface. By decalcifying bone, fibres were discovered by Sharpey to extend in varying quantity through the matrix of ossein. Just as the cartilages are surrounded by a connective-tissue covering, the 'perichondrium,' so the bones are enclosed in a connective-tissue 'periosteum,' from which blood-vessels and nerves penetrate to the canals.

Such is the structure of typical bone in mammals, whether it be preceded by cartilage or formed directly in connective-tissue membranes. But the finer structure of bone may vary considerably. The Haversian canals, serving chiefly for nutrition, are found to be less numerous, or even entirely absent, in the bones of very small animals, and in structures of small size. The bones in the lower classes of vertebrates are often of less regular and elaborate formation. The lamellae may be scarcely indicated, the bone-cells scattered, and the canals in the shape of irregular spaces. Kölliker [270] has shown that, in the Teleostei, the bone may in some cases be poor in matrix and very rich in fibres (*Xiphias*, *Gadus*); in others the bone-cells may be exceedingly rare, or practically absent in the adult tissue (*Pleuronectes*); again, it may acquire a structure similar to that of dentine (Stewart, *Fistularia* [425]). Nevertheless, true bone is undoubtedly developed in all the classes of the Craniata, from the fish upwards, though not in all Craniates.

The question of the origin and growth of cartilage and bone during individual development is important. The history of cartilage in ontogeny is simple enough: undifferentiated cells, in certain regions of the connective-tissue system, secrete a clear matrix round themselves, divide, and still secrete until a mass of cartilage is formed surrounded by the perichondrium. Such a cartilaginous skeleton can continue to grow in all its parts, either retaining or altering its shape according to the needs of the animal. This account, however, is based on comparatively modern investigation. Before the significance of the cells in cartilage was understood, it was for a long time held that cartilage is formed from a fluid blastema by a process of gradual solidification. This process, carried a step farther, was supposed to give rise to bone with the aid of calcification.

Such a crude theory had to be abandoned when the importance of the cells came to be appreciated. But it was still supposed, until the middle of last century, that cartilage becomes actually converted into bone by the solidification and calcification of the existing matrix, and by the modification of the enclosed cells into branching bone-corpuscles. This view received at first the support of Schwann, Tomes, Virchow, Kölliker, Ranvier, and others, and appears to be still held in a more or less modified form

by some modern authors. *A priori*, it seems to be in the highest degree improbable that such highly differentiated cells as those of cartilage should be able to so entirely change their form and function. All analogy would lead us to suppose that, as a rule, highly differentiated tissues become very limited in their powers of growth, and can only produce more tissue of a nature similar to their own. Moreover, there is much evidence against this theory of conversion.

More than a century and a half ago, Nesbitt (1736) denied, on general grounds, the genetic connection between bone and cartilage. Describing two species of ossification yielding the same bony substance, one in membrane and the other in cartilage, he pointed out that in the latter case the connection between the bone and the cartilage is loose. It was not till the middle of the last century that Nesbitt's speculations were placed on a sound basis of observation by Sharpey, the founder of the modern theory of the development of bone in cartilage by *substitution*. Sharpey showed that membrane-bones are developed in connective tissue without being preceded by cartilage; that, in the case of cartilage-bones, the outer layers may be deposited beneath the periosteum without the intervention of cartilage; and finally, that, even in the case of true 'endochondral' ossification, the bone is not formed by the conversion of previously existing cartilage, but by the invasion, so to speak, of bone-forming tissue from without. Blood-vessels penetrate into the cartilage, the cartilage-cells become peculiarly modified, the original matrix becomes calcified, then destroyed and absorbed, and finally it is replaced by a new deposit secreted by cells brought in with the vessels (Fig. 43).

These views of Sharpey, now almost universally adopted and much extended, met at first with great opposition. The triumph of the new theory of 'substitution' abroad was greatly helped by the careful researches of H. Müller in 1858, and of Gegenbaur in 1864. It is now established that through the work of active immigrating cells, which accompany the fine blood-vessels, channels are eaten away or dissolved in the cartilage matrix. Other immigrating cells, called 'osteoblasts' by Gegenbaur, deposit the new matrix or lamellae of ossein on the walls of the cavities so formed. The osteoblasts become surrounded by their own secretion, and so converted into bone-cells united to each other only by fine threads of protoplasm (Fig. 43). The typical Haversian systems are not well marked at first, but generally become developed during the latter stages of growth of the bone.

Three varieties of bone can be distinguished: the endochondral, of which the development has just been noticed; the sub-periosteal, or perichondral; and the membrane bone. To the first variety of ossification is due very much less of the adult skeleton than was at

first supposed. In ontogeny it is the latest to appear; it is formed chiefly in the region of the epiphyses, and is almost entirely of a purely provisional character. By far the greatest bulk of the endo-

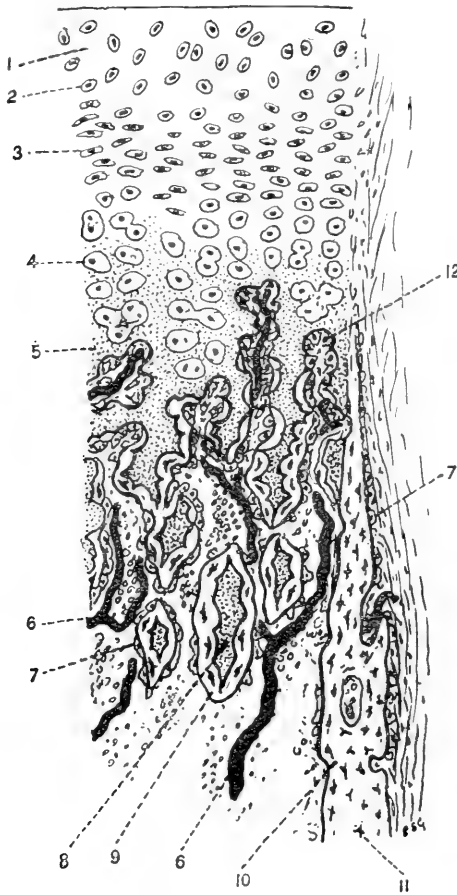

FIG. 43.

Enlarged view of a portion of a section through the phalanx of a mammalian foetus showing the development of bone (from a preparation lent by Dr. G. Mann). 1, hyaline cartilage matrix; 2, cartilage cell; 3 and 4, the same becoming modified near the region of ossification; 5, calcified cartilage matrix; 6, blood-vessels invading the cartilage; 7, osteoblasts depositing bone; 8, island of cartilage, remains of matrix surrounded by newly-deposited bone; 9, endochondral bone substituted for cartilage; 10, perichondral bone deposited outside; 11, bone-cell; 12, invading cells destroying cartilage.

skeleton is of the second or sub-periosteal variety. This is the first bone to appear in the ossification of the limb-bones, for instance, and is deposited layer upon layer by the osteoblasts lining the

inner surface of the periosteum (perichondrium of earlier stages). Intramembranous bones are formed, but usually to a much smaller extent, in the region of the skull, the pectoral girdle, and exoskeleton generally.

How a rigid structure like bone can grow while in continuous functional activity, and still retain its shape while increasing in size, are questions which soon suggested themselves. Certain authors, like Todd and Bowman, Strelzoff and Kastschenko, held that bones enlarge by interstitial growth and expansion; others, like Hunter, Kölliker, and Stieda, supported the opposite, and now generally accepted, view that bone once formed does not expand, but grows by the deposition of new layers on its surface. While the osteoblasts are continually adding new material in one place, other cells, termed osteoclasts, may be destroying the older portions in another. Thus a bone may alter in shape, or may increase in size, retaining its form, as the needs of the animal demand. In this way the greatest mechanical efficiency is secured, with the least weight and expenditure of material, all superfluous bony substance being removed in the formation of medullary cavities.

There remain, perhaps, a few cases in which bone is formed by the actual conversion of cartilage with its cells. It has been described by Schmid-Monnard [388*a*] in Teleostean fish, by Kastschenko in Amphibia, and by Gegenbaur [153] in Mammalia. But even here appearances are probably deceptive. Stephan [424] has explained how apparent conversion may be due to the gradual change of 'perichondrium' into 'periosteum'; so that if this layer ceases to produce cartilage and takes to producing bone, sections show a gradual transition from one to the other. Thus, it would be the activity of the growing tissue which changes, not the already formed skeleton which undergoes conversion.

A comparative study of the general development of the skeleton was begun by Dugés in Amphibia [123]; by von Baer, Rathke, Reichert, Jacobson, Kölliker, Parker [323, etc.] in various groups of vertebrates. They concluded that the history of the development of a bone affords important evidence concerning its homology. The 'cartilage-bones,' connected with the endoskeleton, were called 'primary'; the 'membrane-bones,' which appeared to have been added from without, were called 'secondary.' It was argued that homologous bones must develop in a similar way; in other words, it was thought that a 'primary' bone could not be homologous with a 'secondary' bone. This morphological distinction, between bone developed inside the perichondrium and bone developed more superficially, was found to be so strongly supported by the facts, that it became almost a dogma that bones of unlike development could not be homologous.

Such hard-and-fast rules rarely, if ever, hold good in Zoology. Gegenbaur, to whom we owe so much of our knowledge of the morphology of the vertebrate skeleton, adopted a wider view, and held that bone originated in the skin, and only secondarily came into connection with the more deep-lying cartilage—that, in fact, ‘secondary’ bones have become gradually converted into ‘primary.’

Both Gegenbaur [159] and Schmid-Monnard state that the ‘squamosal’ (pterotic) of certain Teleostei arises as a membrane-bone, then becomes closely connected with the cartilaginous cranium, and finally continues to develop as an endochondral bone. Histogenesis would, in such a case, be no criterion for homology. In the course of phylogeny, bones, originally intramembranous, might develop more and more directly as cartilage-bones, so that they could no longer be distinguished from them (p. 266). There is also reason to believe that, in some cases, the reverse may happen, the cartilaginous stage being suppressed. Thanks to the researches of Williamson [496*a*], Leydig, Gegenbaur, and more especially O. Hertwig [211-12], the ontogenetic and phylogenetic connection of the dermal bones with denticles, like those developed in the skin of Elasmobranch fish, has been traced. Williamson considered that the plates and scales of fish were formed by the combination of superficial denticles with underlying dermal bone. Hertwig supposed that by the enlargement of the basal plate, whereby the hollow tooth-like denticle is fixed in the dermis, or by the fusion of adjacent basal plates, such superficial bones are developed as are found covering the skull or the roof of the mouth in the lower Gnathostomes (see, however, p. 215).

Now Hertwig contended that true dermal bones can always be traced back, in the lower forms, to the denticles from which they were derived; even when in the higher vertebrates such bones have sunk below the skin, and become closely united to the endoskeleton. Further: that dermal bones always lie outside the perichondrium, and may cover over cartilage-bones; and that cartilage-bones can never be traced back to denticles, and are developed entirely in direct relation to the cartilaginous skeleton. The same result, therefore, was reached on this theory, from a study of comparative anatomy, as had previously been reached by Kölliker and others, from a more strictly histological point of view. These conclusions are opposed to those of Gegenbaur and his pupils. While adhering to the view that bone was originally developed in relation to dermal denticles, the latter school holds that in the case of the cartilage-bones, both perichondral and endochondral, the osteoblasts derived from the surface have migrated farther inwards, and finally come to invade the cartilage itself. Whether ossification extends inwards by such migration, or by a sort of infection,



by a spreading inwards, as it were, of the tendency to form bone within the connective tissue system, remains a doubtful point; but the main conclusion, that the phylogenetic development of the bony skeleton has, on the whole, followed this course, is now generally accepted.

Glancing briefly at the parts played by bone and cartilage in the general development of the vertebrate skeleton, we find that the endoskeleton appeared first, and in the form of cartilage (Cyclostomes). Subsequently, it would seem, the skin became covered with tooth-like scales, the primitive exoskeleton of fish. The first bone may then have been developed in relation to these, and it is to such superficial bones that the term 'primary' should be applied. Owing to the necessity for further consolidation, it became advantageous either for the cartilages to be strengthened by an abundant deposit of lime salts (Chondrichthyes, p. 122), or for the process of ossification to extend inwards in the connective tissue to the deeper regions. Moreover, bony plates, superficial in origin, may, in the course of evolution, sink so as to come into close connection with the underlying skull and pectoral girdle (Vrolik [476], Walther [480], Osteichthyes, p. 212). The development of the denticles, and their relation to the bones of the skeleton, are dealt with further on (p. 214)

The skull becomes more developed in the Gnathostomes. The nostrils and nasal sacs are paired. The two capsules usually develop in continuity with the trabeculae, which fuse in front into an ethmoid cartilage forming a median nasal septum (Fig. 6). The brain-case is more complete, though membranous fontanelles generally remain above and below in the chondrocranium. An occipital region is always continuous with the parachordals and auditory capsules, and includes several 'scleromeres' behind; so that not only are the glossopharyngeal and vagus nerve-roots invariably enclosed in the skull, but also one or more segmental elements of the hypoglossal (p. 10).

The characteristic mouth is bounded above and below by the biting jaws, developed from the first pair of visceral arches. This arch bends over the angle of the mouth, the upper limb becoming separated as the palato-quadrata bar, or primary upper jaw; the lower limb forming Meckel's cartilage, or primary lower jaw (Fig. 5). There are never more than eight pairs of gill-slits. The first, or spiracle, is always different from the others, is generally not pierced, and is often vestigial. It is followed by the hyoid arch behind, and the remaining slits by corresponding branchial arches. These visceral arches develop as paired cartilages next to the wall of the pharynx, internal to the muscles, nerves, blood-vessels, and coelom. Below they join a series of median

elements lying above the ventral longitudinal blood-vessel. All these structures become greatly modified in the higher and terrestrial vertebrates.

While the notochord itself decreases in importance as a skeletal axis in the adult, the vertebral column becomes more and more developed. Vertebral centra of some sort, either within or outside the notochordal sheaths (p. 99), are almost always formed in connection with the bases of the arches. The centra are therefore primarily intersegmental, like the neural arches (Fig. 45). In the caudal region, behind the abdominal coelom, corresponding haemal or ventral arches meet below, enclosing a space in which run a caudal artery and vein. Further forward the haemal arches often tend to

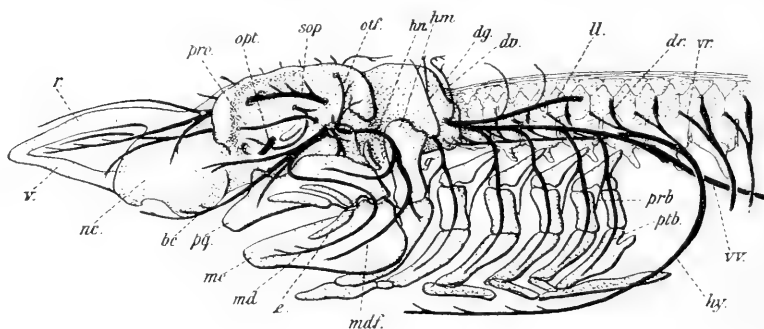

FIG. 44.

Skeleton and nerves of the head of *Mustelus laevis*, Risso (the nerves partly from Allis). *bc*, buccal nerve; *dg*, dorsal branch of glossopharyngeal; *dr*, dorsal root of spinal nerve; *dv*, dorsal branch of vagus; *e*, labial cartilage; *g*, glossopharyngeal; *hm*, hyomandibular, the spiracle is indicated by a dotted line in front, and the prespiracular cartilage is shown in front of the spiracle; *h.n*, hyomandibular nerve; *h.y*, hypoglossal nerve; *l.l*, lateral-line branch of facial nerve; *m.e*, Meckel's cartilage; *md*, mandibular nerve; *md.f*, mandibular branch of facial nerve; *n.c*, nasal capsule; *opt*, optic nerve; *ot.f*, otic branch of facial; *p.q*, palato-quadrate; *prb*, pretrematic nerve; *pro*, profundus nerve; *pt.b*, post-trematic nerve; *s.op*, superior ophthalmic branch of trigeminal and facial; *r*, dorsal rostral cartilage; *r.r*, ventral root; *v.r*, visceral branch of vagus.

disappear, being represented by mere stumps; or they may be prolonged as separate ribs embracing the abdominal cavity, the so-called pleural or ventral ribs, lying outside the peritoneum on the inner surface of the myotomes (Fig. 40), (Bruch [66], Dollo [119], Göppert [179], Claus [79]). True or dorsal ribs, on the contrary, are situated above in the horizontal longitudinal septum, which in all Gnathostomes separates the myotomes into dorsal and ventral portions (Fig. 40). It is to A. Goette that we are indebted for the clear exposition of this important distinction [167].

The neural arch generally meets above the neural canal a median neural spine situated in the longitudinal median septum. The homology of the 'neural spines' throughout the Gnathostomes

is more than doubtful (pp. 101 and 105). The haemal arches are similarly completed below by haemal spines.

In the lower Gnathostomes (Pisces) the median dorsal and ventral fins are provided with endoskeletal supports, generally in the shape of rods known as pterygiophores, radials, or somactidia (Lankester). Now the question arises as to the morphological

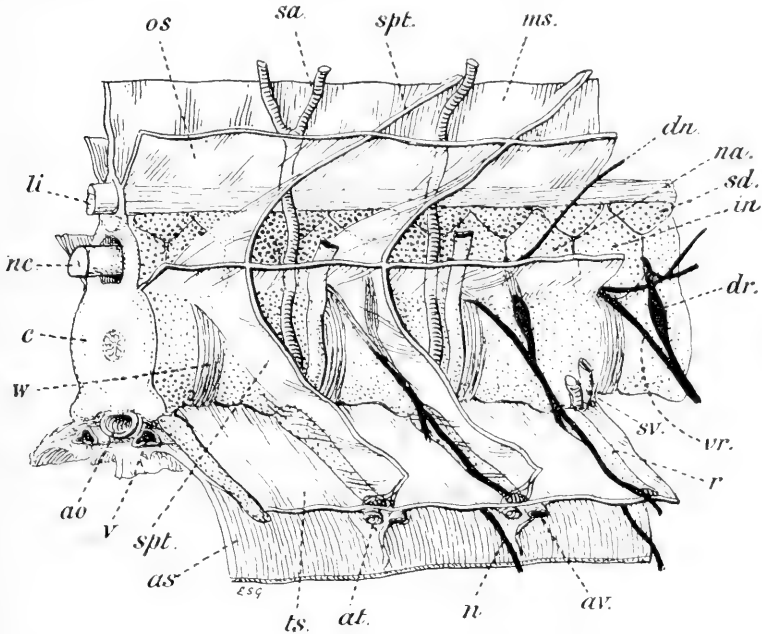

FIG. 45.

*Seyllium canicula*, L. Left-side view, enlarged, of a portion of the vertebral column and ribs with the connective tissue septa, to show their relation to the blood-vessels and nerves. *ao.*, dorsal aorta; *as.*, abdominal wall; *at.*, artery; *ar.*, vein; *c.*, centrum; *d.n.*, dorsal nerve; *d.r.*, ganglion of dorsal root; *in.*, interdorsal; *li*, dorsal ligament; *m.s.*, median dorsal septum; *n.*, ventral nerve; *na.*, basidorsal; *n.c.*, nerve-cord; *r.*, rib; *s.a.*, segmental dorsal artery; *sd.*, supradorsal; *spt.*, vertical transverse septum passing between successive myotomes; *s.v.*, segmental dorsal vein; *t.s.*, chief transverse horizontal septum in which lie the ribs; *o.s.*, oblique upper longitudinal septum, a similar lower septum occurs between it and the transverse horizontal septum; *v.*, posterior cardinal vein; *v.r.*, ventral spinal root; *v.*, intervertebral ligament.

significance of this supporting skeleton. Is it a special appendicular skeleton, separate from the axial skeleton (skull and vertebral column) as held by Cuvier and Huxley? Or is it derived from the axial skeleton itself (Gegenbaur)? In the Cyclostomes, the cartilaginous rays of the median fins reach down to the neural tube, and may even fuse to a continuous cartilage passing down each side, so as to enclose the nerve-cord and notochord (p. 32 and Fig. 19). In most of the Teleostomi the dorsal fin skeleton

reaches, or articulates with, the neural spines (p. 105), and in the Dipnoi there is no distinction between the two (p. 234). Moreover, the ventral lobe of the caudal fin is almost always supported by direct prolongations of the haemal arches; and the dorsal lobe in Selachians is usually borne by cartilaginous median 'spines,' articulated to the vertebral column, yet more numerous than the vertebrae (Fig. 46, B). All these facts seem to uphold the second hypothesis, according to which the 'neural spines' and the fin-radials represent the proximal and distal regions of an originally

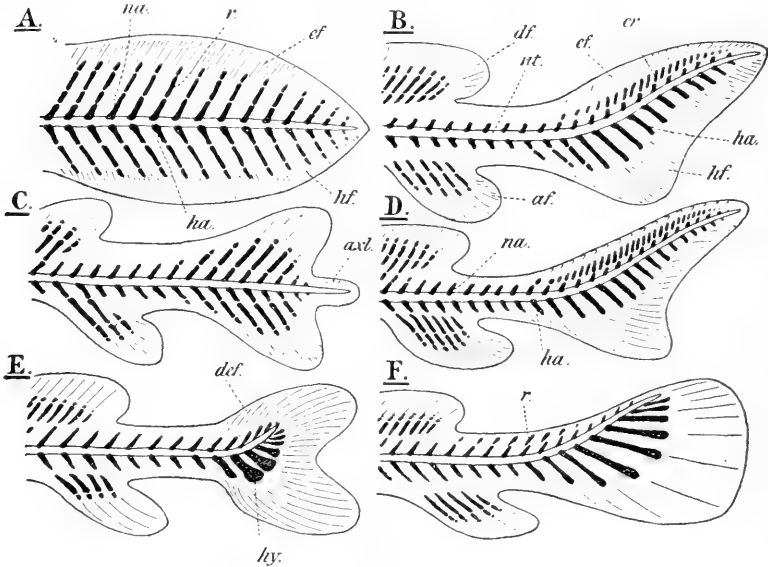

FIG. 46.

Diagrams showing the modifications of caudal fins, and the relations of the endoskeletal radials of median fins to the axial skeleton. A, diphyccercal type, with equal dorsal and ventral lobes (Dipnoi); B, heterocercal type (Selachii); C, modified diphyccercal (Coelacanthini); D, heterocercal (Chondrostei); E, homocercal type (Teleostei); F, abbreviate heterocercal type (Amiioidei). *a.f.*, anal fin; *axl.*, axial lobe; *c.r.*, epichordal radial; *def.*, dorsal lobe partly formed by epichordal lobe; *d.f.*, dorsal fin; *cf.*, epichordal lobe; *h.a.*, haemal arch; *hf.*, hypochordal lobe; *hy.*, hypural arch; *na.*, neural arch; *nt.*, notochord; *r.*, radial. The endoskeleton is black.

continuous skeletal rod with several joints. We should not, then, believe that the fin-skeleton has developed independently at the base of the fin itself, and has grown inwards centripetally; but, on the contrary, we should consider the wide separation of the radials from the vertebral column in some fish (Elasmobranchs) as secondary. Thus the discrepancies in number, and the want of concordance in position, of the arches and fin-radials would be due to concentration and modification of the originally corresponding elements (Fig. 46); the nonconformity of the two sets of supports may be either the cause or the effect of their separation.

Since, in many fish, the unpaired fin extends uninterruptedly along the dorsal mid-line to the tip of the tail, and along the ventral mid-line forwards as far as the anal region or even beyond; and since, in many of those fish which in the adult state have discontinuous dorsal, caudal, and anal fins, these separate fins develop as differentiations in a continuous embryonic fin-fold, it seems very probable that the median fins of the primitive Gnathostomes formed continuous folds. By the obliteration of certain regions they became subdivided. This view is further borne out by the fact that we find quite or almost continuous median fins amongst some of the most primitive groups of fish (Pleuracanthini, Dipnoi). Moreover, traces of the fin-skeleton and musculature are found between the discontinuous fins of such fish as *Acanthias*, *Irhina* (Figs. 50, 52), *Pristis* (Goette [167], Thacher [437], Mivart [300]), and *Gadus*. We may conclude, at all events, that the unpaired fins are longitudinal median structures, internally segmented like the body itself, and involving many segments. The metamerism is evident in the skeleton, often composed of a series of separate jointed rods corresponding in number to the neural arches, or a multiple thereof. The muscles also are segmented, being as a rule developed from special outgrowths of the myotomes, the muscle-buds (Dohrn [118], Mayer [297], Harrison [197], Goodrich [176]) (Fig. 47). A single bud grows into the fin-fold from each myotome on each side (*Scyllium*, *Salmo*). The muscle-forming cells may, however, be given off not as definite buds, but from a mere proliferation of the myotome. The nerves which supply the fin-muscles are branches of the spinal nerves of the segments belonging to the myotomes from which they were developed. The buds of the right and left sides correspond in pairs, and between each such pair is developed a skeletal radial (Fig. 47).

The exact correspondence between the body segments and the fin segments is usually disturbed by 'concentration' and by concrescence, which accompany the breaking up of the continuous fold into separate fins. The base of each separate portion tends to become narrower, and thus a dorsal fin which in the embryo developed from some dozen segments, may in the adult come to occupy only some half-dozen or fewer. As a rule, more buds arise in the embryo than come to full development in the adult, some being suppressed at each end, where concentration is most pronounced. The skeletal and muscular elements thus become relatively compressed, and this concentration may take place more at one end of the fin than at the other (Fig. 47). Owing to concentration radial fin-muscles may become more or less widely separated from the myotomes which gave rise to them, and the nerves are made to converge towards the narrowed base of the fin to supply them; thus are formed longitudinal 'collector' nerves,

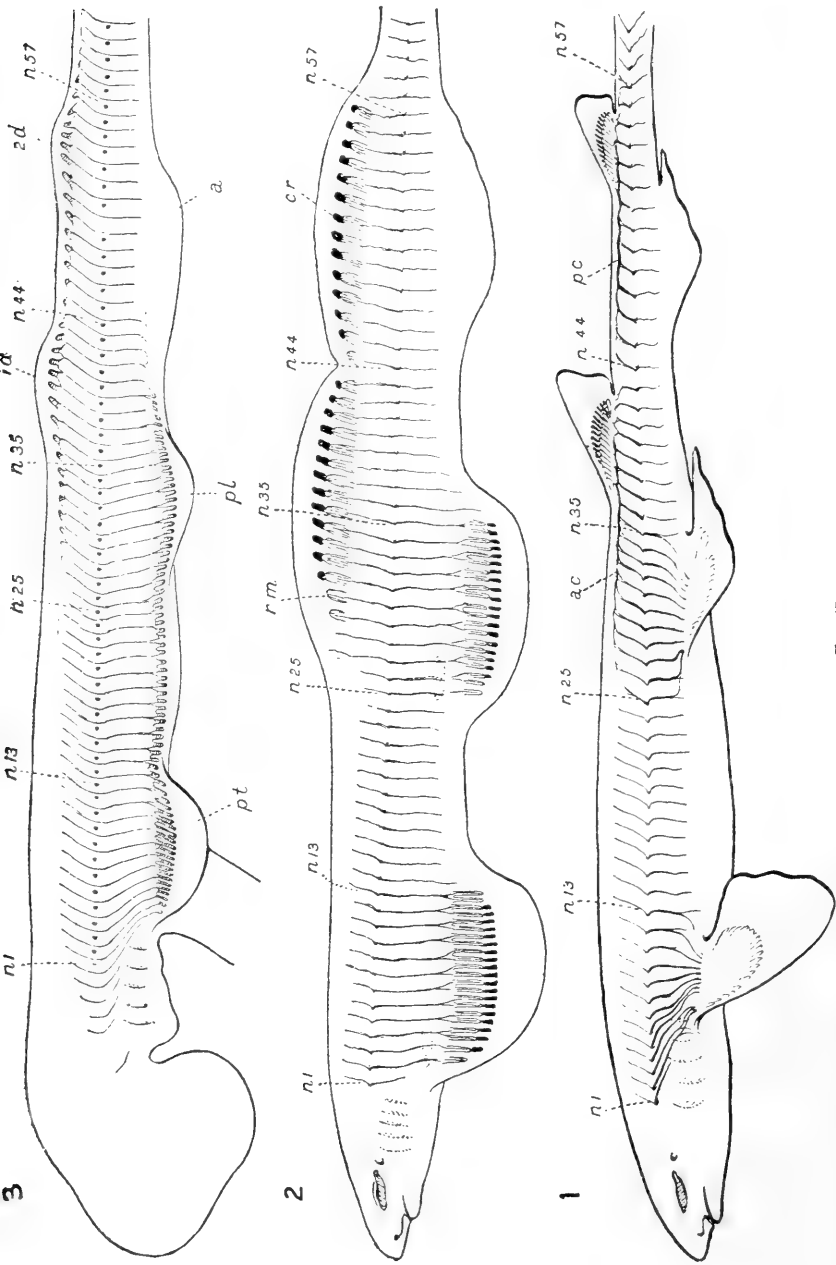

FIG. 47.

Diagrams of *Scyllium caucuta*. 1, the adult, showing the nerve-supply of the fins. 2, an adult with the fins expanded, and their nervous, muscular, and skeletal segmental elements distributed as if concentration had not taken place; the girdles are not shown, but the nerve-foramina in them are indicated by shaded oval areas. 3, an embryo, about 19 mm. long, in which are shown the ganglia, the myotomes, and the muscle-buds. a, anal fin; a.e., anterior collector nerve of first dorsal fin; c.f., (black) cartilaginous radial fin partially hidden by the radial muscle; a, 1-57, spinal nerves and ganglia; p.c., collector nerve of second dorsal fin; p.t., pelvic fin; p.l., pelvic fin; r.ab., radial muscle; r.pc., radial collector nerve; r.m., radial muscle; n.1 and 24, first and second dorsal fins. (From *Quart. Journ. Micro. Sci.*)

especially in front of the fins. Concrescence, the second factor, may introduce profound modification (Thacher [434], Mivart [300]). Not only do the skeletal radials often fuse, forming basal plates or jointed axes of most varied shapes (Figs. 48-50, 52-54), but the muscular segments also possibly mix to some extent in ontogeny, and lose their primitive metamerism.

The very important subject of the origin of the paired limbs of Gnathostomes must now be discussed. As it is generally agreed that the primitive form of these must have been the fin-like 'ichthyopterygium,' the evolution of the fish fin only need for the present be considered. What appear to be the less modified fish possess a pair of pectoral fins supported by a pectoral girdle behind the gills, and a pair of pelvic fins supported by a pelvic girdle passing just in front of the anus.

According to one theory, that of Gegenbaur [155, 157, 162], the paired limbs are modified gill-structures; the girdles representing the gill-arches, and the fin-fold and the fin-skeleton representing the gill-flap and its gill-rays. The position of the fins far back, especially of the pelvic fins, is explained as due to the shifting backwards or migration of these posterior arches, which have lost their original branchial function. This may shortly be called the gill-arch theory.

A second and rival theory, that of Balfour [27-29], Thacher [434], and Mivart [300], holds that the paired fins are of the same nature as the median fins, and have been developed from paired longitudinal lateral fin-folds; the somactidia, or endoskeletal radials, would, in both cases, have arisen for the stiffening of the fin-folds. The girdles would have been developed by the extension inwards of these rays so as to afford a firm basal support to the fins. This, the most generally accepted view, is known as the lateral-fold theory.

The paired fins develop, on the whole, just like the unpaired fins. They appear as longitudinal folds of the body-wall into which grows mesenchymatous mesoderm. Muscle-buds push their way into the fin-fold from the neighbouring myotomes (Dohrn [118], Rabl [336, 338], Mollier [301-302]), two growing out of the lower end of each myotome in the fin region in Elasmobranchs (Fig. 47), or one from each myotome in other forms. The buds spread outwards, dividing into upper and lower halves, which form the dorsal and ventral radial muscles of the adult fin. Endoskeletal radials, somactidia, are differentiated between the upper and lower muscle-buds. At first the girdle, basals, and peripheral radials appear as a continuous rudiment of pro-cartilaginous cells. Later on the individual elements seen in the adult arise as separate chondrifications, leaving non-cartilaginous joints (Balfour [28], Mollier [301], Ruge [377a]).

Since the girdles are ingrowths from the base of the fin-skeleton, it is natural that some of the nerves should become surrounded by them, and in the adult pass through foramina to supply the fin.

It is difficult to find any facts which actually support the gill-arch theory, and much evidence may be urged against it. If developed from gill-septa, lying across the long axis of the body, such transverse folds would rather hinder than favour progression. Moreover, the two pairs would presumably be at first close together, behind the other gills in a position very disadvantageous mechanically. Now, in ontogeny, a paired fin never makes its appearance as a dorso-ventral fold; but, on the contrary, always as a more or less longitudinal ridge.

The position of the pelvic fins is attributed (Gegenbaur) to their backward migration. But neither in primitive fishes generally nor in their early fossil representatives is there any evidence of a more anterior pelvic fin. When, as in some Teleostei (p. 425), the pelvic fins are far forwards, their position is on good evidence considered to be secondary.

The presence of rudimentary muscle-buds in front of the paired fins is supposed to indicate backward migration. This, however, can hardly be the case, since such buds are also found behind these same fins. It has been urged that the presence of a 'nerve-plexus' or collector nerve (Davidoff [97-99]) at and in front of the base of the pelvic fins, and that the greater extension of the collector in the young than in the adult, are evidence of backward migration. But, again, such a plexus and extension are found at the posterior end of the fins.

It is true that an attempt has been lately made (Fürbringer [143], Braus [48]) to account for the position of the pelvic fins by the assumption that the primitive Gnathostomes had much more numerous gill-arches extending much farther back than in known forms; but of this there is no evidence. That the paired limbs occupy very different relative positions on the trunk is an obvious and striking fact, which will be dealt with farther on (p. 79).

The gill-arch theory gives no intelligible account of the participation of a large number of segments in the formation of the musculature and nerve-supply of the paired limbs. Yet it is always the case that a considerable, and sometimes a very large number of nerves and myotomes contribute towards them; and the area from which they are supplied is wider than the actual base of the fin (Fig. 51). Speaking quite generally, the lower the class of vertebrate concerned, the more segments take part in the formation of the paired limbs (Braus [46]).

If the skeleton of the paired fins were derived from gill-rays, we should expect their muscle-supply to be drawn, not from the myotomes at all, but from the 'lateral-plate' musculature, inner-



vated from the dorsal roots (p. 3 and Fig. 1). In the head region although the visceral arches may be supplied with epi- and hypo-branchial muscles derived from myotomes, yet the great bulk of the musculature of these arches belongs to the lateral-plate mesoblast. It is true that the trapezius muscle, attached to the scapula, is of similar origin and is supplied from the vagus, but it does not penetrate into the fin; and, at all events, in the pelvic region there is no trace of other than segmental muscles. Still more inexplicable on Gegenbaur's theory is the position of the girdles with regard to the nerves, blood-vessels, coelom, etc. For, whereas these lie outside the gill-arches, in the case of the girdles we find not only that the relative position of the structures is reversed, but that the nerves often actually pierce the girdle to reach the fin. In fact, the girdles lie in the outer body-wall, while the visceral arches lie in the wall of the alimentary canal. Finally, this theory offers no explanation whatever of the striking resemblance borne by the paired fins to the median fins in every detail of structure and development—a resemblance so close that it can only be supposed that they are organs of essentially the same nature. Especially remarkable is the identity in structure of the dermal fin rays (pp. 122, 212).

Turning now to the rival fin-fold theory, it is found that if difficulties in its application do occur, yet the greater part of the evidence of embryology and of comparative anatomy is distinctly in its favour.

The paired limbs, especially the fins of fish, as already mentioned, always appear as longitudinal folds. The folds may be very short. The continuity of the folds from the pectoral to the pelvic regions is not really an essential point. Possibly from the first the paired fins, and indeed the median fins also, were discontinuous. Nevertheless, such facts as the great extension of the muscle-buds and of the 'nerve-plexus' both before and behind the fins [46], the concentration of the fins, the frequent presence of a greater number of buds in earlier than in later stages, the presence in some fish (such as *Pristiurus* and *Scyllium*: Dohrn [118], Braus [47, 50]) of such buds in all the trunk segments, may be considered as evidence supporting Balfour's view of the original continuity of the folds.

It has been convincingly shown (Thacher [434], Mivart [300]) that the various types of the endoskeleton of the median fins of fishes, with more or less well-developed basal plates, or rays branching from an axis (Figs. 48-50, 52), have been formed from a series of primitively discrete segmental radials (somactidia) by a concretion or fusion of their bases, often accompanied by concentration or gathering together at the narrow base of the fin (p. 106). That the similar manifold types of the endoskeleton of the paired fins have

arisen in the same way can scarcely be doubted. Indeed, it is

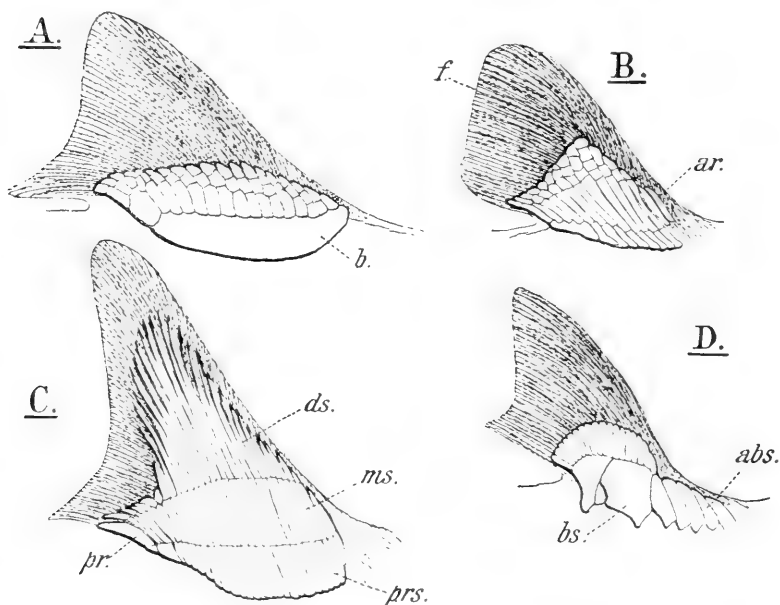

FIG. 48.

Dorsal fins, with the endoskeleton exposed, of: A, *Notidanus* (*Heptanchus*) *cinereus*, Gm.; B, *Ginglymostoma cirratum*, Gm.; C, *Zygaena malleus*, Risso; D, *Rhynchobatus djeddensis*, Forsk. (After Mivart.) *abs*, anterior radials lying on vertebral column; *a.r.*, anterior radial; *b.*, longitudinal basal; *bs*, basal; *d.s.*, distal segment of radial; *f.*, fin web supported by ceratotrichia; *m.s.*, median segment of radial; *p.r.*, posterior radial; *pr.s.*, proximal segment of radial. These figures illustrate the formation of basals by the concrescence of radials.

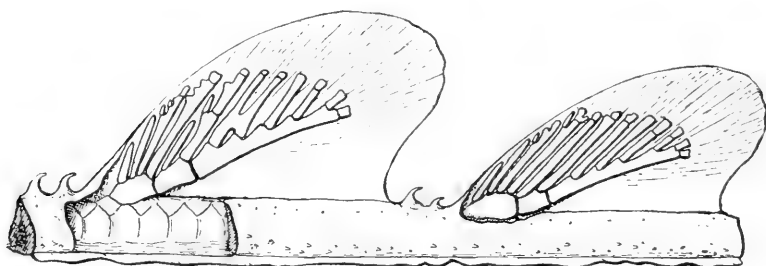

FIG. 49.

Left-side view of a portion of the tail of *Raja*. The vertebral column has been exposed in front, also the endoskeleton of the two dorsal fins, showing the concrescence of the radials at their base to form a posterior axis.

necessary to assume this even on Gegenbaur's theory, which derives the fin-skeleton from originally separate gill-rays.

The objection often raised that, in Elasmobranchs, the fin-radials

become differentiated in a continuous procartilaginous rudiment (Balfour [28], Ruge [337*a*]), and not as separate rudiments, applies equally to the median fins (Balfour, Braus [50, 176]). Moreover, in Teleosts, and possibly in many other fish, the radials are separate from the first (Harrison [197]). It is also urged that the metamerism of the radial muscles of the adult fin does not correspond to that of the embryo (Braus [50]). Now, although it may be true

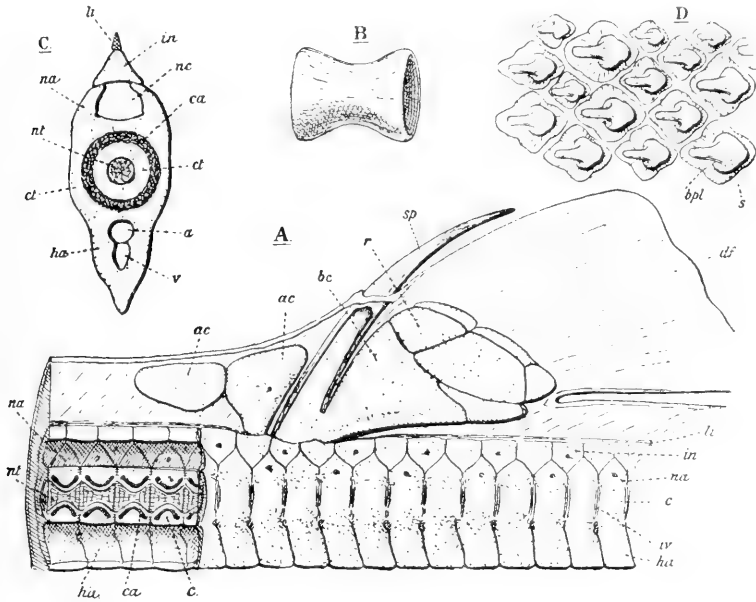

FIG. 50.

*Acanthias vulgaris*, Risso. A, dorsal fin and portion of the vertebral column which has been cut through longitudinally in front. B, calcified cylinder of a centrum. C, transverse section of the vertebral column, caudal region. D, surface view of denticles as disposed in the skin. a, canal for aorta; ac, anterior cartilages (either modified radials or neural spines); bc, basal cartilage; b.pl, basal plate; ca, calcified cylinder; ct, cartilaginous centrum; d.f, dorsal fin; h.a, haemal arch; in, interdorsal; iv, intervertebral ligament; li, dorsal ligament; n.a, neural arch; n.c, neural canal; nt, notochord; s, blunt spine; sp, fin spine, with base cut away to expose cartilage core; r, radial; v, canal for caudal vein. The cartilage is dotted.

that muscle-buds fuse at their base, that a nerve-plexus is formed, and that the substance of an adult radial muscle may not be derived entirely from one bud, yet it is doubtless derived mainly from that bud the position of which it continues to occupy throughout development, and the radial muscles correspond in number and relative position to the buds from which they have been formed (Figs. 47, 51). In this respect also the median resemble the paired fins. Indeed, it is very doubtful whether any fusion of neighbouring buds takes place at all in such low forms as the Elasmobranchs

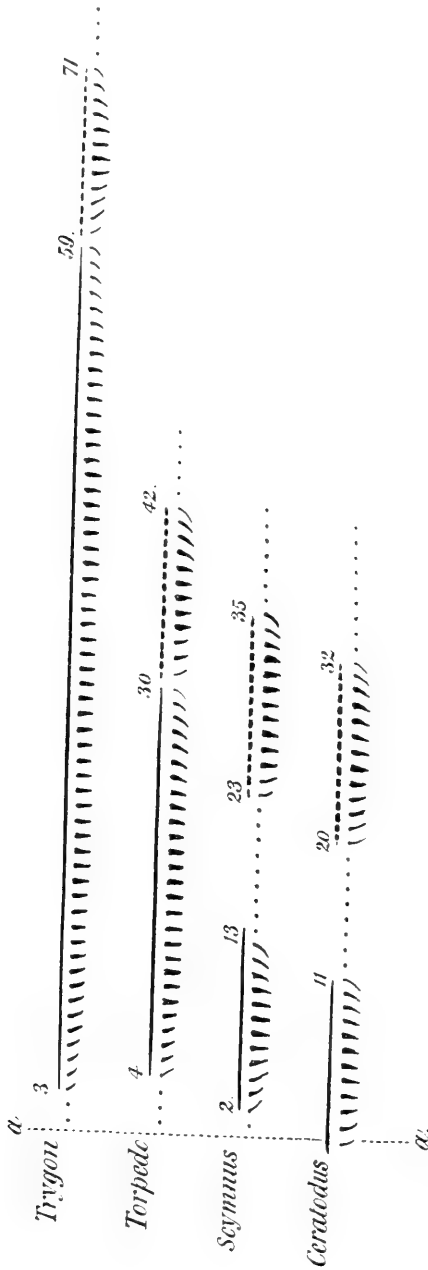

FIG. 51.

Diagrams, drawn to the same scale, indicating the nerve-supply of the paired fins in four fish. The spinal nerves are represented by the series of dots and strokes, the latter being those nerves which share in the formation of the 'limb plexus.' The thick horizontal line extends over the region supplying the pectoral fin, and the broken line over that supplying the pelvic fin. The line *a-a* shows the limit between the head and the trunk, and the numbers indicate the order of the true spinal nerves (from the results of H. Brauns).

(Goodrich [176]), and there is evidence that in *Raja*, for instance, the radial muscles of the pectoral fin retain the primitive metamerism.

We have now to account for the apparent migration of the limbs. Even if the ancestral Gnathostome had possessed continuous paired fin-folds, the position of the paired limbs cannot be accounted for in phylogeny merely by their persistence in certain regions and suppression in others. In all classes there has been perpetual

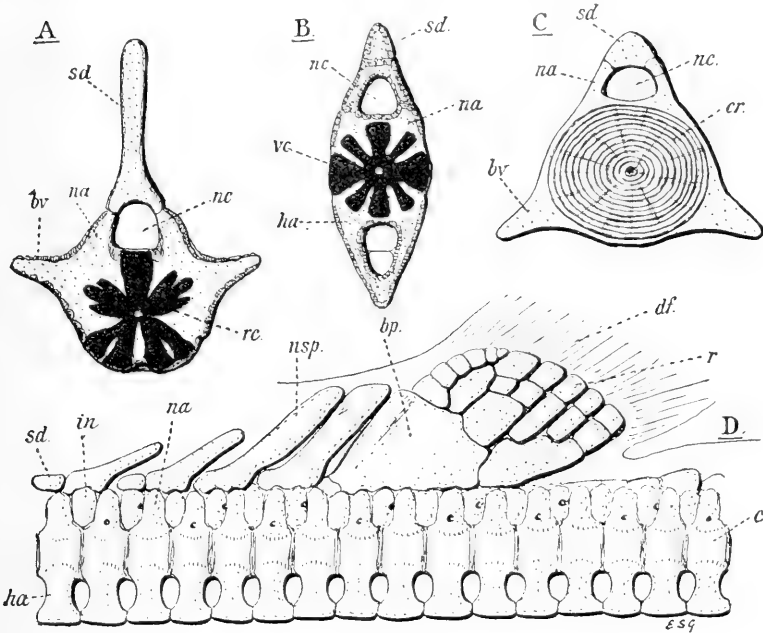

FIG. 52.

Transverse section through the centre of A, a trunk vertebra of *Raja*. B, a caudal vertebra of *Rhinabatus granulatus*, Cuv. C, a trunk vertebra of *Rhina squatina*, L. D, left-side view of a portion of the vertebral column, and of the skeleton of the first dorsal fin of *Rhina squatina*, L. *bp*, basal; *bv*, basiventral (haemal arch); *c*, centrum; *c.r.*, calcareous ring; *df*, dorsal fin; *ha*, haemal arch; *in*, interdorsal; *na*, basidorsal (neural arch); *nc*, neural canal; *n.sp.*, neural spine (or anterior radial); *r*, distal end of radial; *rc* and *re*, radiating calcification (black); *sd*, supradorsal.

alteration of the position occupied by the paired limbs, just as in the case of the unpaired fins of fish (Figs. 47, 51). It has been held (Gegenbaur) that these changes of position are due to the actual migration of the paired limbs from one place to another. Now embryology affords no evidence for this view. In ontogeny there is little or no migration of the whole fin. Considerable *apparent* motion is brought about by processes of concentration, growth, and reduction. It has already been mentioned that any trunk segment

may contribute to the production of a limb (p. 75), and we find that the segments of the region occupied by the limb in the adult always share in its development. The limb, as a whole, retains its position throughout ontogeny (Fig. 47). But if reduction takes place in front, and growth takes place behind or *vice versa*, if, in other words, certain segments cease to contribute at one end, and certain other segments begin to contribute at the other, then apparent motion takes place backwards or forwards. This may be further complicated by unequal concentration at the two ends. The nerve-

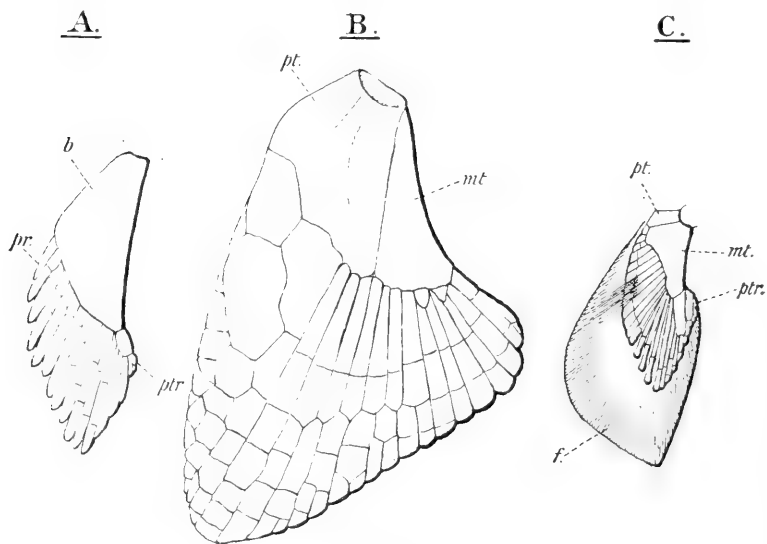

FIG. 53.

Skeleton of the pectoral fin of A, *Scymnus lichia*, Cuv. (after Gegenbaur); B, *Heterodontus* (*Cestracion*) *Philippi*, Lac. (after Gegenbaur); C, *Centrophorus calceus*, Gthr. (after Woodland). In the latter the web of the fin is represented. *b*, basipterygium; *f*, fin-web; *mt*, metapterygium; *p.r.*, preaxial radials; *pt*, propterygium; *ptr*, postaxial radials.

supply of the adult limb is a sure guide to the identification of the segments from which the muscles have been derived. Segments before and behind the limb-plexus may no longer enter into the formation of the limb owing to reduction; but the adult nerves undoubtedly show which segments contribute most to the musculature.

That, in a series of metameric myotomes and nerves, each motor nerve remains, on the whole, faithful to its myotome throughout the vicissitudes of phylogenetic and ontogenetic modifications, may be considered as established. However, by means of a nerve-plexus, nerves may come into secondary connection with muscles not originally belonging to them, at all events in the higher vertebrates (Tetrapoda). The nerve-plexus of a limb is brought about not by

the nerve deserting one muscle for another, but owing to the fusion of muscle-buds, or cells. Strictly speaking, even then the nerves probably remain faithful to the muscle substance of their own segment, though it may be combined in one muscle with fibres derived from other segments supplied by other nerves. The limb-plexus is, however, formed not so much by an intermingling of the nerves as by a gathering together of these nerves from a number of segments into common collector trunks (Fig. 47). This collecting does not necessarily disturb the metameric order of the structures concerned. It is due to concentration (Mollier [301], Goodrich [176]) in so far as it concerns the motor fibres, and alters neither their

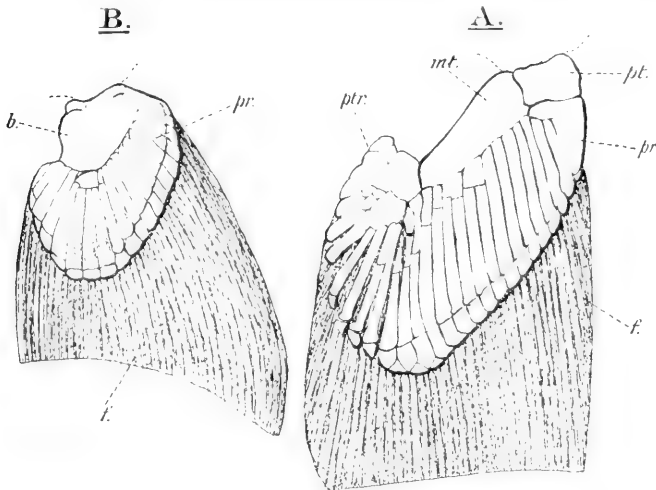

FIG. 54.

*Callorhynchus antarcticus*, Lac. The web of the fin, and the ceratotrichia, have been cut across. (After Mivart.) *b*, basipterygium; *f*, fin-web; *mt*, metapterygium; *p.r.*, preaxial radials; *pt*, propterygium; *pt.r.*, cartilages representing postaxial radials.

proximal roots nor their peripheral destination. Thus we find that even in such a fin as that of *Ceratodus*, the development of which is so abbreviated and obscured (Semon [400a], Braus [48]), the preaxial and postaxial muscles are regularly supplied from nerves belonging to segments in order from before backwards.

Now, as Fürbringer has shown in his admirable works [142, etc.], a limb-plexus shifts backwards or forwards like the limb it supplies. Its change of position can be accounted for neither by the theory of inter- and excalation of segments, nor by the supposition that the nerves actually move through the segments. It is, therefore, by progressive growth in one direction, and by corresponding reduction in the other, that change of position takes place. The motion is only apparent, and is not due to the

actual migration of the ready-formed material from one segment on to another, but may be said to be due to 'transposition' from one set of segments to another set up or down the series.

In the Teleosts, where within comparatively recent times the pelvic fins have shifted from an abdominal to a thoracic, and from a thoracic to a jugular position, the nerve-supply is correspondingly modified (Guitel [187]). In the last instance it may even be drawn to some extent from a segment supplying the pectoral fin (*Lepidoleprus* [Stannius, 416], *Uranoscopus* [von Jehring, 245]).<sup>1</sup>

In spite of the fact that the muscles in the fins of fish are not always attached to the cartilages, yet there is no reason to believe that the mesenchymatous mesoblast from which the latter are developed is not derived from the same segments. We conclude that the limbs are always developed from the segments corresponding to their position in the adult, as indicated by the nerve-supply. Change of position is not brought about by migration, but by progressive growth at one end accompanied by reduction at the other. Migration is apparent, not real.

Finally, with regard to the origin of the paired fins, it may be concluded that the position of the girdles in the body-wall, the perforation of these girdles by a number of nerves supplying the fins, the structure of the endoskeleton of the fins, the derivation of their musculature and nerve-supply from a large and varying number of segments, above all, the remarkable resemblances between the development and adult structure of the paired and unpaired fins, and the presence in both of exactly similar dermal fin-rays (p. 212), that these and other facts mentioned above are strong evidence for the lateral-fold theory, and receive their natural explanation from it.

In the Gnathostomata, the nasal sacs and the nostrils are distinctly paired. They do not come into connection with the hypophysis. The latter (Fig. 10) is always small and develops as an ingrowth of the ectoderm, on the roof of the buccal cavity, which grows towards the infundibulum. As a rule, it becomes nipped off, and converted into a glandular mass, the pituitary body, lying inside the cranial cavity, attached to the infundibulum.

The thyroid loses all trace of an endostylar structure, and forms a glandular mass. A large vascular organ, the spleen, is always present, situated near the stomach. The latter organ is generally well differentiated and U-shaped, and the intestine to some extent coiled. A renal portal circulation is established in the kidneys (p. 114).

The ear has one horizontal and two vertical semicircular canals.

<sup>1</sup> An investigation into the development of these fins is much needed, and would be sure to yield interesting results.



The dorsal and ventral roots of the spinal nerves of the trunk always combine to form mixed branches. The sympathetic nervous system becomes well differentiated, with segmental and visceral ganglia.

Other, and perhaps more important, differences are found in the structure of the urinogenital organs (p. 27). As already mentioned, we find a succession of excretory organs in the ontogeny of the Craniata, which is more thoroughly carried out in the Gnathostomes than in the Cyclostomes. Something must here be said concerning the development of these organs in the Craniata generally (see also p. 365).

A very large number of embryologists, among whom one may mention Balfour [26, 29], Sedgwick [395-6], Rückert [376-7], Rabl [337], Semou [397], Brauer [45], Kerens [258], van Wijhe [496], Field [137], Wheeler [486], Price [335], and Felix [135-6], have studied this subject in various groups. Felix has recently published an excellent summary of our present knowledge of it [136].

A pronephros is found in the embryo of all Craniates, although it generally appears to be incompletely developed, or degenerate. In Elasmobranchs and Amniota it is vestigial and probably never functional.

In the early stages of development the segmented mesoblastic somites separate off gradually from the unsegmented lateral mesoblast (p. 3), a slender stalk alone for a time connecting the two together. It is from this connecting stalk, generally containing a lumen whereby the myocoel communicates with the splanchnocoel, that the pronephric tubules arise, either directly or indirectly. This rudiment of the pronephric tubule, the nephrotome, may be nipped off as a solid block, which subsequently acquires a lumen and joins on to the lateral plate, or it may from the first be fused with the lateral plate (Teleost). In the typical fully developed organ each tubule resembles a mesonephric tubule, and consists of a segmental ciliated funnel opening into the coelom, the coelomostome (outer funnel, or primary nephrostome of the communicating canal). This leads by a narrow canal (Ergänzungskanal) to the renal chamber or capsule (Bowman's capsule of the Malpighian body, the 'urocoele'). Into this small chamber opens a funnel (inner funnel, or 'urostome') leading into the main renal canal. The renal capsule and its canal arise as an outgrowth of the tubule. All the pronephric tubules join a longitudinal duct, which passes backwards to open into the cloaca. This is called the pronephric duct, or segmental duct. Into the renal chamber projects a blood-vessel, supplied from the aorta, known as the glomerulus.

Now such a complete tubule is rarely found in the pronephros (Figs. 55, A; 56, A). It occurs, however, in Ganoids, Apoda (Gymno-

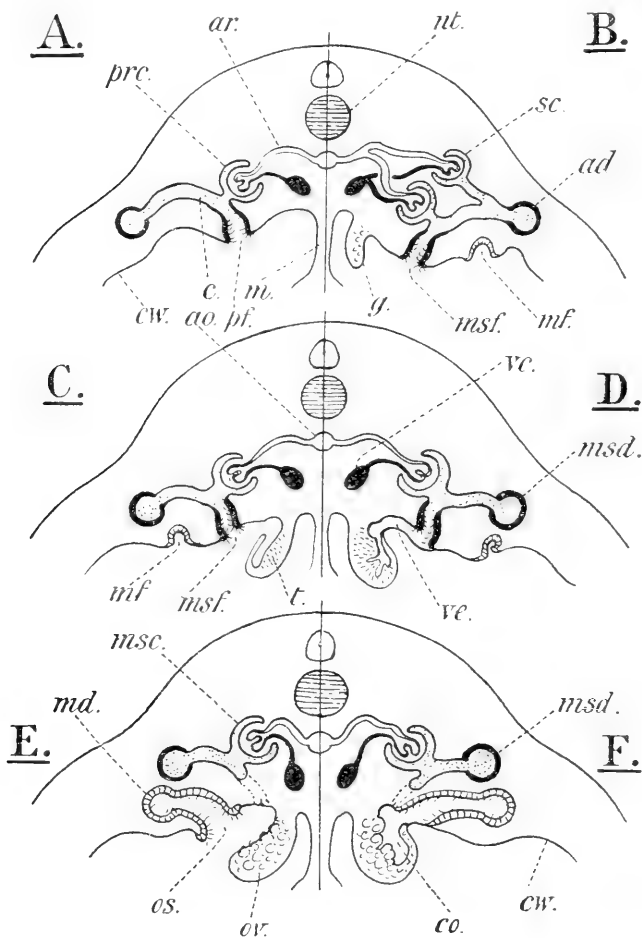

FIG. 55.

Diagrams of the urinogenital organs of the Craniata, seen in transverse sections of the trunk. A, pronephros; B, mesonephros; C, young stage in development of male; D, adult male; E, female with 'free' ovary; F, female with closed ovisac (*Lepidosteus* and most Teleostei). *a.d.*, archinephric duct (which becomes the mesonephric duct in all except A); *ao*, aorta; *ar*, artery to glomerulus; *c*, main tubule; *c.o.* cavity of ovary closed off; *c.w.*, wall of coelom; *g*, genital ridge; *m*, mesentery; *m.d.*, Müllerian duct; *m.f.*, Müllerian fold (developing duct); *ms.c.*, mesonephric capsule; *ms.d.*, mesonephric duct; *ms.f.*, mesonephric funnel; *nt*, notochord; *os*, ostium of oviduct; *ov*, ovary; *p.f.*, pronephric funnel; *v.c.*, cardinal vein.

phiona), and less typically in Myxinoids. As a rule, the pronephric tubules gradually dwindle at the anterior and posterior end of the organ, and even the middle tubules are often incomplete. For

instance, the renal capsule and glomerulus are only developed in the three groups just mentioned and the Teleostei. Generally the pronephros consists merely of coiled ciliated tubules leading from the coelom to the connecting duct. In some cases the renal chambers may fuse into a longitudinal pronephric chamber, and the glomeruli may also combine into a single 'glomus.'

A second set of blood-vessels may project into the coelom, near the coelomostome; these constitute the 'outer glomerulus' found in Actinopterygii, Dipnoi, most Amphibia, and Amniota. The region of the coelom surrounding the outer glomerulus may become incompletely separated off from the abdominal coelom, forming an 'outer chamber,' as in Ganoids, Anura, and Urodela, and to some extent in the Amniota. On the contrary, in others the coelomostome may, apparently, open out so that the renal chamber merges with the general coelom (Elasmobranch?, *Petromyzon*?).

It is important to notice that at first the tubules are strictly segmental, although subsequently they may shift and become closely packed together (Myxinoid), or even fuse to a single opening (Elasmobranch).

In the anterior region the longitudinal canal, which lies outside the somatopleure, is formed by the fusion of the distal extremities of the pronephric tubules (Fig. 56). Further back a region of varying length may be developed by a direct folding off of a longitudinal ridge of the somatopleure. Lastly, the terminal portion of the duct, which opens into the cloaca, is usually formed by the growing backwards of the free posterior extremity of the duct. Here, again, we meet with great variation. While in the *Gymnophiona* [45] the pronephric duct extends backwards almost entirely by free growth, in the Anura and Teleostei it develops to a great extent as a folding off of the somatopleure. Further, in the Cyclostomes there is evidence of the whole duct being really formed by the fusion of segmental rudiments representing tubules, much reduced in *Petromyzon* [486], but reaching fuller development in *Bdellostoma* [335].

The number of distinct tubules forming the head kidney, or pronephros, varies considerably. In the higher vertebrates it is never large—from two to six—but the number of rudiments is always larger. The *Gymnophiona* may have as many as ten [45], and the Myxinoids about twenty tubules.

The pronephros soon loses its importance as an excretory organ, and its function is assumed by the mesonephros (Wolffian body). With few exceptions (Cyclostomes, p. 43; and Teleostei, p. 364), the pronephric tubules disappear almost completely in the adult, or contribute to the formation of the funnel of the Müllerian

duct or oviduct (p. 90). The pronephric duct, however, persists, although it may become much modified.

There is no fundamental distinction between the pro- and the mesonephros; in the Myxinoids [335] and Gymnophiona [45] the transition from one to the other is gradual. Such differences as are found in the development appear to be chiefly due to the

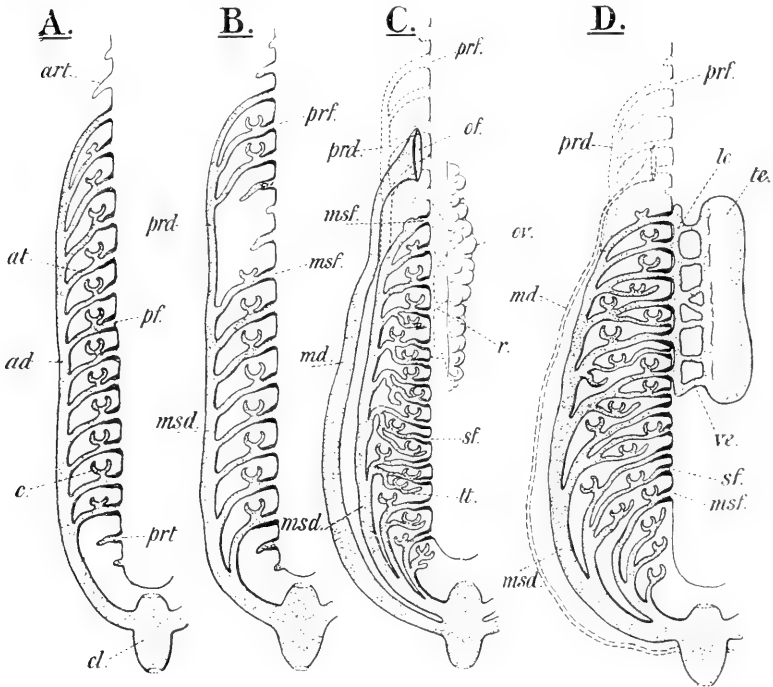

FIG. 50.

Diagrams of the urinogenital system in the Craniata. A, hypothetical ancestral stage with continuous archinephros. B, Cyclostome with anterior pronephros. C, female Gnathostome (adult). D, male Gnathostome (adult). *a.d.*, archinephric duct; *art.*, anterior vestigial tubule; *a.t.*, archinephric tubule; *c.*, Malpighian capsule; *cl.*, cloaca; *i.c.*, longitudinal canal; *m.d.*, Müllerian duct; *ms.d.*, mesonephric duct; *ms.f.*, mesonephric funnel; *o.f.*, coelomic funnel; *ov.*, ovary; *pf.*, coelomostome (funnel); *pr.d.*, pronephric duct; *pr.f.*, pronephric funnel; *pr.t.*, posterior vestigial tubule; *r.*, vestigial network of vasa efferentia; *s.f.*, secondary funnel; *t.t.*, tertiary tubule; *v.e.*, vas efferens. The vestigial oviduct and the embryonic pronephros are represented by dotted lines in C and D.

fact that, as the mesonephros arises later, the mesoblastic somites are by that time more completely differentiated.

The mesonephric tubule, like the pronephric, arises from the mesoblastic stalk (nephrotome, intermediate cell-mass, Ursegmentstiel) connecting the somite with the lateral mesoblastic plate. These rudiments generally become completely separated off from the somite, and sometimes also from the lateral plate, at an

early stage. They form more or less solid masses, which may fuse into a continuous strand on either side. Subsequently they become hollowed out, forming coiled tubules with Malpighian capsules (urocoeles) and glomeruli, and generally coelomostomes (mesonephric funnels) (Fig. 55, B). The main canal of the tubule grows outwards towards the longitudinal duct of the pronephros, with which it fuses. This duct is now partly or entirely converted into a mesonephric duct (Fig. 56, B). If the nephrotome has become completely separated off from the lateral plate, the opening to the coelom may be reacquired; but as a rule it persists throughout the development of the tubule. At first the mesonephric tubules are strictly segmental; in Myxinoids only do they remain so (p. 50). In other Craniates, at all events throughout the greater length of the mesonephros, a varying number of new tubules are formed from masses of cells nipped off from the first rudiment. All the mesonephric tubules are therefore derived from the same original series of rudiments by a sort of budding. These secondary tubules acquire the typical structure and relations, excepting for the coelomic funnel which is not developed. The tubules become crowded, and their metameric order is lost. The coelomostomes survive only in adult Elasmobranchs and Amphibia (Bles [36]). The mesonephric tubules are developed from the anterior to the posterior end of the abdominal cavity, but some tubules in front and behind may degenerate.

In some fish (Elasmobranchii) and in Amphibia the posterior region of the mesonephros is much more developed than the anterior, and functions as the chief excretory organ. But in the Amniota the mesonephros disappears almost entirely in the later stages of development, and is replaced behind by the permanent kidney or metanephros. In essential structure the metanephros resembles the mesonephros, but it never has any coelomostomes, shows no obvious trace of segmental order, and possesses its own duct, the ureter. Some authors believe the metanephros to be entirely formed by an outgrowth from the hinder end of the mesonephric duct (Minot, Schultze, etc.); but others have shown (Sedgwick, Schreiner, Felix [135], etc.) that only the ureter and the collecting tubes are so developed, the excretory tubules and capsules being derived from a separate rudiment. The metanephric rudiment is in the shape of a mass of cells continuous with the mesonephric rudiments in front, and derived like these from the intermediate cell-mass, but of more posterior segments. Coelomostomes are here permanently lost.

Much controversy has taken place with regard to the morphological significance of the three divisions of the excretory organ. One of three views may be held: they are merely three regions of a once continuous kidney, which have come to function,

and so to develop at different times; or they represent three organs; or again three separate longitudinal series of excretory tubules one above the other, homodynamous, but not strictly homologous. That the first view is, at all events in a general sense, correct can hardly be doubted now that we know that there is no essential difference between the pronephric and the mesonephric tubules (Sedgwick [296], Brauer [45], Price [335], Kerens [258]). When the pronephros and mesonephros appear to overlap, as seems to be the case in birds, for instance (*Felix*), the 'mesonephric' tubules of the pronephric segments are probably comparable to the secondary generations of tubules further back. It also seems clear that the metanephros represents merely the specialised and retarded hinder end of the series (Semper [404], Balfour [29], Sedgwick, Schreiner [390*b*]). The chief difficulty lies in the relations of the ducts.

We may assume, perhaps, with Rückert [376] that there was originally a metameric series of coelomostomes opening independently to the exterior (p. 27). Subsequently these fused at their distal ends to form a longitudinal duct opening behind. At this stage, then, the ancestral Craniate possessed an archinephros (Lankester), consisting of a continuous series of archinephric tubules opening into a single archinephric duct on each side (Fig. 56, A). No living Craniate presents such a structure, but obvious traces of it are seen in the Cyclostomes (*Bdellostoma*, Price [335]), where a continuous series of metameric tubule rudiments is formed, some of which become the pronephros and others the mesonephros. Some tubules disappear between the pro- and mesonephros; others disappear at the hinder end of the series. Here, in the Myxinoids, the metameric order is preserved in the abdominal region, no secondary tubules are formed, and the single duct persists.

In the Craniata, however, not only may several series of tubules be produced in the abdominal region (meso- and metanephros), but these only secondarily come into connection with the already completely developed longitudinal duct of the pronephros. If, as seems certain, this duct was originally formed by the fusion all along its course of archinephric rudiments, it would appear that the process of formation of the hinder region of the duct by the free growth backwards of the anterior portion is due to secondary modification, correlated with the late development of the hinder tubules. The pronephric tubules, together with the first series of mesonephric tubules (metamerically arranged and provided with coelomic funnels), would thus represent the original archinephric series. Possibly this series has been suppressed in the metanephric region. The limit between the pro- and mesonephros is not fixed, and differs considerably in the various classes; it is quite indefinite and has doubtless been gradually established. The front end of

the mesonephros and its duct may exactly resemble the pronephros both in structure and development.

We may conclude, then, that all the kidney tubules and their ducts are derived from one source, the nephrotome or intermediate cell-mass, that the multiplication of tubules takes place by a budding process from this rudiment, the earlier being more ventral and the later more dorsal; that the pro-, meso-, and metanephros are not so many regions of one single continuous series, but that, in the Petromyzontia and Gnathostomata, the mesonephros is formed of one primary and several generations of secondary tubules, the hindmost of which become further specialised as the metanephros.

The archinephric longitudinal duct (provisional pronephric) becomes bodily converted into the mesonephric duct, except in the Elasmobranchs, where a splitting takes place resulting in the formation of a Müllerian duct and a mesonephric duct. The significance of this fact is discussed below.

Some very important differences between the systems of excretory and genital ducts in the Cyclostomes and in the Gnathostomes must now be considered. As already mentioned (p. 45), in the former the excretory duct on each side remains single, and the generative cells escape to the exterior through paired short funnel-like openings at the hinder end of the abdominal coelom. The coelomostomes, in the Gnathostomata, retain to some extent their original function as genital ducts, and the single longitudinal archinephric duct is always replaced by two ducts. Where a metanephros occurs it also acquires its own special duct, probably by the gradual separation of the distal end of its tubules from those of the mesonephros, and their union to a common canal opening separately into the cloaca. Of the two ducts mentioned above the first is the Müllerian duct, which functions in the adult female as the oviduct; the second is the Wolffian duct, which, in the male sex, acts as a sperm-duct or vas deferens in all Gnathostomes, and also as a urinary duct in those Gnathostomes in which the mesonephros (Wolffian body) represents the adult kidney (Pisces and Amphibia).

In the male sex of all Gnathostomes the testis is shut off from the coelom, and (except in some Teleostomes in which the conditions are highly specialised, p. 364) its products are poured by means of fine canals, the vasa efferentia, into the tubules of the mesonephros, through these into the mesonephric duct, and so to the exterior (Figs. 55, D; 56, D). Originally the vasa efferentia probably extended along the whole length of the gonad (*Ceratodus*, *Lepidosteus*); later they became restricted to the anterior (Elasmobranch), or to the posterior region (*Lepidosiren*, etc.).

As in the case of the ovary, so in that of the testis, the primary

germ-cells sink below the coelomic epithelium, and give rise to a system of canals which generally join to a longitudinal testis-canal. From this runs the network of transverse canals, vasa efferentia; and these usually join again near the base of the mesonephros (Fig. 56) to a longitudinal canal, into which open the mesonephric tubules leading to the Malpighian capsules. This plan of structure is found throughout the Gnathostomes, with slight modifications, being only secondarily altered in some specialised groups (Teleostomes, p. 364; Anura). Thus, the spermatozoa are never shed into the body-cavity in the Gnathostomes.

The network of canals joining the testis to the mesonephros is derived from three sources in ontogeny: the testis canals, the fold of coelomic epithelium closing in the longitudinal canal (and vasa efferentia) near the base of the testis, and the kidney tubules which open into it. These three factors may contribute in varying proportions. The continuous system of canals in the male is, then, formed from a longitudinal chamber of the coelom closed off near the base of the genital ridge, into which open, on the one hand, the testicular canals, and, on the other, the mesonephric funnels (Fig. 55, C and D). Rudiments of these ducts may be present in the female (Spengel [414], Mihalkovics).

The female sex in the Gnathostomata presents a more primitive condition (again with the exception of some Teleostomes, which will be dealt with later, p. 367). The ova are shed into the abdominal coelom, and are carried out by the open-funnelled Müllerian ducts (Figs. 55, E; 56, C).

Much controversy has taken place concerning the exact homology of the genital ducts; into the details of the question we need not enter here. Putting aside for the present the Teleostomes (p. 367), it may be pointed out that both the Müllerian and the Wolffian duct are present in both sexes; and that, while the latter is clearly the mesonephric duct, the real difficulty lies in determining the homology of the former.

That the oviducts in the Elasmobranch, the Dipnoan, the Amphibian, and the Amniote are homologous structures cannot be doubted on the evidence of comparative anatomy; the position of the ostium abdominale, the course of the duct running along the abdominal wall outside the mesonephros, the posterior opening into the cloaca—these and other characters are essentially similar in all the Gnathostomes mentioned above. Yet on the uncertain evidence of embryology this conclusion is sometimes denied.

It has been clearly demonstrated (Balfour [27], Rabl [337]) that the archinephric duct, in the Elasmobranch embryo of both sexes, becomes split into two from before backwards, in such a way that the pronephric tubules remain connected with one of the resulting tubes (the 'pronephric' or Müllerian duct), and



the mesonephric tubules with the other (the mesonephric or Wolffian duct). Meanwhile the pronephric funnels fuse to a single opening (ostium abdominale), which shifts backwards to open at the anterior end of the abdominal coelom (p. 132). In the male the Müllerian duct undergoes more or less complete degeneration, especially in its middle region. On the contrary in the female, the Müllerian duct enlarges into the oviduct of the adult. From this it was concluded that the pronephric duct became modified into the oviduct.

In the Amniota, however, no such intimate connection between the developing oviduct and the pronephros can be traced. As a rule, the duct arises in front from a groove or outgrowth of the coelomic epithelium, along the mesonephric ridge, which then grows freely backwards to open into the cloaca. The groove, which is not directly derived from pronephric funnels, gives rise to the abdominal funnel; the free process to the tube of the oviduct. At first sight these facts seem quite irreconcilable with the account of the development of the duct in the Elasmobranch; but, if we reflect that the kidney tubules and ducts are themselves outgrowths of the coelomic epithelium, the difference does not appear so fundamental. In the Elasmobranch the rudiments of both the pronephric tubules and oviduct come off together and separate later; in the Amniote they appear separate from the first. Moreover, the distinction between the two modes of development is to some extent broken down by what we know of the ontogeny of these organs in the Amphibia. Here the Müllerian duct is formed to a greater extent from a groove-like outgrowth, which grows backwards close to the pronephric duct, and possibly to some extent is derived from the latter. The oviducal funnel has been shown (Rabl [339], Hall [192*a*]) to be either partly derived from (*Salamandra*) or developed in close connection with the pronephric funnels (*Amblystoma*).

It should not be overlooked that most of the speculations on the homology of the oviduct have been biassed by our knowledge of its development in the Elasmobranch, which is more complete and was earlier acquired than that of the origin of the oviduct in other forms. The derivation of the Müllerian from the archinephric (pronephric) duct may not be primitive at all, and it might well be held that, whereas in all other Gnathostomes the oviduct develops more or less directly from the coelomic epithelium, in the Elasmobranch alone has its rudiment become secondarily involved with the rudiment of the pronephros.

A knowledge of the development of these organs in the lowest Teleostomes, and especially in the Dipnoi, would doubtless shed great light on the subject. In conclusion it may be said that: throughout the Craniata the mesonephric duct is the converted archinephric (pronephric) duct; and that the oviduct (Müllerian

duct) is directly or indirectly derived from the coelomic epithelium, and may be connected in development with the pronephros. All these ducts and tubules, whether urinary or genital, being coelomostomes in origin. Provisionally one may suppose that the function of carrying the ova to the exterior early became restricted to the more anterior coelomostomes, belonging probably to the pronephric region, and that the spermatozoa, on the other hand, passed out through the coelomostomes of the mesonephric region.

The chief characters which distinguish the Gnathostomata from the Cyclostomata may be summarised as follows:—There is a general advance in the complexity of the various systems of organs, and in histological differentiation. The primitive metamerism is more completely obscured by specialisation, especially in the head region, where several postauditory myotomes become reduced, and several occipital segments are added from behind to the skull. The vagus and some components of the hypoglossal nerve thus come to pass out through the skull wall. A dermal exoskeleton arises superficially, and the whole endoskeleton becomes much more developed; true teeth are present. The pituitary ingrowth is small, and remains below the infundibulum. The nostrils and nasal capsules are paired; the ear has three semicircular canals. The first visceral arch forms an upper and a lower biting jaw. Paired pectoral and pelvic limbs are developed (in fish similar in structure to the unpaired fins). A renal portal system occurs in the kidney. A spleen is present. The genital products are carried to the exterior by ducts. In the female an oviduct is developed from the coelomic epithelium. The spermatozoa of the male are never shed into the body-cavity, but escape through the mesonephric tubules and duct to the exterior.

The Branch Gnathostomata, including the five Classes Pisces, Amphibia, Reptilia, Aves, and Mammalia, was divided by Huxley [229] into the Ichthyopsida (Pisces and Amphibia), the Sauropsida (Reptilia and Aves), and the Mammalia. Since this classification expresses rather the existence of three grades of structure than of three divergent phylogenetic lines of development, it will not here be adopted. The Reptiles must be placed next to the Amphibians in any phylogenetic scheme.

The Gnathostomes might be divided into the Ichthyomorpha (Pisces) and the Tetrapoda (Amphibia, Reptilia, Aves, Mammalia). But, again, there are serious objections to the isolation of the first group, although the second seems genuine enough. For the Class Pisces includes a heterogeneous assemblage of sub-classes, from some one of which, no doubt, the Tetrapoda have been derived. Therefore, until our knowledge of the internal relationships of the

Class Pisces is more advanced, until it can be split up into its phylogenetic constituent branches, it is best to preserve it as a provisional group of convenience, representing the first Grade of the Gnathostomata.

### Grade I. Class PISCES.

This, the lowest Class of the Gnathostomata, contains all the true fish. Like the Cyclostomes, they are still adapted to an aquatic life, and preserve many primitive points of structure which must have characterised the early ancestors of all Gnathostomes.

Throughout life the Pisces breathe by means of gills borne on the visceral arches. The gill-slits are formed by ectodermal pits meeting endodermal outgrowths. But whereas in the Cyclostomes the inner pouches are large, and give rise to the gill-lamellae by a folding of their endodermal lining, in the Pisces the ectodermal pits are relatively more developed. Their gill-slits are closely approximated and transversely elongated; and open, as a rule, widely both inwards and outwards. The gill-lamellae tend to grow towards the exterior; and, indeed, arise in the embryo of the higher fish (and Amphibia) as projections of the ectoderm, into which pass branches of the primary aortic arch. But the difference is more apparent than real, and even in these cases the endoderm seems to grow outwards below the ectoderm, forming a gill-lamella with merely a superficial covering of ectoderm (Greil [185-6]).

Goette [169] considers that the gill-lamellae of the Cyclostomes and of the Gnathostomes are not homologous (except perhaps the spiracular gill). There can be little doubt, however, that the gills of all the Craniata are really derived from some common origin (Dohrn [114*a*, 115]). Possibly they are divergent forms from some original less specialised gill in the covering of which both the ecto- and the endoderm took a share (Moroff [303]). The ectoderm spreading inwards seems to have gradually encroached upon the endoderm; less, however, in the gill-slits of Elasmobranchs than in those of higher fish.

The structure of a free branchial bar is very constant in the Pisces. Along its inner edge is the skeletal arch (Fig. 57); outside this in the embryo is the coelomic canal, opening below into the pericardial cavity. From the walls of this canal (lateral plate) are developed the visceral muscles. The primitive aortic arch passes along the posterior face of the bar; but in the adult it becomes variously broken up into an efferent (branchial vein) and one or two afferent vessels (branchial arteries), communicating with each other through the lamellae. The vessels run up the outer side

of the skeletal arch, the efferent being always the innermost next to the arch.

Since, in each gill-pouch, the branchial lamellae are usually distinctly grouped in an anterior row on the posterior face of one bar, and a posterior row on the anterior face of the next bar (Fig. 26), each complete gill is said to consist of two hemibranchs.

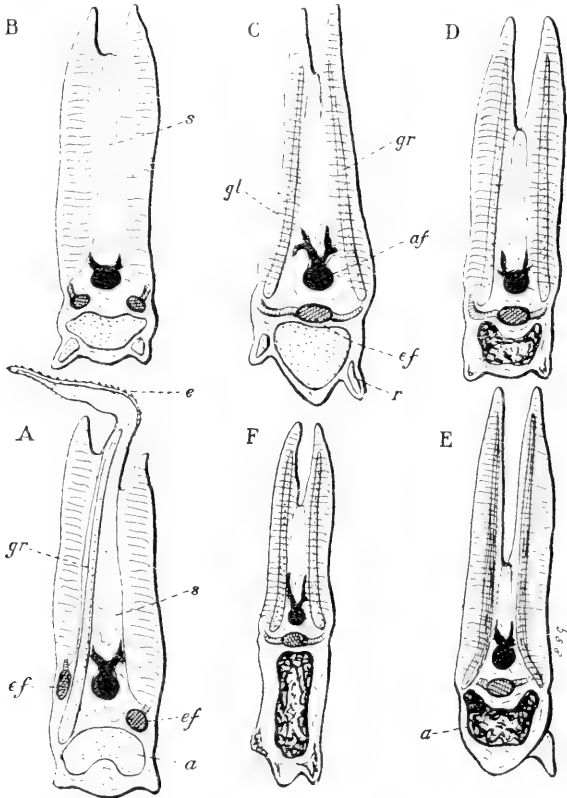

FIG. 57.

Sections across the gill-arch of A, *Mustelus*; B, *Ceratodus*; C, *Acipenser*; D, *Lepidosteus*; E, *Salmo*; F, *Polypterus*. *a*, skeletal arch; *af*, afferent artery (black); *e*, septum reaching external surface; *ef*, efferent artery (cross hatched); *gl*, gill-lamellae; *gr*, supporting gill-ray; *r*, gill-raker; *s*, septum, largest in A, and smallest in E. Anterior lamellae to the right.

In the reduced first or spiracular gill-slit is present never more than one hemibranch, the anterior or 'mandibular,' borne on the mandibular arch. The hyoid bar may bear a posterior 'hyoidean' hemibranch; and the succeeding bars may each have a complete gill (or holobranch). The last bar, embedded in the body-wall, can, of course, never bear more than an anterior hemibranch, and is

generally gill-less. The way in which the gills and the visceral arches become specialised is of great importance in classification.

Primitively, no doubt, each gill-pouch opened independently to the exterior, as is still the case in most Elasmobranchs. The region between consecutive gill-pouches became narrowed to a thin septum bearing the gill-lamellae (Fig. 26). The skin, with its exoskeleton, was still continuous along the outer edge of the septa.

In most fish, however, the free edge of the hyoid gill-flap, the septum of the hyoid arch, grows backwards as an opercular flap covering the branchial openings. Accompanying the development of this operculum (Figs. 26, 57) is a reduction of the other septa, so that the gill-lamellae come to project freely at their outer ends in the branchial chamber.

It is impossible as yet to decide what was the original number of gill-slits and arches in the common ancestor of the Pisces. But, since seven branchial slits and arches are found behind the hyoid arch in some living Selachians (*Heptanchus*, p. 140), and traces of a seventh arch may be identified in the larynx of Amphibia, it seems probable that the early forms had at least eight gill-slits (counting the spiracle). This conclusion is supported by the discovery of vestiges of gill-clefts, behind the normal six, in some living fish, and by the fact that the number of clefts becomes progressively reduced from behind forwards in more specialised forms (five branchial slits in most fish, four in Holocephali, three in many Teleosts).

The primitive jaws, derived from the first visceral arch (p. 18), become directly or indirectly attached to the skull. In front, the upper or palato-quadrato bar is generally movably connected with the lateral ethmoid region of the skull by the palato-basal or ethmoid process. Behind, the quadrato region of the bar may either be directly fused to the auditory capsule (Dipnoi, Fig. 206), or it may be supported away from the skull by the dorsal element of the hyoid arch, the hyomandibular (Selachii, Teleostomi, Figs. 58, 59), or again it may be connected with the auditory capsule both by an articulation above and by the hyomandibular (Notidani, Fig. 59). Huxley [230] named these three types of skull and jaw suspension autostylic, hyostylic, and amphistylic respectively. In the autostylic type the hyomandibular becomes much reduced, and may disappear. In the hyostylic type, on the contrary, it becomes very large, and may give rise to a separate ventral element, the symplectic. The amphistylic type appears to be the least specialised of the three, and here the hyomandibular is only moderately developed. The structure of the suspensorial apparatus is of great importance in classification, but it must be borne in mind that convergence may occur. For instance, a pseud-autostylism has been almost certainly

developed in at least two cases, *i.e.* the Holocephali and the Teleostei (p. 437).

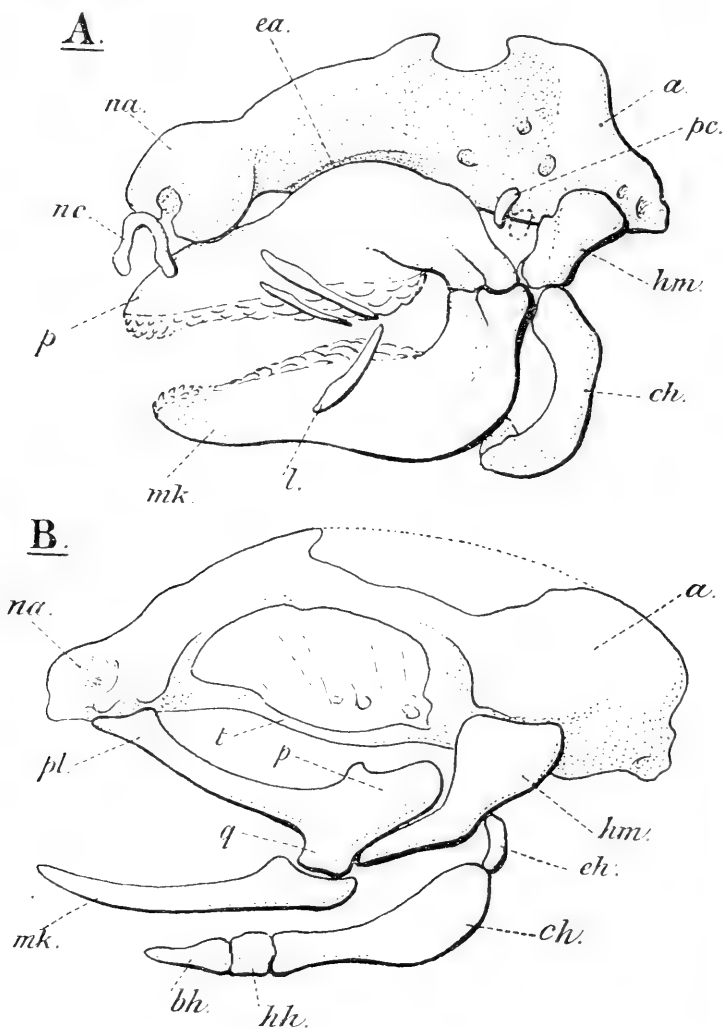

FIG. 58.

Skull, jaws, and hyoid arch of A, *Heterodontus (Cestracion) philippi*, Lac.; and B, *Salmo* (after Parker, modified). *a*, auditory capsule; *bh*, basihyal; *ch*, ceratohyal; *ea*, ethmoid articulation; *ch*, epihyal (stylohyal); *hh*, hypohyal; *hm*, hyomandibular; *l*, labial; *mk*, Meckel's cartilage; *na*, nasal capsule; *nc*, nasal cartilage; *p*, palato-quadrate; *pc*, prespiracular; *pl*, palatine region; *q*, quadrate region; *t*, trabecula. A dotted ring indicates the spiracle in A.

To grasp the full significance of Huxley's comparisons of these various modes of attachment of the jaws, we must briefly refer

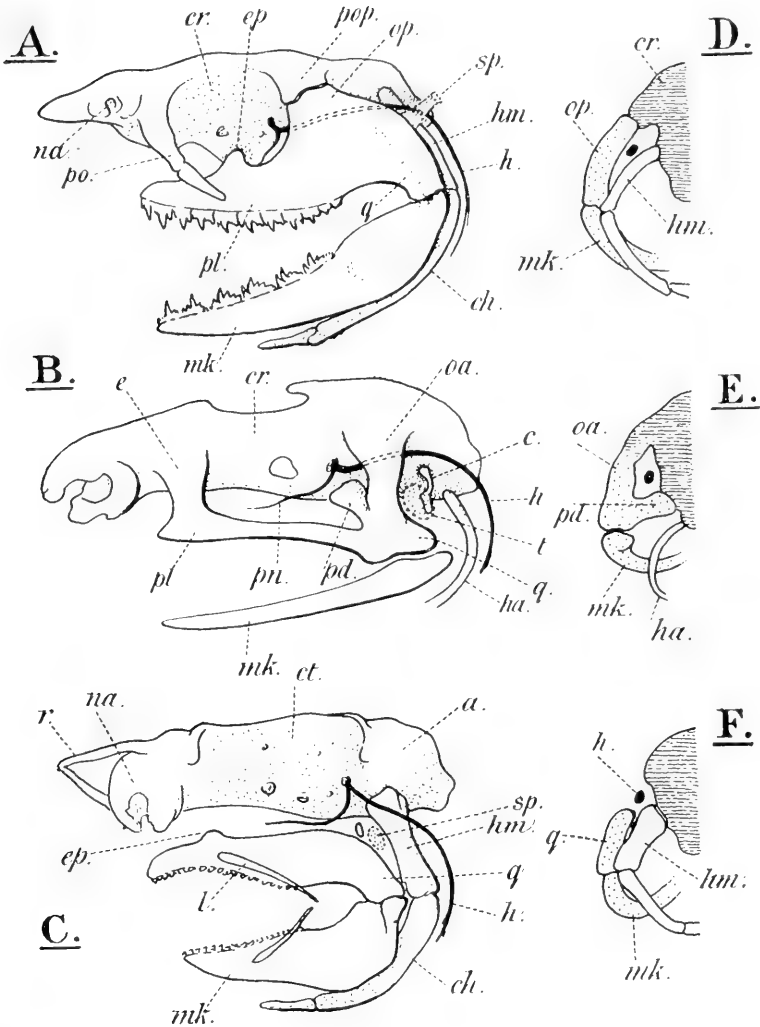

FIG. 59.

Diagrams of, A and D, an amphistylic skull (*Heptanchus*), B and E, an autostylic skull (*Rana*), and C and F, a hyostylic skull (*Seyllium*). A, B, and C, left-side views. D, E, and F from behind (the mandibular arch being dotted, and the cranium shaded). c, columella auris; ch, ceratohyal; cr, cranium; e, junction of ethmoid and palatine cartilages; e.p, ethmoid process; h, hyomandibular branch of facial nerve; h.a, hyoid arch; hm, hyomandibular; l, labial; mk, Meckel's cartilage; na, nasal capsule; o.a, junction of otic process of quadrate with the auditory capsule; o.p, otic process; pd, palato-basal process; pl, palatine region; p.n, palatine branch of facial nerve; po, preorbital process; po.p, postorbital process; pt, palato-quadrate cartilage; q, quadrate region; r, rostral process; sp, spiracle; t, tympanum.

to the condition found in the lower Pentadactyle vertebrates (Amphibia and most Reptilia). In these the palato-quadrate arch is not only continuous in front with the ethmoid region of the cranium, but also behind with the auditory region. The quadrate is forked proximally; the lower limb, or pedicle of the suspensorium, is usually fused with, or firmly fixed to, the anterior outer region of the ear capsule; the upper limb, or otic process, is fused to this capsule above. In the canal so formed, between the limbs of the quadrate and the capsule, the hyomandibular branch of the facial nerve passes backwards to its peripheral destination, crossing over the spiracular gill-cleft (or Eustachian tube and tympanic cavity, Fig. 59, B). The postspiracular hyomandibular cartilage takes no share in the support of the upper jaw. This is the typical autostylic attachment, which among the Pisces is found in the Dipnoi only.

In the amphistylic Notidanidae, the superior otic process (Fig. 59, A) would appear to be represented by the large upgrowth of the quadrate region of the upper jaw, which articulates with the post-orbital process of the auditory capsule, and passes outside and above the hyomandibular nerve. In the anterior palato-basal process, which articulates more ventrally with the cranium behind the optic foramen, Huxley saw the representative of the 'pedicle of the suspensorium.' The relation this process bears to the nerves, however, shows that this view is untenable. Possibly the pedicle is not represented at all in Elasmobranchs, and the anterior process probably represents merely the ethmoid process, found articulating in front of the orbit in most fish. It has shifted back in the Notidanidae, which are provided with an exceptionally wide gape.

Gegenbaur looked upon the articulation of the otic process as representing the primitive attachment of the arch [153]. Huxley, on the contrary, considered it to be secondary [230]. It would certainly seem that the mandibular arch must have been originally attached more ventrally, below the nerve exits (by the palato-basal process) like the other visceral arches. Nevertheless, the otic articulation appears to have been established very early, since there is reason to believe that it existed not only in the Jurassic Cestraciontidae (*Hylodius*, p. 144), but also in the Cladoselachii (p. 185), *Acanthodii* (p. 189), and *Pleuracanthodii* (p. 180).

The notochord secretes an outer thin elastica externa and an inner fibrous sheath, often very thick (Hasse [201], Klaatsch [265], Schauinsland [384]). Outside there is the mesoblastic skeletogenous layer (Fig. 60). Neural arches develop in this layer, and also haemal arches, which in the trunk are represented by lateral basal processes (parapophyses). In some fish, Polypteridae and the



Actinopterygii, the notochordal sheaths remain unbroken throughout ontogeny, the vertebral centra being formed round them intersegmentally. Generally the vertebral rings, or half-rings, developed in connection with the arches constrict the notochord, so as even to obliterate it in the middle of each centrum (Fig. 94).

In other fish, the Dipnoi, the mesoblastic cells of the skeletogenous layer at the base of the arches pierce the thin elastica

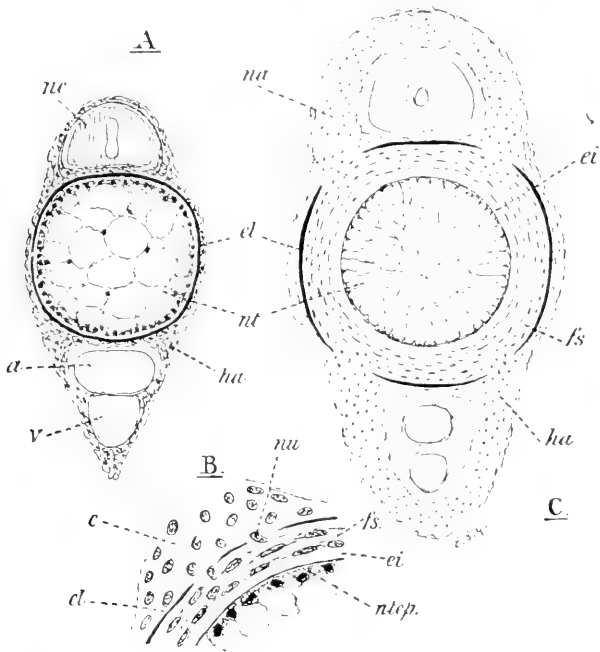

FIG. 60.

*Scyllium canicula*, L. Transverse section of the vertebral column of the tail of a young embryo. A, the base of the neural arch in an older embryo; B, of a later stage; C, all magnified. a, caudal artery; c, cartilage; ci, 'elastica interna' or inner layer of the fibrous sheath; cl, elastica externa; fs, fibrous sheath which becomes invaded by mesoblastic cells; ha, haemal arch; na, neural arch; nc, nerve-cord; nt, notochord; ntop, notochordal epithelium; nu, nuclei of mesoblastic cells passing through the broken elastica externa; v, caudal vein.

externa, and invade the fibrous sheath into which they migrate at four points in its circumference in each segment. Here they give rise to a small amount of cartilage; without, however, forming distinct centra (Fig. 204). But in the Elasmobranchs the invasion is much more thorough. Almost the whole thickness of the wide sheath is formed of intrusive mesoblastic tissue in late stages. The original fibrous sheath often remains next to the notochord as a clear thin layer, the so-called elastica interna (Fig. 60). Both

inside and outside the *elastica externa* the mesoblastic tissue may develop into cartilage, continuous with the arches, and forming hour-glass-shaped centra constricting the notochord segmentally. The remains of the ruptured *elastica* may thus become buried in the centrum.

Such centra, formed at all events partly inside the sheaths, are called chordal centra, in contrast to those of the first type, the perichordal centra, which develop outside the sheaths.

The structure of the vertebral column is by no means uniform. A varying number of elements may serve to arch over the neural and haemal canals, and the centra themselves may show traces of a complex build. Attempts have been made to reduce the various types of structure of the vertebral column, not only of the Pisces, but also of the Tetrapoda, to a single scheme of homologous parts (Gadow and Abbott [146], Schauinsland [384]). But it is doubtful whether such a proceeding is really justifiable, since the different types may well have been independently developed. Moreover, when comparing different regions of the vertebral column together, authors often try to interpret the structure in agreement with some artificial scheme uniform throughout; but it should be remembered that there is no reason to believe that the arrangement of the dorsal elements was ever exactly like that of the ventral, or that of an anterior segment ever exactly like that of a posterior.

The elements entering into the composition of a single vertebral segment are very variable, both in number, in size, and in shape. Yet it appears to be possible to reduce them to the following common plan of four chief paired elements. The neural canal is arched over by two elements: the neural arch (basidorsal [146], caudal arch [384]) behind, and the intercalary arch (interdorsal [146], cranial arch [384]) in front. Below are found corresponding elements enclosing the haemal canal: a haemal arch (basiventral [146], caudal arch [384]), and an interhaemal arch (interventral [146], cranial arch [384]). The interdorsals, and especially the interventrals, are liable to reduction. It is very difficult in ontogeny to follow the exact limits between consecutive segments, since the myocommata spread out when they reach the vertebral column, and the myotomes become very much bent. But the blood-vessels passing upwards from the aorta and cardinal veins may be taken to indicate the original anterior limit of a segment. The spinal nerves pass out in front of the vessels to reach the myocommata (Fig. 45). The neural arch lies between the nerve and the vessel. The basidorsals and interdorsals vary greatly in relative development; they frequently surround the nerve-roots. The roof of the neural canal may be closed above (as in Elasmobranchs) by a row of median or paired elements, the supradorsals. On the top of these runs the longitudinal ligament. Above this

ligament generally occur a row of spinal elements. These median spines form the connecting link between the axial skeleton of the vertebral column (see pp. 69 and 105) and the appendicular skeleton of the median fins; possibly (Goette [167]) they should be reckoned rather with the latter than with the former.

Assuming that the different types of vertebral arches found in fish have been evolved from such a primitive complex structure, we find that in the course of specialisation the basidorsals and basi-ventrals persist generally as the most important elements, while the others tend to disappear, or to fuse with them.

Both the dorsal ribs and the pleural ribs may be considered as

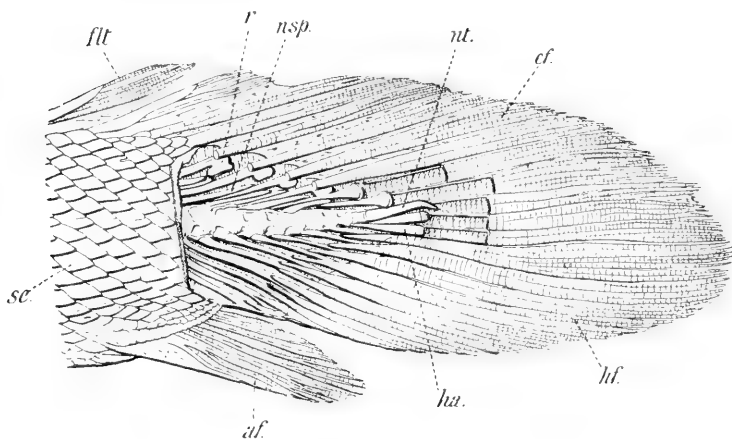

FIG. 61.

Dissected tail of *Polypterus bichir*, Geoffr. (After K lliker.) *af*, anal fin; *cf*, epichordal fin; *flt*, dorsal finlet; *ha*, haemal arch; *hf*, hypochordal fin; *n.sp.*, neural spine; *nt.*, slightly upturned tip of the notochord; *r*, endoskeletal radial; *sc*, scales. The proximal ends of the dermal rays have been cut off to expose the radials and tip of the notochord. This tail is probably secondarily diphyceal.

prolongations of the basiventrals; these basals may remain separate or 'autogenous' when ossified (in many primitive Teleostei (Figs. 336, 358), tail of *Amia*, etc.), or they may fuse with the centra. Either the ribs or the basiventrals may undergo reduction and disappear.

In the formation of the haemal canal behind the abdominal region it is the basiventral, not the pleural rib which becomes the haemal arch. The haemal spine is sometimes separate (*Amia*), but often appears to be merely a prolongation of the arch (most Teleosts, Fig. 63), and the ribs may persist as well (Fig. 336).

In no fish with a heterocercal or homocercal tail are the haemal spines and radials typically represented in the hypochordal fin (p. 104).

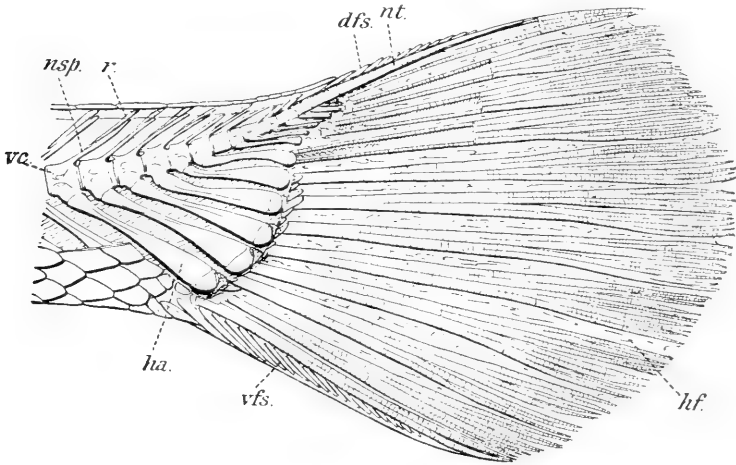

FIG. 62.

Dissected tail of *Lepidosteus*. (After Kölliker.) *dfs*, dorsal fulcral scales; *ha*, expanded haemal arch; *hf*, hypochordal fin; *n.sp.*, neural spine; *nt*, upturned tip of the notochord; *r*, dorsal radial; *vc*, vertebral centrum; *vfs*, ventral fulcral scales. The proximal ends of the dermal rays have been cut off to expose the endoskeleton.

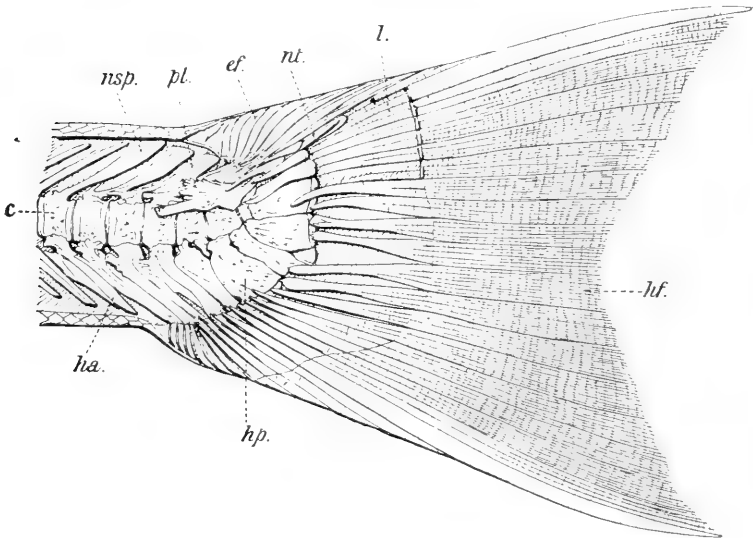

FIG. 63.

Dissected tail of *Salmo*. (After Kölliker.) *c*, centrum of caudal vertebra; *ef*, epichordal dermal ray; *ha*, haemal arch; *hf*, hypochordal fin; *hp*, expanded haemal arch or hypural; *l*, dermal ray of opposite (right) side; *n.sp.*, neural spine; *nt*, upturned extremity of the notochord; *pl*, covering bony plate (modified neural arch?).

This ventral lobe is invariably supported by single rigid skeletal pieces, the haemal arches. Some traces of subdivision may be found in Elasmobranchs, and distal nodules of cartilage may be present in these and other fish; but it is still an open question

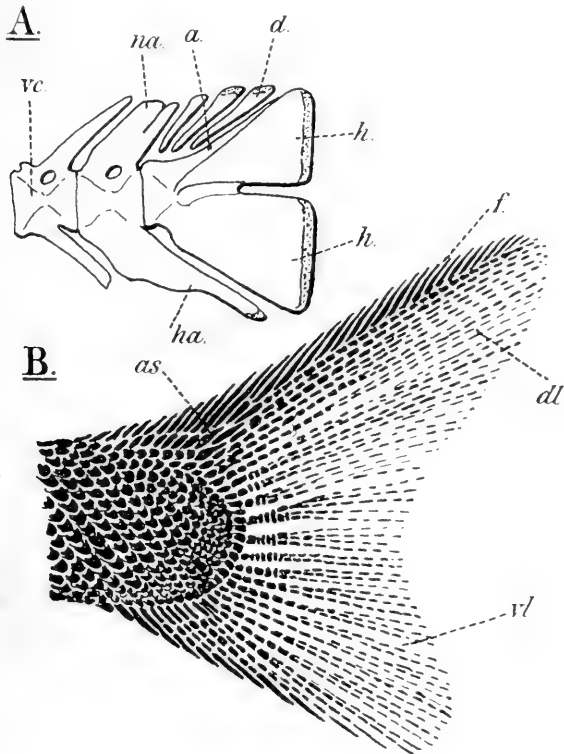

FIG. 61.

A, endoskeleton of the tail of *Cottus gobio*, L. (After Lotz.) B, tail of *Pachycormus heterurus*, Ag., showing the last external trace of the heterocercal structure. *a*, bony sheath of tip of notochord; *as*, scales covering the upturned tip of notochord; *d*, dorsal radials(?); *dl*, dorsal lobe of hypochochordal fin; *f*, fulcra; *h*, hypural bone; *h.a.*, haemal arch; *n.a.*, neural arch and spine; *vc.*, vertebral centrum; *vl*, ventral lobe of hypochochordal fin.

whether the radials have fused with the arches, are represented by the nodules, or are altogether absent (Fig. 46).

Doubtless the notochordal axis primitively extended in a straight line to the extremity of the tail, as it still does in Cyclostomes and Cephalochordates. The median fin fold probably stretched continuously along the dorsal edge to the tip of the tail, and again ventrally from the tip to near the anus (p. 71). But such a simple structure is rarely if ever found in either living or

extinct Pisces. It is generally represented by one or two dorsal fins, one anal (post-anal) fin, and a caudal fin formed of a dorsal (epichordal) and a ventral (hypochordal) lobe. The name diphy-cercal has been given to the primitive symmetrical caudal fin; and

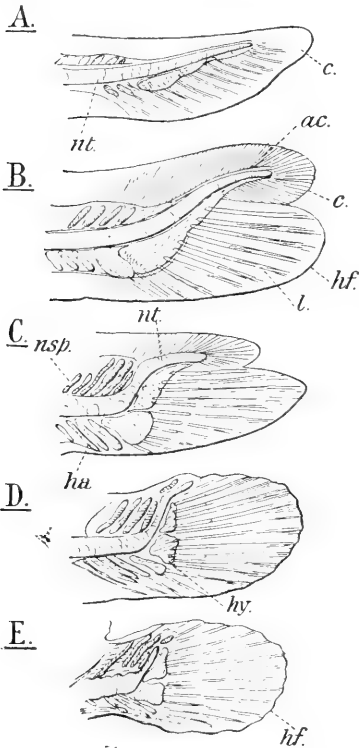

FIG. 65.

Successive stages in the development of the homocercal tail of the Flounder, *Pleuronectes flesus*, L., showing the disappearance of the axial lobe, *c*, and growth of the hypochordal fin, *h.f.* *ac*, actinotrichia; *h.a.*, haemal arch; *hy.*, hypural cartilage; *l.*, dermal ray; *n.sp.*, neural spine; *nt*, notochord. (After A. Agassiz.)

it has been shown that the asymmetrical, heterocercal, caudal fin could be derived from it by a bending upwards of the notochordal axis, accompanied by a reduction of the epichordal and an enlargement of the hypochordal lobe (Fig. 46). A further step in specialisation gives rise to the homocercal type, found in the Teleostei, by the shortening of the axis, the more complete suppression of the dorsal lobe, and the greater development of the ventral lobe (Figs. 63, 64). The homocercal caudal fin acquires a secondary outward symmetry. As Huxley [226] and Agassiz [2] long ago showed, fish with the more specialised tails pass through the more primitive stages in development: from the diphy-cercal to the heterocercal, and thence to the homocercal type (Fig. 65). But in the process the middle or axial lobe, in which runs the notochord, becomes relatively reduced; so that, whereas in primitive diphy-cercal and heterocercal tails the notochord reaches to or near the tip (Elasmobranchs, Dipnoi, Chondrostei), in the more abbreviate heterocercal and homocercal tails of the Holostei the hypochordal fin projects far beyond it (Figs. 61-66).

As will appear later, it seems probable that the heterocercal tail has been independently acquired in more than one group (p. 233); and that, in some cases, fish whose ancestors possessed asymmetrical caudal fins have reacquired an outward symmetry, making them superficially similar in appearance to the primitive diphy-cerca

type (p. 480). The name *gephyrocercal* has been applied to these pseudo-diphycercal tails.

Turning now to the relation between the axial and the appendicular skeleton of the median fins, which has already been alluded to above (pp. 69 and 101), we find that in the Pleuracanthids amongst the Chondrichthyes, in the Dipnoi, and in many Teleostomes (Coelacanth, many Teleosts) the radials of the fins correspond to, and may articulate with, the neural and haemal spines. As a rule, the more complete is the fin, the more thorough is the continuity

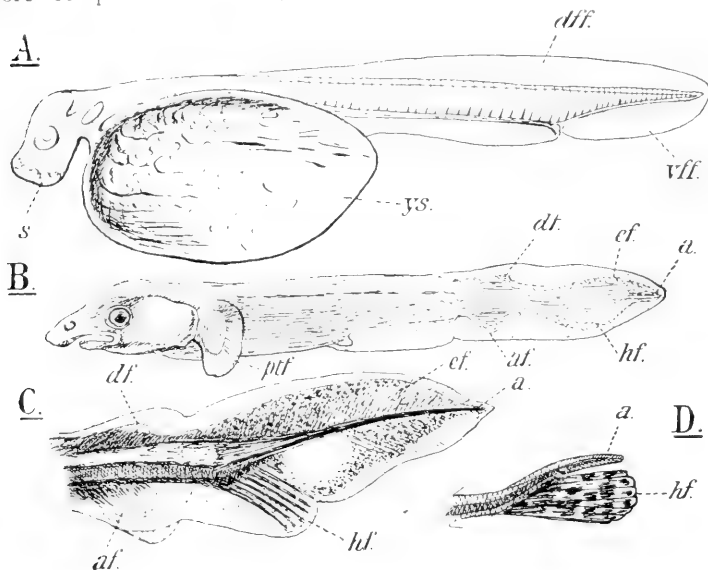

FIG. 66.

The development of the caudal fin of *Lepidosteus*. (After A. Agassiz.) A, young larva with anterior sucker, *s*; yolk-sac, *ys*; continuous dorsal and ventral fin folds, *dff* and *vff*; and straight notochord. The latter stages, B, C, and D, show the upbending of the notochord, the dwindling of the axial lobe, *a*, which disappears in the adult (cp. Fig. 65), and the great development of the hypochordal fin, *hf*. *a*, *f*, anal, *d*, *f*, dorsal, *e*, *f*, epichordal, and *pt*, *f*, pectoral fin.

between the two sets of skeletal rods. Now it is important to notice that in the Elasmobranchs, where the median fin breaks up into isolated dorsal and anal fins, the neural spines above the longitudinal ligament and the haemal spines tend to disappear completely (except perhaps in the epichordal lobe of the caudal fin), and the radials are free to concentrate and coalesce far from the vertebral column (Fig. 46, B). Traces of the spines remain only in such forms as the Rajiformes, where the fin skeleton is closely connected by them to the arches (Fig. 52). On the contrary, in the Teleostomi the series of neural and haemal spines usually remains complete and unaffected by the concentration of the fin-radials. These may

either articulate with (caudals of *Eusthenopteron*, *Coelacanthus*, etc.) or alternate with the spines (majority of Teleostei). In the Teleostomi, then, the division between the axial and the fin skeleton takes place at the distal end of the spines (p. 69).

The skeleton of the paired fins differs considerably, not only among the larger groups of the Pisces, but even among closely allied families and genera. That the various types have been derived from some common ancestral form, by the fusion and modification of originally separate and uniform elements, is most probable (p. 73); but what that original type may have been it is at present impossible to say for certain. Palaeontological evidence alone could enable us to decide this question.

According to Gegenbaur [157, 162], the original type resembled the skeleton of the pectoral and pelvic fins of *Ceratodus* (Fig. 213). Such an 'archipterygium' consisted of a median axis, articulating with the girdle, and provided with an anterior preaxial and a posterior postaxial series of radials. The radials were arranged in pairs, diminishing in size towards the tapering distal extremity. The archipterygium may be described as 'mesorachic' and 'rachiostichous' (Lankester). That such a 'biseriate' fin skeleton is a very ancient type can hardly be doubted. It is found not only in archaic living fish (*Ceratodus*, Howes [218], Braus [48]), but also there is evidence that it was possessed by the Dipnoi and the Osteolepidoti (Crossopterygii) of the Devonian epoch (p. 282). Moreover, it is also found in the pectoral fin of the Carboniferous *Pleuracanthodii* (p. 181, Fig. 148).

As Gegenbaur has shown [158, 162], the various types of the paired-fin skeleton found in the Teleostomi may be derived from the archipterygium on the supposition that the axis has become much shortened, that the radials have been reduced in number, and that the postaxial radials have almost or entirely disappeared (Fig. 68). The 'rhipidostichous' type of skeleton of the paired fins of Elasmobranchs, in which the radials have a fanlike arrangement, may be deduced in much the same way from the archipterygium. But here the reduction has been less complete (Figs. 96, 134); and it is unnecessary to assume that the pelvic fins of the Chondrichthyes have ever fully conformed to the rachiostichous type, since even in the *Pleuracanthodii* the pelvics are monostichous (Fig. 150), *i.e.* have only one series of radials.

The origin of the archipterygium itself remains to be explained. The objections to Gegenbaur's theory of its derivation from gill-rays has been dealt with elsewhere (p. 74). Following Haswell [198*a*] and Mollier [301], we may suppose that it has been formed by the great concentration of a large number of radials to a very narrow base, giving rise to a central axis, and leaving their distal



ends diverging on either side (Fig. 67).<sup>1</sup> The view that the archipterygium represents the ancestral form of the pelvic fin of the Osteichthyes, and of the pectoral fin of both the Osteichthyes and the Chondrichthyes, is thus quite reconcilable with a 'lateral-fold theory.' But even so, it is probable that the ancestral type was not as perfectly mesorachic as the modern *Ceratodus* fin, and that a certain number of preaxial rays (pro- and mesopterygium)

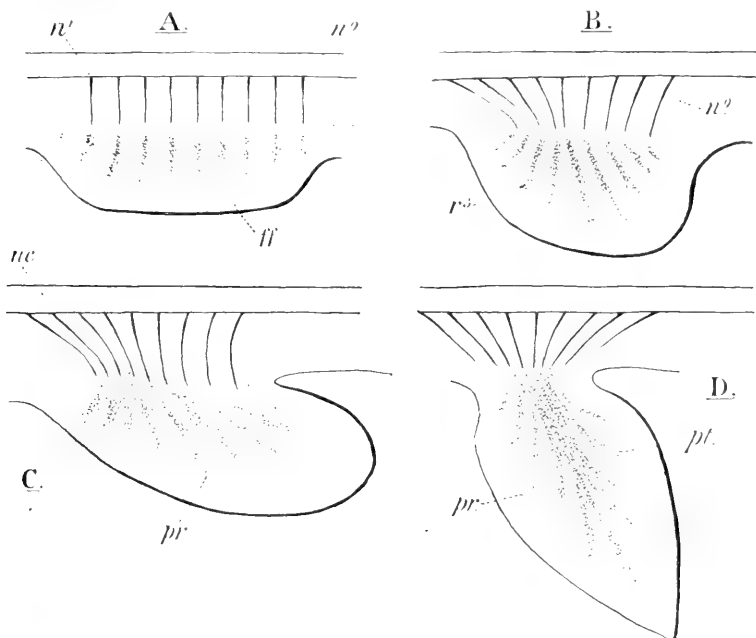

FIG. 67.

Diagrams to show the result of concentration on the skeleton and nerve-supply of a paired fin. A, B, C lead towards the Selachian type of fin; A, B, D towards the Dipnoan type.  $n^{1-9}$ , nine spinal nerves supplying the fin;  $n.c.$ , nerve-cord;  $r$ , radials represented as seen in an early embryonic stage;  $pr$ , preaxial, and  $pt$ , postaxial radials;  $f.f.$ , fin fold.

remained articulating with the girdle (as in *Pleuracanthus* and *Cladodus*, p. 183).

The other theory, favoured by Balfour [28], Thacher [434], A. Smith Woodward [503], and others, is that the originally separate

<sup>1</sup> If it is objected that in *Ceratodus*, where the adult fin has about thirty radials and radial muscles, only about three segments have been shown to contribute muscle-buds in the embryo (Semon [400a]), it must be answered that this result is not trustworthy, since Davidoff [99] and Braus [46] have found twelve motor nerve-roots contributing to the limb-plexus. With regard to the development of the cartilages, it has already been shown that, in Elasmobranchs, the originally separate radials become differentiated in a continuous procartilaginous rudiment, somewhat as in *Ceratodus* (p. 73).

and parallel (orthostichous) somactids or radials of the paired-fin folds, becoming concentrated, fused at their base, giving rise to a 'pleurorachic' and 'monostichous' type of skeleton (Fig. 68). In such a fin, the axis lay in the body-wall, and bore a single row of radials along its outer edge. This type of fin skeleton may be found in the median fins of Elasmobranchs and other fish (p. 75 and Figs. 87, 150), but not in the pectoral fin of any living form. The pelvic fins, however, in Elasmobranchs and the lower Actinopterygii very nearly conform to it (Fig. 96). But among the early fossil

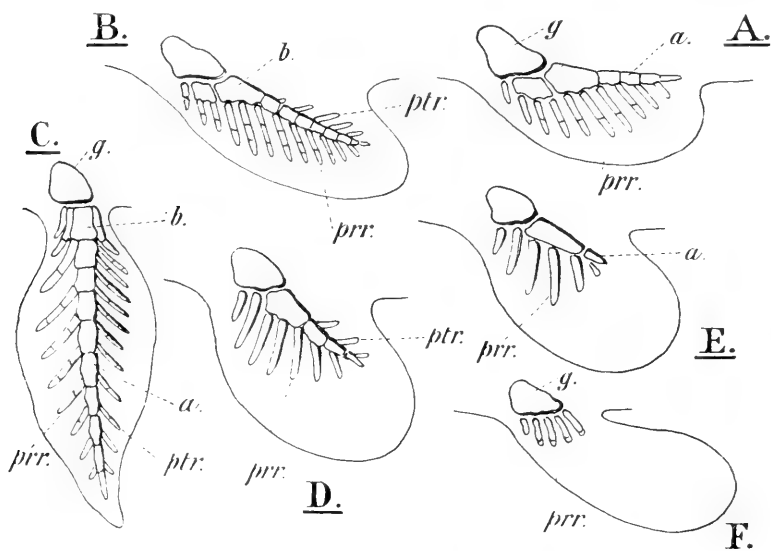

FIG. 68.

Diagrams showing the possible derivation from each other of the various types of pectoral fin skeleton in the Osteichthyes. A, pleurorachic type (*Cladodus*). B, hypothetical stage leading to the mesorachic type C (*Ceratodus*). D, hypothetical type leading to E (*Acipenser*, *Amia*). F, teleostean type, reached either from A through E, or from C through D and E. a, segment of axis; b, basal of axis; g, pectoral girdle; pr.r., preaxial radial; ptr., postaxial radial.

Chondrichthyes (Cladoselachii, Fig. 155) pectoral fins are found which possibly have a skeleton of this character (Dean [104]). Phylogenetically, the pleurorachic fin could become mesorachic by the freeing of its hinder edge from the body-wall, and by the shifting of the axis towards the centre of the fin-lobe, so that radials should come to develop on the growing postaxial side.<sup>1</sup> The rhipidostichous fins would be, to some extent, intermediate forms (Fig. 68). The chief objection to this view, and it is a

<sup>1</sup> The ontogenetic formation of the axis in one region of the fin or another is, as Mollier has shown [301], due to the concentration of the radials about a different ideal axis. In the Rajidae there may be two axes in one fin (p. 128 and Fig. 121).

weighty one, is that it becomes difficult to avoid the supposition that the archipterygial type of fin has been independently developed in the Pleuracanthodii and the Dipnoi (p. 244).

The development of an outstanding basal stem, or axis, bearing peripheral radials, is clearly seen in the median fins of certain fossil and living fish (A. Smith Woodward [503], Thacher [434], Mivart [300], and Figs. 251, A ; 147). The dorsal fins of the Rajidae (Fig. 49) and the anal fins of the Pleuracanthodii are good examples. The orthostichous arrangement of the radials in the paired fins of the higher Teleostomes (p. 302 and Fig. 243) is almost certainly secondary, and due to the reduction of the axis.

It is important to notice, as a general primitive character, that the endoskeleton of the fins typically has no articulations ; that is to say, it moves as a whole, being articulated to the girdle, but is not subdivided into regions moving on each other, as is the case with the limbs of the Tetrapoda. Further, we find that, in the more specialised fish, the endoskeleton has a tendency to become reduced, and the exoskeletal dermal rays, on the contrary, become increasingly important as supporters of the web of the fins. These dermal fin-rays, or dermatrichia [175], are found in both the paired and the unpaired fins of all Pisces. They form a very characteristic innovation diagnostic of the Class, and will be described below (pp. 122 and 212).

Turning to the vascular system, we find a symmetrical heart lying in a pericardium, situated ventrally, between the pectoral girdle and the basibranchial plate underlying the oesophagus (Fig. 303). The pericardial coelom is almost (Chondrichthyes, Chondrostei) or quite (Teleostei, Lepidosteidae, Amiidae) closed off from the abdominal coelom by a transverse septum. Here the right and left ductus Cuvieri and the hepatic veins join to enter the sinus venosus. This leads into a thin-walled atrium, opening into a muscular thick-walled ventricle. There are two sinu-atrial and two atrio-ventricular valves. The ventricle is prolonged forwards into a contractile conus arteriosus, leading to the ventral aorta (Stöhr [426], Boas [38-39], Röse [373]). Inside the conus are rows of semi-lunar valves (Fig. 69). In the more specialised Teleostei the base of the aorta is swollen into a non-contractile bulbus, and the conus is reduced to a narrow strip supporting only one row of valves (p. 363).

As a primitive type of circulation we may take that of a Selachian (Hyrtl, Balfour [27], Hochstetter [214-15], Dohrn [114], Rabl [336], Parker [314-15]). The median ventral aorta, morphologically a forward prolongation of that longitudinal ventral 'subintestinal' vessel of which the heart itself is a specialised portion (p. 26), and like that vessel developing from originally paired

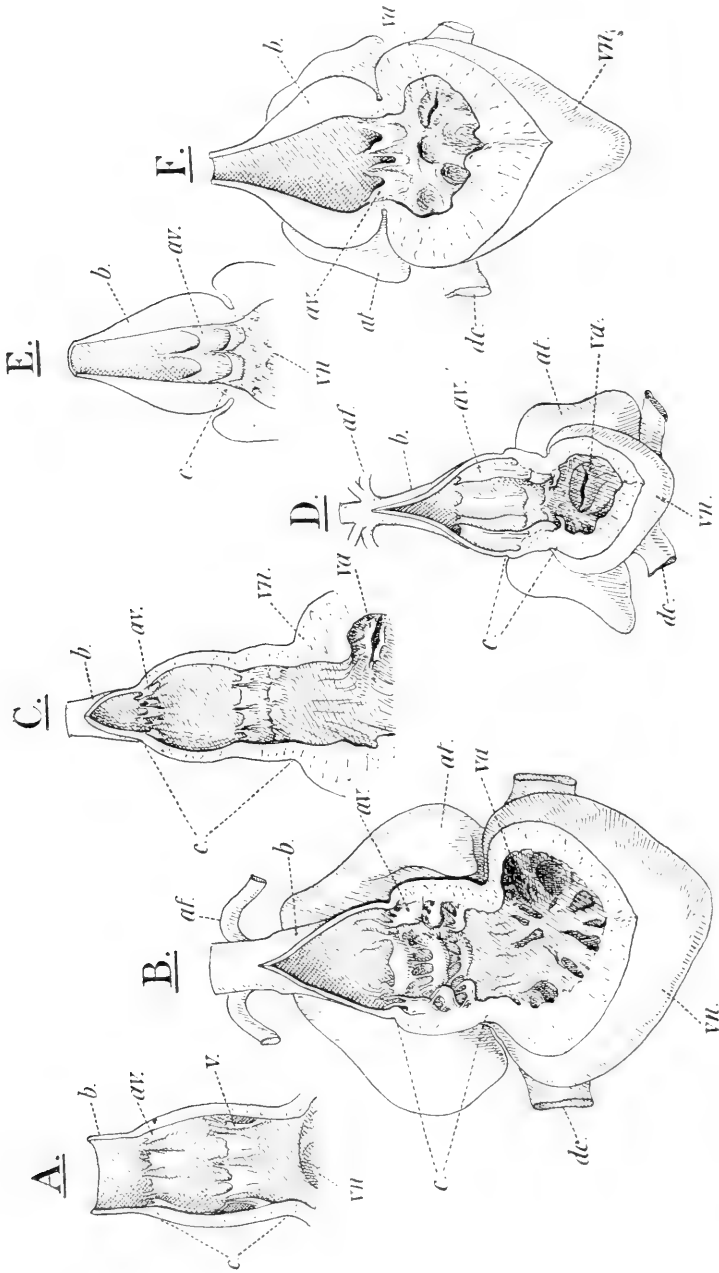

FIG. 69.

A, conus arteriosus of *Clupea harengus*, Gm. B, heart of *Clupea harengus*, Gm. C, conus of *Atriplex sarda*, L. D, heart of *Atriplex sarda*, L. E, bulbus of *Atriplex sarda*, L. F, heart of *Salmo salar*, L. (After Boas.) *af*, posterior afferent branchial vessel; *at*, atrium; *av*, *av*, anterior valve; *b*, base of ventral aorta, which becomes the bulbus arteriosus in E and F; *c*, muscular contractile conus arteriosus which disappears in F; *dc*, ductus Cuvieri; *v*, posterior valve; *va*, atrio-ventricular aperture guarded by two valves; *va*, ventricle. The bulbus conus and ventricle have been slit along the ventral mid-line, and stretched open to expose the valves.

rudiments (Mayer [297a]), runs forward below the branchial skeleton (Fig. 71). It provides five afferent branchial arteries, the first of which passes up the hyoid arch to supply its posterior hemibranch. These afferent vessels and the efferent vessels are partially derived from, and replace, the embryonic complete aortic arches, six in number, running up the mandibular, hyoid, and succeeding four branchial arches. The paired rudiments of the dorsal aorta unite to form a single median vessel behind; but in front they diverge and join again below the brain to form in the embryo a complete circle, the circulus cephalicus (Fig. 72). It is this region which receives the efferent or epibranchial vessels. The continuity of the circulus is usually interrupted behind the hyoid arch in later development in Selachians, and indeed in all Gnathostomes except the Teleostei (Fig. 72). In Selachians the circulus disappears, the aorta becoming single and median to below the base of the skull (Fig. 71). The mandibular arch also is broken off below, with the development of the jaws, and the reduction of the spiracular slit, so that the vessels in this region of the head become much modified. In most Osteichthyes the hyoid arch is likewise interrupted below, and the hyoidean hemibranch then receives blood only from the efferent vessel of the next

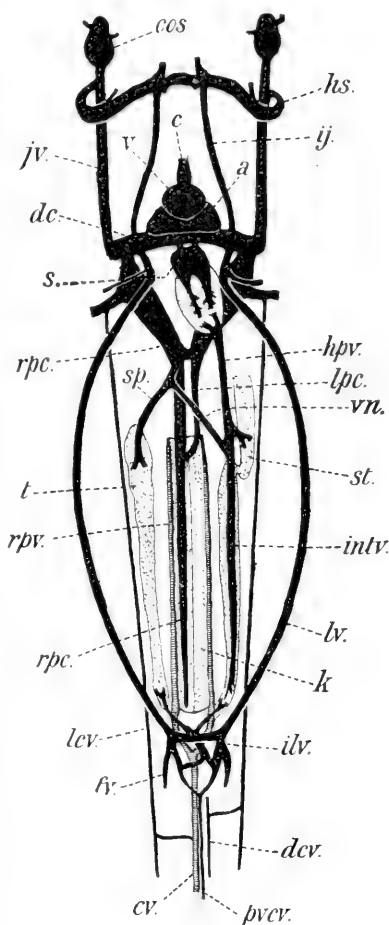

FIG. 70.

Diagram of the venous system of *Mustelus antarcticus* (after T. J. Parker), ventral view. *a*, atrium; *c*, conus; *cos*, orbital sinus; *c.v.*, caudal vein; *d.c.*, ductus Cuvieri; *d.c.v.*, hinder portion of dorsal cutaneous vein; *f.v.*, vein from pelvic fin; *h.p.v.*, hepatic portal vein passing up into liver; *h.s.*, hyoid sinus; *i.j.*, inferior jugular; *il.v.*, iliac vein; *int.v.*, intestinal vein; *j.v.*, jugular vein; *k*, kidney; *l.c.v.*, left lateral cutaneous vein; *l.v.*, lateral vein; *l.p.c.*, left posterior cardinal; *l.v.*, lateral vein; *p.v.c.v.*, posterior ventral cutaneous vein; *r.p.c.*, right posterior cardinal; *r.p.v.*, right renal portal vein; *s*, hepatic sinus; *sp.*, spermatic vein; *st*, stomach; *t*, testis; *v.*, ventricle; *vn.*, vein joining portal to posterior cardinal.

branchial arch (p. 258 and Figs. 72, 220). The dorsal portion of the mandibular aortic arch (anterior carotid) having lost its

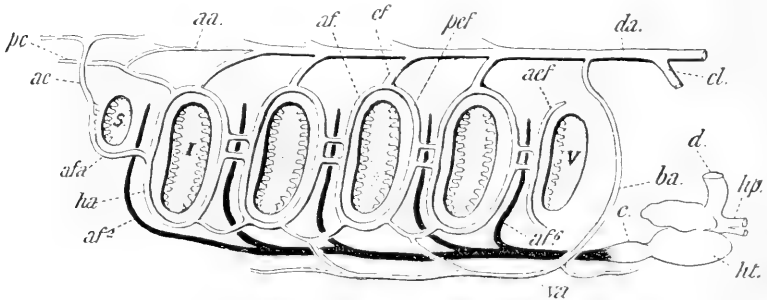

FIG. 71.

Diagram of the branchial circulation of an Elasmobranch fish (modified from T. J. Parker). *a.a.*, median anterior prolongation of aorta; *a.c.*, anterior carotid, efferent vessel of spiracular gill (pseudobranch); *a.e.f.*, efferent vessel from last hemibranch; *a.f.*, anterior efferent vessel; *af¹-af⁵*, five afferent vessels from ventral aorta; *af.a.*, afferent artery of spiracular gill; *c.*, conus leading to ventral aorta; *cl.*, coeliac artery; *d.*, ductus Cuvieri; *d.a.*, dorsal aorta; *ep.*, epibranchial artery; *h.a.*, hyoid efferent vessel; *hp.*, hepatic veins; *ht.*, heart; *p.c.*, posterior carotid; *p.e.f.*, posterior efferent vessel; *s.*, spiracle; *v.a.*, ventral artery; I-V, branchial slits.

connection with the ventral aorta, acquires a new supply of blood for the spiracular gill from the efferent vessel of the hyoid arch. It passes thence across the floor of the orbit, through the lateral

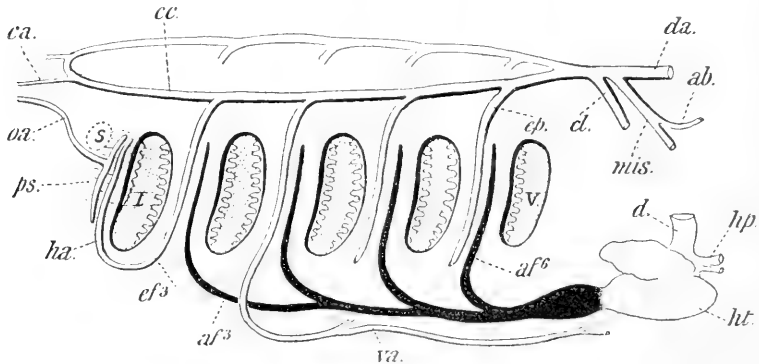

FIG. 72.

Diagram of the branchial circulation of a Teleostean fish (modified from T. J. Parker). *a.b.*, artery to air-bladder; *af³-af⁶*, four afferent vessels from ventral aorta; *c.a.*, carotid artery; *c.c.*, circulus cephalicus; *cl.*, coeliac artery; *d.*, ductus Cuvieri; *d.a.*, dorsal aorta; *ef³*, efferent vessel of first branchial arch; *ep.*, epibranchial artery; *h.a.*, hyoidean artery (afferent vessel of pseudo-branch); *hp.*, hepatic vein; *ht.*, heart; *mis.*, mesenteric artery; *o.a.*, ophthalmic artery (efferent vessel of pseudo-branch); *ps.*, pseudo-branch (hyoidean gill, possibly with spiracular gill); *s.*, position of spiracle (closed); *c.a.*, ventral artery; I-V, five branchial slits.

carotid foramen, into the cranial cavity, where it joins its fellow from the other side (front end of the original circulus cephalicus), and gives off paired cerebral arteries and a median spinal artery.

From the efferent vessel of the hyoid arch springs also a posterior carotid (internal carotid), which gives off a branch to the orbit, and piercing the base of the skull, enters the pituitary depression of the

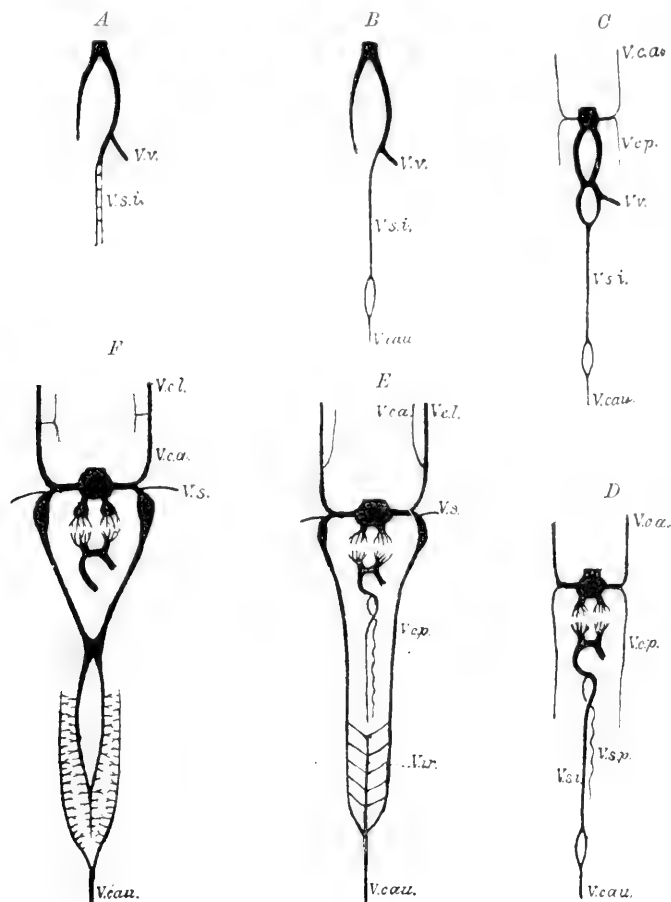

FIG. 73.

Diagrams of the development of the Venous System in the Selachian. (After Rabl and Hochstetter, from Hertwig's *Handbuch*.) Six stages. *V.v.*, vitelline vein running into the left omphalo-mesenteric; *V.s.i.*, subintestinal vein; *V.cau.*, caudal vein; *V.ca.*, anterior cardinal vein; *V.cp.*, posterior cardinal vein; *V.sp.*, vein of spiral valve; *V.cl.*, external jugular vein; *V.s.*, subclavian vein; *V.ir.*, interrenal vein.

cranial cavity. It joins the cerebral artery of the opposite side. Segmental parietal vessels are given off by the aorta, and branches to the limbs and viscera. Among the latter the coeliaco-mesenteric, the coeliac, the lieno-gastric, the anterior, and the posterior mesenterics are the most important.

The post-cardiac portion of the embryonic subintestinal vein contributes to the formation of the hepatic portal and renal portal systems. It runs below the intestine, bifurcates to surround the rectum, and joins again to a median caudal vein. This posterior portion comes into connection with the hinder ends of the posterior cardinals, and separates off from the intestinal portion (Fig. 73). In front the subintestinal vein joins the paired omphalo-mesenteric veins, forming a complete loop, which subsequently becomes broken up into capillaries in the liver. The anterior ends of the loop form the hepatic veins; the posterior ends form the portal veins, receiving blood from the remains of the subintestinal and from other newly formed veins of the alimentary canal.

The cardinal veins receive the segmental parietal veins and enter the ductus Cuvieri. The anterior cardinal of the embryo, running ventrally below the spinal nerves, is partially replaced by a large jugular vein (anterior cardinal sinus) passing forwards outside the nerves to the head. This sinus sends a branch down the hyoid arch, which joins the ventral inferior jugular vein (Fig. 70). The posterior cardinals, having joined the caudal vein, break up in the adult kidney, or mesonephros, into the renal portal system of capillaries. Two ventral longitudinal epigastric or lateral veins unite just above the pelvic girdle, receive the iliac veins, then run forward to open into the ductus Cuvieri, near which point they receive the brachial veins (Figs. 70, 74).

A special yolk-sac circulation is established in the embryos of those fish whose eggs are supplied with a very large quantity of yolk. It may be entirely venous and derived from the subintestinal vein (Teleostei, Fig. 75), or partly arterial and partly venous (Elasmobranchs, Fig. 76). In the latter case are found a vitelline artery—a branch of the aorta passing out to the yolk-sac on one side—and a vitelline vein returning behind to the hepatic-portal region of the subintestinal vein (Balfour [29], Ziegler [512], Wenckebach [485]). In the Elasmobranch the stalk of the yolk-sac comes off from the gut in front of the hepatic diverticulum; in the Teleostomes the yolk is situated farther back, on or behind the diverticulum.

In the intestine of all living Pisces, excepting the Teleostei (p. 362), is found a 'spiral valve'; it is a spiral infolding of the wall provided with blood-vessels, and serving to increase the absorptive surface (Figs. 77, 78 [Parker, 313]). Another primitive structure is the cloaca—formed partly by the expansion of the posterior end of the enteron, partly by an invagination from the exterior. Into the cloaca open the rectum by the anus in front, and the urinary and genital ducts farther back (Fig. 90).

Although it is not possible to give a satisfactory definition of a large group like the Pisces, exhibiting such a wide range of



structure, yet their chief diagnostic characters may be summarised

as follows:—The dermal skeleton is in the form of denticles and scales. There are median fins supported by endoskeletal radials (somactidia); and paired limbs of similar structure. All these limbs are fins adapted to aquatic life, and have the web strengthened with

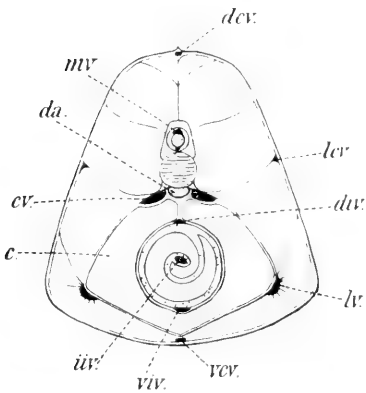

FIG. 74.

Transverse section of the trunk of *Mustelus antarcticus*, Gthr. (after T. J. Parker), showing the veins. *c*, abdominal coelom; *c.v.*, posterior cardinal; *d.a.*, dorsal aorta; *d.c.v.*, dorsal cutaneous vein; *d.i.v.*, dorsal intestinal vein; *i.i.v.*, internal intestinal vein at edge of spiral valve; *l.c.v.*, lateral cutaneous vein; *l.v.*, lateral vein; *m.v.*, eponic vein.

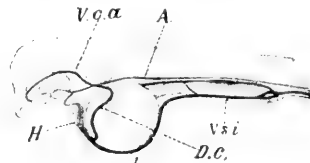

FIG. 75.

Embryo of *Gobius*. (After Wenckebach, from Hertwig's *Handbuch*.) *A*, aorta; *H*, heart; *V.c.a.*, vena cardinalis anterior; *V.s.i.*, vena subintestinalis; *D.C.*, ductus Cuvieri.

dermal fin-rays (dermotrichia). An elaborate system of lateral-line organs extends over the head and trunk. The heart retains an undivided atrium, and pumps venous blood into the branchial lamellae of the gill-arches. Not more than eight gill-slits are pierced, of which the first is the relatively small spiracle. As characters which are considered primitive, but are often lost through specialisation, may be mentioned: an unconstricted notochord, a diphycceral tail, a large number of radials in the median and paired fins, an amphistylic attachment of the jaws, a large

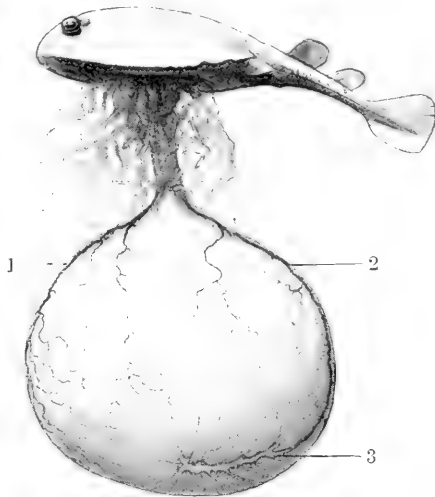

FIG. 76.

*Torpedo* embryo with yolk-sac. (After Rückert, from Hertwig's *Handbuch*.) 1, vitelline artery; 2, vitelline vein; 3, remains of the peripheral sinus.

embryo with yolk-sac, a large

number of uniform teeth succeeding each other throughout life, a separate opening for each gill-slit, an optic chiasma, a contractile conus arteriosus, a purely venous heart, a pericardium communicat-

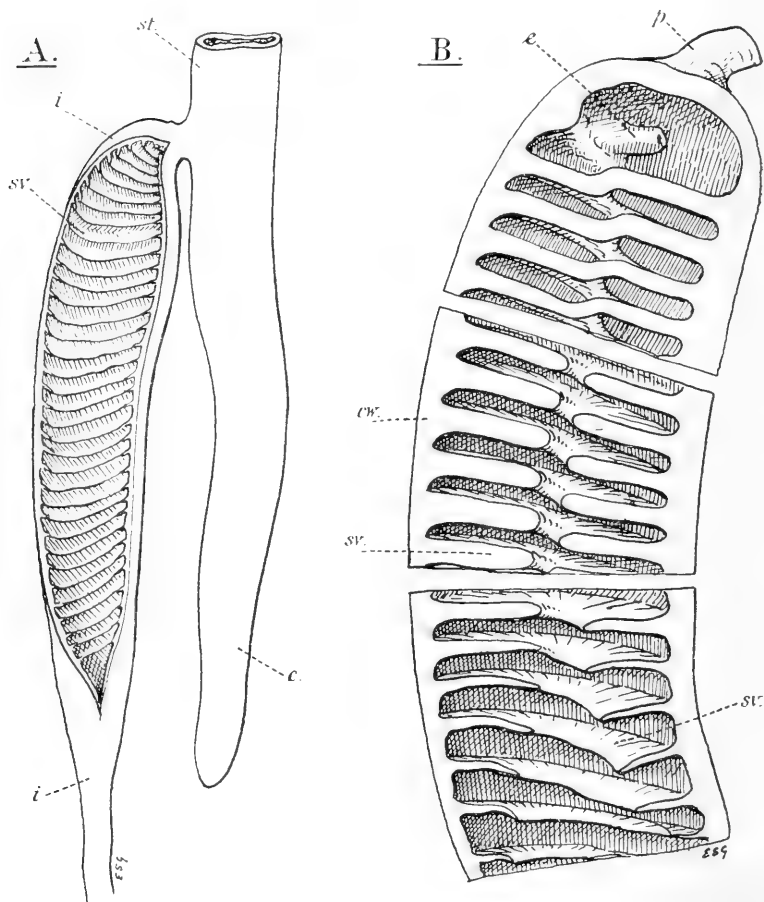

FIG. 77.

A, stomach and intestine of *Chirocentrus dorab*, Forsk., opened up to show the spiral valve. B, three portions of the intestine of *Alopias vulpes*, M. and H., cut longitudinally. c, caecum; c/w, cut wall; e, entrance of pyloric end; i, intestine; p, pyloric end of stomach; st, stomach; s.v., spiral valve. The upper piece is cut through on the near side of the middle line; the lower pieces through the middle line.

ing with the abdominal coelom, a spiral intestinal valve, a 'free' ovary, a well-developed oviduct, and a cloaca.

The Pisces are such an ancient class, their remains having been found even in the Lower Silurian rocks, and so many side twigs of

their phylogenetic tree have been pruned off by natural selection, that the branches which survive to the present day can be easily classified into well-defined groups. But when we come to deal with the extinct forms, we are at once met with the familiar difficulties in the construction of a phylogenetic system: the discovery of intermediate forms; apparent primitive simplicity due to degeneration; apparent close relationship due to convergence.

In the eighteenth century, Artedi, a friend of Linnaeus, founded the modern classification of fish by dividing them into three groups: the Chondropterygii, the Malacopterygii, and the Acanthopterygii. A great advance was made in the first half of the nineteenth century in our knowledge of the structure and classification of fish by the publication of Cuvier and Valenciennes's *Histoire Naturelle des Poissons* [95]. These authors separated all the 'bony fish' as one group from the Chondropterygii. But among the latter were still included the Cyclostomes and the Sturgeons, with the Elasmobranchs. A third epoch was marked by the appearance of the work of L. Agassiz on fossil fish [4]. Relying chiefly on the characters of the exoskeleton, he divided the true Pisces into Placoidi, Ganoidei, Cycloidei, and Ctenoidei. The skin of the first division is provided with 'placoid' denticles; that of the second, with thick shiny bony scales; the third, with rounded, thin, overlapping, concentrically lined scales; the fourth, with similar scales bearing spiny processes behind. Although Agassiz greatly forwarded the study both of living and of extinct fish,

yet his classification in these four orders is not natural. The order Ganoidei included several unrelated but convergent forms, such as *Polypterus*, *Acipenser*, *Ostracion*, and *Lepidosiren*; and the separation of the Cycloidei from the Ctenoidei was very artificial. Johannes Müller [307] united these two orders in the sub-class Teleostei; and purged the Ganoidei of the Dipnoi and of

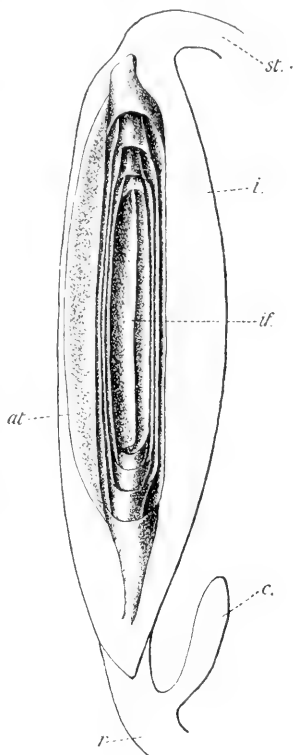

FIG. 78.

Intestine of *Zygocentrus mulleri*, opened up to show the spiral valve. (After T. J. Parker.) *at.*, attachment of spiral valve; *c.*, rectal gland; *i.*, intestine; *i.f.*, inner free edge of valve; *st.*, stomach.

the armour-bearing Teleosteans. Huxley [227-8], Cope [91], Zittel [512], and others have since made important contributions. To A. Günther we are indebted for many improvements, especially in the detailed classification of modern fish [189, 191]. His grouping of the Pisces in the two sub-classes Palaeichthyes and Teleostei does not express a phylogenetic division. The Palaeichthyes are characterised by the possession of an optic chiasma, a contractile conus arteriosus, and a spiral intestinal valve, as was shown by J. Müller, C. Vogt, and others. Now these are all primitive ancestral characters in the class. They appear to have been lost by the Teleostei, not to have been acquired by a diverging single branch giving rise to the Palaeichthyes.

Modern advances in the taxonomy of fish are chiefly due to Traquair [441-469], Smith Woodward [505], Gill [164-5], Boulenger [40-42], and others.

Following, rather, the example of Cuvier, Valenciennes, and Duméril [124], we divide the Pisces into two main groups, corresponding to two diverging sub-classes, the Elasmobranchii and the Teleostomi (see Table of Contents, p. vii). Undoubtedly the Dipnoi either are a specialised branch of the Teleostomi or have, at all events, been derived with these from a common ancestral stock. The sub-classes Dipnoi and Teleostomi, therefore, form one division, the Osteichthyes. With the Elasmobranchii are associated two extinct sub-classes (Pleuracanthodii and Cladoselachii); together these make up the second great division, the Chondrichthyes. Between these two divisions may provisionally be placed an assemblage of extinct fish, the Ostracodermi, whose affinities are very imperfectly known. Another group of doubtful origin, the Acanthodii, is provisionally retained with the Chondrichthyes (Stannius [417], Huxley [229], Bridge [57], Brown Goode [64], Jordan [250], Gregory [184], Hay [204]).

### **Sub-Grade I. CHONDRICHTHYES.**

This is a provisional assemblage of fish which, speaking generally, are lowly organised, and preserve several primitive features. The normal optic chiasma, the contractile conus arteriosus, and the spiral intestinal valve are all present in the living forms.

True bone is never developed, either in connection with the endoskeleton or in the form of superficial plates and scales. The dermal exoskeleton is entirely composed of 'placoid' scales or denticles (except for the dermal fin-rays, p. 122, and Acanthodii). Very rarely (Acanthodii, p. 189) bone-like tissue occurs, but it appears to be merely calcified connective tissue. Occasionally the

bases of neighbouring denticles may fuse; in this way have probably arisen the dermal plates sometimes found in fossil Chondrichthyes (p. 168). The placoid scales (Williamson [496*a*], Hertwig [211], Klaatsch [264]) are essentially hollow cones of dentine surrounding a pulp-cavity. Dentine, which forms the bulk of the hard

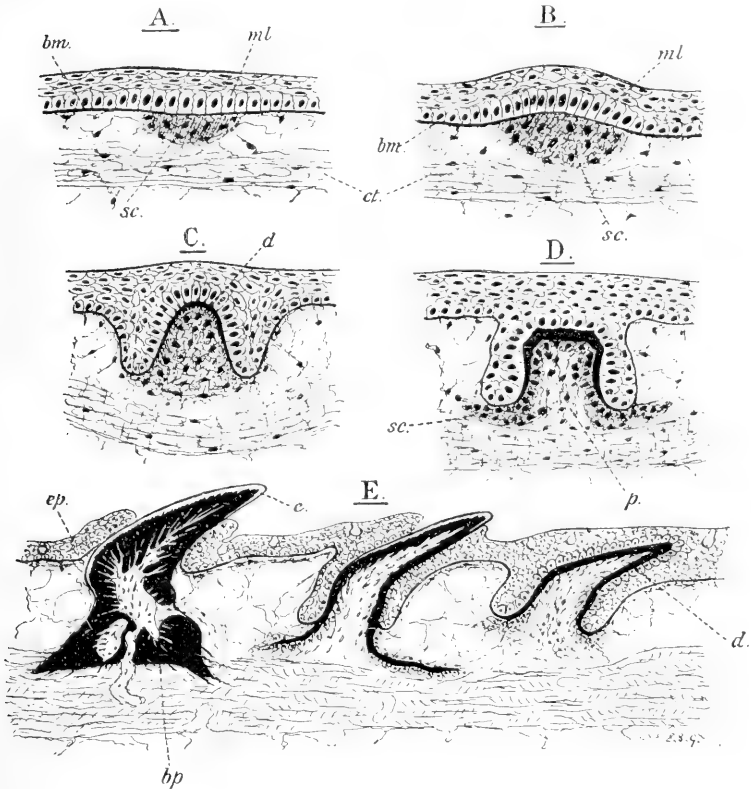

FIG. 79.

Successive stages in the development of the denticles of the Dogfish, *Scyllium canicula*, L. In A is seen the first gathering of the scleroblasts, *sc*, below the basement membrane, *bm*; in C, the first deposition of dentine, *d* (black); in E, three stages (from right to left) in the formation of the basal plate, *b.p.* *ct*, connective-tissue deep layer of cutis; *e*, "enamel" (white); *ml*, modified epidermal cells; *p*, pulp-cavity. A-D, transverse, E, longitudinal section, enlarged.

tissue of the teeth of all Gnathostomes, is of mesoblastic origin. It is secreted by the odontoblasts lining the pulp-cavity, and consists of a hard calcified matrix traversed by a multitude of minute nearly parallel canaliculi (dental tubules) with delicate branches. No cells are included in the dentine, but fine processes of the odontoblasts extend up the canaliculi (Figs. 79, 81). The

first appearance of dentine takes place immediately beneath the epidermis, in direct continuity with the basement membrane, of which it may be considered to be a thickening (Fig. 79, A-D). It is secreted by a group of mesoblastic cells (odontoblasts), the rudiment of the future dental papilla or pulp. Dentine differs from bone not only in that it contains no cells, but also in that it grows on one surface only—the surface next to the dentinal pulp. As a rule, the base of the dentine cone spreads inwards into the underlying connective tissue, and may change in structure from true dentine to a looser kind of trabecular calcified tissue. A 'basal plate' is thus formed, which tends to cut off the pulp-cavity below, leaving only one or two narrow openings whereby

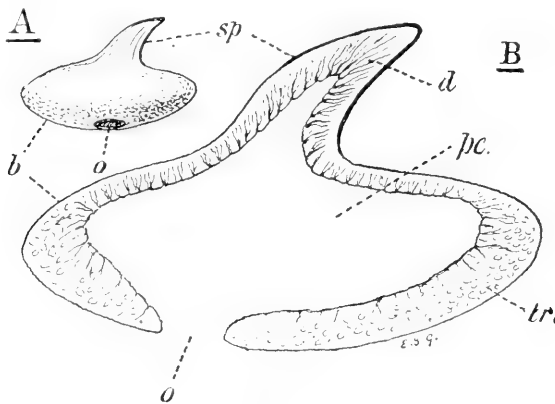

FIG. 80.

Median dorsal denticle of *Raja blanda*. A, left-side view. B, section much enlarged. *b*, basal plate; *d*, dentinal tubules; *o*, opening of pulp-cavity, *pc*; *s.p.*, projecting spine; *tr*, modified trabecular dentine.

the blood-vessels, nerves, and lymph-channels can pass through. The distal region of the denticle breaks through the epidermis and emerges freely on the surface. It is covered with a shiny enamel-like layer. Of the real nature of this layer observers are still uncertain. According to Leydig and Röse [372], it is a special outer zone of vitrodentine, with very fine canaliculi. It does not appear to be true enamel, secreted by the epidermal cells, such as is found on the teeth of higher vertebrates. Tomes [439] believes it to be formed by the combined action of the epidermis without and the odontoblasts within.

We may here briefly describe the chief varieties of dentine found in fish (Tomes [438, 440], Röse [372], Owen [311*a*]). They may be classified as follows: typical dentine, with numerous canaliculi radiating from a central pulp-cavity (Fig. 79); plicidentine,

folded dentine developed round a pulp with outstanding ridges (*Lepidosteus*, Fig. 81, B); vasodentine, with branching pulp-channels, but few or no canaliculi (*Merluccius*, Fig. 81, A); osteodentine, or trabecular dentine, with anastomosing branches of the pulp-cavity (*Esox*, Fig. 81, C; *Lamna*); vitrodentine is the name given to the outermost enamel-like layer generally found on Elasmobranch teeth and denticles, as described above. Intermediate forms exist between these varieties, and occasionally

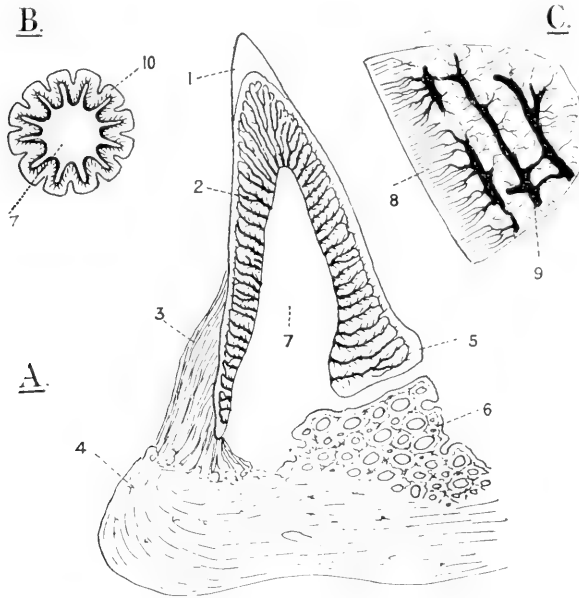

FIG. 81.

A, section through a tooth and jaw of the Hake, *Merluccius vulgaris*. (Partly after Tomes.) B, transverse section of the tooth of *Lepidosteus*. C, enlarged view of a small piece of the tooth of *Esox lucius*. 1, enamel tip; 2, vasodentine; 3, elastic ligament; 4, bone of jaw; 5, free outer edge of tooth-base; 6, bone of attachment forming socket for tooth-base; 7, pulp-cavity; 8, dentine layer at surface of tooth; 9, osteodentine canals; 10, folded wall of dentine.

dentine may come to resemble bone, with laminae and enclosed cells.

The placoid scales do not indefinitely increase in size. New denticles may develop from fresh 'germs' between the old ones, and these when old and worn out may be shed (Steenstrup).

Along the inner margin of the jaws, the teeth, which are merely specialised denticles, arise at the bottom of a deep dental groove (Fig. 39). Here new generations of teeth are continually being produced, and as they grow older they move up to the biting edge of the jaw, pushing the older teeth before them. Thus the old

and worn teeth drop off, and are replaced from behind by new ones.

The teeth, in Elasmobranchs, and indeed in all Chondrichthyes excepting the Acanthodii, are not firmly fixed to the jaw, but are merely attached to the cartilaginous jaws by connective tissue. They may become much specialised in structure and disposition, leading to the development of a highly characteristic dentition in various groups. Occasionally several tooth-germs may fuse to form compound teeth. Large specialised denticles may also be found on the body. Among these are to be reckoned the powerful spines,

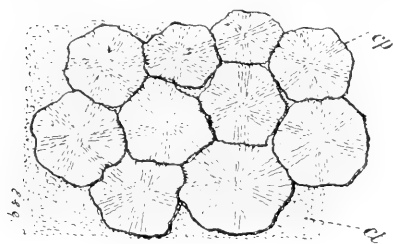

FIG. 82.

*Raja blanda*, Holt. *cp.*, surface of the cartilage, showing prismatic calcifications, *et.*

which often occur in front of the fins (Markert [291]). In some cases (*Acanthias*, Fig. 50) these are merely large hollow cones of the ordinary structure, resting on a cartilaginous radial.

The endoskeleton remains cartilaginous; but is often strengthened, especially on its surface, by the deposition of calcareous salts, generally in the form of prismatic plates (Fig. 82). In living Chondrichthyes the notochordal fibrous sheath is always invaded by the surrounding mesoblastic layer (p. 99, Fig. 60). The median fin-folds are always more or less subdivided, and the caudal fin usually becomes heterocercal. The vertebral column extends to the extremity of the dorsal lobe.

Both the median and the paired fins are provided with very numerous horny fin-rays, or ceratotrichia. This is one of the most characteristic features of the group (Mayer [297], Klaatsch [264], Goodrich [175]). The ceratotrichia are slender, unjointed rods of homogeneous fibrous substance secreted by the mesoblastic cells. As a rule, they are very much more numerous than the underlying somactidia. At the growing distal edge of the fin they are seen to originate immediately below the basement membrane. But later on they sink into the connective tissue, and to their proximal ends are attached the radial muscles of the fins. The ceratotrichia are developed on both sides of the fins, and proximally embrace the ends of the median cartilaginous radials (Fig. 83).

In all the living Elasmobranchs, except the highly specialised Holocephali, the gill-slits always open to the exterior independently. This was probably also the case in the extinct Chondrichthyes (with the possible exception of the Acanthodii). Where the gill-septum reaches the surface, a strip of the ordinary denticle-bearing skin passes between the openings (Figs. 26, 57).



The number of branchial slits is larger in some Chondrichthyes (Notidani) than in any other Pisces, and this may be a primitive character. We find, also, that among the least differentiated and earliest representatives the upper jaw (palato-quadrate) is often broad behind, and articulated by an otic process to the auditory capsule. It is possible that this amphistylic type of jaw-articulation was possessed by the common ancestor of the whole group of Chondrichthyes (p. 95). In the Elasmobranchii, and apparently also in the Pleuracanthodii, the gill-septa are supported by a single posterior series of cartilaginous gill-rays (Figs. 57, 99). If, as seems probable, a similar single series of rays existed in the Cladoselachii, this character might distinguish the whole Division from the Osteichthyes, in which there are two series. But there is some reason to believe that this was not the case in the Acanthodii (p. 190).

The Chondrichthyes retain most of the structures mentioned above as being characteristic of primitive fish; the absence of true bone, of scales other than denticles, and the formation of the jaws from the palato-quadrate bar and Meckel's cartilage, distinguish them from the rest of the Pisces.

The classification of the Chondrichthyes still presents many difficulties. The first two sub-classes described below (Elasmobranchii and Pleuracanthodii) have many characters in common, and are distinguished from all other Pisces by the development in the male of copulatory 'claspers.' These are specialised posterior portions of the pelvic fins. It seems very unlikely that the claspers should have been developed independently in the Elasmobranchs and in the Pleuracanthodians.<sup>1</sup> At the same time, to unite these two groups into one sub-class would perhaps be to separate them too far from the Cladoselachii. Until the structure and affinities of the latter are better understood, it cannot be decided whether they are

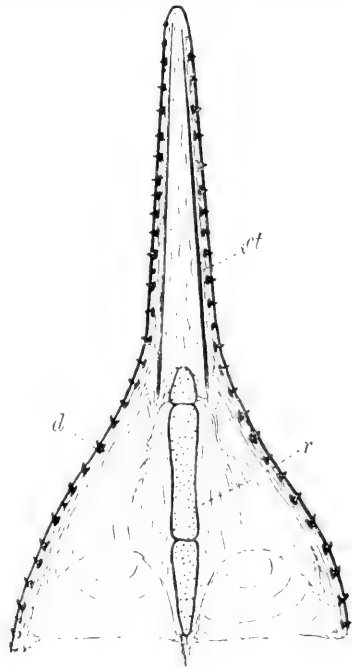

FIG. 83.

Diagram of a section through the dorsal fin of *Scyllium*. *ct*, ceratotrich; *d*, denticle; *r*, endoskeletal radial. (From *Quart. Journ. Micr. Sci.*)

<sup>1</sup> For a discussion of the morphology of the skeleton of the paired fins, see pp. 73, 106; for the copulatory claspers, see p. 129.

Elaismobranchs which have lost the claspers, or an early offshoot

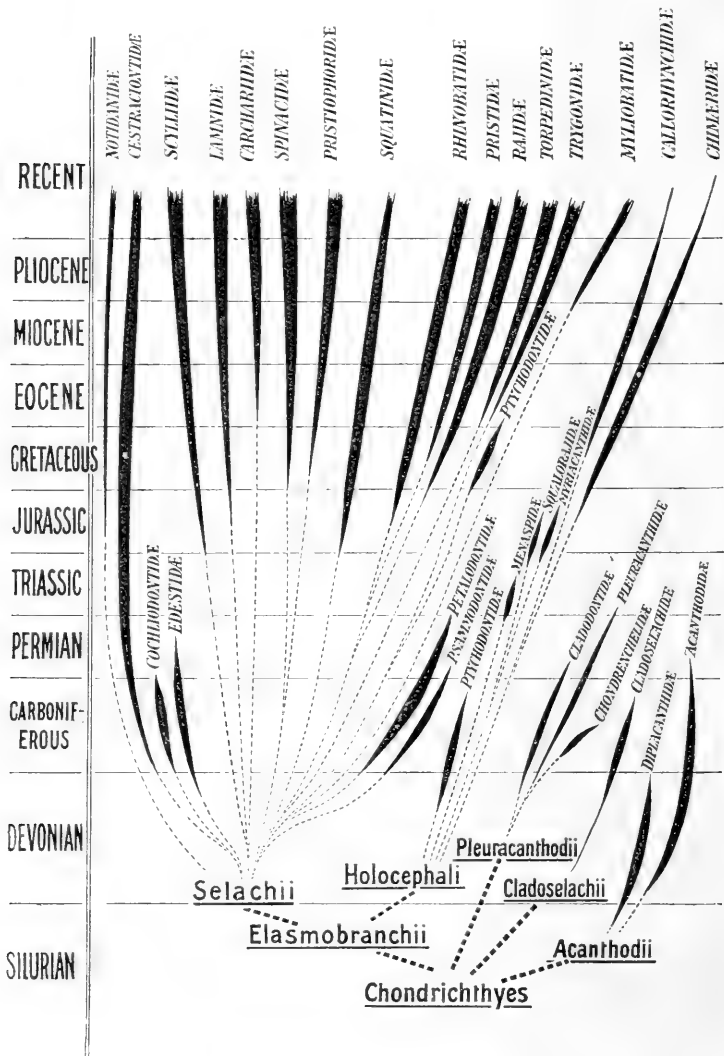

DIAGRAM II.

Diagram illustrating the Phylogeny of the Chondrichthyes, and their distribution in the geological strata. The actual range of distribution is shown in black; the dotted lines indicate hypothetical connections.

sprung from the Chondrichthyan stem before claspers were developed. The affinities of the Acanthodii are still less clear.

## Sub-Class 1. ELASMOBRANCHII.

The mouth is never quite terminal, a rostrum of considerable size, supported by cartilaginous processes of the skull, being generally produced in front. The two palato-quadrate cartilages meet below the skull in front. The nostrils are more or less ventral, in front of the mouth, and are incompletely subdivided into anterior and posterior openings by a small flap (Figs. 114, 117). They lead into wide nasal cavities with two rows of olfactory folds. A fronto-nasal process grows down between the nostrils in the embryo, and either fuses with the upper lip so as completely to separate the nostrils from the mouth (Fig. 114) or its edges form

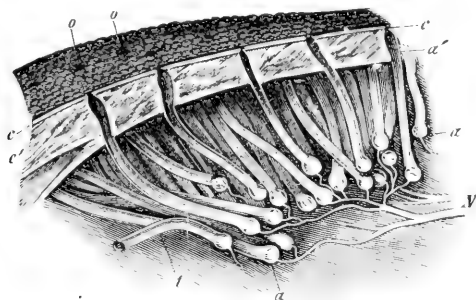

FIG. 84.

Portion of the snout of *Scyllium* in section, showing ampullary tubes. (After Gegenbaur, from Sedgwick's *Zoology*.) *a*, ampulla; *a'*, passage of a tube through the dermis; *c*, epidermis; *c'*, dermis; *n*, nerve; *o*, external openings of tubes; *t*, tube.

two deep grooves running from the mouth to the nostril on each side (Fig. 103). The latter system, with 'confluent' nostrils, appears to be the most primitive, and is found both in the Selachii and in the Holocephali. The auditory vesicle often remains open to the exterior by a narrow ductus endolymphaticus, even in the adult (Fig. 13), and the sacculus contains a mass of small otoliths. The eye, enclosed in a cartilaginous sclerotic, has a pigmented tapetum, but the ventral ciliary process attached to the lens is small; it contains a muscle for accommodation (Fig. 346).

The distribution of the lateral-line system on the head, fairly constant among the Selachii, may here be described (Figs. 11, 85). The main lateral line of the trunk runs forward on to the head, where it may give off a transverse occipital branch; continuing as a short temporal canal and a postorbital canal, it divides into a dorsal supraorbital and a ventral suborbital branch extending on to the snout. Portions of a hyomandibular and mandibular canal are also present, though generally interrupted (ep. p. 220, and Figs.

85 and 196, where the nerve-supply of these canals is given). The very characteristic groups of sensory ampullae, supplied by the facial nerve (Fig. 84), are distributed on the head, as shown in Figs. 11 and 85. These deep-seated organs communicate with the exterior by long tubes opening by conspicuous pores on the surface (Fig. 84).

Among the characteristic features of the brain one may mention the following. The prosencephalon (Fig. 7) is large, of paired origin, and may contain paired cavities, but shows little or no sign of external division, especially in the Rajiformes. The thickened floor and wall of the telencephalon merges in front with that of the

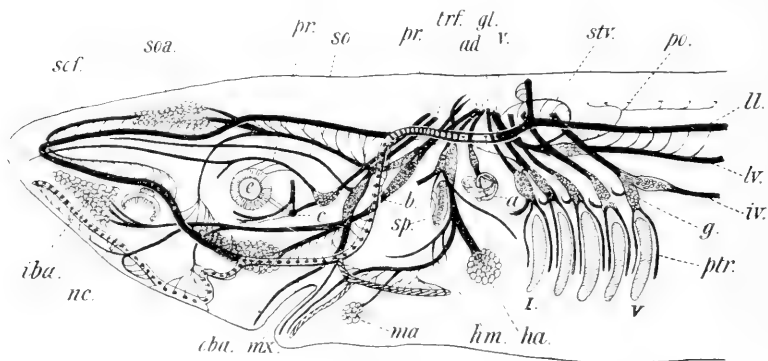

FIG. 85.

Diagram of the head of *Laemargus*, showing the cranial nerves and sense-organs. (After Ewart and Mitchell.) The lateral-line canals are indicated as in Fig. 196, p. 222. *a*, auditory labyrinth; *ad*, auditory nerve; *b*, buccal branch of facial; *c*, ciliary ganglion on branch of oculomotor; *c*, eye; *g*, epibranchial ganglion on branch of vagus; *gl*, glossopharyngeal; *h.a.*, hyoid group of ampullae of Lorenzini; *h.m.*, hyomandibular branch of facial; *i.b.a.*, inferior group of ampullae; *i.v.*, intestinal branch of vagus; *l.l.*, lateral-line canal of trunk; *l.v.*, lateral-line branch of vagus; *m.a.*, mandibular group of ampullae; *mx.*, maxillary branch of trigeminal; *n.c.*, nasal sac; *ob.a.*, suborbital group of ampullae; *p.o.*, pit-organ; *pr.*, profundus; *p.tr.*, post-trematic branch of branchial nerve; *s.o.f.*, superior ophthalmic branch of trigeminal; *s.o.a.*, superior group of ampullae; *s.o.f.*, superior ophthalmic branch of facial; *sp.*, spiracle; *str.*, supra-temporal branch of vagus; *t.r.f.*, roots of trigeminal and facial; *v.*, vagus root; I-V, five branchial slits.

prosencephalon, obliterating the thin lamina terminalis, and forming a mass of nervous tissue covering the sides, front wall, and roof of the telencephalon (Figs. 7, 86). It is into this often immensely developed prosencephalic mass that the lateral ventricles project. At the sides, or in front, arise large diverging olfactory lobes; these may either be near the cerebrum or they may be drawn out into long olfactory tracts, expanding anteriorly into olfactory bulbs close to the nasal capsules. The epiphysis is long, and reaches forwards in Selachians to below the superior fontanelle of the skull; but there is no pineal eye. As in many other fish, the lobi inferiores and saccus vasculosus are well developed in the infundibular region. The cerebellum is very large and often convoluted; the restiform bodies, at the sides of the medulla, may also be prominent.

The phosphorescence of Elasmobranchs, mentioned by Aristotle, appears to be due to special little organs scattered over the skin (Burekhardt [71], Johann [246]).

The median fins are always subdivided; the caudal is heterocercal in internal structure, though the axis is almost straight in many living sharks.

The endoskeleton of the paired fins is very variable in detail, owing to concentration and fusion of the radials (somactidia). A large number of segments contribute to their formation—generally ten or more. The pectoral fins have a well-marked outstanding muscular lobe, supported by a rhipidostichous skeleton (p. 106).

Gegenbaur, in 1865, attempted to show, in an important work

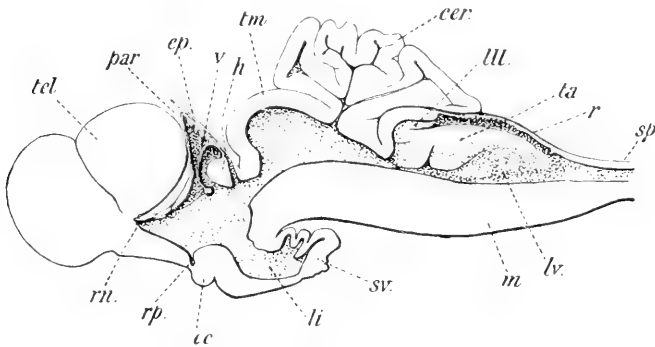

FIG. 86.

Longitudinal section of the brain of *Acanthias*. (After Johnston.) *cer*, cerebellum; *ep*, epiphysis; *h*, nucleus habenulae; *li*, lobus inferior; *l.l.l.*, lobus lineae lateralis; *l.v.*, lobus visceralis; *m*, medulla; *o.c.*, optic chiasma; *par*, paraphysis; *r*, roof of fourth ventricle; *r.n.*, recessus neuroporicus; *r.p.*, recessus praeropticus; *sp*, spinal cord; *s.v.*, saccus vasculosus; *t.a.*, tuberculum acusticum; *tel*, telencephalon; *t.m.*, tectum mesencephali; *v*, velum transversum.

[153], that the ground-plan of the pectoral-fin skeleton consisted of three basal pieces, the pro-, meso-, and metapterygium, articulated to the girdle, and each bearing a number of radials. Later, he compared this skeleton to the 'archipterygium' of *Ceratodus* [157]. The pro- and mesopterygium were considered to be formed by the fusion of the basal joints of the preaxial radials. The metapterygium, on the contrary, with sometimes some distal elements, was supposed to represent the original axis. Vestiges of postaxial rays are occasionally found (Fig. 53). The metapterygium was held by Gegenbaur not to be formed by conrescence.

This distinction, drawn between the posterior and largest basal (the metapterygium) and the others, does not seem to be justified either by comparative anatomy or by embryology. Indeed, Huxley [230] identified the original axis in the mesopterygium. All the basals are probably formed by conrescence, and an endless variety

of detail is presented by the different families and genera. There may be a single basal, as in *Scymnus* (Fig. 53, A); two basals, as in *Heterodontus* and *Chimaera* (Fig. 54, A); three, as in *Scyllium* or *Acanthias*; or five, as in *Myliobatis*. In the Rajidae, also, an anterior axis develops quite similar to the metapterygial axis (Fig. 121).

The pelvic fin is much less completely constricted off than the pectoral; its skeleton is simpler. In the Selachii, the fanlike

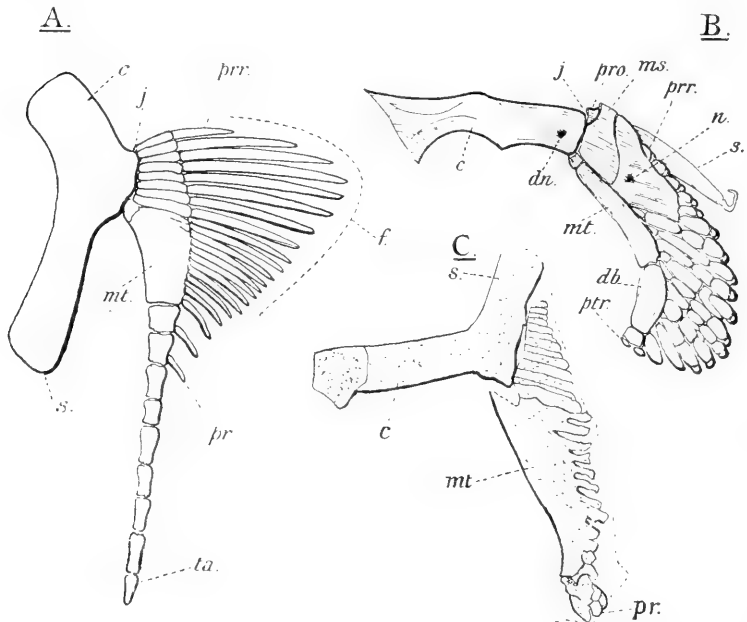

FIG. 87.

Skeleton of the pectoral arch and fin of A, *Cladodus Neilsoni*, Traq.; B, *Chlamyloselachus anguineus*, Garman; and C, *Symmorium reniforme*, Cope. (A restored from Traquair's figure, B and C after Braus.) *c*, coracoid region; *d.b.*, distal basal or 3rd segment of metapterygial axis; *d.n.*, diazonal nerve foramen; *f*, problematical fin outline; *j*, joint between girdle and fin; *ms*, mesopterygium; *mt*, metapterygium; *n*, nerve foramen; *p.r.*, posterior preaxial radial; *pr.*, propterygium; *pr.r.*, anterior preaxial radial; *pt.r.*, possibly postaxial radial; *s*, scapular region; *ta*, distal segment of metapterygial axis.

arrangement of the radials, although to some extent visible at the posterior end, is never as pronounced as in the pectoral fin. Except for a few radials which may articulate with the girdle, the single series is attached to one longitudinal basal, the basiptyergium, lying in the body-wall. Postaxial rays, if ever present, have disappeared, leaving but occasionally a doubtful remnant (Figs. 96, 101). The pelvic fin is almost or quite monostichous.

The articulation of radials to the pelvic girdle in front of the metapterygium is doubtless a primitive character; it is an indication

of the derivation of the girdle from the base of the radials, and is conspicuous in the Pleuracanthodii (p. 181), in the Notidani, and to a less extent in many sharks, but is lost in the Dipnoi. The Holocephali, however, have the radials of the pelvic fin radiating from the edge of a single basal plate, like a fan (Fig. 54, B).

The fossil Elasmobranchs give little or no help for the interpre-

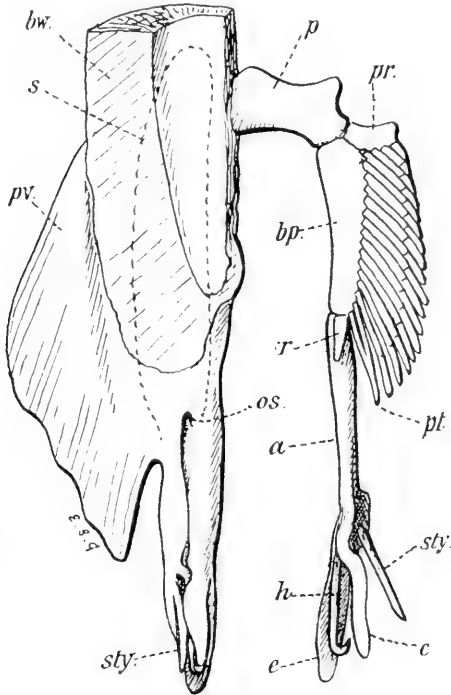

FIG. 88.

Dorsal view of the pelvic girdle and fins of a male *Acanthias vulgaris*, Risso; the skeleton has been exposed on the right side. *a*, axial cartilage of clasper; *bp*, basipterygium; *bw*, cut body-wall; *c*, dorsal covering plate; *e*, ventral plate; *h*, hook; *os*, opening of glandular sac; *p*, pelvic girdle; *pp*, propterygial, or anterior basal; *pr*, posterior radial; *pt*, pelvic fin; *r*, modified radial; *s*, outline of glandular sac embedded in body-wall dorsal to girdle; *sty*, hard style.

tation of the skeleton of the paired fins. The fact that the pectoral, as a rule, differs so much from the pelvic, shows that one, or both, have departed considerably from the primitive type (p. 108).

We may here describe the modifications of the skeleton of the pelvic fin brought about by the development of the "clasper," mixipterygium, or copulatory appendage of the male (Gegenbau [155], Petri, Jungersen [254-5], Huber [222]). The pelvic fin-

fold is produced at its hinder margin into an outstanding lobe. The basipterygium is continued backwards into this lobe as a cartilage rod, consisting, as a rule, of two short anterior and one long posterior segment. A dorsal groove carrying the skin with it is



FIG. 89.

*Raja blanda*, Holt. Dorsal view; the cartilaginous skeleton has been completely exposed on the right side. *a, b, c, d, f*, cartilages of clasper; *al*, anterior lobe of pelvic fin; *bp*, basipterygium; *cl*, clasper; *c.p.*, covering-plate; *i.p.*, iliac process; *o.s.*, opening of sac; *p*, pelvic girdle; *p.p.*, prepubic process; *pr.r.*, enlarged preaxial radial; *pt*, posterior preaxial radial; *s*, dotted line indicating ventral glandular sac; *st*, second segment of basipterygial axis; *sty*, styliform cartilage.

developed along this terminal piece, which becomes hollowed out to receive it. The edges of the cartilage are rolled round so as almost completely to enclose the groove in a split tube open at both ends (Fig. 88). Spermatozoa may pass in at the front and out at the hind end. The internal tegumentary tube projects forward as a blind sac, and from its wall develops a special gland. The main



cartilage is usually produced into a sharp calcified style, near which terminal pieces are developed (Fig. 88).

Among the Selachii, Huber distinguishes three main types of modification of some importance in classification. Type A: with

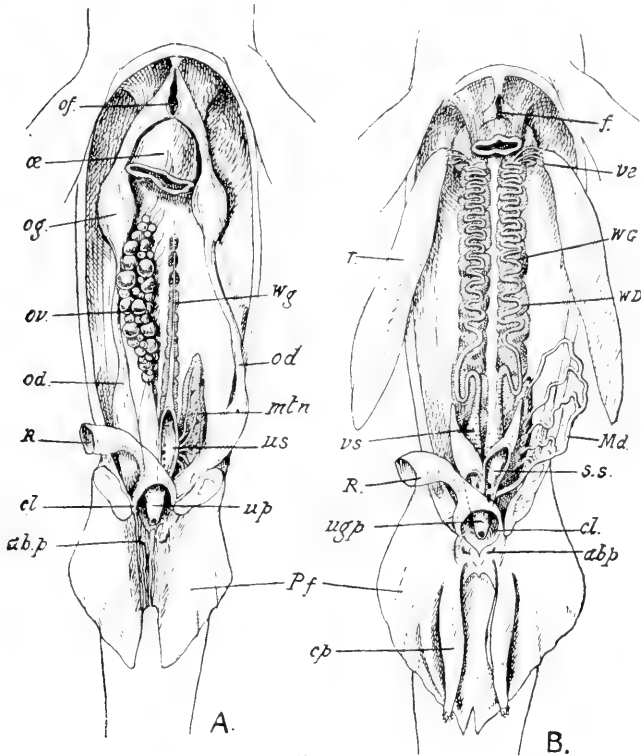

FIG. 90.

A, Urinogenital system of the female, B, of the male dogfish (*Squalium*). *ab.p.*, abdominal pores; *cl.*, cloaca; *cp.*, claspers of the male; *f.*, rudiment of the oviducal opening in the male; *Md.*, metanephric ducts; *mcn.*, metanephros; *od.*, oviduct; *oe.*, cut end of oesophagus; *og.*, oviducal gland; *ov.*, ovary; *Pf.*, pelvic fins; *R.*, rectum; *s.s.*, sperm-sacs; *u.p.*, urinary papilla in the female; *u.g.p.*, urogenital papilla in the male; *u.s.*, urinary sinus; *ve.*, vasa efferentia; *v.s.*, vesicula seminalis; *W.d.*, Wolffian duct; *W.g.*, Wolffian gland or mesonephros. (After G. C. Bourne.)

a prominent hard terminal style, piercing the skin; a tegumentary fold partially covering the groove; and the whole internal cavity glandular. Type B differs from the former in having the tegumentary fold inside, the overlapping edges of the main cartilage more developed and turned in, and the terminal cartilages reaching to or beyond the end of the style. Type C: the gland is specialised and of tubular structure; and one, two, or three of the accessory pieces form flattened sheathing-plates (Fig. 89). Type A

occurs in the Notidani, Heterodonti, and Squaliformes; Type B in the Scillioidei; Type C in the Rajiformes. The copulatory appendage of the Pleuracanthodii seems to have been of very similar structure; but that of the Holocephali acquires a trifold instead of a tubular main cartilage (p. 174).

The primitive optic chiasma, conus arteriosus with valves, and spiral valve are all retained in living Elasmobranchs. Except in *Chlamydoselachus*, which retains a single efferent vessel as in the embryo (Ayers [24]), the gill-bearing branchial arches are provided with two efferent vessels. The posterior of one arch joins the anterior of the next, above the slit, to form the epibranchial artery (Fig. 71).

The mesonephric kidneys are differentiated into an anterior 'genital' region and a posterior excretory region (Fig. 90). The latter, which is sometimes called the metanephros, is large and normally developed; but its collecting ducts become to a great extent separated off from that of the front tubules, and in the male may join to a single duct or ureter on each side. They open into the base of the mesonephric ducts, which join to a median sinus in both sexes (Fig. 90). The excretory tubules of the anterior region of the kidney are relatively unimportant. In the male the mesonephric duct swells to a seminal vesicle behind, and forms a coiled epididymis in front, receiving the vasa efferentia from the testis. The urinogenital sinus receives the seminal vesicles and the ureters in the male, and in the Selachii is continued forwards in paired blind 'sperm-sacs.' The urinogenital papilla opens into the cloaca behind the anus.

The large oviducts of the female open independently into the cloaca between the anus and the urinary papilla (Fig. 90). Their anterior coelomic funnels join to a common ostium on the ventral surface of the oesophagus and in front of the liver.

The Müllerian duct (oviduct) is developed in both sexes, remaining as a vestige in the adult male. It is derived from the pronephros (Balfour [27], Rabl [337]). The rudimentary pronephric funnels combine to one opening, shifting backwards to a position behind the pericardial septum (p. 90). The duct is split off from the archinephric duct, which thus becomes divided into an oviduct or Müllerian duct, and a mesonephric or Wolffian duct. As a rule, the egg is large, heavily laden with yolk; fertilisation is internal, and cleavage meroblastic. A large narrow-stalked yolk-sac remains for a considerable time protruding from the ventral surface of the embryo, often even after birth. A lobe of the yolk-sac may also lie in the abdominal coelom. The vitello-intestinal duct arises from the anterior end of the intestine.

A characteristic horny case, secreted by a special glandular region of the oviduct (Fig. 91), and containing an albuminous

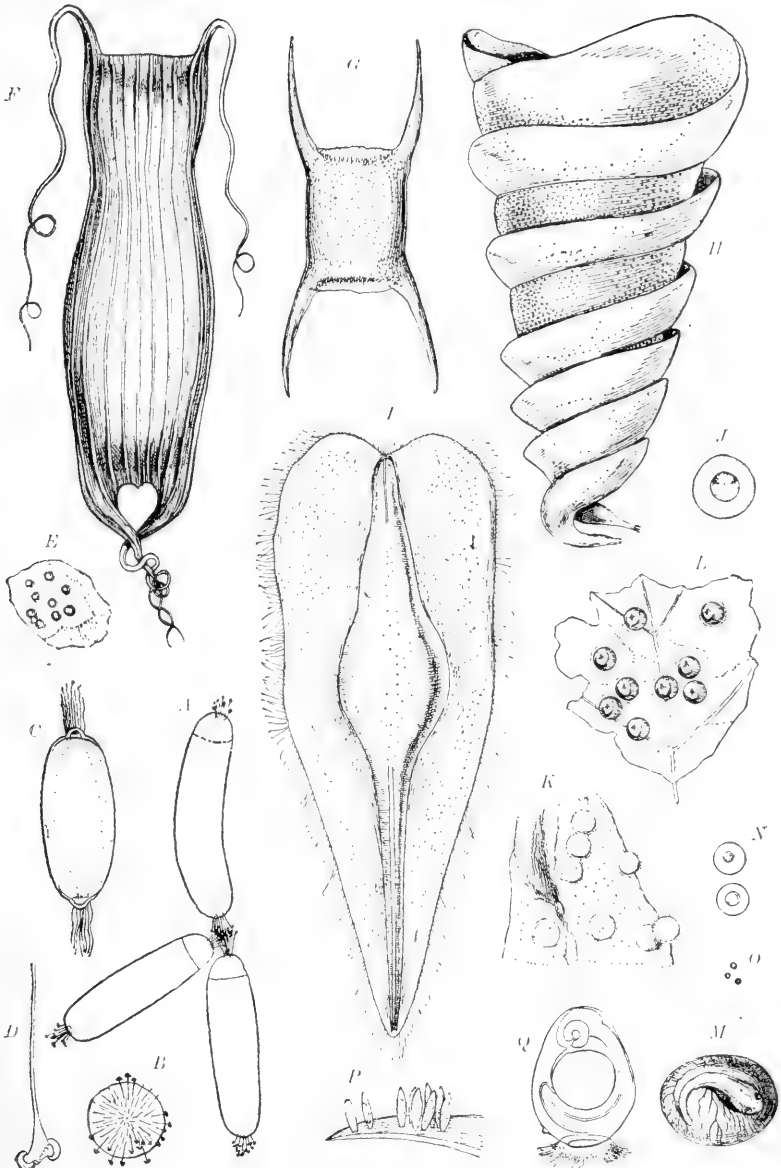

FIG. 91.

Eggs and egg-cases of fishes. (From Dean.) A, *Billostoma*, egg-case; B, upper pole of the same showing hooks and micropyle (after Ayers); C, *Myxine* (after Steenstrup); D, a process of the same; E, *Petromyzon marinus*; F, *Scyllium* (after Günther); G, *Raja*; H, *Heterodontus* (after Günther); I, *Cellorhynchus* (after Günther); J, *Ceratodus* (after Simon); K, *Lepidosteus*; L, *Acipenser*; M, *Arius*, showing larva (after Günther); N, *Serranus*; O, *Alosa*; P, *Blennius*, egg-capsules attached; Q, the same enlarged (after Güitel).

fluid, surrounds the egg when it is laid. In *Laemargus*, however, fertilisation appears to be external, and the eggs are comparatively small. This is probably a secondary modification.

Many Selachians are viviparous. In these, the egg-case becomes reduced to a thin membrane (*Mustelus*) or disappears altogether (*Torpedo*), and the wall of the oviduct develops bunches of secreting villi or cotyledons (Duméril [124]). While the embryo Trygonid or Myliobatid takes in the nutritive fluid through its

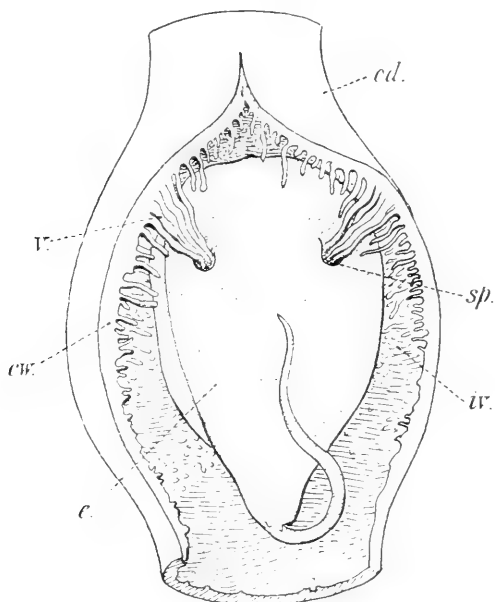

FIG. 92.

*Pteroplatea micropora*, Bl. Schm. Portion of oviduct opened to show the embryo inside. *c.w.*, cut wall of oviduct; *e.*, embryo; *i.v.*, internal wall with villi; *od.*, oviduct; *sp.*, spiracle of embryo; *c.*, long villi entering spiracle.

mouth or spiracles, in *Pteroplatea* (Wood-Mason and Alcock [6, 498]) the maternal villi actually penetrate through the spiracles into the alimentary canal of the embryo (Fig. 92). In some of the Selachians with villate oviducts (*Mustelus*, *Carcharias*) an intimate connection is established between the wall of the oviduct and the highly vascular yolk-sac. A placenta is thus formed in which maternal villi fit closely into corresponding crypts in the embryonic yolk-sac (J. Müller).

A number of gill-lamellae become elongated into threads, projecting to the exterior as transitory larval external gills, and may serve as organs of absorption (Fig. 76).

The Elasmobranchs are distinguished by the possession of a heterocercal tail, ventral nostrils only incompletely subdivided by a flap, a single series of cartilaginous branchial rays on each arch, ampullary organs, a brain in which the front wall becomes much thickened, a copulatory clasper in the male, an oviducal gland in the female which secretes a horny egg-capsule.

The sharply divided orders, Selachii and Holocephali, into which the Elasmobranchii are at the present day classified, appear to have been already well marked in Devonian times. The modern Holocephali are highly specialised in many respects, but possess all the essential characteristics of Elasmobranch structure. On the other hand, they differ fundamentally from the Dipnoi, with which they have sometimes been associated on account of a vague resemblance between the two groups in the skull and vertebral column.

### Order 1. SELACHII.

In this order, which includes the most primitive of living fish, the spiracle, and the hemibranch on its front wall, are generally preserved. The branchial slits always open independently to the exterior, and are placed primitively in front of the pectoral girdle.

The cartilaginous brain-case is large and very complete, excepting for an anterior dorsal fontanelle (Fig. 93). The two orbits often communicate by a canal through the floor in the pituitary region. The optic capsule may be connected with the cranium by a cartilaginous peduncle. The intracranial notochord is usually much reduced and a definite occipital joint becomes established (Gegenbaur [153], Parker [318]).

The notochord becomes much constricted by the mesoblastic cells invading the sheath (p. 99), and vertebral centra are almost always developed (Goette [167], Hasse [200], Klaatsch [265]). These are usually strengthened by special calcifications, which first take the form of a constricted cylinder (Fig. 50) developed in the inner layer near the notochord. There may be added radiating longitudinal lamellae between the bases of the arches (Fig. 94), or concentric cylinders outside the original one (Fig. 52). Hasse called these three types the cyclospondylous, asterospondylous, and tectospondylous respectively, and classified the Selachii accordingly (Fig. 95). That these characters of the centrum are of considerable taxonomic value there can be no doubt, but the distinction between the various types does not seem to be as clear and sharp as was supposed. Both radiating and concentric calcifications may be plainly shown in the same vertebra (*Cetorhinus*). The radiating calcifications may be developed centrifugally from the primary cylinder (most Scyllioidei), or they may grow inwards centripetally

from the outer layer (*Raja*). This outer layer is sometimes, at all events, formed outside the *elastica externa*, by a spreading out of

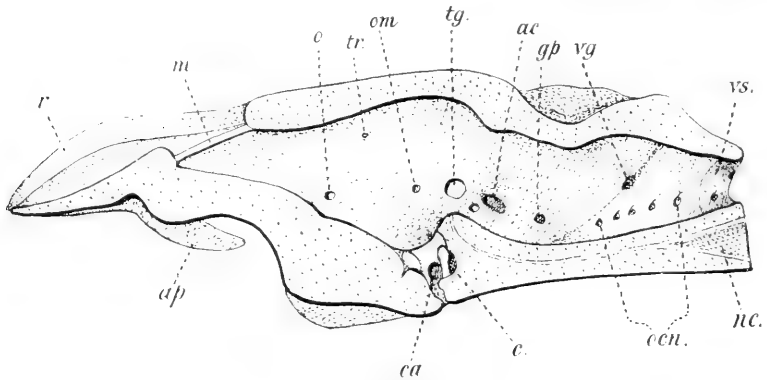

FIG. 93.

Inner view of the right half of the skull of *Heanchlus*. (After Gegenbaur.) *ac*, foramen for auditory, *gp*, for glossopharyngeal, *o*, for optic, *ocn.*, for spino-occipital, *om*, for oculomotor, *tg*, for trigeminal, *tr*, for trochlear, *vg*, for vagus, and *vs*, for occipito-spinal nerve; *a.p.*, antorbital process; *c*, carotid foramen; *ca*, interorbital canal; *m*, membrane over fontanelle; *r*, rostrum.

the bases of the arches, which finally meet round the notochordal centrum. A compound centrum is thus formed, partly 'perichordal'

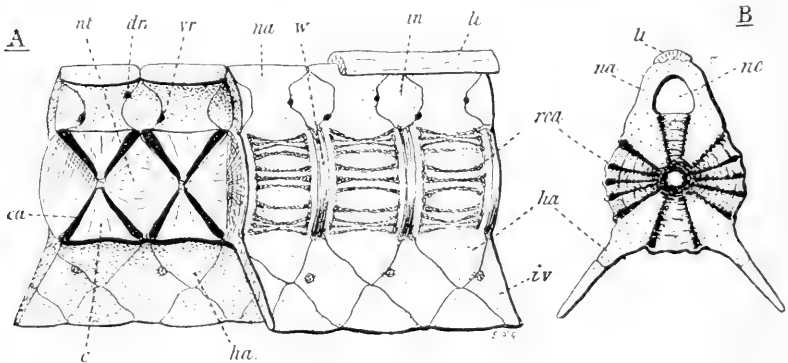

FIG. 94.

*Lumina coraubicca*, Gm. A, portion of the vertebral column of the trunk, partly cut longitudinally (right-side view). B, transverse section of the same through the middle of a centrum. *c*, centrum; *ca*, calcareous constricted ring; *dr*, foramen for dorsal nerve-root; *ha*, basiventral; *in*, interdorsal; *iv*, interventral; *lu*, ligament; *na*, basidorsal; *nc*, neural canal; *nt*, notochord; *rca*, radial calcifications; *v*, foramen for ventral root; *v*, intervertebral ligament.

and partly 'chordal' (p. 100). The ventral root of the spinal nerves, as a rule, comes out either behind or through the neural arch (basidorsal); the dorsal root either behind or through the

intercalary (interdorsal). In the caudal region there are generally two centra and two sets of arches to each segment (marked by one pair of myotomes and of spinal nerves); this diplospondyly probably ensures greater flexibility in the tail (Hasse [200], Ridewood [361]).

The dorsal ribs are often well developed in the horizontal septum; of separate pleural ribs only traces are perhaps found in the anterior caudal region (p. 68).

The dorsal fins are always much concentrated; the skeleton may be either far removed

from the vertebral column (*Scyllium*) or closely connected with it (*Raja*, Fig. 49 and p. 105).

The pectoral girdle consists of a cartilaginous bar with a well-developed dorsal scapular region and a ventral coracoid region. Ventrally the two halves are either fused or joined together by fibrous connective tissue. A varying number of diazonal nerves pass through the girdle to the fin.

The two halves of the pelvic girdle fuse together in the mid-ventral line to form a transverse bar (Fig. 96), generally pierced by nerves. The pelvic girdle, on the whole, appears to have undergone reduction, and almost all trace of a dorsal iliac process has vanished in the sharks.

The hyomandibular is large. The jaws are movably articulated to the cranium, the suspensorium being hyostylic, in all modern forms except the Notidani (p. 96).

The lateral-line system of sense-organs, on the head and trunk, sinks below the skin into a tube, which remains in communication with the exterior by short canals between the sense-organs (Fig. 97) (Ewart and Mitchell [134], Garman [148]).

A dorsal thick-walled coecum, the rectal gland (Fig. 78), is present at the hind end of the intestine (Howes [220]).

Except in *Chlamydoselachus*, the branchial arches of the Selachii, like those of the Dipnoi, have two efferent arteries (Fig. 57), and, further, the epibranchial arteries differ from those of other Pisces in that they correspond to the slits and not to the bars, being formed by the union of a posterior efferent vessel of one bar with an anterior efferent vessel of the bar next behind (Fig. 71).

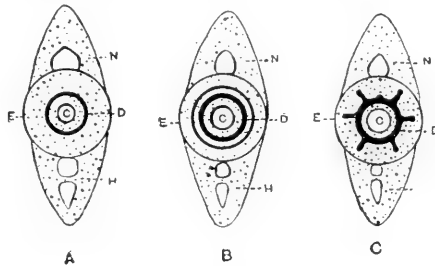

FIG. 95.

Diagrammatic transverse sections of vertebrae, to illustrate the, A, cyclospondylous, B, tectospondylous, and C, asterospondylous condition. C, notochord; D, central calcareous ring; E, elastica externa; N, neural, and H, haemal arch. (After Hasse, from Sedgwick's *Zoology*.)

One may diagnose the Selachii as: Elasmobranchs with subdivided and much concentrated median fins; a constricted noto-

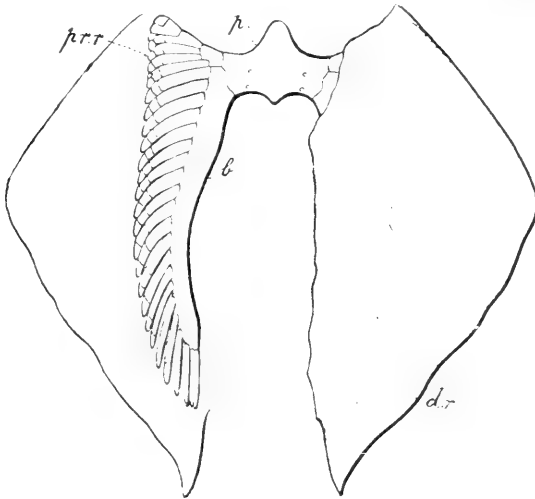

FIG. 96.

Ventral view of the pelvic girdle and fins of *Heptanchus cinereus*, Gm. The skeleton is completely exposed on the left side. *b*, basipterygium; *d.r.*, web of fin supported by ceratotrichia; *p.*, pelvic cartilage; *p.r.r.*, series of preaxial radials. (From *Quart. Journ. Micr. Sci.*)

chord, an invaded notochordal sheath, and centra, if present, of chordal origin; dorsal ribs; the two halves of the pelvic girdle

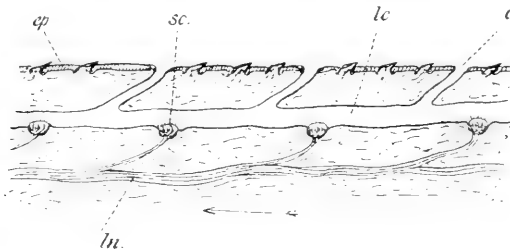

FIG. 97.

Diagram of the lateral-line canal of a Selachian seen in a section vertical to the surface. *ep.*, epidermis; *l.c.*, longitudinal canal; *l.n.*, lateral-line nerve; *o.*, opening of branch canal on surface; *s.o.*, sense-organ.

fused together; a wall between the cavity of the auditory capsule and of the brain-case, a large hyomandibular cartilage; epibranchial arteries corresponding to the branchial slits; gill-slits opening separately to the exterior; and a rectal gland.

The Selachii may be divided into two groups. In the first, the



attachment of the jaws is more or less amphistylic, the branchial slits are six or seven in number, and there is only one dorsal fin. In the second group, the jaws are attached in modern forms on the

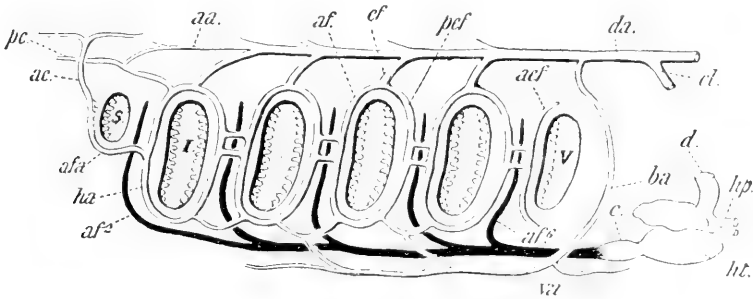

FIG. 98.

Diagram of the branchial circulation of an Elasmobranch fish (modified from T. J. Parker). *a.a.*, median anterior prolongation of aorta; *a.c.*, anterior carotid; *aef.*, anterior efferent vessel of spiracular gill (pseudobranch); *ae.*, efferent vessel from last hemibranch; *af.*, anterior efferent vessel; *af*<sup>1-6</sup>, five afferent vessels from ventral aorta; *afa.*, afferent artery of spiracular gill; *c.*, conus leading to ventral aorta; *cl.*, coeliac artery; *d.*, ductus Cuvieri; *da.*, dorsal aorta; *ef.*, epibranchial artery; *he.*, hyoid efferent vessel; *hp.*, hepatic veins; *ht.*, heart; *pc.*, posterior carotid; *pef.*, posterior efferent vessel; *s.*, spiracle; *va.*, ventral artery; I-V, branchial slits.

hyostylic plan, there are not more than five branchial slits (with one exception, p. 152), and there are two dorsal fins (Müller u. Henle

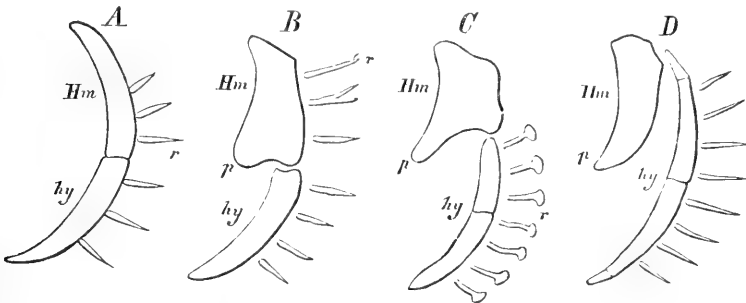

FIG. 99.

Diagram showing the principal modifications in the arrangement of the hyoid arch in the Selachii. (After Gegenbaur, from Sedgwick's *Zoology*.) A, in *Heptanchus*; B, in a shark; C, in *Torpedo*; D, in *Raja*. *Hm.*, hyomandibular; *hy.*, lower part of hyoid arch; *p.*, process supporting jaw-articulation; *r.*, branchial rays.

[308], A. S. Woodward [505], Duméril [124], Regan [346], Jaekel [238], etc.).

## GROUP I.

## Sub-Order 1. NOTIDANI.

These sharks have a skull and jaw apparatus built on the amphistylic plan. In *Heptanchus*, the palato-quadrates are firmly

articulated to the auditory capsule by its otic process (Fig. 59, A); in *Hexanchus*, the articulation is looser; finally, in *Chlamydoselachus*, the otic process, though large, does not quite reach the skull. The gape of the jaws is very wide; the hyomandibular is elongated and directed backwards. The palato-quadrates have a basal process placed far back, and are only loosely joined together in front. There is a long occipito-spinal region, behind the vagus foramen, the skull not being clearly marked off from the vertebral column (Fig. 93). There is no triradiate rostral cartilage, and the floor of the orbit is not cartilaginous. The nostrils are not confluent with

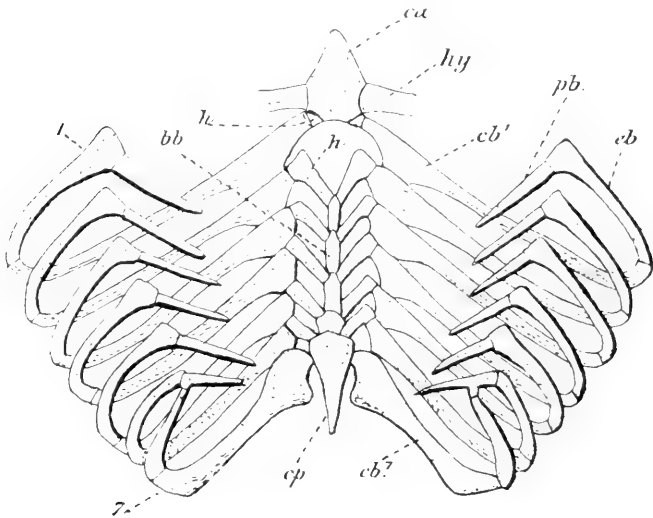

FIG. 100.

Branchial arches of *Heptanchus*. (After Gegenbaur.) *bb*, basibranchial; *ca*, basihyal; *cb*<sup>1-7</sup>, ceratobranchials; *cp*, fused 6th and 7th basibranchials; *cb*, epibranchial; *h*, hypobranchial; *hy*, ceratohyal; *pb*, pharyngobranchial.

the mouth. The spiracle is small. There are six branchial arches and slits in *Hexanchus* and *Chlamydoselachus*, seven arches and slits in *Heptanchus* (Fig. 100). The slits remain widely open externally.

One moderately concentrated dorsal fin alone is present. There is an extensive anal fin. The radials in the median fins are numerous, and tend to fuse into elongated basal pieces (Fig. 48). The tail is but slightly heterocercal. The notochord is largely persistent, vertebral centra being feebly developed, especially in *Chlamydoselachus*, where the notochord remains quite uncontracted in the anterior region (Fig. 101). *Heptanchus* and the fossil *Notidanus*, however, have well-developed centra behind, where calcifications of the asterospondylous type may occur. A consider-



able transitional region is found between the trunk and the posterior diplospondylous part of the vertebral column; here the arches are double in each segment, but not the centra.

The copulatory appendages (p. 131) resemble those of the sub-orders *Heterodonti* and *Squaliformes*, but they are smooth.

The rostrum is small in *Heptanchus*, scarcely at all developed in *Heacanthus* and *Chlamydoselachus*. The skull and visceral arches afford evidence that the Notidani are the most primitive group of the Selachii.

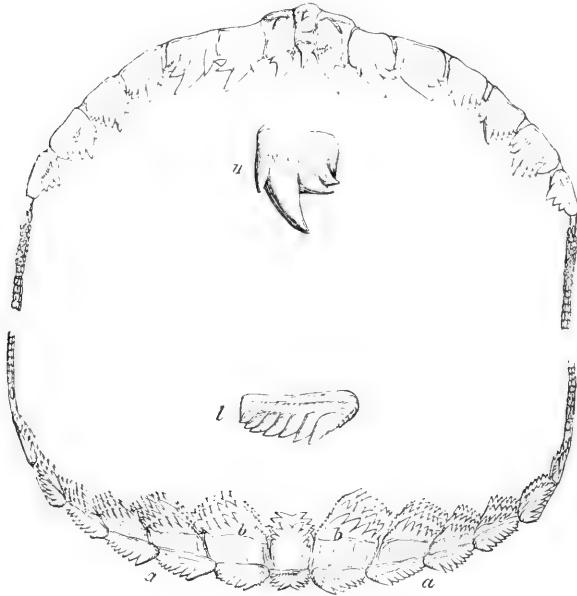

FIG. 102.

Dentition of *Heptanchus (Notidanus) indicus*, Cuv. *a*, teeth in function; *b*, teeth in reserve; *u*, upper, and *l*, lower tooth of natural size. (After Günther.)

**FAMILY CHLAMYDOSELACHIDAE.** One of the most remarkable of living sharks, *Chlamydoselachus*, is isolated in this family (Fig. 101, A). The mouth is nearly terminal, and the nostrils are more lateral than ventral. The edges of the gill-septa are expanded into overlapping folds. The groove-like structure of the lateral line of the trunk is perhaps secondary (Fig. 101, E). The teeth, with three long cusps developed separately (Röse [374]), have a striking resemblance to those of the *Pleuracanthodii*, which appears to be due to convergence. The pelvic girdle is unusually long, and pierced by a double series of nerve foramina (Fig. 101, G) (Garman [147]).

*Chlamydoselachus*, Garman; Pacific and Atlantic Oceans, and Pliocene of Europe.

FAMILY NOTIDANIDAE. These typically amphistylic sharks have a more normal Selachian structure, and have diverged chiefly in their dentition. In modern genera the teeth are very unlike in the two jaws. In the lower jaw they are long, very compressed, and with a saw-like edge (Fig. 102). The gradual differentiation of this type of tooth, from one with a broad base supporting a large cusp and a few small ones, and closely resembling that of *Hybodus* (p. 144), can be traced in the fossil genus *Notidanus* (A. Smith Woodward [505]). The upper teeth have departed much less from the primitive type.

The fact that in the Jurassic *N. eximius*, Wagn., the centra are more calcified even than in *Heptanchus* points to the modern forms being somewhat degenerate.

*Notidanus*, Cuvier; Jurassic and upwards, Europe and New Zealand. *Heptanchus*, Raf.; Atlantic and Mediterranean Seas. *Hexanchus*, Raf.; warm and tropical seas.

## GROUP II.

In these Selachians the number of branchial slits does not exceed five (except in *Pliotrema*, p. 152); the notochord becomes much constricted by usually well-developed centra; the occipital region of the skull is clearly marked off from the column, and the occipito-spinal region very much shortened; a cartilaginous floor is formed below the orbit, except in the Rajiformes. The external branchial openings are, as a rule, considerably diminished in length by the overgrowth of the skin above and below.

An anal fin is present, except in the Subdivision 2 (p. 151, Squaliformes and Rajiformes), where it appears to have been lost. There are two dorsal fins.

## DIVISION A.

With little or no rostrum and no triradiate supporting cartilage, the mouth being almost terminal. The attachment of the jaws of the early forms is amphistylic; that of the later forms hyostylic.

### Sub-Order 1. HETERODONTI.

An ancient sub-order dating back beyond the Carboniferous epoch, probably to the Devonian, but surviving at the present day in one genus only, *Heterodontus* (*Cestracion*). In this modern Port Jackson shark the notochord is much constricted by well-developed asterospondylous centra; the jaws are hyostylic, but with a very extensive palato-basal articulation, so that the hyomandibular scarcely acts as a real support (Fig. 58). The teeth of *Heterodontus* are highly modified in both jaws, those towards the centre being small and pointed, those towards the sides being blunt and flattened into crushing plates. Several rows of teeth are functional at the same time (Fig. 107).

Early fossil forms are found, such as *Hybodus* (A. S. Woodward [500], Brown [63]), in which the teeth are much less specialised, resembling those of the early Notidanids. The teeth of *Hybodus* are nearly uniform, with a long cusped crown and a sharp central cusp. Those of *Synechodus* and *Acrodus* become blunter at the sides than towards the middle of the jaws (Fig. 104). Finally, the dentition of *Asteracanthus* closely resembles that of *Cestracion* and *Heterodontus* (Fig. 105). In the Cochlodontidae it is still further specialised by fusion. The teeth are very solid, being formed of vasodentine with fine branching pulp-canals.

The vertebral centra of *Palaeospinax* and *Synechodus* were

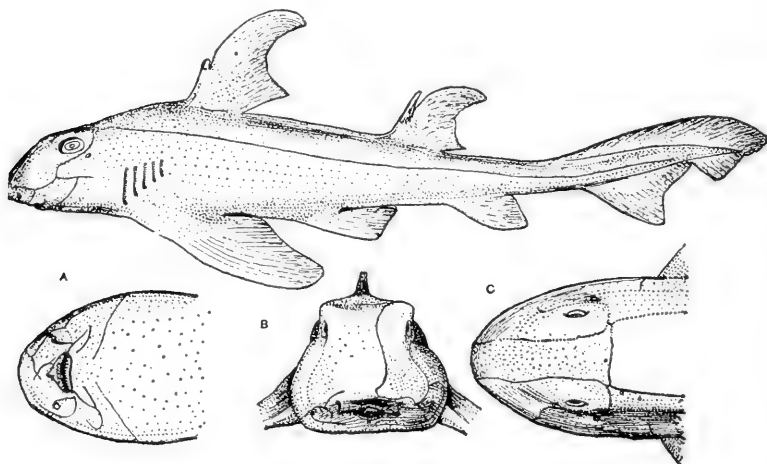

FIG. 103.

The Port Jackson shark, *Heterodontus (Cestracion) philippii*, Lac. (After Garman, from Dean.) A, ventral, B, front, and C, dorsal view of head.

well-developed and calcified, with distinct radial calcifications in the latter genus; but *Hybodus* shows no centra at all, and possibly had a primitive unconstricted notochord; nor have centra been found in *Acrodus* and *Asteracanthus*.

Most important of all, however, is the development of the jaws; for it is well established [500] that *Hybodus* and *Synechodus* had typical amphistylic skulls, with the palato-quadrates and hyomandibulars as in the Notidanidae and other primitive Elasmobranchs (p. 97). Now if this series of Heterodonts is correctly associated as a monophyletic group, it must be supposed that the hyostylic arrangement has been developed independently in the Heterodonti and in the members of Division B (p. 148). The Heterodonti must, if we accept this view, be definitely separated off from the other sharks, as a distinct offshoot from a more primitive



FIG. 104.

*Synechodus lubriensis*, Mackie. Dentition  $\times 2$ , with enlarged views of teeth from six rows: Upper Cretaceous, Sussex. (From A. S. Woodward, *Brit. Mus. Catal.*)

amphistylitic stock. In this connection it is interesting to notice that the hyostylism of *Heterodontus* differs considerably from that of other sharks (Huxley [230], Gegenbaur [153], and Fig. 58).

Family CESTRACIONTIDAE. The dorsal fins are armed with strong spines on the anterior edge, immediately in front of the endoskeletal

radials, which are much concentrated, and fused proximally to a large basal. In *Hybodus* the spines have a serrated posterior edge apparently formed by the fusion on to the spine of a double series of denticles (Fig. 106).

The nostrils are confluent with the mouth. A strong supraorbital crest is developed, bearing two pairs of specially enlarged spines in the male *Hybodus*, *Acrodus*, and *Asteracanthus*. The spiracle is very small, and placed below the eye. The base of the pectoral fin grows forward below the last three branchial slits. The pectoral girdle is very powerful. The teeth become differentiated into grinding plates at the sides, but do not fuse. The egg-case of *Heterodontus* is provided with a peculiar spiral lamina (Fig. 91, H).

*Hybodus*, Ag.; Triassic and Jurassic, Europe.

*Sphenacanthus*, Ag., *Tristychius*, Ag., from the

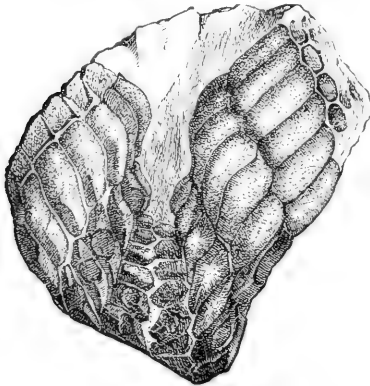

FIG. 105.

Portion of the lower jaw and teeth of *Asteracanthus* (*Strophodus*) *medius*, Owen; Great Oolite, Caen. (From *Brit. Mus. Guide*.)



FIG. 106.

Spine of *Hybodus subcarinatus*, Ag. (After Owen.)

Carboniferous of Europe. *Orodus*, Ag.; Carboniferous of Europe and America. *Wodnika*, von Munst.; Permian. *Acrodus*, Triassic to Cretaceous. *Asteracanthus* (*Strophodus*), Ag., *Palaeospinax*, Eg., *Cestracion*, Cuv.; Jurassic, Europe. *Synechodus*, A. S. W.; Cretaceous, Europe and New Zealand. *Heterodontus* (*Cestracion*), Blainv.; Port Jackson shark, Pacific (Fig. 103).

Family COCHLIODONTIDÆ. Incompletely known fossils chiefly from Carboniferous strata (Davis, Owen, A. S. Woodward). *Helodus* had an anal fin and a spinous dorsal. The teeth resemble those of *Cestracion*, but are farther modified. Not only do neighbouring teeth tend to fuse at the sides, but also successive generations; so that paired crushing plates are produced, the worn outer edge of which is coiled inwards.

*Helodus*, Ag., with detached teeth; *Psephodus*, Ag., with the two outer rows fused; *Pleuroplax*, A. S. W.; *Deltodus*, Ag.; *Cochliodus*, Ag., with a



small inner and larger outer plate; *Paecilodus*, M'Coy; *Deltoptychius*, Ag., both plates join to a single large plate on each side; *Diplacodus*, Davis—all from the Carboniferous of Europe. *Xystrodus*, Ag., *Sandalodus*, N. and W.; Carboniferous of N. America and Great Britain.

Family EDESTIDÆ. Certain peculiar coils of teeth in a single row have been found, which have been variously interpreted by palaeontologists as compound spines, as the armature of a twisted snout (Karpinsky [256]), or as a spirally coiled row of median symphyseal teeth of the lower jaw of a fish allied to the Cestraciontidae (A. S. Woodward [503], Eastman [127]).

The last interpretation certainly is most in harmony with what we

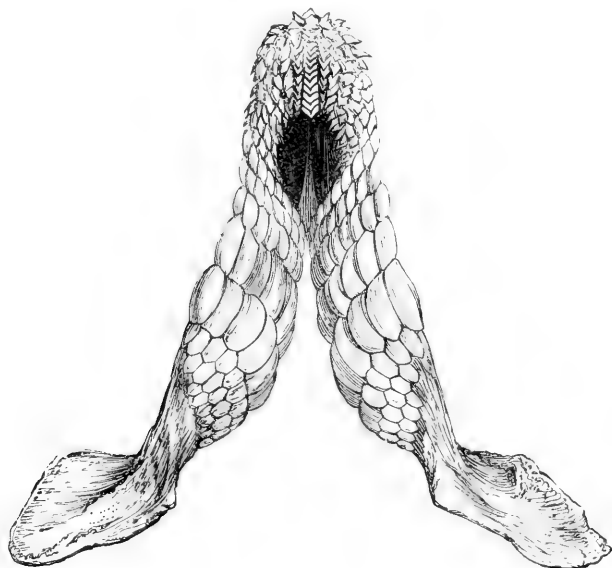

FIG. 107.

Upper jaw of *Heterodontus* (*Cestracion*) *Philippi*, Lac., the Port Jackson shark. (After Owen.)

know of the succession and position of the teeth in other Selachii. Already in the Coeliodonts the inrolling of the worn edge of the compound tooth-plates is seen; and the little Devonian Selachian *Protodus* seems to show the initial stage in the formation of a spiral coil of a single row of teeth (A. S. Woodward). In *Campodus* the median teeth, which are not much compressed, form a short coil of about thirteen teeth, and there are series of lateral teeth resembling those of the Cestraciont *Orodus* (Eastman). Only the median coil is known in the more modified *Edestus* and *Helicoprion*. Here the teeth are much compressed, and there may be as many as 150 in a single coil (Fig. 108).

*Protodus*, A. S. W.; Devonian, England and Canada. *Campodus*, Kon., Carboniferous; *Edestus*, Leidy, Carboniferous; *Helicoprion*, Karp.; Carboniferous and Permian—Europe and North America.



FIG. 108.

Spiral row of teeth of *Helicoprion bessonovi*, Karp. ; Permo-Carboniferous, Russia. A, new teeth being formed; B, teeth in use; C, old teeth passed out of use. (After Karpinsky, from *Brit. Mus. Guide*.)

## DIVISION B.

Only the hyostylic type of jaw attachment is known to occur in these fish. The notochord is always constricted.

A rostrum is present, generally strengthened by cartilage; it appears, however, to have been lost in the Squatinidae and Centrobatidae.

### SUBDIVISION 1.

#### Sub-Order 1. SCYLLIOIDEI.

An anal fin is present and the dorsal fins are spineless. The centra are generally asterospondylous; concentric calcifications may appear (*Cetorhinus*), as well as the more usual radial calcifications, but there are generally four radiating wedge-shaped masses of uncalcified cartilage converging towards the centre from the bases of the arches (Fig. 94). The rostrum is supported by three cartilages, which generally meet at a point in front (Fig. 59, C). The palato-basal articulation is loose, and the process reduced. The teeth remain fairly simple, the median cusp enlarging to a sharp piercing cusp (*Sphenodus*), or a flattened conical cutting blade (*Carcharodon*). The spiracle is small, or may be closed up.

Family SCYLLIIDAE. With nasal grooves nearly or quite reaching the mouth, and small sharp teeth. The extinct *Mesiteia* had calcified rings supporting the lateral-line canal, resembling those of the Holocephali (p. 169, A. S. Woodward [499]).

Some of the Orectolobinae are adapted to a bottom-living habit; the rostrum is reduced, the head and trunk depressed, and the spiracles enlarged (especially in *Eucrossorhinus*).

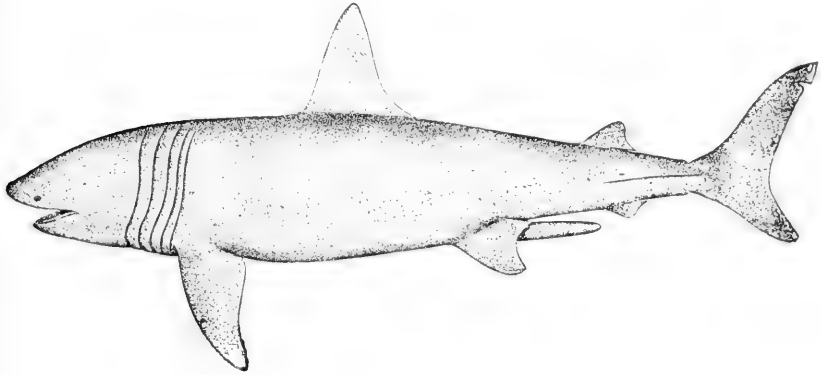

FIG. 109.

*Cetorhinus maximus*, Gum. (From Jordan and Evermann.)

SUB-FAMILY 1. SCYLLIINAE. *Palaeoscyllium*, Wagn.; Jurassic, Bavaria. *Mesiteia*, Kromb.; Cretaceous, Asia. *Scyllium*, Cuv. (*Scylliorhinus*); widely distributed, occurs in the Cretaceous strata of Europe and Asia. *Pristiurus*, Bon.; European coasts, and Jurassic, Bavaria.

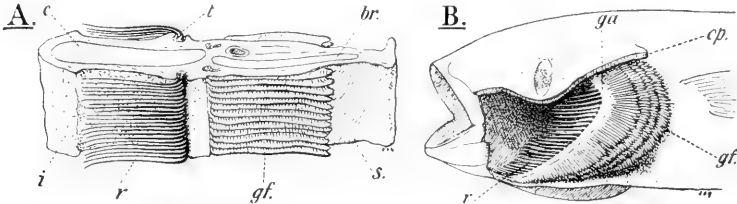

FIG. 110.

A, portion of a branchial arch of *Cetorhinus* (*Selache*) *maximus*, Cuv. B, head of a Mackerel, *Scomber scomber*, L., from which the left operculum has been removed. *br*, gill-ray; *c*, cut surface of ceratohyal; *ga*, gill-arch; *gf*, gill-lamella; *i*, inner surface of gill-arch; *op*, cut edge of operculum; *r*, anterior gill-raker; *s*, outer septum; *t*, posterior gill-raker.

SUB-FAMILY 2. ORECTOLOBINAE. *Chiloscyllium*, M. and H.; Indian Ocean and Pacific, and Miocene, Europe. *Ginglymostoma*, M. H., tropical seas; and Eocene, Europe and N. America. *Stegostoma*, M. and H.; Indian Ocean. *Orectolobus*, Bon. (*Crossorhinus*, M. and H.); Pacific. *Eucrossorhinus*, Regan.

\* Family LAMNIDAE. Large sharks without naso-oral grooves, with wide external gill-slits, and with spiracles minute or closed. A lateral

keel is developed on each side of the tail. A pit is present at the base of the caudal fin. The large pointed teeth are filled with osteodentine.

In *Cetorhinus* (which is sometimes placed in a separate family) the teeth are small and very numerous, and the branchial arches are provided on both sides with a comb-like series of gill-rakers (Fig. 110). These are enormously elongated denticles, uncalcified, and of horny consistency (Turner [470]). Although strikingly like the gill-rakers of certain

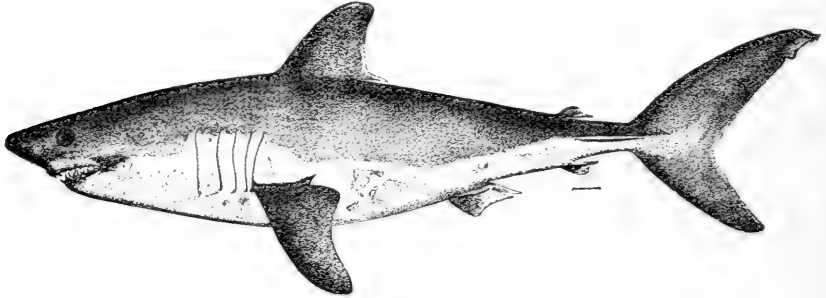

FIG. 111.

*Lamna cornubica*, Gm. (From Jordan and Evermann.)

Teleostei, yet they are of quite different origin. The deep-sea genus *Mitsukurina* has a protractile mouth and spatulate snout.

SUB-FAMILY 1. LAMNINAE. *Orthacodus*, A. S. W.; Jurassic, Europe. *Scapanorhynchus*, A. S. W., Cretaceous, Europe and Asia, is perhaps the same as the living *Mitsukurina*, Jordan, Japan. *Odontaspis*, Ag, *Lamna*, Cuv. (Fig. 111), and *Oxyrhina*, Ag, in tropical and temperate seas,



FIG. 112.

*Alopias (Alopius) vulpes*, Gm. (After Day, *Fishes of India*.)

extend down to Cretaceous; *Alopias*, M. and H. (Fig. 112), and *Carcharodon*, M. and H., to Eocene. *Cetorhinus*, Blainv. (*Selache*, Cuv.) (Fig. 109); Atlantic, and Pliocene, Belgium.

SUB-FAMILY 2. RHINODONTINAE. *Rhinodon*, one of the largest sharks, reaching the length of some 70 feet, has gill-rakers like *Cetorhinus*. The nostrils are near the margin of the mouth, which is almost terminal. The minute conical teeth are very numerous.

*Rhinodon*, Smith; southern and tropical seas.

Family CARCHARIIDAE. Usually pointed hollow teeth. No oronasal grooves. The spiracle may be absent (*Carcharias*, *Sphyrninae*).

A third eyelid, or nictitating membrane, is present (Fig. 113); it appears to be a specialised anterior region of the lower lid.

**SUB-FAMILY 1. CARCHARINAE.** With an elongated rostrum. *Mustelus* has acquired a blunt crushing dentition.

*Carcharias*, Cuv., and *Galeocerdo*, M. and H., of world-wide distribution, extend down to Eocene in the Old and the New World. *Galeus*, Cuv., and *Mustelus*, Cuv.; distribution general, and to Eocene, Europe. *Hemipristis*, Ag.; to Eocene, Europe, Asia, and N. America.

**SUB-FAMILY 2. SPHYRNINAE.** Specialised forms in which the head is produced at the sides into flat processes carrying the eyes and nostrils outwards. The cartilaginous skull is correspondingly modified, large extensions of the pre- and postorbital regions supporting the eyes.

In *Sphyrna* the process is only moderately developed, but in the "Hammer-headed" *Zygaena* it is extraordinarily large (Fig. 114).

*Sphyrna*, Raf., and *Zygaena*, Cuv. (sometimes united in one genus); tropical and subtropical seas, Miocene, Europe, and N. America.

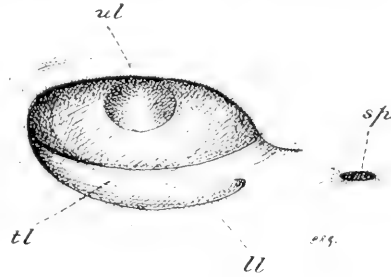

FIG. 113.

Left eye of *Mustelus laevis*, Risso. *ll*, lower eyelid; *sp*, spiracle; *tl*, third eyelid or nictitating membrane; *ul*, upper eyelid.

## SUBDIVISION 2.

Without anal fin. The vertebral centra are often cyclospindylous, with a simple constricted calcified cylinder (*Acanthias*, Fig. 50). Sometimes they are tectospondylous, with numerous complete concentric cylinders (*Rhina*, Fig. 52); or again they may have radiating calcifications (*Raja*). Only the hyostylic type of skull is known. The spiracle is well developed. The nostrils are usually separated from the mouth.

### Sub-Order 1. SQUALIFORMES.

These retain the shark-like body, with its large swimming tail. The branchial slits are never ventral.

**Family SPINACIDAE.** The gill-slits extend not more than half-way below the level of the pectoral girdle. Vertebrae cyclospindylous (*Acanthias*, Fig. 50; *Spinax*, etc.); or uncalcified, and with very large remains of the notochord (*Laemargus*, *Echinorhinus* [487]). The teeth are generally of moderate size; frequently they are more modified in the lower than in the upper jaw (*Spinax*, *Laemargus*); and their points are often turned aside so that the inner margin forms the cutting edge (Fig. 39).

A large hollow spine, fixed on the anterior cartilaginous radial, is

developed in front of the dorsal fins in *Centrina*, *Centroscyllum*, *Acanthias*, and *Centrophorus*. The radials of these fins are much concentrated, and fused proximally to a large basal resting on the vertebral column, as in *Cestraciontidae* (Fig. 50). In the other genera the fin-skeleton is similarly modified, but the spines appear to have been lost. Occasionally (*Acanthias*, Fig. 50) may be seen in front of the dermal spine traces of radials, or perhaps of neural spines. The Spinacids are mostly viviparous (p. 134). *Laemargus*, on the contrary, lays its eggs before they are fertilised (Burckhardt [72], Helbing [206-7]).

*Acanthias*, Risso (*Squalus*, L.), and *Centrophorus*, M. and H., widely distributed in temperate seas, date back to the Cretaceous epoch.

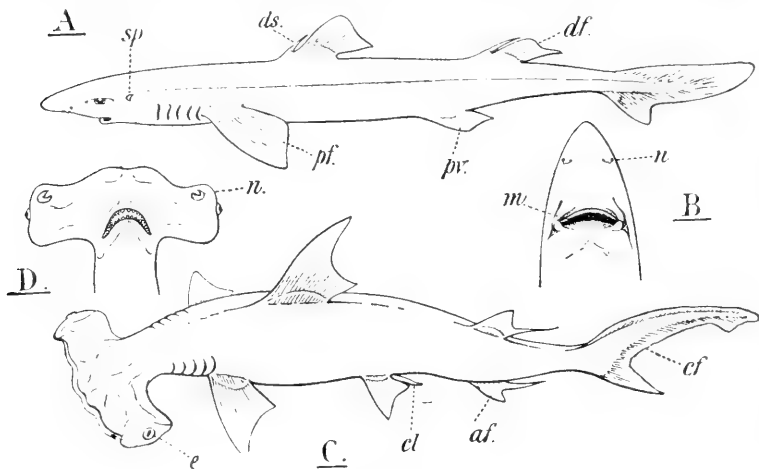

FIG. 114.

A, *Acanthias vulgaris*, Risso; and B, ventral view of the head of the same (after Day, modified). C, *Zygaena tudes*, Val. *a.f.*, anal, *c.f.*, caudal, *d.f.*, dorsal, *p.f.*, pectoral, and *p.v.*, pelvic fin; *cl.*, clasper; *d.s.*, dorsal spine; *e.*, eye; *m.*, mouth; *n.*, nostril; *sp.*, spiracle.

*Centrina*, Cuv.; Mediterranean and Atlantic; Miocene, Europe. *Spinax*, Cuv., *Scymnus*, Cuv., *Echinorhinus*, Blainv.; Atlantic and Mediterranean; Pliocene, Europe. *Centroscyllum*, M. and H., *Laemargus*, M. and H.; N. Atlantic.

Family PRISTIOPHORIDAE. *Pristiophorus* has an elongated, flat rostrum armed with a series of large denticles, or teeth, at its edge, reaching to the angles of the mouth (Fig. 115). Below the rostrum hang two pairs of sensory tentacles. The large spiracles are crescentic. *Pliotrema* is remarkable in the possession of six pairs of branchial slits (Regan [347]). The teeth are small and conical. The pectoral fins are large, but well marked off at their base from the body. The vertebrae are tectospondylous, and the tail has lateral keels.

The remarkable resemblance between this family and the Pristidae is considered to be due to convergence (Jaekel [237a]). A detailed comparison of the two would be sure to yield interesting results. Fossil

remains, of simpler structure than the modern species, are found in the Cretaceous of Mount Lebanon (A. S. Woodward [503]).

*Pristiophorus*, M. and H.; Pacific; Cretaceous, Mt. Lebanon. *Pliotrema*, Regan, S. African.



FIG. 115.

*Pristiophorus cirratus*, Lath., ♀. (After Jaekel, from Dean.)

### Sub-Order 2. RAJIFORMES.

The body becomes more or less depressed. The branchial slits take up a distinctly ventral position; while the large crescentic spiracle, which is now inhalent, remains near the eye, on the dorsal surface. A movable valve, containing the prespiracular cartilage,

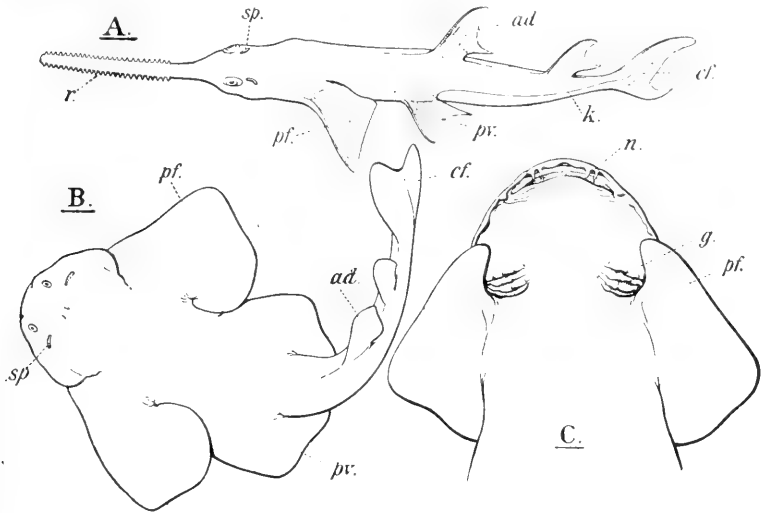

FIG. 116.

A, *Zygæna tudes*, Cuv. (After Cuvier.) B, dorsal view, and C, ventral view of *Rhina squatina*. *ad*, first dorsal fin; *cf*, caudal fin; *g*, gill-slit; *n*, nostril; *pf*, pectoral fin; *pv*, pelvic fin; *r*, rostrum with lateral teeth; *sp*, spiracle.

is formed on its anterior face (Division 2). The movable eyelids are lost. The tail becomes reduced in size, less heterocercal; and the dorsal fins shift backwards, even the first being always behind the pelvic, on the tail. The trunk appears to spread outwards, chiefly owing to the enormous development of the pectoral fins. These not only may extend backwards so as to meet the pelvic

fins, but also grow forwards, passing above the branchial slits (Squatinae, Division 1). Further, the pectoral fins fuse with the sides of the head (Division 2), and may grow forwards, below the eyes and above the mouth and nostrils, to meet in the middle line at the front end of the rostrum. This remarkable development of the pectoral fins can be followed in the ontogeny of young skates (Fig. 117). By the coalescence of radials an anterior endoskeletal axis is developed in the pectoral fin, similar to the original posterior axis (Fig. 121) (Gegenbaur [153], Howes [219]). To support these

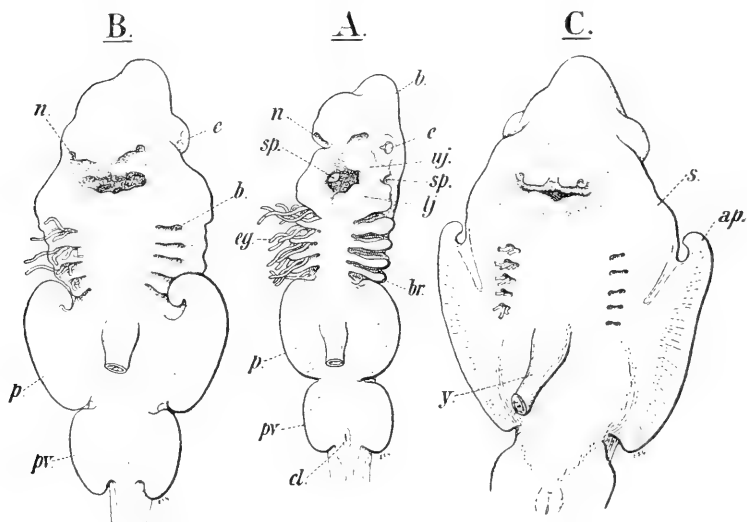

FIG. 117.

A, B, and C, three successive stages in the development of *Torpedo occlata*, Raf. The external gill-filaments have been removed on the left side. *ap*, anterior region of pectoral fin growing forward; *b*, region of fore-brain; *br*, fourth branchial arch; *d*, cloacal aperture; *e*, eye; *eg*, external gills; *l, j*, lower jaw; *n*, opening of nasal sac; *p*, pectoral fin; *pv*, pelvic fin; *s*, ridge along which the pectoral fin will grow; *sp*, spiracle; *u, j*, upper jaw; *y*, stalk of yolk-sac.

huge fins, the anterior vertebrae become fused into a continuous tube (Fig. 118), the pectoral girdle becomes firmly attached to it above, by a specially differentiated suprascapula (Fig. 118), and greatly strengthened and widened at the sides for the reception of the basals. The lateral-line system becomes much modified, spreading over the expanded pectoral fins (Fig. 127). The ampullae, also, may be extended over their surface. A very definite articulation, by means of two condyles, is established between the occipital region of the skull and the rigid vertebral column (Fig. 119). The preorbital process of the skull may become very large, forming a separate jointed piece attached to and supporting the pectoral fin (Fig. 120). The mouth becomes transverse, and the two halves of



the jaws fuse together across, the palato-basal articulation being lost. The attachment is hyostylic. The hyoid arch, however, becomes peculiarly modified; for, while the hyomandibular is specialised to support the jaws only, losing its branchial rays, the remainder of the arch becomes separately attached to the skull by a ligament and a small epiphyal (*Raja*, Fig. 99). The basal elements of the branchial arches come to form a slender anterior transverse bar, and a large posterior plate (Fig. 120). The last (5th) branchial arch becomes firmly attached to the pectoral girdle behind (Fig. 125). Along the dorsal edge of the vertebral column large median cartilages are often present; they appear to be true neural spines (p. 105), and accordingly the radials of the dorsal fins (which are

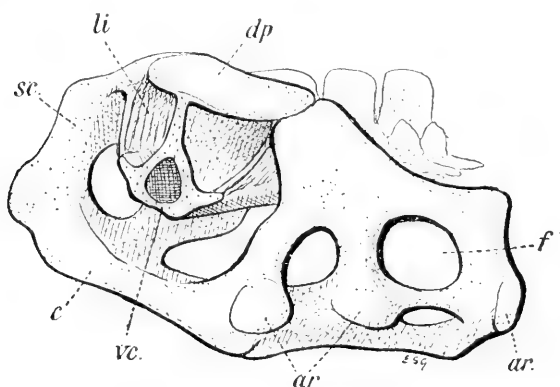

FIG. 118.

Pectoral girdle and portion of the vertebral column of *Raja blanda*, Holt; oblique left-side view. *ar*, articular facets for pectoral fin; *c*, coracoid region; *d.p.*, dorsal plate; *f*, foramen; *li*, ligament; *sc*, scapular region; *v.c.*, vertebral column.

much concentrated), when present, reach down to the neural arches (Fig. 49).

The ribs tend to disappear. In the depressed forms the ventral surface of the body becomes smooth and white, while the dorsal surface, on the contrary, may be highly coloured and armed with large sharp denticles.

Almost all the divergences mentioned above from the normal and more primitive type of Selachian structure may be directly correlated with the habit of swimming, not with the tail, but with the pectoral fins, and of living on the sea-bottom.

#### TRIBE 1.

The large pectoral fins are produced forwards, but not fused to the head. The branchial slits are partly ventral, partly lateral,

and not visible from above. The skeleton preserves many of its shark-like characters, and in all essentials resembles that of the Squaliformes.

Family SQUATINIDAE. The body and head are considerably depressed, but the tail is still powerfully developed (Fig. 116). It has lateral keels.

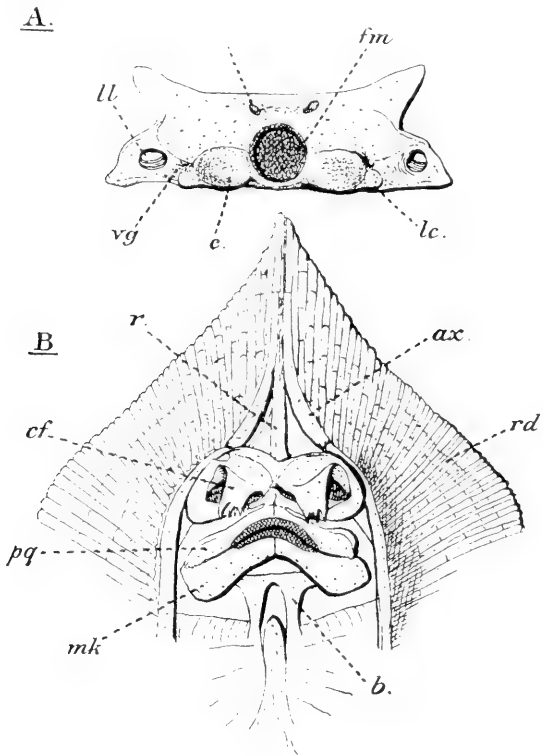

FIG. 119.

A, occipital region of the skull of *Raja* from behind. B, skull and anterior portion of pectoral-fin skeleton of *Trygion tuberculata*, Lac., ventral view. (Both after Gegenbaur.) *ax*, anterior axis of fin; *b*, basihyal; *c*, occipital condyle; *cf*, nasal flap; *e*, endolymphatic foramen; *lc*, lateral condyle; *ll*, foramen for lateral-line canal; *mk*, Meckel's cartilage; *pq*, palatoquadrate; *r*, vestigial rostrum; *rd*, radial; *vg*, vagus foramen.

The mouth is very far forward, there being no rostrum. The teeth are small and conical. The anterior vertebrae may be slightly modified, but not fused. The centra are typically tectospondylous (Fig. 52). Neural spines are well represented (Fig. 52). In the form of the palatoquadrate cartilage, with its powerful palato-basal process, of the hyoid arch, and of the pectoral girdle, the Squatinidae differ from the next Division, and resemble the Squaliformes. Obviously they are more closely related to the latter than to the Scyllioidei. In the structure of

its pelvic 'claspers' *Rhina* distinctly resembles the Rajidae, and differs from the Squaliformes. On the whole, it is a beautifully intermediate form between the shark-like and ray-like families. Many authors place the 'Angel-fish' with the sharks; however, it is scarcely possible to believe that so many skate-like characters have been independently

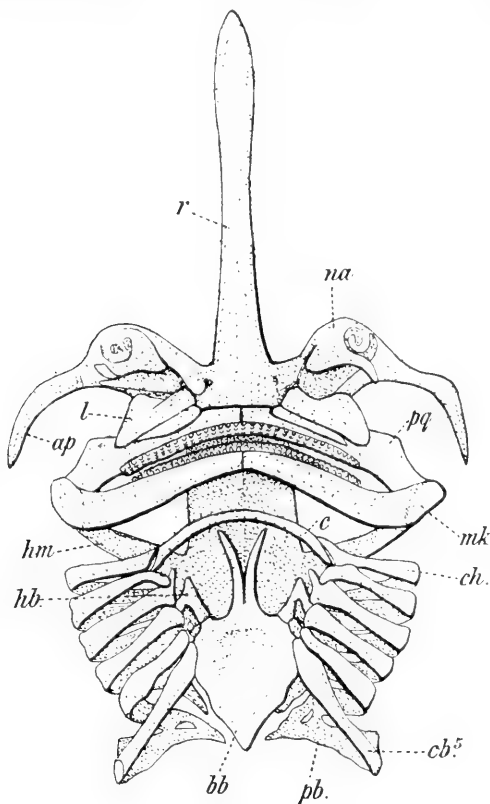

FIG. 120.

Skull and visceral arches of *Raja*, ventral view. (After Gegenbaur.) *a.p.*, antorbital process; *bb*, compound basibranchial; *c*, basihyal; *cb<sup>5</sup>*, fifth ceratobranchial; *hb*, hypobranchial; *hm*, hyomandibular; *l*, labial; *mk*, Meckel's cartilage; *na*, nasal capsule; *pb*, pharyngobranchial; *pq*, palato-quadrates; *r*, rostrum.

acquired, and it seems more reasonable to suppose that the Squatinidae represent an early offshoot from near the base of the Rajiform stem. They were represented in Upper Jurassic times by a well-differentiated species, *Squatina speciosa*, differing from the modern *Rhina* chiefly in the possession of fewer calcified concentric lamellae in the vertebrae (A. S. Woodward [503]).

*Squatina*, Bel.; to Jurassic, Europe.

*Rhina*, Angel-fish, Klein; tropical and temperate seas.

## TRIBE 2.

The pectoral fins fuse in front with the sides of the head, and the branchial openings are quite ventral. The rostrum, as a

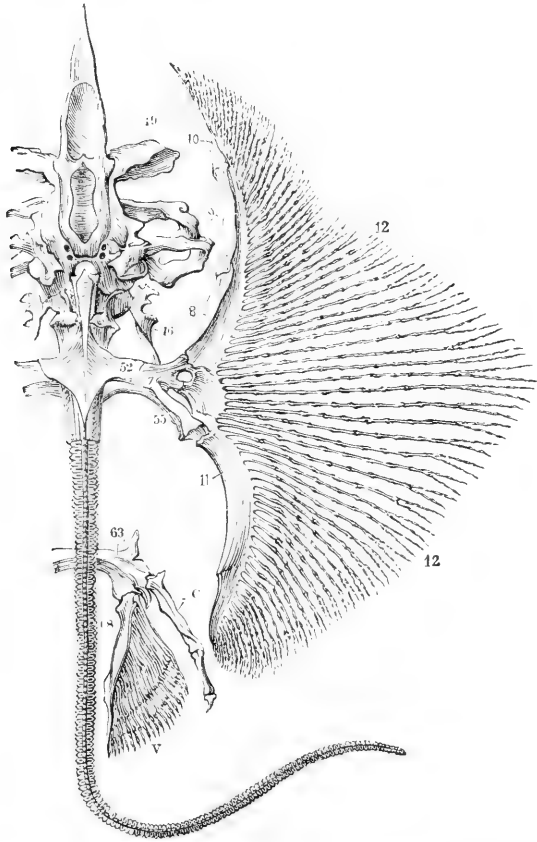

FIG. 121.

Skeleton of *Raja batris*, L. (From Owen, *Anat. of Vertebrates*, by permission of Messrs. Longmans and Co.) 7, scapular region of pectoral girdle; 8, 9, 10, segments of anterior axis of pectoral fin; 11, posterior axis; 12, radials of expanded pectoral fin; 19, preorbital process; 52, cartilage plate joining scapula to vertebral column; 55, posterior outgrowth of pectoral girdle; 63, pelvic girdle; 63, basipterygium; c, anterior enlarged radial; z, pelvic-fin radials.

rule, is much developed. In this division most of the changes in the skeleton described above (p. 154) are carried out. Extra-branchials are preserved in the Rhinobatidae and in *Trygon*. The iliac process may be much developed; since it is large in the Holocephali and in the Tetrapoda, this is possibly a primitive character.

Except in the first two families, the nostrils are confluent with the mouth, there being a well-marked fronto-nasal process.

Although the main trend of the evolution of this Division has been towards adaptation to a bottom-living habit, yet divergencies can be traced amongst the various families. Accordingly, we divide it into three groups (Jaekel [238]). In Group A, Rhinoraji, are developed a large median rostral cartilaginous process, and a pelvic girdle with paired prepubic processes. Group C has no cartilaginous rostrum, and a median prepubic process. Group B, containing the *Tropedinidae*, is perhaps an offshoot from Group A, having the same type of pelvic girdle, but losing the rostrum almost completely. It is, however, quite possible that the more shark-like *Pristidae* and *Rhinobatidae* represent a primitive group from which the

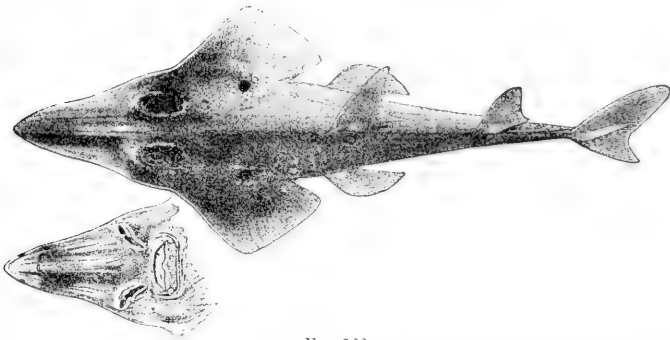

FIG. 122.

*Rhynchobatus djeddensis*, Forsk. Dorsal view, and ventral view of the head. (After Day, *Fishes of India*.)

Rajidae, the *Torpedinidae*, and the *Centrobatoidei* have arisen as three diverging branches.

#### GROUP A. RHINORAJI.

The rostrum is supported by a large median cartilaginous process of the skull (Fig. 120). The tail becomes slender and the dorsal fins shift back towards its tip. Two longitudinal keels develop along its sides. Paired prepubic processes are present on the pelvic girdle (Fig. 121).

Family RHINOBATIDAE. The head and trunk are much depressed, forming a 'disk' produced forwards into a large rostrum; the very large pectorals do not yet reach the snout (Fig. 122). Their endoskeletal radials attain neither the rostrum nor the large preorbital processes in the Jurassic species. The tail is relatively small, is losing its heterocercal shape by the reduction of the ventral lobe, but still blends in front with the trunk. The blunt teeth are closely set on the jaws, and may form an

undulating grinding pavement (Fig. 123). In the Jurassic species the anterior vertebrae remain free, or are less fused than in the modern species. No oro-nasal grooves, except in *Trygonorhina*, which with its confluent nostrils is so skate-like that it is difficult to say whether it should be put here or in the family Rajidae.

*Rhinobatus*, Black; tropical and temperate seas; to Upper Jurassic, Europe, and Cretaceous, Syria. *Rhynchobatus*, M. and H. (Fig. 122); Indian seas and Pacific. *Trygonorhina*, M. and H., *Platyrrhinoidea*, Gar.; Pacific.

Family PRISTIDAE. The body is shark-like and little depressed, with a well-developed caudal region and slight longitudinal keel (Fig. 116). The first dorsal is almost on a level with the pelvic. The pectorals are large, but do not reach the skull, although passing forwards into a fold on the head. The teeth are numerous, small, and blunt.

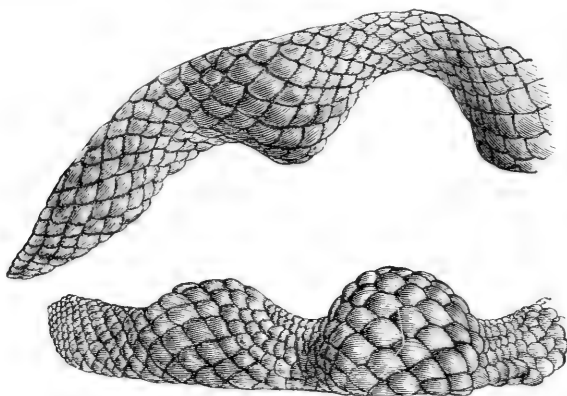

FIG. 123.

Dentition of *Rhynchobatus* sp. (After Günther.)

In the modern Saw-fish, *Pristis*, the rostrum is drawn out into a long flattened blade bearing a single series of large teeth along its lateral edge (Fig. 116). Each of these modified denticles has a persistently growing base deeply embedded in a socket in the hard calcified cartilage of the rostrum. The Cretaceous genus *Sclerorhynchus* (A. S. Woodward [503]) shows a more primitive condition, in which the rostral teeth are small and lie in the skin. Jaekel [238] considers that the shark-like shape of the body has been secondarily acquired, and that the Pristidae are derived from the Rhinobatidae. In no other way can we account for the condition of the pectoral fins, branchial slits, and vertebral column, characters acquired apparently in adaptation to a mode of life which the Pristidae have abandoned.

*Sclerorhynchus*, A. S. W.; Cretaceous, Syria. *Propristis*, Davis; Eocene, Egypt. *Pristis*, Lath.; tropical and subtropical seas; Eocene, Europe and N. America.

Family RAJIDAE. The adaptation to bottom living is carried to

almost its extreme condition (Fig. 129, A). The slender tail is sharply marked off from the large 'disk.' Small dorsal fins are usually carried near its extremity, and the caudal is much reduced or absent. The tail is triangular in section, with paired longitudinal keels; some of its muscles are usually converted into an electric organ (Fig. 124) (Ewart [132]). The rhombic disk is formed chiefly by the huge pectoral fins, whose anterior axis and radials reach forward to the pre-orbital process and beyond. In *Platyrrhina* they almost, and in *Sympterygia* they quite meet in the middle line. The basihyal is a very slender transverse rod, and the basibranchials are fused to a simple broad plate, perhaps including some hypobranchials.

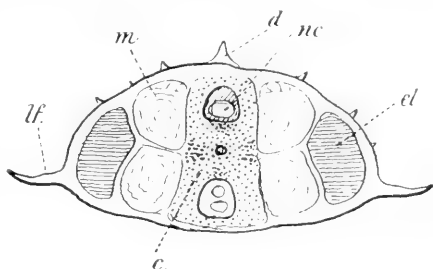

FIG. 124.

Transverse section of the tail of *Raja clavata*. *c*, vertebral centrum; *d*, dorsal denticle; *el*, electric organ; *lf*, longitudinal fold; *m*, myotome; *nc*, nerve-chord.

The pelvic girdle bears a pair of prepubic processes. In *Cyclobatis* not only these but also the iliac processes are very long. The pelvic fins are deeply notched, an anterior lobe being developed which is supported by specially enlarged anterior radials (Fig. 89). The ribs are very short. The teeth are small, blunt or pointed, and may differ in the two sexes. The dorsal surface is frequently armed with very large denticles, which may fuse into compound plates (*Acanthobatis*).

The pelvic girdle bears a pair of prepubic processes. In *Cyclobatis* not only these but also the iliac processes are very long. The pelvic fins are deeply notched, an anterior lobe being developed which is supported by specially enlarged anterior radials (Fig. 89). The ribs are very short. The teeth are small, blunt or pointed, and may differ in the two sexes. The dorsal surface is frequently armed with very large denticles, which may fuse into compound plates (*Acanthobatis*).

*Belemnobatis*, Thioll., *Asterodermus*, Ag.; Jurassic, Europe. *Acanthobatis*, Larr.; Miocene, Europe. *Oncobatis*, Leidy; Pliocene, N. America. *Cyclobatis*, Eg.; Cretaceous, Syria. *Raja*, Cuv.; temperate and tropical seas, to Cretaceous in Syria, and Eocene in Europe. *Platyrrhina*, M. and H.; Pacific, and to Eocene, Europe. *Sympterygia*, M. and H.

#### GROUP B. TORPEDINOIDEI.

The family Torpedinidae is perhaps an offshoot from Group A, which it resembles in the structure of the pelvic girdle. It differs, however, in the loss of the median rostral process and in the development of anterior electric organs. The ceratotrichia are lost.

Family TORPEDINIDAE. In general structure the electric rays resemble the Rhinobatidae, but the tail is more distinctly marked off from the disk. The caudal fin is usually little developed, and the body is smooth. The disk is very rounded; the median rostral cartilage has been lost in *Torpedo*, but in *Narcine* a considerable rostrum remains. The edge of the disk is supported by the expanded pectorals, which do not nearly meet in front, the wide intervening space being filled by paired rostral processes, and the greatly enlarged preorbital cartilages articulating in front of the nasal capsules (Fig. 125). In *Torpedo*,

while the hyoid copula has disappeared, the basal elements of the branchial arches fuse to a single large plate. But the hypobranchials are more distinct than in the Rajidae. The ceratohyal is articulated to the hyomandibular (*Torpedo*), or to the first branchial arch (*Hypnos*). The jaws become very slender and crescentic, and bear small teeth.

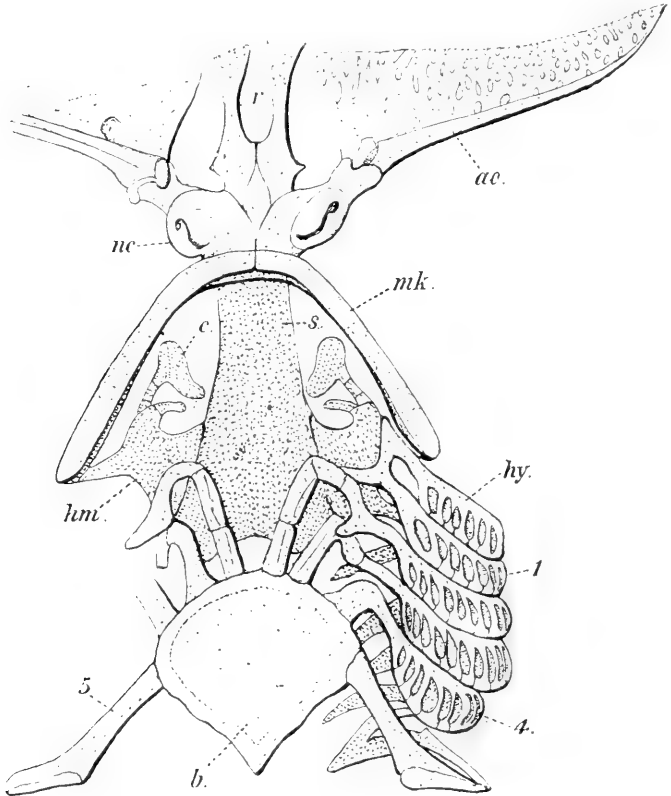

FIG. 125.

Ventral view of the skull and visceral arches of *Torpedo*. (After Gegenbaur.) *ao*, enlarged autorbit process; *b*, fused basibranchials; *c*, spiracular cartilage; *hm*, hyomandibular; *hy*, hyoid arch; *mk*, Meckel's cartilage; *nc*, nasal cartilage; *r*, rostral process; *s*, base of cranium; 1-4, first four branchial arches; 5, fifth branchial arch, which abuts against the pectoral arch.

The two halves of the pectoral girdle are not firmly fused ventrally, neither do they articulate as in the Rajidae with the vertebral column, but join above it to a median piece. The pelvic girdle has paired pre-pubic processes. The ribs are well developed. A large electric organ, supplied by a branch of the facial, and by four branches of the vagus group of nerves, is situated between the branchial pouches and the pectoral fin, on each side of the head (Fig. 126). This organ, formed of vertical prismatic columns of tissue, is probably a greatly enlarged and



modified portion of the visceral muscles, and of totally different origin from that of the Rajidae (Fritsch [141]).

The Torpedinidae appear to be much more closely allied to the Rajidae than to the Centrobatoidei. Yet there is reason to believe that they should be derived independently from some Rhinobatid-like ancestor

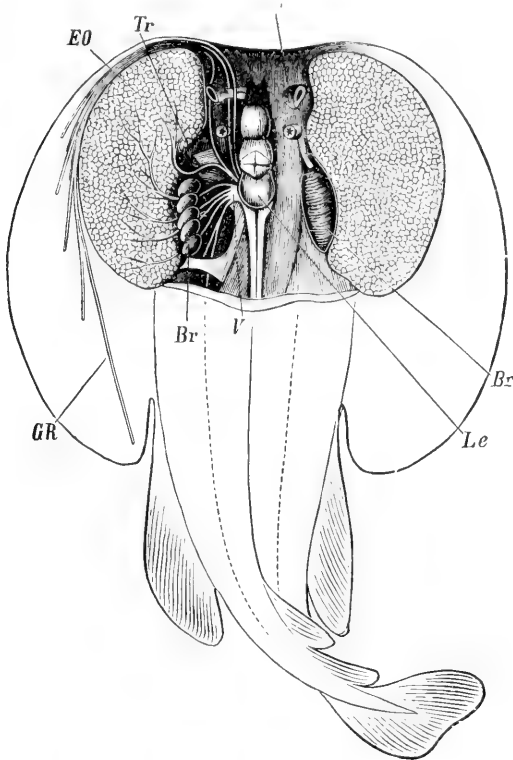

FIG. 126.

Torpedo with electric organ, *E.O.*, and brain exposed; dorsal view. On the right side only the dorsal surface of the organ is exposed; on the left the nerves which supply it are shown. *Br.*, branchial sacs; *GR.*, sensory canals of lateral-line system; *Le.*, electric lobe of brain; *O.*, eye; *Tr.*, trigeminal nerve; *V.*, vagus nerve. (After Gegenbaur, from Sedgwick's *Zoology.*)

(Jaekel). Of living genera *Narcine* is perhaps the most primitive, and *Torpedo* one of the most specialised.

*Torpedo*, Dum.; Mediterranean, Atlantic, and Indian Ocean, to Eocene, Europe. *Hypnos*, Dum.; Australian. *Narcine*, Henle; tropical seas, and Eocene, Italy. *Astrope*, M. and H.; Indian Ocean. *Temera*, Gray; Indian seas.

#### GROUP C. CENTROBATOIDEI.

The rostral cartilage is usually lost, but the skeleton of the pectoral fins grows forward to meet in front of the skull (Fig. 119, B).

The tail becomes very distinctly marked off, and slender; the single dorsal fin which alone remains not moving down towards the tip of the tail, but being situated near its base. The pelvic girdle has a median and no lateral prepubic process.

Family TRYGONIDAE. The large rhombic disk is completed in front of the skull by the pectoral fins, which meet in the middle line. Their anterior axis rests on the preorbital process. The skeletal rostrum is represented only by a median strand of connective tissue (Fig. 119). A slender horseshoe-shaped basihyal is present; but the basibranchials are fused into a single large plate, apparently together with the hypo-

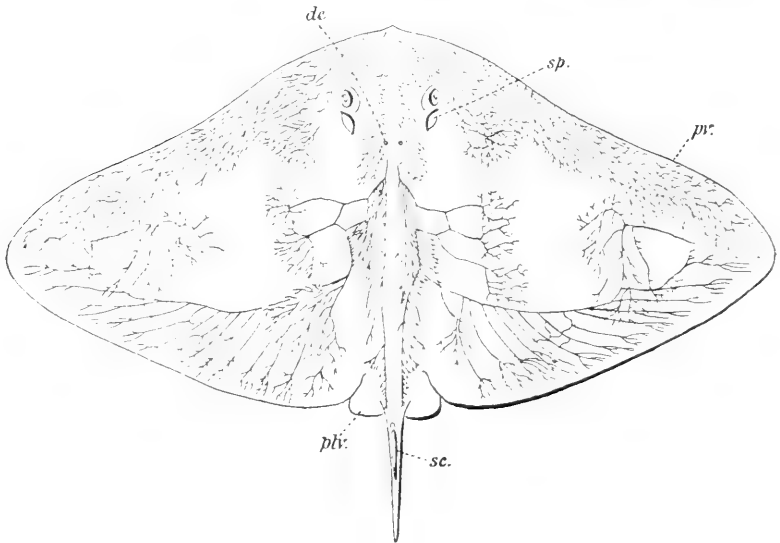

FIG. 127.

Dorsal view of *Pteroplatea Valenciennii*, Dum. (after Garman), showing the extensive development of the lateral-line organs. *dc*, endolymphatic openings; *pv*, pectoral fin; *plv*, pelvic fin; *sc*, spine; *sp*, spiracle.

branchials. The ceratohyal is attached either to the skull directly or to the base of the hyomandibular. The stout transverse jaws bear numerous small and usually sharp teeth. The tail is slender, varying much in development. In *Urolophus* it bears a terminal fin, and in *Trygonoptera* a dorsal fin; but as a rule it is whip-like, and has lost almost all trace of the fins. On the other hand, it is generally provided with one or more large serrated spines (Fig. 127), whence their name Sting-Rays. These spines are placed behind the fins, not in front as in other Selachians.

*Xyphotrygon*, Cope; Eocene, N. America. *Urolophus*, M. and H., and *Trygon*, Ad.; warm seas, and to Eocene, Italy. *Urogymnus*, M. and H.; Indian seas. *Pteroplatea*, M. and H. (Figs. 92, 127); temperate and tropical seas. *Trygonoptera*, M. and H.; Australian.

Family PTYCHODONTIDAE. A group of Cretaceous fish of which little is known except the teeth. The dentition somewhat resembles that of the Myliobatidae, there being longitudinal rows of teeth, of which the middle row is the largest (Fig. 128). The large teeth are nearly square in shape, and composed of thick vasodentine, with a ridged surface (Owen [311*a*], A. S. Woodward [505*a*]). In the shape of the jaw they approach the Trygonidae.

*Ptychodus*, Ag.; Cretaceous, Europe and N. America.

Family MYLIOBATIDAE. As in the last family, the pectoral fins generally meet in front of the skull; but their anterior, preorbital

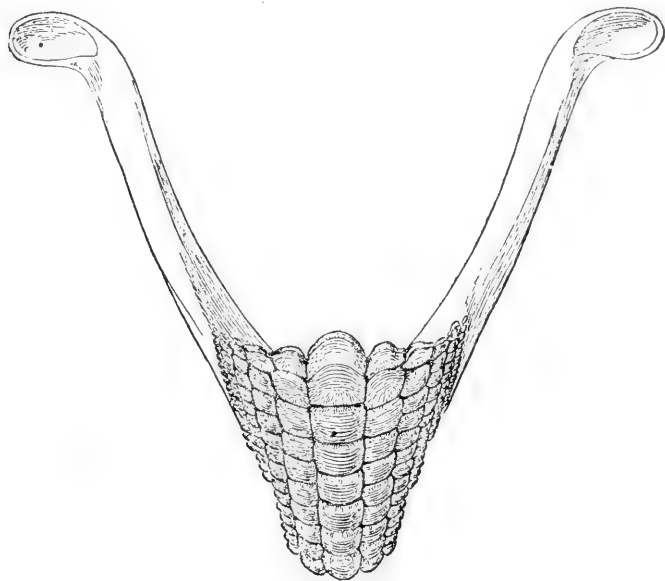

FIG. 128.

Lower jaw of *Ptychodus decurrens*, Ag.; Cretaceous, Sussex. (After A. S. Woodward, from *Brit. Mus. Guide*.)

portions become separated off from the rest of the fin, so as to form a special anterior cephalic fin, median in the Myliobatinae (Fig. 129, B). In the Dicerobatinae this fin is developed as paired horn-like projections (Fig. 129, C).

The head, with its large protruding eyes, projects dorsally above the level of the disk. The skeleton resembles that of the Trygonidae; but the ceratohyal is attached to the first branchial arch. The skin is smooth, excepting for a strong serrated spine which generally lies behind a single small dorsal fin, near the base of the elongated whip-like tail (Fig. 129).

SUB-FAMILY 1. MYLIOBATINAE. With a median 'cephalic fin,' quite continuous with the pectorals in *Promyliobatis*. The teeth form a flat grinding pavement (Fig. 130), of which the central row becomes

greatly enlarged and transversely elongated. They form a mosaic of closely fitting blocks of vasodentine.

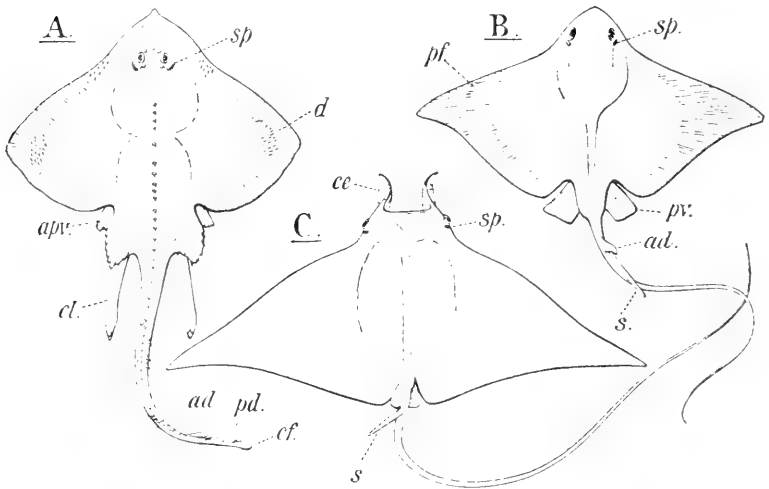

FIG. 129.

Dorsal view of, A, *Raja clavata*, L.; B, *Myliobatis aquila*, L.; C, *Cephaloptera giornae*, Lac. (After Day.) *ad*, anterior dorsal fin; *apv*, anterior lobe of pelvic fin; *ce*, "cephalic" fin; *cl*, caudal fin; *d*, clasper; *d*, patch of large denticles; *pd*, posterior dorsal fin; *pf*, pectoral fin; *pv*, pelvic fin; *s*, spine; *sp*, spiracle.

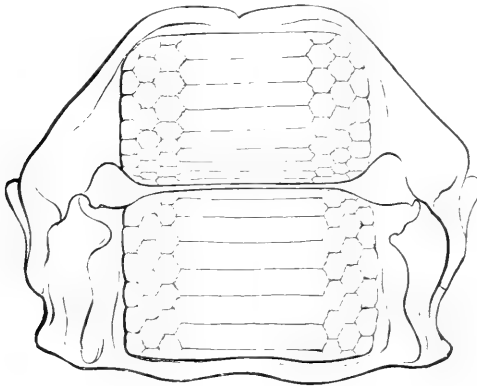

FIG. 130.

Jaws and teeth of the Eagle-Ray, *Myliobatis aquila*, L. (After Owen.)

*Myliobatis*, Cuv., and *Aeobatis*, M. and H., warm seas; to Eocene, Europe and N. America. *Promyliobatis*, Jaekel; Eocene, Italy.

SUB-FAMILY 2. DICEROBATINÆ. With paired cephalic-fin processes. The teeth, which are closely set in many rows, may be small and almost

uniform, or some middle rows may be enlarged (Figs. 131, 132). In *Ceratoptera* they are absent from the upper jaw.

*Dicerobatis* (*Cephaloptera*), Blainv., *Ceratoptera*, M. and H., and *Rhinoptera*; warm seas; the latter to Eocene, Europe.

Family PSAMMODONTIDAE. Known only from fossil teeth, which are transversely elongated, flattened, and adapted for grinding. They are

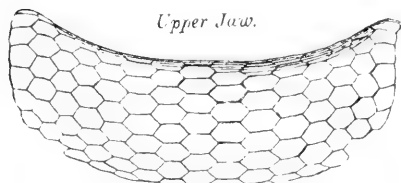

Front.

Front.

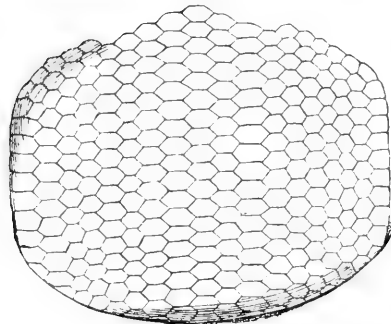

Lower Jaw.

FIG. 131.

Teeth of *Rhinoptera polyodon*, Gthr.  
(After Günther.)

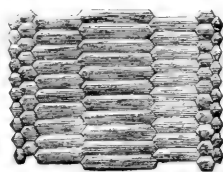

FIG. 132.

*Rhinoptera Woodworthi*, Ag.  
(After Owen.)

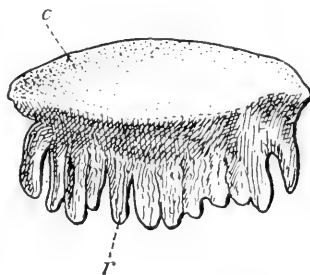

FIG. 133.

Tooth of *Polyrhizodus pusillus*,  
M'Coy; Carboniferous Limestone,  
Armagh. (After M'Coy.) *c*, outer  
grinding surface; *r*, basal root.

closely set in longitudinal rows, somewhat as in the Myliobatidae, with which this family is generally associated.

*Copodus*, Davis, *Psammodus*, Ag.; Lower Carboniferous, Europe and N. America. *Archaeobatis*, Newb.; Lower Carboniferous, N. America.

#### INCERTAE SEDIS.

Family PETALODONTIDAE. These palaeozoic Selachians are chiefly known from remains of the dentition, which is much specialised. In the case of *Janassa* it has been ascertained that the body was depressed and expanded, with large pectoral fins reaching forward and perhaps fusing with the head (Münster, Jaekel [240]). The jaws were wide and strong, bearing powerful grinding teeth set one behind the other in regular rows. Apparently the old teeth remained to support the newer growing up from behind. As a rule, each tooth has a distinctly marked crown and root. In *Polyrhizodus* the root is subdivided (Fig. 133). The affinities

of this family are still obscure; usually they are associated with the Myliobatidae, but possibly they are more closely related to the Squatinidae (Jaekel).

*Petalodus*, Owen; *Polyrhizodus*, McCoy; *Janassa*, Münster; Carboniferous, Europe and North America.

## Order 2. HOLOCEPHALI.

The Holocephali, a very ancient group of highly specialised marine fish, date from the Devonian, and flourished especially in the Mesozoic times. At the present day they are represented only by a few genera scattered over the world.

In their general organisation they closely resemble the Selachians: the skeleton is mainly cartilaginous and without true bone; the two dorsal, the anal, the caudal, and the paired fins are all provided with typical ceratotrichia; there are pelvic 'claspers' in the male. Moreover, in living forms the egg is large, heavily laden with yolk, and laid in a horny capsule secreted by the oviduct (Fig. 91, I). The alimentary canal with its spiral valve, the heart with its contractile conus and several rows of valves (Lankester [277]), the urinogenital organs, in fact, all the viscera, are built on the Selachian plan. But the Holocephali have become much specialised in many respects, though in some few points they have perhaps preserved some very primitive characters.

They differ from the Selachian, in the absence of a rectal gland, which may, however, be represented by glandular patches; in the absence of an attenuated anterior 'genital' portion of the female mesonephros; in the slight differentiation of the stomach, and the small number of turns made by the spiral valve. Lastly, the development is in the main quite Selachian in character; but the cleavage is of the holoblastic type.

The skin in the adult of modern genera is smooth over the general surface of the body. A covering of powerful denticles was present in such early forms as *Squaloraja* and *Chimaeropsis* (Fig. 137, B); they are usually preserved in living Holocephali only on the claspers and frontal prehensile process of the male, and may also be present in rows on the head and back of the young as in *Callorhynchus*.

They have no enamel, but an outer layer of vitrodentine as in Selachians, and the pulp-cavity is almost filled up. The large spine, almost universally present on the front edge of the first dorsal fin, may be considered as a modified denticle; it consists of vasodentine. In the Myriacanthidae dermal plates of similar structure are developed on the head; these have also probably been derived from denticles (A. S. Woodward [506]).

The lateral-line system is very well developed (Garman [148, 149], Collinge [90]). As a rule, the canal is an incompletely closed or a widely open groove, and its wall is strengthened by crescentic ossicles or small plates, probably modified denticles (Fig. 135, B). Deeply embedded ampullary organs are present on the head.

A peculiar rostrum supported by cartilage processes is developed on the snout. In living genera the nostrils are found to be ventral with grooves leading to the mouth, as in many Selachii. The lips are strengthened with large complex labial cartilages (Fig. 134). The gape of the mouth is small (Fig. 144).

The eyes become very large, and the orbits tend to come close together in the middle line. The membranous side-walls of the brain-case, near each other in *Callorhynchus*, in *Chimaera* form an interorbital septum above the brain, which throws backwards and downwards the diminished brain-cavity (Fig. 135). Thus the brain lies below the septum. The branchial slits are reduced, in modern forms, to four, and are covered over by a membranous operculum borne by the hyoid arch and its well-developed branchial rays. The gill-slits and arches are drawn-close together as in the higher operculate fish, and the septum between the gill-lamellae is considerably reduced as in the Dipnoi (Fig. 57), no doubt owing to the development of the operculum. The spiracular slit has been lost. There is no spiracular gill, but a posterior hyomandibular hemibranch, three holobranchs, and an anterior hemibranch on the fourth branchial arch.

The whole structure of the jaws and skull has been profoundly modified in connection with the development of permanent paired grinding plates. There are generally a small anterior 'vomerine' plate and a posterior large 'palatine' plate on the upper jaw, and a corresponding large plate on the lower jaw (Fig. 141) (Jaekel [241], Dean [110a, etc.]). These plates are generally differentiated into an extensive flattened basal region, and more prominent grinding ridges or tritoral areas; the former of trabecular or vasodentine, the latter with a covering of vitrodentine (Fig. 141). They have persistently growing bases, are not shed and replaced, and in the embryo show no distinct signs of having been formed by the fusion of separate denticles. Yet they must be considered as the modified derivatives of the teeth of the upper and lower jaws, and the tubercles often present on the 'tritons' may represent originally separate elements. To support the grinding plates the jaws are strengthened and shortened. The two rami of the lower jaw are fused in front, while the palato-quadrate cartilage is fused to the ethmoid region of the skull in front and to the auditory capsule behind (Fig. 135) (Huxley [230], Dean [110a], Schauinsland [383]). The branchial arches are normal; the hyoid arch, however, shows no large hyomandibular element, but





facial nerve, it would appear more probable that the hyomandibular is indistinguishably fused both with the auditory capsule and with the quadrate, the spiracle being suppressed (Fig. 135). If this interpretation is correct, the autostylism of the Holocephali differs radically from that of the Dipnoi, and has probably been derived from a hyostylic structure. Cartilaginous branchial rays are present in single series, as in the Selachii (p. 123), and are much developed on the hyoid arch to support the operculum (Fig. 134).

One of the most characteristic organs of the Holocephali is the

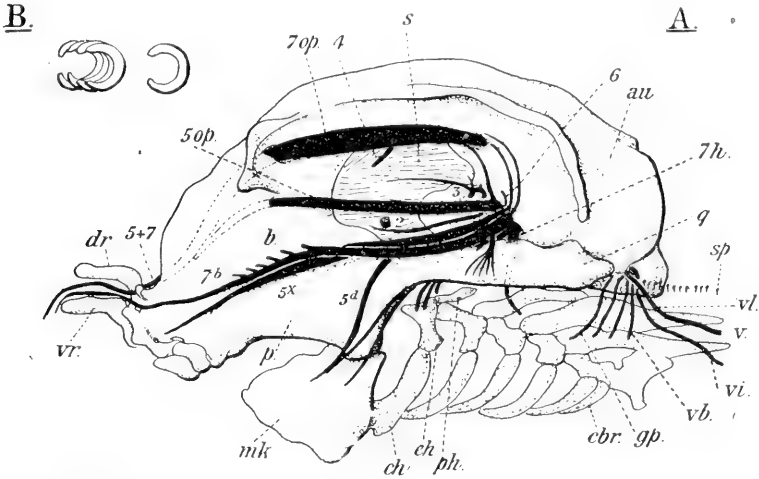

FIG. 135.

*Callorhynchus antarcticus*, Lac. A, skeleton and nerves of the head of a young specimen (after Schauinsland's figures). *au*, auditory capsule; *b*, buccal branch of facial nerve; *cbr*, 5th ceratobranchial; *ch*, ceratohyal; *dr*, dorsal median rostral cartilage; *ch*, epihyal; *gp*, glosso-pharyngeal nerve; *mk*, Meckel's cartilage; *p*, palato-quadrate region; *q*, quadrate, or probably hyomandibular, region; *s*, interorbital septum; *sp*, spinal nerve-roots; *vb*, *vi*, *vl*, branchial, intestinal, and lateral-line branches of vagus nerve; *v.r.*, ventral paired rostral cartilage; 2, optic, 3, oculomotor, 4, pathetic, 5, trigeminal, 6, abducent, and 7, facial nerves. B, calcified skeletal supports of the lateral line.

frontal clasper, or tenaculum, found in all undoubted members of the group from the Jurassic time onwards, but in the male sex only. It is a movable median process, supported by a cartilaginous axis articulated to the skull above and in front of the orbit (Figs. 141, 144). Long and pointed in the Myriacanthidae and Squalorajidae, short and with a swollen tip in the later forms, it is always armed with denticles. The origin of the tenaculum is unknown; its derivation from the front end of the dorsal fin has been suggested by Dean ([110a], Reis [351a]).

The cartilaginous auditory capsule, unlike that of the Selachian, is widely open to the cranial cavity internally, and the basiscranial axis is strongly bent upwards. The skull extends backwards so as

to enclose several occipito-spinal nerves. There is a well-defined convex condyle articulating with the vertebral column.

The notochord in the Holocephali (Hasse [200], Schauinsland [383], Klaatsch [265]) is persistent and uncontracted. It is

surrounded by a thick fibrous sheath into which mesoblastic skeletogenous cells migrate through the ruptured elastica externa (Fig. 136). These cells form complete rings, which acquire a calcified bone-like structure, and are much more numerous than the segments of the body. In *Callorhynchus* the rings are not developed; they are, on the contrary, very strong and closely packed in the extinct *Squaloraja* (Fig. 137). True centra never occur. There are no ribs. Normal cartilaginous neural and haemal arches are present and do not meet round the notochord, except in the modified anterior region. Interneurals (interdorsals) and rarely interhaemals (interventrals) occur, and supradorsals complete the neural tube above. Immediately behind the skull (Fig. 134) some dozen or more vertebral segments are fused below the anterior dorsal fin; here is formed a continuous cartilage enclosing the notochord and nerve-cord, and stretching upwards into a dorsal process with which articulates the cartilage of the fin. The axial cartilage tube and its dorsal process may be considered as made up of fused vertebrae; in living genera its compound structure is shown by the numerous nerve apertures, and in the extinct

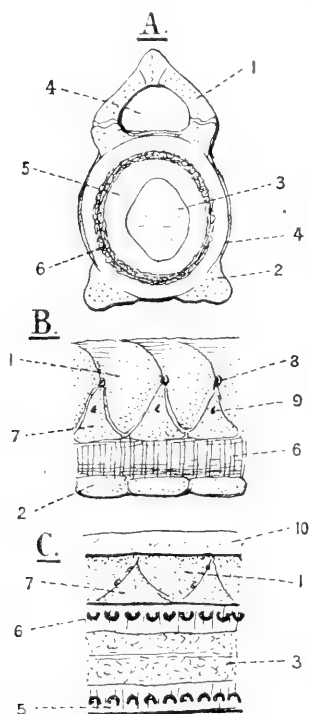

FIG. 136.

*Chimera monstrosa*, L. Vertebral column: A, transverse section; B, side view; and C, longitudinal median section. (All after Hasse, slightly modified.) 1, inter-dorsal; 2, basiventral; 3, notochord; 4, elastica externa and connective tissue; 5, fibrous sheath; 6, calcified ring; 7, basiventral; 8, dorsal nerve-root foramen; 9, ventral nerve-root foramen; 10, supradorsal.

*Squaloraja* and *Myriacanthus* traces of segmentation appear in it (Fig. 141, B) (Dean [110a]).

The first dorsal fin is characteristically modified, the radii being represented by the single cartilaginous plate just mentioned, to which is firmly fixed the dorsal spine. The whole fin, spine and all, is movable and can be folded back or erected. In *Myriacanthus* two or three cartilages support the spine. The

second dorsal fin is extended, and its simple rod-like radials appear to be in a primitive undifferentiated condition. The dorsal (axial) lobe of the heterocercal caudal fin is much elongated and tapers

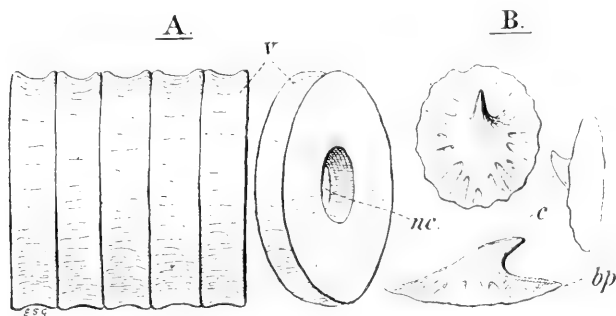

FIG. 137.

*Squidoraja polyspondyla*, Ag. Enlarged views of, A, vertebral rings; B, denticles. *bp*, basal plate; *c*, projecting spine; *nc*, cavity for notochord; *v*, vertebral ring.

into a long whip-like end. In *Harriotta* the long tail is straight, and scarcely betrays its original heterocercal character (Fig. 145). The anal fin shifts far back to near the caudal; it is often very small, and is not present in *Harriotta*.

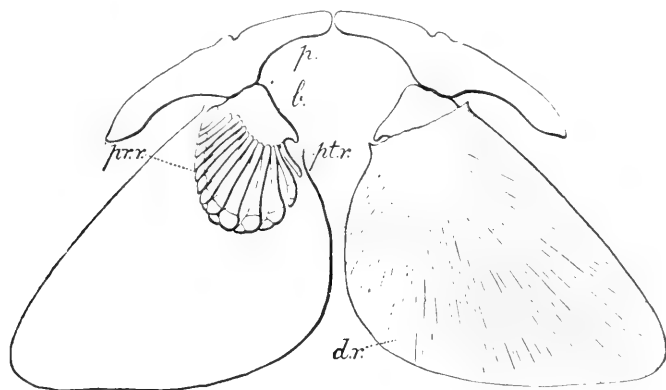

FIG. 138.

Ventral view of the pelvic girdle and fins of *Chimæra monstrosa*, L., ♀. The skeleton is completely exposed on the left side. *b*, basipterygium; *dr*, web of light fin with ceratotrichia; *p*, pelvic cartilage; *p.r.*, preaxial radials; *p.t.r.*, postaxial radials. (From *Quart. Journ. Micr. Sci.*)

The pectoral girdle is formed of stout cartilages fused in the middle ventral line. They support the skeleton of the fin, which is essentially of the typical Selachian kind, with many fan-like rays attached to a metapterygium (Fig. 134). The pelvic fin has a very similar but smaller skeleton (Fig. 138). The pelvic girdle, on the

other hand, differs considerably from that of the Selachian, in that the two halves are not fused and the iliac process is well developed. In the male an anterior clasper, armed with denticles and lodged in

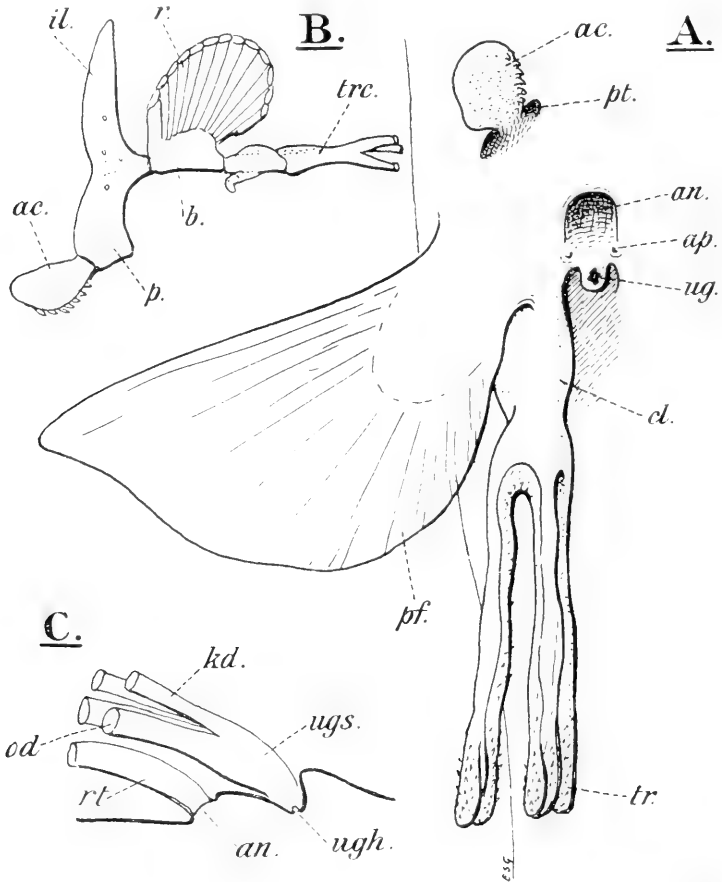

FIG. 139.

*Chimæra monstrosa*, L. A, ventral view of the right pelvic fin of a male. B, ventral view of the left half of the pelvic girdle and pelvic fin of a male (after Davidoff). C, diagram showing the opening of rectum and urinogenital sinus in the female. *ac*, anterior clasper armed with denticles; *an*, anus; *ap*, abdominal pore; *b*, basipterygium; *cl*, posterior clasper; *il*, iliac process; *kd*, kidney duct; *od*, oviduct; *p*, pelvic cartilage; *pf*, pelvic fin; *pt*, pocket into which the anterior clasper can be withdrawn; *r*, radial; *rt*, rectum; *tr*, trifold extremity of clasper; *trc*, its cartilage cut short; *ug*, urinogenital papilla; *ugh*, its opening; *ugs*, urinogenital sinus.

a pouch, is borne by a cartilage attached to the girdle, at all events in living Holocephali and in *Squaloraja* (Figs. 139, 141). This anterior clasper, unique amongst fish, is doubtless formed by the

modification of the front end of the pelvic fin, just as the posterior clasper is formed from the hind end; in *Squaloraja* its isolation is less pronounced, since intermediate radials are preserved articulating with the pelvis (Dean [110a]).

The brain, while resembling that of a shark in its general structure, is remarkable for the great development of the restiform bodies, the relatively small olfactory bulbs, and more especially for the great elongation of the diencephalon (thalamencephalon) widely separating the cerebral hemispheres from the optic lobes, a stretching of the mid-brain which is related to the formation of an interorbital septum. The cerebral hemispheres are more distinctly paired than is usual among Selachii (Fig. 140).

It may be concluded that the Holocephali are the descendants of some primitive form of shark with unconstricted notochord, which diverged from the main stem in pre-Devonian times, and became specialised in the loss of the denticles, spiracle, and cloaca, and in the acquisition of a spine-bearing dorsal fin close behind the head, of a cephalic prehensile organ in the male, of a pronounced rostrum, of peculiar vertebral rings, of an opercular flap, and above all of a fixed upper jaw and grinding plates. It is in the elaboration of these grinding plates that progress has been most marked up to the present day.

The chief characters of the Holocephali may be enumerated as follows: the gill-openings are covered by a hyoid opercular flap, the spiracle being closed; a rostrum is present, the mouth is small, and the teeth specialised into permanent grinding plates; the palato-quadrate is fixed to the skull, the hyomandibular reduced, and an interorbital septum developed dorsal to the brain; the lateral line is incompletely closed; the notochord is unconstricted, the sheath invaded, but no centra are formed; the first dorsal fin is specialised to support a spine, the second remains unconcentrated; a cephalic tenaculum, and an anterior and a posterior clasper, are present in the male; the cloaca is absent (Fig. 139).

The earliest remains of true Holocephali occur in Jurassic strata. These fossils are in all essentials like the modern forms, yet in some few points they show a more primitive structure. For instance, as already mentioned, the covering of denticles is more complete, the anterior end of the vertebral column less fused up,

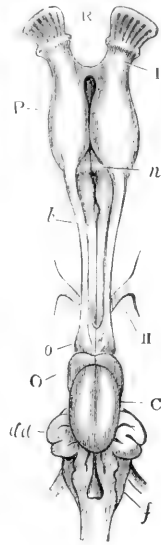

FIG. 140.

Dorsal view of the brain of *Chinacera anomstrosa*, L. (From Owen, *Anat. of Vertebrates*, by permission of Messrs. Longmans and Co.) l, olfactory lobe; n, optic nerve; c, cerebellum; dd, restiform body; m, myelencephalon; o, optic lobe; from o to n extends the elongated diencephalon, b.

and the pelvic girdle and fin more normal. Unfortunately, palaeontology throws but little light on the ancestry of Chimaeroids; for the genera from Devonian rocks, which are only very doubtfully referred to this Order (Ptyctodontidae), are much too imperfectly known to afford any trustworthy evidence on the subject.

#### GROUP A.

Where known, the body is found to be covered with denticles, the rostrum long and depressed, the tenaculum straight and pointed, the dental plates thin and without well-defined grinding areas.

Family SQUALORAJIDAE. Large denticles are scattered over the elongated and depressed body. The head appears to have been flattened and expanded with a long depressed rostrum. Above the latter was a long movable tenaculum, or frontal clasper, armed with denticles (Fig. 141, B). No dorsal fin spine is known. The tooth-plates, four above and two below, are thin and without well-differentiated tritoral areas (Fig. 141, D).

*Squaloraja*, Riley; Lower Lias, England.

Family MYRIACANTHIDAE. The head bears several tuberculated paired dermal plates, of vasodentine, which may have projected from the sides of the head and lower jaw (Fig. 142). There is a large compressed rostrum with bent tip as in *Callorhynchus*. Long calcified rods are generally interpreted as labial cartilages. The teeth, consisting of paired palatine, vomerine, and prevomerine plates above, and two mandibular and a presymphysial tooth below, are thin and have ill-defined tritoral areas (Fig. 141, A). A tuberculated dorsal-fin spine is present.

*Myriacanthus*, Ag.; Lower Lias, England. *Chimaeropsis*, Zittel; Lower Kimmeridgian, Bavaria.

#### GROUP B.

With a quite or almost scaleless body, and a short tenaculum bearing denticles on its swollen extremity. The teeth become thicker, and usually have distinct grinding patches (Fig. 141). The dorsal fin spine is smooth.

Family CALLORHYNCHIDAE. The rostrum has an expanded end. The large teeth have well-marked tritoral areas. No calcareous rings are present in the notochordal sheath. The cartilaginous support of the mixipterygium is comparatively simple. The lateral-line canal is a closed tube opening by pores in the adult.

*Callorhynchus*, Gronow; Pacific, and Cretaceous, New Zealand (Fig. 143).

Family CHIMAERIDAE. The rostrum is quite short. Anterior tritors are present on the teeth. The notochordal sheath has small calcified fibro-cartilage rings; and the clasper divides into three branches, each with a cartilage axis (Fig. 139). The lateral-line organs are in an open groove [281].

*Chimaera*, L.; widely distributed in the deep seas; Pliocene, Italy

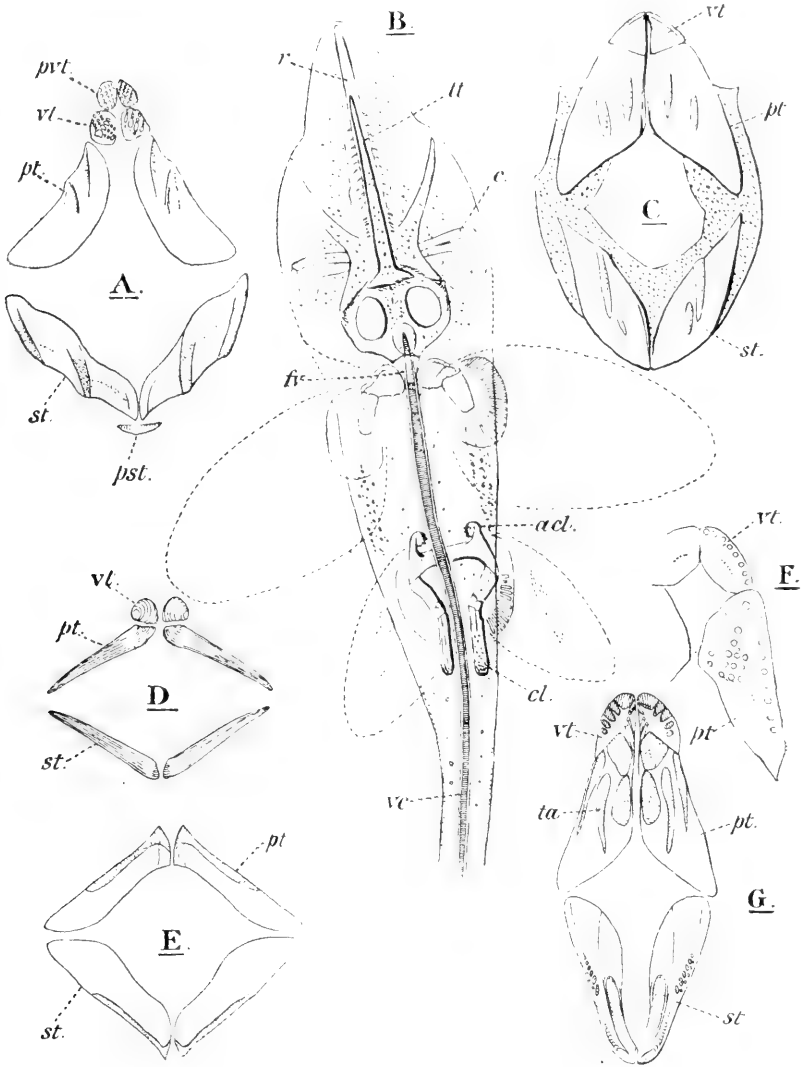

FIG. 141.

A, dentition of *Myriacanthus*. B, dorsal view of *Squaloraja polyspondyla*, Ag. C, dentition of *Callorhynchus*; D, of *Squaloraja*; E, of *Rhynchodus*; F, of *Harriotta elegans*. D and G, *Elasmodus Hunteri*, Eg. (All after Deau.) *a.cl.*, anterior clasper; *c.*, paired cartilage; *cl.*, clasper; *f.v.*, fused postoccipital vertebrae; *pst.*, 'predentary' tooth; *pt.*, 'palatine' tooth-plate; *pvt.*, 'prevomerine' tooth; *r.*, rostrum; *st.*, tooth-plate of lower jaw; *ta.*, tritoral area; *tt.*, tentaculum; *vc.*, vertebral column; *vt.*, 'vomerine' tooth.

(Fig. 114). *Ganodus*, Ag. ; Jurassic, England. *Ischyodus*, Eg. ; Jurassic and Cretaceous, Europe and New Zealand. *Elasmodectes*, Newt. ; Cretaceous, England. *Elasmodus*, Eg. ; Eocene, Europe (Fig. 141, G).

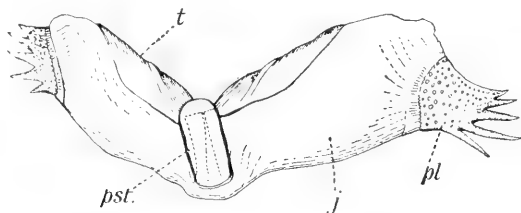

FIG. 142.

Restored mandible of *Myriacanthus*. (After Dean.) *j*, jaw ; *pl*, dermal plate ; *pst.*, presymphysial tooth ; *t*, mandibular tooth.

Family RHINOCHEMAERIDAE. The proboscis is very long and pointed. Narrow calcified rings are present round the notochord, the clasper is long but of simple structure, the olfactory bulbs are remote from the

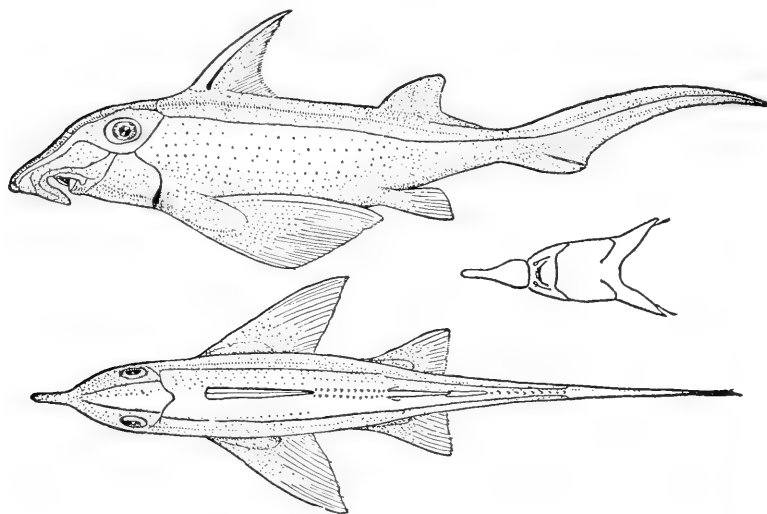

FIG. 143.

*Callorhynchus antarcticus*, Lac. (After Garman, from Dean.) A, dorsal aspect ; B, ventral view of head.

cerebrum, and the lateral-line canal opens only by a very narrow slit. The teeth have cutting edges, but no tritons in *Rhinochimaera* ; and tuberculated tritons in *Harriotta* (Fig. 141, F).

*Rhinochimaera*, Garman, and *Harriotta*, G. and B. ; Pacific (Fig. 145).



## INCERTAE SEDIS.

Family PTYCTODONTIDAE. Scarcely anything but the dental plates with tritons is known (Fig. 141, E). There appear to have been one pair in each jaw meeting at the symphysis and beak-like [125].

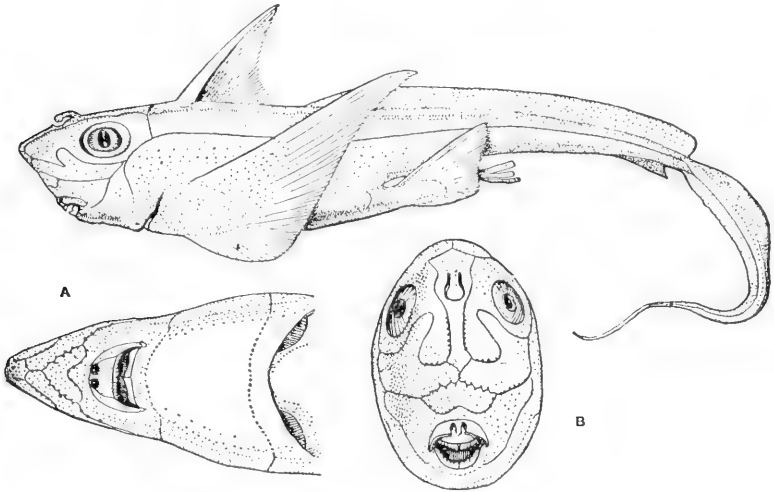

FIG. 144.

*Chimacra monstrosa*, L. ♂. (After Garman, from Dean.) A, ventral, and B, front view of head.

Recently, however, Jaekel [242*a*, 243*a*] has described some dermal plates in association with Ptyctodont teeth (*Rhamphodus*). In this genus, according to Jaekel, the dermal armour forming a pectoral girdle points

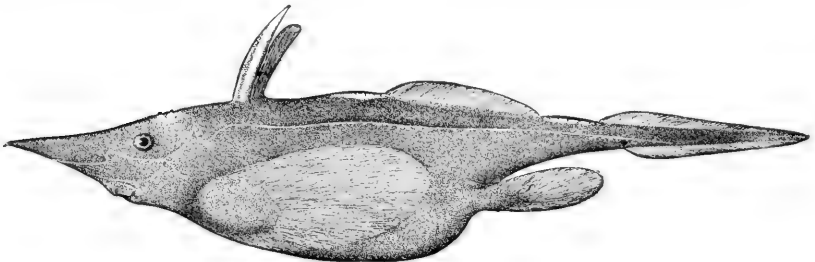

FIG. 145.

*Harriotta Raleighana*, G. and B. (From Jordan and Evermann.)

to an affinity with the Acipenseroidei; but Dollo (121*a*) contends with justice that the armour of *Rhamphodus* resembles rather that of the Coccosteomorphi, with which he would associate them. The Ptyctodontidae, like the Menaspidae, were almost certainly devoid of the spine

so characteristic of the dorsal fin of the Holocephali. A better knowledge of the histological structure of the dermal plates of these families is much needed.

*Ptyctodus*, Pander, *Rhynchodus*, Newb. ; Devonian, Europe and N. America. *Palaeomyxus*, A. S. W. ; Devonian and Carboniferous, N. America. *Rhamphodus*, Jaekel ; Devonian, Germany.

Family MENASPIDAE. In this family may be provisionally included certain incompletely known fossil fish the affinities of which are still very uncertain, but which appear to be more closely related to the Holocephali than to any other order.

*Menaspis* has a general covering of denticles strengthened into a sort of cephalic shield bearing a series of paired lateral spiny processes, perhaps homologous with the spiny plates of *Myriacanthus*. Three unequal pairs of long curved rods of calcified fibrocartilage may be compared to the so-called labial cartilages of the same genus. The dentition consists of four grinding plates like those of *Rhynchodus*. Such remains of the paired fins and mucus canals as have been found resemble those of Chimaerids. *Menaspis* seems to be allied to *Myriacanthus* (Dean [1106]). It is possible that the Devonian fossil described by Traquair under the name *Gemundina Sturtzii* [467] belongs to this group.

*Menaspis*, Ewald ; Permian, Europe.

### Sub-Class 2. PLEURACANTHODII (Ichthyotomi).

Of all the Palaeozoic Chondrichthyes the Pleuracanthodii are by far the best known, their skeleton having been described in full by Brongniart [62], Koken [269], Döderlein [113], Reis [353], and others, and especially in the admirable work of Fritsch [139].

*Pleuracanthus* is shark-like in shape, with a large nearly terminal mouth, a powerful median occipital spine, well-developed paired fins, a long tapering tail, almost if not quite diphycceral, and elongated median fin-folds. The dorsal fin is almost continuous, begins but a short way behind the head, and is only separated by a notch from the caudal. The median ventral fin is subdivided into two anal lobes and a long caudal (Fig. 146).

The dermal skeleton is little developed, being represented by small denticles near the mouth, along the back, and on the clasper of the male. Large pointed tricuspid teeth arm the jaws ; like the occipital spine they are formed of vasodentine (Fig. 148).

The endoskeleton was entirely cartilaginous, with well-developed prismatic calcifications. The skull and jaws resemble those of the Notidanidae ; the pre- and postorbital processes are large, and the attachment of the jaws is of the amphistylic type. Five branchial arches, subdivided like those of the Selachii, are present (bearing small teeth) ; the median basibranchials seem to be somewhat reduced in number. The notochord was persistent, and probably quite unstricted ; no distinct centra are found

(Fig. 146). Well-developed arches occur above and below, but the intercalaries are small or absent; there are short ribs. The neural spines articulate with a series of dorsal radials formed of three segments. In the caudal fin these radials are segmental; but in the dorsal fin they are twice as numerous as the arches. No such radials have been found in the ventral lobe of the caudal, a fact which argues against the fin being truly diphycceral.

In the region of the anal fins the radials, still articulating with the haemal arches, become fused in a variable manner, showing most clearly how such concrescence may lead to the formation of a fin-axis (Fig. 147).

Behind the occipital spine, which seems to have been movable, the neural arches point forwards.

The two halves of the pectoral girdle remain separate, and each has a small dorsal and ventral segment (Fig. 148). Most interesting is the skeleton of the fin, which is built on the archipterygial or mesorachic plan, with a tapering jointed axis bearing a preaxial series of radials in front and a postaxial series behind. The preaxial are the more numerous, and some of them may be articulated to the girdle itself. The pelvic girdle is formed of two separate cartilages (Figs. 149, 150, 151). The skeleton of the pelvic fin never appears to be of the mesorachic type; although the radials have evidently been concentrated in much the same manner as in the pectoral to form a segmented axis, there is no series of postaxial radials. One postaxial radial has, however, been described (Fig. 150). In the male the axis

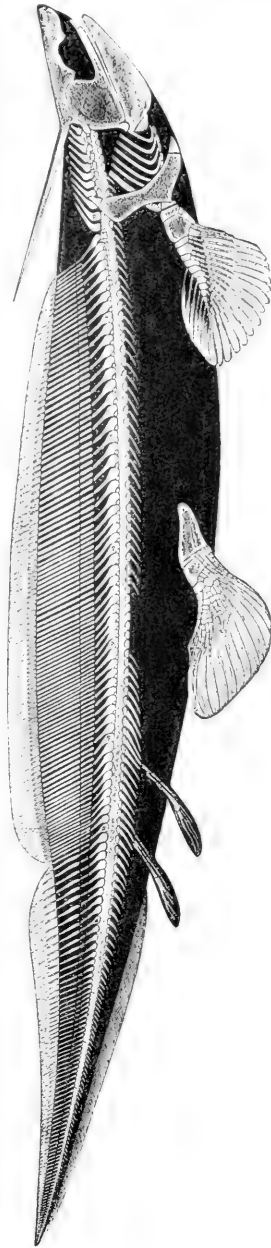

FIG. 146.

*Pleuracanthus Decheni*, Goldf.; Lower Permian, Bohemia. Skeleton and outline restored. (After Fritsch, slightly altered, from *Erid. Mus. Guide.*)

is modified and prolonged, much as in the Selachians, to form a clasper armed with sharp hooks.

Ceratotrichia are present in all the fins of *Xenacanthus*, but

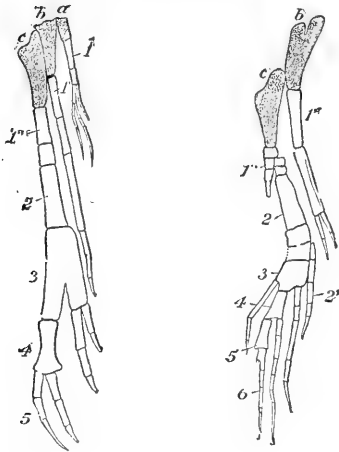

FIG. 147.

Skeleton of anal fins of *Pleuracanthus* (*Xenacanthus*) *Decheni*, Goldf. a, b, c, haemal arches; 1-6, segments of fin-radials. Right border preaxial, and left postaxial. (After Fritsch, from A. S. Woodward.)

have not been described in *Pleuracanthus*. There is evidence from the fossilised faeces of the presence of a spirial valve.

*Cladodus* (Traquair [464]), which seems to be allied to *Pleuracanthus*, and has a similar dentition and head-skeleton, differs considerably in the structure of the pectoral fin. The pectoral girdle is of the typical form (Fig. 87). The fin-skeleton consists of a number of anterior radials, whose proximal joints are incompletely fused to a basal articulating with the girdle; behind it articulates a second basal formed by the coalescence of more posterior radials. It is the base of a long many-jointed axis, which represents the metapterygium and may have been lodged in the body-wall.

This axis has presumably arisen from the bases of a single series of radials, which have almost disappeared behind; in this case the fin is strictly uniserial. On the other hand, it may have been derived from a mesorachic fin, like that of *Pleuracanthus*, by the suppression of the postaxial radials. This on the whole seems to be the more probable explanation of its structure.

The pectoral-fin skeleton of *Symmorium*, which is supposed to be allied to *Cladodus*, has been described by Cope [92]; but it is much more like that of a Selachian (Fig. 87).

That the Pleuracanthodii are closely related to the Selachii is shown by the structure of the skull and visceral arches, and the presence of a pelvic clasper; but the unconcentrated character of the radials of the median fins, and the persistence of the girdles in two halves, point to their having been derived from a common ancestral form more primitive than any known member of that Order. In these two respects they approach the Holocephali. The ancestral Chondrichthyan, parent both of the Elasmobranchii and of the Pleuracanthodii, must have had an amphistylic skull, and paired fins with concentrated radials forming a fairly well-defined axis. Whether a postaxial series of radials was present in the

pectoral fin at this stage remains doubtful, but there is little evidence of their existence in the pelvic fin (p. 181). The reduction of the dermal skeleton, and the development of a large occipital spine in the first family, are signs of specialisation. Possibly the Pleuracanthodii are related to the Cladoselachii through the Cladodontidae (Dollo [121], etc.). The Pleuracanthodii appear in the Devonian epoch, and seem to die out in the Permian.

Family PLEURACANTHIDAE. *Pleuracanthus*, Ag.; Lower Permian, Europe. (*Xenacanthus*, Beyr.; Carboniferous and Permian, Europe; possibly the same as *Pleuracanthus*.) *Diplodus*, Ag.; Carboniferous and

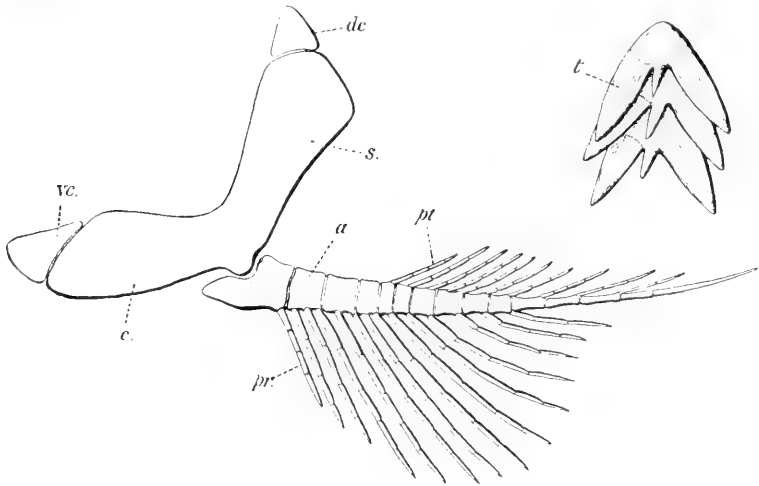

FIG. 148.

Left pectoral girdle and fin-skeleton of *Pleuracanthus Gaudryi*, Fr. *a*, segmented axis of fin; *c*, coracoid region; *dc*, dorsal cartilage; *pr*, preaxial radial; *pt*, postaxial radial; *s*, scapular region; *vc*, ventral cartilage. On the right three teeth of *Orthacanthus* (from Fritsch), *t*.

Permian, N. America. *Diacranodus*, Garm.; Permian, N. America [61].

Family CLADODONTIDAE. With teeth having many small lateral cusps, and uniserial pectoral-fin skeleton (Fig. 87). The rest of the skeleton is scarcely known at all (Traquair [464], Braus [49]).

*Cladodus*, Ag.; Devonian, Carboniferous, and Permian of N. America, and Europe. *Symmorium*, Cope, Carboniferous, N. America, possibly belongs to this sub-class (Fig. 87) (Cope [92]). *Dicentrodus*, Traq.; Mid. Carboniferous, Scotland. *Phaebodus*, St. J. and W.; Devonian, N. America.

Family CHONDRENCHELYIDAE. An incompletely known fossil described by Traquair [452a]; it is like *Pleuracanthus*, but lacks the dorsal spine, and has only one dorsal radial to each segment.

*Chondrenchelys*, Traq.; Lower Carboniferous, Dumfriesshire.

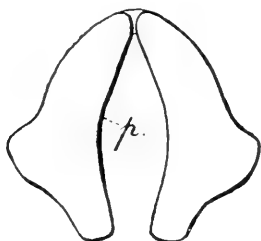

FIG. 149.

Pelvic girdle of *Pleuracanthus Gaudryi*, Brogn. (From *Quart. Journ. Micr. Sci.*)

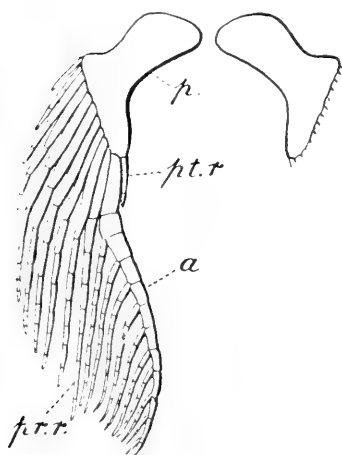

FIG. 150.

Ventral view of the pelvic girdle and right fin of a female *Pleuracanthus Oelbergensis*, Fr. *a*, jointed axis; *p*, pelvic cartilage; *p.r.*, preaxial radial; *p.t.r.*, postaxial radial. (After Fritsch, from *Quart. Journ. Micr. Sci.*)

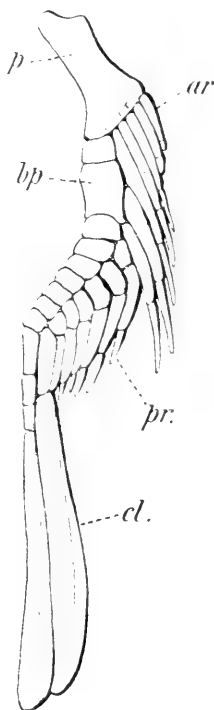

FIG. 151.

Pelvic girdle and fin-skeleton of a male *Pleuracanthus Oelbergensis*, Fr. (After Fritsch.) *a.r.*, anterior preaxial radial resting on girdle; *bp*, segmented basipterygial axis; *cl*, modified radials of clasper; *p*, pelvic girdle (left half); *p.r.*, preaxial radials.

### Sub-Class 3. CLADOSELACHII.

The extinct family Cladoselachidae contains some of the earliest and most interesting of the fossil Chondrichthyes. Isolated sharp-cusped teeth have long been known, under the name *Cladodus*, from Devonian and Lower Carboniferous strata; but it is only lately that more or less complete fossils have been found (Newberry [309], Dean [102, 104]).

In general shape *Cladoselache* resembles a Notidanid except that the tail ends in a sharply upturned tip (Fig. 152). The caudal fin has a large ventral lobe. Horizontal keels extend along

the tail. Two dorsal fins are present, but apparently no anal. There are paired pectoral and pelvic fins of remarkable structure. No rostral process projects beyond the mouth; the orbits are surrounded by a double ring of dermal plates, probably formed of fused denticles. Small denticles are distributed over the body; their histological structure has unfortunately not yet been described. The lateral line runs between two rows of denticles. Broad-based teeth, with a large median and smaller lateral cusps, are closely

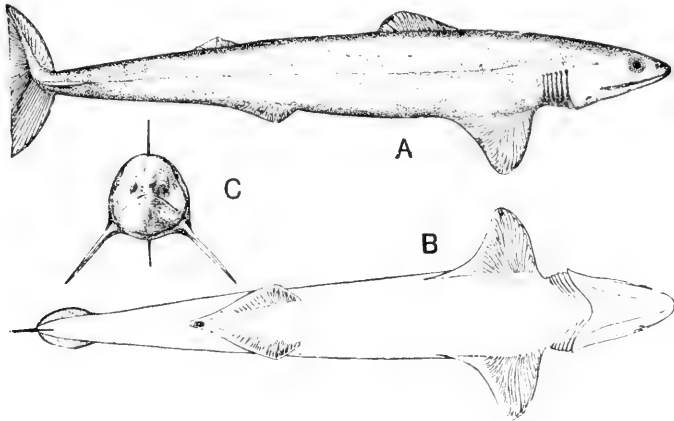

FIG. 152.

*Cladoseleache Fyleri*, Newb.: Upper Devonian, Ohio. A, right-side view; B, ventral view; C, front view; restored. (After Dean, from A. S. Woodward, *Proc. Geol. Assoc.*)

set in rows transverse to the jaws (Fig. 153). The skull resembles that of the Notidanidae; also the jaws, which are amphistylic, with a broad palato-quadrato cartilage and long backwardly directed hyomandibular. The branchial arches were five, or possibly six or seven, in number. The

notochord was probably unstricted; no centra, but neural and haemal arches without intercalaries, have been found. The endoskeletal supports of the median and paired fins are unjointed, extend to near the edge of the



FIG. 153.

Teeth of *Cladoseleache*, from different regions of the jaws. (After Dean, *Fishes Living and Fossil.*)

fin-web, and the ceratotrichia are but little developed. Possibly this extension is primitive; but it must be noted that it occurs also in the Rajiformes and certain other Selachians. The dorsal lobe of the caudal fin is borne by segmental radials, and the ventral by numerous slender cartilages crowded in its lower half (Fig. 154).

The chief points of interest in the paired fin are the breadth of the base, which shows no sign of constriction from the body-wall either in front or behind; and the correlated slight concentration of the radials. Yet the radials are numerous, and are stouter at the pre-axial border than at the postaxial, where considerable concentration may have taken place without producing the posterior notch characteristic of the fins of most other fish. Only vague indications of girdles can be made out; the pelvic radials seem to have remained separate in the body-wall without fusing to a basipterygium (Fig. 155); the pectoral radials fuse to some extent, at all events, to form basal pieces.

No claspers have been found in the Cladoselachii; we must therefore suppose that this sub-class diverged from the main stem before the Chondrichthyes had acquired them. The antiquity of the strata in which the Cladoselachii occur, their general proportions and simplicity of structure, their dentition, amphistylic jaws, and paired fins, all favour the view that they are primitive. The strongly heterocercal tail, and the circumorbital

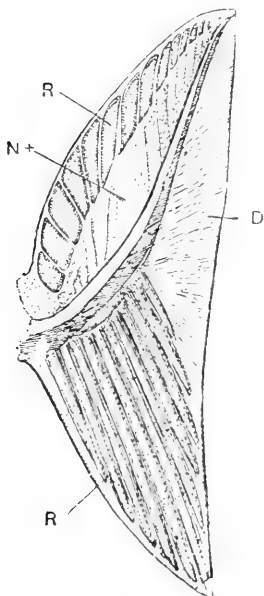

FIG. 154.

*Cladoselache Fyleri*, Newb. Caudal fin. (After Dean, from A. S. Woodward.) D, fin-membrane with dermal rays; N, neural spines; R, endoskeletal radials.

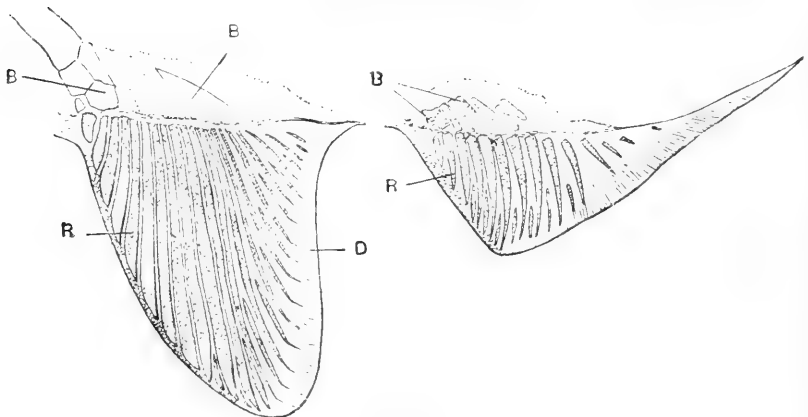

FIG. 155.

*Cladoselache Fyleri*, Newb. Left pectoral and pelvic fins. (After Dean, from A. S. Woodward.) B, basal cartilages within the body-wall; D, dermal fin-membrane with dermal rays; R, endoskeletal radials.



ring, are the only clearly specialised characters they possess; and in these they approach the Acanthodii. Another point of resemblance is the manner in which the paired fins merge posteriorly into the body-wall. Important differences, however, separate these two sub-classes.

Family CLADOSELACHIDAE. *Cladoselache*, Dean; Cleveland Shale (Upper Devonian or Lower Carboniferous).

#### Sub-Class 4. ACANTHODII.

Among the earliest known fossil Vertebrata are certain spiny fish, which are generally associated with the Elasmobranchii.

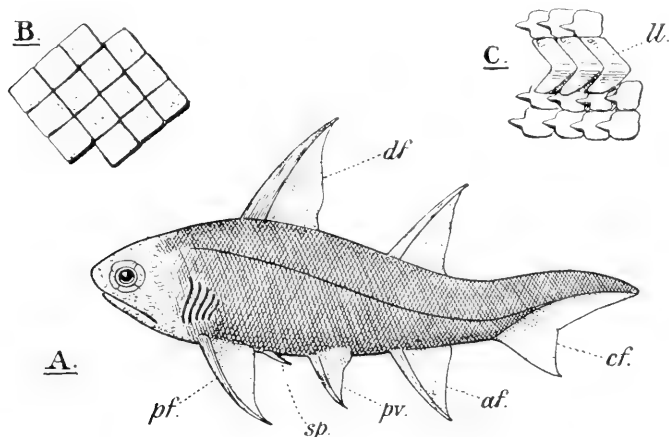

FIG. 156.

A, restoration of *Diplacanthus striatus*, Ag. (after Traquair). B, scaling of *Acanthodes gracilis*, Beyr., enlarged (after Zittel). C, scales of the lateral line of *Protacanthodes pinnatus*, Fr., enlarged (after Fritsch). *a.f.*, anal, *c.f.*, caudal, *d.f.*, dorsal, *p.f.*, pectoral, and *p.v.*, pelvic fin; *ll.*, lateral-line scales; *sp.*, spine.

These Acanthodians extend from the Upper Silurian to the Permian epoch; their structure has been studied of late more especially by Fritsch [139], Reis [351-2], A. S. Woodward [505], Traquair [462, 460], Dean [111], and others. Shark-like in general shape, they have a fusiform body, blunt snout, and distinctly heterocercal tail. The hypochordal lobe of the caudal fin is large, the epichordal scarcely developed.

An anal and one or two dorsal fins are present, each with a powerful spine at its anterior edge; these spines are single structures of vasodentine, as in the Holocephali, and probably are enlarged denticles (Fig. 158). The web of the fin is attached in front to the hinder edge of the spine, and along its whole extended base to

the body. The paired fins are of similar form, with a strong anterior spine and thin membranous web, supported, however, in some cases by ceratotrichia with calcified base (Reis [352]). The mouth is wide, the orbit far forward, and the nostrils were probably placed as in Selachians. The five gill-slits opened independently to the exterior.

The whole body is covered with minute closely fitting dermal scales (Fig. 156). These scales, which are generally loosely compared to placoid scales, differ fundamentally from the denticles of Elasmobranchs (Reis [352], Goodrich [178]). They have a deep-lying solid base expanding superficially into a more or less quadrangular shiny plate sometimes ornamented, or produced to a point. There is no pulp-cavity; the scale is made up of concentric layers

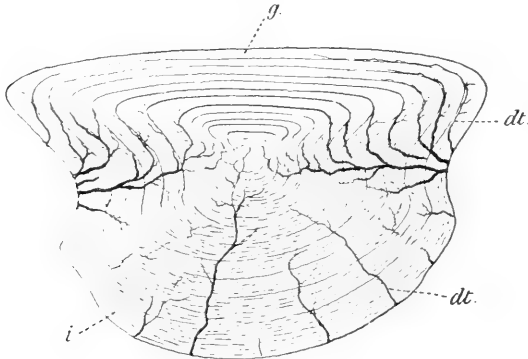

FIG. 157.

Transverse section of the scale of *Acanthodes* sp.; Lower Carboniferous, Edinburgh.  
*dt*, branching canaliculi; *g*, outer shiny layer; *i*, inner more opaque layer.

of bony substance without bone-cells; minute branching canaliculi penetrate into this substance from the outside, and it therefore has some resemblance to dentine (Fig. 157). The outer layers resemble ganoiné, and there is no enamel. In fact, the Acanthodian scale, except for the absence of cells and vascular channels, is just like a small ganoid scale (especially like the scale of *Cheirolepis*, p. 311). It differs so markedly from the denticle that it is impossible without intermediate forms to say whether it has been derived from the Elasmobranch placoid scale. On the other hand, the resemblance it bears to the ganoid scale is very possibly due to convergence.

The scales spread on to the caudal fin, in rows simulating lepidotrichia, and to a less extent on to the other fins also. On the head they increase in size and form a covering of close-fitting plates. Four or more similar plates surround the orbit. The

scales and the spines are probably of similar origin; and ridge-scales, somewhat intermediate in shape, may extend from the base of the dorsal fin on to the head (*Parerus*).

A varying number of spines may also be found between the pectoral and the pelvic fin (Figs. 156, 164); their presence has been taken to indicate the former continuity of these two fins (Cope, A. S. Woodward [503]). It is to be noticed that there is no concentration of the base of the fins, no notching of the posterior edge such as is found in other fish, with the exception of the Cladoselachidae, the fin passing gradually into the body behind.

The lateral line runs usually between two rows of scales, as in Elasmobranchs (Fig. 156, C). But in *Euthucanthus gracilis* it was

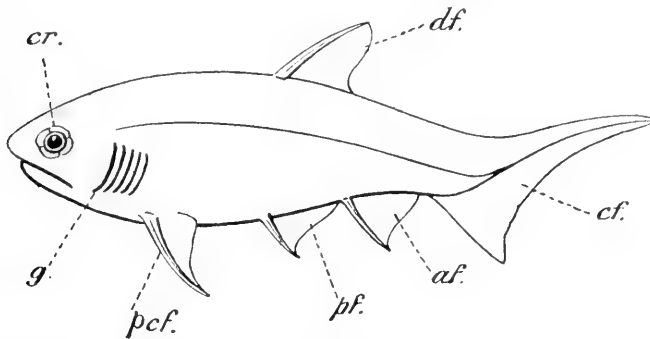

FIG. 158.

Restoration of *Cheiracanthus Murchisoni*, Ag. (After Traquair.) *a.f.*, anal, *c.f.*, caudal, *d.f.*, dorsal, *pc.f.*, pectoral, and *pv.f.*, pelvic fin; *cr.*, circumorbital ring; *g.*, five branchial slits.

covered over and enclosed by double rows of modified scales (Dean [111]).

Of great interest is the skeleton, which shows certain unexpected points of resemblance to that of the Osteichthyes. The notochord appears to have been persistent and uncontracted; there are slender neural arches, and similar haemal arches thickened at the base of the hypochordal fin. Traces have also been found (Dean [111]) of dorsal radials forming a row separate from the vertebral column. Radials also appear in the front region of the hypochordal fin strengthened with dermal scales. The skull and visceral arches seem to have closely resembled those of the amphistylic Elasmobranchs (Fig. 159). The palato-quadrates has a large otic process, the hyomandibular is elongated, the five branchial arches have the usual epi-, cerato-, hypo-, and basi-branchial elements. Most remarkable is the strengthening of the primary upper and lower jaws with hard bone-like tissue. This tissue is probably never typical bone; but it resembles it very closely,

and contains numerous cells which may have branching processes. The marginal teeth of the jaws, sometimes large and multicuspid, are firmly fixed to these 'bones' in some genera (Fig. 160). As a rule, the teeth are small, or absent. Sometimes, however,

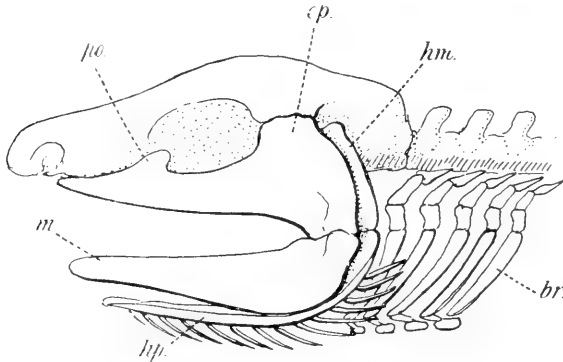

FIG. 159.

Diagram of the skull and visceral arches of an Acanthodian. *br*, fifth branchial arch; *hm*, hyomandibular; *h.p.*, calcified plate bearing similar branchial rays (?); *m*, Meckel's cartilage; *o.p.*, otic process of the palato-quadrates; *p.o.*, ethmoid process.

they are of considerable size, and Dean has described in *Ischnacanthus* rows of teeth, with large central and small lateral cusps, resembling those of primitive sharks (Cladoselachians, etc.). The ceratohyal seems to be covered with a plate bearing a series (or two series, Rohon [367]) of long branchial rays, all of similar hard

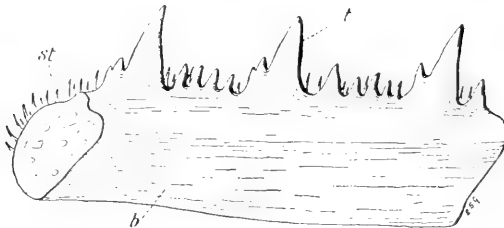

FIG. 160.

Portion of lower jaw of *Ischnacanthus*, L. Devonian, Forfar; outer view.  
*b*, bone-like tissue; *st*, inner teeth; *t*, marginal tooth.

tissue or of dentine (A. S. Woodward [505], Reis [352]). Long branchial rays also occur on the branchial arches; but whether in single or in double series is not yet clear. Perhaps more peculiar still is the structure of the pectoral girdle. It remains in some of the fossils (*Acanthodes*, Fig. 162), in the shape of a rod fixed to the base of the spine; in others (*Parexus*, Fig. 161), a broad clavicular

plate is added above; while in the Diplacanthidae a girdle is composed of two ventral claviculars and two larger dorsal supraclaviculars, all of bone-like tissue (Fig. 163). The endoskeleton of the fins must have been very much reduced or absent in most cases, in correlation with the great development of the dermal spines; but *Acanthodes* is said (Reis [352]) to possess some short radials at the base of the pectoral fin.

The Acanthodii were placed with the 'Ganoids' in the older classifications; Huxley [227] considered them to be rather intermediate between these and the Elasmobranchs; A. S. Woodward places them with the Elasmobranchs [505]. That



FIG. 161.

*Parexus falcatus*, Powrie; Lower Old Red Sandstone, Scotland. Skeleton of pectoral girdle and fin. *b*, 'supraclavicular'; *cl*, 'clavicular' plate; *s*, fin-spine. (From A. S. Woodward, *Brit. Mus. Catal.*)



FIG. 162.

*Acanthodes Wardi*, Es; Upper Carbonif., Staffordshire. Skeleton of pectoral fin and girdle. *b*, 'supraclavicular'; *c*, ceratotrichia; *s*, fin-spine. (From A. S. Woodward, *Brit. Mus. Catal.*)

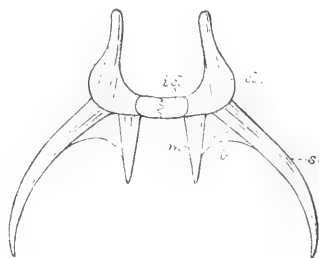

FIG. 163.

*Diplacanthus striatus*, Ag.; Lower Old Red Sandstone, Scotland. Skeleton of pectoral arch and fin. *cl*, 'supraclavicular'; *icl*, 'clavicular' plate; *b*, basal region of pectoral fin; *s*, anterior, and *m*, posterior spine. (From A. S. Woodward, *Brit. Mus. Catal.*)

they are far removed from any known Osteichthyes is shown by the absence of an operculum, of marginal jaw-bones, etc. (for it must be remembered that the jaws of the Acanthodii represent the palato-quadrates and Meckel's cartilage); affinity, on the other hand, is shown in the structure of the scales, and the development of hard tissue which bears some resemblance to bone. On the whole, the Acanthodii seem to be nearer to the Chondrichthyes, with which we shall place them on account of the general form of the body, structure of the skeleton, the amphistylic character of the jaws, the position of the lateral line, and the presence of ceratotrichia. They resemble the Cladoselachii in general shape, in the jaws, fins, and heterocercal tail, and in the circumorbital ring of plates. It would be interesting to compare the finer structure of the scales in these two groups. Dean [103] considers the Acanthodii to be related to, but more specialised than, the Cladoselachii.

Family DIPLACANTHIDAE. The spines are much developed, may be serrated and grooved; they usually occur between the pectoral and pelvic fins. In *Diplacanthus* there are two dorsal spines on each side (Fig. 163). There are two dorsal fins, and usually clavicular plates.

*Diplacanthus*, Ag. (Fig. 156, A); *Parexus*, Ag.; *Mesacanthus* (Fig. 164, B); *Ischnacanthus*, Eg.; Devonian, Scotland. *Climacius*, Ag. (Fig. 164, A); Devonian, Scotland and England.

Family ACANTHODIDAE. The intermediate spines are vestigial or absent; the remaining spines are more slender; there is only a single

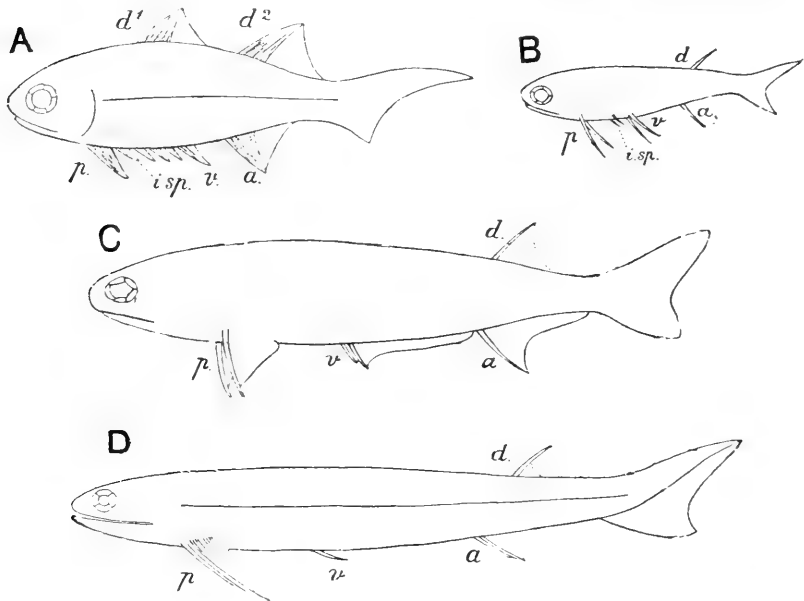

FIG. 164.

A, *Climacius scutigera*, Eg., Lower Old Red Sandstone, Forfarshire; B, *Mesacanthus Mitchellii*, Eg., *ibid.*; C, *Acanthodes sulcatus*, Ag., Lower Carboniferous, Edinburgh; D, *Acanthodes gracilis*, Roemer, Lower Permian, Bohemia; restored outlines. (A after A. S. Woodward, B and C after Traquair, D after Fritsch, from A. S. Woodward, *Proc. Geol. Assoc.*) a, anal, d, dorsal, p, pectoral, and v, pelvic fins; i.sp., paired ventral spines.

dorsal fin; and the pelvic fin tends to dwindle in size as the pectoral becomes larger.

*Acanthodes* (*Acanthoëssus*), Ag.; Devonian, Europe and N. America (Fig. 164, C and D); Carboniferous and Permian, Europe. *Cheiracanthus*, Ag. (Fig. 158); Devonian, Scotland. *Acanthodopsis*, H. and A.; Carboniferous, Great Britain. *Protacanthodes*, Fr.; Permian, Europe.

#### INCERTAE SEDIS.

Family GYRACANTHIDAE. Isolated large spines and small tubercles, found in Palaeozoic deposits, and to which the names *Gyracanthus* and *Oracanthus* have been given, have long been a puzzle to palaeontologists. Quite recently, A. S. Woodward has shown that they belong to a fish

apparently allied to the Acanthodii [507]. The body of Gyracanthides seems to have been broad, short, and somewhat depressed; the tail well-developed and heterocercal. An anal and a dorsal fin are found; each provided with a strong anterior spine, from which the membrane stretched back along the body as in Acanthodians. Very large pectoral and smaller pelvic spines indicate the paired fins; a groove along the hind edge of these spines probably marks the attachment of the fin-web, which, however, is unknown (Fig. 165). The head, trunk, tail, and fins are all covered with closely fitting quadrangular scales of small and nearly uniform size. Unfortunately the minute structure of these scales is still unknown; but there is said to be a small pulp-cavity, which would point to their being flattened denticles, rather than true Acanthodian scales [507]. The fin-spines, composed of vasodentine, have a hollow base, and are superficially ornamented with grooves and tubercles. Neither endoskeleton, nor teeth, nor circum-orbital plates have been found; but there are "two pairs of hollow, broad, triangular, free spines, of fibrous texture, fixed near the insertion of the pectoral fin-spines"; these also have a tuberculated ornamentation on one surface.

The systematic position of the Gyracanthidae is by no means clear. While resembling the Acanthodii in many characters [507], these interesting fossils show some affinity to the Ostracodermi (more especially the Pteraspidomorphi) in the structure of the dermal spines and plates. Possibly they form a connecting-link between these two groups, and will afford a valuable clue to the real position of the Acanthodii.

*Gyracanthus*, Ag. (Fig. 165); Lower Devonian, Canada; Carboniferous, Europe, N. America. *Oracanthus*, Ag.; Carboniferous, Europe, N. America.

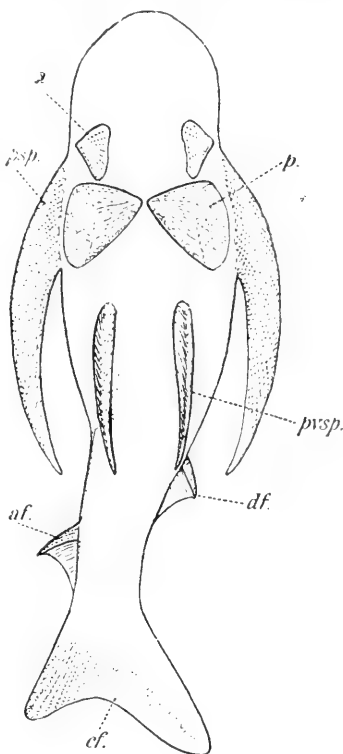

FIG. 165.

*Gyracanthus Murrayi*, A. S. W.; Carboniferous, Victoria; restored. (After A. Smith Woodward.) Ventral view, with the tail twisted so as to show the dorsal fin. *a*, anterior, and *p*, posterior paired body-spines; *af*, anal, *cf*, caudal, and *df*, dorsal fin; *p.sp.*, pectoral spine; *pe.sp.*, pelvic spine.

## Sub-Grade 2. OSTRACODERMI.

THIS is a merely provisional group, in which are gathered some of the oldest and least satisfactorily known Palaeozoic fish. So aberrant are they in structure that their very right to be placed among the Pisces at all has been disputed (Cope, A. S. Woodward [503, 505]). Cope, indeed, suggested that they are allied to the Cyclostomes. While the relationship to each other of the various orders included in this Division remains almost as obscure as ever, the affinities of the Pteraspidomorphi to the Elasmobranchii, through the Coelolepidae, seem to be now well established by the researches of Traquair. On the other hand, the presence in the Cephalaspidomorphi and Pterychthiomorphi of true bone in the exoskeleton, and of fin-rays and fulera having considerable resemblance to the lepidotrichia and fulera of the Osteichthyes, points doubtfully to some connection with the latter. The fact that true jaws have not yet been detected has little weight, since no remains of any part of the endoskeleton have been preserved in these very ancient fossils (except, perhaps, in the tail of some Anaspida, p. 206). The Ostracodermi have very few characters in common beyond the possession of a single dorsal fin, a heterocercal tail, and a tendency, so to speak, for the head and trunk to become enclosed in dermal shields. In all, except the Anaspida, the lateral-line system has been described. The mouth is ventral, and some sort of branchial opening can generally be made out. No very definite traces of nasal or of auditory organs can be seen, though there are occasional vague indications of their presence. Paired orbits and a median pore or depression, probably due to a pineal organ, are generally, if not universally, present. It is to be noted that normal paired limbs have never been found in any member of the group; but in some the body expands at the sides into a longitudinal fold (Coelolepidae), or distinct flap (Cephalaspidae), or jointed appendage (Pterychthyidae), which may represent a pectoral limb. Of a separate pelvic limb there is not the slightest trace.<sup>1</sup>

<sup>1</sup> The very interesting fragments from the Lower Old Red Sandstone described by Traquair under the name *Farnellia tuberculata* possibly belong here. This fossil has polygonal scutes and ring-like centra. Similar scutes have been found in the Silurian Ludlow bed (A. S. Woodward).



## Order 1. PTERASPIDOMORPHI (Heterostraci).

It is chiefly to the works of Lankester [276] and Traquair that we are indebted for our knowledge of the strange fossils included in this Order. The anterior region of these fish, including the head and trunk, is broad and dorso-ventrally depressed. Behind, they usually narrow rapidly to the distinctly heterocercal tail, with a ventral caudal fin-lobe. A single median dorsal fin is sometimes (Coelolepidae), perhaps always, present. A longitudinal fold or ridge on each side may possibly represent the paired fins (Traquair [465-9]). Small lateral orbits are found near the anterior margin. They are situated wide apart, unlike those of the Cephalaspidomorphi. The mouth was probably in the form of a transverse ventral slit. There is no trace of teeth or jaws. A cloacal aperture has been found in *Drepanaspis* (Fig. 169). *Thelodus* and *Cyathaspis* show signs of some six or seven branchial pouches (Fig. 172). In *Pteraspis*, also, there is a pair of small lateral apertures near the edge of the dorsal shield, which may represent spiracles (Fig. 170). The exoskeleton varies from a covering of scattered denticles in the Coelolepidae to plates and scales of complex structure in the other families. But it is characteristic of the whole group that true bone-corpuscles are never present (Huxley [224]).

The origin of the dermal plates, according to Traquair [466], is as follows:—In *Lanarkia* the whole body is covered with spine-like denticles; cones of dentine without basal plate, and with tubules radiating from a central pulp-cavity, which is widely open below (Fig. 167). The shagreen of *Thelodus* consists also of separate denticles; but they are broader and flatter, and the opening of the pulp-cavity is generally narrowed to a small central aperture, although no distinct basal plate is developed. These placoid scales of typical dentine, with perhaps a superficial enamel, are set nearer together, and may fit closely together by their crenulated edges (Fig. 166). Now in the Psammosteidae the plates and scales have a superficial covering of exactly similar closely fitting denticles with crenulated edges, which, however, are fixed to an underlying layer of spongy bone-like substance (Fig. 166, D, H). The inner surface of these plates may be strengthened by a laminated layer of similar substance. Thus the primitively isolated denticles appear to have become connected together by a secondary development of 'bone' in the deeper layers of the connective tissue. The compound plates, then, acquire a structure bearing a striking resemblance to that of the cosmine-covered scales of the Osteolepidoti (p. 217). The denticles, already much elongated in *Psammosteus*, become converted into smooth ridges of dentine, forming a nearly even layer over

the entire surface of the scales and plates of the Pteraspidae (Fig. 166, E, I).

Thus we seem to be able to trace a genetic connection between the very aberrant Pteraspids and some early kind of shark, through the Coelolepidae; but whether the four families given below really form a phyletic series remains doubtful.

The Pteraspidomorphi are among the most ancient of vertebrate

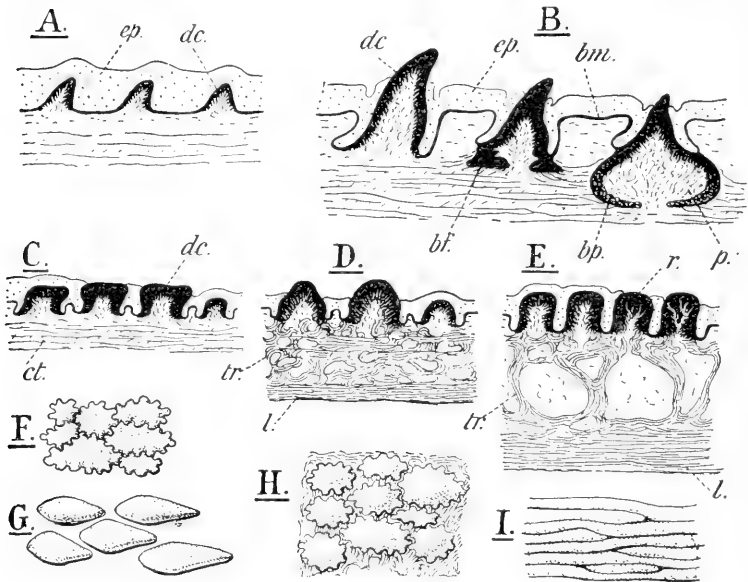

FIG. 166.

Diagrams of the structure and development of the dermal skeleton of A, an early stage, and B, later stages of Elasmobranchs; C, *Thelodus*; D, *Psammosteus*; E, *Pteraspis*, all in section at right angles to the surface; the dentine is black. F-I, enlarged views of the outer surface of the dermal skeleton of, F, *Thelodus* head; G, *Thelodus* tail; H, *Psammosteus* shield; and I, *Pteraspis* shield. *bf*, expanded basal plate; *bm*, basement membrane; *ct*, connective tissue; *dc*, dentine cap; *ep*, epidermis; *l*, bony lamellae; *p*, pulp-cavity; *r*, surface ridge; *tr*, bony trabeculae of vascular layer.

animals; they flourished in Upper Silurian and Devonian times, beyond which they do not appear to have survived.

**Family COELOLEPIDAE.** The body is flattened dorso-ventrally, and expanded on each side into a longitudinal flap of considerable size. A single dorsal fin is present. The exoskeleton is in the form of numerous scattered placoid scales; either sharp, conical, and tooth-like as in *Lanarkia* (Fig. 167), or more flattened and closely fitting as in *Thelodus* (Fig. 168). No lateral-line system has been made out (Traquair [466], Rohon [371]).

*Thelodus*, Ag.; *Coelolepis*, P.; Upper Silurian and Devonian, Europe. *Lanarkia*, Traq.; Upper Silurian, Scotland.

Family DREPANASPIDAE. The expanded depressed body is shaped much as in *Thelodus*; but the tail, although heterocercal, is not so distinctly bilobed, and no dorsal fin has been found (Fig. 169). The whole animal is covered with plates and scales, ornamented with stellate

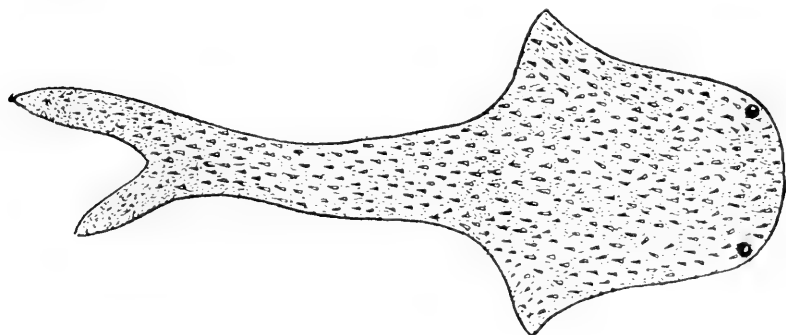

FIG. 167.

Diagrammatic restoration of *Lanarkia spinosa*, Traq. Dorsal view with the tail twisted to show the heterocercal caudal fin. The eyes appear near the anterior border. (After Traquair, *Trans. Roy. Soc. Edin.*)

tubercles or ridges. A large median dorsal plate is situated above, two 'rostral' plates at the anterior edge; a large median ventral plate occurs below, with a median 'mental' in front. The mouth was situated in the transverse slit between the rostrals and the mental; and a cloacal aperture seems to have been placed behind the ventral. Anterior and

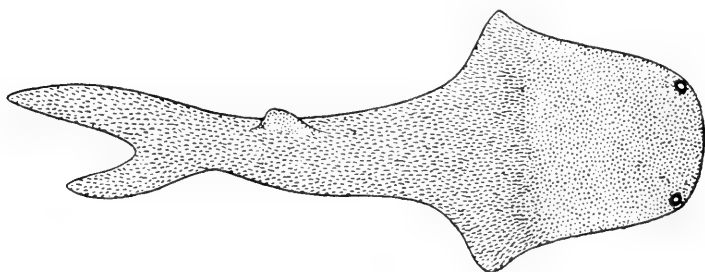

FIG. 168.

Diagrammatic restoration of *Thelodus scoticus*, Traq. Dorsal view with the tail twisted to show the caudal and dorsal fins. The eyes are shown near the anterior border. (After Traquair, *Trans. Roy. Soc. Edin.*)

posterior ventro-lateral plates occur, also a pair of lateral plates are pierced by a hole, which probably represents the orbit. The eyes were, then, rather ventral than dorsal, and far apart. The lateral flaps, the expanded edge of the body, are enclosed in long 'postero-lateral' plates. The spaces between the large plates are covered with a mosaic of smaller polygonal plates, which are continued on to the tail and caudal fin, where they acquire the shape of imbricating scales diminishing in size behind.

The dorsal and the ventral edge of the tail are strengthened with a median series of stout fulcral scales (Traquair [467-8]).

*Drepanaspis*, Schlüter; Lower Devonian, Prussia.

Family PSAMMOSTEIDAE. Incompletely known fossils, represented by large convex plates, isolated fragments apparently the posterior corners of the lateral flaps, scales, and fulcra. All these are covered with an outer layer of denticles, often with closely fitting crenulated edges, strikingly like those of *Thelodus*. The denticles are fixed on an

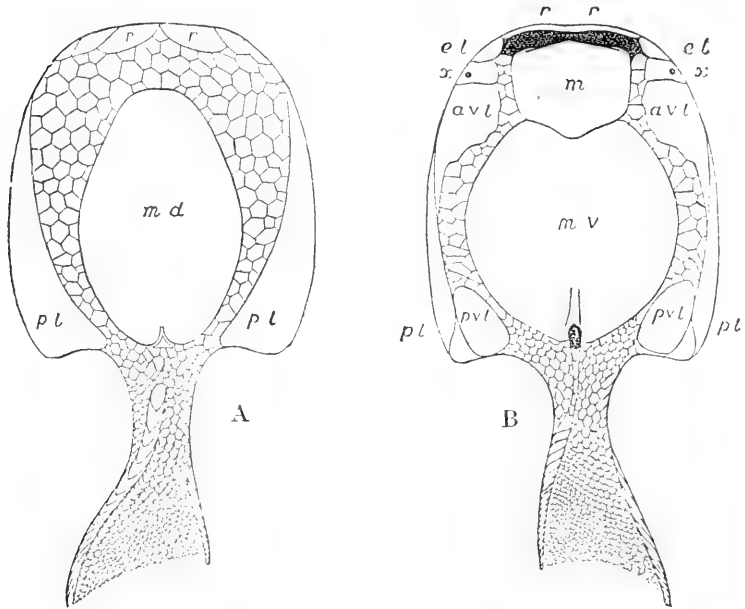

FIG. 169.

Restoration of *Drepanaspis gemüdenensis*, Schl. Dorsal (A) and ventral view (B). Lower Devonian, Bundenbach. (After Traquair, from *Brit. Mus. Guide*.) *a.v.l.*, anterior ventro-lateral; *e.l.*, external labial; *m.*, mental, behind the mouth; *m.d.*, median dorsal; *m.v.*, median ventral; *p.l.*, postero-lateral; *p.v.l.*, posterior ventro-lateral; *r.*, rostral; *x.*, orbital plate with orbit; cloacal aperture behind the median ventral plate.

underlying layer of bony substance with large vascular spaces (Fig. 166, D and H). The plates are frequently marked with superficial polygonal areas, somewhat like those of the Cephalaspid armour (Traquair [466]).

*Psammosteus*, Ag.; Devonian, Europe.

Family PTERASPIDAE. The head and body are narrower, and the lateral flaps are but little developed (Fig. 171). The exact shape of the tail is unknown, but there is reason to believe that it was heterocercal. No dorsal fin has been observed (Lankester [276], Traquair [466], Drevermann [122], Alth [19a]).

The best-known genus, *Pteraspis*, has the entire dorsal region of the head and body covered by a bony shield, projecting into a rostrum in

front, and a sharp median spine and two lateral angles behind (Fig. 170). This shield appears to be made up of seven plates, distinct only in the

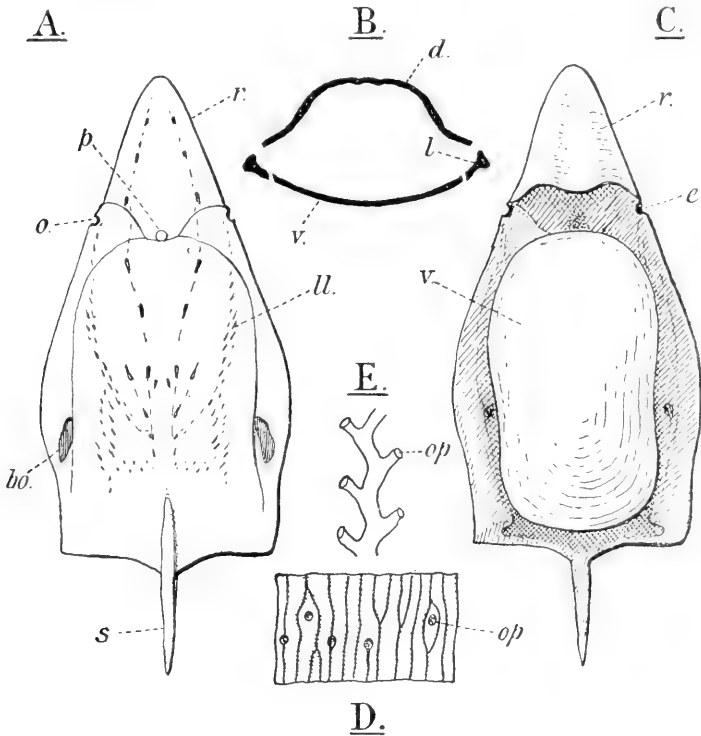

FIG. 170.

A, dorsal view of the shield of *Pteraspis rostrata*, showing the openings of the lateral-line system. B, transverse section (after Patten). C, ventral view of the same, with the ventral shield, *v*. D, enlarged surface view of the shield of *Palaeaspis*. E, enlarged view of the course of the lateral-line canal below the surface in *Palaeaspis*. *bo*, opening, possibly branchial; *d*, dorsal plate; *e*, orbit; *l*, lateral plate; *o*, orbit; *op*, opening of lateral-line canal; *p*, position of internal pineal pit; *r*, rostral plate; *s*, spine; *v*, ventral plate.

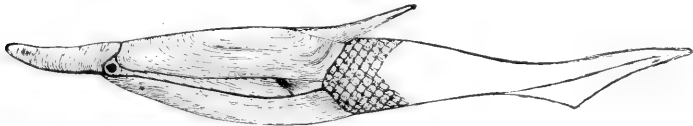

FIG. 171.

Restoration of *Pteraspis rostrata*, Ag.; Lower Old Red Sandstone. (After A. S. Woodward, *Brit. Mus. Catol.*) Left-side view; the tail and fin only in outline.

young. The rostral plate surrounds a preoral projection, two orbital plates are pierced with holes which presumably harboured the eyes, a

very large convex dorsal plate bears the spinal plate behind, and is flanked on either side by a cornual or postero-lateral plate. The latter doubtless represents the lateral flap in the Coelolepidae and Drepanaspidae. A median internal depression between the orbits is taken to mark the position of the pineal body; and an oblique slit in each cornual may represent a gill-opening.

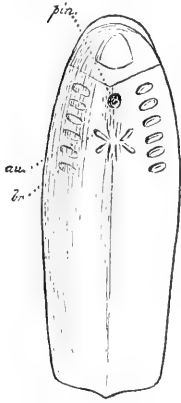

FIG. 172.

?*Cyathaspis sturi*, von Alth. Natural mould from visceral surface of dorsal shield. (After A. S. Woodward.) *au.*, impression of auditory organ (?); *br.*, impressions of branchial sacs (?); *pin.*, *pit.*, for pineal body (?).

Fitting below the dorsal shield is a large convex ventral shield formed of a single piece (Fig. 170, C). The mouth was between it and the rostral. The tail-region is covered with imbricating scales. An elaborate system of lateral-line canals, opening to the exterior by a double series of pores, is present in the dorsal shield (Fig. 170, D, E) (A. S. Woodward [503]).

In microscopic structure the plates resemble those of *Psammosteus* (p. 195); but the superficial placoid scales have become converted into long ridges. The caudal scales are of the same nature.

In *Cyathaspis* the rostral shield is quite short, and the orbits do not appear to have been enclosed in the carapace (Fig. 172).

The Pteraspidae would seem to represent an extreme stage in specialisation, in which the dorsal and ventral median plates, already present in *Drepanaspis*, have extended and fused with neighbouring plates, the small intervening plates or scales having disappeared.

*Pteraspis*, Kner; Devonian, Europe. *Palaeaspis* (*Holaspis*), Clayp.; Silurian, N. America; Devonian, Europe. *Cyathaspis*, Lank.; Silurian and Devonian of Europe.

## Order 2. CEPHALASPIDOMORPHI (Osteostraci).

Like the Coelolepidae, these Palaeozoic fish have an expanded depressed head-region, which narrows behind to a heterocercal tail (Fig. 173). There is a single dorsal fin. The lateral edge of the broad front region, which probably includes at least the most anterior portion of the trunk, extends into a longitudinal flap in the Ateleaspidae. This lateral expansion closely resembles the similar flap in the Coelolepidae. It may represent a paired fin-fold, for in the Cephalaspidae it is developed into a well-defined outstanding scaly lobe with a narrow base (Fig. 173).

The mouth was ventral, and what appears to be a ventral cloacal slit has been described in *Cephalaspis* at the root of the tail (Patten [326]). Traces of six gill-pouches have been seen in *Cephalaspis* (Jaekel [243]) on the under surface of the head-region; a number of ventral paired openings in *Tremataspis* possibly indicate branchial openings (Fig. 176) (Rohon [371]).

The orbits are placed close together on the top of the head (Figs. 174, 175), roofed over by a thin bony plate, and separated only by a narrow bridge. The orbits are partially floored by bone in *Tremataspis*. The interorbital space is occupied by a plate, which

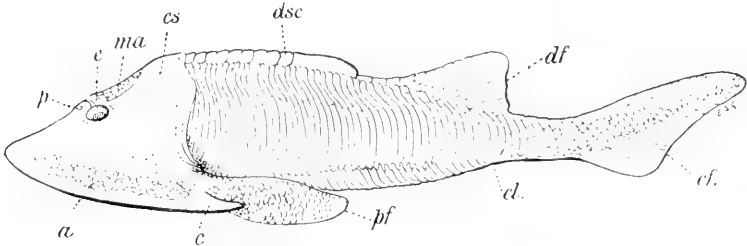

FIG. 173.

Restoration of *Cephalaspis Lottii*. *a*, lateral area with polygonal plates; *c*, cornu of cephalic shield; *cf*, caudal fin; *cl*, position of cloaca; *c.s.*, cephalic shield; *d.f.*, dorsal fin; *d.sc.*, dorsal ridge scales; *e*, orbit; *ma*, median area with polygonal plates; *p*, position of antorbital fossa.

may be quite free (*Tremataspis*) and bears on its inner surface a median depression possibly for a pineal body. In front of the orbits is an internal cavity opening, at all events in some genera (*Tremataspis*), by a median pore to the exterior. It has been suggested that this aperture represents an olfactory organ,<sup>1</sup> or a median eye. A series of pits in the cephalic shield of *Tremataspis* indicates the presence of a lateral-line system of sense-organs (Patten [325]).

The Cephalaspidomorphi are, for the most part, entirely covered over with plates and scales consisting of three layers. The outer layer of dense dentine-like substance bears spinelets or tubercles. The middle layer is pierced with vascular spaces; the inner layer is lamellated. True bone-cells are found in all three (Huxley [224], Lankester [276]).

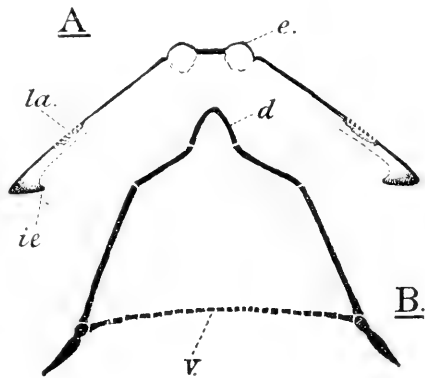

FIG. 174.

Transverse sections of *Cephalaspis*. (After Patten.) *A*, through the cephalic shield and eyes; *B*, through the trunk. *d*, dorsal ridge scale; *e*, ocular scale; *ie*, inturned margin; *la*, lateral area of small scutes; *v*, ventral scales.

<sup>1</sup> Some authors believe the Cephalaspids to be monorhinal, and allied to the Cyclostomes.

In the Ateleaspidae the scales on the sides of the body are set in transverse rows, which fuse at the sides to transverse plates in

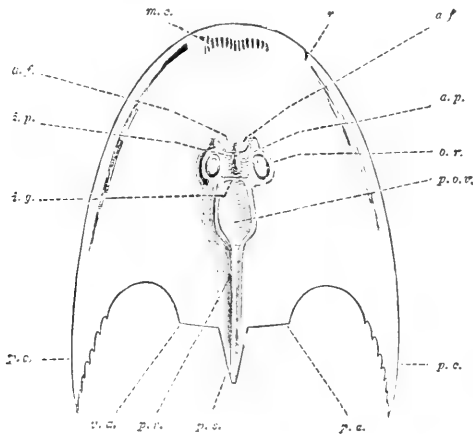

FIG. 175.

*Cephalaspis Lyelli*, Ag.; restoration of dorsal shield. (After Lankester, from A. S. Woodward.) *a.f.*, antorbital fossa; *a.p.*, antorbital prominences; *i.g.*, interorbital groove; *i.p.*, interorbital plate; *m.c.*, 'marginal cells'; *o.r.*, orbital rim; *p.a.*, posterior angle; *p.c.*, posterior cornu; *p.ov.*, postorbital depression; *p.r.*, posterior ridge; *p.s.*, posterior spine; *r.*, rim.

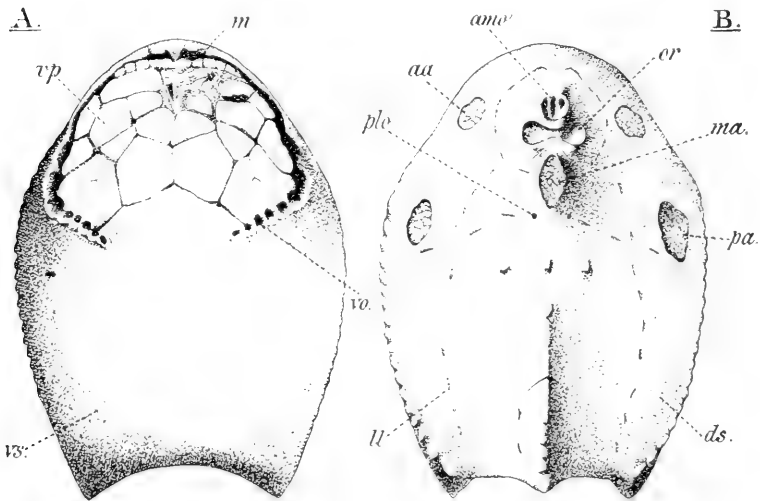

FIG. 176.

*Tremataspis Schmidtii*, Rohon, enlarged. A, ventral, and B, dorsal view of the shields. (After Patten.) *aa.*, anterior area with polygonal plates; *am.o.*, anterior median opening; *ds.*, dorsal shield; *ll.*, pits of lateral line; *m.*, mouth; *ma.*, median area with plates; *or.*, orbit; *pa.*, posterior area with plates; *ple.*, lateral opening; *v.o.*, ventral openings, probably branchial; *v.p.*, ventral plates; *v.s.*, ventral shield.



the Cephalaspidae. Small scales like those of *Thelodus* are also present in certain regions.

In the Cephalaspidae the scales also extend on to the fins, forming linear series closely resembling the lepidotrichia of Teleostome fish; and a ridge of strong scales is present along the back, and along the sides of the trunk, which thus acquires a triangular section (Fig. 174). The tail of the Tremataspidae is unknown, and may have been naked. The expanded anterior region in the Ateleaspidae is covered with a flexible armour of small polygonal plates; but in the Cephalaspid these fuse together over the head-region, so as to form a large rigid dorsal shield with rounded anterior border, and two posterior horns (Fig. 175). The compound origin of the shield is betrayed by the persistence of polygonal areas, marked out by vascular channels in the middle layer; also by the presence of an oval postorbital depression, and paired lateral spaces, in which the polygonal plates remain separate (Fig. 173). These probably indicate flexible areas over the brain and gill-chambers. The cephalic shield of the Tremataspidae is still more thoroughly fused, extending round to the ventral surface, so as to form an almost complete box (Fig. 176).

These dermal structures have probably been formed by the fusion of small denticles and an underlying plate, as in the case of the Pteraspids; but the stages in the process have not yet been so clearly demonstrated, nor has the presence of bone-cells in the superficial layer been explained.

The structure of the exoskeleton of the Cephalaspidomorphi is now very thoroughly known, thanks to the labours of Lankester, Rohon, A. S. Woodward, Patten, and Traquair. Yet their affinities remain obscure. They differ markedly from the Pteraspidomorphi in the position of the orbits, and in the presence of bone-cells in the exoskeleton. The resemblance in shape between *Thelodus* and *Ateleaspis* seems, however, to point to some relationship between the two orders (Traquair [466]).

Family ATELEASPIDAE. The head-region has a rounded margin expanding into a rounded flap on each side. There are no shields, but polygonal plates and scales, bearing sharp spinelets on their surface [466, 469].

*Ateleaspis*, Traquair; Upper Silurian, Scotland (Fig. 177).

Family CEPHALASPIDAE. The head-region is covered dorsally by a large shield with inturned edge, and ventrally with polygonal scales. The shield may bear a posterior median spine, and its posterior corners may be produced backwards into immense cornua (*Eukeraspis*). In *Auchenaspis* (*Thyestes*) the shield extends on to the trunk, several series of trunk-scales having apparently been incorporated into its hinder region. The interorbital plate is fixed. The cephalic shield is generally ornamented with tubercles, and may bear tooth-like spines along its edge. A

large fin-like lobe, covered with scales continuous with the shield at its base, projects from each side of the body behind the cephalic shield in *Cephalaspis* (Fig. 173 [505, 276, 326]).

*Cephalaspis*, Ag., and *Auchenaspis*, Ag. (*Thyestes*, Eich.); Upper Silurian and Devonian, Europe. *Eukeraspis*, Lank., Silurian, and *Didymaspis*, Lank., Devonian, England.

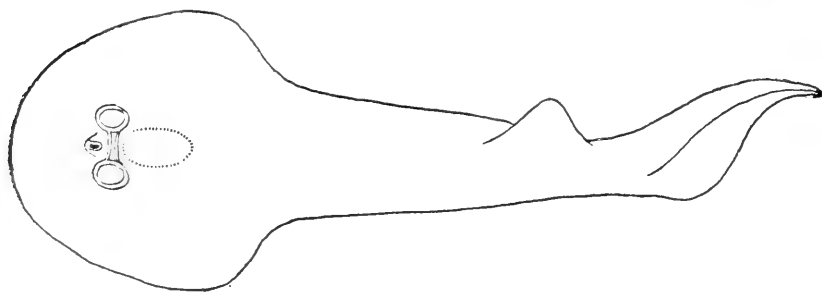

FIG. 177.

Diagrammatic restored outline of *Atelaspis tessellata*, Traq., the tail being turned so as to appear in profile. The orbits are shown near the middle of the head-shield, and in front of them the antorbital fossa and median pore. (After Traquair.)

Family TREMATASPIDAE. The almost smooth cephalic shield is continuous round the sides on to the ventral surface. Ventrally, behind the mouth, is an area covered by closely fitting plates, and between these and the edge of the shield are a series of apertures, presumably branchial. The interorbital plate is free; the orbits roofless. No lateral flaps are known [371, 325].

*Tremataspis*, Schmidt; Upper Silurian, Russia (Fig. 176).

### Order 3. ANASPIDA.

An order founded by Traquair [466] for the reception of two genera of very aberrant structure from the Silurian rocks of Scotland, *Lasanius* and *Birkenia*, to which has been added a less well-

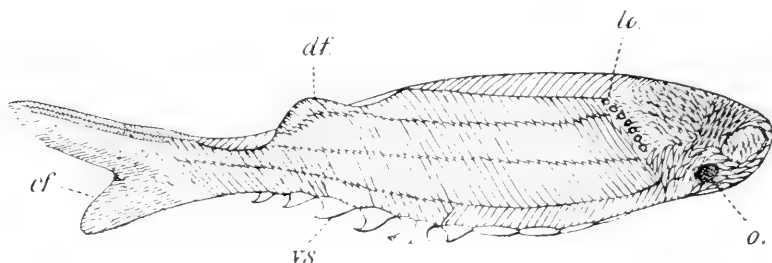

FIG. 178.

*Birkenia elegans*, Traq.; restored. (After Traquair.) *cf*, caudal fin; *df*, dorsal fin; *lo*, lateral openings, possibly branchial; *o*, orbit; *cs*, large ventral scales.

known genus, *Euphanerops*, from the Upper Devonian of Canada (A. S. Woodward [503a]). They are fish-like in shape, with fusiform body and heterocercal tail (Figs. 178, 179). The ventral lobe of the caudal fin is well marked. They have hard exoskeletal scales, the histological characters of which are not thoroughly known, and in which no bone-cells have been found; and both *Birkenia* and *Lasanius* have a median ventral row of strong projecting scales. *Birkenia* and *Euphanerops* have a small median dorsal fin; but in none of the Anaspida is there any trace of paired fins or flaps.

The mouth appears to have been ventral, below the rounded snout. Neither nostrils nor orbits can be certainly identified, although a pair of rounded spaces in *Birkenia* and two skeletal rings in *Euphanerops* may possibly indicate the position of the eyes on each side of the head. In the former genus, also, is seen a row of eight small holes set obliquely on each side at the back of the head, which are supposed to represent gill-openings, and recall similar apertures in *Tremataspis* (p. 204). The systematic position of the Anaspida remains quite uncertain. The heterocercal tail and the dorsal fin they possess in common with other Ostracodermi; in the disposition of the scales on the trunk, and in the presence of a row of branchial (?) openings, they approach the Cephalaspidomorphi.

Family BIRKENIIDAE. *Birkenia* is completely covered with scales, small on the head, larger on the trunk, and smaller again on the caudal fin. On the body they are chiefly set in regular oblique rows inclined forwards and downwards (Fig. 178). The scales have a slightly tuberculated surface [466].

*Birkenia*, Traq.; Silurian, Scotland.

Family LASANIIDAE. A single row of small scales followed by a set of eight parallel oblique rods placed on either side behind the head, together with a ventral row of very uniform recurved scutes, seem to represent all that remains of the bony exoskeleton in *Lasanius*. Possibly the parallel rods passed between gill-slits. There are indications of rays on the caudal fin [466, 469].

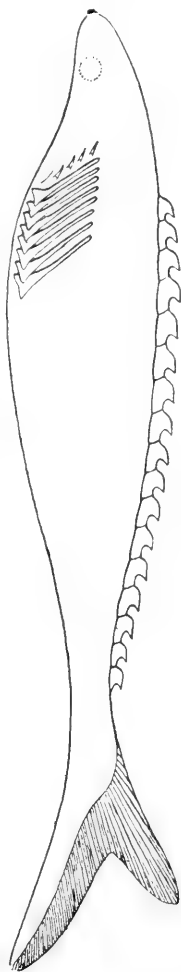

FIG. 179.  
Restored outline of *Lasanius problematicus*, Traq. Right-side view. (After Traquair.)

*Lasanius*, Traq. ; Silurian, Scotland (Fig. 179).

Family EUPHANEROPIDAE. Small scattered shagreen granules are found on the head, enlarging on the trunk into narrow scales disposed much as in *Birkenia*; towards the tail are some quadrangular scales with enamel-like surface. The granules extend on to the fins, in which traces of dermal rays and also of endoskeletal supports can be made out. The ventral row of scutes is less marked than in the other families [503a].

*Euphanerops*, A. S. Woodward ; Upper Devonian, Canada.

#### Order 4. PTERICHTHYOMORPHI (Antiarchi).

This is a small compact group of Ostracodermi, remarkable for the great development of the dermal armour. The plates and scales are of true bone, with bone-cells throughout; their surface is ornamented with tubercles and ridges, but bears no distinct evidence of having been formed of fused denticles (Fig. 180). Vascular

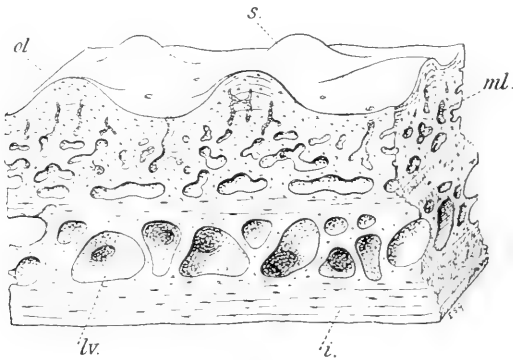

FIG. 180.

Enlarged view of a small piece of the shield of *Bothriolepis canadensis*, Wht. ; Upper Devonian, Canada. *i.*, inner bony lamellae; *l.v.*, large vascular space; *m.l.*, middle vascular layer; *o.l.*, outer bony lamellae; *s.*, surface ornament.

cavities are developed in the middle layer, and the inner layer is lamellated as usual. A very complete and accurate knowledge of the outer structure of these Palaeozoic fish has been obtained of late years from the researches of Pander [312], Traquair [452, 461], A. S. Woodward [503, 505], Patten [328], and Rohon [370].

The broad rounded head is covered with a shield, which articulates behind with a larger trunk shield or cuirass, completely surrounding the body. Both are composed of closely united plates, separated by fine sutures. The tail-region bears a dorsal fin and an unforked heterocercal fin (Fig. 181). An anterior dorsal fin-fold has been described in *Bothriolepis* immediately behind the carapace

(Patten [328]). In *Asterolepis* and *Pterichthys* the tail is covered with imbricated scales, smaller scales extend in rows on to the fins, and powerful fulcral scales lie along the mid-dorsal line and the anterior edge of the fins. *Bothriolepis* has an almost naked caudal region. The lateral-line system is represented by grooves running round the cephalic shield, passing ventrally in front of the mouth, and down the sides of the trunk-cuirass on to the tail. The course of these grooves on the head is very different from that pursued in typical Pisces.

In front of the mouth below are placed two dermal 'maxillary' plates, with toothed edges, which seem to represent jaws. On the outer edge of each is a notch, perhaps indicating a nostril (A. S. Woodward [503]). The mouth is limited behind by two small semilunar plates at the edge of the ventral trunk-shield. The two orbits are situated close to each other near the middle of the cephalic shield. Each is protected by a thin, convex, bony plate; and between them is a free quadrangular plate, with a deep inner excavation, possibly for a pineal organ.

The plates composing the cephalic shield do not agree in number or disposition with the normal structure of the skull of a Teleostome. Their arrangement, and also that of the plates forming the trunk-cuirass, will best be understood by consulting Fig. 181. A large plate on each side of the head appears to have been movable and with a free edge—it may represent an operculum. The one median and four paired plates composing the ventral trunk-shield bear a remarkable resemblance to the plastron of the Coccosteids (p. 261). According to Patten [328] the cuirass had a free membranous edge behind, leaving a branchial opening between it and the trunk. But the position of the branchiae, and indeed their very presence, has not yet been definitely determined. Probably they were within the cephalic shield.

Articulating near the front edge of the cuirass are two most remarkable two-jointed, freely movable appendages, with serrated anterior edge. They are completely encased in long plates. The cavity inside the appendage communicates with that of the body by an aperture in the cuirass. Most authors compare these appendages to pectoral fins (Fig. 181).

So striking is the resemblance between the Pterichthyomorphi and the Coccosteorphi, not only in the general shape of the body and the development of the cephalic and trunk shields, but also in the minute structure of the dermal skeleton, that they were for a long time associated by the older authors. Yet the two groups differ in several fundamental characters. The presence of pectoral appendages in the former, their absence in the latter; the presence of pelvic fins in the latter, their absence in the former; and above all, the possession of recognisable upper and lower toothed jaw-bones

in the Coccosteomorphi, are evidence of wide divergence. On the other hand, the Pterichthyomorphi have much in common with the

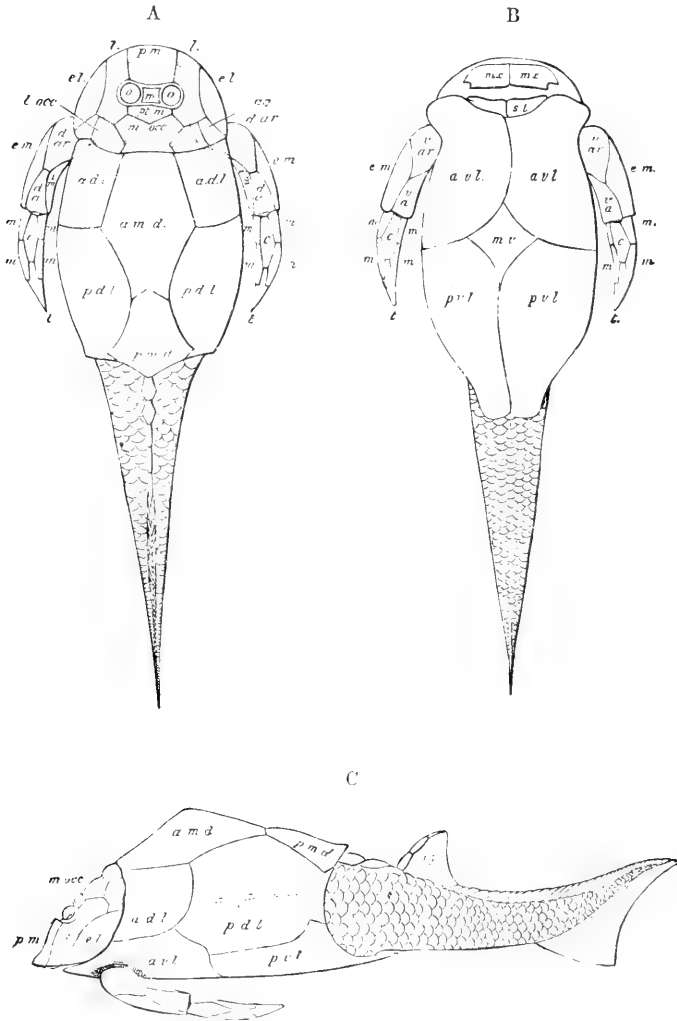

FIG. 181.

*Pterichthys Milleri*, Ag. Dorsal (A), ventral (B), and left lateral aspects (C); restored. (After Traquair, from A. S. Woodward, *Proc. Geol. Assoc.*) *a.d.l.*, anterior dorso-lateral; *ag*, angular; *a.m.d.*, anterior median dorsal; *a.v.l.*, anterior ventro-lateral; *c*, central; *d.a.*, dorsal anconeal; *d.ar.*, dorsal articular; *e.l.*, extra-lateral; *e.m.*, external marginal; *i.m.*, internal marginal; *l.*, lateral; *l.occ.*, lateral occipital; *m.*, median; *m., m., m., m.*, marginals; *m.occ.*, median occipital; *m.v.*, median ventral; *mx*, maxilla; *o*, ocular; *p.d.l.*, posterior dorso-lateral; *pm*, pre-median; *p.m.d.*, posterior median dorsal; *ptm*, postmedian; *p.v.l.*, posterior ventro-lateral; *sl*, semilunar; *t*, terminal; *v.a.*, ventral anconeal; *v.ar.*, ventral articular. Dotted lines indicate the course of lateral-line canals.

Cephalaspidomorphi. Especially important is the position and structure of the orbits—so peculiar amongst Pisces, and so essentially similar in both cases. The pectoral appendages may, moreover, be compared with the paired flaps of *Cephalaspis*, also covered with dermal armour.

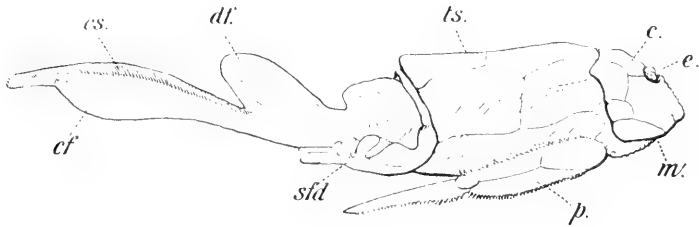

FIG. 181A.

*Bothriolepis*; restored. (After Patten.) *c*, cephalic shield; *c.f.*, ventral lobe of caudal fin; *c.s.*, dorsal lobe of caudal fin; *d.f.*, second dorsal fin; *e*, eye; *m*, mouth; *p*, pectoral jointed appendage; *s.f.d.*, fold of skin (pelvic fin?); *t.s.*, thoracic shield.

Family ASTEROLEPIDAE. *Asterolepis*, Eich.; *Pterichthys*, Ag.; *Microbrachius*, Traq.; Devonian, Europe. *Bothriolepis*, Eich.; Devonian, Europe and Canada.

### Sub-Grade 3. OSTEICHTHYES.

The remainder of the true fish are included in this sub-grade. Many important characters distinguish them from the Chondrichthyes, which remain at a lower grade of organisation. The cartilaginous endoskeleton becomes to a considerable extent reduced in the adult, and replaced by true bone, or some bone-like tissue derived from true bone (p. 355).

The exoskeleton is also modified and strengthened by the development of bony tissues. Whilst the primitive placoid scales (denticles) may remain, at all events in certain regions, the body is protected by the development of a new kind of bony scale or

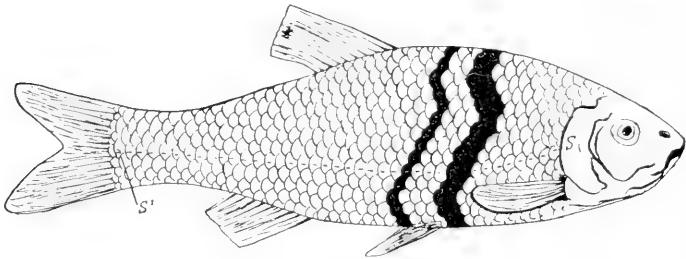

FIG. 182.

*Leuciscus rutilus*. Right-side view, showing the scales. Some of the lines of scales have been marked in black, to demonstrate their correspondence with the myotomes. S, lateral line. (After A. Hase.)

plate below them. The structure of these plates is very variable; and their exact ontogenetic and phylogenetic relation to the overlying denticles is often difficult to understand. On the trunk and tail of the lower Osteichthyes are generally found thick, shiny, more or less rhomboid scales in oblique rows corresponding numerically to the myotomes (Figs. 182, 183, 193). Each scale to some extent overlaps its neighbours from before backwards like the tiles of a roof, and the anterior deep-lying edge is often produced into an articulating process. In the higher forms the scales become thinner, more deeply imbricating, less closely articulated, and may lose their metameric disposition.

Agassiz [4] classified the fish into the groups Placoidei, Ganoidei, Cycloidei, and Ctenoidei, according to the character of



their scales. The first have only 'placoid' scales (denticles, see p. 119). The second have the flat rhombic shiny scales mentioned above. The third have thin rounded scales. Lastly, the Ctenoidei have similar thin scales, but provided with spiny

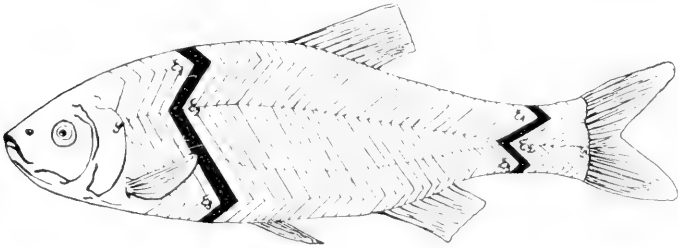

FIG. 183.

*Leuciscus rutilus*. Left-side view, showing the myotomes, two of which are marked in black. E, longitudinal transverse septum; S, lateral line. (After A. Hase.)

projections. Recent work tends to show that the 'cycloid' and 'ctenoid' scales are closely allied forms derived from the more primitive 'ganoid' scale, and that they all three differ very

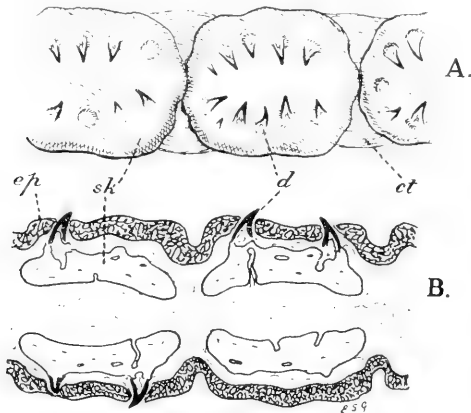

FIG. 184.

Dermal fin-ray of *Polypterus bichir*, Geoffr., enlarged. A, surface view of a few segments. B, longitudinal section of the same. ct, connecting ligament; d, denticle; ep, epidermis; sk, bony plate or segment of lepidotrich.

fundamentally from the 'placoid' type (Williamson [496a], Hertwig [212], Klaatsch [264], A. S. Woodward [505]).

The true scale (as distinguished from the placoid denticle) of the Osteichthyes sinks deep into the connective tissues, it is rarely shed, and generally grows throughout life by the addition of successive layers of bony substance. Scales differ, however, very

considerably both in their mode of growth and histological structure (p. 214). In the more specialised fish they undergo modification in diverse ways — becoming spine-like (*Gymnodontes*), or few, large, and plate-like (*Acipenser*, *Loricariidae*), or sometimes disappearing altogether.

Besides these body-scales are found scale-like exoskeletal elements set end to end in rows, and forming jointed dermal fin-rays, called *lepidotrichia* (Goodrich [175]), supporting the web

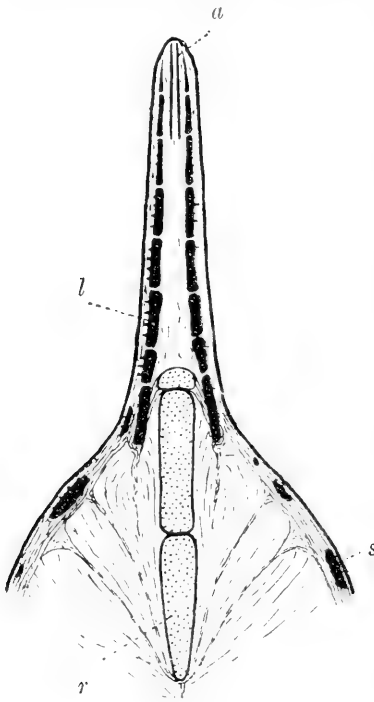

FIG. 185.

Diagram of a section through the dorsal fin of *Acipenser*. *a*, actinotrich; *l*, lepidotrich; *r*, endoskeletal radial; *s*, body-scale. (From *Quart. Journ. Micr. Sci.*)

of both the paired and the median fins (Figs. 184, 185, 186, 187). The minute structure of these fin-rays is almost or quite identical with that of the scales of the fish to which they belong. This is true more especially of the lower forms. In some, such as *Amblypterus*, there is a perfect gradation in form and arrangement between the body-scales and the fin-ray elements. But, as a rule, the transition is more abrupt, the segments of the rays acquiring a squarish or oblong shape, and not overlapping (Fig. 249). Both the scales and the segments of the lepidotrichia are embedded in the dense connective tissue, the fibres of which enter the substance of the bone. Movable joints are formed by the fibrous matrix remaining unossified between them (see pp. 214 and 356).

Large superficial dermal plates are developed in the Osteichthyes on the head and shoulder-girdle, which also resemble the scales in structure and development. There can be no doubt that these bones are of the same nature as the scales on the body, though probably they were never exactly like them in shape or disposition. In the course of the differentiation of the now widely divergent groups included in the Osteichthyes the dermal bones have undergone many important changes, yet a fundamental plan can be made out which is common to all the more primitive forms (Figs. 236, 240, 250-51).

The bones covering the head consist essentially of a paired series of frontals between the orbits, nasals in front and parietals behind. Circumorbital bones surround the eye-sockets; a transverse row of small bones (often called supratemporals) covers the occipital region, and forms a transition between the cranial plates and the scales of the body; and the sides of the cranial roof are completed over the auditory region by paired pterotics (squamosals) overhanging the articulation of the jaws. The upper jaw is bounded on either side by a toothed premaxillary and maxillary. Each ramus of the lower jaw is provided with an outer toothed dentary and posterior lower angular; to these should be added a dermal articular and a coronoid (complementary). The dermal articular plate seems to be the last element of a series of infradentaries found in certain early forms (*Megalichthys*, etc.). Ventrally the space between the rami is covered with gular plates, of which a row extends upwards on either side on to the hyoidean opercular flap, where they expand into the subopercular and opercular bones.

On the roof of the buccal cavity are a median posterior parasphenoid underlying and supporting the basis cranii, and paired anterior vomers. Large pterygoids and smaller palatines cover the palato-quadrates, which do not form the biting edge of the jaw, and are usually separated in the middle line in front. A splenial on either side lines the inside of the lower jaw.

All these internal bones may be toothed, and are indeed to a great extent formed by the cementing together of numbers of small teeth (p. 217). Similar bony plates with teeth may be found on the gill-arches. To this list of primitive cranial dermal bones should perhaps be added a median ethmoid in front, a median occipital behind, and a median gular below.

Limiting the branchial chamber behind is the dermal shoulder-

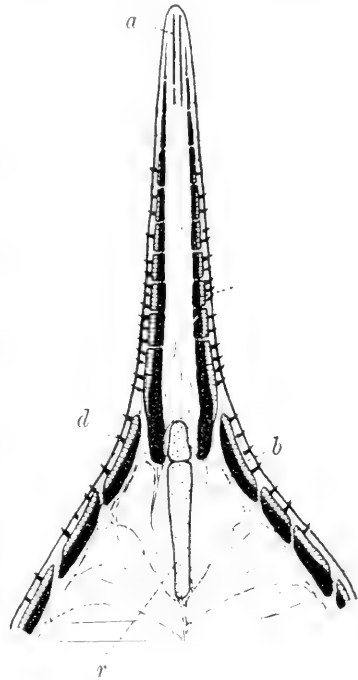

FIG. 186.

Diagram of a section through the dorsal fin of *Lepidosteus*. *a*, actinotrich; *b*, scale; *d*, denticle; *l*, lepidotrich; *r*, radial. (From *Quart. Journ. Micr. Sci.*)

girdle (Figs. 241, 263). This consists of a series of paired bones: the clavicle below overlies the coracoid; the cleithrum strengthens the region where the pectoral fin articulates, covering the scapula; the uppermost is the post-temporal (suprascapular), which in all typical Osteichthyes unites the dermal shoulder-girdle firmly with the otic region of the skull (Fig. 302). A supratemporal (extrascapular) may occur between the pterotic and the post-temporal.

All these scales, bones, and lepidotrichia are in primitive forms of similar structure, and are presumably of homologous nature. Lying in the connective tissue of the dermis outside the muscles, they are covered over by a layer of mesoblastic tissue and the unbroken epidermis. Only the larger bones extend into the deeper layers of the connective-tissue system.

True denticles (dermal teeth), similar in structure and development to those of the Elasmobranch, are found in some living Teleostomes scattered over the surface of the scales and lepidotrichia. They are either fixed (*Lepidosteus*, *Polypterus*, Figs. 184, 264) or movably attached to the underlying bone (Silurids, Fig. 373). Some fossil forms (Coelacanthidae, Fig. 262) are known to have possessed an abundant supply of similar denticles, and possibly they were widely distributed among early Teleostomi.

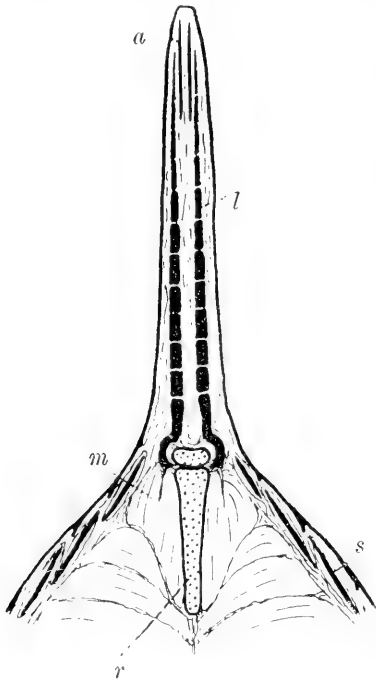

FIG. 187.

Diagram of a section through the dorsal fin of a Teleost. *a*, actinotrich; *l*, lepidotrich; *m*, radial muscle; *r*, endoskeletal fin-radial; *s*, scale. (From *Quart. Journ. Micr. Sci.*)

What has been the history of the 'ganoid' scale is still an

undecided question. Since such bony scales occur even in Silurian rocks, it is doubtful whether the clue to their origin will be found in any known fossil. The most favoured theory is that of Williamson [496*a*], which has been extended by the researches of O. Hertwig [212] and others (Rohon [369, 371], Pander [312], Gegenbaur [163], etc.). According to Hertwig's view, the history of the scales and plates has been as follows. Starting from a condition, such as still persists in modern Elasmobranchs, where the body

is covered with isolated placoid scales, it is supposed that the denticles developed extensive basal plates in the dermis; by the coalescence of adjoining basal plates were formed larger plates or scales studded on their outer surface with small denticles. The modification, spreading out, or fusion of the denticles then gave rise to the ganoine, and the ornamentation of tubercles and ridges found on the surface.

This theory is open to several objections. Firstly, the 'placoid' denticle is never found separate from its basal plate, which is merely

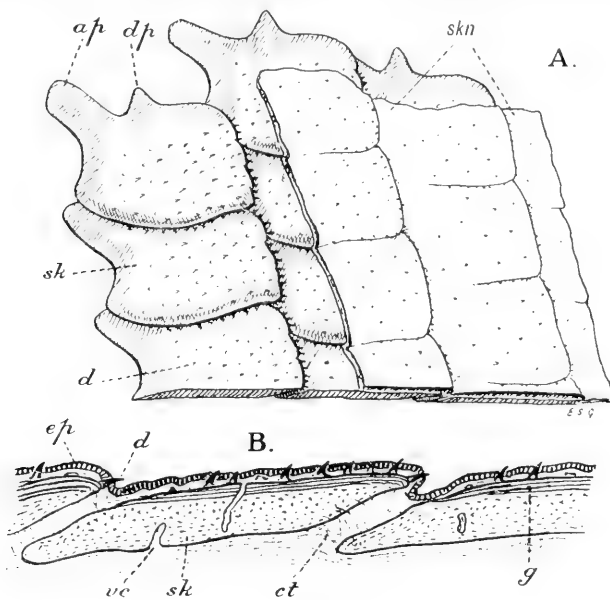

FIG. 188.

*Lepidosteus osseus*, L. A, surface view of trunk-scales from which the skin and connective tissue have been removed on the left side. B, longitudinal section through the skin and scales. *a.p.*, anterior articulating process; *c.t.*, connective tissue of cutis; *d.*, denticle; *d.p.*, dorsal articulating process; *ep.*, epidermis; *g.*, ganoine layer; *sk.*, scale; *skn.*, skin covering scales; *v.c.*, vascular canal.

an extension of it inwards. In the Osteichthyes, on the contrary, denticles are developed separately, often later than the underlying bony plate, and only secondarily become connected with it. Secondly, the basal plate of a placoid scale is never formed of true bone, but either of dentine or of some allied substance. Thirdly, the scale often sinks away from the epidermis, and grows by the addition of new layers over its surface (cp. p. 356). The shiny ganoine layer of the scales of the Osteichthyes, being formed by the mesoblast, must not be confused with true enamel deposited by the epidermis.

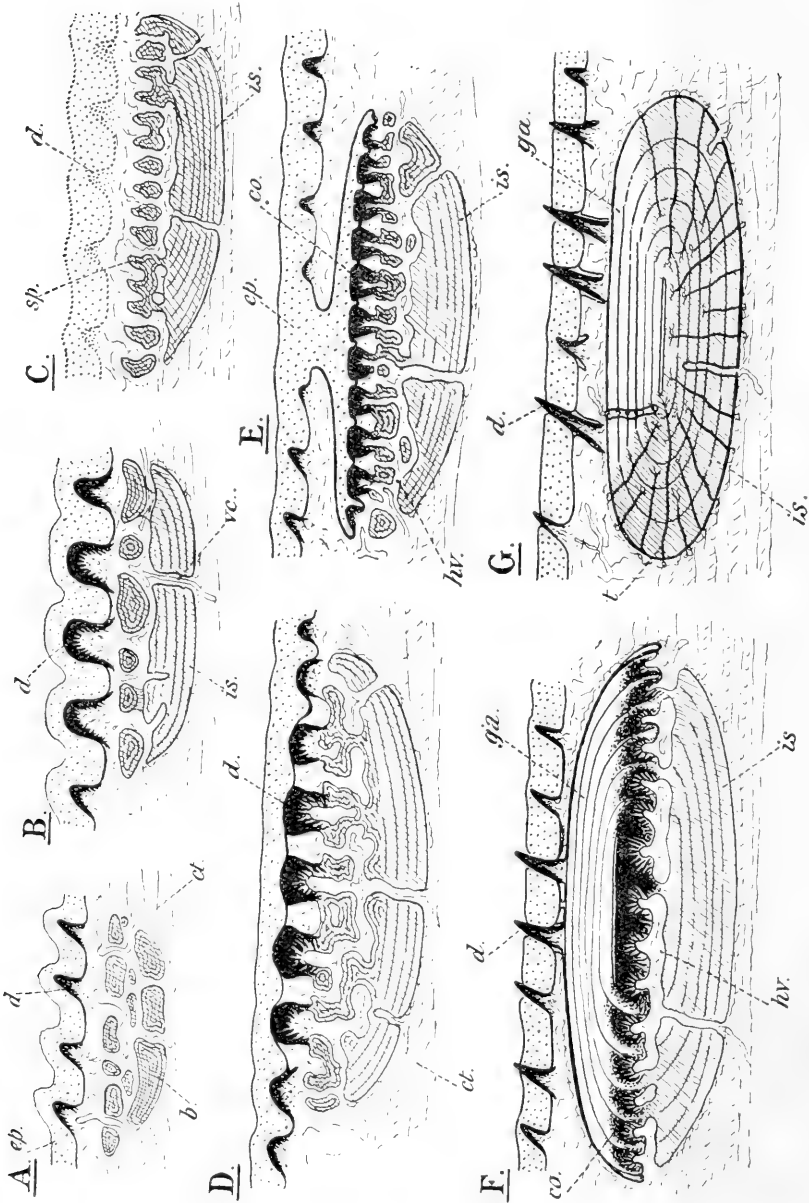

FIG. 189.

Diagrams showing the possible origin of the 'cosmoid' scale E, the Rhizodont scale C, the 'palaeosmoid' scale F, and the 'lepidosteoid' scale G, from a simple condition A through stage B, or B and D. A, B, D, hypothetical stages showing the fixation of superficial denticles, *d*, on to an underlying bony epidermalis; *b*, pierced by vascular canals; *hr*, connective layer derived from denticles; it is lost in C, and not developed in G. *ga*, surface tubercle or spine; *st*, surface tubercle or spine; *ep*, epidermalis; *ga*, outer ganoin laminae; *sp*, surface tubercle or spine; *ls*, connective tissue of cutis;

According to Williamson's original theory the scales and plates of the Osteichthyes have been formed by "the confluent aggregation and superficial depression of a number of placoid teeth" overlying and becoming fused with a lower bony plate. We have seen how admirably this theory accounts for the structure of the exoskeleton of the Pteraspidomorphi (p. 195); will it equally well account for that of the ganoid scale?

We must carefully distinguish between two very different kinds of scales hitherto called 'ganoid' (Goodrich [178]). The first, which is the true *ganoid* scale, occurs in the Actinopterygii. The second may

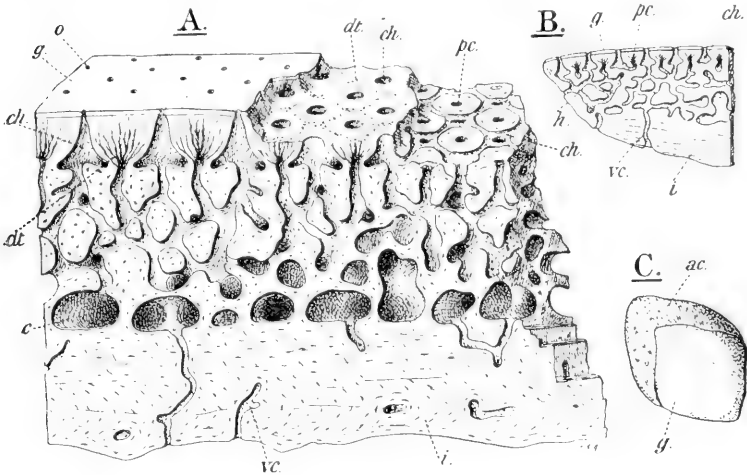

FIG. 190.

Scale of *Megalichthys Hibberti*, Ag.; Carboniferous, England. A, piece of a thick transverse section, much enlarged. B, section through the hind edge, enlarged. C, outer view of a scale. *ac*, anterior region covered by next scale; *c*, large vascular cavity; *ch*, chamber of cosmine layer; *dt*, canaliculi of cosmine; *g*, thin outermost shiny layer; *h*, irregular vascular canals; *i*, bony inner layer or isopedine; *o*, opening of chamber on surface; *pc*, pulp-cavity from which canaliculi radiate; *vc*, vertical canal.

be called the *cosmoid* scale, and is found only in the Dipnoi and Osteolepidoti (Figs. 189, 190). The latter is formed of three layers: a middle layer of bone with large vascular anastomosing channels; an inner layer of bony "isopedin," in which the matrix is deposited in successive laminae, and the cells are arranged in parallel planes; and an outer layer of "cosmin" (Williamson [496*a*]). This cosmine is of complex structure, being formed of cell-less matrix in which vertical vascular spaces alternate with 'pulp-cavities' from which radiate fine canaliculi. It resembles dentine (Fig. 190). A thin layer of enamel or vitrodentine covers its outer surface.

The 'ganoid' scale, on the other hand, consists of concentric layers of skeletal substance, passing both above and below. Two

distinct types of true ganoid scales can be distinguished [178]. The first—the Palaeoniscoid type—has four layers: isopedine below, a vascular layer, a layer with canaliculi branching from a horizontal system of canals (comparable to the cosmine layer), and lastly, a layer of successive lamellae of enamel-like, cell-less substance—the ganoine (Fig. 191). The second—the Lepidosteoid type—has the ganoine above and the isopedine below, but only a few irregular transverse vascular channels; there is no real cosmine-like layer, and the scale is characterised by a number of small tubules passing

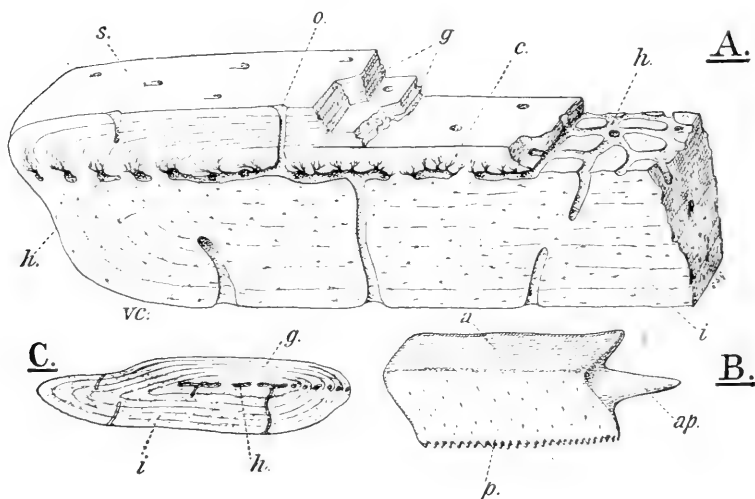

FIG. 191.

*Eurymotus crenatus*, Ag.; Lower Carboniferous. A, diagrammatic and much enlarged view of a piece of the scale. B, enlarged outer view of a scale. C, transverse section of a scale, enlarged. *a*, anterior covered region; *ap*, articulating process; *c*, fine canaliculi of cosmine layer; *g*, ganoine layer; *h*, system of horizontal canals; *i*, isopedine layer; *o*, opening on outer surface of vertical canals; *p*, posterior exposed shiny surface; *s*, outer surface; *v.c.*, vertical canal.

inwards at right angles to the lines of growth from the lower and lateral surfaces (Fig. 192) (Reissner [355], Scupin [394]).

Whilst the cosmoid scale grows only by the addition of new cosmine round its edge, and of new layers of isopedine on its under surface, the ganoid scale grows by the addition of concentric layers over its entire surface, each of which contains elements of all the strata of the scale. No living fish has a cosmoid scale. It is probable that the ganoid is derived from the cosmoid type of scale, which may be supposed to have sunk away from the epidermis, becoming inclosed in a mesodermal pocket by which the new complete concentric layers are deposited. If, as Williamson suggested, the cosmine or dentine layer represents an original set of super-



ficial placoid scales fused together, the presence of denticles on the top of modern ganoid scales can only be explained as a new set developed after the scale has sunk below the surface (see Figs. 188-9). On the other hand, it is, of course, possible that the cosmine is only a peculiarly specialised layer of the independently formed scale, since intermediate stages in its formation have not yet been found. The different varieties of scales described above are of great taxonomic importance.

In the primitive Pisces the organs of the lateral-line system have become distributed over the head and body according to a definite pattern (p. 19), and have sunk in a subdermal tube opening on the surface by pores (p. 220 and Fig. 195). The pattern of

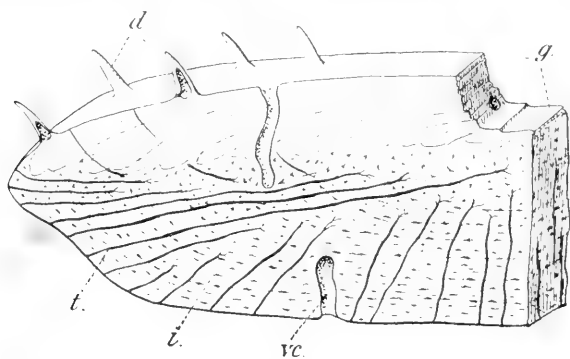

FIG. 192.

Much enlarged view of a piece of the scale of *Lepidosteus osseus*, L. *d*, superficial denticles; *g*, ganoin layer; *i*, inner bony layers, or isopelinae; *t*, tubules with branching inner ends; *vc*, vascular canal.

the lateral line remains very constant, on the whole, throughout the Osteichthyes, though it undergoes secondary modification in detail. But the tube in which the sense-organs have sunk necessarily becomes inclosed in the dermal plates of the head and scales of the body. There is thus established a definite relation between the exoskeleton and the lateral line, which is often of great service in tracing the homologies of the various bones concerned. In all primitive Osteichthyes the lateral-line canal on the body pierces through every scale along its course, passing from its upper surface in front to its lower surface behind (Fig. 194). A sense-organ is situated between each pair of scales, and a tube leads to a pore approximately above the centre of each scale. Secondary lateral lines may be developed dorsally and ventrally essentially similar to the main line, of which they are branches. In front the line passes through the dorsal elements of the shoulder-girdle (post-temporal)

on to the head. By a subdivision and branching of the pore canal a number of small pores may replace the original primary pore.

We have already seen (p. 125) that the canals of the lateral-line system follow a fairly uniform course on the head in the various groups of fish. The Elasmobranchii and Osteichthyes agree well in this respect (Allis [9, 19], Garman [148], Clapp [78], Herrick [210], Collinge [85-89], etc.). Now the connection established with the cranial bones is as follows (Figs. 196, 500, A). The trunk lateral line passes by means of the post-temporal on to the supra-temporal or the pterotic (squamosal); from this point a transverse

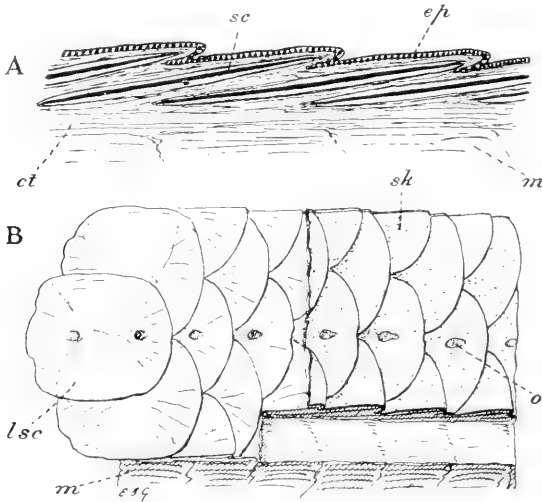

FIG. 193.

*Leuciscus cephalus*, L. A, longitudinal section through the skin, scales, and muscles. B, surface view of body-wall; the skin has been removed on the left, and the myotomes exposed below on the right. *ct*, connective tissue; *ep*, epidermis; *lsc*, lateral-line scale; *m*, myotome; *o*, opening of lateral-line canal; *sc*, scale in connective-tissue pocket; *sk*, skin.

branch is often sent off towards the middle line running as a rule in the supratemporal bones—it may be called the supratemporal or occipital branch. The organs in this region of the canal are supplied by the supratemporal twig of the vagus. The main line then continues horizontally through the pterotic, forming a short temporal canal supplied by the otic branch of the glossopharyngeal (this short region does not always occur). The canal is prolonged forward to behind the orbit—postorbital line—through the pterotic and post-frontal. It is supplied by the otic branch of the facialis. Next it passes below the orbit and forwards to the nostrils; the ramus buccalis facialis supplies this infraorbital canal, which passes through the post-, infra-, and preorbital ('lachrymal') bones. Starting from the junction between the postorbital and infra-

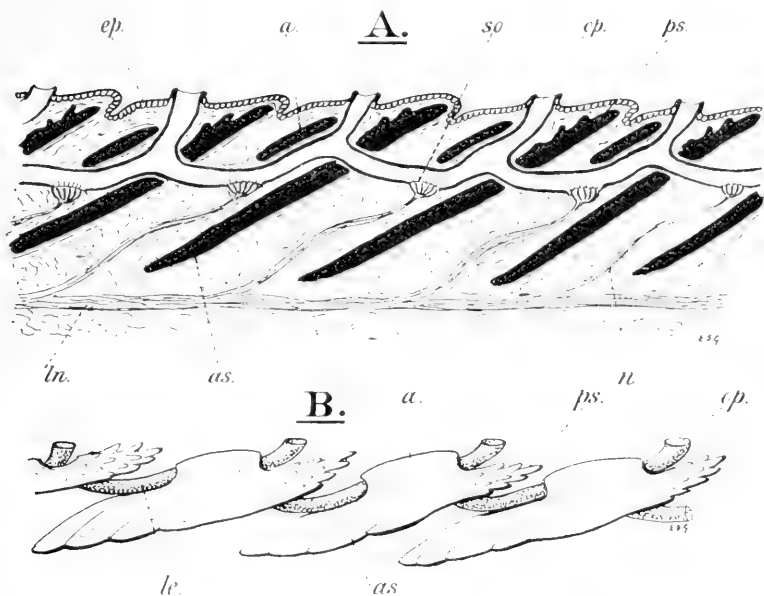

FIG. 194.

Diagrams showing the relation of the lateral-line canal to the scales on the trunk of *Perca fluviatilis*, L. A, longitudinal section. B, the scales and the canal seen from the side. *a*, arch covering the canal; *a.s.*, anterior region of scale; *ep*, epidermis; *lc*, lateral-line canal; *ln*, lateral-line nerve; *n*, nerve to sense-organ; *cp*, external opening of canal; *p.s.*, posterior ctenoid edge of scale; *s.e.*, sense-organ in canal.

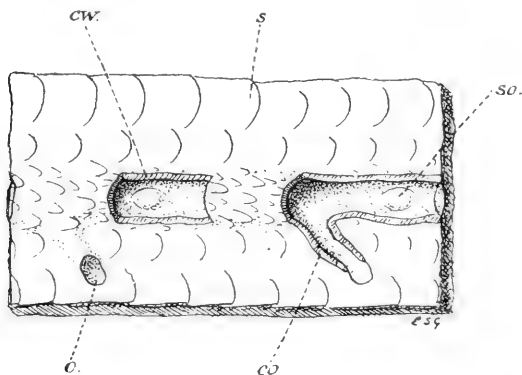

FIG. 195.

*Gadus morhua*, L. Surface view of the skin, enlarged, showing the lateral line. *c.o.*, cut wall of canal to opening; *c.w.*, cut wall of main canal; *o*, opening; *s*, scale; *s.o.*, sense-organ (neuromast).

orbital canals is the supraorbital canal, which passes through the frontal and nasals to the snout, where it may join the infraorbital. It is the superior ophthalmic branch of the facialis which innervates the supraorbital canal. Lastly, the ramus hyomandibularis facialis supplies a hyomandibular canal, which passes down the preopercular and forwards through the dermarteular to the dentary.

It frequently happens that, in the more specialised fish, where the cranial bones and scales become thin, lose their superficial layers, and sink far below the surface, the system of canals again

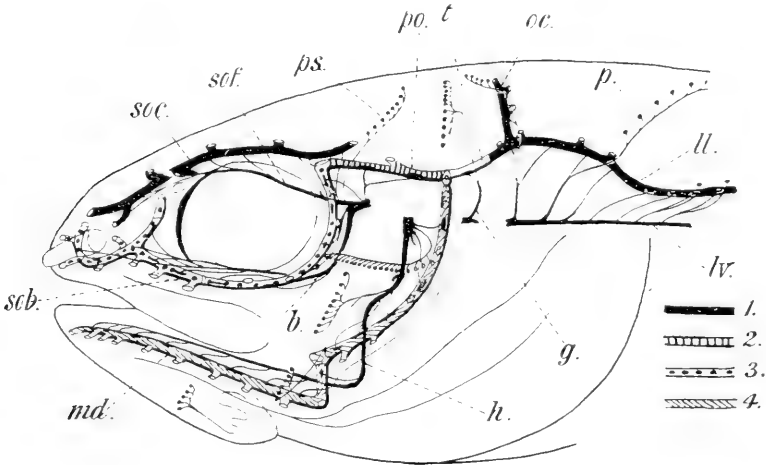

FIG. 196.

Diagram of the head of *Amia calva*, L., showing the system of lateral-line canals and pit-organs, and their nerve-supply (from Allis). *b*, buccal branch of facial nerve; *g*, dorsal branch of glossopharyngeal; *h*, hyomandibular branch of facial; *ll*, lateral line of trunk; *lv*, lateral-line branch of vagus; *md*, mandibular canal; *oc*, occipital or supratemporal canal; *p*, pit-organs on trunk; *po*, postorbital canal; *ps*, pit-organs on head; *scb*, suborbital canal; *scf*, supraorbital canal; *s.o.f.*, superior ophthalmic branch of facial; *t*, temporal canal. The system of distinguishing the canals is indicated on the right of the figure: 1, supraorbital, and main canal of trunk; 2, postorbital; 3, suborbital; 4, hyomandibular (the same system is used in Fig. 85).

becomes free. Every stage in the process of the liberation of the canals from the underlying bones may be traced in the Teleostei. Special tubular bones often become separated off, and are left in these fish to protect the sensory canals (Figs. 328, 456). Lastly, in both the Teleostei and Dipnoi the lateral line may so far degenerate that the sense-organs remain, at all events along the body, exposed on the surface, and no longer sink in a tube at all.

The chondrocranium, well developed in many Osteichthyes, is much reduced in the more specialised groups, and is distinguished in all by the disappearance of the cartilaginous wall separating the cavity of the skull from that of the auditory capsule (Figs. 303, 358).

The ossification of the endoskeleton, so characteristic of these fish, has already been dealt with in a general way above (p. 60). Most Teleostomes have a number of endochondral bones in the cranium and visceral arches, which are comparable with those found in the terrestrial vertebrates; but since they are mostly absent from the modern Dipnoi, and many of them have not yet been shown to occur in extinct Dipnoi, it cannot be asserted that they were present in primitive fish ancestral to these sub-classes. The description of these bones of the endoskeleton may therefore be left till later (p. 266). We may mention, however, that ventral (or pleural) ribs are present throughout the Osteichthyes.

In all the Osteichthyes an operculum is present on the hyoid arch. It covers the branchial apertures, never more than five in number, and is supported by bones the largest of which, the opercular, is articulated to the hyomandibular.

The air-bladder is one of those important structures which distinguish the Osteichthyes from the Chondrichthyes. Some kind of air-bladder is found in all the divisions of the former group, and it can hardly be doubted that it is only absent in those Teleostomes in which it has been lost. But in size, structure, disposition, and blood-supply the air-bladder is so variable, that it is by no means certainly homologous throughout the Osteichthyes.

The air-bladder always develops as a diverticulum of the alimentary canal—generally from the oesophagus, but sometimes farther back from the stomach. In *Polypterus* it is ventral and bilobed, lying below the alimentary canal (Fig. 197, A); the large left and smaller right lobe unite, and open through a muscular vestibule, or rudimentary 'larynx,' by a median ventral aperture into the oesophagus far forward. A somewhat similar muscular vestibule opens ventrally into the oesophagus (either in the middle line or slightly to the right) in the Dipnoi. But here the vestibule leads into a ductus pneumaticus which passes round the right side of the alimentary canal to expand dorsally into the air-bladder, a median (*Ceratodus*, Fig. 197, B), or bilobed sac (*Protopterus*, Fig. 198). Blood is supplied to the bladder in *Polypterus* and in the Dipnoi by paired afferent 'pulmonary arteries,' derived from the last (fourth) branchial arch, the sixth of the embryonic series (Fig. 197). The blood is returned to the heart in *Polypterus* by paired efferent vessels, opening into the hepatic vein near the sinus venosus; in the Dipnoi by paired vessels uniting and passing directly to the sinus venosus itself on the left side. That the air-bladder of the Dipnoi was originally ventral, and that its dorsal position has been secondarily acquired, is clearly shown by the course of the ductus pneumaticus, and of the left afferent and the left efferent vessels which pass round

below the oesophagus towards the right side (Parker [324], Spencer [413]). Moreover, in the embryo, the bladder develops as a median ventral outgrowth (Semon [399], Neumayer [308*b*]).

In all the Actinopterygii the air-bladder is essentially a median dorsal organ, lying below the vertebral column and aorta and above

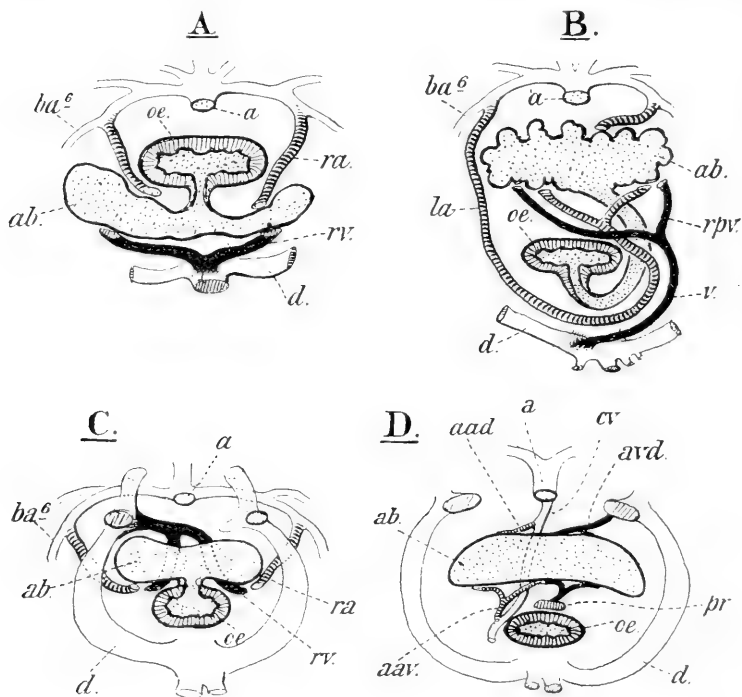

FIG. 197.

Diagrams illustrating the blood-supply of the air-bladder in A, *Polypterus*, B, *Ceratodus*, C, *Amia*, and D, a Teleost. The blood-vessels are seen from behind, and cut short in transverse section. *a*, dorsal aorta; *a.a.d.*, anterior dorsal artery from the coeliac; *a.a.v.*, ant. ventral artery; *a.b.*, air-bladder; *a.v.d.*, anterior dorsal vein to the cardinal; *ba<sup>6</sup>*, 4th aortic arch (6th of the series); *cv*, coeliac artery; *d*, ductus Cuvieri; *la*, left pulmonary artery; *oe*, oesophagus; *pr*, portal vein receiving posterior vein from air-bladder; *r.a.*, right 'pulmonary' artery; *r.p.v.*, right (branch of) 'pulmonary' vein; *rv*, right vein from air-bladder; *v*, left 'pulmonary' vein.

the alimentary canal, often outside the abdominal coelom. The communicating ductus pneumaticus passes down the dorsal mesentery to open into the oesophagus. The ductus is short, and the opening wide in the more primitive forms (*Lepidosteus*, *Amia*, *Acipenser*). But although the bladder is dorsal in the Actinopterygii, the opening of the ductus varies considerably in position. In the Chondrostei, *Amia*, *Lepidosteus*, and the majority of the Teleostei, it is quite or nearly median and dorsal;

but in others, such as *Salmo*, the Siluridae, Cyprinodontidae, Percopsidae, and Galaxiidae, it opens more or less on the right. On the contrary, in the Mormyridae, Notopteridae, Gymnotidae, Cyprinidae, and Characinidae, it opens somewhat on the left (Fig. 199), and in some genera of the last family, such as *Erythrinus* and *Macrodon*, the ductus passes down to open quite on the left side of the oesophagus (Rowntree [375]).

The evidence of ontogeny seems to show that the difference in the position of the opening is due rather to secondary shifting than

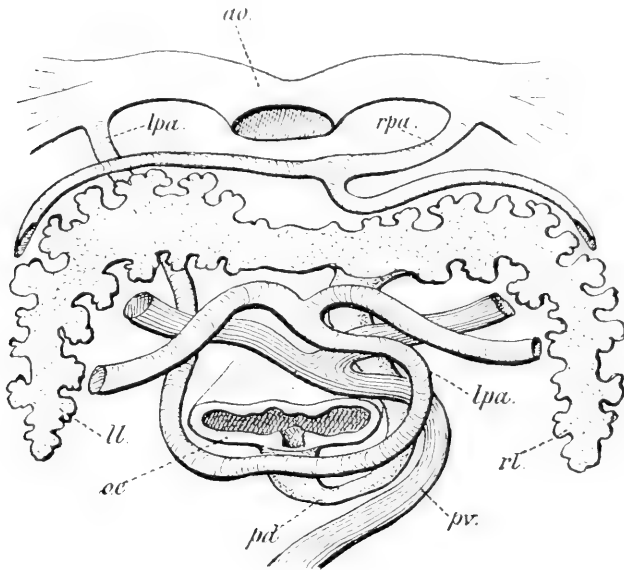

FIG. 198.

Diagram showing the relations of the oesophagus, *oc*, the pneumatic duct, *p.d.*, the bilobed air-bladder and its blood-supply in *Protopterus*, seen from behind. *ao*, junction of aortic arches to dorsal aorta; *l.l.*, left lobe of air-bladder; *l.p.a.*, left pulmonary artery; *p.v.*, pulmonary vein; *r.l.*, right lobe of air-bladder; *r.p.a.*, right pulmonary artery.

to the retention of a more primitive position in the aberrant fish (Moser [304], Piper [330]).

With regard to the original condition of the air-bladder, attempts have been made to derive these various organs found in the Osteichthyes from some single ancestral form.

Boas suggested that the bladder was originally dorsal and median; that, together with its duct, it split into right and left halves; that these separated, passed round the oesophagus, and reunited ventrally to open finally by a median ventral glottis. This explanation, however, cannot be applied to the Dipnoi (p. 223),

and there is nothing in *Polypterus* to support it. According to Sagemehl [379], the bladder, originally ventral and bilobed, has shifted round the right side in the Dipnoi, and the left side in the Actinopterygii. The median dorsal sac of the latter would represent the left lobe only, and such genera as *Erythrinus* would show an intermediate stage in the shifting. This theory is inconsistent with the structure of *Amia*, where not only are the bladder and its opening median and dorsal, but the bladder receives a right and a left afferent vessel directly from the last branchial arch (sixth of the embryonic series), and the nerve-supply is also paired and symmetrical. It is true that the right and left efferent vessels join and, passing to the left of the oesophagus, enter the left ductus

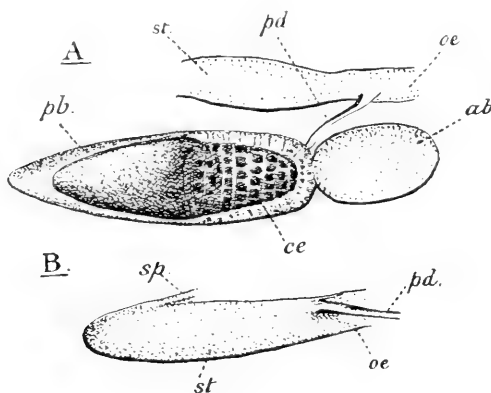

FIG. 199.

A, air-bladder of *Lebiasina unimaculata*, opened to show internal cells. B, stomach of *Ichthyoborus niloticus*, showing entrance of pneumatic duct. *ab*, anterior division; *ce*, cellular wall; *oe*, oesophagus; *pb*, posterior division; *pd*, pneumatic duct; *s.p.*, pyloric end of stomach; *st*, stomach. (After Rowitree.)

Cuvieri (Fig. 197, C); but it is easier to suppose that the return stream of the blood has been diverted to the left side, than that the arterial and nervous supply have been entirely readjusted after the shifting of the air-bladder from a ventral to a dorsal position. In all the Actinopterygii (excepting *Amia*) the blood-supply of the air-bladder resembles that of the other abdominal viscera (Figs. 197, 351). As a rule, there appears to be a double arterial supply, from the coeliac artery in front and from the dorsal aorta behind; the blood is returned to the cardinal veins from behind, and the portal vein from in front (Corning).

A third possibility remains to be considered. According to this the most plausible theory, the air-bladder may be derived from paired outgrowths, possibly a posterior pair of modified gill-pouches (Spengel [415], Goette [170]). The ventral union of such out-



growths, supplied from the aortic arches, might give rise to the bladder of *Polypterus*; while from their more complete fusion dorsally might be formed the bladder of *Amia*, etc. The return of the blood to the veins behind the heart is difficult to explain on this hypothesis, and it must be confessed that the problem of the homology of the air-bladder is not yet satisfactorily solved.

The primitive position of the nostrils seems to have been in the Osteichthyes, as in the Chondrichthyes, on the ventral surface of the snout. Such it was apparently in the early Teleostomes (Osteolepidae), and such it remains in the Dipnoi. But in all the living Osteichthyes, with the exception of a few specialised genera (p. 445), the nostrils are double. The groove on either side of the fronto-nasal process, already described in the Elasmobranchs (p. 125), closes over to form a complete canal in the Dipnoi; so that in the adult the nasal sac communicates with the exterior by an external anterior nostril, and with the buccal cavity by an internal posterior nostril, as in Pentadactyle vertebrates (Fig. 207). In the Actinopterygii and Polypteridae the nostrils remain separated from the mouth, and migrate towards the dorsal surface of the snout. No distinct fronto-nasal process, and no groove to the mouth develop; but the nostril becomes subdivided into two by a narrow bridge. The two openings so formed are probably homologous with the internal and external nostrils of the Dipnoi. There are no movable eyelids.

The Osteichthyes, with the exception of the specialised Teleostei, retain many primitive characters such as the spiral valve in the intestine, the contractile conus of the heart with many rows of valves, and the chiasma of the optic nerves. The urinogenital organs, also, are built on much the same plan in the primitive forms as in the Elasmobranchs; but the cloaca is lost in all living forms except the Dipnoi.

We conclude that the development of true bone in the endoskeleton, of scales on the body, of lepidotrichia on the fins, of a special set of bony plates on the head and shoulder-girdle, of marginal jaw-bones, of a connection between the dermal shoulder-girdle and the skull, of pleural ribs, of an operculum covering the gill-openings, of an air-bladder, and of double nostrils, justify the inclusion of the Dipnoi and Teleostomi in a separate sub-grade—the Osteichthyes.

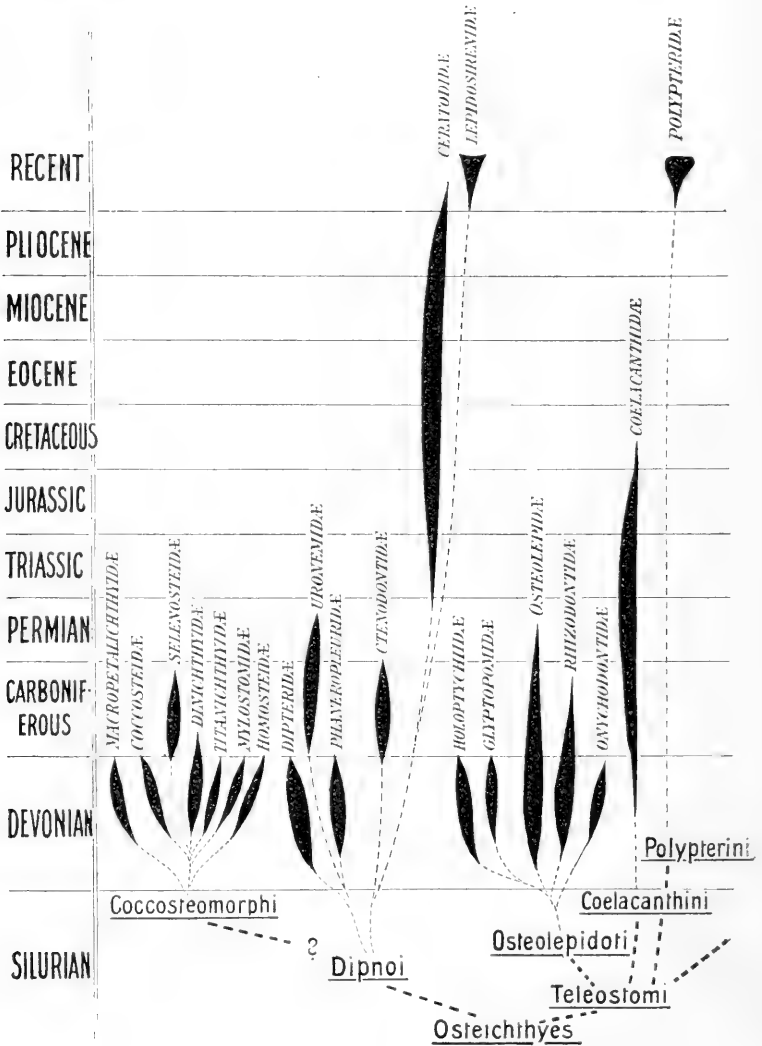

DIAGRAM III.

Diagram illustrating the Phylogeny of the Osteichthyes, and the distribution of the Families in the geological strata.

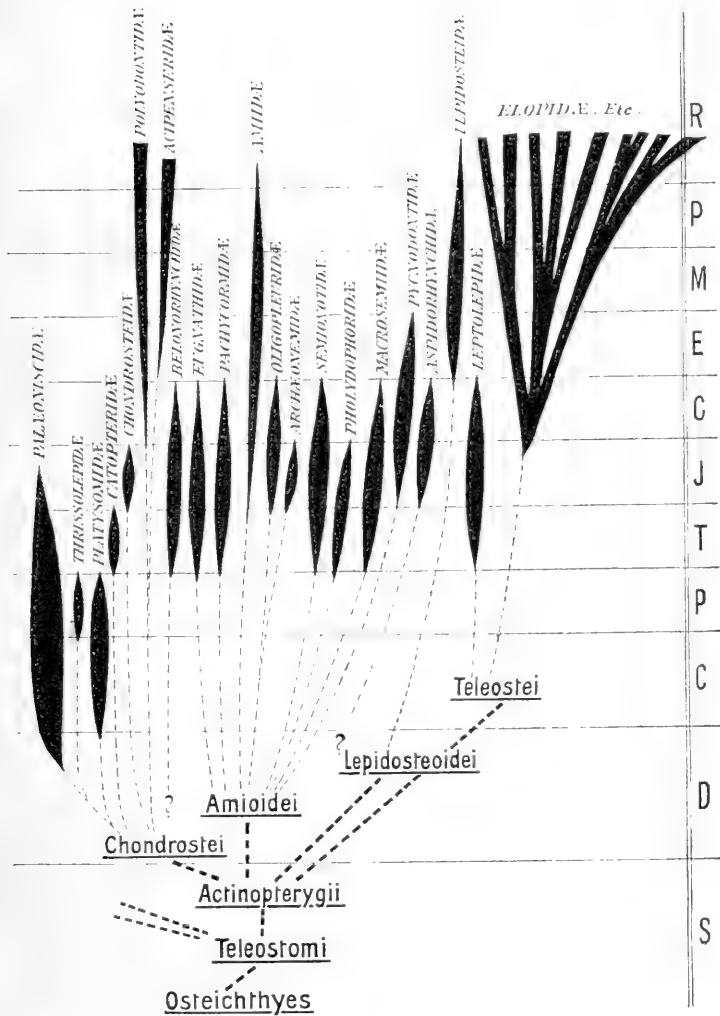

DIAGRAM III. (continued).

## GROUP A.

IN this group may be provisionally associated the two sub-classes Dipnoi and Coccosteomorphi. Some authors (A. S. Woodward [503, 505], Eastman [128-9]) definitely place the extinct *Coccosteus* and its allies in one sub-class with the Dipnoi; this step seems, however, to be premature, considering how incomplete is our knowledge of the former, and how much the two groups differ from each other. It still remains to be proved whether the Coccosteomorphi were truly autostylic, and even then whether they were more nearly related to the Dipnoi than to the Teleostomi. The affinities of these sub-classes is discussed in greater detail below.

### Sub-Class 1. DIPNOI.

The Dipnoi are among the most interesting of fish. On the one hand, they have a close affinity to the Osteolepidoti; on the other, they present many striking points of resemblance to the Amphibia, which cannot all be put down to convergence.

For the correct delimitation of this group we are chiefly indebted to Huxley [230], Günther [190], and Traquair [447]. Already in the Devonian epoch two strongly marked types of structure are found among the Dipnoi, exemplified by *Dipterus* and *Phaneropleuron*, showing that, even then, considerable divergence had taken place. First founded by J. Müller for *Lepidosiren*, the group of living Dipnoi was shown by Huxley to be characterised by the autostylic attachment of the jaws. Subsequently Traquair demonstrated that the fossil forms were likewise autostylic.

The scales are cycloid and overlapping. In modern genera they are thin, and embedded below the surface in pockets in the connective tissue of the dermis (Fig. 200). *Dipterus* has thick scales, with a shiny pitted surface. In microscopic structure they closely resemble the scales of the Osteolepidoti, with an outer layer of typical cosmine, separated by a trabecular layer of bone from an underlying sheet of isopedine. Smaller elongated quadrangular scales of the same structure extend in rows over the median and paired fins to their very edge (Fig. 202). This scaling of the fins is characteristic of the sub-class.

There are no true fulcra in any Dipnoi. The head and shoulder of *Dipterus* are provided with plates of a structure similar to that

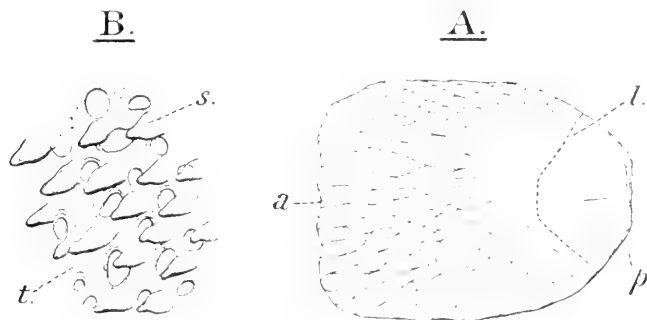

FIG. 200.

A, scale of *Ceratodus Forsteri*, Kretzl. B, enlarged view of a portion of the outer surface of the scale of *Protopterus annectens*, Owen. *a*, anterior edge; *l*, front limit of exposed region of scale; *p*, posterior edge; *s*, spine; *t*, layer of bone-like tissue.

of the scales. The lateral-line canals are embedded in these plates and scales in the early forms.

A minute comparison of the exoskeleton of the fossil and living Dipnoi yet remains to be made. In the more modified forms the

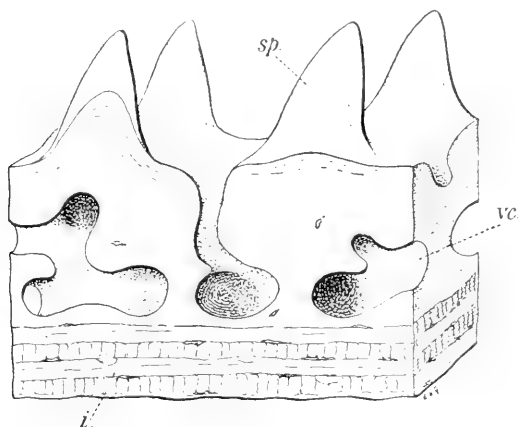

FIG. 201.

Enlarged view of a small portion of the scale of *Phaneropteron curtum*, Whit.; Upper Devonian, Canada. *i*, inner bony layer; *sp*, surface spinelet; *vc*, vascular space.

ganoid surface disappears from the plates, leaving only sheets of bone, sunk far below the surface in living genera. The scales also lose their cosmine layer, which appears to be represented by numerous

small spine-like processes, highly characteristic (Fig. 200, B), and not to be confused with denticles. This spiny covering is found in all the living genera, and even in the Devonian Phaneropleuridae (Fig. 201); it is therefore an important and old-established form of scaling not found in any other sub-class. The trabecular and isopedine layers remain,

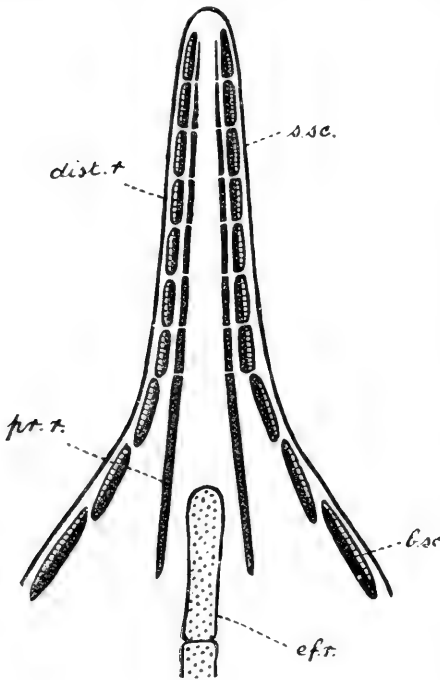

FIG. 202.

Diagram of a section through the dorsal fin of *Dipterus*. *b.sc.*, body-scales; *dist. r.*, distal jointed region of the camptotrich; *e.f.r.*, radial of fin; *p.r. r.*, proximal unsegmented region of the camptotrich; *s.sc.*, scale overlying dermal ray. (From *Quart. Journ. Micr. Sci.*)

though in living genera bone-corpuscles are no longer present (Wiedersheim [490], Klaatsch [264], Goodrich [178]).

The dermal fin-rays are always jointed, generally branched, and are formed of a bony substance containing bone-cells (Fig. 203). They are slender, much more numerous than the endoskeletal radials, with an unjointed proximal piece deeply embedded in the connective tissues and muscles, so as to considerably overlap the radials [175]. In the modern degenerate Dipnoi the dermal rays, or *camptotrichia*, become fibrous and little calcified, thus somewhat resembling the *ceratotrichia* of Elasmobranchs. But in the early fossils they are thoroughly bony, and approach lepidotrichia in structure.

The distal-jointed region of the camptotrichia is, however, always covered over externally by true scales; and in *Dipterus* these fit closely in rows along the rays (Figs. 202, 226). It is, therefore, possible either that in Dipnoi we have lepidotrichia, which have sunk deep below the surface, and been covered over by a new set of scales; or that the camptotrichia really are modified *ceratotrichia*, with which the more superficial true scales are becoming associated. A still closer union of these two elements might have given rise to the typical lepidotrichia of primitive Teleostomes. Whatever may have been the history of the camptotrichia, they differ considerably from the dermal rays of other fish [175].

No actinotrichia have been observed in young, or adult, Dipnoi (pp. 212, 273).

The vertebral column has a persistent unconstricted notochord. Although, judging from living forms (Fig. 204, A), the elastica externa is ruptured, and the mesoblastic cells invade the thick fibrous notochordal sheath to some extent, yet complete vertebral bodies are never formed so as to constrict the notochord in the typical manner. But in *Ceratodus* the notochord is pushed inwards alternately, above and below, by the cartilaginous masses, which grow from the basidorsals and basiventrals (Fig. 204, B). The extreme tip may be entirely surrounded by cartilage.

There is, then, a thick fibrous sheath in which are partially embedded cartilaginous basidorsals and basiventrals. Small and irregular intercalaries (interdorsals and interventrals) are occasionally present. The basidorsals extend upwards as ossified neural arches meeting above the nerve-cord; along the top of these arches runs a longitudinal ligament, above which again are a series of neural spines. The latter may be fused to the arches in the hinder region. Similarly the caudal region is provided with haemal spines and arches, continued in front into basal cartilages and pleural or ventral ribs (Fig. 204, C) lying just outside the peritoneum. There are no true ribs.

All living Dipnoi are provided with a diphyccercal tail, and continuous dorsal and ventral median fins (Fig. 205).

*Dipterus*, however, has two separate dorsal and one anal fin, and a heterocercal tail (Fig. 226). In *Phaneropleuron* with a separate anal only, and *Scaumenacia* with an anal and two dorsal fins, we have intermediate conditions (Fig. 227). Dollo [120] has very plausibly argued that these Dipnoi represent a degenerating series leading to an extreme form like *Lepidosiren*, in which the body becomes more elongated and eel-like, the tail becomes straightened, and the median fins fuse together. It must be remembered, however, that the Carboniferous genus *Uronemus* already has continuous median

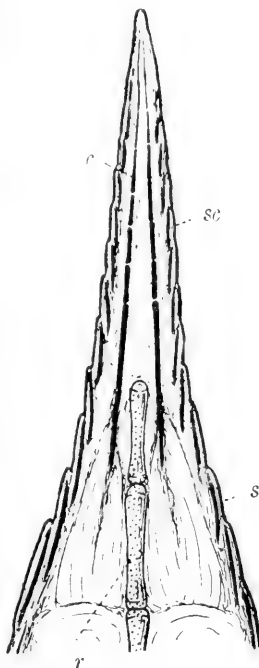

FIG. 203.

Diagram of a section through the dorsal fin of *Ceratodus*. *c*, camptotrich; *r*, endoskeletal radial; *s*, body-scale; *sc*, superficial fin-scale. (From *Quart. Journ. Micr. Sci.*)

fins and a diphycecal tail. The Dipnoi may well have been derived from some earlier form of similar shape (Fig 227).

It is important to notice that the fin-supports, radials or somactids, are segmented and intimately connected with the axial skeleton (Fig. 205). The radials and neural spines together form continuous three-jointed ossified rods. When the dorsal and anal fins are separate, the proximal segments may be concentrated and fused (*Scaumenacia*, A. Smith Woodward [503]). This tendency is also seen in the anal region of the continuous fin of *Ceratodus*.

That the ventral caudal lobe in modern Dipnoi is supported by separate radials, and not by rigid unjointed haemal spines, would

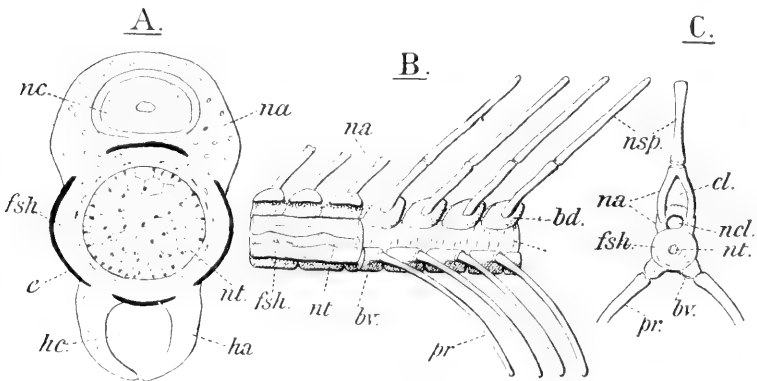

FIG. 204.

A, transverse section of vertebral column of a young *Protopterus*, showing the invasion of the fibrous notochordal sheath by the mesoblastic cells. B, left-side view of a portion of the vertebral column (abdominal region) of *Ceratodus Forsteri*, Krefft., of which the anterior half has been cut longitudinally. C, view of the same cut across. *bd*, basidorsal cartilage; *bv*, basiventral cartilage; *cl*, canal for ligament; *c*, elastica externa; *fsh*, fibrous sheath; *ha*, haemal arch (basiventral); *hc*, haemal canal; *na*, neural arch; *nc*, nerve-cord; *ncl*, neural canal; *nsp*, neural spine; *nt*, notochord; *pr*, pleural rib.

seem to be due to the genuine diphycecal character of the tail, and not, as Balfour supposed [30], to the loss of the caudal fin itself. This character indicates a primitive structure (p. 101), and weighs against Dollo's theory.

The notochord extends to near the pituitary region; there is no distinct joint between the skull and the vertebral column, which pass gradually into each other. Several vestigial vertebral segments seem to be incorporated into the hind part of the skull behind the vagus nerve. In *Ceratodus*, besides the hypoglossal roots, two complete spinal nerves pass through this region; three neural arches and spines are found attached to it above, and a pair of enlarged 'cranial ribs' articulate to it at the sides (Figs. 206, 209). Such cranial ribs are found in all living Dipnoi, and even in such



early genera as the Devonian *Scaumenacia*. The bone described

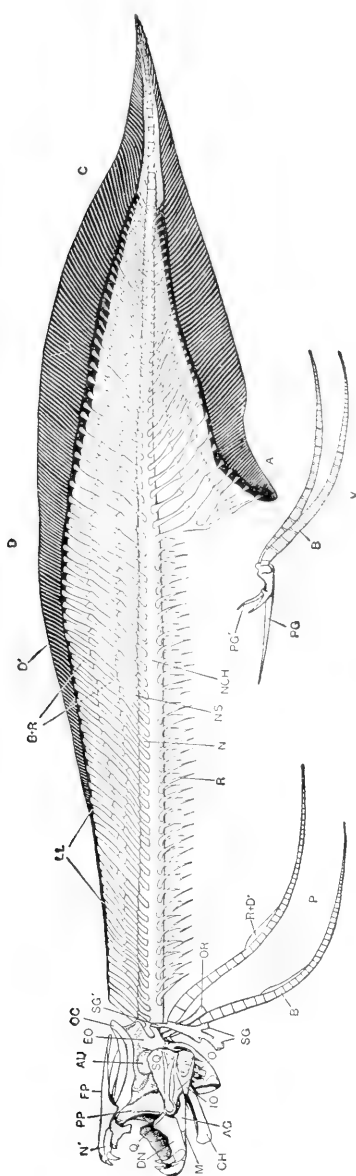

FIG. 205.

Skeleton of *Protopterus annectens*, Owen. (After A. Graf, from Deane, *Fishes, Fossils and Fossils*.) A, anal region of median ventral fin; AG, angular; AU, auditory capsule; B, basal or axial cartilage; B+R, median radials; C, caudal region; D, dorsal region of median dorsal fin; CH, ceratohyal; D', deutery; EO, epidural; E+P, frontoparietal; E', epidural; E+P', frontoparietal; FC, frontoparietal; M, Meckel's cartilage; N, neural arch; N', nasal; NS, neural spine; NCH, neural cartilage; PG, pelvic girdle; P, pectoral fin; P+G, pelvic girdle; P+G', pelvic girdle; P', pectoral fin; P+G', pectoral girdle; R, pleural rib; R+D', web of fin supported by minute radials and dermal rays; S+G, pectoral girdle; S+G', scapular region; SG, squamosal; T, pelvic fin.

by Huxley as an exoccipital, the only endochondral ossification in the skull of living Dipnoi, appears to represent the first of the

occipital neural arches, since it is placed between the hypoglossal and the first occipitospinal nerve (Fürbringer [141a]).

The chondrocranium, complete, thick, and without fontanelles in *Ceratodus* (Fig. 206), is less complete in the Dipneumones,

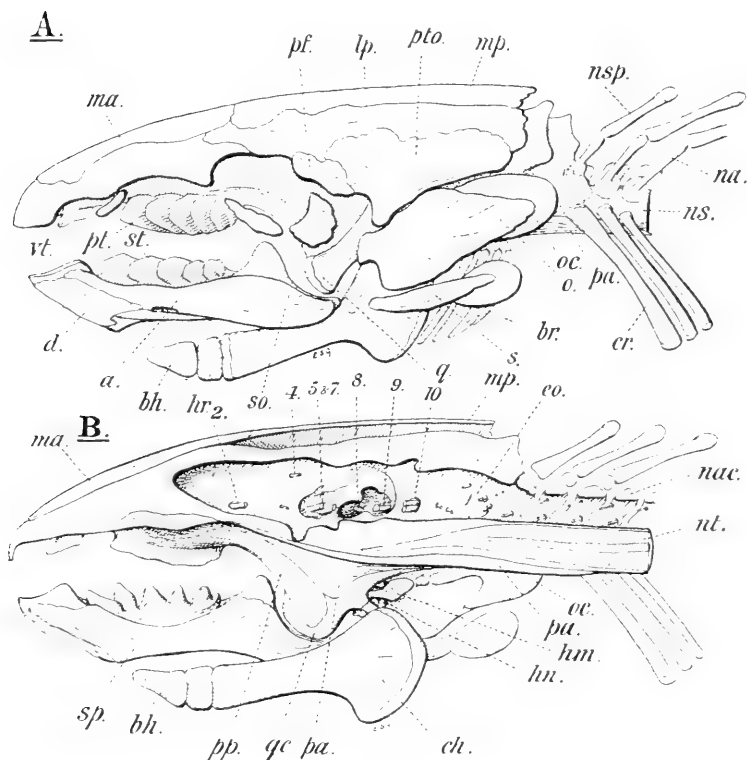

FIG. 206.

*Ceratodus Forsteri*, Kieft. A, outer view of left half; B, inner view of right half. *a*, angular; *bh*, basihyal; *br*, fifth branchial arch; *ch*, ceratohyal; *cr*, 'cranial rib'; *d*, dentary; *co*, 'exoccipital'; *hm*, hyomandibular; *hn*, hyomandibular nerve; *hr*, hypohyal; *l.p*, lateral plate; *m.a*, median anterior, and *m.p*, median posterior plate; *n.a*, neural arch; *n.a.c*, cartilage of neural arch; *n.s*, notochordal sheath; *n.sp*, neural spine; *nt*, notochord; *o*, opercular, and *oc*, its cartilage; *pa*, parasphenoid; *pf*, postfrontal; *pp*, pterygo-palatine; *pt*, palatine tooth; *pto*, pterotic (?); and *q*, its downward process covering the quadrate cartilage, *qc*; *s*, subopercular; *so*, suborbital; *sp*, splenial; *st*, splenial tooth; *vt*, vomerine tooth.

where the trabeculae remain recognisable, and the wall of the brain-case is to some extent formed by membrane bones above, below, and at the sides (Fig. 209). The cavity of the auditory capsule is widely open to the interior as in Teleostomes. Fenestrated cartilaginous nasal capsules are present; also separate nasal cartilages, at all events in *Ceratodus* (Fig. 207).

It is in the connection of the skull with the visceral arches that the Dipnoi have diverged most conspicuously from other fish. The

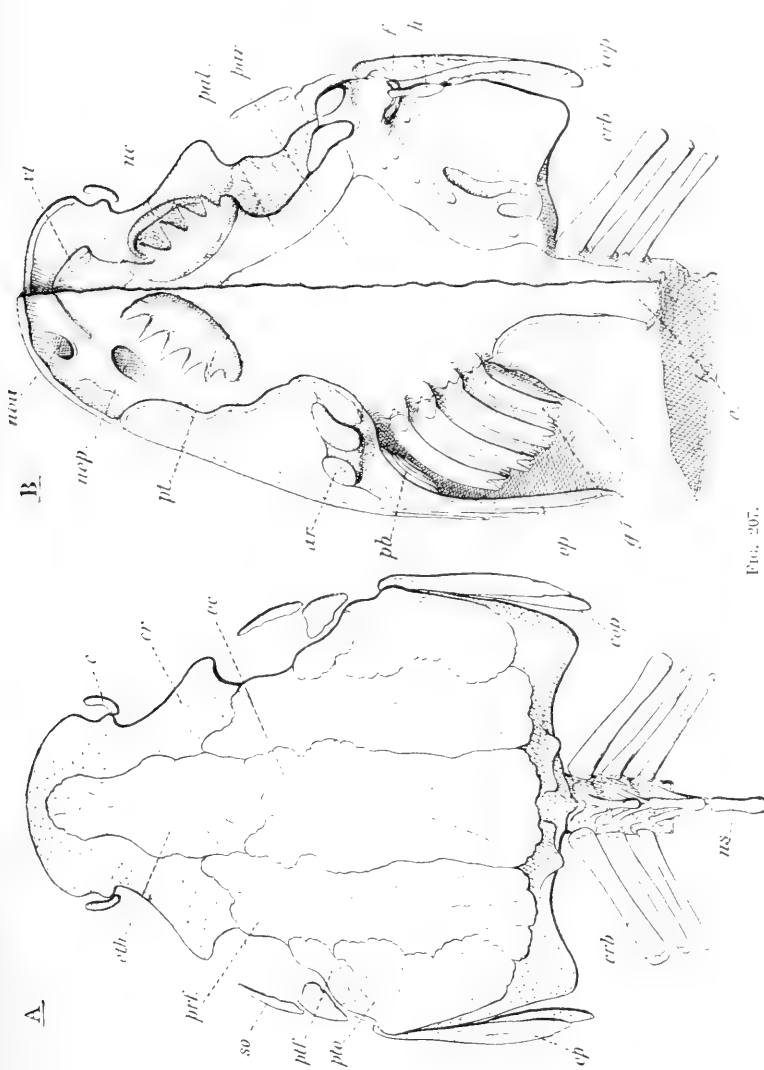

FIG. 207.

*Cretodus Fausstleri*, Krefft. A, dorsal view of the skull. B, ventral view of the head; on the left the lower jaw has been removed and the gills cut across, on the right the skeleton has been exposed. *at.*, articular facet of squamate; *cc.*, labial cartilage; *ccp.*, opercular cartilage (hyoid rays?); *ec.*, cartilaginous cranium; *erb.*, cranial rib; *eth.*, anterior median plate (ethmoid); *h.*, hyomandibular branch of facial nerve; *qi.*, fourth gill; *h.*, vestigial hyomandibular; *nc.*, nasal cartilage; *ncs.*, anterior nostril; *ncps.*, posterior lateral nostril; *ncs.*, neural spine; *os.*, oesophagus; *op.*, posterior median plate (occipital); *op.*, operculum; *pal.*, palatopterygoid bone; *pl.*, parasphenoid; *plb.*, pseudobranch; *plc.*, lateral plate (prefrontal); *plc.*, palatine tooth; *prf.*, postfrontal; *prf.*, pterotic; *so.*, suborbital; *us.*, vomerrine tooth.

modern genera are completely autostylic (p. 95). The pterygoquadrate bar is firmly fused to the cranium in front and behind. The spiracle disappears; and the hyoid arch is well developed, with a median basihyal, paired hypohyals, and large ossified ceratohyals

(Fig. 206). But the hyomandibular takes no share in the support of the jaws. It disappears, indeed, entirely in the Dipneumones, where the ceratohyals alone remain, and, as Huxley showed [230] (Ridewood [358], Sewertzoff [408]), is represented in *Ceratodus* by a minute vestigial cartilage, overlying the hyomandibular branch of the seventh nerve (Fig. 206). Of the structure of the hyoid and branchial arches in the fossil forms we know practically nothing, but there is no reason to think that it differed essentially from that of modern Dipnoi. Traquair has shown that *Dipterus* was autostylic [447]. The branchial arches in *Ceratodus* are fairly well developed with epibranchial elements, and even some pharyngobranchials; but in the Dipneumones they are reduced to mere unsegmented cartilaginous rods. On the other hand, a small cartilage in front of the first branchial slit led some observers (Wiedersheim [489], Bridge [56a]) to believe that there are six branchial arches in the Dipneumones, one gill-cleft having disappeared behind the hyoid arch. But the distribution of the nerves, blood-vessels, etc., does not support this view, and the cartilage rod appears to be a secondary development from the base of the gill-rakers (K. Fürbringer [141a]).

Among the chief characters of the dermal bones of the skull which distinguish modern Dipnoi from the more primitive early Osteichthyes, we may mention the sinking of the bones beneath the surface, leaving the sensory canals in the skin, the overgrowth of these bones by scales, and their reduction in number; the preponderance of large median elements, the loss of the nasals, premaxillae, and maxillae, and the great reduction or entire disappearance of the dentary; the correlated absence of teeth on the margin of the mouth; the presence of a pair of strong pterygo-palatine bones, bearing large compound palatine teeth; the development of corresponding large teeth below on the splenials; the absence of the ventral and lateral gular series, the small size of the opercular and subopercular, and the absence of a pineal foramen. So far have these Dipnoi departed from the normal type, that the homology of the cranial bones cannot yet be determined with certainty.

Passing backwards to the Devonian forms, we find skulls more nearly resembling those of the primitive Teleostomes. In the Phaneropleuridae (Fig. 208) are large paired frontals and parietals, meeting in the middle line, followed behind by a median occipital. The supraorbital sensory canal is carried by a row of plates, the prefrontal, supraorbitals, and postfrontal. It is continued backwards through two posterior bones, probably representing the squamosal (pteroic) and supratemporal. A chain of bones, enclosing the infraorbital canal, passes below the orbit from the post-

frontal behind to the prefrontal in front. The eye is surrounded by an inner ring of circumorbital bones. Two large ventral gular plates are present, but no lateral gulars. The operculum is supported by a large opercular and what is probably a subopercular. Unfortunately the cheek region is still incompletely known, and the course of the opercular sensory canal remains to be determined. In *Ctenodus* (Fig. 209) the paired frontals and parietals are smaller, and a median plate appears between them. This plate becomes larger in *Dipterus*, where the frontals and parietals are

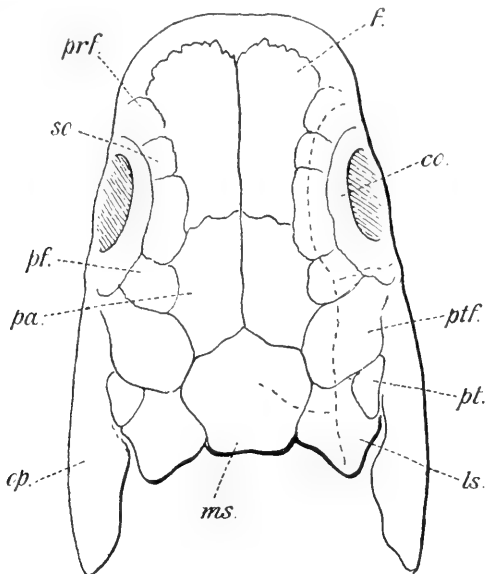

FIG. 208.

Restoration of the head of *Phaneropteron*. *co*, circumorbital; *f*, frontal; *ls*, pterotic(?); *ms*, median supratemporal (occipital); *op*, opercular; *pa*, parietal; *pf*, posterior supraorbital; *prf*, prefrontal; *pl*, small lateral plate; *ptf*, postfrontal; *so*, supraorbital. The course of the lateral-line canals is indicated by a dotted line on the right side.

smaller (Fig. 210). The superficial cranial bones of *Dipterus* become more numerous and often strangely irregular, suggesting a secondary subdivision of the lateral plates, somewhat as in the Sturgeons among the Actinopterygii. *Ceratodus* has diverged in a different direction (Figs. 206-7): the parietals and frontals are no longer recognisable as such; the anterior median bone (ethmoid) meets the large posterior occipital (fronto-parietal); the supra-orbital and lateral series of bones seem to be represented by two large 'lateral' plates (dermal-lateral ethmoid of Bridge), outside which lie the postfrontal and the 'squamosal.' The latter bone, with the 'lateral' and the occipital, forms a roof over the

jaw muscles. Now this 'squamosal' is generally likened to that of the Amphibia, to which it bears a remarkable resemblance. Since, in *Ceratodus sturii* (Teller [433]), it harbours the postorbital sensory canal, it is probably the homologue of the pterotic (squamosal) of the hyostylic fishes. As it spreads downwards over the quadrate it appears to be a prespiracular bone, and therefore can hardly represent, as has been suggested, the preopercular of other Osteichthyes. For, in these, the hyomandibular sensory canal, supplied by the post-spiracular hyomandibular branch of the seventh nerve, is lodged in the preopercular. In fact, a true preopercular has never

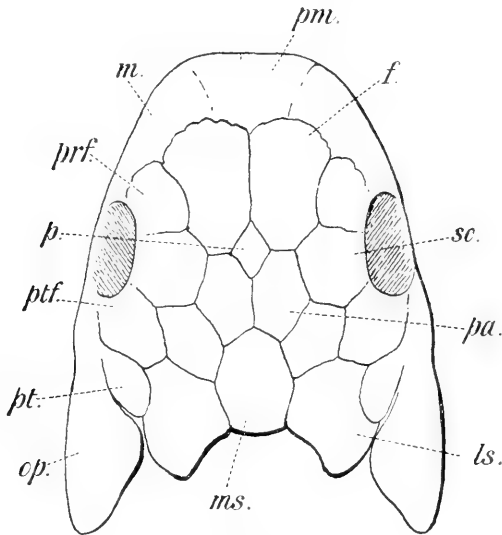

FIG. 209.

Restoration of the head of *Ctenodus*. *m.*, maxilla; *pm.*, premaxilla; *p.*, median plate; other letters as in Fig. 208.

been shown to exist in the Dipnoi. The two opercular bones are small, but retain on their inner surface small cartilages, which appear to be remnants of branchial rays of the hyoid arch. Branchial rays, however, are not found on the gill-arches of modern Dipnoi (Fig. 97).

The Dipneumones differ from *Ceratodus* chiefly in the further modification of the dermal bones. The postorbitals and suborbitals are gone. The 'ethmoid' remains in front, and a large median bone lying on the chondrocranium, and partly below the muscles, probably represents the occipital. The 'laterals' project freely behind over the muscles (Fig. 211). It is obvious that the cranial bones of the modern Dipnoi are in a very specialised condition.

The nostrils in all Dipnoi are on the ventral surface of the snout. There are separate anterior or external nares leading into the nasal chambers, and posterior or internal nares opening from these into the mouth (Fig. 207). These separate openings are formed in the embryo by the arching over of the nasal grooves, and are doubtless correlated with the air-breathing function of the oesophageal bladder.

In the Devonian forms the nostrils are in the same position, and the blunt snout is covered dorsally by a bony shield, probably

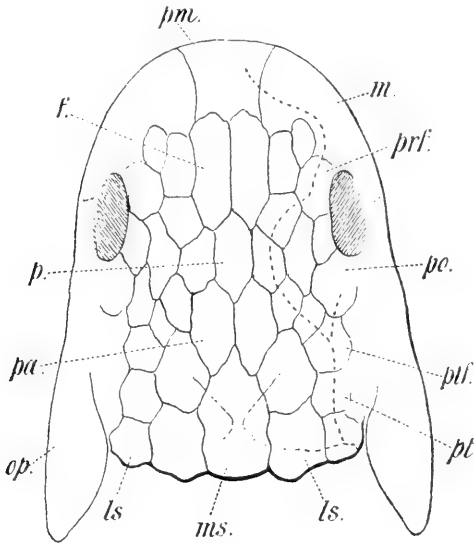

FIG. 210.

Restoration of the head of *Dipterus*. *m*, maxilla; *pm*, premaxilla; *p*, median plate; the other letters as in Fig. 208.

representing the fused premaxilla and maxilla, with, perhaps, the nasals as well. In modern Dipnoi these bones have disappeared.

The palate is characteristically simple and very uniform in structure. A large expanded parasphenoid is flanked on both sides by a pterygo-palatine bone, bearing in front a large grinding tooth. Two much smaller and simpler 'vomerine' teeth are generally situated in front (Figs. 207, 210A). These tooth-plates are developed in the embryo from rows of separate denticles which become fused together by their bony bases (representing the palatine and vomer) (Fig. 210B).

In the lower jaw Meckel's cartilage persists, covered by an angular behind, and by a large toothed splenial internally. The dentary has disappeared in the Dipneumones, is vestigial in *Ceratodus*,

but larger in the early fossils (Figs. 206-7, 225). The jaws of the Dipnoi have undergone profound modification in connection with the development of the great compound tooth-plates.

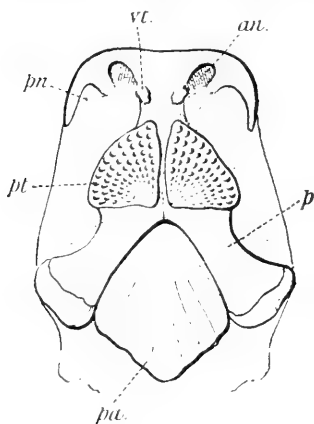

FIG. 210A.

Ventral view of the palate of *Dipterus* restored. *a.n.*, anterior nostril; *p.*, palato-ptyergoid bone; *p.s.*, parasphenoid; *p.n.*, posterior nostril; *p.t.*, palatine tooth; *v.t.*, vomerine tooth.

Correlated with this are the complete fusion of the pterygo-quadrate bar in front and behind with the skull, the reduction of the hyo-mandibular and of the marginal teeth and bones of the jaws, and the growth of the splenial and pterygoid bones. It can scarcely be doubted that the Dipnoi have been derived in remote pre-Devonian times from ancestors possessing a more normal palatal dentition, marginal teeth and bones, a detached quadrate, and a hyo-mandibular of moderate size.

The two halves of the simple cartilaginous pectoral girdle fuse in the middle line in *Ceratodus* (Fig. 212). In this and other primitive Dipnoi there are paired ventral clavicles overlying the coracoid region, and paired cleithra

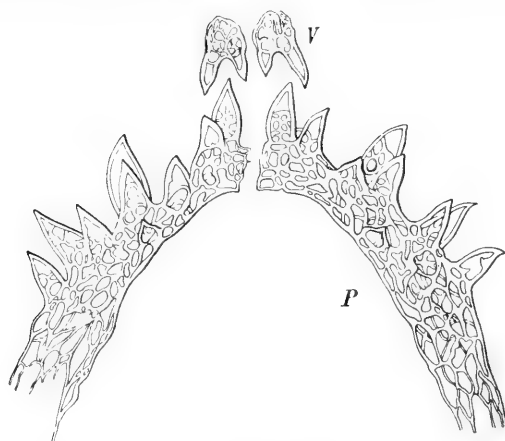

FIG. 210B.

Upper dentition of a young *Ceratodus Forsteri*. (After Semon, from Gegenbaur, *Vergl. Anat.*) *V*, vomerine plate; *P*, palatine plate. The denticles are joined at their base by a delicate bony network.

over the scapular region. The cleithrum is connected with the skull by a post-temporal. In the Dipneumones the shoulder-girdle



is reduced; the post-temporal is vestigial, and suspended in a ligament; a very small cleithrum surmounts the clavicle, and the

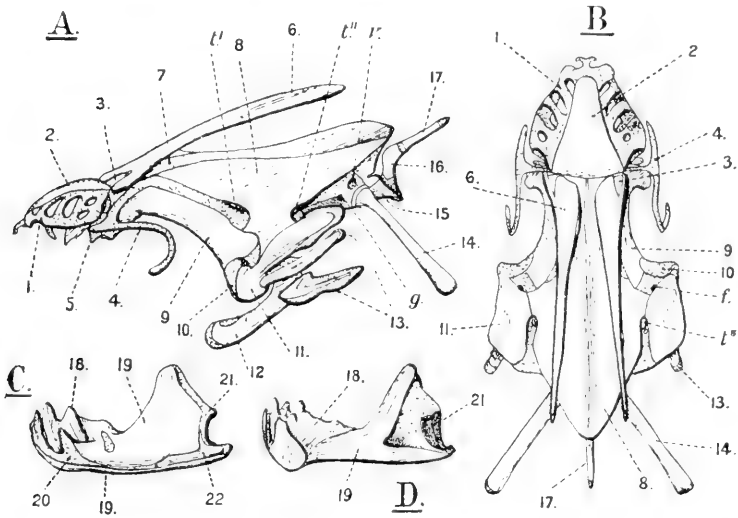

FIG. 211.

*Lepidosiren paradoxa*, Fitz. (After Bridge.) A, left-side view, and B, dorsal view of the skull. C, outer view of the left, and D, inner view of the right ramus of the lower jaw. 1, nasal capsule; 2, ethmoid; 3 and 7, process of pterygo-palatine; 4, antorbital cartilage; 5, palatine tooth; 6, lateral (dermal lateral ethmoid); 8, occipital (fronto-parietal); 9, pterygo-palatine; 10, quadrate; 11, squamosal; 12, ceratohyal; 13, subopercular and opercular; 14, cranial rib; 15, parasphenoid; 16, neural arch; 17, neural spine; 18, splenial tooth; 19, splenial; 20, Meckel's cartilage; 21, articular cartilage; 22, angular; *f*, foramen for facial, *g*, for glossopharyngeal, *t*, for trigeminal, and *c*, for vagus nerve.

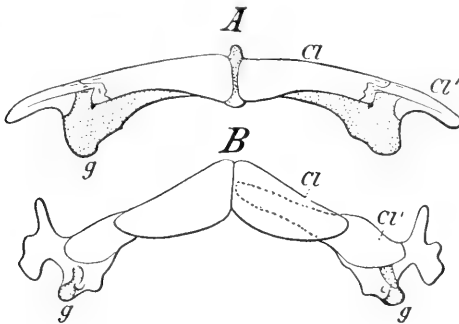

FIG. 212.

Pectoral girdle of A, *Ceratodus*; B, *Polypterus*. Ventral view. (From Gegenbaur, *Vergl. Anat.*) *cl*, clavicle; *cl'*, cleithrum; *g*, articular facet for fin-skeleton.

cartilage is subdivided into a ventral median piece, and two more dorsal pieces supporting the fins.

The pelvic girdle, unossified and known only in living genera, is remarkably amphibian. It consists of a median ischio-pubic cartilage. There are paired lateral or prepubic processes, and a large median epipubic process (Fig. 213).

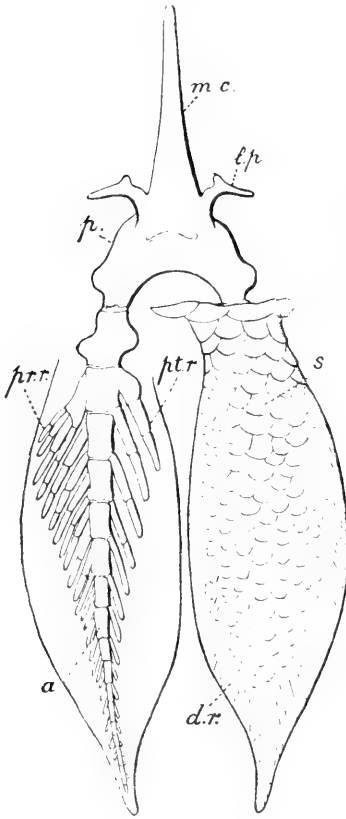

FIG. 213.

Ventral view of the pelvic girdle and fins of *Ceratodus Forsteri*, Kr. The skeleton of the right fin is completely exposed. *a*, jointed axis; *d.r.*, dermal rays; *l.p.*, lateral process; *m.c.*, median process; *p.*, pelvic cartilage; *p.r.*, postaxial radials; *p.r.r.*, preaxial radials; *s.*, scaly covering of axial region. (Partly after Davidoff, from *Quart. Journ. Micr. Sci.*)

The fin-skeleton has already been mentioned (p. 106). In *Ceratodus* both the pectoral and the pelvic fins are leaf-shaped, covered with scales, and with dermal rays set all round both along the preaxial and the postaxial edges. They are provided with a tapering segmented median skeletal axis (Fig. 213). The first segment articulates proximally with the girdle and distally with the second segment by means of a true joint. In *C. sturi* it was ossified. From the second outwards some twenty segments bear preaxial and postaxial radials, of which the latter are the smallest and most numerous. When at rest the preaxial margin of the pectoral fin is borne upwards; the reverse is the case with the pelvic fin. *Lepidosiren* and *Protopterus* have much reduced filamentous paired fins, with a slender jointed cartilaginous axis. The former has lost all trace of lateral radials; but small preaxial radials remain in *Protopterus* (Fig. 205).

The fin-skeleton is entirely cartilaginous in living Dipnoi, and scarcely any traces of it remain in any known fossils. Since, however, these have all lobate fins like those of *Ceratodus*, there can be hardly any doubt, judging from the scale-covered axial region, the dermal rays, and what remains of the axis in some fossils, that the endoskeleton in the extinct Dipnoi was of essentially similar character. It may safely be assumed that the early forms had typical rachiostichous and mesorachic paired fins.

The brain deserves particular notice : few organs in the Dipnoi so clearly show the isolation of this sub-class from other fish. On the whole, the brain is primitive in structure ; it lacks the special characteristics of the Elasmobranch or of the Teleostome ; so far as it is distinctly advanced, it approximates to the Amphibian type (Beauregard [35], Burckhardt [69], Bing and Burckhardt [73]). The brain is long and narrow, and has large ventricles. A large and simple medulla is followed by a very small cerebellum (Figs. 214-15). The mid-brain is long and fully exposed ; the optic lobes are fused in *Protopterus*. There is a velum transversum. Most remarkable are large paired cerebral prolongations projecting far beyond the lamina terminalis. These 'hemispheres' are separate, and in the Dipneumones have thickened nervous walls above and at the sides as well as below (Fig. 281) ; in *Ceratodus*, however, which has a less developed and perhaps somewhat degenerate brain, the roof of the prosencephalon is epithelial, like that of the greater part of the brain. In the Dipneumones the relatively small olfactory lobes are attached in front to the cerebral hemispheres ; but the rhinencephalon of *Ceratodus* is drawn out into a tract expanding into a large hollow olfactory bulb near the nasal capsule. The ganglion cells are stratified in the fore-brain.

The dentition is most characteristic. The dental plates, already described, are firmly fused to the underlying bones, and not replaceable. They are composed of thick dentine, round numerous tubular and often branching pulp-cavities. The grinding surface, in modern forms, is provided with high radiating ridges. These ridges are really formed in the embryo by the growth and fusion of originally distinct small conical teeth (Fig. 210A, Semon [401], Fig. 210B). All external trace of their

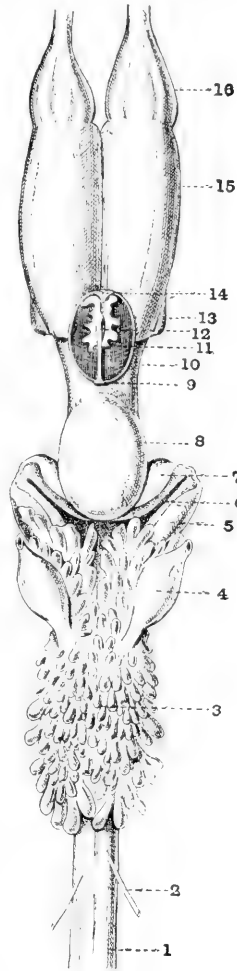

FIG. 214.

Dorsal view of the brain of *Protopterus annectens*, Owen. (After Burckhardt, from Sedgwick's *Zoology*.) 1, spinal cord ; 2, dorsal root of first spinal nerve ; 3, diverticula of 4, the saccus endolymphaticus ; 5, medulla oblongata ; 6, fourth ventricle ; 7, cerebellum ; 8, mesencephalon (fused optic lobes) ; 9, stalk of pineal body ; 10, thalamencephalon ; 11, velum transversum ; 12, pineal body ; 13, lobus hippocampi ; 14, choroid plexus ; 15, cerebral hemisphere (prosencephalon) ; 16, olfactory lobe.

compound nature is lost in recent Dipnoi; but in the early fossils the ridges are set with conical tubercles (Fig. 210A); and in

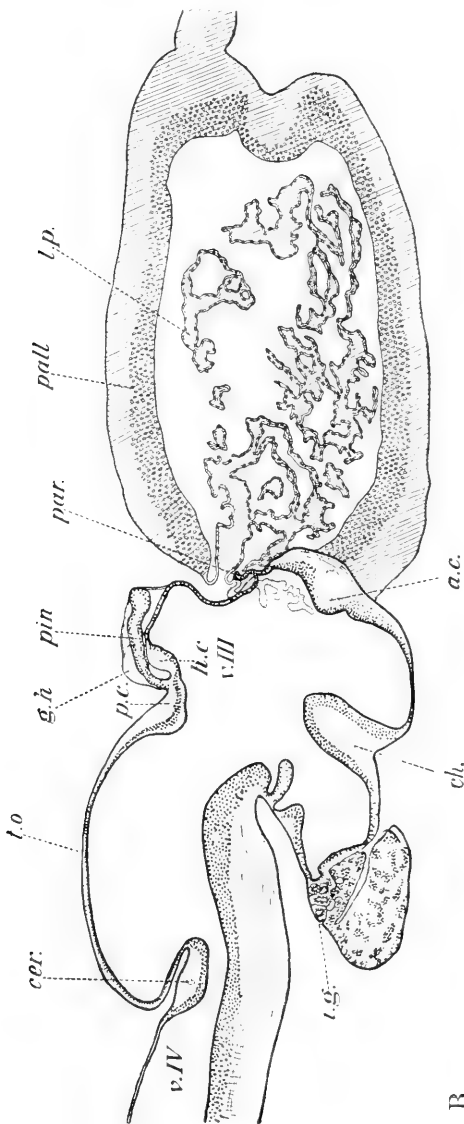

FIG. 215.

Longitudinal section of the middle region of the brain of *Lepidosiren paraguayana*, and also through the left cerebral hemisphere. (From Kerr, Budgett Mem. Vol.) a.c., anterior commissure; cer., cerebellum; ch., optic chiasma; d.s., dorsal sac; g.h., habenular ganglion; h.c., habenular commissure; l.o., infundibular gland; l.p., lateral plexus; pall., pallidum of cerebral hemisphere; par., paraphysis; p.c., posterior commissure; pin., pineal body; s.v., sacrus vasculosus; t.o., tectum opticum; v.III, third ventricle; v.IV, fourth ventricle.

some, such as *Uronemus* and perhaps *Conchopoma* (Traquair [458]), the separate conical teeth are not fused even in the adult. Much

smaller compound vomerine teeth are set on the ethmoid cartilage in front. They probably drop off in fossils, where they have never actually been found.

The pharynx leads into an oesophagus, stomach, and straight intestine, fastened by an incomplete ventral as well as dorsal mesentery. A well-developed spiral valve is present (Günther [190], Parker [324], Hyrtl [232]). The cloaca receives the anal, genital, and urinary openings. Paired abdominal pores are present.

*Ceratodus* has five open branchial slits. The first, behind the hyoid arch, has a hyoidean hemibranch. It is a pseudobranch supplied indirectly from the first epibranchial artery (Spencer [413],

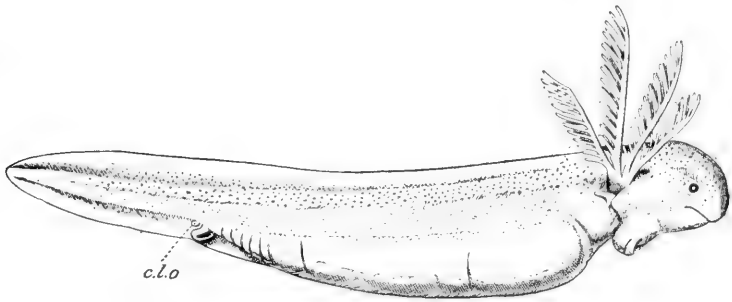

FIG. 216.

Larva of *Lepidosiren pycnanota*, Nat. (After Kerr, from Sedgwick's *Zoology*.) *c.l.o.* cloacal opening; four external gills are shown, also the rudiments of the paired limbs, and the adhesive organ below the head.

Kellicott [257]). The following four arches bear complete gills (Figs. 207 and 220).

*Protopterus* has also five open clefts, with a hyoidean hemibranch, two complete gills on the third and fourth arches only, and a few gill-lamellae (an anterior hemibranch) on the fifth arch (Fig. 221). Only four open gill-clefts remain in the adult *Lepidosiren*, where the hyobranchial slit is closed.

Larval gills are present in all recent Dipnoi; in *Protopterus* and *Lepidosiren* (Kerr [259], Budgett [67*a*], Semon [399]) they extend freely to the exterior as branching processes from several gill-arches (Fig. 216). In the former genus they may remain outside the operculum in the adult (Fig. 221), and are supplied with afferent and efferent vessels from the last three aortic arches.

The complete gill-arches show in section (Fig. 57) a broad septum beyond which the lamellae project a little. There are a single afferent and two efferent vessels; but there is reason to believe that the latter are not strictly comparable to those of Elasmobranchs. Alone among the Osteichthyes, the Dipnoi have

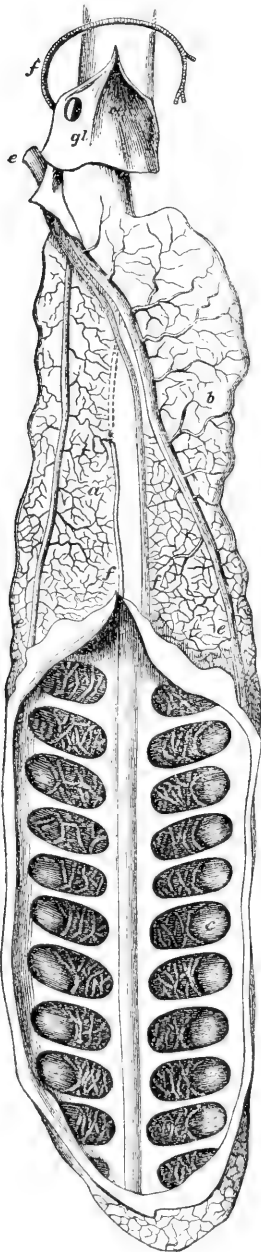

FIG. 217.

Air-bladder of *Centrodorus foveolatus*, Kr. Opened at its hind-end to show its cellular structure. *a*, right, and *b*, left side of bladder; *e*, cellular pouch; *c*, pulmonary artery; *d*, pulmonary vein; *gl*, glottis exposed by opening the oesophagus, *w*. (After Günther.)

no branchial rays on the branchial arches. Gill-rakers with cartilaginous supports are present.

An opercular fold from the hyoid arch completely covers the gill-clefts; and in the Dipneumones the external opening is narrowed down to a small aperture.

As the importance of the gills diminishes that of the air-bladder increases. As described above (p. 223), it is morphologically ventral, arising as a median ventral outgrowth of the oesophagus (Fig. 217). While the muscular glottis remains ventral, the posterior saccular dilatation shifts round to a dorsal position. It is highly vascular and functions as a lung (Günther [190], Spencer [413]), the deeply folded inner wall being cellular in structure.

The vascular system is of great interest, showing many points of resemblance to that of the Amphibia as well as primitive characters (Owen [311], Lankester [277], Boas [38], Spencer [413], Parker [324], Kellicott [257], Röse [373]). The heart, unlike that of other fish, is in a thin-walled pericardium. It is completely twisted, so that the sinus venosus lies dorsal to the atrium which passes in front of the conical ventricle (Figs. 218-19). The sinus receives all the venous systemic blood from the two ductus Cuvieri, the vena cava posterior, and the hepatic veins. But the pulmonary vein, coming

from the air-bladder, passes right through the sinus venosus to the left side of the atrium, and discharges the arterial blood almost straight into the ventricle. This incipient division of

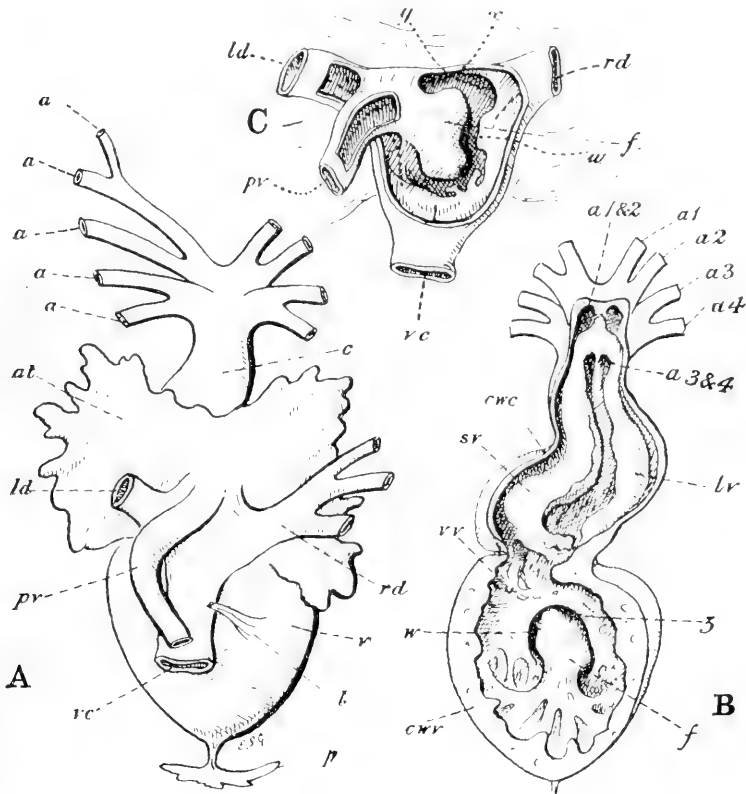

FIG. 218.

Heart of *Protopterus annectens*, Owen. A, dorsal view. B, opened, ventral view. C, the sinus venosus opened. *a*, cut arterial arches; *a* 1 and 2, entrance from conus to first two arches; *a* 3 and 4, entrance to last two arches; *at*, atrium; *c*, conus arteriosus; *c.w.c*, cut wall of conus; *c.v.v*, cut wall of ventricle; *f*, fibrous plug closing the passage from ventricle to atrium and passing into the sinus; *l*, dorsal attachment to pericardial wall; *l.d*, left ductus Cuvieri; *lv*, longitudinal ridge; *p*, small portion of pericardial wall; *p.v*, pulmonary vein; *r.d*, right ductus Cuvieri; *sv*, longitudinal compound valve; *v*, ventricle; *v.c*, vena cava inferior; *w*, dotted line indicating course of venous blood from the shallow sinus venosus, through the atrium (C) into the ventricle on the right of the plug (B). In C the dotted lines *ld*, *rd*, and *vc* pass into the sinus venosus; the lines *x* and *y* into the cavity of the atrium opening widely into the sinus; the line *p.v* passes down the pulmonary vein to enter the ventricle on the left of the plug (Z in B).

the heart into a venous and an arterial channel is continued in the atrium, where an incomplete interauricular wall is developed as a thick projecting plug, and is even carried on into the ventricle. Of the four main longitudinal rows of valves found in the spirally

twisted conus of *Ceratodus*, one is so enlarged as to longitudinally divide the cavity into two channels. In the Dipneumones, and especially in *Lepidosiren*, where this subdivision of the cavities of the heart is more completely carried out, these valves fuse to a longitudinal fold. The pulmonary blood entering the left side of the atrium is thus borne forward to the first two aortic arches, and the venous blood to the last two (Figs. 218, 221).

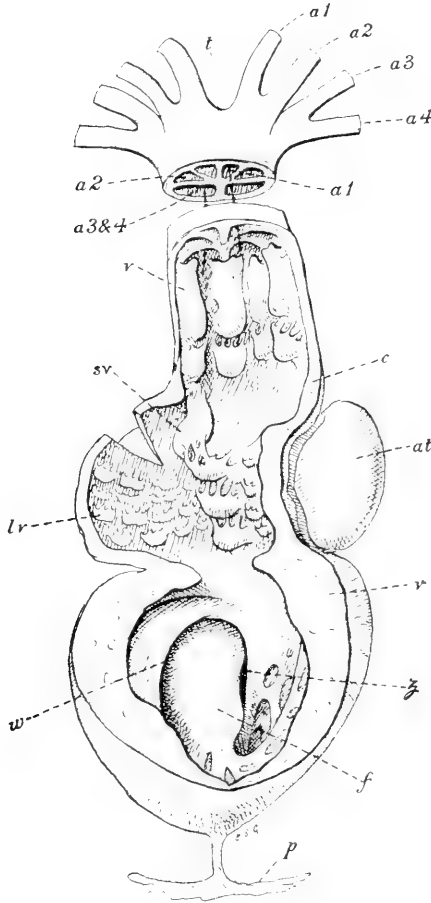

FIG. 219.

*Ceratodus Forsteri*, Krefft. Ventral view of the heart dissected so as to expose the inside of the ventricle and conus, and the disposition of the aortic arches.  $a^{1-4}$ , four aortic arches, a dotted line passes up the base of the 1st and combined 3rd and 4th; at, atrium; c, cut wall of conus; f, plug filling the atrio-ventricular opening; lr, small posterior valves; p, portion of wall of pericardium; s.c, specialised row of enlarged valves; t, truncus; v, anterior valve, also cut wall of ventricle; w and z, dotted lines passing into the sinus venosus. (Compare Fig. 218, p. 249.)

From the truncus arteriosus, the short remnant of the ventral aorta, spring four pairs of afferent branchial vessels, passing up the first four branchial arches. Four corresponding pairs of epi-branchial arteries are formed by the junction of two efferent vessels in each arch in *Ceratodus* (Fig. 220). They join the dorsal aorta. From the posterior epibranchial, the sixth aortic arch, counting the mandibular as the first, is given off a pulmonary artery to the air-bladder. The presence of two efferent vessels in each branchial bar in both the Dipnoi and the Selachii is probably of no phylogenetic significance; in the relation of the epibranchial

arches to the bars the Dipnoi are the more normal (p. 111). On the other hand, the reduction of the ventral aorta, the gathering



together of the epibranchial vessels to form the dorsal aorta, the

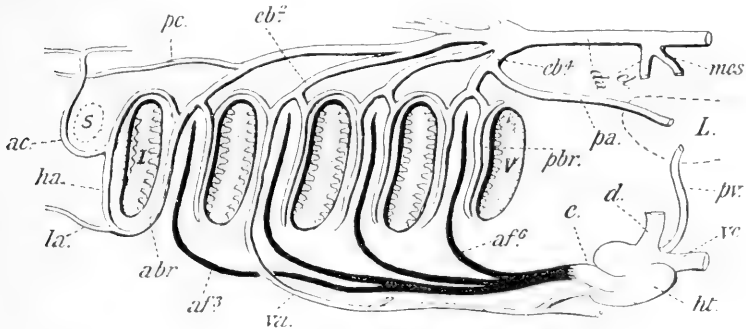

FIG. 220.

Branchial circulation of *Ceratodus* (from Spencer's figures). I-V, five branchial slits; *abr*, anterior efferent vessel; *a.e.*, anterior carotid; *af*<sup>1-6</sup>, four afferent vessels (corresponding to the original arches<sup>4-6</sup>); *c.*, conus; *cl.*, coeliac artery; *d.*, ductus Cuvieri; *cb*<sup>2-4</sup>, second and fourth epibranchial arteries; *h.a.*, hyoid artery (from original 2nd arch); *L.*, air-bladder; *l.a.*, lingual artery; *mes.*, mesenteric artery; *p.a.*, pulmonary artery; *pbr.*, posterior efferent vessel; *p.c.*, posterior cardinal; *p.v.*, pulmonary vein; *s.*, position of closed spiracle; *v.a.*, ventral artery; *v.c.*, vena cava inferior. The gills are represented on the hyoid and next 4 branchial arches.

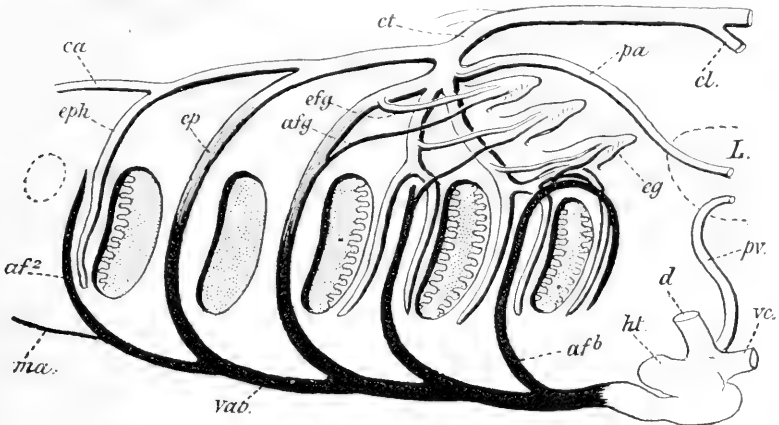

FIG. 221.

Branchial circulation of *Protopterus* (from Parker's figures). *af*<sup>2-6</sup>, afferent branchial arteries; *af.g.*, afferent vessel to external gill; *ca.*, carotid; *cl.*, coeliac artery; *c.t.*, left branch of dorsal aorta formed by junction of branchial efferent vessels; *d.*, ductus Cuvieri; *ef.g.*, efferent vessel of external gill; *e.g.*, external gill; *ep.*, epibranchial region of arterial arch of first gill-less branchial arch; *ep.h.*, epibranchial vessel of hyoid arch; *ht.*, heart; *L.*, lung; *m.a.*, median artery; *p.a.*, pulmonary artery; *p.v.*, pulmonary vein; *v.a.*, ventral aorta; *v.c.*, vena cava posterior. The five branchial slits are shaded; the first two branchial arches are without gills. A dotted line indicates the position of the obliterated spiracle.

structure of the conus, and the position of the auricles, are features in which they distinctly approach the Amphibia.

The aortic arches of the first two gill-less branchial bars of the

Dipneumones pass directly, without breaking up into capillaries, to the aorta, as in terrestrial vertebrates. In *Ceratodus*, but not in the

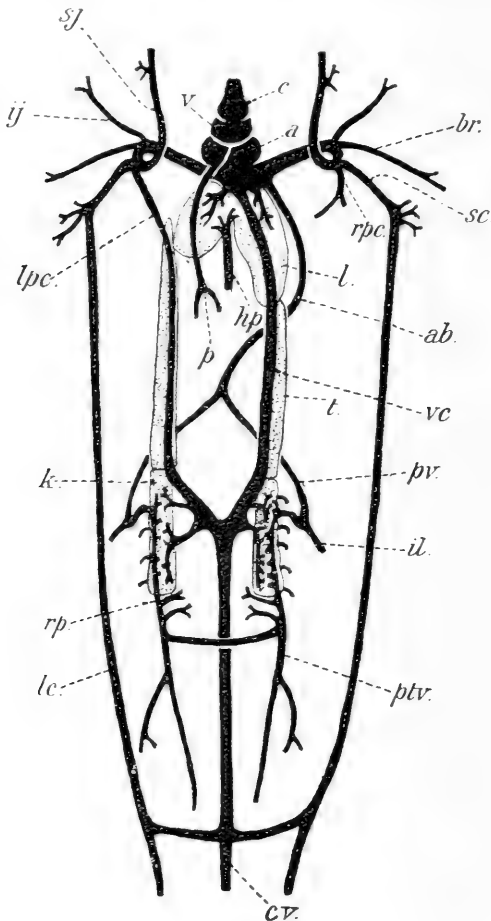

FIG. 222.

Diagram of the venous system of *Ceratodus Forsteri*, dorsal view. (After Spencer.) *a*, atrium; *ab*, anterior abdominal vein; *br*, branchial vein; *c*, conus; *c.v.*, caudal vein; *h.p.*, hepatic portal vein; *l.j.*, inferior jugular vein; *il*, iliac vein; *k*, kidney; *l*, liver; *l.c.*, lateral cutaneous vein; *l.p.c.*, left posterior cardinal; *p*, pulmonary vein; *p.v.*, posterior vein from body-wall; *p.v.*, pelvic vein; *r.p.*, renal portal vein; *r.p.c.*, right posterior cardinal; *sc*, subclavian vein; *s.j.*, jugular vein; *t*, testis; *v*, ventricle; *v.c.*, vena cava.

Dipneumones, the hyoidean hemibranch is a pseudobranch, receiving blood only from the efferent system (Spencer, Parker, Figs 220-21).

Three chief points of interest are found in the venous system (Figs. 222-4). Firstly, the pulmonary blood is returned directly to the heart by a vein passing to the left side of the sinus venosus, as

mentioned above. Secondly, the right posterior cardinal is interrupted in front, and contributes to the formation of a posterior vena cava, carrying blood from the caudal vein and kidney directly to the sinus venosus. Thirdly, in *Ceratodus* at all events, an anterior abdominal vein opens into the right ductus Cuvieri; it is formed by the junction of two pelvic veins, themselves derived from iliac and renal portal veins. This epigastric, or anterior abdominal vein, so amphibian in appearance, is probably homologous with the lateral veins of Elasmobranchs.

The kidneys, the gonads, and their ducts differ but little in *Ceratodus* from those of other primitive fish, such as the Elasmobranchs (Günther [190], Semon [402-3], Kerr [260-61], Parker [324]). An elongated mesonephros, which loses its coelomic funnels in the adult, pours its secretion into a duct opening into a median cloacal caecum. The caecum, derived from the fused bases of the ducts, is placed above the rectum. Long oviducts, in the female, having open funnels in the front region of the abdominal cavity, pass back to open into the cloaca (Fig. 355).

In the male *Ceratodus* the semen is carried by numerous vasa efferentia into the kidney, passes through certain of the renal capsules and tubules to the mesonephric duct, and thereby reaches the cloaca (Fig. 356).

*Lepidosiren* is more specialised in that the vasa efferentia are few in number, arise from a sterile tubular posterior portion of the testis, and pass into the posterior region of the kidney. Finally, in *Protopterus* one vas efferens alone remains on each side, leading into the modified tubular region of the kidneys, which meet in the middle line. The Müllerian ducts persist to a great extent in the adult male Dipnoi, opening independently into the cloaca. The eggs,

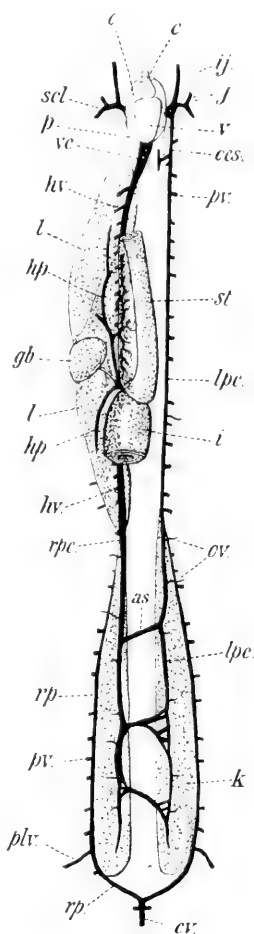

FIG. 223.

Diagram of the venous system of *Protopterus annectens*, Owen, ventral view. (After W. N. Parker.) *as*, anastomosis between posterior cardinals; *c*, conus; *c.v.*, caudal vein; *g.b.*, gall-bladder; *h.p.*, hepatic portal vein; *h.v.*, hepatic vein; *i*, intestine; *i.j.*, inferior jugular vein; *j.*, jugular vein; *k*, kidney; *l*, liver; *l.p.c.*, left posterior cardinal; *o*, otrium; *oes.*, oesophagus; *o.v.*, ovarian vein; *p*, pericardium; *p.v.*, parietal vein; *r.p.*, renal portal; *r.p.c.*, right posterior cardinal; *scl*, subclavian vein; *st*, stomach; *v.*, ventricle; *v.c.*, vena cava.

provided with a considerable amount of yolk, and surrounded by a gelatinous coat secreted by the oviduct, undergo total but unequal cleavage. The larvae, except in *Ceratodus*, have feathery external gills and a ventral sucker of attachment below the head (Fig. 216).

The structure of the Dipnoi may be summarised as follows:—As primitive characters: the spiral valve, the contractile conus, the cloaca, the unconstricted notochord, the ventral nostrils. As specialised

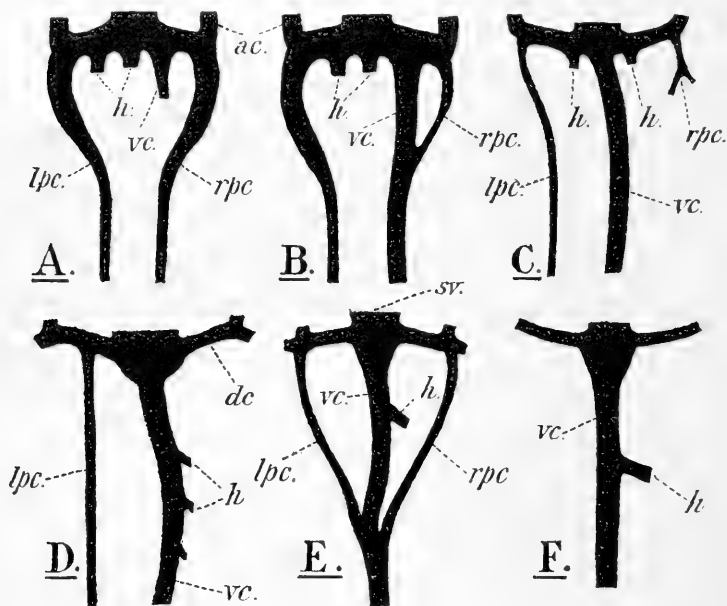

FIG. 224.

Diagrams illustrating the formation of the vena cava in the Dipnoi and Amphibia (after Kellicott). A, *Ceratodus*, early larva; B, *Ceratodus*, later stage; C, *Ceratodus*, adult; D, *Protopterus*; E, *Salamandra*; F, *Ranu*. a.c., anterior cardinal; d.c., ductus Cuvieri; h, hepatic veins; l.p.c., left, and r.p.c., right posterior cardinal; v.c., vena cava.

characters: the camptotrichia, the loss of the spiracle and pineal eyes, the reduction of the hyomandibular, the autostylism, the loss of the marginal jaw-bones and teeth, the permanent grinding plates formed from coalesced internal teeth, the median pelvic cartilage, the twisting of the air-bladder to a dorsal position, the special pulmonary circulation, the incipient vena cava inferior, the large paired cerebral hemispheres. It must be mentioned also that the scales are rounded, the notochordal sheath is invaded, the median fin-radials articulate with the axial skeleton, pleural ribs only are present, the paired fins have a jointed median axis, and the air-bladder has a ventral opening.

## TRIBE 1.

Family PHANEROPLEURIDAE. With a diphyccercal, or very slightly heterocercal tail. The anal fin is separate in *Phaneropleuron*, and in *Scaumenacia* there are two dorsal fins as well (Fig. 227). There are large paired parietals and frontals. The median cranial bones are little developed (Fig. 208). Two large inferior jugular plates are present. The scales are thin, with bone-cells, and are covered with spinelets as in *Ceratodus* (Fig. 201). The dermal fin-rays are strong and bony in this and the next two families. The teeth have tuberculated ridges (Huxley [227-8], Miall [299], Whiteaves [488], Jaekel [237], Traquair [459, 462]).

*Phaneropleuron*, Huxley; Upper Old Red Sandstone, Scotland; Devonian, Canada. *Scaumenacia*, Traquair; Devonian, Canada.

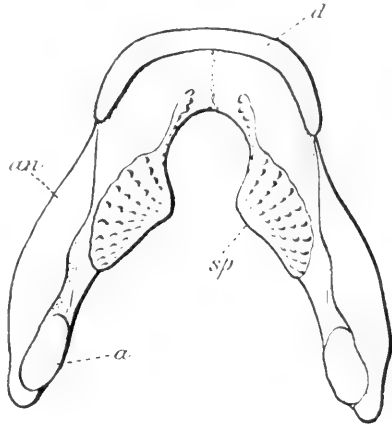

FIG. 225.

Dorsal view of the lower jaw of *Dipterus*. *a*, articular; *an*, angular; *d*, dentary; *sp*, splenial tooth on the splenial bone.

Family URONEMIDAE. The median fins are continuous, and the tail is diphyccercal (Fig. 227). The palatine and splenial groups of teeth are not fused into dentary plates. The cranial bones are numerous, and

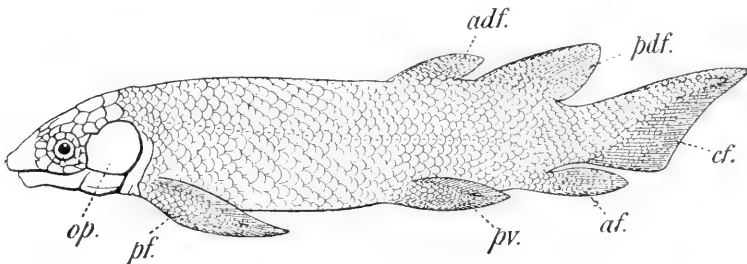

FIG. 226.

*Dipterus Valenciennesii*, Sedgw., restored. (After Traquair, slightly modified.) *a.d.f.*, anterior dorsal fin; *a.f.*, anal fin; *c.f.*, caudal fin; *op*, operculum; *p.f.*, pectoral fin; *p.v.*, pelvic fin.

disposed as in *Dipterus*; the presence of gular plates is doubtful. The scales are thin (Traquair [458]).

In the continuity of the median fins and the simple condition of the teeth these fossils are perhaps the most primitive Dipnoi known. In the

structure of the skull, with large median elements, they approach *Dipterus*.

*Uronemus*, Ag.; Carboniferous, Scotland. Probably also *Conchopoma*, Kner; Permian, Germany.

Family DIPTERIDAE. A heterocercal tail, and two dorsal and one anal fin (Fig. 226). The superficial cranial bones and the scales are thick, and covered with an outer layer of cosmine (Figs. 202, 210, 225). The head-plates are numerous, the median series large, and the parietals and frontals small. The ossification of the endoskeleton seems to be more complete than in modern Dipnoi; the auditory capsule, the quadrate, and

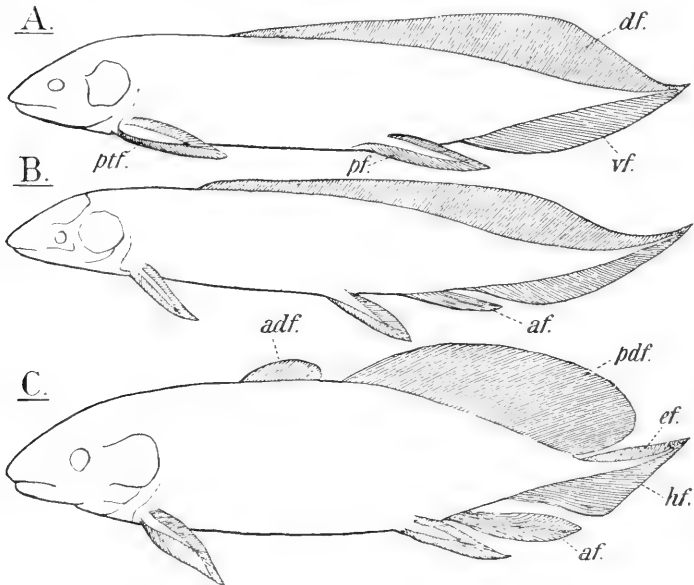

FIG. 227.

Restorations from Traquair of A, *Uronemus lobatus*, Ag., Lower Carboniferous; B, *Phaneropteron Andersoni*, Huxley, Upper Devonian; C, *Scaumenacia curta*, Whiteaves, Upper Devonian. *a.d.f.*, anterior dorsal fin; *a.f.*, anal fin; *d.f.*, dorsal fin; *ef.*, epichordal lobe, and *h.f.*, hypochordal lobe, of caudal fin; *p.d.f.*, posterior dorsal fin; *p.f.*, pelvic fin; *pt.f.*, pectoral fin; *v.f.*, ventral fin.

the articular are bony. Paired ventral gular plates are present. The teeth have tuberculated ridges [299, 312, 447, 505].

According to Dollo, *Dipterus* represent the most primitive Dipnoan type (see p. 233). The presence of typical cosmine is a striking point of resemblance with the Osteolepidoti. The more pronounced ossification may perhaps also be primitive. But the arrangement of the cranial covering bones points rather to the Dipterids being a highly specialised offshoot from the base of the Dipnoan stem.

*Dipterus*, Sedg. and Murch. *Conchodus*, M'Coy; Devonian, Europe. *Palaeodaphus*, v. Ben. and de Kon. *Ganorhynchus*, Traq.; Devonian, Europe, and N. America.

## TRIBE 2.

In the following three families the gular plates and the cosmine layer are lost; the dermal bones sink beneath the skin; in the living genera the lateral-line system is in the skin, the organs being quite superficial on the body, and sunk in canals only on certain regions of the head; the tail is diphycercal, and the median fins are continuous. They show progressive specialisation and degeneration, though probably not forming a true monophyletic series.

Family CTENODONTIDÆ. The covering bones of the skull resemble those of *Dipterus*; but the frontals and parietals are of considerable size,

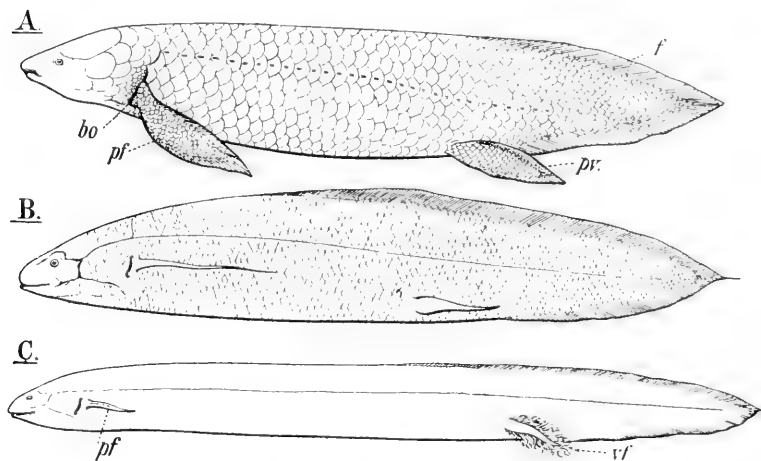

FIG. 228.

A, *Ceratodus Forsteri*, Krefft. B, *Protopterus annectens*, Owen (after Lankester). C, *Lepidosiren paradoxa*, Fitz. (after Lankester, modified). *b.o.*, branchial opening; *f.*, median fin; *pf.*, pectoral fin; *pv.*, pelvic fin; *vf.*, vascular villi present on the male.

and the anterior median plate is small (Fig. 209). The ridges of the teeth are set with tubercles.

*Ctenodus*, Ag.; Carboniferous, Europe and N. America. *Sagenodus*, Owen; Carboniferous, Europe.

Family CERATODIDÆ. The cranial bones are thin and much reduced in number. Two large median bones, 'ethmoid' and 'occipital' (p. 238), and two large paired 'lateral' bones, probably including the frontals and parietals, cover the head, and are themselves overlaid with scales. Circumorbital bones, postfrontals and 'squamosals,' complete the covering. The chondrocranium is thick, complete, and unossified (Figs. 206-7). The hyomandibular persists as a vestige; the hyoid and branchial arches are better developed than in the *Lepidosirenidae*. The gills are well developed, and the air-bladder or lung is a median sac.

The paired fins have an endoskeleton with biserial radials, and are covered with scales (Fig. 213). The ridges on the teeth have lost the tubercles.

*Ceratodus*, Ag. (Fig. 228) ; Triassic and Jurassic, Europe, N. America, Africa, Asia, Australia ; Cretaceous, C. Africa, Patagonia. *Ceratodus* (*Neoceratodus*), living in Queensland. *Gosfordia*, A. S. W. ; Triassic, N.S. Wales.

Family LEPIDOSIRENIDAE. The most specialised and degenerate of Dipnoi. The body becomes much elongated, especially in *Lepidosiren*, the scales are reduced in size, the naked filamentous paired limbs are vestigial (Fig. 228). The dermal fin-rays are soft, scarcely jointed, and with few cells.

The head is covered with soft, scale-bearing skin, and the dermal bones are deeply sunk, and still further reduced in number. Two large median bones cover the incomplete chondrocranium above ; two elongated lateral bones pass back from the orbits at the sides ; and two 'squamosals' cover the quadrates (Fig. 209). The dentaries and post-temporals are lost ; the opercular bones are very small. The branchial arches are much reduced, and all trace of the hyomandibular has gone.

As described above, the teeth, gills, heart, and male genital ducts are highly specialised. The lung-sac is bilobed. A remarkable growth of vascular filaments develops during the breeding season on the pelvic limbs of the male *Lepidosiren* (Fig. 228). They appear to function as accessory gills (Lankester [278], Kerr [259]).

*Lepidosiren*, Nath. ; South America ; *Protopterus*, Owen ; Tropical Africa.

*Affinities.*—It is clear that the early Dipnoi approach closely to the primitive Teleostomes in general structure. Moreover, in both them and the Osteolepidae we find similar lobate fins, large paired inferior gulars, a layer of typical cosmine, powerful palatine and splenial teeth, and a blunt snout with ventral nostrils. The Dipnoi are probably a specialised offshoot from the base of the Teleostome stem, which acquired an autostylic structure before the hyomandibular had become very large, and before the hyostylysm of the ancestor had become fully established. But such a pre-Devonian ancestral form must have differed so considerably from any known genus that it seems better for the present to keep the Dipnoi separate from the Teleostomi in our classification.

### Sub-Class 2. COCCOSTEOMORPHI (*Arthrodira*).

A group of heavily armoured Palaeozoic fish, which often attained a formidable size. The large broad head has the orbits placed very far forwards, and apparently two small nasal openings near the extremity of the blunt snout. The pineal eye is indicated by a foramen, or an internal depression, in a median cranial plate. Both the head and the anterior region of the trunk are covered with a shield of closely fitting or fused bony plates. Those on the trunk encircle it in a complete cuirass, which usually articulates with the cranial shield by means of a pair of elaborately differen-



tiated ginglymoid joints. The trunk tapers into a tail, quite or very nearly diphyercal. There is a single dorsal fin. Of pectoral fins there is no definite trace, and the pelvic fins are only known from rare remains of the endoskeleton. The body was apparently naked in most cases, though scattered tubercles have been found in *Selenosteus* (Dean [109]), and thin cycloid scales are stated to occur in Coccosteids (Jaekel [244]). The structure of the dermal bones is very like that of *Asterolepis*. They have, in the more primitive genera, a tuberculated surface; in others, such as *Titanichthys*, the ornamentation has gone, the bones having probably sunk below the skin. The dermal plates are formed of true bone with bone-cells, an internal lamellated layer, a middle vascular trabecular layer, and an external layer of denser substance. Neither typical ganoine nor cosmine, neither denticles nor even dermal fin-rays have been described. An elaborate and fairly normal system of lateral-line canals is indicated on the cranial shield by grooves; they extend on to the lateral, and even on to the ventral, regions of the body-cuirass. In the Anarthrodira (Dean [109]) the canals are sunk below the surface of the bones.

The endoskeleton is scarcely known except in *Coccosteus* (Fig. 232). The notochord appears to have been persistent and uncontracted; no remains of centra are found. There are no ribs, but well-developed haemal and neural arches are present. The dorsal fin is supported by a series of two-jointed radials attached to and corresponding with neural arches. A skeletal plate possibly belongs to an anal fin (Fig. 232). Two basal pieces, with traces of radials, seem to represent a pelvic girdle and pelvic fins. These endoskeletal structures are of calcified cartilage.

The dermal plates are best known in *Coccosteus* (Pander [312], Traquair [454, 457], A. S. Woodward [505]). An anterior ethmoid (rostral) between the nares is followed by a 'posterior ethmoid' or pineal plate. There is a large median occipital behind; paired 'preorbitals' (= prefrontals + frontals?) and 'centrals' (= parietals) cover the skull above; circumorbital plates surround the eye; 'postorbitals' (= postfrontals) and 'marginals' (= pterotics) cover the sides; 'external occipitals' (supratemporals) complete the shield behind (Fig. 229). Toothless premaxillae and maxillae (suborbitals) are found on the upper jaw; the latter expands behind to cover the cheek, and bears on its posterior edge a crescentic plate, which is supposed to have supported a movable operculum. As indicated above, these plates can, with more or less certainty, be homologised with the bones of more normal Osteichthyes.

The solid trunk-cuirass may represent a much-modified dermal pectoral girdle (Figs. 229, 229A). The ventral shield consists of four paired and two median plates, of which the anterior is compared to an interclavicle. In front are two elongated inter-lateral bones

(= clavicles ?); and at the sides are an anterior lateral (= cleithrum) and anterior and posterior dorso-laterals (= supra-clavicles ?). A median dorsal completes the arch above. It is the anterior dorso-lateral which articulates with the external occipital by the characteristic joint. On the whole, the arrangement of the dermal plates is very uniform throughout the sub-class. In some genera the outer end of the interlateral is produced into a prominent spike, which may be formed of a separate plate (*Phlyctaenaspis* [Traquair, 459],

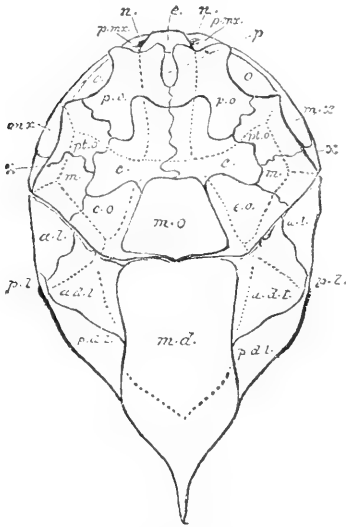

FIG. 220.

*Coccosteus dracipicus*, Ag.; restored. Cranial and dorsal shield, dorsal view. (After Traquair, from A. S. Woodward.) *a.d.l.*, anterior dorso-lateral; *a.l.*, anterior lateral; *c.*, central; *e.*, ethmoid; *e.o.*, external occipital; *m.*, marginal; *m.d.*, median dorsal; *m.o.*, median occipital; *m.s.*, maxillo-suborbital; *n.*, nostril; *o.*, orbit; *p.*, pineal; *p.d.l.*, posterior dorso-lateral; *p.l.*, posterior lateral; *p.m.x.*, premaxilla; *p.o.*, pterorbital; *p.o.*, postorbital; *o.*, opercular (?). Dotted lines indicate the course of the lateral-line canals.

*Brachydirus* [v. Koenen], *Pholidosteus* [Jaekel, 244]). These paired fixed or movable processes have been compared to the limbs of *Asterolepis* and the cornua of Cephalaspids (Figs. 230A and 231).

The jaws have no marginal teeth; but there are vomerine and palatine teeth supported by palatal bones above, and corresponding teeth on a bone of the lower jaw, which is probably the splenial (Figs. 232, 234). The Coccosteomorphi become greatly specialised in their dentition. The teeth, indeed, appear to have always been continuous with the supporting bone, and possibly are merely tooth-like processes. Whereas in *Coccosteus* the teeth are of normal conical shape, in *Titanichthys* they are developed into formidable piercing and cutting dental plates, formed merely of dense bone, not of dentine [80a].

If the description by Jaekel [242, 244] of an angular and an articular bone in the lower jaw be confirmed, all doubt will be set

aside as to whether the Coccosteomorphi are true Teleostomes (Fig. 230)—a conclusion which is further strengthened by his discovery of thin cycloid scales on the body.

For the view advocated by some authors (Newberry, A. S. Woodward, Eastman [128]) that the Coccosteomorphi are specialised Dipnoi, it must be confessed that there is no convincing evidence. One may note a general similarity in the disposition of the cranial bones, with large median plates; the structure of the tooth-bearing bones resembles that of the Dipnoi, and is consistent with the view

that the jaws were autostylic in their attachment, but such has not yet been proved to be the case. The only character in which the two groups resemble each other and diverge from other Osteichthyes is the dentition: the reduction of the marginal teeth, and the special development of vomerine, palatine, and splenial tooth-plates. In the Dipnoi, however, these plates are of true dentine (p. 245).

The Coccoosteomorphi so far known differ greatly from the Dipnoi in the absence of true bone in the endoskeleton, of dermal fin-rays, and of normal pectoral fins.

On the other hand, they have in common with the Pterichthymorphi, with which they were associated by the earlier observers (Agassiz, Hugh Miller, Zittel, Jaekel), the structure of the dermal plates, and the cuirass encircling the trunk. Its ventral shield especially is very like in both cases; and the lateral processes of

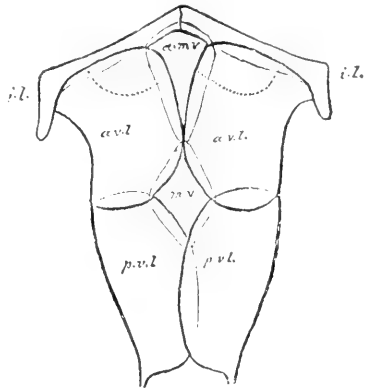

FIG. 229A.

*Coccosteus decipiens*, Ag. Ventral shield, restored. (After Traquair, from A. S. Woodward.) *a.m.v.*, anterior median ventral; *a.v.l.*, anterior ventro-lateral; *i.l.*, inter-lateral (clavicle?); *m.v.*, median ventral; *p.v.l.*, posterior ventro-lateral. Dotted lines indicate the course of lateral-line canals.

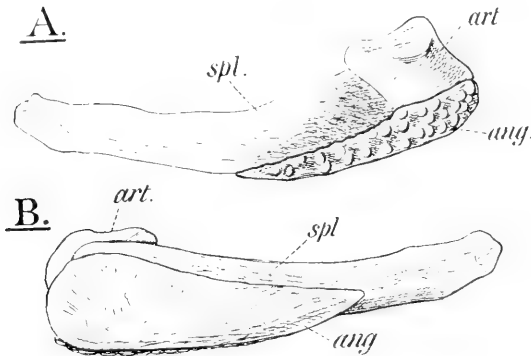

FIG. 230.

Lower jaw of *Pholidosteus Friedeli*, Jkl. A, outer view; B, inner view (after Jaekel). *ang.*, angular; *art.*, articular; *spl.*, splenial.

*Phlyctaenaspis*, mentioned above, may conceivably represent the pectoral limbs of *Pterichthys*. Such resemblances may, however, very well be due to convergence, and so do not outweigh the

many important differences. The real affinities of the Coccosteomorphi are still obscure.

The Sub-Class may be divided into two Orders—the Anarthrodira (Dean [109]) and the Arthrodira.

### Order 1. ANARTHRODIRA.

A small group of incompletely known fish, perhaps representing a less specialised type than the Arthrodira. Large sculptured plates extend dorsally from the cranial shield over the trunk. There appears to be no differentiated joint between the armour of the two regions, the limit being marked only by an internal shelf of bone. But perhaps the whole shield belonged to the skull, and there was no trunk-armour (Eastman [129]). The lateral-line canals are sunk below the superficial ornamental layer and open by a double series of pores. There is no separate pineal plate, and the frontals are widely separated by the median occipital which meets the ethmoid.

Family MACROPETALICHTHYIDAE. *Macropetalichthys*, Norm. and Owen; Devonian, N. America and Europe. (? *Asterosteus*, Newb.; Devonian, N. America.)

### Order 2. ARTHRODIRA.

The cranial shield is movably jointed with the cuirass of the trunk. The 'centrals' (parietals) touch in the middle line, separating, as a rule, a pineal from the median occipital plate. Superficial grooves indicate the position of the lateral-line canals.

#### Sub-Order 1. ARTHROTHORACI.

The two joints between the shields are typically developed. Doubtless in correlation with the powerful dentition there is

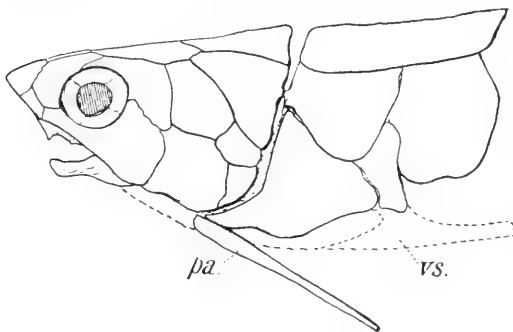

FIG. 230A.

*Coccosteus hickensis*, v. Koen. Restoration of head and trunk shields. *ps.*, pectoral spine; *vs.*, ventral shield. (After Jaekel.)

generally a considerable space between the two dorsal shields above, allowing the cranial shield to be uplifted; the lower jaw appears to have but little play, being closely followed by the ventral plates. The orbits were bound behind and below by a maxilla (sub-orbital). Except in the Coccosteidae, the preorbitals do not exist.

Family COCCOSTEIDAE. The preorbitals (frontals) meet behind the pineal. The teeth are conical and of moderate size. The statement that they extend on to the symphysis is probably erroneous (Jaekel [244]). In some the ventral shield is produced at each side into a process bearing a spine (Traquair [459]), which in others may be long and movable (Fig. 231).

*Cocosteus*, Ag., *Brachydirus*, v. Koen; Devonian, Europe. *Phlyctenaspis*, Traq.; Devonian, Europe and N. America. *Acanthaspis*, *Pholidosteus*, Jaekel; Devonian, Europe.

Family SELENOSTEIDAE. The mandibular bones bear a row of conical teeth along the anterior and the symphyseal edge (?). The cranial shield has no orbital notches, and two diverging posterior wings (Fig. 233).

*Selenosteus*, Dean, *Diplognathus*, Newb.; Cleveland shale, N. America.

Family DINICHTHYIDAE. With three pairs of biting bony plates, on the vomers, palatines, and splenials with anterior beak-like processes (Fig. 234).

*Dinichthys*, Newb.; Devonian, N. America and Europe.

Family TITANICHTHYIDAE. Very large fish, with slender toothless jaws and very broad head.

*Titanichthys*, Newb.; Devonian, Carboniferous, N. America.

Family MYLOSTOMIDAE. The teeth are in the form of crushing plates (Dean [108]).

*Mylostoma*, Newb.; Devonian, N. America (Fig. 233).

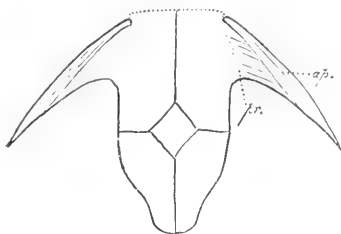

FIG. 231.

*Acanthaspis decipiens*; Devonian, Spitzbergen. Ventral view of body-shield, restored. (After A. S. Woodward, *Fert. Palaeontology*.) *ap.*, lateral spine; *pr.*, process supporting it.

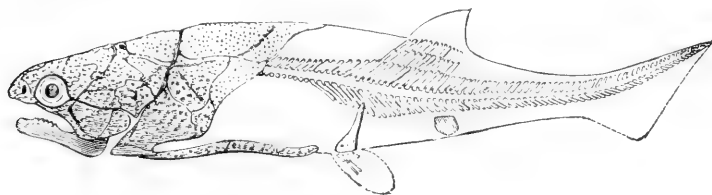

FIG. 232.

*Cocosteus decipiens*, Ag.; Lower Old Red Sandstone. (After A. S. Woodward, *Brit. Mus. Catal.*) Left-side view, with dermal shields and endoskeleton.

## Sub-Order 2. TEMNOTHORACI.

The very extensive and broad cranial shield is closely but movably joined to the trunk-armour. The orbits are surrounded by the post- and preorbitals; the latter do not meet behind the pineal (Fig. 235).

Family HOMOSTEIDAE. *Homosteus*, Asmuss; Devonian, Europe.

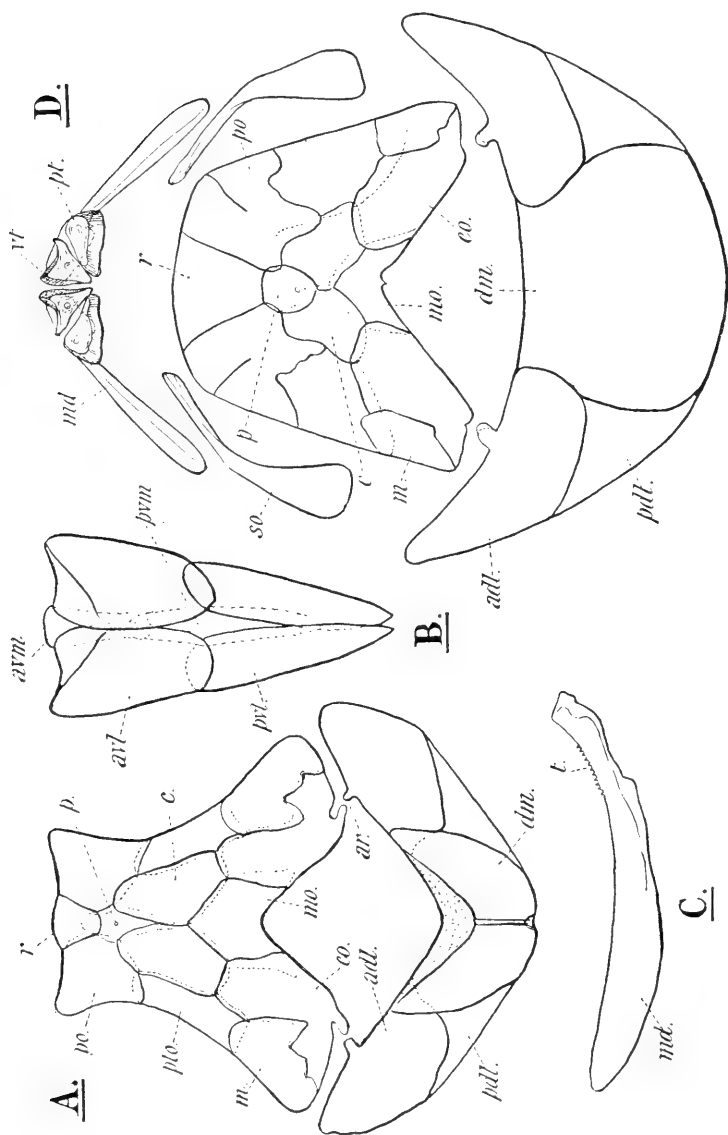

FIG. 233.

A, dorsal cephalic and thoracic shields of *Selenosteus Kriegeri*, Dean; B, ventral shield; and C, left ramus of the lower jaw of the same; D, shields and jaws of *Mylosoma variabilis*, Newb. (All after Dean.) *a.d.l.*, antero-dorso-lateral; *a.v.l.*, antero-ventro-lateral; *a.v.m.*, antero-ventro-medial; *c.*, central; *d.m.*, dorso-medial; *e.o.*, external occipital; *m.*, marginal; *md.*, mandible; *mo.*, median occipital; *p.*, pineal foramen; *p.d.l.*, postero-dorso-lateral; *po.*, preorbital; *p.v.l.*, palatine tooth in position over lower jaw; *p.v.m.*, postero-ventro-lateral; *p.v.m.*, postero-ventro-medial; *r.*, rostrum; *r.v.m.*, postero-ventro-lateral; *so.*, suborbital; *t.*, teeth of lower jaw; *v.l.*, vomerine tooth in position over lower jaw.

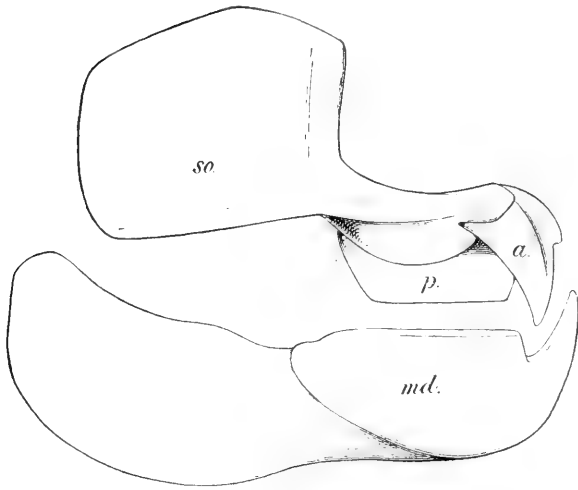

FIG. 234.

Outer view of right jaws of *Dinichthys intermedius*, Newb.; Upper Devonian, Ohio. *a.*, anterior upper piercing plate; *md.*, lower piercing and cutting plate; *p.*, posterior cutting plate; *so.*, sub-orbital, showing lateral-line groove. (From *Brit. Mus. Guide*.)

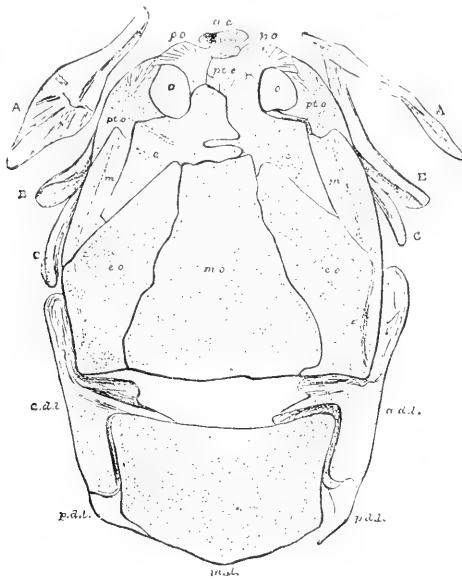

FIG. 235.

*Homosteus milleri*, Traq. Cranial and dorsal shields, etc., restored. (After Traquair, from A. S. Woodward.) A, B, C, undetermined bones; *a.d.l.*, anterior dorso-lateral; *ac*, ethmoid; *c.*, central; *c.o.*, external occipital; *m.*, marginal; *m.d.*, median dorsal; *m.o.*, median occipital; *o.*, orbit; *p.d.l.*, posterior dorso-lateral; *po*, preorbital; *pte*, pineal; *pto*, postorbital. Double dotted lines indicate the course of lateral-line canals.

## GROUP B.

### Sub-Class TELEOSTOMI.

ON the head of the Teleostomi are usually to be noticed a preponderance of the paired cranial bones (a pineal foramen), and the strengthening of the margins of the jaws with well-developed tooth-bearing premaxillae and maxillae above, and dentaries below. The outer, biting edges of the mouth and the main rows of functional teeth are no longer supported by the palato-quadrate arch and Meckel's cartilage; the latter dwindles in importance anteriorly, and the former becomes chiefly concerned in the roofing of the palate. The cartilaginous cranium becomes very completely ossified, not only by the development of endochondral bones in the deeper parts, but also by the ingrowth from the surface of certain of the dermal bones. It is sometimes difficult to decide to which of these two categories some of the bones belong. Transition stages from the dermal or membrane bone to the endochondral, and perhaps also from the endochondral to the dermal, are frequently found (p. 66). It also may happen that the main plate of a given bone develops independently from that part which protects the lateral line, the two often only fusing in the adult; thus a bone may acquire the appearance of having been originally formed by the combination of two really distinct elements, whereas in reality, as explained above (p. 222), the separation is secondary.

The periotic capsule becomes invaded by the postfrontal (sphenotic) from in front, and the pterotic ('squamosal') from behind (Figs. 237-8, 303-5). The former bone helps eventually to lodge the anterior vertical semicircular canal of the ear, gradually encroaching on the upper and anterior region of the auditory capsule. In the more specialised fish (most Teleostei), the postfrontal abandons the surface and sinks below, becoming a purely 'cartilage bone,' except for the lateral-line element which may remain above. In *Amia* the two portions are sometimes well developed and separate (Allis [12]). Similarly, the pterotic invades the posterior upper region of the auditory capsule, and lodges the horizontal semicircular canal. A bone known as the epiotic (external occipital) develops on the upper posterior and inner region of the capsule,



sharing in the protection of the horizontal semicircular canal and the posterior vertical canal. This epiotic, like the opisthotic and prootic, arises in close relation with the cartilage, and probably has never been superficial. The prootic (petrosum) occupies the anterior ventral region of the auditory capsule, generally

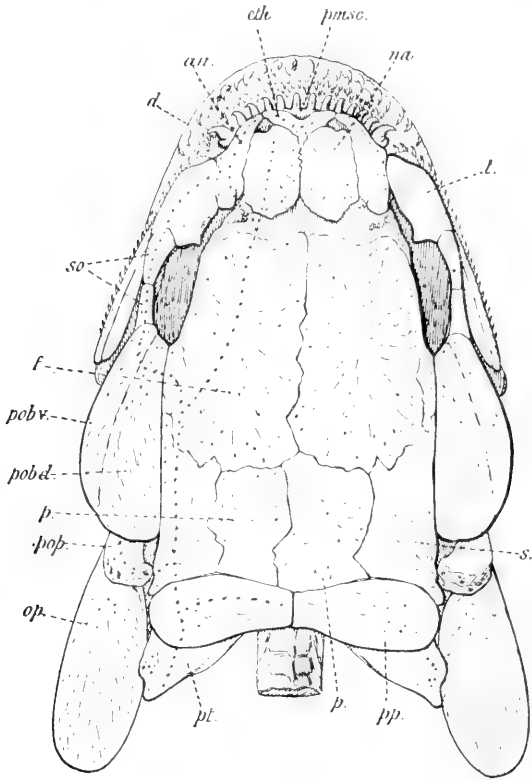

FIG. 236.

Dorsal view of the skull of *Amia calva*, L. (After Allis.) The course of the lateral-line system is indicated by a dotted line on the left side. *an*, adnasal; *d*, dentary; *eth*, mesethmoid; *f*, frontal; *l*, lachrymal or first suborbital; *na*, nasal; *op*, opercular; *p*, parietal; *pmse*, premaxilla; *pobd* and *pobv*, dorsal and ventral postorbitals; *pop*, preopercular; *pp*, supra-temporal; *pt*, post-temporal; *s*, pterotic; *so*, suborbitals.

surrounds the exit of the facial nerve, and lodges the anterior semicircular canal. The opisthotic (intercalare), situated behind it, may cover the outer horizontal canal; but is often small, and sometimes absent (many Teleostei). As Huxley showed [229], the number and disposition of these 'otic' bones is very constant among Teleostomes, and many if not all of them can be identified in the terrestrial Vertebrates.

The foramen magnum is bounded by paired exoccipitals at the sides, and a median basioccipital below. In the Teleostei (Figs. 305, 381) a median supraoccipital appears above (p. 326). The exoccipitals, which are pierced by the glossopharyngeal, the vagus,

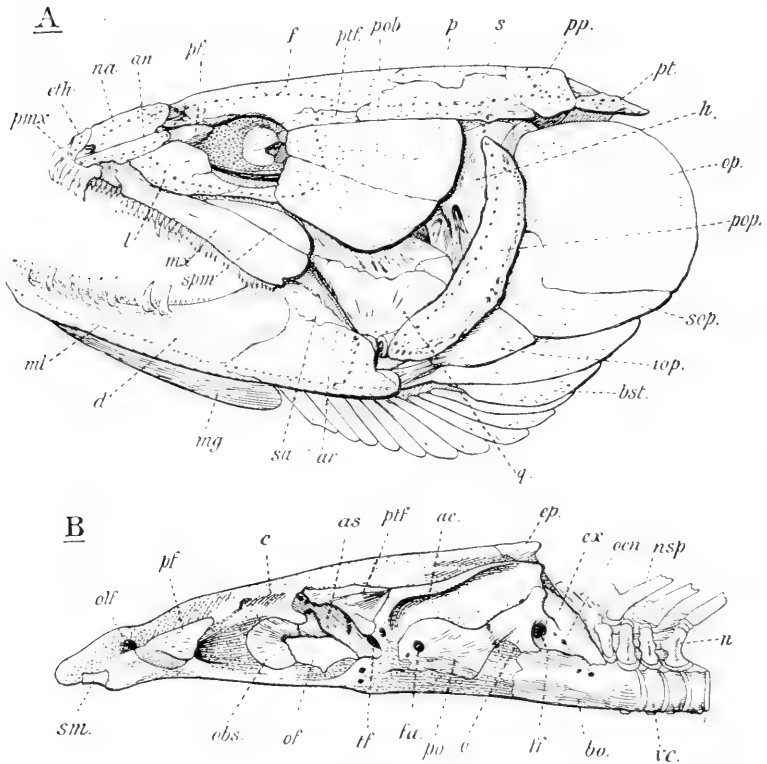

FIG. 237.

*Acilia calva*, L. (After Allis, slightly altered.) A, left-side view of the skull. B, left-side view of the cranium, from which the dermal bones have been removed. Cartilage is dotted. *a.c.*, auditory capsule; *aa*, adnasal; *ar*, dermartercular; *as*, alisphenoid; *bo*, basioccipital; *bst*, branchiostegal ray; *c*, cartilaginous cranium; *d*, dentary; *ep*, epiotic; *eth*, mesethmoid; *ex*, exoccipital; *f*, frontal; *fa*, foramen for facial nerve; *f*, foramen for vagus; *h*, hyomandibular; *io*, interopercular; *l*, lachrymal; *m.g.*, median gular; *m.l.*, lateral line in mandible; *mx*, maxilla; *n*, neural arch; *na*, nasal; *n.sp.*, neural spine; *o*, opisthotic; *obs*, orbitosphenoid; *oc.n.*, foramen for spino-occipital nerve; *olf*, olfactory capsule; *op*, opercular; *p*, parietal; *pf*, prefrontal; *pms.*, premaxilla; *po*, prootic; *pob*, post-orbital; *pop*, preopercular; *pp*, supratermporal; *pt*, post-temporal; *ptf*, postfrontal; *q*, quadrate; *s*, pterotic; *s.a.*, supra-angular; *sm*, septomaxillary; *sop*, subopercular; *spm*, supra-maxilla; *t.f.*, trigeminal foramen; *v.c.*, vertebral centrum.

and the occipito-spinal nerves, replace cartilage of compound segmental origin (p. 12). The basioccipital forms the floor of the brain-cavity behind, develops round the anterior end of the notochord, and corresponds to the vertebral centra situated farther back

(p. 11). Generally, it has a concave posterior face, just like that of a centrum, to which the vertebral column is attached without distinct articulation. Paired basisphenoids appear in the region of

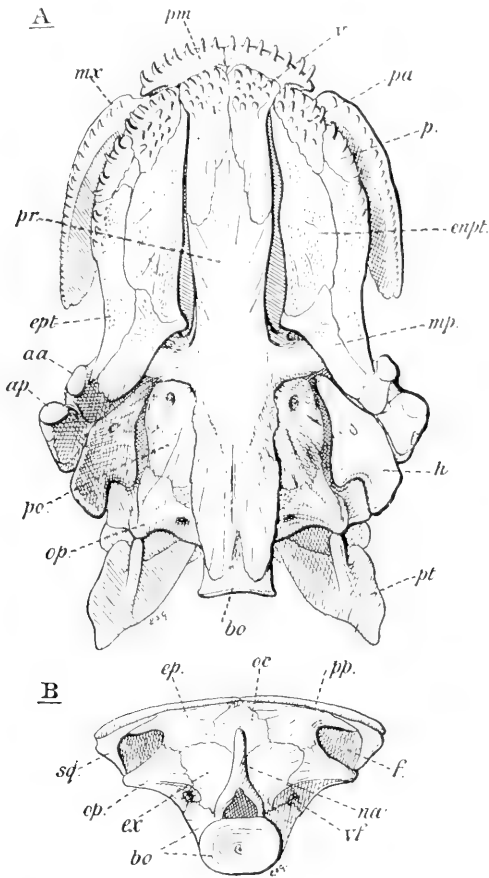

FIG. 238.

*Amia calva*, L. A, ventral view of skull and upper jaw. B, posterior view of skull. *aa*, articular surface of quadrate, *ap*, of symplectic; *bo*, basioccipital; *enpt*, entopterygoid; *ep*, epiotic; *ept*, ectopterygoid; *ex*, exoccipital; *f*, posterior temporal fossa; *h*, hyomandibular; *mp*, metapterygoid; *mx*, maxilla; *na*, neural arch, whose centrum is fused to basioccipital; *cc*, occipital cartilage; *op*, opisthotic; *p* and *pa*, palatine bones; *pm*, premaxilla; *po*, prootic; *pp*, supratemporal; *pv*, parasphenoid; *pt*, post-temporal; *sq*, pterotic; *v*, vomer; *v.f*, vagus foramen.

the pituitary fossa, and may fuse to a median bone. The lateral wall of the brain-case between the orbits is strengthened by an alisphenoid in the region of the trigeminal foramen, and by an orbitosphenoid near the optic foramen. The antorbital cartilage

is invaded by the prefrontal (lateral ethmoid), originally a superficial bone, which may sink below the surface in higher forms (p. 345). A median ethmoid may grow into the cartilaginous internasal septum from above, and sometimes the vomer also from below. Little paired septomaxillaries (Fig. 237) may occasionally be found in the nasal capsule near the articulation of the maxilla (Parker [319], Bruch [65], Sagemehl [379], etc.).

Accompanying the great development of the bones of the skull is a corresponding reduction of the chondrocranium (Parker [319], Swinnerton [431], Gaupp [151*a*]). The cartilaginous walls of the brain-case are, as a rule, very incomplete. A large fontanelle is found above, limited behind by an arch, the tectum synoticum,

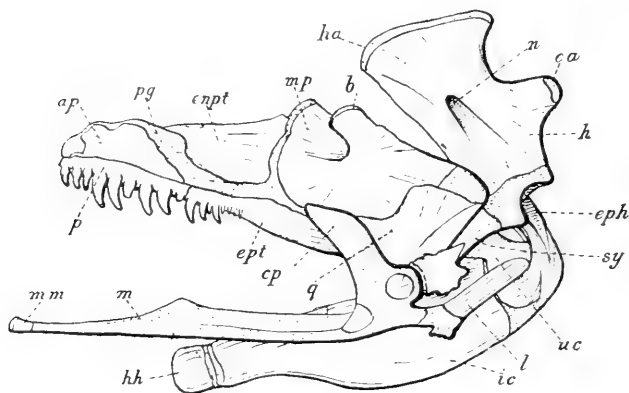

FIG. 239.

*Amia calva*, L. Skeleton of the left jaws and hyoid arch, from which the dermal bones of the lower jaw have been removed. (After Allis, slightly modified.) The cartilage is dotted. *a.p.*, endochondral palatine; *b.*, process articulating with prootic; *c.p.*, coronoid process; *enpt*, endopterygoid; *eph*, epiphyal; *ept*, ectopterygoid; *h.*, hyomandibular; *h.a.*, its articular head; *hh*, hypohyal; *i.c.*, ventral segment of ceratohyal; *l.*, ligament; *m.*, Meckel's cartilage; *m.m.*, mento-Meckelian; *mp*, metapterygoid; *n.*, foramen for hyomandibular nerve; *o.a.*, articular head for opercular; *p.*, palatine (dermal); *pg*, palato-ptyergoid cartilage; *q.*, quadrate; *sy.*, symplectic; *u.c.*, upper segment of ceratohyal.

between the auditory capsules. A hypophysial space below separates the two trabeculae, which fuse in front to form the nasal and antorbital cartilage, but hardly contribute at all to the closure of the side walls (Fig. 58).

The attachment of the jaws is always of the hyostylic type. The hyomandibular is large, and supports the quadrate some distance from the cranium (Figs. 239, 302, 456). At its anterior end the palato-quadrate bar has a palatine bone; it often bears teeth and may be subdivided into an endochondral and a dermal element (*Amia*, Allis [10], Fig. 239; *Lepidosteus*, van Wijhe [494]). Usually it articulates with both the ethmoid region of the skull and the maxilla. There follow behind a dermal ectopterygoid (pterygoid)

and endopterygoid (mesopterygoid); bones which often are toothed. An endochondral quadrate bears the lower jaw; and an endochondral metapterygoid joins on to the hyomandibular above it. Thus the hyomandibular, symplectic (when present), and palatopterygo-quadrate usually form one rigid arch. How far these three pterygoid bones are all present in primitive and early forms is uncertain.

The palato-ptyerygoid arch articulates in front with the ethmoid cartilage laterally, by an ethmo-palatine articulation. The right and left arches do not, therefore, meet below the snout as in the Chondrichthyes (except in the Acipenseroidei). It is interesting to notice that in certain (perhaps in all the primitive forms) of the lower Teleostomes (Pycnodontidae, Aspidorhynchidae, Macrosemiidae, Pholidophoridae, Lepidosteidae, Lepidotidae, Amiidae) the metapterygoid sends inwards a process (Fig 239), which quite or

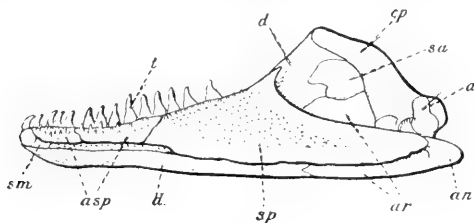

FIG. 240.

Inner view of the lower jaw of *Amia calva*, L. (After Allis.) a, articular; an, angular; ar, dermarterial; asp, anterior splenials; cp, coronoid cartilage; d, dentary; sa, supraangular; sm, mento-Meckelian; sp, splenial with minute teeth; t, marginal tooth.

nearly articulates with the trabecular region of the skull between the optic and the trigeminal foramina (van Wijhe [494], Reis [349]); a vestige of this process appears in the embryos of some Teleostei (*Salmo*, Swinnerton [431], Winslow). This connection may perhaps represent the lower articulation of the quadrate in auto-stylic skulls—the pedicle of the suspensorium (p. 97). In that case it would point to the Teleostomi having preserved a trace of the original connection between the mandibular arch and the cranium (p. 97).

The large cartilaginous hyomandibular generally ossifies in two pieces—a hyomandibular bone above articulating with the skull, and a symplectic below, connected with the quadrate (Fig. 239). In *Polypterus*, however, there is no symplectic (see p. 295); and in some Teleosts, such as the Siluridae and Anguilliformes (Apodes), it appears to have been lost.

The different relation of the seventh nerve to the hyomandibular is of some interest (van Wijhe). Whereas in Selachians the main hyomandibular branch issues from the skull in front of the articula-

tion and passes outwards and backwards over the hyomandibular cartilage, in the Acipenseridae it issues below and passes behind the hyomandibular; in *Amia*, *Lepidosteus*, and the Teleostei it passes through it. *Polypterus* displays an intermediate condition in which the mandibular branch passes in front and the hyoid branch behind the hyomandibular. Doubtless these differences are due to the shifting forward and upward of the articulation.

Epihyal (interhyal), ceratohyal, hypohyal, and basihyal elements are generally present (Fig. 331). The basibranchials are usually well represented, and many of the branchial arches may have infra- and suprpharyngeals. As a rule, the branchial arches are extensively ossified.

There are some interesting points to be noticed concerning the teeth of the Teleostomes which may be mentioned here. As a rule, they develop regularly in a dental fold, succeeding each other throughout life; but they differ much in size, shape, and mode of attachment (Tomes [440]). While in the Selachii the teeth are merely bound by connective tissue to the jaws, in the Teleostomes they usually become firmly fixed and cemented on to the dermal jaw-bones by bony substance, which is reabsorbed when the tooth is shed. Frequently, however, some of the teeth (*Esox*, *Gadus*, *Lophius*) are movably attached by means of an elastic ligament on the inner side, allowing them to be folded back when food is taken in (Fig. 81). Rarely the teeth are planted in sockets (Saurodontidae), to the sides of which they may become anchylosed (Scomber). Sometimes they are placed in a deep groove. The normal process of succession may become much modified. In many fish the new tooth grows underneath the old one so as to replace it 'vertically' (Fig. 448). In others, successive generations of teeth may become cemented together, forming a beak-like covering to the jaws, with cutting edge or grinding surface; such compound teeth have been independently developed in several families (Diodontidae, Figs. 451, 453, p. 440; Hoplognathidae, Fig. 439, p. 431).

Correlated with the presence of a complete opercular flap, we find the septum supporting the branchial lamellae undergoing greater and greater reduction in the Teleostomes. It is short in the Chondrostei, and almost absent in the Teleostei. The lamellae project, therefore, more and more freely into the branchial cavity, and the branchial rays supporting them invariably form a double series on each arch, not a single series as in Selachians (Fig. 57).

Breathing valves are often developed on the jaws, serving to direct the stream of water through the gills (Dahlgreen [96], Allis [13]).

The axial and appendicular skeleton become very thoroughly

ossified in the Teleostomes. True bone is present in the earlier and more primitive forms; but it may become much modified later, and in many Teleostei may lose all trace of bone-cells (p. 355). A return to the cartilaginous condition may, on the other hand, have taken place in certain degenerating groups (Chondrostei).

The vertebral column differs markedly in structure from that of other fish, more especially the Elasmobranchs, in that the notochordal sheaths remain throughout growth intact (Fig. 338). However much the notochord may be constricted, the mesoblastic cells never pass through the *elastica externa* to invade the fibrous sheath [265, 471a, 130]. The early and primitive Teleostomes may have possessed permanently unconstricted notochords, as is still the case with the living Chondrostei; but even amongst the Devonian genera annular bony vertebral bodies are found. The vertebral centra, whether simple or complex, are formed in connection with the neural and haemal arches in the connective-tissue skeletogenous layer outside the notochordal sheaths, and are distinguished as perichordal centra from the chordal centra of the Elasmobranchs (p. 100).

As a rule, the neural and haemal spines form a very complete series, and fuse with the corresponding arches (p. 352). The median fin-radials are present either in equal number or a multiple thereof. As already mentioned (p. 109), the radials (somactidia), both in the paired and the unpaired fins, project as a rule but little into the fin-fold, which becomes more and more completely supported by the dermatrichia. The endoskeletal radii, then, diminish and retreat to the base of the fins as the lepidotrichia increase in importance. At the same time, each radial becomes more definitely related to individual lepidotrichia, in the dorsal and anal fins only, of the higher Teleostomi (p. 321; Bridge [56], Harrison [196], Goodrich [175]). Whereas in the lower forms the dermal rays are much more numerous than the endoskeletal, in the higher fish they come to correspond in position and number, each double (right and left) lepidotrich forming an elaborate articulation with its supporting radial (Figs. 301A, 311). The median fins of the Actinopterygii are thus beautifully adapted to folding, being capable of erection or depression at the will of the animal. Similar articulations for the lepidotrichia occur in the paired fins.

Lepidotrichia are found on the fins of all Teleostomi; but the presence of small actinotrichia at the edge of all the fins in the adult is quite characteristic of the group (Harrison [196], Goodrich [175]) (Figs. 186, 187). These delicate unjointed horny fibres are the only dermatrichia in the embryonic fins. They closely resemble the ceratotrichia of Elasmobranchs, with which they are in all probability homologous (p. 122). The actinotrichia develop in the

mesoblastic cells below the epidermis, and they remain at the

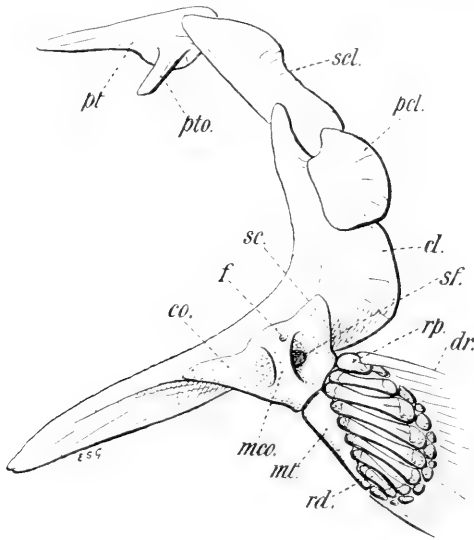

FIG. 241.

Skeleton of the right pectoral fin and right half of the pectoral girdle of *Amia calva*, L., seen from within. *cl.*, cleithrum; *co.*, coracoid; *dr.*, lepidotrich; *f.*, nerve foramen; *m.co.*, meso-coracoid arch; *mt.*, metapterygium; *p.cl.*, postclavicle; *p.t.*, post-temporal; *p.to.*, its lower process to opisthotic; *rd.*, distal preaxial radial; *rp.*, proximal preaxial radial; *sc.*, scapula; *s.cl.*, supra-clavicle; *sf.*, scapular foramen. The cartilage is dotted.

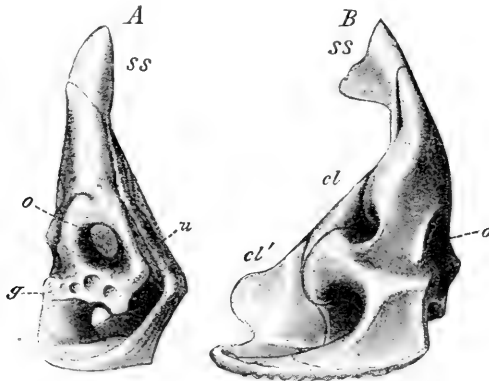

FIG. 242.

Left pectoral girdle of *Acipenser sturio*. A, oblique view from behind. B, inner view. (From Gegenbaur, *Vergl. Anat.*) *cl.*, cleithrum; *cl'*, clavicle; *g.*, articular facets for pectoral fin-skeleton; *o.*, *u.*, open channel; *ss.*, dorsal cartilage.

growing edge of the fin-web, sinking deeper into the connective tissue, while the less numerous but more important lepidotrichia



are formed outside them in the now more superficial mesoblastic layers (Fig. 343). Only in the fatty or adipose fin of certain Teleostei (Salmonidae, Siluridae, etc.) do the actinotrichia acquire considerable size in the adult, and in these fins they form the sole organs of support.

The skeleton of the paired fins has already been discussed above (p. 106), and will be further dealt with below (p. 302); but we may here consider the structure of the limb-girdles.

The endoskeletal pectoral girdle consists of a bar of cartilage, extending dorsally as the scapular region and ventrally as the coracoid region (Figs. 241-3). The two halves do not fuse ventrally, and as a rule are widely separated, resting on the dermal covering bones (clavicle and cleithrum, p. 214). Among living Teleostomi



FIG. 243.

Inner view of the right half of the endoskeletal pectoral girdle and fin of *Salmo salar*. L. c, coracoid; d.c, distal cartilages of radials; mc, mesocoracoid arch; r, fifth radial; s, scapula; s.f, scapular foramen.

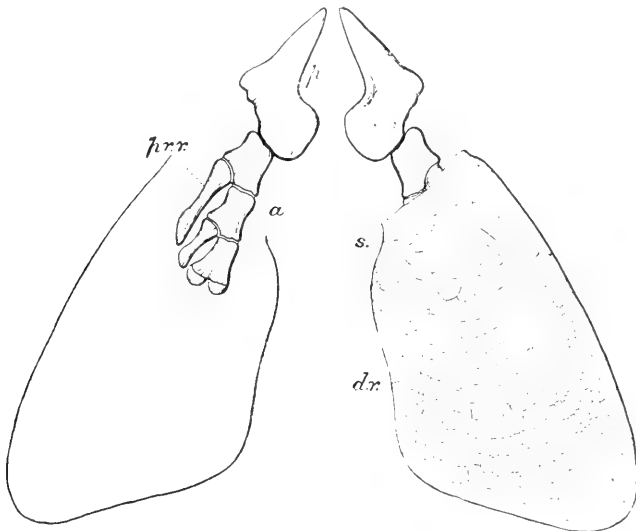

FIG. 244.

Ventral view of the pelvic girdle and fins of *Eusthenopteron Foordi*, Whitt.; restored. The skeleton of the right fin is completely exposed. a, jointed axis. (From *Quart. Journ. Micr. Sci.*)

the girdle is ossified, except in *Amia* and the Chondrostei. A bony coracoid appears below, and a bony scapula above, generally pierced by a large foramen. In all the lower sub-orders, and in some of the less specialised Teleostei, we find a third inner anterior process differentiated from the coracoid, known as the mesocoracoid (precoracoid of Parker [317], Fig. 243), which may be separately ossified. This mesocoracoid arch, although absent in *Polypterus*, is probably a primitive structure inherited from a

common ancestor. A more detailed study of the fossil genera would throw light on this question, which is of considerable importance in classification (Gegenbaur [153], Boulenger [42]).

The essential features of the dermal pectoral girdle have been described above (p. 214). It becomes much modified in the higher Actinopterygii.

The two halves of the originally cartilaginous pelvic girdle ossify, except in the Chondrostei, in the form of two horizontal bones lying in the abdominal wall, meeting ventrally in front, and bearing the fin-skeleton at their hinder end (Figs. 244-248). The dorsal iliac process is scarcely if at all represented. Small cartilages may remain at the anterior ends of the bones, and rarely the two halves of the girdle may fuse to a small median cartilage (*Gadus*, Fig. 247).

On very insufficient evidence it has been argued that the occasional small anterior cartilages represent the true girdle, and that the large pelvic bones are the modified basipterygia of the fins (Davidoff [97-9], Gegenbaur [163], Wiedersheim [491-2]). While Wiedersheim considered these cartilages to represent the first rudiments of a developing girdle, Gegenbaur, on the contrary, looked upon them as its last vestiges. Since, however, the pelvic bones are found normally developed in Teleostomes from the Devonian to the present epoch (*Eusthenopteron*, Fig. 244, Goodrich [173]), there

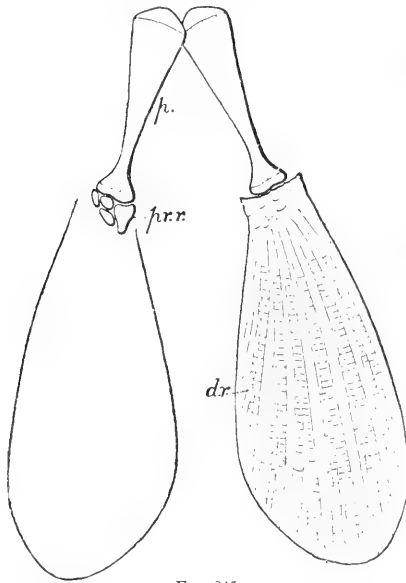

FIG. 245.

Ventral view of the pelvic girdle and fins of *Amia calva*, Bon. The skeleton of the right fin is completely exposed. *dr.*, web of left fin with lepidotrichia; *p.*, pelvic bone; *p.r.r.*, preaxial radial, or remains of axis. (Partly from Davidoff, from *Quart. Journ. Micr. Sci.*)

is no reason for rejecting the old view that they are the two halves of the girdle, comparable to those found in Holocephali and Pleuracanthodii. In the Dipnoi and Elasmobranchii only the two halves become intimately fused together, as in the higher terrestrial Vertebrates.

The living Teleostomes differ from the Dipnoi (and the Chondrichthyes) in several important respects besides those mentioned above: the branchial lamellae are supported by a double series of rays on each arch; the brain is characterised by the preponderance of the hind- and mid-brain over the fore-brain and the small development of the anterior region of the fore-brain (telencephalon), which retains a simple epithelial roof (Figs. 283, 353). The basal ganglia thicken below; but there are no paired cerebral outgrowths. There is no cloaca, the urinogenital opening being behind the anus.

The ova are relatively small, and generally extremely numerous. Those of the lower Teleostomes (*Polypterus*, *Lepidosteus*, *Acipenser*, *Amia*) are provided with comparatively little yolk, and are quite or nearly holo-blastic in cleavage. The larvae have organs of fixation, in the shape of paired suckers in front of the mouth, unlike those of the Dipnoi and Amphibia which are ventral and behind the mouth. In the Teleostei the yolk is relatively very large in amount and the cleavage meroblastic. Frequently their eggs float freely in the sea with the help of an oil-globule of light specific gravity (Dean [105], Agassiz [3], Balfour [30], etc.).

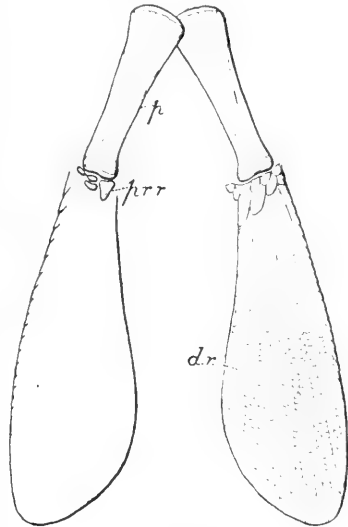

FIG. 246.

Ventral view of the pelvic girdle and fins of *Lepidosteus osseus*, L. The skeleton is completely exposed on the left side. *dr*, web of left fin with lepidotrichia; *p*, pelvic bone; *p.r.r.*, preaxial radial, or remains of axis. (Partly after Davidoff, from *Quart. Journ. Micr. Sci.*)

The orders Ganoidei, Ctenoidei, and Cycloidei of Agassiz (p. 210), founded merely on the structure of the scales, were shown by Johannes Müller to be to a great extent artificial. Following rather the example of Cuvier, and trusting chiefly to distinctions of internal anatomy, Müller determined the limits of the group Ganoidei anew [307], purging it of its foreign elements. He divided Agassiz's three orders into two sub-classes, the Ganoidei

and Teleostei, placing two orders in the former, the Holostei (*Lepidosteus* and *Polypterus*) and the Chondrostei (Acipenserini and Spatulariae). Thus was laid the foundation of our modern classification. Müller's Ganoidei are distinguished from the Teleostei by the possession of a valvular contractile conus, a spiral valve, and an optic chiasma. C. Vogt [474a] subsequently showed that *Amia* belongs to this group.

The next great step was made by Huxley [227]. Treating the fossil in conjunction with the living fish, he subdivided the Ganoidei into Amiadae, Lepidosteidae, Crossopterygidae, Chondrosteidae, and Acanthodidae. The foundation of the group Crossopterygidae was a great advance, for in it were gathered

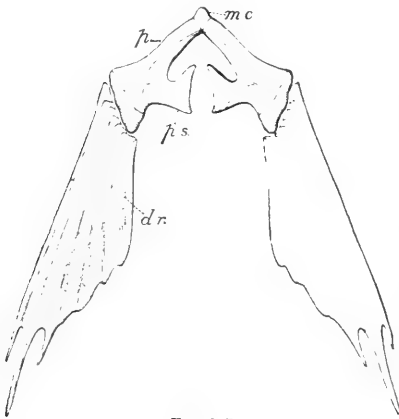

FIG. 247.

Ventral view of the pelvic girdle and fins of *Gaidus narchana*, L. *d.r.*, dermal rays (Lepidotrichia); *m.c.*, median cartilage; *p.*, pelvic bone; posterior process. (From *Quart. Journ. Micro. Sci.*)

together with *Polypterus* a number of related but hitherto scattered genera clearly distinguished from the remainder of the Ganoidei. On the other hand, the work of Cope, A. S. Woodward, and others on extinct fish has tended to break down the distinction between the Ganoidei and Teleostei. It is now coming to be recognised that none of these older classifications is strictly in accordance with a phylogenetic scheme.

The reunion of the Amiadae, Lepidosteidae, and Chondrosteidae into the one group Actinopterygii by Cope [91a] was the next important move

towards a more natural classification. But the Crossopterygidae of Huxley, the only common and diagnostic character of which is the possession of a pair of large gular plates, tend now to fall apart into a number of diverging groups whose mutual affinities are very doubtful. The Dipnoi have been separated off as a specialised offshoot, related to but probably not derived from any known Osteolepidotid (p. 258). It is true that the Crossopterygidae have more or less 'lobed' paired fins fringed with dermal rays, but so have many other fish; and the supposition that the endoskeleton of these fins has been derived from the rachistichous and mesorachic type found in Dipnoi rests on speculations which are neither firmly established nor generally accepted (p. 282).

The Teleostomi, as originally defined by Owen, included the Ganoidei, Dipnoi, and Teleostei. We now use the term in a more

restricted sense as comprising the Actinopterygii and three other orders, Osteolepidoti, Coelacanthini, and Polypterini. All these orders, except the last, were already represented in Devonian times. Their exact relationship to each other remains a problem to be solved.

The chief characters of the Teleostomi may be summarised as follows: The paired series of bones preponderate on the cranial roof. The pineal foramen is often preserved. Teeth are borne on marginal dermal bones on the jaws; the skull is hyostylic, the hyomandibular large; there is a palatal pterygoid compound plate. The lateral gular plates are usually present. The notochordal sheaths remain intact, although generally the notochord is constricted, and perichordal vertebrae developed. The series of neural and haemal spines remains little, or not at all, affected by the subdivision and concentration of the median fins. The two halves of the endoskeletal pectoral girdle remain separate and tend to dwindle in importance, being to a great extent replaced by dermal bones; the pelvic girdle is in the form of paired ventral bones, or cartilages. The skeleton of the paired fins may show distinct signs of being built on the 'archipterygial' plan; but the axis is generally posterior, and much reduced, or altogether absent (Teleostei). All the fins are provided with lepidotrichia and marginal actinotrichia. Besides the cosmoid, ganoid, or teleostean scales which clothe the body, there is frequently preserved a general superficial covering of dermal denticles.

Living Teleostomes have the branchial rays supporting the gill-lamellae in a double series; a brain in which the prosencephalon is not differentiated; a separate anus and urinogenital aperture; and

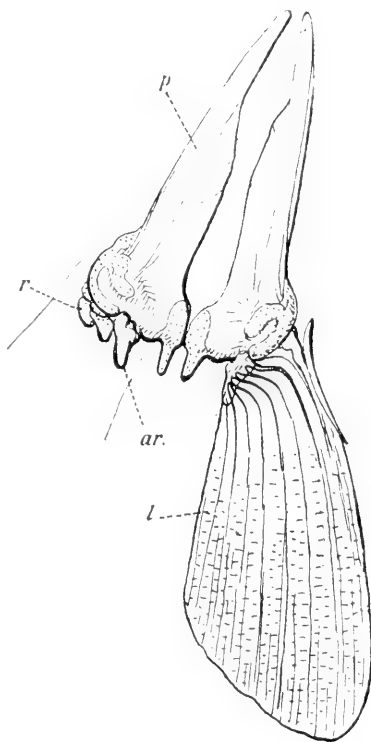

FIG. 248.

Ventral view of the pelvic girdle and left pelvic fin of *Salmo salar*, L. (Modified from Bruch.) *ar*, posterior radial or remains of basipterygium; *l*, lepidotrichia; *p*, pelvic bone; *r*, radial.

comparatively small ova. (The nostrils usually are dorsal; but this was certainly not always the case in the extinct Osteolepidoti; see below.)

### Division 1.

#### Order OSTEOLEPIDOTI (Crossopterygii, Osteolepida).

The Osteolepidoti flourished from the Middle Devonian to the end of the Carboniferous epoch; only one genus is known to extend into the Permian, *Megalichthys*, the largest of this order. Thanks to the researches of Pander [312], Huxley [228], Traquair [443, 445, 450], Whiteaves [488], A. S. Woodward [505], and others, our knowledge of the external form and internal skeleton of the Osteolepidoti is fairly complete.

The scales vary in shape from the rhomboid (*Osteolepis*, Fig. 250) to the cycloid form (*Holoptychius*, Fig. 253). They are never, strictly speaking, 'ganoid' (p. 218); but may be thick and shiny, or thin and unpolished. In the first case their exposed surface is covered with a layer of typical cosmine (Fig. 190 and p. 217), which in others seems to be reduced, or to disappear

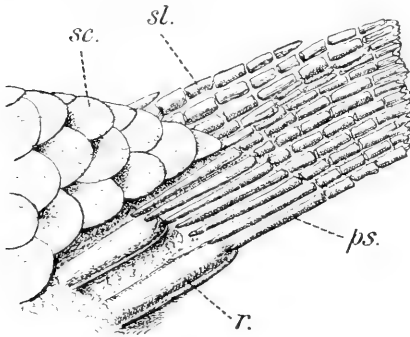

FIG. 249.

Anterior edge of the dorsal fin of *Eustichopteron Foordi*, Wht. *ps.*, base of dermal ray; *r.*, endoskeletal radial; *sc.*, scale; *sl.*, thickened scale-like segment of anterior dermal ray.

entirely, leaving the bony layers exposed (Fig. 249). The cranial plates and the lepidotrichia agree in structure with the scales. True denticles have not yet been definitely shown to exist.

The proximal end of each lepidotrich extends inwards below the body-scales, just as these overlap each other (p. 210). In *Osteolepis* the scales overlap the dermal ray to a slight degree, in *Glyptolepis* for a considerable length, still further in *Glyptopomus*, and finally, in *Holoptychius* the unjointed proximal segment of the lepidotrich is almost as deeply embedded as in *Dipnoi* (p. 232).

The orbit is small and situated far forward. The anterior cranial bones (premaxillae, nasals, ethmoid, and even frontals and prefrontals) tend to fuse to a continuous shield covering the snout, especially in the Osteolepidae (Figs. 250, 257). It is the presence of this shield, sometimes with paired notches below, which leads to the conclusion that the nostrils were ventral, unlike those of living

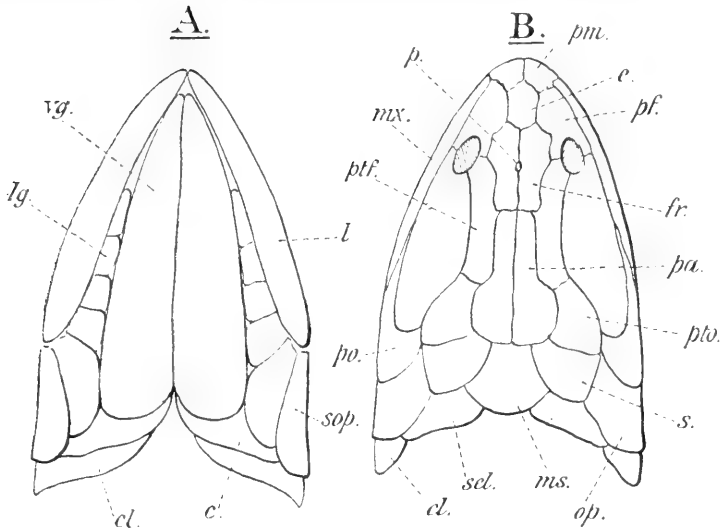

FIG. 250.

Restoration of *Glyptopomus*. A, ventral, and B, dorsal view of the head, (After Huxley, slightly modified.) *e*, clavicle; *cl*, cleithrum; *c*, ethmoid; *fr*, frontal; *l*, lower jaw; *lg*, lateral gular; *m.s*, median supratermporal; *mx*, maxilla; *op*, opercular; *p*, pineal foramen; *pa*, parietal; *pf*, prefrontal; *pm*, premaxilla; *po*, preopercular; *ptf*, postfrontal; *pto*, pterotic; *s*, supratermporal; *sel*, supraclavicle; *sop*, subopercular; *vg*, ventral gular.

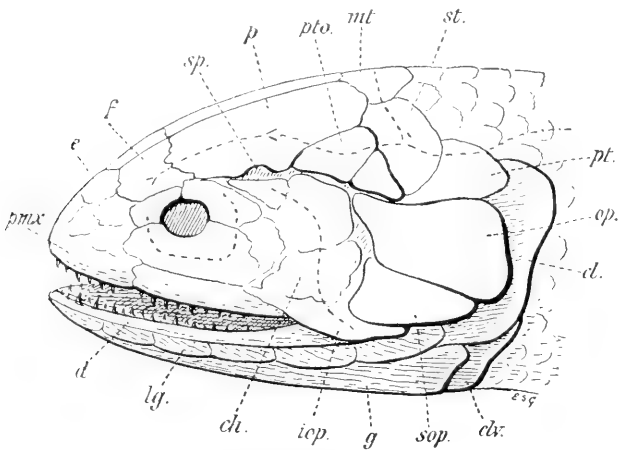

FIG. 251.

Restored head of *Holoptychius Andersoni*, Ag. *ch*, cheek-plates (=preopercular?); *cl*, cleithrum; *clv*, clavicle; *d*, dentary; *c*, mesethmoid; *f*, frontal; *g*, paired ventral gular; *icp*, interopercular; *lg*, lateral gular; *mt*, median supratermporal; *op*, opercular; *p*, parietal; *pmx*, premaxilla; *pt*, post-temporal; *pto*, pterotic; *sop*, suboperculum; *sp*, notch, possibly indicating spiracle; *st*, supratermporal.

Teleostomes (Polypterini and Actinopterygii). The extensive cheek region is covered partly by the postorbitals and partly by one or more large plates representing the preoperculum (Fig. 251). Sometimes a normal preoperculum is present, with separate cheek-plates in front (Fig. 256). A row of three supratemporal plates covers the occipital region.

The lower jaw is provided, as a rule, with a series of infra-dentaries. On either side of the large paired inferior gular plates a series of lateral gulars extends upwards to the sub-opercular and opercular bones (Fig. 250). The interopercular has not been identified for certain. The anterior median gular, if present, is small. On the inner side of the mandible, the splenial bears large teeth, and may be subdivided into several ossicles. Large teeth are also present above in the vomerine and palatine regions. The wall of these teeth tends to become much folded (p. 285).

The paired fins have an outstanding scale-covered lobe of considerable size. In some (Holoptychiidae) this central axial region is elongate and tapering, 'acutely lobate,' with a fringe of lepidotrichia on either side, thus closely resembling the fin of *Ceratodus* (Fig. 254). Unfortunately, the internal skeleton is unknown in these forms; but it would appear to have been

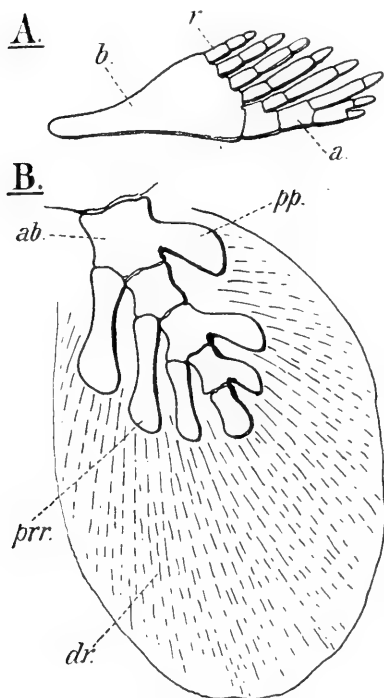

FIG. 252.

A, endoskeleton of the second dorsal fin of *Glyptolepis leptopterus*, Ag. B, skeleton of the left pectoral fin of *Eusthenopteron Forrdi*, Whit.; restored. *a*, segment of longitudinal axis; *ab*, basal segment of axis; *b*, basal; *d.r.*, dermal rays; *p.p.*, postaxial process (radial?); *pr.r.*, preaxial radial; *r*, radial.

built on the mesorachic plan, with a jointed central axis bearing preaxial and postaxial radials. In the Osteolepidae the fins, especially the pelvics, are shorter, and less acutely lobate; in these also the endoskeleton is unknown. The Rhizodontidae have lobate fins departing from the mesorachic type: here the preaxial edge and its dermal rays are becoming stronger than the postaxial, as in the Actinopterygii, while the skeletal axis is somewhat posterior (Fig.



258). In this family the endoskeleton is well ossified, and has been described (Traquair [443], A. S. Woodward [505]). The pectoral fin has a jointed bony axis of from three to five segments, bearing each a well-developed preaxial radial; large posterior processes from some of the axial segments may possibly represent postaxial radials (Fig. 252).

The skeleton of the pelvic fin (Traquair [459], Goodrich [173]) is less well developed, but is built on the same plan, with three to four axial segments bearing preaxial radials (Fig. 244). The asymmetrical (pleurorachic) fins of the Rhizodonts are supposed to be developed from the mesorachic (archipterygial) type (p. 106);

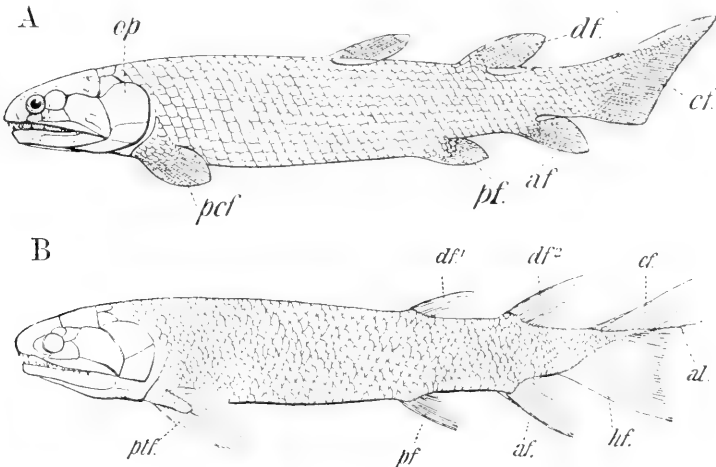

FIG. 253.

A, *Osteolepis macrolepidotus*, Ag.; restored. (After Traquair.) *a.f.*, anal fin; *c.f.*, caudal fin; *d.f.*, second dorsal fin; *op.*, opercular; *pc.f.*, pectoral fin; *p.f.*, pelvic fin. B, restoration of *Tristichopterus alatus*, Eg.; Old Red Sandstone, Caithness. (After Traquair.) *a.f.*, anal, *d.f.*, dorsal, *e.f.*, epichordal, *h.f.*, hypochordal, *p.f.*, pelvic, and *pt.f.*, pectoral fin; *a.l.*, axial lobe of caudal fin.

but it must be remembered that there is as yet no proof of the existence of a typical mesorachic endoskeleton in the paired fins of any Teleostome.

The tail is either diphycceral or more or less heteroeceral; but the upper epichordal lobe never quite disappears, and is supported by dermal rays. Such tails, in which the epichordal lobe is only somewhat smaller than the hypochordal, may be called heterodiphycceral.

#### Sub-Order 1. HAPLISTIA.

This sub-order contains only the single species described by Traquair under the name *Tarrasius problematicus* from the Lower Carboniferous rocks of Glencartholm, Scotland [449, 455]. It

differs from the other Osteolepidoti in the possession of continuous dorsal and ventral median fins.

Family TARRASIIDAE. The dermal bones of the skull and operculum appear on the whole to resemble those of the Osteolepids. The front region of the trunk is naked; but the caudal region is covered with small quadrangular scales, which scarcely overlap and have a superficial resemblance to the scales of an Acanthodian. The tail is diplocercal, and the notochord was persistent, there being no centra. A series of radials, more numerous than the vertebral arches, supports the median fins. The pectoral fin has a small rounded basal lobe; no pelvic fin has been found. This important genus is still incompletely known; its affinities are still very uncertain. In this connection it would be most interesting to ascertain the structure of the outer shiny layer which covers the dermal skeleton.

*Tarrasius*, Traq.; Lower Carboniferous, Dumfriesshire.

### Sub-Order 2. RHIPIDISTIA.

With subdivided median fins.

Family HOLOPTYCHIIDAE. The pectoral fins are acutely lobate, and the pelvic fins rather less acutely lobate. The tail is heterocercal, with a large lower and smaller upper lobe. There is no pineal foramen. The

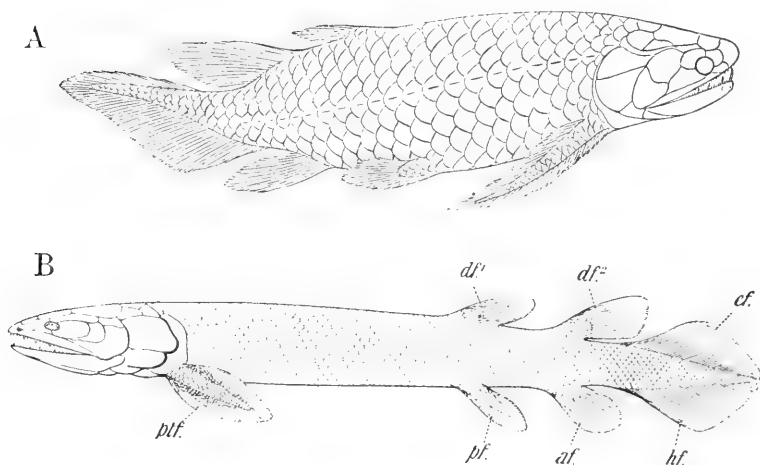

FIG. 254.

A, *Holoptychius Flemingi*, Ag.; Upper Old Red Sandstone, Dura Den; restored. (After Traquair, from A. S. Woodward.) B, restoration of *Glyptopomus Kinnairdi*, Huxley; Devonian. (After Huxley, modified.) *af*, anal, *df*, dorsal, *cf*, epichordal, *hf*, hypochordal, *plf*, pelvic, and *plf*, pectoral fin.

vertebrae appear never to have been ossified. The notochord was possibly uncontracted. The scales are cycloid, and deeply overlapping; their exposed surface covered with a modified cosmoid layer sculptured in ridges and knobs (Rohon [369]). The teeth acquire a marvellous complexity of structure owing to the infolding of the wall, especially near the base; it is owing to this feature that the family has been named Dendrodontidae (Owen [311a, 368, 453, 462]).

*Glyptolepis*, Ag., and *Holoptychius*, Ag. (Fig. 254); Devonian, Europe and America. *Dendrodus*, Owen; Devonian, Europe.

Family GLYPTOPOMIDÆ. Like the preceding family; but the paired fins less acute, the tail diphyccercal, and the scales mostly rhomboidal and only slightly overlapping, though sculptured. There is a pineal foramen [228].

*Glyptopomus* (*Glyptolaemus*), Ag. (Fig. 254); Devonian, Europe and North America.

Family OSTEOLEPIDIDÆ. The scales are rhomboid, and, like the cranial plates, have a thick layer of shiny cosmine. There are large strong scales at the base of the fins, and a median anterior gular. The cranial roof bones are often fused together, especially in front. A pineal foramen is preserved, except in *Megalichthys*. The teeth are but little folded. The paired fins have a short and somewhat obtuse lobe. The tail may be very slightly heterocercal (heterodiphyccercal) as in *Diplopterus* (Fig. 255), or quite heterocercal as in *Osteolepis* (Fig. 253) [312, 227-8].

*Osteolepis*, Val. (Fig. 253); *Thursius*, Traquair; *Diplopterus*, Ag. (Fig. 255); Devonian, Scotland. *Megalichthys*, Ag.; Carboniferous and Lower Permian, Europe and North America.

Family RHIZODONTIDÆ. The scales overlap deeply, and are generally thin, cycloid, sculptured, and without cosmine. A shiny cosmine layer is, however, preserved in *Gyroptychius*, in which genus the scales are somewhat rhomboid. The caudal fin is diphyccercal or heterodiphyccercal (*Tristichopterus*). Usually there are three well-marked lobes, into the middle one of which projects the extremity of the notochord (Figs. 253 and 258). The paired fins are obtusely lobate, and not strictly mesorachic; the fin-lobe is somewhat triangular and the anterior edge is strengthened (p. 282). There is in some a small median anterior gular plate, and the teeth are considerably folded at their base. The endoskeleton is generally well ossified, bony, ring-like centra being frequently present [488, 445, 450].

It is evident from the structure of the paired fins that the Rhizodonts differ considerably from the previous three families, and they should perhaps not be included in the same Order (Figs. 244, 252).

*Gyroptychius*, McCoy; *Tristichopterus*, Eg. (Fig. 253); Devonian,

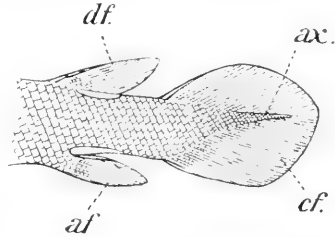

FIG. 255.

Tail of *Diplopterus Agassizii*, Traill. (After Traquair.) ax, extremity of axis; af, anal fin; cf, hypochordal fin; df, dorsal fin.

Scotland. *Sauripterus*, Hall; *Cricodus*, Ag.; Upper Devonian,

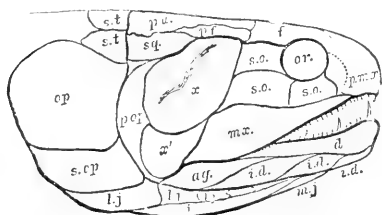

FIG. 256.

*Rhizodopsis sauroides*, Will. Right-side view of head, restored. (After Traquair, from A. S. Woodward.) *ag*, angular; *d*, dentary; *f*, frontal; *i.d.*, infradentary; *j*, paired inferior gular; *Lj*, lateral gulars; *m.j*, median inferior gular; *m.x.*, maxilla; *op*, opercular; *or*, orbit; *pf*, post-frontal; *pmx*, premaxilla; *pp*, preopercular; *pa*, parietal; *s.o.*, suborbitals; *s.op*, subopercular; *st*, supra-temporals; *sf*, pterotic (squamosal); *x, x'*, cheek-plates.

Europe and North America. *Eusthenopteron*, Whiteaves (Fig. 258); Upper Devonian, Canada. *Rhizodus*, Owen; *Strepsodus*, Young; *Rhizodopsis*, Young (Fig. 256); Carboniferous, Europe and North America.

Family ONYCHODONTIDAE. Incompletely known Osteolepidoti with tuberculated cycloid scales, and mandibular teeth with folded base, of which some very large ones are situated at the symphysis.

*Onychodus*, Newb.; Devonian, England and North America.

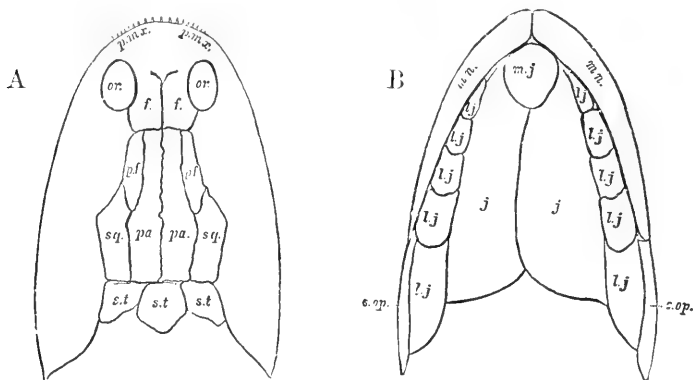

FIG. 257.

*Rhizodopsis sauroides*, Will. A, dorsal view of skull, restored. (After Traquair, from A. S. Woodward.) *f*, frontal; *or*, orbit; *pa*, parietal; *pf*, post-frontal; *pmx*, premaxilla; *sq*, pterotic; *st*, supratemporals. B, ventral view of head, restored. (After Traquair, from A. S. Woodward.) *j*, paired inferior gular; *Lj*, lateral gulars; *m.j*, median gular; *mn*, mandible; *sup*, subopercular.

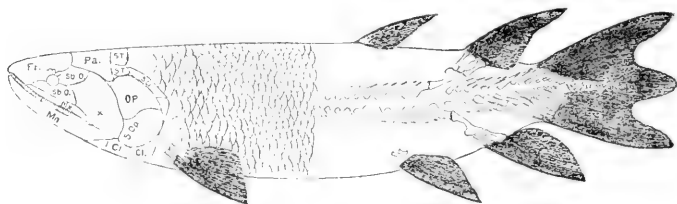

FIG. 258.

*Eusthenopteron foordi*, Whiteaves; restored. (After Whiteaves, from A. S. Woodward.) *cl*, cleithrum (clavicle); *fr*, frontal; *i.cl*, clavicle; *mn*, mandible; *mx*, maxilla; *op*, opercular; *pa*, parietal; *sc*, supraclavicle; *sop*, subopercular; *st*, supratemporal; *sub*, suborbital; *x*, cheek-plate.

## Division 2.

## Order COELACANTHINI.

These remarkable fish appear first in the Devonian and persist in the Cretaceous rocks. They are very uniform in structure throughout this long period, and are clearly marked off from

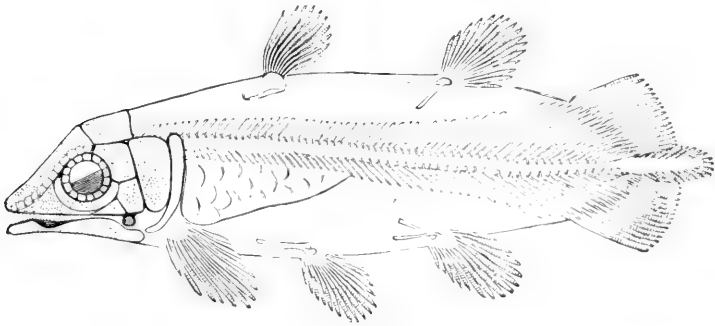

Fig. 259.

*Undino gulo*, Eg.; Lower Jurassic, Dorset. Restoration, omitting scales and supraclavicle, and showing the calcified air-bladder. (From A. S. Woodward, *Brit. Mus. Catal.*)

related Teleostomes by well-defined characters. Huxley [228], Münster, Wellburn [484], Winkler, Willemoes-Suhm, Reis [350, 354], and other authors have given us a very complete description of their skeleton.

The notochord appears to have been persistent and unconstricted; at all events, no trace of centra is found. The tail is diphycceral, and subdivided into three lobes, of which the central one projects far beyond the epi- and hypochordal lobes, and has no ossified endoskeletal supports. The neural arches, haemal arches, and pleural ribs are well developed and ossified. The arches are fused to the spines, and to these are articulated in the caudal region a corresponding series of somactidia or radials, supporting the lepidotrichia of the epi- and hypochordal fins (Fig. 259). Unlike what occurs in all Teleostomes excepting the higher Actinopterygii (p. 321), these lepidotrichia agree in number with the endoskeletal radials, and are closely connected with them. One anal and two dorsal fins are present; they have remarkable projecting, scale-covered lobes, with

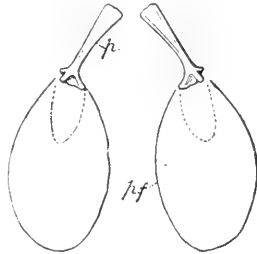

FIG. 260.

Ventral view of the pelvic girdle and fins of *Holophagus gulo*, Huxley. *p.* pelvic bone; *pf.* outline of fin. (From *Quart. Journ. Micr. Sci.*)

numerous dermal rays; but the endoskeletal supports are preserved only in the shape of peculiar forked bones near the base of the anal and second dorsal fins, and of a bony plate below the anterior dorsal fin. These bones seem to represent the coalesced inner segments of

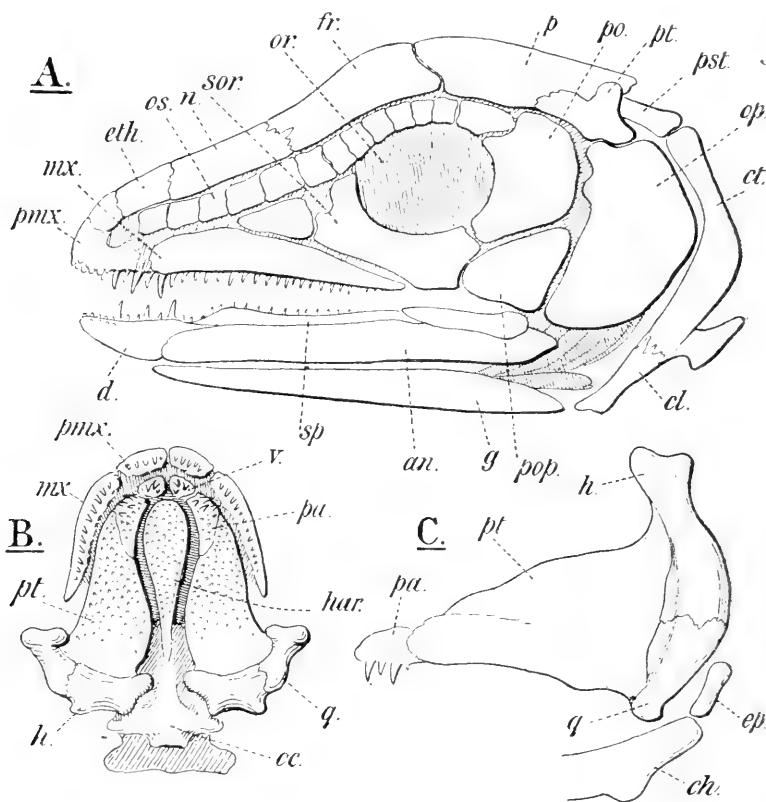

FIG. 261.

*Macropoma Mantelli*, Ag.: Cretaceous, England. Restoration of the skull, side-view (A), and ventral view (B); left palato-quadrate and hyoid arch (C). *an.*, angular; *ch.*, ceratohyal; *cl.*, clavicle; *ct.*, cleithrum; *d.*, dentary; *ep.*, epihyal; *eth.*, ethmoid; *fr.*, frontal; *g.*, paired gular; *h.*, hyomandibular; *har.*, parasphenoid; *mx.*, maxilla; *n.*, nasal; *os.*, occipital region; *op.*, opercular; *or.*, orbit; *os. n. sor.*, row of supraorbitals; *p.*, parietal; *pt.*, palatine; *pmx.*, premaxilla; *po.*, postorbital; *pop.*, preopercular; *pst.*, post-temporal; *pt.*, pterotic (in A), pterygoid (in Band C); *q.*, quadrate; *sor.*, suborbital; *sp.*, splenial; *v.*, vomere.

the concentrated radials. The paired fins are of the obtusely lobate type. In the only case where the skeleton of the pectoral fin is known, it is in the form of a posterior short basipterygium and four preaxial radii (A. S. Woodward [288]). The endoskeleton of the pelvic fins is not preserved, excepting for two elongated bones representing the pelvic girdle (Fig. 260).

The skull is well ossified both outside and in (Figs. 259, 261, A). The ossified prootics and opisthotics show that the cranium closely resembled that of the lower Actinopterygii. The orbit is large, not far forward, and surrounded by a ring of plates. The exact position of the nostrils is unknown. There appears to be no separate row of supratemporals; and a peculiar series of small parafrontals passes above the orbit towards the snout. The hyomandibular is closely connected with the quadrate and pterygoid plate in a very Teleost-like manner (Fig. 261, C). Teeth are distributed over the roof of the mouth, small ones on the pterygoids and the expanded anterior end of the parasphenoid, and larger teeth on the palatines and vomers. The maxillae and premaxillae are toothed, but the dentary is small and usually toothless. A large splenial bears the

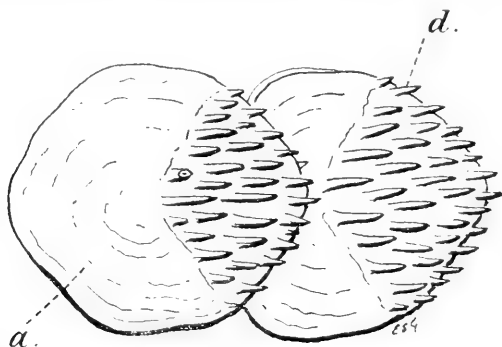

FIG. 262.

Two scales of *Macropoma Montelli*, Ag. *a.*, anterior smooth region; *d.*, denticle fixed on posterior exposed region.

teeth of the lower jaw. There are large paired gular plates, but no lateral gulars, nor is any subopercular or preopercular found. A large opercular is present. Post-orbitals cover the cheek. The epihyal, ceratohyal, and five branchial arches are ossified, also a median forked bone below, which may represent the basibranchials. Clavicles, cleithra, and post-temporals (or supraclavicles?) can be made out in the dermal shoulder-girdle. The scales are thin, deeply imbricated, and either cycloid or with a pointed posterior border. They are composed of the usual inner bony layers, over which is found in some genera (*Coelacanthus*) a striated enamel-like ornamentation of doubtful significance; in other genera (*Macropoma*) the exposed surface of the scales is studded with fixed denticles of typical structure (Fig. 262). Similar denticles are found on the lepidotrichia, and, in more or less modified form, on all the dermal bones of the head (Williamson [496a]).

The large air-bladder is conspicuous in fossil Coelacanthus owing to the calcification of its wall (Fig. 259).

Family COELACANTHIDAE. *Coelacanthus*, Ag., ; Devonian to Permian, Europe ; Carboniferous, North America. *Undina*, Münster (*Holophagus*, Eg.) (Fig. 259) ; *Libys*, Münster ; *Coccoderma*, Quenst. ; *Heptanema*, Bell ; Jurassic, Europe. *Diplurus*, Newb. ; Trias, North America. *Macropoma*, Ag. (Fig. 261) ; Cretaceous, Europe.

### Division 3.

#### Order POLYPTERINI.

This Order includes only two genera of living African fish, *Polypterus* and *Calamoichthys*, of great interest and importance. No fossil representatives of the Order have yet been found, and

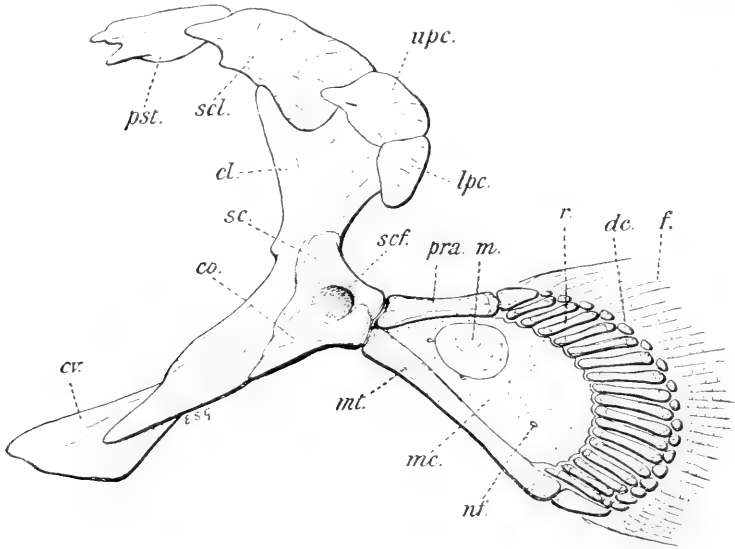

FIG. 263.

Skeleton of the right half of the pectoral girdle and of the right fin of *Polypterus bichir*, Geoffr. ; inner view. *cl.*, cleithrum ; *co.*, coracoid ; *cr.*, clavicle ; *d.c.*, distal radial cartilage ; *f.*, dermal rays ; *lpc.*, lower postclavicle ; *m.*, mesopterygial bony plate ; *mc.*, mesopterygial cartilage ; *mt.*, metapterygium, or postaxial radial ; *n.f.*, nerve-foramen ; *pra. m.*, preaxial radial ; *pst.*, post-temporal ; *r.*, radial ; *sc.*, scapula ; *sc.f.*, scapular foramen ; *sc.*, supraclavicle ; *u.pc.*, upper postclavicle.

although Huxley showed some points of resemblance between the Polypterini, the Osteolepidoti, and the Coelacanthini, and united them in the one group Crossopterygidae [227], yet it must be confessed that the living forms remain very isolated, and that their systematic position is still very uncertain. J. Müller [307], Huxley [227], Leydig [282], Traquair [441-2], Allis [13, 14], Boulenger [41], Pollard [334], and Bridge [54] have studied the anatomy and



osteology of the Polypterini; Steindachner [422*b*], Budgett [67-8], and Kerr [263] have contributed valuable knowledge of the larval development of *Polypterus*. The two genera are essentially similar, and since *Polypterus* is better known and appears to be less specialised than *Calamoichthys*, it will here receive greater attention.

The body of *Polypterus* is fusiform; that of *Calamoichthys* eel-

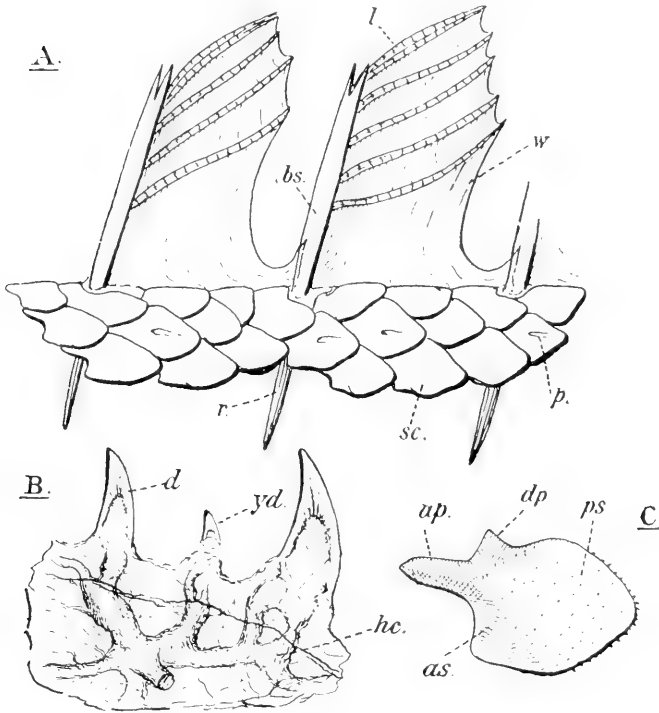

FIG. 264.

*Polypterus bichir*, Geoffr. A, two dorsal finlets and neighbouring scales. B, much enlarged view of a fragment of a scale with denticles. C, outer view of scale, enlarged. *a.p.*, anterior articulating process; *a.s.*, surface covered by next scale; *b.s.*, basal scale of finlet; *d.*, denticle; *d.p.*, dorsal articulating process; *h.c.*, vascular canals; *l.*, lepidotrich; *p.*, lateral-line pore; *p.s.*, exposed posterior surface bearing minute denticles; *r.*, endoskeletal radial; *sc.*, scale; *w.*, web of fin; *y.d.*, detached dentine cap of young denticle.

like (Figs. 274, 275). In both the pectoral fin has a narrow base, and a prominent lobe covered with scales on its outer side. The lobe has a fringe of numerous lepidotrichia. It was to this superficial structure that Huxley gave the name 'Crossopterygian'; but the outward shape of the fin is of minor importance, and in its internal skeleton it differs greatly from that of the acutely lobate fins of *Ceratodus*, or even from the fin of *Eusthenopteron* (p. 282). The pelvic fin has been lost in *Calamoichthys*. In *Polypterus* it is very

like that of the Actinopterygii, with a very small lobe. The tail is outwardly diphyccercal (p. 104). The median dorsal fin, continuous in the larva with the epichordal lobe of the tail [422b, 67], becomes broken up in the adult into a series of finlets of peculiar structure (Figs. 264, 272) (Steindachner, Traquair [441]). Each is supported in front by a strong movable elongated scale of paired origin, bearing at its distal end a number of normal lepidotrichia. There is an anal fin. The body is covered with thick rhomboid shiny scales, with a small articulating superior and a larger anterior process (Fig. 264). The scales differ markedly in their finer structure from those of the Osteolepidoi, and are built on essentially the same plan as the true ganoid scales of the Actinopterygii (p. 217). They consist of three principal layers passing into each other at

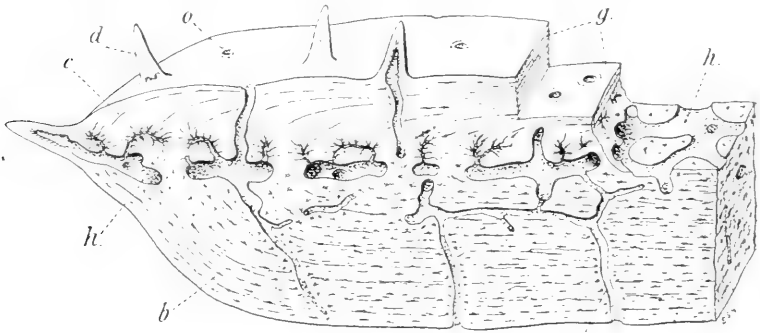

FIG. 265.

Portion of a thick transverse section of the scale of *Polypterus bichir*, Geoffr., much enlarged. *b*, inner bony or isopedine layer; *c*, canaliculi of the cosmine layer; *d*, superficial denticle; *g*, ganoine layer; *h*, system of horizontal vascular canals; *o*, opening of vertical canal on outer surface; *c, c*, vertical canal.

the sides: bony lamellae below, ganoine lamellae above, and a layer with vascular canals and dentinal tubules between these two (Fig. 265). The dentinal tubules are chiefly, if not exclusively, given off by fine canals derived from the vascular channels; this intermediate layer obviously corresponds to the middle layer in the scales of the Palaeoniscids (Fig. 288). The scales grow by the addition of concentric layers, and are, in fact, typical ganoid scales (p. 218). Moreover, to their outer surface are generally fixed small sharp denticles, sometimes scattered over the whole exposed surface of the scale, more often restricted to its free edge. The lepidotrichia are of the same structure (Fig. 184), and also the dermal bones of the shoulder-girdle and skull, but on the latter the denticles are absent.

The skull has no pineal foramen; the orbits are small and far forward. The double nares are on the dorsal surface of the snout,

and the anterior nostril has a tubular prolongation. The dermal cranial bones depart considerably from the typical Teleostome arrangement (Figs. 265A, 266). On the one hand, some bones seem to have fused together; on the other, a large number of small additional plates are present (Allis [13, 14], Collinge [87], etc.). The pterotics (squamosals) and parietals are represented by a single pair of bones in which run the lateral-line canals. Behind these parietals is a transverse row of paired supra-temporals. The post-frontal is hidden below the frontal, and the post-orbital is the first of a long series of small ossicles extending back to the operculum. Some of these are movable and cover the external opening of the persistent spiracle, situated at the outer side of the parietal (Fig. 266, A). The cheek is protected by a large preopercular plate, harbouring the hyomandibular sensory canal. An opercular and a subopercular are present in *Polypterus*, but no interopercular; in *Calamoichthys* neither subopercular nor interopercular are found. There is a pair of large ventral gular plates only; the lateral gulars have been lost (Fig. 273). In the lower jaw are found an articular, a dentary, and an angular (dermarticlar?) externally, and a toothed splenial internally. The latter has a strong coronoid process, near which lies a labial cartilage. The palate has a large parasphenoid, spatulate in front, paired vomers, ectopterygoids, and endopterygoids, all covered with small teeth. A small endochondral palatine hidden behind these articulates with the prefrontal. A metapterygoid is

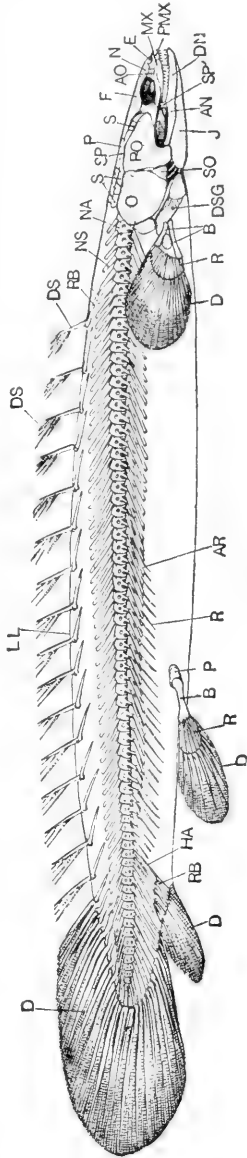

FIG. 265A.

Skeleton of *Polypterus bichir*, Growth. (After Dean, *Fishes Living and Fossil*.) AN, angular; AO, antorbital; AR, dorsal rib; B, basal; D, dentary; DS, dorsal fin support; DSG, dorsal fin support; E, ethmoid; F, frontal; HA, hyomandibular arch; J, joint; L, lateral line; MA, maxilla; N, nasal; NA, nasal arch; NS, nasal spine; O, opercular; P, pelvic cartilage; PMX, premaxilla; R, radial; S, spiracle; SP, splenial.

also present. The quadrate is only loosely connected with the hyoid arch, and bears the articulation for the lower jaw (Figs. 266-7):

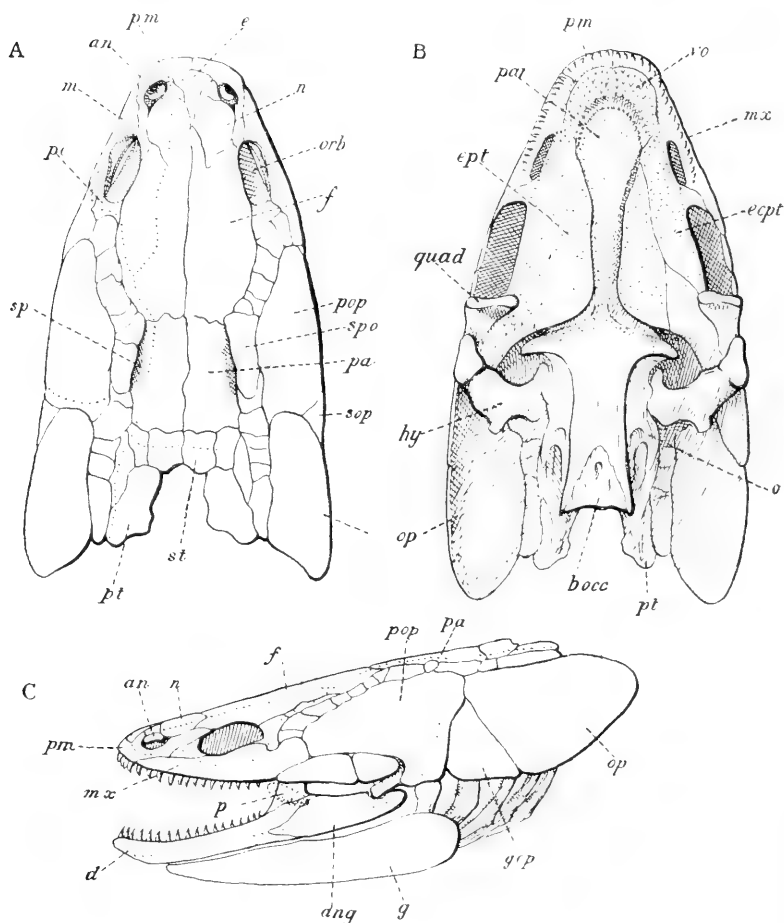

FIG. 266.

Skull of *Polypterus bichir*, Geoff. A, dorsal, and C, lateral view. (Modified from J. Müller and Allis.) B, ventral view, without the lower jaw. *an*, adnasal; *ang*, angular; *boc*, basi-occipital; *d*, dentary; *e*, mesethmoid; *ecpt*, ectopterygoid; *ept*, endopterygoid; *f*, frontal; *g*, paired gular; *gop*, suboperculum; *hy*, hyomandibular; *m*, maxilla; *n*, nasal; *o*, opisthotic; *op*, opercular; *orb*, orbit; *p*, labial cartilage (dotted); *pa*, parietal; *par*, parasphenoid; *pm*, premaxilla; *po*, postorbital; *pop*, preopercular; *pt*, post-temporal; *quad*, quadrate; *sop*, suboperculum; *sp*, spiracle; *spo*, spiracular plate; *st*, supratemporal; *vo*, vomer. A dotted line indicates the course of the lateral-line canal.

The palato-ptyergoid bar is, in fact, chiefly connected to the skull by the palatine and long pterygoid articulation. The hyomandibular

is an elongated bone sharing but little in the support of the jaws. There is no symplectic. Stylohyals, ceratohyals, and hypohyals are present. There are only four branchial arches, all with cerato- and hypobranchial, some with epibranchial, pharyngo- and supra-pharyngo-branchial as well. The basibranchials are, however, fused to a single plate. All the visceral arches are well ossified. A pair of bones, analogous to and perhaps homologous with the urohyal (p. 350), extend backwards from the ceratobranchials. The chondrocranium is extensively preserved even in the adult. A single ossification behind seems to represent the combined basi-occipital and exoccipitals. In the auditory capsule are a large opisthotic, probably including the epiotic, and a small prootic closely

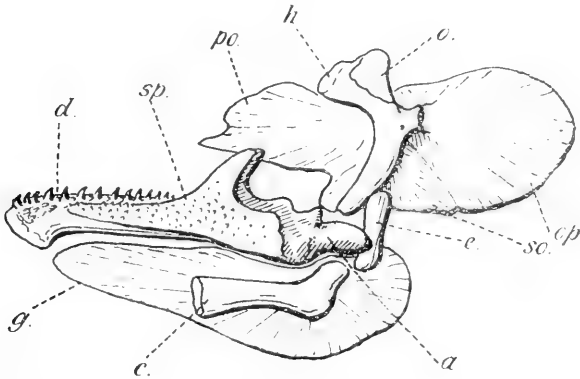

FIG. 27.

*Polypterus bichir*, Geoffr. Inner view of the lower jaw and hyoid arch. *a*, articular; *c*, ceratohyal; *d*, dentary; *e*, epihyal; *g*, inferior gular; *h*, hyomandibular; *o*, small dermal ossicle; *op*, opercular; *po*, preopercular; *so*, subopercular; *sp*, splenial.

connected to the parasphenoid (van Wijhe [494]). The cranial walls between the orbits are strengthened by two peculiar bones which surround the pituitary fossa and fuse ventrally; these 'sphenoids' probably represent both the alisphenoid and the orbito-sphenoid of other fish.

The dermal pectoral girdle consists of paired clavicles, cleithra, postclavicles, and supraclavicles (Fig. 212); the post-temporals are closely connected with the skull (Figs. 265A, 263). The endoskeletal girdle has an ossified scapula and coracoid, but no meso-coracoid arch (p. 276). This, and the small size of the 'primary' pectoral girdle, are points of resemblance with certain Teleosts. The skeleton of the pectoral fin is very peculiar (Gegenbaur [153, 162], Klaatsch [266]). It consists of two ossified basal rods, articulating with the girdle, between which is a wide cartilaginous plate with a bony centre. Attached to these is a row of distal ossified radials

and outer cartilage nodules (Fig. 263). Budgett [67] has shown that the fin-skeleton is really of the pleurorachic rhipidostichous type (p. 106), similar to that of the Selachii and lower Actinopterygii (*Amia*, p. 302). The posterior basal represents the axis or metapterygium; the anterior basal, the median plate, and the distal elements being derived from the preaxial radials partially fused at their base (Fig. 268). Still more Actinopterygian is the skeleton of the pelvic fin; here only four bony radials are preserved, separately articulating with the pelvic girdle. Two long bones with some small anterior cartilages represent the girdle (Fig. 269).

The axial endoskeleton is well ossified. The notochord is very much constricted by the solid bony amphicoelous centra (Fig. 265A).

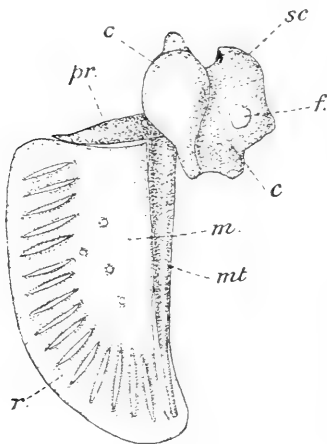

FIG. 268.

Reconstruction of the pectoral girdle and fin-skeleton of a larval *Polypterus*, enlarged. (After Budgett.) *c*, coracoid region; *f*, foramen; *m.*, mesopterygial cartilage plate; *mt*, metapterygium; *pr.*, propterygium; *r.*, radial; *sc*, scapular region.

The neural arches are continuous with the neural spines above. Throughout the abdominal region each centrum bears a pair of true dorsal ribs stretching outwards in the transverse septum to the skin, and a pair of ventral or pleural ribs below (p. 68); the former increase in length forwards, the latter increase in length backwards, and pass gradually into haemal arches. The extremity of the vertebral column stops far short of the edge of the caudal fin; it is almost, but not quite, perfectly straight, the end of the notochord being just a little turned upwards both in the larva and in the adult (Koelliker [271], Budgett [67]), and enclosed with the nerve-cord in a cartilage sheath, as in *Lepidosteus* and *Amia*. Although the tail is outwardly symmetrical,

there is reason to believe that it is not truly diphyccercal, but has been derived from a more heterocercal form. For, while the dorsal spines are separate from the radials in the epichordal lobe, in the hypochordal lobe the lepidotrichia rest on direct prolongations of the haemal arches as in typical heterocercal fins (Fig. 61, p. 101). Two points of interest are to be noticed in the anal fin: the proximal segments of the radials still articulate for the most part with the haemal spines, and some of them fuse together, as in the median fins of some Osteolepidoti (Fig. 252); and the dermal rays are still much more numerous than the radials (Fig. 265A). In the caudal

and dorsal fins each lepidotrich is related to one radial. The radials supporting the dorsal finlets are each formed of a single piece, which, as in the Holostei (p. 322), projects not at all beyond the body into the base of the fin (Bridge [56]).

There are four branchial slits, and neither mandibular nor hyoidean gill. The gill-lamellae project freely at their end into the gill-chamber; but there is more septum preserved than in the higher Actinopterygii (p. 95 and Fig. 57). A double series of cartilaginous rays supports the lamellae. A remarkable pinnate external gill is developed on the hyoid arch of the larva (Fig. 272). The ventral air-bladder, with cellular walls, and a symmetrical arterial blood-supply from the last branchial arch, has already been described (p. 223). The teeth are of simple conical shape, without foldings. There is a gastric caecum, and the intestine bears a single pyloric caecum (Fig. 270).

The brain of *Polypterus* shows many generalised characters (Bing and Burekhardt [73], Kerr [263]). The medulla is primitive in its form, the thinness of its walls, the large size of its ventricle, and the structure of its roof. The small cerebellum has a thin median zone, with thickenings at the sides, projecting forwards below, representing the valvula so much developed in the higher

Actinopterygii (p. 305). The optic lobes are of moderate size and paired. The roof of the fore-brain is epithelial and crossed by a deep velum transversum; large corpora striata are developed below. There are no cerebral hemispheres. In the young *P. palmas* the olfactory bulbs are sessile; but in the adult *P. bichir* they are stalked. On the whole, the brain of the Polypterini represents a primitive low stage of differentiation leading towards the Actinopterygian type (Fig. 271). With the brain of the Dipnoi or Amphibia it shows no particular affinity,

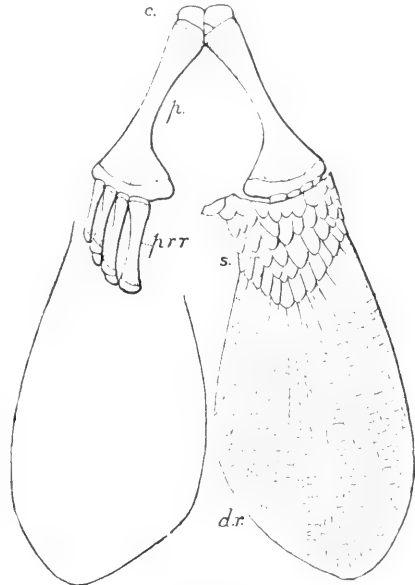

FIG. 269.

Ventral view of the pelvic girdle and fins of *Polypterus bichir*, Geoffr. The skeleton of the right fin is completely exposed. *c.*, anterior cartilage; *d.r.*, lepidotrichia supporting web of fin; *p.*, pelvic bone; *p.r.*, preaxial radials; *s.*, scaly-covered lobe. (From *Quart. Jour. Microsc. Sci.*)

and it differs markedly from that of the Elasmobranch. In the sacculus of the membranous labyrinth is found a large solid otolith, like that of the Actinopterygii Holostei.

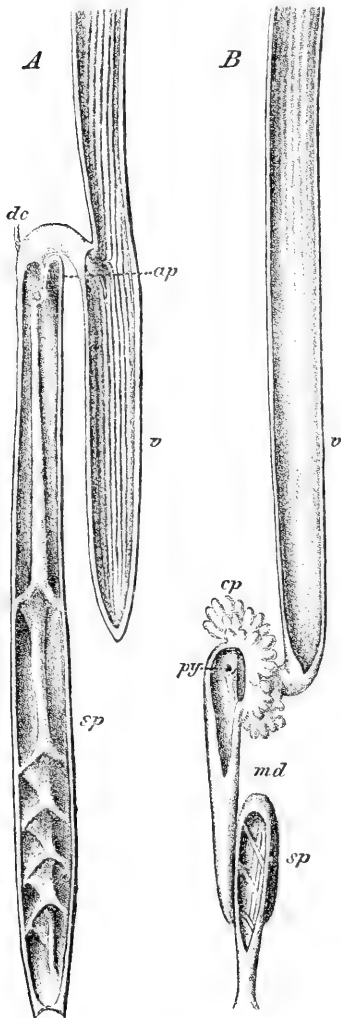

FIG. 270.

Alimentary canal of A, *Polypterus*; and B, *Lepidosteus*. (From Gegenbaur, *Vergl. Anat.*) *ap*, caecum; *c.p.*, pyloric caeca; *dc*, hepatic duct; *md*, intestine; *py*, pylorus; *sp*, spiral valve; *v*, stomach.

The urinogenital organs of the female are normal. Each oviduct opens into the coelom in front, and into the base of the mesonephric duct behind; the ova thus pass to the exterior by a median urinogenital pore behind the anus (Fig. 355). In the male the ducts are more specialised (Budgett [68]). The testis sac passes directly into a tube leading backwards to open into the urinary sinus, formed by the junction of the mesonephric ducts (Fig. 356, C and F). The spermatozoa pass out through the median urinogenital pore without entering the kidney. This separation of the vas deferens from the mesonephros is probably secondary, and may be considered to have been brought about by the same gradual process as in the Dipnoi (p. 253). The freeing of the vas deferens from the mesonephros, however, is not evidence of any close relationship with the Dipnoi, since it is found to have taken place independently in the Teleostei (p. 366) and in the Amphibia (some Anura).

Owing to the presence of lobate paired fins, of paired gulars, of rhomboid scales, and of an outwardly diphyccercal tail, and to a considerable similarity in the disposition of the roofing cranial bones, Huxley placed the Polypterini in his sub-order Crossopterygidae [227]. Comparing the living with the fossil genera, the resemblance of the paired fins is merely superficial, that of the cranial bones only general; the tail is probably secondarily sym-



metrical, and the scales are of very different structure. Of all this evidence the presence of paired gulars is the only item

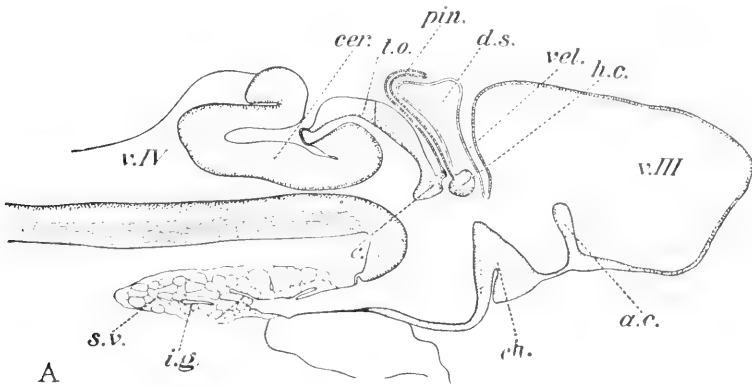

FIG. 271.

Median longitudinal section of the brain of *Polypterus bichir*. (From Kerr, Budgett Mem. Vol.) *a.c.*, anterior commissure; *c.*, posterior commissure; *cer.*, cerebellum; *ch.*, optic chiasma; *d.s.*, dorsal sac; *h.c.*, habenular commissure; *i.g.*, infundibular gland; *pin.*, pineal body; *s.v.*, saccus vasculosus; *t.o.*, tectum opticum; *v.III*, third ventricle; *v.IV*, fourth ventricle; *vel.*, velum.

above suspicion. The preopercular spreading over the cheek resembles that of certain Osteolepidoti (*Osteolepis*, *Eusthenopteron*), but is not a character of much importance. The bones of the palate are remarkably like those of the Coelacanth; and there is

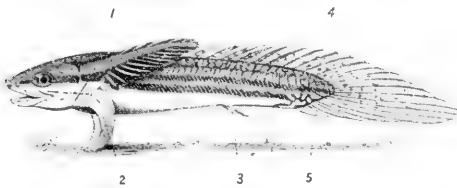

FIG. 272.

Larva of *Polypterus laprodei*, Stein. (After Budgett, *Trans. Zool. Soc.*) 1, external gill; 2, pectoral, 3, pelvic, 4, dorsal, and 5, anal fin.

also a resemblance with the latter in the agreement between the lepidotrichia and the radials in the caudal fin, in the shape of the pelvic bones, and in the absence of lateral gulars. On the other hand, many characters point to a closer affinity with the

Actinopterygii: the formation of the scales, the skeleton of the paired fins, the presence of double dorsal nostrils, the otolith. Excepting for the ventral opening of a bilobed air-bladder, the viscera also resemble those of the lower Actinopterygii; the structure of the brain, heart, and alimentary canal supports this view.

These facts would hardly justify us in placing the Polypterini among the known Actinopterygii; but they necessitate the

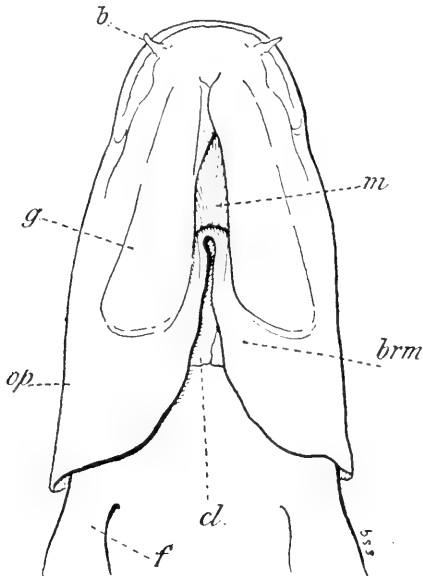

FIG. 273.

*Polypterus lapradii*, Stdr. Ventral view of head. *b*, barbel; *br.m.*, branchiostegal membrane; *cl.*, clavicle; *f*, pectoral fin; *g*, paired gular plate; *m*, intergular membrane; *op*, opercular region.

separation of the Order from the fossil forms generally associated with it.

The peculiar subdivision of the dorsal fin is the most distinctive newly acquired character of the Polypterini; presumably the finlets have been derived from a continuous dorsal fin, and this alone is a serious difficulty in the way of deriving these fish from any known extinct forms, except perhaps *Tarrasius*. A more detailed knowledge of this interesting fossil genus is greatly needed (p. 283).

Family POLYPTERIDÆ. *Polypterus*, Geoffr. (Fig. 274); *Calamoichthys*, Smith (Fig. 275); Equatorial Africa.

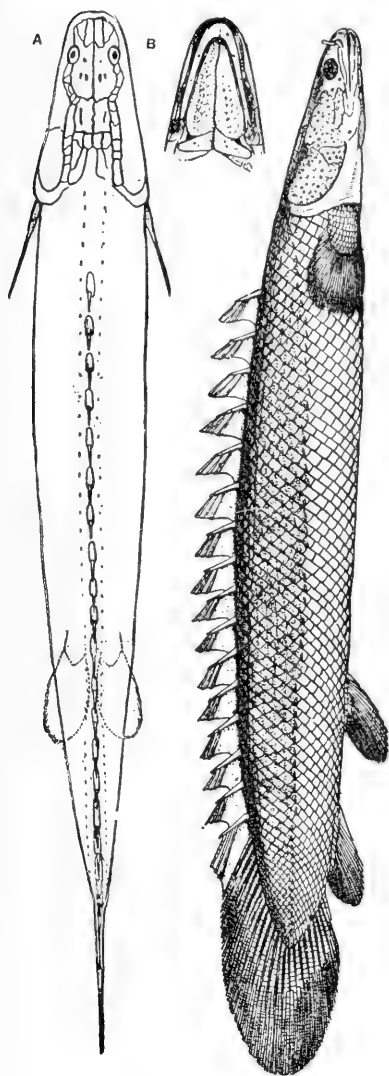

FIG. 274.  
*Polyppterus lichti*, Geoffr. A, dorsal view; B, ventral view of head. (Modified, after L. Agassiz, from Dean.)



FIG. 275.  
Right-side view of *Udmatoichthys ruberatus*, Smith. (After Dean, *Fishes Living and Fossil*.)

## Division 4.

## ACTINOPTERYGII.

The paired fins are non-lobate, the radials having been so much reduced that they scarcely project beyond the body-wall, and the

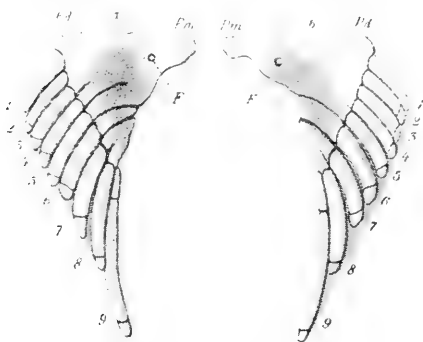

FIG. 276.

Ventral view of the cartilaginous skeleton of the pelvic girdle and fin of *Scaphirhynchus*. (After Rautenfeld.) *Pm*, median, and *Pd*, dorsal process of girdle; *F*, nerve-foramen; 1-9, radials.

p. 108). All distinct trace of an axis has disappeared in the pelvic

fin of the Holostei, where the few remaining radials articulate directly with the pelvic bone (Figs. 245-8). This is also the case with the pectoral fin of the Teleostei (Figs. 243, 480). But in *Amia* and *Lepidosteus* a basal element persists, bearing several radials (Fig. 241); and here the fin appears to be built on the rhipidostychous plan, with a post-axial axis. Very interesting and important is the skeleton of the paired

fins in the Chondrostei (Davidoff [98], Wiedersheim [492], Rautenfeld [343], Thacher [434], Salensky [380], Mollier [301]).

web of the fin is almost entirely supported by the dermatrichia. The same is the case in the median fins. It cannot be said that there is any evidence of a biserial arrangement of the radials in the paired fins of the Actinopterygii, yet it is usually supposed that they have been derived from such an archipterygium by the loss of the post-axial radials (Gegenbaur [158, 162], Braus [48]; see

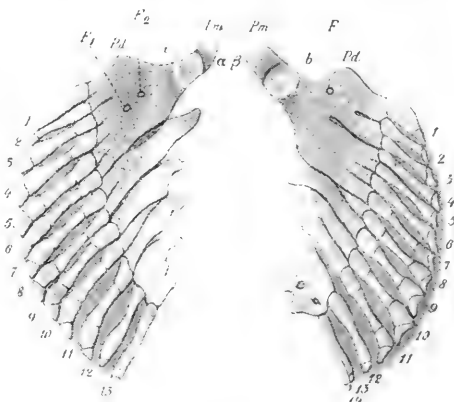

FIG. 277.

Ventral view of the endoskeleton of the pelvic girdle and fin of *Polyodon folium*, Lac. (After Rautenfeld.) *Pm*, median, and *Pd*, dorsal process of girdle; *F*, *F*<sub>1</sub>, and *F*<sub>2</sub>, nerve-foramina; 1-13, radials.

The pectoral fin has a fairly normal skeleton, conforming to the rhipidostycheous plan, with a postaxial axis (Fig. 279); but the pelvic fin has a remarkable structure, differing from that of all other Osteichthyes. No definite line of demarcation exists between the pelvic girdle and the skeleton of the fin itself (Figs. 276-8). The radials, forming a single series, are articulated to basals, which are more or less independent posteriorly, but become fused to the girdle in front. A skeleton is thus formed somewhat resembling that of Cladoseleache, and suggesting a derivation from a primitive orthostichous type (Wiedersheim [492], Regan [345]) rather than from an outstanding axis in a projecting lobe (see p. 108). Dorsal processes, analogous if not homologous with the iliac process, are developed along the basal region of the fin of *Polyodon*. In *Scaphirhynchus cataphractus* the internal end of the pelvic cartilage may be segmented off as a separate element. So far as is known, the radials of the dorsal and anal fins undergo little concentration, and do not tend to fuse together proximally as in the lower Teleostomi and the Dipnoi. The tail is heterocercal, homocercal, or gephyrocercal, never truly diphyrcercal (Belonorrhynchidae?). When the median fin is subdivided, as is the case in all except some Teleostei, a

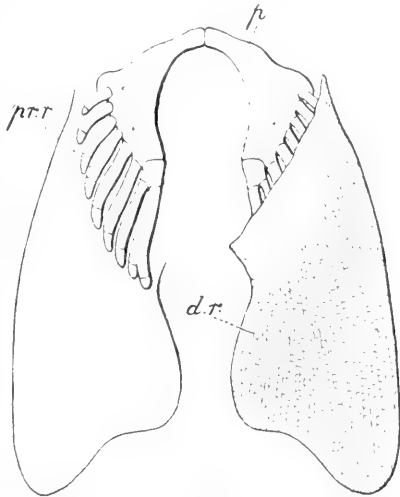

FIG. 278.

Ventral view of the pelvic girdle and fins of *Acipenser sturio*, L. The skeleton of the right fin is completely exposed. *dr*, lepidotrichia supporting web of fin; *p*, pelvic cartilage; *p.r.r.*, preaxial radials. (From *Quart. Journ. Micr. Sci.*)

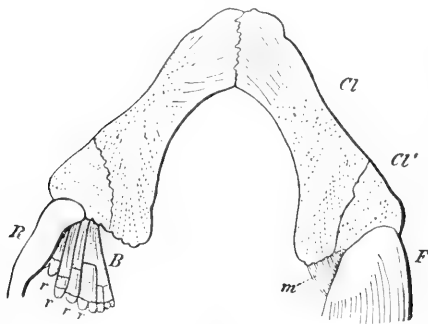

FIG. 279.

Pectoral girdle and fins of *Acipenser sturio*. Ventral view. (From Gegenbaur, *Vergl. Anat.*) *B*, postaxial edge of fin-skeleton; *cl*, clavicle; *cl'*, cleithrum; *F*, base of left fin; *m*, muscle; *E*, enlarged preaxial dermal ray; *r*, endoskeletal radials.

single anal and a single

dorsal separate from the caudal. Those cases in which there appear to be two or more dorsals (Teleostei, p. 480) are probably due to secondary modification. In all the more primitive groups fulcral scales are found on the extreme anterior edge of some or all of the fins, especially on the dorsal edge of the caudal. The fulcra are quite peculiar to this Division, and consist of a double series of elongated scales (Fig. 286); often the opposing scales fuse to V-shaped fulcra (Fig. 280). In the gular series of plates the most anterior median is generally large and the paired series become very numerous and narrowed (Figs. 285-7). They are converted into freely movable branchiostegal rays. The two foremost may be longer than the others, but never occupy the space between the two rami as in the Osteolepidoti, Coelacanthini, and Polypterini, and are probably not homologous with the paired gulars of the first two Orders. The body-scales and dermal plates of the more primitive forms are of the true ganoid structure (p. 218). Usually the scales have peg and socket articulations, and the peg often appears as the continuation of an inner thickened ridge. But these scales, like the

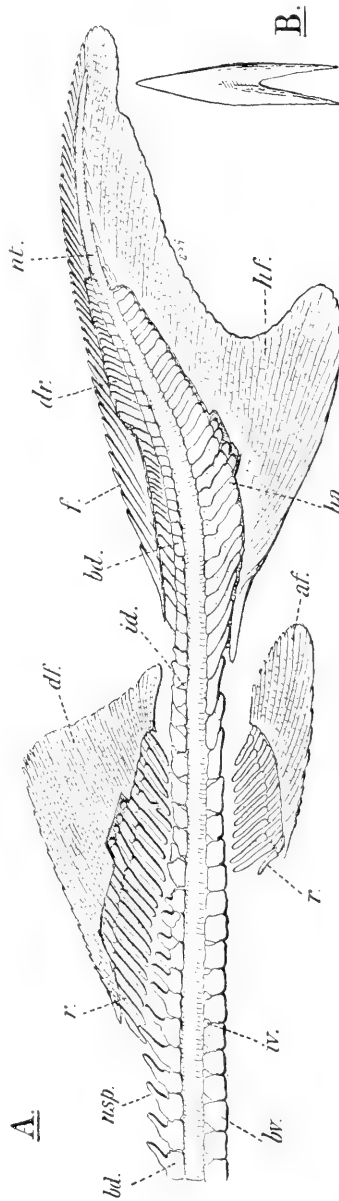

FIG. 280.

A, vertebral column and median fins of *Acipenser ruthenus*, L.; the endoskeletal supports of the fins have only been completely exposed here and there. B, fulcral scale from the tail of *Acipenser sturio*, L. a.f., anal fin; b.f., basiodorsal; d.f., dorsal fin; d.r., dorsal spine; n.sp., neural spine; i.v., intervertebral; i.d., interdorsal; h.a., haemal arch; h.f., hypochordal fin; t, tail.

branchiostegal rays and the fulera, may in the course of divergent evolution undergo great modification and reduction. In the primitive forms the cranial bones conform to the ordinary Teleostome plan; the preoperculum does not cover the cheek, as is so often the case in the Osteolepidoti.

The brain in the Actinopterygii acquires a very characteristic structure. The preponderance of the hind- and mid-brain over the fore-brain, which has already been noticed in the Teleostomes in general, becomes more pronounced, especially in the Teleostei. There is a large cerebellum, which, instead of bulging almost entirely on the surface, as, for instance, in the Selachian, extends forwards and inwards into the ventricle of the mesencephalon. In the

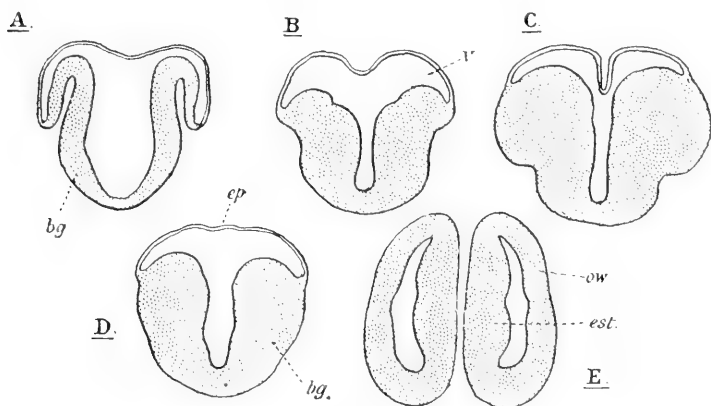

FIG. 281.

Diagrams of transverse sections through the secondary fore-brain of A, *Polypterus* (after Burckhardt); B, *Acipenser* (after Goronowitsch); C, *Amia*; D, *Salmo*; E, *Protopterus* (after Burckhardt).

Chondrostei the solid cerebellum projects but little into the mesocoel, and forms but a rudiment of this valvula cerebelli (Fig. 282), which becomes very large in the Teleosts, filling almost completely the cavity of the mid-brain (Fig. 352). Large paired hollow optic lobes are conspicuous, except in the Chondrostei, their roof (tectum opticum) covering the valvula. The diencephalon becomes shortened and partially hidden above; below there is a large infundibular outgrowth, with very well developed lobi inferiores and saccus vasculosus (Figs. 282-3, 353). The fore-brain is remarkably undeveloped; no cerebral hemispheres are formed, the lamina terminalis becomes almost horizontal, the basal ganglia (corpus striatum and epistriatum) are the only conspicuous paired thickenings, and the whole of the roof remains epithelial (Fig. 281). A large velum transversum is present, but the ventricle remains undivided in the middle line. The olfactory lobes are sessile in the

lower forms, but may be stalked in the Teleostei. The ganglionic cells become clearly stratified (Goronowitsch [180], Mayser [298], Rabl-Rückert [340], Johnston, Mihalkowikz).

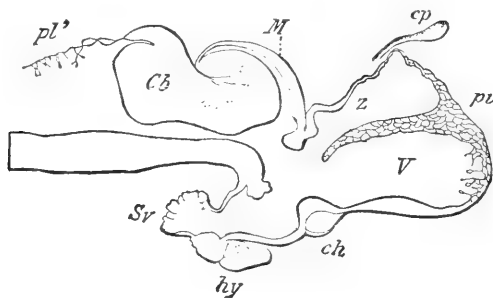

FIG. 282.

Median longitudinal section of the brain of *Acipenser ruthenus*. (After Goronowitsch, from Sedgwick's *Zoology*). *Cb*, cerebellum; *ch*, optic chiasma; *cp*, pineal body; *hy*, pituitary body; *pi*, roof of telencephalon with choroid plexus; *M*, roof of mesencephalon; *pl*, roof of myelencephalon; *Sv*, saccus vasculosus; *V*, cavity of telencephalon; *z*, cavity of thalamencephalon.

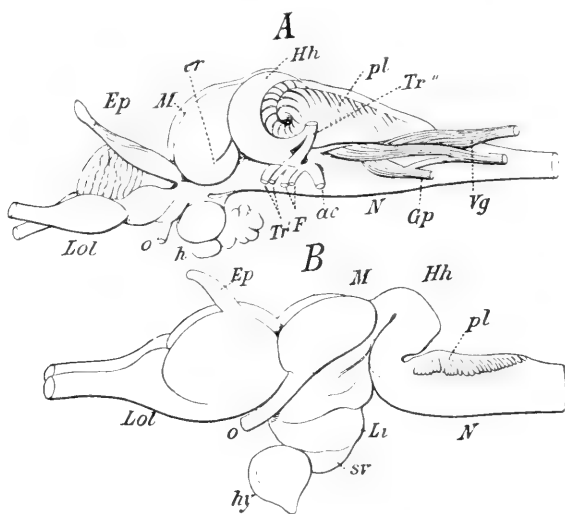

FIG. 283.

Left-side view of brain of A, *Acipenser ruthenus*; and B, *Amia calva*. (After Goronowitsch, from Gegenbaur, *Veigl. Anat.*) *ac*, auditory nerve; *Ep*, epiphysis; *F*, facial nerve; *Gp*, glosso-pharyngeal nerve; *h* and *hy*, hypophysis; *Hh*, cerebellum; *Li*, lobus inferior; *Lol*, olfactory lobe; *M*, mesencephalon; *N*, myelencephalon; *o*, optic nerve; *pl*, choroid plexus; *Tr'* and *Tr''*, trigeminal nerve; *sr*, saccus vasculosus; *Vg*, vagus nerve.

The urinogenital organs are discussed elsewhere (p. 365); but it may here be mentioned that the cloaca is lost, the anus opening separately in front, and the genital and urinary ducts lead into a



sinus opening behind. In the Teleostei, however, the sinus may disappear, all the openings coming to the surface (Fig. 354).

The Actinopterygii first appear in early Devonian strata, and have since become the dominant group of fish. The recent advances in our knowledge of the structure and classification of the more primitive fossils formerly included in the Ganoidii are due to Wagner, Vetter, Thiollière, Pietet, Heckel, Zittel, Pander [312], Traquair [446, 448, etc.], and A. S. Woodward [505]. They are now generally subdivided into four sub-orders of equal rank; but the Lepidosteidae and Amiidae are so closely related to the Teleostei, that we prefer to unite these three groups in one Sub-division, the Holostei, to be distinguished from the Chondrostei (Heckel [205a], Pietet, Wagner [477], Vetter [473], Davis [100], Thiollière [473], Zittel [513], Crook [94], Kner and Steindachner [268], Loomis [285]).

#### SUBDIVISION 1.

#### Order CHONDROSTEL.

This group contains the most ancient and the most primitive known Actinopterygii. The definite association of the Palaeoniscidae and Platysomidae with the Acipenseroidei is due to Traquair [446, 448] (one of the Palaeoniscids, *Cheirolepis*, is found as the first representative in Lower and Upper Devonian rocks). They seem to have diverged in three principal directions, leading to the Platysomidae, Chondrosteidae, and Catopterydae. The affinities of the Belonorhynchidae are very doubtful, and they are only provisionally placed here. The degenerate Chondrostei are considered to be the only direct survivors at the present day of the sub-order; but it must be remembered that the belief in their close affinity to the Palaeoniscids rests on slender evidence. The whole endoskeleton is very incompletely ossified, remaining for the most part cartilaginous, and in consequence is very incompletely known in the extinct species.

The notochord in living forms is quite unconstricted, and surrounded by a very thick sheath outside which are no true centra. The vertebral column was presumably of the same structure in the fossils; but traces of centra have been described in *Pygopterus* and *Phanerosteon* (Traquair [446], Fritsch [139]). Only pleural ribs occur in the living Chondrosteidae; but they are unknown in the extinct families. The dorsal ribs are absent.

In *Acipenser* the persistent notochord, surrounded by its thick fibrous sheath and its thin *elastica externa*, bears along its dorsal surface a cartilaginous neural tube formed by a series of large

basidorsals (neural arches) and small interdorsals (Figs. 280, 284). The former have ossified dorsal extremities embracing the powerful

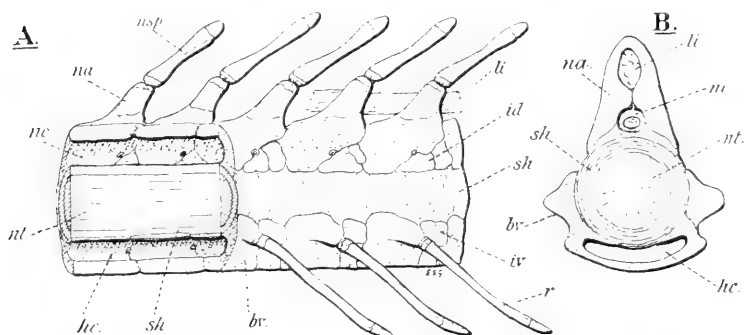

FIG. 284.

Vertebral column of *Acipenser sturio*, L., from the trunk region. A, left-side view of a piece partly cut through longitudinally; B, the same cut transversely. *br*, basiventral; *hc*, haemal canal; *id*, interdorsal; *iv*, intervertebral; *li*, longitudinal ligament; *na*, basidorsal; *nc*, neural canal; *n.sp.*, neural spine; *nt*, notochord; *r*, pleural rib; *sh*, notochordal fibrous sheath bounded outside by the elastica externa.

longitudinal ligament, and to which articulate the long neural spines. Ventrally runs a cartilaginous haemal tube formed by

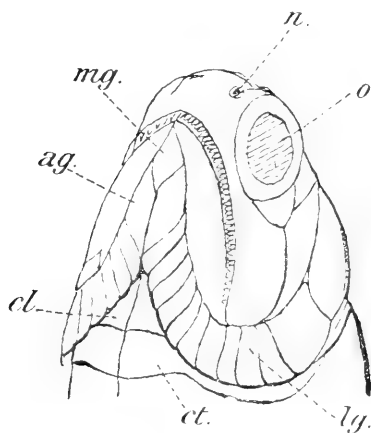

FIG. 285.

Oblique ventral view of the head of *Goniatulus punctatus*, Ag.; Calciferous Sandstone, Wardle. (After Traquair.) *ag.*, enlarged anterior lateral gular; *cl.*, clavicle; *ct.*, cleithrum; *lg.*, lateral gular; *mg.*, median gular; *n.*, nostril; *o.*, orbit.

a corresponding series of basi-ventrals and interventrals, and surrounding the aorta. The neural arches and spines of the Palaeoniscids seem to have been similar (*Cocrolepis*). The endoskeleton of the median fins resembles rather that of the Selachian than that of the Holostei (Fig. 280). In the dorsal and anal it is in the form of segmented rods, of which the two proximal pieces are long and sometimes ossified, while the distal segments are very much shorter (Bridge [56]). There is little concrescence, but probably considerable concentration, as the radials are more numerous than the segments in which they lie. Primitive character

is also shown in the overlapping of the distal ends of the radials by the base of the lepidotrichia, which are much more numerous. In

*Coccolepis*, however, they only slightly exceed the radials in number (A. S. Woodward [501]). The tail is typically heterocercal, and generally distinctly forked owing to the great development of the anterior region of the hypochordal lobe. Along the upper edge of the dorsal lobe (Fig. 280) runs the vertebral column, the epichordal fin being represented externally only by the row of fulera—it is this which distinguishes the heterocercal tail of the Chondrostei from that of other fish.

There is no interoperculum, and no large paired inferior gulars, although in Palaeoniscids the first pair of lateral gulars may be enlarged. The anterior median gular is small or absent. The scales vary from the rhombic to the cycloid type, or persist as large plates. The articulating peg projects from the dorsal edge. They often differ considerably in structure on various parts of the body, and it is characteristic that while on the trunk the scales are disposed in the usual oblique rows bending backwards and downwards, this disposition is suddenly reversed on the tail, where they pass downwards and forwards (Fig. 290). Elongated rhomboid scales are preserved on the tail even when they are lost on the trunk.

The frequent presence of a hyoid demibranch, of a spiracle, and of a spiracular pseudobranch, indicates primitive structure. It has been noticed above that the brain shows certain primitive characteristics; the same may be said of the urinogenital organs and other viscera.

#### Sub-Order 1. PALAEONISCOIDEI.

In which the scales are of the palaeoniscoid type of structure (p. 218), with ganoine and cosmine (Figs. 191, 288).

Family PALAEONISCIDAE. These are the most primitive and earliest of the Actinopterygii. They appear in the Lower Devonian, are abundant in the Carboniferous and Permian, and die out in the Jurassic times. The dermal skeleton is covered with ganoine. The scales are usually rhomboid, with articulating pegs; but in some (*Coccolepis*, *Cryphiolepis*) the scales are cycloid and deeply imbricating on the trunk, and in *Phanerosteon* the trunk is almost scaleless.

The orbits are far forward and the snout blunt, so that the nostrils are lateral, or even ventral, rather than dorsal. The superficial cranial bones differ but little in plan from those of the normal Teleostome. The opercular, subopercular, and lateral gulars form a very continuous series. The preopercular is narrow and bent forwards, the maxilla spreads backwards over the cheek; the premaxilla is small; a large median ethmoid probably includes the nasals. The orbit is surrounded by a narrow ring of few bones. The supratemporals are a narrow row of transversely set bones; the post-temporal is large (Figs. 285-7).

The hyomandibular is elongated backwards and connected with a broad pterygoid plate. A symplectic has not been found. The lower jaw has dentary, angular, splenial, and articular bones.

Numerous radials occur in the pelvic fin of *Coccolepis* (A. S. Woodward [501]), the only genus in which the endoskeleton of the fins is known.

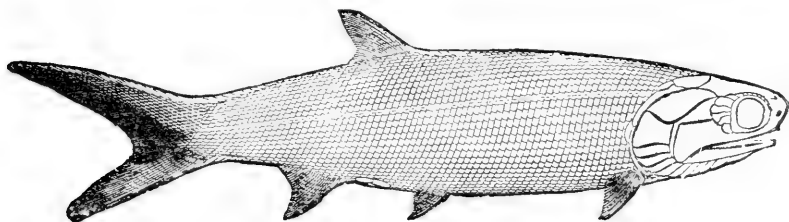

FIG. 286.

*Palaeoniscus macrodonus*, Ag.; restored. (After Traquair, from A. S. Woodward.)

Sub-Family CHEIROLEPIDINAE. The Devonian *Cheirolepis* in the minute size of its scales fitting close together, but scarcely overlapping, approximates to the Acanthodii (Fig. 288); but otherwise it is a genuine Palaeoniscid. The proximal lengthened segment of the lepidotrichia passes inwards below the body-scales, overlapping the endoskeletal radials. The

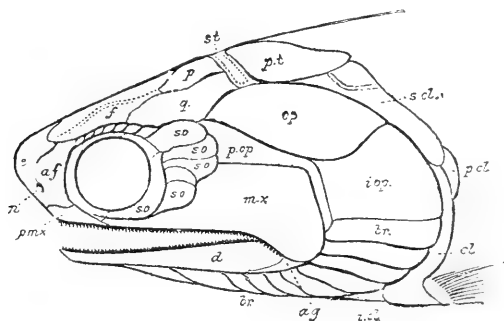

FIG. 287.

Head of *Palaeoniscus macrodonus*, Ag.; restored. (After Traquair, from A. S. Woodward.) *af*, prefrontal; *an*, angular; *br*, branchiostegals (lateral gulars); *cl*, cleithrum; *d*, dentary; *e*, ethmoid; *f*, frontal; *i.cl*, clavicle; *i.op.*, subopercular; *mx*, maxilla; *n*, narial opening; *op*, opercular; *p*, parietal; *p.cl*, post-clavicle; *p.op.*, preopercular; *pt*, post-temporal; *pmx*, premaxilla; *q*, pterotic (squamosal); *sc*, supraclavicle; *so*, circumorbital ring and postorbitals; *st*, supratemporal. Dotted lines indicate the course of lateral-line canals.

anterior paired gulars are large, and there are large laniary teeth on the jaws (Traquair [444]).

*Cheirolepis*, Ag.; Devonian of Europe and Canada.

Sub-Family PALAEOONISCIDINAE. The paired gular plates are not much enlarged, the scales are of normal size, the lepidotrichia scarcely extend inwards, and the teeth are usually quite small [446].

*Canobius*, Traq.; *Cryphiolepis*, Traq.; *Gonatodus*, Traq.; *Nematoptychius*,

Traq. ; *Rhadinichthys*, Traq. ; *Holurus*, Traq. ; *Phanerosteon*, Traq. ; Carboniferous, Europe. *Eurylepis*, Newb. ; Carboniferous, N. America. *Pygopterus*, Ag. ; *Palaeoniscus*, Bl. (Fig. 286) ; Permian, Europe.

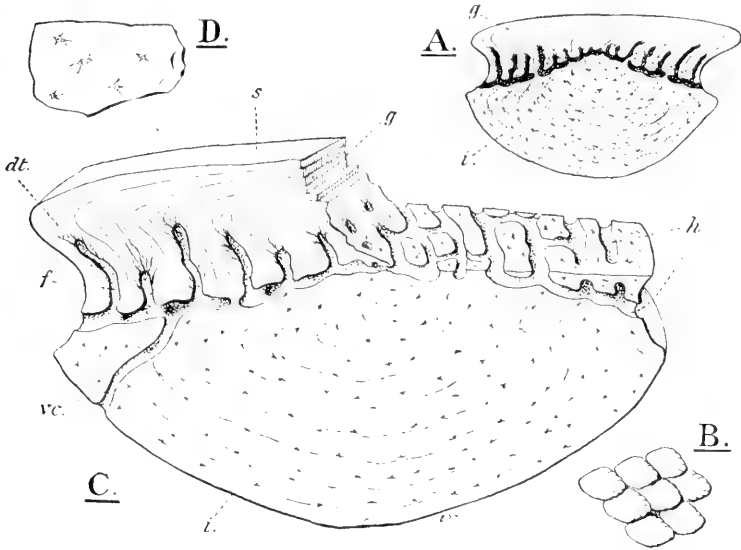

FIG. 288.

*Cheirolepis*, sp., L. Devonian. A, transverse section of scale. B, outer view of scales enlarged. C, much enlarged view of a piece of a scale cut transversely. D, a fragment of the inner bony layer, magnified. *dt*, canaliculi of cosmine layer; *f*, vertical blind canals (pulp-cavities); *g*, ganoine layer; *h*, system of horizontal vascular canals; *i*, inner bony layer, isopidine; *s*, shiny outer surface; *vc*, vertical canal.

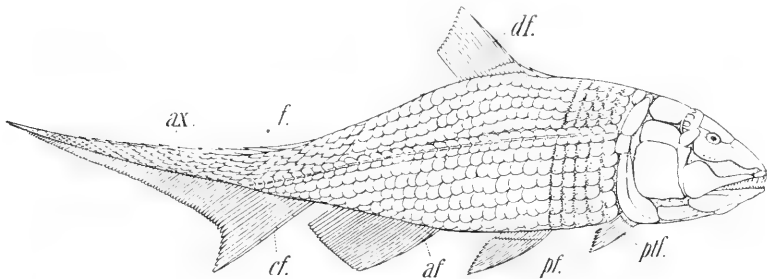

FIG. 289.

Restoration of *Trissolepis Kounovicensis*, Fr. (After Fritsch.) *af*, anal fin; *ax*, scale-covered tail; *cf*, hypochordal fin; *df*, dorsal, *pf*, pelvic, and *plf*, pectoral fin; *f*, fulcral scale.

*Amblypterus*, Ag. ; Europe. *Acrolepis*, Ag. ; Europe and N. America ; Permian and Carboniferous. *Elonichthys*, Geibel ; Carboniferous in Europe and N. America ; Permian in Europe. *Gyrolepis*, Ag. ; Trias, Europe. *Apateolepis*, A. S. W. ; *Atherstonia*, A. S. W. ; *Myriolepis*, Eg. ;

Trias, N.S. Wales. *Coccolepis*, Ag. ; Trias, N.S. Wales, and Lower Lias, England. *Oxygnathus*, Ag. ; *Centrolepis*, Eg. ; Lower Lias, England.

Sub-Family TRISSOLEPINAE. Very like Palaeoniscinae ; but there are no fulcra except on the upper caudal lobe, the lepidotrichia are

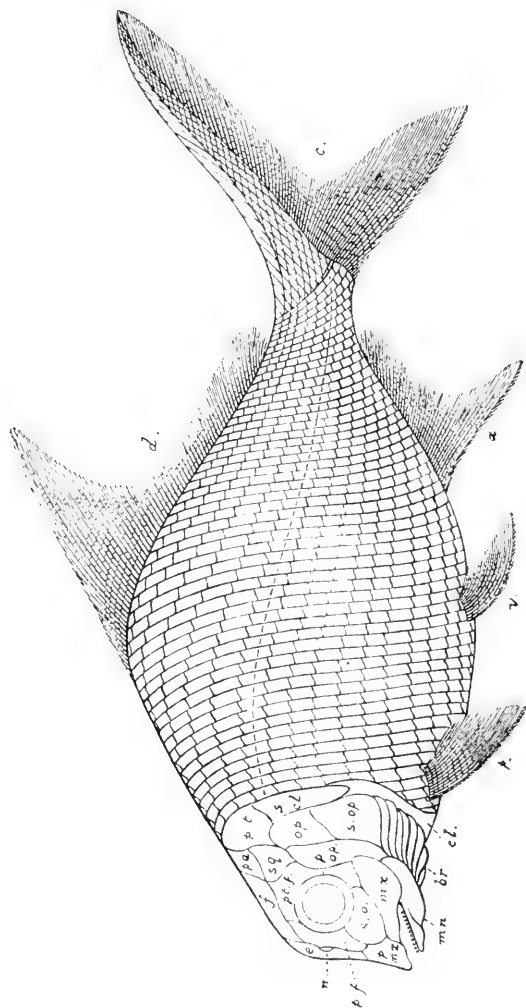

FIG. 290.

Restored outline of *Mesolepis scottaris*, Young; from the North Staffordshire Coalfield. (After Traquair, *Trans. Roy. Soc. Edin.*, v. 46.) *a*, anal; *c*, caudal; *cl*, clavicle; *d*, dorsal; *e*, eye; *f*, frontal; *g*, gill; *h*, nostril; *mb*, mandible; *mx*, maxilla; *n*, nostril; *op*, opercular; *p*, pectoral; *pmx*, premaxilla; *pmx*, premaxilla; *pp*, preopercular; *pt*, post-temporal; *plf*, post-frontal; *psf*, supraclavicle; *sp*, suborbital; *subp*, subopercular; *sp*, pterotic (squamosal); *v*, pelvic.

unbranched, and the scales behind the head have toothed edges, while those on the hinder trunk-region are cycloid, and those on the tail remain rhomboid. The palate is strongly toothed (Fritsch [139]).

*Trissolepis*, Fritsch ; Permian, Bohemia (Fig. 289).

: Family PLATYSOMIDAE. In everything but the shape of the head

and trunk, which become very much compressed and deepened, and the accompanying extension of the dorsal and anal fin, the *Platysomidae* closely resemble the *Palaeoniscidae* (Fig. 290). *Eurynotus*, *Mesolepis*, and *Platysomus* are three stages in change of form. As the body deepens the scales become transversely elongated, the articular pegs being at their upper end (Fig. 191). The jaws become more pointed, and the pelvic fins become reduced in size (*Platysomus*), or apparently disappear altogether as in *Cheirodus*. No symplectic is known, the hyomandibular becomes nearly vertical, and the mouth is diminished (Fig. 291). The teeth may be considerably modified, becoming swollen and tritoral. In *Cheirodus* and *Cheirodopsis* the palatal and splenial teeth fuse to grinding plates. This family is found in Carboniferous and Permian strata [444, 448].

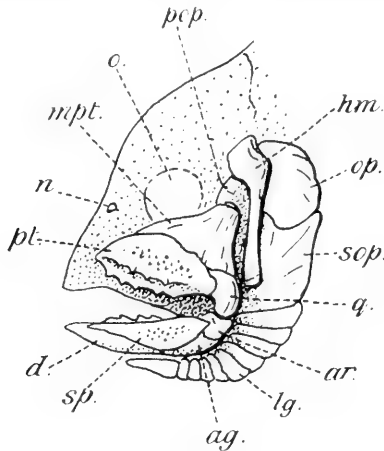

FIG. 291.

*Cheirodus granulatus*, Young. Restoration showing the bones associated with the mandibular and hyoid arches. (After Traquair.) *ag*, angular; *ar*, articular; *d*, dentary; *hm*, hyomandibular; *mpt*, metapterygoid; *n*, position of nostril; *o*, orbit; *op*, opercular; *pcp*, preopercular; *pt*, pterygoid; *q*, quadrate; *scp*, subopercular; *sp*, splenial.

*Eurynotus*, Ag.; *Mesolepis*, Young (Fig. 290); *Wardichthys*, Traq.; *Cheirodus*, McCoy; *Cheirodopsis*, Traq.; Carboniferous, Great Britain. *Globulodus*, Münster; Permian, Europe. *Platysomus*, Ag.; Carboniferous and Permian, Europe.

**FAMILY CATOPTERIDAE.** A triassic family of fusiform fish resembling the *Palaeoniscidae* in general structure; but with an abbreviate heterocercal tail, and lepidotrichia which only slightly exceed the radials in number. The latter also appear to be formed chiefly of one long proximal segment. In the characters just mentioned the *Catopteridae* undoubtedly approach the *Holostei*, with which they should possibly be classified. The head and shoulder girdle are quite *Palaeoniscid*. The ganoid scales are rhombic; the teeth slender and conical [505].

*Catopterus*, Redf.; Trias, N. America. *Dictyopyge*, Eg. (Fig. 292); Trias, N. America and Europe.

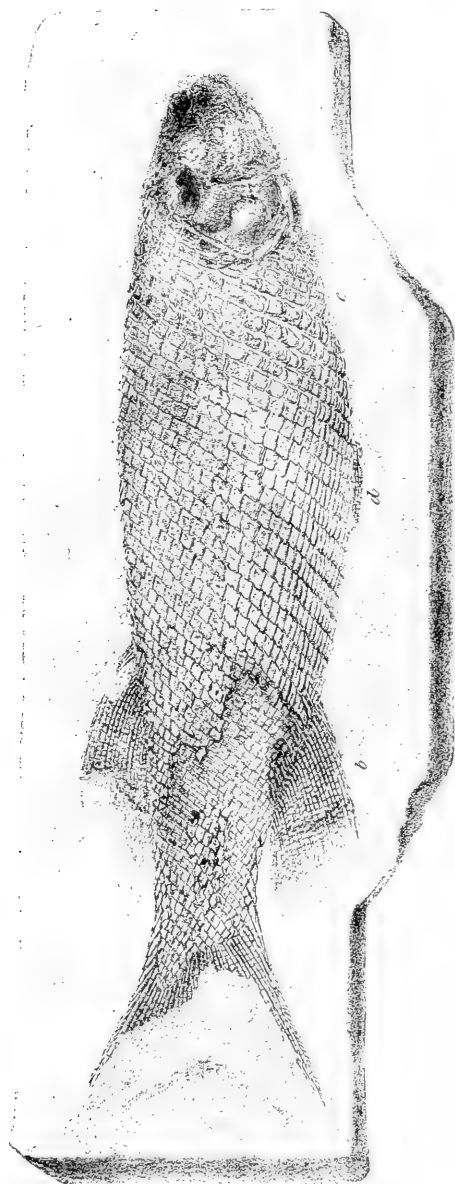

FIG. 292.

*Diadromus macrurus*, Redf. Right-side view. Triassic, Virginia. (After Egerton, from *Brit. Mus. Catol.*)



## Sub-Order 2. ACIPENSEROIDEI.

According to the researches of Traquair [451] and A. S. Woodward [505], the families in this group form a degenerating series starting from a type similar to the Palaeoniscids; they reach the highest degree of differentiation in the Acipenseridae.

The body remains fusiform with a typical bifurcated heterocercal tail. The dorsal and anal fins are moderately short. The orbits are far forward, near the olfactory capsules, but the snout becomes greatly prolonged beyond them and the mouth.

This rostrum is borne by a prolongation of the median ethmoid cartilage (Fig. 293). The cartilaginous cranium is, indeed, in living forms massively developed, and extends far back, passing gradually

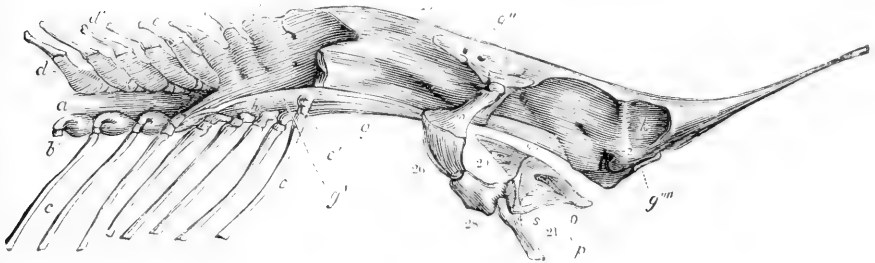

FIG. 293.

Left-side view of the skull and vertebral column of *Acipenser*. The branchial arches have been removed. (From Owen, *Anatomy of Vertebrates*, by permission of Messrs. Longmans and Co.) *a*, notochordal sheath; *b* and *c*, basiventral; *d*, pleural rib; *d'*, basidorsal; *d''*, interdorsal; *e*, neural spine; *f*, cartilage cranium; *f'*, anterior neural arches fused on behind; *g, g', g'''*, parasphenoid; *g''*, articular of hyomandibular; *g'''*, vomerine plate; *i*, orbit; *l*, nasal capsule; *m*, hyomandibular; *o*, maxilla; *p*, palatine; *s*, 'jugal'; 20, pterygoid cartilage; 26, hyomandibular cartilage; 28, symplectic; 32, dentary.

into the vertebral column. Some half-dozen sclerotomes are more or less completely fused with the back of the skull behind the vagus (Sewertzoff [406]); there is no break between the skull and the vertebral column, and the notochord passes uninterruptedly forwards to the pituitary region (Fig. 293).

The whole cranium is supported below by an immense parasphenoid, and the vomers are pushed forwards to below the rostrum. The palato-quadrates meet in the middle line, which is exceptional among Teleostomes, and lose their articular connection with the ethmoid and sphenoid regions of the skull. The jaws are weakened, become freed from the skull, and lose the premaxilla. The large hyomandibular is only loosely connected with the jaws by means of ligaments and a large symplectic. The five branchial arches are well developed. The frequent presence of a hyoid demibranch (opercular gill), of an open spiracular cleft, and of a spiracular pseudobranch, indicates primitive structure. The gill-

lamellae are attached to a septum for about half their length (p. 95). The brain and other internal organs are of generalised structure (p. 305).

The scales possibly preserve some true ganoine in some of the early genera; but they never show any trace of the cosmine or of the network of vascular canals seen in Palaeoniscids. In *Acipenser* they are formed merely of concentric layers of bone.

The chief degenerate characters of the more recent forms are shown by the loss of the ganoine on the dermal skeleton, the loss of

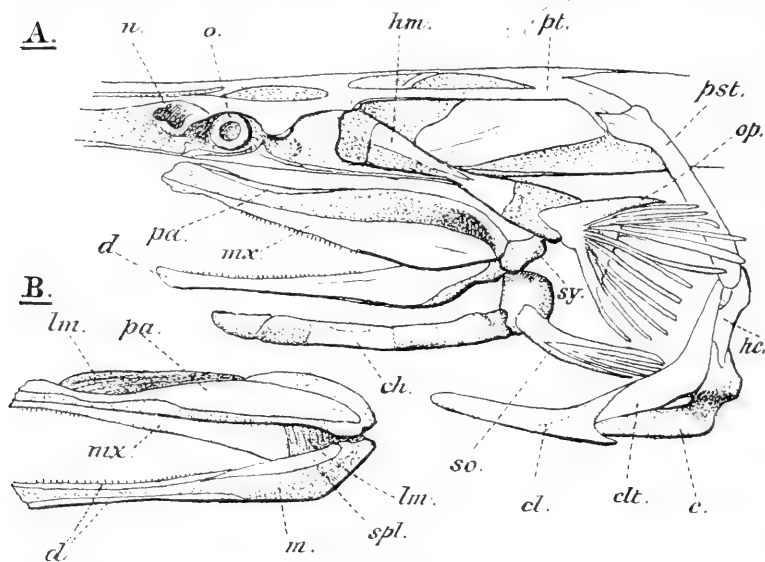

FIG. 294.

*Polyodon filium*, Lac. (After Traquair.) A, left-side view of skull, jaws, and pectoral girdle; B, inner view of right jaws. c, coracoid; ch, ceratohyal; cl, clavicle; ch, cleithrum; d, dentary; hc, postclavicle; hm, hyomandibular; lm, levator muscle; m, Meckel's cartilage; mx, maxilla; n, olfactory capsule; o, optic capsule; op, opercular; pa, palatine; pst, post-temporal; pt, pterotic; so, subopercular; spl, splenial; sy, symplectic.

scales on the trunk, of branchiostegal rays, of the median gular, and the reduction of the opercular bones; the loss of fulera, except on the tail; the irregularity and subdivision or loss of the dermal cranial bones; the loss of the premaxillae and reduction of the teeth; the appearance of a median series of bones on the skull; the relative lack of ossification in the endoskeleton. There seems, on the other hand, to be a compensating recrudescence of cartilage.

Family CHONDROSTEIDAE. The trunk appears to be scaleless; rhombic ganoid scales are found on the tail only. The paired frontals, parietals, postfrontals, and pterotics (squamosals) are still normally developed, and not separated by a median series (Fig. 295).

Four paired and one median (occipital) supratemporal are present; also an opercular, a large subopercular, and numerous branchiostegal rays. The exact condition of the rostrum and of the sides of the head is not known, but a suborbital and a small 'jugal' (preopercular?) are found. There is no median gular; but about ten branchiostegal rays (Fig. 295). The pterygoids, palatine, dentary, angular, and articular are still present. The jaws are rather small and apparently toothless. The rest of the skeleton closely resembles that of the sturgeons. The Chondrostei are the earliest of this group and occur in the Lias (Egerton, Traquair [451]).

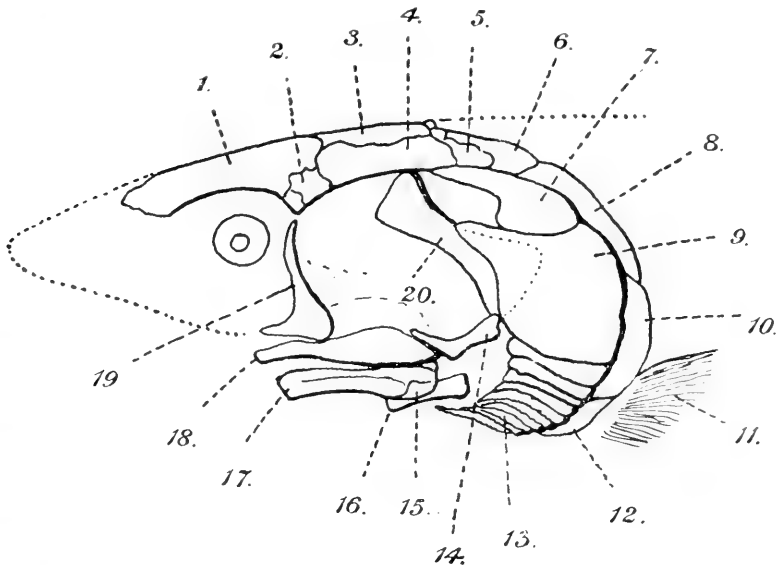

FIG. 295.

*Chondrosteus acipenseroides*, Egerton. Head and pectoral girdle restored. (After Traquair.) 1, frontal; 2, postfrontal; 3, parietal; 4, pterotic; 5, supratemporal; 6, post-temporal; 7, opercular; 8, supraclavicle; 9, subopercular; 10, cleithrum; 11, pectoral fin; 12, clavicle; 13, branchiostegal; 14, jugal (preopercular?); 15, angular; 16, ceratohyal; 17, dentary; 18, maxilla; 19, suborbital; 20, hyomandibular.

*Chondrosteus*, Ag., Lower Lias, and *Gyrosteus*, Ag., Upper Lias—England.

Family POLYODONTIDAE. These fish have minute scales on the trunk; small and separate in *Crossopholis*, quite vestigial in *Polyodon*. A Cretaceous genus, *Pholidurus*, alone retains the ganoin (A. S. Woodward). An enormous flattened rostrum without barbels is developed in *Polyodon*. The roofing bones of the skull are very incomplete and more modified even than in the next family; few can be recognised (Fig. 294). On the other hand, the mouth and jaws with minute teeth are more normally developed (Bridge [52], Allis [18]). Elongated frontals, parietals, and nasals cover the cranium above; an interrupted series of median bones runs forwards on the rostrum, but not behind the orbits.

The postfrontals and pterotic seem to have fused, and behind them comes an enormous post-temporal. The bones at the side are still further reduced than in *Acipenser*. The operculum and suboperculum are vestigial and the interoperculum and branchiostegals have disappeared. The palatopterygoid cartilage has only one ossification in front (palatine?). There are no ribs, and the endoskeleton is very little ossified. The lateral-line canals on the head are to a great extent freed from the large bones and enclosed in special ossicles (Allis [18]).

*Polyodon* has a spiracle and a pseudobranch, but no hyoidean hemi-

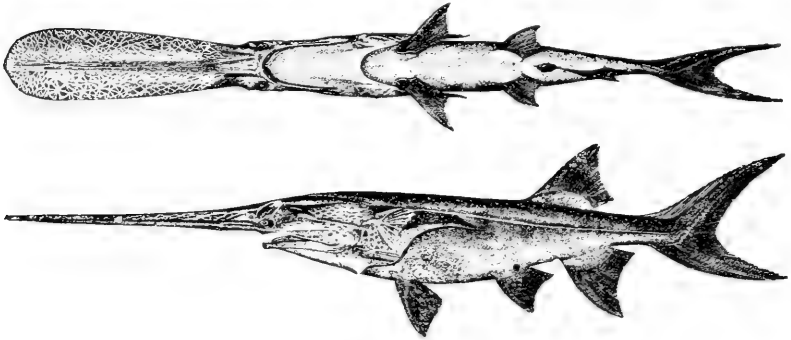

FIG. 296.

The spoon-bill sturgeon, *Polyodon folium*, Lac. Ventral and side view. (After Goode, from Dean.)

branch. The gill-rakers are especially developed. The air-bladder is cellular.

In the mouth and jaws the Polyodontidae are less, in the rostrum and bones of the head they are more, specialised than the Acipenseridae.

*Pholidurus*, A. S. W. ; Upper Cretaceous, England. *Crossopholis*, Cope ; Eocene, N. America. *Psephurus*, Günther (Fig. 297) ; China. *Polyodon*, Lac. (*Spatularia*) ; Mississippi (Fig. 296).



FIG. 297.

*Psephurus gladius*, Mart. (After Günther.)

Family ACIPENSERIDAE. The typical arrangement of the cranial roof-bones is much disturbed by the disappearance of some and the subdivision of others. The paired dorsal series can still be recognised (Fig. 298), but they are separated by a number of median osteoscutes, of which a large posterior occipital probably represents the median supratemporal of *Chondrosteus*. Small scutes cover the very prominent rostrum, below which hangs a transverse series of four sensory barbels (Fig. 300). The mouth becomes peculiarly modified, suctorial, protrusible,

and reduced in size. The small jaws, toothless in the adult, together with the palato-quadrate arch, form a specialised apparatus connected with the powerful hyomandibular by a large symplectic (Fig. 293). A maxilla and a 'jugal' are present as in *Chondrosteus*, also ossifications probably representing the palatine, ectopterygoid, metapterygoid, and quadrate in the expanded cartilage of the palato-quadrate arch. A single bone is supposed to represent the vomers. Only a dentary is developed on Meckel's cartilage. In old specimens of *Acipenser* ossifications appear in the chondrocranium, which probably represent the opisthotics, prootics, orbitosphenoids, and two lateral ethmoids. The visceral arches are partly ossified (Parker [321], van Wijhe [494], Collinge [86]). Supra-, post-, and suborbitals persist, also a large opercular, an interopercular, and a subopercular; the opercular membranes are confluent below. There are no branchiostegals. In *Acipenser*, but not in *Scaphirhynchus*, the spiracle persists, with a pseudobranch. A hyoidean hemibranch is present.

On the trunk are five longitudinal rows of large rhombic plates, and some scattered small irregular spines (Fig. 299). The front edge of the pectoral fin is strengthened by a powerful spine rigidly attached to the small first radial articulating with the shoulder-girdle; this spine represents a much enlarged pair of lepidotrichia in which the joints have been obliterated. No ganoine is

found on the exoskeleton; it is merely replaced by layers of bone, of which the scales and plates are entirely composed. The internal organs are of generalised character (p. 309). The air-bladder is simple (p. 223).

*Acipenser*, L. (Fig. 299); freshwater and marine, Europe, Asia, and N. America; Lower Eocene, England.

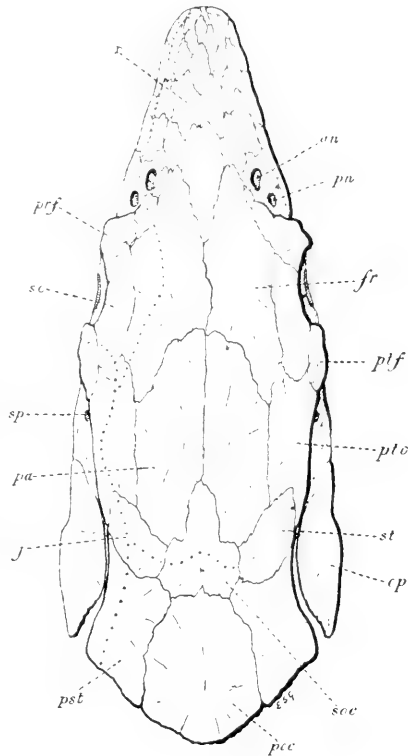

FIG. 298.

Skull of *Acipenser sturio*, L.; dorsal view. A dotted line indicates the lateral line according to Collinge. a.n., anterior nostril; fr., frontal; j., junction of post-orbital, occipital, and trunk branches of lateral-line system; op., opercular; pa., parietal; p.n., posterior nostril; poc., postoccipital; prf., prefrontal; pst., posttemporal; ptf., postfrontal; pto., pterotic; r., rostral plates; so., supraorbital; soc., supraoccipital; sp., spiracle; st., supratemporal.

*Scaphirhynchus*, Heckel (Fig. 300); rivers of N. America and Central Asia.

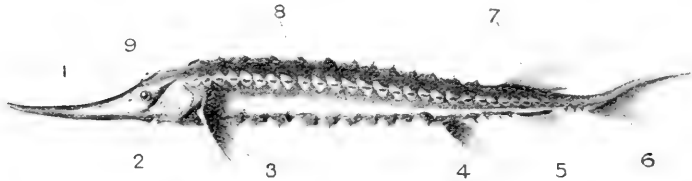

FIG. 299.

*Acipenser ruthenus*, L.: the sterlet. (After Cuvier.) 1, rostrum; 2, mouth; 3, pectoral, 4, pelvic, 5, anal, 6, caudal, and 7, dorsal fin; 8, dorsal bony scute; 9, nostrils.

#### INCERTAE SEDIS.

Family BELONORHYNCHIDAE. An extinct family of fish from Triassic and Liassic deposits, which have been placed sometimes with the 'Ganoids' (Heckel [205*a*]), at other times with the Teleostei (Pictet, Lütken, Zittel [512]). They have been placed by A. S. Woodward [505] among the Chondrostei; but their real position seems so uncertain, that it is better not to include them in that sub-order for the present. The presence of clavicles and the possession in the median fins of lepidotrichia which are more numerous than the supporting radials, the most important characters they have in common with the Chondrostei, are after all but signs of primitiveness; which evidence is, moreover, somewhat invalidated by the fact that the radials resemble rather those of higher Actinopterygii in being mainly composed of a



FIG. 300.

*Scaphirhynchus platyrhynchus*, Raf. (From Jordan and Evermann.)

long proximal segment. The symmetrical caudal fin is apparently of the abbreviate diphyccercal type, quite unlike that of any Chondrosteian or primitive Holostean, and suggesting affinity with the Osteolepidoti. The dermal bones of the skull form a continuous shield in the adult, extending far back over the occiput, over the sides of the head, round the orbit, and forwards projecting into a greatly elongated pointed snout (Fig. 301). The lower jaw is similarly drawn out; it is very deep behind. The dentition consists of large and small conical teeth. There appear to be no median or lateral gulars, and only one large opercular.

No scales occur on the body, but generally a dorsal, a ventral, and two lateral longitudinal rows of scutes. The fulcra are vestigial or absent.

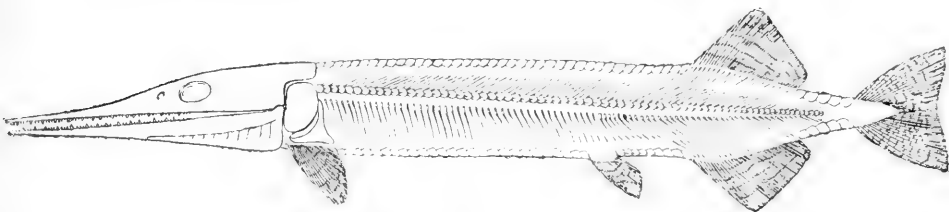

FIG. 301.

*Belonorhynchus*. (After A. S. Woodward.)

The notochord was persistent. There are no centra, but well-developed bony ribs, haemal and neural arches and spines. As in the higher Holostei, the neural arches bear articulating zygapophyses. This most puzzling assemblage of characters has not yet been satisfactorily explained.

*Belonorhynchus*, Bronn (Fig. 301); Trias, N.S. Wales; Jurassic, Europe. *Saurichthys*, Ag.; Trias, Europe. ?*Saurorhamphus*, Heckel; Cretaceous, Europe.

**Subdivision 2. HOLOSTEI.**

The three sub-orders included in this subdivision belong to a higher grade of organisation than the fish we have hitherto dealt with. They have certain characters in common which at once distinguish them. The endoskeleton is very thoroughly ossified. In the anal and dorsal fins the lepidotrichia correspond in number to the radials. In the caudal fin of the Amioidei and Lepidosteoidei the correspondence is incomplete, and in the caudal of the Teleostei the dermal rays still greatly exceed the haemal arches in number

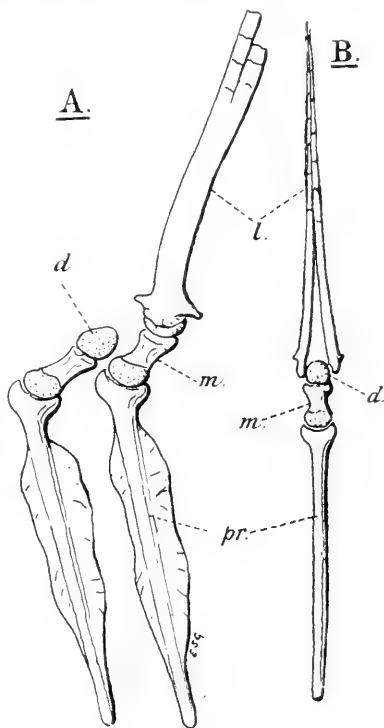

FIG. 301A.

*Esox lucius*, L. A, two radials of the dorsal fin, left-side view. B, radial and dermal ray from in front. d, distal cartilage; m, median segment, and pr., proximal segment of radial; l, lepidotrich, broken short in A.

(Figs. 62-3). The lepidotrichia can be erected and depressed in all the fins except the caudal (Fig. 301A). The median radials project not at all beyond the level of the body-wall, and are composed of three-jointed rods as a rule; the proximal segment is long (interspinous bone), the two distal segments short, the outer one being rigidly fixed in the bifurcated base of the lepidotrich. The tail is abbreviate heterocercal, homocercal, or of some more modified type (p. 353); but the hinder end of the upper lobe of the heterocercal tail of the larva (the axial lobe) is always lost during

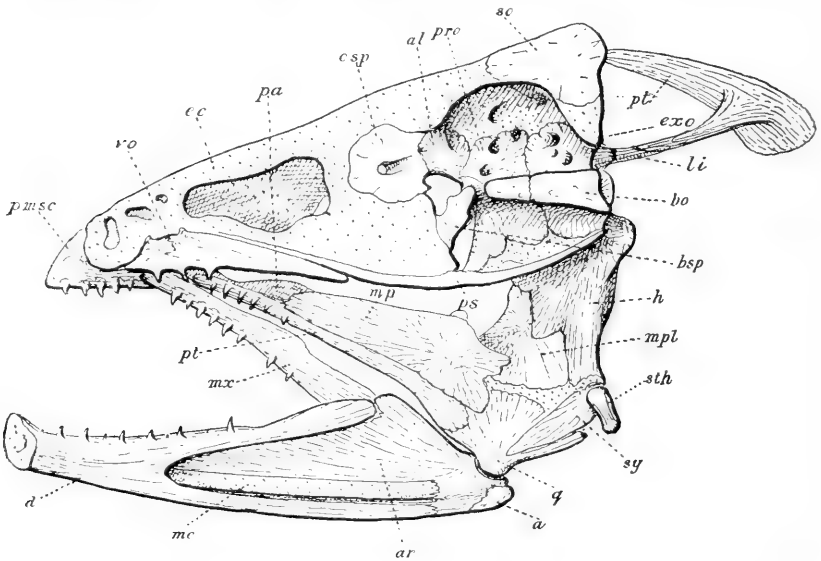

FIG. 302.

Skull of *Salmo salar*, L., cut longitudinally. (After Bruch.) *a*, angular; *al*, alisphenoid; *ar*, articular; *bo*, basioccipital; *bsp*, basisphenoid; *d*, dentary; *e.c.*, ethmoid cartilage; *exo*, exoccipital; *h*, hyomandibular; *li*, ligament; *m.c.*, Meckel's cartilage; *mpl*, metapterygoid; *mpt*, mesopterygoid; *mx*, maxilla; *osp*, orbitosphenoid; *p*, post-temporal; *pa*, palatine; *pmsc*, premaxilla; *pro*, prootic; *ps*, parasphenoid; *pt*, pterygoid; *q*, quadrate; *sth*, stylohyal; *sy*, symplectic; *vo*, vomer.

development, and the notochord does not reach the extremity of the tail in the adult. Therefore the adult caudal fin is formed chiefly from the hypochordal lobe, but also to a small extent from the epichordal lobe (Fig. 46). The radials of the paired fins are still more reduced than in the Chondrostei. The clavicle is lost, its place being taken by the cleithrum, and the endoskeletal pectoral girdle is relatively small (Fig. 241). The maxilla generally both acquires a free posterior end and bears one or two supra-maxillary bones. In the two first sub-orders the lower jaw is still provided with a dentary, angular, supra-angular (coronoid), splenial, and articular (Figs. 237-240). Of the inferior gulars only a single





present with rare exceptions. The preoperculum serves to bind the hyomandibular, symplectic, and quadrate bones into a rigid arch supporting the jaws (Figs. 360, 456).

Whereas in the Elasmobranchii, Dipnoi, and Chondrostei the otolithic masses in the auditory labyrinth are aggregates of small separate nodules or crystals, in the Holostei (and also in *Polypterus*, p. 298) they form large solid calcareous structures. The spiracle opening never persists, though a pit is found in *Amia* and *Lepidosteus* (Wright [509]), which opens into the pharynx and lies near the auditory capsule; it probably represents the 'auditory' diverticulum of the spiracle of Selachians [359].

Of these characters the arrangement of the lepidotrichia and the loss of the clavicle point most clearly to an advance over the Chondrostei, and seem to prove that the three next sub-orders must have branched off from a common ancestor.

The structure of the skull in the Teleostomes has already been dealt with in a general way above (p. 266); it will be convenient here to describe certain modifications of importance which occur in the Holostei, and are of some taxonomic significance although they may possibly have arisen independently in several groups through convergence.

In the lower fish the cranial cavity, often but very incompletely filled by the brain, extends forwards between the orbits, and the olfactory nerve reaches the nasal organ directly by piercing the cranial wall. In the Holocephali alone among the Chondrichthyes is an interorbital septum formed between the huge orbits, and it is above the brain. There is a tendency among the Holostei for the brain-case to become more and more narrowed between the orbits, until finally the two sides come together in the mid-line, giving rise to a septum as a rule partly membranous (Fig. 304). The septum forms usually from below upwards; thus the optic foramina become closely approximated, or even confluent. The narrowing in front obliges the brain to retreat to the hinder region of the cranial cavity. Now since the nasal sacs are situated in front of the orbits, either the olfactory bulbs remain near them or they retreat with the brain. In the first case the bulbs give off short olfactory nerves and retain their connection with the prosencephalon by means of greatly drawn-out olfactory tracts. In the second, more usual, case the bulbs cling close to the brain and the olfactory nerves are lengthened out; they are then compelled to pass on either side of the very thin septum, and reach the nasal capsules in front by crossing more or less freely through the orbit (Figs. 304, 508). Intermediate conditions are found within certain families, as, for instance, in the Characinidae (Sagemehl [379]), where *Citharinus* has a moderately long tractus and short olfactory nerves inside

the cavum cranii, and piercing the prefrontal; *Hydrocyon*, whose nerves are longer and crossing the front of the orbit, has the bulbous further back; and finally, *Erithrinus*, with sessile bulbs, has

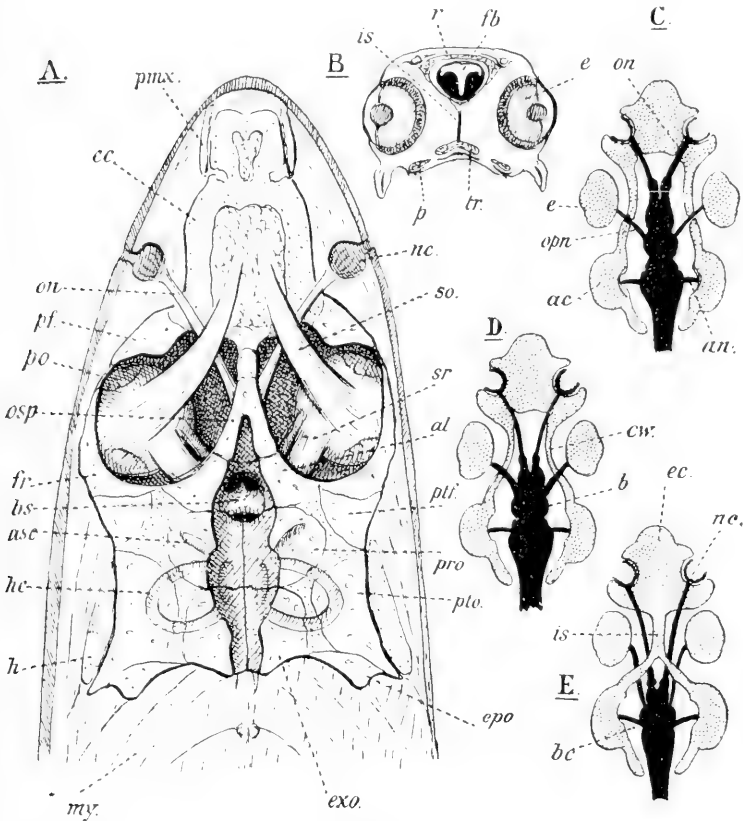

FIG. 304.

A, *Salmo salar*, L.; longitudinal section through the head exposing the sense-organs, and brain-cavity viewed from above (after Bruch). B, transverse section of the head of a young *Salmo trutta*, L., in the region of the fore-brain. C, D, and E, three diagrams showing the development of the interorbital septum. *a.c.*, auditory capsule; *al.*, alisphenoid; *a.n.*, auditory nerve; *a.s.c.*, cavity for anterior semicircular canal; *b.*, optic lobe; *b.c.*, brain-cavity; *bs.*, basi-sphenoid; *c.w.*, cranial wall; *e.*, eye; *c.c.*, ethmoid cartilage; *epo.*, epiotic; *exo.*, exoccipital; *f.b.*, fore-brain; *fr.*, frontal; *h.*, hyomandibular; *h.c.*, cavity for horizontal semicircular canal; *i.s.*, interorbital septum; *my.*, myotome; *n.c.*, nasal capsule; *o.n.*, olfactory nerve; *op.n.*, optic nerve; *osp.*, orbitosphenoid; *p.*, palatine; *pf.*, prefrontal; *pmx.*, premaxilla; *p.o.*, ossification of optic capsule; *pro.*, prootic; *ptf.*, postfrontal; *r.*, cranial roof; *s.o.*, superior oblique muscle; *s.r.*, superior rectus muscle; *tr.*, trabecula.

olfactory nerves passing out of the orbitosphenoid freely across the orbit. The septum in the Gadiformes, on the other hand, is formed below the brain-case, and the narrow brain-cavity is continued for-

wards to the nasal sacs (Figs. 353, 508); in it run the olfactory tracts (Gadidae) or nerves (Macruridae). It is probable that similar modifications have taken place independently in several families; but what is not likely is that fish which have once reached one extreme form (with sessile bulb) should be able to give rise to genera which exhibit the other extreme. In the classification of such a modern group as the Teleostei, where every scrap of evidence is of value, the relation of the brain to the septum is therefore of great importance. The median septum of the Lepidosteoidi, chiefly in front of the orbits, is probably due to the elongation of the snout (ethmoid septum), and not strictly homologous with that of the Teleostei.

Another new formation in the Holostean skull is the so-called eye-muscle canal, or myodome (Figs. 302-5, 358). In all fish the four recti muscles are attached close together to the inner wall of the orbit near the basis cranii in the basisphenoid region. Now in *Amia* and many Teleostei these muscles pass farther inwards and backwards into a space hollowed out in the floor of the cranium. This canal is arched above by transverse wings of the prootics, and its roof is completed by membrane in front and at the sides, so that it does not really open into the cavum cranii. Its floor is formed either by the prootics (*Amia*) or, when these fail to meet in the middle-below, by the parasphenoid (many Teleostei). Moreover, in the latter case when the canal extends far back it may be closed above by the alisphenoid, prootic, and basioccipital, below by the parasphenoid; but in the dried skull the canal may open behind between the basioccipital and the parasphenoid (*Clupea*, *Elops*, *Salmo*, etc.).

Lastly, the occipital region is of interest. In no fish below the Teleostei is a median supraoccipital bone known to occur (Figs. 238, 305, 329). Superficial dermal occipital plates are often found, and may possibly have given rise to the supraoccipital, but there is no evidence that it is derived from such plates. Rather does the supraoccipital seem to have been developed from the neural spines of one or more of those vertebrae that have last been incorporated in the occipital region of the skull ([497] and p. 11). A difficulty encountered by this view is the fact that already in *Lepidosteus* (Shreiner [390a]) some six or seven sclerotomes have been included in the skull without the appearance of a bony supraoccipital, and there is no evidence that the Teleostean skull holds more segments (Fig. 322). Ontogeny supports the view that it is an endochondral bone. The limit between the skull and the vertebral column in the lower Holostei is somewhat indefinite: in *Lepidosteus* and many Teleosts one, and in *Amia* two occipital neural arches remain separate while their corresponding centra fuse with the occipital region. It is, of course, quite possible that the supra-

occipital is derived from neither of these sources, but is a new ossification.

The intestinal spiral valve is already much reduced in *Amia* and *Lepidosteus*; in the Teleostei it usually disappears altogether.

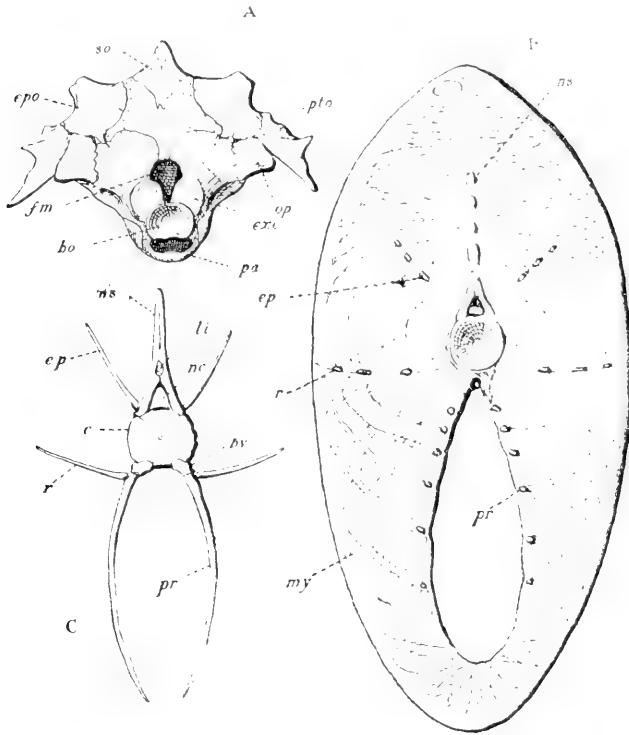

FIG. 305.

*Salmo salar*, L. (After Bruch.) A, skull from behind. B, transverse section of the trunk. C, transverse section of a trunk vertebra. *bo*, basioccipital; *br*, basiventral; *c*, centrum; *ep*, epipleural; *epo*, epiotic; *exo*, exoccipital; *fm*, foramen magnum; *li*, longitudinal ligament; *my*, myotome; *nc*, neural canal; *ns*, neural spine; *op*, opisthotic; *pa*, parasphenoid below the myodome; *pr*, pleural rib; *pto*, pterotic; *r*, rib; *so*, supraoccipital.

### Order 1. AMIOIDEI.

The three sub-orders of the Holostei differ in the structure of the vertebral column. In the Amioidei the notochord is sharply constricted by well-formed centra in the only living species, *Amia calva*, but in the earlier, more primitive forms it appears to have persisted to a much greater extent. The Amioidei are distinguished by the presence of separate pleuro- and hypocentra, at all events in a certain region. In the Actinopterygii we have hitherto

dealt with, the vertebral centra, formed in the skeletogenous layer in connection with the bases of the neural and haemal arches, are derived almost equally from the dorsal and the ventral elements; with the help of bony tissue these are bound together into a single ring-like or biconcave centrum. Now in *Amia* well-developed bony centra occur along the trunk region, each bearing

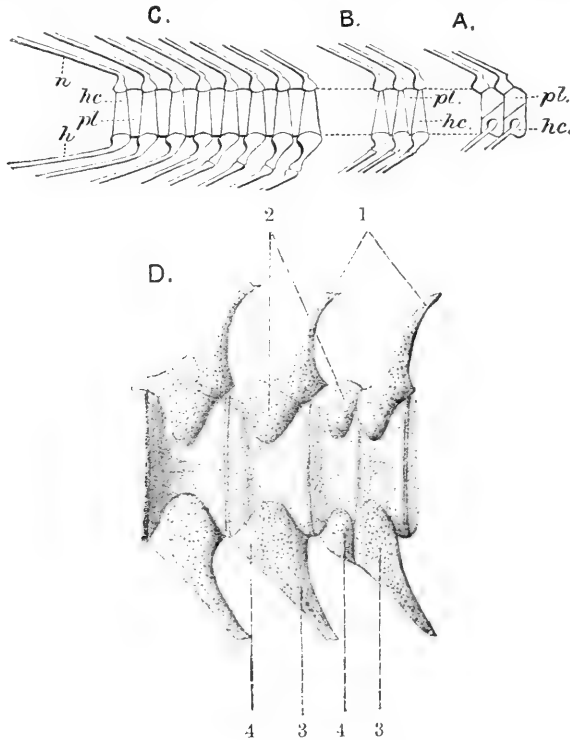

FIG. 306.

A, B, C, diagram of three regions of the vertebral column of *Eurypterus*. (From A. S. Woodward, *Vert. Palaeontology*.) *h*, haemal arch; *hc*, hypocentrum; *n*, neural arch; *pl*, pleurocentrum. D, left-side view of three segments of the vertebral column of a 7.5 cm. long *Amia calva*, taken at the junction between trunk and tail. 1, basidorsals (neural arches); 2, basidorsals; 3, basiventrals; 4, interventrals. (After Schauinsland, from Hertwig's *Handbuch*.)

a neural arch surmounted by a spine, and, except in the first two segments, basiventrals which carry the long pleural ribs. The neural arches are separated from the centra by cartilage, and a pair of cartilaginous nodules are found between them (the interdorsals). Farther back, in the caudal region (except at its extremity), there appear to be alternate centra with and without arches. Here occur anterior centra bearing a pair of vestigial cartilaginous interdorsals and a pair of similar interventrals, followed by posterior centra

bearing separate arches above and below (Fig. 311). At the junction between the two regions may be found intermediate conditions, incompletely divided centra (Fig. 306, D). Each pair of centra belongs to one segment and corresponds to one spinal nerve. They therefore represent one normal centrum divided into a pre- and postcentrum (pleuro- and hypocentrum) (Schmidt [388], Schauinsland [384], Hay [203]). The extinct Amioidei show great variety in the structure of the centrum. *Euryormus* has pre- and postcentra as in *Amia*; but in the anterior region each segment is composed of an upper crescentic piece and a ventral rather larger piece; the series of dorsal crescents are wedged in

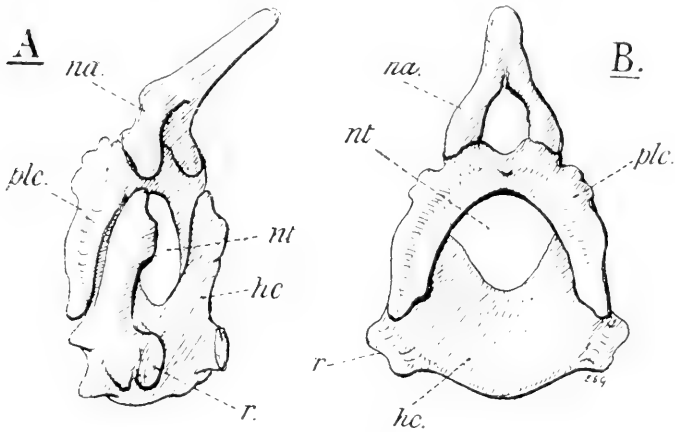

FIG. 307.

Vertebra of *Osteorhachis lewisi*, A. S. W.; Oxford Clay, Peterborough. A, oblique side view from behind; B, front view. *hc*, hypocentrum; *na*, neural arch; *nt*, aperture for notochord; *plc*, pleurocentrum; *r*, parapophysis for rib.

between the ventral crescents (Fig. 306, A, B, C). In *Caturus* the whole length of the vertebral column contains complex centra. In *Euthymotus* the ventral are much larger than the dorsal crescents. From the structure of *Euryormus* it would appear that the dorsal wedges represent incomplete precentra formed chiefly by the interdorsals, while the ventral and generally larger wedges represent the postcentra formed by the basiventrols. The basidorsals form typical arches, but in these genera appear to contribute little to the centra. Thus, some of the elements which go to make up a centrum in a typical vertebra (p. 100) seem to remain separate throughout life in these fish. A somewhat similar but not identical splitting of the centrum takes place in the Amphibia.

The skull and visceral arches in *Amia* are perhaps less specialised than in any other living Teleostome (Figs. 236-240); the chondro-

cranium persists to a considerable extent, yet most of the bones typical of this group are well represented (Allis [10, 11], Franque [138], Bridge [51], Shuffelt [409]). In the extinct genera the cheek is usually covered by special plates, and the circumorbital bones are more complete. There is a small eye-muscle canal in *Amia* and the Semionotidae, and only two supratemporals (extra-scapulars). Two free occipital neural arches overlie the foramen magnum, the corresponding centra of which have been included in the basi-occipital. The maxilla projects freely backwards and bears a supra-maxilla. The opercular bones are well developed. There is a single median gular, possibly homologous with the large paired inferior gulars of the lower Osteichthyes (Fig. 312). The scales are of the lepidosteoid type.

*Amia* has no spiracular opening or gill, nor any opercular gill. There is a considerable bulbus arteriosus (Fig. 69, p. 110), and paired pulmonary arteries (p. 226). The viscera in *Amia* remain in an unspecialised condition. The air-bladder is cellular, there are no pyloric caeca. The urinogenital organs will be dealt with below (p. 366). The cleavage of the egg is holoblastic, and the larva has preoral adhesive organs.

According to A. S. Woodward, the Amioidei include several families which have diverged along two different main lines. The oldest, the Semionotidae, and the possibly related Macrosemiidae, would lead to the highly specialised Pycnodontidae with deep compressed bodies and grinding teeth. From the other branch would arise the predaceous sharp-toothed families Eugnathidae, Pachycormidae, and Amiidae. That the last three families are closely related there can be scarcely any doubt; the general proportion of the body, the fins, the vertebral column, the skull, etc., all support this view. But the affinities of the Pycnodontidae are very doubtful. It may also be doubted whether the Semionotidae are really more closely related to the Amioidei than to the Lepidosteoidae; certain specialisations in the structure of the skull would seem to bring them nearer to the latter. *Lepidotus* is possibly not an Amioid, but a primitive Lepidosteoid.

Family EUGNATHIDAE. Triassic, Jurassic, and Cretaceous fish of elongate shape, with deeply forked caudal and short dorsal and anal. The mouth is wide and the hyomandibular directed backwards. The scales and cranial bones are 'ganoid,' there are small teeth on the palate, large pointed teeth on the jaws and the vomers (sometimes fused). The fulera are biserial, the scales thick and rhomboid, with a dorsal articular peg (*Eugnathus*), or thin and almost cycloidal (*Caturus*, *Eurycormus*). The notochord may be persistent, without centra (*Caturus*); but generally with vertebrae composed of separate post- and precentra (hypo- and pleurocentra). The centra of *Neorhombolepis* and others are probably formed by the fusion of these elements.



*Allolepidodus*, Deeke ; Trias, Europe. *Heterolepidotus*, Eg. ; *Ptycholepis*, Ag. ; *Caturus*, Ag. (Fig. 309) ; Triassic and Jurassic, Europe. *Callopterus*,

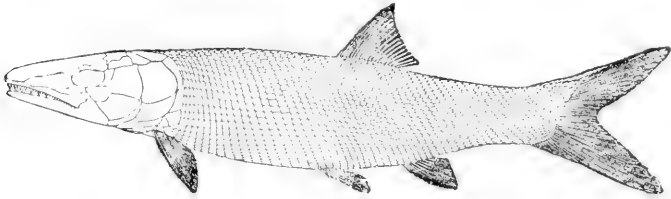

FIG. 308.

*Eugnathus orthostomus*, Ag. , Lower Jurassic, Dorsetshire ; restored. (After A. S. Woodward.)

Thiol. ; *Osteorhachis*, Eg. (Fig. 307) ; *Eurycormus*, Wagner ; *Eugnathus*, Ag. (Fig. 308) ; Jurassic, Europe. *Neorhombolepis*, A. S. W. ; Jurassic and Cretaceous, England. *Lophrostomus*, Eg. ; Cretaceous, England.

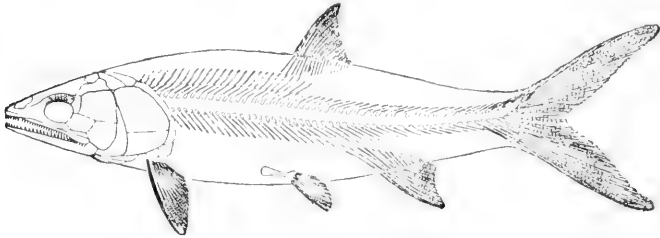

FIG. 309.

*Caturus furcatus*, Ag. ; Upper Jurassic, Bavaria ; restored, without scales. (After A. S. Woodward.)

Family PACHYCORMIDAE. They are similar in outward shape to the last ; but the ethmoid and vomer combine to form a prominent rostrum which separates the premaxillae, especially in *Protosphyraena*. The

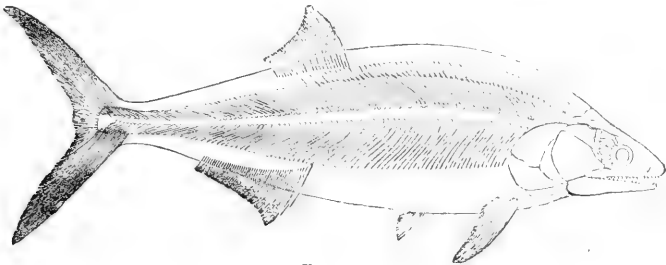

FIG. 310.

*Hypticormus insignis*, Wagner ; Upper Jurassic, Bavaria ; restored, without scales. (After A. S. Woodward.)

branchiostegals become very numerous ; pointed teeth arm the jaws, vomer, and splenial ; in *Hypticormus* there is a very large pair on the last two bones. The fulcra are vestigial. The scales thin and rhombic,

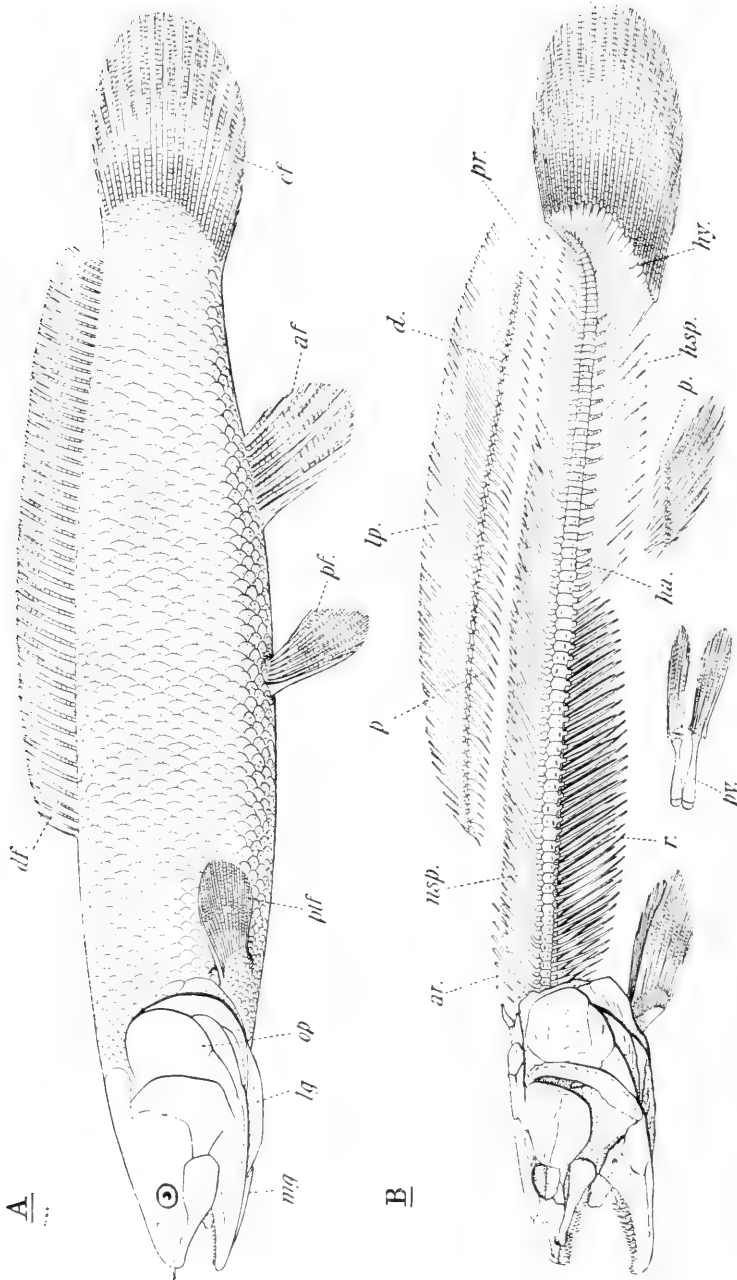

FIG. 311.

*Awa melano*, L. A after Brown Goode, slightly altered. B after Franque, slightly altered. *a.f.*, anterior dorsal radials; *c.f.*, caudal fin (hypochordal); *d.*, distal segment of dorsal radial; *h.a.*, haemal arch; *h.sp.*, haemal spine; *hy.*, hypural arches; *l.g.*, lateral gulars; *l.p.*, lepidotrichia; *m.g.*, median gular; *n.s.p.*, neural spine; *op.*, operculum; *p.*, proximal segment of radial; *p.f.*, pelvic fin; *p.d.*, posterior dorsal radials; *p.p.*, pectoral fin; *p.r.*, pleural rib; *r.*, radial.

or with rounded hinder edge; they are small or absent. As a rule, there are no distinct vertebral bodies. The pectoral and caudal fins are very large, and the hypochochordal lobe is supported by a much-expanded haemal arch. The pelvics are small and far forwards.

*Euthynotus*, Wagner; *Sauropsis*, Ag.; *Asthenocormus*, A. S. W.; *Pachycormus*, Ag.; *Hypsocormus*, Wagner (Fig. 310); Jurassic, Europe. *Protosphyraena*, Leidy; Cretaceous, Europe and North America.

Family AMIIDAE. These fish differ from those of the previous family chiefly in external shape. The body is fusiform, the dorsal and anal fins

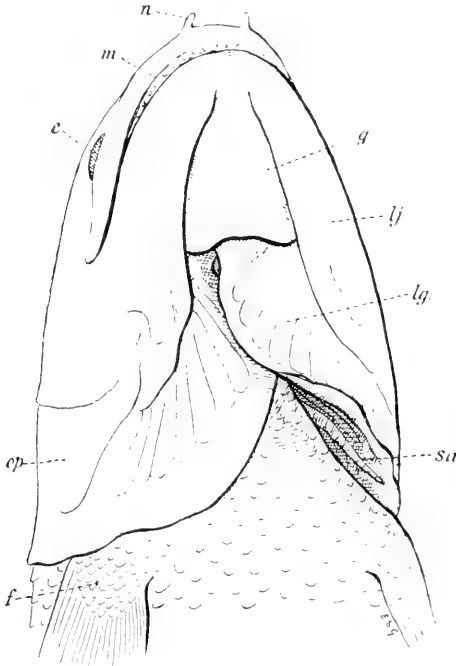

FIG. 312.

Head of *Amia calva*, L.; oblique ventral view. *e*, eye; *f*, pectoral fin; *g*, median gular plate; *l.g.*, lateral gulars or branchiostegal rays; *l.j.*, lower jaw; *m*, mouth; *n*, nostril; *op*, operculum; *sa*, serrated appendage.

become lengthened, and the caudal, which is little if at all forked, shows no external sign of heterocercy. Fulcra, small on the median, are absent from the paired fins. The scales are thin, squarish, and deeply overlapping. The ganoine is represented in *Amia* only by the surface ornamentation on the scales, and this genus has lost all fulcra [508]. There are vestigial cheek-bones, but a large median gular remains. *Amia* has a special serrated bony plate projecting into the branchial chamber (Fig. 312). The hypo- and pleurocentra form complete alternating rings in the caudal region (Fig. 311). In *Liodesmus* the notochord was persistent.

*Liodesmus*, Wag. ; Jurassic, Bavaria ; *Megalurus*, Ag. ; 'Jurassic, Europe ; Cretaceous, Brazil. *Amiopsis*, Kner ; Cretaceous, Europe. *Amia*, L., living, North America ; Miocene and Eocene, Europe.

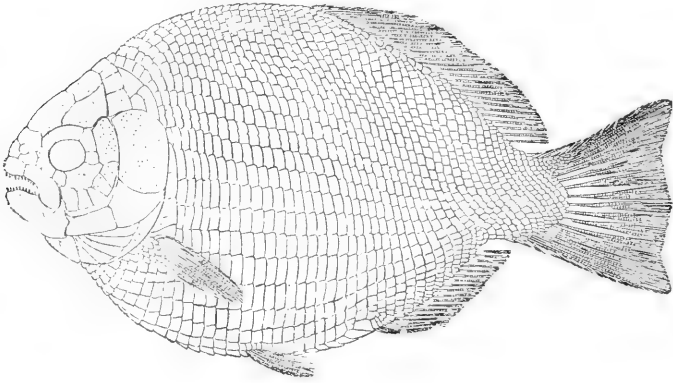

FIG. 313.

*Dapedius politus*, Leach ; Lower Jurassic, Dorsetshire. (After A. S. Woodward, *Vert. Palaeontology*.)

Family SEMIONOTIDAE. The trunk becomes deepened, especially in *Dapedius*, where it is much compressed, and there is a corresponding extension of the dorsal and anal fins. The mouth is small, and the teeth differentiated into an outer pointed series on the jaws, and inner grinding teeth, often very massive and rounded, on the splenial pterygoids and

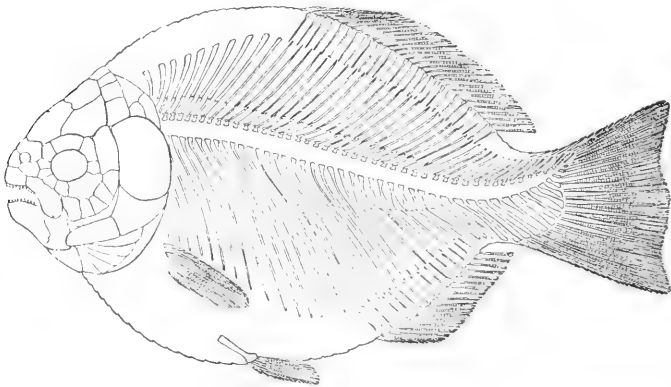

FIG. 314.

*Dapedius politus*, Leach ; restored, with scales removed. (After A. S. Woodward, *Vert. Palaeontology*.)

vomers. The latter may fuse to a single bone (*Lepidotus*). In the more specialised forms the grinding teeth form a pavement. The head is completely covered by plates with ganoid ornament (Figs. 315, 316). A

ring of many circumorbitals, several supratemporals, and a number of small cheek-plates occur, but the median gular may be absent (*Lepidotus*).

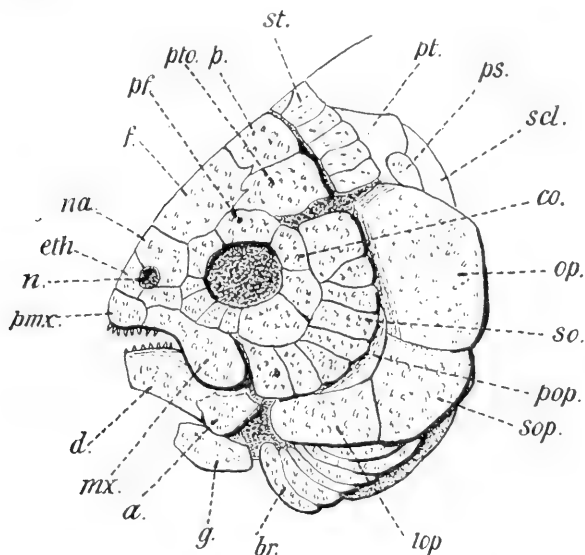

FIG. 315.

Left-side view of the head of *Dapedius*. (After Traquair.) *a.*, angular; *d.*, dentary; *co.*, post-orbital; *eth.*, ethmoid; *f.*, frontal; *g.*, median gular; *top.*, interopercular; *mx.*, maxilla; *n.*, nostril; *na.*, nasal; *op.*, opercular; *p.*, parietal; *pf.*, postfrontal; *pmx.*, premaxilla; *pop.*, preopercular; *ps.*, supratemporal (?); *pt.*, post-temporal; *pte.*, pterotic (squamosal); *scl.*, supraclavicle; *so.*, cheek-plates; *sop.*, subopercular; *st.*, supratemporal.

In these characters, and in the formation of an interorbital septum, and especially in the position of the nostrils at the end of an elongated snout, *Lepidotus* resembles the Lepidosteoidei.

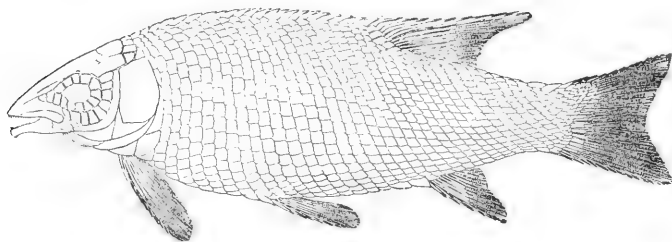

FIG. 316.

*Lepidotus minor*, Ag.; Upper Jurassic, Dorsetshire; restored. (After A. S. Woodward, *Vert. Palaeontology*.)

The vertebral arches, spines, and ribs are well developed; but the notochord appears to have been persistent, at all events only ring-like centra are found. The fulcra are large, in single or double rows, the

scales rhombic with slight peg and socket articulations; but they may become cycloid on the tail (*Aetheolepis*).

Semionotids are found in Permian, Triassic, and Jurassic rocks. The most specialised are the latest. *Acentrophorus* and *Semionotus* are still fusiform.

*Acentrophorus*, Traq.; Permian, Europe and North America. *Serrolepis*, Quend.; *Sargodon*, Pl.; *Colobodus*, Ag.; Triassic, Europe. *Semionotus*, Ag.; Triassic, Europe, South Africa, North America. *Lepidotus*, Ag. (Fig. 316); Rhaetic to Wealden, Europe; Jurassic, India; Cretaceous, Brazil. *Cleithrolepis*, Eg.; Triassic, N.S. Wales, South Africa. *Aetheolepis*, A. S. W.; *Aphnelepis*, A. S. W.; Jurassic, N.S. Wales. *Dapedius*, Leach (Figs. 313-15); Lias, Europe. *Tetragonolepis*, Bronn; Jurassic, Europe and India.

Family MACROSEMIIDAE. This family of Mesozoic fish is probably allied to the Semionotidae and Eugnathidae. The body is elongate with a usually much lengthened dorsal fin, which is divided in *Propterus* and *Notagodus*. The scales are rhombic, but may become very thin in the later Jurassic forms (*Macrosemius*). They are provided with peg and socket articulations. The fulera also are somewhat degenerate, being present on the caudal fin only in some (*Macrosemius*). Although delicate, the skeleton is well ossified. The mouth is small, the hyomandibular vertical or inclined forwards. The sides of the cranium are incomplete. The opercular bones are complete, the branchiostegals numerous, and a median gular has been found in *Ophiopsis*. A notochord of considerable size persisted, since the centra are in the form of rings, which may be double in the tail-region (*Ophiopsis*). Nine radials have been counted at the base of the pectoral fin. The teeth are usually strong, pointed or styliform, on the jaws and inner bones of the mouth [505, 512].

*Legnototus*, Eg.; Rhaetic, England. *Ophiopsis*, Ag.; *Histonotus*, Ag.; *Petalopteryx*, Pictet, *Macrosemius*, Ag.; *Propterus*, Ag.; *Notagodus*, Ag.; Jurassic, Europe.

Family PHOLIDOPHORIDAE. Amioids of elongate shape. No coronoid has been found in the lower jaw, but there may be a vestige of the splenial. There are fulera and more or less rhombic deeply overlapping scales, with peg and socket articulations. The scales are of the lepidosteoid structure, with fine canaliculi. The vertebral centra are often divided horizontally into upper and lower elements (hypo- and pleurocentra), which, however, never form double rings or crescentic wedges. It is chiefly on account of the structure of the lower jaw that this and the next two families have been removed from the Amioidei, by A. S. Woodward, and placed at the base of the Teleostei. The allied Oligopleuridae bridge over the gap between them and the next Order in some respects.

The remarkable genus *Thoracopterus*, with huge pectoral fins and a large and powerful ventral lobe of the caudal fin, was a 'flying fish' of the Triassic age. *Gigantopterus*, of similar form, is closely allied (Abel [1]).

*Pholidophorus*, Ag.; Triassic and Jurassic, Europe; Trias, Australia. *Thoracopterus*, Bronn; *Gigantopterus*, Abel; *Peltopterus*, Kner; Trias, Europe. *Pleuropholis*, Eg.; Jurassic, Europe.

Family ARCHAEONEMIDAE. Differing from the last in the possession of thin cycloid scales, and ridge scales along the mid-dorsal and ventral lines.

*Archaeonemus*, A. S. W.; Jurassic, N.S. Wales.

Family OLIGOPLEURIDAE. In these the ganoine is vestigial, the scales thin, overlapping, and more or less rounded, the centra annular or amphicoelous, and generally well ossified. The first centrum has two disks.

*Oligopleurus*, Thiol.; Jurassic, Europe. *Ocnoscopus*, Costa; Jurassic and Cretaceous, Europe. *Spathiurus*, Davis; Cretaceous, Mt. Lebanon.

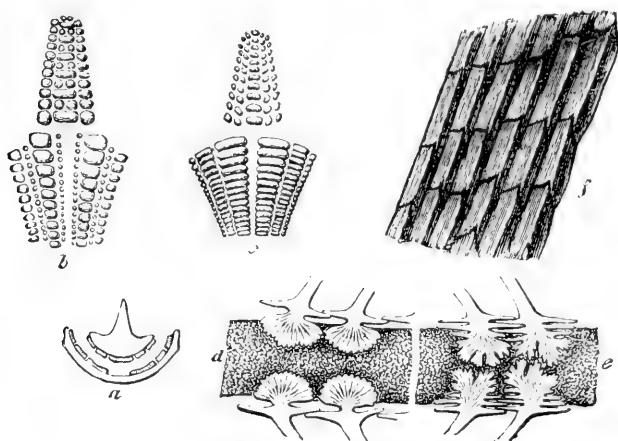

FIG. 317.

*a*, transverse section of the jaws of a Pycnodont, showing the two halves of the splenial dentition opposing the vomerine teeth above; *b*, vomerine and splenial teeth of *Microdon*; *c*, vomerine and splenial teeth of *Coelodus*; *d*, portion of vertebral column of *Coelodus*, showing the persistent notochord (shaded) and the expanded bases of the neural and haemal arches; *e*, the same of *Pycnodont*; *f*, inner view of scales, showing mode of interlocking by pegs and sockets, continued as longitudinal ribs. (After J. J. Heckel, from A. S. Woodward.)

Family PYCNODONTIDAE. This is a highly specialised family of deep-bodied compressed fish found in deposits from the Lower Lias to the Eocene. The dorsal and anal fins are greatly extended backwards, the pectorals small, and the pelvises vestigial (Fig. 319). The caudal fin, externally symmetrical, is of the abbreviate heterocercal type and often strongly forked. Fulcra are absent or vestigial. The scales are rhombic but greatly lengthened transversely (Fig. 317). They usually have a large internal keel which projects above and below, forming articulating pegs, or may fit closely by irregular sutures (*Mesturus*). The scales may be absent from the tail, and sometimes appear to grow only on the anterior half of the body (*Mesodon*, *Microdon*). There is a covering of ganoine. The arrangement of the cranial bones is remarkable and inconstant; it has been variously interpreted (Zittel [512], A. S. Woodward [502-3], Henning [208]). The orbits are high up in the head,

and the facial region descends very suddenly to the small mouth with its pointed jaws (Fig. 318). There is reason to believe that many of the

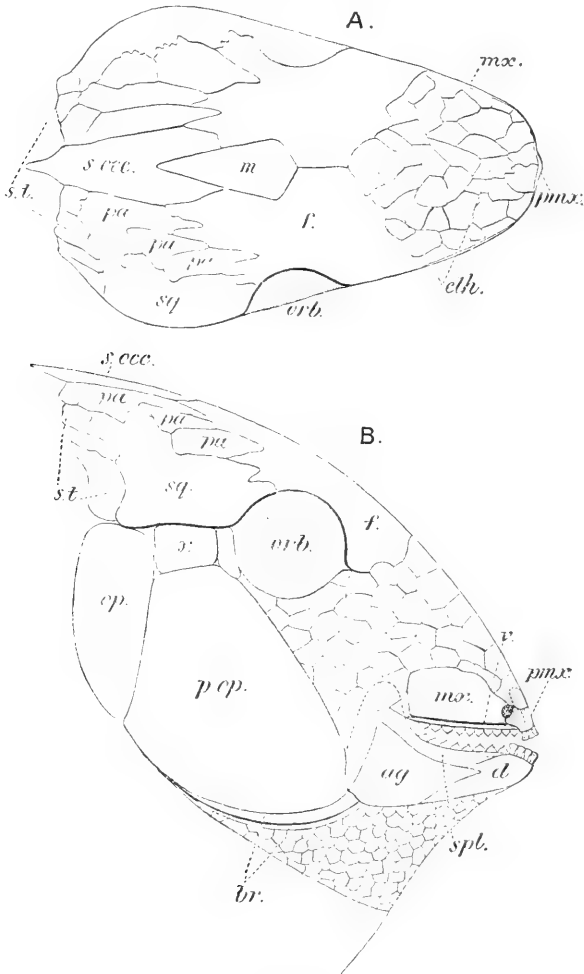

FIG. 318.

*Mesturus lewisi*, A. S. W. Restoration of head, A, from above; B, from the side. (After A. S. Woodward, *Vert. Palaeontology*.) *ag*, angular; *br*, branchiostegals; *d*, dentary; *eth*, ethmoidal plates; *f*, frontal; *m*, median plate; *mæ*, maxilla; *op*, operculum; *orb*, orbit; *pop*, preoperculum; *pa*, parietal plates; *p.mæ*, premaxilla; *s.ccc.*, supraoccipital plate; *st*, supra-tritorals; *spl*, splenial bearing tritoral teeth; *sq*, pterotic (squamosal); *v*, vomer bearing tritoral teeth; *x*, small plate.

usual bones have by a process of degeneration been split up into a number of small irregular plates, as in the Acipenseridae.

Taking *Mesturus* as an example (A. S. Woodward [502]), we find



the snout covered with numerous plates; two large frontals partly separated by a median bone; irregular small bones representing the parietals, separated in the mid-line by a large occipital plate; several small supratemporals; a single bone representing the pterotic and post-frontal; the orbit limited below by small plates which extend over the sub- and preorbital region. There appears to have been a small opercular and a large preopercular extending over the cheek, an exceptional thing amongst Actinopterygians; no sub- or interoperculum. Only two

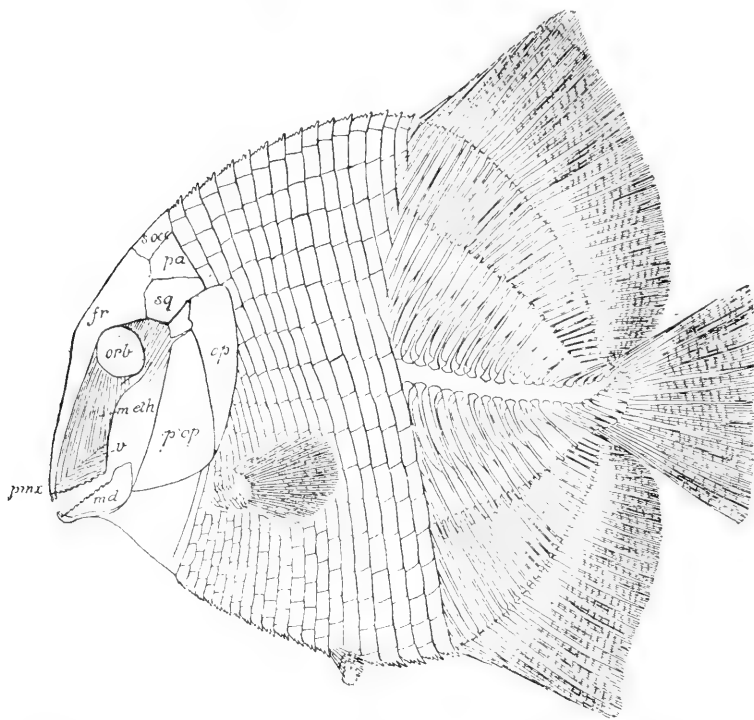

FIG. 319.

*Mesodon macropterus*, Ag.; Upper Jurassic, Bavaria; restored. (After A. S. Woodward, *Vert. Palaeontology*.) *fr*, frontal; *meth*, mesethmoid; *md*, mandible, showing narrow dentary in front; *op*, opercular; *orb*, orbit; *pop*, preopercular; *pa*, parietal; *pmx*, premaxilla; *sq*, supraoccipital; *sq*, pterotic (squamosal); *v*, vomer. The caudal region is destitute of scales.

branchiostegal rays remain, and the place of the median gular is taken by a mosaic of small plates. The gill-opening is small. The jaws and palate are much specialised to bear a grinding dentition. The maxilla is slender and toothless. Sharp prehensile teeth occur on the small premaxilla and dentary; the slender toothless palato-quadrate arch becomes fixed for a considerable length to the basis cranii. On the splenials and opposing fused vomers are longitudinal rows of blunt enlarged grinding teeth. As specialisation increases the rows become fewer and more regular, and the teeth larger (Fig. 317).

The notochordal axis shows no trace of centra, and was probably persistent and unstricted. The neural and haemal arches are well ossified and continuous with the spines, become greatly expanded, and develop articulating processes (Fig. 317). The pleural ribs expand in the same way. The bases of these arches tend to grow round the notochord to a small extent in *Coelodus*, to a great extent in *Pycnodus*, where the dorsal almost meet the ventral.

Many of the most important structural characters of the Pycnodontidae are correlated with the development of a grinding dentition. Although their systematic position cannot be considered as definitely established, yet their removal from the Platysomatidae by Traquair and A. S. Woodward has brought to light their affinity to the Semionotidae. In the structure of the vertebral arches they approach the Teleostei.

*Mesodon*, Wagner (Fig. 319); *Mesturus*, Wagner; *Microdon*, Ag.; Jurassic, Europe. *Athrodon*, Sauvage; *Gyrodus*, Ag.; *Coelodus*, Heckel; Jurassic and Cretaceous, Europe. *Coccodus*, Pictet; *Xenopholis*, Davis; Cretaceous, Mt. Lebanon. *Pycnodus*, Ag.; Cretaceous and Eocene, Europe. *Palaeobalistum*, Blainv.; Cretaceous and Eocene, Europe and South America.

## Order 2. LEPIDOSTEOIDEI.

This order dates only from Eocene times, and contains a single genus, *Lepidosteus* (J. Müller [307], Balfour and Parker [30 and 320], van Wijhe [494], Kölliker [271], Collinge [85], Allis [19]). The body is elongate, the dorsal and anal fins short, and the caudal abbreviate-heterocercal (Figs. 324, 62). Thick rhombic ganoid scales cover the trunk and tail. These scales may bear numerous small true denticles on their surface (Fig. 192), and are provided with peg and socket articulations. The dermal bones have a similar layer of ganoine. A long snout is produced by the elongation of the jaws in a manner which is quite characteristic in that the nostrils and nasal sacs are carried to the extremity. It is therefore the ethmoid region which is lengthened, and the olfactory nerves reach the nasal capsules through long canals in the ethmoid cartilage. Paired fulcra arm the edges of the fins (Fig. 62). On the skull are to be noticed the usual paired supratemporals, parietals, and frontals; the pterotics are large, and the nasals are represented by elongated ethmo-nasals and small anterior nasals. There is no pineal foramen. A long preoperculum runs along the ventral edge of the operculum, most of the cheek region being covered by numerous irregular plates (Fig. 320). Characteristic of the upper jaw is the subdivision of the maxilla into a row of several toothed bones. The teeth are strong and pointed, with the wall radially folded at the base (Fig. 81, B). There is an extensive interorbital septum, the large exoccipitals meet above the foramen magnum, and no myodome is developed (Fig. 321). An articulation takes place between the prootic and the meta-pterygoid. The hyoquadrate

arch is very long, the articulation of the lower jaw being in front

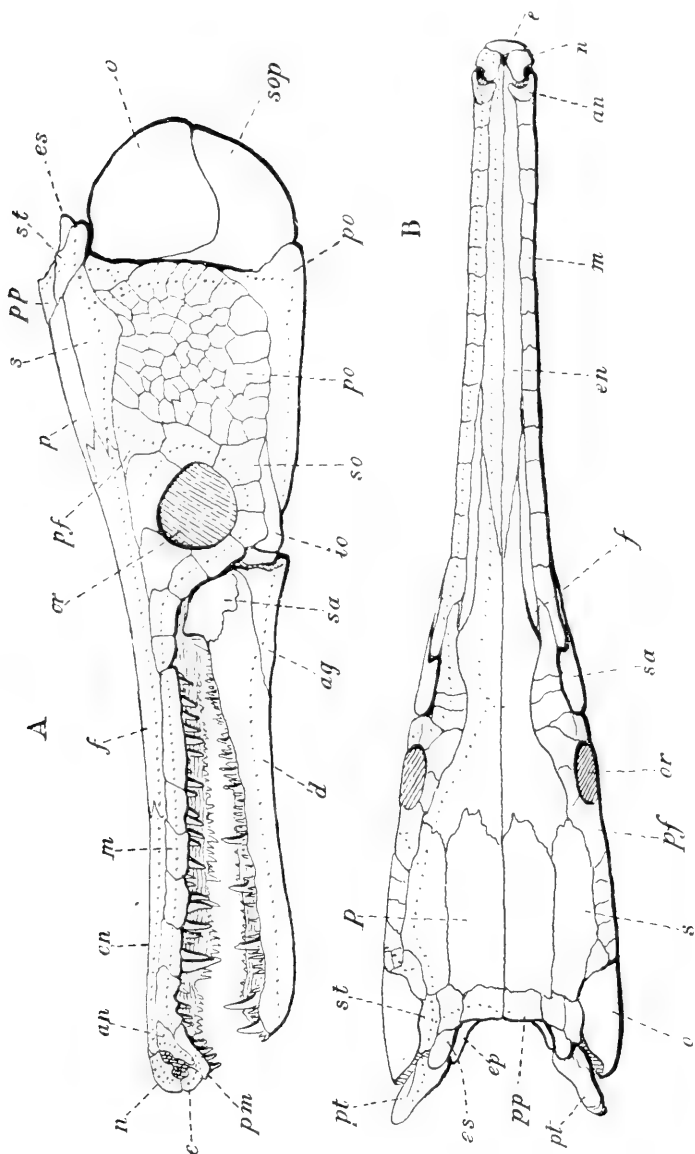

FIG. 329.

A, left-side view of the skull of *Lepidosteus viridis*, Gm. (After A. S. Woodward, modified.) B, dorsal view of the skull of *Lepidosteus viridis*, Gm. (After A. S. Woodward, modified.) The lateral-line canals are indicated by a dotted line. (After Allis and Collinge.) ag, dentary-articular; an, angular; ar, articular; es, epiotic; f, frontal; m, maxilla; n, nasal; o, orbit; p, parietal; pm, premaxilla; po, postorbital; pp, postparietal; pf, postparietal; sa, supraorbital; so, supraorbital; st, supratemporal.

of the orbit. There is no median gular, and the branchiostegal rays are reduced to three.

The vertebral centra (Gegenbaur [154], Balfour and Parker [30]) are quite exceptional among fishes for having a concave posterior and a convex anterior face; they are thus opisthocoelous (Fig. 322). The skeleton of the paired fins resembles that of *Amia*, though more reduced.

The spiracle is closed, but a well-developed opercular gill persists (hyomandibular posterior demibranch), Müller [305]. The pyloric caeca are numerous, and the median dorsal air-bladder is

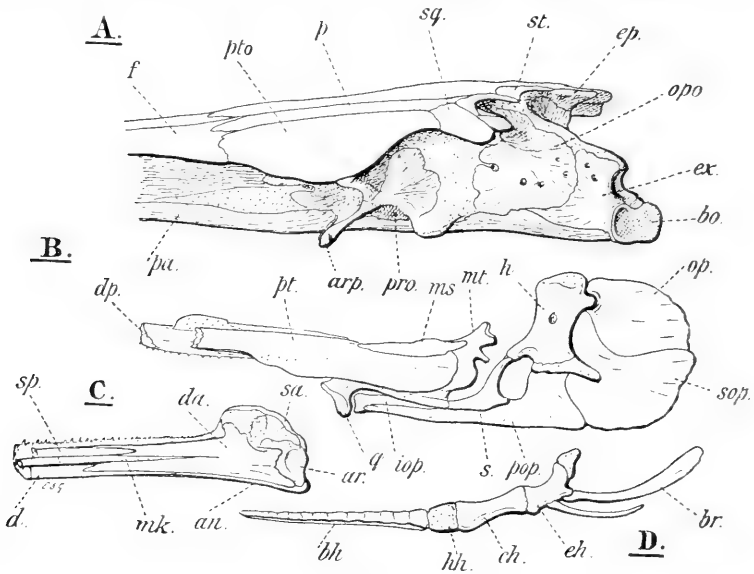

FIG. 321.

*Lepidosteus osseus*, L. A, oblique view of the skull from behind; B, inner view of the right opercular bones and upper jaw broken short in front; C, inner view of the hind end of the lower jaw; D, lower portion of hyoid arch, belonging to B. *an*, angular; *ar*, articular; *ar.p*, articular process for metapterygoid; *bh*, basihyal; *bo*, basioccipital condyle; *br*, branchiostegal; *ch*, ceratohyal; *d*, dentary; *da*, posterior splenial; *dp*, palatine; *eh*, epihyal; *eh*, epiotic; *ep*, epiotic; *ex*, lateral wing of basioccipital (fused neural arches); *f*, frontal; *h*, hyomandibular; *hh*, hypohyal; *op*, opercular; *oyo*, exoccipital (probably including opisthotic); *p*, parietal; *pa*, parasphenoid; *pop*, preopercular; *pro*, prootic; *pt*, ectopterygoid; *pto*, postfrontal; *q*, quadrate; *s*, symplectic; *sa*, supra-angular; *sop*, subopercular; *sp*, splenial; *sq*, pterotic; *st*, supratermporal.

lung-like with cellular walls (p. 224). The conus arteriosus is very long, with very many rows of valves (Fig. 323). In the presence of a closed ovisac, communicating only to the exterior by the oviducts, *Lepidosteus* shows a remarkable resemblance to the Teleostei (Fig. 355, D, and p. 366). The genital ducts in both sexes open together with the kidney ducts by a median pore. The cleavage of the egg is meroblastic. The larva has preoral adhesive organs.

In many respects, such as the elongation of the snout, the position of the nostrils, the forward position of the articulation

of the jaw, the covering of the cheek with small plates, the presence

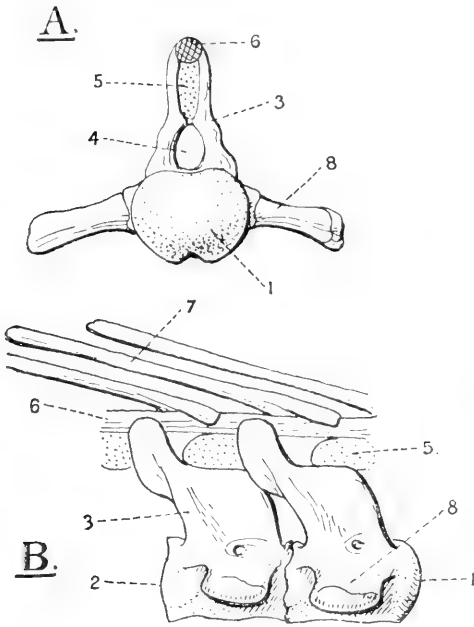

FIG. 322.

*Lepidosteus osseus*, L. A, vertebra from in front; B, vertebral column of trunk, right-side view. (After Balfour and Parker.) 1, convex anterior surface of centrum; 2, concave posterior surface of centrum; 3, neural arch (basidorsal); 4, neural canal; 5, interdorsal cartilage; 6, longitudinal ligament; 7, neural spine; 8, transverse process of centrum (parapophysis).

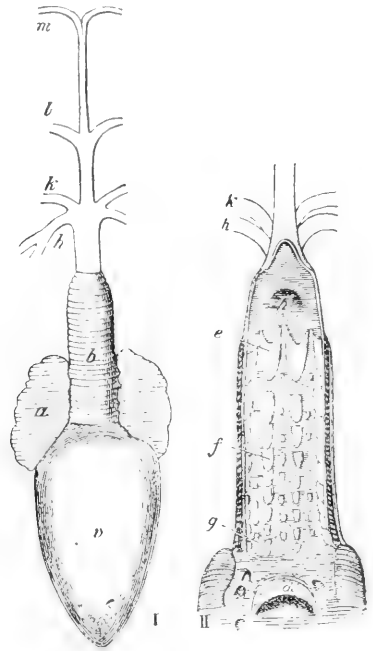

FIG. 323.

Heart of *Lepidosteus osseus*, L. I, ventral view. II, conus arteriosus opened. a, atrium; b, conus; c, f, g, transverse rows of valves in conus; h, k, l, m, four afferent branchial vessels; n, ventricle. (From Günther.)

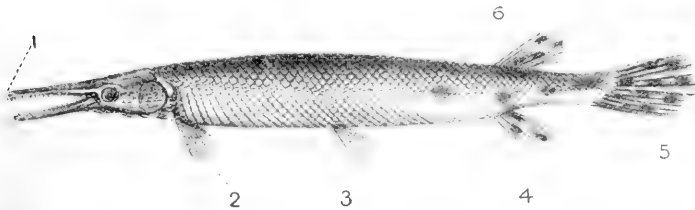

FIG. 324.

*Lepidosteus osseus*, L. 1, nostrils; 2, pectoral, 3, pelvic, 4, anal, 5, caudal, and 6, dorsal fin.

of an interorbital septum and of paired fulera, and the absence of a median gular, *Lepidotus* approaches the structure of this

order; very possibly *Lepidosteus* is merely a specialised late remnant of the family Semionotidae.

Family LEPIDOSTEIDAE.

*Lepidosteus*, Lac. ; Eocene, Europe; Eocene and living, North America (Fig. 324).

#### INCERTAE SEDIS.

Family ASPIDORHYNCHIDAE. Certain Mesozoic fishes, with very elongate body (Fig. 320), and a sharp long snout formed by the upper and lower jaws, are included in this family (Reis [349], A. S. Woodward [505], Assmann [21]). There are deep rhombic ganoid scales, with peg and socket articulations. Ganoid bones cover the skull; a large cheek-plate protects the side of the head; there are several lateral but no median gulars. The very long upper jaw is formed by the premaxillae and a portion of the maxillae which are in several pieces. The shorter lower jaw is provided with a distinct prementary bone. Sharp teeth are set on the jaws and palate. The nostrils are immediately in front of



FIG. 325.

*Aspidorhynchus acutirostris*. Blainv. ; Upper Jurassic, Bavaria; restored.  
(After A. S. Woodward.)

the orbit. A short dorsal fin is opposed to a similar anal, and the caudal is quite homocercal in appearance (Fig. 325). Small fulcra are found only on the median fins. The Aspidorhynchidae are placed as a rule near the Lepidosteidae, which they resemble in the subdivision of the maxilla and absence of a median gular plate. But they differ from them in many important characters, such as the position of the nostril, the shape of the tail, and the possession of simple annular vertebral centra. On the other hand, they approach the Pholidophoridae in these same characters, and they also have a median vomer as in all Teleostei. Possibly they represent a specialised offshoot from some early Amioid stock.

*Aspidorhynchus*, Ag. (Fig. 325); Jurassic, Europe. *Belonostomus*, Ag. ; Cretaceous, Europe, Asia, America, Australia.

### Order 3. TELEOSTEI.

Almost all the living Osteichthyes are included in this the highest Order of fish. The typical Teleostei are characterised by certain modifications of which the chief are the following: the loss of the ganoine covering the exoskeleton; the rounded thin overlapping scales; the simple annular or amphicoelous bony vertebral

centra; the intermuscular bones; the homocercal tail with hypural bones; the further reduction of the radials of the paired fins; the spine-like postclavicle; the supraoccipital (p. 326); the unpaired vomer; the simplification of the lower jaw, which loses the supraangular and splenial, preserving only the dentary angular and articular; the absence of special cheek-plates, and loss of the median gular; the median urohyal; the reduction of the conus and its valves, and compensating development of the truncus arteriosus; the loss of the optic chiasma and of the spiral valve; the special vas deferens, and ovarian sac.

Many of these characters are not possessed by the lower forms,

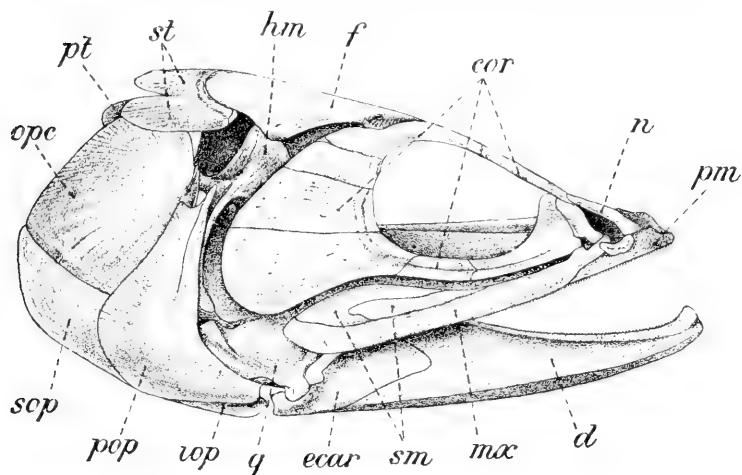

FIG. 326.

Right-side view of the skull of *Elops saurus*, L. (From Ridewood, *Proc. Zool. Soc.*) *cor*, circumorbitals; *d*, dentary; *ecar*, dermotic; *f*, frontal; *hm*, hyomandibular; *iop*, interopercular; *mac*, maxilla; *n*, nasal; *opc*, opercular; *pm*, premaxilla; *pop*, preopercular; *pt*, posttemporal; *q*, quadrate; *sm*, supramaxillaries; *scp*, subopercular; *st*, supratemporals.

either because the new structures have not yet become developed or because certain ancestral characters are not yet lost. The Teleostei are the most recent of all the Actinopterygian Orders; they are not known to occur below the Jurassic, and thus offer to the systematist at once the best opportunity for tracing out phylogeny, and a most confusing number of intermediate forms. For the most recent advances in the classification we are chiefly indebted to Gill [165], Günther [191-92], Sagemehl [379], Jordan [250-51], A. S. Woodward [505], and Boulenger [40-42].

In the skull we notice a general tendency, already referred to (p. 222), for the dermal bones to sink deep below the surface, leaving lateral-line ossicles in the skin (Allis [16, 19]), Parker [319], Schleip [387], Gaupp [151a]. The prefrontal (ectethmoid,

parethmoid) and post-frontal (sphenotic), and even the pterotic ('squamosal'), may thus become converted into entirely cartilage bones. The parietal region often becomes grown over by the trunk myotomes from behind (as in the Gadidae, Fig. 328), and the supraoccipital then develops a vertical crest. The muscles may simply cover the parietals or they may project into a post-

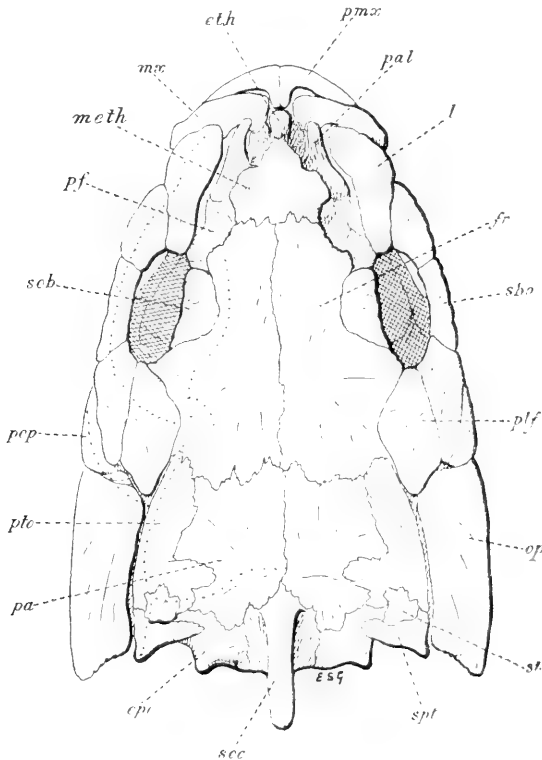

FIG. 327.

Dorsal view of the skull of *Cyprinus carpio*, L. A dotted line indicates the lateral-line canals on the left side. *epo*, epiotic; *eth*, pre-ethmoid (rostral); *fr*, frontal; *l*, lachrymal; *meth*, mesethmoid; *mx*, maxilla; *op*, opercular; *pa*, parietal; *pal*, palatine; *pf*, prefrontal; *pmx*, premaxilla; *pop*, preopercular; *pof*, postfrontal; *pte*, pterotic; *sob*, supraorbital; *scc*, supraoccipital; *spl*, supratemporal; *st*, anterior supratemporal.

temporal foramen, as in *Amia*, tending to separate the parietals from the cranial wall. This post-temporal fossa is often present in the lower families (Elopidae, Albulidae, Osteoglossidae, Clupeidae, etc.). It may be roofed over by the epiotic and pterotic as well as the parietal. A supratemporal (extrascapular) is often present, but is lost in the higher sub-orders (Figs. 329-31).

The position of the parietals is important. It may safely



be assumed that the condition in which the parietals meet in the middle line and are not separated by the supraoccipital is primitive; it is found in the lower Teleostomes, where, indeed, the supraoccipital has not yet appeared (p. 326). But, although it is the rule in the lower sub-orders that the parietals meet, yet even in the Clupeiformes there are genera in which the supraoccipital touches the frontals underneath the parietals (*Elops*, *Albula*, *Chanos*), and among the Acanthopterygii the parietals may sometimes meet

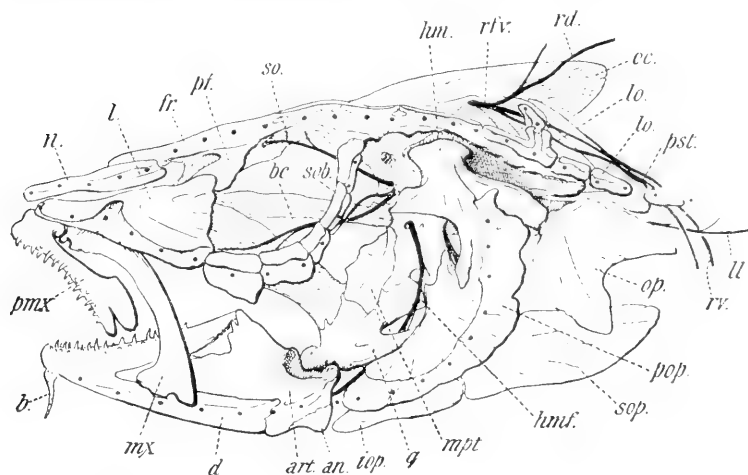

FIG. 328.

Left-side view of the skull of *Gadus morrhua*, L. The branches of the facial nerve are shown, and the course of the lateral-line system (by a series of dots, partly after Cole. an, angular; art, articular; b, barbel; b.c, buccal branch of facial supplying suborbital canal; d, dentary; fr, frontal; hm, hyomandibular; hm.f, hyomandibular branch of facial supplying its lateral-line canal; top, interopercular; l, 'lacrimal'; ll, lateral-line branch of vagus; lo, lateral-line ossicles; mpt, metapterygoid; mx, maxilla; n, nasal; oc, crest of supraoccipital; op, opercular; pf, prefrontal; pmx, premaxilla; pop, preopercular; pst, post-temporal; q, quadrate; r.d, branch of facial supplying region of dorsal fin; r.fr, dorsal recurrent branch of facial; rr, branch of facial supplying region of pectoral fin; s.o, superior ophthalmic branch supplying supraorbital canal; sob, suborbital; sop, subopercular).

(Cyttidae, Scorpaenidae, Triglidae (Boulenger [42], Ridewood [362-65])). Their union in such cases may be secondary.

Frequently, especially in the higher forms (Acanthopterygii), not only the basioccipital, but the exoccipitals as well, bear articular facets for the vertebral column, and join below the foramen magnum.

Two more characteristics of the Teleostean skull may be noticed: the presence of a supraoccipital bone, the origin of which has already been discussed (p. 326); and the fact that the vomer is single and median, not paired as in almost all lower forms.

No certain trace of either the splenial or the coronoid has been found in the lower jaw of a Teleost; but the median gular is preserved

in one family only of living Teleostei, the Elopidae (Fig. 376). In others the right and left branchiostegal membranes either are

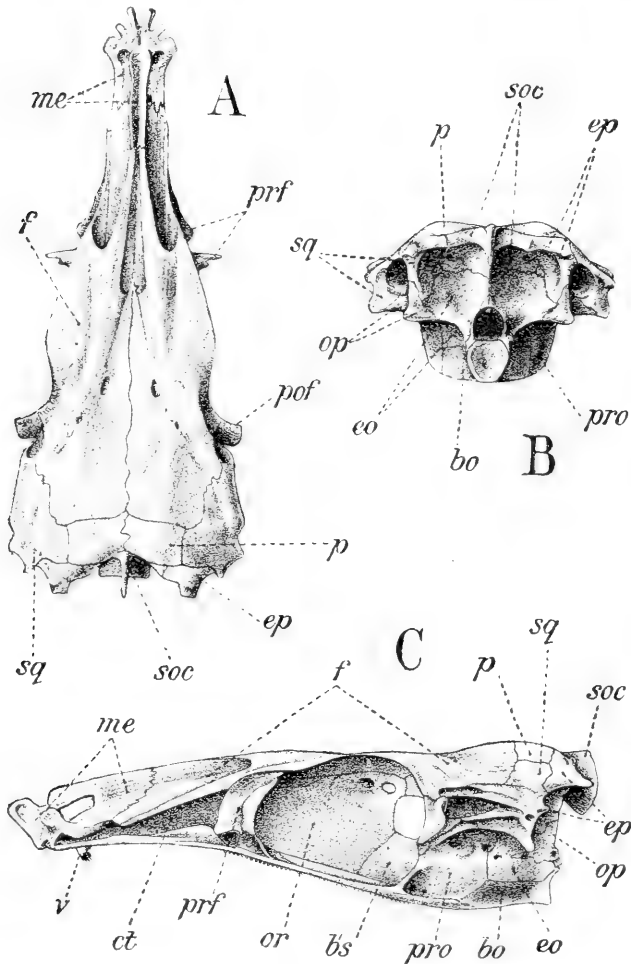

FIG. 329.

Skull of *Alluda conorhynchus*, B. and S. (From Ridewood, *Proc. Zool. Soc.*) A, dorsal view; B, view from behind; C, left-side view. *bo*, basioccipital; *bs*, basisphenoid; *ct*, cartilage; *eo*, exoccipital; *ep*, epiotic; *f*, frontal; *me*, mesethmoid; *op*, opisthotic; *or*, orbitosphenoid; *p*, parietal; *pof*, postfrontal; *prf*, prefrontal; *pro*, prootic; *soc*, supraoccipital; *sq*, pterotic (squamosal); *v*, vomer.

confluent in the mid-ventral line below the isthmus, or, in the more modified forms, they may run forwards without meeting. The branchial slits are continued ventrally far forwards between the

rami of the lower jaw, and separated by a narrow 'isthmus' supported by the basibranchials and urohyal.

The opisthotic varies in a remarkable manner, being very large in some (Gadidae), small in others (Esocidae, etc.), or absent (Mormyridae, etc.). An interorbital septum is present (p. 324), except in the Cypriniformes (Ostariophysi; see, however, the Galaxiidae and Gadidae). In what is probably its more primitive condition it is formed partly by cartilage, partly by the orbitosphenoids meeting and fusing in the middle line (Salmonidae); in other cases it is entirely bony (*Albula*, Fig. 329), or almost entirely membranous (Elopidae, Gadidae, etc.). The basisphenoid, paired or median, is always small and often absent. The orbitosphenoid

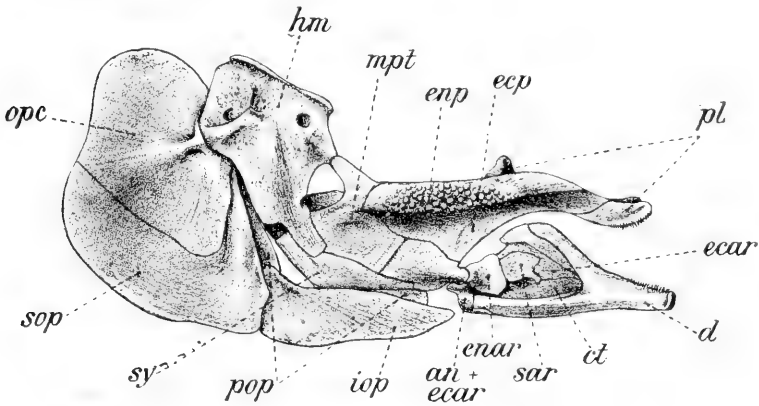

FIG. 330.

*Albula conorhynchus*, B. and S. Left hyopalatine arch, etc.; inner view. (From Ridewood, Proc. Zool. Soc.) an + ecar, angular fused to dermal articular; d, dentary; ecar, dermal articular; ecp, ectopterygoid; enar, articular (endosteal); enp, endopterygoid; hm, hyomandibular; iop, interopercular; mpt, metapterygoid; ope, opercular; pl, palatine; pop, preopercular; q, quadrate; sar, sesamoid articular; sop, subopercular; sy, symplectic.

is rarely found outside the lowest sub-orders. The palatine articulates in front either by a single large head with the ethmoid cartilage or the prefrontal bone, or by two heads as in the Salmonidae and others (Swinnerton [431]); or the anterior articulation alone remains (*Gasterosteus*, *Belone*, etc.). Various and peculiar are the modifications undergone by the mouth and jaws in the Teleostei. The premaxillae become very movable, free behind, and loosely articulated in front in the higher forms. The maxilla loses its teeth and ceases to occupy the margin of the mouth. The two bones come to lie parallel to each other; the former articulating with the anterior mesethmoid region, the latter with the vomer and lateral ethmoid region and palatine (Fig. 456). Frequently the jaws are protrusible (p. 375), in which case the dorsal process of the premaxilla is usually much elongated and

slides backwards and forwards over the ethmoid, the maxilla being pushed forward by the palatine (Figs. 333, 441). An accessory

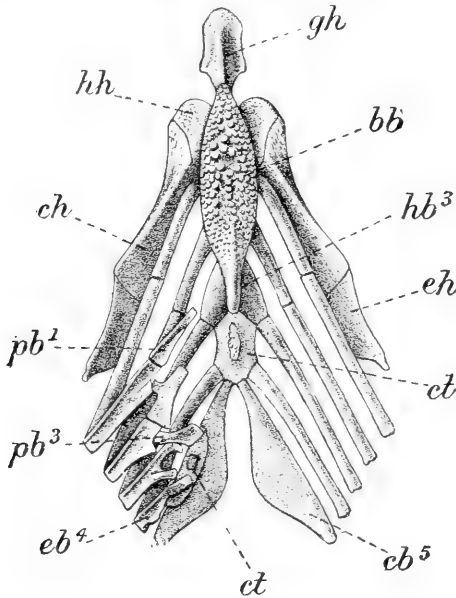

FIG. 331.

*Albulus conorhynchus*, B. and S. (From Ridewood, *Proc. Zool. Soc.*) Dorsal view of the hyobranchial skeleton; the epi- and pharyngobranchials have been removed from the right side. *bb*, dentigerous plate covering the three first basibranchials; *hb*<sup>3</sup>, fifth ceratobranchial; *eb*<sup>4</sup>, fourth epibranchial; *ch*, ceratohyal; *ct*, cartilage; *eh*, epihyal (or upper ceratohyal); *et*, fourth and fifth basibranchials fused and covered with small dentigerous plate; *gh*, thin bony plate covering the basihyal (glossohyal); *hb*<sup>3</sup>, third hypobranchial; *hh*, hypohyal; *pb*<sup>1</sup> and *pb*<sup>3</sup>, first and third pharyngobranchials.

masticating apparatus is often developed on the branchial arches (Fig. 460).

The median urohyal, attached in front to the hypohyals and

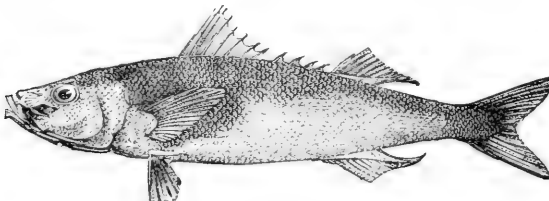

FIG. 332.

*Erythrichthys nitidus*, Rich. (After Günther.)

passing back between the sternohyoid muscles, is quite peculiar to the Teleostei (Figs. 303, 358); similar but paired bones occur in *Polypterus*.

The dermal pectoral girdle is generally remarkable for the backward and inward prolongation of a styliform postclavicle deeply

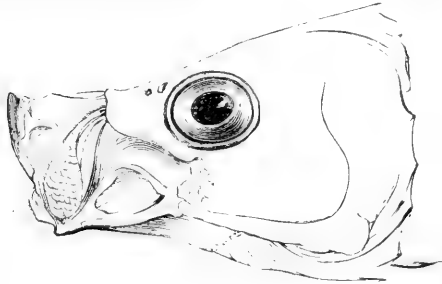

FIG. 333.

Head of *Erythrichthys nitidus*, Rich., with mouth protracted. (After Günther.)

embedded in the body-wall (Fig. 452). Almost always the radials of the pectoral fin are reduced to three or four short radii and one very

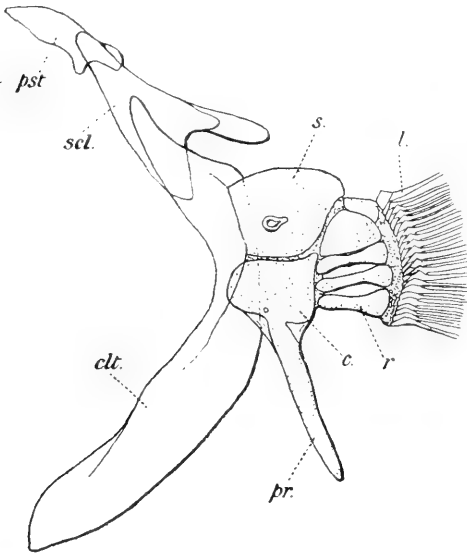

FIG. 334.

Skeleton of the right half of pectoral girdle and right fin of *Fierasfer acus*, L. (After Emery.) *c*, coracoid; *clt*, cleithrum; *l*, lepidotrich; *pr*, ventral process; *ps.t*, post-temporal; *r*, 5th radial; *s*, scapula with small foramen; *scl*, supraclavicle. The cartilage is dotted.

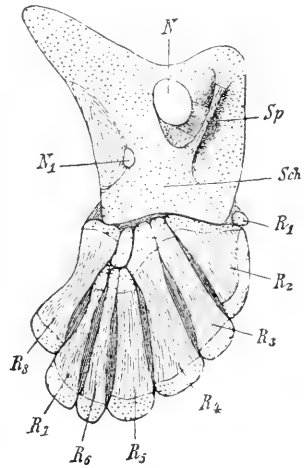

FIG. 335.

Endoskeleton of the pectoral girdle and fin of *Malapterurus electricus*. (After Sagemehl, from Gegenbaur, *Vergl. Anat. Wirbeltiere*.) *N*, scapular foramen; *N<sub>1</sub>*, nerve foramen; *R<sub>1-6</sub>*, radials; *Sch*, girdle; *Sp*, mesocoracoid.

small radial fixed to the base of the anterior dermatrich. There may be a few distal nodules of cartilage. All trace of an axis has vanished, and the radials appear to be all of preaxial origin.

However, a ventral process of the coracoid present occasionally in the adult (Fig. 324), but more frequently in the early stages of development, has been supposed to represent the fin axis (Swinnerton [432], Haller [194]). But in some few cases there is a greater number of radials (*Anguilla*, *Malapterurus* (Fig. 335), *Muraenolepis*). Whether this larger number really represents the survival of a more primitive condition, as Sagemehl supposed, it is difficult to say; on the whole, it seems more probable that it does not. Vestiges remain of the pelvic radials only in lower

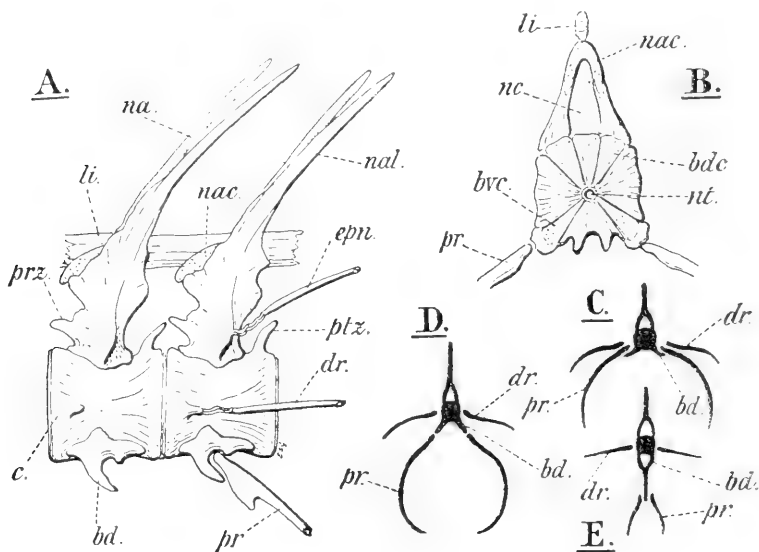

FIG. 336.

A, left-side view of two trunk vertebrae of *Esox lucius*, L. B, vertical median section of the same. D, C, and E, *Thyanus vulgaris*, Cuv. C, anterior trunk region; D, posterior trunk region; E, caudal region. *bd*, basiventral (haemal arch); *bd.c*, basidorsal cartilage; *bvc*, basiventral cartilage; *c*, centrum; *dr*, dorsal rib (epipleural); *epn*, epineural; *li*, longitudinal ligament; *na*, basidorsal (neural arch); *n.a.c.*, its cartilage (interdorsal?); *n.o.l.*, left neural arch; *n.c.*, neural canal; *nt*, notochord; *p.r.*, pleural rib; *prz*, anterior articulating process; *ptz*, posterior articulating process.

forms. The pelvic girdle consists of two bones sometimes united in front by cartilage (*Gadus*, p. 276), sometimes expanding behind into large plates spreading towards the middle line (Siluroids, etc., Fig. 365).

The vertebral centra show no signs of compound structure. As a rule, they are more or less solid and biconcave (Figs. 336, 337), the notochord in living genera being usually constricted to a mere fibrous thread (Goette [167], Grassi [182], Scheel [385]). The centra are generally, but not always, co-ossified with the arches and these with the spines. Intervertebral articulations are formed by

the development of anterior zygapophyses on the neural or haemal arches which rest on corresponding processes in front, or these may be supplemented by processes dorsal and ventral from the centra themselves (Fig. 339). The basiventrols in the abdominal region form outstanding processes of the centrum (parapophyses, 'transverse processes'), to which the pleural ribs may be articulated. More dorsal ribs (epipleurals) generally are attached near the

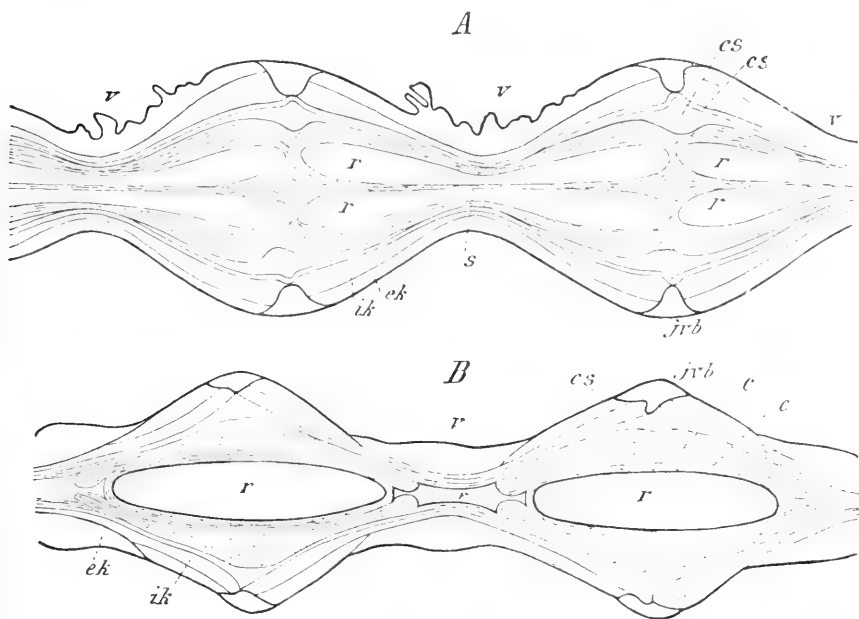

FIG. 337.

Longitudinal section through the vertebral column of A, *Boobus vulgaris*; and B, *Naucrates ductor*. (From Gegenbaur, *Verh. Anat.*) c, notochord; cs, notochordal sheaths; ek, outer, and ik, inner bony layer; jrb, intervertebral ligament; r, space; s, axial strand; v, centrum.

parapophysis; as they extend outwards in the horizontal septum they are analogous, if not homologous, with the dorsal or true ribs of Elasmobranchs, etc. Slender intermuscular bones (Fig. 305) also frequently extend into the connective tissue septa from the centra (epicentrals), or neural arches (epineurals). The tail in all but the lowest families is completely homocercal (Figs. 63-65). As a rule, the haemal arches of one or more of the most posterior vertebrae become greatly expanded and are known as hypural bones (Huxley [226], Kölliker [271], Ryder [378], Dollo [120]). The hypurals may coalesce. In many groups, however, the tail tapers to a symmetrical end, and acquires the appearance of a diphyccal

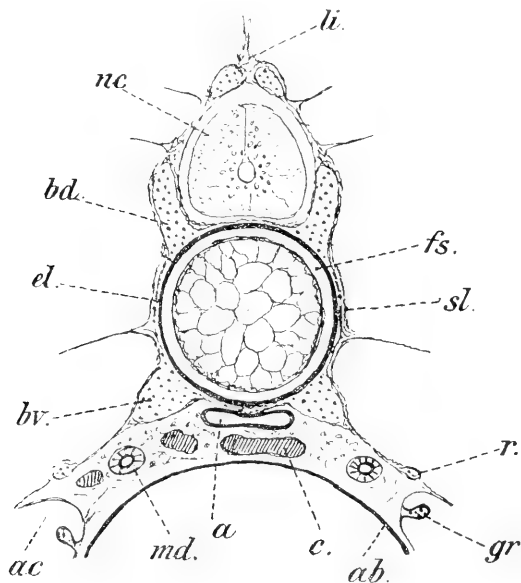

FIG. 338.

Transverse section of the vertebral column in the trunk of a very young Trout (*Salmo*), enlarged. *a.b.*, dorsal wall of air-bladder; *a.c.*, abdominal coelom; *bd.*, basidorsal cartilage; *bv.*, basiventral cartilage; *c.*, posterior cardinal vein; *cl.*, elastica externa; *fs.*, fibrous sheath surrounding notochord; *gr.*, genital ridge; *li.*, dorsal longitudinal ligament; *md.*, mesonephric duct; *nc.*, nerve-chord; *r.*, rib; *sl.*, skeletogenous tissue.

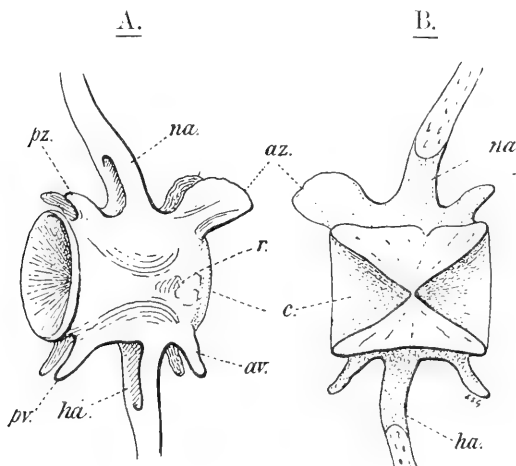

FIG. 339.

Caudal vertebrae of *Thynnus vulgaris* (Cuv. and Val.). A, right-side view; B, left-side view of the same cut in half. *a.v.*, anterior ventral process; *az.*, anterior 'zygapophysis'; *c.*, centrum; *ha.*, haenal arch; *na.*, neural arch; *p.v.*, posterior ventral process; *p.z.*, posterior 'zygapophysis'; *r.*, place of attachment of rib.



structure (Figs. 340, 341). This is brought about by the reduction of the extreme tip of the heterocercal or homocercal fin in the later stages of development; such a false or secondary diphyocercal fin is called gephyrocercal (Ryder [378]). The structure of the actual upturned tip of the notochord varies greatly, being naked in *Esox*, with a cartilaginous sheath in *Salmo*, *Elops*, etc., a bony urostyle in

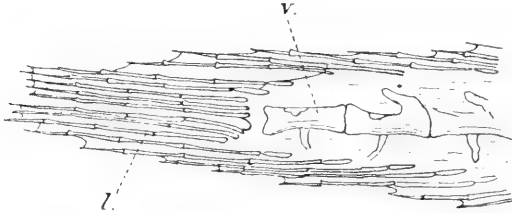

FIG. 340.

Skeleton of the extremity of the tail of *Fierasfer dentatus*, Cuv. (After Emery.)  
*l*, lepidotrich; *v*, last vertebra.

Acanthopterygii and others. Special bony plates may lie on each side of it (Fig. 63) (Lotz [286]).

It is to be noticed that although the caudal fin is chiefly of hypochordal origin (p. 104), yet a considerable portion of the upper lobe may be derived from the epichordal fin (Fig. 46). The composition of the caudal fin thus varies in different families, and a more exact study of its development might yield useful results.

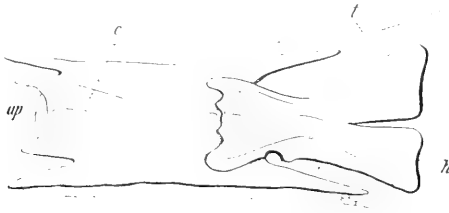

FIG. 341.

*Callionymus lyra*, L. Left-side view of the two last caudal vertebrae, enlarged. *ap*, anterior articulating process; *c*, centrum; *h*, hypural expansion; *t*, outline of tail.

In a large number of the more primitive Teleostei the bone in the adult is of normal structure with branching bone-cells, vascular canals, and a lamellated matrix (p. 61); but in many others it becomes strangely modified (Kölliker [270], Schmidt-Monard [388*a*], Stewart [425]). For instance, in *Salmo* and *Thymallus* the cells lose their branching processes; in *Xiphias gladius* the lamellated matrix is deposited round vascular canals some of which give off fine tubules; but the bone-cells are very scarce or altogether absent. *Fistularia* and the Pleuronectidae have likewise lost the cells and

the bone somewhat resembles dentine; while in *Gadus* the skeleton is formed of bony matrix with irregular spaces, but neither Haversian canals nor bone-cells.

The scales also almost always lose their bone-cells, and the lower lamellae become transformed into thin, tough, and pliable layers of crossing fibres without any vascular canals, over which is deposited a more calcified layer (Fig. 193). The varied ornamentation on the surface of Teleostean scales is due to modifications in this outer layer, in the form of ridges, spines, etc. (Figs. 342, 441, C). In the ctenoid variety of scale it grows out into sharp spines situated on the posterior free border (*Gobius*, *Holocentrum*, etc.); or over the whole exposed surface (*Solea*, *Mugil*, etc.). Lens-shaped calcifications are sometimes scattered in the inner regions of the scale.

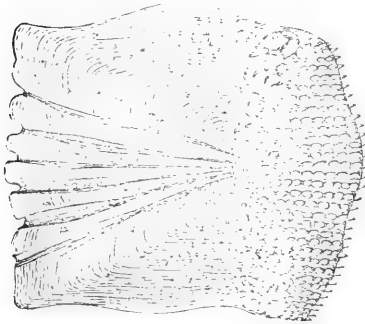

FIG. 342.

Ctenoid scale of *Engrichthys nitidus*, Rich.  
(After Günther.)

Both the outer and the inner layers grow by the addition of new lamellae on the outside. No trace of true ganoin is found in modern Teleostei; but it is possible that the outer calcareous layer has been derived from it. In some families the scales become modified into spines, either small and embedded in the skin, or large and freely projecting (Diodontidae). Such spines do not represent modified denticles, from which they differ fundamentally.

True denticles with dentine cone and pulp-cavity do, however, occur in large numbers on the dermal skeleton of the Siluroids, where they are movably articulated to the underlying bones (Fig. 373). This puzzling fact can at present only be accounted for on the supposition that the Siluroidei have been derived from ancestral Teleosts in which the dermal denticles were still present, as they are in *Polypterus* and *Lepidosteus*.

The Teleostean scale develops like the ganoid (Hofer [215a], Klaatsch [264], Ussow [471], Hase [198]). Mesoblastic cells gather together below the basement membrane, forming papillae which project slightly into the epidermis. In the middle of each mass of scleroblasts as it spreads out appears a thin lamella of skeletal substance (Fig. 343, A). This increases in size and thickness by the addition of new layers, the scleroblasts covering its entire surface. The surrounding tissue becomes the loose packet in which the adult scale is lodged (Fig. 193). The front edge of the scale grows inwards; the hinder edge outwards, carrying the epidermis with it.

Deep-sea Teleostean fish are variously modified in adaptation to their peculiar environment, and among the most characteristic structures developed in them are the phosphorescent organs. These differ considerably in the various genera and in the different parts of the same animal. The more elaborate phos-

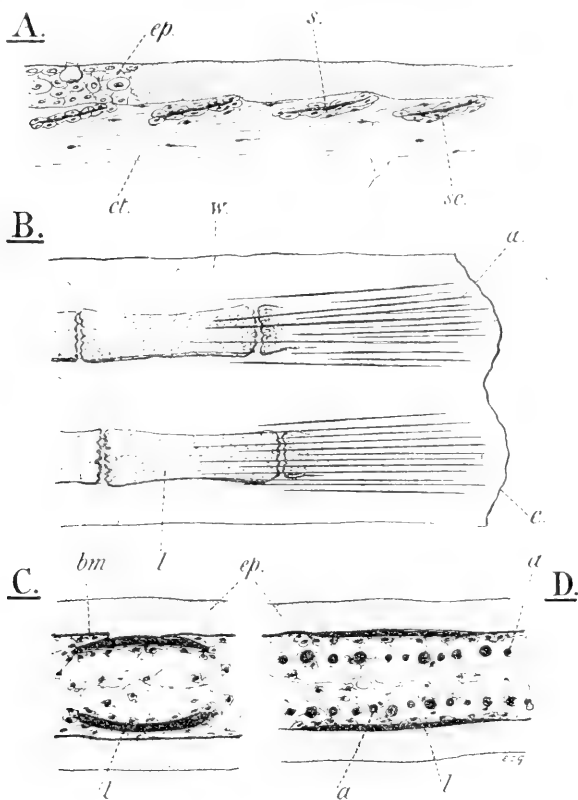

FIG. 343.

A, early stage in the development of the scales of the Mimus, *Leuciscus phoxinus*, L. B, portion of the free edge of the dorsal fin of a young Siluroid, showing the actinotrichia underlying the lepidotrichia at the growing margin. C, transverse section of the developing lepidotrichia of the Trout, *Salmo trutta*, L. All enlarged. a, actinotrich; b,m, basement membrane; c,t, connective tissue; c, growing edge; l, lepidotrich; s, pocket lined with scleroblasts enveloping the developing scale, sc; w, web of fin.

phorescent organs have a cellular lens set in the opening of a cup, which contains an epithelium of large cells. These are the cells which secrete the light-giving substance, and the walls of the cup, generally covered with pigment, act as a reflector (Fig. 345). Organs of this character may be present on the head or body, and may be distributed in regular lines, or scattered over the whole

surface more or less evenly (Fig. 344). Occasionally they occur near the eyes, and so placed as to direct the light inwards. Sometimes they appear to be directly derived from the lateral line on the body, and may be lodged in a specially enlarged series of scales (Fig. 417). The interesting suggestion has been made that, since they give out light of various colours, these luminous organs fulfil the same function among deep-sea fish living in the dark as do pigments among animals in daylight (Brauer [43-44], Lendenfeld [280]).

The lateral line is often excessively developed on the head, large mucus cavities being excavated in the bones (Scorpenidae). On the trunk the canal may be obliterated so that the organs lie in the skin (p. 222).

The Teleostei never have more than four complete gills, and

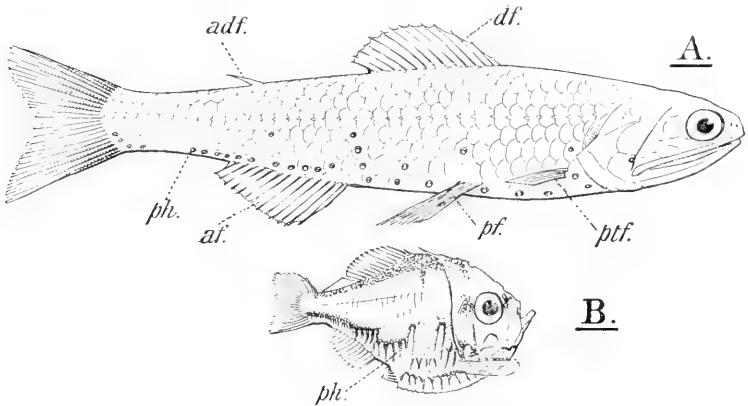

FIG. 344.

A, *Scopelus engraulis*, Gthr. B, *Polyipnus spinosus*, Gthr. (After Günther.) *a.f.*, anal fin; *adf.*, adipose fin; *d.f.*, dorsal fin; *p.f.*, pelvic fin; *ph.*, phosphorescent organ; *pt.f.*, pectoral fin.

often less in the specialised groups. Frequently there is a pseudo-branch of variable structure and doubtful morphological significance. It may be well developed and in the form of gill-lamellae, as in the Pleuronectidae; or it may be more or less completely hidden below the skin or even deeply sunk in the tissues. In many cases it is said to be altogether absent. The blood-supply is derived from the efferent system of vessels, and usually from the hyoidean artery (second vascular arch); while it leaves the pseudo-branch by the ophthalmic artery (Fig. 72). It has not yet been determined for certain whether this pseudobranch is derived from the mandibular or the hyoidean gill; the latter seems to be its place of origin in many cases, but in others it may develop from both sources. (Allis [15], Cole and Johnstone [84], Dohrn [115], Maurer [294-95]).

The sclerotic of the eye may be ossified. The ventral muscle of accommodation is present as usual; but there projects besides, to the back of the lens, a vascular process from the choroid fissure, the characteristic campanula Halleri (Fig. 346). A very large solid otolith usually occurs in the sacculus of the ear, and smaller ones in the utriculus and lagena (Retzius [356]).

The duct of the air-bladder, always dorsal except in some

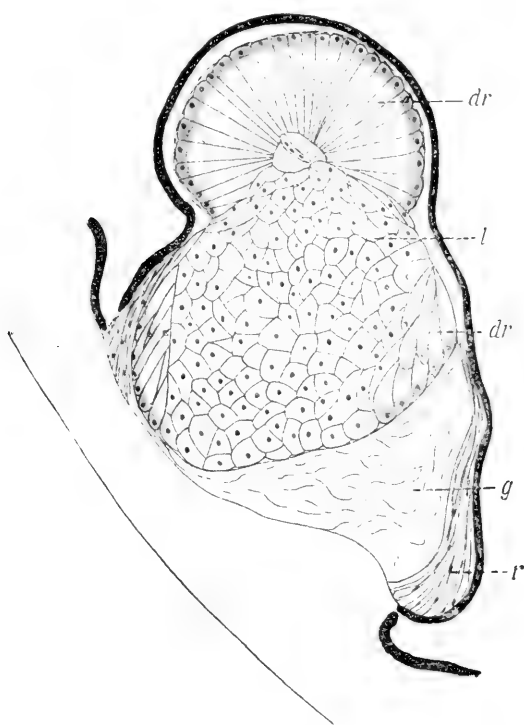

FIG. 345.

Section through epidermis and phosphorescent organ of *Stomius*. (After Brauer.) *dr*, glandular cells which secrete the light-producing substance; *g*, transparent gelatinous tissue; *l*, lens; *r*, reflector; pigment surrounds the organ except on the surface turned towards the epidermis.

Characinids (p. 225), is generally longer and has a much narrower lumen than in the lower Teleostomes; the lumen may become reduced or disappear, and the air-bladder be quite cut off in the adult from the alimentary canal—a fact which led authors to divide the Teleostei into Physostomi with open, and Physoclisti with closed pneumatic duct.

The shape of the air-bladder undergoes all sorts of modifications: in the Cyprinidae it is constricted into a small anterior and a larger

posterior chamber; in *Otolithus* a median chamber has paired lateral prolongations (Fig. 349); in the Sciaenidae and Polyxenidae innumerable branching diverticula are given off (Fig. 348); in *Callichthys* the complication is still greater. The cavity of the air-bladder is sometimes divided into compartments (Siluridae (p. 377)), or small alveoli (*Erythrinus*). In the Herring (Fig. 383) a special opening to the exterior is formed behind the anus (Weber); while a communication is established with the right branchial cavity in the physoclistous *Caranx trachiurus* (Moreau). The bladder is a

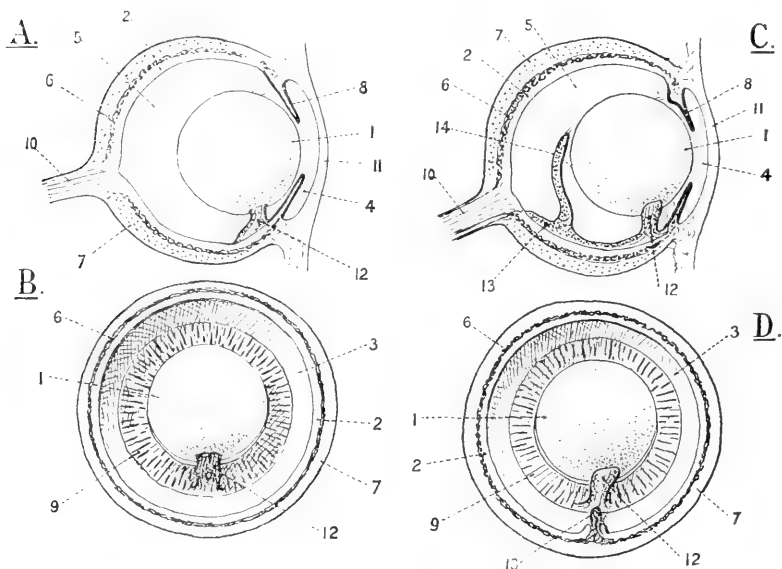

FIG. 316.

A and B, eye of *Acanthius vulgaris*, Risso. B and C, eye of *Salmo salar*, L. A and C, section of eye vertical to surface, leaving the lens intact. B and D, inner view of the outer half of the eyeball, showing the lens in position. 1, lens; 2, cut surface of retina; 3, retina; 4, anterior chamber or aqueous humour; 5, posterior chamber or vitreous humour; 6, pigment layer; 7, cut edge of sclerotic; 8, iris; 9, ora serrata; 10, optic nerve; 11, cornea; 12, ventral accommodating muscle (ciliary process); 13, vascular ridge from choroid fissure; 14, vascular process (campanula Halleri). (Goodrich and Graton.)

hydrostatic organ, is never supplied direct from the aortic arches (p. 226), and never functions quite as a lung; but on its inner wall are developed retia mirabilia, highly vascular patches, which secrete the gases in the bladder (Hasse [199]).

Caecal outgrowths towards the head and tail occur in a large number of families (Berycidae, Siluridae, Clupeidae, etc.). A connection between them and the ear is often established. In the simpler cases a diverticulum on each side abuts against a membranous fenestra of the periotic capsule, so that pressure or vibrations can be communicated from the bladder to the perilymph

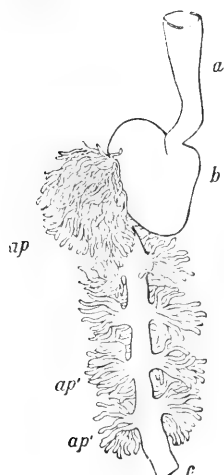

FIG. 347.

*Chatoessus*. (After Hyrtl, from Gegenbaur.) Oesophagus, *a*; stomach, *b*; and intestine, *c*; with pyloric appendages, *ap* and *ap'*.



FIG. 349.

Air-bladder of *Otolithus* sp. (After Günther.)



FIG. 348.

Air-bladder of *Pogonias chromis*, L. (After Günther.)

surrounding the labyrinth of the ear (Mormyridae, Serranidae, Berycidae, Sparidae, Gadidae, Notopteridae; Bridge and Haddon [58]). The diverticulum in other genera may penetrate the prootic and pterotic bones and may touch the labyrinth (most Clupeidae, Hyodontidae; Ridewood [357]). The most complex arrangement is that found only in the Cypriniformes, as de-

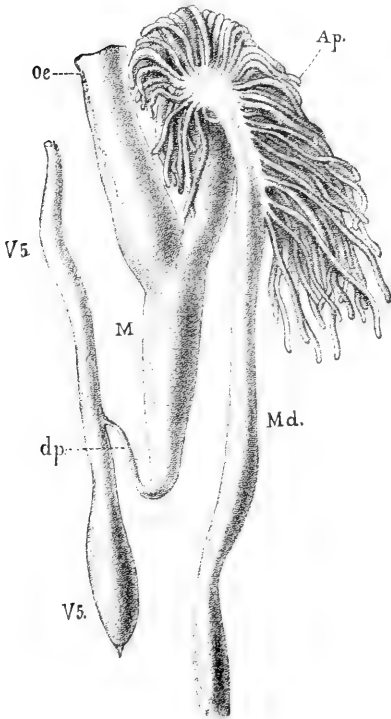

FIG. 350.

Alimentary canal and air-bladder of *Alosa vulgaris*. (From Gegenbaur, *Vergl. Anat.*) *A.p.*, pyloric appendages; *d.p.*, ductus pneumaticus; *M.*, stomach; *Md.*, intestine; *Oe.*, oesophagus; *V5.*, air-bladder.

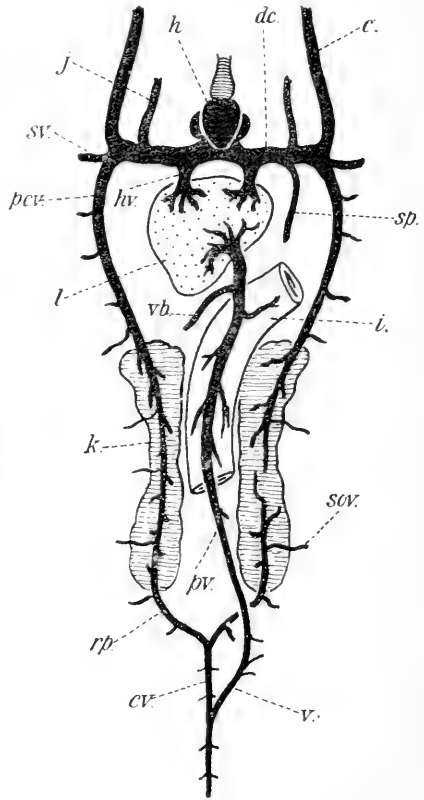

FIG. 351.

Diagram of the venous system of a Teleost, ventral view. *c.*, superior jugular vein; *c.v.*, caudal vein; *d.c.*, ductus Cuvieri; *h.*, heart; *h.v.*, hepatic vein; *i.*, intestine; *j.*, inferior jugular vein; *k.*, kidney; *l.*, liver; *p.c.v.*, posterior cardinal vein; *p.v.*, portal vein; *r.p.*, renal portal vein; *s.o.v.*, somatic vein; *s.p.*, spermatic vein; *s.v.*, subelavian vein; *v.*, vein uniting caudal with portal (not always present); *v.b.*, vein from air-bladder.

scribed below (p. 373). Often the air-bladder is lost (among the Scopelidae, Symbranchiidae, Pleuronectidae, Lophiidae, etc.).

The spiral valve of the intestine has disappeared in all living Teleosts except *Chirocentrus* (Cuvier and Valenciennes [95] (Fig. 77, A)). Vestiges of it may perhaps remain in some Salmonidae



(Rathke) and *Gymnarchus* (Assheton). The intestine becomes lengthened and sometimes much coiled. The pancreas almost disappears. The pyloric caeca vary greatly in development (Fig. 350).

Already in *Amia* the bulbus arteriosus (base of the truncus) of the heart is large and the conus small, in the Teleostei the non-contractile bulbus is still larger and the conus reduced to a mere vestige bearing a single row of valves. A larger remnant of the conus with two rows of valves occurs in *Albula* (*Butirinus*) and *Osteoglossum* (Boas [39]), and in *Tarpon* and *Megalops* (Senior [405]) (Figs. 69, 303).

Many variable and minor differences occur in the vascular system [8, 314, 131, 417, 360]. The lateral epigastric veins disappear, or may be represented by a prolongation of the hepatic

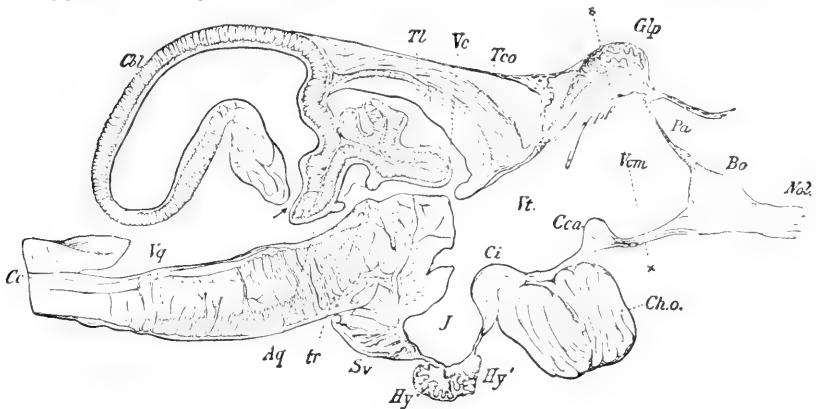

FIG. 352.

Median longitudinal section of the brain of a Trout (*Salmo*). *Aq*, aqueductus Sylvii; *Bo*, olfactory lobe; *Cbl*, cerebellum; *C.c.*, central canal of spinal cord; *Cca*, anterior commissure; *Cho*, optic nerve; *Ci*, inferior commissure; *Glp*, pineal body; *Hy* and *Hy'*, hypophysis; *J*, infundibulum; *Nol*, olfactory nerve; *Pa*, roof of telencephalon; *pf*, velum transversum; *S.v.*, sacculus vasculosus; *Tc*, pia mater; *Tl*, roof of mid-brain; *tr*, crossing fibres of fourth nerve; *V.c.*, valvula cerebelli; *Vcm*, ventricle of telencephalon; *Vg*, fourth ventricle; *Vt*, third ventricle. (After Rabl-Rückhard, from Sedgwick's *Zoology*.)

portal into the caudal vein. Direct communicating vessels through the kidneys to the posterior cardinals tend to reduce the renal portal system (Fig. 351). The vascular supply of the air-bladder has been described above (p. 226).

The chief modifications in the brain have already been mentioned (p. 305). It is to be noticed that it is much concentrated, and in spite of the great development of the hinder parts, the prosencephalon is scarcely differentiated and has an epithelial roof. The valvula cerebelli attains its greatest development, and the optic lobes may be huge. The Teleostei are distinguished by the absence of an optic chiasma, the optic nerves crossing each other outside the brain without mixing (Figs. 352-53).

The mesonephric kidneys, without coelomic funnels, are often enlarged in front into a mass of lymphatic tissue developed in connection with the larval pronephros (Balfour [29]); behind they give off two mesonephric ducts which join together and open behind the anus by a median pore. The sinus formed at their junction may be produced into a mesoblastic urinary bladder, which, of course,

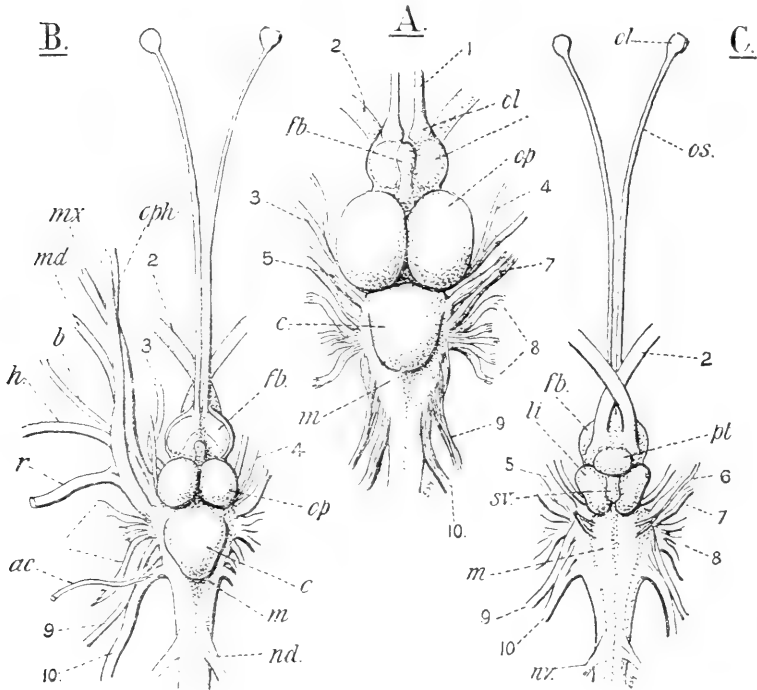

FIG. 353.

Brain of *Esox lucius*. Dorsal view (A). Brain of *Gadus morhua*. dorsal view (B); ventral view (C). 1, olfactory, 2, optic, 3, oculomotor, 4, pathetic, 5, trigeminal, 6, abducens, 7, facial, 8, auditory, 9, glossopharyngeal, and 10, vagus nerve. *ac*, accessorius, *b*, buccal, *h*, hyomandibular, *md*, mandibular, *mx*, maxillary, *oph*, superior ophthalmic, and *r*, dorsal recurrent nerve branch; *c*, cerebellum; *fb*, forebrain; *li*, lobus inferior; *m*, myelencephalon; *ol*, olfactory lobe; *op*, optic lobe; *os*, olfactory tract; *pl*, pituitary body.

is not homologous with that of the terrestrial vertebrates (Fig. 354).

In *Fierasfer* and *Zources* (Emery [131]), and to a less extent in *Lepadogaster* (Guitel [188]), the pronephros functions in the adult.

Never do the generative products of the male pass through the kidney (p. 89). The elongated testes, which are shut off from the abdominal coelom as in all other Gnathostomes, are directly

prolonged backwards into ducts which join and open to the exterior, or open into the base of the urinary ducts (Figs. 354, 356, B).

A few Teleosts have free ovaries which shed the ova into the coelom in the normal manner. In these cases the ova are carried out either by oviducts of considerable length (*Osmerus*) or very short (other Salmonidae) (Fig. 355, E), or again they may pass out by mere pores representing the last stage of degeneration of the oviduct (Anguillidae, Galaxiidae, Notopteridae, Hyodontidae, Osteoglossidae, and *Misgurnus*, a Cyprinid) (Hyrtl [232a], Rathke [342], MacLeod [288]).

The opening of the genital ducts to the exterior varies much in

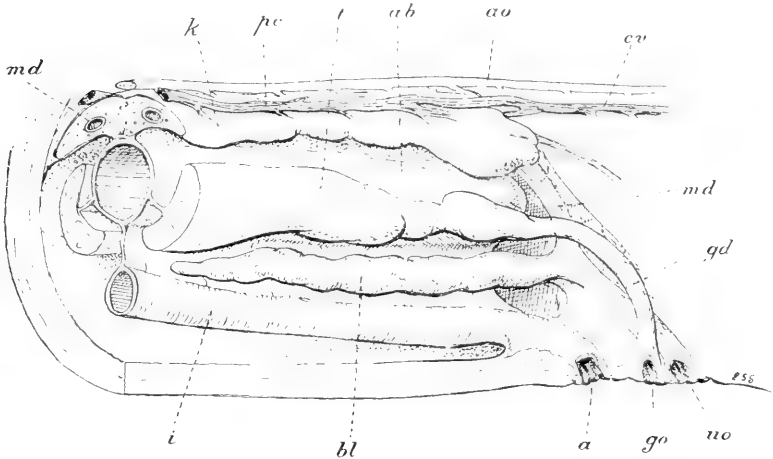

FIG. 354.

Left-side view of a dissection of a male *Esoc lacius*, L., showing the median apertures of the rectum, genital ducts, and kidney ducts. *a*, anus; *ab*, air-bladder, blind hinder end; *ao*, dorsal aorta; *bl*, urinary bladder; *cv*, *gd*, vas deferens; *go*, genital opening; *i*, intestine; *k*, kidney (mesonephros); *md*, mesonephric duct; *pc*, posterior cardinal; *t*, testis; *uo*, urinary opening.

position among the Teleostei. As a rule, the oviducts or pores open by a median aperture between the anus and the urinary pore (Fig. 354, 356, E). The cloaca has been lost, though traces of it may perhaps be seen in some lower forms. The sperm-ducts may open into the base of the mesonephric ducts or bladder, as in Eels, *Anableps*, *Percu*, *Zoarces*, *Cyclopterus*, etc.; or by a special opening, *Clupea*, *Scarus*, *Trigla*, *Tinca*, etc.; or together with the anus, *Lota*; or with both the anus and the kidney, Lophobranchii (Hyrtl, Stannius [417]).

The urinogenital organs of the Teleostei present features which are very difficult to explain and have given rise to much controversy (Rathke [342], Huxley [231], Waldeyer [478], Semper [404], Balfour [29, 30], Brock [59, 60], Weber [482], Jungersen [253],

Haller [193], Howes, Felix [136]). We may here briefly discuss their morphology. In both sexes the gonads arise as a longitudinal thickening of the coelomic epithelium, near the base of the mesentery, which hangs in the body-cavity as the genital ridge (Fig. 338). On the outer side of this fold the genital cells are developed.

First of all with regard to the absence of a direct communi-

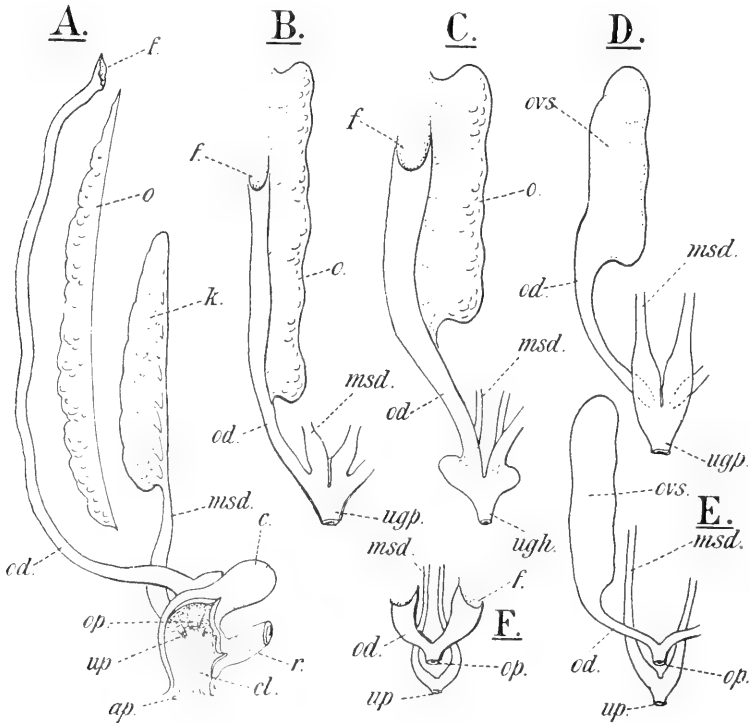

FIG. 355.

Diagrams of the female urinogenital ducts in the Dipnoi and Teleostomi derived from the figures of various authors. A, *Protopterus* (after Ayers and W. N. Parker). B, *Polypterus* (after Budgett). C, *Amia* (after Hyrtl and Huxley). D, *Lepidosteus* (after Balfour and Parker). E, a Teleost with closed ovisac. F, a Salmonid (after Weber). *a.p.*, abdominal pore; *c.*, cloacal bladder; *cl.*, cloaca; *f.*, open funnel of oviduct; *k.*, mesonephros; *ms.d.*, mesonephric duct; *o.*, ovary; *od.*, oviduct; *op.*, genital papilla and pore; *ovs.*, closed ovisac; *r.*, rectum; *ug.p.*, urinogenital papilla; *u.p.*, urinary pore. In all the figures, except F, only the right oviduct is completely drawn.

cation between the testis and the mesonephros, characteristic of all the Teleosts. This is doubtless secondary. A system of spaces and canals develops from the testis, and from these is formed near the base of the peritoneal fold supporting the testis a longitudinal duct which grows back to the external opening (Fig. 356, B). It seems very probable that this sperm-duct represents the longitudinal canal found in other Gnathostomes uniting the testicular canals, and into

which open the mesonephric tubules (p. 89). Primitively vasa efferentia stretched across from testis to collecting duct, and from duct to kidney along the whole length of the two organs, as in the Chondrostei and *Lepidosteus* (Fig. 356). But whereas in the Elasmobranchs the vasa efferentia became restricted to the anterior end (p. 132), in the Dipnoi they became restricted more and more to the posterior end (p. 253). Independently the same specialisation seems to have taken place in the Teleostomes, both in

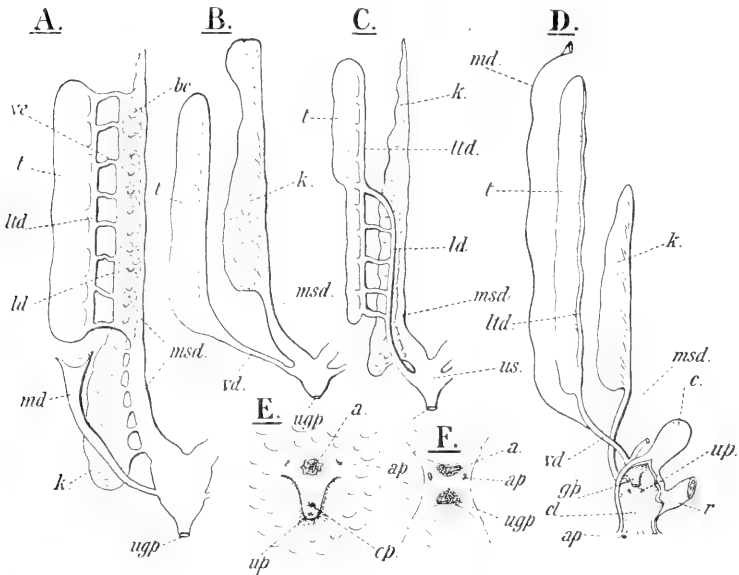

FIG. 356.

A, B, C, and D, diagrams of the urinogenital organs in male Dipnoi and Teleostomi. A, *Acipenser* (*Lepidosteus* and *Ami* are similar, but without the funnel *m.d.*). B, Teleostei; and C, *Polypterus* (from Budgett's figures). D, *Protopterus* (from W. N. Parker's figures). E, urinogenital papilla of a female *Salmo*, ventral view. F, similar view of a male *Polypterus* (after Budgett). *a*, anus; *a.p.*, abdominal pore; *b.c.*, renal capsule; *c.*, cloacal bladder; *g.p.*, genital papilla; *k.*, mesonephros; *l.d.*, longitudinal duct; *l.t.d.*, longitudinal testis duct; *m.d.*, Müllerian duct; *ms.d.*, mesonephric duct; *o.p.*, oviducal pore; *r.*, rectum; *t.*, testis; *u.g.p.*, urinogenital pore; *u.p.*, urinary pore; *u.s.*, urinogenital sinus; *v.d.*, vas deferens; *v.e.*, vas efferens.

the Polypterini (p. 298) and the Teleostei. The longitudinal duct has, in these, lost all connection with the kidney, and shifted its opening farther and farther backwards, finally becoming quite independent (Budgett [68]).

Turning now to the female organs, several questions arise: Which is the primitive condition among the Teleostei, the closed ovarian sac or the free ovary? the long oviduct of *Osmerus* or the genital pore of *Anguilla*? are the oviducts homologous with the Müllerian duct of other forms or with the sperm-duct of Teleosts? The oviduct may be distinguished into two portions: an anterior

ovarial part in connection with the ovary itself; and a posterior part, passing back behind to the pore. In the Anguilliformes the genital ridge remains as a simple band, with ova on its outer side. In many Teleosts, such as *Rhodeus*, *Gobio*, *Cobitis*, *Esox*, *Clupea*, and the Cyprinidae, this genital fold bends upwards and outwards, thus fusing with the coelomic wall (Fig. 55, F), so as to form an ovarian sac with a lateral 'parovarial' canal, blind in front. Or there may appear on the outer surface of the genital ridge itself a groove, which folds round so as to form when closed up a central or 'entovarial' canal. The genital surface of the ovary so enclosed may become much folded (*Perca*, *Acerina*, etc.). That the parovarial and the entovarial ducts are not fundamentally distinct seems clear; moreover, in *Salmo* the ovary is folded to form a parovarial canal in front and a short open entovarial canal behind, which is not produced backwards (Felix [136]).

The posterior duct is formed by a backward growth of the wall of the ovisac and of its lumen. There is no sharp distinction between the two, but a gradual passage from the fertile wall of the ovary to the sterile wall of the duct. In some fish, as *Zoarces* and *Cyclopterus*, the ovary reaches to quite near the pore.

As to the first question, whether the free ovary is primitive or not in the Teleostei, Balfour inclined to the view that it is secondary, since already in *Lepidosteus* there is a closed ovisac [30]. Brock, on the other hand, holds it to be primary [60]. The sporadic occurrence of this character among Teleosts of different families is very strong evidence in favour of Balfour's view that it is a return to the primitive condition. Much more difficult is it to determine the homology of the oviduct. Waldeyer and Semper held that it represents the Müllerian duct of other Gnathostomes, the whole ovary having been enclosed by the tube, in forms with a closed sac. Rathke and others have held that the oviduct is entirely derived from the ovary, the posterior portion being a backward prolongation. Jungersen adopts Balfour's suggestion that the closed sac is formed by a junction of an ovarian canal with the open mouth of a short Müllerian duct. The free condition in Teleosts would be brought about by the failure of these two structures to fuse.

The oviducts and sperm-ducts are so similar in the Teleostei, that they are generally considered to be homologous with each other and not with the Müllerian duct. In *Polypterus* and *Lepidosteus* the anterior region of the oviduct develops as a parovarial canal, into which open, in early stages only, the mesonephric funnels (Fig. 55). The comparison with the longitudinal duct of the male is obvious (Budgett [68]). But the homology will not apply in the case of the Chondrostei (Fig. 356, A), where (Müllerian?) ducts with open funnels exist in both sexes, and the male has a longitudinal testicular canal as well (Hyrtl [233a], Semon [398]).

In conclusion, it must be remembered that, in all Gnathostomes except perhaps the Teleostei, the relative position of the organs in question when enumerated from the middle line outwards is as follows: the genital ridge near the base of the mesentery, the mesonephric ridge with the peritoneal funnels, then the Müllerian duct (Fig. 55). When the latter develops as a closing groove it is in that position. Now in the Chondrostei there are short open-mouthed ducts, leading behind into the base of the mesonephric ducts; these oviducts appear to be genuine Müllerian ducts. The short wide-mouthed oviducts of the Salmonidae and the pores of the Anguilliformes are probably of the same nature (Fig. 355). At all events, no other representatives of the Müllerian ducts can be found in these fish. We may suppose, then, that in *Polypterus*, *Lepidosteus*, and most Teleosts the Müllerian groove (developing duct) has shifted to the base of the ovary, so as to occupy the same place as the male collecting duct of the testis; or that the short Müllerian duct has combined with the homologue of the testicular duct in front, thus forming the parovarial portion of the oviduct, which remains open in *Polypterus* and closes in *Lepidosteus* and the majority of the Teleostei. This latter view seems the more probable (Fig. 355).<sup>1</sup>

To classify the Teleostei according to a phylogenetic scheme is a very difficult matter. The more highly specialised forms fall into groups which are fairly well defined, but the position of less differentiated families is not yet well determined owing to lack of palaeontological evidence. If we were to attempt the reconstruction of a primitive Teleost ancestral to all living forms, we should have to attribute to it the following characters: a skull with typical superficial covering bones, with no interorbital septum, with a median gular plate; a mesocoracoid; a homocercal tail; one dorsal and one anal fin; a spiral valve; a conus provided with two rows of valves; cycloid scales and superficial denticles.<sup>2</sup>

No living fish is known to combine these characters, though, except the last, all appear scattered among certain members of the lowest division of the Teleostei as given in modern classifications—the Isospondyli (Cope, A. S. Woodward), Malacopterygii (Boulenger), or Clupeiformes (p. 386). This sub-order represents not a well-defined branch, but at most an assemblage of divergent families, from some one or more of which the other more specialised families may have arisen. Further, if, following A. S. Woodward, we include with them the Pholidophoridae and their immediate allies,

<sup>1</sup> We cannot hope to reach a definite conclusion on this difficult subject until the development of the ducts in such forms as *Osmerus*, *Amia*, *Acipenser*, and the Dipnoi has been made known.

<sup>2</sup> It is, of course, possible that the denticles on the surface of the body of the Siluridae have been, so to speak, reacquired; the bony plates on which they rest seem to be secondary, since they often overlie the normal bones of the skull.

possessing compound vertebrae, abbreviate heterocercal tail, ganoid scales with peg and socket articulation, fulcra, and possibly a splenial and supra-angular, it becomes obvious that the group (Isospondyli) can no longer be fitted into any phylogenetic scheme. The Leptolepidae, however, may be classed as primitive Teleosts, and the remaining families can be grouped together into various sub-orders with considerable confidence, but of the relationship between these sub-orders, of their exact position on the phylogenetic tree, we know as yet comparatively little.

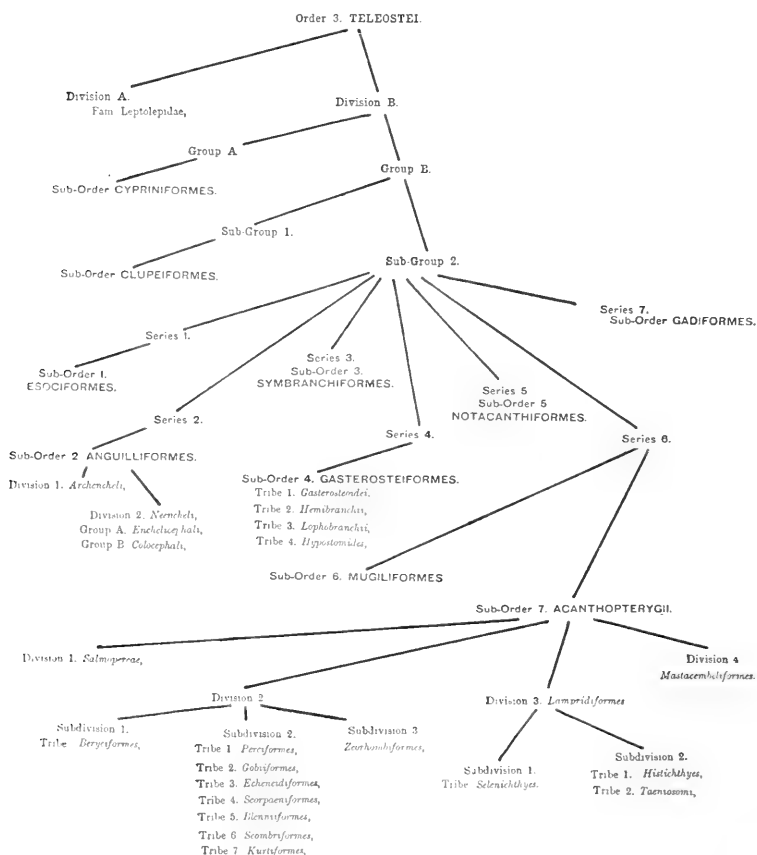

DIAGRAM IV.—PHYLOGENY OF THE TELEOSTEI.



## Division A.

Although preserving the ganoine, the scales in these fish are never of a rhombic ganoid character, but of the cycloid type. The splenial and fulera have disappeared, the centra are undivided. The tail is scarcely yet homocercal, and there are no expanded hypurals.

Family LEPTOLEPIDAE. The tail is still much as in the Amioidei. The scales are cycloid and thin, but ganoine covers both them and the cranial dermal bones. The annular bony centra are pierced by the notochord; the neural arches remain separate from the centra and spines in

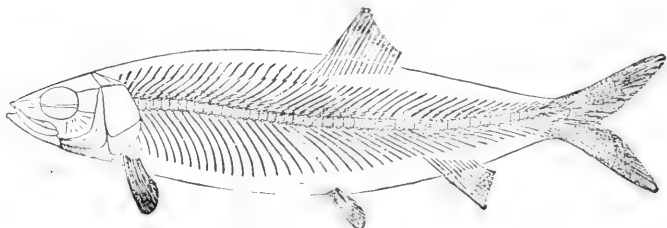

FIG. 357.

*Leptolepis dubius*, Blainv. ; Upper Jurassic, Bavaria ; restored, without scales.  
(After A. S. Woodward.)

the abdominal region. There is no median gular. The Leptolepidae appear in the Trias and die out in the Cretaceous epoch, when the modern Teleostean types begin to dominate over all others.

*Leptolepis*, Ag. (Fig. 357) ; Lias to Cretaceous in Europe ; Trias in N.S. Wales. *Aethalion*, Münster ; Europe. *Lycoptera*, J. M. ; Jurassic, Asia. *Thrissops*, Ag. ; Jurassic and Cretaceous, Europe.

## Division B.

The tail is truly homocercal, with expanded hypurals, or it is gephyrocercal. The ganoine has vanished, and the centra are always well ossified and amphicoelous, except in degenerate forms. Frequently the hinder region of the dorsal fin is differentiated as an adipose fin (p. 275), in the older families. The scales are of the cycloid or etenoid type, or derived therefrom.

## Group A.

## Sub-Order CYPRINIFORMES (Ostariophysii).

This group is remarkable for the absence of the interorbital septum, which appears to some extent only in certain Characinidae, and for the presence of a superficial covering of denticles in the Siluroidei. The dermal bones of the head still, for the most part, lie near the surface and harbour the lateral-line canals (Fig. 327). Very generally there is a fontanelle between the parietals. Usually

the pseudobranch is absent; the mesocoracoid arch and the closed ovarian sac are preserved.

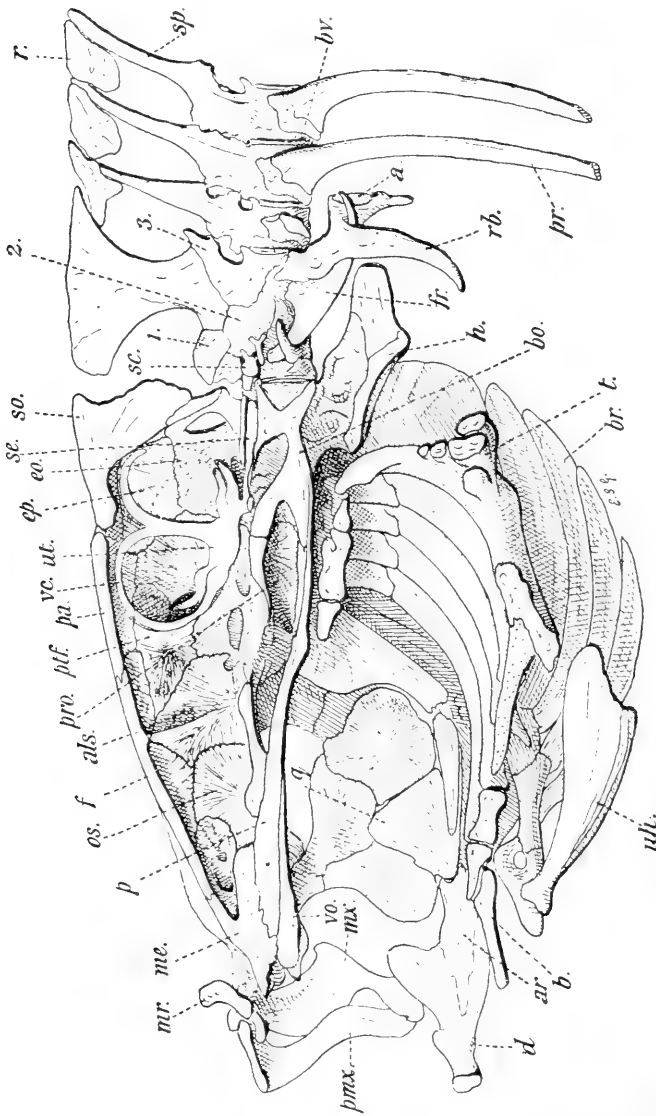

FIG. 358.

*Cyprinus carpio*, L. Skull and visceral arches cut in half, and first few vertebrae. The membranous labyrinth of the right ear and the left Weberian ossicles are shown; the rib of the fourth vertebra has been removed. *a*, surface of modified third rib, which presses on air-bladder; *als*, alisphenoid; *ar*, articular; *b*, basihyal; *bo*, basioccipital; *br*, branchiostegal ray; *bv*, basiventral (parapophysis); *d*, dentary; *eo*, exoccipital, below it roots over the sinus; *ep*, epiotic; *f*, frontal; *fr*, triptis; *h*, horny pad on mastreating process of basioccipital; *me*, mesencephalic; *mr*, median rostral; *mx*, maxilla; *os*, orbitosphenoid; *p*, parosphenoid; *pa*, parietal; *pmx*, premaxilla; *plf*, pleural rib; *pro*, eye-muscle canal partly roofed over by prootic; *plf*, postfrontal; *q*, quadrate; *r*, radial; *rb*, modified rib; *sc*, scaphium, with interalarium below it; *sc*, median sinus entolymphaticus; *so*, supraoccipital; *sp*, neural spine; *t*, teeth on fifth branchial arch; *ul*, urohyal; *u*, utricle; *v.c.*, vertical semicircular canal; *vo*, vomer; 1, 2, 3, elements of first three vertebrae, 1 and 3 probably neural arches, 2 possibly basiventral.

From all other fish this sub-order is distinguished by the possession of a most remarkable apparatus, connecting the ear with

the air-bladder, first described by Weber [481]. It is essentially the same in all the families (Sagemehl [379], Wright [510], Bridge and Haddon [58], Bloch [37], Grassi, Storensen). The right and left membranous labyrinths join across below the medulla by a transverse canal, from which pass backwards a pair of sacculi and a median sinus endolymphaticus. The latter lies in the atrium, an extension of the perilymph cavity lodged in the basioccipital (Fig. 358).

On each side, from a membranous fenestra of the atrium, stretches a chain of four ossicles to the air-bladder. The largest and hindmost ossicle, the tripus (malleus), lies on the anterior wall of the air-bladder; the foremost and smallest, the claustrum, on the membranous wall of the atrium; the scaphium (stapes), with a process fitting over the atrial fenestra, and the intercalarium (incus) complete the chain (Fig. 359). Observers differ as to the exact homology of Weber's ossicles. The tripus is believed to represent the rib of the third vertebra (Sagemehl); the intercalarium the neural arch of the second vertebra (Wright); the scaphium the neural arch, and the claustrum

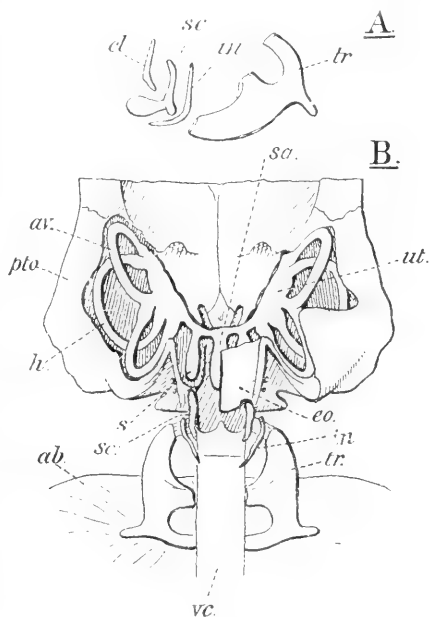

FIG. 359.

*Macrurus nemurus*. A, the Weberian ossicles. B, portion of the skull, the labyrinth, and Weberian apparatus diagrammatically represented from above (from the figures of Bridge and Haddon). *ab.*, air-bladder; *av.*, anterior vertical canal of the ear; *cl.*, claustrum; *eo.*, exoccipital; *h.*, horizontal canal; *i.n.*, intercalarium; *pto.*, pterotic; *s.*, sacculus; *sc.*, scaphium; *tr.*, tripus; *ut.*, utricle; *v.c.*, vertebral column.

the spine of the first vertebra (Wright). Sagemehl and Grassi consider that the claustrum is derived from the skull. More probably the two last ossicles represent the first neural arch and rib. The anterior vertebrae are much modified in connection with Weber's apparatus.

The air-bladder often comes quite close to the skin, just behind the pectoral girdle, forming a sort of tympanum, in many Cyprinidae, Characinidae, and Siluridae.

An adipose fin is found in all the families excepting the

Cyprinidae. Often there are spinous serrated anterior dermal rays on the median and paired fins; such spines are formed by the enlargement and ankylosis of the segments of the lepidotrichia from the base outwards, unfused segments frequently remaining at the tip. In the pectoral girdle, besides the mesocoracoid arch, must be noticed the great development of the coracoids, which often meet in a ventral suture (Fig. 365). The Cypriniformes have diverged in two chief branches: the Characiniidae depart least from the primitive type, and lead to the Cyprinidae and eel-like Gymnotidae; the other branch includes the Siluroidei, among which are some of the most specialised of Teleosts.

#### TRIBE A. CHARACINOIDEI.

This includes the more generalised forms, with parietals distinct and not separated by the supraoccipital, well-developed opercular bones, three

A.

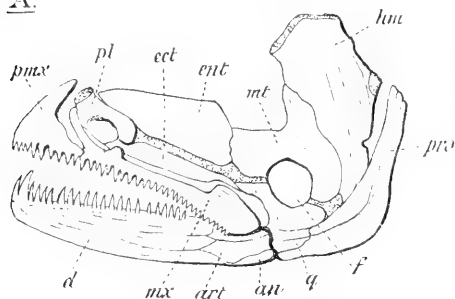

B.

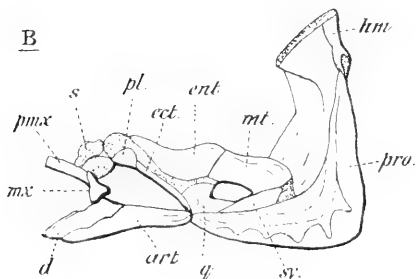

FIG. 360.

Left jaw-bones of *A*, *Erythrinus unitaeniatus*, Spix.; and *B*, *Citharinus Geoffroyi*, Cuv. (After Sagemehl.) *an*, angular; *art*, articular; *d*, dentary; *ect*, ectopterygoid; *ent*, entopterygoid; *f*, foramen; *hm*, hyomandibular; *mt*, metapterygoid; *mx*, maxilla; *pl*, palatine; *pmx*, premaxilla; *pro*, preopercular; *q*, quadrate; *s*, cartilage; *sy*, symplectic.

to five branchiostegals, and a symplectic. Except on the first four segments, the anterior parapophyses are usually short, separate from the centrum, and bearing pleural ribs. The second and third centra become fused and the parapophyses of the fourth vertebra enlarged, bent downwards, and applied to the air-bladder, which is generally subdivided into an anterior and a posterior chamber (Fig. 199). From the latter comes the pneumatic duct. Epipleurals and epineurals are present.

Family CHARACINIDAE. The scales are cycloid or with a hinder ctenoid edge. The maxilla may be toothed as well as the premaxilla and dentary; the teeth may be powerful and

with several cusps (Fig. 360). Sometimes an incomplete interorbital septum is present. The anterior chamber of the air-bladder may be

cellular as in *Erythrinus*; in *Citharinus* there is an accessory respiratory diverticulum of the gill-cavity. There are many pyloric caeca and an adipose fin [379].

*Tetragonopterus*, Ag.; Tertiary, Brazil. *Hydrocyon*, Cuv.; *Alestes*, M. and T.—Africa. *Crenuchus*, Günth.; *Brycon*, M. and T.; *Chalceus*, Cuv.; *Serrasalmo*, Lac.; *Piabucina*, C. and V.—America. *Distichodus*, M. and T.; *Citharinus*, Cuv.—Africa. *Macrodon*, M. and T.; *Erythrinus*, Gron.—America. *Phago*, Günth.; *Neoborus*, Blgr.; *Xenocharax*, Günth.

FAMILY CYPRINIDÆ. The scales are cycloid; sometimes they are absent, and in the leather carp variety of *Cyprinus* they are represented by only a few very large scales on the body. Barbels are often present. The mouth has a small gape, is usually protractile, toothless, and margined only by the premaxilla (Figs. 327, 358). The protractility of the jaw in the Cyprinoid has doubtless been acquired independently of that of the Acanthopterygii, and differs fundamentally from it in the manner in which it is brought about (Sagemehl [379]). In the Carps the dorsal processes of the premaxillae are short, do not reach the cranium, but are joined to it by a ligament in which lies a median 'rostral' bone (Fig. 327). It is by the stretching of the ligament and motion of the rostral that the jaw is brought forward. The rostral is a specialised portion of the ethmoid cartilage. In the Catostominae the maxilla still contributes to the margin of the mouth. A fenestra is present in the exoccipital. The lower pharyngeals (fifth branchial arches) are strong and armed with powerful teeth, which in many genera bite against a horny pad borne on a ventral process of the basioccipital (Fig. 358). A sensitive palatal organ is situated in front of this masticator.

The second and third dermatrich of the dorsal and pectoral fins are often serrated spines. There are no pyloric caeca.

In *Cobitis*, *Homaloptera*, and their near allies the air-bladder is small, with a subdivided cavity, and is partially or entirely enclosed in a bony capsule, apparently formed by the ossification of its walls. This affords a very interesting case of parallelism when compared with certain of the Siluroidei (p. 377), in which the reduced air-bladder is also encapsuled, but by very different means. *Gastromyzon* is remarkably flattened ventrally, its expanded paired fins contributing to form a sucker-like surface of attachment.

*Rhodeus*, and allied genera, are remarkable for the development of a long ovipositor, a tubular outgrowth from the urinogenital opening of the female.

SUB-FAMILY 1. CATOSTOMINÆ: The 'Suckers.' *Sclerognathus*, Gthr.; *Catostomus*, Le S. (Fig. 361); *Carpioides*, Raf.; *Moxostoma*, Raf.—N. America; some in Tertiary deposits.

SUB-FAMILY 2. CYPRININÆ: The Carps. Carp, *Cyprinus*, L. (Fig. 362); Barbel, *Barbus*, Cuv.; Gudgeon, *Gobio*, Cuv.; Minnow, *Leuciscus*, Klein; Tench, *Tinca*, Cuv.; *Rhodeus*, Ag.; *Aspius*, Ag.—Europe, and to Miocene or Oligocene. *Catla*, C. and V.; E. Indies. *Labeo*, Cuv.; Africa and Asia. *Rohtsichthys*, Bleek; *Leptobarbus*, Bleek.—E. Indies. *Luciosoma*, Blkr.; *Hypophthalmichthys*, Blkr.—China. Bream, *Abramis*, Cuv.; *Alburnus*, Heck.—Northern hemisphere.

SUB-FAMILY 3. COBITIDINAE: The Loaches. *Botia*, Gray ; E. Indies. *Misgurnus*, Lac. ; *Cobitis*, Art.—Europe and Asia. *Acanthopsis*, van H. ; *Apua*, Blyth—E. Indies.

SUB-FAMILY 4. HOMALOPTERINAE. *Homaloptera*, van H. ; *Helgia*, Vin. ; *Glaniopsis*, Blgr. ; *Gastromyzon*, Gthr.—Asia.

Family GYMNOTIDAE. This family has undergone great specialisation.

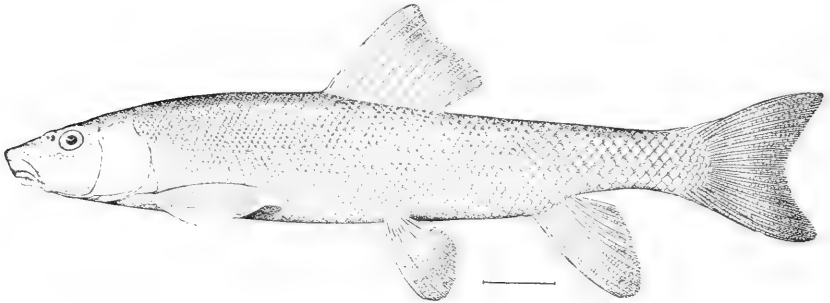

FIG. 361.

*Catostomus occidentalis*, Ayres. (From Jordan and Evermann.)

These fish acquire an eel-like body, covered with cycloid scales or naked. The dorsal fin disappears or remains only as an adipose strip. The caudal region is much elongated, and also the anal fin ; the caudal is

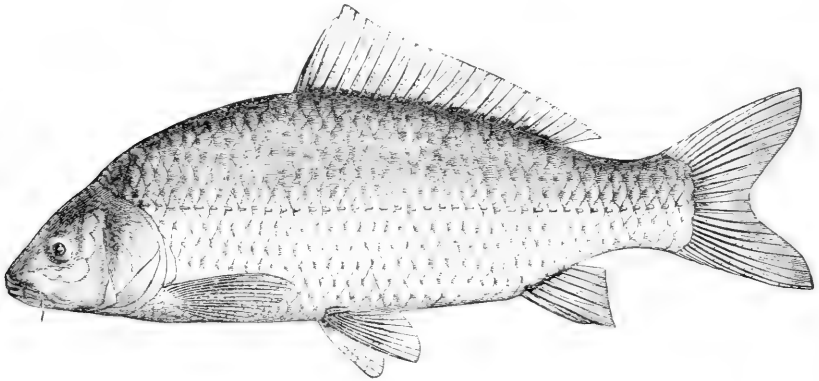

FIG. 362.

*Cyprinus carpio*, L., the Carp. (From Seeley, *Freshwater Fishes of Europe*.)

reduced or absent. The small mouth is frequently borne at the end of a long snout. A shortening of the abdominal cavity takes place, accompanied by the shifting forward of the anus even to below the snout. The gill-opening is reduced in size.

The Electric Eel (*Gymnotus electricus*) has a powerful electric organ formed by the modification of the myotomes along the caudal region ; it

is also remarkable for the possession of a large number of pectoral radials (8), like *Anguilla* (Sagemehl [379] and Fig. 363).

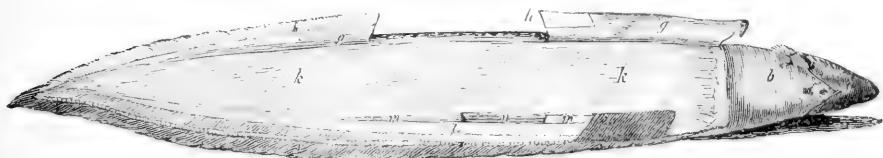

FIG. 363.

*Gymnotus electricus*, L., dissected so as to show the electric organs on the right side, *k* and *l*; *h*, reflected body-wall. (From Owen, *Anatomy of Vertebrates*, by permission of Messrs. Longmans and Co.)

*Gymnotus*, Cuv. ; *Carapus*, M. and T. ; *Sternopygus*, M. and T. ; *Sternarchus*, Cuv. ; *Rhamphichthys*, M. and T.—S. America.

#### TRIBE B. SILUROIDEI.

Normal Teleostean scales are never present, the body being either naked or covered with overlapping plates, or armed with a stiff cuirass. Possibly both these are modified scales (Fig. 373). On the head and shoulder region the dermal skeleton is usually very well developed; the bones being generally ornamented, close-fitting, and expanded so as to form a cephalic shield, in which may become involved the post-temporal and supraclavicle (Fig. 366). The cleithrum may also develop a large dermal plate. The postclavicle is absent. There is no eye-muscle canal; and no distinct parietals, these bones being probably fused with the supra-occipital, formed by the combination of a large dermal plate with an endochondral element (unless the parietals are represented by two small supratemporal bones pushed outwards and backwards). Only one pterygoid persists; there is no symplectic bone, and the palatine is toothless, often rod-like, and sometimes vestigial. The subopercular has the appearance of a branchiostegal ray, and the maxilla generally becomes converted into a small ossicle supporting the cartilaginous axis of the barbel (Figs. 364, 366, 367). The premaxilla, dentary, vomer, and generally the pterygoid, are toothed [252, 274, 286, 290, 332, 410].

The anterior vertebrae are more modified than in the Characinidae. A complex vertebra, behind the small first centrum, is made up of three, four, or even five centra, forming a single mass which may be co-ossified with the first centrum and the basioccipital. The parapophyses are long, especially in front, and those of the fourth, and sometimes also of the fifth vertebra, are immensely enlarged and project outwards to articulate with the massive post-temporal (Fig. 367). The latter has one limb articulating with the basioccipital, and another with the epi- and pterotic. The enlarged parapophyses more or less thoroughly invest the anterior chamber of the air-bladder, sometimes in a complete bony capsule [58].

The air-bladder is typically subdivided internally into an anterior transverse chamber and paired posterior chambers. In many cases it undergoes degenerative changes, becoming very small and almost solid, the

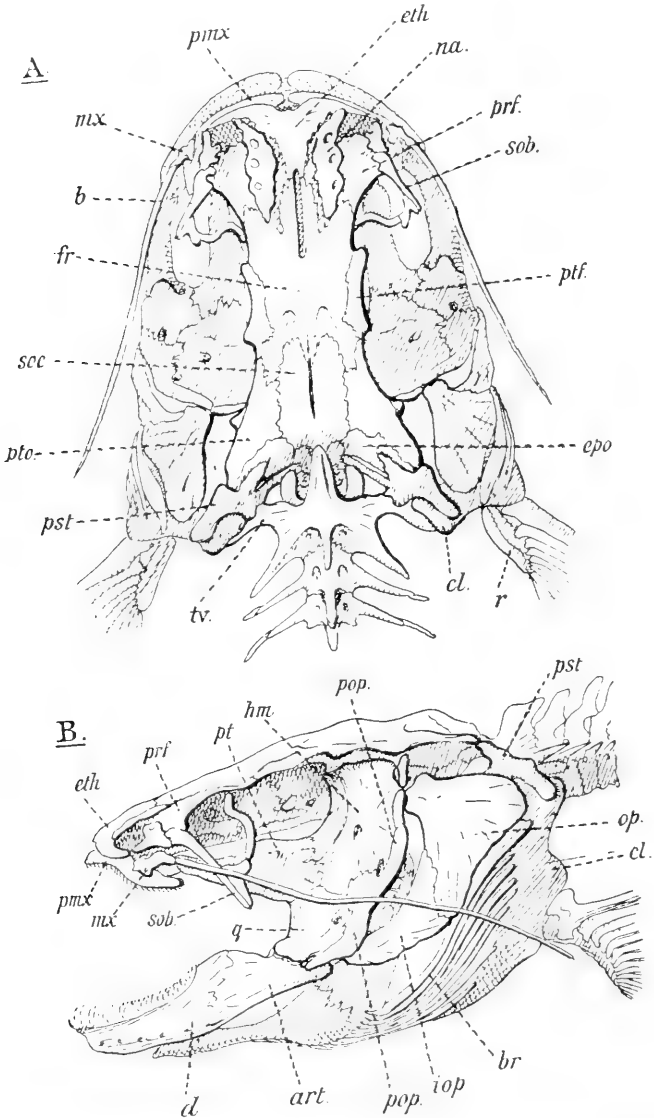

FIG. 364.

A, dorsal view, and B, left-side view of the skull and pectoral girdle of *Silurus glanis*, L. (After Juge, slightly altered.) *art.*, articular; *b.*, barbel; *br.*, branchiostegal; *cl.*, cleithrum; *d.*, dentary; *epo.*, epiotic; *eth.*, mesethmoid; *fr.*, frontal; *hm.*, hyomandibular; *iop.*, interopercular; *mx.*, maxilla; *na.*, nasal; *op.*, opercular; *pmx.*, pre-maxilla; *pop.*, preopercular; *pst.*, post-orbital; *pt.*, pterygoid; *ptf.*, postfrontal; *pbo.*, pterotic; *q.*, quadrate; *r.*, radial; *sob.*, sub-orbital; *scc.*, supraoccipital; *t.v.*, transverse process of the compound first vertebra abutting against the cleithrum.



front chamber alone persisting (*Clarias*, *Saccobranchus*, *Bagarius*, Loricariidae, etc.). In some (*Auchenipterus*, etc.) a peculiar elastic spring apparatus is developed from the expanded parapophysis of the fourth vertebra, which acquires a thin pliable base, and can be moved by muscles so as to alter the pressure in the bladder and produce a sound (J. Müller, Bridge and Haddon [58]). There are no pyloric caeca. Accessory respiratory organs are sometimes developed. Certain anterior lepidotrichia in the dorsal and pectoral fin may become modified into powerful spines (Bagrinae, Doradinae, etc.), connected by an elaborate locking joint. In *Amiurus*, for instance, the first interspinal plate is a small ossicle with its dermal ray a small scute; the second ray is a U-shaped bone at the base of the large defensive spine, which is the third dermotrich resting on a large plate belonging to the third radial. In the Bagrinae and Doradinae there is a regular dorsal buckler thus formed in connection with the dorsal fin (Fig. 366).

*Callomyx* produces a stridulating sound by the scraping of the first dorsal radial between the ridged laminae of the deep cleft of the combined fourth and fifth neural spines (Haddon).

The Siluroidei present some most striking superficial resemblances to the extinct Cephalaspidae and Coccosteidae. So close is the likeness (especially among the Clariinae and Loricariidae) as even to deceive so acute an observer as Huxley [227]. It is now generally admitted that the resemblance between these Siluroidei and the Devonian fossils is due to convergence.

**FAMILY SILURIDAE.** These fish usually have an adipose fin. The tail-region is extremely long in the Clariinae, where both the anal and the dorsal fins are extended; and in the Silurinae, where the dorsal is very short and the anal very long. The opercular bones are somewhat reduced.

*Clarias* has accessory respiratory organs in the branchial cavity (Fig. 368); and in *Saccobranchus* a large diverticulum, supplied with blood from the aortic arches, extends back from the branchial

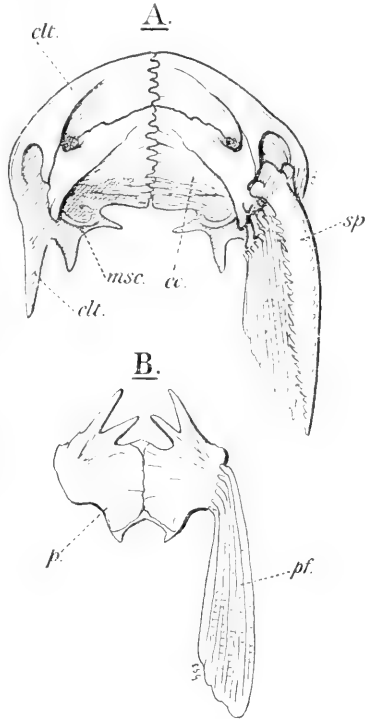

FIG. 365.

*Auchenoglanis biscutatis*, Geoffr. A, ventral view of the pectoral girdle and left pectoral fin. B, ventral view of the pelvic girdle and left pelvic fin. *clt.*, cleithrum; *cc.*, coracoid; *msc.*, mesocoracoid; *p.*, pelvic bone; *pf.*, pelvic lepidotrichia; *sp.*, pectoral spine or first lepidotrich.

cavity below the trunk-muscles and acts as a lung (Fig. 369) (Burne [75]).

Sub-Family DIPLOMYSTACINÆ. In which the maxilla is still toothed, and of considerable size. *Diplomystax* (*Diplomystes*), Dum.; Chile.

Sub-Family CLARIINÆ. *Clarias*, Gron.; *Heterobranchus*, St. H.—Africa and Asia; Pliocene, India. *Copidoglanis*, Gthr.; Asia,

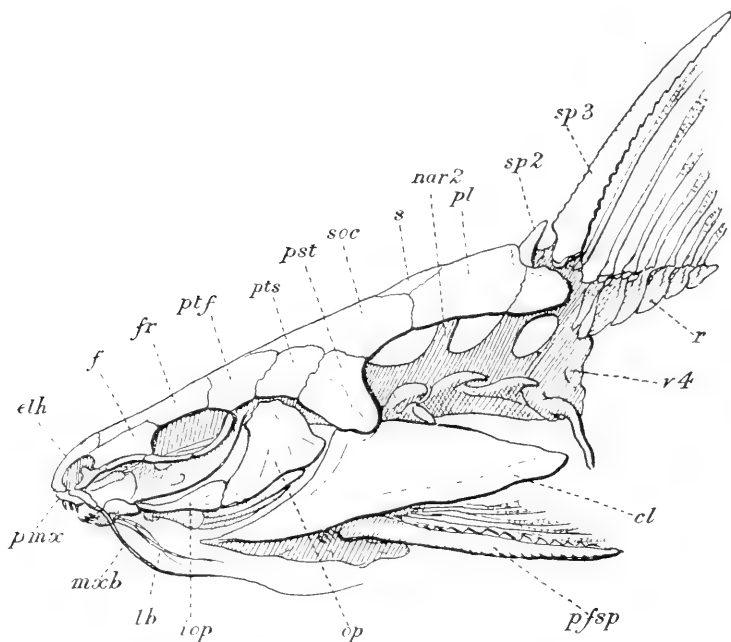

FIG. 366.

*Synodontis schal*, Schn. (After Brühl, modified). Skull, pectoral girdle and fin, anterior vertebrae, and dorsal fin. *cl*, expanded cleithrum; *eth*, mesethmoid; *f*, prefrontal; *fr*, frontal; *iop*, interopercular; *lb*, lower barbels; *mxb*, maxillary barbel; *nar<sup>2</sup>*, neural arch of second vertebra; *op*, opercular; *p.f.sp*, pectoral-fin spine; *pl*, lateral bony plate; *pmx*, premaxilla; *ptf*, postfrontal; *pst*, post-temporal; *pts*, pterotic; *r*, dorsal radial; *s*, first dorsal spine?; *soc*, supraoccipital plate; *sp<sup>2</sup>* and *sp<sup>3</sup>*, second and third spines; *v<sup>4</sup>*, fourth vertebra fixed to anterior vertebrae.

Australia. *Cuidoglanis*, Gthr.; Australia. *Channolabes*, Gthr.; *Clariallabes*, Blgr.—Africa.

Sub-Family SILURINÆ. *Silurus*, L. (Fig. 370); Europe and Asia, and Tertiary. *Saccobranchus*, C. and V.; *Helicophagus*, Blkr.—Asia. *Pseudotropius*, Bl.; Asia, and Tertiary. *Eutropius*, M. and T.; *Schülbe*, Cuv.—Africa. *Eumeda*, Cost.; *Neosilurus*, Stnd.—Australia.

Sub-Family BAGRINÆ. *Macrones*, Dum.; *Rita*, Bl.—Asia, and Pliocene. *Arius*, C. and V.; tropics; Eocene, Europe. *Amiurus*, Bl.; Asia, America; Miocene, N. America. *Rhineaster*, Cope; Eocene, N. America. *Bucklandium*, König; Eocene, England. *Chrysichthys*,

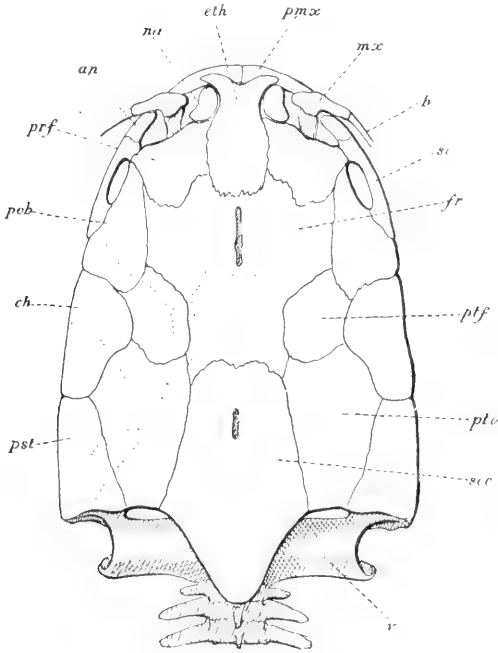

FIG. 367.

Skull and anterior vertebrae of *Clarias magur*, H. B. A dotted line indicates the course of the lateral line according to Pollard. *an*, anterior suborbital; *b*, barbel; *ch*, lateral cheek-bone, possibly preopercular?; *eth*, ethmoid; *fr*, frontal, possibly including parietals; *mx*, maxilla; *na*, nasal; *pmx*, premaxilla; *pob*, postorbital; *prf*, prefrontal; *pst*, post-temporal; *ptf*, post-frontal; *pto*, pterotic; *so*, suborbital; *soc*, supraoccipital, possibly including parietals; *v*, expanded processes of anterior vertebrae, partially enclosing anterior chambers of air-bladder.

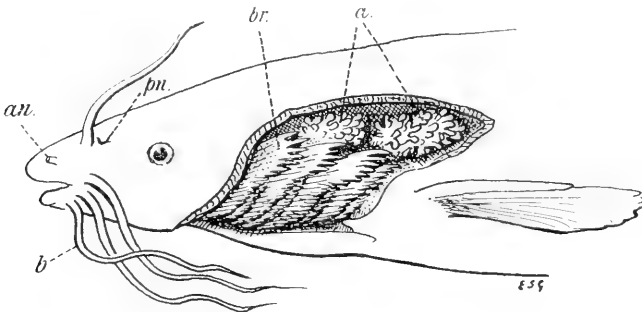

FIG. 368.

Left-side view of head of *Clarias lazera*, C. and V., with branchial chamber exposed by removal of operculum. *a*, accessory respiratory organs attached to top of gill-arches; *an*, anterior nostril; *b*, barbel; *br*, gill-lamellae; *pn*, posterior nostril.

Bl. ; *Auchenoglanis*, Gthr.—Africa. *Pimelodus*, Lac. ; *Callophysus*, M. and

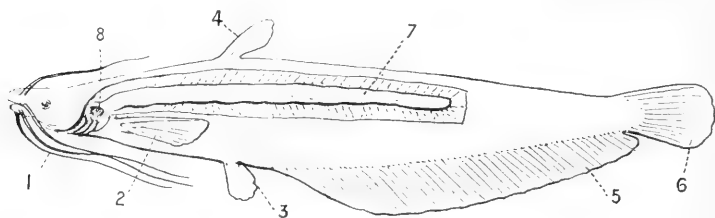

FIG. 369.

Left-side view of *Saccobranchus fossilis*, L., dissected to show the air-sac. 1, barbel; 2, pectoral, 3, pelvic, 4, dorsal, 5, anal, and 6, caudal fin; 7, branchial sac; 8, its opening into branchial chamber.

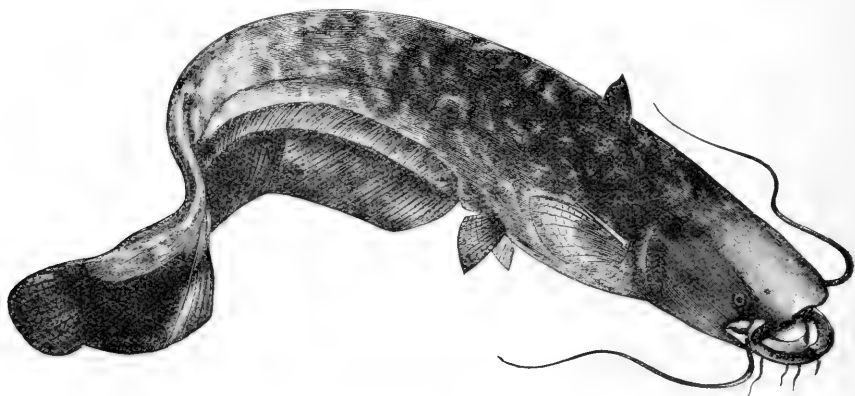

FIG. 370.

*Silurus glanis*, L. (From Seeley, *Freshwater Fishes of Europe*.)



FIG. 371.

*Malapterurus electricus*, Gm. (After Günther.)

T. ; *Nannoglanis*, Blgr. ; *Conorhynchus*, Blkr. ; *Notoglanis*, Gthr.—America. *Nedystoma*, Og. ; *Pachyula*, Og.—Australia.

Sub-Family DORADINAE. *Synodontis*, Cuv. ; *Phractura*, Blgr. ; *Euchilichthys*, Blgr.—Africa. *Bagarius*, Bl. ; Asia, and Tertiary. *Sisor*,

H. B.; *Chaca*, C. and V.—Asia. *Doras*, Gthr.; *Oxydoras*, Kner; *Callomystax*, Gthr. *Glanidium*, Lützk.; *Cetopsis*, Ag.—America.

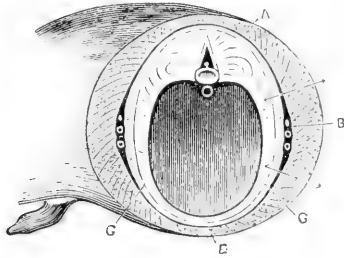

FIG. 372.

Section of *Malapterurus electricus*, Gm., showing the electric organ, A. B, vascular layer; E, adipose tissue; G, muscles. (From Owen, *Anatomy of Vertebrates*, by permission.)

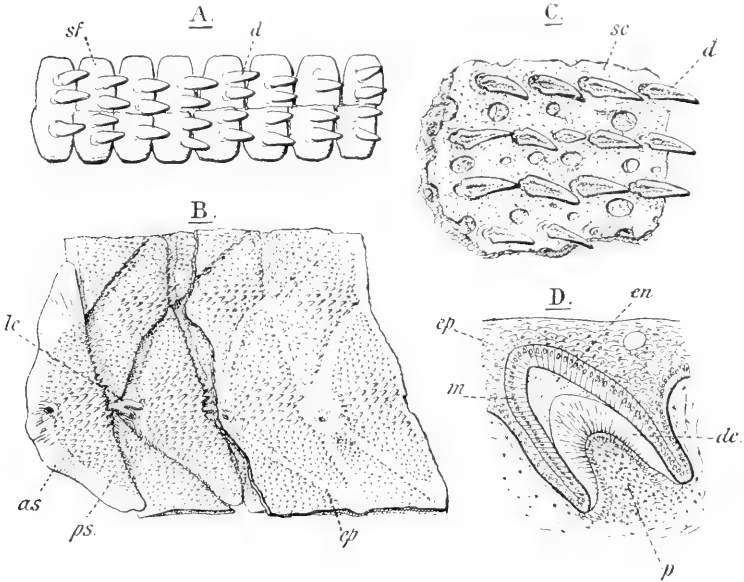

FIG. 373.

*Plecostomus Commersonii*, Val. A, piece of lepidotrich, enlarged. B, several scales, from which the skin has been removed on the left. C, small piece of the surface of a scale, much enlarged. D, section through a developing denticle of Hypostoma (D, after Hertwig). *a.s.*, smooth anterior region; *d.*, denticle; *d.c.*, dentine cap; *en.*, enamel cap; *ep.*, epidermis; *lc.*, lateral-line canal; *m.*, enamel organ; *p.*, pulp; *sc.*, scale; *sf.*, segment of lepidotrich.

Sub-Family MALAPTERURINAE. *Malapterurus*, Lac.; Africa; with a large electric organ (Figs. 371, 372) (Fritsch [141]).

Family CALLICHTHYIDAE. The small mouth is ventral and provided with minute teeth. The body is armoured with two rows of overlapping bony plates which, like the surface of the cranial bones, are beset at their hinder edge with movable denticles (p. 369). There is a strong pectoral spine and an adipose fin.

*Callichthys*, L. ; *Corydoras*, Lac.—S. America.

Family LORICARIIDAE. These are closely allied to the last, but (except in *Arges*) the bony plates are more numerous and form a complete rigid armour on the head and body. The dermal bones are studded with denticles and the small teeth resemble these in structure. It is curious to note that the denticles may be much larger in the male than in the female. The modified suctorial mouth is below the flattened head, which generally develops a prominent lateral edge and snout (Figs. 374, 375). The orbits shift dorsally, the posterior nostrils moving close to them. The parapophyses have disappeared, the pleural ribs are sessile, and the anterior neural spines bifid. There is no adipose fin and the

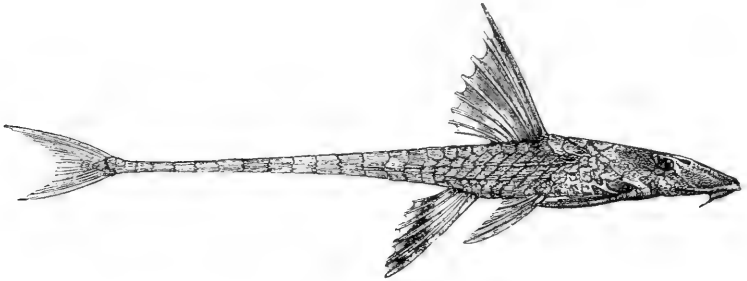

FIG. 374.

*Loricaria lanceolata*, Gthr. Upper Amazons. (After Günther.)

gill-opening is small, the opercular bones being also much reduced. The pectoral spine is usually very large. The intestine becomes much coiled.

Sub-Family ARGINAE. With a naked body and strong ribs.

*Arges*, C. and V. ; *Astroblepus*, Humb.—S. America.

Sub-Family LORICARIINAE. With complete bony armour and slender ribs.

*Plecostomus*, Gthr. ; *Chaetostomus*, Heck. ; *Loricaria*, L. (Fig. 374) ; *Acestra*, Kner—S. America.

Family ASPREDINIDAE. The head is wide and depressed, the body naked and tapering to a long tail ; the gill-opening minute. The large air-bladder is not enclosed by bone. The pectoral spine is very powerful. Although the skelton resembles that of the Loricariidae in many points, yet there is a leaning towards the Siluridae. There is a small dorsal shield ; the bones of the operculum are vestigial, the opercular disappearing altogether. The female carries the eggs embedded in the skin below the head and belly.

*Aspredo*, L. ; *Bunocephalus*, Kner ; *Dysichthys*, Cope—S. America.

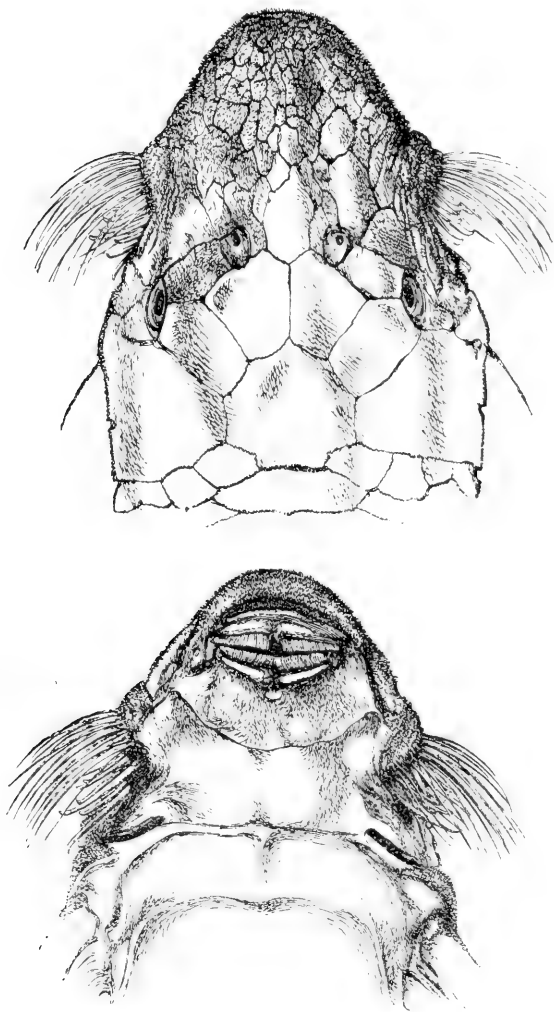

FIG. 375.

Upper and lower side of the head of *Ancistrus (Chaetostonus) heteracanthus*, Gthr. Upper Amazons. (After Gün'hr.) Tufts of enlarged denticles are shown at the sides.

### Group B.

The lower members of this group preserve many primitive characters, such as the median gular, mesocoracoid arch, spiral valve, conus with two rows of valves, all of which are found in the first sub-order only; moreover, the oviducts may have open internal funnels (p. 367). There is an interorbital septum, not always completely formed, however (Osteoglossidae, Galaxiidae, Gadidae). With the single exception of the Gadiformes (p. 478), these fish have the cranial cavity shortened, the brain situated far back, the olfactory lobes lying immediately in front of the fore-brain, and the elongated olfactory nerves passing forward on either side of the interorbital septum when present (p. 324). There are neither denticles nor Weberian ossicles. The lines of divergence among the lower forms are too indistinct to be followed out with certainty. The group may be divided into eight sub-orders, of which two, the Esociformes and the Mugiliformes, seem to lead towards the Acanthopterygii.

### Sub-Group 1.

#### Sub-Order CLUPEIFORMES (Isospondili, Malacopterygii).

This is a purely artificial assemblage of lowly organised families retaining the mesocoracoid arch, pneumatic duct, a comparatively large number of vertebral segments, and numerous lepidotrichia in the paired fins. The scales are cycloid as a rule.

The segments of the lepidotrichia are not co-ossified into spines; neither is the head, as a rule, overgrown with scales, and the dermal cranial bones frequently remain in their primitive position near the surface (p. 213).

It should be noticed that in the skull the parietals usually, but by no means always, meet in a median suture; the eye-muscle canal is generally present; the maxilla always, except in the Albulidae, forms the posterior margin of the upper jaw; and the symplectic is absent in the Mormyridae, Phractolaemidae, and Cromeriidae. The hypural bones may remain unfused (Elopidae, Saurodontidae, etc.). Epineurals are generally and epipleurals rarely present. A complete scapular foramen is usually developed. The number of pelvic lepidotrichia varies from as many as sixteen in the Elopidae to as few as five in the Osteoglossidae and Stomiidae.

The Clupeiformes might perhaps be subdivided into two groups, one containing the Elopidae, Albulidae, Osteoglossidae, Mormyridae, Notopteridae, Hyodontidae, and Halosauridae, in which the parietals meet in the middle line, and the other the



remainder of the families; but it is very doubtful whether such a division is natural (p. 346). Ridewood has recently given an account of the skull of these fish [363].

Family ELOPIDAE. Both the maxilla and premaxilla enter the margin of the upper jaw. The parietals meet in spite of the junction below of the frontal with the supraoccipital. The two supratemporals are large and meet (*Elops*) (Fig. 326). It is remarkable that the median gular plate is preserved (Fig. 376), though often in a vestigial condition. Small teeth are present not only on the marginal jaw-bones but also on all the bones of the palate including the parasphenoid, and on the glossohyal and pharyngeals. The eye-muscle canal is present. There is a scapular foramen, and three of the radials rest on the coracoid. Usually there are enlarged axillary scales (Fig. 376).

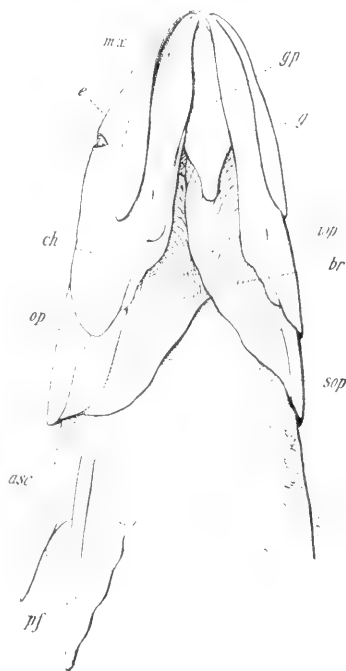

FIG. 376.

Head of *Elops saurus*, L.; oblique ventral view. *a.sc.*, axillary scale; *b.c.*, branchiostegal ray; *ch.*, preopercular region; *e.*, fold of skin over eye; *g.*, lower jaw; *g.p.*, gular plate; *i.op.*, interopercular region; *m.c.*, maxilla; *op.*, opercular; *p.f.*, pectoral fin; *s.op.*, subopercular.

*Elops*, L. (Fig. 377); tropical seas; Eocene, Europe. *Megalops*, Lac.; *Tarpon*, J. and E.; S. American Atlantic Coast, Indo-Pacific; Eocene, Europe. *Elopopsis*, Heckel; *Esoclops*, A. S. W.; Europe; *Osmeroides*, Ag.; Europe, Asia; *Notelops*, A. S. W.; *Rhacolepis*, Ag.; S. America—all Cretaceous.

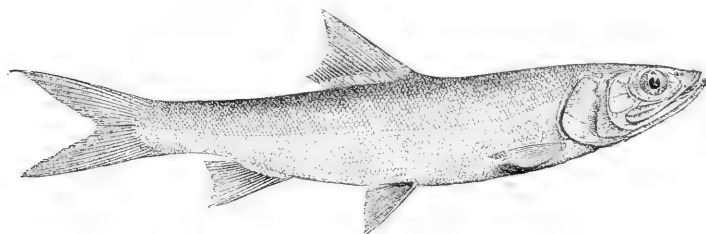

FIG. 377.

*Elops saurus*, L. (After Day, *Fishes of India*.)

Family ALBULIDAE. This family dates from Cretaceous times like

the Elopidae, to which they are doubtless closely allied. The skeleton differs in the absence of a gular plate, in the partial or complete withdrawal of the maxilla from the margin of the mouth, which is small, in the presence of a third, pterotic, branch to the post-temporal, in the articulation of only two radials with the coracoid, and in the larger size of the postclavicle, which is formed of three pieces. The parasphenoid is expanded, and bears numerous grinding teeth opposed to a similar patch of teeth on the basibranchials (Figs. 330-31). Two rows of valves remain in the conus (p. 363).

*Albula* has a flattened transparent larva very similar to the *Leptocephalus* larva of the Anguilliformes.

*Albula*, B. and S. (*Butirinus*); tropical seas. *Anogmius*, Cope; Cretaceous, N. America. *Pterothrissus* (*Bathythrissa*), Hlg., deep-sea, Pacific.

Family MORMYRIDAE. A most remarkable family of freshwater African fish, highly specialised in some respects. In the Mormyridae the head may become drawn out into a long decurved snout carrying

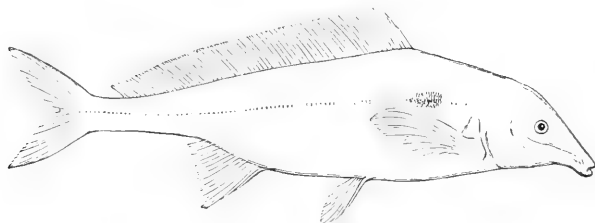

FIG. 378.

*Mormyrus oxyrhynchus*, Geoff. (After Günther.)

the small mouth at its extremity, and sometimes provided with a ventral appendage (Fig. 378). The premaxillae fuse and the maxilla, palatal, and pharyngeal bones are toothless. The large scale-like supratemporal covers a wide lateral fossa. The opisthotic, symplectic, entopterygoid, and supramaxilla are absent. The hyopalatine arch is firmly fixed to the skull, the palatine being fused to the vomer. Paired tendon bones, comparable to those of *Polypterus*, project backwards from the hypobranchials. The suboperculum is small, concealed below the operculum, or absent. The branchial opening is narrowed. Diverticula are given off by the air-bladder to the auditory capsules, and the bladder is cellular in *Gymnarchus*. A peculiar diverticulum grows on the bulbous arteriosus. The brain of these fish is remarkable for its large size, owing chiefly to the great dorsal development of the tuberculum impar and vagus centres. A thick glandular skin covers the head and even the eyes, which are often somewhat degenerate. In most genera the caudal region is long, and the anal fin considerably lengthened; *Gymnarchus* acquires an eel-like shape with tapering tail, while the pelvic, anal, and caudal fins disappear.

All the Mormyridae seem to have electric organs developed in the

caudal muscles; they are especially powerful in *Gymnarchus*. This genus is also remarkable for its larval stage with a large yolk-sac and external gills (Fig. 379, Budgett [67a], Assheton [20]). All African.

Sub-Family MORMYRINAE. Differs from *Gymnarchus* in having a simple air-bladder, toothed parasphenoid and glossohyal, special bones alongside the electric organs, a foramen in the scapula, or between it and the coracoid, and complete fins.

*Mormyrops*, J. M.; *Petrocephalus*, Marc.; *Mormyrus*, L.; *Gnathonemus*, Gill; *Stomatohinus*, Blgr.; *Marcusenius*, Gill.

Sub-Family GYMNARCHIDAE. *Gymnarchus*, Cuv.

Family HYODONTIDAE.

*Hyodon* seems to be related both to the Notopteridae and to the Mormyridae. It differs from the latter in possessing a wide mouth, with strong teeth on the maxillae as well

as the premaxillae, a symplectic, and in the absence of a closed ovisac (p. 368). There is the same lateral temporal fossa covered over by an expanded supratemporal, and vesicle of the air-bladder, which here lies against a fenestra of the auditory capsule. The pterygoids are separate, and the hyopalatine arch movably articulated. A prominent toothed

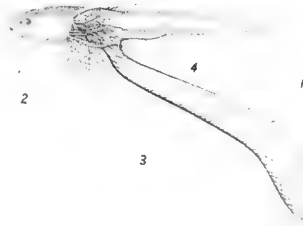

FIG. 379.

Larva of *Gymnarchus niloticus*, Cuv. (After Budgett, *Trans. Zool. Soc.*) 1, yolk-sac; 2, external gills; 3 and 4, subintestinal vein.

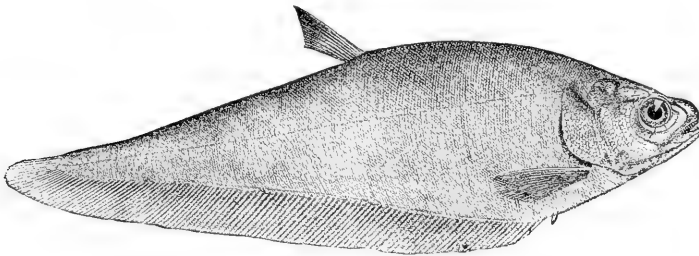

FIG. 380.

*Notopterus koptir*, Lac. (After Day, *Fishes of India.*)

ridge is formed by the parasphenoid. The very large coracoids meet ventrally in a keel. The body is elongate and compressed.

*Hyodon*, Le S.; rivers of N. America.

Family NOTOPTERIDAE. Another small family, allied to the two last. These highly specialised fish have a very compressed body, a very short trunk followed by a long tapering caudal region, with a dorsal fin small or absent. The tail is gephyrocercal, and the caudal fin continuous with the very long anal (Fig. 380). The pelvic fins are reduced or absent.

The supratemporal does not cover the lateral fossa, and there is no subopercular, but in most other respects the bones of the skull resemble those of *Hyodon*. The upper branch of the post-temporal is incomplete or absent, paired bones are attached to the basibranchials as in *Mormyrus*, and mid-ventral adpleurals form a keel joining the pleural ribs below. As in *Hyodon*, the ovaries are 'free,' that is, not closed off from the abdominal coelom.

*Notopterus*, Lac. ; Africa and E. Indies ; Tertiary, Asia. *Xenomystus*, Gthr. ; Africa.

Family OSTEOGLOSSIDAE. The skull [55, 364] has a distinctly primitive appearance, the superficial bones being close to the skin and having a sculptured surface. The wide nasals, frontals, and parietals meet in the middle line, and the supraoccipital scarcely reaches the surface. As in most primitive Teleosts, there is an eye-muscle canal, blind behind, an opisthotic, and, as a rule, a toothed parasphenoid, which, moreover, sends out a process to articulate with the entopterygoid (p. 271). Both the premaxilla and maxilla are toothed, and share in forming the margin of the mouth ; there is no supramaxilla. The interorbital septum is but incompletely formed ; the orbitosphenoid when ossified is paired (*Arapaima*, Ridewood). The dermal articular may be distinct from the endosteal articular. The subopercular is small, often hidden behind the preopercular, and likewise the interopercular. The scales are large, thick, and cycloid. In *Heterotis*, at all events, the ovaries are free, and the larva has external gills (Budgett [67a]). The Osteoglossidae are an ancient family dating from Eocene times ; they seem to be more closely allied to the Albulidae than to any other family. In the more specialised genera the caudal region is generally much developed, the dorsal and anal fins may be extended, so that the pelvics are relatively far forward. *Heterotis* has a spiral suprabranchial accessory breathing organ (Hyrtl [233c]).

*Dapedoglossus*, Cope ; Eocene, N. America. *Brychaetus*, A. S. W. ; Eocene, England. *Osteoglossum*, Vand. ; *Arapaima*, Müll.—S. America. *Heterotis*, Ehr. ; Africa. *Scleropages* ; Indo-Pacific.

Family SAURODONTIDAE. An extinct family closely allied to the Chirocentridae, but rather more primitive. An eye-muscle canal and a normal symplectic are present. The parietals are separated. The ribs are sessile, the neural arches separate from the centra, and there are no compound hypurals. Characteristic of the family is the setting of the teeth in deep sockets. Sometimes a prementary bone is present (*Saurocephalus*, *Saurodon*).

*Saurocephalus*, Harlan ; *Saurodon*, Hays — Cretaceous, Europe and N. America. *Cladocycilus*, Ag. ; Cretaceous, Europe and S. America.

Family CHIROCENTRIDAE. This family, present in Cretaceous strata, but also surviving at the present day, is possibly derived from the Saurodontidae, but differs from them in having the large teeth not in regular sockets, the symplectic hidden by the quadrate and hyomandibular.

A normal postclavicle is not present. There is a large axillary scale above the level of the pectoral fin. The large coracoids

meet below to form a ventral keel. The pelvics are very small. Both epineurals and epipleurals are present. The air-bladder is partly cellular, the pseudobranch and pyloric caeca have disappeared; but most remarkable of all is the retention of a distinct though rudimentary spiral valve in the intestine (Fig. 77).

*Platine*, Ag.; Eocene, Italy. *Chiromystus*, Cope; Brazil; *Chirocentrites*, Heckel; Istria—Cretaceous. *Ichthyodectes*, *Portheus*, Cope; N. America and Europe; Cretaceous. *Chirocentrus*, Cuv.; Indo-Pacific; and Lignite, Sumatra.

Family PHRACTOLAEMIDAE. A small family founded for a single highly specialised African genus. The head is very small and the toothless jaws protractile, the mouth when at rest being folded back on to the top of the snout. The nostril is single on each side, with a barbel in front. The intestine is very long and convoluted. *Phractolaemus* appears to be allied to the Osteoglossidae (Boulenger [42]), but it has lost the symplectic, the myodome, and the postclavicle. The interoperculum is enormous; moreover, the parietals are widely separated by the frontals meeting the supraoccipital. The caudal region is very short.

*Phractolaemus*, Blgr.; W. Africa.

Family CLUPEIDAE. The Herrings form a large family already well represented in Cretaceous times. On the whole, they are of a generalised structure; but the small parietals are separated by the prominent supraoccipital (Fig. 381). A superior temporal fossa, between the frontal and parietal, and a pre-epiotic fossa are characteristic of almost all Clupeid skulls (Fig. 381, B). Prootic and pterotic bullae, in which is lodged the diverticulum of the air-bladder, and an auditory fenestra are usually present. The eye-muscle canal is generally open behind. The upper jaw is of very variable structure; one or two supramaxillae are usually present; teeth may be placed on both the premaxilla and maxilla (*Engraulis*), or on the former only (*Pellonula*), or on neither (*Chatoëssus*); the maxilla may be large and firmly fixed to the premaxilla (*Thrisopatrinae*), or movably articulated to the ethmoid behind (*Clupeinae*). In some the maxilla is prolonged backwards beyond the angle of the mouth, a peculiarity which is carried to an extreme in *Coilia*.

The number of branchiostegal rays varies from thirteen in *Dussumieria* to four in *Chanos*; and of pelvic lepidotrichia from eleven to six. The hypural bones remain simple. There is a remarkable development of intermuscular bones, epineurals, epipleurals, and adpleurals; and usually the pleural ribs are joined below by a series of median V-shaped scales so as to form complete hoops; similar dorsal ridge scales may be present. The coracoids join to a ventral keel; and the postclavicle is quite peculiar in that it overlaps outside the clavicle.

Caecal prolongations of the air-bladder rest against the auditory fenestra, and the pneumatic duct opens into the stomach. In *Clupea* the hinder end of the air-bladder opens directly to the exterior by a pore on the left of the anus, a quite unique arrangement among fish (Fig. 383).

*Chanos* is the type of an aberrant sub-family, sometimes associated with the Albulidae (A. S. Woodward [505]), in which the cranial fossae,

auditory bullae, and fenestra are absent, and the maxilla excluded from the gape of the small mouth.

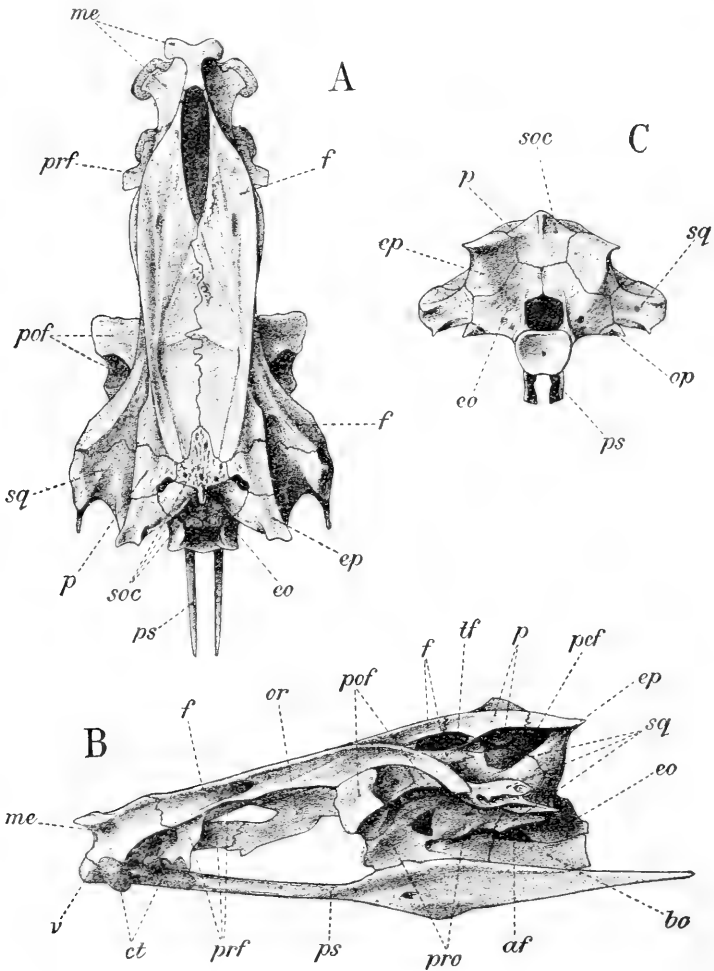

FIG. 381.

Skull of *Clupea finta*, Cuv. (From Ridewood, *Proc. Zool. Soc.*) A, dorsal view; B, left-side view; C, view from behind. *ps*, parasphenoid; *t.f.*, temporal fossa. Other lettering as in Fig. 329, p. 343.

Sub-Family THRISSOPATRINAE. *Thrissopater*, Gthr.; Cretaceous, England.

Sub-Family ENGRAULINAE. *Spaniodon*, Pictet; Cretaceous, Asia. *Engraulis*, Cuv., Anchovy; warm seas; Eocene, Europe. *Cetengraulis*, Gthr.; *Dussumieria*, C. and V.; *Coilia*, Gray (Fig. 384)—Indo-Pacific.

Sub-Family CLUPEINAE. *Pseudoberya*, P. and H.; *Histiobrissa*, A. S. W. *Scombroclupea*, Kner; Eocene, Europe and Asia Minor. *Clupea*, L.; recent; and Eocene, Europe. *Diplomystus*, Cope, Pacific;

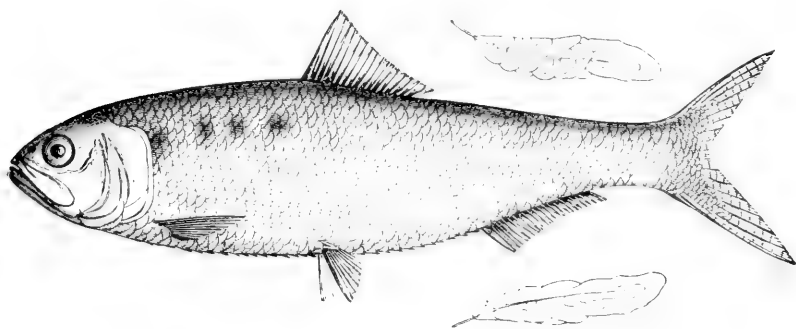

FIG. 382.

*Clupea alosa*, L., the Shad; with caudal scales. (From Seeley, *Freshwater Fishes of Europe*.)

Eocene, Europe, Asia, N. America. *Pellonula*, Gthr.; Atlantic. *Oulaxo-thrissa*, Blgr.; Africa. *Chatoessus*, C. and V.; Pacific and C. America.

Sub-Family CHANINAE. *Chanos*, Lac.—Indo-Pacific; *Chanoides*, A. S. W.—Eocene, Europe. *Prochanos*, Bass.; Cretaceous, Europe.

Family CROSSOGNATHIDAE. An extinct group of imperfectly known Cretaceous fish probably related to the Clupeidae.

*Crossognathus*, Pictet; *Scyllaemus*, Cope; Cretaceous, Europe.

Family SALMONIDAE. Although the parietals are often separated by

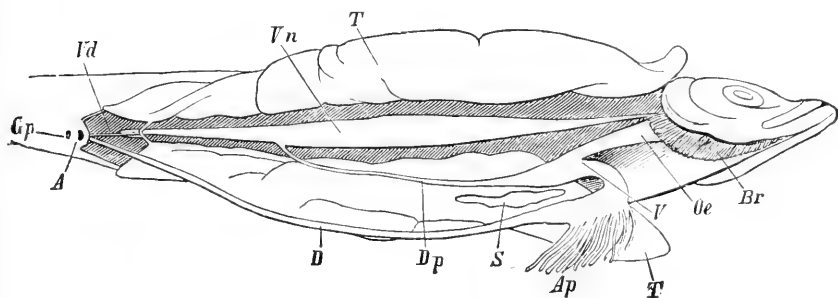

FIG. 383.

*Clupea harengus*, L., with the viscera exposed. (After Brandt, from Claus and Sedgwick.) A, anus; Ap, pyloric appendages; Br, gills; D, intestine; Dp, pneumatic duct; Gp, genital pore; Oe, oesophagus; S, spleen; T, testis; V, stomach; Vd, vas deferens; Vn, air-bladder.

the supraoccipital meeting the frontals, yet they sometimes spread over and join above in a median suture. On the whole, the skeleton is primitive, and the chondrocranium is particularly well preserved (Fig. 302). There is an adipose fin; pyloric appendages vary in number from 200 to a few, or may be absent (*Microstoma*); the air-bladder, which is

usually large and simple, may also be lost (*Salanx*). The ovary is free, the oviducts being short (*Osmerus*), or reduced to mere pores (p. 367).

*Salmo*, L., Salmon and Trout (Fig. 385); Northern hemisphere; Pleistocene. *Mallotus*, Cuv.; N. Asia and N. America; Pleistocene. *Coregonus*, Art., Whitefish; *Osmerus*, L., Smelt; *Thymallus*, Cuv., Gray-

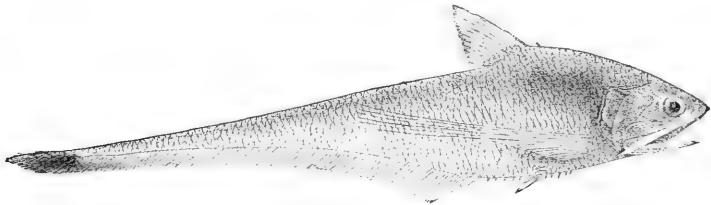

FIG. 384.

*Coilia dussumieri*, C. and V. (After Day, *Fishes of India*.)

ling—Northern hemisphere. *Argentina*, Art.; Europe. *Salanx*, Cuv.; China. *Suciotrutta*, Gthr.; Caspian Sea, Russia, N. America. *Opisthoproctus*, Peters (Fig. 401, A).

Family ALEPOCEPHALIDAE. A family of deep-sea fish apparently related to the last, but with neither adipose fin nor postclavicle. All have lost the air-bladder; *Platytrectes* the pelvic fins; and some, like *Aleposaurus*, have lost the scales.

*Alepocephalus*, Risso; *Bathytroctes*, Gthr.; *Aleposomus*, Gill; *Leptoderma*, Vaill.; *Platytrectes*, Gthr.

Family STOMIATIDAE. Specialised deep-sea fish, with very delicate scales or naked skin, and usually numerous well-developed phosphorescent

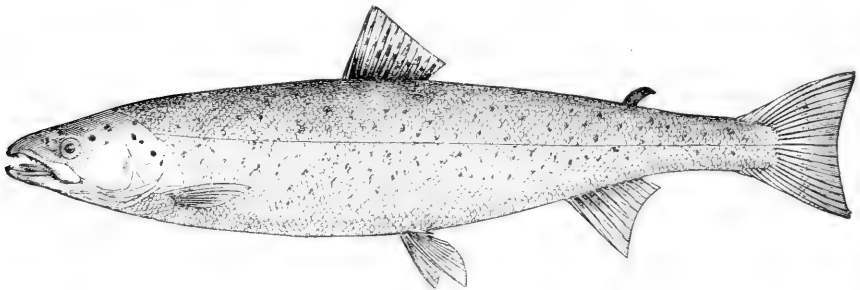

FIG. 385.

*Salmo salar*, L.; the Salmon. (From Seeley, *Freshwater Fishes of Europe*.)

organs. The maxilla is large and toothed; the parietals meet in a median suture (*Chauliodus*). The branchial opening is very wide, the post-temporal being attached near the middle line. There is often a hyoid barbel and an adipose fin. The air-bladder may be absent and the paired fins reduced. In this one family Boulenger has united the Stomiidae and Sternoptychidae of Günther.



Sub-Family CHAULIODONTINAE. Elongated, with the dorsal fin far forwards, a very wide gape, and formidable dentition.

*Chauliodus*, B. and S.

Sub-Family GONOSTOMATINAE. Elongate, with the dorsal fin far back; sometimes a barbel (*Astromethes*).

*Astromethes*, Rich.; *Gonostoma*, Raf.; *Maurolicus*, Cocco; *Photichthys*, Hutt.

Sub-Family STERNOPTYCHINAE. The body is very short and deep, the pelvic fins vestigial or absent.

*Argyropelecus*, Cocco; *Sternoptyx*, Herm.; *Polyipmus*, Gthr. (Fig. 344, B).

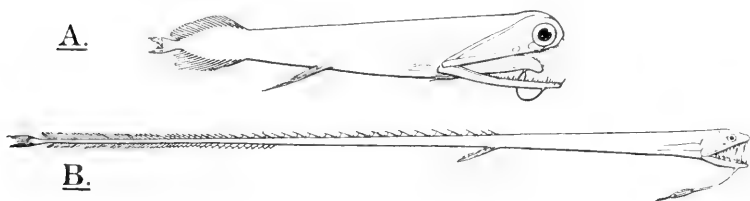

FIG. 386.

A, *Malacosteus indicus*, Gthr. (After Günther.) B, *Idiacanthus ferox*, Gthr. (After Günther.)

Sub-Family STOMIATINAE. Elongate, with the dorsal far back, a wide gape, and large pointed teeth. Often there is a barbel, and the pectoral fins may be vestigial or absent.

*Stomias*, Cuv.; *Macrostomias*, Br.; *Photonectes*, Gthr.; *Malacosteus*, Ayres (Fig. 386, A). *Stylophthalmus*, Br. (Fig. 401, B). *Idiacanthus*, Gthr. (Fig. 386, B).



FIG. 387.

*Gonorhynchus greyi*, Rich. (After Günther.)

Family GONORHYNCHIDAE. An ancient family dating from Eocene times, and represented at the present day by a single specialised genus, *Gonorhynchus*, which has the head and body covered with small ctenoid scales, and carries a ventral barbel on the prolonged snout. The supra-occipital separates the parietals, the premaxilla articulates with the maxilla and excludes it from the margin of the small mouth. Teeth are absent (*Notogoneus*), or present on the palate only. There is no myodome and no air-bladder. These fish are possibly related to the Scopelidae (A. S. Woodward).

*Gonorhynchus*, Gronov (Fig. 387); Indo-Pacific. *Notogoneus*, Cope; Eocene, Europe and N. America. *Charitosomus*, Marck; Cretaceous, Europe and Asia Minor.

Family CROMERIIDAE. Including the minute fish, *Cromeria*, from the White Nile. The small inferior mouth is toothless, the maxilla not excluded, the parietals separated, the branchial opening narrow, the body scaleless. There is no postclavicle, no symplectic, and no myodome.

*Cromeria*, Blgr. ; Africa.

Family PANTODONTIDAE. A little African freshwater flying-fish, *Pantodon*, seems to be closely related to the Osteoglossidae, although it has become highly specialised in the development of its paired fins. The slender curved mesocoracoids meet in the middle line. The large pectorals have the postaxial edge prolonged into a soft web joining on to the side of the body ; and the pelvics, bearing only seven dermatrichia, some of which are filamentous, are placed far forwards almost under

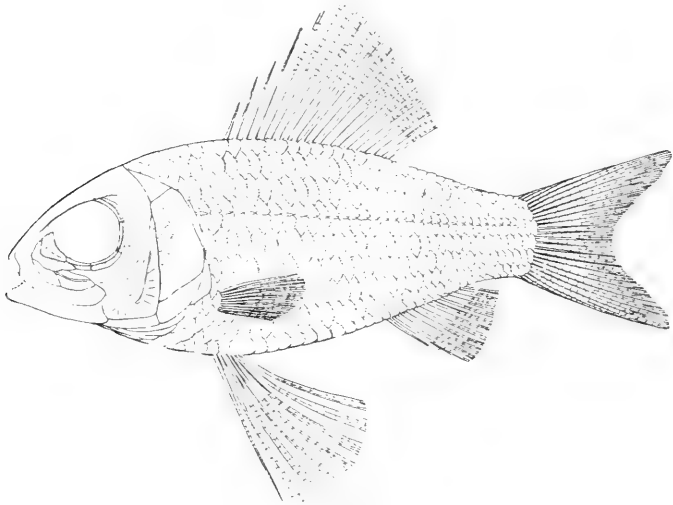

FIG. 388.

*Ctenothrissa verillifer*, Pictet ; Upper Cretaceous, Mount Lebanon ; restored ; left-side view.  
(After A. S. Woodward, *Proc. Geol. Assoc.*)

the pectorals. They are thoracic in position, although the girdle is not fixed to the pectoral arch. The cranial bones are not sculptured, yet they resemble those of the Osteoglossidae except in the fusion of the premaxillae, and the loss of the sub- and interopercular. The auditory capsule is swollen into a thin-walled bulla (Peters, Boulenger [42], Ridewood [364]).

*Pantodon*, Peters ; W. Africa.

Family CTENOTHRISSIDAE. A small extinct group of obscure affinities, with very large pelvic fins (with eight dermatrichs) placed far forward. The anterior dermal rays of the dorsal fin are unjointed. Premaxillae and large maxillae, with small teeth, border the gape. The parietals meet.

Like the Pantodontidae, which they resemble somewhat in structure,

the Ctenothrissidae are placed in the Clupeiformes chiefly on account of their osteology ; yet in the position of their pelvic fins and the spine-like dorsal rays, they approach the Acanthopterygii, with which they are possibly related.

*Ctenothrissa*, A. S. W. (Fig. 388), and *Aulolepis*, Ag. ; Cretaceous, Europe and Asia Minor.

### Sub-Group 2.

In which the mesocoracoid arch is lost and a higher level of general specialisation is reached, usually accompanied by the closure of the pneumatic duct, the development of spines and ctenoid scales, and the modification of the maxilla into a toothless bone, separately articulated, and lying behind the premaxilla. This last character has been independently developed in the Cypriniformes and probably also in several of the following sub-orders. Except in the Berycidae (Starks [421]) and Lampridiformes (Regan [344]), the orbitosphenoid is lost. Seven sub-orders are included, some of which are merely provisional assemblages of families, whose affinities are by no means clearly established. Indeed, the origin of the Anguilliformes, for instance, is quite unknown ; but, since the Acanthopterygii appear to be more closely related to two of the sub-orders than to the others, we can distinguish five divergent series which may be of some phylogenetic value.

### Series 1.

#### Sub-Order 1. ESOCIFORMES (Haplomi).

This is a provisional sub-order containing some of the least specialised forms of Sub-Group 2 (Starks [420]). They are without true spines, and are usually physostomous (with an open pneumatic duct). As a rule, the parietals are separated and the orbitosphenoids absent. The pelvic fins are abdominal, and may have numerous dermal rays ; the dorsal fin single, though occasionally followed by an adipose fin.

In general structure the Esociformes resemble the Clupeiformes, the Cyprinodontids lead towards the Mugiliformes, while the Scopelids and Stephanoberycids approach the Acanthopterygii (Boulenger). Fossil forms are known from the Eocene upwards.

### TRIBE 1.

The parietals meet, separating the frontals from the supraoccipital ; the post-temporal is simple ; the neural arches and parapophyses generally autogenous (Swinnerton).

Family GALAXIIDAE. The toothless maxillary, though behind the premaxillary, shares in the margin of the mouth. There is no eye-muscle canal, and the interorbital septum is but incompletely formed. *Neochanna* has lost the pelvic fins. Scaleless.

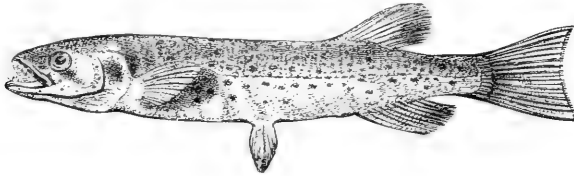

FIG. 380.

*Galaxias truttaceus*, Cuv. (After Günther.)

*Galaxias*, Cuv. (Fig. 389); rivers of S. Africa, S. Australasia, and S. America. *Neochanna*, Gthr.; New Zealand.

Family HAPLOCHITONIDAE. Differ from the former in the exclusion of the maxillary from the margin of the jaw, the presence of an eye-muscle canal, and an adipose fin. *Prototroctes* has small scales.

*Haplochiton*, Jen.; S. America. *Prototroctes*, Gthr.; Australasia.

#### TRIBE 2.

The frontals join the supraoccipital so as to separate the parietals, the parapophyses when present are fused to the centra, and usually there is no eye-muscle canal.

SUB-TRIBE A. The maxillae are not excluded from the margin of the mouth; there are no parapophyses on most of the precaudal vertebrae.

Family ENCHODONTIDAE. An extinct family from the Cretaceous, related to the Scopelidae, naked or with small scales, and sometimes with dermal scutes. Usually an adipose fin. The maxilla may be toothed, the preopercular may have a spine (*Halec*, *Eurypholis*), and the pelvic fins may be far forward.

*Enchodus*, Ag., Europe, Asia, N. America; *Eurypholis*, Pict.; *Halec*, Ag., Europe, Asia; *Cimolichthys*, Leidy, Europe, N. America; *Leptecodon*, Will., N. America; *Pantopholis*, Davis, Asia—all from Cretaceous strata.

Family ESOCIDAE. The Pikes are among the least specialised of this sub-order, except in their dentition, which is composed of numerous powerful sharp teeth on the jaws, palate, and visceral arches. The forked post-temporal rests on the epiotic and exoccipital. There is no adipose fin, and the pelvic may have eleven dermal rays. The vertebral arches are autogenous. There is a prenasal bone.

*Esox*, Cuv.; Europe, Asia, N. America; and Miocene, Europe. *Umbra*, Kram.; Europe, N. America.

Family DALLIIDAE. Specialised fish, closely related to the Esocidae, in which the skeleton is thin and soft, the post-temporal incompletely ossified, the pectoral fin has lost its radials, and the pelvics preserve only three dermal rays (Starks).

*Dallia*, Bean (Fig. 390); Siberia and N. America.

SUB-TRIBE B. The mouth margined by the premaxilla only. An adipose fin usually present.

Family SCOPELIDAE. A large and important family of marine fish, dating from Cretaceous times. Many of them are deep-sea forms with brilliant phosphorescent organs (Fig. 344, A). The pelvic fins, with from seven to ten dermal rays, may be placed far forwards.

*Ipnops* has lost its eyes, and acquired two large cephalic phosphorescent organs; *Odontostomus* is scaleless and has enormous eyes and barbed teeth; *Bathypterois* has lengthened sensitive filaments borne by specialised lepidotrichia (Fig. 512, A). The air-bladder may be lost.

*Sardinioides*, van der M.; *Acrognathus*, Ag.; *Leptosomus*, van der M., Europe and Asia; *Rhinellus*, Ag.; *Sardinius*, van der M., Europe and N. America; *Nematonotus*, A. S. W., Syria; *Scopeloides*, Wettstein; *Dactylopopon*, van der M.; *Parascopelus*, Sauv.; *Anapterus*, Sauv.; *Apateodus*, Ag., Europe; all from the Cretaceous. *Scopelus*, Cuv.;

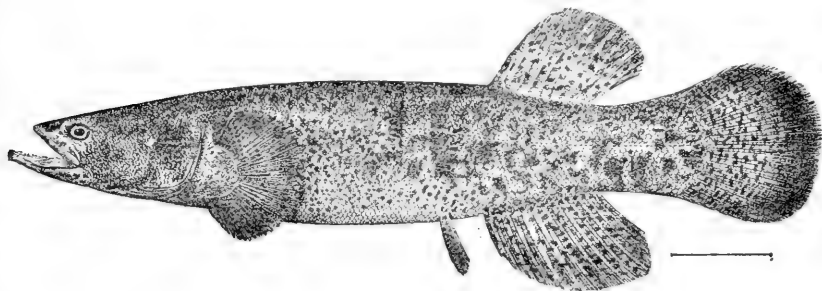

FIG. 390.

*Dallia pectoralis*, Bean. (From Jordan and Evermann.)

*Ipnops*, Gthr.; *Sudis*, Raf.; *Paralepis*, Risso; *Bathypterois*, Gthr.; *Harpodon*, Les.; *Odontostomus*, Cocco; *Benthosaurus*, G. and B.

Family ALEPIDOSAURIDAE. Powerfully toothed elongated fish, with an immense dorsal fin, no scales, no air-bladder, and a simple post-temporal attached to the opisthotic. The single genus appears to be closely allied to the Scopelidae.

*Alepidosaurus*, Lowe (Fig. 391); Atlantic and Pacific.

Family CETOMIMIDAE. Deep-sea fish, whose affinities are very uncertain, with a huge mouth, small teeth, and no scales. *Cetomimus* has lost the pelvic fins, and has very small eyes.

*Cetomimus*, G. and B. (Fig. 392); *Rondeletia*, G. and B.

SUB-TRIBE C. The maxillae are excluded from the margin of the mouth, which usually has a small gape, with the suspensorium produced forwards; and the centra have well-developed parapophyses. Without an adipose fin.

Family KNERIIDAE. With toothless non-protractile jaws, small scales, opercular membranes confluent, a narrow gill-opening, pelvic fins with nine dermotrichs.

*Kneria*, St.; rivers of Tropical Africa.

Family CHIROTHRICIDAE. Premaxillae very slender. Teeth small or absent; sometimes dermal scutes. The fins are remarkably large, the pelvics being of enormous size, with some eighteen dermal rays, and placed far forwards quite near the pectorals. The family is known from the Cretaceous only.

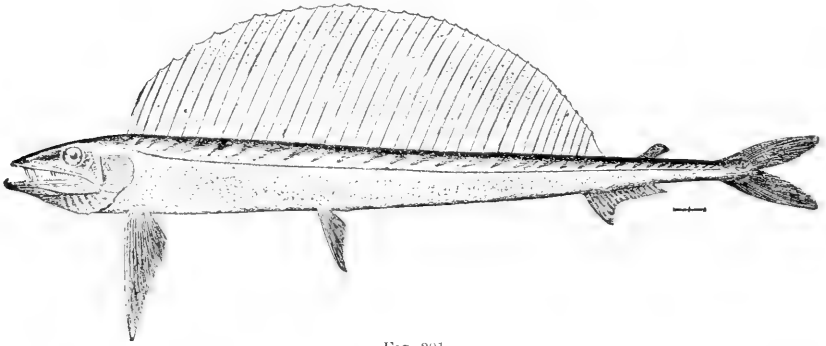

FIG. 391.

*Alepidosaurus ferox*, Lowe. (From Jordan and Evermann.)

*Chirothric*, P. and H.; *Telepholis*, van der M.; and *Exocoetoides*, Davis—Cretaceous, Europe and Asia Minor.

Family CYPRINODONTIDAE. The mouth is protractile; teeth are present on the jaws and pharyngeals, but rarely on the palate; the palato-quadrate arch is more or less reduced. Not more than seven pelvic dermal rays. The air-bladder may be lost.

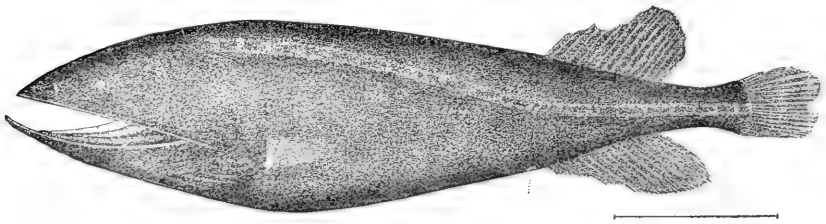

FIG. 392.

*Cetomimus Gilli*, G. and B. (From Jordan and Evermann.)

The Cyprinodonts, which are often of extremely small size, frequently exhibit remarkable sexual differences, the male being smaller and more brilliant in colouring. In the male the anal fin may be modified to serve as an intromittent organ (Fig. 393). They are often viviparous.

*Procatopus* is distinguished by having the pelvic fins far forward below the pectorals, and *Anableps* by a remarkable adaptation of its eyes for seeing both in the air and in the water as it swims at the surface, the cornea being divided into two dissimilar halves (Fig. 394).

GROUP A. Carnivorous ; with strong jaws and short intestine. *Anableps*, Art. (Fig. 394); America. *Gambusia*, Poey (Fig. 393); America. *Orestias*, C. and V.; mountains of S. America. *Prolebias*, Sauv.; and *Pachylebias*, A. S. W.—Miocene, Europe. *Cyprinodon*, Lac.; America and

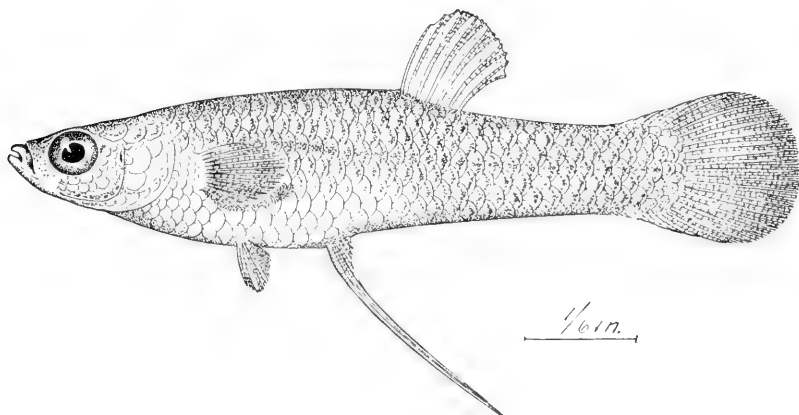

FIG. 393.

*Gambusia affinis*, Brd. and Grd., male. (From Jordan and Evermann.)

Mediterranean region. *Haplochilus*, M<sup>c</sup>Cl.; America, India, Africa. *Fundulus*, C. and V.; Europe, America, Africa.

GROUP B. Mud-eating ; with long convoluted intestine and weak jaws. *Poecilia*, Gthr.; *Mollienesia*, Les.; *Platypoecilus*, Gthr.; *Girardinus*, Poey—S. America.

FAMILY AMBLYOPSIDAE. Closely related to the Cyprinodonts ; but with a scarcely protractile mouth, and pelvic fins vestigial or absent. The anus moves forward to near the head. Viviparous.

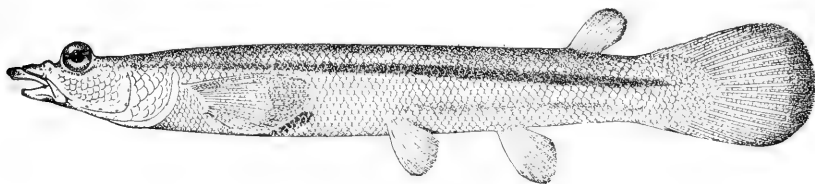

FIG. 394.

*Anableps Doyii*, Gill. (From Jordan and Evermann.)

Some, like *Chologaster*, live in the open, and are pigmented and provided with normal eyes. Others, like *Amblyopsis* and *Typhlichthys*, live in caves, and lose their colour and their eyes.

*Chologaster*, Ag.; *Amblyopsis*, De Kay (Fig. 395); *Typhlichthys*, Ger.—N. America.

SUB-TRIBE D. The air-bladder is closed, the lower pharyngeals

are fused, long parapophyses bear ribs, and there are lateral longitudinal rows of ridged scales.

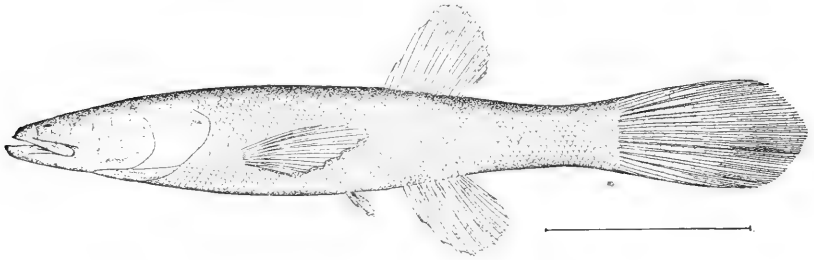

FIG. 395.

*Amblyopsis spelaeus*, De Kay. (From Jordan and Evermann.)

Family SCOMBRESOCIDAE. The air-bladder may be cellular, the stomach is indistinctly marked, and the maxilla is not excluded. The post-temporal is simple, and the post-clavicle lost. Scales cycloid. Sometimes there is a series of dorsal finlets (*Scombrox*). In *Hemirhamphus*

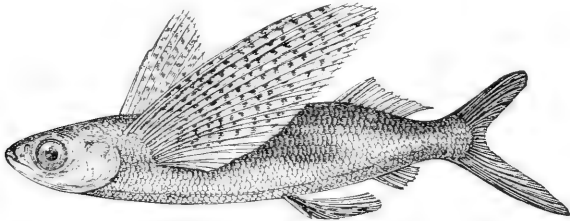

FIG. 396.

*Exocoetus collopterus*, Gthr. (After Günther.)

the lower jaw, and in *Belone* and *Scombrox* both jaws are prolonged into a slender beak. The pectoral fins acquire a large size, especially in the Flying-Fish *Exocoetus* (Fig. 396); and the pelvic fins may also be enlarged. It is interesting to compare these modifications with those 'Flying-Fish'



FIG. 397.

*Hemirhamphus brasiliensis*, L. (From Jordan and Evermann.)

belonging to other groups (Pholidophoridae, Semionotidae, Dactylopteridae; Abel [1]). *Hemirhamphus* is sometimes viviparous, and the anal fin may be modified into a copulatory organ, as in Cyprinodonts.



SUB-FAMILY 1. BELONINAE, with zygapophyses, and the maxilla fused to the premaxilla; *Belone*, Cuv., Gar-Fish. SUB-FAMILY 2. EXOCOETINAE, with separate maxilla, no zygapophyses, and enlarged third upper pharyngeals; *Scombrosox*, Lac.; *Hemirhamphus*, Cuv. (Fig. 397)—tropical and temperate seas; and Eocene, Europe. *Arrhamphus*, Gthr.; Pacific. *Exocoetus*, Art. (Fig. 396); tropical seas.

#### INCERTAE SEDIS.

Family AMMODYTIDAE. A small family of elongated marine fish, whose systematic position is very uncertain; they are placed near the Scombrosoxidae by Boulenger, in the Ophidiidae by many authors.

In the extinct *Cobitopsis* the pelvic fins are present and abdominal, in the modern forms they are lost. The parietals are separated, the

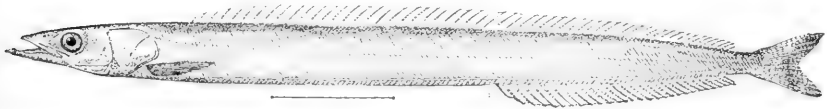

FIG. 398.

*Ammodytes americanus*, De Kay. (From Jordan and Evermann.)

maxillae excluded from the margin of the mouth, which is protractile, the scales small and cycloid, the teeth small or absent, the air-bladder absent, and there are no parapophyses.

*Ammodytes*, L. (Fig. 398), Sand Eel; Northern hemisphere. *Hypoptychus*, Steind.; Japan. *Cobitopsis*, Lom.; Oligocene, France.

### Series 2.

#### Sub-Order 2. ANGUILLIFORMES (Apodes).

The Eels are a highly specialised group. They acquire a very elongated shape; the median fins are extremely long and usually confluent behind; the tail is truncated, both hypural bones and caudal fin being lost, and ends in a symmetrical cephalic tip (Fig. 400). The paired fins also tend to disappear, traces of the pelvics being found only in the extinct *Urenchelys*, which is also remarkable for the possession of a caudal fin (A. S. Woodward [504-5], Hay [205]). As a rule, the number of vertebrae is greatly increased, and the notochord persists more than usual among modern Teleosts. The parietals meet above. It is in the visceral skeleton that the modifications are most conspicuous. Normal premaxillae are never found; either they have been lost or they have fused with the ethmoid and vomer (Fig. 402); these two bones coalesce. The maxillae themselves may be absent (Muraenidae); and even the pterygo-quadrato arch may become discontinuous

(Muraenidae), or disappear (Synphobranchidae, Saccopharyngidae). In fact, the interpretation of the bones of the upper jaw is often doubtful. The symplectic is absent, and the mandible contains only an articular and a dentary.

The pectoral girdle has become freed from the skull, there being no post-temporal (Fig. 399). Often more than five radials are found in the pectoral fin, a peculiarity which is to be noticed in *Gymnotus* and the Muraenolepidae.

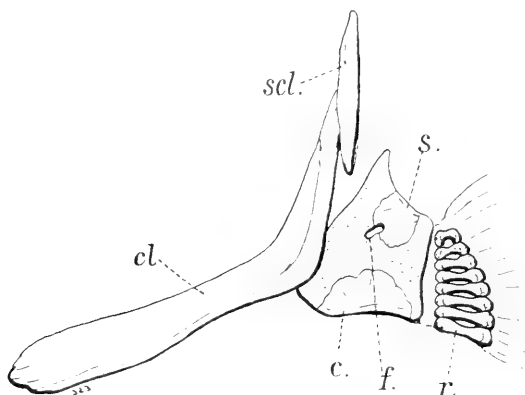

FIG. 399.

Skeleton of the left half of the pectoral girdle and of the fin of *Anguilla vulgaris*, L. c, coracoid; cl, cleithrum; f, foramen; r, eighth radial; s, scapula; scl, supraclavicle. The cartilage is dotted.

The scales are rudimentary or absent. The branchial opening becomes much narrowed; the air-bladder has an open duct and there are no pyloric caeca. The ova are discharged through mere genital pores (p. 367).

The remarkable deep-sea form, long known as *Leptocephalus*, has been shown to be the larval stage of the Anguilliformes, which metamorphoses into the elver; the latter grows into the adult form (Delage [111a], Grassi [182a]).

#### Division 1. ARCHENCHELI.

The caudal fin and hypural bones are still present, also the pelvic fins. The jaws are toothed, and the palatopterygoid arch is normally developed. The scales are vestigial or absent.

Family URENCHELIDAE. Represented by extinct genera from Cretaceous strata.

*Urenchelys*, A. S. W.; Cretaceous, England and Mt. Lebanon.

*Anguillavus*, Hay; Cretaceous, Mt. Lebanon.

## Division 2. NEENCHELI.

The pelvic and caudal fins have been lost.

## GROUP A. ENCHELICEPHALI.

Toothed maxillae are present, and the palatopterygoid arch is usually complete.

Family ANGUILLIDAE. The skull is well ossified; but the bones are sunk deeply, and only one of the circumorbital series remains in front. The opercular bones are of moderate size, and the branchial arches well

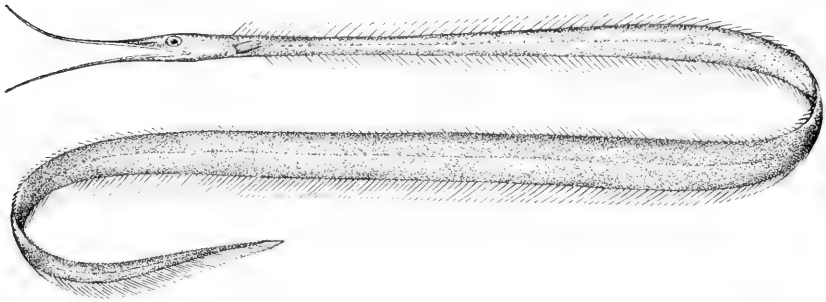

FIG. 400.

*Labichthys carinatus*, G. and R. (From Jordan and Evermann.)

developed (Fig. 402). The branchiostegal rays long and curled inwards. *Anguilla*, *Sinenchelis*, and *Ilyophis* have vestigial scales.

*Eomyrus*, St.; *Rhynchorhinus*, A. S. W.; Eocene, England. *Anguilla*, Shaw; widely distributed, and Eocene, Europe. *Nettastoma*, Raf.;

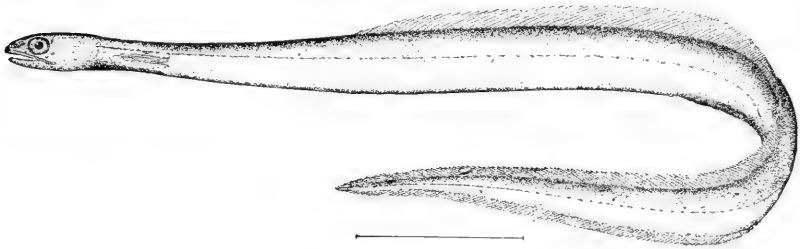

FIG. 400A.

*Derichthys serpentinus*, Gill. (From Jordan and Evermann.)

Pacific, Mediterranean; and Eocene, Europe. *Sinenchelys*, Gill; *Ilyophis*, Gilbert—deep-sea. *Conger*, Kp.; *Congromuraena*, Kp.; *Uroconger*, Kp.; *Myrus*, Kp.; *Ophichthys*, Gthr.; *Moringua*, Gray.

Family NEMICHTHYIDAE. Small and extraordinarily slender deep-sea eels with the anus near the head, and often the jaws produced into delicate diverging points.

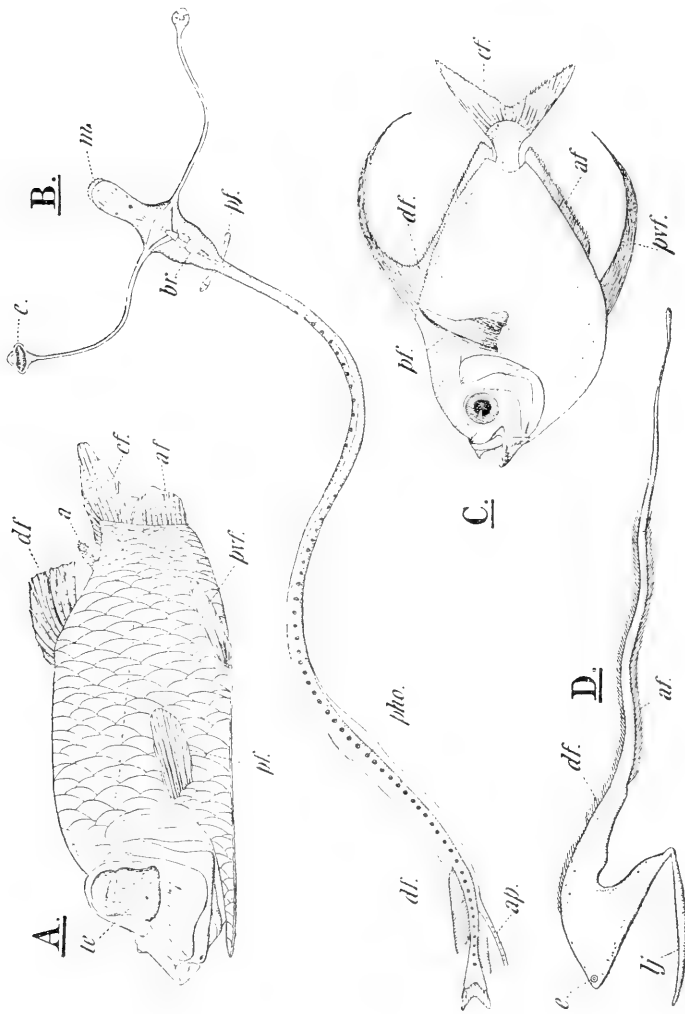

FIG. 401.

A, *Opisthoproctus soleatus*, Vaill. ; B, young *Stylophthalma paradoxus*, Brauer ; D, *Macropharynx longicaudatus*, Brauer (after Brauer) ; C, *Lampris gattius*, Retz. (after Cuvier and Valenciennes). *a*, adipose fin ; *a.f.*, anal ; *c.f.*, caudal ; *d.f.*, dorsal ; *p.v.f.*, pectoral ; and *p.v.f.*, pelvic fin ; *a.p.*, anal papilla ; *br.*, brain ; *c.*, eye ; *l.j.*, lower jaw ; *m.*, mouth ; *ph.o.*, phosphorescent organs ; *t.e.*, telescopic eye.

*Nemichthys*, Rich. ; *Dysomma*, Alc. ; *Spinicomer*, G. and R. ; *Labichthys*, G. and B. (Fig. 400) ; *Gavialiceps*, Alc. ; warm seas.

Family DERICHTHYIDAE. Another small deep-sea eel with a snake-like neck. The maxillae are fused to the skull.

*Derichthys*, Gill (Fig. 400A) ; Atlantic.

Family SYNAPHOBANCHIDAE. Deep-sea forms in which the pterygo-palatine arch is lost, and the branchial openings are confluent below. There are small scales.

*Synaphobranchus*, Johns.

Family SACCOPHARYNGIDAE. Extraordinarily modified deep-sea eels with a much-reduced skeleton. The mouth is enormously enlarged, the palato-quadrate arch incomplete, the hyomandibular very movable, and the jaws greatly lengthened (Fig. 401, D). Mere loose rods represent the gill-arches, and the branchiostegals have been lost.

A small flexible snout overhangs the mouth, and close behind it are the small eyes.

*Saccopharynx*, Mitch. (Fig. 401, D); *Eurypharynx*, Vail.; *Macropharynx*, Br.; *Gastrostomus*, G. and R.—Atlantic.

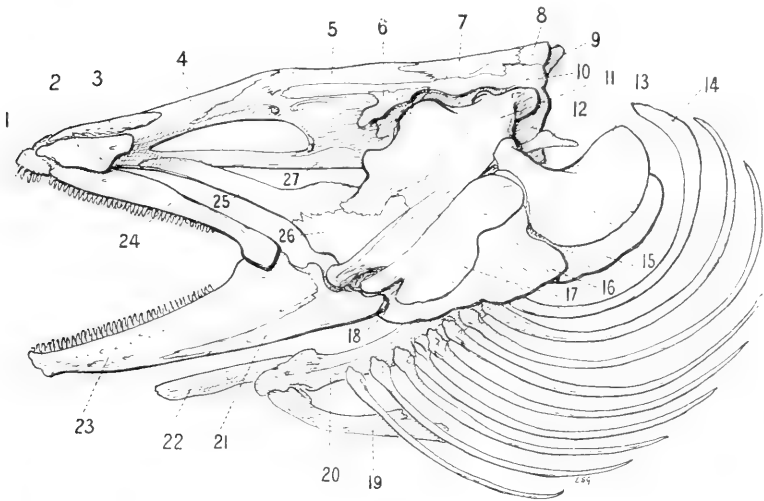

FIG. 402.

Left-side view of skull and hyoid arch of the Conger Eel, *Conger vulgaris*, Cuv. 1, vomer; 2, preorbital; 3, nasal; 4, ethmoid; 5, frontal; 6, postfrontal; 7, parietal; 8 and 9, supra-occipital; 10, pterotic; 11, hyomandibular; 12, epibranchial; 13, opercular; 14, branchiostegal; 15, subopercular; 16, interopercular; 17, preopercular; 18, angular; 19, urohyal; 20, ceratohyal; 21, articular; 22, basihyal; 23, dentary; 24, maxilla; 25, pterygoid; 26, quadrate; 27, parasphenoid.

#### GROUP B. COLOCEPHALI.

The head is much compressed, the palatal bones very abnormal, and the place of the premaxilla and maxilla seems to be taken by the toothed ethmo-vomer and pterygoid. Behind the palato-ptyerygoid arch is incomplete; the hyomandibular bearing the quadrate is firmly attached to the skull. The opercular bones are all present, but very small. The mouth is often provided with very formidable teeth pointing backwards. The branchial

apparatus is usually reduced, and the branchiostegals delicate or absent. The gill-opening is narrowed to a small round aperture, and the gill-clefts small. The pectoral fins, and even the girdle, may be lost.

Family MURAENIDAE. The body is scaleless and generally conspicuously coloured. The tail is very long (Fig. 403).

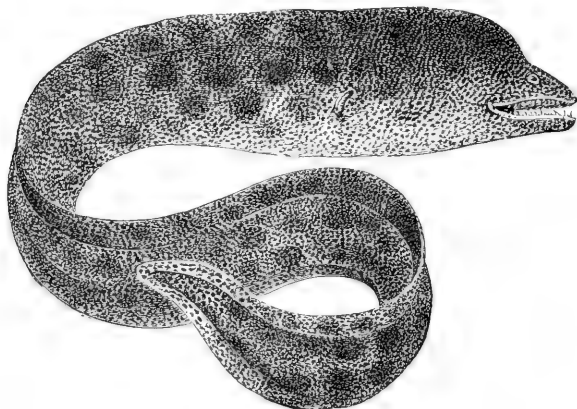

FIG. 403.

*Muraena picta*, Ahl. (After Günther.)

*Muraena*, L. ; *Thyrsoidea*, Kp. ; *Myroconger*, Gthr. ; *Enchelycore*, Kp. ; *Lycodontis*, McCl. ; *Channomuraena*, Rich.

### Series 3.

#### Sub-Order 3. SYMBRANCHIFORMES.

A small group of very highly specialised fish whose affinities cannot yet be determined. They have a superficial resemblance to the Eels, from which they differ in many important osteological characters, and in the possession of closed ovisacs. The air-bladder is absent.

The skull is like that of the Clupeiformes; the parietals meet, the maxillae, however, are almost excluded from the margin of the mouth, and the hyopalatine arcade is closely fitted to the narrow, firmly ossified cranium. The trunk being much lengthened and the tail short, the anus is usually far back, and there are a large number of vertebrae. In *Chilobranhus* the tail is long. Strong parapophyses bear short ribs. The centra are slightly opisthocelous.

The branchial openings have joined in a single ventral opening (Fig. 405); the opercular bones, and especially the gills, become reduced, respiration is carried on chiefly in the wall of the buccal cavity and intestine, and the circulation is consequently much modified (Hyrtl [233*b*], Volz [475]). The dorsal aorta is formed by the junction of the last pair of aortic arches, which are complete (Fig. 404); the jugulars return the blood from the head and other arches directly to the heart.

The scales are either minute (Amphipnoidae) or altogether absent (Symbranchidae). Dermal folds without lepidotrichia alone represent the vestiges of the median fins; and the paired fins have been lost, leaving only a slender pectoral girdle, attached to the skull in the Symbranchidae, but free in the Amphipnoidae.

Unknown in the fossil state, these peculiar fish, which have now been separated from the Anguilliformes and placed in a special sub-order, may have been derived from some primitive group which had lost the mesocoracoid arch, or perhaps even from some member of the Clupeiformes or Esociformes (Boulenger [42]).

**Family SYMBRANCHIDAE.** The post-temporal is still present and attached to the skull. *Symbranchus* has well-developed gills; but *Monopterus* has only vestigial gill-lamellae on three arches.

*Symbranchus*, Bl. (Fig. 405); America, E. Indies. *Monopterus*, Lac.; E. Indies and Archipelago.

**Family AMPHIPNOIDAE.** The slender pectoral girdle is free, the post-temporal having been lost. Gill-lamellae are found on the second arch

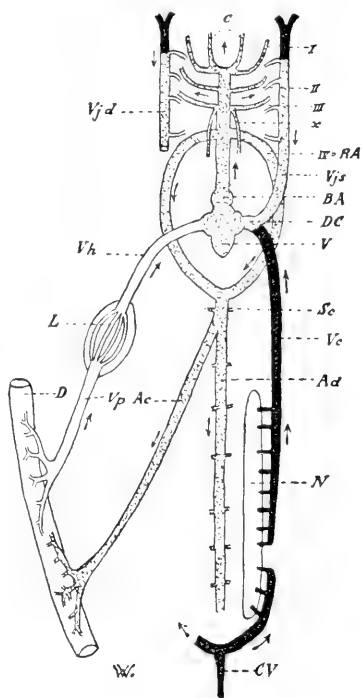

FIG. 404.

Diagram of the circulation in *Monopterus javanensis*, Lac. The right kidney and its veins have been removed; the right jugular vein is incomplete. Arrows show the direction of the blood-stream. White vessels contain arterial blood, shaded vessels mixed, and black vessels venous blood. I-IV, four gill-arches; A.c. coeliac artery; A.d. dorsal aorta; BA, bulbus; c. caroidid; C.V. caudal vein; D, gut; D.C. ductus Cuvieri; L, liver; N, kidney; R.A = IV, radix aorta; V, ventricle; V.c. cardinal vein; V.h. hepatic vein; V.jl, right jugular vein; V.js, left jugular vein; V.p, portal vein; x. afferent vessel of third gill-arch. (From W. Volz.)

only, and are supplemented by two extensible lung-like air-sacs, backward prolongations of the branchial chamber.

*Amphipnous*, Müll. ; E. Indies.



FIG. 405.

*Symbranchus bengolensis*, M'Cl., and upper teeth. (After Day, *Fishes of India*.)

#### Series 4.

#### Sub-Order 4. GASTEROSTEIFORMES (Catosteomi, Hemibranchii, Lophobranchii).

This sub-order is an assemblage of fish for the most part highly specialised, which were first brought together by A. S. Woodward. The Flute-mouths (Fistulariidae) and Sticklebacks (Gasterosteidae), which Cope had already united in the group Hemibranchii, and the

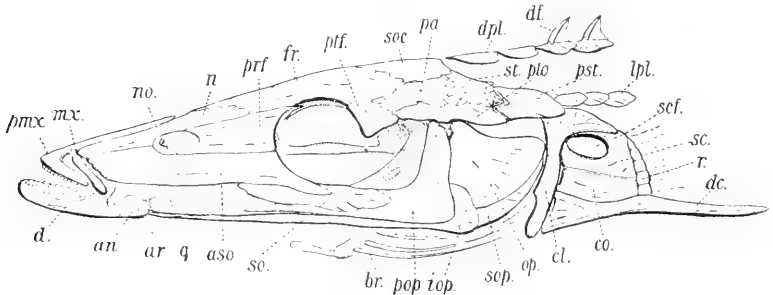

FIG. 406.

Skull and pectoral girdle of *Gasterosteus spinachia*. *an*, angular; *ar*, articular; *aso*, anterior suborbital; *br*, branchiostegal; *cl*, cleithrum; *co*, coracoid; *d*, dentary; *d.c.*, dermal coracoid plate; *d.f.*, dorsal fin spine; *d.pl.*, dorsal dermal plate; *fr*, frontal; *l.pl.*, lateral dermal plate; *mx*, maxilla; *n*, nasal; *no*, nostril; *op*, opercular; *pa*, parietal; *pmc*, premaxilla; *pop*, preopercular; *prf*, prefrontal; *pst*, post-temporal; *ptf*, postfrontal; *pto*, pterotic; *q*, quadrate; *r*, radial of pectoral fin; *sc*, scapula; *sc.f.*, scapular foramen; *so*, suborbital; *sec*, supraoccipital; *sep*, subopercular; *st*, supratemporal.

Pipe-Fishes (Lophobranchii of Cuvier), have been shown to be related (A. S. Woodward [505], Swinnerton [431], Starks [419], Gill [164]).

The snout becomes greatly produced by the elongation of the region between the orbit and the mouth; the nostrils remain near



the eye, and the mouth becomes terminal (Figs. 410-13). The maxillae are toothless, and almost or quite excluded from the margin of the gape. The branchial apparatus becomes reduced. The cranial bones remain superficial; the frontals joining the supra-occipital, and separating the parietals when these are present (M'Murich [289]). Ectopterygoids are generally absent. A short eye-muscle canal may be present, but it is usually vestigial or absent. The post-temporal is never typically forked, and is usually fixed to the skull. The supra- and postclavicle are generally absent. A foramen is present in the scapula, or between it and the cleithrum.

The paired fins are often reduced, especially the pelvics, which are abdominal in position. Typical scales are rarely present, being generally represented by rows of scutes of an osseous substance without bone-cells. These scutes may be ankylosed to the endoskeleton, and may form a complete armour in Lophobranchs. Large paired scutes come into secondary connection with the limb-girdles, and are almost always present, firmly fused in the adult to the ventral edge of the coracoids (Figs. 406, 407). It is these bony plates which were formerly supposed to represent 'infraclavicles' (true clavicles), homologous with those of the Chondrostei and Osteolepidoti. Spines are sometimes present in the fins (Gasterosteidae). The canal of the lateral line, the mesentery, and the pyloric caeca are lost as a rule. The gills are reduced to four or less.

Most of the families of the Gasterosteiformes can be traced back to Eocene deposits. The origin of the sub-order is still quite unknown.

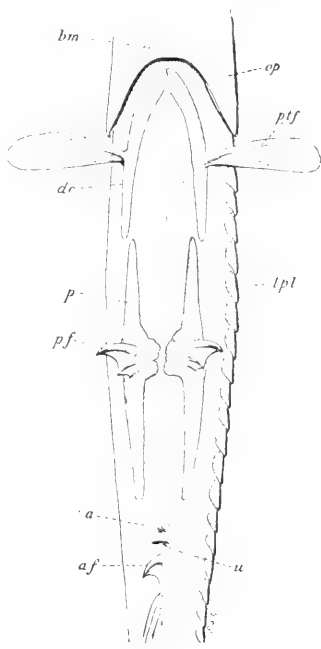

FIG. 407.

Ventral view of the trunk of *Gasterosteus spinachia*, L. *a*, anus; *a.f.*, spine of anal fin; *b.m.*, confluent branchiostegal membranes; *dc*, dermal plate attached to pectoral girdle; *l.pl.*, lateral dermal plates; *op*, operculum; *p*, dermal plate attached to pelvic girdle; *p.f.*, pelvic fin spine; *pt.f.*, pectoral fin; *u*, urimogenital opening.

#### TRIBE I. GASTEROSTEOIDEI (Hemibranchii, in part).

The Sticklebacks are the least modified of this sub-order. The skull is of fairly normal structure, the anterior region not excessively prolonged (Fig. 406). The body is elongated, scaleless, and usually provided with

lateral and dorsal rows of scutes. Large paired scutes are attached to the pelvic as well as to the pectoral girdles (Fig. 407). The pelvic fins

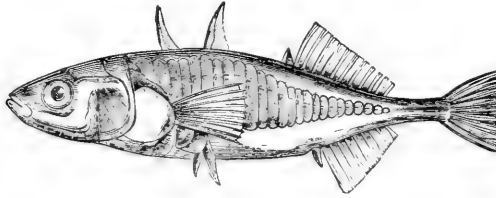

FIG. 408.

*Gasterosteus aculeatus*, L. (After Heckel and Kner, from Claus and Sedgwick.)

have one or two spines, and sometimes one or two jointed dermatrichs. The pectoral radials are quite short (Fig. 406). The anterior region of the dorsal fin is represented by a series of finlets with isolated spines (Fig. 408). The anal fin has an anterior spine.

Family GASTEROSTEIDAE. The ribs are slender and free, and the pelvic fins have not more than two jointed dermatrichs.

(*Gasterosteus*, Art., Sticklebacks (Fig. 408); *Apeltes*, De K.; *Eucalia*, Jord.; *Spinachia*, L.—Northern hemisphere.

Family AULORYNCHIDAE. With a longer and more tubiform snout, an elongated body, and four jointed dermatrichs in the pelvic fin. The ribs are expanded and fixed to the lateral scutes.

*Aulorhynchus*, Gill; N. Pacific.



FIG. 409.

Ankylosed anterior four vertebrae of *Fistularia*. (From Owen, *Anatomy of Vertebrates*, by permission.)

## TRIBE 2. HEMIBRANCHII.

The snout is extremely long and tubiform, the skull consequently much modified, the symplectic and neighbouring bones being much lengthened. The pelvic fins are spineless, with from three to six lepidotrichia. The ribs are reduced or absent, but parapophyses are usually present. This Tribe is distinguished by the specialisation of the anterior vertebrae, four of which generally become enlarged, elongated, and often fused together (Fig. 409).

SUB-TRIBE A. PROTOSYNGNATHOIDEI. Slender free ribs are present, and the anterior vertebrae are slightly elongated. This extinct group is less

specialised than the next.

Family PROTOSYNGNATHIDAE. *Protosyngnathus*, v. d. M.; Tertiary of Sumatra.

SUB-TRIBE B. AULOSTOMOIDEI. The body is very elongate; the occipital condyle becomes distinctly convex, and long ossified ligaments extend

backwards from the epiotic region and the pectoral girdle, somewhat as in the Mugilidae. The pectoral radials are of normal shape and rather large.

Family AULOSTOMATIDAE. The body is covered with small ctenoid scales, and there are isolated dorsal fin spines. The suborbitals are lost, and the palatines united and fused to the skull. Each of the transverse processes is formed from two adjacent vertebrae.

*Aulostoma*, Lac. ; Atlantic ; Eocene, Europe.

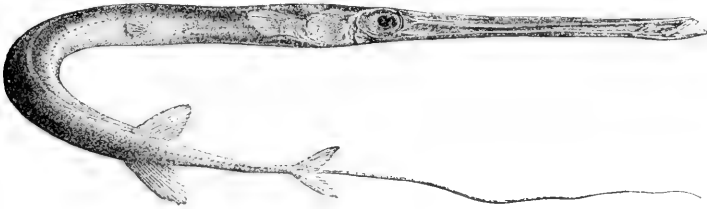

FIG. 410.

*Fistularia serrata*, Cuv. (After Day, *Fishes of India*.)

Family FISTULARIIDAE. The body is quite naked or with vestigial scutes, and without dorsal fin spines. The caudal fin bears a long filament supported by the middle lepidotrichia.

*Fistularia*, L. (Fig. 410) ; tropical Atlantic and Indo-Pacific Oceans ; and Eocene, Europe.

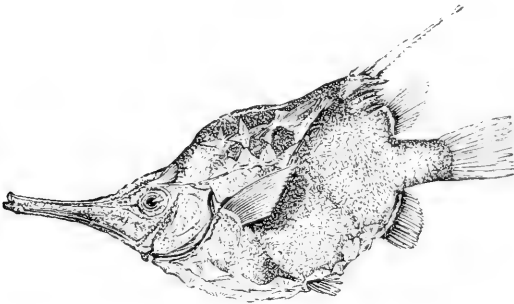

FIG. 411.

*Centriscus humerosus*, Rich. (After Günther.)

SUB-TRIBE C. CENTRISCOIDEI. With a comparatively short compressed body, an anterior dorsal fin with a stout spine, very short pectoral radials, no ribs, no suborbitals, and no teeth.

Family CENTRISCIDAE. The body is covered with rough scales, and scutes, some of which are fused to the neural spines and to the transverse processes of the modified anterior vertebrae.

*Rhamphosus*, Ag. ; Eocene, Italy. *Centriscus*, Cuv. (*Macrorhamphosus*, Lac.) (Fig. 411) ; Atlantic and Pacific.

Family AMPHISILIDAE. Scaleless, but with a complete armour of scutes fixed to the endoskeleton. The tail is shortened and twisted ventrally, the dorsal fin projecting beyond it.

*Amphisile*, Cuv. (Fig. 412); Indo-Pacific Ocean; and Eocene and Oligocene, Europe.

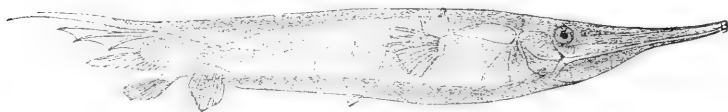

FIG. 412.

*Amphisile scutata*, L. (After Day, *Fishes of India*.)

### TRIBE 3. LOPHOBRANCHII.

Toothless elongate fish, with scutes, very small pectoral radials, no air-bladder, and gill-lamellae in the form of rounded lobes.

SUB-TRIBE A. The anterior division of the dorsal fin is spiny. The pelvic fins of the female coalesce to form an egg-pouch.

Family SOLENOSTOMIDAE. *Solenostomus*, Lac.; Indian and Pacific Oceans.

SUB-TRIBE B. With spineless fins and scaleless body, enclosed in segmental rings of armour formed by overlapping scutes attached to the vertebral

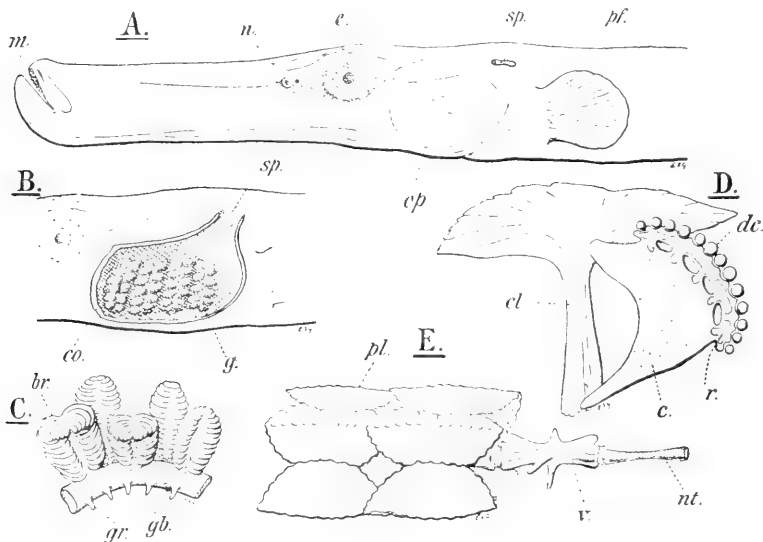

FIG. 413.

*Synnathus acus*, L. A, left-side view of the anterior region; B, the left branchial chamber exposed by the removal of its outer wall; C, enlarged view of a portion of a branchial arch; D, skeleton of the right half of the pectoral girdle and fin, inner view; E, portion of the tail—a caudal vertebra is shown behind, and a portion of the notochord is exposed. *br*, branchial lamella; *c*, coraco-scapular cartilage; *cl*, cleithrum; *c.o.*, cut opercular wall; *d.c.*, distal cartilage supporting lepidotrich; *e*, eye; *g*, gill; *g.b.*, gill-bar; *g.r.*, gill-raker; *m*, mouth; *n*, nostril; *nt*, persistent constricted notochord; *op*, operculum; *pf*, pectoral fin; *pl*, bony dermal plate; *r*, 5th radial; *sp*, opening of branchial chamber; *v*, vertebra.

processes. The pectoral radials are very small, with a row of distal cartilages (Fig. 413, D). The pelvic fins are absent in the adult, though traces of

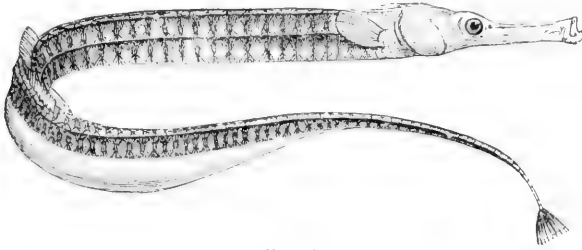

FIG. 414.

*Syngnathus acus*, L., ♂, with subcaudal brood-pouch. (After Günther.)

them appear in the embryo *Nerophis* (Huot [233]). The tail is attenuated with a small fin, or it is prehensile and finless (*Nerophis*, *Hippocampus*). The skeleton is to a great extent cartilaginous, and the notochord largely persistent, though constricted. The visceral skeleton is much reduced, and the four gills are considerably modified. The lamellae have lost their pectinate character, become less numerous, and acquired a rounded shape (Fig. 413, B, C). The branchial openings are narrowed to small apertures dorsally placed (Fig. 413, A). Brood-pouches are generally developed in the male.

Family SYNGNATHIDAE. With a very elongated body. The pectoral fins have been lost in *Nerophis* and *Gastrotoceus*. The latter carries its eggs in a soft abdominal membrane, and *Syngnathus* on its belly without pouch; but in others the eggs are carried in pectoral, abdominal, or subcaudal ventral pouches.

*Syngnathus*, L. (Fig. 414), temperate and tropical seas; and Eocene, Europe. *Siphonostoma*, Kaup., Atlantic; Miocene, Europe. *Calamostoma*, Ag.; *Pseudosyngnathus*, K. and S.; Eocene, Europe. *Nerophis*, Kp.; Atlantic, Indian Ocean.

Family HIPPOCAMPIDAE. The scutes are buttressed, and immovable sideways. The head is bent at right angles to the body, and the tail is curved and prehensile. There is a ventral ovisac. The 'Sea-Horses' are among the most specialised of fish in general structure, and sometimes they are further provided with branching dermal processes simulating seaweed (*Phyllopteryx*).

*Hippocampus*, Leach (Fig. 415); temperate and tropical seas. *Phyllopteryx*, Sw., and *Gastrotoceus*, Kp.; Pacific.

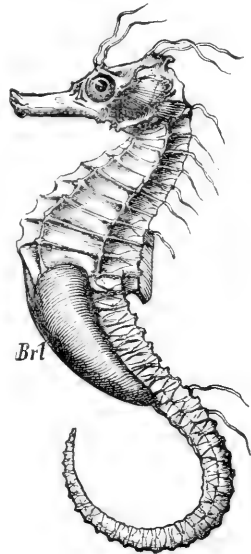

FIG. 415.

Male of *Hippocampus* sp. *Brl*, ventral brood-pouch. (From Claus and Sedgwick.)

TRIBE 4. HYPOSTOMIDES (*Incertae sedis*).

A small group of highly specialised fish the systematic position of which is very uncertain, although they are usually associated with the Lophobranchs.

The body is short and depressed; the head produced into a long snout beyond the mouth, which is small, ventral, and toothless. Rings

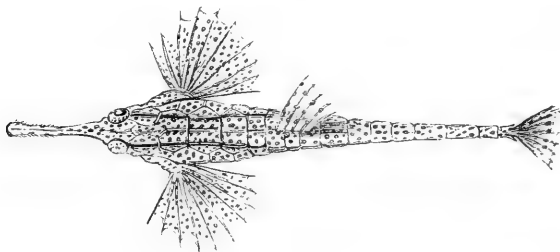

FIG. 416.

*Pegasus natans*, L. (After Günther.)

of scutes cover the body. The gill-opening is very small. The enlarged, horizontal pectoral fins bear five spinous dermatichs. Pelvic fins are represented by a few dermal rays behind the pectoral. There are no ribs, no air-bladder, no symplectic, and no preopercular.

Family PEGASIDAE. *Pegasus*, L. (Fig. 416); Indo-Pacific.

## Series 5.

## Sub-Order 5. NOTACANTHIFORMES (Heteromi).

This is a group of highly specialised, mostly deep-sea fish, of somewhat doubtful affinity, to which have been added the extinct Dercetidae. In the modern forms the caudal region is relatively long, with a tapering extremity from which the caudal fin has disappeared. A snout is usually present (especially in the Halosauridae and Notacanthidae). The pelvic fins are abdominal, and the median fins may be spiny. The duct of the air-bladder is closed. The parietals meet in a median suture, and the pectoral girdle is joined to the skull by a reduced simple post-temporal, attached to the supraoccipital, or by a mere ligament. When present, the scales cover the head as well as the body.

This sub-order was founded by Boulenger [42] to include the *Lyopomi* and *Heteromi* of Gill, highly specialised deep-sea fish, and a few other doubtfully related genera.

## DIVISION 1.

There are separate dorsal, anal, and caudal fins.

Family DERCEIIDAE. An extinct family of fish with elongate body, extended dorsal and short anal fin, seven or eight dermal rays in the pelvic fin, and no spines. The scales are vestigial, either very small or absent; but a row of large scutes extends along each side. There is a snout, a large mouth bordered by the premaxillae, and small teeth. These Cretaceous fossils possibly represent a stage in phylogeny before the caudal fin was lost.

*Dercetis*, Ag.; Europe. *Leptotrachelus*, van der M.; Europe and Asia. *Pelargorhynchus*, van der M.; *Stratodus*, Cope—North America.

## DIVISION 2.

The tail is pointed, and the caudal fin has been lost, while the anal has become very long. The pectoral fins are generally inserted high up, especially in the Notacanthidae and Halosauridae.

## TRIBE 1.

There are cycloid scales, and the anus is normally situated.

Family HALOSAURIDAE. The border of the small mouth is formed by the premaxillae and maxillae, both provided with minute teeth. The preopercular is vestigial. All the dermal rays are soft, the dorsal fin is short. A canal for the notochord pierces the centra. The ova are shed freely into the coelom. *Halosauropsis* has phosphorescent organs along a series of enlarged lateral scales.

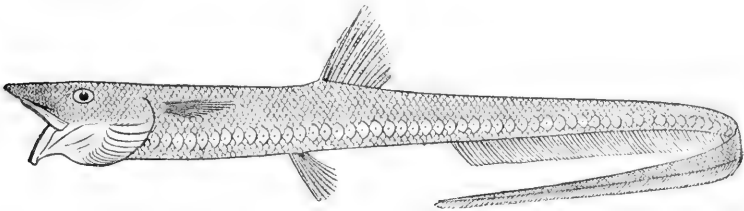

FIG. 417.

*Halosauropsis nigerrimus*, showing the phosphorescent organs lodged in the large scales of the lateral line. (After Alcock, *Naturalist in Indian Seas*.)

*Echidnocephalus*, van der M.; *Enchelurus*, van der M.—Cretaceous, Europe and Mount Lebanon. *Halosaurus*, Johnson; *Halosauropsis*, Coll.—deep-sea (Fig. 417).

Family LIPOGENYIDAE. The genus *Lipogenys* differs from the preceding family chiefly in the possession of spines in the anal fin and three spines in the pelvic fin, and in the modification of the mouth, which is small, suctorial, and ventral. The jaws are toothless and specialised. Small scales cover the body.

*Lipogenys*, G. and B.; North Atlantic (Fig. 418).

Family NOTACANTHIDAE. The dorsal fin is represented by a series of separate spines. Spines are also found in the anal and pelvic fins.

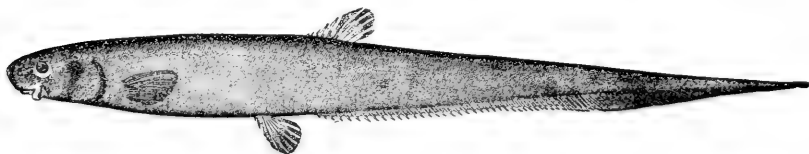

FIG. 418.

*Lipogenys Gillii*, G. and B. (From Jordan and Evermann.)

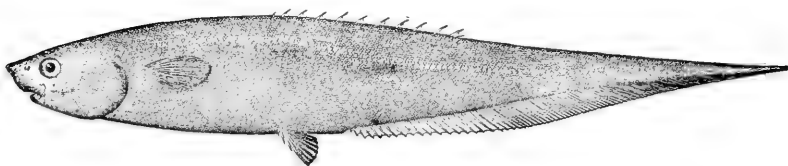

FIG. 419.

*Notacanthus analis*, Gill. (From Jordan and Evermann.)

The premaxillae alone enter the margin of the small inferior mouth. The suborbitals and post-temporal have been lost.

*Notacanthus*, Bl. ; depths of the Mediterranean, Atlantic, and Pacific (Fig. 419).

#### TRIBE 2.

Scaleless fish, with the anus near the head ; a situation which may be related to their habit of living inside other animals, such as Bivalves and Holothurians.

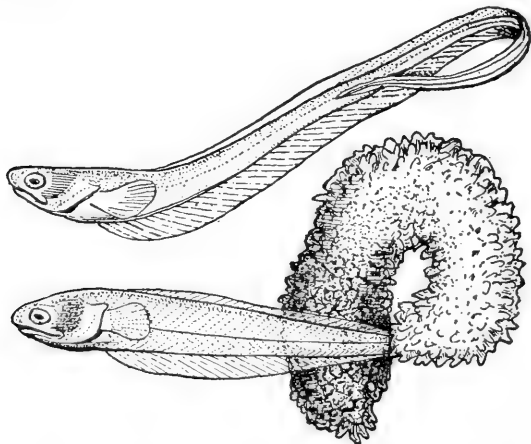

FIG. 420.

*Fierasfer acus*, Kaup; one specimen emerging from a holothurian. (After Emery, from Dean.)



Family FIERASFERIDAE. The dorsal fin is elongated like the anal. Only the premaxillae border the small inferior mouth. Special muscles are developed for dilating the front end of the air-bladder. Neither pelvic fins, nor spines, nor pyloric caeca, nor suborbitals are present. There are exoccipital paired condyles, not found in other Notacanthiformes (Emery [131]). Possibly belonging to the Zoarcidae.

*Fierasfer*, Cuv.; widely distributed (Fig. 420).

### Series 6.

In these fish the air-bladder loses its open communication with the gut, except in the Stephanoberycidae and some of the lowest Acanthopterygians (p. 426); the toothless maxilla is usually completely excluded from the margin of the mouth; the supraoccipital meets the frontals so as to separate the parietals; and several anterior dermal rays of the dorsal and of the anal fin, and the front dermal ray of the pelvic fins, as a rule, become converted into jointless spines (p. 424).

### Sub-Order 6. MUGILIFORMES (Percesoces).

The families included in this sub-order form an assemblage of very doubtful phylogenetic value (Starks [418]). They are not bound together by any very distinctive characteristics, and most of those modifications which do occur—such as the development of spines, and the moving forward of the pelvic girdle, which may become joined to the pectoral girdle by ligament—are approximations to the Acanthopterygian type of structure. Again, the constant presence of one spine and five (or not more than five) jointed dermatrichs in the pelvic fins, except in the Ophiocephalidae and aberrant Icosteidae, strongly suggests affinity with the Perciformes. As a rule, scales completely cover the head. The Mugiliformes are not known for certain to occur below the Eocene strata.

### TRIBE 1.

With two separate dorsal fins, the anterior with spines. Except in the Sphyraenidae, the pelvic bones are attached by ligament to the symphysis of the cleithra, and ribs are borne by strong parapophyses.

SUB-TRIBE A. Family SPHYRAENIDAE. With free pelvic bones, and sessile anterior ribs. The large mouth is armed with formidable teeth. With cycloid scales.

*Sphyraena*, Bl., Sch.; warm seas; Eocene, Europe and N. America.

SUB-TRIBE B. Family ATHERINIDAE. The pelvic bones are connected by ligament to the cleithra. The pectoral fins are inserted high up. With cycloid or ctenoid scales.

*Atherina*, L. ; Atlantic, Mediterranean ; Eocene, Europe. *Rhamphognathus*, Ag. ; Eocene, Europe. *Chirostoma*, Sw. ; *Labidesthes*, Cope ; *Menidia*, J. and G.—America.

SUB-TRIBE C. Closely related families distinguished by a strange modification of the girdles : the pelvic bones are not attached to the cleithra,

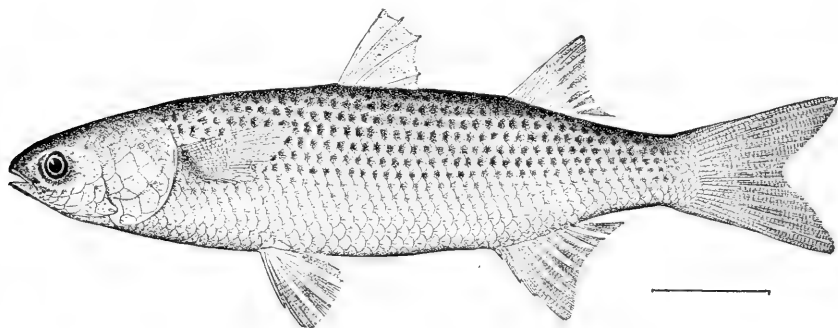

FIG. 421.

*Mugil cephalus*, L. (From Jordan and Evermann.)

but are firmly connected with, and supported by, the postclavicles, a very peculiar modification paralleled only in the Centriscidae.

FAMILY MUGILIDAE. The Mulletts are distinguished by the possession of a very perfect filtering apparatus on the gill-arches, formed by the gill-rakers ; and peculiarly modified pharyngeals. The oesophagus has long

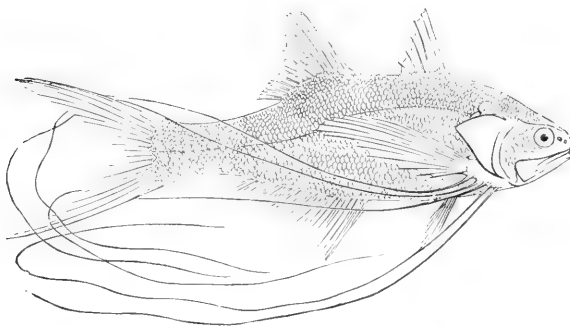

FIG. 422.

*Pentanemus quinquarius*, L. (After Günther.)

thin internal papillae, and there is a muscular gizzard-like stomach. The scales are cycloid, and the pectoral fins are inserted high up.

*Mugil*, L. (Fig. 421), Grey Mulletts ; wide range ; Oligocene, Europe. *Myzus*, Gthr. ; *Anostomus*, Gron. ; *Joturus*, Poey.

FAMILY POLYNEMIDAE. The scales are ctenoid, and the pectoral fins are low down. The pectoral fin radials appear to have fused with the

scapula to form a ventral prolongation, supporting a fascicle of filamentous dermal rays separate from the main fin (Fig. 422); a highly specialised condition.

*Pentanemus*, Art. ; *Polymemus*, L. ; *Galeoides*, Gthr.—tropical seas.

### TRIBE 2.

With one dorsal fin, of which the front portion may be spinous. The anterior vertebrae without parapophyses and with sessile ribs.

SUB-TRIBE A. The dentition is very feeble; the pseudobranch is provided with a row of gill-rakers; and the oesophagus has two lateral pouches beset with internal papillae.

Family TETRAGONURIDAE. With a pair of lateral keels near the end of the tail; specialised rhomboidal scales set in obliquely transverse rows, in each of which the scales are connected together; and with free pelvic girdle. The air-bladder is lost.

*Tetragonurus*, Risso; warm seas.

Family STROMATEIDAE. These are closely related to the preceding; but they have cycloid scales, the pelvic bones may be attached by ligament to the cleithra; and the body becomes very deep and compressed, much as in *Lampris*. The air-bladder and the pelvic fins may be lost.

*Nomeus* has enormous pelvic fins, which fold in ventral grooves.

*Platycormus*, V. D. M.; *Homosoma*, Eocene. *Nomeus*, Cuv.; *Cubiceps*, Lowe; *Stromateus*, Art.; *Centrolophus*, Lac.

SUB-TRIBE B. Family ICOSTEIDAE. Although lacking both spines and oesophageal pouches, the aberrant Rag-Fish are probably allied to the Tetragonuridae, which they resemble in the possession of gill-rakers near the pseudobranch. The vertebrae have increased in number (70); the scales when present are cycloid, and the pelvic bones are free.

*Icosteus*, Lock; *Icichthys*, J. and G.; *Acrotus*, Bean—Pacific American coast.

### TRIBE 3.

The head is covered with large scales; there are generally parapophyses bearing the ribs; and a distinguishing character is the

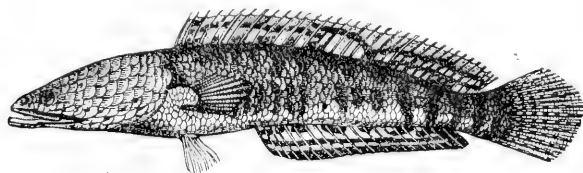

FIG. 422.

*Ophioccephalus striatus*, India. (After Günther.)

possession of an accessory suprbranchial chamber. The branchiostegal membranes are confluent below the isthmus. The pelvic bones are joined by ligament to the cleithra.

SUB-TRIBE A. Without spines, and with pelvic bones some way behind the cleithra.

Family OPHIOCEPHALIDAE. With large suprabranchial cavities, into which project vascular folds from the wall (Fig. 424). Cycloid scales. *Channa* has lost the pelvic fins.

*Ophiocephalus*, Bl. (Fig. 423); Asia. *Channa*, Grom.; Africa.

SUB-TRIBE B. LABYRINTHICI. With ctenoid scales, and a more or less spiny border to the opercular bones; the pelvic bones quite near the cleithra; and the broad intergular membrane covered with large scales.

Into the suprabranchial chamber project thin vascular lamellae supported by bone from the first branchial arch (Fig. 425) (Henninger [209], Cuvier [95], Zograff [514], Day [101]). Spines occur on the anal and dorsal fins. The body is broad and compressed.

Family ANABANTIDAE. The vascular lamellae are most elaborate, the pelvic girdle only loosely attached; the pelvic fins have a

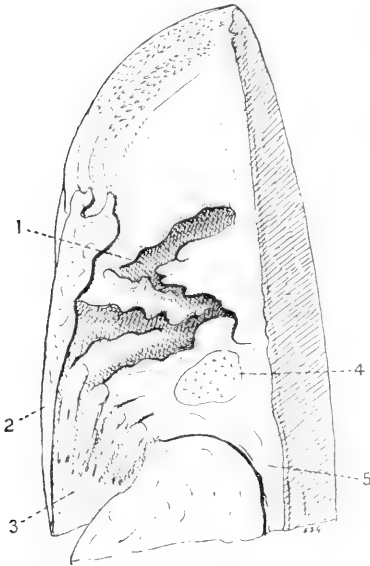

FIG. 424.

Ventral view of left half of head of *Ophiocephalus striatus*, Bl., from which the lower jaw, etc., have been cut away to expose the gullet and the branchial cavities. 1, accessory branchial cavity into which project respiratory folds; 2, operculum; 3, branchial cavity; 4, toothed superior pharyngeal plate; 5, oesophagus.

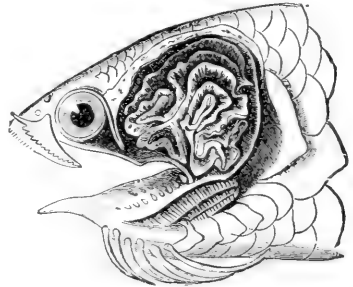

FIG. 425.

Head of *Anabas scandens*, Dald. (After Cuvier, from Sedgwick's *Zoology*.) The operculum has been removed to show the excavated superior pharyngeal (pharyngobranchials).

spinous and five soft dermal rays, and the cranial bones have a smooth surface forming a complete covering to the head and cheeks. The preopercular is movable, and said to be used in climbing.

*Anabas*, Cuv.; E. Indies, Africa.

Family OSPHROMENIDAE. The cranial bones are more irregularly sunk; and the pelvic bones point upwards to the cleithra, with which they are closely bound. The pelvic fins are modified; the outer dermo-trich being excessively long and jointed, while the others become reduced (Fig. 426). The anal fin reaches far forwards.

*Helostoma*, K. and H.; *Betta*, Blk.; *Osphromenus*, Com.; *Trichogaster*,

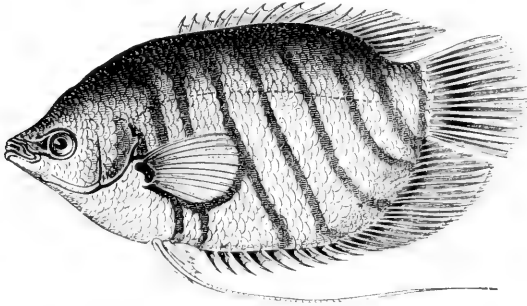

FIG. 426.

*Oosphromenus olfax*, Comm. (After Günther.)

Schn.—E. Indies. *Micracanthus*, Sauv. ; Africa. *Luciocephalus*, Blk. ; *Polyacanthus*, K. and H.

#### TRIBE 4.

Family CHIASMODONTIDAE. Of very doubtful relationship are these voracious deep-sea fish. The skeleton resembles that of the Atherinidae, but the operculum is reduced. The scales are small or absent.

*Chiasmodon*, Johns. ; *Pseudoscopelus*, Gthr. ; *Champsodon*, Gthr.

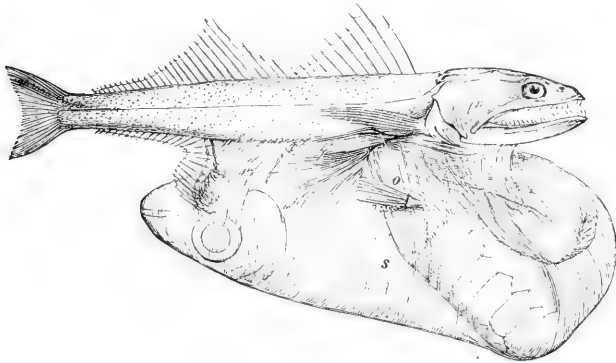

FIG. 427.

*Chiasmodon niger*, Johns. ; obtained in the North Atlantic at a depth of 1500 fathoms ; the specimen has swallowed a large *Scopelus* (s) ; o, pelvic fin. (After Günther.)

#### TRIBE 5.

Family STEPHANOBERYCIDAE. The affinities of this family are yet more uncertain. The pneumatic duct remains open ; the median fins are spineless ; the pelvic fins are abdominal, and provided with 1 spine

and 5 jointed dermal rays; but the cranial bones are spiny, the scales sometimes ctenoid (*Stephanoberyx*), and sometimes cycloid (*Malacosarcus*).  
*Stephanoberyx*, Gill; *Malacosarcus*, deep-seas (Fig. 428).

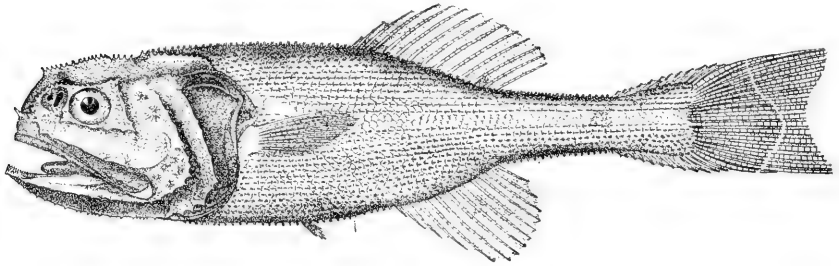

FIG. 428.

*Stephanoberyx monacae*, Gill. (From Jordan and Evermann.)

#### Sub-Order 7. ACANTHOPTERYGII.

The cranial dermal bones are mostly deeply sunk and often covered over with scales (Fig. 434A). The parietals are separated by the supraoccipital in the middle line, with rare exceptions apparently due to secondary growth (*Scorpaenidae*, *Cottidae*, *Trig-*

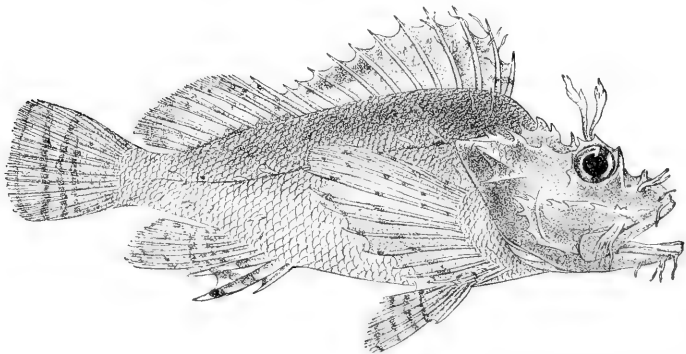

FIG. 429.

*Scorpaenopsis rosea*, Day. (After Day, *Fishes of India*.)

*lidae*, and *Zeidae* (Ridewood [362]). The toothless maxilla is almost or completely excluded from the margin of the mouth (Fig. 456). The scales are ctenoid, and spines are generally developed on the median and paired fins, and spiny processes on the opercular bones (Fig. 429); the fin-spines show no sign of segmentation, unlike those of the Ostariophysi they are rigid to the extreme tip (Vaillant). Perhaps the most remarkable and constant characteristic of the

sub-order is the fact that the pelvic fins are always very far forward. Except in the Salmopercae, the pelvic bones are attached to the cleithra, and the pelvic fins are 'thoracic' or 'jugular,' with usually much less than eighteen dermal rays. Excepting in a few of the lowest genera, the pneumatic duct is closed. Among more primitive characters may be mentioned a continuous dorsal fin, the presence of a toothed palate, an eye-muscle canal, a scapular foramen, both pleural ribs and epipleurals attached to them, and four complete gills with five branchial slits. All these characters, however, are liable to great modification in the more specialised families, and it is in this sub-order that the Teleostei attain their highest development.

Extremely numerous and diversified at the present time, the Acanthopterygii make their appearance only in the Cretaceous epoch. They may be classed in two Divisions, to the second of which most of the modern forms seem to belong.

#### Division 1. SALMOPERCAE.

The pelvic fins are, strictly speaking, abdominal, not being closely attached to the cleithral symphysis.

Family PERCOPSIDAE. An interesting intermediate family of distinctly perch-like structure; but the pelvic fins are not attached to the

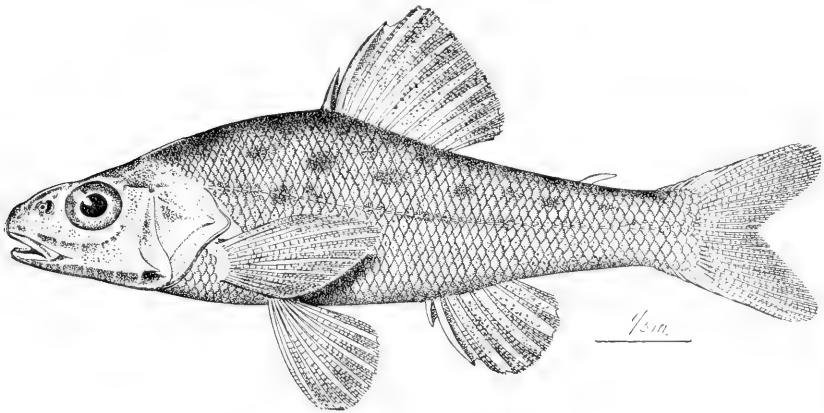

FIG. 430.

*Columbia transmontana*, Eig. (From Jordan and Evermann.)

pectoral girdle, although close to it, and there is an adipose fin. The scales are strongly ctenoid, and do not cover the head. The air-bladder has an open duct. The bones of the skull have large mucous cavities. The myodome and epipleurals are absent. One radial rests on the

coracoid. Spines occur in the dorsal and anal, but not in the pelvic fin, which has 9 jointed lepidotrichs.

*Percopsis*, A. G. ; *Columbia*, Eig. (Fig. 430) ; N. America.

### Division 2.

The pelvic fins are thoracic or jugular, closely attached to the pectoral girdle. The pneumatic duct may remain open in a few Berycidae, Serranidae, and Sparidae, but disappears in the others.

The Division may be classified into six Subdivisions, chiefly according to the structure of the fins and girdles.

### Subdivision 1.

The pelvic fins are thoracic. A perforate scapula and a coracoid are present, only one or two of the pectoral radials being articulated to the latter. Except in a few cases, there is an eye-muscle canal.

### TRIBE 1. BERYCIFORMES.

The pelvic fins are thoracic, with one spine, and usually many dermal rays. The dorsal and anal fins are spiny, the teeth small, villiform.

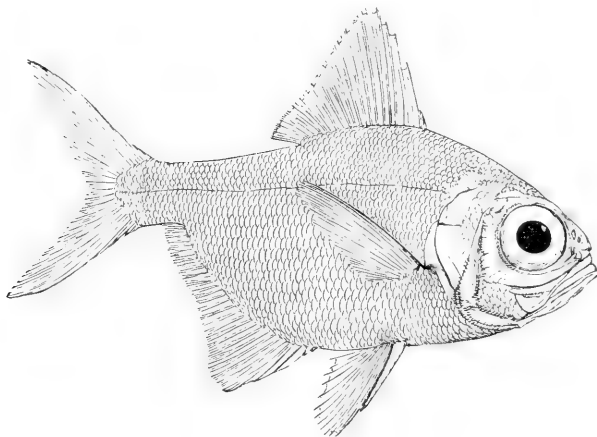

FIG. 431.

*Beryx deculaetylus*, C. and V. (After Günther.)

Family BERYCIDAE. This the most ancient family of the Acanthopterygii persists at the present day, and is distinguished by the possession of from six to thirteen soft rays on the pelvic fins. The jaws are protractile ; the myodome and subocular shelf of the suborbitals are present.



The Berycidae preserve the orbitosphenoid, as well as the alisphenoid and basisphenoid (Starks [421]).

*Hoplopteryx*, Ag. (*Beryx*) (Fig. 432); *Sphenocephalus*, Ag.—Cretaceous, Europe. *Acrogaster*, Ag.; *Hoplopteryx*, Ag.—Cretaceous, Europe and Mt.

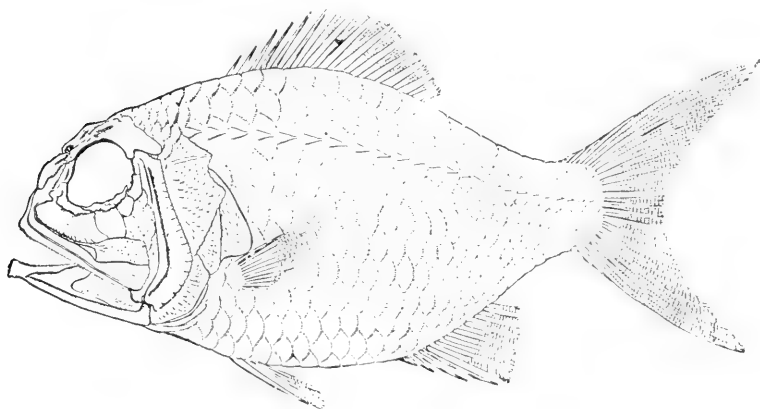

FIG. 432.

Restoration of *Hoplopteryx lewesiensis*, Mantell; from the English Chalk.  
(After A. S. Woodward, from *Brit. Mus. Guide*.)

Lebanon. *Dinopteryx*, A. S. W.; Cretaceous, Mt. Lebanon. *Myripristis*, Cuv.; *Holocentrum*, Cuv.—tropical seas; and Eocene, Europe. *Beryx*, Cuv. (Fig. 431); *Gephyroberyx*, Blgr.; *Polynixia*, Lowe; *Plectromus*, Gill; *Caulolepis*, Gill; *Trachichthys*, Shaw—tropical seas.

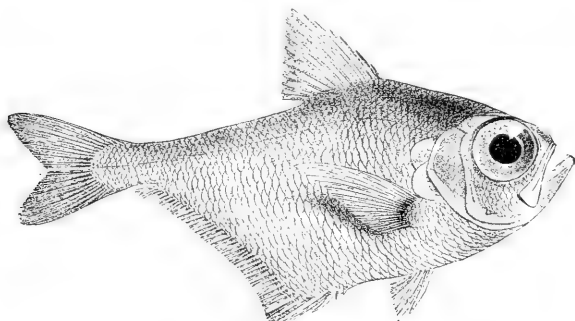

FIG. 433.

*Pempheris russelli*, Day. (After Day, *Fishes of India*.)

Family APHREDODERIDAE. Perhaps allied to the last, but with non-protractile jaws, and the anus very far forwards. They have no myodome, no orbitosphenoid, and no subocular shelf.

*Aphredoderus*, Les.; North America. *Asineops*, Cope; Eocene, North America.

Family PEMIPHERIDAE. The soft pelvic rays are reduced to five. *Bathyclupea* preserves the open pneumatic duct, has no median spines, and has subjugular pelvic fins. The family's systematic position is very doubtful.

*Pempheris*, C. and V. (Fig. 433); *Bathyclupea*, Alc.; *Parapriacanthus*, Steind.—tropical seas.

Family MONOCENTRIDAE. The snout is very obtuse, the ribs are lost

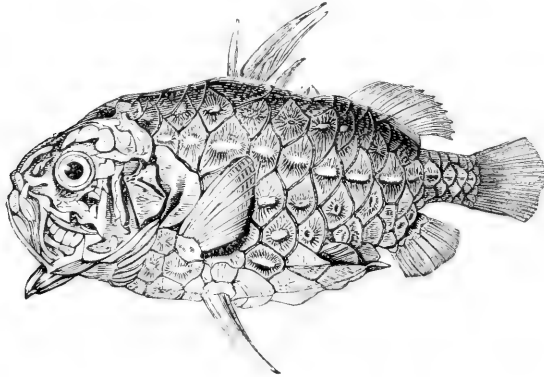

FIG. 434.

*Monocentris japonicus*, Htt. (After Günther.)

on the first half-dozen vertebrae, only two or three soft dermal rays remain on the pelvic fin, and the scales are closely set in a rigid armour.

*Monocentris*, Sch. (Fig. 434); Indo-Pacific.

### Subdivision 2.

This is founded chiefly on the structure of the pelvic fins. If the persistent occurrence of one spine and not more than five jointed 'soft' dermal rays in these fins is of any phylogenetic significance, all or some of these families must have been derived from a common ancestor which branched off from the Beryciform stock.

### TRIBE 1. PERCIFORMES.

Spines are usually well developed, and the pelvic fins are thoracic and provided with one spine and four or five jointed rays. The subocular shelf is not always present; it is an ingrowth, from one or more of the suborbitals, supporting the eyeball (Fig. 436, B). The pectoral radials are generally flattened and expanded at each end. It is scarcely possible as yet to attempt to group phylogenetically the numerous families included in this Tribe.

SUB-TRIBE A. I. With a subocular shelf (Fig. 436, B).

Family SPARIDAE. The Sea-Breams, are deep-bodied fish, with a

continuous dorsal fin and from five to seven branchiostegals. The palate is usually toothless; but the teeth on the jaws become very powerful, those in front being modified as incisors and those farther back as flat grinders (Fig. 435). Rarely hermaphrodite (*Chrysophrys*).

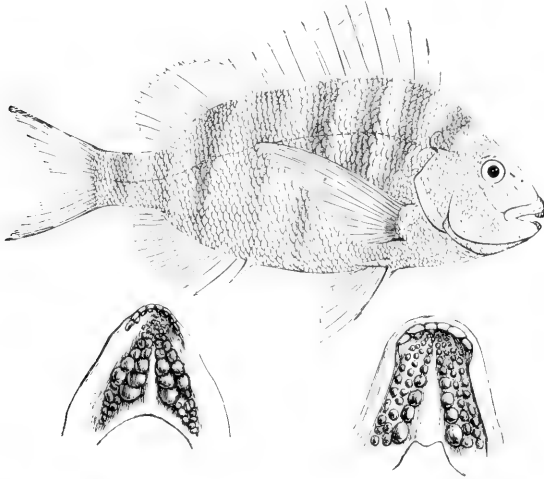

Fig. 434A.

*Sargus oris*, Mitch., the Sheep's-head. Right-side view and dentition. (After Gunther.)

*Sparnodus*, Ag.; *Trigonodon*, Sism.—Eocene, Europe. *Sargus*, Cuv. (Fig. 434A); *Sparus*, Kl.; *Pagrus*, Cuv.; *Pagellus*, C. and V.—widely distributed, and Miocene. *Dentex*, Cuv.; *Cuesio*, Com.; *Bor*, Cuv.; *Chrysophrys*, Cuv.

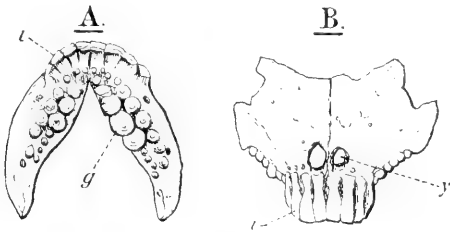

FIG. 435.

A, dorsal view of the lower jaw of *Sargus rufescens*, C. and V. (After Owen.) B, front view of the upper jaw of *Sargus retula*, C. and V. (After Owen.) *i*, incisiform teeth; *g*, grinding teeth; *y*, young teeth.

Family MULLIDAE. Closely related to the preceding; but with a feeble dentition, only four branchiostegals, and with two scapular foramina. The dorsal is subdivided.

*Upeneoides*, Blk.; *Mullus*, L., Red Mullet; *Mulloides*, Blk.; *Upeneus*, C. and V.; widely distributed in warm seas.

Family SERRANIDAE. Very like the Sparidae; but usually with a toothed palate, and sometimes with the lower pharyngeals united

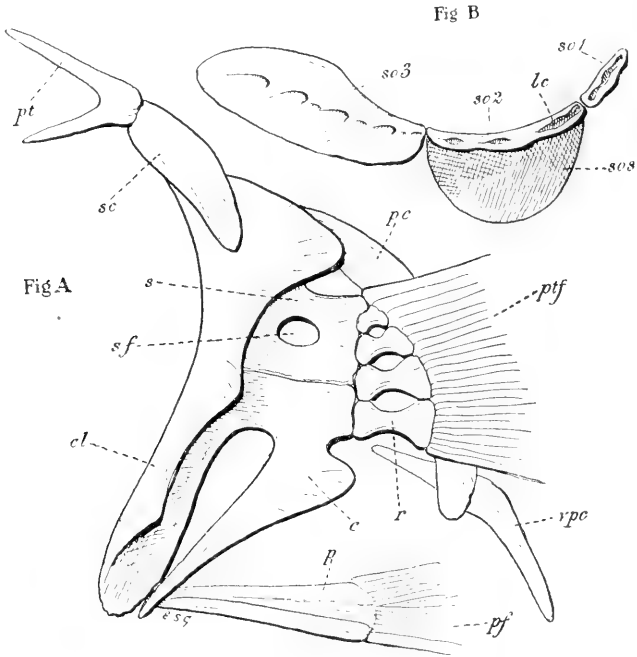

FIG. 436.

A, left half of the pectoral girdle, left pectoral fin, and pelvic girdle of *Serranus cobrilla*, L. B, suborbitals of the same, showing the subocular shelf, enlarged. c, coracoid; cl, cleithrum; lc, lateral line suborbital canal; p, right pelvic bone; pc, postclavicle; p.f, left pelvic fin; p.t, post-temporal; pt.f, pectoral fin; r, radial; s, scapula; sc, supraclavicle; s.f, scapular foramen; sc1-3, suborbitals; so.s, suborbital shelf; v.pc, ventral postclavicle.

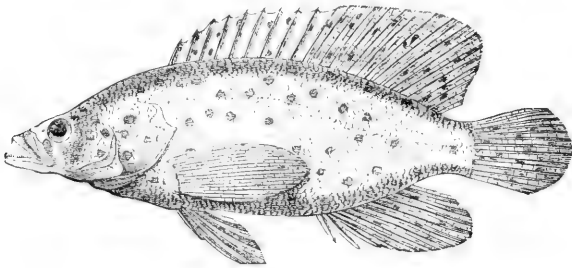

FIG. 437.

*Serranus altivelis*, C. and V. (After Günther.)

(Centrogenys). The spinous dorsal may be separate. Often hermaphrodite. The male *Chilodipterus* and *Apogon* carry the developing eggs in their mouth.

*Prolates*, Prieny. ; Upper Cretaceous, France. *Morone*, Mitch. ; *Serranus*, Cuv. (Fig. 437) ; *Percichthys*, Ger. ; *Anthias*, Schn. ; *Apogon*, Lac. (Fig. 438)—of wide distribution, and Eocene. *Grammistes*, Art. ; *Priacanthus*, C. and V. ; *Centropomus*, Lac. ; *Pomatomus*, Risso ; *Ambassis*,

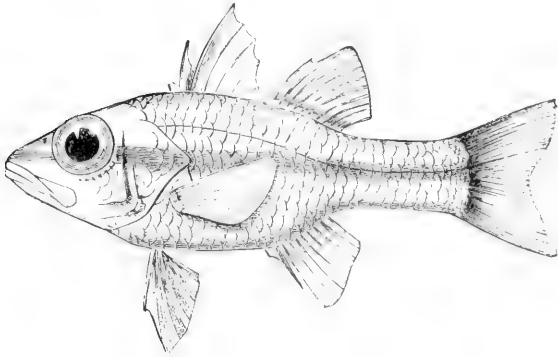

FIG. 438.

*Apogon frenatus*, Val. (After Günther.)

Com. ; *Chilodipterus*, Lac. ; *Cirrhitus*, Lac. ; *Pentaceros*, C. and V. ; *Mesoprion*, Cuv. ; *Centrogeus*, Rich.

Family SCIAENIDAE. With a separate spinous dorsal fin ; the lower pharyngeals often united ; and very large slime-cavities in the cranial bones. The palate is usually toothless, and the large air-bladder often has many diverticula.

*Pogonias*, Cope ; Atlantic ; Miocene, N. America. *Umbrina*, Lawley ; widely distributed, and Lower Pliocene, Italy. *Arripis*, Jen. ; *Sciaena*, Art. ; *Ancylodon*, C. and V. ; *Eques*, Bl. ; *Otolithus*, Cuv.

Family PSEUDOCHROMIDIDAE. Differing from the Sciaenidae chiefly in the feeble development of the spines on the lengthened dorsal and anal fins.

*Pseudochromis*, Rüpp. ; *Cichlops*, M. and T. ; *Lopholatilus*, G. and B., Tile-Fish ; *Opisthognathus*, Cuv. ; *Latilus*, C. and V. ; *Bathymaster*, Cope—widely distributed, marine.

Family CEPOLIDAE. Like the preceding ; but with a very elongated tail, and dorsal and anal fins. Only a few feeble spines.

*Cepola*, L. ; *Acanthocephala*, Blk.—widely distributed.

Family HOPLOGNATHIDAE. Differing from the Serranidae in having a toothless palate, and the teeth of the jaws fused to a strong beak.

*Hoplognathus*, Rich. ; Pacific (Fig. 439).



FIG. 439.

Dentition of *Hoplognathus* sp.  
(After Günther.)

Family SILLAGINIDAE. With a toothed palate, but a separate spinous dorsal and elongate soft dorsal and anal.

*Sillago*, Cuv. ; Indo-Pacific.

INCERTAE SEDIS.

Family ANOMALOPIDAE. Two genera of deep-sea Perciform fish may be provisionally placed here ; their osteology is still unknown. They are remarkable for the possession of a large movable phosphorescent organ below the eye ; it can be turned outwards when lit up and in use, and turned back into the orbit when extinguished.

*Anomalops*, Kner (*Heterophthalmus*, Bleeker) ; *Photoblepharon*, Weber ; S. Pacific.

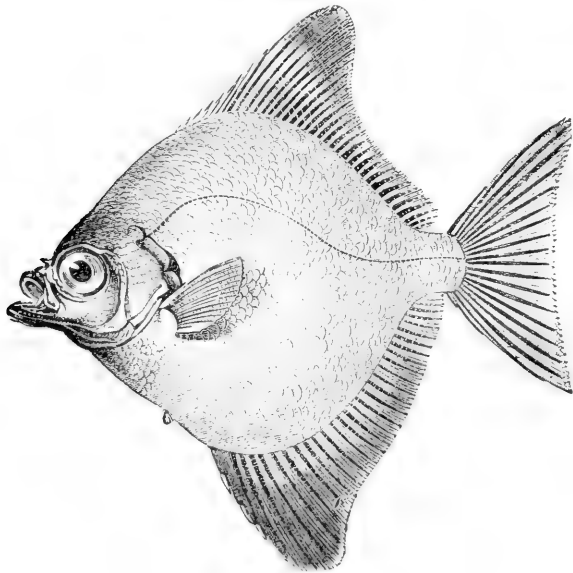

FIG. 440.

*Psettus argenteus*, L. (From Günther.)

SUB-TRIBE A. II. With a subocular lamina. The body tends to acquire a very flattened rhombic shape, with the elongated dorsal and anal fins along the hinder edges. The pelvics become vestigial. The mouth becomes very protractile, and the teeth very small, villiform.

Family SCORPIDIDAE. The post-temporal is normal.

*Aipichthys*, Stein. ; Cretaceous, Europe (?). *Scorpis*, C. and V. ; *Atypichthys*, Gthr. ; *Atyposoma*, Blgr. ; *Psettus*, Com. (Fig. 440)—Indo-Pacific.

Family CAPROIDAE. The post-temporal is fused to the skull. The mouth is very protractile. They clearly approach the Chaetodontidae in structure, and perhaps should be placed in the next sub-tribe.

*Protantigonia*, Kr. ; Miocene, Europe. *Antigonia*, Lowe ; tropical seas. *Cupros*, Lac. (Fig. 441) ; Atlantic, Mediterranean.

SUB-TRIBE B. CHAETODONTIFORMES. The following are some of the chief characters which appear in this sub-tribe : the jaws become

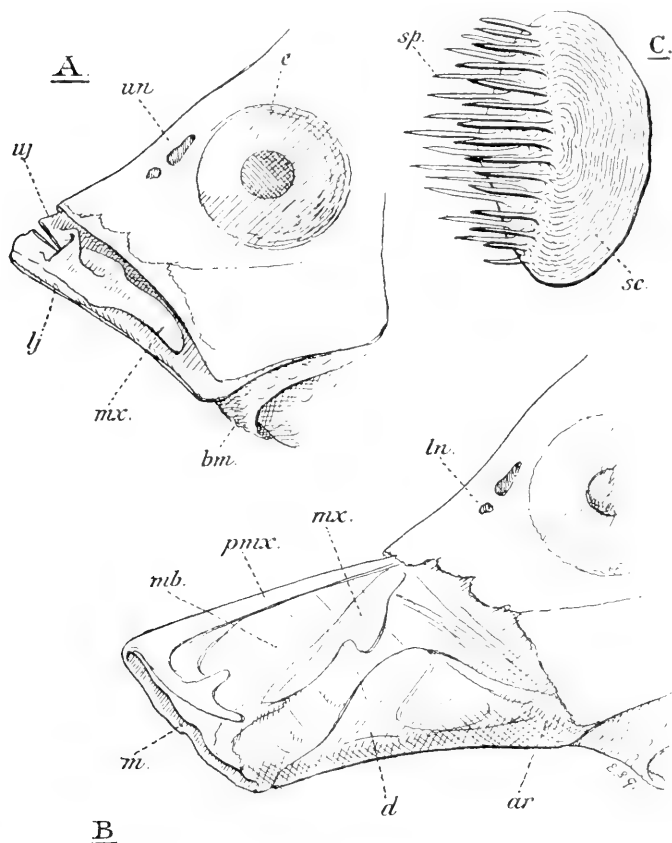

FIG. 441.

*Cupros aper*, L. A, head with jaws retracted. B, head with jaws protracted. C, scale, enlarged. *ar*, articular ; *b.m.*, confluent branchiostegal membranes ; *d*, dentary ; *e*, eye ; *l.j.*, lower jaw ; *ln.*, anterior nostril ; *m.*, mouth ; *mb.*, membrane ; *mx.*, maxilla ; *pmx.*, premaxilla ; *sc.*, anterior smooth region ; *sp.*, spines on posterior exposed region ; *u.j.*, upper jaw ; *u.n.*, posterior nostril.

shortened, the mouth small, the palate toothless, the gill-membranes confluent below ; the post-temporal becomes firmly fixed to the skull, losing its forked character ; the pelvic bones meet, and tend to fuse in the middle line ; the pelvic fins acquire a jugular position ; the scales become modified into plates or prominent spines ; the intestine becomes long and coiled ; the vertebrae are reduced to never more than twenty-five in

number. The head is more or less completely covered with the scale-bearing skin. Among the Chaetodontiformes are some of the most specialised of Teleostean fish; they diverge greatly from the Perciform stock from which they appear to have arisen.



FIG. 442.

Skull of *Ephippus faber*, Br. *a*, enlargement of frontal, and *b*, of supraoccipital; *c*, interorbital septum; *d*, basis cranii. (After Günther.)

*Platax*, C. and V. (Fig. 444)—tropical seas; Eocene, Europe. *Chelmo*, Cuv.; *Parapsettus*, Stnd.

**DIVISION A. SQUAMMPENNES.** These still preserve many of the primitive characters: there are a subocular shelf, ctenoid scales, four gills, paired and median fins with spines, and well-developed pleural ribs. The body-scales extend between or over the dermal rays of the median fins. They are probably more closely related to Sub-Tribe B than to any other Perciformes.

**Family CHAETODONTIDAE.** The body becomes very compressed and deep, the mouth produced forward, the 'face' more vertical, and a very high supraoccipital crest is continued at the sides into the pterotic crest; it is enormously enlarged in *Ephippus* (Fig. 442); the minute setiform teeth are set in bands. The opercular bones may be armed with spines; in *Holacanthus* there is a prominent preopercular spine.

*Chaetodon*, Art. (Fig. 443); *Holacanthus*, Lac.; *Pomacanthus*, Lac.; *Ephippus*, Cuv.;

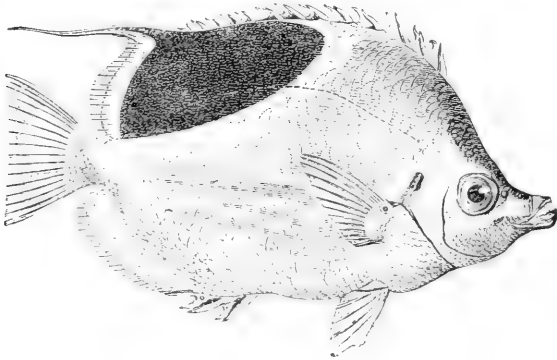

FIG. 443.

*Chaetodon ephippium*, C. and V. (After Günther.)

**Family DREPANIDAE.** Very like the last, but having lost the subocular shelf, and with very long specialised pectoral fins.

*Drepane*, C. and V.; Indian Ocean.



**DIVISION B. PLECTOGNATHI.** Here the maxilla becomes fixed to, and generally fused with, the premaxilla; the jaws become short and stout, and the upper jaw does not slide forwards, but becomes hinged on the ethmoid so as to bite up and down (Fig. 453). The subocular shelf is lost; the post-temporal loses its lower branches and fuses with the supratemporal. The pelvic bones become firmly united, narrow, and elongated. The gill-membranes fuse with the isthmus, and the branchial opening becomes restricted.

**SUBDIVISION A. Family TEUTHIDIDAE.** The body is compressed, the tail armed with movable lateral spines fitting in a groove, the dorsal and anal fins with many spines, the small jaws provided with a single row of

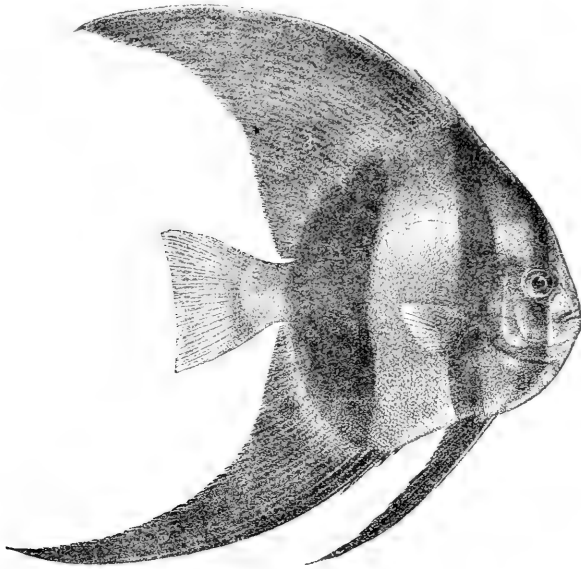

FIG. 444.

*Platax teira*, Forsk. (After Day, *Fishes of India*.)

incisiform teeth, the palate toothless, the gill-membranes attached. The post-temporal is still forked.

*Teuthis*, L. (Fig. 445); Indo-Pacific. *Archaeoteuthis*, Wettst.; Eocene, Europe.

**Family SIGANIDAE.** The post-temporal is not rigidly fixed, the suborbital shelf is lost, but the myodome is present. The parietal is lost. The pelvic fin has 6-7 spines, and the pelvic is peculiar in having a posterior as well as an anterior spine, and four soft rays (Starks [422a]).

*Siganus*, Forsk.; Pacific.

**Family ACANTHURIDAE.** The body is compressed, covered with minute ctenoid or spinous scales. One spine and five jointed dermo-

trichs in the pelvic fin. The teeth vary, but are generally incisiform. Parapophyses are present bearing ribs and epipleurals. The tail is provided usually with lateral plates or sharp defensive spines. Bony plates near the base of the dorsal spines. A median bony horn develops above the eyes in *Naseus*.

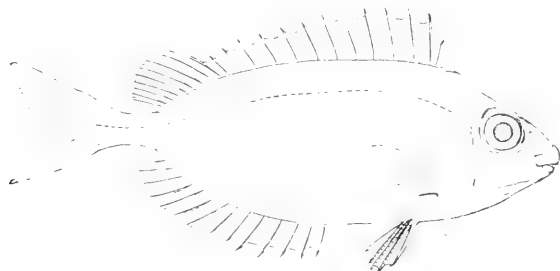

FIG. 445.

*Teuthis nebulosa*, Q. and G. (After Günther.)

*Naseus*, Cuv.; *Acanthurus*, Forsk. (Fig. 446)—tropical seas; Eocene, Europe. *Aulorhamphus*, de G., Eocene; and *Apostasis*, Kr., Miocene, Europe. *Zanclus*, C. and V.; *Colocopus*, Gill; *Prionurus*, Lac.—tropical seas.

SUBDIVISION B. The opercular bones become reduced, the myodome and the ribs are lost; if present the pelvic bones are fused in the middle line; also the pelvic fins, which are reduced to a spine and a few small dermal rays, may disappear altogether. The gill-opening is very narrow (Regan [344]).

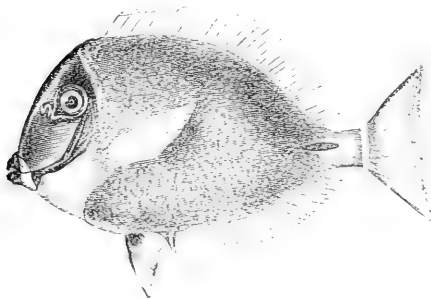

FIG. 446.

*Acanthurus leucosternum*, Benn. (After Günther.)

complete gills are present. The orbit is carried very high up on the skull.

SERIES 1. The spinous dorsal consists of one or more spines, of which the first immediately behind the skull is generally very large, and, when erect, may be locked by the second. There are generally only about nineteen vertebrae. The teeth are conical or incisiform. Branchial opening quite small.

A. The pelvic bones are fixed; but there are still vestiges of paired

BRANCH 1. SCLERODERMI. The supraclavicle is vertical and the pectoral radials normally developed (Fig. 452, B). The dentary is fused to the articular, and the teeth usually strong and incisor-like (Fig. 448). Four

pelvic fins in the form of two large spines and a few jointed dermal rays. The scales are rounded and spiny.

Family TRIACANTHIDAE. The premaxilla is protractile, and remains separate. The hyopalatine arch is firmly fixed. From three to six dorsal spines. The deep-sea genus *Halimochirurgus* has a long tubular snout.

*Acanthopleurus*, Ag., Oligocene; *Spinacanthus*, Ag., Eocene—Europe. *Triacanthus*, Cuv. (Fig. 447); *Triacanthodes*, Blkr.; *Halimochirurgus*, Alc.—Indo-Pacific.

B. The body is somewhat compressed, and covered with spiny scales or scutes. The co-ossified pelvic bones bear only a single median spine suspended in a scaly fin-fold; but even this spine may be lost (Monacanthidae). The premaxilla is firmly fixed to the maxilla.

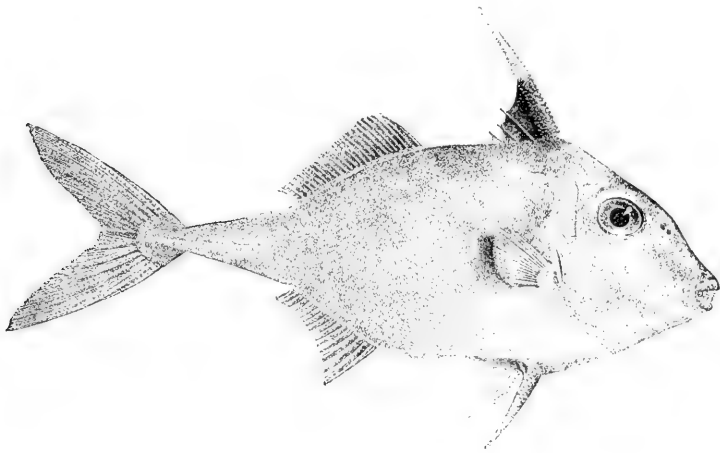

FIG. 447.

*Triacanthus brevicestris*, T. and S. (After Day, *Fishes of India*.)

Family BALISTIDAE. The 'Trigger-Fishes' have two or three dorsal spines, and generally large scales or scutes.

*Acanthoderma*, Ag.; Oligocene, Europe. *Balistes*, Cuv. (Figs. 448-9); *Paraluteres*, Blkr.; *Aluteres*, Cuv.; *Psiloccephalus*, Sw.—warm seas.

Family MONACANTHIDAE. The 'File-Fishes' have one strong dorsal spine, and generally a second vestigial spine behind it. The pelvic fin is vestigial or absent. The body is covered with small spiny scales.

*Monacanthus*, Cuv. (Fig. 450).

SERIES 2. (OSTRACODERMI). There is no spinous dorsal fin, and the whole body, excepting the jaws, base of the fins, and caudal pedicle, is encased in a rigid carapace of hexagonal plates. The vertebrae are reduced to 16-14; the epipleurals and the pelvic girdle and fins have disappeared. The clavicles, coracoid, and postclavicle are greatly expanded below the carapace. The hyopalatine arch is fixed. The premaxilla is firmly united to the maxilla.

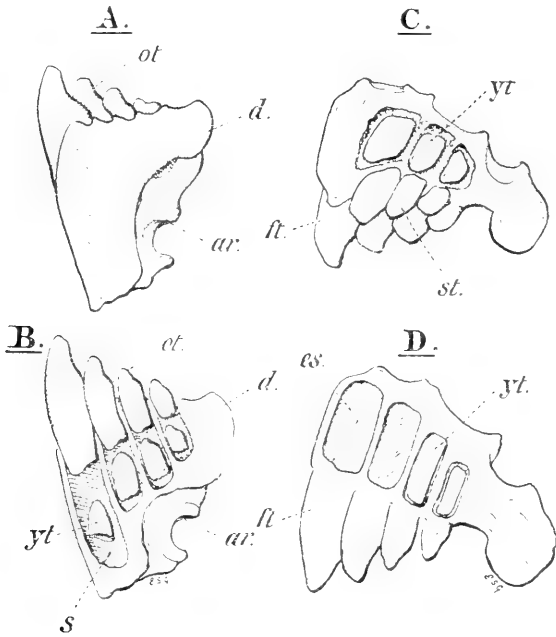

FIG. 448.

*Balistes viridescens*, Bl. Schn., File fish, from specimens in British Museum. A, lower jaw, inner view; B, lower jaw, outer view; C, upper jaw (premaxilla), inner view; D, upper jaw, outer view. *ar*, articular; *d*, dentary; *es*, empty socket from which the growing tooth has been removed; *ft*, tooth of first row; *ot*, older worn tooth; *st*, tooth of second row; *yt*, younger tooth about to replace the older one.

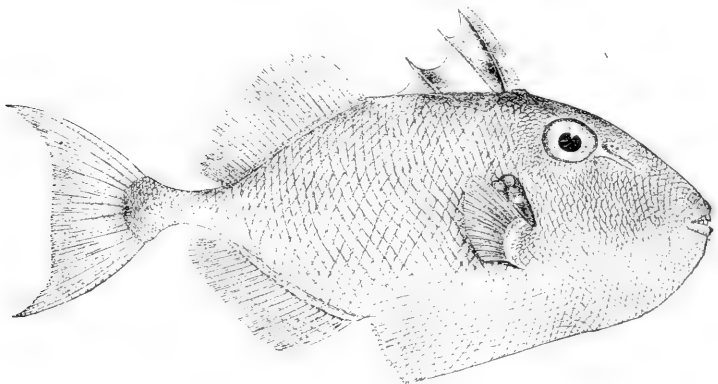

FIG. 449.

*Balistes stellaris*, B. and S. (After Day, *Fishes of India*.)

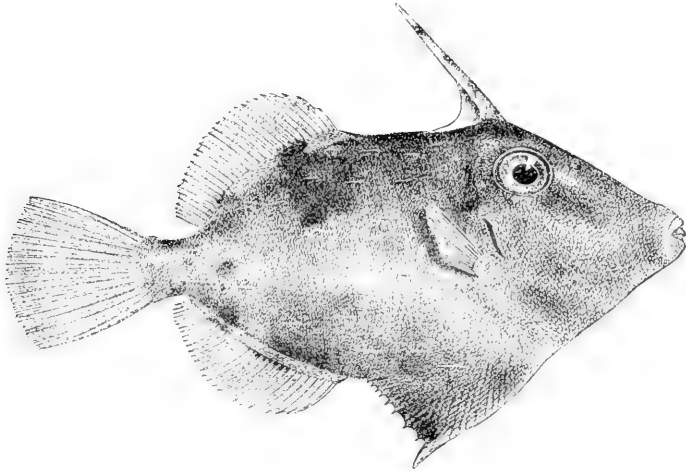

FIG. 450.

*Monacanthus tomentosus*, Blkr. (After Day, *Fishes of India*.)

Family OSTRACIONTIDÆ. 'Trunk'- or 'Coffer-Fish,' with long narrow teeth. The carapace has an almost vertical front edge, angular sides, and often large frontal and anal horns.

*Ostracion*, L.; tropical seas; Eocene, Europe. *Aracana*, Gr.; *Lactophrys*, Sw.—tropical seas.

BRANCH 2. TRIODONTES.

Family TRIODONTIDÆ. A family intermediate between the first and third sub-groups, whose exact position it is difficult to determine. The teeth coalesce into a beak, single below but paired above. The spinous dorsal and the pelvic fins have disappeared, there is a dilatible oesophageal sac. Yet a movable pelvis is present as in the Balistidae, which they resemble in many characters of the skeleton. There are twenty vertebrae, and the body is covered with small spiny plates.

*Triodon*, Keinw.; E. Indies.

BRANCH 3. GYMNODONTES.

There are no normal scales, no dorsal spinous fin, no pelvic fin

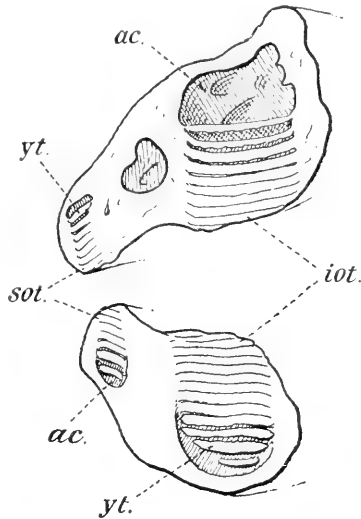

FIG. 451.

*Chilomyeris reticulatus*, L. Porcupine fish; from specimens in British Museum. Vertical median section of both jaws. *ac.*, alveolar cavity in which young teeth develop; *i.o.t.*, grinding surface formed by inner set of old tooth-plates; *s.o.t.*, grinding surface formed by outer set of old tooth-plates; *yt.*, young tooth-plates.

or girdle, no epipleurals, and no parapophyses. The teeth when present are fused into plates in which vertical succession takes place (Figs. 451, 453). The basis cranii is simple; the interoperculum rod-like and concealed; the suture between the dentary and articular remains, also a

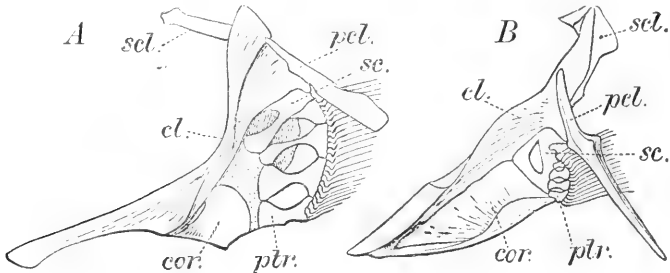

FIG. 452.

Inner view of right half of pectoral girdle with pectoral fin of (A), *Diodon punctulatus*, Kp.; and (B), *Balistes cetrucosus*, L. cl., cleithrum; cor., coracoid; pcl., postclavicle; ptr., radial; se., scapula; scl., supraclavicle. (After Regan, *Proc. Zool. Soc.*)

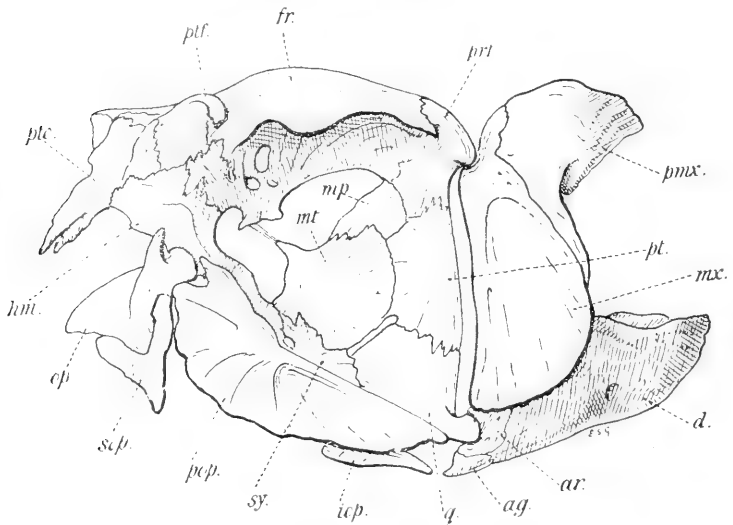

FIG. 453.

Skull and jaws of *Dicotylichthys punctulatus*, Kaup. ag., angular; ar., articular; d., dentary; fr., frontal; hm., hyomandibular; icp., interopercular; mp., mesopterygoid; mt., metapterygoid; mx., maxilla; op., opercular; pml., premaxilla; pop., preopercular; ptf., postfrontal; pt., pterygoid; pto., pterotic; q., quadrate; scp., subopercular; sy., symplectic.

separate angular. The spines of the anterior vertebrae are bifid. The supraclavicle is usually oblique (Fig. 452, A).

A. In which the crushing beak is very massive, the skull is broadened, and the hyopalatine arch very firmly fixed or fused to the skull, the palatine being generally continuous with the vomer (Fig. 453). The gills are reduced to three in number, and one branchiostegal is much

enlarged. The nostrils are often modified; the nasal sacs may protrude as a papilla, the nostrils become confluent, and finally the sac open freely to the exterior (Regan [344]). The papilla then becomes a mere

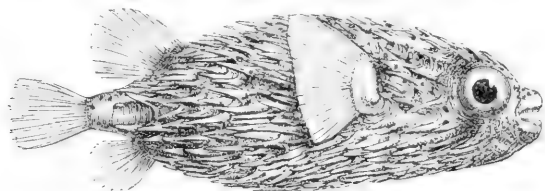

FIG. 454.

*Diodon maculatus*, Gthr. (After Günther.)

appendage in which end the olfactory nerves. The oesophagus is provided with a large diverticulum, which on being filled with water inflates the fish to an almost spherical shape, the defensive spines scattered over the body thereby being erected (Thilo [435]). These spines, fixed in the skin by three basal processes, may acquire a very large size, and are the modified scales (Figs. 454-5).

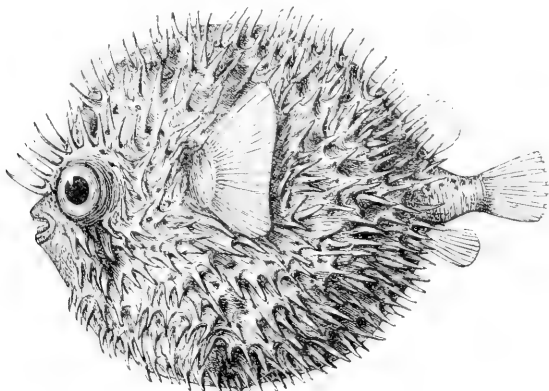

FIG. 455.

*Diodon maculatus*, Gthr., inflated. (After Günther.)

Family TETRODONTIDÆ. The beaks are divided by a median suture. There may be as many as twenty-nine vertebrae, and small plates are rarely found in the skin.

*Tetrodon*, L.; tropical seas and African rivers; Eocene, Europe. *Ephippion*, Bibr.; *Tropidichthys*, Blkr.; *Xenopterus*, Holl.; *Chonerhinus*, Blkr.—tropical seas.

Family DIODONTIDÆ. The 'Porcupine Fish' have beaks without suture, the vertebrae reduced to twenty-two, and the skin armed with spines only.

*Diodon*, L. (Figs. 454-5); tropical seas; Eocene, Europe; Miocene, Java, N. America. *Dicotylichthys*, Kaup; *Chylomycterus*, Blkr. (Fig. 453); *Trichocyclus*, Gthr.—tropical seas.

B. Family MOLIDAE. The beaks have no median suture; the body is compressed and truncated behind, the vertebrae numbering seventeen, and the caudal being replaced by the dorsal and anal fins which join posteriorly. There are no inflatable sacs, the skin is naked or with small spines. The skeleton is very fibrous, and very imperfectly ossified.

(*Orthogoriscus*, B. and S. (*Mola*, Cuv.); *Ranzania*, Nardo—Atlantic.

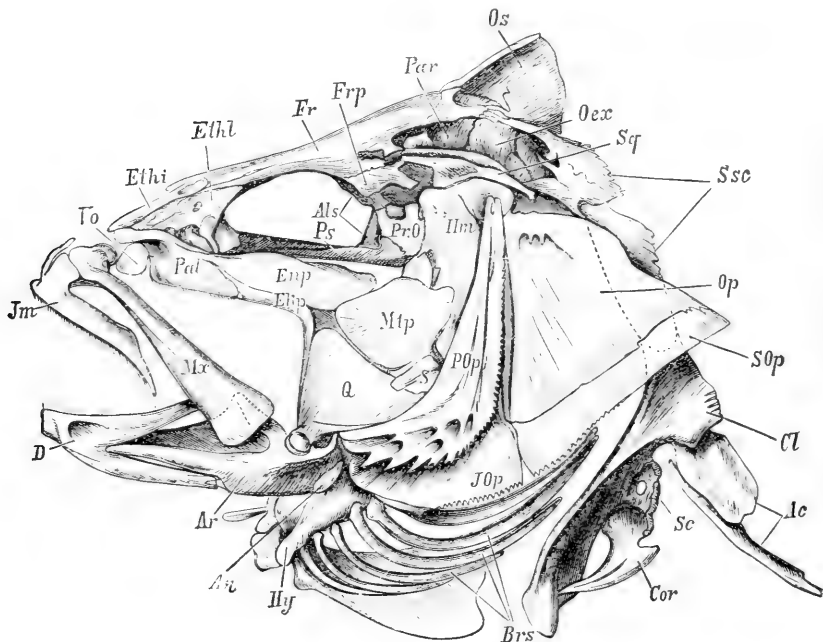

FIG. 456.

Skeleton of head and shoulder-girdle of *Perna fluviatilis*, L. (After Cuvier, from Claus and Sedgwick.) *Ac*, postclavicles; *Als*, alisphenoid; *An*, angular; *Ar*, articular; *Brs*, branchiostegal rays; *Cl*, cleithrum; *Cor*, coracoid; *D*, dentary; *Ekp*, ectopterygoid; *Enp*, endopterygoid; *Ethl*, mesethmoid; *Ethl*, prefrontal; *Fr*, frontal; *Frp*, postfrontal; *Hm*, hyomandibular; *Hj*, hyoid arch; *Jm*, premaxilla; *JOp*, interopercular; *Mty*, metapterygoid; *Mx*, maxilla; *Oex*, occipital; *Op*, opercular; *Os*, supraoccipital; *Pal*, palatine; *Par*, parietal; *POp*, preopercular; *PrO*, prootic; *Ps*, parasphenoid; *Q*, quadrate; *S*, symplectic; *Sc*, scapula; *Sop*, subopercular; *Sy*, pterotic; *Ssc*, supraclavicle and post-temporal; *To*, vomer.

SUB-TRIBE C. The subocular shelf has been lost.

Family ACROPOMATIDAE. Somewhat intermediate between the Serranidae and the Percidae.

*Acropoma*, Schlg.; *Dinolestes*; *Malacichthys*, Död.; *Propoma*, Gthr.; *Synagrops*, Gthr.—Pacific.

Family PERCIDAE. Chiefly freshwater fish, with not more than three anal spines, a mouth at most feebly protractile (Fig. 456), and a divided dorsal fin.

*Prolates*, Pr.; Cretaceous, Europe. *Cyclopoma*, Ag.; Eocene, Europe.



*Mioplosus*, Cope; Eocene, N. America. *Smerdis*, Ag.; Oligocene, Europe. *Lates*, C. and V.; Africa, Asia, Australia; and Eocene, Europe. *Labrax*, C. and V., 'Bass,' Atlantic; Eocene, Europe. *Perca*, L.; *Lucioperca*, Cuv.; *Acerina*, Cuv. (Fig. 457); *Boleosoma*, Dk.—N. America. *Aspro*, Cuv.; Europe.

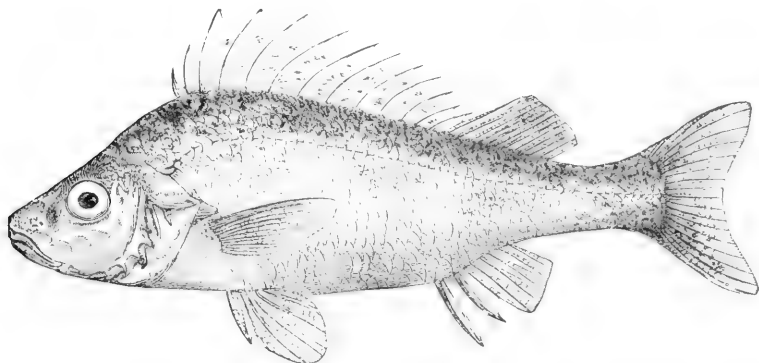

FIG. 457.

*Acerina cernea*, L., the Pope. (From Seely, *Freshwater Fishes of Europe*.)

Family CENTRARCHIDAE. Freshwater fish differing from the last chiefly in the larger number of anal spines (3-14), the deeper body, and the undivided condition of the dorsal fin.

*Lepomis*, Raf.; *Micropterus*, Lac.; *Centrarchus*, Cuv.; *Pomotis*, C. and V.; *Pomoxys*, Raf.—N. America.

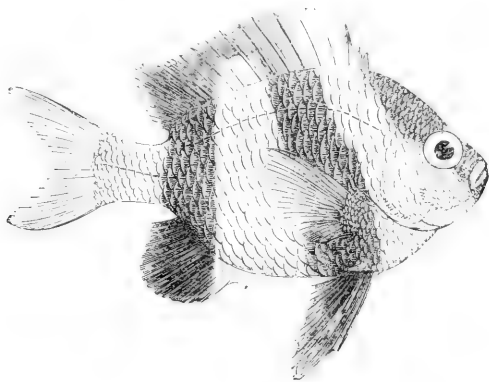

FIG. 458.

*Dascyllus aruanus*, L. (After Günther.)

Family CYPHOSIDAE. With incisiform teeth and densely scaled fins.

*Cyphosus*, Lac.; *Medialuna*, J. and F.; *Sectator*, J. and F.—Indo-Pacific.

Family LOBOTIDÆ. With conical teeth, a toothless palate, and very protractile mouth.

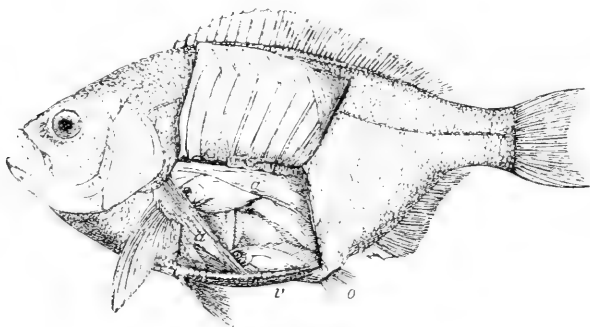

FIG. 459.

*Dittusa argentea*, dissected to show the fully developed young, ready for expulsion by the genital orifice, *o*, *o*, folds of the ovarian sac; *v*, anus. (After Günther.)

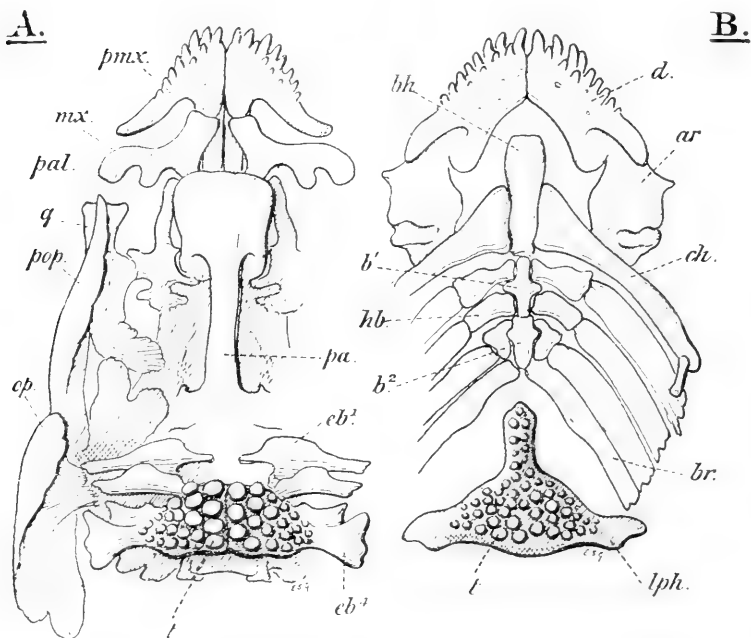

FIG. 460.

*Labrus maculatus*, Bl. (Wrasse, from specimens in British Museum.) A, ventral view of skull, with dorsal portion of branchial arches. B, dorsal view of lower jaw and ventral portion of branchial arches. *ar*, articular; *b*<sup>1-2</sup>, two basibranchials; *bh*, basihyal; *br*, fourth ceratobranchial; *ch*, ceratohyal; *d*, dentary; *cb*<sup>1-3</sup>, pharyngobranchials; *hb*, hypobranchial; *lph*, lower pharyngeal (5th ceratobranchials); *mx*, maxilla; *op*, opercular; *pa*, parasphenoid; *pal*, palatine; *pmx*, premaxilla; *pop*, preopercular; *q*, quadrate; *t*, pharyngeal teeth.

*Lobotes*, Cuv.; Atlantic, Mediterranean, Indo-Pacific. *Datnioides*, Blk.; E. Indian Ocean and rivers.

Family NANDIDAE. With a very protractile mouth, very slender maxilla, and no endopterygoid.

*Nandus*, C. and V.; *Badis*, Blk.; *Cutopra*, Blk.—S. E. Asia. *Polycentropsis*, Blgr.; W. Africa. *Mono-cirrus*, Hekl.; *Polycentrus*, M. and T.—S. America.

Family GERRIDAE. With a very protractile mouth, toothless palate, premaxilla with an upward process, and lower pharyngeals more or less coalesced.

*Equula*, Cuv.; *Gazza*, Rüpp.; *Gerres*, Cuv.—tropical seas.

Family PRISTIPOMATIDAE. With toothless palate, small teeth, and undivided dorsal.

*Pristipoma*, Cuv.; *Haemulon*, Cuv.; *Diagramma*, Cuv.; *Pentapus*, Cuv.—tropical seas.

Family TRICHODONTIDAE. Scaleless marine fish, with very upturned mouth, toothless palate, divided dorsal and elongated anal.

*Trichodon*, Cuv.; *Arctoscopus*, J. and E.—N. Pacific.

Family LACTARIIDAE. With toothed palate, small deciduous cycloid scales, and short spinous dorsal fin. The scapula has two foramina.

*Lactarius*, C. and V.; S. Asiatic coast.

Family LATRIDIDAE. With small scales, villiform teeth, and the pelvic fins relatively far back.

*Latris*, Rich.; Australia and New Zealand.

Family HAPLODACTYLIDAE. With the pelvic fins relatively far from the pectorals; a large soft portion of the dorsal.

*Haplodactylus*, C. and V.; *Chironemus*, Cuv.; *Chilodactylus*, Lac.—Pacific and southern seas.

SUB-TRIBE D. (PHARYNGOGNATHI). The palate is toothless, but the pharyngeals strongly toothed, and the lower pharyngeals are firmly united (Fig. 461). The body is usually somewhat deepened, and the dorsal fin remains continuous.

1. With a single nostril on each side.

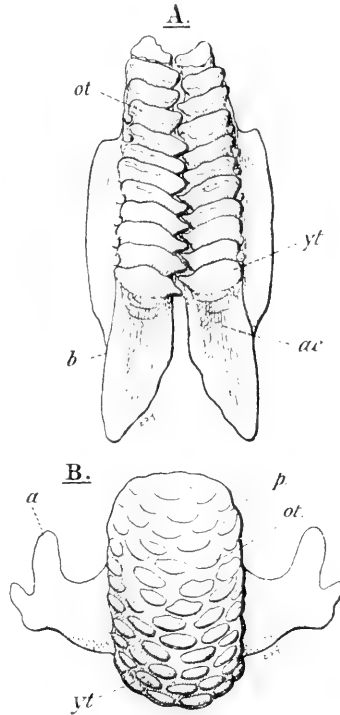

FIG. 461.

*Pseudoscarus muricatus*, C. and V., from specimens in the British Museum. A, upper, and B, lower pharyngeals. *a*, 5th ceratobranchial; *ac*, alveolar cavity in which teeth develop; *b*, right pharyngobranchial; *ot*, old teeth fixed and worn down; *p*, grinding plate; *yt*, young teeth succeeding the old teeth. Succession is from before backwards above, and from behind forwards below.

Family POMACENTRIDAE. The subocular shelf is preserved. Brilliantly coloured marine fish, with gills reduced to three and one hemibranch. Outwardly they resemble the Chaetodontidae.

*Heliastes*, C. and V.; *Azurina*, J. and E.; *Pomacentrus*, Lac.; *Dascyllus*, Cuv. (Fig. 458); *Amphiprion*, Bl. Schn.—warm seas.

Family CICHLIDAE. Freshwater fish, without subocular shelf or supramaxilla, and with a suture separating the pharyngeals.

*Tilapia* (*Chromis*), Smith; *Tropheus*, Blgr.; *Lamprologus*, Schilt.; *Hemichromis*, Pet.; *Asprotilapia*; *Plecodus*, Blgr.; *Pseudotropheus*—Africa.

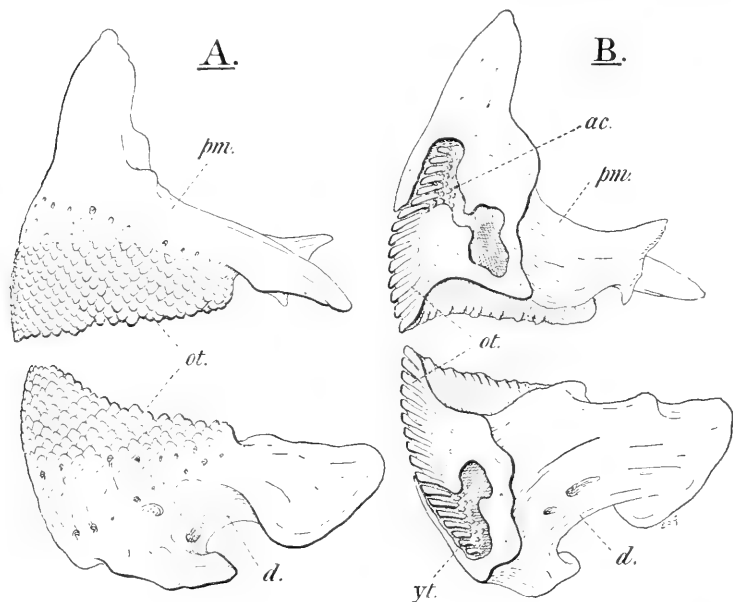

FIG. 462.

*Pseudoscarus muricatus*, C. and V. Parrot fish; from specimens in British Museum. The upper and lower jaws. A, outer left-side view; B, view of the jaws cut vertically. *ac.*, alveolar cavity in which young teeth develop; *d.*, dentary; *ot.*, old worn teeth near edge of jaws, firmly held in bony cement; *pm.*, premaxilla; *yt.*, loose young teeth about to replace older teeth.

*Acara*, Hekl.; *Heros*, Hekl.; *Cichla*, Cuv.; *Chaetobranchius*, Hekl.; *Geophagus*, Hekl.—America. *Etroplus*, C. and V.; E. Indies.

2. With normal nostrils and subocular shelf.

Family EMBIOTOCIDAE. Viviparous fish, with deep furrows along the base of the dorsal fin. The anal may be peculiarly modified in the male.

*Abeona*, Gir.; *Cymatogaster*, Gibb.; *Embiotoca*, Ag.; *Ditrema*, Schl. (Fig. 459); *Hysterocarpus*, Gibb.—Pacific.

3. With normal nostrils, and no subocular shelf. Gills reduced to three and one hemibranch.

Family LABRIDAE. The Wrasses are brilliantly coloured marine fish,

with strong pointed teeth on the jaws, and conical or tubercular teeth on the pharyngeals (Fig. 460).

*Phyllodus*, Ag.; *Pseudosphaerodon*, Ntlg.; *Egertonia*, Coc.; *Platy-laemus*, Dix.—Eocene, Europe. *Labrodon*, Gerv.; Eocene, Europe and New Zealand. *Julis*, Cuv.; tropical seas; Miocene, Europe. *Labrus*, L.; Mediterranean, Atlantic; Miocene, Europe. *Otenolabrus*, C. and V.; *Chaerops*, Rüpp.; *Tautoga*, Mitch.; *Chilinus*, Lac.; *Cossyphus*, C. and V.; *PlatyGLOSSUS*, Kl.; *Epibulus*, Cuv.; *Novacula*, C. and V.

Family SCARIDAE. Closely related to the preceding family, the Parrot-Wrasses differ chiefly in having expanded pharyngeals bearing tessellated flattened teeth, and the teeth of the jaws more or less completely fused into a firm beak (Fig. 462). Generally brilliantly coloured.

*Scarus*, Forsk.; Mediterranean, Atlantic; Eocene, Europe. *Coridodax*, Gthr.; *Callyodon*, C. and V.; *Scarichthys*, Blkr.; *Pseudoscarus*, Blkr.; *Odax*, C. and V.; *Siphonognathus*, Rich.—chiefly tropical seas.

#### TRIBE 2. GOBIFORMES.

The skull is usually somewhat depressed, with a blunt snout, the bones not serrated, and there is no eye-muscle canal. The base of the pectoral fin is generally extended and almost at right angles to the vertebral column, the scapula and coracoid more or less reduced or vestigial, so that the radials may touch the cleithrum. The four or five

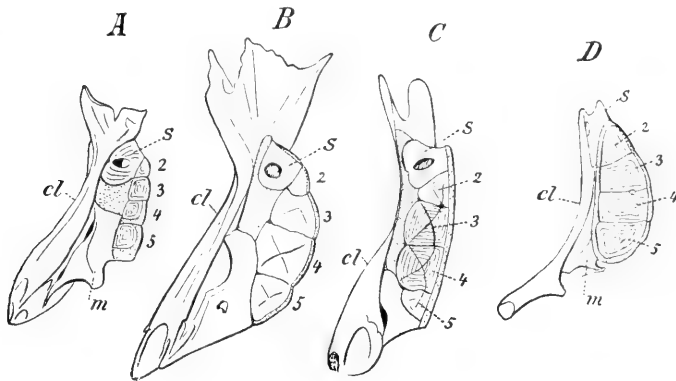

FIG. 463.

Pectoral endoskeleton and cleithrum of A, *Peristedion cataphractum*; B, *Trigla hirundo*; C, *Hemitripterus acadianus*; D, *Gobius guttatus*. cl, cleithrum; m, coracoid; s, scapula; 2-5, radials. (From Gegenbaur, *Vergl. Anat. Wirbeltiere*.)

radials, of which one to two rest on the coracoid, are much flattened, forming a narrow plate (Fig. 463, D). Characteristic is the modification of the pelvic fins: they are thoracic, close together, and expanded so as to form an adhesive disc, often completed by a transverse membrane joining the fins behind. Usually there are several flexible spines in the dorsal, one in the anal, and one spine and four or five soft lepidotrichia in the pelvic fins. As a rule, there are no pyloric caeca and no air-bladder.

Family GOBIIDAE. The dorsal fin has a separate soft hinder portion; the anterior portion is supported by flexible spines, and may be reduced. The dentition and scaling varies; the scales may be smooth, ctenoid, or absent. There is no lateral line, and usually a large anal papilla.

*Periophthalmus* is modified for progression on land, and has powerful pectoral fins, and protruding eyes brought up on to the top of the head. Fossil forms have not yet been determined with certainty. Marine and freshwater, widely distributed.

*Gobius*, Art.; widely distributed. *Eleotris*, Gron.; freshwater, tropics. *Benthophilus*, Eisch.; Caspian. *Periophthalmus*, Schn.; tropics.

### TRIBE 3. ECHENEIDIFORMES (Discocephali).

Distinguished by the extraordinary modification of the separate anterior dorsal fin, which extends on to the head as far as the snout, and becomes flattened out into an oval sucking disc with transverse ridges,

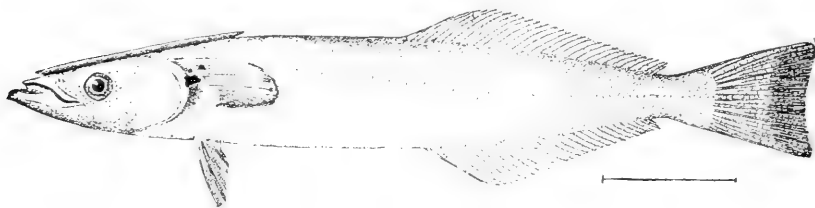

FIG. 464.

*Remora brachyptera*, Lowe. (From Jordan and Evermann.)

strengthened by a double series of serrated plates seemingly the modified lepidotrichia (Figs. 464-5) (Storms [427]). The skull is correspondingly flattened, its bones are deeply sunk and smooth, and there is no eye-muscle

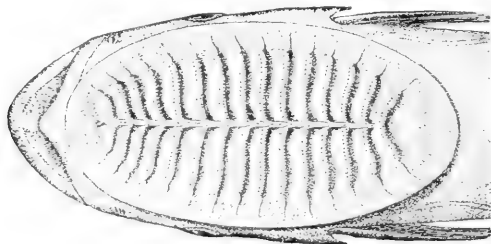

FIG. 465.

Sucking disc of *Remora brachyptera*, Lowe. Dorsal view. (From Jordan and Evermann.)

canal. The supraclavicle is reduced. The scapula perforate, and three radials rest on the coracoid. Already in the Eocene fully differentiated representatives of this family are found. It appears to have no close affinity to the Scombriformes, with which it was long associated.

Family ECHENEIDIDAE. The scales are small, cycloid, the suborbital arch slender, the maxilla fixed to the premaxilla. The pectoral fin is placed high up, beneath the disc. The posterior dorsal and anal fins are spineless. There are pyloric caeca, but no air-bladder. The Eocene genus *Opisthomyzon* has a quite small sucker.

*Opisthomyzon*, Cope; Eocene, Europe. *Echeneis*, Art., 'Sucking-Fish'; *Remora*, Gill. (Fig. 464)—warm seas.

#### TRIBE 4. SCORPAENIFORMES (Scleroparei).

A natural group of fish, which appear to have been derived from some primitive Perch-like form, and have diverged in several special directions. They are distinguished by the possession of an enlarged posterior suborbital (3rd), which spreads backwards over the cheek (Fig. 466), sometimes becoming firmly fixed to the preoperculum (*Scorpaena*, etc.). This characteristic 'suborbital' stay is not fully developed in the more primitive genera, and may be again reduced in the more specialised. The parietals often meet in the middle line; and the gills may be reduced to three and a half. The pectoral radials are generally in the form of flattened plates.

The fins and scales are generally very spiny, also the head, which tends to become covered with a bony cuirass. Some of the anterior dermal rays of the pectoral fin rest directly on the scapula, with which one or more of the radials seem to have fused (Fig. 467). Whilst about thirty vertebrae occur in the less specialised families (Scorpaenidae), the number increases to fifty or sixty in the Comephoridae and Cottidae.

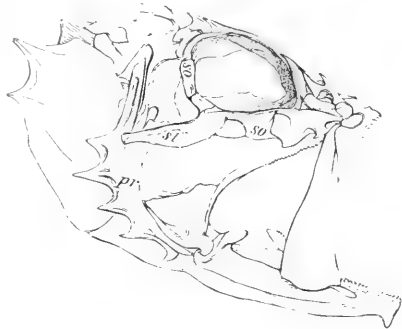

FIG. 466.

*Scorpaes pereoides*, Sol. (After Günther.) Right-side view of skull. *pr*, preopercular; *so*, suborbital; *st*, bony stay from third suborbital.

SUB-TRIBE A. The pectoral arch has the perforate scapula and the coracoid normally disposed, and with the latter articulate two of the flattened radials (Figs. 463, 467).

A. Family SCORPAENIDAE. The cephalic cuirass is incomplete; the spinous portion of the dorsal is armed with strong spines, often provided with poison glands, but is not separate. The anal generally has three spines. The cranial bones are usually very spiny, often distorted, and fleshy processes may be developed on the head. The myodome is present. The base of the pectoral fin is broad and vertical, and one or two lower dermal rays may be separate. The radials are constricted. The scales may be lost, and the gills reduced to three and a half, one slit being

closed. The air-bladder may be lost. An eye-muscle canal is present, and the parietals may meet above the supraoccipital (p. 347). The dorsal spines are often provided with poison-glands.

*Ampheristus*, Koenig; *Histiocephalus*, A. de Z.—Eocene, Europe. *Scorpaena*, Art. (Fig. 468); warm seas; Miocene, Europe. *Sebastes*, C. and V.; *Setarches*, Johns.; *Pterois*, Cuv.; *Apistus*, C. and V.; *Agriopus*, C. and V.; *Chorismodactylus*, Rich. (Fig. 469); *Pelor*, C. and V.—warm seas.

Family TRIGLIDAE. The head is completely covered by a cuirass, formed partly by the suborbitals (Fig. 470). The anal fin is spineless, the dorsal fin becomes subdivided, and the pelvic fins are widely separated. Two or three of the ventral (anterior) dermal pectoral rays become specialised as independent feelers capable of separate movement (Hamburger [195]). The pectoral fin is generally large and brilliantly coloured. The post-temporal is

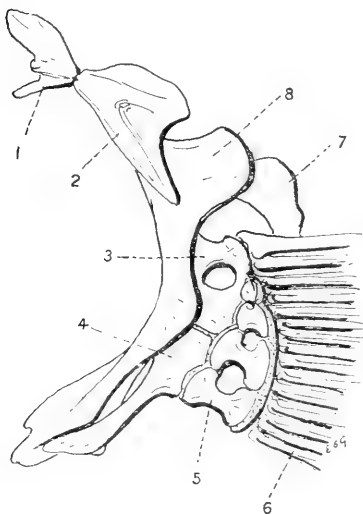

FIG. 467.

Skeleton of left half of pectoral girdle and fin of *Pterois volitans*. 1, post-temporal; 2, supraclavicle; 3, scapular; 4, coracoid; 5, radial; 6, lepidotrich; 7, postclavicle; 8, cleithrum.

fused to the skull, and the myodome is present. The body is covered with rough scales, or sometimes with an armour of bony plates (*Peristedion*) (Fig. 472).

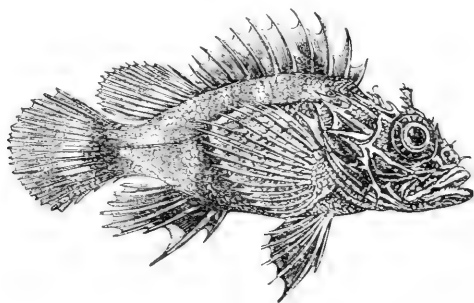

FIG. 468.

*Scorpaena lyonoensis*, Rich. (After Günther.)

*Trigla*, Art. (Fig. 471); warm and temperate seas; Miocene, Italy. *Lepidotrigla*, Gthr.; *Prionotus*, Lac.; *Peristedion*, Lac.—warm seas.

B. Family AGONIDAE. The cephalic cuirass is complete, and usually



spiny. The myodome is lost; the post-temporal fixed, the pelvic fins close together with one spine and two soft rays, and the anal spineless. Bony plates cover the body.

*Agonus*, Bloch, the 'Pogge,' widely distributed.

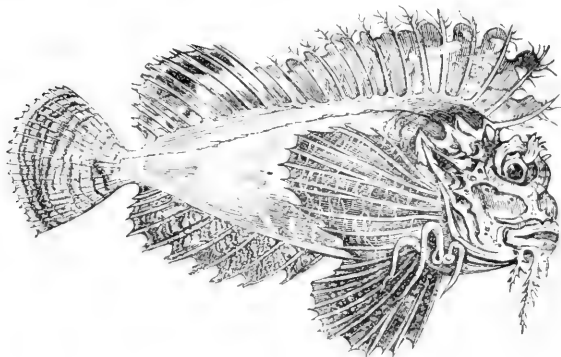

FIG. 469.

*Chorismoductylus multibarbis*, Rich. (After Günther.)

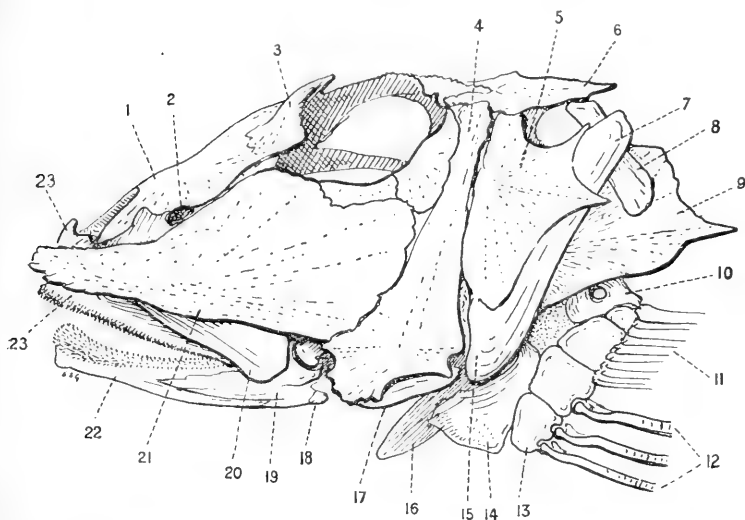

FIG. 470.

*Trigla gurnardus*, L. Left-side view of skeleton of head and pectoral girdle. 1, nasal; 2, nasal capsule; 3, prefrontal; 4, preopercular; 5, opercular; 6, pterotic; 7, subopercular; 8, supraclavicle; 9, cleithrum; 10, scapula; 11, lepidotrichia; 12, three free specialised lepidotrichia; 13, radial; 14, coracoid; 15, subopercular; 16, cleithrum; 17, interopercular; 18, angular; 19, articular; 20, maxilla; 21, enlarged suborbital; 22, dentary; 23, premaxilla.

C. Family DACTYLOPTERIDAE. Resembling the preceding family in the complete armature of the head, the subdivision of the dorsal fin, and the fusion of the post-temporal; but the myodome is lost. The head is short; the cephalic cuirass extends far back. The dorsal fin is preceded

by free spines; the pelvics are close together; and the pectorals are enormously developed in the adult, and subdivided into a shorter anterior

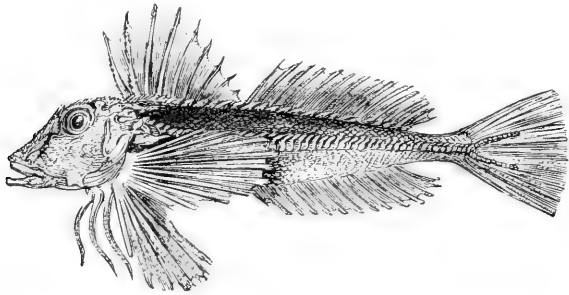

FIG. 471.

*Trigla pleuracanthica*, Rich. (After Günther.)

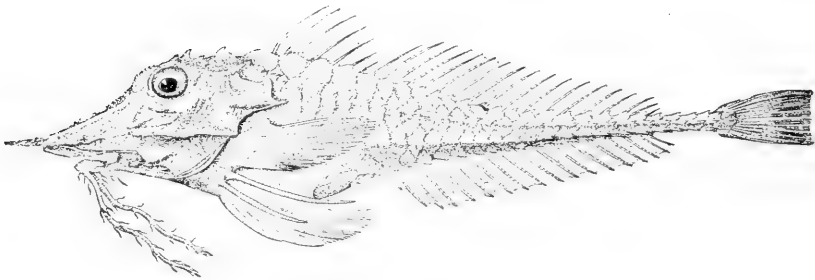

FIG. 472.

*Peristedion miniatum*, Goode. (From Jordan and Evermann.)

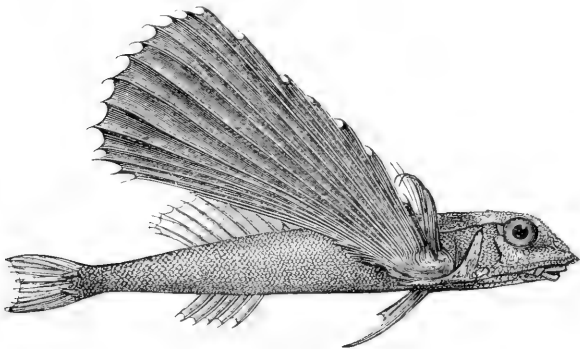

FIG. 473.

*Dactylopterus volitans*, L. (After Günther.)

and a longer posterior division. The supraclavicle has been lost, and the postclavicle is reduced. The three posterior radials rest on the coracoid, and are peculiarly lengthened. The Flying Gurnard, *Dactylopterus*, and

the flying-fish, *Exocoetus*, present a most interesting case of convergence of structure (p. 402).

*Dactylopterus*, Lac., the Flying Gurnard (Fig. 473); Atlantic and Indian Ocean.

Family HEXAGRAMMIDAE. With an eye-muscle canal, rather smooth cranial bones, few spines, and a continuous or incompletely divided dorsal. The posterior nostril is reduced to a minute pore. Scales small.

*Hexagrammus*, Steller; *Pleurogrammus*, Gill; *Ophiodon*, Gir.; *Zaniolepis*, Gir.—N. Pacific.

Family COMEPHORIDAE. Without eye-muscle canal, with few and feeble spines. With very large pectoral, and small or no pelvic fins. *Comephorus*, adapted to deep waters, is colourless, and has very large eyes; moreover, the suborbital stay is reduced, and the whole skeleton very delicate.

*Anoplopoma* (*Scombrocottus*), Ayres; N. Pacific. *Trigloopsis*, Gir.; deep Canadian lakes. *Comephorus*, Lac.; *Cottocomephorus*, Pell.—Lake Baikal.

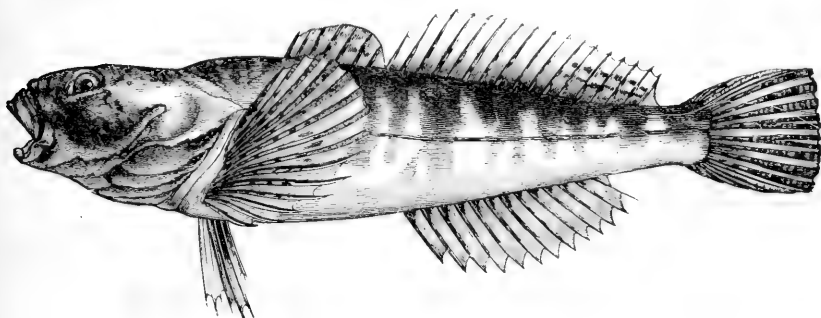

FIG. 474.

*Cottus gobio*, Cuv., the Miller's Thumb. (From Seelye, *Freshwater Fishes of Europe*.)

Family RHAMPHOCOTTIDAE. With spiny cranial bones and incomplete cuirass, no myodome, and gills reduced to three and a half, with narrowed opening. The flat post-temporal is fixed to the skull. Small spiny scales. Vertebrae few (24).

*Rhamphocottus*, Gthr.; Pacific coast of N. America.

SUB-TRIBE B. The scapula is widely separated from the coracoid, so that some of the flat plate-like radials rest on the cleithrum. The scales tend to disappear, or to be modified into spines embedded in the skin. The myodome is present.

Family COTTIDAE. The spinous dorsal is usually separate; but the scales and spines on the fins and head are less developed than in the Scorpaenidae, as a rule. The eyes are generally placed high and close together, the teeth small, the gills sometimes reduced to three and a half, the anal spineless. The vertebrae may be numerous, especially in later forms.

*Eocottus*, A. S. W.; Eocene, Italy. *Lepidocottus*, Sauv.; Miocene and Oligocene, Europe. *Cottus*, Art. (Fig. 474); *Icelus*, Kr.; *Jordania*,

Stks. ; *Triglops*, Reinh. ; *Blepsias*, C. and V. ; *Scorpaenichthys*, Gir.—Northern seas. *Sclerocottus*, Fisch. ; Antarctic. *Psychrolutes*, Gthr. ; N. Pacific.

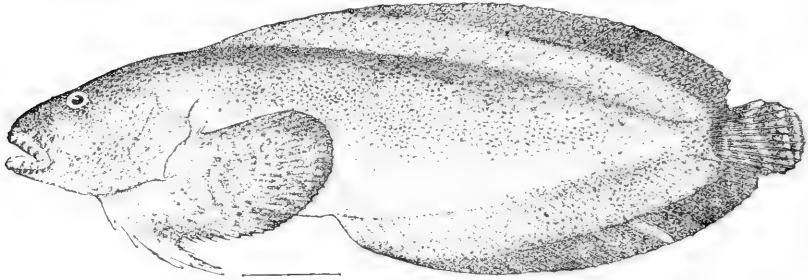

FIG. 475.

*Liparis Dennyi*, J. and S. (From Jordan and Evermann.)

Family CYCLOPTERIDAE. Differing from the closely allied Cottidae in the reduction of the size of the branchial opening, the spines, and scales, and in the formation of a sucking disc by the pelvic fins (Fig. 476). There is no myodome. The thick skin is naked or with scattered embedded spines and tubercles.

*Cyclopterus*, Art., the Lump-Sucker ; *Liparops*, Garm. ; *Liparis*, Art. (Fig. 475) ; *Paraliparis*, Coll.—marine, widely distributed.

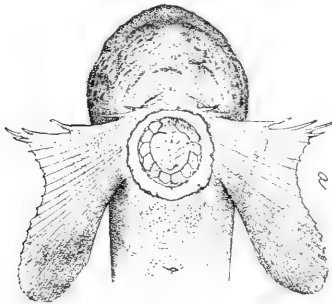

FIG. 476.

*Liparis Dennyi*, J. and S. Ventral view, showing sucker formed by the united pelvic fins. (From Jordan and Evermann.)

SUB-TRIBE C. With a very depressed spiny head, no eye-muscle canal, well-developed scapula and coracoid, and very flattened radials, widely separated pelvic fins, and spineless anal.

Family PLATYCEPHALIDAE. With small scales.

*Platycephalus*, Schn. ; Indo-Pacific.

Family HOPLICHTHYIDAE. With an incomplete cuirass, the post-temporal fused to the skull, and an armour of bony spiny plates.

*Hoplichthys*, C. and V. ; *Bembras*, C. and V.—W. Pacific.

#### TRIBE 5. BLENNIFORMES (Jugulares + Pediculati).

The families contained in this fifth Tribe, which seem to have started from some primitive Perch-like fish with pelvics bearing one spine and five dermal jointed rays, and a subocular shelf at least on the second suborbital, form perhaps but an artificial assemblage. The second and third divisions (B and C) are doubtless related to each other, and perhaps also to some of the more specialised Perciformes ;

but the position of Sub-Tribe A is less certain. The Trachinidae and their allies were for long associated with the Gadiformes, from which they have been distinguished by Boulenger [40].

The pelvic fins are placed in front of the pectorals, being 'jugular' or even 'mental' in position. The base of the pectoral fin is usually vertical and extended. Frequently the foramen lies not in the scapula, but between it and the coracoid (Fig. 477, A). The spines and scaling are generally reduced; the more specialised families become much modified and give rise to some of the most phantastic forms of fish.

**SUB-TRIBE A.** Two of the short flattened pectoral radials rest on the coracoid, and some of the anterior dermal rays on the scapula, as in the Scorpaeniformes (Fig. 477, A).

**FAMILY TRACHINIDAE.** The Weevers have a subocular lamina on the second suborbital, well-developed pleural ribs and epipleurals, the foramen between the scapula and coracoid, and a long opercular spine. The mouth is large and protractile, the snout very short, the spinous dorsal short and separate, the tail lengthened with a long soft dorsal and anal. The pelvic fins have one spine and five jointed dermatrichs. The air-bladder has been lost, and the small cycloid scales are set in oblique bands.

*Trachinus*, Art., the Weever; Mediterranean and E. Atlantic; Miocene, Europe.

**FAMILY PERCOPHIIDAE.** Differ from the preceding in the disposition of the scales, the wide separation of the pelvics, and the position of the foramen in the scapula (Fig. 477, B).

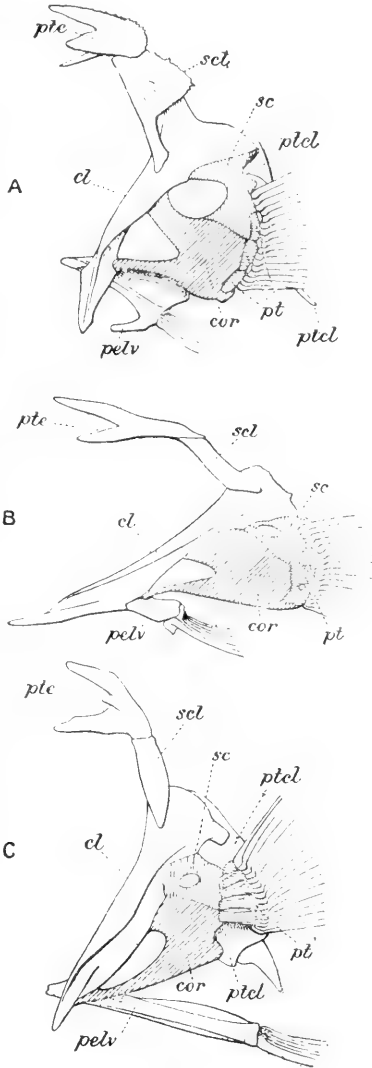

FIG. 477.

Skeleton of the pectoral and pelvic girdles and fins of (A) *Trachinus draco*, L.; (B) *Percophis brasiliensis*, Q. and G.; (C) *Cautolatilus princeps*. Left-side view. (After Boulenger.) cl, cleithrum; cor, coracoid; pelv, pelvic girdle; pt, radial; ptcl, postclavicle; pte, post-temporal; sc, scapula; scl, supraclavicle.

*Percophis*, C. and V.; coast of Brazil. *Bleekeria*, Gthr., and *Embo-lichthys*, J. and E., Indo-Pacific, are perhaps of this family.

Family LEPTOSCOPIIDAE. Like the foregoing, but without subocular lamina.

*Leptoscopus*, Gill. (Fig. 478); *Bembrops*, Std.; *Parapercis*, Std.; *Neopercis*, Olg.; *Chimarrichthys*, Sauv.; *Pleuragramma*, Blgr.—Southern hemisphere.

Family NOTOTHENIIDAE. Like the Trachinidae; but without subocular shelf, and sometimes with a scapular foramen (*Trematomus*); the scales, also, are ctenoid, though they may disappear, as well as the spinous dorsal. The pelvic fins are wide apart, and the nostril is usually single.

*Notothenia*, Rich.; *Acanthaphritis*, Gthr.; *Chaenichthys*, Rich.; *Cryod-raco*, Dollo; *Bovichthys*, C. and V.; *Gymnodraco*, Blgr.; *Gerlachia*, Dollo; *Bathyraco*, Gthr.; *Racovitzia*, Dollo; *Trematomus*, Blgr.—Southern seas.

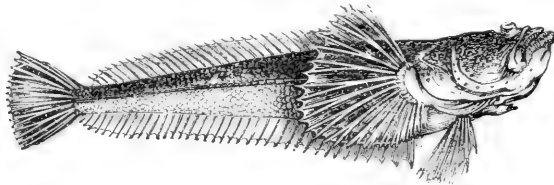

FIG. 478.

*Leptoscopus macropygus*, Rich. (After Günther.)

Family URANOSCOPIIDAE. Like the Trachinidae; but the foramen is in the scapula, and the reduced radials are fused to the scapula and coracoid. The head is much modified, very broad, with the eyes on the top, a very short snout, and an almost vertical mouth. The spinous dorsal may be lost, also the scales.

*Uranoscopus*, L.; *Anema*, Gthr.; *Ariscopus*, J. and S.; *Kathetostoma*, Gthr.—Mediterranean and tropical seas.

SUB-TRIBE B. The subocular shelf is absent, and the suborbital arch generally not ossified. The entopterygoid, the eye-muscle canal, and the epipleurals are lost.

Family CALLIONYMIDAE. Scaleless marine fish with a protractile mouth, widely separated pelvic fins with a spine and five soft dermotrichs, and a separate spinous dorsal. The vertebrae are few, the two last are enlarged, and many neural spines are bifid. The forked post-temporal is fixed to the skull. A fenestra is present between the scapula and coracoid, and the three broad radials rest on the latter. The gill-opening is reduced to a small aperture above the operculum. The sexual coloration of the male is often very vivid.

*Callionymus*, L., the Dragonet; widely distributed. *Vulsus*, Gthr., Celebes.

Family GOBIESOCIDAE: The Cling-Fishes, are scaleless and spineless, with a protractile mouth and simple post-temporal. The ventral

surface of the abdomen is occupied by a large complex sucker formed

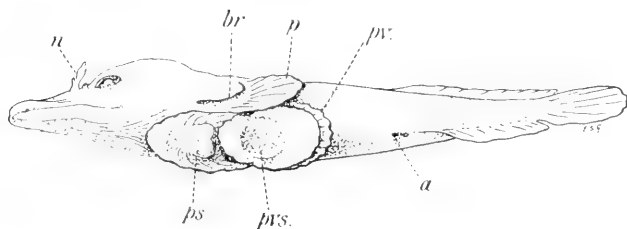

FIG. 479.

Oblique ventral view of *Lepidogaster gowanii*, Lac. *a*, anus; *br*, branchial opening; *u*, nostril; *p*, left pectoral fin which joins the right to form the edge of the pectoral sucker, *ps*; *pw.*, pelvic fins combined to form the pelvic sucker, *pvs.*

partly by the pelvics widely separated, and partly by the pectoral fins (Fig. 479); the pelvic bones, cleithra, and postclavicles are expanded to support it, and the whole pectoral girdle is much modified. The median fins are spineless.

*Gobiesox*, Lac.; *Chorisochismus*, Barn.; *Lepidogaster*, Gowan; *Leptopterygius*, Tr.; *Diplocrepis*, Gthr.—widely distributed, marine.

#### Family TRICHONOTIDAE.

Resembling the Callionymidae, but with an ossified suborbital arch, a more normally forked post-temporal, wide gill-openings, a single dorsal, and scales. Numerous vertebrae.

*Trichonotus*, Schn.; *Taeniolabrus*, St.—Indian Ocean. *Hemerocoetes*, C. and V.; N. Zealand.

**SUB-TRIBE C.** The pectoral dermal rays all rest on the radials, of which there are generally four or five, two or three touching the scapula. The scapula is

usually perforate, but often much reduced (Fig. 480). The pelvic fins have a spine and four dermatrichs, but are liable to reduction. The body has a short trunk, large head, and long tapering tail; both the anal and the dorsal fin are usually lengthened, the latter often reaching to the head and giving rise to separate cephalic rays.

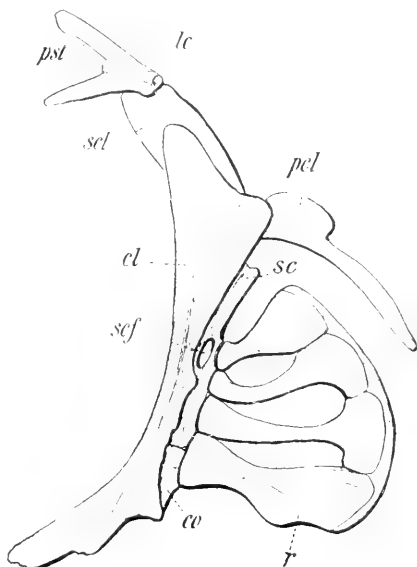

FIG. 480.

Left pectoral girdle and fin-skeleton of *Bleinnius gattorugine*, Bl. *cl*, cleithrum; *co*, coracoid; *l.c.*, lateral line canal; *pel*, postclavicle; *pst*, post-temporal; *r*, 4th radial; *sc*, scapula; *scf*, scapular foramen.

Family BLENNIIDAE. The subocular shelf is usually developed. The maxilla contributes to the margin of the protractile mouth. Generally with many dorsal spines, and a distinct caudal fin. The dentition is sometimes very formidable, as in *Anarrhichas* (Fig. 483). Some genera (*Alticus*) become adapted to progression on land, and closely resemble the Gobiid *Periophthalmus*.

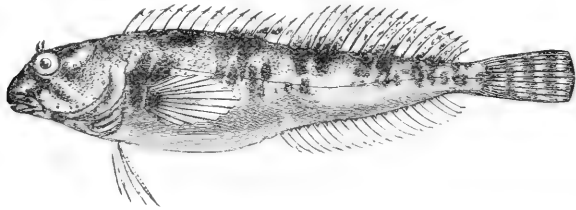

FIG. 481.

*Blennius vulgaris*, Poll., the Blenny. (After Seeley, *Freshwater Fishes of Europe*.)

*Pterygocephalus*, Ag.; Eocene, Italy. *Clinus*, Cuv.; *Blennius*, Art. (Fig. 481)—temperate and tropical seas; Miocene, Europe. *Anarrhichas*, Art.; *Chasmodes*, C. and V.; *Petroscirtes*, Rüpp.; *Salaria*, Cuv.; *Stichaeus*, Kröyer; *Blenniops*, Nils.; *Pataecus*, Rich.; *Gadopsis*, Rich.; *Opisthocentrus*, Kner; *Xiphasia*, Blk. (Fig. 482)—widely distributed, chiefly marine.



FIG. 482.

*Xiphasia setifer*, Sw. (After Day, *Fishes of India*.)

Family PHOLIDIDAE. Differing from the preceding in the absence of a subocular shelf, and of parapophyses on the precaudal vertebrae. Pelvics absent or vestigial. Only spines in the dorsal. The lips are thickened.

*Pholis* (*Centronotus*), Fl.; *Apodichthys*, Gir.—Northern seas.

Family ZOARCIDAE. Degenerate forms, separated by Jordan and Evermann from the Gadidae, with which they used to be associated, but from most of which they differ by the possession of a perforate scapula, and usually well developed pseudobranch, and homocercal tail.



The caudal fin may, however, disappear from the tip of the tapering tail, and the very elongate dorsal and anal fins may then meet. There is no subocular shelf, and the pelvics are often vestigial or absent, and

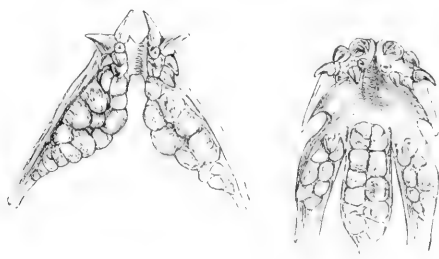

FIG. 483.

Dentition of the Wolf-fish, *Anarrhichus lupus*, L. (After Günther.) Upper teeth on the right, lower teeth on the left.

also the scales. As a rule, there are no spines, except sometimes in the hinder regions of the dorsal. The gill-membranes fused to the isthmus.

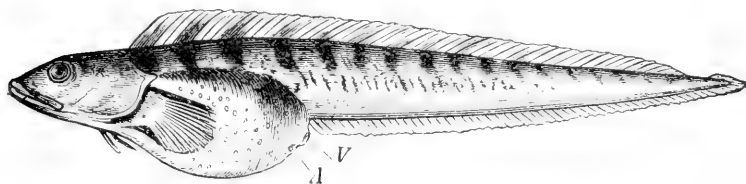

FIG. 484.

*Zoarces viviparus*, L. (From Claus and Sedgwick.) A, anus; V, urinogenital aperture. The jugular pelvic fins are seen below the head.

*Zoarces* and others are viviparous. Some deep-sea forms lose their eyes, as *Typhlosus*, *Aphyonius*; also the cave-forms *Stygicola* and *Lucifuga*.

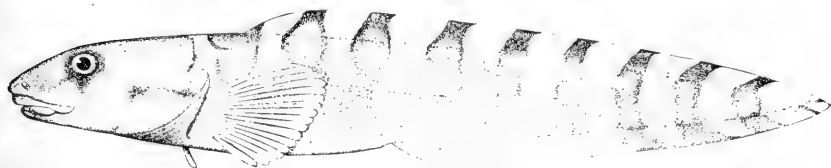

FIG. 485.

*Lycodes perspicillum*, Kr. (From Jordan and Evermann.)

*Zoarces*, Cuv. (Fig. 484); *Lycodes*, Reinh. (Fig. 485); *Lamprogrammus*, Alc.; *Lycocara*, Gill; *Gymnelis*, Reinh.; *Melanostigma*, Gthr.; *Neobythites*, G. and B.; *Typhlonus*, Gthr.; *Rhodichthys*, Coll.; *Aphyonius*, Gthr.; *Brotula*, Cuv.—marine. *Stygicola*, Gill; *Lucifuga*, Poey (Fig. 486)—caves of Cuba.

Family CONGROGADIDAE. Spineless, eel-shaped Blennies, with thickened lips, a suborbital shelf, and the small post-temporal fixed to the skull. No pelvic fins; gill-membranes united, but free from the isthmus.

*Congrogadus*, Gthr.; Indo-Pacific. ? *Hierichthys*; Japan.

Family OPHIDIIDAE. Degenerate fish, allied to the Zoarcidae, which have lost the caudal fin, and have the pelvics placed very far forward below the mouth, and reduced to a forked filament. Many from the deep seas.

*Ophidium*, L.; *Lepophidium*, Gill; *Genypterus*, Phil.—Atlantic, Indian, and Pacific Oceans.

Family PODATELIDAE. Specialised forms perhaps allied to the Blenniidae. The protractile mouth is inferior, with minute teeth or toothless. The pelvic fins are reduced to a filament with two rays. The long anal is continuous with the caudal, the dorsal is short. Scaleless and spineless. The post-temporal is loosely attached and the perforate scapula remains cartilaginous; the radials are represented by a small plate of cartilage.

*Podateles (Ateleopus)*, Blgr.; deep seas near Japan and India.



FIG. 486.

*Lucifuga dentatus*, Poey; from the Caves of Cuba. (After Günther.)

SUB-TRIBE D. The trunk, and especially the head, becomes widened and depressed, the mouth, as a rule, very large, the teeth sharp, the gill-opening narrow, and the gills reduced. Neither a suborbital arch nor an eye-muscle canal is present. The pleural ribs are lost in all, and the epipleurals in all but the Batrachidae. The post-temporal is flat and fixed to the skull, while the supraclavicle becomes much lengthened. The scapula and coracoid are modified, and the radials tend to become lengthened, expanded distally, and reduced in number. The scales are generally absent or modified into spines or tubercles.

DIVISION 1. BATRACHI. The scapula and coracoid are reduced, and there are four or five radials. The gill-opening is moderately large and normally situated.

Family BATRACHIDAE. With a very large mouth and depressed head; a small spinous dorsal, and pelvic fins with one spine and two or three jointed rays; naked or with small scales. *Thalassophryne* has perforated poisonous opercular and dorsal spines. *Batrachus tau* has eggs relatively very large for a Teleost.

*Opsanus (Batrachus)*, Raf.; *Porichthys*, Gir.; *Thalassophryne*, Gthr.; *Thalassothia*, Berg.—tropical and temperate seas.

DIVISION 2. PEDICULATI. The scapula and coracoid are lengthened and project outwards, and the two or three elongated radials loosely articulated with them; a more or less prominent and jointed or genucled lobe is thus formed by the base of the pectoral fin. Although the

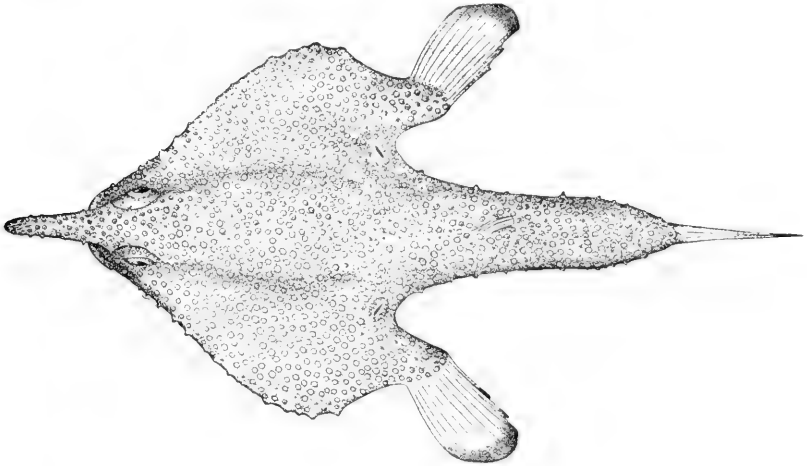

FIG. 487.

*Ogcocephalus vespertilio*, L. Dorsal view. (From Jordan and Evermann.)

opercular bones remain large, the branchial opening is reduced to a pore, generally behind the attachment of the pectoral. The caudal fin is well developed, the tail as a rule not lengthened, and the anal and soft dorsal fins short. The spinous dorsal becomes peculiarly modified into one or more separate spines extending on to the snout. Here the anterior spine

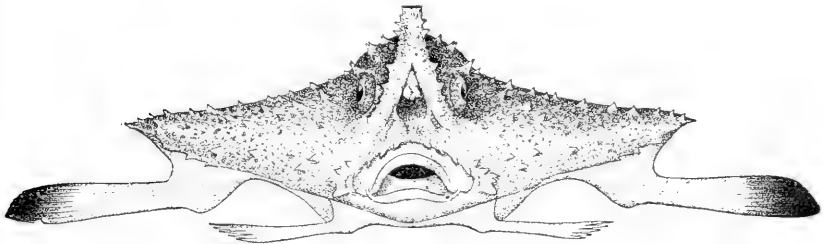

FIG. 488.

*Ogcocephalus vespertilio*, L. Anterior view. (From Jordan and Evermann.)

is developed into a movable lure, often with a fleshy terminal appendage, which can be dangled in front of the mouth (Fig. 489). Branching fleshy outgrowths simulating seaweed, etc., are often distributed over the body. So strangely modified is the structure of these fish that they are often placed in a separate sub-order; they appear, however, to be merely specialised Blenniiformes.

1. With a very wide head and large mouth, terminal, or directed upwards; and the gill-opening below or behind the base of the pectoral.

Family LOPHIIDAE. In these Fishing-Frogs, or Anglers, the pectoral fin is scarcely geniculated, and has two radials. The pelvic has one spine and five jointed rays, and is not much modified.

*Lophius*, Art., 'Angler'; tropical and temperate seas; Eocene, Italy. *Chirolophus*, Sw.; *Lophiomus*, Gill.

Family CERATIIDAE. The scarcely geniculated pectoral has three radials. The pelvics have disappeared, also the scales. They inhabit the deep seas, and the skeleton is imperfectly ossified.

*Ceratias*, Kröy.; *Aceratias*, Br.; *Himantolophus*, Rhdt.; *Melanococtus*, Gthr.; *Onirodes*, Lütke. (Fig. 489); *Liocetus*, Gthr.; *Linophryne*, Coll.

Family ANTENNARIIDAE. The lobe of the pectoral forms a distinct angle or geniculation, and has three radials. The pelvics have four or five rays, and project outwards. As a rule, two large fleshy processes project

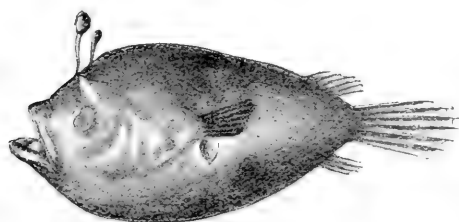

FIG. 489.

*Onirodes glomerosus*, deep-sea Angler from the Indian Ocean with rudimentary subcutaneous eyes. (After Alcock, *Naturalist in Indian Seas*.)

above the head. *Chaunax* lives in the deep sea and can inflate its abdomen like a Gymnodont.

*Antennarius*, Com.; *Chaunax*, Lowe; *Saccarius*, Gthr.; *Pterophryne*, Gill; *Brachionichthys*, Blkr.—warm seas.

2. The gill-pore is below and behind the base of the pectoral; the mouth of moderate size becomes inferior, while the snout is produced into a long tentacle provided with a phosphorescent organ at its tip.

Family GIGANTACTINIDAE. A deep-sea fish resembling the Ceratiidae in structure, but covered with small spines. The pelvics are absent.

*Gigantactis*, Brauer; Indian Ocean.

3. A rather small and more or less inferior mouth. The gill-opening is above the base of the pectoral, which is strongly geniculated. The pelvic fins, with five dermotrichs, project strongly outwards, and like the pectorals are adapted for walking (Figs. 487-8). Usually there is a long snout, below which may be lodged the lure, the only remains of the spinous dorsal. The body in the pectoral region becomes greatly expanded, and is covered with tubercles or spines.

Family MALTHIDAE. There are three pectoral radials; the teeth may be villiform. The gills may be reduced to two.

*Malthe*, Cuv.; *Malthopsis*, Alc.; *Coelophrys*, Br.; *Dibranchus*, Ptrs.; *Ogcocephalus*, Fisch. (Figs. 487-8)—chiefly deep-sea, tropical.

#### TRIBE 6. SCOMBRIFORMES.

Although difficult to distinguish by definition from the closely allied Perciformes, this appears to be a natural assemblage of related families.

The dorsal and anal spines are few and feeble; there is no subocular shelf. The most distinctive character is seen in the caudal fin: the caudal pedicle is constricted, and the vertebral column ends in a very symmetrical hypural bone; the fin is deeply forked, and supported by lepidotrichia conspicuously symmetrical about the median axis, with closely approximated bases, forked, and embracing the hypurals, which

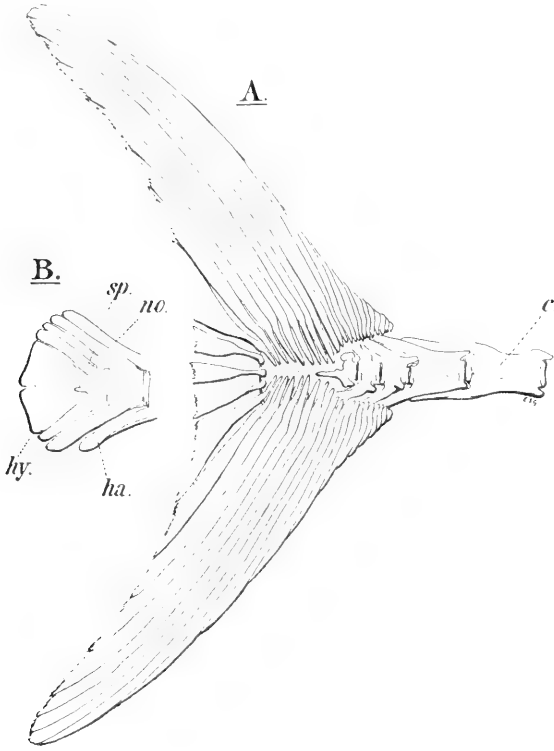

FIG. 490.

A, skeleton of the tail of *Thynnus vulgaris*, Cuv. and Val., Tunny fish. B, terminal caudal vertebrae of *Scomber scomber*, L., Mackerel. c, centrum; ha, haemal arch; hy, hypural compound bone, partially concealed in A by the dermal rays; no, neural arch; sp, spine.

they may almost completely conceal (Fig. 490). The tail is often keeled, and the hypural spine strongly developed. The pelvic fins, except when reduced, have the usual single anterior spine, and five lepidotrichia. The scales are cycloid as a rule and tend to disappear. Usually the gill-openings are very wide, the gill-membranes free from the isthmus, the gill-rakers very well developed, the opercular bones unarmed in the adult, the air-bladder large, and the pyloric caeca numerous.

1. The premaxillae are at most slightly protractile. With a deep

body, elongate dorsal and anal fins without distinct spinous portions, and usually large cycloid scales often connected together by processes.

Family BRAMIDAE. With about forty-five vertebrae. In *Pteraclis* and its allies the median fins may be greatly expanded. The pleural ribs often are much widened, and the coracoid becomes very large. *Pteraclis* has enormous dorsal and anal fins.

*Brama*, B. and S. ; *Bentenia* ; *Pteraclis*, Gron. ; *Pterycombus*, Fries.

2. The premaxillae are protractile ; and the cycloid scales small or absent, except along the lateral line, where they may be enlarged into scutes. Generally there is a special spinous division of the dorsal and anal fins ; the latter may be detached. The body is slightly deepened, and there are about twenty-five vertebrae.

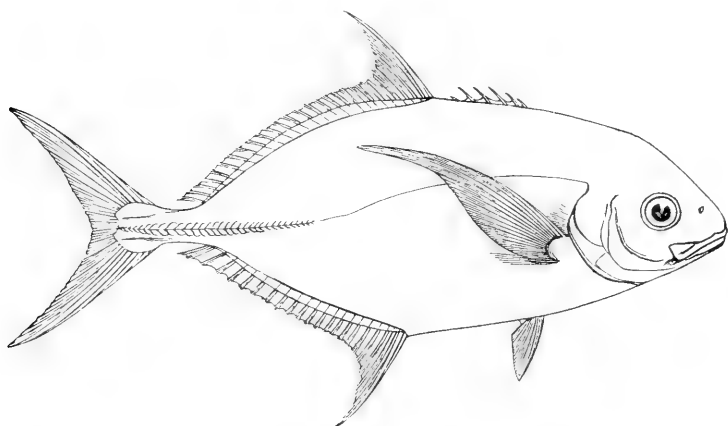

FIG. 491.

*Caranx ferdau*, Forsk. (After Günther.)

Family CARANGIDAE. The spinous dorsal is often much reduced, and the spines vestigial. Sometimes free spines in front of the anal. The scales may be lost.

*Vomeropsis*, Heck. ; *Carangopsis*, Ag. ; *Semiophorus*, Ag. (Fig. 492) ; *Ductor*, Ag.—Eocene, Italy. *Caranx*, Lac. (Fig. 491) ; *Seriola*, Cuv. ; *Lichia*, Cuv. ; *Mene*, Lac.—wide range ; and Eocene, Italy. *Selene*, Lac. ; *Naucrates*, Cuv. ; *Trachynotus*, Lac. ; *Paropsis*, Jen. ; *Chorinemus*, C. and V. ; *Vomer*, C. and V.

Family RHACHICENTRIDAE. Differing from the preceding chiefly in the absence of parapophyses. There are small scales.

*Rhachicentrus*, Kp. ; Atlantic and Indian Ocean.

3. Mouth not protractile, the cycloid scales are usually small or absent, the body becomes elongated, and there are no free spines, but there may be a separate spinous dorsal fin. No parapophyses, except in the Xiphiidae.

Family SCOMBRIDAE. The anal and posterior dorsal fins are broken up behind into a series of finlets each supported by a radial. The spinous dorsal folds back into a groove. From thirty to fifty vertebrae, and the pectoral fins inserted high up. *Gastrochisma* has enormous pelvics, which fold into a ventral groove (Fig. 494).

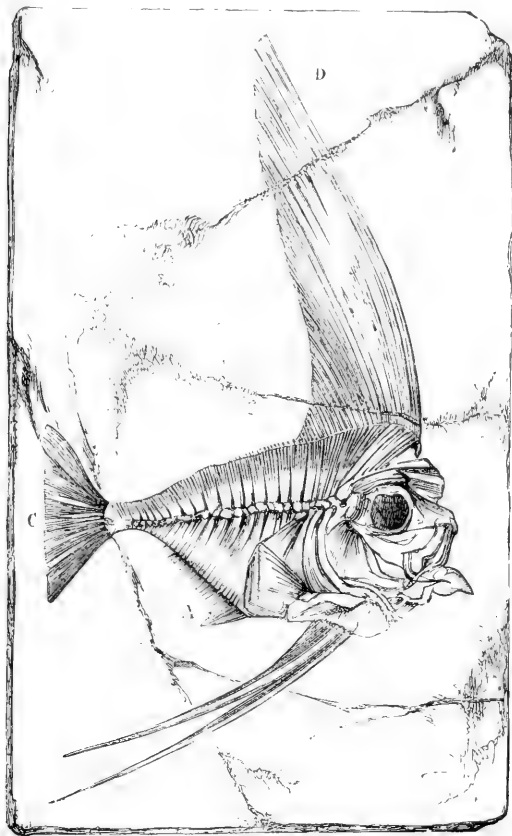

FIG. 492.

*Semtophorus velicans*, Bl.; Upper Eocene, Monte Bolca. (From Günther, after Agassiz).  
A, anal, C, caudal, and D, dorsal fin.

*Isurichthys*, A. S. W.; *Palimphytes*, Ag.—Oligocene, Europe. *Eothynnus*, A. S. W.; *Scobrinius*, A. S. W.; *Sphyraenodus*, Ag.—Eocene, Europe. *Cybium*, Cuv.; *Auxis*, Cuv.; *Thynnus*, Cuv. (Fig. 493)—Atlantic, Indian Ocean; and Eocene, Europe. *Scomber*, L.; warm and temperate seas; and Oligocene, Europe. *Sarda*, Cuv.; *Acanthocybium*, Gill; *Gastrochisma*, Rich. (Fig. 494).

Family TRICHIURIDÆ. The pectoral fins are inserted low down, and the body much compressed. Starting from Mackerel-like forms, such as *Thyrsites*, the body gradually acquires a very elongate, band-like shape. At the same time the vertebrae increase in number, and the originally

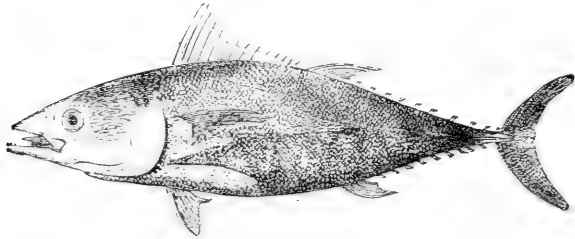

FIG. 493.

*Thygnus thynnus*, L. (After Günther.)

distinct spinous portion becomes continuous with the soft portion of the dorsal, the tail tapers to a point, while the caudal fin finally disappears, as in *Trichiurus*. The pelvics are likewise lost. The teeth become very powerful and sharp.

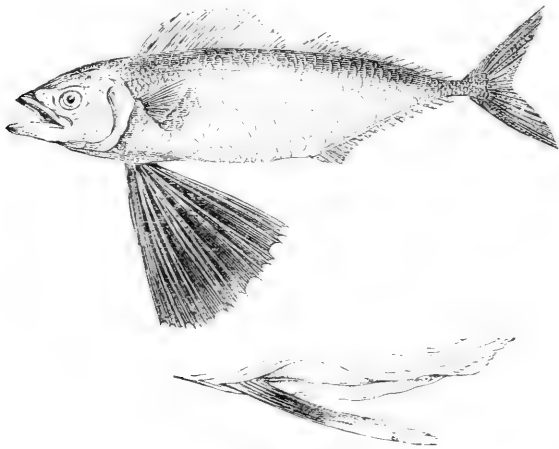

FIG. 494.

*Gastrochisna melampus*, Rich. The lower figure shows the groove into which the pelvic fins can be folded. (After Günther.)

*Thyrsitocephalus*, von K.; Oligocene, Europe. *Thyrsites*, C. and V.; *Lepidopus*, Gou. (Fig. 495)—widely distributed; Oligocene, Europe. *Epinnula*, Poey; *Nealotus*, Johns.; *Dicrotus*, Gthr.; *Trichiurus*, L. (Fig. 496); *Benthodesmus*, Goode; *Eupleurogrammus*, Gill; *Gempylus*, C. and V.

Family CORYPHAENIDÆ. The body is elongate, compressed, with very blunt snout, and large deep head, on to which extends the un-



divided dorsal. The pectorals are small. The pelvics fold into a groove. About thirty vertebrae. Small cycloid scales, and large teeth. No air-bladder.

*Coryphaena*, Art. 'Dolphin'; warm seas.

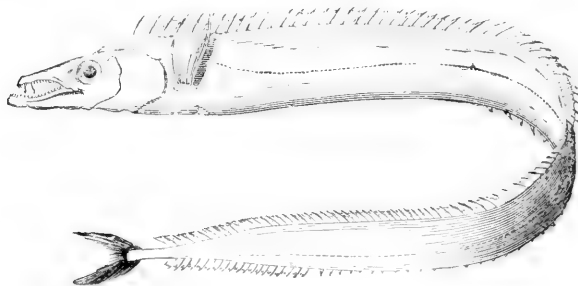

FIG. 495.

*Lepidopus caudatus*, Euphr. (After Günther.)

Family LUVARIDAE. With a large head and very short snout, but the dorsal fin far back, and a very feeble dentition. About twenty-three vertebrae. The pelvic bones are fused, and the pelvic fins small. There is a small gill-opening. The post-temporal is enormous.

*Luvarus* (*Ausoniu*), Raf.; Mediterranean, Atlantic, Pacific.

4. The body becomes much lengthened, and the jaws produced into a sharp rostrum. The dorsal and haemal spines expand into flattened plates. The teeth are minute or absent.

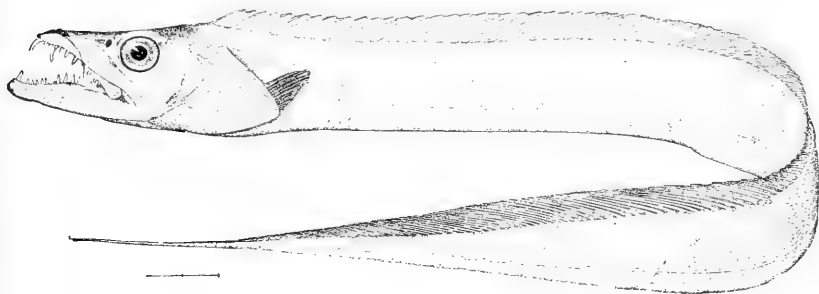

FIG. 496.

*Trichiurus lepturus*, L. (From Jordan and Evermann.)

Family PALAEO RHYNCHIDAE. The ribs completely encircle the abdomen. The pectoral fins are small, and the pelvic fins large. From fifty to sixty vertebrae.

*Hemirhynchus*, Ag.; Eocene, Europe. *Palaerhynchus*, Bl.; Oligocene, Europe.

Family HISTIOPHORIDAE. The lengthened lower jaw bears a pre-dentary bone. The dorsal and anal fins more or less subdivided; the

dorsal often of huge size. The upper jaw is produced into a long spear-like 'sword.' The teeth are small, the air-bladder large and sacculate, the scales elongate. About twenty-four vertebrae. The pelvic fins are reduced, having only one to three dermal rays.

*Xiphiorhynchus*, van Ben.; *Ancestrus*, A. S. W.—Eocene, Europe. *Histiophorus*, Lac. (Fig. 497); warm seas; Eocene, Europe. *Tetrapterus*, Raf.

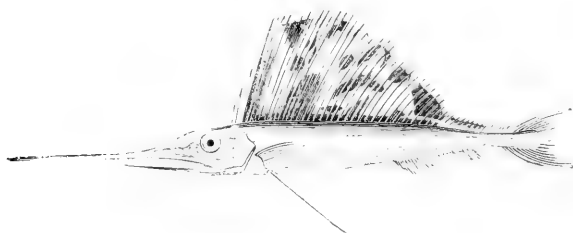

FIG. 497.

*Histiophorus pulchellus*, C. and V. (After Günther.)

Family XIPHIIDAE: The Sword-Fish, has twenty-six vertebrae, no teeth, a very long flattened rostrum formed chiefly by the upper jaw, and no pelvic fins. The young have both teeth on the jaws and granulations in the skin.

*Xiphias*, Art.; world-wide range.

#### TRIBE 7. KURTIFORMES.

This tribe contains a single aberrant genus, *Kurtus*, with a short dorsal and long anal fin, each having a few small spines; pelvic fins thoracic in position, and provided with one spine and five jointed rays; and small pectorals supported by four radials on the coracoid. The scapula is absent. Most of the ribs are fixed to the ossified wall of the air-bladder. There is no subocular shelf, and the occipital crest is developed into a remarkable hook-like process. Minute scales cover the compressed body. The teeth are villiform.

Family KURTIDAE. *Kurtus*, Bl.; Indian and Pacific Oceans.

#### Subdivision 3. ZEORHOMBIFORMES.

In this group are placed the asymmetrical Flat-Fish, and two families supposed to represent remnants of the symmetrical ancestral forms which gave rise to them. The body is always much compressed, and very deep; the dorsal and anal fins are elongate; the abdominal region is shortened and the caudal lengthened; the caudal fin is normal, without, however, the spine usually found on the side of the hypural bone; and the pelvic fins have from seven to nine dermal rays. Transverse parapophyses, pleural ribs, and

epipleura are generally present; and some of the anterior radials of the anal are usually fused to a single strong bone connected with the haemal arches, as is often the case in deep-bodied fish. The air-bladder is closed. On the whole, the symmetrical forms resemble in structure the Berycidae; but the Pleuronectidae become much modified, and lose all trace of spines on the fins. Owing chiefly to this fact, they were classed with the Gadidae as Anacanthini by J. Müller [306]; but there can be no doubt that they have no special affinity with the Cods. Whether the Zeidae and Amphistiidae, as suggested by Thilo [436] and Boulenger [40], are really closely related to them must not be considered as definitely established. Both the Amphistiidae and the Pleuronectidae appear in Eocene deposits.

## BRANCH A.

Symmetrical fish retaining well-developed spines in the fins, and an eye-muscle canal. The gills become reduced to three and a half.

Family ZEIDAE (Cyttidae). The mouth is protractile; the spinous dorsal well differentiated, but not quite separated; the anal with a detached front portion bearing from one to four spines; the pelvics with one spine and six to eight jointed rays. Very variable is the squamation, which may consist of small scales joined together in transverse rows, or of larger scales, sometimes with bony scutes at the base of the dorsal and ventral fins and along the edge of the body (*Zeus*). The post-temporal is forked, but fixed to the skull; three out of four of the pectoral radials rest on the perforate scapula. The vertebrae are numerous, from thirty to forty-six.

*Cyttoides*, Wett.; Oligocene, Europe. *Zeus*, Art., 'John Dory'; warm seas; Pliocene, Europe. *Cyttus*, Gthr.; *Cyttopsis*, Gill; *Zenion*, J. and E.—warm seas.

## BRANCH B.

In which the spinous portions of the very elongated median fins become reduced, and evenly continuous with the posterior soft portions (Fig. 498). While the more primitive forms retain their symmetry (Amphistiidae), the Pleuronectidae undergo modifications related to their habit of swimming and resting on the sea-bottom on one side.

Family AMPHISTIIDAE. This extinct family distinctly approaches the Flat-Fish in structure, but retains the bilateral symmetry. There are twenty-four vertebrae, small spines on the dorsal and anal fins, one spine and eight soft rays in the pelvic, and the scaling is normal.

*Amphistium*, Ag. (Fig. 498); Eocene, Europe.

Family PLEURONECTIDAE. The spines, the eye-muscle canal, and the air-bladder are lost. The changes which bring about the secondary asymmetry of the adult affect many organs in the body, and are effected during the lifetime of every individual. The embryo Pleuronectid and

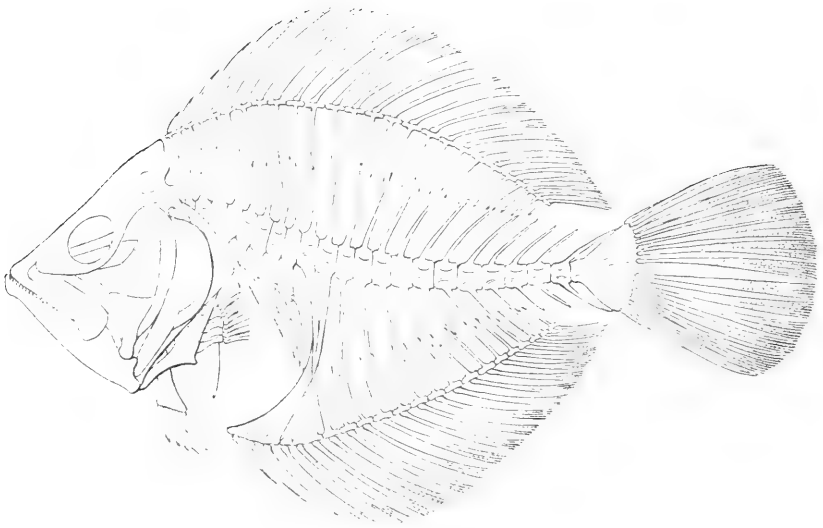

FIG. 498.

Restoration of *Amphistium paradoxum*, Ag.; Upper Eocene. (After Boulenger.)

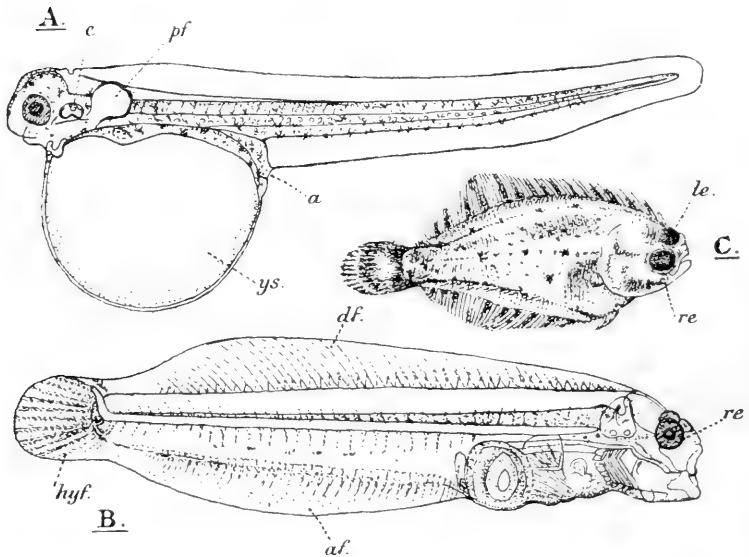

FIG. 499.

Enlarged views of three successive stages in the development of *Pleuronectes platessa*, L. (After Cole and Johnstone.) Stages A and B are still symmetrical. a, anus; a.f., anal fin; d.f., dorsal fin; e, ear; h.y.f., hypochordal caudal fin; l, left eye, which migrates; p.f., pectoral fin; r.e., right eye, which remains on the 'ocular' side; y.s., yolk-sac.

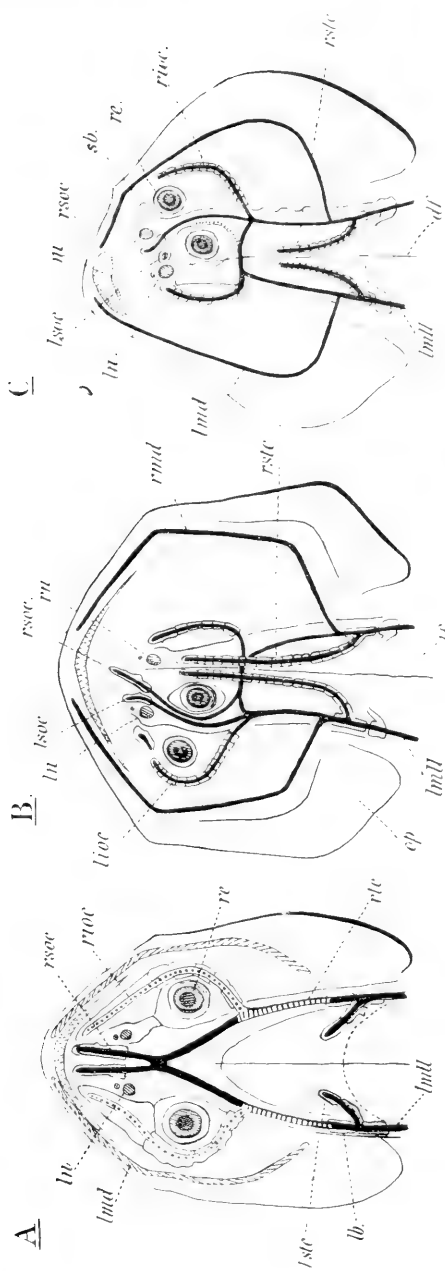

FIG. 500.

Diagrams of the lateral-line system on the head of A, *Gadus*; B, *Pleuronectes platessa*, L.; C, *Rhombus maroccanus*, L. (From Traquair, slightly modified.) *df*, line of dorsal fin; *lsc*, left canal ossicle; *lsc*, left infraorbital; *lmd*, left mandibular; *lmd*, left mandibular canal; *m*, mouth; *op*, operculum; *eye*, right eye; *eye*, right eye; *rsc*, right supra-temporal; *rsc*, right supra-temporal; *rsc*, right post-orbital canal; *rsc*, right supra-temporal; *sb*, detached suborbital (cp. Fig. 196).

even the free-swimming larva are structurally symmetrical; but in later stages the eye of one side is brought round until it occupies a position above the eye of the other side. Thus in the adult the two eyes lie on the same side, which is now carried upwards, and the lower side

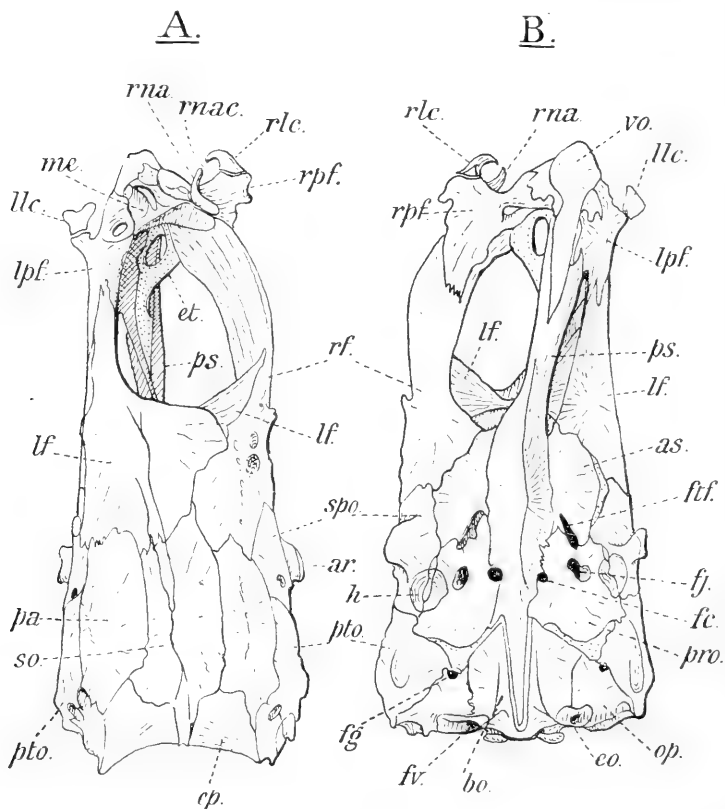

FIG. 501.

*Pleuronectes platessa*, L. (After F. J. Cole and J. Johnstone.) A, dorsal, and B, ventral view of skull, showing the torsion of the front region. *ar*, large process of right side; *as*, alispheroid; *bo*, basioccipital; *co*, exoccipital; *cp*, epiotic; *ct*, ethmoid cartilage; *fc*, carotid foramen; *fg*, glossopharyngeal foramen; *f.j*, jugular foramen; *f.t.f*, trigeminal and facial foramen; *f.v*, vagal foramen; *h*, socket for hyomandibular; *l.f*, left frontal; *l.lc*, left lachrymal; *l.pf*, left prefrontal; *me*, mesethmoid; *op*, opisthotic; *pa*, parietal; *pro*, prootic; *ps*, parasphenoid; *pto*, pterotic; *rf*, right frontal; *r.lc*, right lachrymal; *r.na*, right nasal; *r.na.c*, right nasal cavity; *r.pf*, right prefrontal.

is left 'blind.' The migrating eye may remain near the dorsal edge of the head, as in the more primitive genus *Psettodes* (Fig. 502); or it may move farther down on the 'ocular' side (*Pleuronectes*, *Solea*, Fig. 503). In this case the eye of that side also moves down, so as to allow more room; and sometimes, as in *Synaptura* (Fig. 504), the two eyes may come very close together, and the orbits become confluent near

the middle of the lateral surface of the head. The dorsal fin may now grow forward in a straight line on to the head (*Pleuronectes*, etc.); or even to near the end of the snout (*Rhombosolea*, *Cynoglossus*). The line marked by the fin on the head is not the true dorsal mid-line, for this has become distorted on to the ocular side, as is shown by the course of the lateral-line canals, and the bones of the skull (Fig. 500). The orbits are far forward, and as the eye shifts, the front end of the skull (and even the brain) becomes correspondingly distorted; the relations of the bones are considerably altered. For instance, the frontal of the blind side is twisted round, loses its original connection, and acquires a new connection with the prefrontal below, or dorsal to, the shifted eye (Fig. 501). The mouth, still wide and symmetrical in *Psettodes*, becomes smaller, and more and more distorted on to the blind side, on which alone the teeth may be developed. As was first clearly explained by Traquair [441a], the shifting of the eyes is brought about, not by one eye leaving

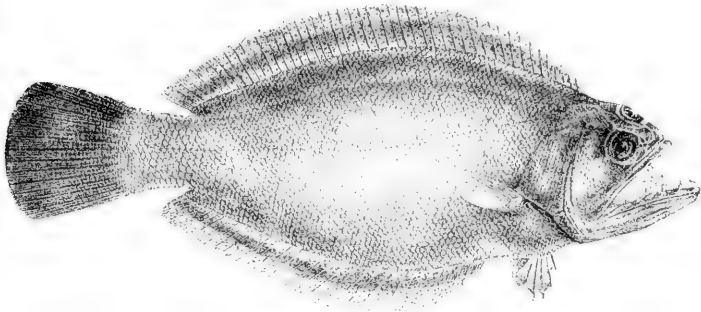

FIG. 502.

*Psettodes erumei*, B. and S. (After Day, *Fishes of India*.)

its socket to move across to the opposite side, but by the twisting of the whole anterior region of the head—an adaptation to a peculiar mode of life which affects almost all the other organs as well. The branchial opening becomes more restricted. The median fins become longer, extending forwards and backwards; in the most specialised genera, like *Cynoglossus*, the tail tapers to a point, the dorsal and anal fins being confluent at the tip. Asymmetry is not pronounced in the pectoral fins; but the radials are reduced generally to mere cartilaginous vestiges, and the post-temporal may lose its inner limb. The pelvic fins, bearing from five to seven dermatotrichia, may be distorted; that on the ocular side becoming elongated in the same line as the anal (Fig. 502). The behaviour of the nostrils during torsion varies in different genera: in some, *Solea*, the nostrils retain their position on the blind side; in *Pleuronectes* they migrate with the eye, but remain near the dorsal edge of the lower side; *Arnoglossus* has the dorsal fin passing forward below them. The anus is very far forward and median; but the urinogenital papilla of the male and urinary papilla of the female are brought on

to the ocular side. Owing to the forward growth of the anal fin, the radials of which meet the haemal arches, the abdominal cavity becomes excessively shortened, and the viscera may extend backwards on either side in blind coelomic diverticula (*Solea*). The pyloric caeca may be absent. The scales are cycloid or ctenoid. The vertebrae, twenty-four in number in *Psettodes*, may be much more numerous in higher genera.

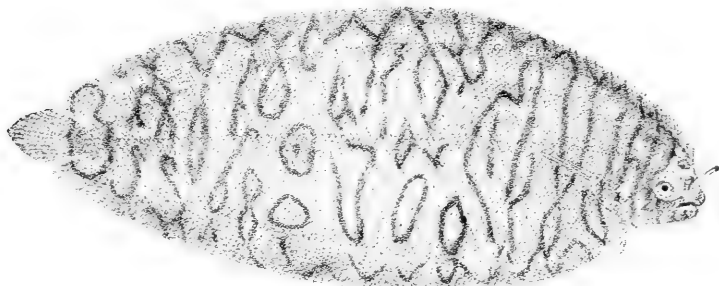

FIG. 503.

*Solea heterorhina*, Blkr. (After Day, *Fishes of India*.)

Concerning the asymmetry it is interesting to note that in *Psettodes* the eyes may be either on the right or on the left side; while in some genera like *Hippoglossus*, *Pleuronectes*, and *Solea*, they are on the right; and in others, like *Psetta*, *Arnoglossus*, and *Cynoglossus*, the left is the ocular side. Always there is a difference in colour between the two sides, the lower being white and the ocular strongly pigmented.



FIG. 504.

*Synaptura albomaculata*, Kp. (After Day, *Fishes of India*.)

(*Psetta*) *Rhombus*, Kl.; N. Atlantic, Mediterranean; and Eocene. *Solea*, Cuv. (Fig. 503); wide range, Miocene. *Psettodes*, Benn. (Fig. 502); *Ammotretis*, Gthr.; *Achirus*, Lac.; *Hippoglossus*, Cuv.; *Pleuronectes*, Art.; *Citharus*, Blkr.; *Rhomboidichthys*, Blkr.; *Arnoglossus*, Blkr.; *Zeugopterus*, Gotzsch; *Synaptura*, Ctr. (Fig. 504); *Cynoglossus*, H. B.; *Symphurus* (*Plagusia*)—all marine.



## Division 3. LAMPRIDIFORMES (Allotriognathi).

Quite recently the Taeniosomi of Gill have been joined with the Lamprididae and the Veliferidae to form this Division by Regan [348]. It is characterised by the compression of the body, the peculiar mechanism of the protractile mouth, and the presence of an orbitosphenoid (except in *Stylephorus*), a bone which has been lost in all the Acanthopterygii except the Berycidae.

The scales are reduced, being either very small or absent. The covering bones of the skull are, for the most part, deeply sunk; there is usually a remarkably large occipital crest. Whilst in other Acanthopterygii it is the premaxilla alone which slides forwards on the ethmoid, when the maxilla is pushed forwards by the palatine to protrude the mouth, in the Lampridiformes the maxilla itself moves forwards, sliding on the vomer and ethmoid. There is no supramaxilla, no subocular shelf, a short eye-muscle canal, and no opisthotic. The paired fins are spineless, and the pelvics may have as many as seventeen rays. The pelvic girdle is more or less closely connected to the coracoids. The air-bladder is closed, the dentition feeble.

The Lampridiformes are all marine, of either pelagic or deep-sea habit; they are unknown as fossils. They appear to be specialised forms derived from ancestors resembling the Berycidae, and have now diverged in two directions.

## SUBDIVISION 1.

## TRIBE SELENICHTHYES.

*Lampris* (Fig. 401, C) has a very deep compressed body and spineless fins; the pelvics may have seventeen dermal rays. The pelvic bones articulate with the very large expanded coracoids. Only three short pectoral radials are present, one of which rests on the coracoid; and the dermal rays partly spring from the scapula. There are forty-six vertebrae, without parapophyses, the ribs being strong and sessile. The maxillaries take a share in the margin of the toothless mouth.

Family LAMPRIDIDAE. *Lampris*, Retzius, the brilliantly coloured King-Fish; Mediterranean, Atlantic, and Pacific (Fig. 401, C).

## SUBDIVISION 2.

The mesethmoid is behind the prefrontals, and the frontals cover an anterior chamber on the skull. The two pelvic bones project upwards between the coracoids.

## TRIBE 1. HISTICHTHYES.

The body is deep and compressed; there are two spinous rays in the dorsal fin, and eight or nine rays in the pelvic, and the pectoral dermal rays rest partly on the scapula and partly on the four radials; one of these articulates with the coracoid. The ribs are attached to parapophyses; there are thirty-three vertebrae.

Family VELIFERIDAE. *Velifer*, Schleg.

## TRIBE 2. TAENIOSOMI.

The very compressed body is elongated, and may attain a length of 20 feet, with some ninety vertebrae. The dorsal fin is very long, and is supported by unjointed dermal rays. The anal is short or absent. Parapophyses are present, but the ribs are more or less completely reduced. Of the three pectoral radials at least two rest on the coracoid. The post-temporal has become simple.

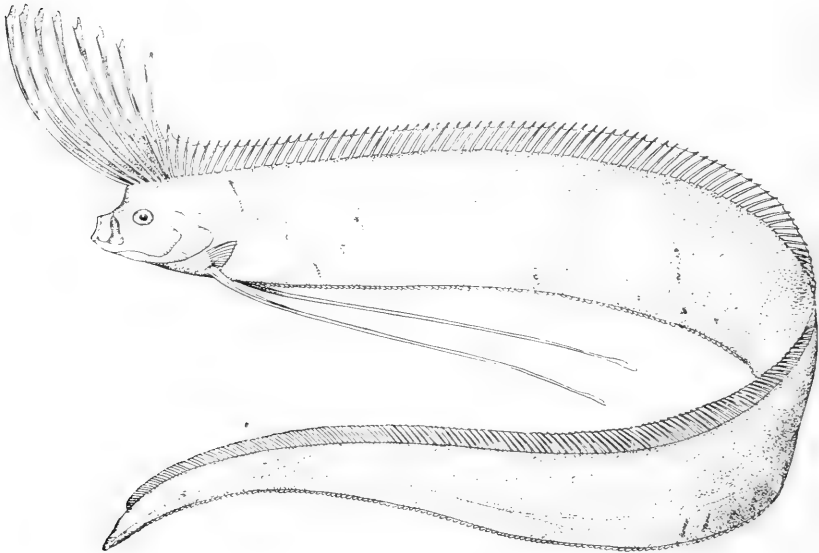

FIG. 505.

*Regalecus glesne*, Asc. (From Jordan and Evermann.)

Family LOPHOTIDAE. The pelvic fins, if present, are small, widely separated, and with five or six dermatrichs. The anus is near the hind end of the body, with a small anal fin just behind it. A long spine represents the first dorsal ray.

*Lophotes*, Giorna; warm seas. *Eumecichthyes*, Regan.

Family TRACHYPTERIDAE. The pelvic fins are close together, but the dermal rays may be reduced to one (*Regalecus*). The anus is about

half-way up the body, and the anal fin has been lost. The caudal fin has disappeared in *Regalecus*, but in *Trachypterus* is strangely modified, the dermal rays being separated into two diverging fascicles (Fig. 506).

*Trachypterus*, Gouan (Fig. 506), and *Regalecus*, Brunn (Fig. 505)—widely distributed.

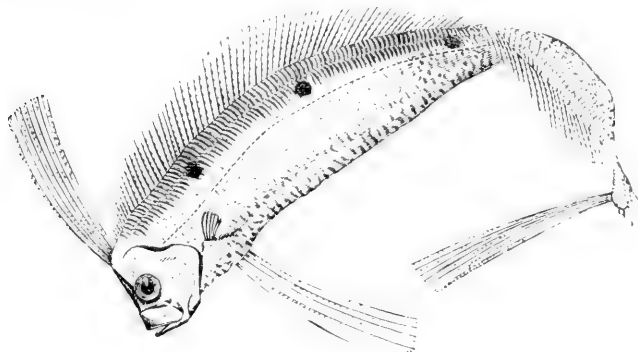

FIG. 506.

*Trachypterus tucua*, Schm. (After Günther.)

Family STYLEPHORIDÆ. The deep-sea genus *Stylephorus* is very much specialised, having lost the pelvic fins, the arches of the vertebral column, the orbitosphenoid, and the greater part of the pterygo-palatine bar. The ceratohyals are widely separated below, the ethmoid is carried by the parasphenoid far from the vomer, and the lower jaw has acquired a huge size in spite of the presence of a very small tubular mouth (Starks).

*Stylephorus*, Shaw ; Pacific.

#### Division 4. MASTACEMBELIFORMES (Opisthomi).

A small group of Acanthopterygian fishes which have acquired a deceptive resemblance to the Eels, not only in outward shape but also in internal structure. The body is elongate, the tail gephyrocercal, the long dorsal and anal fins confluent at its tip; the snout is prolonged as a pointed movable appendage; the pelvic fins have been lost. The dorsal fin is continued forwards as a series of detached spines, and spines are also present in the anal fin. The scales are very small. The nostril is single on each side, the non-protractile mouth is bordered by the premaxillae. The parietals are separated by the supraoccipital which joins the frontals; and the pectoral girdle is attached, not to the skull, but to the vertebral column. The numerous trunk vertebrae bear transverse processes and ribs. The air-bladder is closed. These fish are adapted to air-breathing, the branchial opening being small and ventral.

The affinities of the Mastacembeliformes are obscure; but they appear to be highly specialised forms allied perhaps to the Blenniidae, with which they are frequently associated.

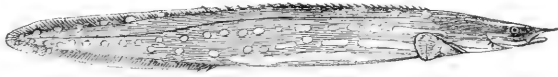

FIG. 507.

*Mastacembelus argus*, Gthr. (After Günther.)

Family MASTACEMBELIDAE. *Mastacembelus*, Gron. (Fig. 507), and *Rhynchobdella*, Schu.—tropical Asia and Africa.

### Series 7.

#### Sub-Order 8. GADIFORMES (Anacanthini).

Whilst showing many points of resemblance to some of the Acanthopterygii (Blenniiformes), this sub-order preserves certain apparently primitive characters which seem to indicate that it branched off at an early time, and that the resemblances are due more to convergence than to close affinity (Boulenger [42]; Regan [344*a*]).

The cranial bones are mostly deeply sunk below the surface; the frontals are often fused; the supraoccipital is well developed, with a high median crest, and separates the parietals (Fig. 328); the opisthotic is peculiarly large, growing downwards so as to separate the prootic from the exoccipital. There is no eye-muscle canal, and no basisphenoid. But by far the most important characteristic of the Gadiform skull concerns the interorbital region. Here the interorbital septum is membranous, and really only developed below the cranial cavity; for the narrow channel in which run the olfactory nerves or tracts is a continuation of the cranial cavity itself (Fig. 508). Indeed, in the Gadidae, alone among the living Teleostei with the exception of the Cypriniformes, the brain is continued far forwards, the olfactory bulbs being close to the nasal sacs (Fig. 353). The olfactory nerves or tracts, then, do not pass through the orbital cavities as in the higher Teleostei (with the exception of the Galaxiidae). This peculiar relation of the septum points to the origin of the Gadiformes from some remote ancestral fish, possibly even outside the Group B in which they are here provisionally included. Spinous rays are found only in the dorsal fin of some Macrurids. The scapular foramen is between the scapula and the coracoid, or rarely in the scapula (*Gadomus*). The coracoid is imperforate. The number of pectoral radials varies

from three in *Gadomus* to six in *Macrurus* and ten in *Muraenolepis*. This increase above the usual number, five, is probably secondary (p. 404). The pelvic fins, which may have as many as twelve dermal rays, are very far forward, anterior to the pectorals in the

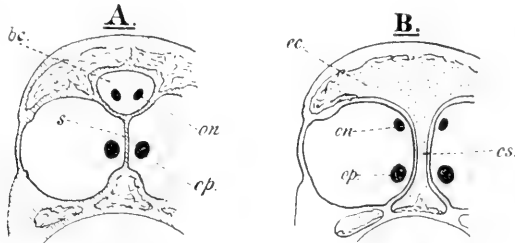

FIG. 508.

Diagrams of a transverse section through the front of the orbit—A, of *Gadus*, B, of *Percu*, to show the position of the olfactory nerves and tracts. *b.c.*, brain-cavity of cranium; *c.s.*, cartilaginous interorbital septum; *e.c.*, ethmoid cartilage; *o.n.*, olfactory nerve in B, olfactory tract in A; *o.p.*, optic nerve; *s.*, membranous interorbital septum.

Gadidae, but the girdle is only loosely attached to the cleithra. Usually pleural ribs as well as epipleurals are present on the trunk vertebrae, except the first two.

Scales generally cover the head; they are cycloid in the

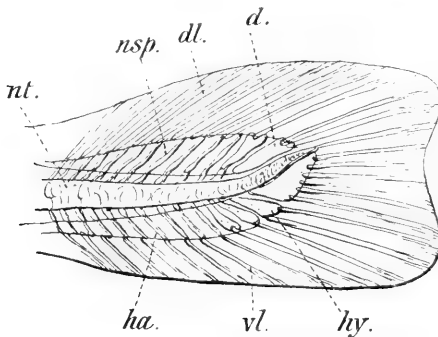

FIG. 509.

Tail of a young Cod. (After A. Agassiz.) *d.*, dorsal cartilage (neural arch?); *dl.*, lepidotrichia of dorsal lobe of caudal fin; *h.a.*, haemal arch; *hy.*, hypural; *n.sp.*, neural spine; *nt.*, notochord.

Gadidae and some Macruridae; but in the latter family they become spinous (Fig. 512, B). The air-bladder is closed, and the pseudobranch usually sunk and glandular. Often a mental barbel is present. The Gadiformes have not been found below the Miocene and Oligocene rocks.

The median fins become outwardly subdivided in a very characteristic manner: in the Macruridae there is a small anterior dorsal, as in all Gadiformes, and the long posterior dorsal and anal dwindle gradually to the end of the tapering tail; but in the Gadidae these two fins become differentiated from a pseudocaudal, and again subdivided into two dorsals and two anals (Fig. 514). The tip of the tail is produced to a fine straight point in Macruridae

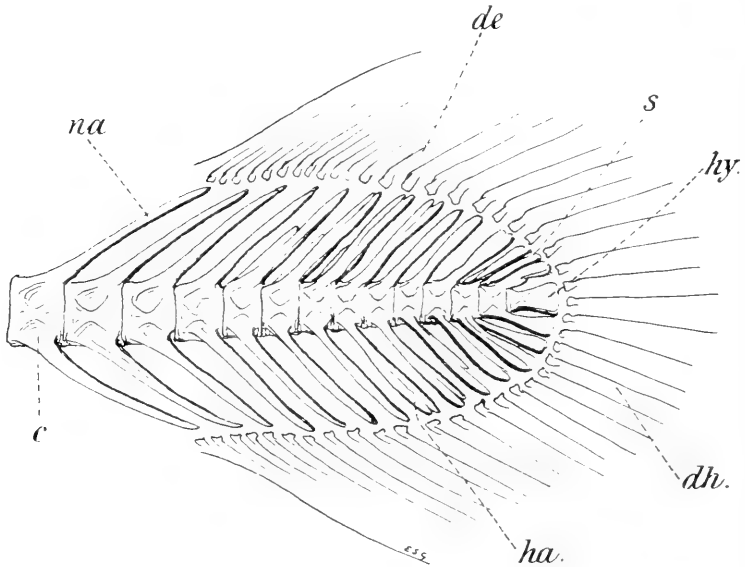

FIG. 510.

Tail end of the vertebral column of *Gadus morhua*, L. Only the base of the dermal rays is indicated. *c*, centrum; *d.e.*, dorsal (epichordal) dermatrichia; *d.h.*, ventral (hypochordal) dermatrichia; *ha*, haemal spine; *hy*, hypural; *na*, neural spine; *s*, detached spine (or radial).

(gephyrocercal); but the homocercal tip is merged, in Gadidae, with portions of the dorsal and anal fins contributing to form a pseudocaudal, having the outward appearance of a diphyocercal fin. This tail fin, however, differs considerably in internal structure from that of all other fish; it has a large dorsal lobe similar to the ventral lobe, and like it supported by the prolongations of a large number of vertebral arches (Figs. 509, 510).

#### DIVISION 1.

The first vertebra is normally joined to the skull.

Family MACRURIDAE. Modified deep-sea fish in which the trunk becomes shortened, the tail tapers to a filament, the dentition becomes

reduced, the mouth, which is protractile, diminishes in size, and a prominent rostrum develops above it (Fig. 511). The rostral process is supported by the enlarged nasals and preorbitals. The eyes are very large.

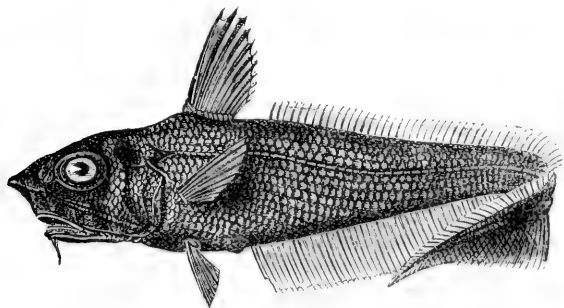

FIG. 511.

*Macrurus australis*, Rich. (After Günther.)

An anterior spinous ray is found in the dorsal of the sub-family Macrurinae. There is a specialised larval form (*Krohnii*) with filamentous extensions of the pelvic fins.

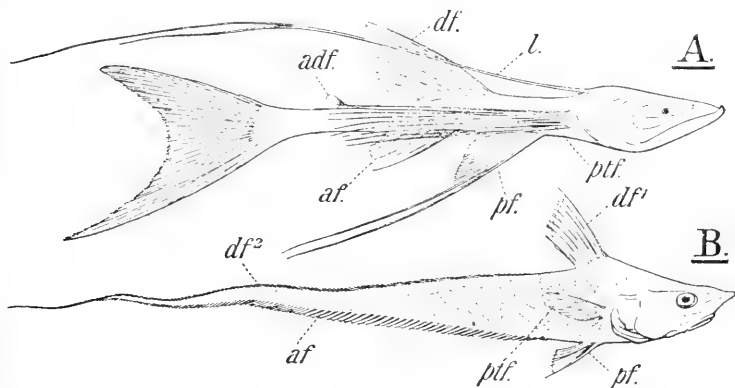

FIG. 512.

A, *Bathypterois longicauda*, Gthr. B, *Macrurus filicauda*, Gthr. (After Günther.) *adf*, adipose, *af*, anal, *df*, dorsal, *pf*, pelvic, and *ptf*, pectoral fin; *l*, filament, probably elongated lepidotrichia of anterior dorsal fin.

Sub-Family BATHYGADINAE. Such primitive genera as *Gadomus* have a terminal mouth, no rostrum, nearly continuous dorsal fins, a scapular foramen, and cycloid scales.

*Gadomus*; *Bathygadus*, Gthr.

Sub-Family MACRURINAE. With a spine on the first dorsal fin, and the first gill-slit narrowed to a small aperture.

*Macrurus*, Bl.; widely distributed in deep seas (Figs. 511-12).

## DIVISION 2.

The first neural arch is sutured to the exoccipitals, and its spine attached to the supraoccipital crest. The pelvic fins are farther forward.



FIG. 513.

*Lota vulgaris*, Cuv., the Burbot. (After Cuvier.) 1, barbel; 2, pelvic, 3, pectoral, 4, anal, 5, caudal, 6, first dorsal, and 7, second dorsal fin.

Family GADIDAE. The Cods have small cycloid scales, the pseudo-caudal fin described above, jugular pelvic fins, with from one to nine dermal rays, a wide mouth, bordered above by the premaxilla; powerful teeth on the premaxilla, dentary, and palate.

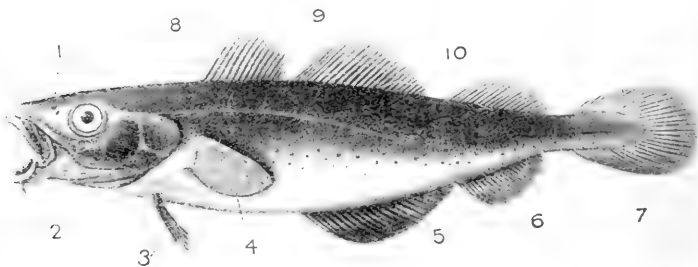

FIG. 514.

*Gadus morhua*, L., the Cod. (After Cuvier.) 1, nostrils; 2, barbel; 3, pelvic, 4, pectoral, 5, first anal, 6, second anal, 7, caudal, 8, first dorsal, 9, second dorsal, and 10, third dorsal fin.

*Nemopteryx*, Ag.; Oligocene. *Gadus*, Art. (Fig. 514); *Brosmius*, Cuv. —Northern hemisphere; Miocene. *Merluccius*, Cuv.; *Motella*, Cuv.; *Lota*, Cuv. (Fig. 513); *Raniceps*, Cuv.; *Phycis*, Cuv.; *Molva*, Nils.; *Haloporphyrus*, Gthr.; *Bregmaceros*, Th.



Family MURAENOLEPIDAE. Represented by a single genus, differing from the Gadidae in the absence of a separate pseudocaudal, the narrowness of the gill-openings, the very large number of pectoral radials, and the disposition of the oblong scales in rows crossing at right angles.

*Muraenolepis*, Gthr. ; Kerguelen.

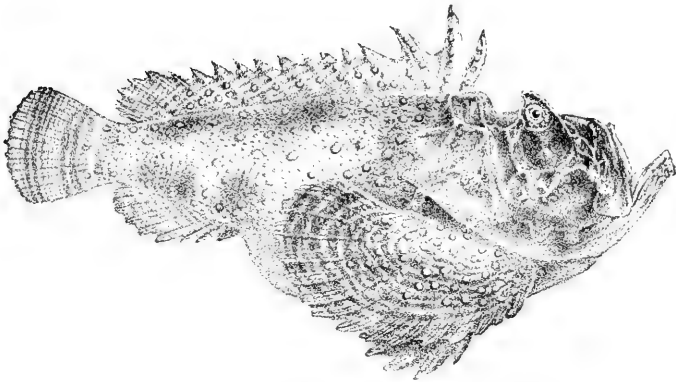

*Syancidium horridum*, L. (After Day, *Fishes of India*.)

## LITERATURE.

1. *Abel, O.* Fossile Flngfische. Jahrb. geol. Reichsanst. vol. lvi., 1906.
2. *Agassiz, A.* On the Young Stages of some Osseous Fishes. Proc. Amer. Acad. vol. xiii., 1877. Devel. of Flounders, *ibid.* vol. xiv., 1878.
3. — The Devel. of *Lepidosteus*. Proc. Amer. Acad. vol. xiii., 1878.
4. *Agassiz, L.* Recherches sur les poissons fossiles, vols. i.-v.; Supplement, Monogr. des poissons fossiles du syst. Dévonien. Neuchâtel, 1833-1844.
5. *Ahlborn, F.* Unters. ii. d. Gehirn d. Petromyzonten. Zeitschr. f. wiss. Zool. vol. xxxix., 1883.
6. *Alcock, A.* Embryonic Hist. of Pteroplatea. Ann. Mag. Nat. Hist. vol. x., 1892.
7. *Alcock, R.* The Peripheral Distribution of the Cranial Nerves of *Ammocaetes*. Journ. Anat. and Phys. vol. xxxiii., 1898-1899.
8. *Allen, W. F.* The Blood Vascular System of the Loricati. Proc. Wash. Ac. Sci. vol. vii., 1905.
9. *Allis, E. P., Jr.* The Anatomy and Development of the Lateral-Line System in *Amia calva*. Journ. Morph. ii., 1889.
10. — The Cranial Muscles and Cranial and First Spinal Nerves in *Amia calva*. Journ. Morph. xi., 1895; and *ibid.*, xii., 1897.
11. — The Sphenoidal Region of the Skull of *Amia calva*. Zool. Bull. vol. i., 1897.
12. — On Certain Homologies of the Squamosal Intercalar Exoccipital and Extrascapular Bones in *Amia calva*. Anat. Anz. vol. xvi., 1899.
13. — The Premaxillary and Maxillary Bones, and the Maxillary and Mandibular Breathing Valves of *Polypterus bichir*. Anat. Anz. vol. xviii., 1900.
14. — The Lateral Sensory Canals of *Polypterus bichir*. Anat. Anz. vol. xvii., 1900.
15. — The Pseudobranchial Circulation in *Amia calva*. Zool. Jahrb., Abt. Anat. v. xiv., 1901.
16. — The Lateral Sensory System in the Muraenidae. Int. Monat. Anat. u. Phys. vol. xx., 1903.
17. — On Certain Features of the Cranial Anatomy of *Bdellostoma Dombeyi*. Anat. Anz. vol. xxiii., 1903.
18. — Lateral Canals and Cranial Bones of *Polyodon folium*. Zool. Jahrb., Abt. Anat. vol. xvii., 1903.
19. — The Latero-sensory Canals and Related Bones in Fishes. Intern. Mon. An. u. Phys. vol. xxi., 1905.
- 19a. *Alth, A. von.* Über *Pteraspis*, etc. Beitr. Palaeont. Oesterr. Ungarns, vol. ii., 1886.
20. *Assheton, R.* The Devel. of *Gymnarchus niloticus*. Budgett Mem. Vol. London, 1907.
21. *Assmann, P.* Über *Aspidorhynchus*. Arch. f. Biontologie, vol. i., 1906.
22. *Ayers, H.* Morph. of the Vertebrate Ear. Journ. Morph. vol. vi., 1892.
23. — Beitr. z. Anat. u. Phys. der Dipnoer. Jen. Zeitschr. v. xxviii., 1884.
24. — Morph. of Carotids (*Chlamydoselachus*). Bull. Mus. Harvard, vol. xvii., 1889.
25. *Ayers, H., and Jackson, C. M.* Morphology of Myxinoidei Skeleton. Journ. Morph. vol. xvii., 1901; and Bull. Univ. Cincinnati, vol. i., 1900.

26. *Ayers, H., and Worthington, J.* The Skin End-Organs of the Trigemini and Lateralis Nerves of *Bdellostoma Dombeyi*. Am. Journ. of Anatomy, vol. vii., 1907.
27. *Balfour, F. M.* The Devel. of Elasmobranch Fishes. Journ. Anat. and Phys., 1876-1878.
28. — On the Devel. of the Skeleton of the Paired Fins Elasmobranchs. Proc. Zool. Soc., 1881.
29. — Comparative Embryology, vol. ii. London, 1881.
30. *Balfour, F. M., and Parker, W. K.* On the Structure and Devel. of *Lepidosteus*. Phil. Trans., 1882.
31. *Beard, J.* Sense-Organs of the Lateral Line and the Morph. of the Vert. Auditory Organ. Zool. Anz. vol. vii., 1884.
32. — The Syst. of Branchial Sense-Organs and their Associated Ganglia in Ichthyopsida. Quart. Journ. Micr. Sci. vol. xxvi., 1885.
33. — The Parietal Eye of the Cyclostome Fishes. Quart. Journ. Micr. Sci. vol. xxix., 1888.
- 33a. — The Old Mouth and the New. Anat. Anz. vol. iii., 1888.
34. — Teeth of the Marsipobranch Fishes. Zool. Jahrb. vol. iii. Anat., 1889.
35. *Beauregard, H.* Encéphale du *Ceratodus Forsteri*. Journ. de l'anat. et phys. vol. xvii., 1881.
- 35a. *Béraneck, E.* Über das Parietalauge der Reptilien. Jen. Zeitschr. vol. xxi., 1887.
36. *Bles, E. S.* Openings in the Wall of the Body-Cavity. Proc. Roy. Soc., 1897.
37. *Bloch, L.* Schwimmblase, Knochenkapsel, und Weber'scher Apparat von *Nemachilus barbatus*, Günther. Jen. Zeit. f. Naturw. vol. xxxiv., 1900.
- 37a. *Blomfield, J. E.* The Thread-Cells and Epidermis of *Myxine*. Quart. Journ. Micr. Sci. v. xxii., 1882.
38. *Boas, J. E. V.* Über Hertz und Arterienbogen bei *Ceratodus* und *Protoperus*. Morph. Jahrb. vol. vi., 1880.
39. — Über den *Conus arteriosus* bei *Butirinus* und bei anderen Knochenfischen. Morph. Jahrb. vol. vi., 1880.
- 39a. *Boveri, T.* Die Nierenanälchen des *Amphioxus*. Zool. Jahrb. vol. v., 1892.
40. *Boulenger, G. A.* Classification of Fishes. Ann. and Mag. Nat. Hist. I. Trachinidae, etc., vol. viii., 1901; II. Berycidae, vol. ix., 1902; III. *Lampris* and the Catostomi, vol. x., 1902; IV. Gadidae and Pleuronectidae, vol. x., 1902.
41. — Poissons du Congo. Brussels, 1901.
42. — Fishes (Teleostei). Cambridge Nat. Hist., London, 1904.
43. *Brauer, A.* Über die Leuchtorgane der Knochenfische. Verh. deutsch. zool. Ges., 1904.
44. — Die Tiefsee-Fische. Erg. deutsch. Tiefsee-Expedition, 1906.
45. — Beiträge z. Kenntniss der Entw. u. Anat. der Gymnophionen: III. Die Entw. der Excretionsorgane. Zool. Jahrb. Abt. Anat. vol. xvi., 1902.
46. *Braus, H.* Über d. Innervation der paarigen Extremitäten bei Selachiern. Jen. Zeitschr. vol. xxix., 1895.
47. — Beitr. z. Entwickl. der Muskulatur u. des peripheren Nervensystems der Selachier: I. Teil, Die metotischen Urvirbel u. spino-occipitalen Nerven; II. Teil, Die paarigen Gliedmassen. Morph. Jahrb. vol. xxvii., 1899.

48. *Braus, H.* Die Muskeln u. Nerven der *Ceratodus*-flosse. Zool. Forsch. Denkschr. Med. Nat. Ges. Jena, 1901.
49. — Über neuere Funde versteinertes Gliedmassenknorpel von Selachiern. Verh. Phys. Med. Ges. Würzburg, vol. xxxiv., 1901.
50. — Die Entw. d. Form der Extremitäten u. d. Extremitätenskelets. Hertwig's Handb. Entw. Wirbeltiere, vol. iii. Jena, 1906.
51. *Bridge, T. W.* The Cranial Osteology of *Amia calva*. Journ. of Anat. and Phys. vol. xi., 1877.
52. — On the Osteology of *Polyodon folium*. Phil. Trans. vol. clxix., 1879.
53. — Pori abdominales. Journ. Anat. and Phys. vol. xiv., 1879.
54. — Some Points in the Cranial Anatomy of *Polypterus*. Proc. Phil. Soc. Birmingham, vol. vi., 1887-1889.
55. — The Skull of *Osteoglossum formosum*. Proc. Zool. Soc., 1895.
56. — The Mesial Fins of Ganoids and Teleosts. Journ. Linn. Soc. Zool. vol. xxv., 1896.
- 56a. — Skull of *Lepidosiren*. Trans. Zool. Soc. vol. xiv., 1897.
57. — Fishes. Cambridge Nat. Hist., London, 1904.
58. *Bridge, T. W.*, and *Haddon, A. C.* The Air-Bladder and Weberian Ossicles of the Siluroid Fishes. Phil. Trans. vol. clxxxiv. B, 1893.
59. *Brock, J.* Beiträge z. Anat. u. Histologie der Geschlechtsorgane der Knochenfische. Morph. Jahrb. vol. iv., 1878.
60. — Unters. ü. d. Geschlechtsorgane d. Muraenoiden. Mitth. Zool. Sta. Neapel, vol. ii., 1881.
61. *Broili, F.* Über *Diacranodus texensis*, Cope (= *Didymodus*?). Neues Jahrb. Min. vol. xix. Beil. B, 1904.
62. *Brongniart, C.* *Pleuracanthus Gaudryi*. Bull. Soc. Géol. de France, vol. xvi., 1888.
63. *Brown, C.* Über das Genus *Hybodus* und seine systematische Stellung. Palaeontographica, vol. xlvi., 1900.
64. *Brown Goode, G.* The Fisheries and Fish Industries of the U.S. U.S. Commission of Fish and Fisheries, Sect. 1, 1884.
65. *Bruch, C.* Osteol. des Rheinlachs (*Salmo salar*, L.). 2<sup>te</sup> Ausg. Mainz, 1875.
66. *Bruch, K.* Über eigent. Anhänge der Fisch-Wirbel. Zeitschr. f. wiss. Zool. vol. xi., 1862.
67. *Budgett, J. S.* On the Structure of the Larval *Polypterus*. Trans. Zool. Soc. vol. xvi., 1902.
- 67a. — Breeding-Habits of some West African Fishes, etc. Trans. Zool. Soc. vol. xvi., 1901.
68. — On some Points in the Anatomy of *Polypterus*. Trans. Zool. Soc. vol. xv., 1901.
69. *Burckhardt, R.* Das Centralnervensystem v. *Protopterus annectens*. Berlin, 1892.
70. — Der Bauplan des Wirbeltiergehirns. Morph. Arb. vol. iv., 1894.
71. — On the Luminous Organs of Selachian Fishes. Ann. Mag. Nat. Hist. vol. vi., 1900.
72. — Beiträge z. Anat. u. Systematik der Laemargiden. Anat. Anz. vol. xviii., 1900.
73. *Burckhardt, R.*, and *Bing, R.* Das Zentralnervensystem v. *Ceratodus Forsteri*. Anat. Anz. vol. xxv., 1904; and Denk. Med. Nat. Ges. Jena.
74. *Burne, R. H.* The Porus Genitalis in the Myxinidae. Journ. Linn. Soc. vol. xxvi., 1898.

75. *Burne, R. H.* Aortic Arch. Syst. of *Saccobranchus*. Journ. Linn. Soc. vol. xxv., 1896.
76. — Brain of Fishes, in Catal. of Roy. Coll. Surgeons, 1900.
77. *Cameron.* On the Origin of the Pineal Body as an Amiesial Structure. Proc. Roy. Soc. Edinburgh, vol. xxiv., 1902-1903.
78. *Clapp, Cornelia, M.* The Lat. Line System of *Batrachus Tau*. Journ. Morph. vol. xv., 1898.
79. *Claus, C.* Rippen u. unteres Bogensystem. Sitzb. K. Akad. Wiss. Wien, 1 Abt., 1876.
80. *Claypole, E. W.* Pteraspidian Fishes in the Upper Silurian Rocks of N. America. Quart. Journ. Geol. Soc. vol. xii., 1885.
- 80a. — *Dinichthys*. Proc. Amer. Microsc. Soc. vol. xv., 1894.
81. *Cole, F. J.* On the Cranial Nerves of *Chimaera monstrosa*. Trans. Roy. Soc. Edin., vol. xxxviii., 1896.
82. — The Cranial Nerves and Lateral Sense-Organs of Fishes, with Special Reference to the Genus *Gadus*. Trans. Linn. Soc., s. 2, vol. vii., 1896-1900.
83. — General Morph. of the Myxinoid Fishes. Trans. Roy. Soc. Edin. vol. xli., 1905; and vol. xlv., 1907.
84. *Cole, F. J., and Johnstone, J.* *Pleuronectes*. Liverpool M.B.C. Mem. viii. London, 1901.
85. *Collinge, W. E.* The Lat. Canal System of *Lepidosteus*. Proc. Birmingham Phil. Soc. vol. viii., 1891-1893.
86. — The Sensory Canal System of Fishes: Part I. Ganoidei. Quart. Journ. Micr. Sci. n.s. vol. xxxvi., 1894.
87. — Note on the Lat. Canal System of *Polypterus*. Proc. Birmingham Phil. Soc., vol. viii., 1891-1893.
88. — The Sensory Canal System of Fishes: Teleostei—Sub-Order A, Physostomi. Proc. Zool. Soc., 1895.
89. — The Morph. of the Sensory Canal System in some Fossil Fishes. Proc. Birmingham Phil. Soc. vol. ix., 1895.
90. — On the Sensory and Ampullary Canals of *Chimaera*. Proc. Zool. Soc., 1895.
91. *Cope, E. D.* New and little known Palaeozoic and Mesozoic Fishes. Journ. Acad. Nat. Sci. Philadelphia, vol. ix., 2nd ser., 1884-1895.
- 91a. — Systematic Relations of the Fishes. Proc. Amer. Assoc. Adv. Sci., 1871. On the Phylogeny of the Vertebrata. Proc. Amer. Philos. Soc. vol. xxx., 1892.
92. — On *Symmorium*. Amer. Natur. vol. xxvii., 1893.
93. *Cori, C. I.* Das Blutgefässsystem des jungen *Ammocoetes*. Arb. Zool. Inst. Wien, vol. xvi., 1906.
94. *Crook, A. R.* Knochenfische a. d. mittl. Kreide v. Kansas. Palaeont. vol. xxxix., 1892.
95. *Cuvier et Valenciennes.* Hist. nat. des poissons, 22 vols., Paris, 1828-1848.
96. *Dahlgreen, U.* The Maxillary and Mandibular Breathing-Valves of Teleost Fishes. Zool. Bull. vol. ii., 1898-1899.
97. *Davidoff, von M.* Über das Skelett der hinteren Gliedmasse der Ganoidei holostei und der physostomen Knochenfische. Morph. Jahrb. vol. vi., 1880.
98. — Beiträge zur vergl. Anatomie der hinteren Gliedmasse der Fische: Part I. p. 450; Morph. Jahrb. vol. v., 1879; Part II. p. 433, *ibid.* vol. vi., 1880.
99. — Beiträge zur vergl. Anatomie der hinteren Gliedmasse der Fische: III. *Ceratodus*. Morph. Jahrb. vol. ix., 1884.

100. *Davis, J. W.* On the Fossil Fishes of the Carboniferous Limestone Series of Great Britain. Trans. Roy. Dublin Soc. (2), vol. i., 1883.
101. *Day, F.* The Fauna of British India: Fishes, 2 vols., London, 1889.
102. *Dean, B.* Morph. of *Cladosteleche*. Journ. Morph. vol. ix., 1894; and Trans. New York Ac. Sci. vol. xiii., 1894.
103. — Fishes, Living and Fossil. New York, 1895.
104. — The Fin-Fold Origin of the Paired Limbs in the Light of the Ptychopterygia of Palaeozoic Sharks. Anat. Anz. vol. xi., 1896.
105. — On the Larval Development of *Amia calva*. Zool. Jahrb. vol. ix., Abt. Syst., 1897.
106. — On the Embryology of *Bdellostoma*. Festschr. f. C. v. Kupffer, 1899.
107. — The Devonian Lamprey, *Palaeospondylus Gunneri*, Traquair, etc. Mem. New York Ac. Sci. vol. ii., 1900.
108. — On the Characters of *Mylostoma*, Newberry. Mem. New York Ac. Sci. vol. ii., 1901.
109. — On two new Arthrodires from the Cleveland Shale of Ohio. The Relationships of the Arthrognathi. Mem. New York Ac. Sci. vol. ii., 1901.
110. — Notes on Japanese Myxinoids. Journ. Coll. Sci. Tokyo, vol. xix., 1904.
- 110a. — Chimaeroid Fishes. Carnegie Instit. Washington, 1906.
- 110b. — The Permian Fish *Menaspis*. Amer. Geol. vol. xxxiv., 1904.
111. — Notes on Acanthodian Sharks. Am. Journ. of Anatomy, vol. vii., 1907.
- 111a. *Delage, Y.* Congre et Leptocéphale. C.R. Ac. Paris, vol. ciii., 1887.
112. *Dendy, A.* Parietal Eye and Adjacent Organs in *Sphenodon (Hatteria)*. Quart. Journ. Micr. Sci. vol. xliii., 1899.
113. *Döderlein, L.* Das Skelet v. *Pleuracanthus*. Zool. Anz. vol. xii., 1889.
114. *Dohrn, A.* Studien z. Urgesch. des Wirbelthierk.: Der Mund der Knochenfische. Mitth. Zool. Sta. Neapel, vol. iii., 1882. Hypophysis bei den Teleosteern. *Ibid.* vol. iii., 1882.
- 114a. — Visceralbogen bei *Petromyzon*. *Ibid.* vol. v., 1884. Zungenbein u. Kieferapparat der Selachier. *Ibid.* vol. vi., 1885.
115. — Spritzlochkieme der Selachier. *Ibid.* vol. vii., 1886.
116. — Die Thyroidea. *Ibid.* vol. vii., 1886.
117. — Die paarigen u. unpaaren Flossen der Selachier. *Ibid.* vol. v., 1884. Die unpaare Flosse u. da. Reste der Beckenflosse bei *Petromyzon*. *Ibid.* vol. vi., 1885.
118. — Die Occipitalsomite, etc. *Ibid.* vol. xv., 1901, and vol. xvii., 1904.
119. *Dollo, L.* Sur la morph. des côtes. Bull. sc. de la France et Belgique, vol. xxiv., 1892. Sur la morph. de la colonne vertébrale. *Ibid.* vol. xxv., 1893.
120. — Sur la phylogénie des *Dipneustes*. Bull. Soc. Belge Géol. vol. ix., 1895.
121. — Sur quelques points d'éthologie paléont. relatifs aux poissons. Bull. Soc. Belge Géol. et Pal. vol. xx.
- 121a. — Les Ptyctodontes sont des Arthrodères. Bull. Soc. Belge Géol. vol. xxi., 1907.
122. *Drevermann, F.* Über *Pteraspis dunensis*, F. Roem. Zeit. Deut. Geol. Ges. vol. lvi., 1904.
123. *Dugés, A.* Recherches sur l'ostéol. des Batraciens. Mém. Instit. France, vol. vi., 1835.
124. *Duméril, A.* Hist. nat. des poissons, 2 vols. Paris, 1865-1870.

125. *Eastmann, C. R.* Dentition of Devonian Ptyctodontidae. *Am. Nat.* vol. xxxii., 1898.
126. — Asterolepid Appendages. *Am. Journ. Sci.* vol. xviii., 1904.
127. — The Literature of *Edestus*. *Am. Nat.* vol. xxxix., 1905.
128. — Dipnoan Affinities of Arthroires. *Am. Journ. Sci.* vol. xxi., 1906.
129. — The Structure and Relations of *Mylostoma*. *Bull. Mus. Comp. Zool. Harv. Coll.* vol. 1., 1906.
130. *Ebner, V. von.* Über die Wirbel der Knochenfische u. die *Chorda dorsalis* der Fische u. Amphibien. *Sitz. Ak. Wiss. Wien*, vol. cv., 1896.
131. *Emery, C. Fierasfer.* Fauna u. Flora d. Golfes v. Neapel, Monogr. ii., 1880.
132. *Ewart, J. C.* The Electric Organ of the Skate. *Phil. Trans.* vol. clxxix., 1888; and vol. clxxxiii., 1892.
133. *Ewart, J. C.*, and *Cole, F. J.* On the Dorsal Branches of the Cranial and Spinal Nerves of Elasmobranchs. *Proc. Roy. Soc. Edinburgh*, vol. xx., 1893-1895.
134. *Ewart, J. C.*, and *Mitchell, J. C.* The Lat. Sense-Organs of Elasmobranchs: I. The Sensory Canals of *Laemargus*; II. The Sensory Canals of the Common Skate, *Rajabatis*. *Trans. Roy. Soc. Edin.* vol. xxxvii., 1891-1895.
135. *Felix, W.* Die Entw. des Harnapparates. *Hertwig's Handb. Entw. d. Wirbeltiere*, vol. iii. Jena, 1906.
136. *Felix, W.*, and *Bühler, A.* Die vergl. Entw. d. Keimdrüsen u. ihren Ausführungsgänge. *Hertwig's Handb. Entw. d. Wirbeltiere*, vol. iii. Jena, 1906.
137. *Field, H. H.* Pronephros and Segmental Duct in the Amphibia. *Bull. Mus. Comp. Zool. Harvard*, vol. xxi., 1891.
138. *Franque, H.* *Amiae calvae anatomium descripsit tabulae illustravit.* Berlin, 1847.
139. *Fritsch, A.* Fauna der Gaskohle . . . 4 vols. Prag, 1883-1901.
140. *Fritsch, G.* Über den Angelapparat v. *Lophius*. *Sitz. Ak. Berlin*, 1884.
141. — Die electrisch. Fische: I. *Malapterurus*, 1887; II. Die Torpedineen, 1890. Leipzig.
- 141a. *Fürbringer, K.* Morph. d. Skeletes der Dipnoer, etc. *Denk. Med. Nat. Ges. Jena*, vol. iv., 1904.
142. *Fürbringer, M.* Zur Lehre v. den Umbildungen der Nervenplexus. *Morph. Jahrb.* vol. v., 1879.
143. — Über d. spino-occipitalen Nerven. *Festschr. v. C. Gegenbaur*, vol. iii. Leipzig, 1897.
144. *Fürbringer, P.* Unters. z. vergl. Anat. d. Cyclostomen. *Jen. Zeitschr.* vol. ix., 1875.
145. *Gadow, H.* Modifications of Visceral Arches. *Phil. Trans.* vol. clxxix., 1888.
146. *Gadow, H.*, and *Abbott, E. C.* On the Evolution of the Vertebral Column in Fishes. *Phil. Trans.* vol. clxxxvi., 1895.
147. *Garman, S.* *Chlamydosclachus anguineus*. *Bull. Mus. Comp. Zool. Harv.* vol. xii., 1885-1886.
148. — On the Lat. Canal Syst. of Selachia and Holocephala. *Bull. Mus. Comp. Zool.* vol. xvii., 1888.
149. — The Chimaeroids. *Bull. Mus. Comp. Zool. Harvard*, vol. xli., 1904.
150. *Gaupp, E.* Die Metamerie des Schädels. *Anat. Hefte, Erg.* vol. vii., 1897.
151. — Alte Probleme u. neuere Arbeiten über den Wirbeltierschädel. *Anat. Hefte*, 2<sup>te</sup> Abt. vol. x., 1900.

- 151a. *Gaupp, E.* Die Entwicklung des Kopfskelettes. Hertwig's Handb. Entw. Wirbeltiere, vol. iii. Jena, 1906.
152. — Das Hyobranchialskelet. Anat. Hefte, Ergeb. vol. xiv., 1904.
153. *Gegenbaur, C.* Unters. z. vergl. Anat. d. Wirbelthiere. Hft. 2, 1865; Hft. 3, 1872. Leipzig.
154. — Über die Entw. der Wirbelsäule des *Lepidosteus*. Jen. Zeitschr. vol. iii., 1867.
155. — Über das Skelet der Gliedmassen der Wirbelthiere in Allgemein u. der Hintergliedmassen der Selachier insbesondere. Über die Modificationen des Skelets der Hintergl. bei den Männchen der Selachier und Chimaeren. Jen. Zeit. Med. und Naturw. vol. v., 1870.
156. — Über die Kopfnerven v. *Hexanchus*. *Ibid.* vol. vi., 1871.
157. — Über das Archipterygium. *Ibid.* vol. vii., 1873.
158. — Zur Morphologie der Gliedmassen der Wirbelthiere. Morph. Jahrb. vol. ii., 1876.
159. — Über d. Kopfskelet von *Alepocephalus*. Morph. Jahrb. vol. iv. Suppl., 1878.
160. — Über d. Occipitalregion . . . der Fische. Festschr. z. A. v. Kölliker, Leipzig, 1887.
161. — Die Metamerie des Kopfes. Morph. Jahrb. vol. xiii., 1888.
162. — Das Flossenskelet der Crossopterygier und das Archipterygium der Fische. Morph. Jahrb. vol. xxii., 1895.
163. — Vergl. Anatomie der Wirbeltiere, 2 vols. Leipzig, 1898.
164. *Gill, T. N.* Fishes, Standard Nat. History. Boston, 1885.
165. — Families and Sub-Families of Fishes. Mem. Nat. Acad. Sci. Washington, vol. vi., 1893.
166. — Note on the Devonian *Palucospondylus*. Science, vol. iv., 1896.
167. *Goette, A.* Beitr. z. vergl. Morph. d. Skeletsystems. Arch. f. mikr. Anat. vol. xv., 1878; and vol. xvi., 1879.
168. — Entwick. des Flussneunauges (*Petromyzon fluviatilis*). Abh. z. Entw. der Tiere, 5<sup>te</sup> Heft, 1890.
169. — Über die Kiemen der Fische. Zeitschr. f. wiss. Zool. vol. lxix., 1901.
170. — Über der Ursprung der Lungen. Zool. Jahrb. vol. xxi. Anat., 1905.
171. *Göldi, E.* Kopfskelet u. Schultergürtel von *Loricaria*, etc. Jen. Zeitschr. vol. xvii., 1884.
172. *Goodrich, E. S.* On the Coelom, Genital Ducts, and Nephridia. Quart. Journ. Micr. Sci. vol. xxxvii., 1895.
173. — On the Pelvic Girdle and Fin of *Eusthenopteron*. Quart. Journ. Micr. Sci. vol. xlv., 1901.
174. — On the Structure of the Excretory Organs of *Amphioxus*. Quart. Journ. Micr. Sci. vol. xlv., 1902.
175. — On the Dermal Fin-Rays of Fishes. Quart. Journ. Micr. Sci. vol. xlvi., 1903.
176. — On the Devel., etc., of the Fins of Fish. Quart. Journ. Micr. Sci. vol. l., 1906.
177. — On the Systematic Position of *Polypterus*. Rep. Brit. Assoc., 1907.
178. — On the Scales of Fish. Proc. Zool. Soc., 1908.
179. *Göppert, E.* Unters. z. Morph. der Fishrippen. Morph. Jahrb. vol. xxiii., 1895.
180. *Goronowitsch, N.* Das Gehirn v. *Acipenser*. Morph. Jahrb. vol. xiii., 1888.



181. *Graaf, H. von.* Z. Anat. u. Entw. der Epiphyse. Zool. Anz. vol. ix., 1886.
182. *Grassi, B.* Beitr. z. n. Kenntniss d. Entw. der Wirbelsäule der Teleostier. Morph. Jahrb. vol. viii., 1882.
- 182a. — Reproduction of Common Eel (*Anguilla vulgaris*). Quart. Journ. Micr. Sci. vol. xxxix., 1896.
183. *Greene, C. W.* The Phosphorescent Organs in the Toadfish, *Porichthys notatus*, Girard. Journ. Morph. vol. xv., 1899.
184. *Gregory, W. K.* The Orders of Teleostomous Fishes. Ann. N.Y. Acad. Sci. vol. xvii., 1907.
185. *Greil, A.* Bem. z. Frage v. d. Ursprunge der Lungen. Anat. Anz. vol. xxvi., 1905.
186. — Über d. Homologie der Anammierkiemen. Anat. Anz. vol. xxviii., 1906.
187. *Guitel, F.* Dével. des nageoires paires du *Cyclopterus lumpus*. Arch. Zool. Expér. vol. iv., 1896.
188. — Recherches s. l'anat. des reins de q. Gobiésocidés. Arch. Zool. Expér. vol. v., 1906.
189. *Günther, A.* Catalogue of the Fishes in the British Museum. London, 1870.
190. — Description of *Ceratodus*. Phil. Trans., 1871.
191. — An Introduction to the Study of Fishes. Elinburgh, 1880.
192. — Deep-Sea Fishes. "Challenger" Rep. vol. xxii., 1887.
- 192a. *Hall, R. W.* Devel. of Mesonephros and Müllerian Ducts in Amphibia. Bull. Mus. Comp. Zool. Harvard, vol. xlv., 1904.
193. *Haller, B.* Über den Ovarialsack der Knochenfische. Anat. Anz. vol. xxvii., 1905.
194. — Über d. Schultergürtel der Teleostier. Arch. Mikr. Anat. vol. lxvii., 1905.
195. *Hamburger, R.* Über die paarigen Extremitäten von *Squalius*, *Trigla*, *Periophthalmus* u. *Lophius*. Rev. Suisse de Zool. vol. xii., 1904.
196. *Harrison, R. G.* Über d. Entw. d. Skeletteile in d. Flossen d. Teleostier. Arch. f. mikr. Anat. vol. xlii., 1893.
197. — Die Entw. der Flossen der Teleostier. Arch. f. mikr. Anat. vol. xlv., 1895.
198. *Hase, A.* Über das Schuppenkleid der Teleostier. Jena Zeitschr. f. Nat. vol. xlii., 1907.
- 198a. *Haswell, W. A.* Paired Fins of *Ceratodus*. Proc. Linn. Soc. N.S. Wales, vol. vii., 1883. Elasmobranch Skeleton. *Ibid.* vol. ix., 1885.
199. *Hasse, C.* Beob. ü. d. Schwimmlase der Fische. Anat. Studien, vol. i., Leipzig, 1873.
200. — Das natürl. Syst. d. Elasmobranchier. 2 Parts and Supplement. Jena, 1882-1885.
201. — Die Entw. der Wirbelsäule der Dipnoi. Zeitschr. f. wiss. Zool. vol. lv.
202. *Hatschek, B.* Die Metamerie des *Amphioxus* u. des *Ammocoetes*. Verh. Anat. Ges. Wien, 1892. Corrected Anat. Anz. vol. viii., 1893.
- 202a. *Hatta, S.* Metam. Segmentation of Mesoblast in *Petromyzon*, etc. Annot. Zool. Japan, vol. iv., 1901.
203. *Hay, O. P.* The Vertebral Column of *Amia*. Field Columb. Mus. Publ. Zool. vol. vi., 1895.
204. — Bibliography and Catal. of the Fossil Vertebrata of North America. Bull. N.S. Geol. Surv. No. clxxix., 1902.

205. *Hay, O. P.* On a Collection of Upper Cretaceous Fishes from Mt. Lebanon. Bull. Amer. Mus. Nat. Hist. vol. xix., 1903.
- 205a. *Heckel, J. J.* Fossilien Fische Oesterreichs. Denk. Akad. Wien, vol. i., 1850.
206. *Helbing, H.* Beiträge z. Anat. u. Systematik der Lämargiden. Anat. Anz. vol. xxi., 1902.
207. — Beiträge z. Anat. u. Systematik der Lämargiden. Nova Acta Leop. Car. Ak. vol. lxxxii., 1904.
208. *Henning, E.* *Gyrodus* u. die Organisation der Pyknodonten. Palaeont. vol. liii., 1906.
209. *Henninger, G.* Die Labyrinthorgane bei Labyrinthfischen. Zool. Jahrb. vol. xxv., 1907.
210. *Herrick, C. J.* The Cranial and First Spinal Nerves of *Menidia*. Journ. Comp. Neurology, vol. ix., 1899.
211. *Hertwig, O.* Über d. Bau u. Entw. der Placoidschuppen u. der Zähne der Selachier. Jen. Zeitschr. vol. viii., 1874.
212. — Über das Hautskelet der Fische: Part I. Morph. Jahrb. vol. ii., 1876; Part II. *ibid.* vol. v., 1879.
213. *Heymans, J. F.*, and *Stricht, O. van der.* Sur le système nerveux périphérique de l'*Amphioxus*, etc. Mém. Cour. Acad. R. Belgique, vol. lvi., 1896.
- 213a. *Hill, C.* Epiphysis of Teleosts and *Amia*. Journ. Morph. vol. ix., 1894.
214. *Hochstetter, F.* Vergl. Anat. u. Entw. des Venensystems. Morph. Jahrb. vol. xiii. 1888.
215. — Die Entw. d. Blutgefässsystems. Hertwig's Handb. Entw. Wirbeltiere, vol. iii. Jena, 1906.
- 215a. *Hofer, B.* Cycloid- und Ctenoidschuppen. Sitz.-Ber. Morph. Phys. Ak. München, 1889.
216. *Hoffmann, C. K.* Entw. der Selachii. Morph. Jahrb. vol. xxvii., 1899.
217. *Holm, J. F.* The Finer Anat. of the Nervous System of *Myxine glutinosa*. Morph. Jahrb. vol. xxix., 1901.
218. *Howes, G. B.* On the Skeleton and Affinities of the Paired Fins of *Ceratodus*. Proc. Zool. Soc., 1887.
219. — Observations on the Pectoral Fin-Skeleton of the Living Batoid Fishes and of the Extinct Genus *Squaloraja*. Proc. Zool. Soc. 1890.
220. — Intestinal Canal of Ichthyopsida. Journ. Linn. Soc. vol. xxiii., 1890.
221. — On the Affinities, etc., of the Marsipobranchii. Trans. Biol. Soc. Liverpool, vol. vi., 1892.
222. *Huber, O.* Die Copulationsglieder der Selachier. Zeitschr. f. wiss. Zool. vol. lxx., 1901.
223. *Huot, A.* Recherches sur les poissons Lophobranches. Ann. Sci. Nat. vol. xiv., 1902.
- 223a. *Hussakov, L.* Studies on Arthrodira. Mem. Am. Mus. Nat. Hist. vol. ix., 1906.
224. *Huxley, T. H.* On *Cephalaspis* and *Pteraspis*. Quart. Journ. Geol. Soc. vol. xiv., 1858.
225. — On the Theory of the Vertebrate Skull. Proc. Roy. Soc. vol. ix., 1857-1859.
226. — Observ. on the Devel. of some Parts of the Skeleton of Fishes. Quart. Journ. Micr. Sci. vol. vii., 1859.
227. — The Systematic Arrangement of the Fishes of the Devonian Epoch. Mem. Geol. Surv., 1861.

228. *Huxley, T. H.* Structure of the Crossopterygian Ganoids. Mem. Geol. Surv., 1866.
229. ——— Anatomy of Vertebrated Animals. London, 1871.
230. ——— On *Ceratodus Forsteri*. Proc. Zool. Soc., 1876.
231. ——— On the Oviducts of *Osmerus*, etc. Proc. Zool. Soc., 1883.
232. *Hjyrl, J.* *Lepidosiren paradoxa*. Abh. böhm. Ges., 1845.
- 232a. ——— Morph. der Urogenital-Organen der Fische. Denk. Ak. Wien, vol. i., 1850. Das uropoëtische System. *Ibid.* vol. ii., 1851.
233. ——— Schwimmblase v. *Lepidosteus*. Sitz.-Ber. Ak. Wien, 1852.
- 233a. ——— Geschlechts- und Harnwerkzeuge b. d. Ganoiden. Denk. Ak. Wien, vol. viii., 1854.
- 233b. ——— *Amphinous* und *Monopterus*. Denk. Ak. Wien, vol. xiv., 1858.
- 233c. ——— Anat. von *Heterotis Ehrenbergii*. Denk. Ak. Wien, vol. viii., 1854.
234. *Iwanzow, N.* Der *Scaphirhynchus*. Bull. Soc. Imp. Nat. Moscou, vol. i., 1887.
235. *Jackson, C. M.* An Investigation of the Vascular System of *Edellostoma Dombeyi*. Journ. Cincinnati Soc. Nat. Hist. vol. xx., 1901.
236. *Jackson, W. H.*, and *Clarke, W. B.* The Brain and Cranial Nerves of *Echinorhinus spinosus*, etc. Journ. Anat. and Phys. vol. x., 1876.
237. *Jaekel, O.* *Phaneropleuron* und *Hemictenodus*. Sitz. d. Ges. naturf. Freunde, Berlin, 1890.
- 237a. ——— Über die Gattung *Pristiophorus*. Arch. f. Nat. vol. lvii., 1893.
238. ——— Die Eocänen Selachier von Monte Balca. Berlin, 1894.
239. ——— Über die Organisation der Pleuracanthiden. Sitz.-Ber. d. Gesellsch. naturf. Freunde, Berlin, 1895.
240. ——— Über die Organisation der Petalodonten. Zeitschr. deut. geol. Ges. vol. li., 1899.
241. ——— Über jurassische Zähne u. Eier von Chimaeriden. N. Jahrb. f. Min., Beil. 14, 1901.
242. ——— Über *Coccosteus* u. die Beurteilung der Placodermen. Sitz.-Ber. d. Ges. naturf. Freunde, vol. v., 1902.
- 242a. ——— Über *Rhamphodus*. Sitz. d. Ges. naturf. Freunde, Berlin, 1903.
243. ——— *Tremataspis* u. Patten's Ableitung der Wirbeltiere v. Arthropoden. Zeitschr. deutsch. geol. Gesellsch. vol. lv., 1903.
- 243a. ——— Morph. der ältesten Wirbeltiere. Sitz. d. Ges. naturf. Freunde, Berlin, 1906.
244. ——— Über *Pholidosteus*. Sitz.-Ber. d. Ges. nat. Freunde, Berlin, 1907.
245. *Jhering, H. von.* Das periphere Nervensystem der Wirbelthiere. Leipzig, 1878.
246. *Johann, L.* Über eigentümliche epitheliale Gebilde (Leuchtorgane) bei *Spinax niger*. Zeitschr. Wiss. Zool. vol. lxvi., 1899.
247. *Johnston, J. B.* Brain of *Petromyzon*. Journ. Comp. Neurology, vol. xii., 1902. The Cranial Nerve Components of *Petromyzon*. Morph. Jahrb. vol. xxxiv., 1905.
248. ——— The Cranial and Spinal Ganglia and the Viscero-Motor Roots in *Amphioxus*. Biol. Bull. vol. ix., 1905.
- 248a. ——— Morph. of Vertebrate Head. Journ. Comp. Neurology, vol. xv., 1905.
249. ——— The Nervous System of Vertebrates. Philadelphia, 1906.
250. *Jordan, D. S.* A Guide to the Study of Fishes, 2 vols. Westminster, U.S.A., 1905.
251. *Jordan, D. S.*, and *Evermann, B. W.* The Fishes of North and Middle America. Bull. United States Mus. vol. xlvii., 1896-1898.

252. *Juge, M.* Recherches sur les nerfs cérébraux et la musculature céphalique de *Silurus glanis*. Rev. Suisse Zool. vol. vi., 1899.
253. *Jungersen, H. F. E.* Beitr. zur Kenntniss der Entw. der Geschlechtsorgane bei den Knochenfischen. Arb. Zool. Inst. Würzburg, vol. ix., 1889.
254. — Über die Bauchflossenanhänge (Copulationsorgane) der Selachiermännchen. Anat. Anz. vol. xiv., 1898.
255. — Appendices genitales in the Greenland Shark, *Semnius microcephalus*, etc. Danish Ingolf Exped. vol. ii. Copenhagen, 1899.
256. *Karpinsky, A.* Über die Reste v. Edestiden u. die neue Gattung *Helicoprion*. Verh. d. K. russ. miner. Ges. St. Petersburg, vol. xxxvi., 1899.
257. *Kellicott, W. E.* Devel. of the Vascular System of *Ceratodus*. Anat. Anz. vol. xxvi., 1905. Mem. Acad. Sci. New York, 1905.
258. *Kereus, B.* Dével. de l'appareil excréteur des Amniotes. Arch. Biol. vol. xxii., 1907.
259. *Kerr, J. G.* The Devel. of *Lepidosiren paradoxa*. Phil. Trans. vol. cxcii., 1900.
260. — On the Male Genito-Urinary Organs of *Lepidosiren* and *Protopterus*. Proc. Zool. Soc., 1901.
261. — The Genito-Urinary Organs of Dipnoan Fishes. Proc. Philos. Soc. Cambridge, vol. xi., 1902.
262. — The Devel. of *Lepidosiren paradoxa*. Quart. Journ. Micr. Sci. vol. xlvi., 1902.
263. — The Devel. of *Polypterus senegalus*. Budgett Mem. Vol. London, 1907.
- 263a. *Kirkaldy, J. W.* Head-Kidney of *Myxine*. Quart. Journ. Micr. Sci. vol. xxxv., 1894.
264. *Klaatsch, H.* Zur Morph. der Fischeschuppen. Morph. Jahrb. vol. xvi., 1890.
265. — Beiträge z. vergl. Anat. der Wirbelsäule: I. Über der Urzustand der Fischwirbelsäule; II. Über die Bildung knorpeliger Wirbelkörper bei Fischen; III. Zur Phylogesen der Chordascheiden. Morph. Jahrb. vol. xix., 1893; vol. xx., 1893; vol. xxii., 1895.
266. — Die Brustflosse der Crossopterygier. Festschr. f. C. Gegenbaur, Leipzig, 1896.
267. *Klinckowström, A.* Beitr. z. Kenntn. d. Verlaufes der Darm- u. Lebervenen bei *Myxine glutinosa*. Biol. För. Förhand. Verh. d. biol. Vereins in Stockholm, 1889-1890, vol. ii.
268. *Kner, R., and Steindachner, F.* N. Beitr. z. Kennt. d. fossilen Fische Österreich. Denkschr. Akad. d. Wiss. Wien, vol. xxi., 1863.
269. *Köken, E.* Über *Pleuracanthus*, Ag.; oder *Xenacanthus*, Beyr. Sitz.-Ber. d. Gesell. naturf. Freunde, Berlin, 1889.
270. *Kölliker, A.* Über versch. Typen i. d. Struktur d. Skeletes der Knochenfische. Würzburg Verh. vol. ix., 1859.
271. — Über das Ende der Wirbelsäule der Ganoiden u. Teleostier. Leipzig, 1860.
272. *Koltzoff, N. K.* Metamerie des Kopfes von *Petromyzon Planeri*. Anat. Anz. vol. xvi., 1899.
273. — Entwickl. d. Kopfes v. *Petromyzon Planeri*. Bull. Soc. Imp. Nat. Moscou, vol. xv., 1902.
274. *Koschkaroff, D. N.* Das Skelet der Siluroidei. Bull. Soc. Imp. Nat. Moscou, 1905 (1906).

275. *Kupffer, C.* Studien z. vergl. Entw. Ges. d. Kranioten: I. *Acipenser*, 1893; II. and III. *Petromyzon*, 1894, München u. Leipzig.
276. *Lankester, E. R.* The Cephalaspidae (and Pteraspidae). Mon. Palaeontogr. Soc., 1868-1870.
277. — On the Hearts of *Ceratodus*, *Protopterus*, and *Chimaera*. Trans. Zool. Soc. vol. x., 1878.
278. — On the *Lepidosiren*. Trans. Zool. Soc. vol. xiv., 1896.
279. *Lee, F. S.* On the Functions of the Ear and the Lateral Line in Fishes. Am. Journ. Phys. vol. i., 1898.
- 279a. *Legros, R.* Appareil vasculaire de l'*Amphioxus*. Mitth. Zool. Sta. Neapel, vol. xv., 1902.
280. *Lendenfeld, R. v.* The Radiating Organs of the Deep-Sea Fishes. Mem. Mus. Comp. Anat. Harvard, vol. xxx., 1905.
281. *Leydig, F.* Zur Anat. u. Hist. d. *Chimaera*. Arch. f. Anat. u. Phys. 1851.
282. — Hist. von *Polypterus bichir*. Zeitschr. f. wiss. Zool. vol. v., 1853.
283. — Integument und Hautsinnesorgane der Knochenfische. Zool. Jahrb., Abt. Anat. vol. viii., 1894-1895.
284. *Locy, W. A.* Contrib. to the Structure and Devel. of Vertebrate Head. Journ. Morph. vol. xi., 1895.
- 284a. — On a Newly-recognised Nerve. Anat. Anz. vol. xxvi., 1905.
285. *Loomis, F. B.* Die Anat. u. Verwandtschaft der Ganoid- u. Knochenfische aus der Kreide-Formation von Kansas. Palaeontographica, vol. xlvii., 1900.
286. *Lotz, Th.* Über Bau der Schwanzwirbelsäule der Salmoniden, Cyprinoiden, Percoiden und Cataphracten. Zeitschr. f. wiss. Zool. vol. xiv., 1864.
287. *MacBride, E. W.* Devel. of the Oviduct in the Frog. Quart. Journ. Micr. Sci. vol. xxxiii., 1892.
288. *MacLeod, R.* Rech. sur . . . l'appareil reprod. femelle des Téléostéens. Arch. Biol. vol. ii., 1881.
289. *M<sup>r</sup>Murrich, J. P.* Osteol. and Devel. of *Syngnathus*. Quart. Journ. Micr. Sci. vol. xxii., 1883.
290. — The Osteology of *Amiurus catus*, and The Myology of *Amiurus catus*. Proc. Canad. Inst. vol. ii., 1884.
291. *Markert, F.* Die Flossenstacheln von *Acanthias*, etc. Zool. Jahrb. vol. ix. Abt. Anat., 1896.
292. *Marshall, A. M.* On the Head Cavities, etc. Cf. Journ. Micr. Sci. vol. xxi., 1881.
293. — The Segmental Value of the Cranial Nerves. Journ. Anat. and Phys. vol. xvi., 1882.
294. *Maurer, F.* Pseudobranchii der Knochenfische. Morph. Jahrb. vol. ix., 1884.
295. — Die Kiemen u. ihre Gefässe, etc. Morph. Jahrb. vol. xiv., 1888.
296. — Die Elementen d. Rumpfmuskulatur b. Cyclostomen u. höheren Wirbeltieren. Morph. Jahrb. vol. xviii., 1892.
297. *Mayer, P.* Die unpaaren Flossen der Selachier. Mitth. Zool. Sta. Neapel, vol. vi., 1885.
- 297a. — Entw. des Herzens, etc., bei Selachier. Mitth. Zool. Sta. Neapel, vol. vii., 1887.
298. *Mayser, P.* Vergl. Anat. Stud. ii. d. Gehirn der Knochenfische. Zeitschr. f. wiss. Zool. vol. xxxvi., 1881.
299. *Miall, L. C.* Sirenoïd and Crossopt. Ganoids. Monogr. Palaeontogr. Soc. 1878.

300. *Mivart, G.* Notes on the Fins of Elasmobranchs. Trans. Zool. Soc. vol. x., 1879.
301. *Mollier, S.* Die paarigen Extremitäten der Wirbeltiere : I. Das Ichthyopterygium, Anat. Hefte, Abt. 1, vol. iii., 1893 ; III. Die Entw. d. paar. Flossen des Störs, *ibid.* vol. viii., 1897.
302. — Die paarigen Extremitäten der Wirbeltiere : II. Das Cheiropterygium, Anat. Hefte, Abt. 1, vol. v., 1894-1895.
303. *Moroff, Th.* Über die Entw. der Kiemen bei Fischen. Arch. mikr. Anat. vol. lxiv., 1904.
304. *Mosser, Fanny.* Beitr. z. vergl. Entwickl. der Schwimmblase. Anat. Anz. vol. xxiii., 1903.
305. *Müller, F.* Über die Entw. u. Morph. Bedeutung der Pseudobranchie bei *Lepidosteus osseus*. Arch. mikr. Anat. vol. xlix., 1897.
306. *Müller, J.* Vergl. Anatomie der Myxinoiden. Abh. K. Akad. Wiss. Berlin, 1833-1843.
307. — Über d. Bau u. Grenzen der Ganoiden. Abh. K. Akad. Wiss. Berlin, 1846.
- 307a. *Müller, W.* Über das Urogenitalsystem des *Amphioxus* u. der Cyclostomen. Jenaische Zeitschr. vol. ix., 1875.
308. *Müller, J.*, und *Henle, J.* Syst. Beschreibung der Plagiostomen. Berlin, 1841.
- 308a. *Neal, H. V.* Segmentation of Nervous Syst. in *Squalus acanthias*. Bull. Mus. Comp. Zool. Harvard, vol. xxxi., 1898.
- 308b. *Neumayer, L.* Entw. des Darmkanales, etc., bei *Ceratodus*. Denk. Med. Nat. Ges. Jena, vol. iv., 1904.
309. *Newberry, J. S.* The Palaeozoic Fishes of North America. Mon. U.S. Geol. Survey, vol. xvi., 1890.
310. *Osburn, R. C.* Observ. on the Origin of the Paired Limbs of Vertebrates. Ann. Journ. of Anatomy, vol. vii., 1907.
311. *Owen, R.* Description of *Lepidosiren annectens*. Trans. Linn. Soc. vol. xviii., 1839.
- 311a. — Odontography. London, 1840-5.
312. *Pander, C. H.* Die Placodermen des Devonischen System. St. Petersburg, 1857. Die Ctenodipterinen . . . 1858. Die Saurodipterinen, etc. . . . 1860.
313. *Parker, T. J.* Intestinal Valve of the Genus *Raja*. Trans. Zool. Soc. vol. xi., 1880.
314. — A Course of Instruction in Zootomy (*Petromyzon, Raja, Gadus*). London, 1884.
315. — Blood-Vessels of *Mustelus*. Phil. Trans. vol. clxxvii., 1886.
316. — On the Skeleton of *Regalecus argenteus*. Trans. Zool. Soc. vol. xii., 1886.
317. *Parker, W. K.* Shoulder-Girdle and Sternum in the Vertebrata. Ray Society, 1868.
318. — On the Structure and Development of the Skull in Sharks and Skates. Trans. Zool. Soc. vol. x., 1879.
319. — On the Structure and Development of the Skull in the Salmon. Phil. Trans. vol. clxiii., 1873.
320. — On the Development of the Skull in *Lepidosteus osseus*. Phil. Trans. vol. clxxiii., 1882.
321. — On the Structure and Development of the Skull in Sturgeons (*Acipenser*). Phil. Trans., vol. clxxiii., 1882.

322. *Parker, W. K.* On the Skeleton of the Marsipobranch Fishes. Phil. Trans. vol. clxxiv., 1883.
323. *Parker, W. K.*, and *Lettany, G. T.* The Morph. of the Skull. London, 1877.
324. *Parker, W. N.* Anat. and Phys. of *Protopterus annectens*. Trans. Irish Acad. vol. xxx., 1892.
325. *Patten, W.* On the Structure and Classification of the Tremataspidae. Mém. Acad. Imp. Sci. St-Petersbourg, vol. xiii., 1903.
326. — On the Structure of the Pteraspidae and Cephalaspidae. Am. Nat. vol. xxxvii., 1903.
327. — On the Appendages of *Tremataspis*. Am. Nat. vol. xxxvii., 1903.
328. — New Facts concerning *Bothriolepis*. Biol. Bull. vol. vii., 1904.
329. *Pinkus, F.* Die Hirnnerven des *Protopterus annectens*. Morph. Arb. vol. iv., 1895.
330. *Piper, H.* Die Entw. v. Leber Pankreas Schwimmblase u. Milz von *Amia calva*. Verh. Anat. Ges., 1902. Arch. Anat. u. Phys. Suppl., 1902.
331. *Platt, Julia B.* A Contrib. to the Morph. of the Vertebrate Head, based on a Study of *Acanthias vulgaris*. Journ. Morph. vol. v., 1891.
- 331a. — Devel. of Cartil. Skull in *Necturus*. Morph. Jahrb. vol. xxv., 1897.
332. *Pollard, H. B.* The Lateral-Line System of Siluroids. Zool. Jahrb., Abt. Anat. vol. v., 1892.
333. — The Oral Cirri of Siluroids and the Origin of the Head in Vertebrates. Zool. Jahrb. Abt. Anat. vol. viii., 1894-1895.
334. — On the Anatomy and Phylogenetic Position of *Polypterus*. Zool. Jahrb., Abt. Anat. vol. v., 1892.
335. *Price, G. C.* Devel. of the Excretory Organs in *Bdellostoma*. Amer. Journ. Anat. vol. iv., 1904.
336. *Rabl, C.* Theorie d. Mesoderms. Morph. Jahrb. vol. xix., 1892.
337. — Über d. Entw. d. Urogenitalsystems der Selachier. Morph. Jahrb., vol. xxiv., 1896.
338. — Gedanken und Studien über den Ursprung der Extremitäten. Zeitschr. f. wiss. Zool. vol. lxx., 1901.
339. *Rabl, H.* Über die Vorniere u. die Bildung des Müller'schen Ganges bei *Salamandra maculosa*: I. Arch. mikr. Anat. vol. lxiv., 1904.
340. *Rabl-Rückhard, H.* Zur Deutung u. Entw. d. Gehirns der Knochenfische. Arch. f. Anat. u. Phys., 1882.
341. *Ransom, W. B.*, and *Thompson, D'Arcy.* On the Spinal and Visceral Nerves of Cyclostomata. Zool. Anz. vol. ix., 1886.
342. *Rathke, H.* Über die weiblichen Geschlechtsteile der Lachse u. d. Sandaales. Merkel's Arch. vol. vi., 1820. Über die Geschlechtsteile der Fische. Neu. Schr. d. Nat. Ges. Danzig, 1824.
343. *Rautenfeld, E. von.* Skelett der hinteren Gliedmassen von Ganoiden und Teleostiern. Inaug. Diss. Dorpat, 1882; and Morph. Jahrb. p. 325, vol. ix., 1884.
344. *Regan, C. T.* On the Classif. of the Fishes of the Sub-Order Plectognathi. Proc. Zool. Soc. vol. ii., 1903.
- 344a. — Anacanthine Fishes. Ann. Mag. Nat. Hist. vol. xi., 1903.
345. — The Phylogeny of the Teleostomi. Ann. Mag. Nat. Hist. vol. xiii., 1904.
346. — A Classification of the Selachian Fishes. Proc. Zool. Soc., 1906.
347. — Fishes from the Coast of Natal. Ann. Natal Gov. Mus. vol. i., 1906.

348. *Regan, C. T.* On the Anatomy, etc., of the Sub-Order Allotriognathi. Proc. Zool. Soc., 1907.
349. *Reis, O. M.* Über *Belonostomus Aspidorhynchus* u. ihre Bezieh. z. leb. *Lepidosteus*. Sitz. d. K. bayr. Ak. d. Wiss. II. Cl., 1887.
350. — Die Coelacanthinen. Palaeontogr. vol. xxxv., 1888-1889.
351. — Illustrationen z. Kenntn. d. Skeletts v. *Acanthodes Bronni*, Ag. Abh. Senckenb. Nat. Ges. vol. xix., 1896.
- 351a. — *Squaloraja* and *Chimacra*. Geol. Mag. vol. ii., 1895.
352. — Über *Acanthodes Bronni*, Ag. Morph. Arb. vol. vi., 1896.
353. — Das Skelett der Pleuracanthiden. Abh. Senckenb. Nat. Ges. vol. xx., 1897.
354. — *Coelacanthus Lutzensis*, Teller. Jahrb. d. geol. Reichsanst. vol. I., 1900.
355. *Reissner, E.* Über d. Schuppen von *Polypterus* u. *Lepidosteus*. Arch. f. Anat. u. Phys., 1859.
356. *Retzius, G.* Das Gehörorgan der Wirbelthiere: I. Fische u. Amphibien. Stockholm, 1881.
357. *Ridewood, W. G.* The Air-Bladder and Ear of Brit. Clupeoid Fishes. Journ. Anat. and Phys. vol. xxvi., 1891.
358. — On the Hyoid Arch of *Ceratodus*. Proc. Zool. Soc., 1894.
359. — On the Spiracle and Associated Structures in Elasmobranch Fishes. Anat. Anz. vol. xi., 1896.
360. — The Circulus Cephalicus in Teleostean Fishes. Proc. Zool. Soc., 1899.
361. — Caudal Diplospondyly of Sharks. Journ. Linn. Soc. Zool. vol. xxvii., 1899.
362. — On the Cranial Osteology of the Elopidae and Albulidae, etc. Proc. Zool. Soc. vol. ii., 1904.
363. — On the Cranial Osteology of the Clupeoid Fishes. Proc. Zool. Soc. vol. ii., 1904.
364. — Cranial Osteology of the Osteoglossidae, Pantodontidae, and Phractolaemidae. Journ. Linnean Soc., vol. xxix.
365. — Cranial Osteology of the Mormyridae, Notopterygiae, and Hyodontidae. Journ. Linnean Soc. vol. xxix.
366. *Riess, Joh.* Über einige fossile Chimaeriden - Reste. Palaeontographica, vol. xxxiv., 1887.
367. *Rohon, J. V.* Über fossile Fische v. oberen Jenissei. Mém. Ac. St-Pét. vol. xxxvi., 1889.
368. — Die Dendrodonten des Devonischen Systems in Russland. Mém. Ac. Imp. St-Petersbourg, 7 sér. vol. xxxvi., 1889.
369. — *Holoptychius*-Schuppen in Russland. Mélanges géologiques et paléontol. vol. i., St-Petersbourg, 1890. Bull. Ac. Sci., St-Petersbourg, vol. ii.
370. — Über *Pterichthys*. Verh. K. russ. min. Ges. St. Petersburg. vol. xxviii., 1891.
371. — Die obersilur. Fische v. Oesel: Part I. Mém. Ac. St-Petersbourg, vol. xxxviii., 1892; Part II. *ibid.* vol. xli., 1893.
372. *Röse, C.* Über die verschiedenen Abänderungen der Hartgewebe bei niederen Wirbeltiere. Anat. Anz. p. 21, vol. xiv., 1898.
373. — Beitr. z. vergl. Anat. d. Herzens. Morph. Jahrb. vol. xvi., 1890.
374. — Über die Zahnentwicklung von *Chlamydoselachus anguineus*. Morph. Arb. vol. iv., 1895.



- 374a. *Rosenberg, E.* Die Occipitalregion des Cranium einiger Selachier. Dorpat, 1884.
375. *Rowntree, W. S.* The Visceral Anatomy of the Characnidae, etc. Trans. Linn. Soc. vol. ix., 1903.
376. *Rückert, J.* Über d. Entsch. d. Exkretionsorgane bei Selachiern. Arch. Anat. u. Entw., 1888.
377. — Die Entw. d. Exkretionsorgane. Anat. Hefte, Ergeb., 1892.
- 377a. *Ruge, E.* Die Entw. d. Skelettes d. v. Extremität v. *Spinax niger*. Morph. Jahrb. vol. xxx., 1902.
378. *Ryder, J. A.* On the Origin of Heterocercy and the Evol. of the Fins and Fin-Rays of Fishes. U.S. Com. of Fish Report for 1884 (1886).
379. *Sagemehl, M.* Beitr. z. vergl. Anat. der Fische: I. Das Cranium von *Amia calva*, Morph. Jahrb. vol. ix., 1884; II. Gehirnhäute der Knochenfische, *ibid.*; III. Das Cranium der Characniden, *ibid.* vol. x., 1884; IV. Das Cranium der Cyprinoiden, *ibid.* vol. xvii., 1891.
380. *Salensky, W.* Über die Entw. der unpaarer Flossen der störtartigen Fische. Ann. Mus. Zool. Ac. Imp. St-Petersbourg, 1899. Sur le développement . . . *ibid.* vol. iii.
381. *Sappey, Ph. C.* L'Appareil mucipare et sur le syst. lymphatique des poissons. Paris, 1880.
382. *Schaffer, J.* Der feinere Bau und die Entwicklung des Schwanzflossknorpels von *Petromyzon* und *Ammocoetes*. Anat. Anz. vol. xix., 1901.
383. *Schauinsland, H.* Beitr. z. Entw. u. Anat. der Wirbeltiere Sphenodon *Chamaeleo Callorhynchus*. Zoologica, vol. xvi., 1903.
384. — Die Entw. d. Wirbelsäule nebst Rippen u. Brustbein. Hertwig's Handb. Entw. Wirbeltiere, vol. iii. Jena, 1906.
385. *Scheel, C.* Beitr. z. Entw. der Teleostierwirbelsäule. Morph. Jahrb. vol. xx., 1893.
386. *Schelaputin, Gr.* Beiträge z. Kenntniss des Skelets der Welse (Das Cranium von *Clarias*). Bull. Soc. Imp. Nat. Moscou, 1905 (1906).
387. *Schleip, W.* Die Entw. der Kopfknochen bei dem Lachs u. der Forelle. Anat. Hefte, I. Abt. vol. xxiii., 1904.
388. *Schmidt, L.* Wirbelbaues von *Amia calva*. Zeitschr. f. wiss. Zool. vol. liv., 1892.
- 388a. *Schmidt-Monnard, C.* Die Histogenese des Knochens der Teleostier. Zeitschr. f. wiss. Zool. vol. xxxix., 1883.
389. *Schneider, A.* Beitr. z. vergl. Anat. der Wirbeltiere. Berlin, 1879.
390. — Über die Dipnoi. Zool. Beiträge, Breslau, 1887.
- 390a. *Schreiner, K. E.* Occipitalregion von *Amia* und *Lepidosteus*. Zeitschr. f. wiss. Zool. vol. lxxii., 1902.
- 390b. — Entw. der Amnioteniernere. Zeitschr. f. wiss. Zool. vol. lxxi., 1902.
391. *Schulze, F. E.* Über die becherförmigen Organe der Fische. Zeitschr. f. wiss. Zool. vol. xii., 1863.
392. — Über die Sinnesorgane der Seitenlinie bei Fischen u. Amphibien. Arch. mikr. Anat. vol. vi., 1870.
393. *Scott, W. B.* Beitr. z. Entw. Gesch. der Petromyzonten. Morph. Jahrb. vol. vii., 1881. Development of *Petromyzon*. Journ. Morph. vol. i., 1887.
394. *Scupin, H.* Vergl. Studien z. Histologie der Ganoidschuppen. Arch. f. Naturg. vol. lxii., 1896.
395. *Sedgwick, A.* On the Early Devel. of the Wolfian Duct, etc. Quart. Journ. Micr. Sci. vol. xxi., 1881.

396. *Sedgwick, A.* On the Existence of a Head-Kidney in the Chick. Quart. Journ. Micr. Sci. vol. xix., 1879.
397. *Semon, R.* Studien ü. d. Bauplan des Urogenitalsyst. d. Wirbeltiere. Jen. Zeitschr. vol. xix., 1891.
398. — N. ü. d. Zusammenhang der Harn- u. Geschlechtsorgane b. d. Ganoiden. Morph. Jahrb. vol. xvii., 1891.
399. — Die äussere Entwicklung des *Ceratodus Forsteri*. Denk. Med. Nat. Ges. Jena, vol. iv., 1893. Zool. Forsch. vol. i., and Nermentafeln, Jena, 1903.
400. — Das Exkretionsystem der Myxinoiden. Festschr. f. C. Gegenbaur, vol. iii. Leipzig, 1896.
- 400a. — Entw. d. paarigen Flossen der *Ceratodus Forsteri*. Denkschr. Med. Nat. Ges. Jena, vol. iv., 1898.
401. — Die Zahnentwicklung des *Ceratodus Forsteri*. Denk. Med. Nat. Ges. Jena, vol. iv., 1901.
402. — Zur Entw. d. Urogenitalsystem der Dipnoer. Zool. Anz. vol. xxiv., 1901.
403. — Über das Verwandtschaftsverhältnis der Dipnoer u. Amphibien. Zool. Anz. vol. xxiv., 1901.
404. *Semper, C.* Das Urogenitalsystem der Selachier. Arb. Inst. Würzburg, vol. ii., 1875.
405. *Senior, H. D.* The Conus Arteriosus in *Tarpon Atlanticus*. Biol. Bull. vol. xii., 1907.
406. *Sewertzoff, A.* Die Entw. der Occipitalregion der niederen Vertebraten. Bull. Soc. Imp. Nat. de Moscou, 1895.
407. — Die Entw. des Selachierschädels. Festschr. C. v. Kupffer, Jena, 1899.
408. — Zur Entw. des *Ceratodus Forsteri*. Anat. Anz. vol. xxi., 1902.
409. *Shufeldt, R. W.* The Osteology of *Amia calva*. Rep. U.S. Com. of Fish and Fisheries (1883), 1885.
410. *Siebenrock, F.* Über die Verbindungsweise des Schultergürtels mit den Schädel bei den Teleostern. Ann. K. K. Nat. Hofmuseums, Wien, vol. xvi., 1901.
411. *Sollas, W. J.*, and *Sollas, J. B.* The Devonian Fish, *Palaeospondylus Gunnii*, Traquair. Phil. Trans. vol. cxvii., 1903.
412. *Spencer, W. B.* On the Pineal Eye in Lacertilia. Quart. Journ. Mikr. Sci. vol. xxvii., 1886.
413. — *Ceratodus*: The Blood-Vessels. Macleay Memorial Vol., 1892.
414. *Spengel, J. W.* Das Urogenitalsyst. der Amphibien. Arb. Zool. Inst. Würzburg, vol. iii., 1876.
415. — Schwimmblasen Lungen u. Kiementaschen. Zool. Jahrb. Suppl. vol. vii., 1904.
416. *Stannius, H.* Das periphere Nervensysteme der Fische. Rostock, 1849.
417. — Handb. d. Anat. d. Wirbelthiere, 2 vols., 2<sup>te</sup> Aufl. Berlin, 1854-1856.
418. *Starks, E. C.* Osteol. Characters of the Sub-Order Percesoces. Proc. U.S. Nat. Mus., Washington, vol. xxii., 1899.
419. — The Shoulder-Girdle and Characteristic Osteology of the Hemi-branchiate Fishes. Proc. U.S. Nat. Mus., vol. xxv., 1903.
420. — Character of some Fishes belonging to the Order Haplomi. Biol. Bull. vol. vii., 1904.
421. — Osteology of some Berycoid Fishes. Proc. U.S. Nat. Mus. vol. xxvii., 1904.

422. *Starks, E. C.* The Myodome of the Fish Cranium. *Science*, vol. xxi., 1905.
- 422a. — Fishes of the Family Siganidae. *Biol. Bull.* vol. xiii., 1907.
- 422b. *Steindachner, F.* *Polypterus Lapradei*, etc. *Sitzb. Ak. Wien*, vol. lx., 1869.
423. *Steinhard, O.* Über Placoidschuppen in der Mund- u. Rachen-Höhle der Plagiostomen. *Arch. Naturg.* lxix. Jahrg., 1902.
424. *Stephan, P.* Recherches histologiques sur la structure du tissu osseux des poissons. *Bull. Sci. France et Belg.*, vol. xxxiii., 1900.
425. *Stewart, C.* Skeleton. *Catal. Roy. Coll. Surgeons*, 2nd edit. vol. i., 1900.
426. *Stöhr, Ph.* Über den Klappenapparat in Conus Arteriosus der Selachier u. Ganoiden. *Morph. Jahrb.* vol. ii., 1876.
- 426a. — Zur Entw. d. Urodelschädels. *Zeitschr. f. wiss. Zool.* vol. xxxiii., 1879. Zur Entw. d. Anurenschädels. *Ibid.* vol. xxxvi., 1881.
427. *Storms, R.* The Adhesive Disk of *Echeneis*. *Ann. Mag. Nat. Hist.*, 6th ser. vol. ii., 1888.
428. *Strong, O. S.* The Cranial Nerves of Amphibia. *Journ. Morph.* vol. x., 1895.
429. *Studnička, F. K.* Beitr. z. Anat. u. Entw. des Vorderhirns der Cranioten. *Sitz. Böhm. Ges.*, 1895.
430. — Die Parietalorgane, in *Oppel's Lehrb. d. vergl. mikr. Anat. d. Wirbeltiere*, Part V. Jena, 1905.
431. *Swinmerton, H. H.* Morph. of the Teleostean Head Skeleton (*Gasterosteus aculeatus*). *Quart. Journ. Micr. Sci.* vol. xlv., 1902.
432. — Pectoral Skeleton of Teleosteans. *Quart. Journ. Micr. Sci.* vol. xlix., 1905.
433. *Teller, F.* Über den Schädel eines fossilen Dipnoers, *Ceratodus sturii*. *Abh. d. K. K. geol. Reichsanstalt*, vol. xv. part iii. Wien, 1891.
434. *Thacher, J. K.* Median and Paired Fins. *Trans. Connecticut Acad.* vol. iii., 1878.
435. *Thilo, O.* Die Entstehung d. Luftsäcke bei den Kugelfischen. *Anat. Anz.* vol. xvi., 1899.
436. — Die Vorfahren der Schollen (Origin of Pleuronectids). *Bull. Ac. St-Petersb.* vol. xiv., 1901.
437. *Thiollière, V.* *Descr. des poissons du Jura.* Paris, 1854-1873.
438. *Tomes, C. S.* Structure and Devel. of Vascular Dentine. *Phil. Trans.* vol. clxix., 1878.
439. — Structure and Devel. of Enamel of Elasmobranch Fishes. *Phil. Trans.* vol. exc., 1898.
440. — A Manual of Dental Anatomy, 6th edit. London, 1904.
441. *Traquair, R. H.* On the Anat. of *Calamoichthys*. *Ann. and Mag. Nat. Hist.* vol. xviii., 1866.
- 441a. — Asymmetry of the Pleuronectidae. *Trans. Linn. Soc.* vol. xxv., 1866.
442. — On the Cranial Osteology of *Polypterus*. *Journ. Anat. and Phys.* vol. v., 1871.
443. — On the Structure and Affinities of *Tristichopterus alatus*, Egerton. *Trans. of the Roy. Soc. of Edinburgh*, vol. xxvii. (1872-1876), 1874.
444. — On the Struct., etc., of *Cheirolepis*. *Ann. Mag. Nat. Hist.* vol. xv., 1875.
445. — On the Structure of the Lower Jaw in *Rhizodopsis* and *Rhizodus*. *Ann. Mag. Nat. Hist.* vol. xix., 1877.
446. — Palaeoniscidae. *Monogr. Palaeontogr. Soc.*, 1877.

447. *Traquair, R. H.* On the Genera *Dipterus*, *Palaeclaphus*, *Holodus*, and *Cheirodus*. *Ann. Mag. Nat. Hist.* vol. ii., 1878.
448. — On the Struct. and Affinities of the Platysomidae. *Trans. Roy. Soc. Edinburgh*, vol. xxix., 1879.
449. — Report on Fossil Fishes . . . in Eskdale and Liddesdale. *Trans. Roy. Soc. Edinb.* vol. xxx., 1881.
450. — On the Cranial Osteology of *Rhizodopsis*. *Trans. Roy. Soc. Edinburgh*, vol. xxx., 1881.
451. — Notes on *Chondrosteus acipenseroides*. *Geol. Mag.* vol. iv., 1887.
452. — On the Structure and Classification of the Asterolepidae. *Ann. Mag. Nat. Hist.* vol. ii., 1888.
- 452a. — Carboniferous Selachii. *Geol. Mag.* vol. v., 1888.
453. — On the Systematic Position of the Dendrodont Fishes. *Geol. Mag.* vol. vi., 1889.
454. — *Homosteus* compared with *Coccosteus*. *Geol. Mag.* vol. vi., 1889.
455. — Observations on some Fossil Fishes from the Lower Carboniferous Rocks of Eskdale. *Ann. Mag. Nat. Hist.* vol. vi., 1890.
456. — On the Fishes found at Achanarras Quarry, Caithness. *Ann. Mag. Nat. Hist.* vol. vi., 1890.
457. — On the Structure of *Coccosteus decipiens*. *Ann. Mag. Nat. Hist.* vol. v., 1890.
458. — The Fossil Dipnoi and Ganoids of Fife and the Lothians. *Proc. Roy. Soc. Edinburgh*, vol. xvii., 1890.
459. — Notes on the Devonian Fishes of Campbelltown and Seamenac Bay in Canada. *Geol. Mag.* vol. vii., 1890; vol. x., 1893.
460. — On a New Species of *Diplacanthus*. *Geol. Mag.* vol. i., 1894.
461. — The Asterolepidae. *Monogr. Palaeontogr. Soc.*, Part I. 1894; Part II. 1904.
462. — The Extinct Vertebrata of the Moray Firth Area. Harvey-Brown and Buckley's Fauna of Moray Basin, Edinburgh, 1896.
463. — *Palucospondylus Gunnii*. *Proc. Roy. Phys. Soc. Edin.* vol. xii., 1893. *Proc. Zool. Soc.*, 1897.
464. — On *Cladodus Neilsoni*. *Trans. Geol. Soc. Glasgow*, vol. xi., 1897.
465. — On *Thelodus Pagei*, Powrie, Sp. from the Old Red Sandstone of Forfarshire. *Trans. Roy. Soc. Edin.* vol. xxxix., 1898.
466. — Report on Fossil Fishes . . . in the Silurian Rocks of the South of Scotland. *Trans. Roy. Soc. Edin.* vol. xxxix., 1898.
467. — Lower Devonian Fishes of Gemünden. *Trans. Roy. Soc. Edinburgh*, vol. xl., 1893. Supplement, *ibid.* vol. xli., 1895.
- 467a. — *Drepanaspis Gemündenensis*. *Geol. Mag.* vol. vii., 1900.
468. — Additional Note on *Drepanaspis Gemündenensis*. *Geol. Mag.* vol. ix., 1902.
469. — Supplementary Report on Fossil Fishes: Silurian. *Trans. Roy. Soc. Edin.* vol. xl., 1905.
470. *Turner, W.* Branchial Appendages and Teeth of the Basking Shark (*Selache maxima*). *Journ. Anat. and Phys.* vol. xiv., 1879.
471. *Ussow, S.* Zur Anat. und Entwick. der Wirbelsäule der Teleostier. *Bull. Soc. Imp. des Nat. de Moscou*, 1900.
- 471a. — Die Entw. d. Cycloidschuppe der Teleostier. *Bull. Soc. Nat. Moscou*, vol. xi., 1897.
472. *Vaillant, L.* Sur la présence du tissu osseux chez certains poissons des

- terrains paléozoïques de Canyon City (Colorado). C.R. Acad. Sci. Paris, vol. cxxxiv., 1902.
473. *Vetter, B.* Die Fische aus d. lithogr. Schiefer. Mitth. K. min. geol. Mus. Dresden, t. iv., 1881.
474. *Vialleton, L.* Étude sur le cœur des Lamproies. Arch. d'anat. Micr. vol. vi., 1903.
- 474a. *Vogt, C.* Classific. des poissons ganoides. Ann. Sci. Nat. Paris, vol. iv., 1845.
475. *Volz, W.* Der Circulations- u. Respirationsapparat v. *Monopterus javanensis*, Lac. Zool. Jahrb., Abt. Anat. vol. xxiii., 1906.
476. *Vrolik, J. A.* Studien ü. d. Verknöcherung . . . der Teleostier. Niederl. Arch. f. Zool. vol. i., 1873.
477. *Wagner, A.* Urveltlichen Fische. Abh. K. bay. Akad. Wiss. math.-phys. Cl. vol. vi., 1851. Monogr. der fossilen Fische. *Ibid.* vol. ix., 1863.
478. *Waldeyer, W.* Eierstock u. Ei. Leipzig, 1870.
479. *Waldschmidt, J.* Zentralnervensysteme u. d. Geruchsorgans v. *Polypterus bichir*. Anat. Anz. vol. ii., 1887.
480. *Walther, J.* Die Entw. d. Deckknochen des Hechtes. Jen. Zeitschr. vol. xvi., 1883.
- 480a. *Warren, E.* Teeth of *Petromyzon* and *Myxine*. Quart. Journ. Micr. Sci. vol. xlv., 1902.
481. *Weber, E. H.* De aure et auditu hominis et animalium. Leipzig, 1820.
482. *Weber, M.* Abdominalporen der Salmoniden. Morph. Jahrb. vol. xii., 1887.
483. *Weldon, W. F. R.* On the Head-Kidney of *Bdellostoma*. Quart. Journ. Micr. Sci. vol. xxiv., 1884.
484. *Wellburn, E.* On the Genus *Coelacanthus*, etc. Proc. Yorks. Geol. and Pal. Soc. vol. xiv., 1902.
485. *Wenckebach, K.* Entw. der Knochenfische. Arch. f. Mikr. Anat. vol. xxviii., 1886.
486. *Wheeler, W. M.* The Development of the Urogenital Organs of the Lamprey. Zool. Jahrb. vol. xiii. Anat., 1899.
487. *White, P. J.* The Skull and Visceral Skeleton of the Greenland Shark, *Laemargus microcephalus*. Trans. Roy. Soc. Edin. vol. xxxvii., 1891-1895.
488. *Whiteaves, J. F.* Fossil Fishes of the Devonian Rocks of Canada. Trans. Roy. Soc. Canada, vol. iv., 1887; and vol. vi., 1888.
489. *Wiedersheim, R.* Das Skelet, etc., v. *Lepidosiren annectens*. Morph. Studien, vol. i., Jena, 1880.
490. — Zur Histologie der Dipnoerschuppen. Arch. mikr. Anat. vol. xviii., 1880.
491. — Über d. Becken der Fische. Morph. Jahrb. vol. vii., 1881.
492. — Das Gliedmassenskelet der Wirbeltiere. Jena, 1892.
493. — Über d. Kehlkopf der Ganoiden u. Dipnoer. Anat. Anz. vol. xxii., 1903.
494. *Wijhe, J. W. van.* Über das Visceralskelet u. die Nerven des Kopfes der Ganoiden u. von *Ceratodus*. Niederl. Arch. f. Zool. vol. v., 1879-1882.
495. — Ueber d. Mesodermsegmente . . . d. Selachierkopfes. Verh. K. Acad. Wet. Amsterdam, vol. xxii., 1882.
496. — Über d. Mesodermsegmente des Rumpfes u. d. Entw. d. Exkretions-syst. Arch. f. mikr. Anat. vol. xxiii., 1889.
- 496a. *Williamson, W. C.* The Structure of the Scales of Fishes, etc. Part I. Phil. Trans. vol. cxl., 1849. Part II. *ibid.* vol. cxli., 1850.

497. *Willcox, M. A.* Notes on the Occipital Region of the Trout, *Trutta Fario*. Zool. Bull. vol. ii., 1898-1899.
498. *Wood-Mason, J.*, and *Alcock, A.* On the Uterine Villiform Papillae of *Pteroplatea*, etc. Proc. Roy. Soc. vol. xlix. and vol. l.
499. *Woodward, A. Smith.* Palaeontological Contributions to Selachian Morphology. Proc. Zool. Soc., 1886.
500. — On the Relations of the Mandibular and Hyoid Arches in a Cretaceous Shark (*Hybodus dubrisiensis*). Proc. Zool. Soc., 1886.
501. — The Fossil Fishes of the Hawkesbury Series. Mem. Geol. Surv. N.S. Wales, vol. iv., 1890. The Fossil Fishes of the Talbragar Beds. *Ibid.* vol. ix., 1895.
502. — The Pycnodont Fish, *Mesturus*. Ann. and Mag. Nat. Hist. vol. xvii., 1896.
503. — Outlines of Vertebrate Palaeontology. Cambridge, 1898.
- 503a. — *Euphanerops longaevis*. Ann. Mag. Nat. Hist. vol. v., 1900.
504. — Fossil Fishes of the English Chalk. Palaeontogr. Soc., London, 1902.
505. — Catalogue of the Fossil Fishes in the British Museum, 4 vols., London, 1889-1901.
- 505a. — The Jaws of *Ptychodus*. Quart. Journ. Geol. Soc. vol. l., 1904.
506. — On *Myriacanthus paradoxus*. Quart. Journ. Geol. Soc., vol. lxii., 1906.
507. — On a Carboniferous Fish Fauna. Mem. Nat. Mus. Melbourne, No. 1, 1906.
- 507a. *Worthington, J.* The Brain and Cranial Nerves of *Bdellostomà*. Quart. Journ. Micr. Sci. vol. xlix., 1905.
508. *Wright, R. R.* On the Function of the Serrated Appendages of the Throat of *Amia*. Science, vol. iv., 1884.
509. — On the Hyomandibular Clefts and Pseudobranchs of *Lepidosteus* and *Amia*. Journ. Anat. and Phys. vol. xix., 1885.
510. — On the Skull and Auditory Organ of the Siluroid *Hypophthalmus*. Trans. Roy. Soc. Canada, Sect. 4, 1885.
511. *Zarnik, B.* Über segmentale Venen bei *Amphioxus* u. ihr Verhältniss z. Ductus Cuvieri. Anat. Anz. vol. xxiv., 1904.
512. *Ziegler, H. E.* Die Enst. d. Blutes bei Knochenfischembryonen. Arch. f. mikr. Anat. vol. xxx.
513. *Zittel, K. A. von.* Handbuch der Paläontologie, vol. iii. (Pisces, etc.), Munich, 1887. Grundzüge d. Paläontologie, Munich, 1895. Trans. by C. R. Eastman, London, 1902.
514. *Zograff, N.* Labyrinthine Apparatus of the Lab. Fishes. Quart. Journ. Micr. Sci. vol. xxviii., 1888.

## INDEX

Figures given in thick type refer to the systematic position.  
*f.* refers to an illustration. All the numbers refer to pages.

- Abeona*, **446**  
*Abramis*, **375**  
*Acanthaphritis*, **456**  
*Acanthaspis*, **263**; *A. decipiens*, 263 *f.*  
*Acanthias*, 5, 10 *f.*, 71, 122, 127 *f.*, 128, 151, 152; *A. vulgaris*, 9 *f.*, 14 *f.*, 58 *f.*, 77 *f.*, 129 *f.*, 152 *f.*, 360 *f.*  
*Acanthobatis*, **161**  
*Acanthocephala*, **431**  
*Acanthocephalum*, **465**  
*Acanthoderma*, **437**  
*Acanthodes*, 188 *f.*, 190, 191, **192**; *A. gracilis*, 187 *f.*, 192 *f.*; *A. sulcatus*, 192 *f.*; *A. Wardi*, 191 *f.*  
*Acanthodi*, **187**  
*Acanthodiidae*, **192**; skull, 190 *f.*  
*Acanthodopsis*, **192**  
*Acanthoëssus*, **192**  
*Acanthopleurus*, **437**  
*Acanthopsis*, **376**  
*Acanthopterygii*, **424**  
*Acanthuridae*, **435**  
*Acanthurus*, **436**; *A. leucosternum*, 436 *f.*  
*Acara*, **446**  
*Acentrophorus*, **336**  
*Aceratius*, **462**  
*Acerina*, 368, **443**; *A. cernua*, **443**  
*Acestra*, **384**  
*Achirus*, **474**  
*Acipenser*, 94 *f.*, 108 *f.*, 117, 133 *f.*, 212 *f.*, 224, 277, 305 *f.*, 307, 315 *f.*, 316, 318, **319**, 367 *f.*, 369; *A. ruthenus*, 304 *f.*, 306 *f.*, 320 *f.*; *A. sturio*, 110 *f.*, 274 *f.*, 303 *f.*, 308 *f.*, 319 *f.*  
*Acipenseridae*, **318**  
*Acipenseroides*, **315**  
*Acerodus*, 144, **146**  
*Acrogaster*, **427**  
*Acrognathus*, **399**  
*Acrolepis*, **311**  
*Acropoma*, **441**  
*Acropomatidae*, **441**  
*Aeretus*, **421**  
*Actinopterygii*, **302**  
*actinotrichia*, 273  
*adipose fin*, 275  
*Aeobatis*, **166**  
*Aethelion*, **371**  
*Aetheolepis*, 336  
*Agonidae*, **450**  
*Agonus*, **451**  
*Agriopus*, **450**  
*Aipichthys*, **432**  
*air-bladder*, 223, 359; auditory caeca, 360; calcified, 289; bony, 377  
*Albida*, 347, 349, 363, **388**; *A. conorhynchus*, 110 *f.*, 348 *f.*, 349 *f.*, 350 *f.*  
*Albulidae*, **387**  
*Alburnus*, **375**  
*Alepidosauridae*, **399**  
*Alepidosaurus*, **399**; *A. ferax*, 400 *f.*  
*Alepocephalidae*, **394**  
*Alepocephalus*, **394**  
*Aleposaurus*, **394**  
*Aleposomus*, **394**  
*Alestes*, **375**  
*alimentary canal*, 26  
*Allotripodus*, **331**  
*Allotriognathi*, **475**  
*Alopecias*, **150**; *A. culpes*, 150 *f.*  
*Alopius*, 150 *f.*; *A. culpes*, 110 *f.*, 116 *f.*  
*Alosa*, 133 *f.*; *A. culgaris*, 362 *f.*  
*Allicus*, 458  
*Aluteres*, **437**  
*Ambassis*, **431**  
*Amblyopsidae*, **401**  
*Amblyopsis*, **401**; *A. spelaens*, 402 *f.*  
*Amblypterus*, 212, **311**  
*Amia*, 17, 101, 108 *f.*, 224 *f.*, 226, 227, 266, 270, 272, 276, 277, 278, 296, 302, 305 *f.*, 316 *f.*, 324, 326, 327, 328, 329, 330, 333, **334**, 342, 346, 363, 367 *f.*, 369; *A. calva*, 110 *f.*, 222 *f.*, 267 *f.*, 268 *f.*, 269 *f.*, 270 *f.*, 271 *f.*, 274 *f.*, 276 *f.*, 306 *f.*, 328, 332 *f.*, 333 *f.*  
*Amiidae*, **333**  
*Amioidei*, **327**  
*Amiopsis*, **334**  
*Amivurus*, 379, **380**  
*Ammocoete larva*. See *Petromyzon*  
*Ammodytes*, **403**; *A. americanus*, 403 *f.*  
*Ammodytidae*, **403**  
*Ammotretis*, **474**  
*Amphicetus*, **450**  
*Amphioxus*, 1, 2, 2 *f.*, 3, 4, 7, 13, 18, 19, 25, 26, 27, 39, 42, 46, 47, 51, 52  
*Amphipnoidae*, **409**  
*Amphipnous*, **410**  
*Amphiprion*, **446**  
*Amphisila*, **414**; *A. scutata*, 414 *f.*  
*Amphisilidae*, **413**  
*Amphistiidae*, **469**  
*Amphistium*, **469**; *A. paradoxum*, 470 *f.*  
*amphistylic jaws*, 95, 139, 144  
*ampullae*, 19, 125  
*Anabantidae*, **422**

- Anabas*, 422; *A. scandens*, 422 *f.*  
*Anableps*, 365, 400, 401; *A. Doriai*, 401 *f.*  
 Anacanthini, 478  
*Anaplerus*, 399  
*Anarrhichas*, 458; *A. lupus*, 459 *f.*  
 Anarthrodira, 262  
 Anaspida, 204  
*Ancestrus*, 468  
*Anicistrus heteracanthus*, 385 *f.*  
*Ancylostomus*, 431  
*Anema*, 456  
*Anguilla*, 352, 367, 377, 405; *A. vulgaris*, 404  
*Anguillacrus*, 404  
 Anguillidae, 405  
 Anguilliformes, 403  
*Anogninus*, 388  
 Anomalopidae, 432  
*Anomalops*, 432  
*Anoplopoma*, 453  
*Anostomus*, 420  
 Antennariidae, 462  
*Antennarius*, 462  
*Anthias*, 431  
 Antiarchi, 206  
*Antigonis*, 433  
 aortic arches, 47, 111  
*Apateulus*, 399  
*Apatelepis*, 311  
*Apeltes*, 412  
*Aphaelepis*, 336  
 Aphredoderidae, 427  
*Aphredoderus*, 427  
*Aphyonius*, 459  
*Apistus*, 450  
 Apodes, 403  
*Apollichthys*, 458  
*Apogon*, 430, 431; *A. frenatus*, 431 *f.*  
*Apostasis*, 436  
*Apua*, 376  
*Araucana*, 439  
*Arapaima*, 390  
*Archaeobatis*, 167  
 Archaeonemidae, 337  
*Archaeonemus*, 337  
*Archaeoenthis*, 435  
 Archencheli, 404  
 archipterygium, 106; of Pleuracanthus, 181; of *Ceratodus*, 244; of Osteolepidoti, 282  
*Arctoscopus*, 445  
*Argentina*, 394  
*Arges*, 384  
 Arginae, 384  
*Argyropelecus*, 395  
*Ariscopus*, 456  
*Arius*, 133 *f.*, 380  
*Arnoglossus*, 473, 474  
*Arrhamphus*, 403  
*Arripis*, 431  
 Arthrodira, 258, 262  
 Arthrothoraci, 262  
*Asineops*, 427  
 Aspidorhynchidae, 344  
*Aspidorhynchus*, 344; *A. acutirostris*, 344 *f.*  
*Aspius*, 375  
 Aspredinidae, 384  
*Aspredo*, 384  
*Aspro*, 443  
*Asprotilapia*, 446  
*Asteracanthus*, 144, 146; *A. medius*, 146 *f.*  
*Asterodermus*, 161  
 Asterolepidae, 209  
*Asterolepis*, 207, 209, 259, 260  
*Asterosteus*, 262  
*Asthenocormus*, 333  
*Astroblepus*, 384  
*Astromethes*, 395  
*Astrops*, 163  
 asymmetry, 469  
 Ateleaspidae, 203  
*Ateleaspis*, 203; *A. tessellata*, 204 *f.*  
*Ateleopus*, 460  
*Atherina*, 420  
 Atherinidae, 419  
*Atherstonia*, 311  
*Athrodon*, 340  
*Atypichthys*, 432  
*Atyposoma*, 432  
*Auchenaspis*, 203, 204  
*Auchenoglanis*, 382; *A. biscutatis*, 379 *f.*  
 auditory capsule, 11; ossifications in, 266  
 auditory organ, 23  
*Aulolepis*, 397  
*Aulorhamphus*, 436  
 Aulorhynchidae, 412  
*Aulorhynchus*, 412  
*Aulostoma*, 413  
 Aulostomatidae, 413  
 Aulostomoidei, 412  
*Ausonia*, 467  
 autostylic jaws, 95, 171, 237  
*Auzis*, 465  
*Azurina*, 446  
*Badis*, 445  
*Bagaricus*, 379, 382  
 Bagrinae, 380  
*Balistes*, 437; *B. stellaris*, 438 *f.*; *B. verrucosus*, 440 *f.*; *B. viridescens*, 438 *f.*  
 Balistidae, 437  
*Barbus*, 375; *B. vulgaris*, 353 *f.*  
 basidorsal arch, 100  
 basiventral arch, 100  
*Bathyclupea*, 428  
*Bathyltraco*, 456  
 Bathygadinae, 481  
*Bathygadus*, 481  
*Bathymaster*, 431  
*Bathypterois*, 399  
*Bathyrhissa*, 388  
*Bathyroctes*, 394  
 Batrachi, 460  
 Batrachidae, 460  
*Batrachus*, 460; *B. tau*, 460  
*Bdellostoma*, 35, 42 *f.*, 46, 48 *f.*, 49 *f.*, 50, 51, 85, 88, 133 *f.*; *B. Dombeyi*, 30 *f.*, 49 *f.*; *B. Forsterii*, 48 *f.*  
*Bellemnobatis*, 161  
*Belone*, 349, 402, 403  
 Beloninae, 403  
 Belonorhynchidae, 320  
*Belonorhynchus*, 321 *f.*  
*Belonostomus*, 344  
*Bembras*, 454  
*Bembrops*, 456  
*Bentenia*, 464  
*Benthodesmus*, 466  
*Benthophilus*, 448  
*Benthosaurus*, 399  
 Berycidae, 426  
 Beryciformes, 426  
*Berys*, 427; *B. decadactylus*, 426 *f.*  
*Betta*, 422  
*Birkenia*, 204, 205, 206; *B. elegans*, 204 *f.*  
 Birkeniidae, 205  
*Bleekeria*, 456  
 Blenniidae, 458  
 Blenniiformes, 454  
*Blenniops*, 458  
*Blennius*, 133 *f.*, 458; *B. gattorugine*, 457 *f.*; *B. vulgaris*, 458 *f.*  
*Blepsias*, 454  
*Boleosoma*, 443  
 bone, 60; primary and secondary, 65, 67; cartilage-bone, 65; membrane-bone, 65; dermal bone, 66; modified, of Teleostei, 355; section, 61 *f.*, 64 *f.*



- bone-like tissue, of *Acanthodii*, 189; of *Pteraspidomorphi*, 195  
*Bothriolepis*, 206, 207, 209;  
*B. canadensis*, 206 f.  
*Bolia*, 376  
*Bovichtys*, 456  
*Box*, 429  
*Brachiomichthys*, 462  
*Brachydirus*, 260, 263  
brain, 13, 16 f.; of *Actinopterygii*, 305; of *Dipnoi*, 245; of *Elastomobranchii*, 126; of *Teleostei*, 363; of *Teleostomi*, 277  
*Brama*, 464  
Bramidae, 464  
branchia, 41, 93, 272  
branchial bar, 93  
branchiostegal rays, 304  
breathing valves, 272  
*Bregmaceros*, 482  
*Brosmius*, 482  
*Brotula*, 459  
*Brychaetus*, 390  
*Brycon*, 375  
*Bucklandium*, 380  
*Bucocephalus*, 384  
*Butirinus*, 363, 388  
  
*Caesio*, 429  
*Calamoichthys*, 290, 291, 293; *C. calabarius*, 301 f.  
*Callamostoma*, 415  
Callichthyidae, 384  
*Callichthys*, 384  
Callionymidae, 456  
*Callionymus*, 456; *C. lyra*, 355 f.  
*Callomystax*, 379, 383  
*Callophrys*, 382  
*Callopterus*, 331  
Callorhynchidae, 176  
*Callorhynchus*, 133 f., 168, 169, 172, 176, 177 f.; *C. antarcticus*, 81 f., 171 f., 178 f.  
*Callyodon*, 447  
campanula Halleri, 359  
*Campodus*, 147  
camptotrichia, 232  
canal of a Selachian, lateral-line, 138 f.  
*Canobius*, 310  
Caproidae, 432  
*Capros*, 433; *C. aper*, 433 f.  
Carangidae, 464  
*Carangopsis*, 464  
*Caranx*, 464; *C. ferlan*, 464 f.; *C. trachurus*, 360  
*Carapus*, 377  
*Carcharius*, 134, 150, 151  
Carcharidae, 150  
Carcharinae, 151  
*Carcharodon*, 148, 150  
*Carpiooides*, 375  
cartilage, 31, 60; articular, of man, 60 f.  
cartilage and bone, 58; substitution theory, 63  
*Catla*, 375  
*Catopra*, 445  
Catopteridae, 313  
*Catopterus*, 313  
*Catosteomi*, 410  
*Catostominae*, 475  
*Catostomus*, 375; *C. occidentalis*, 376 f.  
*Caturus*, 329, 331; *C. fureatus*, 331 f.  
*Caulolatilus princeps*, 455 f.  
*Caulolepis*, 427  
Centrarchidae, 443  
*Centrarchus*, 443  
*Centrina*, 152  
Centriscidae, 413  
Centriscoides, 413  
*Centriscus*, 413; *C. humerosus*, 413 f.  
Centrobatoidei, 163  
*Centrogenys*, 431  
*Centrolepis*, 312  
*Centrolophus*, 421  
*Centronotus*, 458  
*Centrophorus*, 152; *C. calceus*, 80 f.  
*Centropomus*, 431  
*Centroscyllium*, 152  
centrum, 68, 100; astrospondylous, cyclospondylous, tectospondylous, 135; divided, 328  
Cephalaspidae, 203  
Cephalaspidomorphi, 200  
*Cephalaspis*, 200, 201 f., 204, 209; *C. Lyelli*, 201 f., 202 f.  
cephalisation, 2  
*Cephaloptera*, 167; *C. giovanae*, 166 f.  
*Cepola*, 431  
Cepolidae, 431  
*Ceratas*, 462  
Ceratiidae, 462  
Ceratomidae, 257  
*Ceratodus*, 81, 89, 94 f., 106, 107, 108 f., 127, 133 f., 223, 224 f., 233 f., 234, 236, 238, 239, 240, 241, 242, 243 f., 244, 245, 247, 250, 251 f., 252, 253, 254 f., 255, 258, 282; *C. Forsteri*, 231 f., 234 f., 236 f., 237 f., 242 f., 244 f., 248 f., 250 f., 252 f., 257 f.; *C. sturii*, 240  
*Ceratoptera*, 167  
ceratotrichia, 122  
cerebellum, 13  
*Cestracion*, 80 f., 96 f., 143, 144, 146, 147 f.  
Cestraciontidae, 145  
*Cetengraulis*, 392  
Cetomimidae, 399  
*Cetomimus*, 399; *C. Gillii*, 400 f.  
*Cetopsis*, 383  
*Cetorhinus*, 135, 148, 150; *C. maximus*, 149 f.  
*Chaca*, 383  
*Chaenichthys*, 456  
*Chaerops*, 447  
*Chaetobranchus*, 446  
*Chaetodon*, 434; *C. ephippium*, 434 f.  
Chaetodontidae, 434  
Chaetodontiformes, 433  
*Chaetostomus*, 384, 385 f.  
*Chalceus*, 375  
*Champsodon*, 423  
Chaninae, 393  
*Channa*, 422  
*Channolabes*, 380  
*Channomuraena*, 408  
*Chanooides*, 393  
*Chanos*, 347, 391, 393  
Characinae, 374  
Characinoidei, 374  
*Charitosomus*, 395  
*Chasmodes*, 458  
*Chatoëssus*, 361 f., 391, 393  
Chauliodontinae, 395  
*Chauliodon*, 394, 395  
*Chaunax*, 462  
*Cheiracanthus*, 192; *C. Murchisoni*, 189 f.  
*Cheirodopsis*, 313  
*Cheiroodus*, 313; *C. granulatus*, 313 f.  
*Cheirolepidinae*, 310  
*Cheirolepis*, 188, 307, 310, 311 f.  
*Chelmo*, 434  
*Chiasmodon niger*, 423 f.  
Chiasmodontidae, 423  
*Chiasmodus*, 423  
*Chilinus*, 447  
*Chilobanchus*, 408  
*Chilodactylus*, 445

- Chilodipterus*, 430, **431**  
*Chilomyxterus reticulatus*,  
 440 *f.*  
*Chiloscyllium*, **149**  
*Chimaera*, 128, 169, **176**; *C.*  
*monstrosa*, 24 *f.*, 110  
*f.*, 170 *f.*, 172 *f.*, 173 *f.*,  
 174 *f.*, 175 *f.*, 179 *f.*  
 Chimaeridae, **176**  
*Chimacropsis*, 168, **176**  
*Chimarrichthys*, **456**  
 Chirocentridae, **390**  
*Chirocentrites*, **391**  
*Chirocentrus*, 362, **391**; *C.*  
*dorab*, 116 *f.*  
*Chirolophis*, **462**  
*Chironomystus*, **391**  
*Chironemus*, **445**  
*Chirostoma*, **420**  
 Chirothricidae, **400**  
*Chirothrix*, **400**  
 Chlamydoselachidae, **142**  
*Chlamydoselachus*, 132, 137,  
 140, **142**; *C. anguineus*,  
 128 *f.*, 141 *f.*  
*Chologaster*, **401**  
 Chondrenchelyidae, **183**  
*Chondrenchelys*, **183**  
 Chondrichthyes, **118**  
 chondrocranium, 11  
 Chondrostei, **307**  
 Chondrosteidae, **316**  
*Chondrosteus*, 317, 318, 319;  
*C. acipenseroides*, 317 *f.*  
*Chonerhinus*, **440**  
*Chorinemus*, **464**  
*Chorismadactylus*, **450**; *C.*  
*multibarbis*, 451 *f.*  
*Chorisochismus*, **457**  
*Chromis*, **446**  
*Chrysichthys*, **380**  
*Chrysophrys*, **429**  
*Chylomgeterus*, **440**  
*Cichla*, **446**  
 Cichlidae, **446**  
*Cichlops*, **431**  
*Cimolichthys*, **398**  
 circulation, branchial, 112  
*f.*, 139 *f.*  
*Cirrhites*, **431**  
*Citharinus*, 325, **375**; *C.*  
*Geoffroyi*, 374 *f.*  
*Citharus*, **474**  
*Cladocyclus*, **390**  
 Cladodontidae, **183**  
*Cladodus*, 107, 108 *f.*, 182,  
 183, 184; *C. Neilsoni*,  
 128 *f.*  
*Cladoselache*, 184, 185 *f.*,  
**187**; *C. Fyleri*, 185 *f.*,  
 186 *f.*  
 Cladoselachidae, **187**  
 Cladoselachii, **184**  
*Clariallabes*, **380**  
*Clarias*, 379, **380**; *C.*  
*lazera*, 381 *f.*; *C. magur*,  
 381 *f.*  
 Clariinae, **380**  
 clasper, 129; anterior,  
 174; frontal, 171  
*Cleithrolepis*, **336**  
*Climatius*, **192**; *C. scutigera*,  
 192 *f.*  
*Clinus*, **458**  
 cloaca, 114  
*Clupea*, 326, 365, 368, 391,  
**393**; *C. alasa*, 393 *f.*;  
*C. finta*, 392 *f.*; *C.*  
*harengus*, 393 *f.*  
 Clupeidae, **391**  
 Clupeiformes, **386**  
 Clupeinae, **393**  
*Cnidoglanis*, **380**  
 Cobitidinae, **376**  
*Cobitis*, 368, 375, **376**  
*Cobitopsis*, **403**  
*Coccoderma*, **290**  
*Coccodus*, **340**  
*Coccolepis*, 308, 309, 310,  
**312**  
 Coccosteidae, **263**  
 Coccosteomorphi (Arthro-  
 dira), **258**  
*Cocosteus*, 230, 259, 260,  
**263**; *C. decipiens*, 260 *f.*,  
 261 *f.*, 263 *f.*  
 Coeliodontidae, **146**  
*Coeliodus*, **146**  
 Coelacanthidae, **290**  
 Coelacanthini, **287**  
*Coelacanthus*, 106, 289, **290**  
*Coelodus*, 337 *f.*, **340**  
 Coelolepidae, **196**  
*Coelolepis*, **196**  
 coelom, 3, 26  
*Coelophrys*, **462**  
*Coilia*, 391, 392; *C. dussu-*  
*meri*, 394 *f.*  
*Colobodus*, **336**  
 Colocephali, **407**  
*Colocopus*, **436**  
*Columbia*, **426**; *C. trans-*  
*montana*, 425 *f.*  
 Comephoridae, **453**  
*Comephorus*, **453**  
*Conchodus*, **256**  
*Conchopoma*, 246, **256**  
*Conger*, **405**; *C. vulgaris*,  
 407 *f.*  
 Congrogadidae, **460**  
*Congrogadus*, **460**  
*Congromuraena*, **405**  
*Comorhynchus*, **382**  
*Copidoglanis*, **380**  
*Copodus*, **167**  
*Coregonus*, **394**  
*Coridodax*, **447**  
*Corydoras*, **384**  
*Coryphaena*, **467**  
 Coryphaenidae, **466**  
 cosmine, 217  
 cosmoid scale, 217, 230  
*Cossyphus*, **447**  
 Cottidae, **453**  
*Cottocomephorus*, **453**  
*Cottus*, **453**; *C. gobio*, 103 *f.*,  
 453 *f.*  
 cranial nerves, 6  
*Crenuchus*, **375**  
*Cricodus*, **286**  
*Cromeria*, **396**  
 Cromeridae, **396**  
 Crossognathidae, **393**  
*Crossognathus*, **393**  
*Crossopholis*, 317, **318**  
 Crossopterygian, 291  
 Crossopterygii, **280**  
*Crossorhinus*, **149**  
*Cryodraco*, **456**  
*Cryphiotelepis*, 309, **310**  
 Ctenodontidae, **257**  
*Ctenodus*, 239, 240 *f.*, **257**  
*Ctenolabrus*, **447**  
*Ctenothrissa*, **397**; *C.*  
*vecellifer*, 396 *f.*  
 Ctenothrissidae, **396**  
*Cubiceps*, **421**  
*Cyathaspis*, 195, **200**  
*Cybbium*, **465**  
*Cyclobatis*, **161**  
*Cyclopoma*, **441**  
 Cyclopteridae, **454**  
*Cyclopterus*, 365, 368, **454**  
 Cyclostomata, 30  
 Cyclostome, 6 *f.*, 7 *f.*  
*Cymatogaster*, **446**  
*Cynoglossus*, 473, **474**  
 Cyphosidae, **443**  
 Cyprinidae, **375**  
 Cypriniformes, **371**  
 Cyprininae, **375**  
*Cyprinodon*, **401**  
 Cyprinodontidae, **400**  
*Cyprinus*, **375**; *C. carpio*,  
 346 *f.*, 372 *f.*, 376 *f.*  
*Cytooides*, **469**  
*Cyttopsis*, **469**  
*Cyttus*, **469**  
*Dactylopoigon*, **399**  
 Dactylopteridae, **451**  
*Dactylopterus*, 452, **453**;  
*D. volitans*, 452 *f.*

- Dallia*, 398; *D. pectoralis*, 399 *f.*  
 Dalliidae, 398  
*Dapedius*, 334, 335 *f.*, 336; *D. politus*, 334 *f.*  
*Dapedoglossus*, 390  
*Dascyllus*, 446; *D. aruanus*, 443 *f.*  
*Datnioides*, 445  
*Deltodus*, 146  
*Deltoptychius*, 147  
*Dendrodus*, 285  
*Dentex*, 429  
 denticle, 66, 118, 168; of Teleostei, 356, 384  
 dentine, 119  
 Dercetidae, 417  
*Dercetis*, 417  
 Derichthyidae, 406  
*Derichthys*, 406; *D. serpentinus*, 405 *f.*  
 dermal fin-rays, 109, 122, 212, 230  
 dermal plates of Ostracodermi, 195, 206; of Osteichthyes, 212  
 dermatrichia, 109, 122, 212, 230  
*Diacranodus*, 183  
*Diagramma*, 445  
*Dibranchus*, 462  
*Dicentrodus*, 183  
 Dicerobatinae, 166  
*Dicerobatis*, 167  
*Dicotylichthys*, 440; *D. punctulatus*, 441 *f.*  
*Dicrotus*, 466  
*Dictyopyge*, 313; *D. macrura*, 314 *f.*  
*Didymaspis*, 204  
 diencephalon, 15  
 Dinichthyidae, 263  
*Dinichthys*, 263; *D. intermedius*, 265 *f.*  
*Dinolestes*, 441  
*Dinopteryx*, 427  
*Diodon*, 440; *D. maculatus*, 441 *f.*, 442 *f.*; *D. punctulatus*, 440 *f.*  
 Diodontidae, 440  
 diphyeereal tail, 104  
 Diplacanthidae, 192  
*Diplacanthus*, 192; *D. striatus*, 187 *f.*, 191 *f.*  
*Diplacodus*, 147  
*Diplocrepis*, 457  
*Diploodus*, 183  
*Diplognathus*, 263  
*Diplomystax*, 380  
 Diplomystacinae, 380  
*Diplomystes*, 380  
*Diplomystus*, 393  
*Diplopterus*, 285  
 diplospondyly, 137  
*Diplurus*, 290  
 Dipnoi, 230, 366 *f.*; affinities, 258  
 Dipteridae, 256  
*Dipterus*, 230, 231, 232 *f.*, 233, 238, 239, 241 *f.*, 242 *f.*, 255 *f.*, 256, 257; *D. Valenciennesii*, 255 *f.*  
 Discocephali, 448  
*Distichodus*, 375  
*Ditrema*, 446; *D. argenteum*, 444 *f.*  
 Doradinae, 382  
*Doras*, 383  
*Drepanaspis*, 195, 198; *D. gemmuluensis*, 198 *f.*  
 Drepanaspidae, 197  
*Drepane*, 434  
*Ductor*, 464  
*Dussumieria*, 391, 392  
*Dysichthys*, 384  
*Dysomma*, 406  
 Echeneididae, 449  
 Echeneidiformes, 448  
*Echeneis*, 449  
*Echidnocephalus*, 417  
*Echinorhinus*, 151, 152  
 Edestidae, 147  
*Edestus*, 147  
*Egertonia*, 447  
 egg-case, horny, 132, 168  
 egg-shell, 50  
 Elasmobranchii, 125  
*Elasmodectes*, 178  
*Elasmodus*, 178; *E. Hunteri*, 177 *f.*  
 electric organ, of *Raja*, 161; of *Torpedo*, 162; of *Gymnotus*, 377; of *Malapterurus*, 383; of Mormyridae, 388  
*Eleotris*, 448  
*Elonichthys*, 311  
 Elopidae, 387  
*Elopopsis*, 387  
*Elops*, 326, 347, 355, 387; *E. saurus*, 345 *f.*, 387 *f.*  
*Embiotoca*, 446  
 Embiotocidae, 446  
*Embolichthys*, 456  
 Enchelicephali, 405  
*Enchelurus*, 417  
*Enchelycore*, 408  
 Enchodontidae, 398  
*Enchodus*, 398  
 Engraulinae, 392  
*Engraulis*, 391, 392  
*Eocottus*, 453  
*Eomycus*, 405  
*Eothynnus*, 465  
*Ephippion*, 440  
*Ephippium*, 434; *E. fiber*, 434 *f.*  
*Epibulus*, 447  
 epicentral, 353  
 epidermis, 25  
 epineural, 353  
*Epinnula*, 466  
 epiphysis, 16, 24  
*Eques*, 431  
*Equula*, 445  
*Erythrinus*, 326  
*Erythrichthys nitidus*, 350 *f.*, 351 *f.*, 356 *f.*  
*Erythrinus*, 225, 226, 360, 375; *E. unitaeniatus*, 374 *f.*  
*Esoclops*, 387  
 Esocidae, 398  
 Esociformes, 397  
*Esoc*, 121, 272, 355, 368, 398; *E. lucius*, 121 *f.*, 321 *f.*, 352 *f.*, 364 *f.*, 365 *f.*  
*Etroplus*, 446  
*Eucalia*, 412  
*Euchilichthys*, 382  
*Eucrossorhinus*, 149  
 Eugnathidae, 330  
*Eugnathus*, 331; *E. orthostomus*, 331 *f.*  
*Euceraspis*, 203, 204  
*Eumecichthys*, 476  
*Eumeda*, 380  
 Euphaneropidae, 206  
*Euphanerops*, 205, 206  
*Eupleurogrammus*, 466  
*Eurycormus*, 328 *f.*, 329, 331  
*Eurylepis*, 311  
*Eurynotus*, 313; *E. crenatus*, 218 *f.*  
*Eurypharynx*, 407  
*Eurypholis*, 398  
*Eusthenopteron*, 106, 276, 286, 291, 299; *E. Foardi*, 275 *f.*, 280 *f.*, 282 *f.*, 286 *f.*  
*Euthacanthus gracilis*, 189  
*Euthynotus*, 329, 333  
*Eutropius*, 380  
 excretory system, 27, 83  
 Exocoetinae, 403  
*Exocoetoides*, 400  
*Exocoetus*, 402, 403, 453; *E. callopterus*, 402 *f.*  
 external gills, 134, 247

- eye, 23; of Elasmobranchii, 125; of Teleostei, 359  
 eye-muscle canal, 326  
 eye-muscles, 5
- Fernellia tuberculata*, 194  
*Fierasfer*, 364, 419; *F. acus*, 351 *f.*, 418 *f.*; *F. dentatus*, 355 *f.*
- Fierasferidae, 419  
 fin, dorsal, 214 *f.*  
 fin-ray. See radial and dermal fin-ray  
 fin-skeleton, mesorhachic, monostichous, orthostichous, pleurorachic, rachistichous, rhipidostichous, 106-8  
 fin, skeleton, 69, 106; concrescence, 75; concentration, 71, 75, 105; migration, 79; of Elasmobranchii, 127  
 fin-spines, 374, 424  
 fins, lateral-fold theory, 73; gill-arch theory, 73  
 fins, median, 32, 69, 70 *f.*; development of, 71  
 fins, paired, development and origin of, 73, 107 *f.*; of Elasmobranchii, 127; of Pisces, 106; of Actinopterygii, 302; jugular, 425; thoracic, 425  
*Fistularia*, 62, 355, 412 *f.*, 413; *F. serrata*, 413 *f.*  
 Fistulariidae, 413  
 fulcra, 304  
*Fundulus*, 401
- Gadidae, 482  
 Gadiformes, 478  
*Gadomus*, 478, 479, 481  
*Gadopsis*, 458  
*Gadus*, 62, 71, 272, 276, 352, 356, 471 *f.*, 479 *f.*, 482; *G. morhua*, 221 *f.*, 278 *f.*, 347 *f.*, 364 *f.*, 480 *f.*, 482 *f.*  
*Galaxias*, 398; *G. truttaceus*, 398 *f.*  
 Galaxiidae, 398  
*Galeocerdo*, 151  
*Galeoides*, 421  
*Galeus*, 151  
*Gambusia*, 400; *G. affinis*, 401 *f.*  
*Ganodus*, 178  
 ganoid scale, 217  
 ganoine, 218  
*Ganorhynchus*, 256
- Gasterosteidae, 412  
 Gasterosteiformes, 410  
 Gasterosteioidei, 411  
*Gasterosteus*, 349, 412; *G. aculeatus*, 412 *f.*; *G. spinachia*, 410 *f.*, 411 *f.*  
*Gastrochisma*, 465; *G. melampus*, 466 *f.*  
*Gastromyzon*, 375, 376  
*Gastrostomus*, 407  
*Gastrotocens*, 415  
*Garialiceps*, 406  
 Gazza, 445  
*Gempylus*, 466  
*Genandina Sturtzii*, 180  
 genital duct, 27, 89; of Elasmobranchii, 132; of Dipnoi, 253; of Teleostomi, 366  
 genital pore, 46, 367  
*Genypterus*, 460  
*Geophagus*, 446  
*Geotria*, 54  
*Gephyroberyx*, 427  
 gephyrocercal tail, 355  
*Gerluchia*, 456  
*Gerres*, 445  
 Gerridae, 445  
 Gigantactinidae, 462  
*Gigantactis*, 462  
*Gigantopterus*, 336, 337  
 gills, of Cyclostomes, 41; of Pisces, 93; of Teleostomes, 272  
 gill-arch, 17; mandibular, 18; hyoid, 18  
 gill-rakers, 150, 248  
 gill-rays, 73, 123, 272  
 gill-slits, 17, 93, 122  
*Ginglymostomus*, 149; *G. cirratum*, 76 *f.*  
*Girardinus*, 401  
 girdle, pectoral, 73, 75; dermal bones of, 213; of Teleostome, 275  
 girdle, pelvic, 73, 75; origin of, in Teleostomi, 276; of Actinopterygii, 302  
*Glanidium*, 383  
*Glenopsis*, 376  
*Globulodus*, 313  
*Glyptolaemus*, 285  
*Glyptolepis*, 280, 285; *G. leptopterus*, 282 *f.*  
*Glyptopomidae*, 285  
*Glyptopomus*, 280, 281 *f.*, 285; *G. Kinnairdi*, 284 *f.*  
*Gnathonemus*, 389  
 Gnathostomata, 58  
 Gnathostome, 6 *f.*, 7 *f.*  
 Gobidae, 448
- Gobiesocidae, 456  
*Gobiesox*, 457  
 Gobiiformes, 447  
*Gobio*, 368, 375  
*Gobius*, 115 *f.*, 356, 448; *G. guttatus*, 447 *f.*  
 gonad, 28  
*Gonatodus*, 310; *G. punctatus*, 308 *f.*  
 Gonorhynchidae, 395  
*Gonorhynchus*, 395; *G. greyi*, 395 *f.*  
 Gonozoa, 395  
 Gonostomatinae, 395  
*Gosfordia*, 258  
 Grammistes, 431  
 gular plates, 213, 304  
 Gymnarchidae, 389  
*Gymnarchus*, 363, 388, 389  
*Gymnelis*, 459  
 Gymnodontes, 439  
*Gymnodraco*, 456  
 Gymnotidae, 376  
*Gymnotus*, 377, 404; *G. electricus*, 376, 377 *f.*  
 Gyrocantidae, 192  
*Gyrocantus*, 192, 193; *G. Murrayi*, 193 *f.*  
*Gyrodus*, 340  
*Gyrolepis*, 311  
*Gyropterychius*, 285  
*Gyrosteus*, 317
- Haemulon*, 445  
*Halec*, 398  
*Halimochirurgus*, 437  
*Haloporphyrus*, 482  
 Halosauridae, 417  
*Halosauropsis*, 417; *H. nigerrimus*, 417  
*Halosaurus*, 417  
 Haplistia, 283  
*Haplochilus*, 401  
*Haplochiton*, 398  
 Haplochitonidae, 398  
 Haplodactylidae, 445  
*Haplodactylus*, 445  
 Haplomi, 397  
*Harpodon*, 399  
*Harriotta*, 173, 178; *H. elegans*, 177 *f.*; *H. Raleighana*, 179 *f.*  
 heart, of Cyclostome, 43; of Dipnoi, 249; of Pisces, 109; of Teleostei, 363  
*Helgia*, 376  
*Helicastes*, 446  
*Helicophagus*, 380  
*Helicopirion*, 147; *H. bessonovi*, 148 *f.*

- Helodus*, 146  
*Helostoma*, 422  
*Hemerocoetes*, 457  
 hemibranch, 94  
 Hemibranchii, 410, 411, 412  
*Hemichromis*, 446  
*Hemipristis*, 151  
*Hemirhamphus*, 402, 403; *H. brasiliensis*, 402 *f.*  
*Hemirhamphus*, 467  
*Hemitripterus acadianus*, 447 *f.*  
*Heptanchus*, 76 *f.*, 95, 98 *f.*, 139 *f.*, 140 *f.*, 142, 143; *H. cinereus*, 15 *f.*, 138 *f.*; *H. indicus*, 142 *f.*  
*Heptanema*, 290  
*Heros*, 446  
*Heterobranchus*, 380  
 heterocercal tail, 101, 104  
 Heterodonti, 143  
*Heterodontus*, 128, 133 *f.*, 143, 144, 145, 146; *H. Philippi*, 80 *f.*, 96 *f.*, 147 *f.*  
*Heterolepidotus*, 331  
 Heteromi, 416  
*Heterophthalmus*, 432  
 Heterostraci, 195  
*Heterotis*, 390  
 Hexagrammidae, 453  
*Hexagrammus*, 453  
*Hexanchus*, 136 *f.*, 140, 142, 143  
*Hierichthys*, 460  
*Himantolophus*, 462  
 Hippocampidae, 415  
*Hippocampus*, 415 *f.*  
*Hippoglossus*, 474  
 Histichthyes, 476  
*Histiocephalus*, 450  
*Histionotus*, 336  
 Histiophoridae, 467  
*Histiophorus*, 468; *H. pulchellus*, 468 *f.*  
*Histiograssia*, 393  
*Holacanthus*, 434  
 holobranch, 94  
*Holocentrum*, 356, 427  
 Holocephali, 168  
*Holophagus*, 290; *H. gulo*, 287 *f.*  
*Holopteryx*, 427  
 Holoptychiidae, 284  
*Holoptychius*, 280, 285; *H. Andersoni*, 281 *f.*; *H. Flemingi*, 284 *f.*  
 Holostei, 321  
*Hoburus*, 311  
*Homaloptera*, 375, 376  
 Homalopterinae, 376  
*Homea*, 51; *H. Stouti*, 48 *f.*  
 homocercal tail, 101, 104  
*Homosoma*, 421  
 Homosteidae, 263  
*Homosteus*, 263; *H. milleri*, 265 *f.*  
 Hoplichthyidae, 454  
*Hoplichthys*, 454  
 Hoplognathidae, 431  
*Hoplognathus*, 431  
*Hoplopteryx*, 427; *H. lowesiensis*, 427 *f.*  
 horny teeth, 31  
*Hyodus*, 97, 143, 144, 146; *H. subacriatus*, 146 *f.*  
*Hydrocyon*, 325, 375  
*Hyodon*, 389, 390  
 Hyodontidae, 389  
 hyostylic jaws, 95  
*Hypnos*, 162, 163  
 hypocentrum, 328  
 hypochordal fin, 101, 104  
 hypoglossal muscles, 11; nerve, 11  
*Hypophthalmichthys*, 375  
 hypophysis, 18, 39  
*Hypoptychus*, 403  
 Hypostomides, 416  
*Hypsocormus*, 333; *H. insignis*, 331 *f.*  
 hypural, 353  
*Hysterocarpus*, 446  
  
*Ieelus*, 453  
*Ichthyoborus niloticus*, 226 *f.*  
*Ichthyolectes*, 391  
 ichthyopterygium, 73  
 Ichthyotomi, 180  
*Ichyodus*, 178  
*Ichthyus*, 421  
 Icosteidae, 421  
*Icosteus*, 421  
*Idiacanthus*, 395; *I. ferow*, 395 *f.*  
*Ilyophys*, 405  
 infundibulum, 12, 16  
 interdorsal arch, 100  
 interorbital septum, 169; in Holostei, 324, 390, 398, 478  
 interventral arch, 100  
*Ipops*, 399  
*Ischnacanthus*, 190 *f.*, 192  
 isopedine, 217  
 Isospondili, 386  
*Isurichthys*, 465  
  
*Janassa*, 167, 168  
 jaws, 18; of Pisces, 95; of Dipnoi, 237; of Teleostomi, 266; of Teleostei, 349  
*Jordania*, 453  
*Joturus*, 420  
 Jugulares, 454  
*Julis*, 447  
  
*Kathetostoma*, 456  
 kidney, 27; of Cyclostomata, 45; of Dipnoi, 253; of Elasmobranchii, 132; of Pisces, 83  
*Kaeria*, 399  
 Kneriidae, 399  
*Krokninus*, 481  
 Kurtidae, 468  
 Kurtiformes, 468  
*Kurtus*, 468  
*Kyphosus*, 443  
  
*Labeo*, 375  
*Labichthys*, 406; *L. Curinatus*, 405 *f.*  
*Labidesthes*, 420  
*Labrax*, 443  
 Labridae, 446  
*Labrolon*, 447  
*Labrus*, 447; *L. muten-latus*, 441 *f.*  
 Labyrinthici, 422  
 Lactariidae, 445  
*Lactarius*, 445  
*Lactophrys*, 439  
*Laemargus*, 126 *f.*, 134, 151, 152  
*Lamna*, 121, 150; *L. cornubica*, 136 *f.*, 150 *f.*  
 Lamnidae, 149  
 Lamninae, 150  
 Lamprididae, 475  
 Lampridiformes, 475  
*Lampris*, 421, 475; *L. guttatus*, 406 *f.*  
*Lamprogrammus*, 459  
*Lamprologus*, 446  
*Lanarkia*, 195, 196; *L. spinosa*, 197 *f.*  
 Lasaniidae, 205  
*Lasanius*, 204, 205, 206  
 lateral line, in scales and plates, 219  
 lateral-line system, 19; of Elasmobranchii, 125; of Osteichthyes, 220  
 lateral-plate mesoblast, 3  
*Lates*, 443  
*Latilus*, 431  
 Latrididae, 445

- Latris*, 445  
*Lebiasina limaculata*, 226 f.  
*Lepynomotus*, 336  
*Lepadogaster*, 364, 457; *L. gouanii*, 457 f.  
*Lepidocottus*, 453  
*Lepidoteprus*, 82  
*Lepidopus*, 466; *L. caudatus*, 467 f.  
*Lepidosiren*, 89, 117, 230, 233, 244, 247, 250, 253, 258; *L. paradoxa*, 243 f., 246 f., 247 f., 257 f.  
Lepidosirenidae, 258  
Lepidosteidae, 344  
lepidosteoid scale, 218  
Lepidosteoides, 340  
*Lepidosteus*, 84 f., 89, 94 f., 102 f., 105 f., 121 f., 133 f., 213 f., 214, 224, 270, 272, 277, 278, 296, 298 f., 302, 324, 326, 327, 340, 342, 344, 356, 366 f., 367 f., 368, 369; *L. osseus*, 215 f., 219 f., 277 f., 314 f., 342 f., 343 f.; *L. viridis*, 341 f.  
lepidotrichia, 212, 273, 322  
*Lepidotrigla*, 450  
*Lepidotus*, 335, 336, 343; *L. minor*, 335 f.  
*Lepomis*, 443  
*Lepophidium*, 460  
*Leptecodon*, 398  
*Leptobarbus*, 375  
*Leptocephalus*, 388, 404  
*Leptoderma*, 394  
Leptolepidae, 371  
*Leptolepis*, 371  
*Leptopterygius*, 457  
Leptoscopidae, 456  
*Leptoscopus*, 456; *L. macropygus*, 456 f.  
*Leptosomus*, 399  
*Leptotrachelus*, 417  
*Leuciscus*, 375; *L. cephalus*, 220 f.; *L. phoxinus*, 357 f.; *L. rutilus*, 210 f., 211 f.  
*Libys*, 290  
*Lichia*, 464  
*Linophryne*, 462  
*Liocetus*, 462  
*Liodesmus*, 334  
*Liparis*, 454; *L. Dennyi*, 454 f.  
*Liparops*, 454  
Lipogeniidae, 417  
*Lipogenys*, 417; *L. Gillii*, 418 f.  
*Lotobates*, 445  
Lobotidae, 444  
Lophiidae, 462  
*Lophiomus*, 462  
*Lophius*, 272, 462  
Lophobranchii, 410, 414  
*Lopholatilus*, 431  
*Lophotes*, 476  
Lophotidae, 476  
*Lophrostomus*, 331  
*Loricaria*, 384; *L. lanceolata*, 384 f.  
Loricariidae, 384  
Loricariinae, 384  
*Lota*, 365, 482; *L. vulgaris*, 482 f.  
*Lucifuga*, 459; *L. dentatus*, 460 f.  
*Luciocephalus*, 423  
*Luciopeca*, 443  
*Luciosoma*, 375  
Luvuridae, 467  
*Luvurus*, 467  
*Lycocara*, 459  
*Lycodes*, 459; *L. perspicillum*, 459 f.  
*Lycodontis*, 408  
*Lycoptera*, 371  
lymphatic system, 26  
*Macrodon*, 225, 375  
*Macrones*, 380; *M. nemurus*, 373 f.  
Macropetalichthyidae, 262  
*Macropetalichthys*, 262  
*Macropharynx*, 407; *M. longicaudatus*, 406 f.  
*Macropoma*, 289, 290; *M. Mantelli*, 288 f., 289 f.  
*Macrorhamphosus*, 413  
Macrosemiidae, 336  
*Macrosemius*, 336  
*Macrostomias*, 395  
Macruridae, 480  
Macrurinae, 481  
*Macrurus*, 479, 481; *M. australis*, 481 f.  
*Malacichthys*, 441  
Malacopterygii, 386  
*Malacosarcus*, 424  
*Malucosteus*, 395; *M. indicus*, 395 f.  
Malapterurinae, 383  
*Malapterurus*, 352, 383; *M. electricus*, 351 f., 382 f., 383 f.  
*Mallotus*, 394  
*Malthe*, 462  
Malthidae, 462  
*Malthopsis*, 462  
*Marcusenius*, 389  
Mastacembelidae, 478  
Mastacembeliformes, 477  
*Mastacembelus*, 478; *M. argus*, 478 f.  
*Maurolicus*, 395  
*Medialuna*, 443  
medulla oblongata, 13  
*Megalichthys*, 280, 285; *M. Hibberti*, 217 f.  
*Megalops*, 363, 387  
*Megalurus*, 334  
*Melanocoetus*, 462  
*Melanostigma*, 459  
Menaspidae, 180  
*Menaspis*, 180  
*Mene*, 464  
*Menidia*, 420  
*Merluccius*, 482  
*Merluccius*, 121; *M. vulgaris*, 121 f.  
*Mesacanthus*, 192; *M. Mitchellii*, 192 f.  
mesencephalon, 14  
*Mesiteia*, 149  
*Mesodon*, 337, 340; *M. macropterus*, 339 f.  
*Mesolepis*, 313; *M. scalaris*, 312 f.  
mesonephros, 27, 45, 86  
*Mesoprion*, 431  
*Mesturus*, 337, 338, 340; *M. leedsi*, 338 f.  
metanephros, 27, 87  
metencephalon, 13  
*Micracanthus*, 423  
*Microbrachius*, 209  
*Microdon*, 337 f., 340  
*Micropterus*, 443  
*Microstoma*, 393  
*Mioplosus*, 443  
*Misgurnus*, 365, 376  
*Mitsukurina*, 150  
mixipterygium, 129  
*Mola*, 441  
Molidae, 440  
*Mollienesia*, 401  
*Molva*, 482  
Monacanthidae, 437  
*Monacanthus*, 437; *M. chaeocephalus*, 439 f.  
Monocentridae, 428  
*Monocentris*, 428; *M. japonica*, 428 f.  
*Monocirrus*, 445  
*Monopterus*, 409; *M. javanensis*, 409 f.  
*Mordacia*, 54  
*Moringua*, 405  
Mormyridae, 388  
Mormyriinae, 389  
*Mormyrops*, 389

- Mormyrus*, 389, 390; *M. oxyrhynchus*, 388 f.  
*Morone*, 431  
*Motella*, 482  
mouth, 18, 67  
*Moxostoma*, 375  
mucous glands, 50  
*Mugil*, 356, 420; *M. cephalus*, 420 f.  
Mugilidae, 420  
Mugiliformes, 419  
Mullidae, 429  
*Mulloides*, 429  
*Mullus*, 429  
*Muraena*, 408; *M. picta*, 408 f.  
Muraenidae, 408  
Muraenolepidae, 483  
*Muraenolepis*, 352, 479, 483  
muscles, 3; of eye, 5; epibranchial, 6; hypobranchial, 5; trapezius, 6  
*Mustelus*, 94 f., 134, 151; *M. antarcticus*, 111 f., 115 f.; *M. laevis*, 20 f., 68 f.  
myelencephalon, 13  
Myliobatidae, 165  
Myliobatinae, 165  
*Myliobatis*, 128, 166; *M. aquila*, 166 f.  
*Mylostoma*, 263; *M. variabilis*, 264 f.  
Mylostomidae, 263  
myodome, 326  
myotome, 2  
Myriacanthidae, 176  
*Myriacanthus*, 172, 176, 177 f., 178 f., 180  
*Myriolepis*, 311  
*Myripristis*, 427  
*Myroconger*, 408  
*Myrus*, 405  
*Myxine*, 35, 42 f., 46, 48 f., 51, 133 f.; *M. glutinosa*, 33 f., 35 f., 44 f., 47 f., 50 f.  
Myxinidae, 51  
Myxinoidea, 46  
*Myxus*, 420  
  
Nandidae, 445  
*Nandus*, 445  
*Nannoglanis*, 382  
*Narcine*, 161, 163  
*Naseus*, 436  
*Naucrates*, 464; *N. ductor*, 353 f.  
*Nealotus*, 466  
  
*Necturus*, 11  
*Nedystoma*, 382  
Neencheli, 405  
*Nematonotus*, 399  
*Nematoptychius*, 310  
Nemichthyidae, 406  
*Nemichthys*, 406  
*Nemopteryx*, 482  
*Neoborus*, 375  
*Neobythites*, 459  
*Neoceratodus*, 258  
*Neochanna*, 398  
*Neopercis*, 456  
*Neorhombolepis*, 331  
*Neosilurus*, 380  
nephridia, 27  
*Nerophis*, 415  
nerve-components, 19, 22 f.; acustico-lateral, 19; general cutaneous, 21; general splanchnic, 21; somatic motor, 21; splanchnic motor, 21; splanchnic sensory, 21  
nerve-roots, 2, 4  
nerve supply, 78 f.  
*Nettastoma*, 405  
nictitating membrane, 151  
*Nomens*, 421  
Nostril, median, 39; paired, 82  
nostrils of Elasmobranchs, 125; of Dipnoi, 241; of Osteichthyes, 227  
Notacanthidae, 418  
Notacanthiformes, 416  
*Notacanthus*, 418; *N. anulis*, 418 f.  
*Notagogus*, 336  
*Notelops*, 387  
Notidani, 139  
Notidanidae, 143  
*Notidanus*, 140, 142 f., 143; *N. cinereus*, 76 f.  
notochord, 1, 68, 97  
notochordal sheaths, 31, 97, 273  
*Notoglanis*, 382  
*Notogoneus*, 395  
Notopteridae, 389  
*Notopterus*, 390; *N. kapi-rat*, 389 f.  
*Notothenia*, 456  
Nototheniidae, 456  
*Novacula*, 447  
  
occipital region, 11  
occipito-spinal nerves, 12  
*Odax*, 447  
*Odacothrissa*, 393  
  
*Odontaspis*, 150  
*Odontostomus*, 399  
*Oenoscopus*, 337  
*Ogocephalus*, 462; *O. ves-pertilio*, 461 f.  
olfactory organ, 23  
Oligopleuridae, 337  
*Oligopleurus*, 337  
*Oncobatis*, 161  
*Onirodes*, 462; *O. glomerosus*, 462 f.  
Onychodontidae, 286  
*Onychodus*, 286  
operculum, 169, 223  
*Ophichthys*, 405  
Ophidiidae, 460  
*Ophidium*, 460  
Ophiocephalidae, 422  
*Ophiocephalus*, 422; *O. striatus*, 421 f., 422 f.  
*Ophiodon*, 453  
*Ophiopsis*, 336  
*Opisthocentrus*, 458  
*Opisthognathus*, 431  
Opisthomi, 477  
*Opisthomyzon*, 449  
*Opisthoproctus*, 394; *O. soleatus*, 406 f.  
*Opsanus*, 460  
*Oracanthus*, 192, 193  
Orectobinae, 149  
*Orectobius*, 149  
*Orestias*, 401  
organs, urinogenital, 84 f.  
*Orodus*, 146, 147  
*Orthacanthus*, 183 f.  
*Orthacodus*, 150  
*Orthogoriscus*, 441  
*Osmeroides*, 387  
*Osmerus*, 365, 367, 369, 394  
Ospromenidae, 422  
*Ospromenus*, 422; *O. olfax*, 423 f.  
Ostariophysii, 371  
Osteichthyes, 210  
Osteoglossidae, 390  
*Osteoglossum*, 363, 390  
Osteolepida, 280  
Osteolepidae, 285  
Osteolepidoti, 280  
*Osteolepis*, 280, 299; *O. macrolepidotus*, 283 f.  
*Osteorhachis*, 331; *O. leedsii*, 329 f.  
Osteostraci, 200  
*Ostracion*, 117, 439  
Ostraciontidae, 439  
Ostracodermi, 194, 437  
otic process, 97, 139, 144  
otoliths, 298, 324

- Otolithus*, 360, 361 *f.*,  
431  
*Oxydoras*, 383  
*Oxygnathus*, 312  
*Oxyrhina*, 150
- Pachycormidae, 331  
*Pachycormus*, 333; *P.*  
*heterurus*, 103 *f.*  
*Pachylebias*, 401  
*Pachyula*, 382  
*Paecilodus*, 147  
*Pagellus*, 429  
*Pagrus*, 429  
*Palaeaspis*, 199 *f.*, 200  
*Palaeodaphus*, 256  
*Palaeobalistum*, 340  
*Palaeomyilus*, 180  
Palaeoniscidae, 309  
Palaeoniscidinae, 310  
*Palaeoniscoidei*, 309  
Palaeoniscoid scale, 218  
*Palaeoniscus*, 311; *P. mac-*  
*ropomus*, 310 *f.*  
Palaeorhynchidae, 467  
*Palaeorhynchus*, 467  
*Palaeoscyllium*, 149  
*Palaeospinax*, 144, 146  
Palaeospondylidae, 56  
*Palaeospondylus*, 56, 57;  
*P. Gunnii*, 56, 57 *f.*  
palato-basal articulation,  
97, 271  
*Palmiphys*, 465  
*Palmas*, 297  
*Pantodon*, 396  
Pantodontidae, 396  
*Pantopholis*, 398  
*Paralepis*, 399  
*Paraliparis*, 454  
*Paraluteres*, 437  
*Paranypine*, 47, 48 *f.*, 51  
*Parapercis*, 456  
Paraphysis, 16  
*Parapriacanthus*, 428  
*Parapsetus*, 434  
*Parascopelus*, 399  
*Pareuxis*, 189, 190, 192;  
*P. falcatus*, 191 *f.*  
*Paropsis*, 464  
*Pataecus*, 458  
pedicle of suspensorium,  
97, 271  
Pediculati, 454, 461  
Pegasidae, 416  
*Pegasus*, 416; *P. natans*,  
416 *f.*  
*Pelargorhynchus*, 417  
*Pellonula*, 391, 393  
*Pelor*, 450  
*Peltoleurus*, 337
- Pempheridae, 428  
*Pempheris*, 428; *P. rus-*  
*selli*, 427 *f.*  
*Pentaceros*, 431  
*Pentanemus*, 421; *P. quin-*  
*quarius*, 420 *f.*  
*Pentopus*, 445  
*Perca*, 365, 368, 443,  
479 *f.*; *P. fluviatilis*,  
221 *f.*, 442 *f.*  
*Percosoces*, 419  
*Percichthys*, 431  
Percidae, 441  
*Perciformes*, 428  
Percopiidae, 455  
*Percopsis*, 456; *P. brasili-*  
*ensis*, 455 *f.*  
Percopsidae, 425  
*Percopsis*, 426  
pericardium, 26; of Myxi-  
noid, 50; of Pisces, 109  
*Periophthalmus*, 448, 458  
*Peristedion*, 450; *P. mini-*  
*atum*, 452 *f.*; *P. cata-*  
*phractum*, 447 *f.*  
Petalodontidae, 167  
*Petalodus*, 168  
*Petalopteryx*, 336  
*Petrocephalus*, 389  
*Petromyzon*, 8, 9, 10, 11,  
19, 25, 25 *f.*, 38, 39,  
39 *f.*, 41, 43, 45, 51,  
54, 85; *P. fluviatilis*,  
30 *f.*, 40 *f.*, 53 *f.*, 54 *f.*,  
55 *f.*; *P. marinus*, 31 *f.*,  
32 *f.*, 34 *f.*, 45 *f.*, 52 *f.*,  
133 *f.*  
Petromyzontia, 51  
Petromyzontidae, 54  
*Petroscirtes*, 458  
*Phaebodus*, 183  
*Phago*, 375  
Phaneropleuridae, 255  
*Phaneropleuron*, 230, 233,  
239 *f.*, 255; *P. Ander-*  
*soni*, 256 *f.*; *P. curtum*,  
231 *f.*  
*Phanerostem*, 307, 309,  
311  
pharyngeals, upper and  
lower toothed, 445  
Pharyngognathi, 445  
*Phlyctenaspis*, 260, 263  
Pholididae, 458  
Pholidophoridae, 336  
*Pholidophorus*, 337  
*Pholidosteus*, 260, 262 *f.*,  
263; *P. Friedeli*, 261 *f.*  
*Pholidurus*, 317, 318  
*Pholis*, 458  
phosphorescent organs of  
Selachii, 127; of Tele-  
ostei, 357, 394, 399  
*Photichthys*, 395  
*Photoblepharon*, 432  
*Photonectes*, 395  
Phractolaemidae, 391  
*Phractolaemus*, 391  
*Phractura*, 382  
*Phycis*, 482  
*Phyllodus*, 447  
*Phyllopteryx*, 415  
phylogeny of the Chon-  
drichthyes, 124 *f.*; of  
Osteichthyes, 228, 228 *f.*,  
229 *f.*; of Teleostei, 370;  
of Vertebrata Craniata,  
29  
Physoclisti, 359  
Physostomi, 359  
*Piabucina*, 375  
*Pictet*, 336  
*Pinelodus*, 382  
pinea eye, 24  
Pisces, 93  
placoid scale, 118, 121,  
356  
*Plagusia*, 474  
*Platae*, 434  
*Platinx*, 391  
Platycephalidae, 454  
*Platycephalus*, 454  
*Platycormus*, 421  
*Platygllossus*, 447  
*Platylenus*, 447  
*Platypoecilus*, 401  
*Platyrhina*, 161  
*Platyrhinoidia*, 160  
Platysomidae, 312  
*Platysomus*, 313  
*Platytrectes*, 394  
*Plecodus*, 446  
*Plecostomus*, 384; *P. Com-*  
*mersonii*, 383 *f.*  
Plectognathi, 435  
*Plectroncus*, 427  
Pleuracanthidae, 183  
Pleuracanthodii, 180  
*Pleuracanthus*, 107, 180,  
182, 183; *P. decheni*,  
181 *f.*, 182 *f.*; *P. Gau-*  
*dryi*, 183 *f.*, 184 *f.*; *P.*  
*Oelbergensis*, 184 *f.*  
*Pleurogramma*, 456  
pleurocentrum, 328  
*Pleurogrammus*, 453  
*Pleuronectes*, 62, 472, 473,  
474; *P. flesus*, 104 *f.*;  
*P. platessa*, 470 *f.*, 471 *f.*,  
472 *f.*  
Pleuronectidae, 469  
*Pleuropholis*, 337



- Pleuroplax*, 146  
*Pliotremu*, 143, 152, 153  
*Podateles*, 460  
 Podatelidae, 460  
*Pocilia*, 401  
*Pogonius*, 431; *P. chromis*, 361 f.  
*Polyacanthus*, 423  
*Polycentropsis*, 445  
*Polycentrus*, 445  
*Polyipnus*, 395; *P. spinosus*, 358 f.  
*Polymixia*, 427  
 Polynemidae, 420  
*Polynemus*, 421  
*Polyodon*, 303, 317, 318; *P. folium*, 302 f., 316 f., 318 f.  
 Polyodontidae, 317  
 Polypteridae, 300  
*Polypterus*, 94 f., 117, 214, 223, 224, 226, 227, 243, 271, 272, 276, 277, 278, 290, 291, 293, 296 f., 297, 298 f., 300, 305 f., 324, 350, 356, 366 f., 367 f., 368, 369, 388; *P. bichir*, 101 f., 211 f., 269 f., 290 f., 291 f., 292 f., 293 f., 294 f., 295 f., 297 f., 299 f., 301 f.; *P. luprudei*, 299 f., 300 f.  
 Polypterini, 290  
*Polyrhizodus*, 167, 168; *P. pusillus*, 167 f.  
*Pomacanthus*, 434  
 Pomacentridae, 446  
*Pomacentrus*, 446  
*Pomatomus*, 431  
*Pomotis*, 443  
*Pomozys*, 443  
*Porichthys*, 460  
*Portheus*, 391  
*Priacanthus*, 431  
*Prionotus*, 450  
*Prionurus*, 436  
 Pristidae, 160  
 Pristiophoridae, 152  
*Pristiophorus*, 152, 153; *P. cirratus*, 153 f.  
*Pristipoma*, 445  
 Pristipomatidae, 445  
*Pristis*, 71, 160  
*Pristiurus*, 5, 75, 149  
*Procatopus*, 400  
*Prochanos*, 393  
*Prolates*, 431, 441  
*Prolebius*, 401  
*Promyliobatis*, 165, 166  
 pronephros, 27, 43, 83  
*Propoma*, 441  
*Propristis*, 160  
*Propterus*, 336  
 prosencephalon, 16, 245 f.  
*Protacanthodes pinnatus*, 187 f., 192  
*Protantigonia*, 433  
*Protodus*, 147  
*Protopterus*, 17, 223, 225 f., 234 f., 244, 245, 247, 251 f., 253, 254 f., 258, 305, 366 f.; *P. annectens*, 231 f., 235 f., 245 f., 249 f., 253 f., 257 f.  
*Protosphyraena*, 333  
 Protosyngnathidae, 412  
 Protosyngnathoidei, 412  
*Protosyngnathus*, 412  
*Prototroctes*, 398  
 protractile jaws, 349, 375  
 Psammodontidae, 167  
*Psammodus*, 167  
 Psammosteidae, 198  
*Psammosteus*, 195, 196 f., 198, 200  
*Psephodus*, 146  
*Psephurus*, 318; *P. gladius*, 318 f.  
*Psetta*, 474  
*Psettodes*, 472, 473, 474; *P. erumei*, 473 f.  
*Psettus*, 432; *P. argenteus*, 432 f.  
*Pseudetroplus*, 446  
*Pseudentropius*, 380  
*Pseudoberyc*, 393  
 pseudobranch, 111, 258  
 Pseudochromilidae, 431  
*Pseudochromis*, 431  
*Pseudoscarus*, 447; *P. muricatus*, 446 f.  
*Pseudoscopelus*, 423  
*Pseudosphaerodon*, 447  
*Pseudosyngnathus*, 415  
*Psilocephalus*, 437  
*Psychrolutes*, 454  
*Ptychalis*, 464  
 Pteraspidae, 198  
 Pteraspidomorphi, 195  
*Pteraspis*, 195, 196 f., 198, 200; *P. rostrata*, 199 f.  
 Pterichthyomorphi, 206  
*Pterichthys*, 261; *P. Milleri*, 208 f.  
*Pterois*, 450; *P. colitans*, 450 f.  
*Pterophryne*, 462  
*Pteroplatea micrura*, 134 f.  
*Pteroplatea*, 164; *P. Valenciennii*, 164 f.  
*Pterothrissus*, 388  
*Pterichthys*, 207, 209  
*Pterycombis*, 464  
*Pterygocephalus*, 458  
 Ptychodontidae, 165  
*Ptychodus*, 165; *P. decurrens*, 165 f.  
*Ptycholepis*, 331  
 Ptyctodontidae, 179  
*Ptyctodus*, 180  
 Pycnodontidae, 337  
*Pycnodus*, 340  
*Pygopterus*, 307, 311  
 pyloric caeca, 297  
*Racovitzia*, 456  
 radial, 69  
*Raja*, 76 f., 79 f., 133 f., 136, 137, 139 f., 155, 156 f., 157 f., 161; *R. batis*, 14 f., 158; *R. blanda*, 120 f., 122 f., 130 f., 155 f.; *R. clavata*, 161 f., 166 f.  
 Rajidae, 160  
 Rajiformes, 153  
*Rana*, 98 f., 254 f.  
*Raniceps*, 482  
*Ranzannia*, 441  
 rectal gland, 137  
*Reguleus*, 476, 477; *R. glesne*, 476 f.  
*Remora*, 449; *R. brachyptera*, 448 f.  
 respiratory organs, accessory, 379, 409, 422  
 Rhachicentridae, 464  
*Rhachicentrus*, 464  
*Rhacolepis*, 387  
*Rhadinichthys*, 311  
*Rhamphichthys*, 377  
 Rhamphocottidae, 453  
*Rhamphocottus*, 453  
*Rhamphodus*, 179, 180  
*Rhamphognathus*, 420  
*Rhamphosus*, 413  
*Rhina*, 71, 151, 157; *R. squatina*, 79 f., 153 f.  
*Rhineaster*, 380  
*Rhinellus*, 399  
 rhinencephalon, 16  
 Rhinobatidae, 159  
*Rhinobatus*, 160; *R. granulatus*, 79 f.  
*Rhinochimaera*, 178  
 Rhinochimaeridae, 178  
*Rhinodon*, 150  
 Rhinodontinae, 150  
*Rhinoptera*, 167; *R. polyodon*, 167 f.

- Rhinoraji, 159  
 Rhiptidistia, 284  
 Rhizodontidae, 285  
*Rhizodopsis*, 286; *R. sauroides*, 286 *f.*  
*Rhizodus*, 286  
*Rhodeus*, 368, 375  
*Rhodichthys*, 459  
*Rhomboidichthys*, 474  
*Rhombosotea*, 473  
*Rhombus*, 474; *R. macimus*, 471 *f.*  
*Rhynchobatus*, 160 *f.*; *R. djeddensis*, 76 *f.*, 159 *f.*  
*Rhynchobdella*, 478  
*Rhynchodus*, 177 *f.*, 180  
*Rhynchorhinus*, 405  
 rib, pleural and dorsal, 68, 101  
*Rita*, 380  
*Rohteichthys*, 375  
*Rondeletia*, 399
- Saccarius*, 462  
*Saccobranchus*, 379, 380; *S. fossilis*, 382 *f.*  
 Saccopharyngidae, 407  
*Saccopharynx*, 407  
*Sagenodus*, 257  
*Salamantra*, 254 *f.*  
*Salanz*, 394  
*Salarias*, 458  
*Salmo*, 71, 94 *f.*, 96 *f.*, 102 *f.*, 225, 271, 305, 326, 354, 363, 367, 368, 394; *S. salar*, 110 *f.*, 275 *f.*, 279 *f.*, 322 *f.*, 323 *f.*, 325 *f.*, 327 *f.*, 360 *f.*, 394 *f.*; *S. trutta*, 357 *f.*  
 Salmonidae, 393  
 Salmonperca, 425  
*Sandulodus*, 147  
*Sarda*, 465  
*Sardinius*, 399  
*Sardinoides*, 399  
*Sargodon*, 336  
*Sargus*, 429; *S. ovis*, 429 *f.*; *S. rufescens*, 429 *f.*; *S. retula*, 429 *f.*  
*Saurichthys*, 321  
*Sauripterus*, 286  
*Saurocephalus*, 390  
*Saurodon*, 390  
 Saurodontidae, 390  
*Scaropsis*, 333  
*Scaurorhamphus*, 321  
 scales, ctenoid, cycloid, ganoid, and placoid, 210, 217; development of, 119, 214, 356; cosmoid, 216 *f.*, 217; ganoid, 217; lepidosteoid, 216 *f.*, 218; palaeoniscoid, 216 *f.*, 218; Rhizodont, 216 *f.*; Teleostean, 356  
*Scapanorhynchus*, 150  
*Scaphirhynchus*, 302 *f.*, 319, 320; *S. cataphractus*, 303; *S. platorhynchus*, 320 *f.*  
*Scarichthys*, 447  
 Scaridae, 447  
*Scarus*, 365, 447  
*Scoumenacia*, 233, 234, 255; *S. curta*, 255 *f.*  
*Schilbe*, 380  
*Sciæna*, 431  
 Sciaenidae, 431  
*Sclerocottus*, 454  
 Sclerodermi, 436  
*Sclerognathus*, 375  
 scleromere, 11  
*Scleropages*, 390  
*Scleroparei*, 449  
*Sclerorhynchus*, 160  
 sclerotome, 3  
*Scomber*, 465; *S. scomber*, 149 *f.*  
 Scombrosoicidae, 402  
*Scombrosc.*, 402, 403  
 Scombridae, 465  
 Scombriformes, 462  
*Scombrinus*, 465  
*Scombroclupea*, 393  
*Scombrocottus*, 453  
 Scopelidae, 399  
*Scopelus engraulis*, 358 *f.*  
*Scopeloides*, 399  
*Scopelus*, 399, 423 *f.*  
*Scorpaena*, 450; *S. bynoensis*, 450 *f.*  
*Scorpaenichthys*, 454  
 Scorpaenidae, 449  
 Scorpaeniformes, 449  
*Scorpaenopsis rosea*, 424 *f.*  
 Scorpidae, 432  
*Scorpiis*, 432  
*Scyllaenus*, 393  
 Scyllidae, 149  
 Scyllinae, 149  
 Scyllioidi, 148  
*Scylliorhinus*, 149  
*Scyllium*, 71, 75, 98 *f.*, 123, 125 *f.*, 128, 133 *f.*, 137, 149; *S. canicula*, 58 *f.*, 69 *f.*, 72 *f.*, 99 *f.*, 119 *f.*  
*Seymourius*, 128, 152; *S. lichia*, 80 *f.*  
*Sebastes*, 450; *S. percooides*, 449 *f.*  
*Sectator*, 443  
 segments, of head, 3; of trunk, 2  
*Selache*, 149 *f.*, 150  
 Selachii, 135  
*Selene*, 464  
 Selenichthyes, 475  
 Selenosteidae, 263  
*Selenosteus*, 259, 263; *S. Kepleri*, 264 *f.*  
 Semionotidae, 334  
*Semionotus*, 336  
*Semiophorus*, 464; *S. celicans*, 465 *f.*  
 sense-organs, 19  
*Seriota*, 464  
 Serranidae, 430  
*Serranus*, 133 *f.*, 431; *S. altivelis*, 430 *f.*; *S. cabrilla*, 430 *f.*  
*Serrasalmo*, 375  
*Serrolepis*, 336  
*Seturches*, 450  
 Siganiidae, 435  
*Siganus*, 435  
 Sillaginidae, 432  
*Sillago*, 432  
 Siluridae, 379  
 Silurinae, 380  
 Siluroidei, 377  
*Silurus*, 380; *S. glanis*, 378 *f.*, 382 *f.*  
*Sinenchelys*, 405  
*Siphonognathus*, 447  
*Siphonostoma*, 415  
*Sisor*, 382  
 skull, dermal bones of, 213; development of, 12 *f.*; bones of, 267; segmental theory of, 11; vertebral theory of, 2, 11  
*Smerdis*, 443  
*Solea*, 356, 472, 473, 474; *S. heterorhina*, 474 *f.*  
 Solenostomidae, 414  
 Solenostomoidei, 414  
*Solenostomus*, 414  
 somaticidium, 69  
 somites, 3; prootic, 5; metaotic, 5  
 sound-producing organ, 379  
*Spaniodon*, 392  
 Sparidae, 428  
*Sparnodus*, 429  
*Sparus*, 429  
*Spathiurus*, 337  
*Sphenacanthus*, 146  
*Sphenocephalus*, 427  
*Sphenodus*, 148  
*Sphyraena*, 419  
 Sphyraenidae, 419  
*Sphyraenodus*, 465

- Sphyrna*, 151  
 Sphyrninae, 151  
*Spinacanthus*, 437  
*Spinacia*, 412  
 Spinacidae, 151  
 spinal nerve, 2, 4, 22, 83  
*Spinax*, 5, 151, 152; *S. niger*, 17 f.  
 Spine, vertebral, neural, and haemal, 32, 100, 101, 105  
*Spinicomer*, 406  
 spino-occipital nerves, 11  
 spiral valve, 43, 114; of Teleostei, 327, 362  
 Squaliformes, 151  
*Squaloraja*, 168, 172, 174, 175, 176, 177 f.; *S. polyspondyla*, 173 f., 177 f.  
 Squalorajidae, 176  
*Squalus*, 152  
 Squammipennes, 434  
*Squatina*, 157; *S. speciosa*, 157  
 Squatinidae, 156  
*Stegostoma*, 149  
 Stephanoberycidae, 423  
*Stephanoberyx*, 424; *S. monae*, 424 f.  
*Sternarchus*, 377  
 Sternoptychinae, 395  
*Sternoptyx*, 395  
*Sternopygus*, 377  
*Stichaenus*, 458  
*Stomatorhinus*, 389  
*Stomias*, 359 f., 395  
 Stomiidae, 394  
 Stomiatinae, 395  
*Stratodus*, 417  
*Strepsodus*, 286  
 stridulating organ, 379  
 Stromateidae, 421  
*Stromateus*, 421  
*Strophodus*, 146 f.  
*Stygicola*, 459  
 Stylephoridae, 477  
*Stylephorus*, 475, 477  
*Stylophthalmus*, 395; *S. paradoxus*, 406 f.  
 subocular shelf, 428  
*Suciotrutta*, 394  
 sucker, cephalic, 448; larval, 247, 277; ventral, 455, 457  
*Sudis*, 399  
 Supraoccipital, 326  
 Symbranchidae, 409  
 Symbranchiiformes, 408  
*Symbranchus*, 409; *S. bengalensis*, 410 f.  
*Symmorium*, 182, 183; *S. reniforme*, 128 f.  
*Symphurus*, 474  
*Sympterygia*, 161  
*Synagrops*, 441  
*Synacridium horridum*, 483 f.  
 Synaphobranchidae, 407  
*Synaphobranchus*, 407  
*Synaptura*, 472, 474; *S. albomaculata*, 474 f.  
*Synechodus*, 144, 146; *S. dubrisiensis*, 145 f.  
 Syngnathidae, 415  
*Syngnathus*, 415; *S. acus*, 114 f., 415 f.  
*Synodontis*, 382; *S. schal*, 380 f.  
*Taeniolabrus*, 457  
 Taeniosomi, 476  
*Tarpon*, 363, 387  
 Tarrasiidae, 284  
*Tarrasius*, 284, 300; *T. problematicus*, 283  
*Tautoga*, 447  
 teeth, 121; horny, 31; of Teleostomes, 272  
 telencephalon, 15  
 Teleostei, 344  
 Teleostomi, 266, 366 f.  
*Telepholis*, 400  
*Temera*, 163  
 Tenuthoraci, 263  
*Tetragonolepis*, 336  
*Tetragonopterus*, 375  
 Tetragonuridae, 421  
*Tetragonurus*, 421  
*Tetrapterus*, 468  
*Tetrodon*, 440  
 Tetrodontidae, 440  
 Tenthidae, 435  
*Tenthis*, 435; *T. nebulosa*, 436 f.  
 thalamencephalon, 15  
*Thalassophryne*, 460  
*Thalassothia*, 460  
*Thelodus*, 195, 196 f., 197, 198, 203; *T. scoticus*, 197 f.  
*Thoracopterus*, 336, 337  
*Thrissopater*, 392  
 Thrissopatrinae, 392  
*Thrissops*, 371  
*Thursius*, 285  
*Thyestes*, 203, 204  
*Thymallus*, 355, 394  
*Thynnus*, 465; *T. thynnus*, 466 f.; *T. vulgaris*, 352 f., 354 f., 463 f.  
 thyroid gland, 53, 82  
*Thyrsoites*, 466  
*Thyrsocephalus*, 466  
 Thyrsoidea, 408  
*Tilapia*, 446  
*Tinca*, 365, 375  
 Titanichthyidae, 263  
*Titanichthys*, 259, 260, 263  
 Torpedinidae, 161  
 Torpedinoidei, 161  
*Torpedo*, 115 f., 134, 139 f., 161, 162 f., 163 f.; *T. ocellata*, 154 f.  
*Trachichthys*, 427  
 Trachinidae, 455  
*Trachinus*, 455; *T. draco*, 455 f.  
*Trachynotus*, 464  
 Trachypteridae, 476  
*Trachypterus*, 477; *T. taenia*, 477 f.  
 Tremataspidae, 204  
*Tremataspis*, 200, 201, 204, 205; *T. Schmidtii*, 202 f.  
*Trematomus*, 456  
 Triacanthidae, 437  
*Triacanthodes*, 437  
*Triacanthus*, 437; *T. brevisrostris*, 437 f.  
 Trichiuridae, 466  
*Trichiurus*, 466; *T. lepturus*, 467 f.  
*Trichocyclus*, 440  
*Trichodon*, 445  
 Trichodontidae, 445  
*Trichogaster*, 422  
 Trichonotidae, 457  
*Trichonotus*, 457  
*Trigla*, 365, 450; *T. gurnardus*, 451 f.; *T. hirundo*, 447 f.; *T. pleuraacanthica*, 452 f.  
 Triglididae, 450  
*Triglops*, 454  
*Triglopsis*, 453  
*Trigonodon*, 429  
*Triodon*, 439  
 Triodontes, 439  
 Triodontidae, 439  
 Trissolepinidae, 312  
*Trissolepis*, 312; *T. Kouvoensis*, 311 f.  
*Tristichopterus*, 285  
*Tristichius*, 146  
*Tropheus*, 446  
*Tropidichthys*, 440  
*Trygon*, 158, 164; *T. tuberculata*, 156 f.  
 Trygonidae, 164  
*Trygonoptera*, 164  
*Trygonorhina*, 160

- Typhlichthys*, 401  
*Typhlonus*, 459  
*Typhlosus*, 459  
  
*Umbra*, 398  
*Umbriua*, 431  
*Undina*, 290  
*Undino gulo*, 287 *f.*  
*Upeneoides*, 429  
*Upeneus*, 429  
Uranoscopidae, 456  
*Uranoscopus*, 82, 456  
Urenchelidae, 404  
*Urenchelys*, 403, 404  
urinogenital organs, 27, 83,  
86 *f.*, 131 *f.*; of Selachii,  
132; of Dipnoi, 253; of  
Teleostei, 365  
*Uroconger*, 405  
*Urogymnus*, 164  
*Urolophus*, 164  
Uronemidae, 255  
*Uronemus*, 233, 246, 256;  
*U. lobatus*, 256 *f.*  
  
vagus nerve, 8, 19  
vascular system, 26; of  
Cyclostomes, 43, 47; of  
Pisces, 109; of Dipnoi,  
148; of Teleost, 363;  
of *Monopterus*, 409  
veins, 43, 48, 114  
*Velifer*, 476  
Veliferidae, 476  
vertebrae, transverse sec-  
tions of, 137 *f.*  
vertebral arches, 31, 68;  
neural, haemal, and in-  
tercalary, 100  
vertebral centra, 68, 135;  
chordal, 100; perichor-  
dal, 100  
vertebral column, 31, 68,  
97, 135, 233, 273,  
327, 352; elements of  
segment, 100  
viviparity of Elasmob-  
ranchs, 134; of Teleosts,  
415, 446, 459  
*Uomer*, 464  
*Uomeropsis*, 464  
*Uulsus*, 456  
  
*Wardichthys*, 313  
Weber's apparatus, 373  
*Woduika*, 146  
*Xenacanthus*, 182 *f.*, 183  
*Xenocharax*, 375  
*Xenomystus*, 390  
*Xenopholis*, 340  
*Xenopterus*, 440  
*Xiphasia*, 458; *X. setifer*,  
458 *f.*  
*Xiphias*, 62, 468; *X.*  
*gladius*, 355  
Xiphiidae, 468  
*Xiphiorhynchus*, 468  
*Xyphotrygon*, 164  
*Xystrodus*, 147  
  
yolk-sac, 114, 132; cir-  
culation, 114  
  
*Zanclus*, 436  
*Zaniolepis*, 453  
Zeidae, 469  
*Zenion*, 469  
Zeorhombiformes, 468  
*Zenopteris*, 474  
*Zeus*, 469  
*Zoarces*, 364, 365, 368,  
459; *Z. viviparus*, 459 *f.*  
Zoarcidae, 458  
*Zygæna*, 151; *Z. malleus*,  
76 *f.*, 117 *f.*; *Z. tudes*,  
152 *f.*, 153 *f.*

# STUDIES IN FOSSIL BOTANY

BY  
DUKINFIELD HENRY SCOTT

M.A., LL.D. PH.D., F.R.S.

**Second Edition, containing 212 Illustrations**

DEMY 8vo.

**PRICE 10/6 NET**

BOUND IN CLOTH

*(Post free, price 11/=)*

**OR IN TWO VOLUMES**

**Vol. I., price 6/- net.**

**Vol. II., price 5/- net.**

*(Post free, prices 6/4 and 5/4 respectively)*

## NOTE

THIS book, originally founded on a course of lectures delivered at University College, London, has been completely revised, and to a considerable extent rewritten, in order to bring the new edition into harmony with the results of important recent research. The "Studies" are concerned essentially with those morphological and evolutionary aspects of Fossil Botany on which so much light has been thrown by the work of the last few years.

# AN INTRODUCTION TO STRUCTURAL BOTANY

By D. H. SCOTT

M.A., LL.D. PH.D., F.R.S.

**In Two Parts. Crown 8vo, Cloth. Price 3 6 each.**

**PART I.—FLOWERING PLANTS**

Sixth Edition

**Illustrated with 118 Figures**

**PART II.—FLOWERLESS PLANTS**

Fifth Edition

**Illustrated with 120 Figures**

"In noticing elementary books in these pages, we have lamented nothing more than the want of a book which should do for structural botany what Prof. Oliver's 'Lessons' has long done for the study of the principal natural orders. It seems hard to realise that this grievance is no more, and that we possess such a book in our own language, and a book that no honest critic will fail to assess at a higher value than any known book in any language that has the same scope and aim. Nothing could well be more plain and simple, or more severely accurate or better judged from beginning to end."—*Journal of Botany*.

PUBLISHED BY

ADAM AND CHARLES BLACK, 4, 5, & 6 SOHO SQUARE, LONDON

# THE SENSE OF TOUCH IN MAMMALS AND BIRDS

WITH SPECIAL REFERENCE TO THE PAPILLARY RIDGES

By WALTER KIDD, M.D., F.Z.S.,

Author of 'Use Inheritance,' 'Direction of Hair in Animals and Man,' etc.

Demy 8vo, Cloth, containing 174 Illustrations. Price 5s. net.

(Post free, price 5s. 4d.)

"This is, for the purposes of exact science, undoubtedly a valuable book. . . . As regards the highest mammal, man, it is well pointed out that the sense of touch has been from the very first of extreme importance, and that 'such use of this sense in man must have contributed greatly to his better equipment for the struggle of his life, and thus in a broad way have been governed by a slow, remorseless process of selection.' The book is eminently one for specialists, but the excellence of the numerous illustrations makes it also interesting to the general reader."—*London Quarterly Review*.

"Dr. Kidd's book is the most important contribution to the matter since Miss Whipple's paper was published."—*The Spectator*.

BY THE SAME AUTHOR

## USE - INHERITANCE

ILLUSTRATED BY THE DIRECTION OF HAIR ON  
THE BODIES OF ANIMALS

Demy 8vo, Paper Covers. Price 2s. 6d. net.

(Post free, price 2s. 8d.)

"Such a book as this is calculated, at least, to give pause to the Weismannians. Dr. Kidd has broken ground in a commanding position, and we are anxious to see how his attack can be met."—*The Irish Naturalist*.

"This is an interesting contribution to the dynamic or Lamarckian principles of evolution. . . . The author seems to have made out a good case and to have been led by the legitimate use of the inductive method to what seem to be valid and natural conclusions."—*Science*.

"It is urged that . . . the doctrine that acquired characters are never inherited does not hold good, and hence a Lamarckian explanation of the phenomena must be accepted. The case, as argued by Dr. Kidd, appears to be a strong one, and it will be curious to note what the Weismannians will have to say in reply."—*Knowledge*.

## THE DIRECTION OF HAIR IN ANIMALS AND MAN

Demy 8vo, Cloth, Illustrated. Price 5s. net.

(Post free, price 5s. 4d.)

"Dr. Kidd shows much ingenuity in explaining the various causes which, in his opinion, have produced the different hair-slopes, and the illustrations with which the book is liberally furnished are of considerable assistance to the reader."—*Westminster Review*.

"The description of the facts can be commended. There is evidence that considerable care has been taken in the collection of observations, and the illustrations are excellent."—*Manchester Guardian*.

"That the direction of the hair-slope in mammals varies much is a fact well known to zoologists; but we are not acquainted with any general work, such as the present, in which the facts are put together within one cover. The author has, therefore, in any case, accomplished a piece of work which supplies a definite want in the literature of zoology. The usefulness of this general summary is furthermore enhanced by numerous clear figures which show at a glance the essential facts."—*Lancet*.

PUBLISHED BY

ADAM AND CHARLES BLACK, 4, 5, & 6 SOHO SQUARE, LONDON







Date Due

JUN 14 1988

University of Toronto  
Library

Zoology — 45

DO NOT  
REMOVE  
THE  
CARD  
FROM  
THIS  
POCKET

2001  
L  
Part 9

Acme Library Card Pocket  
LOWE-MARTIN CO. LIMITED

UTL AT DOWNSVIEW



D RANGE BAY SHLF POS ITEM C  
39 11 08 13 07 010 1