





MBL/WHOI



0 0301 0065223 6

A TREATISE ON ZOOLOGY

AGENTS IN AMERICA
THE MACMILLAN COMPANY
66 FIFTH AVENUE, NEW YORK

350.8
L 27

A

TREATISE ON ZOOLOGY

EDITED BY

E. RAY LANKESTER

M.A., LL.D., F.R.S.

HONORARY FELLOW OF EXETER COLLEGE, OXFORD; CORRESPONDENT OF THE INSTITUTE
OF FRANCE; DIRECTOR OF THE NATURAL HISTORY DEPARTMENTS
OF THE BRITISH MUSEUM

PART II

THE PORIFERA AND COELENTERA

BY

E. A. MINCHIN, M.A.

PROFESSOR OF ZOOLOGY IN UNIVERSITY COLLEGE, LONDON

G. HERBERT FOWLER, B.A., Ph.D.

LATE ASSISTANT PROFESSOR OF ZOOLOGY IN UNIVERSITY COLLEGE, LONDON

AND

GILBERT C. BOURNE, M.A.

FELLOW AND TUTOR OF NEW COLLEGE, OXFORD

WITH AN INTRODUCTION BY

E. RAY LANKESTER

LONDON

ADAM & CHARLES BLACK

1900

Made in Great Britain

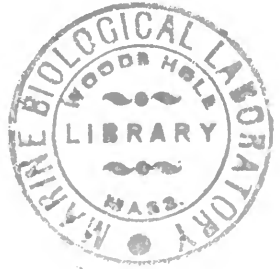

PREFACE

THE present volume is the "Second Part" in order of a comprehensive treatise on Zoology, which has been for some time in preparation under my editorship. In this treatise each of the larger groups of the Animal Kingdom is to be described by a separate author; whilst, as far as possible, uniformity in method and scope of treatment is aimed at. The authors are, for the most part, graduates of the University of Oxford, though it may not be possible to maintain this limitation in future sections of the work.

The general aim of the treatise is to give a systematic exposition of the characters of the classes and orders of the Animal Kingdom, with a citation in due place of the families and chief genera included in the groups discussed. The work is addressed to the serious student of Zoology. To a large extent the illustrations are original. A main purpose of the Editor has been that the work shall be an independent and trustworthy presentation, by means of the systematic survey, or taxonomic method, of the main facts and conclusions of Zoology, or, to speak more precisely, of Animal Morphography.

The treatise will be completed in ten parts of the size of the present one. It will at once be apparent that this limitation necessitates brevity in treatment which, however, will not, it is believed, be found inconsistent with the fulfilment of the scope proposed or with the utility of the work

to students. The immediate publication of the following parts may be expected:—

Part I. Introduction and the Protozoa.

Part II. Enterocœla and the Cœlomocœla—The Porifera—The Hydromedusae—The Scyphomedusae—The Anthozoa—The Ctenophora (the present volume).

Part III. The Echinoderma (published in March 1900).

Part IV. The Mesozoa—The Platyhelminthia—The Nemeritini.

These parts will be issued, without reference to logical sequence, as soon as they are ready for the press. This procedure to some extent evades the injustice of making an author, whose work is finished, wait for publication until other more tardy writers have completed their tasks.

The following authors have undertaken portions of the work:—Professor Poulton, F.R.S., M.A.Oxon.; Professor Weldon, F.R.S., M.A.Oxon.; Professor Benham, D.Sc., M.A. Oxon.; Mr. G. C. Bourne, M.A.Oxon.; Mr. G. H. Fowler, M.A.Oxon.; Professor Minchin, M.A.Oxon.; Mr. F. A. Bather, M.A.Oxon.; Professor J. W. Gregory, D.Sc.; and Mr. E. S. Goodrich, M.A.Oxon.

E. RAY LANKESTER.

August 1900.

CONTENTS

CHAPTER II.—THE ENTEROCÆLA AND THE CÆLOMOCÆLA.

CHAPTER III.—SPONGES—PHYLUM PORIFERA.

CHAPTER IV.—THE HYDROMEDUSÆ.

CHAPTER V.—THE SCYPHOMEDUSÆ.

CHAPTER VI.—THE ANTHOZOA.

CHAPTER VII.—THE CTENOPHORA.

48892

CHAPTER II

THE ENTEROCÆLA AND THE CÆLOMOCÆLA¹

1. THE DISTINCTION BETWEEN THE GRADES PROTOZOA AND METAZOA.—Some discussion of this subject will be found in the first part of the present work. Here we start with the simplest conception of a Metazoon, namely, a multicellular organism (*i.e.* an organism which can be actually as well as optically resolved into a number of constituent "cells" or "cytes") in which the cell-units are differentiated into at least two groups, having contrasted properties and functions instead of being equiformal and interchangeable in function as in the multicellular Protozoa. The production of micro- and macro-gametes or male and female reproductive conjugating cells does not in itself serve to distinguish the Metazoa from the Protozoa, as this occurs not only in multicellular, but also in unicellular Protozoa (*Coccidia*, *Hæmamebæ*). The grouping of at least two different kinds of cell-units to form at least two distinct permanent layers or masses in the adult organism is the essential character of the Metazoa, and it does not constitute a very great chasm between them and some of the aggregated or multicellular Protozoa.

2. DIVISION OF THE METAZOA INTO TWO BRANCHES.—The Metazoa² are divisible into two divergent branches, which possibly may be really two independent stems arising separately from widely different ancestral Protozoa. These are, on the one hand, the Parazoa³ or Sponges, and, on the other hand, the Enterozoa,⁴ which comprise the rest of the animal kingdom. The Parazoa are characterised by being composed of aggregates of cells, of which the outer layer is protective, trophic, and reproductive in function, whilst the

¹ By E. Ray Lankester, M.A., F.R.S.

² The term Metazoa was introduced by Hæckel in his *Studien zur Gastræa Theorie*, Jena, 1877, p. 12 and p. 54. Protozoa is a translation of the German word "Urthiere," and was first used by von Siebold in 1841.

³ This term is due to Sollas; see *Quart. Journ. Microsc. Sci.* N.S. vol. xxiv. p. 614 (1884).

⁴ The name Enterozoa was introduced by me in 1876 (preface to the English translation of Gegenbaur's *Comparative Anatomy*) as a substitute for Hæckel's term Metazoa. It now finds convenient application as the title for one of the two branches into which Metazoa are divisible.

innermost has its units in the shape of goblets from the interior of which rises a vibratile flagellum (choanocytes). They bound a cavity excavated in the mass of cells, and communicating by apertures, with the exterior. By the movements of their flagella they induce the flow of currents of water within the cavity or chamber which they line.¹ The Enterozoa, on the other hand, are in their simplest expression, two-cell-layered sacs, the outer layer of cells—the ectoderm—being protective, respiratory, and excretory, and often provided with vibratile processes, whilst the inner or endoderm cells are essentially concerned in digestion, assimilation, and reproduction and bound a cavity. This cavity is the primitive gut or “archenteron,” and opens to the exterior by a single aperture, the mouth-anus.

The most primitive Enterozoa retain the general features thus indicated, whilst it is possible to trace the development of the individual in the case of representatives of the higher groups of Enterozoa from the same simple structure (the embryonic form known as the Diblastula or Gastrula).

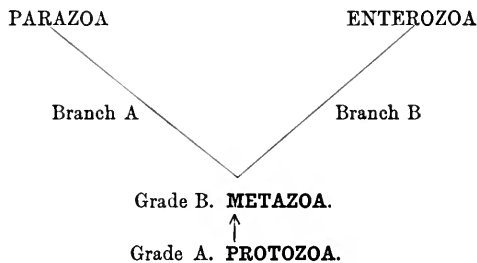

TREE showing primary grades and branches of the Animal Pedigree.

3. STERILITY OF THE BRANCH PARAZOA.—The Parazoa have apparently not given rise to any very great advance or complication of structure. They are represented by the Sponges or Porifera alone.

4. THE DIVISION OF THE BRANCH ENTEROZOA INTO TWO GRADES.—The Enterozoa proceeding from the condition of simple two-cell-layered sacs (Fig. 1) have given rise to an immensely increased complexity of structure, and to a vast diversity of form and internal organisation. The most important step in their progressive development of complexity of structure is the production of a second internal cavity distinct from the gut or archenteron (Figs. 2 and 3). To this second cavity the name “cœlom” is given. Its nature and origin are discussed below.

The presence of the cœlom is of the highest physiological importance. Once developed it became the starting-point for a variety

¹ See further the conclusion of the chapter Porifera, by Prof. Minchin.

FIG. 1.—SECTIONS THROUGH ONE OF THE ENTEROCŒLA (a Scyphistoma polyp) TO SHOW THE SACCULATION AND CONTINUITY OF THE ARCHENTERON AND THE TWO PRIMARY CELL-LAYERS.

ec, ectoderm, and *en*, endoderm, indicated by dark and pale shading respectively. *A*, sagittal section of the diblastula embryo without oral aperture; *B*, similar section of the young polyp after fixation but without oral aperture. *s*, oral in-sinking (stomodæum); *g*, mesogloea. *C*, young polyp with mouth. *sp*, junction of stomodæum and archenteron; *m*, gastric pouch. *D*, transverse section taken so as to cut the gastric pouches (*m*) above their openings into the archenteron; *s*, stomodæum. *E*, a similar section at a later period when four pouches have been formed, *st*, septa. *F*, transverse section at a lower level, showing the continuity of the gastric pouches with the axial portion of the archenteron; *t*, tæniolæ. (After Goette, from Korschelt and Heider.)

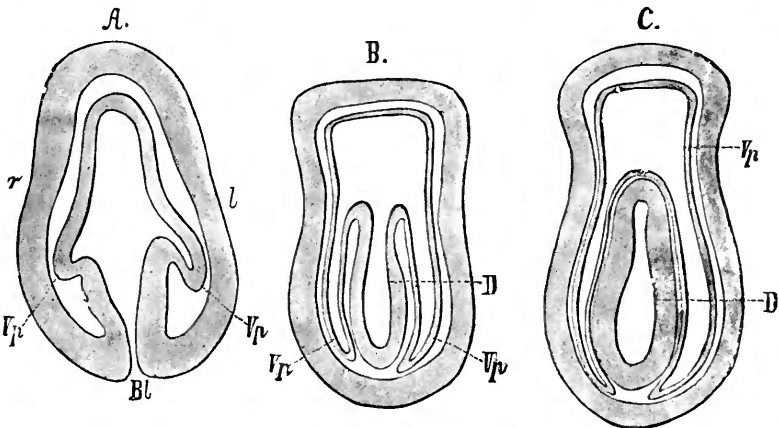
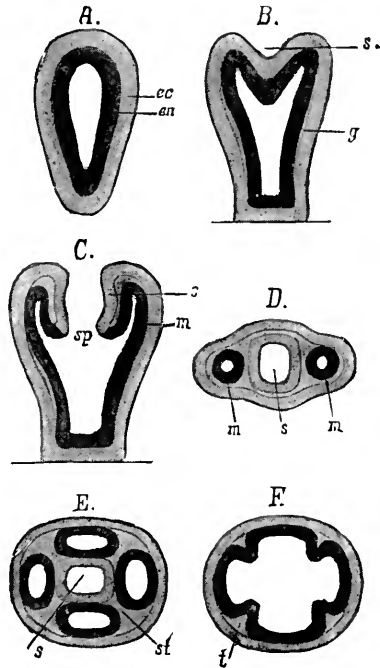

FIG. 2.—SECTIONS THROUGH THE LARVÆ OF AN ECHINODERM (*Asterina gibbosa*) AT SUCCESSIVE STAGES OF GROWTH; A, B, C, TO SHOW THE ORIGIN OF THE CŒLOM AS A PAIR OF ENTEROCŒLOUS POUCHES.

Bl, Blastopore; *D*, archenteron; *Vp*, vasoperitoneal sacs or cœlomic pouches. *r* and *l*, right and left sides. (After Ludwig, from Korschelt and Heider.)

of important differentiations and consequent development of new organs, such as genital ducts and renal excretory glands, besides affecting the mechanical conditions of the body-wall and muscles, and the diffusion of chemical products within the body.

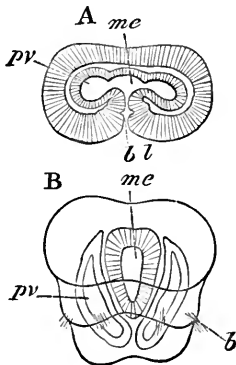
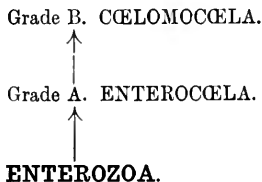

FIG. 3.—TRANSVERSE SECTIONS OF TWO STAGES OF THE LARVA OF THE BRACHIOPOD AROIOPSE TO SHOW THE ORIGIN OF THE CÆLOM AS A PAIR OF ENTEROCÆLOUS POUCHES.

A, younger stage. *bl*, blastopore; *pv*, right coelomic pouch continuous with *me*, the archenteron. *B*, later stage, the cœlomic pouch (*pv*) is now shut off from the archenteron, *me*; *b*, temporary bristles. (After Kowalewsky, from Balfour.)

Accordingly we divide the Enterozoa into those in which the sole cavity is the enteron—the Enterocœla—and those in which the cœlom is present as an independent second cavity—the Cœlomocœla.¹



¹ The two grades which I here call Enterocœla and Cœlomocœla are often designated Cœlentera and Cœlomata. The word Cœlenterata (due to Leuckart, 1848) has been used by some authors. It seems to me that it is legitimate to transpose the components of Cœlentera so as to form the word Enterocœla, and we then are able to form a very much better pair to it than is Cœlomata (Haeckel's term), by coining the word Cœlomocœla. The contrast of animals whose sole cavity is the enteron or gut-chamber with those which have a cœlom as an essential and distinct cavity is thus clearly expressed.

The use of the term enterocœl for the cœlom itself, and of the word Enterocœlia for a large division of cœlomocœlous animals by the Hertwigs may seem to render the conversion of Cœlentera into Enterocœla inconvenient. But the word "enterocœlous" or "enterocœlic" is still quite appropriate as a description of the early phase of development of the cœlom for the very same reason which justifies us in calling polyps and medusæ, Enterocœla or Cœlentera, viz. that we refer to the existence of a cavity which is in origin in the one case, and permanently in the other—a part of the enteron. As to the Hertwigs term "Entero-

5. ENUMERATION OF THE PHYLA INCLUDED IN THE GRADES ENTEROCÆLA AND CÆLOMOCÆLA.—The term “phylum” was introduced by Hæckel to indicate the branches of the animal pedigree of largest size. Setting aside the bifurcation of the Metazoon stem into Parazoa and Enterozoa, we use the term for primary branches. The branches into which a phylum divides are called, in accordance with the practice of all systematists since Linnæus introduced the system, “classes”; those into which a class divides “orders”; those into which an order divides are called families, which are divisible into genera, and these again into species. Breaks may be indicated in any of these groups by the recognition of two or more “grades” within it, whilst divergences of importance giving rise to two or more lines of descent can be further pointed out by the additional groupings furnished by the prefix “sub,” such as sub-phylum, sub-class, sub-order, etc.

We recognise the following phyla in the two grades of Enterozoa :—

GRADE A. **Enterocœla.**

Phyla { HYDROMEDUSÆ.
SCYPHOMEDUSÆ. ANTHOZOA.
CTENOPHORA.

GRADE B. **Cœlomocœla.**

a. *Groups which in the present state of knowledge must be regarded as distinct Phyla.*

PLATYHELMIA.	NEMATOIDEA.	MOLLUSCA.
ECHINODERMA.	CHÆTOGNATHA.	
VERTEBRATA	APPENDICULATA	NEMERTINA.

including the Sub-Phyla including the Sub-Phyla

Hemichorda,	Rotifera,
Urochorda,	Chætopoda,
Cephalochorda,	Arthropoda.
Craniata.	

β. *Groups whose relationship to the above Phyla is at present obscure, and are therefore provisionally treated as distinct Phyla.*

MESOZOA.	ACANTHOCEPHALA.
POLYZOA.	DIPLOCHORDA.

cœlia,” the distinction which it was intended to indicate by contrast with the term “Pseudocœlia” is no longer defensible. And, inasmuch as the Hertwigs themselves also use the term “Cœlenteraten” in their “Cœlomtheorie” for the lower grade of Enterozoa, it seems inadmissible that they should apply a word compounded of the same factors (enteron and koilos) to a totally different set of animals. “Enterocœlomia” and “Pseudocœlomia” would more truly have expressed their meaning than the words they employed. The cavity which they discuss in their book is called “the cœlom,” not “the cœl.”

6. CHIEF ORGANS AND ORGAN-SYSTEMS OF ENTEROCÆLA AND CÆLOMOCÆLA.—Leaving out of consideration special locomotive and prehensile mechanisms, and confining our attention to differentiations of structure corresponding to important physiological processes in the animal economy, we note in comparing Enterocœla and Cœlomocœla that it is by no means merely in the possession of the cœlom that the latter grade rises above the former. In all but the simplest Cœlomocœla (the Platyhelmsia and some few minute forms) we find a BLOOD-VASCULAR SYSTEM, consisting of main arterial and venous trunks connected by ramifying capillaries, present. In rare instances only are the fine capillaries absent, and their place taken by larger trunks. The essential element of this system is a modification of a primary tissue similar to the embryonic connective tissue of Vertebrata. Its distinctive character is that the constituent cells form elongated fibre-like groups, branching and constituting a reticulum, whilst at the same time the cell-substance, instead of giving rise to fibrillar skeletal material, becomes liquefied axially. Thus tubes consisting of rows of elongated nucleated cells are formed containing a highly organised liquid, which is often coloured red with hæmoglobin, and contains the nuclei of disintegrated cells, which were the sources of the hæmoglobinous fluid, as in Chætopoda and some Mollusca (Planorbis) and some Arthropoda. On the other hand, the fluid may be colourless, whilst in it float hæmoglobinous corpuscles, as in Vertebrata, some Mollusca (Solen legumen, Arca), and some Echinoderma, or the fluid may not only itself be colourless but contain only colourless floating corpuscles (most Molluscs, Arthropods, and Echinoderms).

RENAL EXCRETORY ORGANS specially developed in the form of sacs (renal sacs) and tubes (nephridia) are found in the Cœlomocœla, whilst in the Enterocœla, although some cells or even cell groups appear to have a renal excretory function—that is to say, to be concerned in the elimination of nitrogenous waste—there are no definitely constituted renal organs.

THE REGIONS AND GLANDULAR APPENDAGES OF THE ALIMENTARY TRACT are, except in the Platyhelmsia, very differently developed in the Enterocœla and Cœlomocœla. A stomodæum (στόμα, the mouth, and ὀδαῖον, adj. form of ὀδός, a road) results from a tube-like in-pushing of ectoderm in the first formation of the mouth in higher Enterocœla. In the Cœlomocœla we not only get a stomodæum, but an ectodermal proctodæum (προκτός and ὀδαῖον) is similarly formed in connection with the anus, which is rarely absent in that grade, and never present in the lower.

Paired digestive glands of various kinds, having the form of saccular outgrowths of the gut, are present in most Cœlomocœla, and never found in Enterocœla.

The coelom in all but the lowest Cœlomocœla has by its large development led to a very marked separation of the body-wall and the gut-wall, and a consequent independent development of elaborate SYSTEMS of MUSCULATURE in each of these superimposed regions. In the Enterocœla there is no separation of body-wall-musculature and gut-wall-musculature (nor in Platyhelmsia, Nemertina, and Nematoidea among Cœlomocœla).

The SENSE-ORGANS of the Enterocœla attain in some cases a high degree of complexity (optic and auditory structures), but the nerve tissue remains even in the highest to a large extent diffuse, and in the form of a widely scattered network, though ring-like concentration corresponding to the form of the body is to some extent found. In the Cœlomocœla, even among the lowest, a concentration of the nerve ganglion cells to form the CENTRES of a NERVOUS SYSTEM is observed. Various steps in this concentration in the form of longitudinal cords may be observed in lower and higher Cœlomocœla, tending to extreme concentration of the nerve-ganglion-cells, and the protection and special nourishment of the brain and nerve cord so produced.

BRANCHIAL RESPIRATORY ORGANS are frequently developed as feather-like outgrowths or other modifications of the surface in Cœlomocœla. The blood-vessels are distributed in these branchiæ and there receive oxygen, and liberate carbonic acid. In the Enterocœla, the absence of a vascular system is accompanied by the absence of special branchial organs.

In GENERAL FORM and SYMMETRY, as well as in the manifestation of merogenesis, or repetition of parts, the Enterocœla and Cœlomocœla differ greatly. In both a primary bilateral symmetry can be (with a few exceptions among the Enterocœla) detected. But in the Enterocœla this is masked by a dominating tendency to radial symmetry. Such masking of the more primitive bilateral symmetry is rare in Cœlomocœla, where, however, it is exhibited by most of the Echinoderma.

MEROGENESIS.—The Enterocœla frequently give rise to lateral buds, and so to arborescent growths, consisting of many individuals. The Cœlomocœla more rarely produce lateral buds (Polyzoa, Tunicata). The Cœlomocœla often give rise to chains of complete or incomplete individuals by growth, along the oro-anal axis, and partial or complete division at right angles to that axis (metameric segmentation). An apparently similar process is seen in the segmentation and division of the Scyphistoma polyp at right angles to the oro-aboral axis.

The exact historic relationship of metameric segmentation and repetition of parts in the Cœlomocœla to a previously complete production and separation of metameric "buds" or new individuals, requires special consideration in each group of animals in which

metameric segmentation is observed, or even but partial traces of it, can be discovered. Whilst it is certainly not necessary to suppose that metameric segmentation is actually derived from an arrested formation of strobilated buds which at one time were set free, it is nevertheless tolerably certain that the fundamental property of the organism is the same in both cases, bud-strobilation and metameric segmentation, and that whilst (whether it takes the form of antimerism or metamerism, or paramerism) we may indicate the exhibition of this property by the name "merogenesis," we can, with advantage, distinguish the clear and well-marked cases of repetition of "meres" as "eumerogenesis" (*e.g.* *Lumbricus* and *Tænia*, *Agalma* and *Eudendrium*), whilst the blurred and obstructed cases, such as are furnished by the Vertebrates, the Chitons, the Nemertines, and the imperfect antimeres of Holothurians are spoken of as cases of "dysmerogenesis." The cases of eumerogenesis are divisible into those resulting in separation, with or without completion of parts, and those persisting as aggregations with more or with less completeness and differentiation of the "meres."

The cases of dysmerogenesis are more difficult to analyse. Their obscurity and incompleteness may be due to re-integration following upon an earlier historical condition of eumerogenesis, of which there is now no direct evidence (*Chiton*, *Nautilus*), or they may be cases in which merogenesis sets in at an early stage of individual growth and development, but has never in any ancestral form persisted into adult life. In the last-named cases merogenesis has never been more than a transient phenomenon affecting the early stages of the individual, though it leaves obscure and puzzling results of its existence which persist even when full development is attained (? Vertebrates).

7. CONCERNING THE CÆLOM.

(a) *Its historic definition.*

We designate by the name "cœlom" the cavity in Vertebrate animals often called the pleuroperitoneal cavity, to which Haeckel (see historical note below) originally applied the name, and for which he invented it. We further, as a necessary result of morphological theory, designate by the same name "cœlom" the cavity or organ in other groups of animals which we consider to be genetically identical with the primitive pleuroperitoneal cavity of Vertebrates. "Cœlom" is not a term to be used for any and every body-cavity other than the gut (as some eminent writers seem to suppose), but definitely designates a morphological element

of high importance. The numerous embryological and anatomical researches of the past twenty years seem to me to definitely establish the conclusion that the cœlom is primarily the cavity, from the walls of which the gonad cells (ova or spermata) develop, or which forms around those cells. We may suppose the first cœlom to have originated by a closing or shutting off of that portion of the general archenteron of Enterocœla (Cœlentera) in which the gonads developed as in *Aurelia* or as in *Ctenophora*. Or we may suppose that groups of gonad mother-cells, having proliferated from the endoderm, took up a position between it and the ectoderm, and there acquired a vesicular arrangement, the cells surrounding a cavity in which liquid accumulated.

It is not of importance for our present purpose to decide between these two possible origins. They only differ in the earlier or later development of the cavity which the gonad mother-cells surround.

In whichever of these two ways the cavity took its origin as a separate chamber distinct from the archenteron, it was a cœlom, a primitive elementary cœlom, and originated from the cells of the archenteric wall.

Probably more than one pair of such cœloms were formed in the primitive Cœlomocœla, and by their fusion (as occurs in the ontogeny of animals with paired cœlomic pouches) gave rise to larger continuous cavities.

The cœlom is thus essentially and primarily (as first clearly formulated by Hatschek) the perigonadial cavity or gonocœl, and the lining cells of gonadial chambers are cœlomic epithelium. In some few groups of Cœlomocœla the cœloms have remained small and limited to the character of simple gonocœls. This seems to be the case in the *Nemertina*, the *Planarians*, and other *Platyhelminths*. In some *Planarians* they are limited in number and of individually large size; in others they are numerous.

In the great majority of Cœlomocœla the cœlom has vastly extended its area and acquired secondary functions and a leading importance in the physiology and architecture of the animal. In the adult *Echinoderma* and *Vertebrata*, the cœlom is (omitting secondary divisions) a single cavity of very large size, extending in every direction between the body-wall and the gut-wall, and occupied by a specialised fluid—the cœlomic fluid. In the *Chætopoda* it has attained to similar dimensions and is distended by liquid so as to produce tension in the body-wall. In the *Arthropoda* (which are now generally regarded as traceable to *Chætopod*-like ancestors) the cœlom has shrunk back again to relatively small dimensions. It exists in them as the cavity of the gonadial sacs

and of certain excretory organs only.¹ There is reason to believe that this small size of the cœlom in the Arthropoda is not due to a retention of the original small size of the cœlomic sacs, but is to be ascribed to a swelling of another and independent liquid-holding cavity, namely, the blood-vascular or hæmal system which has filled up the space formerly occupied by a capacious cœlom.

(b) *The theory of Phlebædesis—the Cœlom and the Hæmocœl.*

This swelling of the peripheral portions of the hæmal system may be called PHLEBÆDESIS, and the lacunar blood-holding spaces resulting from it form a "Hæmocœl" which has no connection with the cœlom, but has to a large extent encroached on the space which once was occupied by cœlom and caused the reduction of that organ to perigonadial and epinephric remnants.

In the Mollusca the cœlom also appears to have undergone reduction in volume. The pericardial cavity and the more or less extensive ramifications connected with it, as well as the gonadial sacs, are the cœlom of Molluscs. Until recently (1885) it was erroneously supposed that the pericardial system of the Mollusca contained blood. It does not; it is, on the contrary, entirely distinct from the blood-system. In the more primitive Molluscs (some Neomeniæ and Cephalopoda) the pericardial and perigonadial sections of the cœlom are in continuity, and in them also the blood-system appears more completely developed in the form of cylindrical tubes or "vessels" than in other Molluscs. But in all Molluscs as in all Arthropoda² the process of Phlebædesis has taken place, and a voluminous, irregularly distended system of blood-spaces—a Hæmocœl—has suppressed and replaced to a large extent the cœlom. In Lamellibranchs the paired, widely ramifying tubes of the organ of Keber, leading out of the pericardial cœlom, appear to be the reduced representatives of a formerly voluminous cœlom.

It appears that neither in Arthropoda nor in Mollusca is there any breaking through of the swollen blood-cavities into the cœlom.

Before the theory of Phlebædesis was established, it was supposed by many zoologists (of whom I was one) that the cœlom and blood-system were of one common origin, and that in Mollusca and Arthropoda they were in open continuity, and, in fact, to a large extent undifferentiated. This has now been shown to be an erroneous view: the cœlom is distinct from the vascular system in

¹ Possibly other remnants of the cœlom exist as spaces in connective tissue.

² It remains to be ascertained whether the Copepod Crustacean Lernanthropus with its tubular vascular system containing red blood is an exception or not.

origin and essential nature, and the two systems have not even secondarily acquired a connection with one another in either Arthropoda or Mollusca.

It is, therefore, very much to be desired that there should no longer be any continuation of the confusion by the application of the word "cœlom" to the blood-sinuses of Arthropods or of Mollusca.

The independence of the origin of the "hæmal system" or "blood-vascular system" appears to be well established; but it is by no means so clear as to what is the history of the first beginnings and subsequent development of the hæmal system in the animal series, as might be supposed. Whilst we are able to form some conception of the probable history of the vicissitudes of the cœlom from its first appearance to its present condition in the various phyla of Cœlomocœla, we find that few, if any, attempts have been made to trace out the history of the hæmal system in the same series. It is probable that it is one and the same morphological entity, which we recognise as the blood-vascular system or hæmal system, in Vertebrata, Mollusca, Arthropoda, Chætopoda, Nemertina, and Echinoderma. Its function is essentially the absorption and distribution of chemical substances important in the life of the tissues, among the first of these being oxygen gas. How could such a system originate? As ramifying capillary channels or as simple longitudinal trunks? It is certain that the walls of simple blood-vessels, and the blood itself, are closely related in nature to the connective tissues, and in some cases they have been shown to be developed from such tissue. Possibly the earliest vascular system was preceded by solid ramifying cords of connective tissue, which performed absorptive and distributive chemical functions even though not yet tubularised and differentiated into liquid content and enclosing wall. We have no conclusive reason for supposing that the hæmal system must have taken origin within the grade of Cœlomocœla. It is quite possible that we have to look for its origin in the lower grade of Enterozoa—the Enterocœla. This is a subject upon which much speculation is possible, but to which little serious attention has as yet been given. That the hæmal system is connected in origin with a space which often arises between the two primitive cell-layers of the embryo (the blastocœl) has been suggested on the ground of certain embryological observations, but the embryological facts are not in themselves conclusive as to the ancestral arrangements of the parts in question. This question is further considered below under the section "Cœlom and Mesenchyme."

(c) *Intercommunication of Cœlom and Blood-vascular System.*

To return to the cœlom. Whilst there is no direct communication between that cavity and the hæmal system in Arthropoda or Mollusca, yet such a communication does occur in two important groups of Cœlomocœla. In the Vertebrata the lymphatic vessels are in more or less direct communication with the cœlomic cavity, and also open into the hæmal system at more than one point. The condition in *Amphioxus*, as described by Schneider, is such as to give a very free communication between the vascular system and the cœlomic space at the base of the hepatic cœcum. It would be desirable that the existence of this connection in *Amphioxus* should be inquired into again, though there seems to be little doubt as to its existence.

Among the Chætopoda two very striking facts as to the fusion of cœlom and hæmal system have been recognised. The first is the breaking up of the hæmal tissue in *Glycera* and the *Capitellidæ* in such a way as to result in the total disappearance of the hæmal system as a series of vessels whilst its cell-elements remain as corpuscles coloured red by hæmoglobin and floating in the cœlomic fluid. The second is the assumption in certain of the Leeches of a canicular form by a large part of the cœlom and the junction of the canals so formed with the true hæmal system by means of capillaries. A remarkable fact is that portions of the cœlom (the perigonadial portions) are shut off from this combination. We thus obtain in the Leeches in question a uniform fluid, impregnated in most cases with hæmoglobin, circulating in vessels some of which are of hæmal and others of cœlomic origin. The fact that such a free intercommunication exists has been both asserted and denied, but the most recent careful investigations (Goodrich, *Quart. Journ. Micr. Sci.* 1899, vol. xlii. p. 477) leave no doubt that it really obtains. So long as it was held that cœlom and hæmal system were one in origin, and that a fusion of the two obtained in Mollusca and Arthropoda, the case of the Leeches did not appear singular. But our present conception as to the complete independence of the two systems in origin, and the knowledge that they do not intercommunicate in either Mollusca or Arthropoda, renders it desirable that we should have, if possible, a greater certainty than we have at present as to the developmental origin of the channels which are ascribed to cœlom in such Leeches as *Hirudo*. The evidence appears to be in favour of their cœlomic origin, but it is just possible that they are not cœlomic. In *Acanthobdella* and also in *Clepsine* (the former of which is to be regarded as an archaic form) the hæmal system is entirely closed and coexists with a well-developed cœlom into which it does not open.

(d) The Cœlom and Excretory Organs.

The physiological significance of an increase of size of the original cœlomic sacs is not difficult to suggest. Whether in the presence or absence of a hæmal system the accumulation of a quantity of organised liquid in cavities (or in a single cavity formed by the fusion of two or more original cœlomic sacs) must have considerable physiological significance. The cœlomic fluid and the cœlomic epithelium, as well as the floating corpuscles derived from that epithelium, acquire special properties and importance over and beyond the original functions subservient to the maturation of the gonadial cells. The mechanical significance of this liquid-holding chamber and its erectile function, similar to the erectile function of the archenteric cavities in such Anthozoa as the Pennatulids, are noteworthy; but the most important developments of the cœlom are in connection with the establishment of an exit for the generative products through the body-wall to the outer world, and further in the specialisation of parts of its lining epithelium for renal excretory functions.

In the Enterocœla the generative products either escape by rupture of the body-wall outwardly, or are liberated into the archenteron, and so escape by the mouth. Even in the Enterocœla pores exist in many forms which permanently place the peripheral parts of the archenteron in direct communication with the exterior; but these pores do not serve as passages for the generative products (aboral pore of *Peachia*, tentacle pores of Actinians, and polar pores of *Ctenophora*). Though in some cases the generative products of the Cœlomocœla escape from the cœlom by rupture of the body-wall, yet the existence of paired apertures right and left, serving for the exit of the genital products from the cœlomic sacs, must be regarded as a very early feature in the history of the Cœlomocœla. These apertures are not formed by an invagination of the ectoderm, but by an outward, often tube-like growth of the cœlom itself. They become specialised in many groups in the form of more or less coiled canals, and require to be recognised by a distinct name. I propose to call them cœlomoduets.¹ Frequently they are furnished with trumpet-shaped or funnel-like internal mouths. Such funnels are termed cœlomostomes. They exist where the cœlom is large and spacious, and the gonad (ovary or spermary) is not specially enclosed in a duct-forming sheath, shutting it off from the rest of the cœlom (a shutting-off which does take place in the Leeches and Eudrilid Earthworms, and also in Echinoderms and many

¹ There is no convenient Greek equivalent for "duct," and I hold that we are therefore justified in coining such hybrid words as "cœlomoduct," "gonoduct," and "uroduct."

Teleostean Fishes). Such funnel-like cœlomostomes are developed on the cœlomoduets of the ovarian and spermarian segments of the Earthworms and in many Chætopoda, also in Vertebrata (peritoneal funnels of the reno-genital system) and in some Mollusca (reno-pericardiac funnels). The cœlomoduets and the gonocœls, of which they are a part, frequently acquire a renal excretory function, and may retain both the function of genital conduits and of renal organs, or may, where several pairs are present (metamerised or segmented animals), subserve the one function in some segments of the body, and the other function in other segments. Again in some Mollusca (Gastropoda) it appears that the renal function may be developed by the cœlomoduect and gonocœl of the right side, and the oviduical or seminiduical function by those of the left side of the body. This very general assumption by some or all of the primary gonocœls and cœlomoduets of renal excretory functions has led to a confusion of these structures with the primitive ectodermal excretory tubes, which are best distinguished by the name "nephridia." The typical "nephridium" to which the name was originally given (see Lankester, Quart. Journ. Micr. Sci. 1880), is the so-called "segmental organ" of the Earthworm. This occurs as a pair of minute coiled tubes in each segment of the worm's body. Nephridia are distinguished by their independent origin, each from a single superficially placed cell which often is seen to be derived from ectoderm, and probably must be traced to that layer even when it appears as part of the mesoblast. They are also distinguished by their structure, which is primarily that of a number of perforated or drain-pipe cells, placed as it were end to end. It is not necessary to suppose that this uniserical cellular structure is absolutely diagnostic of nephridia, but it seems not improbable that it is so.

Instead of being, as was supposed, the common origin of the renal organs of all the Cœlomocœla, it now appears (see especially Goodrich's series of memoirs in the Quart. Journ. Micr. Sci. 1897-1900) that the nephridia are a primitive form of excretory organ which have been replaced in the higher groups of Cœlomocœla by uropoëtic cœlomoduets. True nephridia are only found in the Platyhelminia, Nemertina, Rotifera, Chætopoda, and in embryonic Mollusca (primitive kidneys of Pulmonata and Lamellibranchia).

The tubular organs, whether renal or genital in function, which have been identified of late years (by myself and others) with nephridia, such as the kidneys of Mollusca, the segmental excretory ducts of Peripatus, the genital and excretory ducts of Arthropods, and the peritoneal funnels and tubules of Vertebrata, are all cœlomoduets and not nephridia in the true sense of that word. A very special cause of the error of those who first attempted to

establish a theory of the uniform origin of the renal organs in all Cœlomocœla from nephridia, is that the nephridia, though primarily superficial and ectodermic, *do* acquire an internal opening into the cœlom in the Chætopoda. The funnel-like internal mouth (nephridiostome) which they often but not always develop under these circumstances is part of the same chain of cells which form the nephridial tube. Moreover, Goodrich has shown that the nephridia which thus penetrate to the cœlom in Chætopoda, may acquire most intimate relations to the cœlomoducts and their cœlomostomes. In the marine forms (Polychæta) this association leads to the formation of complex organs consisting partly of cœlomoduct with cœlomostome and partly of nephridium. These remarkable facts have only recently come to light, and readily explain the confusion which has hitherto prevailed between the ectodermal nephridia and the cœlomic cœlomoducts.

8. THE HISTORY OF THE TERM CŒLOM AND THE THEORIES CONNECTED WITH IT.

(a) *From Haeckel, 1872, to the Hertwigs, 1881.*

The word "cœlom" was introduced into morphological science by Haeckel in 1872. In the first volume of his "Kalkschwämme," p. 468, Haeckel writes as follows:—"Die wahre Leibeshöhle welche bei Vertebraten gewöhnlich Pleuroperitonealhöhle genannt wird, und für welche wir statt dieses neunsylbigen Wortes die bequemere zweisylbige Bezeichnung Coelom (τὸ κοίλωμα, die Hohlung) vorschlagen, findet sich nur bei den höheren Thierstammen bei den Wurmern, Mollusken, Echinodermen, Arthropoden und Vertebraten."

According to the theoretical conception which was justified by the imperfect knowledge of embryological facts of that time, Haeckel regarded the cœlom as a space formed by a "split" in the blastoderm dividing the middle cell-layer into two secondary layers. According to this view the outer of these, the dermal fibrous layer (Hautfaserblatt), adheres to the ectoderm to form the fibrous and muscular layer of the body-wall; the inner, the intestinal fibrous layer (Darmfaserblatt), adheres to the endodermal lining of the gut to form the fibrous and muscular part of the gut-wall. It was natural and justifiable to provisionally identify with the Vertebrate split-space thus formed and distinguished as "the cœlom" the chief cavity lying between gut-wall and body-wall in Mollusca and Arthropoda, as well as the similarly situated cavities of Chætopoda and Echinoderma. The hypothesis as to the origin of the cœlom was that it was formed by the accumulation of nutrient fluids which passed through the wall of the alimentary canal. Thus Haeckel erroneously identified the dis-

tended blood-spaces of Mollusca and Arthropoda with the Vertebrate cœlom, whilst he correctly identified with it the great body-cavities of Chætopods and Echinoderms.

The word "cœlom" was adopted by Haeckel's friend and colleague in the University of Jena, Carl Gegenbaur. In the second edition of his masterly treatise, the "Grundzüge der vergleichenden Anatomie" (English edition 1878, p. 367), Gegenbaur says in regard to the cœlom of Mollusca: "As a rule the vascular system is freely connected with the cœlom, which therefore forms a portion of the hæmal system."

And again, in relation to the cœlom of Arthropoda, he writes (p. 278 of the same work): "The cœlom is found in all the Arthropoda, and forms a portion of the blood-vascular system, so that the peri-enteric fluid found in many Vermes as a fluid different from the blood, is represented in the Arthropoda by the blood itself."

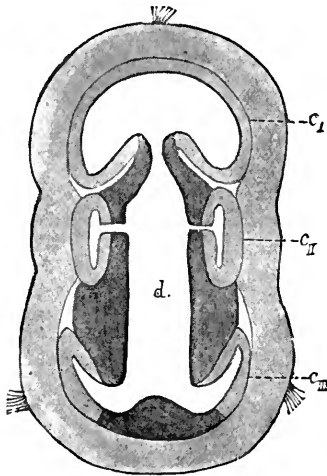

FIG. 4.—LARVA OF BALANOGLOSSUS IN SAGITTAL SECTION TO SHOW THE ORIGIN OF THE CŒLOM AS THREE PAIRS OF ENTEROCŒLOUS POUCHES.

cI, anterior, *cII*, middle, *cIII*, posterior pairs of cœlomic pouches; *d*, archenteron. (After Bateson, from Korschelt and Heider.)

The first of the series of observations, which have ultimately led to a view as to the essential nature of the cœlom different from that of Haeckel and Gegenbaur, already existed before the word cœlom itself was coined. As far back as 1864 Alexander Agassiz (Embryology of the Starfish, in Contributions to the Natural History of the United States, vol. v. 1864) showed in his account of the development of Echinoderma that the great body-cavity of those animals developed as a pouch-like outgrowth of the archenteron of the embryo (see Fig. 2) whilst a second outgrowth gave rise to their ambulacral system; and in 1869 Metschnikoff (Mem. de l'Acad. Imperiale des Sciences de St. Petersburg, series vii. vol. xiv. 1869) con-

firmed the observations of Agassiz, and showed that in Tornaria (the larva of Balanoglossus) a similar formation of body-cavities by pouch-like outgrowths of the archenteron took place (Fig. 4). Metschnikoff has further the credit of having, in 1874 (Zeitsch. wiss. Zoologie, vol. xxiv. p. 15, 1874), revived Leuckart's theory of the relationship of the cœlenteric apparatus of the Enterocœla to the digestive canal and body-cavities of

higher animals. Leuckart had in 1848 maintained that the alimentary canal and the body-cavity of higher animals were united in one system of cavities in the Enterocœla (Verwandtschaftsverhältnisse der wirbellosen Thiere, Brunswick, 1848). Metschnikoff insisted upon such a correspondence when comparing the Echinoderm larva, with its still continuous enteron and cœlom, to a Ctenophor, with its permanently continuous system of cavities and canals. Kowalewsky in 1871 showed that the body-cavity of *Sagitta* was formed by a division of the archenteron (Fig. 5) into three parallel cavities, and in 1874 demonstrated the same fact for the Brachiopoda (see Fig. 3).

In 1875 (Quart. Journ. Micr. Sci. vol. xv. p. 52) Huxley proposed to distinguish three kinds of body-cavity: the schizocœl,

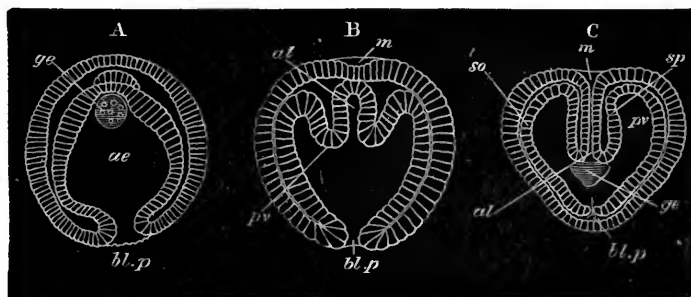

FIG. 5.—THREE STAGES (A, B, C) IN THE DEVELOPMENT OF *SAGITTA* TO SHOW THE ORIGIN OF THE CÆLUM AS A PAIR OF ENTEROCÆLOUS POUCHES.

m, mouth; *al*, alimentary canal; *ae*, archenteron; *bl.p*, blastopore; *pv*, cœlomic pouch; *so*, *sp*, epithelial wall of the same pouch; *ge*, gonad cells. (After Butschli and Kowalewsky, from Balfour.)

formed by a splitting of the mesoblast, as in the chick's blastoderm; the enterocœl, formed by pouching of the archenteron, as in Echinoderms, *Sagitta* and Brachiopoda; and the epicœl. This last name he applied to the atrial chamber of Tunicates and to a supposed chamber in *Amphioxus*, the existence of which he was led to believe in, by the examination of ill-preserved specimens.

Immediately after this I put forward the theory of the uniformity of origin of the cœlom as an enterocœl (Quart. Journ. Micr. Sci. April 1875). I pointed out that inasmuch as it had been shown in many cases that the mesoblast is derived from the hypoblast (wall of the archenteron), it might well be supposed that the splitting of the mesoblast is only a delayed formation of the *lumen* of the enterocœlous pouch: that in fact the mesoblastic somites and solid paired masses are only enterocœl pouches in a *solid* condition, destined after a brief delay to open out as pouches or sacs. My theory of the cœlom as an enterocœl was accepted

by Balfour, and was greatly strengthened by his observations on the derivation of both notochord and mesoblastic somites from archenteron in the Elasmobranchs, and by the publication in 1877 by Kowalewsky of his second paper on the development of *Amphioxus*—in which the actual condition which I had supposed to exist in the Vertebrata was shown to occur (see Figs. 6, 7, and 8), namely, the formation of the mesoblast as paired pouches in which a narrow lumen exists, but is practically obliterated on the

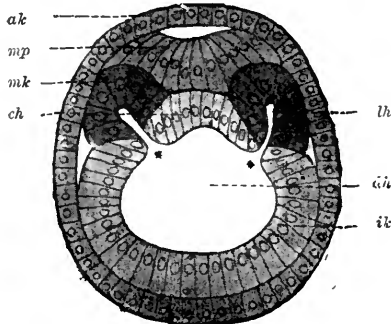

FIG. 6.

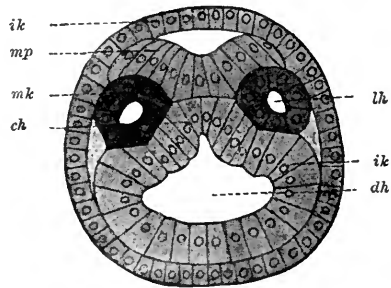

FIG. 7.

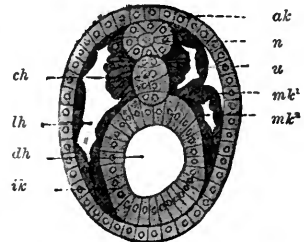

FIG. 8.

FIGS. 6, 7, 8.—TRANSVERSE SECTIONS OF THE BODY OF THREE LARVÆ OF AMPHIOXUS AT SUCCESSIVE STAGES OF DEVELOPMENT IN ORDER TO SHOW THE ORIGIN OF THE CÆLOM AS PAIRED ENTEROCÆLOUS POUCHES.

FIG. 6 shows the cœlomic pouches (*lh*) as part of the enteric wall.

FIG. 7 shows them nipped off as closed sacs.

FIG. 8 shows them pushing their way between ectoderm and endoderm; the right-hand sac has divided into an upper "myocœl" and a lower "splanchnocœl." *ak*, ectoderm, *ik*, endoderm, *mk*, *mk*¹, *mk*², epithelium of the cœlomic wall; *lh*, cœlom; *mp*, foundation of the nerve cord; *n*, nerve cord; *ch*, notochord; *us*, myocœl; *dh*, gut. (After Hatschek, from Hertwig.)

nipping off of the pouch from the archenteron, after which process it opens out again as cœlom.

The chief difficulty which my theory of the uniform nature of the cœlom had to encounter was in bringing the cavities considered to be "cœlom" in the Mollusca and the Arthropoda into the scheme. At this time I accepted, in common with most embryologists, the view of Haeckel and Gegenbaur, that the irregular and more or less spongy space holding blood in those animals is in reality the cœlom, and as a part of that interpretation I accepted the theory that the blood-vascular system is itself only a part of the cœlom cut off from it and specialised in most cases, but con-

fluent with it in the Mollusca and the Arthropoda. Guided by this erroneous view, I suggested that the reduction of the enterocœlous pouches of mesoblast might proceed further than solidification; the process of simplification might well be supposed (I suggested) to go on to the reduction of the number of the cells detached from the archenteric wall, so that eventually a cœlom

FIGS. 9, 10, and 10bis.—THREE VIEWS OF A YOUNG EMBRYO OF THE MOLLUSC *PISIDIUM PUSILLUM*. FIG. 9 IS VIEWED FROM THE SURFACE AND SHOWS THE ECTODERMAL (epiblast) CELLS. FIG. 10 SHOWS THE SAME EMBRYO IN OPTICAL MEDIAN SECTION, WHILST FIG. 10bis SHOWS A FOCUSING TO A PLANE JUST BELOW THE EPIBLASTIC LAYER.

The invaginated archenteric sac (hypoblast), *hy* is seen at one pole. Closely applied to the under surface of the epiblastic layer are numerous branched cells, *me*; similar cells (*p*) appear to be originating by cell-division from the wall of the archenteron. The cells *me* and *p* are "mesenchyme." Possibly among them, near to the archenteric wall, are the mother-cells of the cœlomic pouches. (After Lankester, from Balfour.)

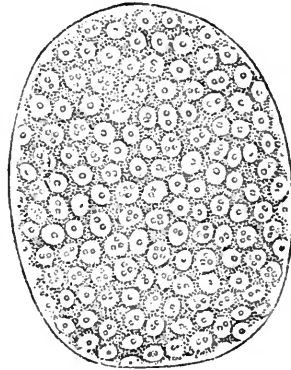

FIG. 9.

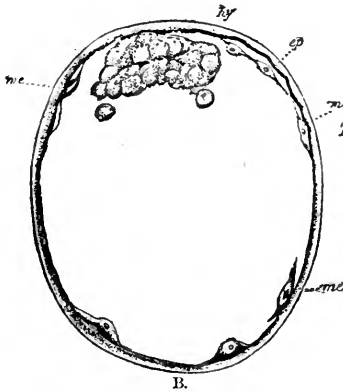

FIG. 10.

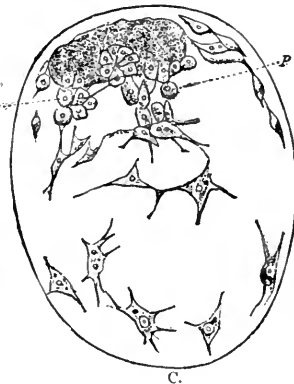

FIG. 10bis.

might be formed by a few wandering cells, or even a pair only of such cells, detached from the archenteric wall, and creeping over the ectoderm and endoderm in the space between them which often is enlarged to form a blastocœl. Such cells do occur in Mollusca (*Cyclas*,¹ *Lymnaeus*, *Paludina*), and probably have to do with the formation of blood-vessels and blood and other skeleto-trophic tissue, though their history has not been traced (see Figs. 9, 10, and 10bis).

¹ See Lankester, "Development of Mollusca," Phil. Trans. 1873.

It is, I think, now certain that they have nothing to do with the formation of cœlom.

On the other hand, later researches, *e.g.* those of Hatschek on *Polygordius* (see Fig. 11), have confirmed the important view, which I deduced from Kowalewsky's account of the origin of the mesoblast in *Lumbricus*, namely, that the first rudiment of the cœlom, instead of detaching itself from the archenteron as a pouch or even a solid mass of cells about to split, may separate from the archenteric epithelium as a single pair of cells, which take up their position in the blastocœl (space between ectoderm and endoderm) in this state of naked simplicity (Fig. 11, *A*), and

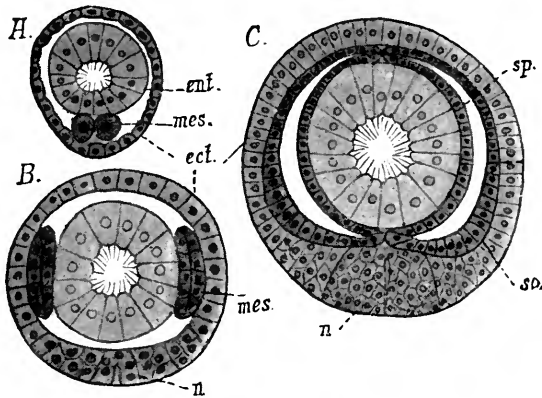

FIG. 11.—TRANSVERSE SECTIONS OF THE LARVA OF THE CHETOPOD *POLYGORDIUS* TO SHOW THE ORIGIN OF THE CÆLOMIC POUCHES FROM TWO PRIMARY CELLS DETACHED FROM THE ARCHENTERIC EPITHELIUM.

A, section of an unsegmented larva, just in front of the anus, showing *ect.*, ectoderm, *enf.*, endoderm, and *mes.*, the two primary mother-cells of the cœlom. *B*, section of an older larva near the tail. *mes.*, the cœlomic rudiments formed by the division and growth of the primitive cœlomic cells; *n*, forecast of the nerve cord. *C*, section of the same larva nearer the head. The splanchnic (*sp.*) and somatic (*so.*) walls of the cœlom have diverged from one another forming the cœlomic cavity. *n*, forecast of nerve cord. (After Hatschek, from Korschelt and Heider.)

then proceed to multiply so as to form a solid mass of cells right and left (Fig. 11, *B*), and finally open out as two well-developed cœlomic sacs (Fig. 11, *C*). This is a fine typical instance of "precocious segregation," the original right and left cœlom cells moving away from their proper and ancestral position in the series of archenteric wall-cells at an astonishingly early period, instead of waiting until they have formed a complete cœlomic sac.

The first important attack upon the theoretical identification by Haeckel, Gegenbaur, and myself of the blood-space of Mollusca with the cœlom is due to the brothers Hertwig, who in their

interesting work, *Die Cœlomtheorie* (Jena, 1881), definitely denied to this space the nature of cœlom. They called it "pseudocœl," and in the same category they placed the body-cavities of the Rotifera, the Polyzoa, and the intercellular spaces of the parenchyma of Platyhelminia. The remaining groups of animals (exclusive of the Cœlentera of Leuckart) they credited with the possession of a true cœlom, which they considered as being always an enterocœl in origin.

The Hertwigs thus practically accepted my theory of the origin and nature of the true cœlom, but rightly refused to include in this category the blood-holding space of the Molluscs. If I proceed to point out where they were mistaken it is in no spirit of reproach, for their work has in this and again in the history of the fertilisation of the egg-cell been of capital importance. It is necessary, as we push our way through the dark, to make mistakes and entertain erroneous hypotheses which, with the increased knowledge of fact due to the work of a vastly increased body of observers, give way to new conceptions in accordance with our improved understanding of the phenomena before us.

The Hertwigs failed to recognise the existence of the true "cœlom" in Mollusca, viz. the pericardial, perigonadal, and renal sacs. Further, they did not recognise that the cavitory system, which they called "pseudocœl" in Mollusca (with, it is true, considerable reservation as to its actual nature), is merely the blood-vascular system in a swollen condition. They also associated under the name "pseudocœl" various spaces in other animals which have nothing in common with one another or with the hæmocœl of Mollusca. Lastly, they maintained (as it now appears erroneously) the cœlomic nature of the hæmocœl of Arthropoda as taught by Haeckel and Gegenbaur, and as at that time accepted by me.

The Hertwigs, in the historical retrospect at the close of their volume *Die Cœlomtheorie*, pay generous tribute to the work of English anatomists in establishing a true theory of the cœlom. They say: "Während in England, wie uns der geschichtliche Ueberblick gezeigt hat, die Entdeckungen von Agassiz, Metschnikoff und Kowalewsky auf einen fruchtbaren Boden gefallen waren und Morphologen wie Huxley, Lankester und Balfour zu weittragenden und zum Theil glücklichen Speculationen veranlasst hatten, ist auf diesem Gebiete in Deutschland keine Bewegung in das Leben gerufen und eine Weiterbildung der besprochenen Theorien nicht versucht worden."

(b) *Progress in the Understanding of the Cœlom from 1881 to 1896.*

Whilst the conception of the cœlom as essentially an enterocœlous pouch, nipped off from the archenteron, is admitted to be

due to English morphologists, the later developments of our knowledge as to what is and what is not "cœlom" are very largely due to the same school.

In 1881 I undertook an investigation of the blood-systems of both Mollusca and Arthropoda, at that time held by me and by nearly all other morphologists to represent cœlom, either in consequence of the confluence of two systems at one time separated, or by survival of an undifferentiated condition.

At that time the pericardium of the Lamellibranchia in particular, and of all other Mollusca by implication, was held to be a blood space in communication by veins with the general blood-system. In *Anodon* the apertures of these veins were pointed out in text-books of Comparative Anatomy on the anterior wall of the pericardium. I found that the fluid in the pericardium of *Anodon* is not blood, and that the so-called apertures of veins on its wall are the apertures of a remarkable branching tubular system (forming, in large part, the organ of Keber, but extending far beyond it). I found, further, that in Gastropoda the pericardium does not contain blood. The red-blooded Lamellibranch, *Solen* (*Ceratisolen*) legumen, which has oval corpuscles coloured by hæmoglobin in its blood, appeared to me likely to furnish a valuable case for the study of this question. One of my pupils, Mr. Penrose (British Association Reports, 1882), and subsequently I myself (*Zoologischer Anzeiger*, 1884), examined *Solen* legumen in the living condition, and also by means of sections, and established the fact that the red blood never enters the pericardial chamber, and, further, that no blood is exuded from the animal's body (by pores or otherwise) when it rapidly retracts the foot after previous expansion. Other investigations which I had commenced in 1867 on the renal organs of *Patella* were resumed, and led me to the conclusion that the pericardial space of Mollusca is not a blood space, and that it is in communication with the renal sacs by ciliated reno-pericardial apertures (often funnels) which lead through the renal sacs ("urocœls," according to our present nomenclature) to the exterior. I thus came to the conclusion that the pericardial chamber (and its Keberian tubules in some Lamellibranchs), together with the gonad sacs, which in *Neomenia* and Cephalopoda communicate with the former, are the real cœlom of Mollusca. At first I adhered to the dominant theory that the blood-holding space is *also* to be regarded as a part of the cœlom but shut off from it. But a subsequent consideration of the blood-system of the Arthropoda, and of the fact that the more primitive Mollusca (the Polyplacophora and the Cephalopoda) have well-developed tubular blood-vessels largely developed, led me to put forward the theory of Phlebædesis. According to this theory, the true cœlom is present in a reduced form in both Mollusca and

Arthropoda, whilst the blood-holding spaces, henceforward to be

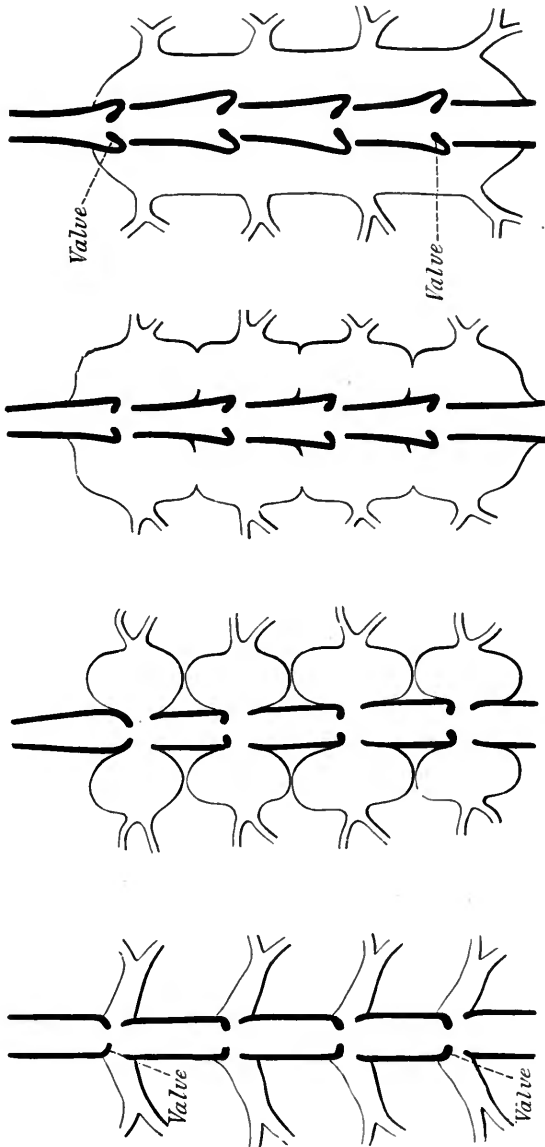

FIG. 12.—DIAGRAM TO SHOW THE ORIGIN OF THE "OSTIATE" HEART OF ARTHROPODA (ON THE RIGHT) FROM THE DORSAL VESSEL OF A CHÆTOPOD (ON THE LEFT), ACCORDING TO THE THEORY OF PHLEBÆDESIS.

The veins entering the Chætopods dorsal vessel are supposed to become distended, and eventually to fuse with one another so as to form the pericardial blood-sinus with its valvular "ostia" opening into the heart. (From Lankester.)

called "hæmocœl," which have been erroneously considered to be parts of the cœlom, are in reality swollen blood-vessels.

A step precedent to the development of the theory of Phlebœdesis was the recognition of the fact that the green glands and "shell glands" of Crustacea, the coxal glands of *Limulus* and *Scorpio*, and the generative ducts of Arthropoda generally, belong to that same system of cœlomic exits or ducts to which the renal organs of Mollusca belong. To these we now give the name "urocœls" and "cœlomoduets" (see below as to this nomenclature), and distinguish them from the true nephridia of the Earthworms and Platyhelmsia, though they were until quite recently all spoken of by the one term "nephridia." Various anatomists have contributed to the establishment of the fact that the tubular glands at the base of the antennæ in Crustacea are connected internally with a frequently very extensive cavity quite distinct from the blood space (Marchal, *Comptes Rendus*, cxi. 12, and cxi. 16; and Weldon, *Quart. Jour. Micr. Sci.* vol. xxxii. 1891, p. 279; and *Journ. Mar. Biol. Assoc.* vol. i., New Series, 1889-90). The gonadial sacs of Arthropoda, like the gonadial sacs of Mollusca, must be regarded as representing a portion of the cœlom, and the cavity into which the other similarly placed ducts open is also in all probability cœlom. The blood system need not, therefore (I argued), be considered as in any way representing cœlom; it is probably only a dilated swollen blood-vascular system which has "crowded out" a good deal of the pre-existing cœlomic chamber or chambers. In 1885 I had arrived at these views, and indicated them in a note to a paper by my pupil, Dr. Gulland, "On the Development of the Coxal Gland of *Limulus*" (*Quart. Jour. of Micros. Sci.* 1885, p. 515). At this time Mr. Adam Sedgwick, of Cambridge, was working at the later stages in the development of *Peripatus*, and early in 1887 announced to the Cambridge Philosophical Society a discovery of the utmost importance in regard to the whole question of the relation of cœlom and vascular system in the Arthropoda. Mr. Sedgwick showed that the cœlom of *Peripatus capensis* is developed as a series of paired cavities in the mesoblastic somites derived from the wall of the archenteron. These paired cœlomic cavities and the axial metenteric cavity are at one time the only spaces to be observed in a transverse section of *Peripatus* (Fig. 13, *A*). The paired cœlomic cavities proceed to divide each into a dorsal and a ventral portion (Fig. 13, *C*). The dorsal portions form the perigonadial cœlom, whilst the ventral portions give rise to the renal tubes and end sacs (epinephric cœlom), which have hitherto been spoken of by Balfour, Sedgwick, myself, and others as nephridia, but should no longer be identified with the excretory tubes of *Oligochæta* and *Platyhelmsia*, to which the name "nephridium" was originally applied by me, and for which alone it should be reserved. The renal cœlomic tubes of *Peripatus* must be classed as "urocœls," pro-

vided with their own proper "cœlomoducts," being excretory modifications of the primary exits or ducts of the cœlom, which served in the ancestral cœlomocelous animal as exits for genital products.

Whilst the dorsal divisions of the cœlomic sacs of *Peripatus* are moving upwards towards the mid-line of the back, a space

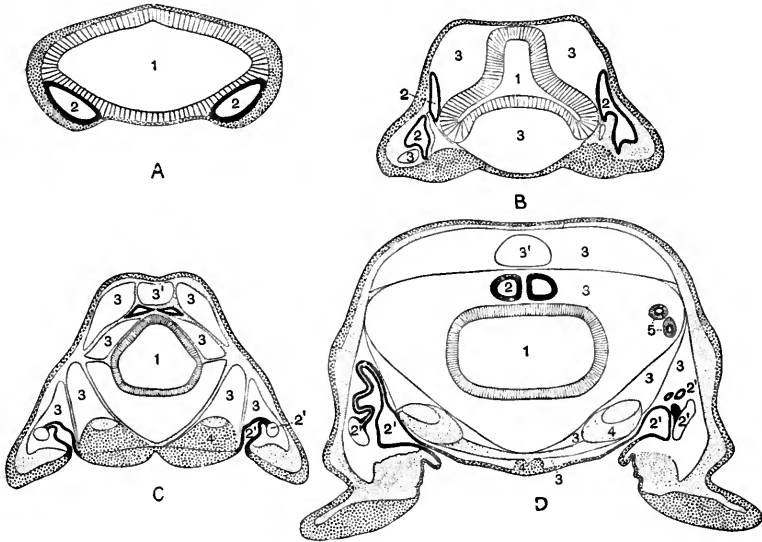

FIG. 13.—TRANSVERSE SECTIONS SHOWING THE BREAKING UP OF THE CÆLOM, AND THE DEVELOPMENT OF THE HÆMOCÆL IN PERIPATUS.

A, section of a young embryo, in which the only cavities present are 1, the gut or metenteron, and 2, the cœlom in the form of a pair of pouches (in each segment) derived from the wall of the primitive archenteron. *B*, section of a later embryo showing the division of the cœlom on each side into a dorsal and a ventral cavity (2, 2), and the appearance of the hæmocel as three longitudinal cavities (3, 3, 3). *C*, section of a later embryo; the dorsal cavities of the cœlom have migrated to the dorsal mid-line; the ventral sacs acquire such an opening to the exterior. *D*, section of a still later embryo. The dorsal portions of cœlom (2) become the gonads (gonocœls); the ventral portions (2') become urocœls with end-sacs (the so-called segmental organs usually, but erroneously identified with "nephridia"). The hæmocel shows a division into several compartments; the heart (3') has made its appearance. The nerve cords (4), already visible in *C*, are well developed, and portions of the slime-glands (5) are seen in section. (After Sedgwick, from Sedgwick's Text-book of Zoology.)

begins to make its appearance between the body-wall and the gut-wall, and rapidly increases in volume (Fig. 13, *B*, 3). This is the blood-space or hæmocel. It is of very great importance that we should have minute and repeated examination of the development of this space in various Arthropoda, since light will thereby be thrown on the primitive lines of historic development of the blood-vascular system. From Mr. Sedgwick's description of the origin and

subsequent development of this space in Peripatus, there can certainly be derived some justification for the view (which has from time to time been expressed by various morphologists) that a space between primitive endoderm and ectoderm formed by the accumulation of liquid in that position, and spoken of as the "blastocœl," is the origin, the point of departure, so to speak, of the blood-vascular system. We cannot, however, consider that this question has been yet brought to a probable solution. Whatever its ancestral origin, it is abundantly clear from Mr. Sedgwick's drawings and statements that the hæmocœl thus formed is entirely independent in its origin of the cœlom, with which it never acquires any kind of connection. Observations tending to extend Sedgwick's discovery to the embryological history of Crustacea and some other Arthropoda have been made since his publication by other observers (see Allen, *Quart. Jour. Micr. Sci.* vol. xxxiv. 1893, p. 403).

At the meeting of the British Association in Manchester in 1887—having been confirmed by Sedgwick's demonstration in the speculations to which I had been led by the consideration of other facts—I formulated a general theory of the origin of the hæmocœl of both Mollusca and Arthropoda by an excessive swelling of the non-arterial portions of the vascular system which, in an earlier ancestral form, had been provided throughout with tubular capillaries and veins. A report of this communication appeared in "*Nature*" of March 1888, and was reproduced with some additional remarks and a diagram (Fig. 12) used on the occasion of the original communication, in the *Quart. Journal of Micros. Science*, 1893, vol. xxxiv. p. 427. This theory I now call the theory of Phlebœdesis.

As stated in the paper above cited, the theory thus named is as follows:—"That the system of blood-containing spaces pervading the body in Mollusca and in Arthropoda is not, as sometimes (and indeed usually) supposed, equivalent to the cœlom or perivisceral space of such animals as the Chætopoda and the Vertebrata, but is in reality a distended and irregularly swollen vascular system—the equivalent of the blood-vascular system of Chætopoda and Vertebrata." The name hæmocœl was proposed by me for this phlebœdetic space or cavity, and was subsequently adopted by Sedgwick in his detailed account of the development of cœlom and blood space in Peripatus. At the same time I showed from injections and silver impregnations of Anodon, Cephalopods, Astacus, and Limulus, that true capillaries are in certain regions of the body in both Mollusca and Arthropoda more largely developed than is generally supposed. I showed that the far-spreading tubules of the organ of Keber in Molluscs, and probably also a system of spaces in the connective tissues of

Astacus and of Limulus, should be regarded as remnants of the coelom, the bulk of which has been filled up by swollen blood-vessels, leaving only epinephric and gonadial sacs in the Arthropoda, pericardial and gonadial sacs in the Mollusca.

Some years later my assistant, Dr. Benham, now Professor in Dunedin, New Zealand, described (Quart. Jour. Micr. Sci. xxxix. 1896) a condition of the blood-vessels in the Chætopod Magelona, which is parallel to that through which the vessels of ancestral Molluscs and Arthropods must have passed. Phlebædesis is carried

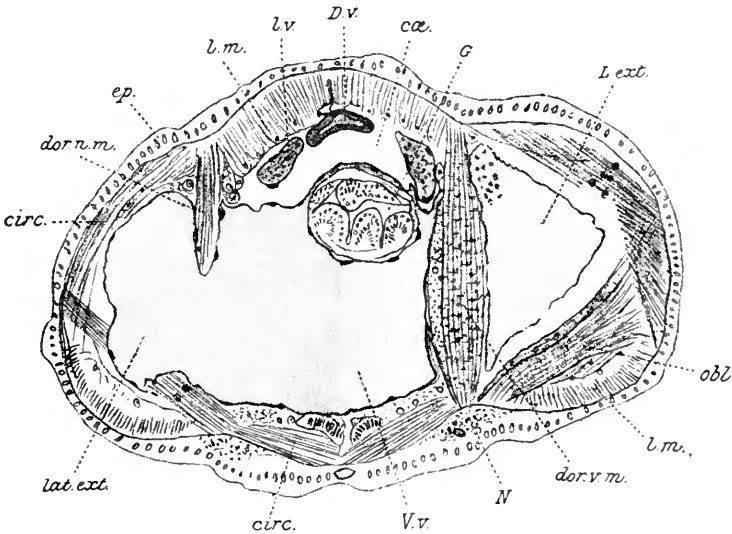

FIG. 14.—TRANSVERSE SECTION OF THE THORACIC REGION OF THE CHÆTOPOD *MAGELONA* TO SHOW THE SWELLING OF THE BLOOD-VESSELS AND CONSEQUENT REDUCTION OF THE COELOM.

D.v., dorsal vessel; *G*, gut; *N*, nerve cord; *V.v.*, ventral vessel greatly swollen, filled with a peculiar corpusculated blood; *lat.ext.*, lateral extension of the same; *ca.*, cælo; *l.v.*, lateral vessel; *l.m.*, longitudinal muscles; *circ.*, circular muscles; *obl.*, oblique muscles; *dor.v.m.*, dorso-ventral muscle. (After Benham.)

to such a point in *Magelona* as to extinguish to a large extent the proper cœloomic cavity (see Fig. 14). This observation seems to be of importance as showing the tendency to Phlebædesis in Chætopods among the ancestors of which the ancestors of both Mollusca and Arthropoda are in all probability to be sought. When we remember further that in some Chætopods the cells which should form the blood-vessels and the blood, may actually break up altogether and give rise to floating hæmoglobinous corpuscles with a total absence of blood-vessels (*Glycera* and *Capitellidæ*), we must admit that it is not surprising that the task

of tracing the origin and history of the blood-vascular system in the animal series is a difficult one and full of pit-falls for the speculative morphologist.

By the establishment of the existence of the cœlom in an independent condition in Mollusca and Arthropoda, having so far as embryological observations have gone, an enterocœlous origin (von Erlanger in *Paludina*,¹ Sedgwick in *Peripatus*), and by the recognition of the spaces at one time confounded with cœlom in those great phyla, as being in reality swollen blood-vessels or

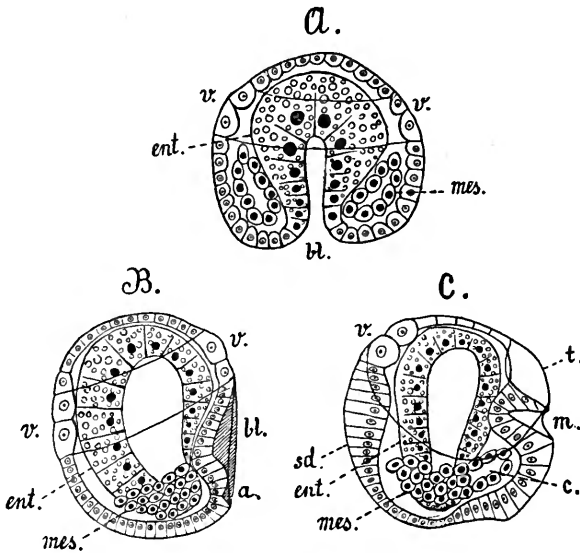

FIG. 15.—YOUNG EMBRYOS OF THE GASTROPOD MOLLUSC *BITHYNIA TENTACULATA* TO SHOW THE APPEARANCE OF THE CŒLOM AT AN EARLY PERIOD AS A PAIR OF POUCHES DERIVED FROM THE WALL OF THE ARCHENTERON (? as solid or hollow outgrowths).

A, frontal section; B and C from the right side. *a*, region of the anus; *bl*, blastopore; *c*, cœlom; *mes*, epithelial cell-wall of the cœlom; *ent*, endoderm; *m*, mouth; *sd*, shell-gland; *t*, prostomial region; *v*, cells of the ciliated band of the velum. (After von Erlanger, from Korschelt and Heider.)

hæmocœl, the theory of the cœlom is brought to a second stage. The results thus emphasised have been gained during the fifteen years which succeeded the publication in 1881 of the Hertwigs' Cœlomtheorie. The existence and the unity of the cœlom throughout the animal series above the Protozoa and Enterocœla, its derivation in all cases from pouch-like growths of the archenteron either actually or with delayed appearance of the lumen, as suggested by me in 1875, seems now to be established with some-

¹ See Fig. 15 and the explanation.

thing like certainty ; and I venture to point out that this further stage of progress, like the earlier which started from the first generalisation of Haeckel of Jena, has been gained by the speculation and observation of the English school of morphologists.

(c) *The Cœlom and the Mesenchyme.*

The recognition of the cœlom as a constant factor of the bodily structure of the higher animal phyla, and of its essential nature as a pair of enterocœlous pouches (or in lower forms as possibly a single pouch, or several such pouches), gives the key for the analysis of that mass of cells lying between the outermost layer of the embryo (epiblast) and the innermost layer (hypoblast) to which in Triploblastic animals, *i.e.* animals with apparently three embryonic cell-layers, the term "mesoblast" has been applied.

Clearly one factor of this "mesoblast" is the rudiment (forecast, Anlage), of the cœlom, whether appearing as a pouch (Fig. 3), or a solid mass of cells (Fig. 11, *B*), or as a single pair of cells (Fig. 11, *A*). There are some reasons for supposing that the whole mesoblast is thus accounted for, and that whatever cells appear in the mesoblast outside and beyond the lining cells of the cœlomic pouches are only secondary derivatives of the wall of the cœlomic pouches. The development of Amphioxus, for instance, seems to be satisfactorily traced to a folding of a sheet of cells, arranged in a superficies one-cell-deep. Thus the embryonic tissues of Amphioxus have a strictly *epithelial* character: the cells all bound a surface. By a primitive infolding of the vesicular monoblastula (or one-cell-layered embryonic vesicle), we obtain the archenteron ; by a second elongated infolding the nerve cord ; by an outgrowth of hollow folds from the archenteron, the primitive cœlom is formed ; and by subsequent foldings of the wall of this chamber (as shown by Hatschek, *Anat. Anzeiger*, August 1888), the myocœl and the splanchnocœl (divisions of the cœlom) are formed. All the main tissues, muscular and skeletal, as well as the tissues arising from the lining cells of the gut and from the epiblast, have an epithelial origin ; there is no accumulation of cells in heap-like masses, no development of branching, irregularly grouped series of cells overlying one another and filling up a space between epithelial layers.

It may be argued accordingly from Amphioxus that, *primarily*, the whole mesoblast in all cases is nothing but epithelial foldings of the cœlomic pouches, and that any and all separate cells not lying in the plane of the epithelial surface are merely due to *secondary* detachment and wandering of a precocious character. It is, however, to be noted that even in Amphioxus the formation of the blood-vessels, large and small, and of the blood has not yet

been traced to an epithelial origin, that is to say, to a folding of the original spherical envelope of the monoblastula, or of one of its derivative folds.

The Hertwigs in *Die Cœlomtheorie*, p. 78, emphasise this distinction in the origin of tissues. They point out that in some animal groups a larger proportion of the adult tissues can be traced to foldings of embryonic epithelia than in others. The irregular heap-like groups of cells, which are not spread out as folds of epithelial surface and so often form a large part of the "mesoblast" of animal embryos, they speak of as "mesenchyme." I am inclined to think that the distinction here made is useful. The mesoblast of Cœlomocœla consists of the epithelial fold of the cœlomic pouch (or its representative cells) *and of mesenchyme*. The question remains as to what is the origin of that mesenchyme. It cannot

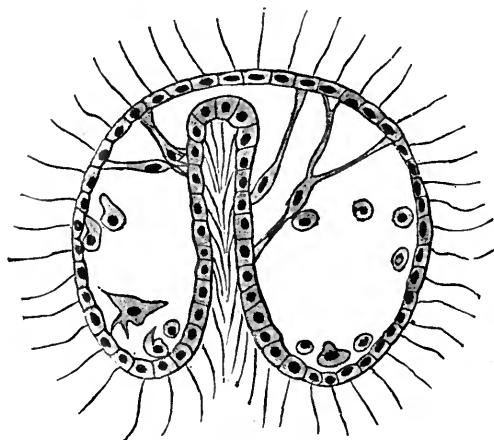

FIG. 16.—GASTRULA STAGE OF AN ECHINOID SHOWING DEEP ARCHENTERIC INVAGINATION DEVOID AS YET OF CŒLOMIC POUCHES, BUT WITH LARGE MESENCHYME CELLS TRAVERSING THE BLASTOCŒL OR CAVITY BETWEEN ECTODERM (epiblast) AND ENDODERM (hypoblast). (After Se-leuka, from Korschelt and Heider.)

be considered as yet sufficiently ascertained to warrant a final conclusion. According to observations made in some groups, mesenchyme is largely derived from epiblast, in others from hypoblast (Fig. 16), in others its appearance in the blastocœl or space of the primitive embryonic vesicle precedes the formation of archenteron itself (Fig. 17). I think that we are bound to bring into consideration here the existence in many Cœlentera of a tissue resembling the mesenchyme of Cœlomocœla. In Scyphomedusæ, in Ctenophora, and in Anthozoa, branched, fixed, and wandering cells are found in the mesogloœa which seem to be the same thing as a good deal of what is distinguished as "mesenchyme" in Cœlomocœla. These appear to be derived from *both* the primitive layers; some produce spicules, others fibrous substance, others again seem to be amœbocytes with various functions. It appears to be probable that, though it may be necessary to distinguish other

elements in it, the mesenchyme of Coelomocœla is largely constituted by cells which are the mother cells of the skeleto-trophic group of tissues, and are destined to form connective tissue, blood-vessels, and blood. The relation of the mesenchyme cells (as shown in such cases as those represented in Figs. 9 and 10) to the blastocœl or primary cavity of the blastula seems to favour the notion that the blood-vascular system has originated from the blastocœl in co-operation, so to speak, with mesenchyme cells. Whether, as is most probable, the mesenchyme also gives rise to muscle cells and muscular tissue is a matter requiring close investigation of cell-lineage, and whether the muscular tissue so formed is or is not confined to that of the walls of blood-vessels. In

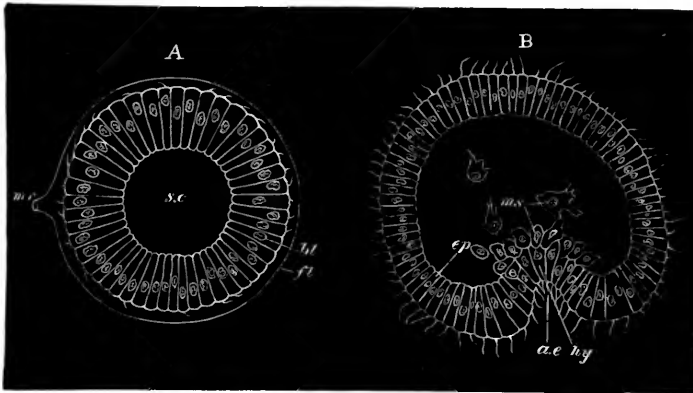

FIG. 17.—SECTIONS OF TWO STAGES IN THE DEVELOPMENT OF *HOLOTHURIA TUBULOSA* TO SHOW THE DEVELOPMENT OF MESENCHYME AT A PERIOD WHEN THE ARCHENTERIC INVAGINATION IS ONLY COMMENCING.

mr, micropyle; *fl*, chorion; *s.c.*, blastocœl; *bl*, cell-layer of the monoblastula; *ep*, epiblast; *hy*, hypoblast; *ae*, archenteric invagination; and *ms*, mesenchyme. (After Seleuka, from Balfour.)

Amphioxus we know that the somatic muscles are formed from epithelial cells of the myocœl division of the cœlom. Is this a primitive or a secondary arrangement? If primitive, it is possible that erstwhile epithelial cells of the cœlom migrate from the pouch-wall in some other embryonic histories and form part of the mass called mesenchyme. We cannot get further with the analysis of mesenchyme until the first origin and subsequent history of every constituent cell in a series of typical examples has been determined. Meanwhile it is a distinct progress to cease from speaking of coelom-forecast (Anlage) and mesenchyme as one entity, viz. "mesoblast," defying analysis. There is no constant morphological factor to be recognised by the name "mesoblast," as has indeed been apparent for many years. Mesoblast includes,

besides the parent-cells of the cœlomic epithelium, the skeletotrophic mesenchyme (mother-cells of connective tissue, blood, and blood-vessels), traceable probably to endodermal parentage, myoblastic mesenchyme probably derived from *both* primary layers and neuroblasts derived almost certainly from both primary layers. The parent-cells of the epiblastic nerve centres usually separate together as a distinct mass at a later period of development from the primary ectoderm, but there is abundant embryological proof that so-called "mesoblast" may contain parent-cells of nerve tissue as one of its constituents (*e.g.* in Cephalopoda). In some cases too the single mother-cells of the nephridia take up their place in the mesenchyme, migrating probably from ectoderm. There is still a very large and very difficult field of research open to the student of cellular embryology. The cell-lineage of mesenchyme and other factors of mesoblast must be determined; it is not enough to have disentangled cœlom from this confused mass. When the cell-lineage of mesenchyme and its tissue products have been cleared up, we shall be able finally to put aside the hasty criticisms and phantastic assertions of those who have grown impatient over the slow and difficult task of Cellular Embryology.

(d) *Third Stage of the Theory of the Cœlom from 1896 to the present day.*

A third stage in the progressive adjustment of the theory of the cœlom is now in progress; it has reference to the relation of the cœlom to renal excretory organs.

It had become abundantly clear in the early days of speculation concerning the cœlom that the reproductive cells both male and female are in all Cœlomocœla epithelial cells of the cœlomic space. In the attempt to define the cœlom this fact was made use of, but it was also maintained by myself and others that the communication of the cœlom with the exterior by at least one pair of renal excretory tubes was characteristic; and the attempt was made (and not unsuccessfully) to identify a given space as one of cœlomic origin by the fact that it was placed in communication with the exterior by means of such renal excretory tubes or sacs.

Led by the principle that it is conducive to an ultimate discovery of the truth to assume uniformity of origin for similar structures in diverse groups as a first hypothesis, rather than to assume a multiplicity of origins, I proposed (in 1877, *Quart. Journ. Micr. Sci.* vol. xvii. p. 429) the name "nephridium" for the simple renal excretory organ, and I took the so-called "segmental organs" of the Earthworm as the type. I identified with this typical nephridium the excretory tubules of Platyhelmsia and Rotifera, the renal sacs of Mollusca, the peritoneal funnels and connected

tubules of Vertebrata, and later the renal tubes discovered by Sängner and Balfour in Peripatus, and the various excretory and genital ducts of other Arthropoda. The name "nephridia" became very generally adopted by morphologists for all of these structures.

It appears, however, that this generalisation was too sweeping, as has been pointed out by Mr. E. S. Goodrich, who has extended to the Cœlomocoela in general the conclusions drawn by Prof. Ed. Meyer from a study of the development of the Polychæta (Meyer, "Die abstammung der Anneliden," *Biolog. Centralblatt.* vol. x. 1890). We have, in fact, hitherto included under the name "nephridium" two quite distinct kinds of renal excretory tubules—the one derived from single cells ultimately though not always actually traceable to ectoderm, the other nothing more than a portion of the cœlom itself communicating by a pore with the exterior. To the first category belongs the type-nephridium—namely, that of the Earthworm, and with it go similar tubules in other Oligochæta and Polychæta, and the excretory systems of Platyhemia and Rotifera. Hence, for these the name "nephridium" must be retained. To the second category belong the peritoneal funnels of many Chætopoda, the funnel-like generative ducts of Oligochæta, the whole series of so-called nephridia, modified and unmodified, in Arthropoda, the renal sacs of Mollusca, and the peritoneal funnels and connected tubules, whether of renal or gonoduct significance, in the Vertebrata. The origin of these structures as parts of the cœlom itself suggests the name of "cœlomic funnels" for them. The excretory activity of the wall of the cœlom and of these specialised parts of it was, it must be supposed, acquired *after* the first development of such conduits and pores to serve as exits for the genital products from the cœlom. The name "cœlomoduct" is proposed now for the first time as the best general term for these passages. Cœlomoducts are to be contrasted with nephridia; formerly they were confused with them. Cœlomoducts are parts of the cœlomic wall itself; nephridia are ingrowths from a superficial nephroblast. In the Mollusca we find embryonic, evanescent renal organs which are nephridia (Pulmonata); these disappear and are succeeded by permanent renal organs which are cœlomoducts.

Nephridia do not always open into the cœlom, *e.g.* those of Platyhemia where the generative sacs are all that represents cœlom. *Cœlomoducts* necessarily open into the cœlom at some stage of their formation if not permanently, since they are part of it. They do not necessarily open directly or indirectly to the exterior, though they usually do so directly.

In the marine Chætopoda, according to the observations of Meyer and Goodrich (*Quart. Journ. Micr. Sci.* 1899), there is often

a remarkable association of nephridium and cœlomoduct to form a complex renal organ.

The theoretical conception that the renal tubules in the animal series are of two distinct kinds, a more primitive and a secondary, dates back to Gegenbaur. Continually the attempt has been made to separate in a distinct category the nephridia formed by a linear series of perforated drain-pipe cells from other so-called nephridia with a lumen surrounded by many cells. It cannot be said that the provisional doctrine of a single category of renal organ in the entire series of Cœlomocœla, for which I am responsible, had obtained very general assent amongst critical embryologists, although the general use of my term "nephridium" for all sorts of renal tubes in all classes of animals might lead to the assumption that such a community of origin was accepted. The necessity for revising the doctrine of uniform origin of renal tubes was pressed upon Goodrich by the careful determinations of the origin of these structures in some cases from ectoderm, in other cases from cœlom, by various embryologists in later years. Thus Sedgwick says in his paper on the development of *Peripatus* in 1888: "It is important to notice that in *Peripatus* the nephridia are parts of the cœlom just as they are in Elasmobranchs. They are commonly spoken of in a manner which implies that they have but little to do with the cœlom beyond opening into it. This way of speaking of them is calculated to mislead. The nephridia are direct differentiations of part of the cœlom" (Q. J. Micr. Sci. vol. xxviii. p. 391). On the other hand, Vejdovsky has no less emphatically and conclusively shown that the nephridia of certain Oligochæta are of ectodermic origin, whilst Bergh and other observers trace them in many cases to peculiar superficially placed mother-cells lying in a so-called mesoblast, each of which by division gives rise to a single row of cells—a nephridium.

This difficulty is resolved by the recognition which we owe to Goodrich of two categories of renal tubes: (*a*) The cœlomic cœlomoducts, which are primarily genital sacs and ducts, and secondarily acquire renal functions; and (*b*) the nephridia, which are primarily excretory tubules and only in the marine Chætopoda acquire functions in connection with the cœlomoducts as genital conduits (see Goodrich, *loc. cit.*).

Thus, then, we arrive at a further stage in the theory of the cœlom. The true nephridia so long supposed to have a morphological connection with it are separated from it altogether. The organs which really belong to it and are, in fact, only parts of it, whether appearing as renal sacs or genital conduits, are the cœlomoducts. The cœlom is now, as a final result of observation and speculation up to the present date, to be conceived of as

originally one or more pairs of detached or coalesced sacs originating ancestrally as pouches of the archenteron from which they become shut off, having for their primary function the development upon their walls of the male and female reproductive cells, and communicating with the exterior by simple or funnel-like or tubular extensions of their own walls. They serve primarily as the sites of the development of the genital products, but secondarily may have a renal excretory function localised in a part of their epithelial lining cells. Very generally they give rise to extensive perivisceral and pericardial sacs, which remain continuous with the original outwardly opening portions, or may be nipped off from them and from each other.

(e) *Nomenclature of the Parts and Derivatives of the Cœlom.*

The various terms which are appropriate to, and useful in, the discussion of the cœlom and its subdivisions require a brief special statement. The terms may be best defined in a series of propositions which are more or less of the nature of a sketch of the evolution of the cœlom.

1. The primitive cœlom may be called a "PROTOCÆLOM" (Goodrich). It is probably multiple. Each protocœlom is in its nature a GONOCÆL (Goodrich), that is to say a cœlomic pouch, the epithelial walls of which produce ova or sperm or both.

2. Probably at a very early period each protocœlom acquired a "CÆLOMOPORE" (Goodrich) or opening to the exterior.

3. The part of the protocœlom connected with the pore frequently becomes narrow and funnel-like, and is then to be distinguished as a "CÆLOMODUCT" (Lankester), whilst the rest of the cœlom may persist as simple gonocœl or undergo further developments.

4. Two (right and left) or more gonocœls may fuse and give rise to an extended cœlomic cavity, the walls of which for the greater part are not concerned in the production of gonad cells. Such an extended cavity is generally known as a "perivisceral cavity" or "perivisceral cœlom." It may be called the "SYNCÆLOM" (Lankester).

5. The syncœlom frequently develops renal-excretory functions in the cells of its lining epithelium.

6. In segmented animals where pairs of "gonocœls" are repeated in each segment, some may retain the function of producing gonad-cells, whilst others become modified as renal-excretory sacs. These latter are to be called "UROCÆLS" (Goodrich).

7. In some cases, *e.g.* some Mollusca, the gonocœl of one side of the body will retain its relation to the generative function,

whilst its pair on the other side of the body becomes a pure urocœl: various modifications of this kind are possible.

8. The cœlomoducts belonging to gonocœls may be called "GONODUCTS" (Lankester), whilst the cœlomoducts connected with urocœls are to be termed "URODUCTS." Similarly the cœlomopores may be called "GONOPORES" and "UROPORES."

9. When the distinction between cœlomoduct and the rest of the cœlom is marked by the development of a funnel-like mouth, this funnel is termed a "CÆLOMOSTOME" (Goodrich). Whilst this is the general term applicable, it will in almost all cases be actually either a "gonostome," *i.e.* a funnel leading from gonadic cœlom into a gonaduct or a "urostome," that is, a funnel leading from uropœtic cœlom into a uroduct.

10. The duct-like portion of cœlom ending in cœlomopore may be to a large extent replaced by ectodermal invagination comparable to the oral ectodermal invagination known as "stomodæum," and to the anal ectodermal invagination known as "proctodæum." It is proposed (Goodrich) to term such ectodermal portions of cœlomic ducts "CÆLOMODÆA" (from τὸ κοιλίωμα, the cœlom, and ὀδαῖον, an adjectival form of ὀδός). The cœlomodæa when existent will, as a rule, be either "GONODÆA" or "URODÆA," and it appears that their ectodermal epithelium may, in some cases, acquire renal excretory functions.

11. Both gonocœls and urocœls with or without specialised gonaducts and uroducts may remain in open continuity with the general cœlom (syncœlom), or they may become closed off from it.

12. The syncœlom (general cœlom) may become separated into various chambers with or without obvious or microscopic communication, *inter se*. It is undesirable to coin special terms for all these chambers, but the possibilities comprise (1) a chamber more especially surrounding, or adjacent to, the main digestive tract, the EPISPLANCHNIC CÆLOM; (2) a PERICARDIAL CÆLOM; and (3) paired EPINEPHRIC CÆLOMS. In Vertebrates, the peritoneal, peripleural, and pericardial cœlomic sacs are well known and distinguished besides other minor divisions. These various divisions of the cœlom may communicate or not with one another, or with gonoducts or uroducts, or both. Any or several of them may be obliterated, or may be reduced to a canalicular form.

13. To be entirely distinguished from cœlomoducts, whether gonocœls or urocœls, are the NEPHRIDIA. Nephridia are probably of ectodermic origin, and in any case arise independently from peculiar superficial nephroblasts or mother-cells. When devoid of internal opening they are called PROTONEPHRIDIA (Hatschek).

14. Nephridia frequently acquire a funnel-like opening into the cœlom. Such openings are called "nephridiostomes."

15. A nephridium may, as may a uroduct or gonoduct, acquire a secondary element by ingrowth of ectoderm at the nephridiopore, its original external opening. This secondary portion must be termed "NEPHRIDIODÆUM" (Goodrich), the word being formed in the same way as stomodæum and cœlomodæum.

16. Nephridia may become "grafted" in various degrees upon uroducts and gonaducts in some animals (*e.g.* the Polychæteous Annelids), giving rise to organs of complex origin which cannot be termed either "nephridia" or "cœlomoducts," since they have a part of each category in their composition. The composite organ thus formed may be termed a "NEPHROMIXIUM" or "NEPHROMIX," in reference to its hybrid composition.

The object of this introductory chapter is now completed. That object has been the vindication of the cœlom as a morphological factor of primary importance in the animal series, and the maintenance of the conclusion that the cœlom by its presence justifies the separation of a higher grade of Enterozoa, the Cœlomocœla, from a lower grade the Enterocœla, in which it is not differentiated as a separate cavity.



CHAPTER III

SPONGES¹

PHYLUM PORIFERA.

CLASS I. CALCAREA (CALCISPONGIAE).

- GRADE 1. HOMOCOELA.
- „ 2. HETEROCOELA.

CLASS II. HEXACTINELLIDA (HYALOSPONGIAE).

- Order 1. **Lyssacina.**
- „ 2. **Dictyonina.**

CLASS III. DEMOSPONGIAE.

- GRADE 1. TETRAXONIDA.
- Order 1. **Carnosa.**
- „ 2. **Tetractinellida.**

- GRADE 2. MONAXONIDA.
- Order 1. **Halichondrina.**
- „ 2. **Hadromerina.**

- GRADE 3. KERATOSA.
- Order 1. **Dictyoceratina.**
- „ 2. **Dendroceratina.**

- GRADE 4. MYXOSPONGIDA.
- (No Orders.)

I. INTRODUCTION.

THE Sponges or Porifera form a well-characterised group of animals, very abundant in all seas, from the equator to the poles, and flourishing at all depths, from the shore-line to the profoundest abysses. One family (or sub-family), and, so far as is known, one only—the *Spongillinae*—has established itself in fresh water, and is represented by a great variety of genera and species in all parts of

¹ By E. A. Minchin, M.A., Professor of Zoology, University College, London.

the globe, wherever suitable conditions are to be found. The sponge faunas of the present day are remarkable not only for the abundance and the wide distribution of particular forms, but also for the bewildering variety of species, genera, families, and orders; and these systematic categories are often defined, on the one hand, by characters of apparently slight and trivial importance; and connected, on the other hand, by numerous intermediate forms, to which it is difficult to assign a definite position in the system. Hence, while the classification of sponges frequently presents great difficulties, at the same time there is perhaps no group which illustrates so strikingly the theory of evolution and descent. Moreover, to judge from the very large number and variety of fossil forms occurring in strata of every horizon, sponges seem to have been at all times equally abundant and widely spread, equally plastic and adaptable, from the earliest geological ages to the present epoch. In contrast with the extreme difficulty often encountered in defining and separating the subdivisions of the Porifera, there is no group of organisms which, taken as a whole, is more easily recognised or more sharply limited, both by reason of its peculiar features of organisation and from the entire absence of forms in any way intermediate between sponges and other forms of life. Hence it is not surprising that the systematic position of sponges always has been, and still is, much disputed. Even their animal nature was not definitely determined till the middle of this century, and at the present day there is much difference of opinion as to their true affinities and proper position within the animal kingdom. These are questions of which the consideration must be deferred until the organisation and development have been discussed.

From the point of view of the student of animal structure and functions sponges offer many points of interest, as representing the simplest type of cell republic found in any animals above the Protozoa. Their organs are, for the most part, single cells, less specialised than in other forms, and therefore able to perform a variety of functions, either simultaneously or at different times. The absence, or at least the slight degree, of co-ordination between their cells represents a primitive grade of organisation which other Metazoa have passed beyond. Hence many problems of histology and cellular physiology are here presented in their simplest form.

II. THE MORPHOLOGY AND LIFE-HISTORY OF SPONGES.

1. *External Characters.*

(a) *Mode of Attachment.*—No sponge is known which, in the adult state, is possessed of locomotor organs, or has any power of free movement. After passing through a transitory larval stage,

during which it swims freely by means of cilia, the sponge passes its whole subsequent existence fixed, except in a very few instances, to some foreign object. The attachment may be *direct*, the base of the sponge being in contact with the substratum, or *indirect*, that is to say, by means of a *root tuft* of long spicules which serve to anchor it as it were in the mud. The latter method is only found amongst those forms, usually inhabitants of deep water, which live in mud or ooze, and it is to be looked upon as a special adaptation to life under such conditions.

Direct attachment is a rule without exception amongst *Calcarea* and is the most usual method in all sponges, being universal amongst forms which inhabit shallow waters and are subject to more or less violent currents. The substratum to which the sponge is fixed may be a rock or alga, or it may be some other animal such as a crab, shell-fish, or tunicate. The adhesion is effected by the cells at the point of attachment, which are glandular in nature, and in some cases secrete a basal plate of spongin or some similar substance. The portion of the sponge body which is in contact with the substratum may be drawn out into a stalk or peduncle, often of considerable length, by which the sponge is raised above its immediate surroundings (Figs. 8, 10, 11, 27, 37, and 38). In such forms the lowermost portion of the stalk may be expanded into a foot or disc, increasing the adhesive surface, or into root-like processes, as in the fossil *Ventriculites* (Fig. 23).

Rooting tufts of spicules are specially characteristic of the order *Lyssacina* of the Hexactinellids, where they are of very frequent occurrence. They are also found in some Tetractinellids (Fig. 24), but are very rare in Monaxonida and are unknown in Keratosa and *Calcarea*.

The instances, very few in number, in which the adult sponge is not fixed in any way, are to be found amongst a few species from deep water. The remarkable form, *Disyringa*, for instance (Fig. 26), lies loosely on the sea-bottom, and a similar state of things is met with in some other Tetractinellids from the deep sea. In such cases the weight of the body, loaded as it is with siliceous spicules, is probably sufficient to prevent the sponge from being passively transported by the comparatively feeble currents to which it is exposed.

(b) *Form and Growth*.—The typical sponge form is that of a hollow vase or sac (Fig. 1), attached by its base to some object. At its upper extremity is a conspicuous opening, termed the *osculum*, and the wall is perforated by numerous minute apertures, the *pores*. During life water enters by the pores, and passes, either directly or after a more or less tortuous course along a system of canals in the body wall, into the central space or *gastral cavity*, to emerge by the osculum.

The primitive vase-like form is retained in some instances throughout life. In other cases it only occurs as a transitory stage (which may even be suppressed) in the life-history, and during subsequent growth it undergoes almost every conceivable modification and complication of form.

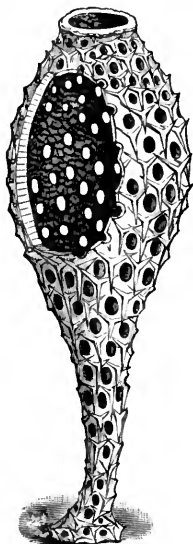

FIG. 1.

Olynthus of *Clathrina primordialis*, H., seen with a low power (after Haeckel). (The oscular rim is not correctly represented; the pores should not be continued up to the edge, but should stop at some distance from it.)

In the first place, any sponge, whether of simple or complex form, may under certain conditions contract itself and close up its pores and osculum. In extreme cases even the gastral cavity becomes obliterated. Such changes of form are of course only of temporary duration and are of no morphological or classificatory value. Sooner or later the sponge expands again and passes back into its normal condition. Nevertheless, sponges in a state of contraction have often been described as if they were the permanent form, and have even been separated from the normal, expanded form as a distinct species, genus, or family; while the temporary obliteration of the osculum or gastral cavity has been dignified by the coinage of the terms *lipostomy* and *lipogastry* respectively. Mistakes of this kind have been the cause of great confusion in the literature, and it is well, therefore, to bear in mind that many sponges are excessively contractile, while there are few that cannot close up their pores and oscula at will—that is to say, as a reaction to certain changes either in the environment or in the internal economy.

Apart from more or less rapid changes of form resulting from contraction, we have to consider a large series of form varieties which are the result of growth, and therefore of greater permanence and importance. It has been mentioned above that the region of attachment may grow out into a stalk, and we have therefore to distinguish, in the first place, between *sessile* and *pedunculate* forms. It is convenient to commence the discussion of the variations in body form by pointing out that almost any shape which a sponge can assume may be further complicated by the growth of a peduncle.

At the outset the numerous form variations of sponges can be classified into two distinct series, which start from a fundamental morphological difference in the mode of growth. In the first place, the primitive vase-like sponge, whether stalked or not, may retain its single osculum and gastral cavity, but become modified in form by unequal growth of the body wall. In the second place, the growth may be such as to lead to the formation of new oscula, each the vent of a separate gastral cavity. Anticipating here the theory

of sponge individuality which we intend to adopt (see below, p. 89), the first-mentioned series may be termed *modifications of the sponge person*, and the second, *modifications of the sponge colony*. Although the two often merge into one another, we may consider them apart, and commence with those cases where the sponge person remains

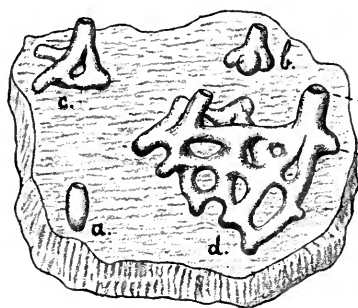

FIG. 2.

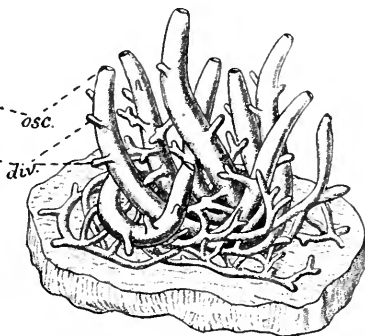

FIG. 3.



FIG. 4.

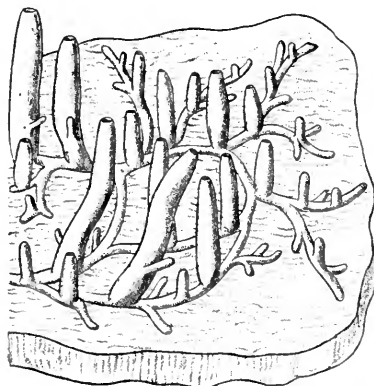

FIG. 5.

FIG. 2.—Young specimens of *Clathrina coriacea*, Mont., $\times 6$. *a*, Olynthus; *b*, older stage, with three diverticula commencing to form; *c*, still older stage, with diverticula anastomosing to form the tubular system; *d*, small colony with two oscula; *osc*, osculum; *div*, diverticula.

FIG. 3.—Small colony of *Leucosolenia Lieberkühni*, O.S., $\times 6$. *osc*, osculum; *div*, diverticula.

FIG. 4.—Arborescent colony of *Leucosolenia complicata*, Mont., $\times 6$.

FIG. 5.—Creeping colony of *Leucosolenia variabilis*, H., with numerous erect, and for the most part simple, oscular tubes, arising from a basal creeping stolon, $\times 6$.

single—that is to say, where the sponge retains a single osculum and gastral cavity.

The wall of a primitive vase-like sponge may increase during growth either in *superficial extent* or in *thickness*, or in both ways at once. We may consider first the results of an increase in the

surface of the body wall. In the first place, such increase may take place more or less evenly and regularly in all parts, but more rapidly in one direction than in another; then the sponge person becomes an elongated cylinder or tube if the growth be chiefly

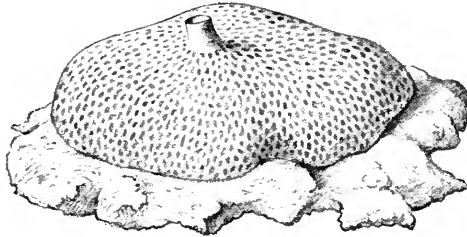

FIG. 6.

Young specimen of *Clathrina reticulum*, O.S., with one osculum, $\times 6$.

vertical, or assumes the form of a cup or saucer if the growth be chiefly horizontal. In the second place, the growth may be uneven or irregular, being more rapid in one part of the sponge body than in another, or taking place chiefly in certain limited regions. In

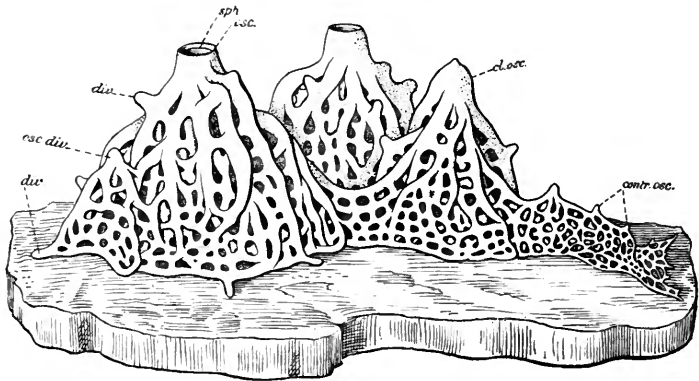

FIG. 7.

Clathrina clathrus, O.S., natural size, semi-diagrammatic combined figure. On the left the sponge is represented in the state of extreme expansion, passing gradually into that of extreme contraction on the right. *osc.*, osculum; *cl. osc.*, closed osculum; *constr. osc.*, elevated "conules" in the contracted portion representing oscula contracted; *sph.*, sphincter of osculum; *div.*, diverticula; *osc. div.*, vertically directed diverticula from which new oscula arise.

such cases either the body wall must be thrown into folds, or the primitive form of a vase or sac will be distorted or modified in various ways.

Instances of both tubular and cup-shaped sponge individuals are common amongst the Hexactinellids. The first type is well seen in such forms as *Regadrella* (Fig. 18) and *Euplectella* (Fig. 15); the second in such a form as *Asconema* (Fig. 17). The tubular forms may assume an erect

cylindrical form (*Euplectella suberea*), or may be more or less curved like a cornucopia (*E. aspergillum*). A remarkable instance of horizontal growth of the body wall is seen in *Caulophacus* (Fig. 20, C), where the wall of the gastral cavity is turned outwards and downwards, and the sponge being at the same time stalked, a form like a mushroom results, in which the upper convex surface of the disc represents morphologically the inner surface of the body, and the rim of the disc is the down-turned margin of the osculum. An approach to this condition is seen in the fossil *Ventriculites*. Some specimens have the body shaped like a paper basket, while others have the margin very much expanded and everted (Fig. 23). Mantell (1822) makes the suggestion that the differences in different specimens of *Ventriculites* may be due to contractility.

A good example, on the other hand, of the effect of rapid local growth is seen in the Hexactinellid sponge *Euryplegma* (Fig. 20, A). Here the primitive vase-like organism grows with great rapidity on one side, and scarcely at all on the other. The result is an ear-like or shell-like form, in which the concave side represents the gastral cavity, and the whole free edge the margin of the osculum (*m.osc*). This mode of growth is carried to its extreme in *Poliopogon* (Fig. 20, B), where the sponge has become simply a curved plate, of which the upper edge represents the oscular margin (*m.osc*), the concave side the gastral cavity.

If the portions of the body wall which grow more rapidly are distributed, so to speak, in patches, the result will be the formation of diverticula or folds. The best instances of this are seen in the calcareous sponges, all of which begin their existence as a vase-like organism of very primitive structure, termed the *Olynthus* (Figs. 1 and 2, a). Hence the Calcarea are specially suited for tracing out the processes of growth by which the often complicated body form is attained.

In the most primitive Calcarea, the Ascons, the *Olynthus* grows in height, becoming tubular, while at various points on the surface hollow diverticula are thrown out on every side. The diverticula increase rapidly in length, and become branched, and by coalescence and anastomosis of the branches there arises a network of tubes, which surround, and open into, the central oscular tube, representing the original *Olynthus*. The continuous cavity which extends through the whole tubar system is, of course, the now greatly ramified and subdivided gastral cavity.

Two types of body form can be distinguished in Ascons as the result of simple variations in the mode of growth above described. In the family *Clathrinidae* the vertical growth of the *Olynthus* is comparatively slow, the horizontal growth of the diverticula comparatively rapid. In the family *Leucosoleniidae*, on the contrary, the *Olynthus* grows rapidly in height, while the diverticula, though more numerous, remain relatively small. Hence the typical Ascon person is, in the genus *Clathrina*, a dense network of ramifying tubes opening by a short and often insignificant oscular tube (Figs. 2, 6, 7, 8; cf. Fig. 65, A), and in the genus

Leucosolenia, a large and erect oscular tube giving numerous diverticula of comparatively small calibre, which increase in length towards the base of the tube, where they tend to branch and anastomose (Figs. 3, 4, 5; cf. Fig. 65, B).

A body form very similar to that of Ascons, and the result of a similar mode of growth, is also of common occurrence in the order Dictyonina amongst Hexactinellids (Figs. 21, 22). The primitive vasiform sponge person becomes first tubular and then branched, and by anastomosis of the branches a network of tubes results.

In the higher calcareous sponges, the order Heterocoela, we find a mode of growth which, though essentially similar to that found amongst Ascons, leads to a body form considerably different, and in most cases much simpler. As typical may be taken the genus



FIG. 8.

Clathrina lacunosa,
Johnst., colony with
two oscula, $\times 4$.

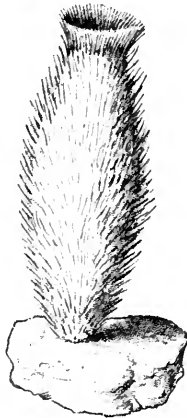

FIG. 9.

Sycon ciliatum, Fabr.,
 $\times 2$.

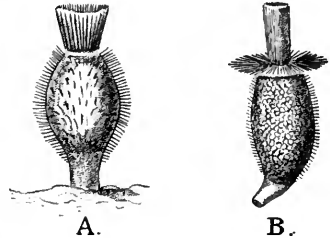

FIG. 10.

A, *Sycon raphanus*, O.S. (after Schmidt),
 $\times 5$. B, *Sycon humboldtii*, Risso (= *Dunstervillea coreyrensis*, O.S.), (after Schmidt),
 $\times 2\frac{1}{2}$.

Sycon, where the *Olynthus* sends out numerous breast-shaped or thimble-shaped diverticula, more or less regularly disposed on every side. New outgrowths continually appear just below the oscular margin and continue to increase in size, but unlike what has been described for Ascons, the diverticula in Sycons have a limited growth. The size attained by the diverticula is greatest at the sides and towards the base of the sponge. As a result of this mode of growth the sponge assumes a *strobiloid* form, which in some primitive types is more or less retained throughout life. In most Sycons, however, the diverticula become united by secondary growths at their apices, and are thus rendered indistinguishable in an external view of the sponge. Hence the effect produced is simply that of a great thickening of the body wall. The Sycons furnish, in fact, a clear instance of the body wall of the primitive

sponge undergoing an *apparent* thickening which is in reality due to the formation of folds and their subsequent coalescence, and it will be seen in discussing the canal system that *all thickening of the wall of the primitive vase-like sponge organism is to be interpreted morphologically in a similar manner.* Since in Sycons and Heterocoela generally the body usually grows more or less evenly in all parts at the same time that diverticula are being formed all round, the primitive form of a vase is more often perfectly preserved in these sponges than in any others, though subject to variations of form of subsidiary importance, such as the addition of a stalk (Fig. 10) which in the genus *Ute* reaches a great length. A remarkable departure from the primitive form is seen, however, in *Grantia labyrinthica* (Fig. 11). The young sponge of this species has the form of a



FIG. 11.

Grantia labyrinthica, Crtr. Three stages of growth. (After Dendy.)



FIG. 12.

Leucandra aspera H., natural size.

stalked cup, with a thick body wall, formed as above described, by folding and coalescence. Further growth of the body wall causes it to be thrown into numerous folds, the edges of which represent the greatly extended oscular margin. Another Heterocoela sponge of aberrant form, requiring no explanation, is *Eilhardia Schulzei* (Fig. 13).

It is evident from the instances that have been adduced, that the changes in the form of the sponge person which result simply from an uneven or local expansion of the surface of the body wall, are numerous and often complicated, but may, however, result in a simple thickening of the body, and a consequent retention of, and reversion to, the primitive form.

As a result of a disproportionate increase in the thickness of

the body wall the primitive vase-like sponge person may assume a more massive form, and in the simplest cases becomes barrel-shaped (Fig. 16) or globular (Fig. 30), according to the degree of

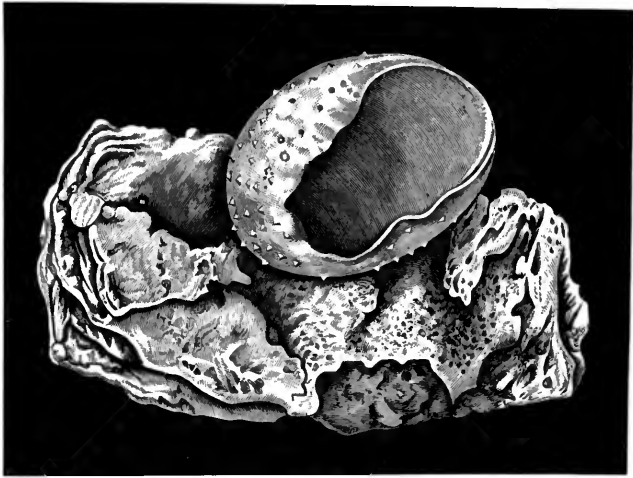

FIG. 13.

Eilhardia Schulzei, Pol. (After Poléjaeff, *Challenger Reports*.) Natural size.

thickening. If the growth predominates at the base of the sponge it acquires the shape of a shallow cone or volcano, the crater being represented by the osculum, and in such forms the vertical height

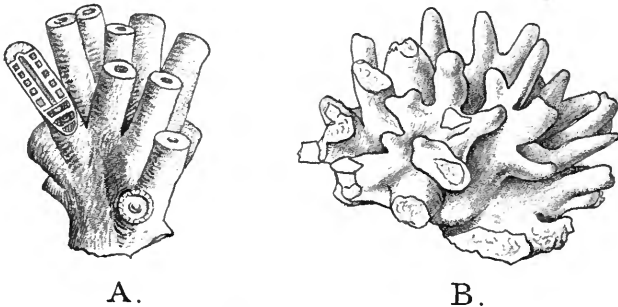

FIG. 14:

A, *Verticillites anastomans*, Mant. (After Zittel.) B, *Petrostroma Schulzei*, Död. (After Döderlein.)

may be very small as compared with the horizontal extent, until in extreme cases the sponge becomes a mere crust, spread over the surface to which it is attached, and rising slightly in the region of the osculum. On the other hand, the sponge may become sub-

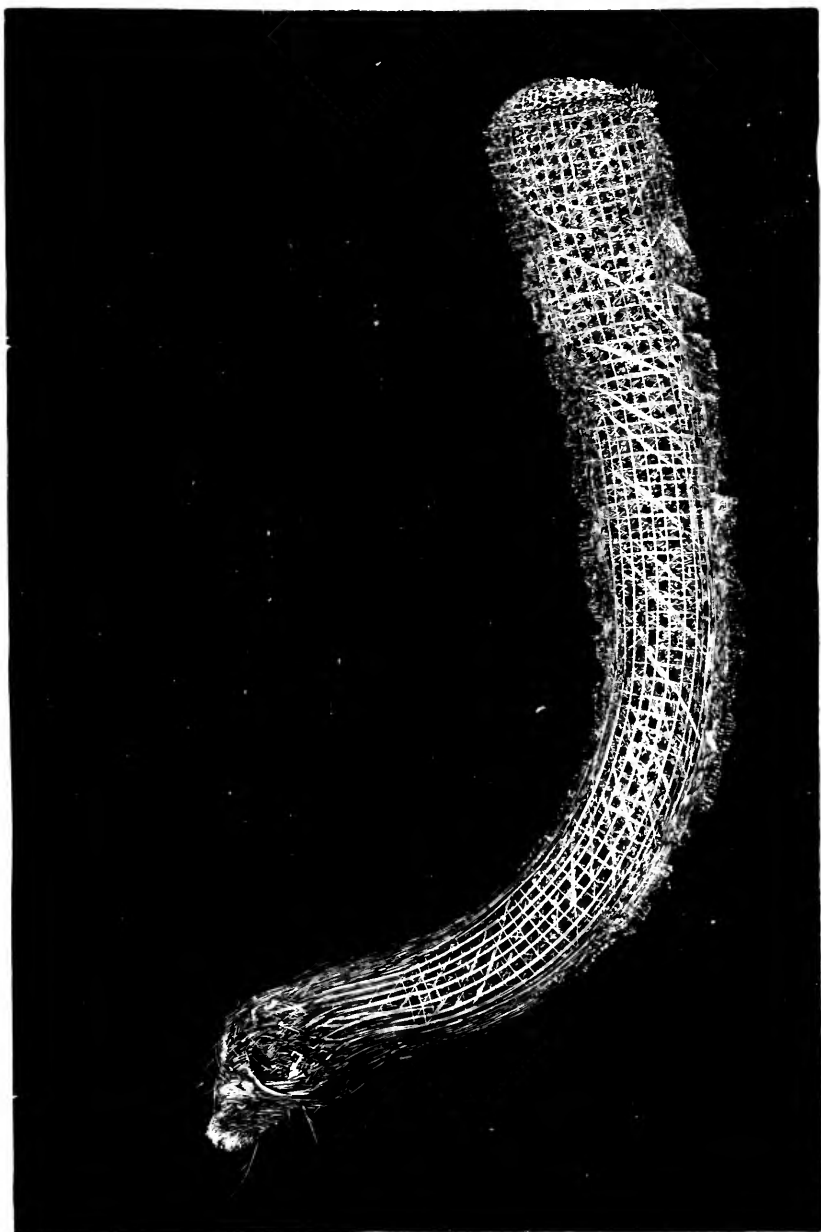

FIG. 15.
Euplectella asperillum, Owen. (After Wyville Thompson.)

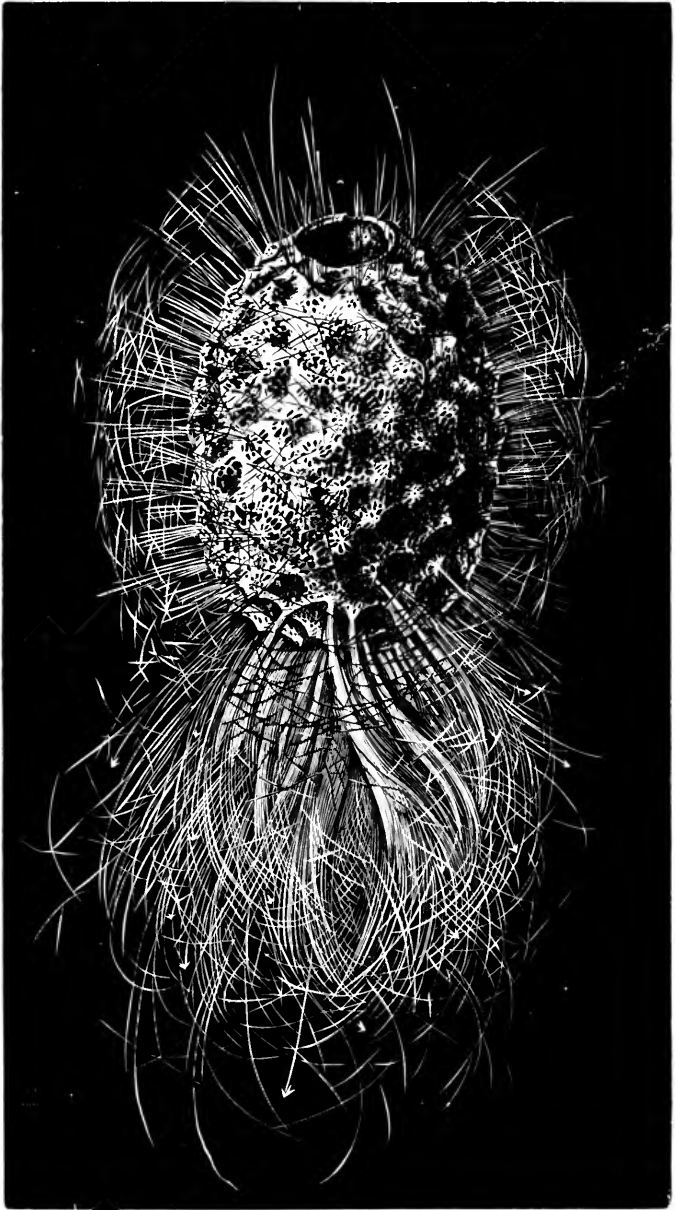

FIG. 16.

Rossella elata, W. Th. (After Wyville Thompson.) Natural size.

cylindrical, and narrower at the base than at the summit, as in the case of *Tentorium* (Fig. 31), and any form of massive sponge may be further complicated by the formation of lobes and irregularities on the surface, or in other ways. In the fossil *Siphonia* the massive sponge has developed a stalk, and has the form somewhat of a rose-bud, at the apex of which the relatively small and reduced gastral cavity opens by the osculum (Fig. 27, *A* and *B*).

Two remarkable sponge forms are seen in the genera *Tribrachion* and *Disyringa* amongst Tetractinellids. Both of them are



FIG. 17.

Asconema setubalense, Kent. (After Wyville Thompson.) $\frac{1}{2}$.

to be regarded as massive forms in which the more or less globular body is not fixed, but lies loosely in the mud at the bottom of the sea, and which have developed peculiarities of structure correlated with their mode of life. Thus *Tribrachion* (Fig. 25) has developed an oscular tube of great length, while in *Disyringa* (Fig. 26) not only is the exhalant aperture prolonged in like manner into an elongated tube, but also an inhalant tube is developed, terminating in a single aperture by which is taken in all the water which enters the canal system. The cavity of the inhalant tube forms a sort of atrial chamber, as it were, in which all the pores are collected, and no pores are found on the surface of the body. *Disyringa* is

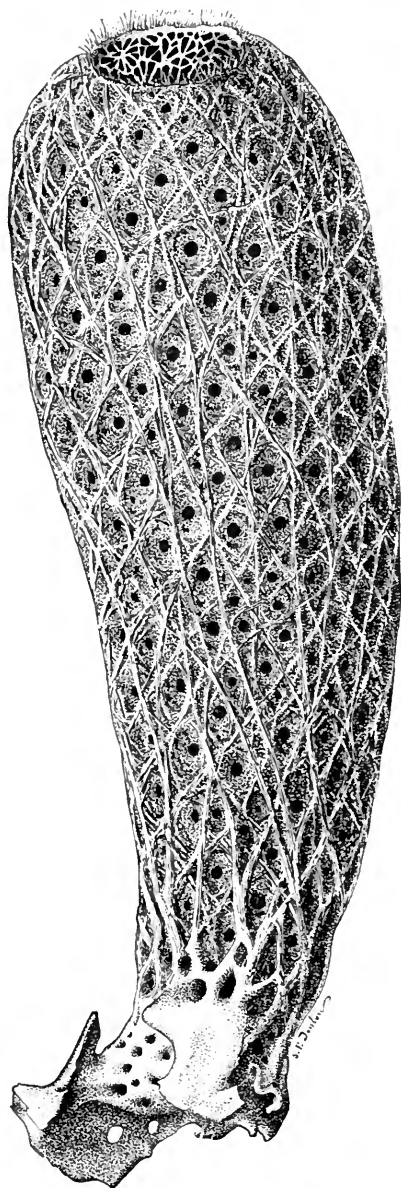

FIG. 18.
Regadrella phoenix, O.S. (After Agassiz.) $\frac{3}{4}$.

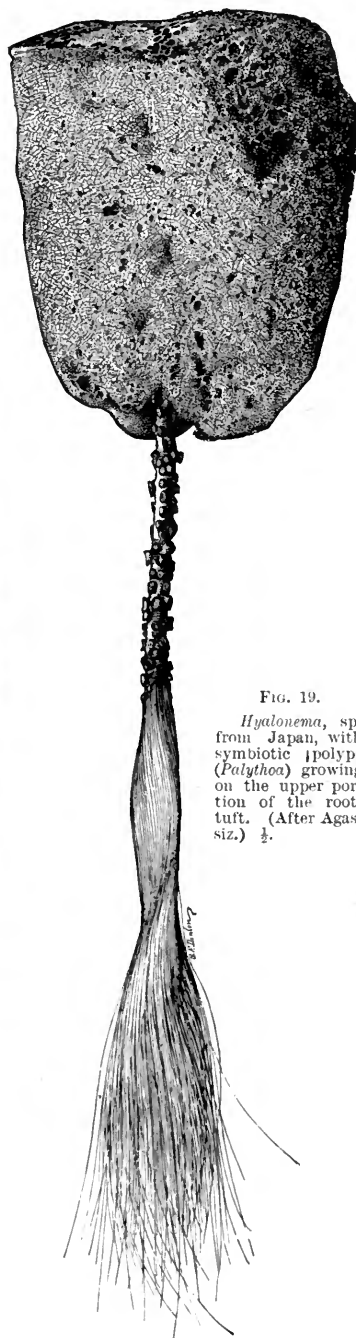

FIG. 19.
Hyalonema, sp.
from Japan, with
symbiotic polyps
(*Palythoa*) growing
on the upper por-
tion of the root-
tuft. (After Agas-
siz.) $\frac{1}{2}$.

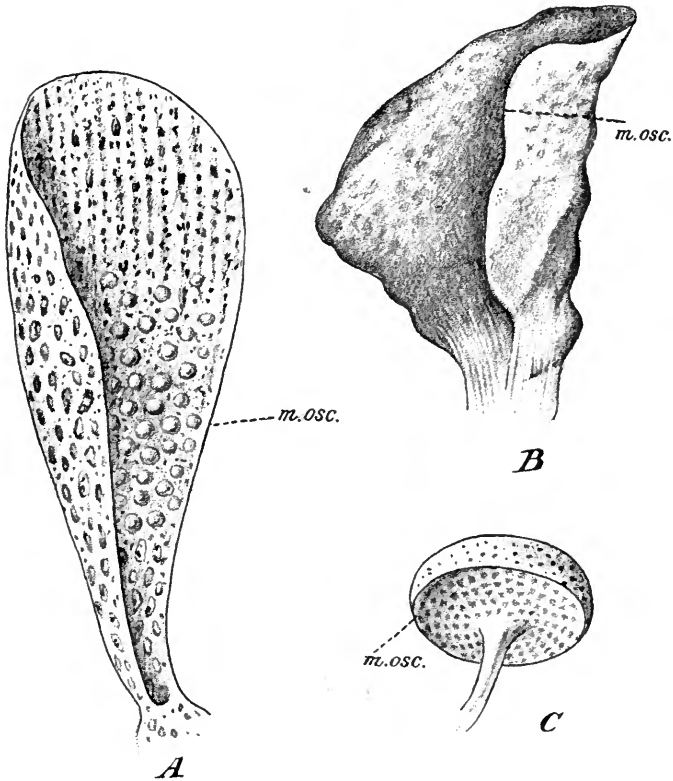

FIG. 20.

A, *Euryplegma auriculare*, F.E.S. *B*, *Poliopogon amadou*, W. Th. *C*, *Cuniclophacus elegans*, F.E.S. All three after Schulze. *A*, reduced $\frac{1}{2}$; *B*, $\frac{1}{3}$; *C*, natural size.

unique amongst sponges in possessing an inhalant tube of this kind, doubtless advantageous to the sponge, living as it does partially buried in the soft ooze.

Having considered the chief types of form which the sponge

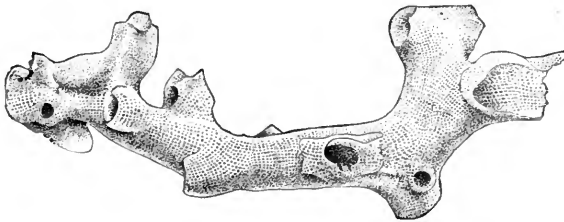

FIG. 21.

Furrca facunda, O.S. (After Agassiz.) $\frac{3}{4}$.

individual may acquire as the result of its particular mode of growth, it remains to discuss the forms assumed as the result of multiplication of individuals which remain united. Since the

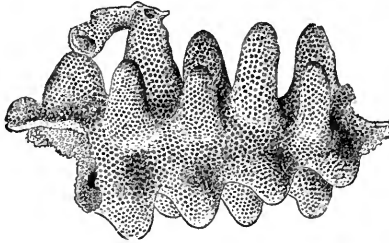

FIG. 22.

Aphrocallistes Bocagei, Wright. (After Agassiz.) $\times 3$.

sponge colony consists of an aggregation of sponge individuals, produced one from another by a process of budding, its form will depend largely in the first instance on the type of sponge persons

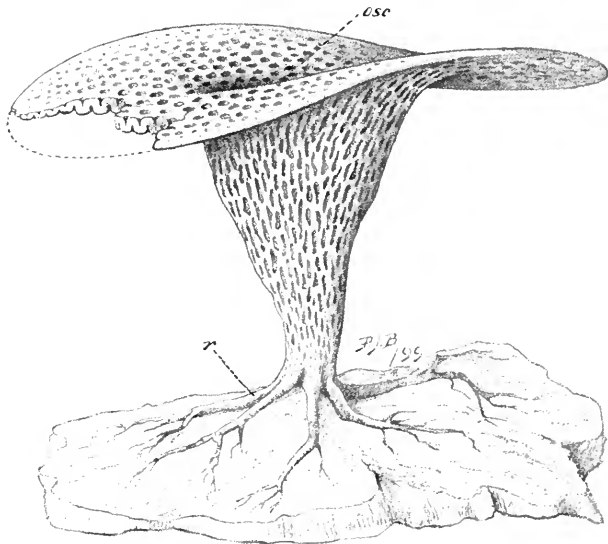

FIG. 23.

Ventriculites, imagined reconstruction. *r*, root-like processes of attachment; *osc*, osculum. A piece of the margin is represented broken away to show the plications which form the in-current and excurrent canals.

of which it is composed. The other factors which influence the form of the colony are, first, the way in which the individuals are united together—that is to say, the manner in which they are budded

off from one another; and secondly, the degree to which the individuals produced in this way become distinct from one another, or remain fused together.

Instances of the way in which the mode of budding and the union of the persons influence the form

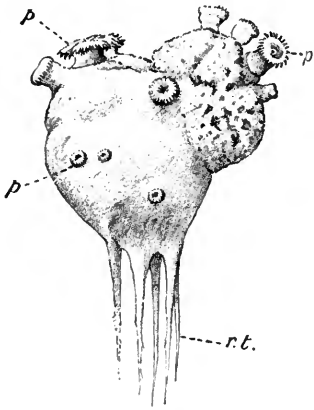

FIG. 24.

Thenea muricata, Bwk., natural size. *r.t.*, root tuft; *p*, symbiotic polyps (*Polythoa*).

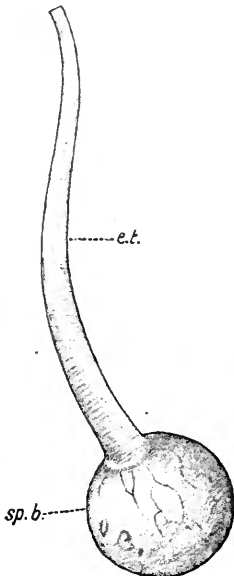

FIG. 25.

Tribrachion Schmidtii, Weltner (after Sollas). *sp.b.*, sponge body; *e.t.*, exhalant tube.

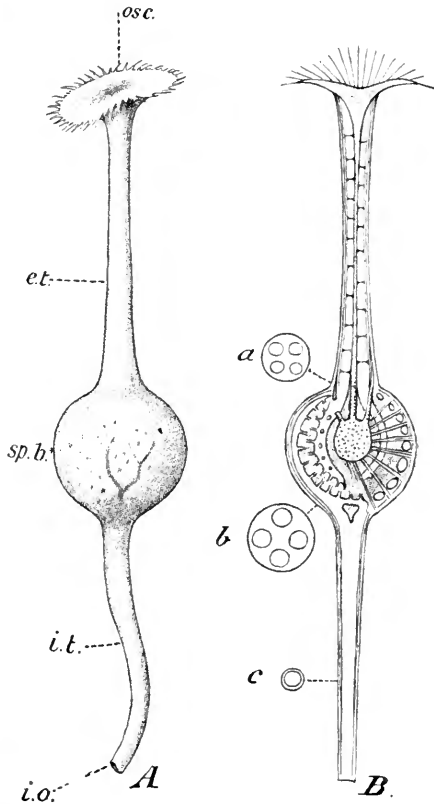

FIG. 26.

Disringa dissimilis, Ridley (after Sollas). *A*, the whole sponge reconstructed from fragments. *i.o.*, incurrent aperture; *i.t.*, incurrent tube; *sp.b.*, sponge body; *e.t.*, exhalant tube; *osc.*, osculum. *B*, diagrammatic vertical (longitudinal) section of the sponge. *a, b, c*, transverse sections at three different points; *a*, showing the four divisions of the excurrent tube; and *b*, the four divisions of the incurrent tube, which at *c* is undivided.

of the colony as a whole are well seen in Ascons, and especially in the genus *Leucosolenia*, where the individuals can be easily

distinguished. In the simplest cases the new oscular tubes arise from the tubar system by the side of the parent individual, and the

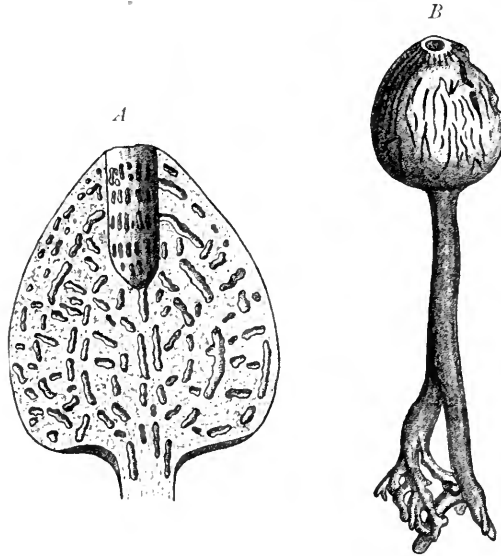

FIG. 27.

Siphonia tulipa, auct. (after Zittel). *A*, a vertical section of the body, natural size, showing the small gastral cavity, the radially directed incurrent canals, and the concentrically disposed excurrent canals. *B*, the entire sponge, half natural size.

colony assumes a compact or bushy form (Fig. 3), which may take on a spreading or an arborescent growth by variations in the mode

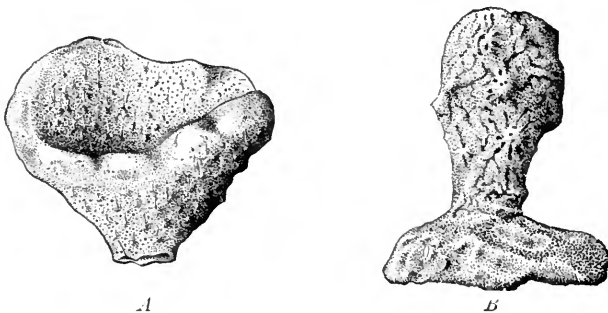

FIG. 28.

A, *Setidium oblectum*, O.S., $\frac{3}{4}$. *B*, *Colinella inscripta*, O.S., $\frac{3}{4}$. (Both after Agassiz.)

of budding. In the spreading forms (Fig. 5) the diverticula at the base of the sponge person come into contact with the substratum and grow to a great length, forming a stolon-like basal network,

ramifying only in one plane, from which arise erect diverticula at intervals which acquire oscula at their extremities, and thus assume the characters of new individuals. In the arborescent forms, on the other hand (Fig. 4), the erect oscular tube sends out numerous

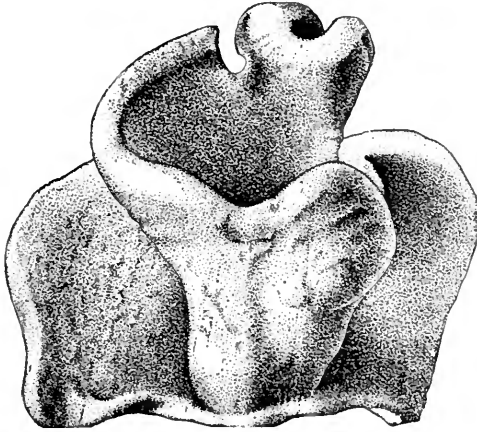

FIG. 29.

Vetulina stalactites, O.S. (After Agassiz). 3.

diverticula along its whole length, which form new oscula at their extremities when still quite short, and the daughter individuals which are thus formed repeat the same process, throwing out diverticula rapidly on every side. In this way arises an arborescent

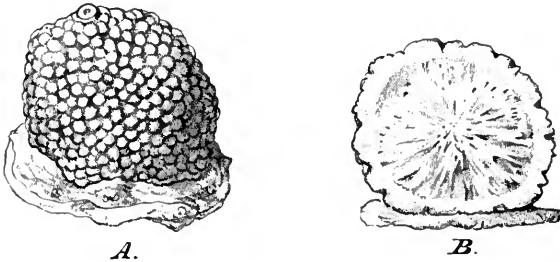

FIG. 30.

A, *Tethya lynceurium*, L., natural size. At the summit is seen the partially retracted osculum. *B*, section across *Suberella* sp., showing the thick cortex and the radial arrangement of the body skeleton.

Ascon colony which creeps over the seaweeds like a climbing plant, attaching itself at intervals by direct contact. Among the Heterocoela, also, erect arborescent colonies are not uncommon, and in *Leucandra aspera* (Fig. 12) rapid growth and budding may lead to

a form resembling a cock's-comb. In the British species *Leucandra nivea*, a spreading colony is formed, composed of numerous flattened volcano-like individuals.

In the cases where the persons of the colony are not distinct from one another, the colony as a whole may have a form scarcely differing from, or even identical with, that of the sponge individual, and in extreme cases the colony can only be distinguished from the individual by its larger size and greater number of oscula. Instances of this are well seen in the genus *Clathrina* among Ascons, where the full-grown colony forms a spreading mass of tubes. Typically the individuals are indicated in these forms by cone-like elevations of the tubar system, each surmounted by an osculum (Fig. 7, *Cl. clathrus*). In some species of the genus, however, the sponge assumes a very compact form, like a cushion when sessile (Fig. 6, *Cl.*

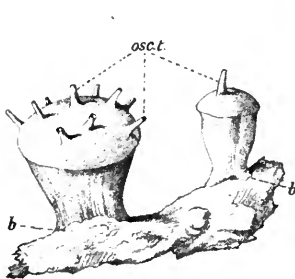

FIG. 31.

Tentorium semisuberites, O.S. On the left-hand, an older specimen with numerous oscula; on the right, a young specimen with one osculum; *osc.t.*, oscular tubes; *b*, base of attachment.

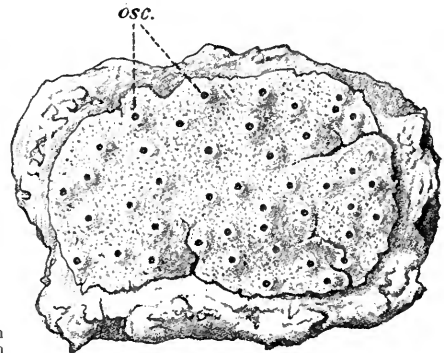

FIG. 32.

Ophlitaspongia seriata, Bwk. *osc.*, oscula.

reticulum), or more or less globular when stalked (Fig. 8, *Cl. lacunosa*), and then the number of oscula alone indicates the number of individuals. In other cases, again, the tubes may ramify in one plane, forming an incrusting colony spread over stones or seaweeds, from which oscular tubes arise at intervals.

Instances of sponge colonies in which the form of the colony is more or less identical with that of the individual are very common also amongst siliceous and horny sponges. The best examples are seen in massive forms, such as *Euspongia* or *Tentorium* (Figs. 39 and 31), where the separate individuals are quite indistinguishable from one another, and are only indicated by the oscula. In such cases the composite individuality of the sponge can scarcely be recognised; it becomes simply a compact growth in which the repetition of a number of similar and complete physiological systems alone marks the primitive individuals.

Most of the sponges in which the loss of individuality is most

marked are inhabitants of shallow water; or, if not, they are forms whose nearest allies are to be found along the shore, and whose ancestors have probably migrated into deeper water in comparatively recent times. In other words, the "impersonal" condition, as it may be termed, seems to have been correlated at its first origin with life in a habitat where the sponge has to contend with, and to adapt itself to, the action of stresses and strains which are always very variable and often very severe, and where the

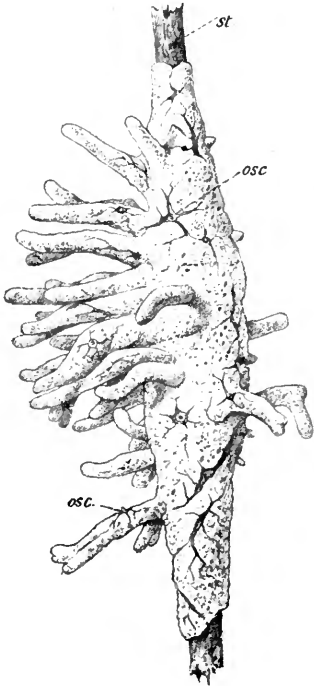

FIG. 33.

Spongilla lacustris, auct. (after Weltner). $\frac{1}{2}$.

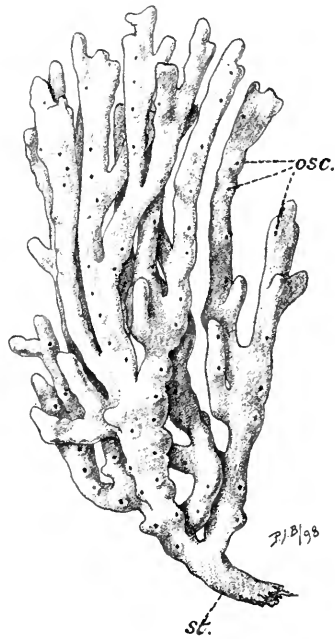

FIG. 34.

Chalina oculata, Pall, half-natural size.
osc, oscula; st, stalk.

form of the sponge becomes of the greatest importance in the struggle for existence. Hence the sponge colony as a whole takes on some characteristic mode of growth which may vary greatly from species to species, or even in different specimens of the same species. In this way a great number of different shapes and forms arise which are often extremely irregular and amorphous, but which can usually be classed under one of a series of typical forms. As the starting-point we may conveniently take a small compact sponge with numerous oscula—that is to say, a colony in which

the persons are indistinguishable except by the exhalant vents of the canal system.

A compact sponge of this kind, if it grows more or less equally in all directions, becomes simply *massive* (Fig. 39). It may, however, grow very greatly in a horizontal direction, and increase very little, or not at all in height; this gives a flat *incrusting* form, in which the oscula may be prominent as elevated cones or tubes, or may be quite inconspicuous (Fig. 32). On the other hand, the

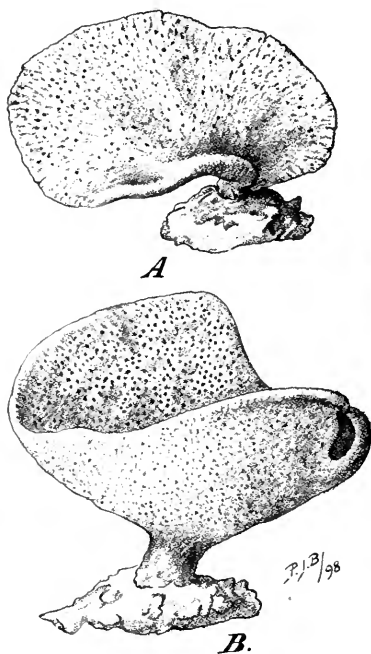

FIG. 35.

Phakellia ventilabrum, Johnst. *A*, flabellate specimen. *B*, cup-shaped specimen.

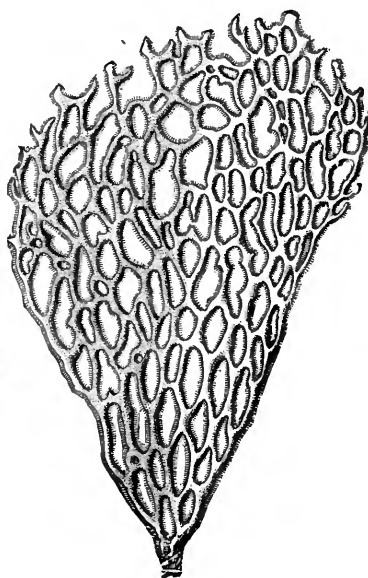

FIG. 36.

Phakellia tenax (after Agassiz). 3.

young sponge may grow very rapidly in height, and in this way a large series of forms arises. In the first place, a sponge which grows vertically may become greatly branched and assume a *dendritic* form (Fig. 34). The numerous oscula are found scattered along the branches, which in their turn may be more or less circular in transverse section, or very flattened. In the second place, rapid growth of the sponge in a vertical direction in height may be combined with a horizontal growth which preponderates in, or is restricted to, a particular vertical plane; the result is a fan-shaped or *flabellate* form (Fig. 35, *A*), a type which may undergo subsequent modifications of great importance.

In flabellate forms the oscula are usually, if not always, found on one side of the sponge, the inhalant orifices on the other side. Flabellate sponges have a great tendency to become folded until the edges come into contact and undergo concrescence. This can be well seen in such a form as *Phakellia ventilabrum*, where some specimens are simply fan-shaped, and others are folded into the form of a funnel or cup, in which the surface which bears the oscula is internal (Fig. 35, B). In this way a large series of sponge forms arises which, according to the relative dimensions of different regions, may be funnel-shaped, cup-shaped, or tubular. In the interior are found the true oscula, and on the exterior the inhalant apertures. The sponge colony in these cases exactly resembles the primitive vasiform sponge individual, or some of its numerous modifications, and at first sight the terminal aperture might be taken for a true osculum, the central space for the gastral cavity, and the exhalant vents in the interior for the excurrent openings of the canal system. Hence the cavity in these secondarily cup-shaped or tubular forms has been termed a *pseudogaster*, and the terminal aperture a *pseudosculum*. In many cases, however, it is impossible to determine either by simple inspection or by dissection whether a cup-shaped or tubular sponge represents a single individual with a true osculum, or a colony with a pseudosculum. Similarly, a flabellate sponge may represent a colony composed of numerous individuals, or it may be, as we have seen in the case of *Euryplegma*, a single individual, modified by its peculiar mode of growth. A knowledge of the development can alone decide which view is the correct one in any given instance.

Another modification of the flabellate type is seen in *Phakellia tenax* (Fig. 36) in which the fan has become fenestrated, resulting in a Gorgonia-like form.

Many deep-sea sponges, especially those of the order Monaxonida, are to be regarded as having migrated downwards from the shore-line in comparatively recent times, and in such forms the influence of life in still water is seen in a great regularity of growth, resulting in the development of a secondary symmetry. A good instance of this is furnished by the remarkable form *Esperiopsis Challengeri* (Fig. 37). Both the genus and the family (*Desmacidonidae*, R. and D. = *Poeciloscleridae*, Tops. pars) to which this sponge belongs comprise some of the commonest and most characteristic sponges of the littoral fauna, and its nearest allies exhibit the variable and often irregular form which in sponges is associated with life in shallow water. Like its allies, the species under consideration is a colony in which the individuals are indistinguishable, but a more tranquil and uniform environment has favoured a regular and symmetrical growth which is clearly not of a primitive type.

(c) *Colour*.—The colours of sponges are very varied, and often very bright, especially in the case of species inhabiting the shore-line, rendering them very conspicuous objects, and contributing largely to the display of colours in the submarine scenery of caves

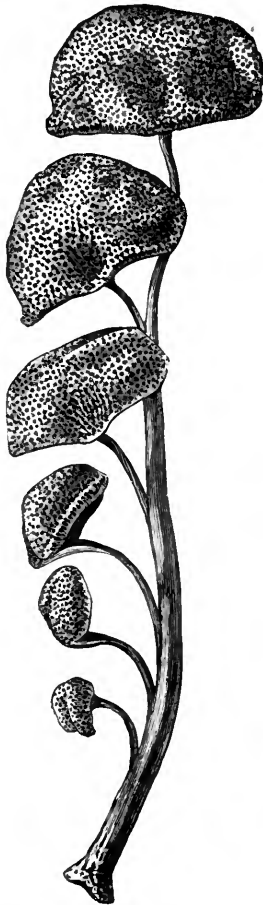

FIG. 37.

Esperopsis challengeri, R. (after Ridley). $\frac{1}{2}$.

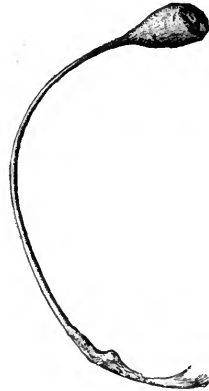

FIG. 38.

Stylocordyla stipitata, Crtr. (after Agassiz). $\frac{2}{3}$.

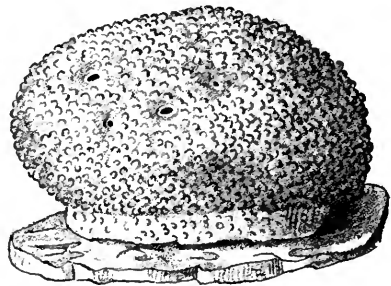

FIG. 39.

Euspongia officinalis, L. (after Schulze). $\frac{1}{2}$.

and sheltered spots along the coast. Many sponges, however, have no special colouring-matter, and then are simply white or gray, the prevailing tint amongst Calcarea. The littoral species of Demospongiae, on the other hand, are usually brightly coloured, especially in the Monaxonida and Keratosa, various shades of yellow, orange, red, or lilac being the prevailing tints, but blue is not uncommon,

Green is a rare colour amongst marine sponges, but is the usual tint of the fresh-water *Spongillinae*, where, however, it is due to chlorophyll. When the chlorophyll is not developed, fresh-water sponges are usually brownish. In marine forms chlorophyll is seldom, if ever, found as a pigment, and the nearest approach to the bright green of *Spongilla* is a dull olive-green of not infrequent occurrence.

Although *Calcarea* are usually colourless, some remarkable and instructive instances to the contrary are found amongst them, especially in certain species of *Clathrina*. Thus *Cl. coriacea*, common along the shores of the British Channel, has a wide range of colour variations, different specimens being white, yellow, orange, red, or lilac. The particular colour which a colony assumes does not seem to bear any fixed



FIG. 40.

Aplysina aërophoba, Ndo. (after Schulze). ♂.

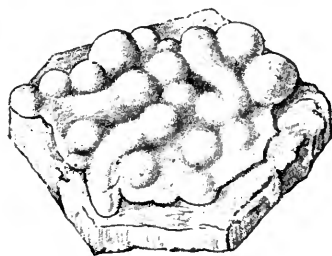

FIG. 41.

Oscarella lobularis, O.S. (after Schulze).
Natural size.

relation to other characters of its form or structure, nor is it as a rule correlated with its habitat, since specimens of the most diverse hues may be found in the closest proximity, growing even on the same stone. On the other hand, the specimens of this species living below the ordinary tide-marks in certain localities are constantly of a pale lemon-yellow colour, and this tint has become fixed as the constant colour of an allied species, *Cl. clathrus*, of the Mediterranean, while *Cl. primordialis*, another Mediterranean species, shows the same variability as *Cl. coriacea*. The larvae of each colour variety have the same tint as their parent, but it is not certain how far the colour is constant during the life-history of a given individual. It is not improbable that it may change according to the circumstances of its metabolism or from other causes at present unknown, since the peculiar cell-granules, which are the seat of the colour, are very variable in quantity and may be almost entirely wanting (temporarily?) in some specimens.

The colouring-matter of sponges is contained in cells of the dermal layer, especially in the epithelium as a rule. Special pigment cells are not found. The colouring-matter is usually very fugitive

and difficult to preserve, being easily dissolved out. In *Calcarea* the cells of the dermal layer, and more especially the flat epithelium and the porocytes, contain numerous opaque granules, which are the seat of the pigment in coloured forms. When the sponge is placed in alcohol, the colouring-matter dissolves rapidly out of the granules, making the specimen a dull white or brownish colour, and in fact reducing it to the condition of the forms without pigment. In many *Demospongiae*, on the other hand, the pigment is more resistant. *Aplysina aerophoba* is remarkable for possessing a pale yellow pigment which becomes blue, and finally black, on exposure to air, apparently by oxidation (Krukenberg). In alcohol it turns reddish-brown.

(d) *Consistence, etc.*—Different sponges yield very different sensations to the touch, according to the degree to which the skeleton is developed, the nature of the materials composing it, or the texture of the surface of the skin. The *Myxospongiae* are soft, slimy, and easily squashed. The more primitive *Ascons*, for example *Clathrina clathrus* (Fig. 7), are excessively delicate when fully expanded, and collapse by their own weight if lifted out of the water, but acquire considerable firmness and rigidity as the result of contraction. Many calcareous and siliceous sponges, on the other hand, have the surface roughened by projecting spicules, while the body may be brittle or friable and easily broken, or it may be very tough and even of almost stony hardness. In the *Keratosa*, the body is yielding and slimy to the feel, but, at the same time, excessively tenacious, very difficult to tear or pull apart. This feature is due to the tough elastic spongin fibres composing the skeleton, and is found also in *Monaxonida* according to the degree to which spongin is developed as a constituent of their supporting framework.

Many sponges have, when living healthily, a strong and disagreeable odour, rather resembling garlic. This characteristic is very pronounced in the common fresh-water sponge.

2. *Anatomy and Histology.*

The Olynthus.

The Organisation of Sponges in General.

(a) *Canal System.*

(b) *Skeletal System.*

(c) *Histology.*

The Olynthus.—The simplest known type of sponge, in structure, as well as in form, occurs, as has been said, as a transitory stage, the so-called *Olynthus*,¹ in the life-history of all calcareous sponges. In the *Olynthus* the problems of sponge anatomy and physiology are reduced to their lowest terms, and all sponges may be regarded ideally as derived from it, even though the *Olynthus* stage may not actually appear in their ontogeny.

¹ The organism in question received its name from Haeckel, who was under the impression that it represented an adult generic type.

The body form of the *Olynthus* is typically that of a hollow vase, as described above, though it may vary a good deal in its configuration. Fig. 2, *a*, shows the *Olynthus* of *Clathrina coriacea*; Fig. 1 represents somewhat diagrammatically, and more highly magnified, that of an allied species, *Cl. primordialis*; and Fig. 60, *h*, that of *Sycon raphanus*. As a type for description may be taken that of a simple Ascon (*Clathrina*).

The wall of the *Olynthus* (Fig. 1) is perforated by numerous pores, and at the summit is situated the large exhalant aperture or osculum, often defended by a contractile sphincter or sieve-membrane. The body wall is composed of two layers of tissue, which may be termed the dermal and gastral layers respectively. The dermal layer is the more externally situated and makes up the greater part of the sponge. The gastral layer lines the interior, but does not reach quite to the extreme margin of the osculum, the opening of which is surrounded by a rim or collar of variable length, made up of the dermal layer alone (Fig. 42, *A* and *D*, *p.c.ep*). Both layers are interrupted by the pores, which perforate the wall everywhere except at the base of attachment and in the oscular rim.

The gastral layer is very simple in its composition, being made up of a single stratum of columnar epithelium, the cells of which are all of one peculiar type (Fig. 42, *A* and *D*, *ch.c*). Each cell bears at its upper free extremity a single vibratile flagellum (*fl*), which springs from the centre of an area enclosed by a delicate cup or collar of protoplasm (*c*). On account of the latter peculiarity these cells have been termed *collar cells* or *choanocytes*, and are very characteristic of sponges. In all sponges that have been studied the gastral layer is composed of these cells and of these alone; on the other hand, similar cells are not known to occur in any Metazoa, but each collar cell is strikingly similar to a protozoan individual of the class Choanoflagellata.

The dermal layer consists mainly of a gelatinous ground substance, which is covered on all its exposed surfaces—that is to say, on the exterior of the body wall and in the oscular rim—by a flattened epithelium (*d.ep*), and contains the skeletal elements and their secreting cells and the pore cells. The flattened epithelium is the contractile layer of the sponge, and where the body wall is in contact with the substratum at the points of attachment, the epithelium is of a glandular nature. The skeleton consists, in *Calcarea*, of spicules of calcite (*sp*) secreted within cells termed scleroblasts (*sp.c*). Each pore (*p*) is a perforation through a single cell, the pore cell or porocyte (*p.c*), which stretches from the external flat epithelium to the internal layer of collar cells, and places the gastral cavity in communication with the exterior by means of an intracellular duct or canal. The pore canal opens towards the interior by a wide aperture (Fig. 42, *A* and *D*, *g.a*) between the

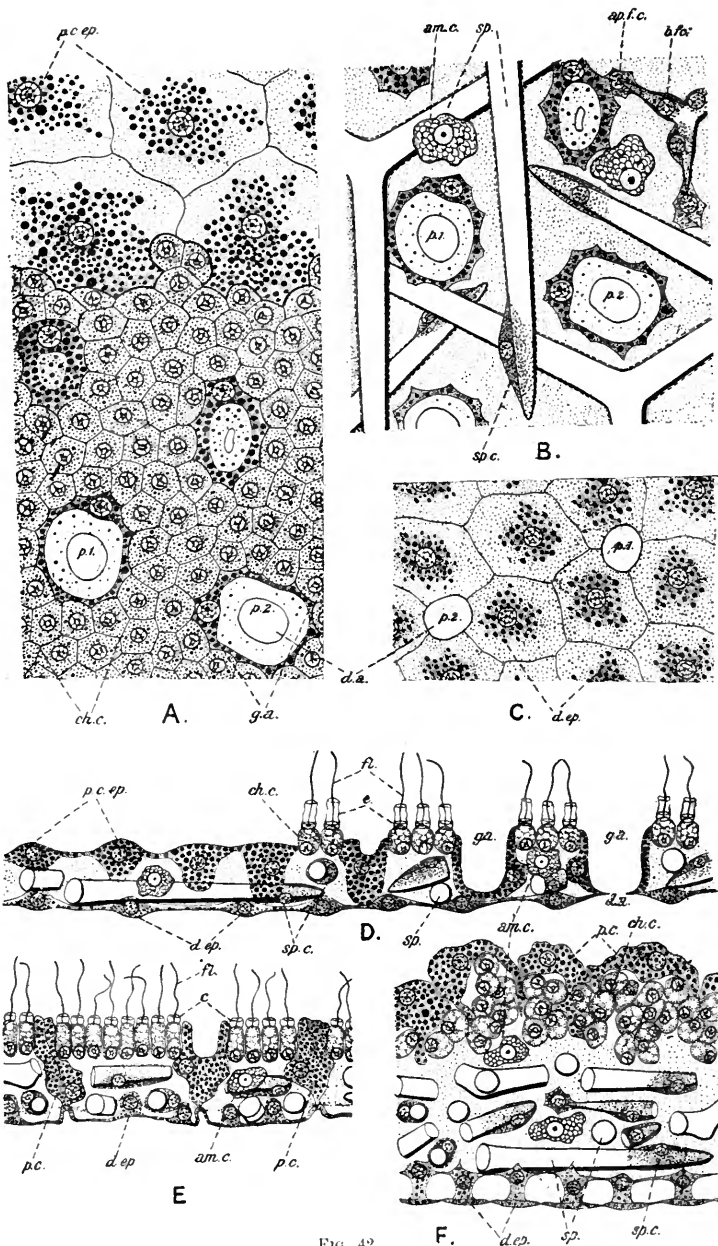

FIG. 42

Histology of the body wall of *Clostrina coriacea*, Mont. *A*, body wall seen from the inside in the region of the ocular rim. *B*, portion of *A*, showing the same three pores (p_1 , p_2 , and another), but with the collar cells removed, to show the underlying parenchyma. *C*, same portion of the body wall, with the pores p_1 , p_2 , but seen from the outside, to show the flat epithelium. *D*, longitudinal section of the body wall, in the region of the ocular rim, fully expanded. *E*, section of the body wall, slightly contracted. *F*, section of the body wall, very contracted. *A*, *B*, and *C*, $\times 750$; *D*, *E*, *F*, $\times 500$. *am.c.*, amoebocytes; *ap.f.c.*, apical formative cell; *b.f.c.*, basal formative cell; *c.*, collars of (*ch.c.*) choanocytes; *d.a.*, dermal aperture of pore; *d.ep.*, dermal epithelium; *fl.*, flagella; *ga.*, gastral aperture of pore; p_1 , p_2 , pores; *p.c.*, porocytes; *p.c.ep.*, porocytic epithelium; *sp.*, spicule; *sp.c.*, spicule cell or scleroblast.

cells of the gastral epithelium, and towards the exterior by a fine opening in a delicate, protoplasmic diaphragm situated on a level with the dermal epithelium (Fig. 42, *A, B, C, and D, d.a.*).

Both scleroblasts and pore cells are derived directly from the dermal epithelium which in the embryo at first constitutes the whole of the dermal layer. Cells of the epithelium migrate inwards to become scleroblasts; other epithelial cells, distinguished by their larger size and numerous granules, become porocytes in two different ways in different regions. In the oscular rim the epithelium lining the interior becomes modified as it approaches the gastral layer, until its cells have the characters of porocytes (Fig. 42, *A, D, p.c.ep.*). As the collared epithelium grows upwards by proliferation of its cells during the growth of the sponge, the lowermost epithelial cells of the oscular rim become surrounded by collar cells which pass between them and isolate them from one another. Each cell of the lining epithelium of the oscular rim when thus cut off from its fellows becomes a pore cell. In other regions of the body wall the ranks of the porocytes may be recruited by the direct immigration of large granular cells of the dermal epithelium, and their subsequent perforation to form new pores.

In addition to the collared cells of the gastral layer and the various cell elements of the dermal layer, the body wall contains numerous wandering cells or *amoebocytes* (Fig. 42, *B, D, E, F, am.c.*), which occur everywhere amongst the cells and tissues. Though lodged principally in the dermal layer, they are not to be regarded as belonging to it, but as constituting a distinct class of cells in themselves. They are concerned probably with the functions of nutrition and excretion, and from them arise the genital products.

The above description of the *Olythus* applies to it in the normal expanded condition, when the sponge is feeding actively, with pores and oscula widely open. The cells of the flattened dermal epithelium, however, as well as the porocytes, are excessively contractile, and by their contraction bring about important modifications in the appearance of the sponge as a whole, as well as in the disposition of its cells and tissues. Each porocyte can close up its apertures and obliterate its lumen by its own contraction, and in this condition the porocyte has the appearance simply of a compact, granular, amoeboid cell. The contraction of the dermal epithelium brings about the closure of the osculum and the contraction of the sponge as a whole. The closure of the osculum is effected more especially by the large granular epithelial cells, destined to become porocytes, which line the oscular rim, and from these cells a special contractile apparatus, such as a ring-like sphincter or a contractile sieve-membrane, is often formed in this region. The flat epithelium covering the exterior, on the other hand, is responsible for the general contraction of the whole body, and by its action brings about a reduction in the internal gastral cavity,

proceeding *pari passu* with a thickening of the body wall, and resulting in a considerable diminution in the size of the sponge as a whole. When the contraction is carried to its extreme, the gastral cavity disappears altogether and the interior of the sponge is filled by a solid mass of cells.

During the contraction of the sponge, the arrangement of its cell elements undergoes great changes, which are very important for interpreting the early stages of the embryonic development. The collar cells become first laterally compressed and very columnar (Fig. 42, *E*), and finally are forced over one another into several layers (Fig. 42, *F*, *etc.*). During these changes the collar shortens, and is finally completely retracted. The spicules are also forced one over the other to form several layers. The porocytes, which at first were lodged in the body wall below (external to) the collar cells, pass between the latter (Fig. 42, *E*), and finally take up a position over (internal to) the collar cells (Fig. 42, *F*), forming an epithelium lining the now greatly reduced gastral cavity. When the contraction reaches the stage in which the gastral cavity is completely obliterated, the collar cells and porocytes fill the gastral cavity as a compact mass of cells, the porocytes being aggregated towards the centre, or rather the axis, of the sponge. Lastly, the cells of the dermal epithelium, the active agents in bringing about the contraction, themselves undergo a remarkable change of form. As the cell contracts, the nucleus and the central protoplasm travel inwards towards the mesogloea, while the peripheral portion of the cell, on the contrary, becomes raised up. In this way the cells lose the flattened plate-like form which they have in the expanded condition (Fig. 42, *D*) and assume each a shape rather like a mushroom, the nucleus being lodged at the base of the stalk (Fig. 42, *F*).

When a contracted Ascon expands again, all the above changes of structure are repeated in reverse order. The gastral cavity appears in the midst of the porocytes which at first form an epithelium lining it, and as the expansion continues, the porocytes become separated and isolated from one another, and then travel outwards to take up their position in the wall and to form pores.

Contractility to a greater or less degree is found in all sponges, but, so far as is known, it is only in the more primitive species of the genus *Clathrina* that it is carried to the extreme degree of obliterating the gastral cavity, and so producing a condition comparable to the pupal stage in the development (*cf.* Figs. 58, 2, and 63, *B*). In those species of the genus which have spicules projecting into the gastral cavity, contraction is never carried so far, while in the majority of sponges the phenomena of contraction are only manifested in the temporary closure of the pores and oscula, both of which structures, but especially the former, readily disappear and appear again. The condition, however, in which an *Olynthus* or any other sponge appears without osculum and pores is always a temporary one.

To sum up the facts with regard to the structure of the *Olynthus*, as found in a calcareous sponge, it is seen that its body wall is built up of *two* distinct layers, and contains *five* kinds of cells and their products; namely—

(1) The dermal layer, divided into a more external contractile stratum, the flat epithelium and the porocytes, and a more internal parenchymal or skeletogenous stratum, the spicules and their cells, embedded in a gelatinous ground substance.

(2) The gastral epithelium, consisting of the collared epithelium.

(3) The wandering cells, which do not constitute a distinct tissue or cell layer, but are found scattered in all parts of the body wall. At certain seasons, some of these cells become germ cells; hence the wandering cells and the reproductive cells may be included together under the general term *archaeocytes*.

It is possible to imagine, however, a still simpler type of *Olynthus* than this, one namely in which a skeletogenous layer has not been evolved. The dermal layer would then consist of a single layer of epithelium and of the porocytes. Such an organism would represent the simplest conceivable type of sponge, and might be termed the Protolynthus. A Protolynthus stage is recognisable, as will be seen, in a contracted, pupal form, in the embryonic condition of Ascons, but as a fully developed and functionally active organism it is not known to occur, even as a transitory stage, in the life-history of any existing sponge.

From the *Olynthus* as a starting-point we may now consider the *organisation of sponges in general*.

(a) *Canal System*.—All the cavities of the body traversed by the currents of water which nourish the sponge, from the time they enter by the pores until they pass out by the osculum, are termed collectively the *canal system*. In the *Olynthus* the canal system has been seen in its simplest type. In other forms it may attain to a high degree of complexity, but its general evolution can nevertheless be reduced to simple processes of growth on the part of the primitive *Olynthus* (Protolynthus), resulting in a folding of the wall, and accompanied by a restriction of the collar cells to certain regions. In the gradual and continuous process of differentiation three distinct grades or types of organisation can be distinguished which, though connected by numerous transitions, may yet be considered as three styles of architecture, so to speak, under which all existing forms may be classified.

First Type of Canal System.—As an example of this type may be taken the *Olynthus* itself (Fig. 43), of which the structure has already been described. The parts of the canal system here are pores, gastral cavity, and osculum.

This type of canal system is only found in Ascons amongst

Calcarea, and, as will be shown when these forms are discussed, the *Olynthus* may undergo various processes of growth and folding of the body wall without departing from this type, of which the essential characteristic is that all the canals and spaces between the pores and the oscular rim are lined by collar cells, and by collar cells only; in other words, that the *gastral layer is continuous* (cf. Figs. 65, 66).

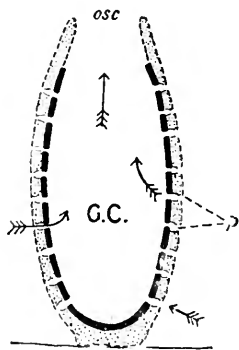

FIG. 43.

Diagram of first type of canal system (*Olynthus*). *p*, pores; *osc*, osculum; *G.C.*, gastral cavity. The arrows show the direction of the currents. In this and in the next three figures, the thick black line represents the gastral layer, and the dotted portion represents the dermal layer.

Second Type of Canal System.—This type arises from the *Olynthus*, first by a process of unequal growth and consequent folding of the body wall, resulting in the formation of a number of blind diverticula of the gastral cavity; and secondly, by the restriction of the collared epithelium to the interior of the diverticula in question, which are hence termed *flagellated chambers* (Fig. 44, *A* and *B*). The central portion of the gastral cavity becomes lined by a flattened epithelium derived from the dermal layer, and similar in all respects to the flat epithelium of the external surface of the body.

Between the flagellated chambers, which may vary considerably in form and length, canals are enclosed along which the water flows to enter the chambers. From their mode of origin it can be seen that the lumen of these *incurrent canals*, as they are termed, is simply a portion of the outer world enclosed between the folds of the body wall, and lined by the flat epithelium of the outer surface; and further, that the apertures by which the water enters the chambers are nothing more than the pores of the *Olynthus*.

At their first formation the diverticula of the body wall are distinct one from another, and may remain so in a few instances, but more often they tend to coalesce where they touch each other, and also, by thickening of their outer or distal extremities, to form a cortex. In this way two sub-grades of the second type can be distinguished. In the first (Fig. 44, *A*) the incurrent canals are wide spaces, continuous with one another between the chambers. In the second (Fig. 44, *B*) the coalescence between the chambers narrows the incurrent spaces to definite canals, which commence by an opening on the outer surface of the cortex. The sponge as a whole now no longer shows a folded surface, but appears simply as if its body wall was greatly thickened, thus reverting in form to the *Olynthus* type. The water enters the incurrent canals by definite apertures on what is now the

outer surface of the body, which have the appearance of pores, and are often so termed; but it is obvious from the development that the pores on the surface of the body in this type are not comparable to those of the *Olythus*, which are represented now by the chamber pores. To avoid confusion it is best to employ a terminology which distinguishes clearly between them, and hence the openings of the incurrent canals may be termed the *ostia*, while the chamber pores receive the special name of *prosopyles*. Similarly, the wide opening by which the current passes out of the chamber may be termed the *apopyle*.

The following parts can, therefore, now be distinguished in the fully developed canal system of the second type (Fig. 44, *B*). The

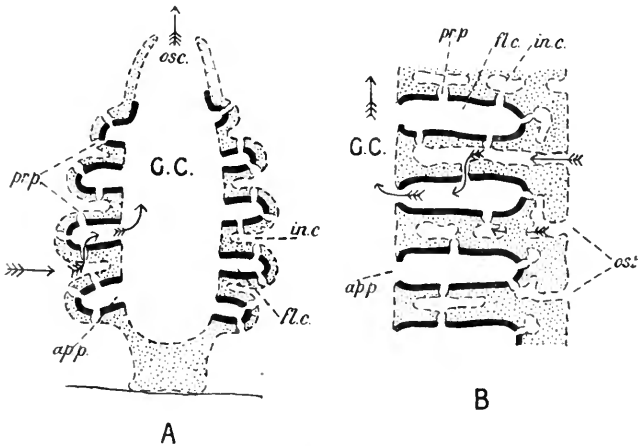

FIG. 44.

Diagrams of the second type of canal system. *A*, simple type, with separate radial tubes. *B*, more complex type, with radial tubes fused and thickened distally to form cortex and incurrent canals; a portion only of the wall is represented. *ost.*, ostia; *in.c.*, incurrent canals; *pr.p.*, prosopyle; *fl.c.*, flagellated chamber; *ap.p.*, apopyle. Other letters as in last.

water enters through the ostia (dermal pores) into the incurrent canals; thence it passes through the prosopyles (chamber pores) into the ciliated chambers; and from them it passes by the wide apopyles into the gastral cavity and out through the osculum. The gastral layer, being restricted to the chambers, is discontinuous, as it is in all types of canal system above the first type.

Third Type of Canal System.—The third type can be derived from the second by a further process of folding of the body wall, giving rise to bays or diverticula of the gastral cavity, into each of which several chambers open together (Fig. 45, *A*). Thus a system of what are termed excurrent or exhalant canals becomes interpolated between the chambers and the gastral cavity proper. In correspondence with this addition to the canal system the in-

current canals also become complicated and ramified. The whole canal system may now conveniently be divided into three parts: (1) The incurrent system, from the ostia to the prosopyles of the ciliated chambers; (2) the chambers themselves; and (3), the excurrent system from the chambers to the osculum.

The canal systems of the third type may become highly differentiated and complicated in their several parts. Both incurrent and excurrent canals may branch repeatedly and undergo various modifications in different regions. Quite apart from the complications of these systems, three stages of evolution are to be

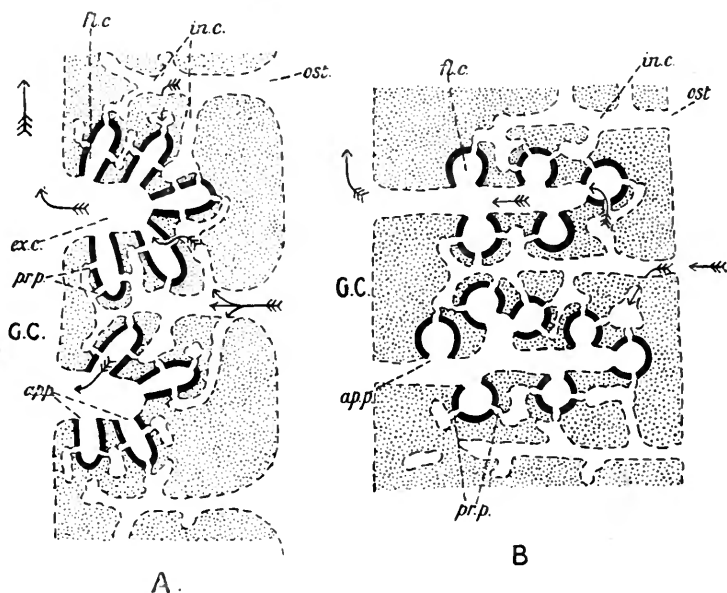

FIG. 45.

Diagrams of the third type of canal system (eurypylous). *A*, more primitive, with elongate chambers. *B*, with rounded chambers. *ex.c.*, excurrent canals. Other letters as in last.

observed in the relations of the chambers to the incurrent and excurrent systems, by means of which canal systems of the third type can be divided into three sub-types.

In the first and most primitive sub-type the chambers open directly into the excurrent canals by their wide apertures or apopyles, and receive their water supply direct from the incurrent canals through the prosopyles (Fig. 45, *A* and *B*). A canal system of this type is said to be *eurypylous*.

In the second sub-type the opening of the chamber into the excurrent canal is drawn out into a tube, usually not of great length, termed an *aphodus* (Fig. 46, *A*, *aph*). The relations of the chamber

to the incurrent canal remain as before. A canal system of this kind is termed *aphodal*.

In the third stage the chamber has, as in the last, an aphodus, and in addition a delicate canalicule termed a *prosodus* interpolated between the chamber and the incurrent canal (Fig. 46, *B*), and derived, probably, by elongation of a prosopyle. Canal systems of this kind are termed *diplodal*.

Thus in the most highly differentiated type of canal system, the following series of parts can be distinguished: ostia, incurrent canals, prosodi, ciliated chambers, aphodi, excurrent canals, gastral

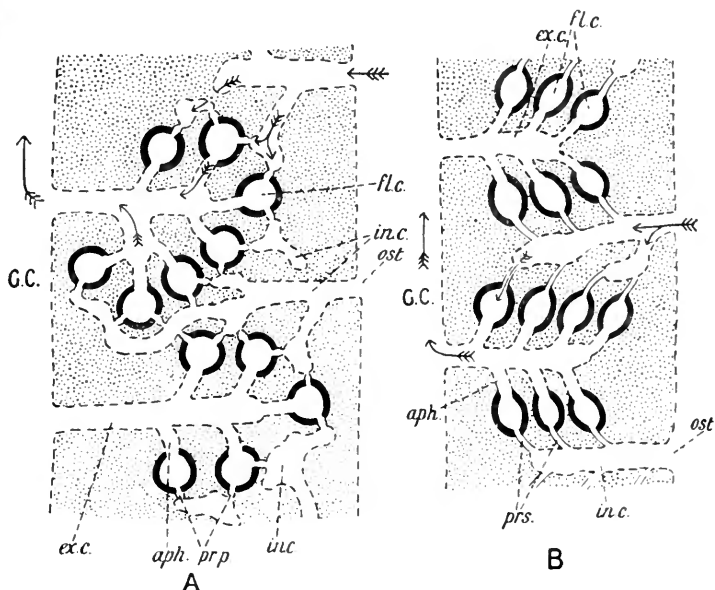

FIG. 46.

Third type of canal system. *A*, aphodal; *B*, diplodal. *aph.*, aphodus; *prs.*, prosodus. Other letters as in last.

cavity, and osculum, and to these may be added further complications of the incurrent system which will be described when dealing with the canal system in the different groups.

The diplodal canal system is regarded by some authors as constituting a fourth type of equal value with the other three.

Osculum, Gastral Cavity, and Pores.—The gastral cavity, properly speaking, extends up the exhalant canals and includes the cavities of the chambers. This is obvious from the development of the canal system that has just been traced. It is more usual, however, as well as more convenient in most cases, to distinguish the cloacal cavity which opens by the osculum, and into which the exhalant canals unite to

pour their contents, as the gastral cavity proper, from the excurrent canal system. In many sponges, especially the thin-walled tubular or sac-like forms, the gastral cavity is wide and spacious; in others, especially in marine or incrusting forms, it may be so much reduced by the thickening of the body wall as to be scarcely distinguishable from the exhalant canals.

It has already been seen (p. 23) that by folding or unequal growth of the sponge, a false gastral cavity may arise, opening by a false osculum (pseudosculum), and containing in its interior the true oscula which simulate the openings of the exhalant canals (cf. Fig. 35, *B*). Conversely, we find in some Hexactinellids a flattening out of the gastral cavity and loss of the osculum, in which case the openings of exhalant canals simulate true oscula (*Caulophacus*, etc., Fig. 20). Hence it is not possible to determine the nature of an excurrent opening by simple inspection, nor even in many cases by its anatomical relations.

Oscula are very often defended in various ways; for instance, by fringes or palisades of sharp spicules, or by sieve-like plates or membranes across the opening (Figs. 15 and 18). In other cases the osculum can be completely closed by a contractile sphincter or diaphragm (Figs. 7 and 40). The oscular aperture may be on the level of the general surface of the body, or raised up to form a special oscular tube, often of great length (Figs. 25, 26, 31), according to the requirements of the sponge.

In the above account of the canal system a clear distinction has been drawn between true pores and ostia. The former are found on the surface only in the canal systems of the first type; in other types the inhalant openings are always ostia. The distinction is not, however, always maintained, and superficial incurrent apertures are often loosely termed pores, without reference to their true nature.

Primitively the ostia are scattered over the whole free surface. They may be restricted, however, to the upper surface, which bears also the oscula, as in *Tentorium* (Fig. 31). In fan-shaped forms the ostia are on one side, the oscula on the other, from which the condition with a pseudosculum and pseudogaster is readily derived. In the boring forms of *Cliona* and its allies the sponge is embedded in a calcareous matrix, but sends lobes up to the free surface, some of which bear the incurrent openings, others the oscula. In many sponges the ostia are aggregated into special sieve-like areas, termed pore sieves. Upprowth of the edges of such a sieve has probably given rise to the remarkable state of things in *Disyringa* (Fig. 26), the highest and most specialised type of sponge so far as canal system is concerned; a single inhalant opening leads by a long incurrent tube into a sort of atrial cavity, surrounding the body of the sponge and containing what appear to be the true ostia. Like the oscula, the ostia also may be defended by spicules or by special contractile mechanisms, often reaching in Demospongiae a high state of elaboration in the so-called *chones* (see below).

Many authors have sought to homologise oscula and pores, often meaning ostia, however, by the latter term. True pores, as will be seen, are distinct from oscula in that the former are intracellular, the latter

intercellular, in nature and formation. On the other hand, the general development of the canal system precludes any homology between ostia and oscula, and the great difficulty often found in distinguishing the two sets of structures in some Demospongiae is clearly secondary. It should be mentioned finally that in *Euplectella* and some of its allies *parietal gaps* are met with in the body wall, leading from the exterior into the gastral cavity (Figs. 15 and 18). These openings have, however, nothing to do with the canal system, and appear to be simply an architectural adaptation to the animal's life-conditions.

(b) *Skeletal System*.—A small number of sponges are entirely without any supporting framework or skeletal structures. A few others, mostly inhabitants of the deep sea, have, according to Haeckel, a *pseudoskeleton* composed entirely of foreign bodies, without any elements secreted by the sponge itself; the true nature of the organisms in question is, however, very doubtful.

The vast majority of sponges, however, possess a true skeleton (*autoskeleton*) composed of elements secreted by the sponge itself (*autophya*, Haeckel), which may be supplemented to a greater or less extent by admixture of foreign particles (*xenophya*, Haeckel), such as sand grains, skeletons of minute organisms, or spicules of other sponges, taken up by the sponge from its surroundings. The autoskeleton is always a secretion of the cells of the dermal layer, and takes the form either of mineral sclerites or *spicules*, or of an organic substance termed *spongin*, occurring usually either as a cementing substance, or as fibres. The spicules may be composed either of carbonate of lime in the form of calcite, or of colloid silica (opal), with in each case a slight admixture of organic matter.

a. *Spicules*.—The morphological variations of the sponge spicule are very numerous, and their classificatory importance necessitates a complete and systematic nomenclature of the principal types of form. Each spicule, of whatever material composed, is typically made up of a greater or less number of *rays* or arms, representing directions of growth, which radiate from the centre of the spicule, *i.e.* from the starting-point of the secretion, and are laid down along a number of ideal *axes*. Theoretically, the number of rays in a spicule will be either equal to, or double, the number of axes. In point of fact, however, the number of rays actually present may be far less than the number ideally possible for any given type of spicule, either as the result of a secondary reduction of spicule rays primitively present, or it may be, by persistence of the spicule in a still more primitive condition in which the full number of rays has not yet been acquired. Thus a spicule with three morphological axes has typically six rays, but the number of the latter may be reduced to two or three or even to a single one.

The number of axes which can be recognised in a given type of spicule is expressed by adjectives terminating in "axon,"

combined with a Greek numeral, as "monaxon," "triaxon," etc. The number of rays present, on the other hand, is connoted in a similar manner by substantives terminating in "actine," or by adjectives terminating in "actinal,"—for example, "diactine," or "diactinal spicule." The former series of terms is usually employed to express rather the ideal type of any given spicule, the latter to describe its actual condition.

The following types of spicule can be recognised in sponges generally, each type exhibiting in its turn innumerable variations:—

(1) The monaxon type of spicule, built upon a single axis, and having therefore simply the form of a rod or needle (Fig. 47, *a*, and *b*). A monaxon spicule may be either monactinal (Fig. 47, *b*) or

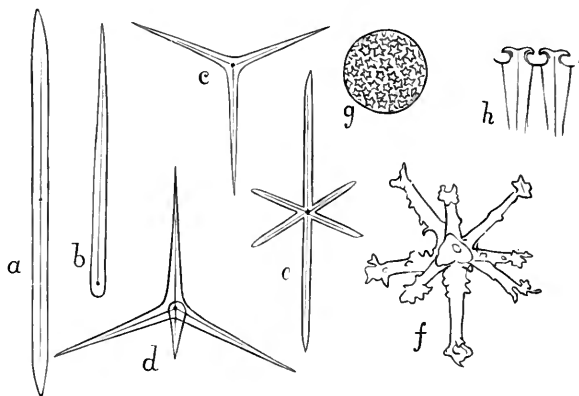

FIG. 47.

Types of spicules (megascleres). *a*, riabdus (diactinal monaxon); *b*, stylus (monactinal monaxon); *c*, triactine; *d*, tetractine (tetraxon type); *e*, hexactine; *f*, desma of an anomocladine Lithistid (secondarily polyaxon); *g*, sterraster (polyaxon); *h*, radial section through the outer part of *g*, showing two actines soldered together by intervening silica, the free ends terminating in recurved spines, and the axis traversed by a central fibre.

diactinal (Fig. 47, *a*), the two rays in the latter case being placed in the same straight line. The axis may be straight or curved (Fig. 48, *a*, *b*, *c*, etc.).

(2) The triaxon type, characteristic of Hexactinellids (Fig. 47, *e*). The primitive spicule is laid down along three axes which cut one another at right angles at a central point, producing a six-rayed or hexactinal spicule, which may undergo a secondary reduction of the rays; but so long as more than one ray persists, it meets its fellow or fellows at angles of 90° or 180° .

(3) The tetraxon type of spicule (Fig. 47, *d*), which may be considered ideally as laid down along four radii of a sphere which meet one another at equal angles at the centre. Hence the primitive form is a tetractine, of which any three rays will appear to meet at angles of 120° , when projected in such a way that the fourth ray

appears as a point. In this type, however, the angles at which the rays meet one another are subject to considerable variation, as well as the rays themselves.

(4) The polyaxon type of spicule (Fig. 48, *m, n, o*), laid down along numerous axes which typically radiate from a common centre.

Subordinate variations of these different types will be described in dealing systematically with the subdivisions of the Porifera. We may mention here, however, one differentiation of the spicules which is often of importance, the distinction, namely, between skeletal spicules or *megascleres*, which by their union in various ways build up the general supporting framework of the body, and flesh spicules or *microscleres*,

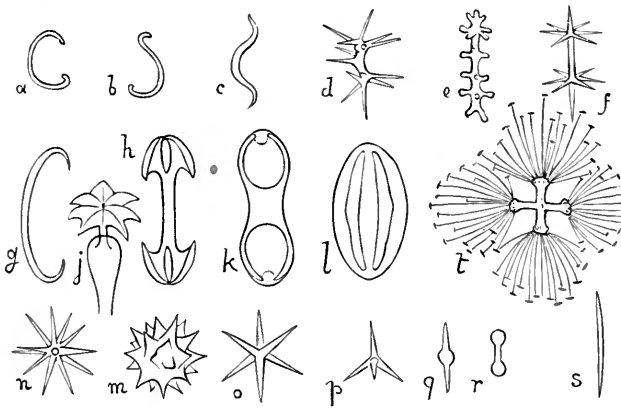

FIG. 48.

Types of spicules (microscleres). *a* and *b*, signaspire viewed in different directions; *c*, toxaspire; *d*, spiraster; *e*, sanidaster; *f*, ampliaster; *g*, sigma; *h*, chela (isochela); *i*, one end of another form of chela; *k, l*, other forms of chela; *m*, spheraster; *n*, oxyaster; *o*, the same, with six actines; *p*, another, with four actines; *q*, another, with rays reduced to two (diactinal monaxon); *r*, tylote microrhabdus; *s*, oxete microrhabdus; *t*, rosette.

which lie scattered more or less freely in the tissues. In many sponges no such distinction can be drawn; in others the distinction is purely functional, and in so far as it has any effect on the morphological characteristics, affects only the size of the spicules. In some cases, however, the difference of function in the two classes of spicules is correlated with divergent morphological characters, so that the distinction between *megascleres* and *microscleres* may become a perfectly sound and useful one.

All spicules, whatever the material of which they are composed, are deposited within cells, termed *scleroblasts*. The origin and relations of these cells will be discussed below in dealing with the histology; we may consider here the development of spicules themselves, which shows important variations. In the first place, a

distinction must be drawn between true or *primary* spicules which owe their first origin to a single mother cell, and *secondary* spicules which can be traced back to more than one cell. Secondary spicules may be due either to a deposit, not of spicular nature (see below, p. 41), of skeletal material upon a primary spicule; or to union of several primary spicules to form a *spicular system*. The latter are usually many-rayed forms, such as the equiangular triradiate and quadri-radiate systems of many *Calcarea* (see below, p. 107), in which each ray represents a distinct primary spicule or spicular element, derived from its own mother cell or *actinoblast*, and fused secondarily with its fellows to form the spicular system. The distinction between these primary and secondary spicules is, however, one entirely independent of their morphological characteristics, since in *Demospongiae* the spicules, with few exceptions, whatever their form or the number of their rays, appear to arise from a single mother cell; while, on the other hand, many spicular systems in *Calcarea* have become secondarily monaxon in form. Nothing is known with regard to the formation of the triaxon spicules of *Hexactinellids*.

The development of a primary spicule is very uniform, and that of a simple monaxon type may be described in general terms as a typical example (cf. Fig. 49, *h-n*). The first portion to be formed is a minute organic rod, placed near the nucleus of the secreting cell. This is the rudiment of the organic axial thread, and round it is deposited the mineral matter.

In calcareous spicules the organic axis is very slender, and the mineral matter subsequently deposited is of a crystalline nature, and almost, if not entirely, free from organic matter; the whole spicule is enveloped in an organic sheath of the same nature as the axial thread, and continuous with it at the apex of the spicule. Sheath and thread are the oldest parts of the spicule, and probably appear first as a minute cell vacuole in which a crystalline deposit subsequently takes place to form the spicule round a denser central portion which becomes the axial thread. The substance of the vacuole, and consequently of the sheath and thread, is of the same nature as the intercellular ground substance or mesogloea of the dermal parenchyma.

In siliceous spicules the organic axis is relatively much larger and more conspicuous. The mineral matter is deposited round it in concentric lamellae of colloid silica, alternating with lamellae of organic nature. One such organic coat probably forms an outer sheath to the spicule, which is not, however, so conspicuous as in calcareous spicules. The organic portions of the spicules grow faster than the mineral portions, so that the axial thread projects at the two extremities of the spicule rays into the protoplasm of the secreting cell. Hence each spicule when freed from organic matter represents an open tube,

with a minute lumen, the axial canal, formerly occupied by the organic axis.

Although a true spicule arises as an intracellular deposit, it usually greatly outgrows the mother cell, and may attain relatively gigantic proportions, as, for instance, in the spicules of the root tuft of *Euplectella* and *Hyalonema*. In such cases it is far from certain how the later growth is effected. It is commonly assumed that other scleroblasts attach themselves to the growing spicule and deposit fresh mineral substance upon it. Growth of this kind has, however, only been demonstrated in the case of the irregular spicules known as desmas (see below, p. 134) of the *Lithistula*, spicules clearly of a secondary nature. In Calcarea, on the other hand, the whole growth of the spicule or spicular element is entirely due to the activity of the original scleroblast and its descendants. The mother cell divides into a greater or less number of formative cells which spread over the growing spicule and build it up to the required size. In other cases only the nucleus of the scleroblast divides, and the spicule ray is enveloped in a nucleated plasmodium. The later development of the spicules of Demospongiae has not been studied, but it is probable that, as in Calcarea, all true spicules, whatever their size, are secreted entirely by the mother cell or by cells derived from it.

When the spicule is fully formed the scleroblast, or at least some of the formative cells derived from it, may persist, adhering to the spicule after their secretive activity has ceased, as is always the case in Calcarea; or they may disappear from the spicule when its growth is complete, as seems always to occur in the case of siliceous spicules.

The above account of spicule development applies equally to the individual rays of the secondary spicular systems in Calcarea, an account of which will be found below (p. 107).

In addition to the secretion of mineral substance in the form of spicules, secondary deposits of silica are formed on the desmas, already mentioned of *Lithistula*, and in the form of cement, uniting spicules together, in Hexactinellids. It is not known accurately in any case how these deposits are laid down, but it is very possible from the mode of their formation that they represent secretions of a cuticular or extracellular nature, and are therefore very different from the spicules.

A true spicule may, in short, be defined as an intracellular secretion of skeletal material, formed either by a single mother cell, or by a number of formative cells all derived from one such mother cell.

β. Spongin is an organic substance allied to silk, but apparently of variable composition. It is generally stated to yield leucin and glycine, but not tyrosine, when heated with sulphuric acid, and its

chemical formula has been estimated at $C_{36}H_{46}N_9O_{13}$ (Krukenberg). According to Hundeshagen,¹ however, some spongin contains a considerable percentage of iodine, while other varieties contain chlorine and bromine. The iodine containing variety—"iodo-spongin"—yields tyrosin when heated with H_2SO_4 .

Spongin, as a skeletal element, occurs in two distinct forms; first, as a cuticular secretion of a tenacious but elastic cementing substance which glues siliceous spicules together into a more or less definite system of skeletal *fibres*; and, secondly, in the form of minute elastic *fibrillae*, secreted within cells, and furnishing a tissue which may be compared to the elastic tissue of higher animals. By atrophy of the spicules in the first case we obtain fibres of pure spongin, as in the so-called horny sponges (see below, p. 139).

A remarkable property possessed by the spongin fibres of many sponges is that of taking up foreign particles of various kinds into their interior. Sand grains, sponge spicules, Radiolarian or Foraminiferan skeletons, and such like bodies which fall on to the surface of the sponge body, become included in the fibres, apparently by adhering to the tip of the fibre at its growing point, where it is continuous, in all probability, with the external cuticle of the sponge body. The absorption of foreign particles into the spongin fibre is therefore not so much a question of their travelling down into it, as of their being passively surrounded by spongin as the fibre grows upwards. The fibres may be so laden with sand grains and foreign bodies that the skeleton appears made up of them, and the spongin is scarcely visible. Sponge skeletons of this kind are termed *arenaceous*. The habit of fortifying the skeleton in this way is one which has been acquired independently by forms of diverse affinities, and is perhaps to be regarded as a specialisation, as it were, of a frequent tendency to form a false skeleton by inclusion of foreign particles in the growing sponge body.

Spongin originates as a secretion of certain cells of the dermal layer termed spongoblasts, which by their discoverer, Schulze, were regarded as belonging to the connective-tissue system, but are now more generally regarded as derived directly from glandular cells of the external flat epithelium. The spongin fibres are formed as a cuticular secretion of the spongoblasts, a fact which explains not only the great similarity, if not identity, in chemical composition that appears to exist between the superficial cuticle of many sponges and the spongin of their skeleton, but also the fact that the two may be directly continuous (*Spongilla*, Evans). The primarily cuticular nature of spongin skeletons further renders intelligible the frequent occurrence of a basal plate of spongin, serving for the attachment of the sponge, especially in sponges belonging to groups (*e.g.* *Clavulina*) in which a spongin skeleton is usually absent. In

¹ Quoted from Lendenfeld, *Zoological Record*, 1895.

one such instance, *Spirastrella decumbens*, R. and D., upgrowths from the basal plate, are said to give rise to a lamellar supporting skeleton (Keller, 1891). Where an internal fibrous spongin skeleton exists, it may be supposed to originate in the first instance either from the upper surface of the sponge body by an ingrowth of spongioblasts from the epithelium, or as an upgrowth from a basal spongin plate. An origin of the first kind would explain the very frequent inclusion in the fibres of foreign bodies of all kinds, which would be absent in fibres derived in the second way; two possibilities which appear to be realised in the two orders of horny sponges (see below).

In the case of the elastic fibrillae, on the other hand, the secretion is intracellular, and comparable to the formation of spicules (see below, p. 50). We thus have an interesting case of a skeletal substance being laid down either as a spicular (intracellular) concretion or as a cuticular (extracellular) cement. These two forms of spongin secretion run parallel to the two forms of mineral (siliceous) deposits already mentioned.

It must be acknowledged, however, that the details of the secretion of the spongin fibres still remain to be clearly investigated. Their cuticular nature is *inferred* from the relations of the spongioblasts to the fibres (see Fig. 50), and from the fact above mentioned of the similarity and even continuity between fibres and cuticle.

The apparent parallelism between the secretion of spongin and of silica suggests strongly the possibility of an interchange taking place between these two forms of skeletal material, whereby one might become substituted for the other in a given instance. Similarly in *Acanthometridae* the siliceous skeleton of other Radiolaria is replaced by an Acanthin skeleton (see Protozoa). Such a substitution is further indicated by the spongin spicules of *Darwinella* (see below, p. 141), upon which investigations are urgently needed to throw light upon this point.

An aberrant type of spongin secretion is said to occur in *Stelletta siemensi* (Keller, 1891) in the form of spherical or oval bodies, each in a follicle-like cavity surrounded by a layer of epithelial cells; but some scepticism is perhaps permissible as to the true chemical nature of these bodies.

(c) *Histology*.—It has already been seen that the *Olynthus* of a simple calcareous sponge is composed of five classes of cells; four of these, namely, flat epithelial cells, skeletogenous cells, collared cells, and archaeocytes, are found in all sponges, each giving rise to several sub-classes. Porocytes have not, however, been recognised as yet in sponges other than *Calcarea* as clearly as could be desired.

(1) *Dermal Epithelium*.—In all sponges an external layer of flattened epithelium is present, though it may apparently degenerate in places into a cuticular covering. With a few exceptions the nature of this epithelium is remarkably uniform, consisting of a

single layer of flattened, plate-like cells (*pinacocytes*, Sollas), with a large spherical or slightly compressed nucleus lodged in the thicker central portion of the cell. Mutual contact between the cells produces a network, with polygonal meshes, of cell outlines, often visible in the living condition, and usually demonstrable without difficulty by means of the silver nitrate reaction. In a few exceptional cases the flat epithelium is ciliated, as in *Oscarella*, *Aplysilla*, and perhaps in some other cases.¹ It is often covered externally by a cuticle secreted by the cells.

The form of the epithelial cells may become greatly modified, as has been described, as the result of contraction, which may cause them to assume a shape like that of a mushroom with a bulbous stalk—the so-called flask-shaped or onion-shaped epithelium. In most cases this form is only temporary; in a few instances, however, it would appear to be the normal form of at least a part of the epithelium, especially where it is of a glandular nature. In *Halisarca* the epithelium of the outer surface—but not that lining the canals—is curiously modified in connection with the abundant secretion of mucus with which this form covers itself.²

In the most primitive sponges, as has been seen in the *Olynthus*, the dermal epithelium performs a variety of functions while remaining a uniform layer of cells. Apart from the fact that in the lowest forms the skeletogenous layer is recruited from it, and that its cells may even secrete spicules while retaining their epithelial position, the dermal epithelium commonly combines contractile (neuromuscular) and glandular functions. Thus in the *Calcarea* sphincters or specially contractile organs are formed simply of ordinary flattened epithelium. In the Hexactinellida we have no evidence of any contractility. In the Demospongiae the primitive condition may be retained or may be superseded in the higher forms by a differentiation of the cell elements corresponding to a physiological division of labour. A separation is effected between more internally placed contractile elements and a more external glandular and protective epithelium proper, and since in the latter the glandular elements may become further differentiated, we have two new groups of cell elements arising from the primitive epithelial cell.

The contractile cells or *myocytes*, Sollas ("contractile fibre cells," Schulze), are fusiform cells, lying below the epithelium, and often forming contractile mechanisms in connection with the larger exhalant or inhalant openings of the canal system. Such con-

¹ Lendenfeld at one time figured in all cases the flat epithelium as flagellated, but these flagella, with few exceptions, are to be regarded as "phantasms of the living."

² The figures of the epithelium given by Schulze (1877) for *H. Dujardini*, and by Merejkowsky (1878) for "*H. Schultzi*," differ considerably.

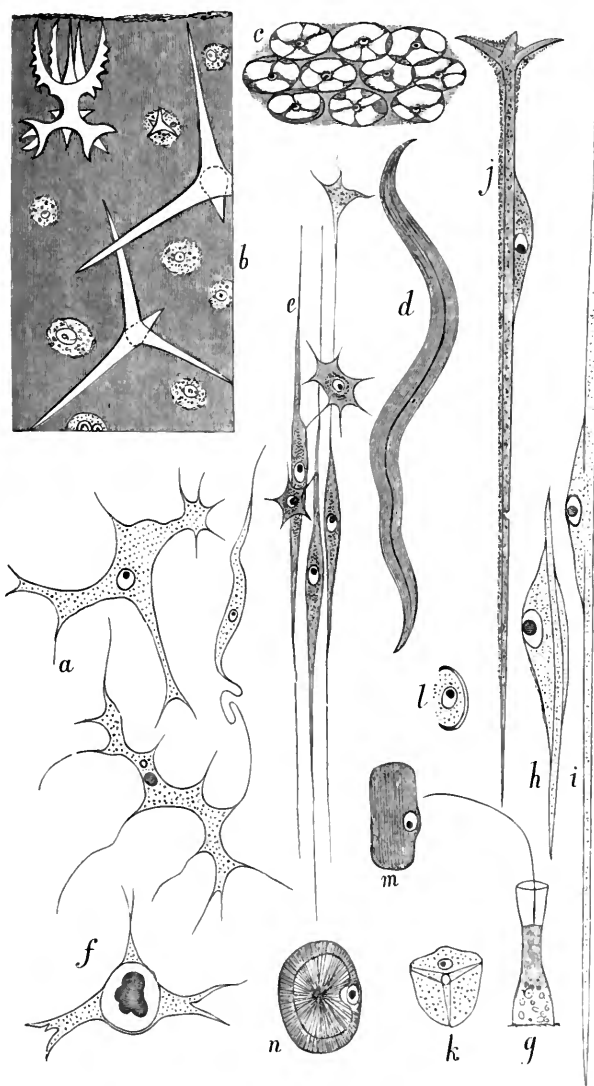

FIG. 49.

Histological elements. *a*, collencytes from *Thenea muricata*; *b*, chondrenchyme, from cortex of *Corticium candelabrum* (the unshaded bodies are microscleres); *c*, cystenchyme, from *Pachymatisma Johnstonii* (partly diagrammatic); *d*, desmocyte, from *Dragmastra Normani*; *e*, myocytes in continuity with collencytes, from *Cinachyra barbata*; *f*, thesocyte, from *Thenea muricata*; *g*, choanocyte, from *Sycon raphanus*; *h-n*, scleroblasts; *h* and *i* of rhabdi, from *Craniella cranium*; *j*, of a triaene, from *Stelletta*; *k*, of a tetracladine desma, from *Theonella winhoei*; *l*, of a sigmaspire, from *Craniella cranium*; *m*, of a dragma, from *Disyrringa dissimilis*; *ns*, of a sterraster, from *Geodia barretti*. (Figs. *b* and *g* after Schulze, the rest after Sollas.)

trivances are very common in Tetractinellids, and in their most elaborate form consist of a ring-like sphincter for closing the aperture, and a layer of radially arranged elements for opening it. In most cases only the sphincter is present. The cells resemble those of the flat epithelium in all respects except in form and position; in fact, it must be confessed that the fact of their being distinct and separate from the epithelium has often been assumed, on the theory of a mesoderm, rather than demonstrated.¹

Distinct glandular elements are not marked out in *Calcarea*, except perhaps in the more columnar form of the epithelium where the sponge is in contact with the substratum. In *Demospongiae* separate gland cells are often present, having, as has been said, a peculiar mushroom-like form. These cells are of special interest, since from them, it would appear, are derived the spongioblasts of the spongin fibres, which by their secretion form a very important addition to the skeleton.

The nature of the mushroom-like gland cells has frequently been misunderstood, it having been supposed that both the external disc-like portion and the more internal stalk contained each a nucleus of their own. In this way two cells were made out of one—an external flattened cell supposed to belong to the dermal epithelium, and a more internal glandular cell, decorated with processes of various kinds, considered as mesodermal or “subepithelial” in nature (von Lendenfeld). The external nucleus figured by this author is, however, non-existent, and the whole cell belongs to the dermal epithelium. In many cases, indeed, *e.g.* in *Calcarea*, the cells described as glandular are simply cells of the flat epithelium in a contracted state.

The spongioblasts are found as a sheath or “mantle” investing the growing spongin fibres. Each spongioblast is of columnar form (Fig. 50), resembling a mushroom-like cell of the epithelium, without, however, the terminal disc. In *Dictyoceratina* the spongioblast layer surrounding the fibres is said to be continuous with the epithelium at the surface of the body, where the tip of the fibre raises the outer skin. The question of the origin of the spongioblasts is one which is, however, urgently in need of renewed investigations, current theories being based more upon assumptions than upon observations, as in many other questions of sponge histology. When the spongin fibres are fully formed, the glandular spongioblast mantle disappears, its cells becoming, according to Schulze (1879), stellate cells of the skeletogenous layer.

Before leaving the epithelium there remains for consideration the question of nervous elements in sponges. The existence of special

¹ Thus Merejkowsky (1878) describes in *Halisarca* a muscular sphincter of fusi-form cells not covered by the “syncytium”; in other words, composed of cells of the flat epithelium.

epithelial or sub-epithelial nerve cells has been affirmed by Stewart (1885) for *Grantia compressa*, and by Lendenfeld (see especially [8]) for various sponges. Sollas also cautiously suggested a similar interpretation for certain elements observed in or near the sphincters of Tetractinellids, and proposed for them the term *aesthacytes*. No proof was at any time brought forward, however, as to the nervous nature of the structures in question, and at the present day the existence of any special nervous apparatus in sponges has become universally discredited, partly because subsequent investigations have been unable to confirm the alleged discoveries, and partly because some of the structures supposed to be sensory receive a simpler explanation in another way. For instance, the so-called "palpocils" and "synocils," described in *Calcarea* by Stewart and Lendenfeld, can easily be found in preparations of these sponges, especially if mounted in glycerine, as already noticed by Lendenfeld

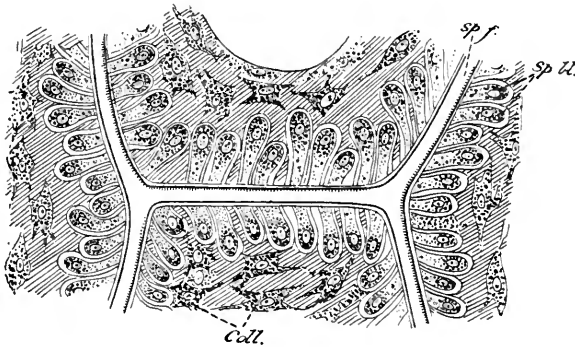

FIG. 50.

Growing spongin fibre, with spongoblasts attached (after Schulze). $\times 550$. *sp. f.*, spongin fibre; *sp. bl.*, spongoblasts; *Coll.*, collencytes.

(1891). They are nothing more than portions of the dermal epithelium raised up into a tent-like elevation by the projecting ray of a calcareous spicule, which has become dissolved in the preparation. In the interior of the papilla thus formed are seen the scleroblast or formative cells of the spicule, spread over the spicule sheath and running up to the tip of the ray; and it is these elements, and perhaps some others also, such as wandering cells, which have been erroneously identified as sense cells.

In the *Olynthus* there can be no doubt that the flat epithelium performs sensory functions of an elementary kind, but it exhibits as little special differentiation for this function as it does for that of contractility. In *Calcarea* generally the same state of things is found; reaction to external conditions is manifested both by the porocytes and by the flat epithelium, but the primitive condition of the dermal layer in this group makes it almost certain that nerve cells do not occur here. Of Hexactinellids nothing can be stated definitely either way. In Demospongiae it is not possible to deny positively *à priori* the existence of nerve cells,

for where contractile cells are differentiated, the existence also of special nerve cells is at least possible. It can only be said that the existing statements with regard to sense cells in sponges are, for the most part, quite untrustworthy, both in matters of fact and observation, as well as of interpretation, and that a complete scepticism with regard to this point is not only justifiable, but even demanded, in the present state of the question.

(2) *Porocytes*.—The description given above for the pore cells of the *Olynthus* may be extended, in its main features, to those of all Calcarea. The porocytes are large, coarsely granular, cells, very contractile, and capable of considerable migration by amoeboid movement. The pore duct arises by an intracellular perforation. In Heterocoela the porocytes form the chamber pores or prosopyles, the so-called dermal pores being intercellular ostia.

In *Clathrinidae* the pores are situated on the surface of the body, on a level with the dermal epithelium, but in *Leucosoleniidae* and in the allied Heterocoela (*Sycon*, *Leucandra*, etc.) the pore is placed at the inner end of a funnel-shaped depression, forming a short afferent canal. For such cells Bidder (1) has suggested the term *pylocytes*.

The origin of the porocytes, from the dermal epithelium, and especially from that lining the oscular rim, has been described above. In the latter region the same cell layer which furnishes porocytes gives rise also to sphincters or contractile membranes for closing the oscular opening, a fact which emphasises the contractile nature of the pore-forming cells. Besides their contractility, a remarkable feature of the porocytes is the readiness with which they give rise to skeletal structures of various kinds. Thus in *Clathrinidae* (and all Calcarea?) the fourth or gastral rays of the quadriradiate spicules are secreted each by a porocyte (see below, p. 108, Fig. 75, 4 and 5). Moreover, in many Calcarea (e.g. *Clathrina coriacea*, encrusting form) the porocytes pass into the gastral cavity between the collar cells, and give rise to a cellular network ramifying throughout the whole gastral lumen. The strands of the network are composed of porocytes placed end to end, and the axis of each strand contains a fibre which has the same staining reactions as the sheaths and axial threads of the spicules. The fibres appear to be formed as an intracellular secretion of the porocytes, which in this way furnish an elastic framework for the support of the delicate sponge body.

The porocytes were long overlooked or interpreted erroneously in Calcarea, and great doubt still attaches to their existence in non-calcareous sponges. A comparison with Calcarea would guide us to seek for them in the prosopyles, but there is as yet no proof that the prosopyles in siliceous sponges are intracellular ducts. Most authors have been unable to decide definitely as to the nature of the prosopyles, but

incline to regard them as intercellular gaps simply, formed by the epithelium of the incurrent canals dipping in towards an interval between the collar cells. On the other hand, the dermal openings of the incurrent canals in Demospongiae have frequently been described as intracellular ducts, especially in very young specimens (Carter, Maas, Delage). It is possible that the openings seen in these cases were those of true porocytes belonging to chambers in direct contact with the outer surface. That the ostia of the incurrent canals should be formed by intracellular perforations of porocytes would be a fact very difficult to interpret in the light of the general evolution of the canal system, as sketched above.

It seems, on the whole, more reasonable to assume at present, until the contrary has been proved, that in siliceous sponges also true (intracellular) pores are to be found at the prosopyles. In that case the prosodus would probably owe its origin to the elongation of a porocyte and its duct, and variations in this respect would explain the contradictory statements made in some cases (e.g. *Oscarella*) as to whether prosodi are present or not. The question is one, however, which cannot be settled without further investigation.

While the existence of intracellular pores, comparable to those of Ascons, is doubtful in siliceous sponges, there seems no doubt that cells comparable to the porocytes exist in a variety of siliceous sponges the so-called *cellules sphéruleuses* of Topsent (in part; see below, p. 59). The cells in question are of lobose, amoeboid form, densely packed with refringent granules, which obscure the nucleus; they resemble, in fact, the contracted porocytes of Ascons. They are very conspicuous cells, and it is therefore remarkable that their pore-forming function, if they possess any such, should not have been observed hitherto; precisely the same fact was, however, true of *Calcarea* until quite recently, porocytes having often been observed, but their relation to the pores overlooked.¹

In many siliceous sponges some of the very granular *cellules sphéruleuses*, which are here regarded as porocytes, secrete fibrils of an elastic substance differing so little in its nature from the spongin that cements the spicules, that it can only be regarded as a variety of it (Loisel [10]). The cells in question, which may be termed spongoblasts, are found sometimes isolated, sometimes in groups, but most commonly in rows, like a string of pearls (Fig. 51, *A*, *a* and *b*). The spongin makes its appearance near the

¹ A possible theory of the porocytes would be that they were cells of the dermal layer which in some cases have acquired a special ingestive or phagocytic rôle in addition to their other functions. Such cells would naturally tend to place themselves near the openings through which the currents enter the sponge body, and might eventually come to surround these apertures. This view would explain not only the alleged differences, mentioned above, in the position of the pore cells in calcareous and siliceous sponges, but would also explain their apparent absence in many of the latter, where it must be supposed that the ingestive mechanisms remain at a lower stage of elaboration. In support of the theory here put forward, it may be pointed out that the porocytes of *Calcarea* entrap and ingest larger bodies, such as Diatoms, which are often to be found in them.

nucleus as a minute spherule easily distinguished by its staining properties from the ordinary cell granules. The spherule grows in length and becomes a rod. The rods of neighbouring cells in each string unite to form a jointed fibre, each segment being separated from the next by an intervening substance less resistant to acids and alkalis (Fig. 51, *B*). The secreting cells next become spindle-shaped, and their contained rods become in consequence elongated and drawn out (Fig. 51, *C* and *D*). At the same time, their substance acquires a denser consistence, more tenacious and less soft. The result is a slender fibril, in which the segmentation gradually ceases to be visible, enclosed in a protoplasmic sheath. During this process the secreting cells gradually lose their

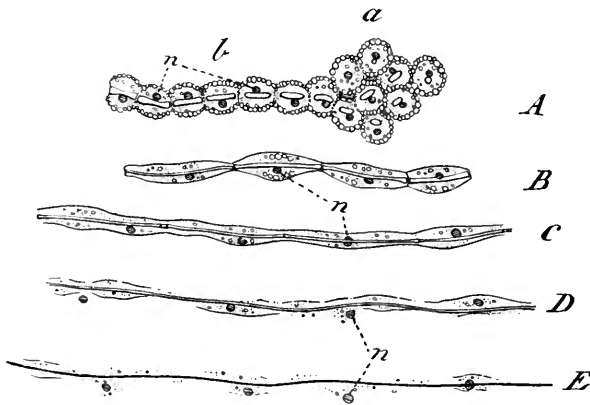

FIG. 51.

Diagrammatic representation of the formation of elastic fibrillae in the interior of spongo-blasts (porocytes?), after Loisel. *A*, spongo-blasts, each containing a minute, rod-like body, disposed irregularly at *a*, arranged in a row at *b*. *B*, the rods are uniting end to end to form a jointed fibril. *C*, later stage, the rods more elongate, and the cells now almost free from spherules. *D*, fibril continuous, cells commencing to degenerate. *E*, fully formed fibril, with adherent cell remnants; *n*, nuclei.

spherules until they are left with a clear cytoplasm and nucleus (Fig. 51, *E*). Finally, the fibrils come to lie free in the parenchyma, losing their enveloping cells, the nuclei of which appear to become scattered in the ground substance. The whole process of fibril formation is thus comparable to the secretion of the spicules, each joint being formed in precisely the same manner as a single monaxon spicule, while the whole fibril represents a number of spongin spicules joined end to end, just as a triradiate calcareous spicule represents a system of monaxons joined at a centre. On the other hand, the secretion of these fibrils appears to be in every way comparable to the secretion by the porocytes of a fibrillar framework in the gastral cavity of many Calcareia. It is therefore highly probable that the *cellules sphéruleuses* represent the porocytes of Calcareia,

and originate like them from the dermal epithelium, from which also arises the spongioblast layer, which by its secretion cements the spicules together. It is possible that the porocytes in siliceous sponges have only a skeletogenous function, and have not acquired any relation to the pores, but this question must at present be considered an open one.

(3) *The Skeletogenous Stratum* is developed to a very variable extent in different sponges. Scarcely recognisable in some, in others it attains great proportions, making up all but a relatively insignificant portion of the total bulk of the sponge body. It consists of a gelatinous ground substance or *mesogloea* ("maltha," Haeckel), which contains cells of various kinds. The mesogloea is the first portion to appear as a structureless layer between the dermal and gastral epithelia, and is probably a secretion of the former. Cells from the dermal epithelium next migrate into the mesogloea, forming a parenchyma which is concerned primarily with the task of furnishing skeletal structures for the support of the sponge body.

The separation, however, between the contractile (epithelial) and skeletogenous (parenchymatous) strata of the dermal layer does not amount to a very hard-and-fast distinction. As regards the function of secreting skeletal structures, we find not only that so important a constituent of the skeleton as spongin owes its origin apparently to cells of the epithelium which have secondarily passed inwards, but that even spicules may be secreted by cells of the epithelium which remain in their primitive position, as in *Leucosolenia*, *Spongilla*, and probably in many other cases. Further, in Ascons, and very probably in all Calcarea, the skeletogenous layer does not grow by multiplication of its cells amongst themselves, but their number is recruited throughout life by immigration of cells from the dermal epithelium; how far the same is true of other sponges has not been investigated. Hence the distinction between the epithelial and skeletogenous tissues is rather one dependent upon a gradual specialisation of function, differing in degree from one species to another, than upon morphological characters of fundamental importance, and there is no reason from the histological point of view for regarding the skeletogenous tissue as constituting a special layer or "mesoderm" possessing the same importance or independence as the dermal or gastral layers.

The cellular elements of the parenchyma may be classified at the outset into scleroblasts and connective tissue cells, the difference between the two being primarily one of function, according, that is to say, as a cell does, or does not, secrete a spicule. Of the two classes of cells thus marked out only one may be present in a given case. Thus in Ascons, and perhaps in Calcarea generally, connective tissue cells are absent, and though they have frequently been described, the cells which have been so interpreted are in reality merely scleroblasts or formative cells which, in the process of

section cutting, have become artificially separated from their spicules. In the Myxospongiae, on the other hand, the parenchyma consists entirely of connective tissue cells, none of which secrete spicules.

The connective tissue cells or *collencytes* (Sollas) are marked out by their clear protoplasm, free as a rule from coarse granules, and by their fine thread-like pseudopodial processes (Fig. 49, *a*). In both respects they usually stand in sharp contrast with the wandering cells or amoebocytes, abundant, as a rule, in all parts of the parenchyma, which in their more ordinary form are remarkable for their very granular protoplasm and thick lobose pseudopodia, giving the cell a form best compared to that of a potato. The collencytes have been observed during life to be actively amoeboid, sending out their thread-like pseudopodia and withdrawing them again. The pseudopodia of two neighbouring cells may come into contact and fuse temporarily. These changes of form may be accompanied also by changes in the position of the cell as a whole (Schulze, 1877, p. 16). As a rule each collencyte has several processes, but in other cases the number may be reduced to two, giving the cell a more or less elongate, bipolar form. Hence the connective tissue corpuscles may be distinguished as stellate and fusiform, the distinction being in most cases merely a temporary one, correlated perhaps with a particular position. By further specialisation, however, of one of these two forms of cells, and the acquisition by it of a definite form and characters, certain classes of tissue elements become marked out. Thus in most Demospongiae there are found special fibre cells or *desmacytes* (Sollas; Fig. 49, *d*), derived doubtless from bipolar collencytes, and furnishing the elements which bind the spicules together into sheaves and fibres to form a continuous skeletal framework or a special fibrous cortex. In other cases, again, the collencytes—probably in the first instance those of the stellate variety—acquire a vesicular structure resembling to some extent the vesicular connective tissue found in many invertebrates. Such cells are termed “cystencytes” by Sollas, and the tissue composed of them, “cystenchyme” (Fig. 49, *c*).

According to the nature of either the cells or the ground substance of the skeletogenous stratum, the body parenchyma may differ greatly both as regards histological characters and consistence in different cases. Sollas has distinguished a number of well-marked types of parenchyma by appropriate terms: *collenchyma*, where the ground substance is abundant, clear, and colourless; *sarcenchyma*, where, on the contrary, the ground substance is relatively less abundant and granular; *chondrenchyma* (Fig. 49, *b*), where the ground substance is dense and the parenchyma of cartilaginous appearance; and finally, *cystenchyma*, which has been mentioned above.

There remain finally for mention those elements of the dermal layer which secrete the spicules. The scleroblasts when separate

from the epithelium, which, as has been said, is not always the case, are usually at first rounded cells, within which a minute spicule appears as an intracellular concretion (Fig. 49, *k*). As the spicule increases in size it outgrows the secreting cell, which assumes the form of a fusiform or stellate corpuscle apposed to the shaft, or attached to the tip, of the growing spicule, and sometimes sending out processes towards other cells (Fig. 49, *h, i*). If the spicule formed is of large size, the cell, or at least its nucleus, commonly divides to furnish two or more formative cells. In *Calcarea*, where the scleroblasts migrate inwards from the external epithelium, they at first resemble the epithelial cells in being very granular, but as the spicule grows the granules gradually disappear, and at the same time the nucleus decreases slightly in size. In *Spongilla* the spiny microscleres are formed within cells of the flat epithelium which have the usual granular nucleus, but the macroscleres are formed within larger cells of the skeletogenous layer, of which the nucleus is at first vesicular in structure, but afterwards becomes granular (Evans). More than one scleroblast may combine together to form a compound spicular system, as in *Calcarea* (see below, p. 108).

In *Calcarea* the scleroblast, or at least one of the two formative cells derived from it, remains attached to the fully formed spicule. In siliceous sponges, on the other hand, no cells have as yet been described attached to the full-grown spicules, and hence it is probable that the scleroblast leaves the spicule when its task of secretion is completed, as occurs also in the case of one of the formative cells in the triradiates of *Clathrinidae*. This fact may perhaps be correlated with the development of a distinct connective tissue system in siliceous sponges, and its absence in the *Calcarea*. In the latter the formative cells that quit the spicules appear to go back to the external epithelium again [17].

(4) *The Gastral Layer* consists in all sponges of one kind of cell and one only, the so-called collar cells, aggregated to form an epithelium of a very peculiar and characteristic type, which furnishes a continuous lining to all but a small part of the gastral cavity, as in *Ascons*, or is broken up into discontinuous cell groups lining the flagellated chambers (see above, p. 32), as in all other known sponges. Each collar cell resembles, as has been said, a single choanoflagellate monad, their most striking characteristic being the possession of a protoplasmic collar surrounding the flagellum, as described above for the *Olythus* (cf. Figs. 52 and 53).

The variations of the collar cells or *choanocytes* of different sponges are limited in their range as compared with the free living, and therefore more adaptable Choanoflagellata. Differences are seen chiefly in the position of the nucleus, in the relative size, shape, and structure of the collar, and in the size of the cell as a whole. The largest collar cells are found in the *Calcarea*, and especially in the family *Clathrinidae*,

amongst which the species *Ascandra falcata*, H., is pre-eminent in this respect, and may be taken as a type (Fig. 52, A). The cells in question are columnar, and about half as long again as they are broad in the fully expanded state. When contracted they become narrower and more elongated, a change due to pressure of the surrounding tissues, and not probably to the activity of the collar cells themselves (Fig. 52, B, c). The large nucleus is lodged at the base of the cell, as is always the case in *Clathrinidae*, at least during the resting state of the cell. Each choanocyte is in contact with its neighbours for about two-thirds of its length, and the distal third forms a freely projecting "neck" (*collum*),

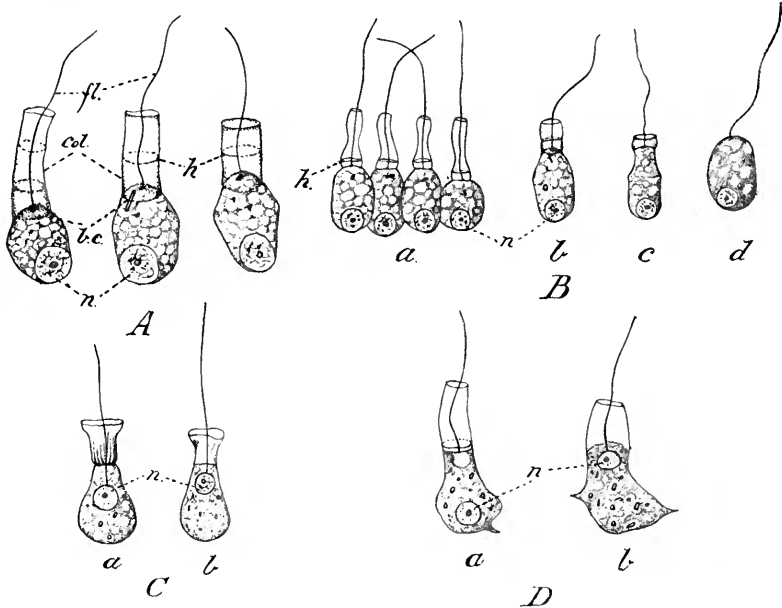

FIG. 52.

Collar cells of various sponges. A, of *Ascandra falcata*, H. B, of *Clathrina coriacea*, Mont.; a, fully expanded; b, less expanded; c, retracted down to hoop; d, condition of complete contraction. C, a, collar cell of *Sycon ciliatum*, Fabr.; b, of *Leucosolenia complicata*, Mont. D, a, collar of *Halichondria panicea*; b, of *Spongilla*; bc, base of collar; Col, collar; fl, flagellum; h, hoops supporting collars; n, nuclei. C, a, after Bidder; D, a and b, after Vosmaer and Pekelharing. D, $\times 1000$; A-C, \times about 850 or 900.

bearing the collar (*collare*). The junction of body and neck is marked by a distinct flange or "shoulder." The base of the collar encloses a mound of protoplasm continuing the neck, from the centre of which arises the flagellum.

The cytoplasm has a very distinct alveolar or vacuolar structure, and larger vacuoles—or it may be, one large vacuole—are commonly found at the upper extremity, just below the flagellum, representing very probably food vacuoles, by means of which the cell ingests food particles captured by the flagellum. Contractile vacuoles have been frequently described by older authors (e.g. James-Clark, the discoverer of the true nature of

collar cells, Savile-Kent, and others), but in more recent times they have not been seen by any observer, and their existence must be considered doubtful.

The cytoplasmic reticulum is clear and as a rule not very granular, but usually contains one or more coarse refringent granules, similar to those found in the dermal epithelium. There are commonly found also a few irregular granulations, perhaps food particles. The nucleus is rounded, slightly irregular in form, and always attached in *Clathrinidae* to the surface of the cell. It contains usually a distinct nucleolus, and an irregular, blotchy, nuclear reticulum.

The single flagellum is long, slender, and of even thickness throughout its length. It arises in *Clathrinidae* always from a distinct granule of peculiar staining properties, situated at the summit of the cell. When the cell is fully expanded, the flagellum in preparation appears homogeneous and difficult to see; but in the contracted state it is dark, granular, and apparently very brittle (Fig. 52, *B, d*). During life

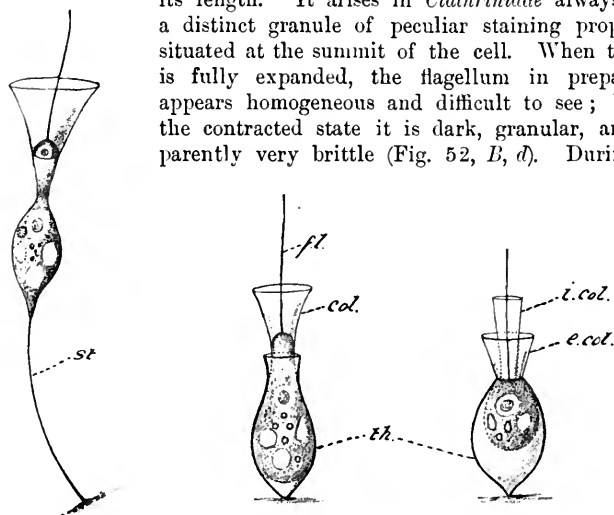

FIG. 53.

Choanoflagellata, after Francé. On the left, *Codonosiga botrytis*, J. Cl., $\times 350$, showing the commencing transverse fission. In the middle, *Salpingoeca fusiformis*, S. K., $\times 500$. On the right, *Diplosiga Entzii*, Francé, $\times 400$. col, collar; i.col, e.col, in *Diplosiga*, internal and external collar; fl, flagellum; st, stalk; th, theca.

it appears, in side view, to have a rhythmical stroke from side to side, with a longer pause on one side than on the other; the beats in the collar cells of *Sycon* are normally about ten to the second (Bidder). Seen in surface view the flagella show a whirling movement, each one moving quite independently of its neighbours (Vosmaer and Pekelharing [30]).

The collar, the most characteristic feature of the cell, is in *Ascandra falcata* a remarkable structure. When fully expanded it reaches a great length, far exceeding that of the cell, and is supported by two hoop-like thickenings or rings—one more proximal, which is very distinct, and one more distal, usually less distinct (Fig. 52, *A* and *B, h*). At the base, up to the first hoop, the collar is thickened and appears finely granular in optical section; beyond the first hoop it becomes much thinner, and its

distal extremity is often difficult to see, especially the actual opening. Hence these cells were at first described and figured by Carter and Dobie as having three flagella—a larger median and two smaller lateral. More usually the collar is found retracted down to the level of the second (distal) hoop, which then appears thickened and easy to make out. Frequently the collar is found still further retracted, and it often ends at the first hoop (Fig. 52, B, c). In the extreme case of contraction of the sponge, no collar is to be made out at all.

In *Clathrina coriacea* there appears to be but a single hoop, corresponding probably to the proximal hoop of *A. falcata*; and in *Sycon*, according to Bidder, the collar is fluted, being supported by about thirty vertical rods or thickenings (Fig. 52, C, a). Within the collar, at its base, Bidder describes a sphincter-like thickening (hoop?). In *Leucosolenia* the collar cells are very similar to those of *Sycon* (Fig. 52, C, b).

In Choanoflagellata, Francé (1897) describes the collar as originating by the folding round of a protoplasmic membrane or band, which runs up the side of the body and is twisted in a spiral round the base of the flagellum. Its structure could be imitated by twisting one end of a broad paper band or ribbon into the shape of a funnel. Nothing of the kind has been described in collar cells.

The details of cell division in the case of the collar cells have not as yet been studied in full, but in *Clathrina coriacea* this process is initiated by the nucleus travelling to the summit of the cell and taking up a position beneath the flagellum. The nucleus then divides, one half passes down, and the cell divides transversely to its long axis. The upper half, bearing the original collar, grows a new basal portion, into which its nucleus travels; the lower portion forms a new collar and flagellum.

In ontogeny the collar cells—that is to say, the ciliated cells of the embryo, which become the collar cells of the adult—have always the nucleus near the distal extremity, and the flagellum arising directly from the nuclear membrane, and passing out through the cell. This condition is retained in the *Leucosoleniidae* and most Heterocoela, and is probably the primitive state of things. When it occurs the larger vacuoles are found at the base of the cell, not at the summit. In *Clathrinidae*, however, the nucleus loses its connection with the flagellum, becomes attached to the side of the cell, and finally travels down to the base, leaving behind it at the upper extremity the distinct granule from which the flagellum arises, representing, perhaps, a centrosome (cf. Fig. 58, 5). It is interesting to note that, as described above, each collar cell in this family when about to divide commences by placing its nucleus in the primitive position at the apex of the cell.

In siliceous sponges the collar cells are much smaller than in Calcarea and often excessively minute. In *Halichondria* the nucleus is apical, as in *Leucosolenia*; in *Spongilla*, on the other hand, it is basal, as in *Clathrina* (Vosmaer and Pekelharing).

Much discussion has been carried on as to the existence of a membrane uniting the margins of the collars, described by Sollas in many Demospongiae, and hence termed "Sollas's membrane." It was asserted by

Sollas that the edges of the collars became united by concrecence, giving rise to a continuous membrane, perforated for the passage of the flagella (cf. Fig. 54). Recent researches have failed to confirm these statements (cf. Vosmaer, Pekelharing, and Bidder), and the appearances seen by Sollas are attributed to defective preservation. The matter cannot yet be considered as settled satisfactorily.¹

Before leaving the subject of the collar cells, it is necessary to mention the frequently alleged transformation of collar cells and their subsequent immigration into the parenchyma to recruit the ranks of other classes of cells. Bidder (1891) formerly asserted the origin of porocytes in Ascons from modification of collar cells, but this view is now hardly tenable in view of the recent investigations which put the origin of the porocytes from the dermal epithelium beyond a doubt (cf. Minchin [17]). More recently Masterman (1894) has asserted that collar cells when full fed become amoeboid and pass into the parenchyma as trophocytes (see below,

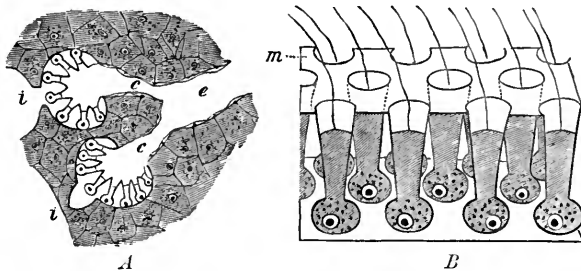

FIG. 54.

Choanocytes with coalesced collars (Sollas's membrane), after Sollas. *A*, longitudinal section through two flagellated chambers of *Anthastra communis*, Soll.; *B*, diagram of the fenestrated membrane produced by coalescence of the collars. *i*, prosopyles; *c*, aphodi; *e*, excurrent canal; *m*, Sollas's membrane.

p. 58), and that further, after having distributed their nutriment to the parenchymal cells, they take up waste products and migrate to the surface of the body, where they act as nephrocytes. It seems more than probable that these statements are founded on mistaken observations.

(5) *The Archaeocytes* represent in many ways the most important cell layer of the sponge, but at the same time the one which, up to the present, has been least studied. They are in their nature unspecialised cells, scarcely modified in structure from the blastomeres of the ovum, and capable of giving rise again, as sexual cells, to the whole organism or, in the gemmules, to any form of tissue (cf. Maas [12]). They stand, therefore, in sharp contrast to the tissue cells, which, having assumed definite morphological characteristics correlated with the performance of particular functions, are only capable of multiplying to form other cells like themselves. The

¹ Numerous descriptions and figures of collar cells have been published by Lendenfeld at various times, but it is not necessary to refer further to them here.

archaeocytes correspond to the germ cells of other Metazoa, but stand on a lower grade than those of any Enterozoa, in so far as the germinal cells here are not idle cells, set apart and biding their time to develop, but actually work for the whole cell colony, performing elementary functions of digestion, distribution, and probably excretion, like leucocytes in other animals. In sponges, to be brief, a leucocyte which has worked for the organism may become a germ cell. In other animals leucocytes and germ cells form two distinct classes of cells, though in Echinoderms at least they appear to have a common origin.

In accordance with these important facts the archaeocytes may be considered from two points of view: first, as wandering cells, or *amoebocytes*; secondly, as reproductive cells, or *tokocytes*. These two categories are not, however, to be regarded as two distinct classes of cells, but simply as two different *phases* in the activity of one and the same kind of cell.

(a) *Amoebocytes*.—The wandering cells of sponges are, as a rule, easily distinguished from other cells of the parenchyma by their lobose, rounded appearance, and the quantity of granules with which their cytoplasm is usually packed, and which obscure the nucleus in a general view of the cell. Very frequently more than one kind of wandering cell can be distinguished, according to the nature of the contained granulations, one kind having coarse, large granules, the other fine granules, as in *Clathrina contorta*. Since these granules are certainly to a great extent dependent upon the state of metabolism of the sponge, these differences may correspond only to variations in the functional activities of the same cell. In other cases, however, differences of function appear to have led to the establishment of well-marked and constant structural differences between the cells, which may affect both nucleus and cytoplasm. Thus in *Spongilla*, Fiedler (1888) has described two kinds of wandering cells which he has termed "Fresszellen" (*phagocytes*) and "Nährzellen" (*trophocytes*) respectively; the former which occur always near the free surfaces of the sponge body are concerned more especially with the ingestion, and perhaps digestion of food; the latter, found in all parts, appear to provide for its distribution. To these two classes must be added a third, belonging really to the class of trophocytes but specially charged, apparently, with the function of storing reserve material, and hence conveniently termed *thesocytes* (Sollas).

It is by no means beyond a doubt that the two classes of wandering cells distinguished by Fiedler have exactly the function which he attributes to them. The trophocytes frequently contain diatoms, and various bodies apparently of the nature of food particles taken up by them; hence their function may perhaps be phagocytic as well as trophocytic. Fiedler's phagocytes, on the other hand, may possibly possess an excretory

function. Their evenly granulated cytoplasm and their superficial position would both favour this view.¹

The thesocytes in *Spongilla* contain a large vacuole filled with substance of an amyloid nature, and in addition a certain number of solid amyloid grains. The presence of these substances is perhaps due to the activity of the chlorophyll corpuscles which the cells contain. For an account of their nature and their reactions to stains, etc., see Lankester (1882).

The thesocytes probably correspond in part to the *cellules sphéruleuses*, a name by which Topsent seeks to distinguish a class of cells found in all sponges, and frequently containing bodies of amyloid nature, representing reserve nutriment. The possession, however, of "spherules," i.e. of large refringent granules, is not one sufficient of itself to distinguish a class of cells. Topsent's *cellules sphéruleuses* are certainly porocytes in Ascons, and are probably the same in many other cases. In some cases, however, they may represent thesocytes, i.e. trophocytes charged with reserve materials. Loisel [10] has shown that in *Reniera* two classes of *cellules sphéruleuses* occur: (1) isolated cells containing nutrient amyloid bodies; (2) cells within which are formed the elastic fibrils. The former, in our opinion, would be thesocytes, the latter porocytes.

The three possible differentiations of the amoebocytes or wandering cells would therefore be ingestive cells or phagocytes, nutritive cells or trophocytes, and finally, storage cells or thesocytes. It is probable, however, that any wandering cell can perform each or all of these functions, and that the characteristics by which one or another of the different kinds of cells can be distinguished are of transitory nature, and mark simply a passing phase of the metabolism.

In addition to the large wandering cells, there occur in Ascons others of excessively minute size, not more than four or five μ in length, each with a minute, faintly staining nucleus and clear cytoplasm. They often occur in nests, as if they had originated from the breaking up of larger cells, and it is possible that this is the manner in which the ordinary wandering cells reproduce themselves in these sponges, and that each of these minute cells is destined in its turn to grow into an ordinary wandering cell. Their complete history is not as yet made out, but this view receives some support from the fact (1) that cells are commonly to be found showing every gradation of character intermediate between these minute cells and the ordinary wandering cells; and (2) that the numerous small cells produced in the ontogeny by breaking up of the posterior granular cells pass in the young sponge into the condition of these minute wandering cells (Fig. 58, 5, *am.c.*).

(β) *Tokocytes*.—From a purely histological point of view the reproductive cells may be regarded as a form of thesocyte, a tropho-

¹ It is not impossible that Fiedler's phagocytes might be simply porocytes (*cellules sphéruleuses*). Cf. footnote to p. 49, *supra*.

cyte in which the absorptive or anabolic power is increased, the distributive or katabolic function largely in abeyance. When special trophocytes exist, the tokocytes in their earliest stages resemble them in all points, and undoubtedly belong to this class of cell elements.

In sponges generally two classes of tokocytes can be distinguished: first, sexual cells or *gonocytes*, the mother cells of ova and spermatozoa of the normal type; secondly, gemmule cells or *statocytes*, such as compose the gemmule in *Spongilla*.

The gemmule cells will be discussed when considering the growth and development of the gemmules; it is sufficient here to say that they arise from the same stock as the sexual cells, and that both in appearance and potentialities they are comparable in every way to blastomeres of

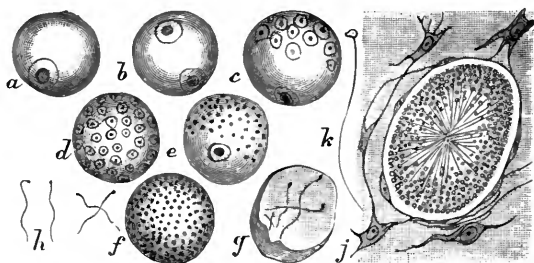

FIG. 55.

Sperm cells of sponges. *a-h*, development of spermatozoa of *Sycon raphanus*, $\times 792$; *h*, mature spermatozoa (after Poléjaeff); *j*, a sperm ball in *Oscarella lobularis*, $\times 500$; *k*, a mature isolated spermatozoon (after Schulze), $\times 800$.

the segmenting ovum. We may consider more especially the origin of the sexual cells.

The spermatogenesis has been studied in a number of forms, and appears to conform to one of two types. In the first type of spermatogenesis, which has been especially studied by Poléjaeff in *Sycon*, and by Fiedler in *Spongilla*, the male gonocyte or *spermatogonium* undergoes a division of the nucleus into two dissimilar nuclei, one of which travels to the periphery of the cell, while the other remains near or at the centre (Fig. 55, *a* and *b*). The protoplasm then segments off in connection with the peripheral nucleus to form a covering cell or *spermatocyst* surrounding a sperm mother cell or *spermatocyte*. The former may remain single (*Sycon*), or may divide again to form two covering cells (*Spongilla*). The spermatocyte undergoes repeated cell division by karyokinesis to form a number of spermatids, each of which becomes a spermatozoon in the usual way, the nucleus giving rise to the head, the cytoplasm to the tail. The result is a mass of spermatozoa or *sperm ball*, enclosed by a covering cell (Fig. 55, *c, d, e, f, g*). The second type of spermatogenesis is essentially similar, but differs in the absence of any covering cell, the whole spermatogonium giving rise to a sperm ball, which may be enclosed in an

adventitious envelope or follicle derived from the cells of the parenchyma (Fig. 55, j). In *Spongilla* also the covering cells tend to disappear and to be replaced by a similar adventitious follicle, which in this case may, however, enclose several sperm balls.

Nothing has as yet been made out with reference to the interesting phenomena of chromosome reduction, now so universally established in other animals. To judge from Fiedler's figures the number of chromosomes is small in *Spongilla*, apparently four in the germ cells and eight in the somatic cells (?). The detailed structure of the spermatozoa also remains to be studied.

The oogenesis and the maturation of the ovum has been studied in *Spongilla* by Fiedler, and more recently in *Sycon* by Maas [15]. As in other cases the history of the ovum may be divided into two periods—the first of *growth*, the second of *maturation*. The ova are formed in all parts of the body by growth of wandering cells.

In *Spongilla* each ovum becomes surrounded by a follicle formed of cells of the parenchyma, amongst which a certain number of trophocytes work their way. The trophocytes are concerned with the nutrition of the ovum; it is remarkable, however, that the granules in the two kinds of cells have different reactions, the nutriment received from the trophocytes being worked up by the ovum into yolk granules, which stain with *bleu de Lyon* in the way characteristic of such granules. When the ovum is full fed no more trophocytes are to be seen in the follicle, which by the growth and pressure of the ovum has assumed an endothelial character. The full-grown oöcyte has a large germinal vesicle containing a large central mass of chromatin or nuclear corpuscle.

During the maturation period the chromatin becomes concentrated and individualised into chromosomes. Two polar bodies are given off in the usual way.¹

The fertilisation has been studied only by Maas in *Sycon*. The spermatozoon penetrates the ovum before formation of the second polar body. The two pronuclei swell up and come together at the middle of the long axis of the ovum. They then break up to form the first segmentation spindle, in which maternal and paternal chromosomes can be recognised side by side, and distinct from one another. The axis of the spindle coincides with the longitudinal axis of the ovum. All subsequent cleavages of the ovum are preceded by typical mitoses.

¹ So Maas; Fiedler, on the other hand, describes the formation of the polar bodies, as well as the cleavage of the ovum, as taking place by means of a peculiar kind of direct division.

TABLE OF THE VARIOUS CLASSES OF CELLS.

Tissue-forming cells— <i>Histocytes.</i>	Dermal Layer .	{	I. Epithelial stratum .	{	1. Pinacocytes (<i>epithelial cells</i>).
			II. Porocytes .		2. Myocytes (<i>contractile cells</i>).
			III. Skeletogenous stratum		3. Gland cells.
	Gastral Layer .	{	IV. Gastral epithelium .	{	4. Spongoblasts.
			V. Amoebocytes (<i>wandering cells</i>) .		5. Pore cells.
	Archaeocytes (<i>primordial cells</i>)	{	VI. Tokocytes (<i>reproductive cells</i>) .	{	6. Scleroblasts.
VII. Choanocytes .			7. Collencytes (<i>stellate cells</i>).		
VIII. Statocytes .			8. Desmacytes (<i>fibre cells</i>).		
					9. Cystocytes (<i>bladder cells</i>).
					10. Choanocytes (<i>collar cells</i>).
					11. Phagocytes (<i>ingestive cells</i>), ¹
					12. Trophocytes (<i>nutritive cells</i>).
					13. Thesocytes (<i>storage cells</i>).
					14. Statocytes (<i>gemmule cells</i>).
					15. Gonocytes (<i>sexual cells</i>).

Historical Review of Sponge Histology.—The earlier observers by teasing up sponges with needles saw amoeboid cells and sometimes ciliated cells. The discovery of the resemblance of the latter to Choanoflagellata was made by James-Clark (1867), who, like most of his contemporaries, considered sponges as Protozoan colonies. It was Leuckart (1854) who first drew attention to the architecture of the sponge as a whole, and compared it to a Coelenterate. Haeckel (1872) formalised this conception, and termed the two layers composing the body wall *dermal* and *gastral* respectively. His names are adopted here in the same sense. The dermal layer, which he termed “exoderm,” and compared to the ectoderm of Coelenterata, was regarded by him as a syncytium, made up of fused cells, the protoplasm of which formed the clear ground substance of the parenchyma, while the nuclei with a small quantity of protoplasm formed the corpuscles. The spicules arose by crystallisation in the ground substance, a condensation of which around the spicule formed its sheath. The gastral layer (“entoderm”) consisted of the collar cells, from which arose the ova and spermatozoa.

Schulze in 1876 exposed the falsity of Haeckel’s syncytium theory by the discovery of the flattened epithelium. Although this was a great advance from the histological point of view, the conceptions of sponge structure which Schulze founded upon it were less happy, and in many respects further from the truth, than Haeckel’s views. He considered the flat epithelium to be partly ectoderm, partly endoderm, the collar cells

¹ It is possible that the phagocytes should be classified under the porocytes (see above, p. 49, footnote).

to be endoderm, and all non-epithelial tissues to be mesoderm. This view, which for twenty years has been dominant, has in many respects retarded our knowledge of the group, especially from the physiological point of view, since it has led to cells of very diverse nature being lumped together as mesoderm (see below, p. 85).

We reject here the mesoderm theory, both on structural grounds, which have already been explained (p. 51), and for further developmental reasons; the fact, namely, that the so-called mesoderm, with the sole exception of the wandering cells, does not represent a primary germ layer set apart once and for all in the embryo, but only a progressively specialised, and somewhat heterogeneous, portion of such a layer, which, in *Calcarea*, as already stated, is continually recruited from the dermal epithelium by immigration of cells. The view here adopted is nearer to that of Haeckel; sponges consist of a dermal layer (not a syncytium) and a gastral layer, together with a number of archaeocytes, not recognised by Haeckel. The homologies of these layers with those of other animals are questions which require special consideration.

3. *Reproduction and Development.*

In sponges generally three modes of reproduction may be distinguished. The first of these may be termed *vegetative* reproduction, and can only be distinguished from ordinary growth by its leading to the formation of new individuals by budding instead of to a simple increase in size in an individual already existing. The other two methods are effected by means of special reproductive cells (tokocytes), and may be distinguished as *asexual*, by means of gemmules or special reproductive bodies, and *sexual*, by means of ova and spermatozoa. The first and third of these methods are seldom absent, the second is less common.

(a) *Vegetative Reproduction.*—At the outset a distinction must be drawn between cases where the new individuals produced are set free (discontinuous budding), and where they are not (continuous budding). In the latter case the budding is in many cases difficult to distinguish from simple growth, and the distinction between the two processes will depend on the criterion adopted of individuality in the sponge organism (see below, p. 89). If the criterion taken be the embryological one, and each osculum be reckoned as the sign of an individual or sponge person, then the formation of a new osculum in a sponge colony may be regarded as a case of budding, which results in the addition of a new person to the colony. In some cases where the persons, in this sense, are distinct and well individualised, the term budding may be well applied, but in other cases the distinction between growth and budding becomes rather artificial.

Continuous budding, as above defined, is of almost universal occurrence amongst sponges, except in forms with well-marked

individuality, such as *Euplectella* and many other Hexactinellids, and a few Demospongiae, in which, so far, it is unknown. Discontinuous budding, on the other hand, is less common, though sufficiently widely spread in all the main groups.

The formation of free buds is seen in its simplest forms in the Ascons amongst Calcarea, and in *Oscarella* amongst Demospongiae. In Ascons a portion of one of the tubes is nipped off as a small spherical reproductive body, as described by Miklucho-Maclay (1868), though arbitrarily contradicted by Haeckel. In *Clathrina* buds are formed during the extreme state of contraction when the tubes have become perfectly solid, and the collar cells form a compact mass of rounded cells obliterating the gastral cavity. Tubes while in this condition are often seen to assume a moniliform-headed appearance, and each head or swelling breaks away and becomes a free, solid, reproductive body consisting of an external dermal layer, containing spicules and a central mass of rounded gastral cells. After drifting about for a time the bud fixes itself, expands to form anew its gastral cavity, and then by acquiring an osculum and pores develops into an *Olynthus*. In the far less contractile *Leucosoleniidae*, on the other hand, the reproductive body, formed in an essentially similar manner by becoming nipped off from the extremity of a diverticulum, is always hollow, its thin wall formed from the same elements as the wall of the sponge. It fixes in the same way as the buds of *Clathrina*, and develops into an *Olynthus* (Vasseur, 1878).

In *Oscarella*, according to Schulze, free buds are formed as papillae protruded from the surface, which become nipped off as little vesicles, each containing ciliated chambers, and surrounded by a flat amoeboid epithelium, which sends out pseudopodia. The vesicle becomes fixed and develops into a little sponge, apparently a minute Rhagon (see p. 125). Of quite a similar type is the formation of free buds in Hexactinellids, the result being the formation of a little Rhagon-like organism (Fig. 76), which in *Lophocalyx* may acquire an osculum before separation from the parent. In all these cases the bud is produced simply as a separation off of a portion of the body, and contains all the layers and tissues which enter into the composition of the parent organism. In *Tethya*, however, the budding appears to be of a different type, and is better considered under gemmule formation (see below, p. 67). It is of interest to note that in many sponges with free buds special adaptations exist, derived from the skeleton, for the purpose of extruding them from the parent body. Thus in *Lophocalyx* (Hexactinellida) the buds are carried outwards from the mother form by long spicules, which finally break off and set the bud free. Similarly in *Tethya* the reproductive bodies are pushed out by the growth of a long monaxon spicule, on the point of which the bud is, as it were, impaled, and in like manner the buds of *Aplysilla* are carried outwards on the tip of a spongin fibre.

The method of propagation by free buds has been successfully imitated in sponge culture by artificial cuttings. The horny sponge of commerce can be propagated in this way, but a considerable time is required for the cuttings to grow into a large sponge.

(b) *Gemmule Formation*.—This method of reproduction, though occurring also in many marine sponges of various groups (Topsent), is seen in its most typical form in *Spongillinae*, where its details have been carefully studied (see especially Zykoff [33]), and which may therefore be taken as a type of gemmule reproduction.

The gemmules are formed in the late autumn as a protection against the winter in Europe, but in the tropics they are more usually formed at the commencement of the dry season, during which the sponge is liable to desiccation. Each gemmule consists essentially of a local aggregation of wandering cells, that is to say, of trophocytes which become laden with refringent granules representing reserve material of the nature of food-yolk. A great number of such cells, which may be termed *statocytes*, migrate by their own activity into one spot in the skeletogenous parenchyma. The cells of the parenchyma then secrete round them an adventitious capsule forming the gemmule envelope (Fig. 56, *A*, *B*, and *C*, *i.ch.e*). The fully formed gemmule is a tough, seed-like body, and consists of a densely packed mass of statocytes surrounded by a special capsule. Each statocyte resembles in appearance a blastomere of a segmenting ovum; its large vesicular nucleus can scarcely be made out in the midst of the yolk granules with which the cells are crammed (Fig. 56, *C*). In the simplest cases the capsule may consist merely of a chitinous membrane; this may, however, be fortified by the addition of a layer of spicules, which may be either the ordinary microscleres of the parent sponge, as in *Spongilla*, or may be composed of special spicules not found ordinarily in the sponge, as in the case of the *amphidiscs* of *Ephydatia* (Fig. 56, *amph*).

The ripe gemmule is very resistant to vicissitudes of moisture and temperature, and in Europe remains dormant until the spring, the rest of the sponge dying away. The gemmules can be separated from the parent sponge, and then give rise each on germination to a tiny sponge individual; but in nature they seem more often to remain entangled in the skeleton of the parent organism, and to repeople it, as it were, on the approach of warmer weather, so that the sponges seem to die in the autumn and revive again in the spring. On germination the capsule bursts and the contents creep out, forming an irregular amoeboid mass. The statocytes multiply actively and become tissue cells of various kinds. The finer details of the process of cell differentiation remain to be accurately studied, but would appear to resemble in all essential points the transformation of the blastomeres into tissue cells during the embryonic development. In fact, *the gemmule is physiologically equivalent to the ovum at the close of segmentation, i.e. to a mass of blastomeres enclosed in a special capsule, and capable each of developing into one or another form of tissue cell, with the difference, however, that the statocytes are not derived like blastomeres from the segmentation of one*

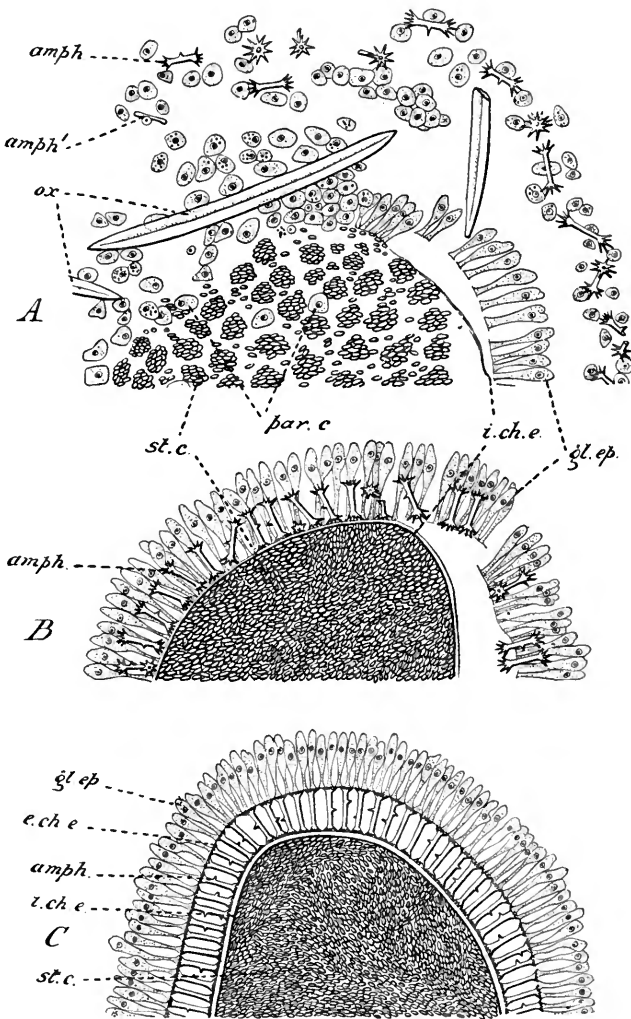

FIG. 56.

Three stages in the development of a gemmule in *Spongilla* (after Zykoff). In *A* the amoebocytes (statocytes), packed with refringent granules, are becoming aggregated at one spot, and the parenchymal cells round them are taking an epithelial form and secreting an adventitious, chitinous envelope; still further away, the amphidiscs are being formed in scattered cells of the parenchyma. In *B* the statocytes are densely packed and enclosed by the chitinous coat with its secreting epithelium; the amphidiscs are now passing between the cells of the latter. In *C* the amphidiscs form a definitely arranged coat internal to the secreting epithelium, which is now placed on the exterior, and is secreting a second chitinous envelope external to the amphidiscs. *amph*, amphidiscs; *amph'*, a young amphidisc; *i.ch.e*, internal, and *e.ch.e*, external, chitinous envelopes; *gl.ep*, glandular epithelium; *ox*, oxeote spicules of the sponge; *par.c*, parenchymal cells; *st.c*, statocytes or gemmule cells.

overgrown gonocyte, but represent each a separate germ cell, which has arisen independently of its fellows by modification of a wandering cell.

It is evident that were a gemmule to be composed of a single enlarged statocyte, a case would arise which would be difficult to distinguish from parthenogenesis. Such seems, as a matter of fact, to be the true interpretation of the "budding" of *Tethya*, in which, according to Deszö, each bud arises from one of a number of large cells, termed by him *Sprosszellen* (germinating cells). Each *Sprosszelle* is contained in a capsule in the cortex and gives rise by division to a multicellular reproductive body, from which a small sponge develops like a bud on the surface of the parent.

Gemmules, similar apparently to those of *Spongillinae*, have been observed by Topsent in many marine sponges, not only in forms allied to *Spongilla* (*Riviera*, etc.), but also in genera so far removed from it in the system as *Cliona* and *Craniella* (*Tetractinellida*).

(c) *Embryology*.—All sponges, so far as is known, develop by means of a ciliated larva, produced from a fertilised ovum which undergoes, in all cases, a total or holoblastic segmentation.¹ After swimming freely for a longer or shorter period, the larva fixes itself and undergoes a complete metamorphosis, after which it develops into a young sponge, with pores and osculum, which commences to feed and grow.

In *Cliona*, the boring sponge, the ova are extruded from the sponge before segmentation has commenced, and go through their whole development outside the maternal body. In all other known cases the ovum goes through its early development, up to the formation of the larva, within the maternal tissues. Hence the early development of sponges may be divided conveniently into three periods: (1) The *embryonic* period, from the ovum to the free swimming larva, usually passed within the maternal tissue; (2) the *larval* or free swimming period; and (3) the *pupal* period, from the fixation to the formation of pores and osculum.

There is scarcely any zoological problem which would appear, from a study of the literature alone, to be so confused and difficult as the embryonic development of sponges. The difficulty proves, however, to be due not so much to the nature of the objects themselves as to the many prejudices and preconceived notions with which they have been studied. We may commence the account of this chapter in sponge morphology with the life-history of a very simple and typical form, such as *Clathrina blanca*, in which the adult structure is in all respects similar to that of the *Olynthus* already described. The embryology of the remaining types may then be studied from a general point of view, by comparing, first, the various types of larva, and secondly, their metamorphosis and organogeny.

¹ For fertilisation see above, p. 61.

(a) *Development of Clathrina blanca*.—The ovum undergoes a regular and total cleavage, resulting in the formation of a hollow, ciliated blastula of oval form. The segmentation cavity is large, and con-

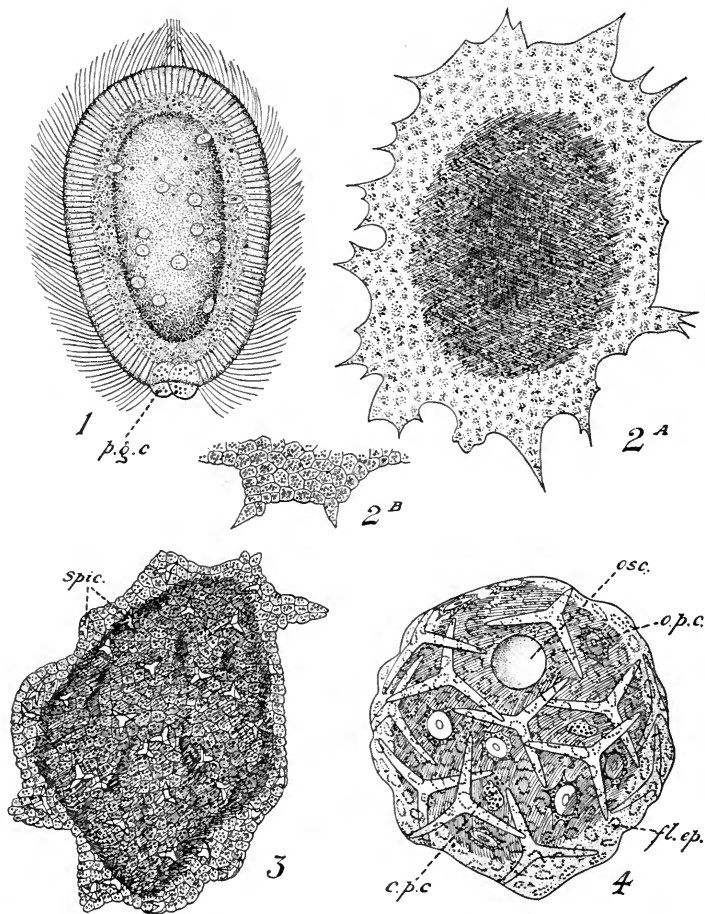

FIG. 57.

Development of *Clathrina blanca* seen as a living object with moderate magnification. 1, larva seen in optical section; 2A, pupal stage of the first day of fixation, metamorphosis complete; 2B, a small portion of the same a few hours later, showing a distinct epithelium on the surface; 3, pupa at the commencement of the third day after fixation, showing the young spicules and the gastric cavity beginning to form; 4, young sponge with pores and osculum, of the fifth day. *c.p.c.*, contracted porocyte; *fl.ep.*, flat epithelium; *o.p.c.*, expanded porocyte; *osc.*, osculum; *spic.*, spicule.

tains a coagulable fluid; its wall is composed of a single layer of columnar, flagellated cells, with compressed or onion-shaped nuclei. At one point, the future posterior pole of the larva, are a pair of

very large granular cells with vesicular nuclei, which represent undifferentiated blastomeres and are destined to give rise to the archaeocytes, and therefore also to the sexual cells of the adult. The flagellated cells, on the other hand, are the ancestors of all the tissue-forming cells of the adult.

The larva is hatched either in this condition or by retardation at a stage slightly in advance of it and swims freely for about twenty-four hours, first at the surface of the water and then near the bottom. Meanwhile, a new class of cell-elements is being formed by modification and immigration of individual cells of the flagellated parietal layer (Figs. 57 and 58, 1). Here and there a flagellated cell is observed to retract its flagellum, while its nucleus undergoes an alteration in shape and structure, becoming spherical, with more evenly distributed chromatin and with a nucleolus. The cell at the same time becomes more compact, draws in its more external portion, and finally migrates from the body wall into the internal cavity of the larva (Fig. 58, 1^a-1^d). As the result of this process, repeated often and at all points in the ciliated layer, with the exception of the extreme anterior pole, the larval cavity becomes filled with a mass of amoeboid cells, and the larva itself shrinks considerably in size. By the second day the larva, which is now ripe for fixation, has become a compact, planula-like organism, consisting of three kinds of cells: (1) The external layer of flagellated cells, destined to become the gastral layer; (2) an inner mass of amoeboid cells, the future dermal layer; and (3) the two still unchanged posterior granular cells. Larvae of this type are termed *parenchymulae*, and are found in the family Clathrinidae and in some Heterocoela.

The larva fixes by the anterior pole, or by one side, and undergoes a complete change of form and appearance, becoming a flattened plate with irregular amoeboid contours (Fig. 57, 2^A). In fact, at the metamorphosis it resembles nothing so much as a small *Amoeba*, whereas when free swimming it might have been mistaken for an Infusorian. At first cell-outlines are not clearly distinguishable on the surface, but towards the end of the first day of fixation the surface can be seen to be covered by a distinct layer of flat epithelium (Fig. 57, 2^B). The metamorphosis of the larva, when complete, is effected by means of radical changes in the relative positions and functions of the different cell-elements of the body (Fig. 58, 2). The majority of the cells of the inner mass of the larva have passed out to the exterior and acquired a superficial position, forming an epithelial layer, the future dermal epithelium enclosing the formerly external ciliated layer. This reversal of position is effected partly by dehiscence, the inner mass bursting out at some part of the larva and growing round the disrupted ciliated layer, and partly by diapedesis, the individual amoeboid cells struggling through the

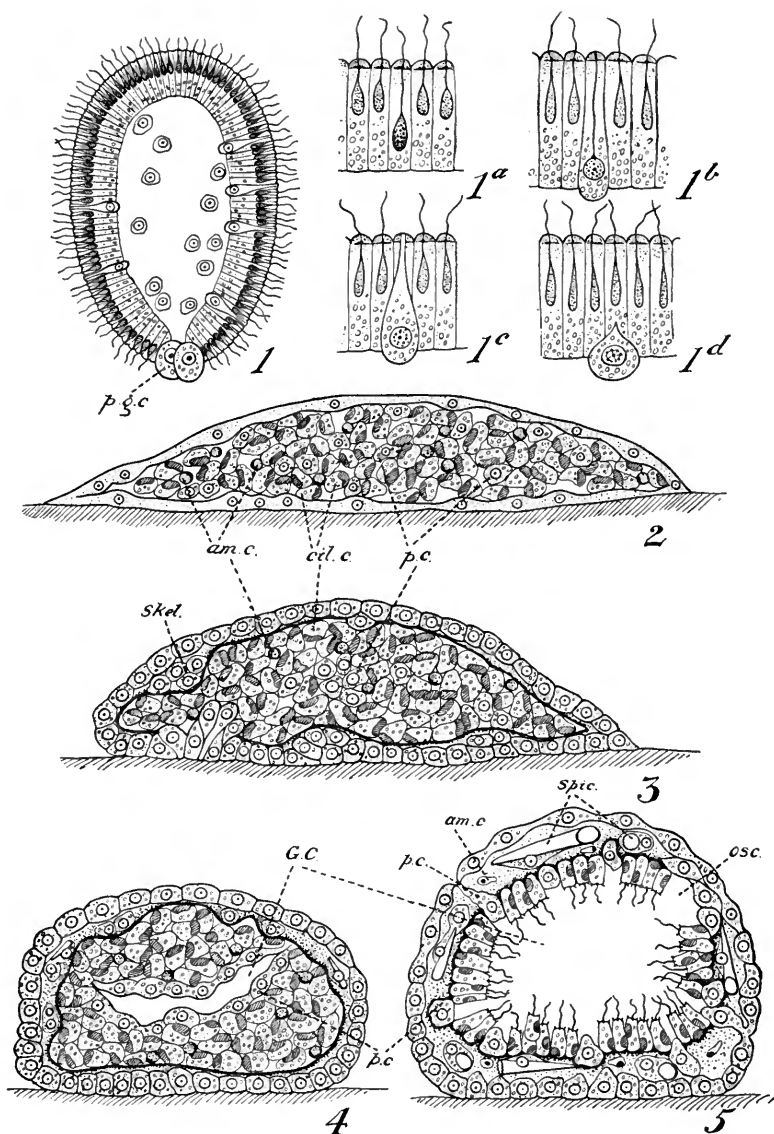

FIG. 58.

Development of *Clathrina blanca* as seen in sections. 1, larva; 1^a-1^d, four stages in the modification and immigration of a ciliated mass cell into the inner mass; 2, section of pupa after completion of metamorphosis (first day); 3, section of pupa on the second day. The immigration of cells from the dermal epithelium, to form the skeletogenous stratum, is going on actively, the porocytes are aggregated in the centre, and the gelatinous ground substance is making its appearance. 4, section of pupa early on the third day. The gastral cavity, lined by porocytes, and the spicules have appeared. 5, section of pupa towards the end of the fourth day. The gastral cavity is lined by gastral cells, which are commencing to develop collars and flagella, while their nuclei are migrating towards the bases of the cells. The spicules are large; the position of the future osculum is indicated; the porocytes are migrating outwards; and the amoebocytes have changed in appearance. *am.c*, amoebocytes; *cil.c*, ciliated cells; *G.C*, gastral cavity; *osc*, osculum; *p.c*, porocytes; *p.g.c*, posterior granular cells; *skel*, skeletogenous stratum; *spic*, spicules.

ciliated layer to the exterior. The epithelium of the upper surface and edges is formed by the first method (overgrowth), that of the central portion of the under surface chiefly by the second method (undergrowth). The ciliated cells of the larva have lost their characteristic form, becoming simply rounded, with an irregularly shaped nucleus attached to one side of the cell; they lie huddled together in a compact mass in the interior, and hence their flagella are very difficult to make out. Scattered amongst the ciliated cells are a certain number of cells of the larval inner mass which still remain in the interior and are destined to become the future porocytes. The greatest change is that undergone by the two posterior granular cells, which have become broken up into a great number of small corpuscles of peculiar aspect rather resembling some varieties of leucocytes. As a result of all these changes the pupa at the completion of metamorphosis, *i.e.* towards the end of the first day of fixation, consists of the following cell-elements: (1) An external, flat epithelium, derived from the inner mass of the larva, enclosing (2) a compact mass of cells, the formerly external ciliated cells of the larva, amongst which are (3) a few porocytes, derived from the larval inner mass, and (4) a great number of minute amoebocytes, derived from the two posterior granular cells of the larva.

The subsequent development is comparatively simple. On the second day of fixation the pupa becomes more compact, and by drawing in its marginal pseudopodia, assumes the form of a bun or cake (Fig. 58, 3). At the same time, a number of the superficial dermal cells have migrated inwards from the epithelium and taken up a position immediately beneath it, where they become grouped in trios to form the triradiate spicules, which arise exactly as in the adult (Fig. 58, 3, *skel*). In this way is initiated the division of the dermal layer into the external contractile and the internal skeletogenous strata. The porocytes meanwhile have become grouped together in the interior of the pupa. The results of these changes are better seen on the third day (Fig. 57, 3), when the young spicules beneath the epithelium have become very obvious; and at the same time the future gastral cavity has made its appearance as a more or less irregular space, or spaces, in the middle of the centrally placed porocytes, which at first form a continuous epithelium lining the cavity (Fig. 58, 4).

Towards the end of the third day the further enlargement of the gastral cavity causes the cells of the porocytic epithelium lining it to become separated and isolated from one another, so that the gastral cells come to form the boundary of the cavity. On the fourth day the pupa has grown in height, chiefly by the development of a now spacious gastral cavity, round which the gastral cells form in most places a single layer (Fig. 58, 5). The porocytes are migrating outwards, and are found either between the gastral

cells, or to the outer side of them, in the dermal layer, so that they begin to be visible on the exterior. The amoebocytes have assumed one of the forms under which they occur in the adult, but their further development has not been followed. The gastral cells begin now to assume a columnar form and the collar and flagellum begin to be clearly visible; they line the whole gastral cavity except at one spot on the upper side, where they are wanting, and the body wall is formed by the dermal layer alone, with an epithelium of porocytes towards the interior; this is the region of the future osculum and oscular rim.

On the fifth day¹ of fixation the pupa becomes a young sponge of more or less tubular form, with an osculum formed by a breaking through of the body wall, and with numerous pores, formed by canalication of the porocytes which now are placed quite superficially (Fig. 57, 4). The collar cells are well formed and functional, and the sponge begins to feed and grow.

In the above development it will be noticed that all the events which take place after the metamorphosis are similar to events which take place constantly during the life of the adult sponge. The spicules are formed by cells which immigrate from the external epithelium, exactly as in the adult, and even the way in which the first porocytes are separated off by the simple fact of their not migrating outwards, at the metamorphosis, in company with the remaining cells of the dermal layer, may be regarded as an abbreviation of the manner in which their numbers are subsequently recruited from the dermal epithelium. The formation of the gastral cavity, its relation to the porocytes, and the movements of the latter are repeated in the same manner and order every time the adult sponge expands itself after becoming completely retracted. In the same way the temporary heaping up and consequent disfigurement of the flagellated cells during the metamorphosis takes place also every time the adult sponge contracts itself, and is not in any way comparable to the immigration of these cells in the larva to form the inner mass, since in the former case no essential histological or physiological change takes place in the cells. Hence it is legitimate to compare the compact pupal stage which results from the metamorphosis to the adult sponge in its completely contracted stage, and it is evident that, were the pupa to expand itself at an early stage without further differentiation of its component cell layers, we should have the simplest conceivable form of sponge, one, namely, in which the body wall was made up of a gastral layer composed of collar cells; a dermal layer composed of flat epithelium and porocytes without a supporting skeletogenous layer; and finally, amoebocytes (archaeocytes) scattered about in the body wall.

A bird's-eye view of the whole life-history, from ovum to *Olynthus*, enables us to distinguish six distinct processes in the development:—

¹ Those dates represent what is probably the most normal course of events but are liable to great variations in different larvae.

- (1) Cell multiplication or segmentation of the ovum.
- (2) Primary cell differentiation into tissue-forming cells (histocytes) and primordial or reproductive cells (archaeocytes).
- (3) Secondary cell differentiation or separation of the histocytes into two primary germ layers (blastogenesis).
- (4) Rearrangement of the cell layers in accordance with their disposition in the adult (metamorphosis).
- (5) Tertiary cell differentiation or tissue formation (histogenesis).
- (6) Growth and acquisition of the body form (morphogenesis).

In *Clathrina* these six processes follow one another in the order here indicated, the first and second taking place during the embryonic period, the third during the larval period, the fourth at fixation, and the fifth and sixth, more or less intermingled, during the pupal period. We shall find that the great apparent differences between the various types of sponge development are in the main the outcome of changes in the order in which these processes occur, and in their relation to the three periods of development, such changes being combined with specific or morphological characters of comparatively slight importance. For instance, all cell differentiation may be thrown back to the embryonic period, thus coming to precede the metamorphosis, and in such cases the larval period is rendered barren, so far as developmental processes are concerned, and may be greatly shortened, lasting only a few hours. In some Ascons, on the other hand, e.g. *Clathrina cerebrum*, the pelagic larva may swim at the surface for three or four days.

(β) *Types of Sponge Larvae*.—In the absence of any knowledge of the developmental history of the Hexactinellids, we may consider first the Calcarea and then the Demospongiae. A very instructive evolutionary series is furnished by the larvae of calcareous sponges, for which the larva of *Clathrina blanca*, described above, may serve as a convenient starting-point.

The larvae of other *Clathrinidae* are parenchymulae very similar to that of *Cl. blanca*, but exhibiting variations in two important features. In the first place, the conspicuous posterior granular cells may vary in number in different species, there being perhaps only one, or as many as four, or even a yet larger number in some cases; or, on the other hand, they may be absent altogether, the body wall being made up entirely of ciliated cells. The latter condition is due in reality to the cells in question having become broken up into minute amoebocytes before the larval period instead of after fixation, and in such cases the inner mass of the larva contains two kinds of cells, which were regarded by Metschnikoff as "endoderm" and "mesoderm" respectively. It is interesting to note that all these variations in the condition of the posterior granular cells or amoebocytes may occur as abnormalities in one species (e.g. *Clathrina blanca*).

In the second place, the apparent absence of posterior granular cells in

some parenchymulae paves the way for an important variation in the mode of formation of the inner mass. We have seen that in *Cl. blanca*

TABLE OF TISSUE LINEAGE OF *CLATHRINA*.

Embryonic Period.	Larval Period.	Pupal Period.	Adult.
Flagellated cells (histocytes) . Posterior granular cells (archaeocytes)	Flagellated cells Amoeboid cells of inner mass Posterior granular cells . . .	Gastral (intestinal) cells . . . Dermal epithelium . . . Porocytes . . . Minute amoebocytes . . .	{ Collar cells . } Gastral layer. Dermal (contractile) epithelium } Dermal layer. Skeletogenous cells . . } Pore cells . . . } Wandering cells (amoebocytes) . } Primordial cells. Sexual cells (gonocytes) }
Blastomeres Ovum			

immigration of cells takes place at any point. When there are no posterior granular cells, however, the immigration may be entirely restricted to the posterior pole, so that the hindermost flagellated cells become con-

tinually modified and pass into the interior, their place being filled by the closing in of the ciliated layer. Thus three types of parenchymulae can be distinguished in the *Clathrinidae*, which may be tabulated as follows:—

Posterior Granular Cells.

1. Present
2. Absent
3. Absent

Immigration.

- Multipolar (Ex. *Cl. blanca*).
- Multipolar (Ex. *Cl. cerebrum*).
- Unipolar (Ex. *Cl. reticulum*).

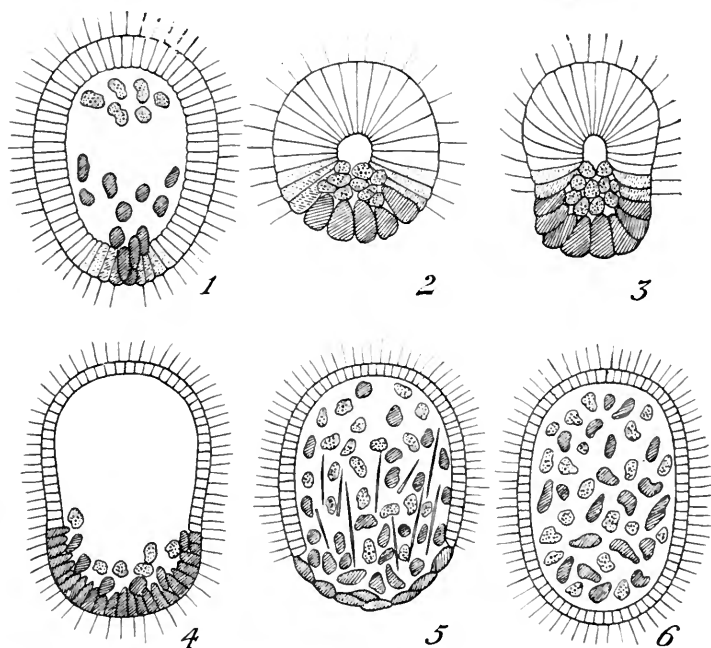

FIG. 59.

Types of sponge larvae, diagrammatic; the ciliated cells are left clear, the dermal cells (inner mass) are shaded, the archaeocytes are granulated. Transformation of ciliated (gastral) into dermal cells is represented by graduated shading. 1, larva of *Clathrina reticulum*; 2, newly-hatched larva of *Leucosolenia* (or pseudo-gastrula stage of *Sycon*); 3, late larva of *Leucosolenia* (or newly-hatched larva of *Sycon*); 4, larva of *Oscarella* (after Maas); 5, larva of *Maxilla* (after Maas); 6, completely ciliated larva of a horny sponge; *Spongilla* is similar, but contains a cavity near to the anterior pole.

The type of parenchymula larva exemplified by *Clathrina reticulum* (Fig. 59, 1) affords an easy transition to the so-called amphiblastula larva found in *Leucosoleniidae*, and in the great majority of *Heterocoela*. To understand the evolution of this type it is necessary to suppose that in a normal parenchymula larva with archaeocytes placed internally, and with immigration at the posterior pole, the segmentation cavity has become greatly reduced, and is practically filled up by the archaeocytes. The consequence of this will be that the ciliated cells which become modified into

non-ciliated dermal cells at the posterior pole must remain where they are, and do not immigrate into the interior. As the process of cell modification continues, there is a constantly increasing accumulation of rounded non-ciliated cells at the posterior pole. The result is a larva with two sharply differentiated regions, an anterior ciliated, and a posterior non-ciliated pole. Just such a larva is found in *Leucosolenia*, in which, when newly hatched (Fig. 59, 2), the non-ciliated region is absent or comparatively small, but increases continually at the expense of the ciliated region. Between the two regions is an equatorial zone of cells intermediate in their characters, and in process of modification, and the centre of the larva is occupied by the archaeocytes or *central cells*. The larva swims about until it is about equally composed of ciliated gastral cells, and non-ciliated dermal cells (Fig. 59, 3). It then fixes by the anterior pole, and the ciliated cells are overgrown by the amoeboid dermal cells. In other respects the development is essentially similar to that of *Clathrina*.

From the larva of *Leucosolenia* it is but a slight step to the well-known, but often misunderstood, development of *Sycon*. In this form the ovum undergoes a total and regular segmentation (Fig. 60, *a, b, c*) and produces a blastula, in which certain cells at one spot, the future hinder pole, are marked out by their larger size, and darker granular appearance (Fig. 60, *d*); these are the archaeocytes, comparable to the posterior granular cells in *Clathrina*.¹ The clearer cells (histocytes) become columnar, and acquire flagella, while the granular archaeocytes pass into the interior of the segmentation cavity, which they nearly fill, and are completely enclosed by the clearer cells; this is the so-called pseudogastrula stage (Fig. 59, 2). The cells at the hinder pole next begin to become modified in the usual way into rounded non-ciliated cells, comparable in every way to those of the inner mass of *Clathrina*, and the number of non-ciliated cells, at first small, increases continually at the expense of the ciliated cells, until the two kinds contribute to the composition of the embryo in about equal proportions. At this stage, when the blastogenesis is complete, the larva is hatched and swims freely; it is made up of columnar flagellated cells at the anterior pole, rounded, non-flagellated cells at the posterior pole, and a central mass of granular amoebocytes (Fig. 59, 3, and Fig. 60, *e*). During the free swimming period the ciliated gastral layer becomes partially overgrown by the

¹ The account here given differs from that of Schulze, who regarded these granular cells as the future dermal layer; for this reason Schulze distinguished the posterior non-ciliated cells of the amphiblastula as granular cells (*Körnerzellen*), from the flagellated cells, though as a matter of fact the latter are in reality the more granular of the two, since they contain yolk, which in the dermal cells becomes worked up and absorbed more quickly. The statements here made are based upon my own observations upon *Leucosolenia*, and the figures of Barrois for *Sycon* and *Grantia*; see also Dendy (1889).

non-ciliated dermal layer (Fig. 60, *f*), the cells of which may form precocious spicules, so that both the metamorphosis and the histogenesis may be said to begin before fixation and during the larval

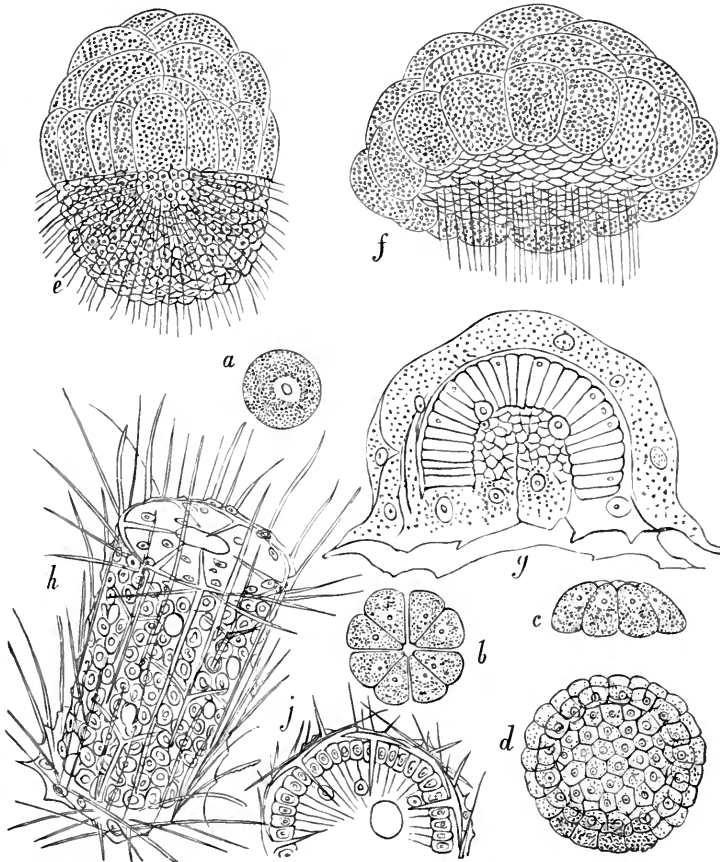

FIG. 60.

Development of *Sycon rophanus* (after Schulze). *a*, ovum; *b*, *c*, ovum segmenting—*b* as seen from above, *c*, as seen from the side; *d*, blastosphere with eight (?) posterior granular cells (archaeocytes), distinguished by their darker appearance; *e*, free swimming larva (amphiblastula); the more centrally placed archaeocytes are not seen; *f*, later stage of the same, showing the ciliated cells becoming overgrown by the non-ciliated; *g*, optical section of pupa in which the gastric cavity has appeared; note the two rounded cells, evidently porocytes, bordering on the cavity; *h*, *j*, young sponge (*Olynthus*) showing the newly-formed osculum with an iris-like contractile membrane from which the oscular rim is formed; *i* in side view, *j*, seen from above.

period. If we compare this larva with that of *Leucosolenia*, as described above, we see that it differs from it only in the fact that the germ layer formation is thrown back, so to speak, from the larval to the embryonic period, so that the *Sycon* amphiblastula

hatches in the condition in which the larva of *Leucosolenia* fixes itself.

In the Demospongiae it is not possible as yet to trace so complete an evolutionary series as in the Calcarea, since the gaps in our knowledge are still very great. No larvae are known amongst Tetractinellids or Aciculina,¹ while amongst Clavulina only *Cliona*, and amongst Dendroceratina only *Aplysilla* have been studied. On the other hand, the life-history of some of the more primitive types, such as *Oscarella* and *Plakina*, and of the Cornacuspongiae (*Halicondrina* and *Keratosa*) have been the subject of careful investigations. As a convenient starting-point the development of *Oscarella* may be selected.

Total and regular segmentation leads in *Oscarella* to the formation of an egg-shaped blastula, with a relatively thin wall which is composed of a single layer of columnar flagellated cells. Over the broader anterior half of the embryo the cells are shorter, and consequently the wall thinner than over the narrower posterior half; the spacious internal cavity is stated to contain no cells. In this condition the larva is born into the world, and swims freely for from twenty-four hours to three days. The anterior half or two-thirds of the larva is yellowish in colour, the posterior portion carmine red, with a dash of brown. During the larval life the differentiation of the germ layers takes place. The thin-walled anterior half, the future gastral layer, remains unmodified. The thick-walled posterior half, on the other hand, destined to become the dermal layer of the sponge, is the seat of considerable change. The cells in this region become more granular and of compact cubical form, and a certain number of them retract their flagella, become amoeboid, and immigrate into the internal cavity (Fig. 59, 4). The majority of the dermal cells, however, remain at the surface, and retain their flagella, a point in which *Oscarella* differs markedly from *Clathrina*, and which is correlated with the fact that in the former the dermal epithelium is ciliated throughout life. In consequence the internal cavity is very far from being filled up, and the larva, though now comparable to an amphiblastula, remains uniformly ciliated all over the surface. Observations upon the archaeocytes remain to be made. The larva thus constituted fixes by the anterior pole, and the gastral cells become invaginated and surrounded by the dermal cells.

In *Plakina* the segmentation is total and regular, and the larva emerges as an egg-shaped blastula of a rose-red colour, rather deeper at the narrower posterior end. The body wall is made up of columnar

¹ Since *Cliona* is known to extrude ova, which segment and develop into larvae outside the body, it is possible that the same mode of development explains the apparent absence of larvae in other Clavulina and in Tetractinellida, etc.

flagellated cells (Fig. 61, *a*). During larval life the cells become modified in their characters, and a certain number pass into the cavity, which is filled, as is commonly the case in sponge larvae, with a coagulable

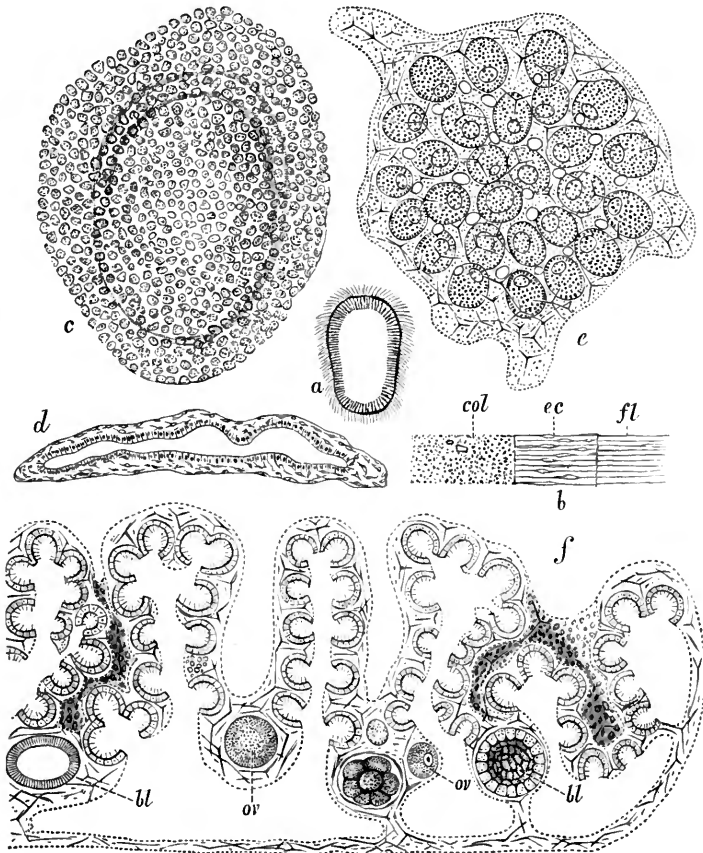

FIG. 61.

Development of *Plakina monolopha*. *a*, larva; *b*, section of the wall of the larva; *ec*, flagellated cells; *fl*, flagella; *col*, coagulum, representing, probably, an albuminous fluid filling the larval cavity, and containing immigrated cells of the flagellated epithelium; *c*, early pupal stage soon after fixation, the gastral cavity being formed by fission; *d*, section across the foregoing; *e*, rhagon stage, with pores, flagellated chambers, and osculum; the latter, not clearly shown in the drawing, is in the slight promontory in the middle of the left side; *f*, part of a section across a full-grown sponge. The attached basal layer is the hypophare: the spongophare (see below, p. 126) is folded to form incurrent and excurrent canals. *ov*, ova (between two of them a stage in the segmentation is seen); *bl*, blastulae. (After F. E. Schulze.)

(albuminous?) fluid. The details of the blastogenesis and of the metamorphosis remain, however, to be investigated. It is probable that they are, on the whole, similar to what occurs in *Oscarella*. In *Halisarca* also the statements are conflicting, and the details of the development are

not very intelligible. According to Metschnikoff, the blastula becomes filled at an early period by "rosette cells" (archaeocytes?). The larva when hatched is solid, with an inner mass enveloped in a layer of flagellated cells which show a differentiation at the hinder end of the body. According to Barrois the development is similar to *Oscarella*. Not much can be drawn from the development of either of these important forms at present.

In the *Monaxonida* and *Keratosa* a highly specialised but essentially simple type of larva is found. The segmentation of the ovum is total but unequal,¹ resulting in the formation of a compact mass of centrally placed *macromeres*, completely or partially surrounded by a superficial layer of *micromeres* (Fig. 62, *A*). The blastomeres next become differentiated *in situ* to form the larva. The micromeres develop into the flagellated gastral cells. The

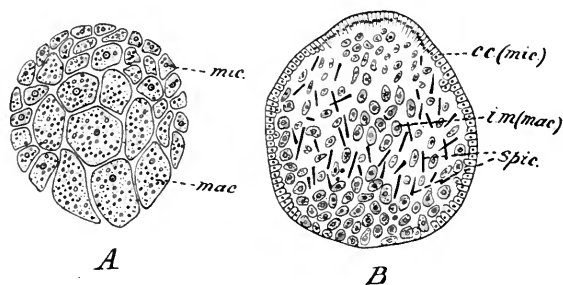

FIG. 62.

Two stages in the prelarval development of *Chalinula fertilis*. *A*, stage in the segmentation; *B*, later stage in which the histogenesis of the larva is advancing. *mic*, micromeres; *mac*, macromeres; *cc*, ciliated cells; *im*, inner mass; *spic*, spicules. (After Maas.)

macromeres, destined to become the dermal layer, do not remain uniform in character, but assume the structural peculiarities of tissue cells of the adult, such as scleroblasts, contractile cells, epidermic cells, etc., some finally remaining undifferentiated as amoebocytes (Fig. 62, *B*). In short, both blastogenesis and histogenesis take place during the embryonic period. The larva when set free has an enveloping layer of flagellated gastral cells, distinguished from the other cell-elements by the minuteness of their nuclei, and either completely enveloping the inner mass (*Dictyoceratina*, *Spongilla*; cf. Fig. 59, 6), or leaving it exposed at the posterior pole (*Halichondrina*, *Cliona*; cf. Fig. 63, *A*, and Fig. 59, 5).² The larva is therefore perfectly comparable to a parenchymula

¹ It may be doubted, however, if the unequal size of the blastomeres is really to be explained as due to a process of meroblastic segmentation comparable to that induced by the presence of food-yolk in many Enterozoa. It is more probable that it is simply due to the fact that the cells destined to give rise to the (smaller) gastral cells divide up oftener than those destined to form (larger) dermal cells.

² In *Aplysilla* the inner mass is said to protrude at the anterior pole (Delage).

or amphiblastula, in which histogenesis has early taken place. The larval period is very short, and fixation takes place by the anterior pole, the flagellated layer becomes broken up and surrounded by the inner mass. The pupal period, being occupied almost exclusively by changes of a morphogenetic nature, is also greatly abbreviated. The flagellated cells of the larva become arranged to form the chambers; the remainder of the sponge body arises from the larval inner mass (Fig. 63, *B* and *C*).

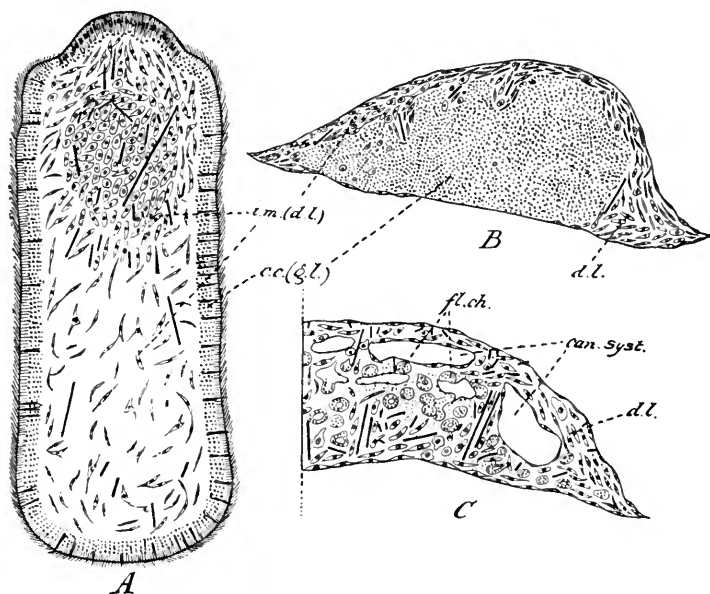

FIG. 63.

Three stages in the development of *Axinella cristagalli*, Maas. *A*, longitudinal section of the larva; *B*, early pupal stage soon after fixation; *C*, late pupal stage shortly before the formation of the osculum; one half only of the section is represented. *i.m.*, inner mass; *c.c.*, ciliated layer; *d.l.*, dermal layer; *g.l.*, gastral layer; *fl.ch.*, flagellated chambers; *can.syst.*, canal system. (After Maas.)

(γ) *Metamorphosis and Organogeny*.—Until the present decade it was almost universally supposed that in all sponges except those with an amphiblastula larva, such as *Sycon*, the ciliated layer of the larva became the dermal epithelium ("ectoderm") of the adult, while the inner mass furnished the collared gastral epithelium ("endoderm") and the connective tissue layer ("mesoderm"). The only point at all disputed was the origin of the flattened epithelium lining the gastral cavity and the canals. Most authorities agreed with Schulze (1884) in deriving from the "endoderm" the flat epithelium of the gastral cavity and of the excurrent canals from the apopyles to the oscular margin, together with the flagellated chambers themselves. The epithelium covering the exterior and lining the incurrent canals up to the prosopyles was supposed, on the

other hand, to be "ectodermal," and formed by flattening out of the ciliated layer of the larva. This mode of interpreting sponge development was more the result of *à priori* reasoning than of actual observation. The morphological similarities existing between sponge and Coelenterate larvae on the one hand, and between adult sponges and coelenterates on the other, led to the assumption that the metamorphoses of the larvae of the two classes were also of an essentially similar type, a belief which was seldom shaken by observation in the case of objects which present so many technical and practical obstacles to microscopic study as do sponge larvae. The development of *Sycon* alone stood apart, and was always difficult to bring into line with the supposed course of the life-history of other forms; and it is greatly to be deplored that Metschnikoff, whose accurate investigations first led to a true understanding of the development of *Sycon*, should have failed to see that the metamorphosis of *Clathrina* was of the same type.

In recent years the careful studies of Maas [11] and Delage [2] have shown the metamorphosis of the larvae of Demospongiae to be of quite an opposite nature to that of the Coelenterate planula, though easily reconcilable with the development of such a form as *Sycon*, since in both cases the flagellated cells give rise to the gastral layer, the inner, or posterior mass of typically non-flagellate cells to the dermal layer of the adult. These observations have been extended by the author to the parenchymula larva of calcareous sponges, and by Maas to the blastosphere of *Oscarella*. There remain at present only *Halisarca* and *Plakina* as types in which statements made under the influence of the older views remain uncontradicted and in need of reinvestigation. The more recent researches upon sponge embryology have made it possible, for the first time, to give a consistent and connected account of the development and to homologise the different types of sponge larva with one another.

Development of Spongilla.—As an aberrant type of sponge development it is necessary to mention that of the freshwater sponges (*Spongilla* and *Ephydatia*). About no other form has so much been written; in no other case are the statements so contradictory or the real facts of the development still so obscure. The questions at issue concern the metamorphosis, and more especially the origin of the ciliated chambers of the adult, on the one hand, and the fate of the flagellated cells of the larva on the other. Thus, according to Ganin, the flagellated cells of the larva become the "ectoderm" of the adult, and the chambers are derived from the inner mass; according to Götte, the flagellated cells of the larva are thrown off entirely, and the whole sponge develops from the inner mass; according to Delage, the flagellated cells of the larva become the ciliated chambers of the adult, but in a roundabout manner, being first devoured in a phagocytic manner by cells of the inner mass, which then carry them inwards and cast them out again to form the chambers, some, however, being entirely digested and absorbed during the process. Maas at first

took the view of Ganin, but later adhered to that of Delage, except as regards the phagocytosis. Finally, Nöldeke agrees with Delage that the flagellated cells are ingested in a phagocytic manner by cells of the inner mass, but believes them to be then completely absorbed, the whole sponge developing, as Götte supposed, from the inner mass alone.

The careful investigations, recently published, of Evans [34] show that, as might be expected from a comparative survey of sponge embryology, the flagellated cells of the larva do furnish the collar cells of the adult, but that they may be supplemented in this function by other cells of the larva in a very interesting manner. In the inner mass there are always to be found large granular cells, similar both in appearance and potentialities to blastomeres of the segmenting ovum or to cells of the gemmule, and marked out by containing a large amount of reserve food material (nutritive vacuoles and yolk-granules). These cells are to be regarded as archaeocytes, which are able to give rise to tissue cells of any kind; while, on the one hand, their destiny, so long as they remain unmodified, is probably to become the amoebocytes of the adult, they may, on the other hand, in their

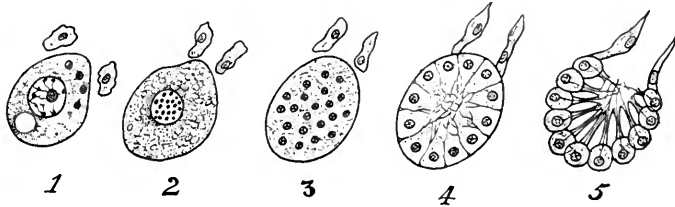

FIG. 64.

Five stages in the development of a flagellated chamber from a blastomere in the inner mass of *Spongilla*. 1, a blastomere and two cells of the inner mass; 2, the nuclear corpuscle of the blastomere has broken up into a number of chromatin bodies within the nuclear membrane; 3, the nucleus of the blastomere has become fragmented; 4, the small nuclei so produced have arranged themselves at the periphery of the cell, the cytoplasm of which is beginning to show lines of cleavage between them; 5, the original blastomere has broken up into a number of collar cells, arranged in a chamber; the two cells of the inner mass form part of the epithelium of the excurrent canal. Slightly schematised. (After Evans.)

capacity of reproductive cells (tokocytes) contribute towards either the dermal or the gastral layer. In the latter case they undergo a sort of fragmentation, affecting first the nucleus and then the cytoplasm, and resulting in the formation of a number of small cells, which, even during the larval period, arrange themselves to form a flagellated chamber, each cell acquiring the characteristic collar and flagellum (Fig. 64, 1-5). The histological composition of the inner mass varies greatly, even in the larvae of one and the same species of fresh-water sponge; in some specimens, chambers, in even their incipient stages of development, are almost or entirely absent from the inner mass; in others they occur abundantly and in various stages of formation. In the latter case the flagellated layer of the larva is perhaps partly absorbed at the metamorphosis, and the chambers of the adult are derived chiefly from those of the inner mass of the larva. In short, the development of *Spongilla* may take different courses in different instances, the end result being, however, the same in all cases. The way in which the chambers and other tissue-

elements arise from the primitive cells of the inner mass is exactly comparable to the origin of all the different kinds of tissue from the one kind of cell-element contained in the gemmule, or to the differentiation of a larva from the mass of uniform blastomeres derived from segmentation of the ovum; and it is probable that this aberrant feature in the larval development of *Spongillinae* is correlated with the acquisition by these sponges of the method of reproduction by means of gemmules, the peculiarities of which have been, or are being, acquired by the larvae also to a greater or less extent.

The main features of sponge embryology may be summarised as follows:—

I. The larva is composed of three classes of cell-elements: (1) Columnar flagellated cells, forming the outer covering or localised at the anterior pole; (2) rounded, more or less amoeboid elements, rarely flagellated, forming the inner mass or aggregated at the posterior pole; and (3) the archaeocytes, usually scattered in the inner mass and often represented by undifferentiated blastomeres.

(a) In the more primitive types the primary differentiation of the cells is into (1) flagellated cells (histocytes), and (3) primordial cells (archaeocytes), and the cells of the inner mass (2) arise by modification of a certain number of flagellated cells, others remaining unmodified as the flagellated cells of the ripe larva.

(b) In less primitive types the blastomeres of the ovum become differentiated *in situ* into flagellated cells, archaeocytes, and cells of the inner mass, the last named becoming still further differentiated histogenetically before or during the larval period.

II. The larva fixes and undergoes a metamorphosis whereby the flagellated cells become placed in the interior, while the cells of the inner mass come to surround them completely.

III. (1) The flagellated cells of the larva become the collar cells of the adult (gastral layer), acquiring a collar. No other tissue elements arise from them, but some (or all?) of the ciliated chambers may arise secondarily from undifferentiated blastomeres or archaeocytes (*Spongilla*); (2) the inner mass gives rise to the dermal layer in its entirety, that is to say, to the whole of the flat epithelium, the porocytes, and the connective tissue layer of the adult; (3) the archaeocytes become the wandering cells of the adult, from which the reproductive cells arise.

With regard to the transformation of larval flagellated cells into the collar cells of the adult, it should be borne in mind that the collar is specially developed when the sponge is actively feeding and becomes completely retracted when at rest. Hence its absence in the larva may be explained by the fact that the nutritive functions are temporarily in abeyance. Taking this fact into account, it is evident that the characteristic collar cells of sponges are direct derivatives, only modified in unimportant details of shape,

and so forth, from the flagellated cells of the larva, which in their turn are the earliest cells to be differentiated, and in the simplest types compose the whole blastula with the exception of the archaeocytes, the primitive germinal cells. The importance of these facts from the point of view of phylogeny cannot be too strongly emphasised.

III. THE PHYSIOLOGY AND BIOLOGY OF SPONGES.

The most important organ of the sponge, from the point of view of metabolism and nutrition, is the canal system. During life and activity the flagella of the collar cells keep up a constant flow of water through the sponge. The current enters at the pores or ostia, streams through the canal system into the gastral cavity, and passes out by the osculum. From the incoming current the sponge obtains its nourishment and a supply of oxygen for respiration; by the outgoing current the waste products of metabolism are removed from the body.

Although, however, the problem might seem a simple one, there is no question which has been so much discussed as the nutrition of sponges. The confusion that prevails is very largely due to imperfect knowledge of the structure of the sponge body. Since sponges are a group in which the cells are largely lacking in co-ordination and show a corresponding independence of action, it is evident that here physiology must to a great extent wait upon histology, and that a clear understanding of the latter is necessary before it is possible to form coherent ideas about the former. Hitherto advances in the physiology of sponge nutrition have been greatly hampered by an indiscriminate use of the word "mesoderm." Since under this term are commonly included cells so different in their nature as porocytes, skeletogenous cells, and amoebocytes, it is clear that not much is gained by ascribing this, that, or the other function to "mesoderm cells."

With regard to the ingestion of food two opposite opinions have prevailed, one set of investigators attributing an ingestive function to the collar cells, another set regarding the "mesoderm cells" as the true phagocytes. Those who hold the former view explain the presence of ingested particles in mesoderm cells as having been passed on to them by the collar cells. The true explanation seems to lie, as Metschnikoff (1892) has pointed out, between these two opinions. The "mesoderm" shows a great difference as regards its degree of evolution in different types. While in some, *e.g.* Ascons, the parenchyma is scarcely developed, in others it reaches a high grade of complication. In accordance with these differences the part played by the parenchyma in capturing food may, in some cases, be very slight, in others very great.

There can be no doubt whatever, from the numerous experiments that have been performed by various investigators, from Carter and Lieberkühn in the fifties up to Vosmaer and Pikelharing at the present

time, that in many sponges at least the collar cells are very active in capturing food. On the other hand, these cells are from their nature and size incapable of ingesting large bodies such as Infusoria or Diatoms. Food of the latter kind could only be absorbed by becoming entangled in the webs of tissue in the incurrent canal system, there to be absorbed by phagocytic wandering cells, or, it may be, by porocytes.

Considered generally, sponges present a gradual evolution as regards the power of ingesting food materials, corresponding to the evolution of the canal system. In the simplest forms, such as Ascons, microscopic food particles are ingested by the collar cells which line the whole gastral cavity; larger bodies, such as diatoms, may be captured by the porocytes, which close upon them like a trap when they enter the intracellular lumen of the pore. The collar cells represent, however, the chief "eating organ" of the sponge, to use Carter's expressive phrase.

In other sponges the complications of the incurrent system represent a progressive elaboration and perfection of an apparatus for assimilation, doubtless, in the first instance, of bodies too large to be absorbed by the collar cells. As the water passes through the inhalant canals and spaces, food in it is captured by cells in the parenchyma, either by phagocytic amoebocytes, or, perhaps, also by porocytes. The function of ingestion may finally be usurped almost entirely by cells in the parenchyma; the collar cells then become concerned only with the production of the current, their ingestive activities being in abeyance (Metschnikoff).

It should be added that, according to the investigations of Loisel [10], some sponges, at least, are able to absorb nutriment in solution, as well as in suspension. The cells of the epithelium exercise in such cases a selective power, well shown by experiments with stains acting *intra vitam*; some substances are permitted to pass through the epithelium into the parenchyma, while others are excluded.

Digestion is in most cases intracellular, ingested bodies being absorbed within cell vacuoles, as in Protozoa. It is possible, however, that, in the case of bodies too large to be so ingested, a kind of intercellular digestion takes place. Lieberkühn, whose accuracy as an investigator is above suspicion, saw Infusoria surrounded by wandering cells in the canals of *Spongilla*, and there gradually absorbed.

Circulation and distribution of nutriment is effected partly by wandering cells, partly, there can be no doubt, by the mesogloea, which acts as an internal medium between the cells and tissues. Loisel compares the mesogloea from the physiological point of view to the interstitial lymph of higher animals. Substances, either solid or fluid, are cast out into it from the cells, and then taken up again by other cells. On the other hand, the transport, especially

of solid materials, is effected largely by the wandering cells, which are capable of active migration.

Excretion in sponges is still a disputed point. Bidder ascribes it to the porocytes. Other authors attribute this function to the choanocytes, especially in those forms in which the parenchyma is most active in the capture of food. Loisel regards the mesogloea as performing the function of excretion by its own activity. Vacuoles and lacunae containing matter to be excreted arise in it and are emptied to the exterior by contractions of the mesogloea itself, aided by cell contractions. The matter must at present be considered very doubtful. There can, however, be little doubt that the wandering cells play a considerable part in excretion as well as in other functions.

Animal Functions.—Sponges in correspondence with the absence of a special nervous system show a great lack of co-ordination in the activities and movements of their cells. Thus the flagella of the collar cells do not beat in unison like the cilia of the epithelia in higher animals, but each works independently of the others (Vosmaer and Pekelharing [30]).

Sensitiveness to external conditions is often exhibited in a marked degree, but in such cases each cell placed superficially possesses this quality equally, and there is no class of cells marked out as sense cells by the possession of special physiological or structural characters. Contractility is probably a quality possessed by all sponges to a certain extent, and in some it is greatly developed. In all cases it appears to reside in the cells of the epithelial stratum of the dermal layer. Bidder, however, regards the power of contraction as largely due to elastic tension of the mesogloea, tending to bring about a contraction of the sponge if not opposed by the activity of the canal system. This, however, would hardly explain the epithelial sphincters often present.

Loisel, as we have seen, considers the mesogloea not merely endowed with passive elasticity, but as actively contractile. This would necessitate a very different view of the nature of the ground substance from that generally held, and requires confirmation before it can be accepted.

Statements have sometimes been made to the effect that the current of the canal system may be reversed and flow into, instead of out from the osculum. If these statements are not simply due, as is very probable, to erroneous observations, they might perhaps be explained, as Vosmaer and Pekelharing suggest, as follows. If, in a sponge with several oscula, one of them is pouring out a very strong current, it might act as a flue, so to speak, and cause the current in the other chimneys (oscula) to stop or even to flow inwards. The authors mentioned have also put forward a theory of the cause of the current through the canal system different from that generally adopted. According to their view the action of the flagella alone is incapable of causing a definite and continuous current, since they are not co-ordinated. The current which can be observed flowing out of the osculum is brought about by the disposition of the pores and the oscular

tube, which act as valves respectively, the former favouring an inflow and hindering an outflow, the latter having a contrary action. The beats of the flagella cause alternating, negative, and positive pressures in the interior of the canal system; the former cause water to flow in at the pores, the latter result in its ejection at the osculum. When the current is once well started it draws, like a flue, and so favours its own continuance, its action being comparable to the fly-wheel of a machine. Closure of the pores at once stops the current, without, however, causing any pressure in the interior, which would be dangerous to delicate tissues. The irregular beats of the flagella then simply cause eddies and vortices in the gastral cavity or chambers.

Bionomics and Natural History.—Sponges have a wide range of habitat and are found living under the most varied conditions of existence, from the shore-line, where they are continually subjected to most violent stresses and strains, down to the calm and placid environment of the ocean abysses. The influence of these different life conditions is seen especially in the body form and in the skeleton. Sponges living on mud or ooze show a further adaptation in the form of an anchoring root tuft (see above, p. 3). Fresh-water sponges require to be able to withstand greater vicissitudes than marine forms, whose environment, however boisterous, is more uniform. As an adaptation to life in fresh water we may mention the gemmules already described. Many siliceous sponges, belonging to families far apart in the system, have the power of excavating calcareous rocks or shells to form tunnels which they inhabit. The *Clionidae* are the best known instances of this. It is not clear how the perforation is effected. The sponge may in later life grow out of its excavations and become simply an incrusting or massive form of the ordinary type.

Animals so full of cavities as are sponges offer a shelter to many other creatures, some of which are always found as commensals of sponges; as instances we may mention various Crustacea, e.g. *Typton*, *Spongiicola*, and Hydrozoa, e.g. *Spongiicola fistularis*, F.E.S. (= *Stephanoscyphus mirabilis*, Allman), found in *Esperella*, and Anthozoa, e.g. *Palythoa* (Figs. 19, 24). Sponges themselves appear to be very distasteful to other animals and are eaten by very few. Some Nudibranchs, however, feed on them and may then mimic closely the sponges upon which they feed; as instances of this we may mention *Jorunna Johnstoni*, which feeds on *Halichondria*, and *Rostanga coccinea*, which lives upon red incrusting sponges. Both these Nudibranchs resemble the sponges upon which they respectively live, both in colour and in surface texture (see Garstang, *Conchologist*, ii. 3 (1892); and *Journ. Mar. Biol. Ass.* iii. 3, p. 220).

The distastefulness of sponges often leads to a symbiosis between them and other animals, especially crabs. *Suberites* commonly grows on the shells of hermit crabs, and soon absorbs the shell, so that the crab inhabits a cavity in the sponge. Other crabs cover themselves with bits of sponge which they plant on their carapace, on which the sponge grows and moulds itself. It is very probable that the distasteful and highly-smelling sponge protects the crab from the attacks of fish or cephalopods, imparting to it, as it were, its own qualities.

Sponges protect their bodies, and especially their apertures, against the attacks of intruders or enemies by fringes and palisades of spicules, and also by excretion of poisonous ferments from the surface of the body which have a strongly oxidising action (*Spongilla*, Loisel). It is perhaps to this that the smell of sponges is due.

As competitors sponges are very dangerous enemies to animals which feed in a similar manner, such as Lamellibranchs, since they grow over their shells and starve them by forestalling their supply of food. In oyster culture a method of preventing this is to grow the oysters on frames, which are occasionally pulled up and exposed during a shower of rain. The fresh water kills the sponges, but the oysters close their shells and are unscathed.

No adult sponge is known to be sensitive to light, but this property is often exhibited by the larvae in a marked degree. The larvae of Ascons are positively heliotropic when newly hatched, and swim at the surface. They then become indifferent to light for a time, which is followed by a third period, during which they are negatively heliotropic and swim at the bottom, previously to fixing themselves. The sensitiveness appears to reside in certain highly refringent granules in the ciliated cells, which in the amphiblastulae are aggregated at the inner ends. In many siliceous larvae there is a patch of pigment at the hinder end, which the larva tends to turn towards the light, with the result that the larva as a whole moves towards the dark.

Individuality.—The discussion of the morphology and physiology of sponges may well be terminated by attempting an answer to the question: What constitutes the individual in a sponge? The most divergent views have been expressed on this point.

The opinions that have been put forward with regard to the constitution of the sponge body by different authors depend, of course, largely upon the views held by them as to the affinities of the group (see below, p. 158). While most of the older writers regarded the cell as the unit of individuality in a sponge, more recent scientific opinion has sought to identify the sponge person with some form of cell aggregate—namely, either with the flagellated chamber, or with so much of the canal system as is centred round a single osculum.

The older observers regarded the sponges as Protozoan colonies, consisting of an aggregate of amoebae or Infusoria (Perty, Dujardin, Lieberkühn, Carter, and Savile-Kent), until the discovery by James-Clark (1867) of the collar cells, and their resemblance to Choanoflagellata, led him and others to regard them as a colony of Choanoflagellata. This view was taken up by Savile-Kent and Carter, the latter terming the collar cell the "spongozoon." At the present day these views and the controversies to which they gave rise have little more than a historical interest.

The view that the sponge person was represented by the flagellated chamber, held at one time by Carter, has its chief advocate in Haeckel, and is based upon a theoretical interpretation of the origin of the canal

system. We have seen that all the forms of canal system originate, in theory, if not in fact, by a folding of the wall of the original *Olynthus*, and that the flagellated chambers represent primitively diverticula of the body wall. Haeckel interprets this folding as a process of bud-formation, each fold representing a distinct individual, comparable to the original *Olynthus* from which it arose. In this way an *Olynthus* becomes in Ascons divided up by a process of gemmation into a number of incompletely separated individuals, united by a common osculum, and each diverticulum represents a bud, capable of becoming a new individual. A Sycon is an *Olynthus* which has undergone strobiloid gemmation, each radial tube being, as it were, a replica of the original *Olynthus*. At first (1872) Haeckel did not extend this theory beyond the second type of canal system, as seen in Sycons, and considered in the case of the third type (Leucons) that the canals arose simply by branching of the pores of an *Olynthus* with a greatly thickened wall. Hence in Leucons the osculum alone was supposed to be the mark of individuality. But since it was abundantly proved that the chambers in the third type of canal system were strictly homologous with those of the second type, Haeckel later (1889) extended this theory to Leucons and other sponges. In all alike the flagellated chamber was regarded as the individual produced by budding and comparable to a diverticulum of an Ascon or to the whole of an *Olynthus*.

In considering this view we may first take it as proved, not only that the flagellated chambers of the second and third types are strictly homologous one with another, but also that they are perfectly comparable with a diverticulum of an Ascon (see above). Any interpretation, therefore, of the morphological nature of the one applies also to the other. That being so, we may limit the scope of our inquiries to a consideration of the question, how far the diverticula of Ascons can be considered as buds. It is certainly true that each such diverticulum may grow out to form a new individual, with its own osculum. The question is, whether the diverticula in all cases are to be regarded as reduced buds, developed from the first as such, or whether, on the contrary, an outgrowth representing a simple fold of the body wall, may not have taken on the functions, so to speak, of a bud, *i.e.* of producing new individuals. The answer given will depend entirely on the theoretical conception adopted as to what constitutes budding, but it certainly seems a more natural and less strained interpretation of the facts to regard the diverticula simply as the result of a process of growth which results in the first instance in an extension of the body wall and an increase of the absorptive surface, and which may lead, in Ascons, to the formation of new individuals, but which in Sycons and other sponges does not, as a rule, do so. The gemmation theory leads in Ascons to a very artificial conception of the morphology of the sponge in cases where the diverticula anastomose into a network, as in *Clathrinidae*. Such a form as *Clathrina reticulum* (Fig. 6), for instance, would then represent many thousands of individuals. It seems more reasonable, therefore, even in Ascons, to reject the view that the diverticula of the body wall are to be regarded primarily as buds. In Sycons and Leucons this reasoning applies with even greater force, and we are unable therefore to accept Haeckel's theory of sponge individuality.

The view that the osculum is the sign of the individual, and that a sponge consists of as many persons as there are oscular openings, seems in every way the most natural conception, and it is certainly the conclusion to which embryology leads. Whatever the type of canal system, the metamorphosis of a single larva, or the development of a free bud or gemmule, results in the formation of a small sponge with a single osculum. Not until the osculum is formed can the sponge feed and grow, and perform its usual functions. The osculum represents, therefore, a physiological, as well as a morphological, centre, and thus presents from several points of view the most satisfactory criterion of sponge individuality.

Although, however, this view is theoretically the most feasible, it, nevertheless, often presents practical difficulties of application in particular instances. We have already seen that, on the one hand, a pseudogaster may be formed by folding up of the body wall so as to enclose a space, primitively external to the sponge, into which the true oscula may open like excurrent canals into a true gastral cavity; and that, on the other hand, a true gastral cavity may flatten out so that the excurrent canals may come to the surface and simulate oscula. In such cases the physiological criteria fail to enable us to recognise the individual, and life-history alone is a guide. Sponges offer great difficulties, in short, to any theory of individuality, and more resemble plants than animals in this respect. The primitively distinct and well-defined individuals become, by increase of the body surface in a vegetative manner, mere growths, *zoa impersonalia*, in which individuality is more or less completely lost.

IV. SYSTEMATIC REVIEW OF THE CLASSES AND ORDERS OF SPONGES.

Since sponges, with very few exceptions, possess a skeleton, composed either of minute spicules of mineral substance, or of fibres of organic nature, it is on the characters of this skeleton that the principal divisions are founded. At the outset one class stands apart from the rest, characterised by a skeleton in which the material is calcareous. Amongst the remainder another group is marked off with almost equal distinctness by the possession of six-rayed spicules of *triaxon* form. After the separation of these two classes, termed respectively *Calcareea* and *Hexactinellida*, there remains a vast assemblage of forms, in which the most divergent types are connected by such a complete and gradual series of intermediate forms, that they must be classified together as a single subdivision of the Porifera, equal in value to the other two. To this class the name Demospongiae has been given, and it comprises sponges in which the skeleton may be composed either of siliceous spicules of various types, but never triaxon; or of fibres of a horny substance, termed *spongin*, which occurs either pure or in

combination with siliceous spicules or foreign bodies ; or, finally, sponges in which a skeleton is absent altogether. By means of these various characters the Demospongiae are further subdivided into a number of smaller groups.

CLASS I. CALCAREA.

The calcareous sponges are a very sharply defined group of the Porifera. No forms are known in the remotest degree intermediate between them and the other classes. As their name implies, their chief characteristic is the possession of a skeleton made up of calcareous spicules, a feature correlated with many other distinctive points of organisation and structure which render a calcareous sponge easy of recognition.

From the point of view of evolution and morphology the Calcarea are of special interest, since in all cases the starting-point of the growth is the primitive vase-like *Olynthus*. The characters of the adult sponge depend upon the particular manner in which the *Olynthus* grows ; and calcareous sponges furthest apart in the system differ, in the *Olynthus* stage, only in the same trivial characters of spiculation or histology which are found in the adult as specific distinctions. The Calcarea thus present a most valuable and convincing demonstration of the theory of evolution. Nevertheless, the powerful attraction and stimulus which they offer to speculative and imaginative intellects has not been without its drawbacks, for in scarcely any other group is the classification and nomenclature in so confused a state ; and it might almost be said that as many systems of the Calcarea have been proposed as there are writers on the group. In spite, however, of this diversity of opinion, no classification of the group has been put forward as yet which can be considered in any way final ; and the most fundamental problems of their phylogeny and natural affinities are still in a very unsettled state.

Canal System.—Considered from the point of view of canal system alone, the Calcarea are divisible into two grades. In the first, the *Homocoela* or Ascons, are found the only known examples of the first type of canal system (see above, p. 31). In the second, the *Heterocoela*, corresponding to Haeckel's two families Sycons and Leucons, the canal system is of the second or third type. Thus in the *Homocoela*, as the name implies, the gastral layer is continuous, *i.e.* the collar cells line the whole gastral cavity ; in the *Heterocoela* it is discontinuous and restricted to the so-called flagellated chambers.

(a) *The Canal System of the Homocoela.*—In the Ascons the primitive *Olynthus* soon assumes a more complicated form, owing to the growth of the body wall being localised chiefly in two

regions; first, at the oscular rim, resulting in elongation of the tubular body; and secondly, at certain spots on the surface of the body, leading to the formation of hollow diverticula or outgrowths of the body wall. The diverticula grow out into tubes which become branched and anastomose with one another, giving rise to a more or less complicated network surrounding a central oscular tube, which represents the original *Olynthus* (Figs. 2-7). New oscula arise either by the perforation of the blind ends of diverticula growing out from the tubar system in a vertical direction, or by fission of a previously existing oscular tube. In the latter case the oscular tube, or, it may be, the primitive *Olynthus* becomes first infolded on each side in a longitudinal direction, so that the transverse section would have the shape of a figure of eight; and then, by meeting of the folds, two distinct oscular tubes are formed. In many cases the fission of the *Olynthus* or oscular tube may stop short of the osculum, so as to give rise to two tubes opening together by a single oscular aperture, and a similar process of longitudinal fission may bring about a multiplication of the tubes in any part of the body. In the stalked species of the genus *Clathrina*, such as *Cl. blanca* or *lacunosa* (Fig. 8), the tubar system arises chiefly by incomplete fission of the *Olynthus* and of the tubes thus formed, and scarcely at all by the outgrowth and anastomosis of diverticula; the latter method is, however, the most usual in *Clathrinidae*, and occurs always in *Leucosolenia*.

The full-grown Ascon individual or colony consists of two parts; a more or less complicated *tubar system* (*t.s.*), opening by one or more *oscular tubes* (*osc.t.*, Fig. 65). The gastral cavity is continued into all the tubes, which are lined everywhere by collar cells, their wall having in all parts the same structure as the primitive *Olynthus*, from which they arose. Between the tubes spaces are enclosed, which, as is obvious from their development, are really external to the sponge. In these spaces, which have been termed the *intercanal system* (*i.c.*), the water circulates before entering through the pores into the gastral cavity.

Two distinct varieties of canal system can be recognised in Ascons which are the result of slight modifications in the mode of growth, and correspond to considerable differences in the external form. In the first variety, characteristic of the family *Clathrinidae* (Fig. 65, *A*), the tubar system is greatly developed, and the oscular tubes are comparatively insignificant, acting as mere vents for the ramified network of tubes of which the body is composed. In the second variety, characteristic of the family *Leucosoleniidae*, the oscular tubes are large and conspicuous, and quite overshadow the tubar system (Fig. 65, *B*). The latter appears either as a series of diverticula from the erect oscular tubes, or as a system of narrow tubes uniting them basally like a stolon, and in both cases branching and giving rise to new oscular tubes. In the *Clathrina*

type the sponge has more the form of a growth, spreading or compact, without distinct individuals. In the *Leucosolenia* type the sponge appears as a collection of distinct *Olynthus* individuals, each throwing out diverticula on every side, from which daughter individuals arise by a process of budding. In *Clathrina* the intercanal system is greatly developed; in *Leucosolenia* the term can scarcely with justice be applied to the interspaces between the diverticula and oscular tubes.

In the family *Clathrinidae* the canal system, though always reducible to the type above described, may undergo certain secondary modifications which may be considered under two heads, according as they affect the gastral cavity or the intercanal system. As an instance of the former kind may be mentioned the frequent widening of the cavity of the

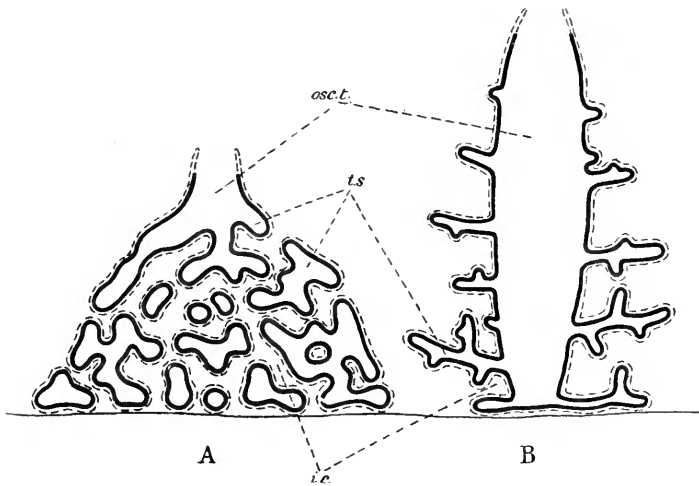

FIG. 65.

Types of canal system in Ascons. The thick black line represents the gastral layer, the dotted line the dermal layer; the pores are not represented. *A*, *Clathrina* type; *B*, *Leucosolenia* type. *osc.t.*, oscular tube; *ts*, tubular system; *i.c.*, intercanal system.

central oscular tube, until it assumes the appearance of a central cloaca or basin, into which the Ascon tubes empty themselves. This modification has reached its limit in the species *Clathrina tripodifera*, Carter (type of Bidder's genus *Dendya*), as described by Dendy (1891), in which the tubular system takes on a radiate arrangement round the very large central cloaca. In the genus *Ascandra*, on the other hand, the gastral cavity is divided up by folds of the gastral layer, which owe their origin to the great development of the spicule rays which project from the wall into the gastral cavity. The diverticula thus formed are not, however, in any way comparable to those seen in the oscular tube of *Leucosolenia*, since in *Ascandra* the folding does not affect the external surface of the body wall, but only the gastral layer.

Modifications of the intercanal system in the simple *Clathrina* type

take place chiefly in one of two ways. First, in compact forms the whole sponge may be enveloped in a sort of outer covering or skin, termed a *pseudoderm*, formed by outgrowths from the Ascon tubes situated most peripherally; as a consequence the primitively wide and irregular entrances between the outermost tubes into the intercanal system become reduced to small orifices termed *pseudopores*. Secondly, the intercanal system may become greatly enlarged towards the centre of the sponge, forming a false gastral cavity or *pseudogaster*. In consequence of these modifications of the intercanal system the sponge may secondarily assume the form of an *Olynthus*, well seen in the species *Clathrina*

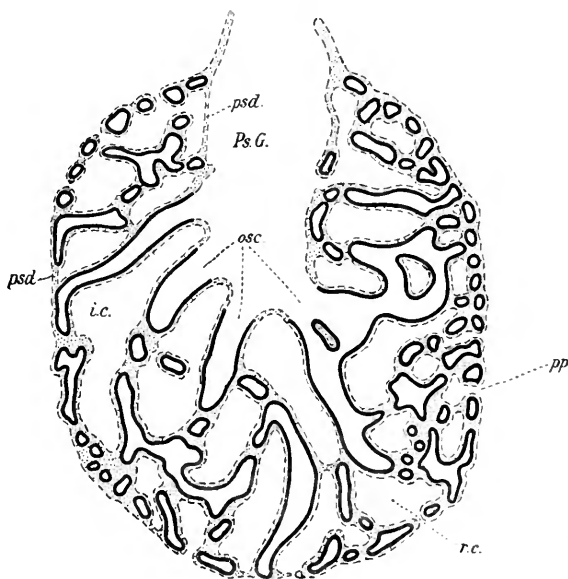

FIG. 66.

Canal system of *Clathrina ventricosa*, Crtr., seen in vertical section. *psd.*, pseudoderm; *Ps.G.*, pseudogaster; *osc.*, oscula; *i.c.*, intercanal system; *pp.*, pseudopores (*r.c.* on the right, should be *i.c.*). Schematised after Dendy.

ventricosa, Carter (Fig. 66). Here, however, the apparent pores are really pseudopores (*pp*) leading into the intercanal system (*i.c.*), and the apparent gastral cavity is a pseudogaster (*Ps.G.*), opening by a pseudosculum. The true oscula (*osc*) open into the pseudogaster, and the wall of the vasiform sponge is made up of the coiled Ascon tubes. A pseudoderm (*psd*) is formed towards the cavity of the pseudogaster as well as towards the exterior of the body wall. The two species *Clathrina ventricosa* and *tripodifera* offer striking examples of homoplasy, since a very similar form and structure is arrived at in perfectly different ways, and the large central cloacae, with their excurrent orifices, are not in the least homologous in the two forms.

The modifications of the canal system in the *Leucosoleniidae*, are such as are the direct result of the modifications of the external form which have already been described. It has been shown that the sponge may take on a bushy, arborescent, or creeping form (Figs. 3, 4, and 5). Since the canal system follows the external form in its arrangement, and is therefore easily understood by simple inspection of the sponge colony, it need not be further considered here.

(b) *The Canal System of the Heterocoela*.—In the calcareous sponges characterised by a discontinuous distribution of the gastral layer and its restriction to the flagellated chambers, the canal system may be of the second or third type, *i.e.* without or with a system of excurrent canals interpolated between the chambers and the gastral cavity (see above, p. 32). The sub-order *Heterocoela* comprises all the forms which were classified by Haeckel under the two families Sycons and Leucons, the former having a canal system of the second, the latter of the third type. The grouping of the genera of *Heterocoela* by characters of the canal system hardly corresponds with their natural affinities, but it is convenient to consider the canal system under its two grades, which we may term the syconoid and leuconoid types respectively. The best examples of the former are seen in the genus *Sycon*, and of the latter in the genus *Leucandra*.

The simplest syconoid type arises from the *Olynthus* by the formation of hollow diverticula of the gastral cavity, just as in *Leucosolenia*. The transitory homocoelous condition represented by the young sponge at this stage is, however, soon passed over. Ingrowths of the dermal layer into the gastral cavity take place between the diverticula (Maas, 1898), and as a result of this invasion, comparable to the similar ingrowths which in Ascons form the endogastral networks frequently present (see above, p. 48), the gastral layer becomes broken up and discontinuous, and confined to the diverticula or radial tubes, while the general gastral cavity becomes lined by a flat epithelium derived from the ingrowing dermal layer. The sponge has now reached the heterocoelous grade of structure, but even in the adult the upper portion of the oscular tube is often found lined by a continuous layer of collar cells which extend from the uppermost ciliated chamber to the commencement of the oscular rim, and represent a remnant of the primitively continuous gastral layer of the *Olynthus*. The ciliated chambers have received in Sycons the special name of *radial tubes*, and they differ further from the diverticula of *Leucosolenia* in that they remain relatively short, soon attaining their limit of growth, while those of *Leucosolenia*, as we have seen, continue their growth indefinitely and ultimately give rise to new oscula. Between the radial tubes spaces are enclosed on the exterior of the sponge which are perfectly comparable in every way to the intercanal system of Ascons, but

which are now better distinguished as the incurrent or inhalant system.

The further development of the syconoid type takes place chiefly by a narrowing of the primitively wide incurrent spaces between the radial tubes, which become closed in to form definite incurrent canals. In the simplest case (Fig. 67) a dermal membrane is formed by outgrowths from the extremities of the radial tubes, in exactly the same way as in the formation

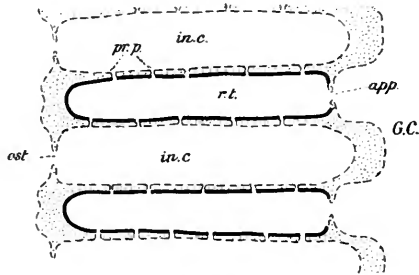

FIG. 67.

Section of the body wall of *Sycon gelatinosum*. The external surface is to the left, the internal surface to the right. *in.c.*, incurrent canal; *pr.p.*, prosopyle; *r.t.*, radial tube (flagellated chamber); *app.*, apopyle; *ost.*, ostium; *G.C.*, gastral cavity.

of a pseudoderm in Ascons, and the entrance to the incurrent space is thus narrowed to a circular aperture, the dermal pore or *ostium* (*ost*), comparable to a pseudopore of *Clathrina ventricosa*. The incurrent space becomes further reduced by coalescence taking place between adjacent radial tubes where they come into contact, thus interposing partitions, as it were, which divide up the continuous incurrent space. Finally, in many forms the dermal layer at the distal extremities of the radial tubes becomes thickened to form a *cortex*, through which the narrow incurrent canals pass to reach the radial tubes (Figs. 68, 69). These changes, and especially the formation of a cortex, have the effect of completely masking the folded and lobed appearance of the body wall, which results from the outgrowth of the radial tubes, and the outer surface of the body presents a smooth, porous surface, so that the form and appearance of the *Olynthus* may be perfectly retained (Figs. 9, 10).

In addition to these changes in the incurrent system, various modifications may take place in the radial tubes, or in their relations to the gastral cavity. In the first place, the radial tubes may become very much branched and secondarily complicated. A more important change, however, from the morphological point of view, is the formation of an excurrent duct connecting the radial tube with the gastral cavity—that is to say, the flagellated chamber is, as it were, carried outwards, and does not open into the gastral cavity directly, but communicates with it by means of a short duct lined by flattened epithelium. At the same time the excurrent aperture, or apopyle, of the chambers may become greatly contracted, appearing as a perforation in a diaphragm separating the chamber from its excurrent duct (cf. Fig. 67).

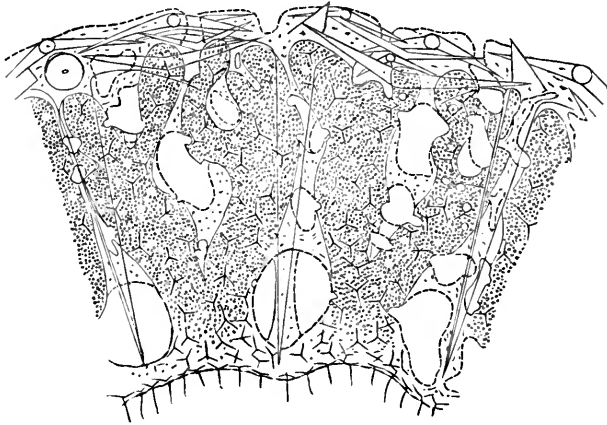

FIG. 68.

Heleropegma nodosgordii, Pol., part of a transverse section. The external surface is uppermost; the gastral surface towards the lower side; the spicules are represented by straight continuous lines; the flat epithelium by dotted lines; the collar cells by numerous small circles rendering the branching radial tubes dark. (After Poléjaeff, *Challenger Reports*.) $\times 50$.

The leuconoid type of canal system has probably been evolved from the syconoid type in more ways than one. There are at least two modes of evolution which can be indicated with tolerable

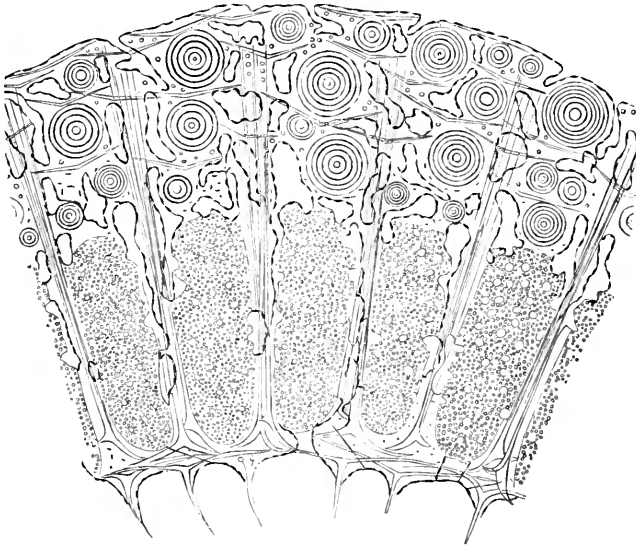

FIG. 69.

Ute argentea, Pol., part of a transverse section. The concentric circles indicate transverse sections of spicules, lying within the cortex. For other points see description of last figure. (After Polejaeff, *Challenger Reports*.) $\times 100$.

certainty. First, in some species of the genus *Leucilla* we find elongated chambers opening several together into short excurrent canals formed by folding or evagination of the whole wall of the gastral cavity (Fig. 70 ; cf. Fig. 44, *A*). Secondly, in other cases the excurrent system owes its origin to the further complication of excurrent chamber ducts such as have been described above in the syconoid type. Thus in *Leucandra aspera* (Fig. 71) a section of the wall of an oscular tube shows the flagellated chambers close to the margin of the osculum opening either directly or by means of an excurrent duct into the gastral cavity. Further down two or more chambers open by a common duct, which may now be termed an excurrent canal. This condition may be due either

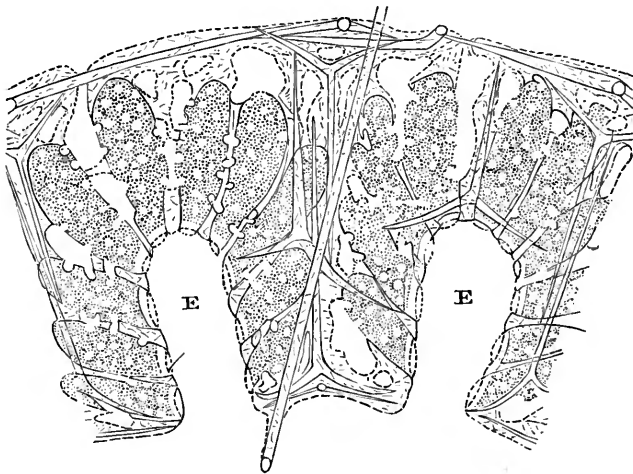

FIG. 70.

Leucilla connexiva, Pol., part of a transverse section. E, excurrent canals ; for other points see description of Fig. 68. (After Polejjaeff, *Challenger Reports*.) $\times 50$.

to the confluence of excurrent ducts primitively distinct, or to the multiplication of the chambers by division. The further removed any spot is from the oscular margin, the more the excurrent system becomes complicated, until a canal system of a typical leuconoid kind is produced. The excurrent canals may branch frequently, and the incurrent system is correspondingly complicated. The chambers, though varying greatly in size and shape, are for the most part small and rounded in form, and open directly into the wide excurrent canals. The canal system when fully developed is thus seen to be of the eurypylous third type. Aphodal and diplodal canal systems are not known amongst Calcareia. A leuconoid type, such as is seen in *Leucandra aspera*, is the highest development of the canal system in this group.

In the above account of the canal system of the *Heterocoela*, a *Leucosolenia*-like form, consisting of an *Olynthus* surrounded by numerous radial diverticula, has been taken as the starting-point, and this proceeding is the more justified, since the

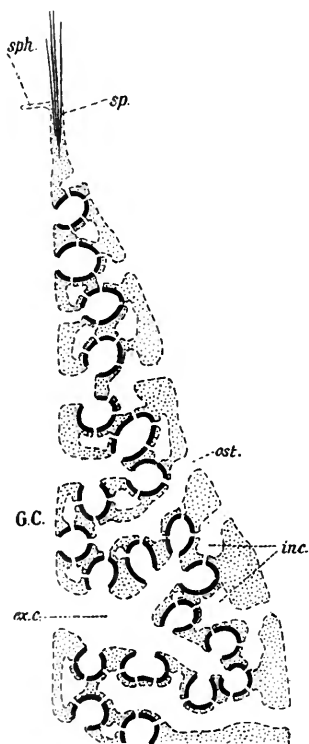

FIG. 71.

Vertical section of the osculum of *Leucandra aspera*, schematised; the thick black lines represent the gastral layer, the dotted lines the dermal layer. *sph.*, oscular sphincter; *sp.*, peristomial fringe of spicules; *ost.*, ostia; *G.C.*, gastral cavity; *inc.*, incurrent canal; *ex.c.*, excurrent canal. Combined from several sections.

majority of *Heterocoela*, and especially the genera *Sycon* and *Leucandra*, and their allies resemble the *Leucosoleniidae* in just those characters of skeleton, histology, and embryology in which the latter differ from *Clathrinidae*. There may be, however, amongst the *Heterocoela* forms which are to be referred back to a *Clathrinid* ancestor which has undergone modifications of the canal system more or less parallel to those which have been followed out above, and though the *Heterocoela* have not yet been studied from this point of view it is highly probable that this is the case. The genus *Ascandra* among *Clathrinidae*, with its folded gastral layer, represents a type of structure which might easily serve as the starting-point for the evolution of a heterocoelous canal system. The curious genus *Heteropegma* of Poléjaeff (1883), for instance, which in its outer form closely resembles a typical *Clathrina*, composed of a network of tubes, seems to be modified from a *Clathrinid* ancestor.

Skeleton.—In the class Calcarea the skeleton is composed of spicules of carbonate of lime in the form of calcite. The skeletal elements are typically quite separate one from another, but if united into a continuous framework, as is known to occur in at least one instance (*Petrostroma*), the union is brought about by fusion taking place between the spicules themselves, and not by means of spongin or any other form of special cementing substance. No distinction can be drawn in this group between megascleres (skeletal spicules) and microscleres (flesh spicules).

The calcareous spicules have a crystalline structure, and each spicule, whatever its form, behaves optically as a single crystal individual. Each spicule ray has an organic axial thread, and is

enveloped in an organic sheath, easily seen when the spicule is dissolved by acid. The mineral substance composing the spicule is almost pure calcite, with traces of sodium, magnesium, and sulphates (Ebner).

Forms of Calcareous Spicules.—Three types of spicule occur in calcareous sponges, the entire skeleton being composed of one or more of these types in varying combinations, namely: (a) monaxon ("acerate" or "oxeote") spicules, of the form of a simple rod or needle; (b) triactinal or triradiate spicules, each with three arms radiating from a centre; and (c) tetractinal or quadriradiate, consisting each of four rays. Of these three types of spicule, the second and third must be classed together, both being often considered as belonging to the tetraxon type; the triradiates, however, represent the more primitive form, to which, in the case of the quadriradiates, an additional ray has been tacked on. Each quadriradiate consists of a basal system of three rays, similar in all respects to a triradiate system, and of a fourth, "apical" or "gastral" ray. Hence the term triradiate system may be employed to denote either a triradiate spicule or the three basal rays of a quadriradiate. In considering, therefore, the modifications and variations of the calcareous spicules, the most natural course will be to discuss first the monaxons, then the triradiate systems, and lastly, the gastral rays of the quadriradiates.

(a) The monaxon spicules vary very greatly in size. They are sometimes straight (Fig. 72, r), but more often curved (Fig. 72, i, q, s), and always have the two ends unlike.

(b) The triradiate systems exhibit modifications of considerable morphological and systematic importance. At the outset it should be remarked that they always lie embedded in the gelatinous tissue of the body wall, with the rays directed more or less tangentially; and since the sponge surfaces are usually curved, the three rays very rarely lie exactly in the same plane, and are often very strongly bent out of it (Fig. 72, a). Hence, in the following discussion of the numerous modifications of form exhibited by the triradiate systems, each will be considered as seen projected in a plane tangential to the body wall at the centre of the spicule.

The triradiate systems may be quite asymmetrical in form (Fig. 72, p), but they more usually conform to some definite and symmetrical pattern. In the latter case they may be either "regular" or "sagittal." Regular systems consist of three similar rays of equal size meeting at equal angles, so that the spicule is symmetrical about three planes (Fig. 72, b). In sagittal systems, on the other hand, there is but one plane of symmetry, and the spicule exhibits a bilaterally symmetrical form, with two paired *lateral* rays and an unpaired *posterior* ray (basal ray, Haeckel). The sagittal form may, however, be produced in one of two ways, which

should be carefully distinguished. In the first place, the angles between the rays may be equal, and the bilateral form is the result of hypertrophy or diminution of one ray (Fig. 72, *c, d*). In the second place, the angles may vary as well as the rays, there being two lateral paired angles and an anterior unpaired one (Fig. 72, *j, l, n, o*). In a natural classification of the triradiate systems, the equiangular sagittal spicules should be classed with the regular forms, and separated from those which are sagittal through variations in the angles. For the latter type Bidder has proposed the

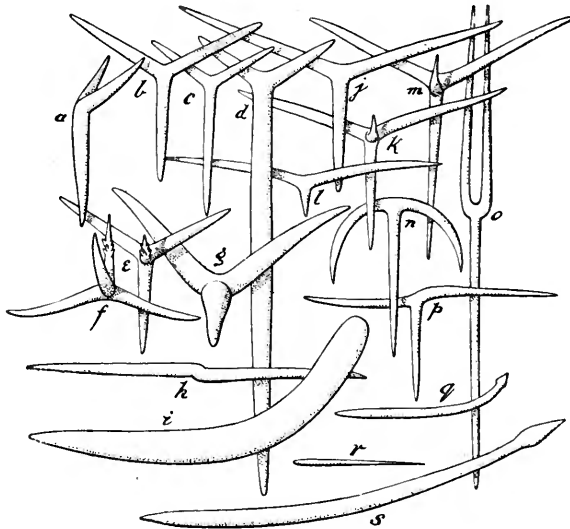

FIG. 72.

Spicules of calcareous sponges. To the left (*a-i*) spicules of *Clathrinidae*; to the right (*j-s*) of *Leucosoleniidae* and *Heterocoela*. *a* and *b*, triradiates of *Clathrina cerebrum*, in profile view and surface view respectively; *c*, sagittal triradiate of *Cl. blanca*; *d*, of *Cl. lacunosa*; *e, f*, quadri-radiates of *Cl. cerebrum*, with spiny gastral rays; *g*, "tripod" of *Cl. cerebrum*; *h*, diactine of *Cl. lacunosa*; *i*, monaxon of *Ascandra falcata*; *j*, triradiate, and *k*, quadriradiate, of *Leucosolenia variabilis*; *l*, triradiate of *Leleupia australis*; *m*, quadriradiate of *Leucosolenia complicata*; *n*, triradiate of *Leucetia pandora*; *o*, "tuning fork" of *Leleupia australis*; *p*, asymmetrical triradiate of *Leucosolenia variabilis*; *q*, monaxon of the same; *r* and *s*, two kinds of monaxons, one small and straight, one large and curved, from *Leucosolenia complicata*.

useful term *alate* spicules, since their rays can usually be distinguished by their form as well as by their inclination; the posterior ray being as a rule straight, the lateral rays more or less curved, like wings on each side.

(*c*) Any of the numerous form varieties of the triradiate system, symmetrical or asymmetrical, regular or sagittal, may become provided with an adventitious gastral ray, and so become a quadri-radiate spicule. The gastral rays vary greatly in length, and may be smooth or beset with small spines (Fig. 72, *e, f, k, m*). They may further be straight or curved, the former being usually associ-

ated with equiangular triradiate systems, the latter with systems which have the angles sagittal, and the curvature is then in the plane of symmetry, being so directed that the tip of the gastral ray points in the opposite direction to the posterior ray. All the numerous variations of the gastral rays are quite independent of the variations in the rays of the basal triradiate system.

Arrangement of the Spicules in the Skeleton.—The simplest types of skeleton are seen in the *Olynthus* stage (Figs. 1 and 60, *h*), which furnishes a natural and convenient starting-point for tracing the evolution of the skeleton. However complicated the structure of the adult sponges, in the *Olynthus* stage they differ from one another, as has been said, by characters merely of specific value, the arrangement and relations of the spicules being of a uniform character.

In the *Olynthus* the spicules form a single layer supporting and protecting the thin body wall. The monaxons are placed more or less tangentially with one end embedded in the tissues, and the other extremity projecting freely on the exterior of the sponge; a situation which explains the difference between the two ends of these spicules (Fig. 60, *h*). The triradiates, on the other hand, are completely embedded in the body wall, and are so placed that one ray of each triradiate points downwards, away from the osculum, while the other two slant obliquely upwards and outwards to the right and left. In this way an unpaired posterior ray is marked off from two paired lateral rays; but the distinction between them may be one which is only recognisable when the spicules are *in situ* in the sponge wall (regular triradiates, Figs. 1 and 42), or the spicule may, on the other hand, exhibit a structural differentiation of the rays, correlated with their position and function in the sponge (sagittal triradiates, Fig. 60, *h*). What has been said of the triradiates applies also to the three basal rays of the quadriradiates, which have an exactly similar orientation; the fourth ray, on the other hand, projects freely into the gastral cavity on the inner side of the body wall, never towards the exterior. If the gastral rays are curved, they always point up towards the osculum.

From the skeleton of the *Olynthus* may be derived that of any adult calcareous sponge by a series of adaptations to the structural requirements of the various parts added during growth.

In the *Homocoela* the skeleton retains in all parts of the body the primitive arrangement in a single layer, seen in the *Olynthus*, but exhibits marked differences in the two families of the sub-order.

The family *Clathrinidae* is characterised by equiangular triradiate systems, a type of spicule doubtless correlated with the reticular form and growth of the sponges themselves (cf. p. 7 *supra*). Monaxons may be present and some of the triradiates may develop gastral rays, but in

the more primitive forms the whole skeleton is made up of triradiates alone. The primitive orientation of the triradiates, found in the *Olynthus*, is only retained, as a rule, in the region of the oscular tube, while in the tubar system generally the arrangement becomes confused so that posterior and lateral rays cannot be distinguished by their position. In some forms, however, characterised by a more erect growth, such as *Cl. blanca* and *lacunosa* (Fig. 8), the posterior ray is indicated by its greater size, so that the triradiates become sagittal, while remaining equiangular (Fig. 72, *c*). In *lacunosa* this feature is carried to an extreme in the stalk, where a distinct peduncular skeleton is developed, composed partly of sagittal triradiates (Fig. 72, *d*), partly of diactinal monaxons, *i.e.* reduced triradiates (Fig. 72, *h*). Some species of *Clathrina* have triradiates of special form on the exterior of the body, as an instance of which may be mentioned the "tripods" of *Cl. cerebrum* (Fig. 72, *g*). In forms with a distinct pseudoderm this membrane may be supported by a layer of special spicules forming a dermal crust.

In the *Leucosoleniidae* the triradiate systems, if symmetrical, are always sagittal—that is to say, alate forms, with paired angles and well-marked posterior and lateral rays (Fig. 72, *j, k, l*). Monaxons are always present in the species of this family (Fig. 72, *q, s*). The sagittal form of the triradiates is correlated with the more erect growth of these forms, and the spicules in question have a constant orientation with regard to the canal system—that is to say, they tend to be so placed that the unpaired posterior ray points in the opposite direction to the course of the water-current. Hence in the oscular tubes the posterior rays point, as in the *Olynthus*, towards the base, while in the diverticula the triradiates become arranged with their posterior rays pointing towards the blind apex (Fig. 73), and the same arrangement is repeated in the secondary and tertiary diverticula formed by branching, so long as they do not exceed a certain length. In this way the diverticula, though arising as simple folds of the wall of the oscular tube or *Olynthus*, acquire a

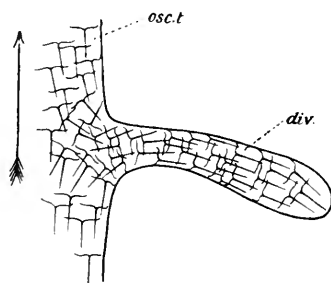

FIG. 73.

Diagram of a diverticulum of *Leucosolenia*, showing the arrangement of the sagittal triradiates in the oscular tube (*osc.t.*) and in the diverticulum (*div.*). The arrow points towards the oscular opening.

special skeleton of their own, distinct from that of the oscular tube in its arrangement, though not as regards the spicules composing it. When the diverticula have grown to a certain length, however, they give rise to new oscula which are formed by perforation of their blind extremities. Where a new osculum is about to be formed, the arrangement of the triradiates which are formed at the growing extremity of the diverticulum first becomes confused, and then reversed, so that in the terminal portion the unpaired rays point away from the apex instead of towards it. In this way the arrangement proper to an

oscular tube is acquired precociously, at a time when the physiological

conditions that prevail are the exact opposite of those with which the arrangement of the spicules is usually correlated.

The arrangement of the spicules in the diverticula and oscular tubes of *Leucosolenia* (Fig. 73) foreshadows, and gives a clue to, the plan of the skeleton in the *Heterocoela*. Taking the simpler syconoid type as the starting-point for this group, we find that at their first origin the ciliated chambers or radial tubes arise as simple diverticula of the gastral cavity, differing only from those of *Leucosolenia* in that they are more numerous and retain a more simple unbranched condition, not giving rise to new oscula. Each radial tube has its wall supported by spicules forming a special *tubar* skeleton, distinct as a rule from the more internal *gastral* skeleton both in arrangement and composition, and representing, therefore, in the latter respect a slight advance in specialisation upon the state of things seen in *Leucosolenia*. In the more primitive types the organisation scarcely advances beyond this point, except for the formation round the osculum of a special *peristomial* skeleton, consisting for the most part of elongated monaxons, and of a *peduncular* skeleton in the stalk. But with fusion between the distal ends of the radial tubes, to form a *cortex*, a special skeleton becomes differentiated in this region also, so that the skeleton of the body wall in a typical *Sycon* consists of three layers: (1) most externally a cortical skeleton, which is said to be "smooth," when it consists of triradiates only, and "hispid," when it contains monaxons, with or without triradiates; (2) a tubar skeleton composed of triradiate systems, some of which may develop a gastral ray; (3) most internally a gastral skeleton, composed mainly of quadriradiates (Figs. 68, 69).

The tubar skeleton shows two distinct types of organisation known respectively as the *articulated* and the *non-articulated*. In the former, which is the more primitive, and directly comparable to the state of things in *Leucosolenia*, each radial tube has its wall supported by sagittal triradiate systems arranged in several series, each with the unpaired posterior rays pointing towards the distal extremity of the chamber (cf. Figs. 74, *a*, and 73). In the non-articulated type of tubar skeleton there is but a single series of these triradiates, each one situated near the base of the radial tube and sending a greatly elongated *posterior* ray towards the apex, which meets, and runs parallel to, a similarly hypertrophied *lateral* ray (Poléjaeff) of a triradiate of the cortical skeleton (Fig. 74, *b*). By interlocking of these two systems of modified spicule rays the chamber acquires a firm and rigid skeleton.

With the evolution of a leuconoid type of canal system the pronounced radial structure seen in the Sycons becomes lost, and the elongated radial tubes become very much shortened and con-

verted into the smaller spherical ciliated chambers of the third type of canal system. As a consequence the regular tubar skeleton disappears and is replaced by an irregular *parenchymal* skeleton supporting the chambers and canal system and making up the greater part of the thick body wall, between the cortical and gastral layers of the skeleton.

One family of *Heterocoela* deserves special mention, however, as regards its skeleton, namely the *Pharetronidae*. The anatomical structure of this family is very imperfectly known, since most of its members are fossil, and therefore cannot be studied at all with respect to their canal system, while in many cases even the hard parts are very unsatisfactorily preserved and the finer details impossible to make out. Two living

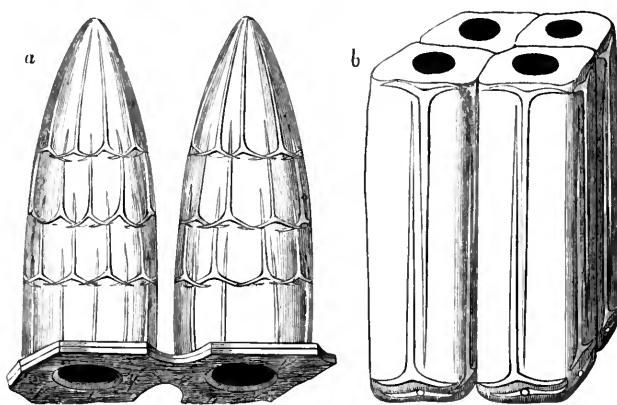

FIG. 74.

Types of tubar skeleton in Sycons. *a*, articulate type; *b*, inarticulate type. (After Haeckel.)

species are known—*Lelapia australis*, Gray, from the coast of Victoria; and the remarkable *Petrostroma schulzei*, Död., from Japan. From a comparison of the living and extinct forms, the *Pharetronidae* would appear to be *Heterocoela*, with a leuconoid type of canal system and with a skeleton of more or less pronounced fibrous structure. The fibres in typical cases are composed wholly or in part of interlocking spicules of a peculiar type, in shape like a tuning-fork (Fig. 72, *o*). The spicules in question are simply entangled to produce the fibres, and are not held together by any special cementing substance. In *Lelapia* and *Petrostroma* the fibres are made up entirely of tuning-forks, but in many fossil forms, as *Sestrostromella*, they contain an axis or core of much larger and stouter triradiates, and other spicules may enter into their composition. In *Lelapia* and the fossil forms the fibres ramify through the whole parenchyma, starting from the gastral skeleton and taking an irregular course towards the cortex, so as to produce an anastomosing net-

work. In *Petrostroma*, however, the fibres are entirely confined to a relatively thin outer "covering layer," which perhaps represents more than the cortex; and the greater portion of the sponge body is occupied by a continuous skeleton framework made up of quadriradiates fused together by secondary deposits of calcite; a type of skeleton not known to occur in any other calcareous sponge, recent or fossil.

Phylogeny of Calcareous Spicules.—The triradiates with sagittal angles occurring in *Leucosolenia* and the greater number of *Heterocoela* are spicules morphologically of a different type from the equiangular triradiates of *Clathrinidae* and a few *Heterocoela*. In the *Clathrinidae* the triradiates are the first spicules to appear, and each is shown by the development to be formed by fusion of three monaxons, a fourth being added in the case of quadriradiates. When independent monaxons occur in this family, they would appear to owe their origin entirely to modification of triradiates (secondary monaxons). In *Leucosoleniidae*, on the other hand, the first spicules to appear are true (primary) monaxons, each secreted by a single cell. The triradiates in this family appear later than the monaxons, and the posterior ray develops at first much more rapidly than the lateral rays.

In the *Heterocoela* the origin of the spicules is less known, but has been studied in *Sycon* by Maas. The greater number of *Heterocoela* resemble the *Leucosoleniidae* more closely than the *Clathrinidae* in both skeleton and canal system.

Histology.—The description given above of the structure of the *Olyntus* may be taken as representing the main traits in the histology of the *Calcarea* generally. It is not necessary to do more here than to describe the development of the three-rayed and four-rayed spicules of *Clathrinidae*, interesting as instances of compound spicular systems derived from more than one mother cell. Each ray has its own scleroblast, or *actinoblast*, as it may be termed.

To form a triradiate spicule three cells migrate into the parenchyma from the dermal epithelium and become arranged in a trefoil-like figure (Fig. 75, 1). The nucleus of each cell then divides into two, in such a way that one nucleus is placed more deeply and one more superficially. Between each pair of sister nuclei a minute spicule ray appears, the three rays being at first distinct from each other, but soon becoming united at the centre of the system (Fig. 75, 2). As the rays grow in length the protoplasm of each actinoblast becomes aggregated round each of the two contained nuclei, and finally more or less completely segmented off to form two *formative cells*, of which the one placed more internally travels to the tip of the spicule ray, while the other remains at the base (Fig. 42, *B*, *b.f.c.*). The apical formative cell (*ap.f.c.*) sooner or later disappears, returning, apparently, to the epithelium. The basal formative cell (*b.f.c.*) remains at the base of the ray (Figs. 42, *B*, and 75, 3) until this portion is secreted to its full thickness. It then migrates slowly outwards along the ray, and in the fully formed spicule is found adherent to the extreme tip (Fig. 42, *B*, *sp.c.*). In the formation of a quadriradiate spicule in the *Clathrinidae*, the three basal rays are formed exactly as has been described for the triradiates. Each quadriradiate spicule represents, in fact, a

triradiate to which an adventitious *gastral* ray has been added. It is remarkable that this fourth ray is derived from a distinct source from the other three, its scleroblast, or *gastral actinoblast*, as it may be termed, being derived from a porocyte at a comparatively late period in the growth of the basal system. After the three basal rays have reached a certain length, the nucleus of a neighbouring porocyte divides, and a portion of the cell, with one of the nuclei, becomes constricted off, grows out towards the minute triradiate, takes up a position over it—*i.e.* internal to it—and secretes a minute spicule ray which becomes fused and tacked on to the basal triradiate system (Fig. 75, 4). The secretion of the gastral ray may commence before its actinoblast is completely separated from the porocyte. In the further development the nucleus of the gastral actinoblast may remain single or divide into two or four nuclei, according to the size of the ray to be formed. In all cases, however, the protoplasm

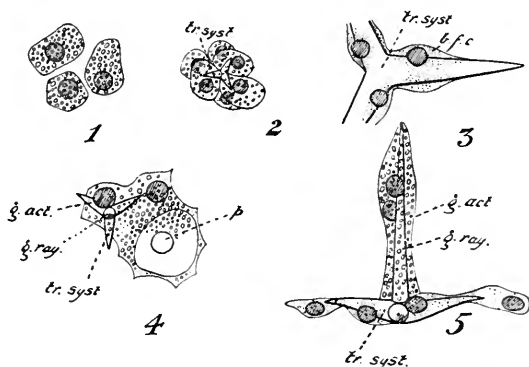

FIG. 75.

Development of equiangular triradiates and quadriradiates in *Clathrina*. 1, trio of actinoblasts; 2, sextet, with young spicule; 3, late stage in the growth of the spicule, after loss of the apical formative cells; 4, division of a porocyte to form a gastral actinoblast; 5, late stage in the secretion of the gastral ray. *tr.syst.*, triradiate system; *b.f.c.*, basal formative cell; *g.act.*, gastral actinoblast; *g.ray.*, gastral ray; *p.*, dermal aperture of pore.

of the actinoblast remains undivided, and covers at first the whole ray (Fig. 75, 5), but later only its tip, in the form of a granular plasmodium, very different in appearance from the formative cells of the basal system which, at first granular, soon become very clear and free from conspicuous granulations.

It is evident from their development that the many-rayed spicules of *Clathrinidae*, and probably of all Calcarea, are compound spicules, representing a spicular system derived from fusion of primitively distinct monaxons. Even the apparently monaxon spicules, always of large size in this family, seem to be derived from a modification of the compound triradiate type. In the *Leucosoleniidae*, on the other hand, the monaxon spicules are always true primary monaxons, derived each from a single mother-cell, and are the first spicules to arise in the development. The triradiate systems of *Leucosolenia* are formed just as in *Clathrina*, from

three mother-cells, each of which divides into a basal and an apical formative cell, but the unpaired ray at first greatly outstrips the other two in its growth.

Classification.—The earliest general classification of the Calcarea was that of Haeckel [7], who divided them by characters of the canal system into Ascons, Sycons, and Leucons. Each of these groups was further classified into seven genera, each genus being characterised by a skeleton made up of one of the seven possible combinations of the three types of spicules.

The threefold division proposed by Haeckel has generally been superseded by the binary classification of Polejaeff [18], who divided the entire group into *Homocoela*, with the gastral layer continuous, and *Heterocoela*, with the gastral layer discontinuous. The former group comprises Haeckel's Ascons, the latter his two remaining groups.

There can be little doubt that Polejaeff's two groups do not represent a natural classification of the group, but only two *grades* of structure. His classification is, in short, a horizontal cleavage of the phylogenetic tree, not a vertical one. It is highly probable that the *Heterocoela* are a polyphyletic group, derived from more than one stock of *Homocoela*.

Amongst the *Homocoela* we have two very sharply defined families; on the one hand, the *Clathrinidae* with reticulate form, equiangular triradiates, collar cells with basal nucleus, and parenchymula larva (*Ascetta* line); on the other hand, the *Leucosoleniidae* with erect form, alate triradiates, collar cells with apical nucleus, and amphiblastula larva (*Ascyssa* line). The divergence between the two families of Ascons indicates the deepest phylogenetic cleft in calcareous sponges. While the majority of the *Heterocoela* approach the *Leucosoleniidae*, a few forms (e.g. *Heteropegma*) certainly find their nearest allies among *Clathrinidae*. Hence a truly natural classification of the Calcarea must proceed along these lines. Nevertheless, any such classification, though to be looked for in the future, seems to us premature and inconvenient at present. The *Heterocoela* have not yet been studied in detail from this point of view, and their phylogenetic connections are not yet sufficiently unravelled. We cannot therefore adopt here for practical purposes the division of Calcarea proposed by Bidder (1898) into the two groups—*Calcaronea* (Calcarea on the *Ascyssa* line) and *Calcinea* (Calcarea on the *Ascetta* line). We retain for the present the two groups of Polejaeff, not as natural orders, but as two *grades* of structure, indicating a frankly artificial classification.

Rauff has recently proposed to divide the Calcarea into two divisions—*Dialytina*, with spicules separate, and *Lithonina*, with spicules united into a continuous framework (*Petrostroma*). This classification is obviously unsuitable for the entire group, but may be usefully employed within the limits of *Pharetronidae*, where we retain it.

As regards families, we adopt in the main the grouping proposed by Dendy, but we are unable, in the first place, to retain his so-called heterocoelous family *Leucascidae*. The true position of the forms included in this family is amongst the *Clathrinidae*. In the second place, we retain

as a natural family the *Pharetronidae*, which Dendy wishes to distribute amongst the other *Heterocoela*.

GRADE A. HOMOCOELA, Pol., s. ASCONES, H.

Gastral layer continuous.

FAMILY 1. CLATHRINIDAE, Minchin. Form reticulate. Triradiate systems always present, equiangular; monaxons present or absent. Collar cells with nucleus at base. Larva a parenchymula. Genera—*Clathrina*, Gray (= *Ascetta*, H., pars. *Ascaltis*, H., pars., etc., and *Leucascus*, D.); Figs. 2, 6, 7, 8; *Ascandra*, H., emend. (= *Homandra*, Ldf., for *Ascandra falcata*, H.); *Dendya*, Bidder, for *Clathrina tripodifera*, Crtr. FAMILY 2. LEUCOLENIIDAE, Minchin. Form erect; monaxons always present; triradiates, if present, alate; collar cells with nucleus apical; larva an amphiblastula. Genera—*Ascyssa*, H.; *Leucosolenia*, Bwk. (= *Ascandra*, H., pars., etc.); Figs. 3, 4, 5.

GRADE B. HETEROCOELA, Pol.

Gastral layer discontinuous and restricted to chambers.

FAMILY 3. SYCETIDAE, D. Chambers elongated, radially arranged round the central gastral cavity, their ends projecting on the dermal surface, not covered by a dermal cortex. Tubar skeleton articulate. Genera—*Sycetta*, H., emend.; *Sycon*, Risso, emend. (Figs. 9, 10); *Sycantha*, Ldf. FAMILY 4. GRANTIDAE, D. With a distinct and continuous dermal cortex covering over the chamber layer, and pierced by inhalant pores. No subdermal sagittal triradiates, nor conspicuous subgastral quadriradiates. The flagellated chambers vary from elongate and radially arranged to spherical and irregularly scattered ones. The skeleton of the chamber layer varies from irregularly articulated to irregularly scattered. Genera—*Grantia*, Fleming (Fig. 11); *Ute*, O.S.; *Amphite*, Han.; *Utella*, D.; *Anamixilla*, Pol.; *Sycyssa*, H.; *Leucandra*, H. (incl. *Polejna*, Ldf.; *Vosmaeria*, Ldf.; and *Teichonella*, Crtr., Figs. 12 and 71); *Eilhardia*, Pol. (Fig. 13); *Leucyssa*, H.; *Lamontia*, Kirk. FAMILY 5. HETEROPIDAE, D. A dermal cortex as in the last. Subdermal sagittal triradiates present. Flagellated chambers as in the last. An articulated tubar skeleton may or may not be present. Genera—*Grantessa*, Ldf.; *Heteropia*, Crtr.; *Vosmaeropsis*, D. FAMILY 6. AMPHORISCIDAE, D. A dermal cortex as in the last. Conspicuous subdermal quadriradiates, with inwardly directed apical rays, are present. Flagellated chambers as in last. Genera—*Heteropegma*, Pol.; *Amphoriscus*, H.; *Syculmis*, H.; *Leucilla*, H. (including *Pericharax*, Pol.); *Sphenophorina*, Breitf. FAMILY 7. †PHARETRONIDAE, Z. Skeleton with fibres formed by interlocking of spicules. SUB-FAMILY 1. DIALYTINAE, Rff. With all spicules separate. Genera—*Lelapia*, Crtr.; **Diaplectia*, Hinde [Ool.]; **Euplocalia*, Steinm. [Tr.]; **Eudea*, Lamx. [Tr. Jur.]; **Colospongia*,

† Fossil and recent.

Laube [Tr.]; **Celyphia*, Pom. [Tr.]; **Himatella*, Z. [Tr.]; **Peronidella*, Zeise (= *Peronella*, Z.) [Jur. Cret.]; **Elasmocoelia*, Roem. [Cret.]; **Conocoelia*, Z. [Cret.]; **Eusiphonella*, Z. [Jur.]; **Corynella*, Z. [Tr. Jur. Cret.]; **Myrmecium*, Goldf. [Tr. Jur.]; **Inobolia*, Hinde [Ool.]; **Lymnorea*, Lamx. [Jur.]; **Stellispongia*, d'Orb. [Tr. Jur.]; **Trachysimia*, Hinde [Jur.]; **Sestrostomella*, Z. [Jur. Cret.]; **Blastinia*, Z. [Jur.]; **Synopella*, Z. [Cret.]; **Oculispongia*, From. [Jur. Cret.]; **Crispispongia*, Qst. [Jur.]; **Elasmostoma*, From. [Jur. Cret.]; **Rhaphidonema*, Hinde [Cret.]; **Pharetrospongia*, Soll. [Cret.]; **Holcospongia*, Hinde [Ool.]; **Pachytilodia*, Z. [Cret.]; **Rauffia*, Zeise [Jur.]; **Euzittelia*, Zeise [Jur.]; **Strambergia*, Zeise [Jur.]; **Thalamopora*, Roem. [Jur.]; (*Polysteganinae*, Rff.); **Verticillites*, Defr. (= *Tremacystia*), [Cret.], (Fig. 14, A). SUB-FAMILY 2. LITHONINAE, Rff. With body spicules united by fusion into a rigid framework; fibres confined to cortical layer. Genus—*Petrostroma*, Död. (Fig. 14, B).

Many of the fossil forms included here under *Dialytinae* will very likely prove, when better known, to belong to the *Lithoninae*.

Incerti sedis—**Protosycon*, Z. [Jur.]; (*Sycettidae* ?).

CLASS II. HEXACTINELLIDA.

The Hexactinellida or *Triaxonia* are a group of sponges characterised in the first instance by the possession of siliceous spicules of the triaxon type, which are therefore primitively six-rayed. This fundamental structural peculiarity is correlated with a very uniform, and at the same time a very characteristic type of organisation, rendering the group one almost as sharply marked off from other sponges as are the *Calcarea*.

To judge by the abundance of fossil remains, the Hexactinellids seem to have been a very abundant group at all times. At the present day they are almost confined to the deep sea, but in this region they are a widespread, and apparently flourishing group. It is to their peculiar habitat, however, that must be ascribed our still very great ignorance with regard to many points, especially of their histology and life-history.

1. *Canal System*.—The embryonic development of the Hexactinellid sponges is not known; but very young specimens, still without an osculum, have been described by Schulze in his great monograph [21], from which it would appear that the starting-point for the development of the canal system in these forms is a stage which has advanced considerably beyond the *Olynthus* condition, and conforms more to the second type of canal system (Fig. 76; cf. Fig. 44), the gastral layer being folded to form flagellated chambers. The wall of the sponge even in these

* Fossil forms: Tr. = Trias, Jur. = Jurassic, Ool. = Oolite, Cret. = Cretaceous.

early stages consists of five layers (Figs. 76, 77): (1) an outer porous skin, the *dermal membrane* (*d.m.*); (2) within this is a space traversed in all directions by strands of tissue, which constitute the *subdermal trabecular layer* (*sd.tr.*); (3) within this is a continuous layer of thimble-shaped flagellated chambers, the blind ends of which are turned towards the dermal surface, and their openings towards the gastral cavity (*fl.c.*); (4) internal to the chambers is another space, traversed by the *subgastral layer* of trabeculae (*sg.tr.*), quite similar in its structure and appearance to the subdermal

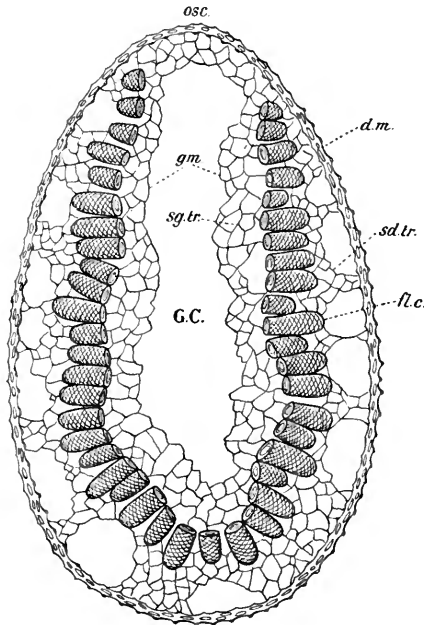

FIG. 76.

Longitudinal section of a young specimen of *Lanuginella pupa*, O.S., with commencing formation of the oscular area. The spicules are omitted from the drawing. $\times 35$. (After F. E. Schulze.) *d.m.*, dermal membrane; *sd.tr.*, subdermal trabecular layer; *fl.c.*, flagellated chamber; *sg.tr.*, subgastral trabecular layer; *g.m.*, gastral membrane; *G.C.*, gastral cavity; *osc.*, region of future osculum.

layer; (5) and finally, the gastral cavity is limited by a porous *gastral membrane* (*g.m.*), which recalls in its structure the dermal membrane. Of these five layers, the third comprises the whole gastral layer; the first, second, fourth, and fifth are differentiations of the dermal layer.

The five layers that have been described recur in the same order and with similar characters in the body wall of all Hexactinellids, which exhibit a remarkable uniformity in this respect. The chief modifications that are met with in the canal system are due

either (a) to a folding of the chamber layer as a whole, or (b) to the folding and branching of the individual chambers.

(a) The simplest cases of the folding of the chamber layer result in a type of canal system which reminds us of what has been described above in the calcareous sponge, genus *Leucilla* (cf. Figs. 70 and 78). Short excurrent bays are formed into which the chambers open, the latter being disposed into radiating groups round each bay. Further development of this process of folding leads to the formation of long branched excurrent canals, and the whole canal system approaches very nearly to the type seen in Leucons. The extent to which the folding of the chamber layer affects the other

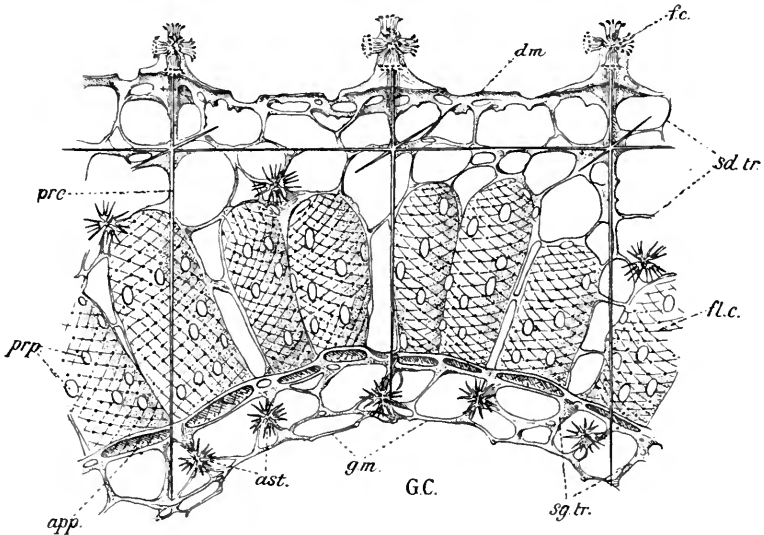

FIG. 77.

Section of the body wall of *Euplectella aspergillum*, Owen. $\times 110$. (After F. E. Schulze.) *f.c.*, floricomes (i.e. a form of hexaster); *prc*, principalia; *ast*, parenchymal hexasters; *prp*, prosopyles; *app*, apopyles. Other letters as in Fig. 76.

layers of the sponge varies considerably. In the simplest cases the subdermal trabecular layer alone is affected (Fig. 78), and extends down into the interspaces between the folds of the chamber layer. In most cases, however, the subgastral trabecular layer is folded with the chamber layer, so that it extends into the excurrent canals, while the subgastral membrane remains unaffected, and either stretches across the openings of the excurrent canals (Fig. 79), or is interrupted at these spots. But in extreme cases, as seen in the family *Hyalonematidae*, the subgastral membrane shares in the folding of the chamber layer and forms a lining to all the excurrent canals. In no case does the subdermal membrane take any share in process of folding.

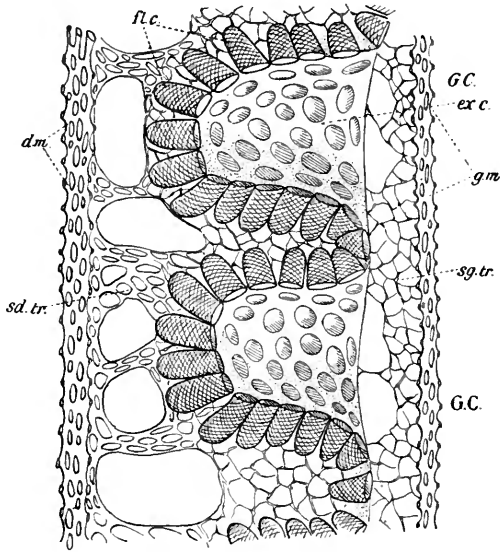

FIG. 78.

Section of the body wall of *Bathydorus fimbriatus*, F.E.S. The spicules are omitted from the drawing. $\times 30$. (After F. E. Schulze.) *ex.c.*, excurrent canals. Other letters as in Figs. 76, 77.

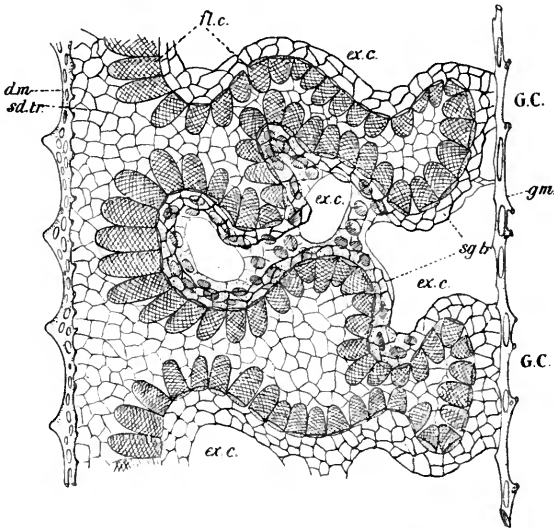

FIG. 79.

Section of the wall of *Taegeria pulchra*, F.E.S. The spicules are omitted. $\times 20$. (After F. E. Schulze.) The letters as in the three preceding figures.

(b) The instances of the chambers themselves being folded or branched are numerous, and an extreme case is seen in the ear-like form *Euryplegma* (Fig. 20, C, and Fig. 80).

This condition is at first sight difficult to distinguish from the condition found in the *Hyalonematidae*, a family remarkable for the fact that the chambers grouped round each excurrent canal are continuous with one another at their apopyles, the gastral epithelium passing on without interruption from chamber to chamber. In fact, each excurrent canal in *Hyalonema* might be thought to be a single, branched chamber, were it not for the important difference that the subgastral layer and the gastral membrane extend, as has been said, into it. This feature at once distinguishes the excurrent sinuses from branched chambers, since no

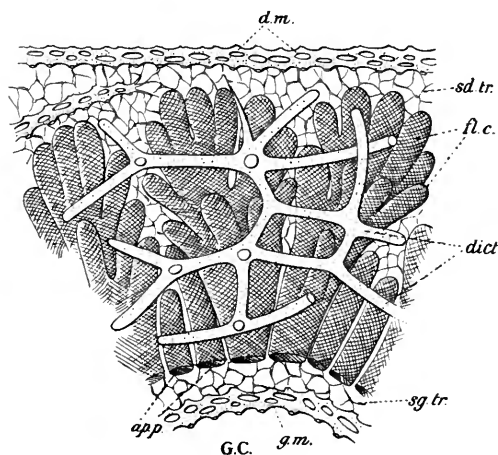

FIG. 80.

Section of the wall of *Euryplegma auriculare*, F.E.S. All spicules are omitted except the dictyonalia. $\times 25$. (After F. E. Schulze.) dict, the dictyonalia formed by union of the principalia one to another.

such extension of the inner layers of the body wall into the lumen of the chambers ever occurs. The condition found in the *Hyalonematidae* would appear therefore to represent a fusion of chambers primitively distinct, or more probably still a condition where the multiplication of chambers by fission has stopped short of completion.

The uniform and simple structure of the body wall in Hexactinellid sponges makes it easy in these forms to determine in any specimen the relations of the gastral cavity, since the anatomy of the young forms (Fig. 76) shows clearly that the subgastral membrane, through which the water passes after issuing from the apopyles and traversing the subgastral framework, is its boundary. Hence any space which is limited by, or borders upon, the subgastral membrane, must be morphologically the gastral cavity. We have already described the series of form modifications whereby the gastral cavity may become greatly widened, and finally, in

such a form as *Caulophacus*, becomes merged, as it were, in the outer world. The converse series of changes, on the other hand, where, by a process of folding, a portion of the outer world becomes enclosed to form a pseudogaster or false gastral cavity, is not known (*pace* Lendenfeld) to occur. The osculum of Hexactinellids is typically a wide aperture, frequently partially closed by a delicate sieve-plate (Fig. 18). In *Euplectella* and its allies (Figs. 15 and 18) *parietal* gaps, which have no relation to the canal system, occur in the body wall, leading into the gastral cavity.

2. *Skeleton*.—The skeleton of the Hexactinellid sponges is of great interest from the morphological point of view, since the spicules exhibit in remarkable manner the persistence of one fundamental type in the midst of infinite variations.

Forms of the Spicules.—The primitive type of spicule in the Hexactinellids is the *regular hexactine*, a form with six similar and equal rays meeting at right angles at a common centre (Fig. 47, *e*). Each ray is traversed by an axial organic thread, which after

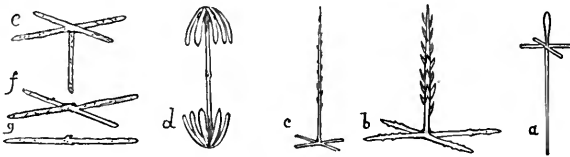

FIG. 81.

Modifications of the triaxon type of spicule. *a*, sword-like hexactine; *b*, *c*, two varieties of the pinulus; *d*, amphidisc; *e*, pentactine; *f*, tetractine; *g*, rhabdus.

maceration becomes a minute canal. The six axial threads meet at a point, forming the so-called *axial cross*, a structure of great importance for determining the morphological centre of the spicule.

Spicules of this form are of common occurrence in most species of the group. More commonly, however, the primitive hexactinal form has become diversified by modifications, which may be grouped into two series.

In the first place, one or more of the rays of the primitive hexactine may vary in size relatively to the other rays, so as to become either greatly hypertrophied, on the one hand, or reduced even to the vanishing point, on the other hand. Unequal development of the rays results in peculiar forms of the hexactine, such as the sword-like hexactines, characteristic of the *Euplectellidae* (Fig. 81, *a*). Complete atrophy, or rather arrested development, of one or more of the rays, causes the primitively six-rayed type to become pentactinal, tetractinal, and so on, until finally only one or two rays remain (Fig. 81, *e*, *f*, *g*), and as the end term of this series we have a simple monaxon rod, which may be either diactinal (*rhabdus*), or monactinal (*style*). So long, however, as there are more rays than

one persisting, they always meet at a multiple of a right angle, and the constancy of the angles between the rays at their origin is a striking feature of the triaxon spicule, though often masked to some extent by curvature of the rays themselves.

In the second place, one or more of the rays of the hexactine, or of one of its reduced forms, may become modified in various ways; as, for instance, by becoming curved, or by the acquisition of spines, knobs, hooks, and so forth, or finally, by the development of secondary branches, which in their turn may be curved or ornamented in various ways. Specially noteworthy, and often of systematic importance, are the various ways in which the rays, or their secondary branches may terminate. Thus to take the hexactine as an example, its rays may end in sharp points (*oxyhexactine*), or in knobs (*tylhexactine*), or discs (*discohexactine*).

By the combination of modifications along different lines, there results a great variety of forms of the triaxon spicule, some of which have received special names and are characteristic of particular families, or subdivisions of the group.



FIG. 82.

Characteristic Hexactinellid spicules. *a*, uncinata; *b*, clavula; *c*, scopula. (After F. E. Schulze.)

As instances of such forms may be mentioned the *pinuli* (Fig. 81, *b, c*), spicules usually pentactinal, sometimes, however, hexactinal, in which one ray directed radially, as regards the sponge body, and always projecting freely from a surface, either internally or externally, develops numerous small spines, and resembles a fir tree; the various forms of aster or rosette (*hexaster*), produced by branching of the rays, and giving rise in their turn to a large series of varieties (*oxyhexaster*, *discohexaster*, "floricome," "plumicome," etc., Fig. 48, *o, t*, Fig. 77, *f, c*); the *amphidiscs* (Fig. 81, *d*) characteristic of the *Hyalonematidae*, rhabdi which bear at their distal extremities disc-like expansions curved towards the centre and prolonged into several tooth-like protuberances; the peculiarly ornamented rhabdi known as *uncinates* (Fig. 82, *a*) and *scopulae* (Fig. 82, *c*), and the monactinal *clavulae* (Fig. 82, *b*), and many other forms too numerous to mention.

Many of the forms of the triaxon spicule depart widely in appearance from the primitive type, and are often difficult to recognise as belonging to it. In tracing the affinities of the spicule, the axial canal affords in many instances a safe clue for the detection both of those parts which are of secondary origin, and those which have been lost, since, on the one hand, it is not continued into the various spines or branches which may be

developed on the primary ray, and, on the other hand, a minute continuation of the axial thread may often be found indicating a ray which has been completely lost. A beautiful instance of the latter kind is seen in the diactines which have the two rays placed in the same straight line (secondary monaxons). In some instances the four undeveloped rays are indicated by four knobs, containing as many axial canals, which form a minute axial cross at the morphological centre of the spicule (Fig. 83, *A*). In other cases the four knobs are further reduced to a slight swelling, or have disappeared altogether (Fig. 83, *B, C*), the minute axial cross remaining, however, to indicate the aborted rays. Finally, even the axial cross may disappear, leaving no trace of the missing rays.

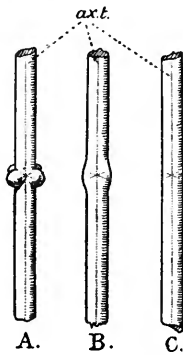

FIG. 83.

Three stages in the reduction of a hexactine to the monaxon condition. In *A* four rudimentary rays are represented by small knobs; in *B* there is only a slight swelling in their place; in *C* they have disappeared altogether. In all three the lost rays are indicated by the minute axial cross in the axial filament (*ax.t.*)

The root tuft with which many Hexactinellids are provided is composed of long thread-like spicules, which in *Hyalonema* may be two feet or more in length, and are furnished with recurved, anchor-like hooks at their distal extremities. Some of these rooting spicules bear at their termination four hooks, placed at right angles to each other, and to the shaft, and containing prolongations of the axial canal; the spicule is therefore pentactinal, with one ray very greatly developed. In others the anchoring hooks are numerous and arranged according to various types of symmetry; they contain no axial canal, and are therefore of secondary origin, but at some point in the shaft of the spicule a minute axial cross can usually be found, proving it to be a much elongated diactine. In a similar way the *scopulae* (Fig. 82, *c*) are seen to be diactinal in their nature, the axial thread not being continued into the terminal branches.

Arrangement of the Spicules in the Skeleton.—According to their position in the sponge body the spicules of Hexactinellids may be divided into several categories, corresponding to the regions of the body which it is their function to support or protect.

(1) *Prostalia.*—Defensive spicules, usually diactinal monaxons, which project over the surface of the body, only found in *Lyssacina*. A special differentiation of such spicules may form a protecting fringe round the osculum, or an anchoring root tuft at the base (*prostalia marginalia et basalia*). Those scattered over the general surface of the body are termed *pleuralia*.

(2) *Dermalia.*—Spicules supporting the dermal membrane; usually hexactinal or pentactinal, with four similar rays lying embedded in the membrane. They are distinguished as *autodermalia*,

or *hypodermalia*, according as their axial cross is placed within, or beneath, the dermal membrane.

(3) *Gastralia*.—Spicules similar in form and function to the last named, but supporting the gastral membrane.

(4) *Parenchymalia*.—Spicules supporting the general parenchyma and the chambers between the dermal and gastral membranes. In the most primitive types of skeleton, as seen in *Holascus* and *Farrea*, the parenchymal skeleton consists of large regular hexactines (*principalia*), arranged to correspond with the intervals between the thimble-shaped chambers, two rays being disposed radially and four tangentially (Fig. 77, *prc*). This primitive type of skeleton may become much modified in various ways, both as regards arrangement and composition, the primitive hexactinal *principalia* becoming modified in form, and supplemented by other spicules (*comitalia*). In the sub-order Dictyonina and in many Lyssacina the principal spicules of the parenchyma are united into a continuous framework, and distinguished as *dictyonalia*.

Union of the Spicules.—In many Hexactinellids the spicules remain separate from one another and simply interlock. In other cases some of the spicules of the parenchyma become united to form a continuous framework. This union is always effected by secondary deposits of silica, never by spongin.

In the simplest method of union, characteristic of Dictyonina, two parallel rays become apposed and united by concentric layers of silica into a beam, in which the primitive component rays are distinguishable by their separate axial canals. In other cases the end of a ray of one spicule becomes soldered to the central node, at which the rays intersect, in another. In other cases again the rays of adjoining spicules crossed in any direction are bound together by web-like lamellae of silica. When two rays are not in contact, cone-like elevations grow out from the sides of opposite rays, meet, and finally fuse to form a connecting siliceous bridge or *synapticula*. Since all these secondary deposits of cementing siliceous material are without axial canals, they can easily be distinguished from the true spicules.

In the Dictyonina the principal spicules of the parenchyma become united early into a framework, and are separate only in the growing portions of the sponge. Their union imposes a check on the growth of the sponge in a lateral direction, but it can continue to grow in length or at the free margin; hence the occurrence in this group of tubular, plate-like, or cup-shaped sponges, the former often very similar in form to those in the calcareous family *Clathrinidae*.

In the *Lyssacina* the spicules either remain separate (*Hyalonematidae*, *Holascinae*), in which case the sponge may attain to a huge size (*Poliopogon gigas*, and others), or they may become united into

an irregular manner at a late stage in the life-history, setting a limit to further growth.

General Remarks on the Skeleton.—Beautiful instances of adaptation to the conditions of life in abyssal depths are seen in the arrangement of the skeleton in sponges of this group. Thus in *Euplectella* the spicules are arranged in fibres which run either longitudinally, or in transverse circles, or diagonally, to form spirals running in two directions. The longitudinal and transverse fibres strengthen the sponge to support the weight imposed upon it by the continual shower of particles, skeletons of *Radiolaria*, etc., raining down upon it from the surface. The spiral fibres correspond to the lines of stress and strain produced in a cylinder fixed at one end and free at the other, which is acted upon by a force at right angles to its axis, and strengthens the sponge against the action of currents. Some species of *Euplectella* are cornucopia-shaped and further strengthened by lateral ridges (Fig. 15); such a form is adapted to constant currents in one direction. Other species, adapted to currents in any direction, are cylindrical and upright, and strengthened equally on all sides (Keller, 1891).

In a brief but suggestive memoir Schulze [22] has drawn attention to the remarkable fact that although the spicules of Hexactinellids are composed, apparently, of non-crystalline material (colloid silica), yet their axes possess the same symmetry as the crystals of the cubic system. Not only is this true of the ordinary hexactine, but it is also seen in many of the less common forms of spicule. Thus the *discocasters* are spicules with eight rays terminating in discs, each disc corresponding in position to one of the eight corners of a cube; again, in the nodes of the dictyonal framework of many forms (e.g. *Aulocystis*), the twelve edges of the regular octahedron are marked out by girder-like trabeculae; and the six secondary planes of symmetry of the cubic system are often indicated by branching of the hexactines, or by their hook-like curvature. These facts invite a renewed investigation of the physical nature of the spicule material; should it prove beyond all doubt to be non-crystalline, then these striking imitations of crystalline axes must be regarded as mechanical adaptations in a supporting framework—the culmination, rather than the starting-point, of the evolution.

3. *Histology.*—The finer structure of the body wall is of very uniform, and at the same time of very simple, composition. The dermal membrane is covered by a flat epithelium, and the underlying parenchyma is composed as in other sponges of a matrix containing collencytes, amoebocytes, and, doubtless, scleroblasts, besides sperm masses and ova. A remarkable feature of the dermal layer is its trabecular structure. Fine strands of tissue stretch in every direction over a continuous lacunar space, furnishing a very complete filtering apparatus for the ingoing water current. As a consequence of this peculiar structure, the connective tissue system is very greatly reduced in quantity, and in the trabeculae there seems to be no sharp distinction between the epithelial and

parenchymal strata, a point in which Hexactinellids are perhaps more primitive than other sponges.

The choanocytes, long unknown, have recently been discovered by Schulze, who describes them in *Schaulinnia arctica* as a uniform layer of columnar epithelium, each cell bearing a collar and flagellum. The body of the cell is slightly constricted towards the middle, and expanded both at its upper and lower ends. At the lower end the base of the cell forms a foot-like plate, which contains the nucleus, and is in contact with the similar basal plates of neighbouring cells to form a continuous protoplasmic membrane, limiting the chamber towards the exterior and interrupted only by the chamber pores or prosopyles. In surface view the basal membrane shows a number of granular strands running from each nucleus to its four neighbours, and so producing the appearance of a network or lattice with approximately rectangular or rhombic meshes; this is the *membrana reticularis* formerly described by Schulze in the *Challenger* material, and then but imperfectly understood. Finer strands, disposed in an irregular manner, ramify in the meshes of the coarser network. At their upper ends also the choanocytes are adherent to one another, just below the origin of the collar, except where a prosopyle traverses the chamber wall. In this way a continuous system of spaces is enclosed between the narrowed middle portions of the cells. The collars are quite separate from one another. The flagellum is connected with the basal nucleus by an axial filament passing down through the body of the cell.

4. *Development.*—Nothing is known of the embryology. Schulze found only immature ova, of the usual type, in the *Challenger* material, and no larvae or even segmentation stages.

5. *Classification.*—The classification here adopted is that applied by Schulze (1887) to recent forms, with a few subsequent additions or emendations. In addition a certain number of fossil genera and families have to be noticed, of which the exact position in Schulze's system is not in all cases clear and cannot be determined without special investigation.¹

SUB-CLASS 1. LYSSACINA, Z.

The spicules of the skeleton either remain separate or are united at a late period of growth in an irregular manner by siliceous masses or by transverse synapticalae.

ORDER 1. Hexasterophora, F.E.S.

Hexasters always present in the parenchyma; ciliated chambers thimble-shaped, sharply separate from one another.

FAMILY 1. EUPLECTELLIDAE, Gray. The dermal skeleton contains sword-shaped oxyhexactines with long proximal ray. (a) SUB-FAMILY 1.

¹ In his most recent work on American Hexactinellids [24] Schulze abandons the subdivisions Lyssacina and Dictyonina as a natural classification, and divides the group into two orders: (1) Amphidiscophora, including the single family *Hyalonematidae*; and (2) Hexasterophora, which is extended to include not only the remaining families of Lyssacina, but also all the Dictyonina.

EUPLECTELLINAE, F.E.S. Tubular forms with transverse terminal sieve-plate; the body wall perforated by circular parietal gaps; distal ray of dermal oxyhexactine bearing a floricate. Genera—*Euplectella*, Owen (Fig. 15); *Regadrella*, O.S. (Fig. 18). (b) SUB-FAMILY 2. HOLASCINAE, F.E.S. Tubular, without parietal gaps or superficially situated floricates; with parenchymal oxyhexasters. Genera—*Holascus*, F.E.S.; *Malacosaccus*, F.E.S. (c) SUB-FAMILY 3. TAAGERINAE, F.E.S. Sack-like or tubular, the thin body wall perforated by parietal gaps of irregular size and distribution. The skeletal lattice work of the body wall forms an irregular meshwork; with superficially situated floricates. *Taegeria*, F.E.S.; *Walteria*, F.E.S. Genera *incerti sedis*—*Habrodictyum*, W. Th.; *Eudictyum*, Marshall; *Dictyocalyx*, F.E.S.; *Rhabdoctyum*, O.S.; *Rhabdoplectella*, O.S.; *Hyalostylus*, F.E.S. FAMILY 2. HERTWIGIDAE, Tops. (1892). Skeletal framework composed of hexactines and diactines united by synaptulae; the free parenchymal spicules are hexactines of two kinds, one confined to the surface; characteristic hexaster, one with four sickle-shaped hooks on each of the principal rays. Genera—*Hertwigia*, O.S.; *Trachycaulus*, F.E.S. FAMILY 3. †ASCONEMATIDAE, Gray (Schulze, 1897). Dermal and gastral skeleton containing pinuli with spined radial rays projecting freely; hypodermalia pentactinal, but no hypogastral pentactines; parenchymal discohexasters. Genera—*Asconema*, Sav. Kent. (Fig. 17); *Aulascus*, F.E.S.; *Sympagella*, O.S.; *Saccocalyx*, F.E.S.; †*Caulophacus*, F.E.S. [Eoc.], (Fig. 20, C). *Calycosoma*, F.E.S.; *Calycosaccus*, F.E.S. FAMILY 4. †ROSSELLIDAE, F.E.S. (Iijima, 1898). The dermalia always without distal radial rays. (a) SUB-FAMILY 1. LEUCOPSACINAE, Iijima. Dermalia not differentiated into autodermalia and hypodermalia. Genera—*Leucopsacus*, Iij.; *Chaunoplectella*, Iij.; *Placoplegma*, F.E.S.; *Aulocalyx*, F.E.S.; *Euryplegma*, F.E.S. (Fig. 20, A); *Caulocalyx*, F.E.S. (b) SUB-FAMILY 2. LANUGINELLINAE, F.E.S. With distinct auto- and hypodermalia; without octasters; plumicomae present; with or without oxyhexasters. Genera—*Lanuginella*, O.S.; *Lophocalyx*, F.E.S. (= *Polylophus*, F.E.S.); *Mellonympha*, F.E.S. (c) SUB-FAMILY 3. †ROSSELLINAE, F.E.S. With distinct auto- and hypodermalia; without octasters or plumicomae; oxyhexasters always present. Genera—*Bathydorus*, F.E.S.; *Vitrollula*, Iij.; †*Crateromorpha*, Gray [Eoc.]; *Aulochone*, F.E.S.; *Hyalascus*. Iij.; *Rossella*, Crtr. (Fig. 16); *Aphorme*, F.E.S.; *Aulosaccus*, Iij. (d) SUB-FAMILY 4. ACANTHASCINAE, F.E.S. With distinct auto- and hypodermalia; octasters and oxyhexasters always present. Genera—*Staurocalyptus*, Iij.; *Rhabdocalyptus*, Iij.; *Acanthascus*, F.E.S.; *Acanthosaccus*, F.E.S.

[Russellidae as yet undescribed; *Schaudinna*, *Trichasterina*, and *Scyphidium*, Schulze, 1899.]

ORDER 2. Amphidiscophora, F.E.S.

Amphidiscs always present in the limiting membranes. No hexasters in the parenchyma. Always with an anchoring root tuft. Ciliated chambers irregular in shape, and not sharply marked off from one another.

† Fossil and recent.

FAMILY 5. †HYALONEMATIDAE, Gray (Schulze, 1893). Pentactinal pinuli in both dermal and gastral membranes. (a) SUB-FAMILY 1. †HYALONEMATINAE, F.E.S. Genera—†*Hyalonema*, Gray [Eoc.], (Fig. 19); †*Pheronema*, Leidy [Eoc.]; *Poliopogon*, W. Th. (Fig. 20, B); **Pyritonema*, McCoy [Sil.]; **Oncosella*, Rff. [Sil.]. (b) SUB-FAMILY 2. SEMPERELLINAE, F.E.S. Genus—*Semperella*, Gray.

To these must be added the following families of extinct Lyssacina :—
 FAMILY 6. *PROTOSPONGIDAE, Hinde (Rauff. 1893). Genera—*Protospongia*, Salter [Camb.]; *Phormosella*, Hinde [Sil.]. FAMILY 7. *DICTYOSPONGIDAE, Rff. Genus—*Dictyophyton*, Hall [Sil. Dev.]. FAMILY 8. *PLECTOSPONGIADAE, Rff. Genera—*Cyathophycus*, Walc. [Sil.]; *Palaeosaccus*, Hinde [Ordov.]; *Acanthodictya*, Hinde [Sil.]; *Plectoderma*, Hinde [Sil.]. FAMILY 9. *BRACHIOSPONGIDAE, Beecher. Genus—*Brachiospongia*, Marsh [Sil.]. FAMILY 10. *PATTERSONIDAE, Rff. Genus—*Pattersonia*, S. A. Miller [Sil.]. FAMILY 11. *RECEPTACULITIDAE, Eichw. Genera—*Ischadites*, Murch. [Ordov. Sil.]; *Sphaerospongia*, Peng. [Dev.]; *Receptaculites*, Defr. [Ordov. Sil. Dev. Carb.]. FAMILY 12. *AMPHISPONGIDAE, Rff. Genus—*Amphispongia*, Salter [Sil.]. FAMILY 13. *MONAKIDAE, Marshall. Genus—*Stauractinella*, Z. [Cret.]. FAMILY 14. *POLLAKIDAE, Marshall. Genera—*Hyalostelia*, Z. [Carb. Cret.]; *Holasterella*, Crtr. [Carb.]; *Spiractinella*, Hinde [Carb.]; *Acanthactinella*, Hinde [Carb.].

Incerti sedis—**Astroconia*, Soll. [Sil.]; **Teganium*, Rff. [Sil.].

(Note.—Families 13 and 14 represent two groups, which, so far as living forms are concerned, have been broken up and distributed amongst other families, and it only remains for the fossil forms to be similarly treated.)

SUB-CLASS 2. DICTYONINA, Z.

The large parenchymal hexactines are from the first united more or less regularly as *dictyonalia* into a firm framework.

ORDER 1. Uncinataria, F.E.S.

With uncinates.

SUB-ORDER 1. CLAVULARIA, F.E.S.

Groups of radially disposed *clavulae* in addition to pentactinal hypodermalia and hypogastralia, sometimes also *scopulae*.

FAMILY 1. FARREIDAE, F.E.S. In the youngest portions of the tubes the dictyonal framework consists solely of a single-layered network with square meshes, each node of intersection bearing on either side a conical boss projecting at right angles. Genera—*Farrea*, Bwk. (Fig. 21); *Claviscopulia*, F.E.S.

SUB-ORDER 2. SCOPULARIA, F.E.S.

Groups of radially disposed *scopulae* in addition to pentactinal hypodermalia and hypogastralia, never with *clavulae*.

* Fossil forms : Camb. = Cambrian ; Ordov. = Ordovician ; Sil. = Silurian ; Dev. = Devonian ; Carb. = Carboniferous ; Eoc. = Eocene ; other references as under Calcarea (above, footnote to p. 111) : if the whole family is known only in the fossil condition, the asterisk is not affixed to each separate genus.

FAMILY 2. † EURETIDAE (Z.), F.E.S. Branched anastomosing tubes, forming an irregular framework or the wall of a cup; dictyonal framework of the tubular wall always several layers, never, as in *Farrea*, a single-layered network. Genera—*Eurete*, Crtr.; *Periphragella*, Marshall; *Lefroyella*, W. Th.; **Tremadictyon*, Z. [Jur.]; **Craticularia*, Z. [Jur. Cret.]; **Sphenaulax*, Z. [Jur.]; **Sporadopyle*, Z. [Jur.]; **Verrucocoelia*, Et. [Jur.]; **Stauronema*, Soll. [Cret.]; **Sestrodicton*, Hinde [Cret.]; **Calathiscus*, Soll. [Ool.].

FAMILY 3. † MELLITIONIDAE, Z. Body in the form of a system of ramified tubes or of a cup with lateral diverticula; dictyonal framework with irregular meshes; parietal skeleton honeycomb-like, with more or less hexagonal canals disposed radially; each such canal occupied by an extension of the chamber layer, and covered over externally by the dermal, internally by the gastral membrane. No scopulae in gastral skeleton. Genus—†*Aphrocallistes*, Gray [Cret. Eoc.], (Fig. 22).

FAMILY 4. † COSCINOPORIDAE, Z. Body cup-shaped or plate-like, the wall traversed by elongated, funnel-shaped, straight canals (incurrent and excurrent), of which the wide openings, covered by the sieve-like limiting membrane, are placed alternately on either surface of the wall, while the other extremity ends in a blind point. Genera—**Coscinopora*, Goldf. [Cret.]; **Leptophragma*, Z. [Cret.]; **Pleurostoma*, Roem. [Cret.]; **Guettardia*, Mich. [Cret.]; *Chonelasma*, F.E.S.; *Bathyziphus*, F.E.S.

FAMILY 5. TRETODICTYIDAE, F.E.S. Incurrent and excurrent canals penetrate the body wall with an oblique, longitudinal, or even curved course, not transversely. Genera—*Hexactinella*, Crtr.; *Cyrtaulon*, F.E.S.; *Fieldingia*, Sav. Kent.; *Sclerothamnus*, Marshall.

ORDER 2. *Inermia*, F.E.S.

Without uncinates or scopulae.

FAMILY 6. † MAEANDROSPONGIDAE, Z. The body consists of a connected system of labyrinthine anastomosing tubes, between which there is a connected interstitial system of interspaces. The water entering by the latter passes through the walls of the tubes and along them either into the gastral cavity or directly to the exterior. Genera—*Dactylocalyx*, Stutchb.; *Margaritella*, O.S.; *Scleroplegma*, O.S.; *Myliusia*, Gray; *Aulocystis*, F.E.S.; **Plocoscyphia*, Rss. [Cret.]; **Etheridgia*, Tate [Cret.]; **Toulminia*, Z. [Cret.]; **Camerospongia*, d'Orb. [Cret.]; **Cystispongia*, Roem. [Cret.].

To these must be added the following extinct families:—FAMILY 7. *STAUDERMIDAE, Z. (with sub-families POROSPONGINAE and STAUDERMINAE, Rff.). Genera—*Cypellia*, Pom. [Jur.]; *Stauoderma*, Z. [Jur.]; *Purisiphonia*, Bwk. [Jur. Cret.]; *Porocypellia*, Pom. [Jur.]; *Casearia*, Qst. [Jur.]; *Porospongia*, d'Orb. [Jur.]; *Ophrystoma*, Z. [Cret.]; *Cinclidderma*, Hinde [Cret.]; *Eubrochus*, Soll. [Cret.]; *Placotrema*, Hinde [Cret.].

FAMILY 8. *CALLODICTYONIDAE, Z. Genera—*Callodictyon*, Z. [Cret.]; *Marshallia*, Z. [Cret.]; *Porochonia*, Hinde [Cret.]; *Becksia*, Schlüt. [Cret.]; *Pleurope*, Z. [Cret.]; *Diplodictyum*, Z. [Cret.]; *Sclerokalia*, Hinde [Cret.].

FAMILY 9. *COELOPTYCHIDAE, Z. Genus—*Coeloptychium*, Goldf.

[Cret.]. FAMILY 10. *VENTRICULITIDAE, Hinde. Genera—*Pachyteichisma*, Z. [Jur.]; *Trochobolus*, Z. [Jur.]; *Phlyctenium*, Z. [Jur.]; *Ventriculites*, Mant. [Cret.], (Fig. 23); *Schizorhabdus*, Z. [Cret.]; *Rhizopoterion*, Z. [Cret.]; *Sporadoscinia*, Pom. [Cret.]; *Coeloscyphia*, Tate [Cret.]; *Sestrocladia*, Hinde [Cret.]; *Licmosinion*, Pom. [Cret.]; *Polyblastidium*, Z. [Cret.]; *Cephalites*, T. Smith [Cret.].

CLASS III. DEMOSPONGIAE.

The sponges included in this class appear at first sight a very heterogeneous collection. The variations of structure are very great, and between the Demospongiae which stand furthest apart in the scale—the Tetractinellids on the one hand, and the Keratosa on the other—the differences are so pronounced that, if considered by themselves, the former might be thought to have less in common with the latter than with, for example, the Hexactinellids. But even between extremes such as these, there is to be found a complete series of intermediate forms, which is nowhere interrupted by any such abrupt distinctions as those which mark off the Demospongiae as a whole from the other siliceous sponges.

The Demospongiae represent, in fact, the class of sponges which is the most widely spread, and most dominant at the present day, comprising all the most familiar examples of the phylum Porifera. Their cosmopolitan distribution places them amidst the most varied conditions of existence, and they respond to the differences of their environment by a wide range of adaptations. The Demospongiae are at once the most plastic and the most highly organised of sponges, as regards histological differentiation or elaboration of anatomical structure. We find here the most perfect types of canal system, and in such a form as *Disyringa* (Fig. 26), with its single incurrent aperture, we find the extreme of individualisation seen in any sponge. On the other hand, those Demospongiae inhabiting the shore-line tend to lose their individuality, and to advance towards an impersonal condition, in which the primitive individual becomes merely an ill-defined physiological centre in a spreading and often amorphous growth.

Canal System.—The starting-point of the post-embryonic growth and development in Demospongiae is a form known as the *Rhagon*, which, like the *Olynthus* of Calcarea, represents a transitory stage from which the existing forms of canal system in this group can be derived by simple processes of growth. Hence the canal system of the groups included under the designation Demospongiae—the Tetractinellida, Monaxonida, Keratosa, etc.—are often known as the *Rhagon* type of canal system.

The *Rhagon* (Figs. 61, *e*, and 84) is a little sponge organism, in

shape like a cake or bun, being usually slightly flattened and spread out, with an irregular, but more or less circular outline. The upper surface of the body is studded with minute pores (prosopyles), leading directly into small rounded flagellated chambers, which in their turn open by wide apopyles into a spacious gastral cavity, lined everywhere by flattened epithelium. The water passes out of the gastral cavity by the osculum, which is often raised up like a chimney from the surface of the body. The lower surface of the body is in contact with the surface of the object to which the sponge is attached, and contains no chambers. Hence two regions can be distinguished conveniently in the body wall; a lower portion, devoid of chambers or pores, the *hypophare*, and an upper portion, containing all the chambers, the *spongophare*.

From the foregoing it will be seen that the Rhagon is considerably in advance of the *Olyntus* as regards organisation, since it has a canal system of the second type, with the gastral layer

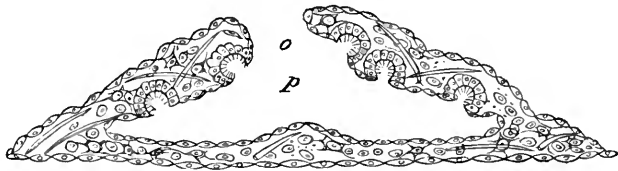

FIG. 84.

Vertical section of a Rhagon, diagrammatic. *o*, osculum; *p*, gastral cavity. (After Keller, \times about 100).

confined to the flagellated chambers, and the gastral cavity lined everywhere by flat epithelium of the dermal layer. No stage with fully formed pores and osculum, and with a canal system in a state of functional activity, is known to occur of a simpler type than the Rhagon in any Demosponge, but a transitory embryonic stage is often found which may be interpreted as a suppressed and contracted *Olyntus* stage (Fig. 63, *B*). No Demosponge is known, on the other hand, which remains in the simple Rhagon condition; growth and folding of the wall lead in all cases to a series of progressive complications.

The simplest adult type of canal system in Demospongiae is represented by such a form as *Plakina monolopha* (Fig. 61, *f*), in which the upper wall or spongophare of the primitive Rhagon has become folded to form a number of lobes or diverticula. The flagellated chambers become restricted to the walls of the diverticula in question, and open into their cavities, which, though in origin simply portions of a continuous gastral cavity, may be distinguished conveniently as *excurrent canals* from the gastral cavity proper, just as the spaces enclosed between the folds of the spongophare may

be termed *incurrent canals*, though in reality spaces external to the sponge. A condition quite similar in the main to that seen in *Plakina monolopha*, occurs also in *Oscarella*, which differs only in having both apopyles and prosopyles drawn out into distinct aphodi and prosodi, so that the very simple canal system in this form is of the diplodal type (Schulze).¹

The further development of the canal system is brought about by processes of growth perfectly similar to those already described in the *Calcarea Heterocoela*; namely, on the one hand, by further folding of the spongophare, leading to considerable branching and complication of both the excurrent and incurrent canals; and, on the other hand, by thickenings of, and fusions between, the outer ends of the diverticula of the spongophare, with the result, first, that the incurrent spaces become more completely enclosed and

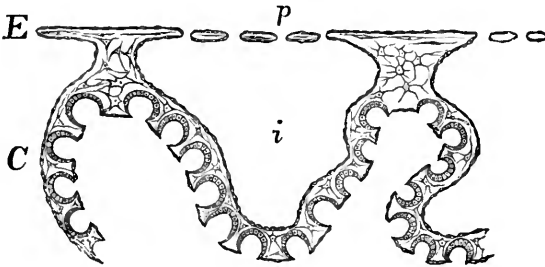

FIG. 85.

Diagram of a transverse section through the outer region of *Tetilla pedifera*. E, ectosome; C, choanosome; e, excurrent canal; i, incurrent canal; p, ostia. (After Sollas, "Challenger" Reports.)

narrowed to form definite canals; and secondly, that a cortical layer is developed on the external surface of the sponge body.

An instructive stage in the evolution of the incurrent system exhibiting but a slight advance on the state of things found in *Plakina monolopha*, is seen in the Tetractinellid genus *Tetilla* (Fig. 85). The dermal layer is greatly thickened at the distal extremity of each diverticulum of the spongophare, and the outer free margin of each such thickening is expanded into a rim or plate which unites with the margins of other and similar thickenings to form a continuous *dermal membrane*, perfectly comparable in its origin to the pseudoderm often formed in an Ascon colony or the dermal membrane of some *Heterocoela*. Over each incurrent canal the dermal membrane is perforated by the *dermal pores* or ostia (*stomions*, Topsent), while the true pores or prosopyles (chamber pores) are now no longer visible on the surface. In consequence of these advances in organisation, two regions of the sponge body can now

¹ The presence of prosodi in *Oscarella* is disputed by some authors, and it is possibly a variable character; cf. p. 49, *supra*.

be distinguished: first, an external or enveloping portion, containing no chambers, termed the *ectosome*; and secondly, an internal portion, containing the chambers, termed the *choanosome*. The former is a new acquisition; the latter constitutes the whole body in such a form as *Plakina monolopha* or in the Rhagon.

In correspondence with these changes the incurrent canal system can now be distinguished territorially, so to speak, into two portions, the one lying in the ectosome, the other in the choanosome. Each portion of the incurrent canal system may exhibit very various modifications in different forms, as the result of different modes of growth on the part of the ectosome. Simple

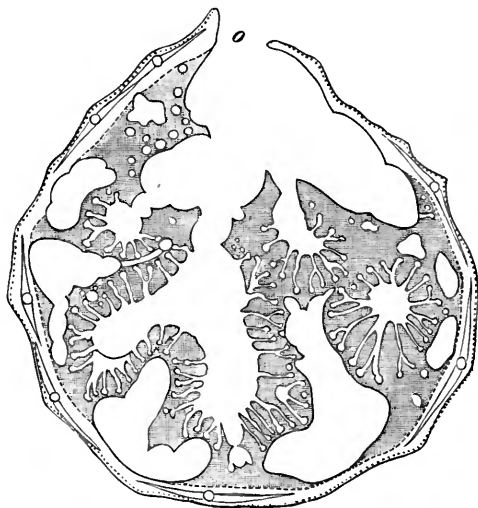

FIG. 86.

Vertical section of *Stelletta phrissens*, Soll. Young specimen, showing the choanosome folded within the cortex. o, osculum. (After Sollas, "Challenger" Report, $\times 50$.)

instances of the two extreme types of the incurrent system, connected, nevertheless, by numerous transitions, are furnished by the genus *Tetilla* on the one hand, and by some species of the genus *Plakina* on the other. In *Tetilla* (Fig. 85) the water on passing through the dermal pores enters wide sinuses lying in the ectosome immediately beneath the dermal membrane, and these spaces can be distinguished as *subdermal cavities* from the narrower portions of the incurrent canals which traverse the choanosome. The distinction between the ectosomal and choanosomal portions of the incurrent system is still better seen in such a form as *Stelletta phrissens* (Fig. 86), where the incurrent canals proper are more narrowed, and contrast with the wider subdermal cavities of the ectosome.

The species of *Plakina*, on the other hand, furnish an interesting series of modifications of another type. In *Plakina monolopha*, as we have seen, there is no ectosome (Fig. 61, f). In *Plakina dilopha*, however, the distal extremities of the lobes of the choanosome are greatly thickened over their whole outer surface, and coalesce with one another to form a thick *cortex*, traversed by the much narrowed incurrent canals. There are in this case neither dermal membrane nor subdermal cavities, and the ectosomal portions of the incurrent system are no wider, and may even be narrower, than the choanosomal portions. *Plakina trilopha* carries this state of things even further, the cortical layer being of greater thickness, and the incurrent canals further complicated by secondary folding of the choanosome. The incurrent canals may widen considerably after traversing the ectosome, to form wide *subcortical crypts*, lying in the choanosome, and therefore not homologous with the subdermal cavities which, as we have seen, belong to the ectosome.

The growth of a cortex, so well seen in a simple condition in *Plakina*, is carried to a high pitch of development in many other sponges, especially in the Tetractinellids and their allies. In a typical corticate sponge the body is enclosed in a tough fibrous rind, often fortified by special differentiations of the skeleton (Fig. 30, B). In such forms the incurrent canal system may commence with an arrangement known as a *chone* (Fig. 87), which may be taken as typifying the extreme of differentiation undergone by the incurrent system. The dermal pores (ostia) are grouped to form pore sieves, and perforate a thin membrane which roofs over a funnel-shaped cavity, termed the ectochone, situated in the cortex, and therefore comparable to a subdermal cavity. The ectochone leads through a narrow aperture, surrounded by a contractile sphincter, into a spacious subcortical crypt, termed the endochone. From the latter come off the incurrent canals (*sensu strictiori*).

Although, in the instances described, the subcortical crypt

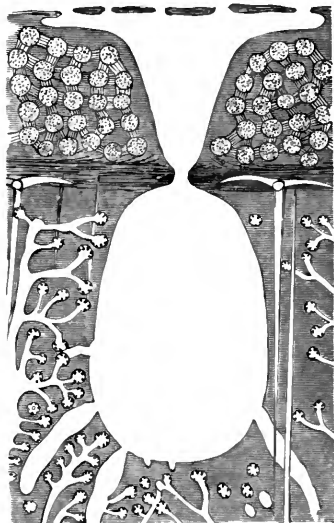
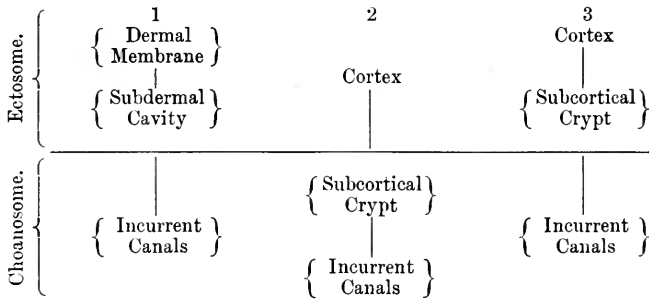

FIG. 87.

Section through the cortex of *Cylindrium eosaster*, Soll., showing the pore sieve overlying the chone, which communicates through a sphincter aperture with the subcortical crypt, lying in the choanosome with its flagellated chambers. The dotted circles in the cortex are sterrasters connected by fibrous strands. (After Sollas, "Challenger" Report, ×73.)

belongs to the choanosome and cannot therefore be compared with a subdermal cavity, it would appear that in other cases a cortex may be developed simply as a great thickening of the dermal membrane, in which case the subcortical crypts may belong to the ectosome and represent subdermal cavities. A cortex is, in fact, a structure which can develop in different ways and may not be homologous in different sponges. The term "subcortical crypt" is to be understood therefore in a descriptive rather than in a morphological sense.

The following table may serve to indicate the homologies of the incurrent system in three typical cases:—



Each of the above types of the incurrent system may be combined with different forms of the canal system considered as a whole, especially as regards the relations of the chambers to the excurrent and incurrent canals. As is plain from what has already been stated with regard to the development from a Rhagon, the canal system of Demospongiae always conforms to what has been termed above the third type; but within the limits of this type of structure, it may be either eurypylous, aphodal (Fig. 88), or diplodal (Fig. 89). Hence the canal system as a whole is liable to very great structural variations in the Demospongiae.

Skeleton.—The skeleton of the Demospongiae exhibits variations of so divergent a character that it is not possible to discuss it in general terms. We have to consider first those forms in which the skeleton is composed of siliceous spicules, some or all of which are of tetraxon type (*Tetraxonida*); secondly, those which always possess siliceous spicules of monaxon form and never tetraxon (*Monaxonida*); and thirdly, those in which proper spicules—*i.e.* spicules secreted by the sponge—are absent and the supporting framework is made up of spongin fibres alone (*Keratosa*).

(a) *Tetraxonida.*—The siliceous spicules which compose the skeleton of the *Tetraxonida* are divisible into megascleres and microscleres—two categories which in the order *Tetractinellida* are sharply distinct from one another, differing not only in size and

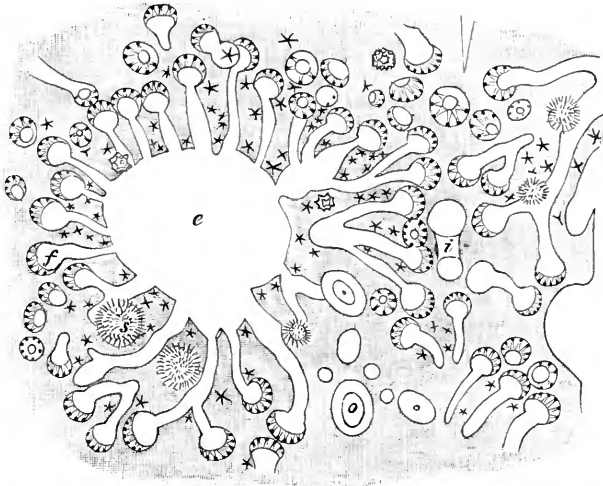

FIG. 88.

Transverse section across an excurrent canal and surrounding choanosome of *Cydonium rosaster*, Soll. *e*, excurrent canal; *f*, flagellated chambers communicating with it by aphodal canals; *i*, an incurrent canal cut across; *s*, a sterraster; *o*, an oxea cut across. (After Sollas, "Challenger" Report, $\times 125$.)

function, but also very frequently in morphological characters. Thus certain forms of microsclere, such as the commonly occurring asters, conform to types of structure not represented among the megascleres. In this respect we find a marked contrast with the Hexactinellida, where all the spicules, even the asters, are variations of the one fundamental triaxon type.

Forms of the Spicules.—In the first place, a distinction must be drawn between the simple (primary) spicules, on the one hand, and the compound (secondary) spicules or *desmas*, characteristic of the sub-order Lithistida, on the other hand. Since the desma is itself founded, in most instances, upon a primary spicule, we may commence with the discussion of the latter.

All primary spicules in the

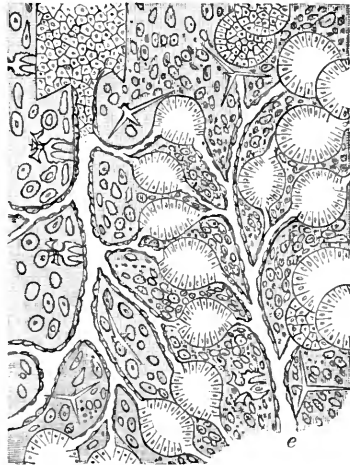

FIG. 89.

Diploidal canal system in *Corticium candelabrum*, O.S. *e*, excurrent canal; the incurrent canal is shown on the left-hand side, near its commencement in the cortex. (After F. E. Schulze, $\times 200$.)

Tetraxonida may be considered ideally—that is to say, from a purely architectural or geometrical point of view, and without prejudice to the question of their actual phylogeny and evolution—as modifications of one of two types: (a) the *tetraxon* type, characteristic of the megascleres, though not confined to them; and (b) the *polyaxon* type, only found among the microscleres. Strictly speaking, the tetraxon type itself could be considered as a modification of the polyaxon, and has probably been derived from it, but for practical purposes it is best to consider the two types separately.

(a) *Tetraxon Type*.—The simplest form of tetraxon spicule has four equal and similar rays meeting at equal angles (Fig. 47, *d* and *p*). Such a spicule is known as a *calthrope*, and though of common occurrence, both among megascleres and microscleres, it is far less abundant than some of the numerous variations of the regular tetraxon form. Departures from the fundamental type are brought about, not only as in the Hexactinellida, by unequal growth or curvature of the rays, or by the acquisition of secondary spines and branches, but also, in contrast to the modifications of the triaxon type, by variations in the angles at which the rays meet.

The simplest modification of the regular tetractine is one correlated in the first instance with the acquisition by it of a definite orientation in the sponge body. One ray, which is directed radially and points towards the interior of the sponge, becomes differentiated from the three remaining rays, which in their turn radiate more or less tangentially from a centre situated close to the outer surface of the sponge. In this way arises the form of spicule known as the *triaene* (Fig. 90, *k, l, m, n*), which is perhaps more than any other characteristic of the order Tetractinellida. The radially directed ray of the triaene, which is usually longer, but sometimes shorter, than the other three, is termed the shaft or *rhabdome*, and the superficially situated rays are known individually as the *cladi* or prongs, collectively as the *cladome*.

The triaene undergoes in its turn numerous modifications, affecting every part of it, and giving rise to a series of forms, each denoted by a special term. Without attempting to enumerate the many varieties of the triaene, it is of interest to consider the variations of the cladi in their relations to the rhabdome, both as regards orientation and size.

In the first place, the three cladi or their axes always meet one another at equal angles, but the angles at which they meet the rhabdome may vary considerably in different instances, though always the same for each cladus in a given spicule. Hence, if a projection be made of the triaene in such a way that the shaft is completely foreshortened and seen as a dot, then the axes of the three cladi, or of their main stems, if they be branched, will appear to meet one another at equal angles of 120° . If the triaene be viewed in profile, on the other hand, so that the shaft

and one of the prongs lie in the plane of the field of vision, then the angle between shaft and prong may vary greatly. The cladi may be directed forwards, *i.e.* so as to point the opposite way to the shaft (prototriaene, Fig. 90, *l*); or outwards, at right angles to the shaft (orthotriaene, Fig. 90, *n*); or even backwards (anatriaene, Fig. 90, *k*). In other words, each cladus may rotate in the plane of the rhabdome, the amount of rotation being always the same for each prong of a given triaene.

In the second place, both the rays of the cladome and the rhabdome may vary greatly in size relatively to one another, and any given ray may become reduced until it finally disappears altogether. In the cladome the process of atrophy, or rather arrest of development, may affect one ray (*diaene*) or two of the rays (*monaene*), or finally, all three, the result in the latter case being a simple monaxon spicule (Fig. 90, *j*), a form of

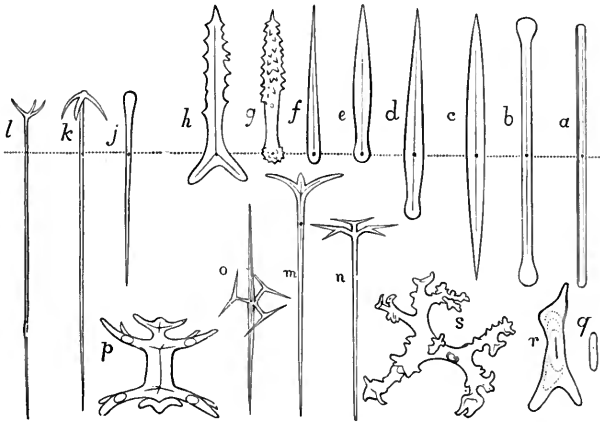

FIG. 90.

Types of megascleres in Demospongiae. *a-d*, rhabdi (*a*, strongyle, *b*, tylote, *c*, oxea, *d*, tylostyle); *e-g*, styli (*e*, tylostyle, *f*, style, *g*, spined tylostyle); *h*, branched monaxon; *j-o*, modifications of the triaene (*j*, cladi reduced, *k*, anatriaene, *l*, prototriaene, *m*, orthotriaene, *n*, dichotriaene, *o*, centrotriaene, *p*, amphitriaene, *q*, crepis of *r*, rhabdorepid, *s*, older and fully formed desma).

common occurrence in the Tetraxonida and known as a *rhabdus* (diactinal) or *style* (monactinal). In cases where all the triaenes are reduced in this way, the sponge may be entirely without tetraxon spicules, its Tetractinellid affinities being shown only in secondary characters, such as the possession of polyaxon microscleres or a cortex, and especially in the radiating arrangement of the large monaxon spicules themselves, an orientation easily intelligible on the assumption of their derivation from the rhabdome of a triaene. Instances of such forms are well seen in the *Placospongiidae* and *Tethyidae*. On the other hand, the modification of the triaene may proceed along a course exactly opposite to that which produces a monaxon, the rhabdome becoming atrophied and leaving the three rays of the cladome as a triactinal spicule, usually situated close to the outer surface of the sponge.

As aberrant forms of the triaene may be mentioned finally the cases

in which the rhabdome is prolonged beyond the cladome (*centrotriaene*, Fig. 90, *o*), or bears a cladome at each extremity (*amphitriaene*, Fig. 90, *p*), and any of the varieties above mentioned of the tetractinal spicule, triaene, or calthrops, may have one or more of its rays forked or branched like a crest. The spicule is then said to be monolophous, dilophous, trilophous, or tetralophous according to the number of rays so affected. When all the rays are branched, the spicule may be termed simply a *lophocalthrops* or *lophotriaene*. A special case of the latter is the *candelabrum* characteristic of the *Corticidae*. Another common spicule, the *dichotriaene* (Fig. 90, *n*), has each cladus forked.

(*b*) *Polyaxon Type*.—The most primitive form of polyaxon spicule is a simple globule or siliceous concretion which, by the acquisition of numerous spines or rays, becomes an *aster*. The latter in its turn undergoes numerous modifications, of which we may note in the first place two series, in one of which the rays meet at a common centre (*euaster*, Fig. 48, *m, n*), while in the other the rays are not centred, but radiate from a longer or shorter axis, usually spiral (*streptaster*, Fig. 48, *d, e*).

Further variation of each of these two sub-types gives rise to a great number of forms. We may notice specially certain forms of systematic importance, as, for example, the *sterraster* (Fig. 47, *g*), in which an aster with numerous rays (in some cases apparently a euaster, in others a streptaster) becomes converted secondarily into a solid spherule by deposits of silica between the rays; the *spiraster*, a streptaster with a spiral axis (Fig. 48, *d*); the *amphiaster*, a streptaster with the rays confined to two whorls at each end of the axis (Fig. 48, *f*); the *sanidaster* (Fig. 48, *e*); and the two modifications of the euaster, termed respectively *oxyaster* and *sphaeraster* (Fig. 48, *m, n*). Of great morphological importance, on the other hand, are the variations of the aster produced by reduction of the rays (Fig. 48, *o, p*). Thus a euaster with only four persistent rays becomes a microcalthrops (Fig. 48, *p*) or primitive tetraxon, which, by curvature, branching, or ornamentation of the rays, gives rise to a large series of microscleres, while increase of size makes it the starting-point of the evolution, wholly or in part, of the megascleres. By a further reduction of the rays of the euaster to two placed in the same straight line, or, it may be, by suppression of the spines and elongation of the axis, in a streptaster, we obtain a minute monaxon or *microrhabdus*, itself the ancestor, so to speak, of many forms of microscleres, and perhaps of megascleres; of the former, the sigmaspire (Fig. 48, *a, b*), perhaps derived immediately from a spiraster by suppression of the rays, deserves special mention.

Secondary Spicules or Desmas.—There remain for consideration the remarkable megascleres known as desmas ("clones," Rauff), characteristic of the sub-order Lithistida. Each desma is formed typically by secondary deposits of silica upon a true spicule termed the *crepis* or foundation, which undergoes an arrest of development.

The crepis may be a minute calthrops, or a rhabdus, or, finally, may be atrophied completely; thus *tetracrepid*, *monocrepid*, and *acrepid* desmas may be distinguished. The layers of silica deposited are at first concentric with the crepis, but subsequently grow out into irregular branches and tubercles, which are quite independent of it. In this way a secondary skeletal element of complicated and often quite irregular form is produced (Fig. 47, *f*; Fig. 90, *q, r, s*).

Phylogeny of the Spicules.—Enough has been said to indicate the probable origin of the primitive tetraxon from the polyaxon aster or globule, and hence the origin of all megascleres from the microscleres. The regular tetraxon type of spicule represents an adaptation to the structure of a primitive Rhagon-like ancestor, in which, by folding of the walls, numerous spherical ciliated chambers lie embedded in a parenchymatous tissue (Schulze). When in such a form, the chambers are as closely packed as possible; each chamber is in contact with three others, and the tetraxon spicule fits exactly into the interspaces between four contiguous chambers.

The evolution of many of the forms of spicules is difficult to follow in detail, since in many cases more than one origin is possible for them, and not enough is known to determine with certainty which was the actual course of the phylogeny, which may indeed have proceeded along more than one direction. Thus in the case of the characteristic triaenes: while, on the one hand, a general comparative survey of their morphology and systematic relations rather indicates an origin for them from the primitive tetraxon calthrops, correlated with the acquisition by the sponge of a distinct cortex; on the other hand, their ontogeny, so far as it is known, and also the existence of certain forms such as the mesotriaene and amphitriaene, favours the view that they have originated by branching of a large monaxon rhabdus (Sollas). Conversely, a double origin is possible for the monaxon megascleres, either by reduction from a triaene, or, by increase of size, from a microrhabdus, derived in its turn from reduction of an aster or a calthrops.

The following scheme may serve to indicate the different courses of phylogeny which are possible:—

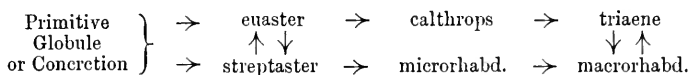

Arrangement of the Spicules in the Skeleton.—By the arrangement of the megascleres two types of skeleton can be distinguished in the order Tetractinellida: the *irregular*, seen in the Lithistida, and a few Choristida; and the *radiate* type (Fig. 91), characteristic of the vast majority of Choristida. Even in the former type, however, all triaenes when present near the surface have the rhabdome directed towards the centre, and to this extent exhibit a radiate structure.

In most, if not all, Choristida the young sponge has a radiate structure when still quite small, the spicules being arranged in sheaves between

the incurrent folds of the canal system, with their main shafts reaching from the centre to the periphery (Fig. 91). During subsequent growth

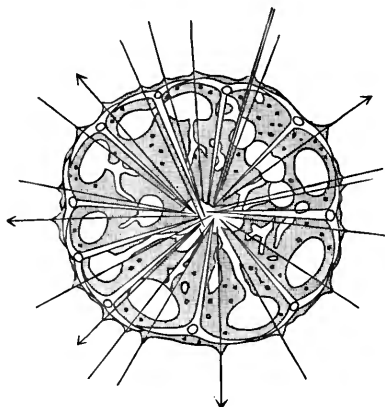

FIG. 91.

Mode of arrangement of spicules in a young Stellettid sponge, *Dragmastra normani*, Soll. (After Sollas.)

the new spicules, which are formed after the sponge has exceeded a certain size, may in a few instances be disposed irregularly, so that the full-grown sponge exhibits no trace of the radiating arrangement, except perhaps close to the outer surface; most usually, however, the spicules formed later retain the radial arrangement, so that the spicule sheaves of the earlier stage are converted into fibres radiating from the centre to the periphery, often with a pronounced spiral twist.

The surface of the sponge may become "hispid" by the projection of radially arranged spicules beyond the limiting epithelium of the body wall, and the "hispidating" spicules may be specially differentiated to form protecting fringes round the openings of the oscula and incurrent canals, or to furnish a root tuft similar to that of some Hexactinellida. A characteristic feature of Tetractinellids is the differentiation of a special cortex, which may have a skeleton distinct from that of the pulp, both as regards arrangement and composition (cf. Fig. 87). Finally, in those forms in which there is an elongated oscular tube, it is supported by a palisade of special spicules forming a cloacal skeleton.

The microscleres are found scattered in the parenchyma, and may be sharply differentiated in the two regions of the body, cortex, and pulp.

Union of the Spicules.—Spongin is said to be present in minute quantities in some forms, but it never has any appreciable importance,¹ and is practically absent, as also any other form of special cementing substance. The spicules are held together by interlocking and by the fibrous cortex. In Choristida they fall apart when macerated. In the Lithistida, however, the complicated desmas interlock by means of the tubercles or their branches to form a compact skeletal framework which imparts to the sponge a

¹ With the exception of *Thymosia*, which is described as having a skeleton of spongin fibres radiating upwards from the base. Each fibre is "verrucose," being composed of nodules of spongin agglomerated together, and contains no foreign bodies (Topsent). More evidence seems to be needed as to the true nature of the fibres in question.

stony hardness. This mode of union of the spicules is termed "zygosis."

(β) *Monaxonida*.—The skeleton of the Monaxonida is composed of siliceous spicules, to which may be added a greater or less amount of spongin. The function of the latter is, in the first instance, that of a special cement, which glues the spicules together, but it may be present in such quantities that it forms the greater part of the skeleton, especially in forms whose habitat exposes them to severe stresses and strains from waves and currents (Keller). Hence the spicules are thrown more and more into the background, and tend to become reduced and rudimentary. In any case, the spicules of Monaxonida are, as a general rule, smaller relatively to the size of the sponge than is the case in Hexactinellids and Tetractinellids, and in order to support the sponge adequately, they tend to become united to form more or less definite tracts of fibres, a type of skeleton which has the further advantage of possessing the flexibility and elasticity essential to a shore life.

The formation of a skeletal framework by union of spicules, permits of a sharp distinction being drawn, as a rule, between megascleres and microscleres, since the former enter into the composition of the body skeleton (skeletal spicules), while the latter are scattered in the tissues (flesh spicules). In some cases, however, the distinction is one of degree and scarcely tenable, as in the *Spongillinae*. In many cases microscleres may be wanting entirely.

Forms of Spicules.—All spicules in this group are either of the monaxon type, or in a few cases among the microscleres, polyaxon. Since, however, monaxon spicules are of frequent occurrence in other groups as reductions of triaxon and tetraaxon types, it is not so much the presence of monaxons, as the absence of other types, which specially characterise the Monaxonida.

(*a*) *The megascleres* are always monaxon, and their variations, though numerous, are within a small compass. The most important distinction that can be drawn depends upon the spicule being monactinal (styli, Fig. 90, *e, f, g*), or diactinal (rhabdi, Fig. 90, *a-d*). In the former case, the slight swelling in the axial thread that marks the starting-point of the growth is near one extremity, which may be termed the proximal end of the spicule; in the latter case, it is near the middle of the shaft. Monactinal spicules always have the two ends unlike, the proximal end being rounded off abruptly, and often knobbed ("tylostyle"). Diactinal spicules, on the other hand, usually have the two extremities similar.

Other variations in the monaxon spicule, apart from fluctuations of size, depend on whether the shaft is smooth or spined, straight or curved, or whether the extremities are sharp ("oxeote"), blunt ("tornote"), rounded ("strongylote"), knobbed ("tylote"), or, in rare cases, branched. The branching is probably due, in most cases, to the development of

spines, which are restricted to the termination of the shaft, and in some cases assume the character of a grapnel (*Proteleia*, *Acarinus*). In the interesting genus *Trikenrion*, however, the spicules which echinate the skeletal fibres (see below) are branched at their inner end so as to have two, three, or even four roots by which they are attached to the skeletal fibre, and the branching here affects the axial thread, producing sometimes an imitation, as it were, of a tetraxon spicule (Fig. 90, *h*).

(*b*) *The microscleres*, though usually monaxon, exhibit a wider range of variation than is to be found amongst the megascleres, owing to their being usually strongly curved or provided with prominent hooks or spines. In this way arise certain constant forms, often of great systematic importance, such as the *sigma* (Fig. 48, *a*, *b*, *g*), the *toxa*, the *chela* (Fig. 48, *h*), specially characteristic of the family *Poeciloscleridae*, and the peculiar *amphidiscs*, developed in connection with the gemmules of some *Spongillinae* (Fig. 56, *amph*).

Of the polyaxon type, both streptasters and euasters are met with, the latter form being, however, of rather exceptional occurrence. It is extremely probable, moreover, that, with few exceptions, the streptaster, when found in this group, represents a minute spined rhabdus, in which the shaft has become shortened and the spines lengthened, and should therefore be regarded as of the monaxon, rather than of the polyaxon type. Spined rhabdi are of common occurrence as microscleres, and in the *Spongillinae* they seem to be of caenogenetic origin and derived from megascleres. The euaster would appear, in at least one family (*Azinellidae*, to represent a further step in the reduction of a monaxon streptaster. In the other cases, where euasters occur (e.g. *Tethyidae*), the true affinities of the sponges that possess them are shown by various secondary characters to be with the Tetractinellida rather than with the typical Monaxonida, and the spicules in question may in such forms be regarded as primary euasters of the true polyaxon type, derived from a Tetraxonid ancestor which has recently lost its tetraxon spicules.

Union of the Spicules and their Arrangement in the Fibres.—Secondary siliceous deposits, for the purpose of uniting the spicules into a framework, are unknown in this group, though in the *Spongillinae* peculiar spicular systems of branching form, due to the fusion of several independent monaxons, are of common occurrence as an abnormality or variation which may become so frequent that in some cases it must be considered as a normal feature of certain species (Evans, 1899).

Union between the spicules is effected either by means of fibrous tissue or by spongin. A well-marked series of gradations can be made out in this respect. In the most primitive types the spicules are held together, if at all, by fibre cells. In the next stage there are to be found amongst the fibre cells a certain number of glandular cells ("spongoblasts"), derived from the external epithelium (see above, p. 46), which become included in the growing fibres and secrete spongin. Next the number of spongo-

blasts, and consequently the amount of spongin, increases *pari passu* with a decrease in the number of fibre cells, which tend to be placed externally to the spongoblasts (cf. Fig. 92, *A, B*). Finally, the spicules become wholly enveloped in spongin, the result being a fibre of spongin containing a core of spicules, the whole enveloped in a fibrous sheath (Fig. 92, *C*). A still further stage, in which the

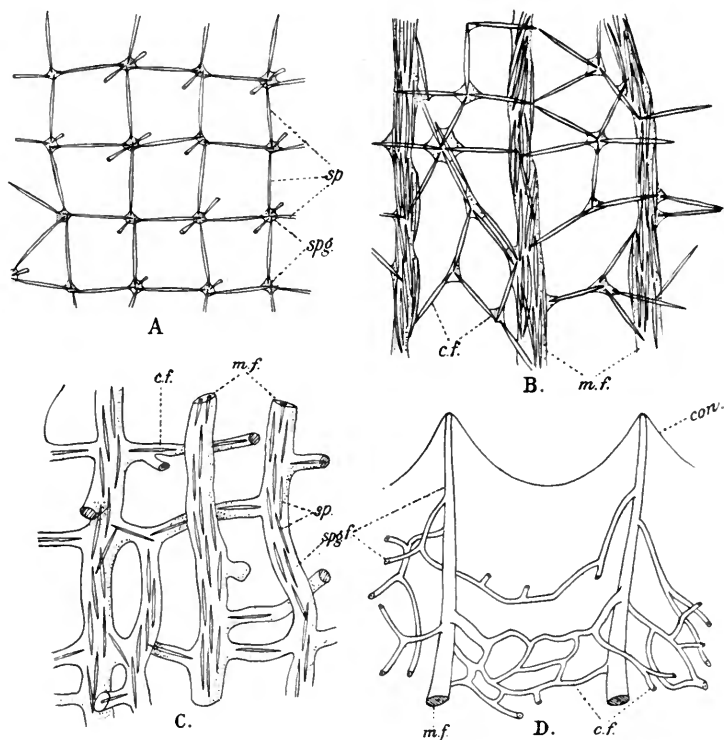

FIG. 92.

The evolution of a spongin skeleton as seen in types of Renierinae and Chalininae and in *Euspongia*. *A*, skeletal framework of *Reniera*; *B*, of *Pachuchalina*; *C*, of *Chalina*; *D*, of *Euspongia*. *sp*, spicules; *spg*, spongin; *m.f.* main fibres; *c.f.* connecting fibres; *spg.f.* spongin fibres; *con.*, conulus.

spicules in the interior of the fibres atrophy and disappear (Fig. 92, *D*), produces a type of sponge skeleton which can only be distinguished from that of the Keratosa by arbitrary definitions (presence or absence of spicules outside the fibres). The place of the spicules is taken in many cases by sand grains or foreign particles of various kinds.

There can, in fact, be found in the Monaxonida every possible stage required for the phylogeny of the true horny sponges

(Dictyoceratina)—an evolution which has probably taken place in more than one family of *Halichondrina*.

When distinct skeletal fibres are present, they are built up of spicules according to one of three distinct patterns or types, which have been named from the families or sub-families which they characterise.

(1) In the Renierine or Chalinine type the fibre is made up of spicules, all of which lie parallel to the direction of the fibre. The spicules may be arranged in a single series, end to end, or in more than one such series (Fig. 92, A-C, and Fig. 93, A).

(2) In the Axinellid type each component spicule is inclined at a variable, but usually acute, angle to the axis of the fibre, giving it a feathery or "plumose" appearance. The spicules so placed are said to "echinate" the fibre (Fig. 93, B).

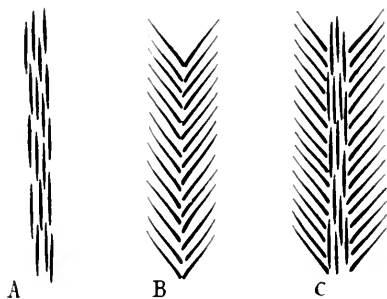

FIG. 93.

Types of skeletal fibre in the Monaxonida. A, Renierine or Chalinine type; B, Axinellid type; C, Ectyonine type.

(3) The Ectyonine type of fibre combines the peculiarities of the other two types, since it is made up of a core of parallel spicules covered by a superficial layer of echinating spicules, which are very rarely similar to those occupying the axis (Fig. 93, C).

Arrangement of the Skeleton at Large.—In the more typical *Halichondrina* the skeletal fibres have a *reticulate* arrange-

ment, in which primary fibres, running vertically towards the surface of the sponge, can often be distinguished from secondary fibres crossing them at right angles (Fig. 93, A, B, and C). In the *Suberitidae* and many *Clavulina*, and to some extent in the *Axinellidae*, the fibres have a more *radiate* arrangement, running from a centre or axis to the surface without any crossing fibres.

In most Monaxonida, whatever the general arrangement of the skeleton may be, a dermal skeleton can usually be distinguished from a main skeleton. In other respects, however, the skeleton shows very little specialisation in different regions. A root tuft is never present.

(γ) *Keratosa*.—In the horny sponges the skeleton consists of fibres of spongin, which in one instance, *Darwinella*, are found combined with isolated spicules of the same substance.

The spongin fibres of *Keratosa* consist typically of two portions, a softer and more granular medullary substance, occupying the axis, surrounded by concentric coats or lamellae of true spongin, forming the cortical substance. According to the proportions of these two constituents, two types of fibres are conveniently distinguished. In the solid or *homogeneous* fibres, the axial substance is very small

in amount, and possibly absent altogether in some cases. In the hollow or *heterogeneous* fibres, on the other hand, the medullary substance is largely developed, making up often the bulk of the fibril, but relatively less abundant in the older fibres than in the younger.

In form the spongin fibres are usually cylindrical, but may be slightly compressed and even flattened or leaf-like in places (*Dendrilla*). The growing portions of the spongin fibre are enveloped in a sheath or "mantle" of spongoblast cells, of columnar epithelial form, which appear to deposit concentric layers of spongin, as a cuticular secretion, upon the surface of the fibre. Many details of the growth remain, however, obscure and in need of further investigation, especially as regards the origin of the medullary substance.¹

When the fibres have attained their definitive growth, the spongoblasts seem to disappear, perhaps becoming converted into connective tissue cells.

As regards the arrangement of spongin fibres to form the skeleton as a whole, two types can be distinguished, the *reticulate* and the *dendritic*. In the reticulate type the skeleton is made up of a continuous network of anastomosing fibres, in which *principal* and *connecting* fibres can be distinguished. The former (Fig. 92, *D*, *m.f*) run vertically upwards to the surface and raise it up into little tent-like projections or *conuli*. The connecting fibres take a more horizontal course. In the dendritic type, characteristic of the family *Aplysillidae*, the skeleton consists of heterogeneous fibres which grow upwards like a tree from a basal plate of spongin, branching freely, but remaining distinct from one another. The terminal branches raise the skin into *conuli*. In the genus *Darwinella* a skeleton of this kind is found combined with separate spicules of spongin having the same structure as the fibres of the skeleton. The spicules in question are of variable form, but in many cases distinctly of a six-rayed or triaxon type; the rays vary, however, from two or three to as many as eight, and the angles at which they meet are irregular and inconstant. Nothing is known regarding their origin and formation.

The property possessed by many sponges of taking up foreign bodies into their fibres has already been noticed (p. 42). In the

¹ According to Lendenfeld, whose results require confirmation, the medullary substance in *Dendrilla* owes its origin to cells derived from the spongoblast layer, which become included in the fibre at its growing point. The function of these cells is supposed to be the production of medullary substance by destruction and modification of the layers of cortical spongin secreted by the enveloping spongoblasts, and they are hence termed by Lendenfeld "spongoclasts," on the analogy of the marrow cells or osteoclasts of Vertebrata. Cells are also stated to occur in the horny fibres of the genus *Ianthella*, but in this case they are found between the spongin lamellae of the cortical layer, and not at all in the medullary substance. In no other cases have cells been observed in the interior of the fibres.

Keratosa, included foreign bodies are always absent in the fibres of the dendritic type of skeleton; on the other hand, they are commonly present in the fibres of the reticulate type, a difference perhaps due, as already suggested above (p. 43), to the fact that the former grow originally from the base of the sponge, while the latter, on the contrary, have, from the first, their growing points at, or near, the upper surface of the sponge body. As regards the amount of foreign bodies taken up by different sponges, a complete series of gradations can be traced. Starting from forms which, like the common bath sponge, have no foreign bodies at all, or only a few, in their principal fibres, we find others in which the amount contained in the principal fibres is greatly increased, the connecting fibres, however, still being free from them; in others again, both principal and connecting fibres are loaded with foreign bodies (Fig. 94). Finally, the whole skeleton appears to be made up of sand grains and similar particles, between which the spongin can scarcely be made out. In fact, in many of these so-called arenaceous sponges the presence of any spongin at all in the skeleton is disputed.

Thus in *Psammopemna*, an extreme type, the skeleton is made up of isolated sand grains, which are stated to be coated each by a thin cuticle (Marshall) composed of spongin (Poléjaeff), and to be united one to another by thin strands of the same substance (Lendenfeld). Haeckel, however, denies the existence of any spongin connecting the sand grains, and has founded a new family, *Psammínidae*, characterised by a skeleton of foreign bodies without any spongin, for the genus *Psammopemna* and its allies.

Two aberrant types of spongin skeleton have been described by Haeckel (1889). In his genus *Cerelasma*, placed by him amongst the *Spongeliidae*, the skeleton is described as consisting of thin spongin lamellae, which branch and anastomose to form a reticular framework. In the meshes of the skeleton are lodged numerous foreign bodies, each as a rule enveloped in a thin coating of spongin. In Haeckel's family *Stannomidae* the skeleton is said to be composed of thin fibrillae of spongin, which may branch but do not anastomose, and between which numerous foreign bodies lie in the gelatinous ground substance. Grave doubts attach, however, to the nature both of *Cerelasma* and the *Stannomidae*, and it is very probable that they are not sponges at all (see p. 154).

There remain for mention, finally, the peculiar *filaments* found in certain genera (*Hircinia*, *Stelospongius*, etc.), combined with a spongin skeleton of the ordinary type. Each filament is a long slender twisted thread, slightly thicker in the middle than towards the extremities, and terminating at each end in a knob. The form has been aptly compared to that of an ordinary skipping-rope, with pear-shaped handles. Each filament has a thin sheath enclosing a softer medulla, traversed from end to end by an axial thread. The greatest uncertainty prevails

as to the true nature of these structures. Their chemical nature has been shown to be different from that of spongin (Schulze); but while some authors are inclined to regard them as foreign to the sponge, and probably organisms of a symbiotic or parasitic nature, others consider them as true products of the sponge tissues. Haeckel, amongst the latter,

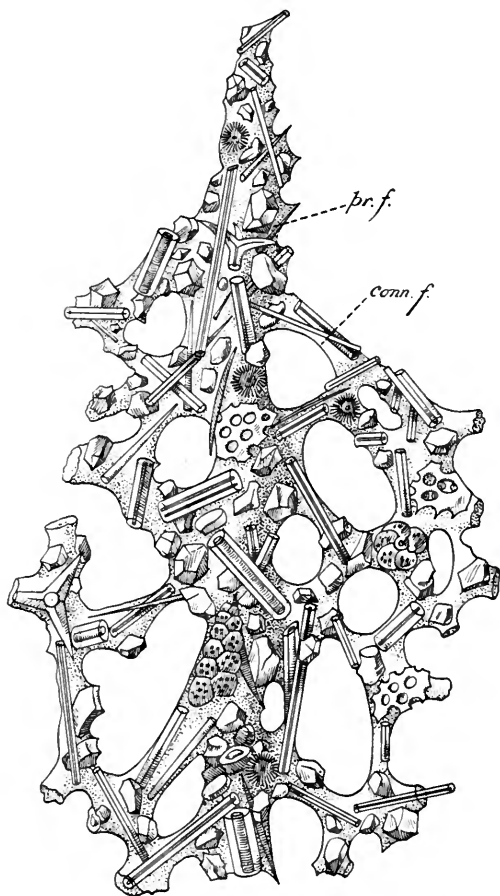

FIG. 94.

Spongin fibres of *Spongia avara*, loaded with foreign particles. *pr. f.*, principal fibre; *conn. f.*, connecting fibre. (After F. E. Schulze.)

compares them with the fibrillae of *Stannomidae*, while Fol professes to trace their origin to fusiform cells of the connective tissue layer, and considers that the family *Filiferæ* (O. Schmidt) should be reinstated for the horny sponges characterised by the possession of filaments. Loisel suggests that they are intracellular spongin filaments of the same nature

as the elastic fibrillae described by him in *Reniera*. The question cannot at present be decided.

Phylogeny of Keratose Skeletons.—In dealing with the Monaxonida, the evolution of the pure spongin fibre, by gradual increase of the spongin and atrophy of the spicules in the skeletal fibres of that group, has already been traced (see above, p. 139). It is highly probable not only that most Keratose skeletons have so originated, but that the evolution of spongin fibres has taken place in this way more than once in different families of Monaxonida independently. On the other hand, it is not improbable that the dendritic fibres of the *Aplysillidae* may have originated in a different way, which, however, it is not possible to indicate satisfactorily at present.

After loss of the spicules, many sponges have acquired the habit of taking up foreign bodies into their fibres, a habit which reaches its extreme in the arenaceous *Spongelidae*. Should some of these forms prove to be really devoid of spongin, an interesting speculation is opened up as to how far such a condition is the culminating point in an evolution which proceeds by diminution and ultimate loss of spongin; or whether it is a more primitive state of things, spongin never having been present.

Histology.—As has been already remarked, the Demospongiae attain to a higher degree of histological differentiation than either the Calcarea or the Hexactinellida; while in the two latter classes we can scarcely recognise more than the six categories of cells indicated by Roman numerals in the table given above (p. 62), in the Demospongiae each of these *cell-species* may be further differentiated into the several *cell-varieties* indicated in our table by Arabic numerals. Since these many forms of cells have already been fully described above, we need not further discuss them here. It should, however, be pointed out that our knowledge of the histology of Demospongiae is still in a very backward condition, and that it is extremely difficult to refer with certainty the numerous forms of cells to their proper position in a phylogenetic classification of the histological elements. Amongst the authors who have especially contributed to our knowledge of these questions in recent years, Topsent deserves especial mention as having been the first to show the connection of the myocytes and the epithelium, and also as having demonstrated the existence in all Demospongiae of *cellules sphéruleuses*. The latter are almost certainly homologous, as pointed out above, with the porocytes of Calcarea, although their connection with pores has not yet been demonstrated and may not exist. In support of this conclusion, reference may be made to the recent investigations of Loisel, above described.

Embryology.—The structure and metamorphosis of the larvae of Demospongiae has been dealt with above at sufficient length. We may refer, however, to two points of interest. The first is the striking fact that in the whole group of Tetractinellida, comprising as it does many abundant shore forms, no larvae are as yet known. The second is the occurrence, in the larvae of Monaxonida, of diagnostic characters corresponding to the systematic position of the adult sponges (Maas). Thus in *Haploscleridae* the larva has a pigmented ring at the posterior pole, the pigment being chiefly lodged in a circle of larger flagellated cells, which bear flagella of a special type, and mark the posterior limit of the

flagellated layer. In the families *Poeciloscleridae* and *Axinellidae* there is no such ring of special flagellated cells, and the whole flagellated layer is pigmented, while the exposed portion of the inner mass is unpigmented. This may be compared to the way in which the families *Clathrinidae* and *Leucosoleniidae*, amongst Ascons, are characterised by the possession of parenchymula and amphiblastula larvae respectively.

Classification.—The subdivision of the class *Demospongiae* is a matter of great difficulty, and one upon which little agreement is to be found amongst the authorities; not because the mutual affinities of the various forms comprised in this group are not clear, but on account of the very frequent occurrence of convergent evolution and parallel adaptations. The characters which can most conveniently be used for defining and delimiting systematic groups, and above all, the characters of the skeleton, have not always a uniform origin, and therefore do not indicate natural relationships. It may, indeed, be said that at present, at any rate, it is not possible to construct a system which shall be at once strictly logical and perfectly natural. The most obvious and simple classification is into four grades, characterised respectively (1) by the possession of tetraxon spicules, (2) by monaxon spicules, without tetraxons, (3) by a horny skeleton, without siliceous spicules, and (4) by the absence of a skeleton of any kind. If these four groups are to have any pretence to being natural, however, it is absolutely necessary to overstep in every case the limits imposed by rigidly logical definitions. Thus in the first sub-class, Tetraxonida, it is necessary to include such forms as *Placospongiidae* and *Chondrosidae* which lack tetraxon spicules and sometimes even spicules of any kind, but whose affinities with the other families of the sub-class are indicated by a number of secondary characters. In the Monaxonida we have three sub-orders which are less closely allied to one another than to forms outside the group, and the same must be said of the two orders of Keratosa. The climax is reached, however, when we come to the so-called Myxospongiae, forms devoid of a skeleton. In the first place, we have to remove *Chondrosia*, which, as has been said, is undoubtedly a degenerate Tetraxonid. Of those that remain, *Oscarella* is certainly a very close ally of *Plakina*, among the Tetraxonida, while *Hexadella*, and probably also *Halisarca*, seem to have close affinities with the *Dendroceratina* amongst the horny sponges. So long, however, as it is by no means certain, in the case of these forms, whether their lack of a skeleton is due to degeneration, or represents, as seems more probable, a primitive feature, and until there is more evidence bearing upon this point, the genera in question, in spite of their divergent affinities, may well be left as a sub-class together, as representing, perhaps, a more primitive grade of organisation than any other Demospongiae. It is inevitable that any system at present proposed should be more or less of a

compromise between logical necessities and natural affinities. It is hoped that the classification here adopted represents such a compromise in which the disturbance of the true relationships is reduced to the unavoidable minimum.

The following scheme represents the four main sub-classes and their principal orders. By means of brackets placed on the right, the (perhaps) more natural affinities of the sub-groups are indicated:—

CLASS DEMOSPONGIAE (SOLL.)		
GRADE I. TETRAxonIDA (Ldf.)	Order 1. Carnosa (Crtr.), Tops. ,, 2. Tetractinellida (Marshall).	} Spiculispongiae (Vosmaer).
GRADE II. MONAxONIDA (R. and D.)	Order 3. Hadromerina (Tops.) Sub-Order 1. Aciculina (Tops.) Sub-Order 2. Clavulina (Vosm.)	
	Order 4. Halichondrina (Vosm.)	} Cornacu- spongiae (Vosmaer).
GRADE III. KERATOSA.	Order 5. Dictyoceratina .	
	,, 6. Dendroceratina .	} Hexa- ceratina (Ldf.)
GRADE IV. MYXOSPONGIDA (Soll.)	Family 1. Halisarcidae (O.S.) ,, 2. Oscarellidae (Ldf.)	

DETAILED CLASSIFICATION OF THE DEMOSPONGIAE.

GRADE I. TETRAxONIDA.

Demospongiae typically with tetraxon spicules.

ORDER 1. **Carnosa** (Crtr.), Tops. *emend.*

Tetraxonida with the spicules greatly reduced in size, and even wanting; no diactinal megascleres or triaenes with long rhabdomes.

SUB-ORDER 1. †MICROTRIAENOSA, Tops.

The characteristic spicules are triaenes with short rhabdomes, not specially differentiated in the ectosome or the choanosome, and often variously ornamented or of aberrant types (*amphitriaenes*, *mesotriaenes*, etc.); microscleres of various kinds. A heterogeneous collection of sponges, of diverse affinities: "chaînons de chaînes brisées, dérivés sans intermédiaires connus" (Topsent). Not divided into families. Genera—

† Recent and fossil.

†*Dercitus*, Gray [Cret.]; *Corticella*, Soll.; *Rhachella*, Soll.; *Thrombus*, Soll.; *Samus*, Gray; **Ditriaenella*, Hinde and Holmes [Eoc.]

SUB-ORDER 2. MICROSCLEROPHORA, Soll.

With tetraxon spicules of small size, comparable to microscleres.

FAMILY 1. †CORTICIDAE, Vosm. With dense sarcenchymatous choanosome and tough chondrenchymatous ectosome; spicules microcalthrops and candelabra, the latter localised at the surface of the body. Genus—†*Corticium*, O.S. [Eoc.]

FAMILY 2. PLAKINIDAE, F.E.S. Choanosome of loose, lacunar structure, collenchymatous; the chondrenchymatous ectosome scarcely or not at all developed; spicules microcalthrops and their derivatives, either by reduction (triaenes, rhabdi) or by complication (branching of the rays). Genera—†*Plakina*, F.E.S. [Eoc.]; *Placortis*, F.E.S.; *Plakinastrella*, F.E.S.; *Plakinolopha*, Tops. (Here *Oscarella* finds its nearest allies.)

SUB-ORDER 3. OLIGOSILICINA, Vosm.

Corticate sponges without tetraxon spicules; siliceous skeleton reduced to polyaxon microscleres (*Chondrilla*) or wanting entirely. FAMILY—CHONDROSIDAE, F.E.S.; Genera—*Chondrosia*, Ndo.; *Chondrilla*, O.S.; *Thymosia*, Tops.

ORDER 2. Tetractinellida (Marshall), Topsent, 1894.

Tetraxonida typically with triaene megascleres, or with desmas.

SUB-ORDER 1. CHORISTIDA, Soll.

No desmas; spicules never articulated to form a coherent skeleton.

TRIBE 1. SIGMATOPHORA, Sollas.

The microsclere when present is a sigmaspire.

FAMILY 1. TETILLIDAE, Soll. With protriaenes, always present, and sigmaspires, often wanting. Genera—*Tetilla*, O.S.; *Chrotella*, Soll.; *Cinachyra*, Soll.; *Craniella*, O.S.; *Tethyopsilla*, Ldf.

TRIBE 2. ASTROPHORA, Soll.

One or more of the microscleres is an aster.

Demus α —*Streptastrosa*, Soll. One of the microscleres is a spiraster or, when this is not the case, one of the megascleres is a calthrop.

FAMILY 2. THENEIDAE, Soll. Megascleres, triaenes; microscleres, spirasters, and amphisters; the ectosome does not form a cortex; ground substance collenchymatous; canal system eurypylous. Genus—†*Thenea*, Gray [Cret.], (Fig. 24).

FAMILY 3. †PACHASTRELLIDAE, Ctrt. Megascleres, calthrops, and rhabdi; microscleres, spirasters, and microrhabdi. Genera—†*Pachastrella*, O.S. [Carb. Cret. Eoc.]; *Calthropella*, Soll.; *Characella*, Soll.; *Poecillastra*, Soll.; *Sphinctrella*, O.S.; †*Triptolemus*, Soll. [Eoc.]

Demus β —*Euastrosa*, Soll. Euasters always present, never spirasters or sterrasters; triaenes, but never calthrops amongst the megascleres.

* Fossil forms.

FAMILY 4. STELLETTIDAE, Soll. Megascleres, triaenes, and rhabdi; canal system aphodal; ground substance of choanosome sarcenchymatous. SUB-FAMILY (a). HOMASTERINA, Soll. Never more than one form of aster. Genera—*Myriastr*, Soll.; *Pilochrota*, Soll. SUB-FAMILY (b). †EUASTERINA, Soll. With two kinds of euasters. Genera—*Anthastra*, Soll.; **Geodites*, Crtr. [Cret. Eoc.]; †*Stelletta*, O.S. [Cret. Eoc.]; *Dragmastra*, Soll. SUB-FAMILY (c). SANIDASTERINA, Soll. With euasters and sanidasters or amphiasters. Genera—*Ancorina*, O.S.; *Tribrachion*, Welt. (Fig. 25); †*Tethyopsis*, Stew. [Cret.]; *Disyringa*, Soll. (Fig. 26); *Stryphnus*, Soll.; *Seiriola*, Han.; *Sanidastrella*, Tops. SUB-FAMILY (d). RHABDASTERINA, Soll. With euasters and microrhabdi. Genera—*Ecionema*, Bwk.; *Papyrula*, O.S.; *Psammastra*, Soll.; *Penares*, Gray; *Algol*, Soll.

Demus γ —*Sterrastrosa*, Soll. The characteristic microsclere a sterraster.

FAMILY 5. †GEODIDAE, Gray. With triaenes. SUB-FAMILY (a). †ERYLINA, Soll. Megascleres, orthotriaenes, and rhabdi, never anatriaenes or prototriaenes; somal microsclere a microrhabdus or spherule. Genera—†*Erylus*, Gray [Eoc.]; *Caminus*, O.S.; *Pachymatisma*, Bwk. SUB-FAMILY (b). †GEODINA, Soll. Megascleres rhabdi, orthotriaenes, or dichotriaenes, frequently also prototriaenes and anatriaenes. Somal microsclere, an aster with numerous rays. Genera—*Cydonium*, Flem.; †*Geodia*, Lam. [Cret.]; *Synops*, Vosm.; *Isops*, Soll. FAMILY 6. †PLACOSPONGIDAE, Gray. Megascleres pin-shaped monaxons ("tylostyles"), no triaenes. Genera—*Placospongia*, Gray; *Antares*, Soll.; *Physcaphora*, Han.; **Rhaxella*, Hinde [Jur.].

Genus *incerti sedis*—**Ophirhaphidites*, Crtr. [Cret.].

SUB-ORDER 2. LITHISTIDA, O.S.

Tetractinellida with a rigid skeleton, due to interlocking of special (secondary) spicules, desmas.

The classification which follows is that of Sollas, founded upon a study of the living forms. In addition there are numerous fossil forms, not sufficiently well characterised to be assigned a definite place in this system, such as the family *Rhizomorina* of Zittel, which should be divided amongst the two families *Corallistidae* and *Azoricidae*; these will be found appended at the end of the system. The new groups and families created by Rauff, whose studies are not yet completed, are indicated in square brackets in their proper places.

TRIBE 1. HOPLOPHORA, Soll.

With special ectosomal spicules and usually some form of microscleres.

Demus α —†*Triaenosa*, Soll. The ectosome contains megascleres, typically triaenes, sometimes, however, monaxons (styles—*Desmanthidae*; rhabdi—*Sulcastrella*); canal system aphodal.

FAMILY 1. †TETRACLADIDAE, Z. With tetracrepid desmas and microscleres. Genera—†*Theonella*, Gray [Eoc.]; †*Discodermia*, Boc. [Eoc.]; *Racodiscula*, Z.; *Kaliapsis*, Bwk.; *Neosiphonia*, Soll.; *Rimella*, O.S.; *Collinella*, O.S. (Fig. 28, B); *Sulcastrella*, O.S.; **Phymatella*, Z. [Cret.]; **Aulaxinia*, Z. [Cret.]; **Callopegma*, Z. [Cret.]; **Trachysycon*, Z. [Cret.];

**Siphonia*, Park. [Cret.], (Fig. 27); **Jerea*, Lamx. [Cret.]; **Polyjerea*, From. [Cret.]; **Bolospongia*, Hinde [Cret.]; **Astrocladia*, Z. [Cret.]; **Thecosiphonia*, Z. [Cret.]; **Calymmatina*, Z. [Cret.]; **Turonia*, Mich. [Cret.]; **Kalpinella*, Hinde [Cret.]; **Thamnospongia*, Hinde [Cret.]; **Pholidocladia*, Hinde [Cret.]; **Ragadinia*, Z. [Cret.]; **Plinthosella*, Z. [Cret.]; **Phymaplectia*, Hinde [Cret.]; **Rhopalospongia*, Hinde [Cret.]; **Spongodiscus*, Z. [Cret.]; **Stuckenbergia*, Tschern. [Carb.]. [FAMILY ARCHAEOSCYPHIDAE, Rauff]; **Archaeoscyphia*, Hinde [Camb.]. [FAMILY CHIASTOCLONELLIDAE, Rauff]; **Chiastoclonella*, Rff. [Sil.].

[SUB-TRIBE ONCHOCCLADINAE, Rauff.]. [FAMILY AULOCOPIIDAE, Rauff.];

**Aulocopium*, Oswald [Sil.]; **Dendroclonella*, Rff. [Sil.].

FAMILY 2. DESMANTHIDAE, Tops. With tetracrepid desmas of one kind, either monorepid or tetracrepid; no microscleres; the ectosomal megascleres monactinal, rendering the outer surface hispid. Genera—*Desmanthus*, Tops.; *Monorepidium*, Tops. FAMILY 3. †CORALLISTIDAE, Soll. [= RHIZOMORINA, Z., pars]. The desmas monorepid and tuberculate. Genera—†*Corallistes*, O.S. [Eoc.]; *Macandrewia*, Gray; *Daedalopelta*, Soll.; *Heterophymia*, Pom.; *Callipelta*, Soll. FAMILY 4. †PLEROMIDAE, Soll. [= MEGAMORINA, Z.]. The desmas monorepid and smooth. Genera—*Pleroma*, Soll.; †*Lydidium*, O.S. [Eoc.]; **Placonella*, Hinde [Jur.]; **Megalithista*, Z. [Jur.]; **Dorydesmia*, Z. [Cret.]; **Casterella*, Z. [Cret.]; **Holodictyon*, Hinde [Cret.]; **Pachypoterion*, Hinde [Cret.]; **Heterostinia*, Z. [Cret.]; **Nematrinion*, Hinde [Cret.]; **Isoraphinia*, Z. [Cret.].

Demus β —*Rhabdosa*, Soll. The ectosomal spicules are *microrhabdi*, or modifications of them (discs). Desmas monorepid.

FAMILY 5. NEOPELTIDAE, O.S. Ectosomal spicules monorepid discs. Genus—*Neopeltis*, O.S. FAMILY 6. SCLERITODERMIDAE, Soll. Ectosomal spicules microrhabdi; other microscleres sigmaspires. Genera—*Scleritoderma*, O.S.; *Aciculites*, O.S. FAMILY 7. CLADOPELTIDAE, Soll. Ectosomal spicule a monorepid desma, highly branched in a plane parallel to the surface; no microscleres. Genus—*Siphonidium*, O.S.

TRIBE 2. ANOPLIA, Soll.

No ectosomal spicules or microscleres.

FAMILY 8. †AZORICIDAE, Soll. [= RHIZOMORINA, Z., pars.]. Desmas monorepid. Genera—*Azorica*, Ctr.; *Tretolophus*, Soll.; *Gastrophanella*, O.S.; *Setidium*, O.S. (Fig. 28, A); *Poritella*, O.S.; *Amphibleptula*, O.S.; *Tremaulidium*, O.S.; *Leiodermatium*, O.S.; *Sympyla*, Soll.; *Petromica*, Tops.

[TRIBE POECILOCLADINIDAE, Rff.]

[SUB-TRIBE ANOMOCLADINAE, Rff.]

FAMILY 9. †ANOMOCLADIDAE, Z. Genera—†*Vetulina*, O.S. [Eoc.], (Fig. 29); **Cylindrophyma*, Z. [Jur.]; **Melonella*, Z. [Jur.]; **Scytalia*, Z. [Jur. Cret.]; **Lecanella*, Z. [Jur.]; **Mastosa*, Z. [Jur.]. [FAMILY ANOMOCLONELLIDAE, Rff.]. **Anomoclonella*, Rff. [Sil.]; **Pycnopegma*, Rff. [Sil.].

[SUB-TRIBE EUTAXICLADINAE, Rff.]

[FAMILY ASTYLOSPONGIDAE, Rff.]. **Astylospongia*, Roem. [Sil.]; **Caryospongia*, Rff. [Sil.]; **Carpospongia*, Rff. [Sil.]; **Astylomanon*, Roem. [Sil.]; **Caryomanon*, Hinde; **Palaeomanon*, Roem. [Sil.]; **Protachilleum*, Z. [Sil.]; **Eospongia*, Bill [Sil.]. [FAMILY HINDIADAЕ, Rff.]. **Hindia*, Duncan [Sil.].

Incerti sedis. [FAMILY RHIZOMORINA, Z. (= CORALLISTIDAE + AZORICIDAE)]. Genera—**Cnemidiastrum*, Z. [Jur.]; **Corallidium*, Z. [Jur.]; **Hyalotragos*, Z. [Jur.]; **Pyrgochonia*, Z. [Jur.]; **Discostroma*, Z. [Jur.]; **Leiodorella*, Z. [Jur.]; **Epistomella*, Z. [Jur.]; **Platychonia*, Z. [Jur.]; **Bolidium*, Z. [Cret.]; **Astrobolia*, Z. [Cret.]; **Chonella*, Z. [Cret.]; **Seliscotho*, Z. [Cret.]; **Chenendepora*, Lamx [Cret.]; **Verruculina*, Z. [Cret.]; **Stichophyma*, Pom. [Cret.]; **Jereica*, Z. [Cret.]; **Coelocorypha*, Z. [Cret.]; **Stachyspongia*, Z. [Cret.]; **Pachinion*, Z. [Cret.]; **Nipterella*, Hinde [Cambr.]; **Pemmatites*, Dun. [Carb.]; **Kazania*, Stuck [Carb.].

GRADE II. MONAXONIDA, R. and D.

Demospongiae with monaxon spicules, without admixture of triaxon or tetraaxon types.

In the classification of this most difficult and perplexing group, which exemplifies in the fullest degree the plasticity of the Demospongiae, and the frequency of adaptive and convergent evolution in this class, we follow the classification of Topsent [26 and 28].

ORDER 1. **Hadromerina**, Topsent.

Monaxonida, usually of massive form, sometimes stalked or cup-shaped. Structure compact. Skeletal framework radiate or without order, seldom fibrous, non-reticulate. Spongin absent, or very feebly developed. Megascleres monactinal or diactinal, usually of one kind only; microscleres, when present, asters or microrhabdi, never chelae or sigmata.

SUB-ORDER 1. †ACICULINA, Tops.

Megascleres diactinal.

FAMILY 1. COPPATIDAE, Tops. Microscleres absent, or in the form of euasters, sometimes with the addition of streptasters. *Spongosorites*, Tops.; *Anisoxya*, Tops.; *Coppatias*, Soll (incl. *Astropeplus*, Soll; and *Dorypleres*, Soll); *Magog*, Soll; *Hemiasterella*, Crtr. (= *Epallax*, Soll); *Asteropus*, Soll. FAMILY 2. STREPTASTERIDAE, Tops. Microscleres streptasters; no euasters. Genera—*Amphius*, Soll; *Scolopes*, Soll; *Trachycladus*, Crtr.; *Rhaphidistia*, Crtr.; *Spiroxya*, Tops.; *Holozea*, Tops. FAMILY 3. †TETHYIDAE, Gray. Globular or massive, with radiating framework and differentiated ectosome; microscleres, when present, typically euasters. Genera—†*Tethya*, Lam. [Eoc.], (Fig. 30, A); *Tethyorrhaphis*, Ldf; *Tuberella*, Keller (Fig. 30, B); *Trachya*, Crtr.; *Heteroxya*, Tops. FAMILY 4. STYLOCORDYLIDAE, Tops. Pedunculate; framework,

radiate in the body, forms longitudinal fibres in the stalk. Genera—*Stylocordyla*, W. Th. (Fig. 38); *Cometella*, O.S.; *Halicometes*, Tops.

SUB-ORDER 2. †CLAVULINA, Vosm.

Megascleres monactinal, usually pin-shaped *tylostyles*, rarely *styles*.

FAMILY 1. †CLIONIDAE, Gray. Boring Clavulina. Genera—†*Cliona*, Grant [Cret. Eoc. Mioc.]; *Dotona*, Crtr.; †*Thoosa*, Hanc. [Eoc.]; †*Alectona*, Crtr. [Eoc.]. FAMILY 2. †SPIRASTRELLIDAE, R. and D. Microscleres, euasters, or streptasters usually accumulated to form an ectosomic crust. Megascleres, tylostyles, or styles; occasionally diactinal. Genera—*Hymedesmia*, Bwk.; *Aenospongia*, Gray; †*Spirastrella*, O.S. [Eoc.]; †*Latrunculia*, Boc. [Eoc.]; *Scerprintus*, Tops. FAMILY 3. POLYMASTIIDAE, Vosm. Without microscleres; cortex differentiated; skeletal framework radiate. Genera—*Polymastia*, Bwk.; *Trichostemma*, Sars.; *Rhaphidorus*, Tops.; *Proteleia*, R. and D.; *Tylexocladus*, Tops.; *Sphaerotylus*, Tops.; *Quasulina*, Norm.; *Ridleia*, D.; *Tentorium*, Vosm. (= *Thecaphora*, O.S.), (Fig. 31). FAMILY 4. †SUBERITIDAE, Vosm. No microscleres; no differentiated cortex; framework not radiate; megascleres nearly always tylostyles. Genera—†*Suberites*, Ndo. [Eoc.]; *Ficulina*, Gray; *Lacosuberites*, Tops.; *Terpios*, Duch. et Mich.; *Pseudosuberites*, Tops.; *Prosuberites*, Tops.; *Rhizaxinella*, Keller; *Semisuberites*, Crtr.; *Axosuberites*, Tops.; *Poterion*, Schlegel.

ORDER 2. †Halichondrina, Vosmaer.

Typically non-corticate; skeleton usually reticulate; microscleres monaxon (sigmata chelae, toxa, microrhabdi), very exceptionally polyaxon (euasters in some *Axinellidae*).

FAMILY 1. †HAPLOSCLERIDAE, Tops. (= HOMORRHAPHIDAE, R. and D. + HETERORRHAPHIDAE, R. and D., pars). Spiculation of a simple type, very often with diactinal megascleres alone; microscleres, if present, never chelae. SUB-FAMILY (a). †CHALININAE, O.S. Skeleton composed of fibres of spongin enveloping diactinal megascleres; the latter often greatly reduced in size and quantity. Microscleres usually wanting. Genera—†*Chalina*, Grant [Eoc.], (Fig. 34); *Pachychalina*, O.S.; *Siphonochalina*, O.S.; *Acerochalina*, R.; *Toxochalina*, R.; *Chalinula*, O.S.; *Spinosella*, Vosm. (= *Tuba*, Duch. et Mich.); *Cacochalina*, O.S.; *Sclerochalina*, O.S.; *Ceraochalina*, Keller. SUB-FAMILY (b). †RENIERINAE, O.S. Skeleton of spicules sometimes with a confused arrangement, sometimes forming a more or less regular network. Spongin wanting or present in small quantities, seldom enveloping the spicules completely. Genera—†*Halichondria*, Flem. [Eoc.]; †*Reniera*, Ndo. [Eoc.]; *Petrosia*, Vosm.; *Metschnikovia*, Grimm; *Pellina*, O.S.; *Eumastia*, O.S.; *Reniochalina*, Ldf.; *Gellius*, Gray; *Rhaphisia*, Tops.; *Menanetia*, Tops.; *Astromimus*, Ldf.; *Damiria*, Keller. SUB-FAMILY (c). †SPONGILLINAE, Gray. Fresh water sponges, for the most part similar to Renierinae. SECTION α. †EUSPONGILLINAE (= SPONGILLINAE, Crtr.). The gemmule, so far as it is known, lacks a coat of special spicules. Genera—†*Spongilla*, Lam. [Jur.], (Fig. 33); *Lubomirskia*, Dyb. SECTION β. MEYENINAE, Vejd. The gemmule, when present, has an envelope containing special spicules. Genera—*Trochospongilla*, Vejd.;

†*Ephydatia*, Lamx. (= *Meyenia*, Crtr.); *Heteromeyenia*, Potts; *Tubella*, Crtr.; *Parmula*, Crtr.; *Carterius*, Potts; *Uruguayia*, Crtr.; *Potamolepis*, Marshall; *Lessepsia*, Keller. SUB-FAMILY (d). GELLIODINAE, Tops. Skeleton formed of long thick spicular fibres, with very little spongin as a rule; but in *Phoriospongia* and *Sigmatella* the spicules of the fibres are replaced by foreign bodies (arenaceous fibres) and the spongin is abundant. Microsclere usually sigmata. Genera—*Gelliodes*, R.; *Stylo-trichophora*, D.; *Cladocroce*, Tops.; *Phoriospongia*, Marshall; *Chondropsis* [Crtr.], D. (= *Sigmatella*, Ldf.). SUB-FAMILY (e). PHLOEODICTYINAE, Crtr. Massive sponges with a thick cortex and fistular appendages. Framework of choanosome, a network of spicular fibres. Microscleres, when present, sigmata. Genera—*Rhizochalina*, O.S.; *Oceanapia*, Tops. FAMILY 2. †POECILOSCLERIDAE, Tops. (= DESMACIDONIDAE, R. and D. + HETERORHAPHIDAE, R. and D., pars.). Megascleres almost always monactinal; microscleres various, but almost always including chelae. SUB-FAMILY (a). †ESPERELLINAE, R. and D. Skeletal fibres without echinating spicules; megascleres of ectosome similar to those of choanosome, or differing only in size. Genera—†*Esperella*, Vosm. (= *Esperia*, Ndo.), [Eoc.]; *Gomphostegia*, Tops.; †*Esperiopsis*, Crtr. [Eoc.], (Fig. 37); †*Amphilectus*, Vosm. [Eoc.]; *Stylotella*, Ldf.; *Desmacella*, O.S.; *Biemma*, Gray; *Monanchora*, Crtr.; †*Hamacantha*, Gray (= *Vomerula*, O.S.), [Eoc.]; *Pozziella*, Tops.; †*Cladorhiza*, M. Sars [Eoc.]; †*Chondrocladia*, W. Th. [Eoc.]; *Axoniderma*, R. and D.; *Melioderma*, R. and D.; *Artemisina*, Vosm.; *Phelloderma*, R. and D.; †*Desmacidon*, Bwk. [Eoc.]; *Batzella*, Tops.; *Homaeodictya*, Ehlers; †*Guitarra*, Crtr.; [Eoc.]; *Sideroderma*, R. and D.; *Joyeuxia*, Tops.; *Microtylotella*, D.; *Amphistrella*, D. SUB-FAMILY (b). †DENDORICINAE, Tops. Skeletal fibres without echinating spicules. Megascleres of ectosome, as a rule, different from those of choanosome, and usually diactinal. Genera—*Dendoryx*, Gray; *Lissodendoryx*, Tops.; †*Iophon*, Gray [Eoc.]; *Iotrochota*, R.; *Leptosia*, Tops.; *Tedania*, Gray; *Trachytetania*, R.; †*Forcepia*, Crtr. [Eoc.]; †*Melonanchora*, Crtr. [Eoc.]; *Histoderma*, Crtr.; *Cornulum*, Crtr.; *Yvesia*, Tops. SUB-FAMILY (c). †ECTYONINAE, Crtr. Skeletal fibres with echinating spicules, which are usually spined. Genera—†*Myxilla*, O.S. [Eoc.]; *Pocillon*, Tops.; *Plumohalichondria*, Crtr.; *Stylostichon*, Tops.; *Microciona*, Bwk.; *Hymenaphia*, Bwk.; *Tylosigma*, Tops.; *Acheliderma*, Tops.; †*Acarus*, Gray [Eoc.]; *Pytheas*, Tops.; *Humigera*, Gray; *Spanioplton*, Tops.; *Clathria*, O.S.; *Echinoclathria*, Crtr.; *Agelas*, Duch. et Mich.; *Ophlitaspongia*, Bwk. (Fig. 32); *Ectyonopsis*, Crtr.; *Rhaphidophlus*, Ehlers; *Echinonema*, Crtr.; *Clathriodendron*, Ldf.; *Plectispa*, Ldf.; *Clathriopsamma*, Ldf.; *Aulena*, Ldf.; *Echinodictyum*, R.; *Kalykenteron*, Ldf.; *Fusifera*, D. SUB-FAMILY (d). †BUBARINAE, Tops. With special diactinal spicules, localised at the surface of attachment or forming the axis of the sponge; or with special megascleres (rhabdostyles). Genera—†*Plocamia*, O.S. (= *Dirrhopalum*, R.), [Cret. Eoc.]; *Suberotelites*, O.S.; *Bubaris*, Gray; *Cerbaris*, Tops.; *Rhabderemia*, Tops.; *Hymenhabdia*, Tops. FAMILY 3. †AXINELLIDAE, R. and D. Megascleres typically monactinal; diactinal spicules, when present, usually of subsidiary importance in building up the skeletal framework. Microscleres wanting or few in

number. Body form erect, lamellar, cup-shaped, or branched; skeleton fibres plumose, often more or less radiate in arrangement. Genera—†*Hymeniacion*, Bwk. [Eoc.]; *Phakellia*, Bwk. (Figs. 35, 36); *Ciocalypta*, Bwk.; *Tragosia*, Gray; *Syringella*, O.S.; †*Azinella*, O.S. [Carb. Eoc.]; *Raspailia*, Ndo.; *Higginsia*, Higgin (= *Dendropsis*, R. and D.); *Thrinacophora*, R.; *Auleta*, O.S.; *Dictyonella*, O.S.; *Acanthella*, O.S.; *Halicnemis*, Bwk.; *Amorphinopsis*, Crtr.; *Vosmaeria*, Fristedt; *Sollasella*, Ldf.; *Trikentrion*, Ehlers; *Tetranthella*, Ldf.; *Vibulinus*, Gray (= *Stelligera*, Ldf.); *Sigmazinella*, D.

APPENDIX—*Monaxonida incerti sedis*. Genera—**Climacospongia*, Hinde [Sil.]; **Lasiocladia*, Hinde [Dev.]; **Acanthorrhaphis*, Hinde [Cret.]; **Atractosella*, Hinde [Sil.]; **Haplition*, Young [Carb.]; **Trichospongia*, Bill [Cambr.].

GRADE III. KERATOSA.

Demospongiae in which the skeleton consists of fibres of spongin, without "proper" spicules.

The Keratosa are divided by Lendenfeld into the two orders—*Monoceratina*, including those forms whose nearest affinity is with the Monaxonida, and *Hexaceratina*, supposed to be descended from the Hexactinellida, and including the *Aplysillidae* and the *Halisarcidae* (Myxospongida).

As regards the *Hexaceratina* so called, the theory of their affinity is based partly upon the resemblance of the (frequently) triaxon horny spicules of one genus (*Darwinella*) to the triaxon siliceous spicules of Hexactinellids, and partly upon resemblances in their canal systems. Since, however, nothing whatever is known of the origin and formation of either of the two kinds of spicules in question, the assumption of their genetic connection, however enticing as a speculation, is scarcely sufficiently well founded for use as a systematic character; and the fact that the *Aplysillidae* and *Halisarcidae* have thimble-shaped chambers is not conclusive proof of their affinity either with one another or with the Hexactinellids.

On the other hand, Lendenfeld's two groups undoubtedly represent a sharp and natural cleavage of the Keratosa, after removal of the *Halisarcidae*, and we therefore retain them with an alteration of the names. The one, characterised by a reticulate type of skeleton, we term *Dictyoceratina*; the other in which the skeleton is dendritic, we term *Dendroceratina*.

ORDER 1. *Dictyoceratina* (= *Monoceratina*, Ldf.).

The spongin skeleton has the form of a network (or rather feltwork) of anastomosing fibres.

FAMILY 1. SPONGIDAE, Gray. Skeletal fibres solid; ground substance round the chambers granular; canal system aphodal. Genera—*Euspongia*, Bronn (Fig. 39); *Hippospongia*, F.E.S.; *Cacospongia*, O.S.; *Coscinoderma*, Crtr.; *Stelospongia*, O.S.; *Hircinia*, Ndo.; *Phyllospongia*, Ehlers; *Carterospongia*, Hyatt. FAMILY 2. SPONGELIIDAE, Ldf. Fibres solid, usually with considerable quantities of foreign bodies; ground

substance round the chambers clear; canal system eurypylous. Genera—*Spongelia*, Ndo.; *Velinea*, Vosm.; *Psammoclema*, Marshall; *Psammopemma*, Marshall. FAMILY 3. APLYSINIDAE, F.E.S. Fibres hollow, canal system aphodal. Genera—*Aplysina*, Ndo. (Fig. 40); *Luffaria* (Duch. et Mich.), O.S.; *Verongia*, Bwk.; *Thorecta*, Ldf.

ORDER 2. **Dendroceratina** (= **Hexaceratina**, Ldf., *pars*).

Spongin fibres dendritic, arising from a basal plate of spongin, and not anastomosing.

FAMILY 4. APLYSILLIDAE, Vosm. Canal system eurypylous, with large elongated chambers; in *Darwinella*, spicules of spongin. Genera—*Aplysilla*, F.E.S.; *Darwinella*, Müller; *Ianthella*, Gray; *Dendrilla*, Ldf. (Here *Hexadella*, Tops., finds its nearest allies, and perhaps also *Halisarca*, Duj.).

KERATOSA (? FORAMINIFERA) *incerti sedis* (HAECKEL, 1889 [8]).

FAMILY—AMMOCONIDAE. "Keratosa without spongin fibres. Pseudo-skeleton composed of xenophya (or manifold foreign bodies), which are disposed in the thin malthar plate of the porous tubular body. Canal system tubular, developed on the Asconal type (similar to that of the *Asconidae*)." Genera—*Ammolynthus*, H.; *Ammosolenia*, H.; *Ammoconia*, H.; *Prophysema*, H. FAMILY—PSAMMINIDAE, Ldf. "Keratosa without spongin fibres. Pseudo-skeleton composed of xenophya . . . which are cemented together and enclosed by the transparent maltha. Canal system vesicular, developed on the Leuconal type (similar to that of the *Spongiellidae*)." Genera—*Psamina*, H.; *Holopsamma*, Crtr.; *Psammopemma*, Marshall. FAMILY—STANNOMIDAE, H. "Keratosa with a fibrillar spongin skeleton, composed of thin, simple, or branched spongin fibrillae, never anastomosing or reticulated. Pseudo-skeleton composed of xenophya . . . which are crowded in the transparent maltha, never in the homogeneous fibrillae. Canal system vesicular . . . on the Leuconal type. . . ." Genera—*Stannophyllum*, H.; *Stannarium*, H.; *Stannoma*, H.

GRADE IV. MYXOSPONGIDA, Soll.

Sponges devoid of a skeleton in any form.

FAMILY 1. OSCARELLIDAE, Ldf. With spherical ciliated chambers. Genus—*Oscarella*, Vosm. (Fig. 41). FAMILY 2. HALISARCIDAE, O.S. With elongated, sack-like ciliated chambers. Genera—*Halisarca*, Duj.; *Bajulus*, Ldf.; *Hexadella*, Tops.

APPENDIX TO CLASSIFICATION.

Under the names *Octactinellida* and *Heteractinellida*, Hinde (1887) has described two groups of Palaeozoic sponges, each with a very aberrant type of spicule, which cannot be brought either under the triaxon or tetraaxon type.

In the *Octactinellida*, represented by the single genus *Astraeospongia*

of Roemer, the typical spicule (megasclere) has eight rays (Fig. 95, *A*). Six of the rays are placed in one plane, which may be termed horizontal, and in which they radiate out at equal angles of 60° from a common centre. The two remaining rays radiate from the centre in opposite directions, forming a vertical axis which cuts the horizontal plane at right angles. Spicules of this normal type are, however, less frequent than a modification in which the two vertical rays are reduced to nodules or are absent altogether, thus producing a flat, six-rayed star (Fig. 95, *B*).

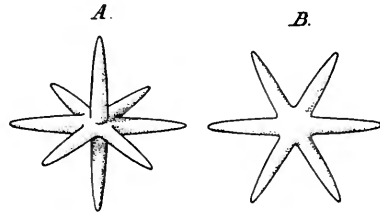

FIG. 95.
Spicules of *Astracospongia*. *A*, octactine;
B, hexactine. (After Hinde.)

In the *Heteractinellida* the typical spicule is a huge euaster with from six to thirty rays, coming off from a common centre at different angles (Fig. 96, *A*). This type form is again less common than some of its modifications. By the rays being placed nearly in one plane, in which they are confluent at their bases, a disc-like star is produced (Fig. 96, *B*),

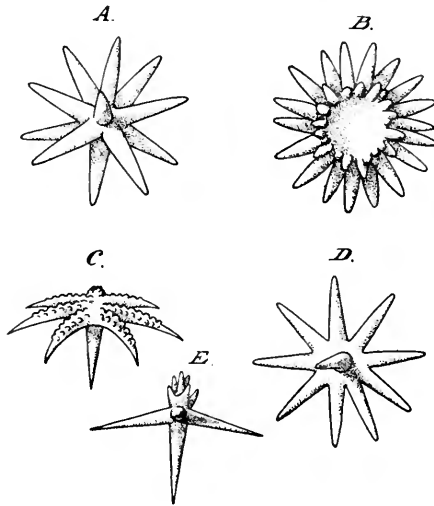

FIG. 96.

Spicules of *Heteractinellida*. *A*, typical polyactine; *B*, rosette-like form; *C*, *D*, *E*, nail-like forms—*C* and *E* in profile, *D* from below. (After Hinde.)

which may further have three or four rays coming off at right angles, or nearly so, from one surface of the disc. A characteristic modification of this type produces nail-like spicules (Fig. 96, *C*, *D*, *E*), in which there is a disc with six to nine rays projecting horizontally, from the centre of which a stout ray is given off in a vertical direction. The rays may be equal or

unequal in size, and may be straight or tapering, blunt or sharp, smooth or with warts on one surface.

Should these observations be confirmed, it is evident that we have here two groups of equal systematic importance with the Hexactinellids and Demospongiae, which have not left descendants persisting to our time. In addition, therefore, to the three classes now existing, we should have to add the following:—

CLASS 4. *OCTACTINELLIDA, Hinde.

With octactinal megascleres. Genus—*Astraeospongia*, Roemer [Sil. Dev.].

CLASS 5. *HETERACTINELLIDA, Hinde.

With polyactinal megascleres. *Tholiasterella*, Hinde [Carb.]; *Asteractinella*, Hinde [Carb.].

V. THE DISTRIBUTION OF SPONGES IN SPACE AND TIME.

The orders and families, and even as a rule the genera, of the Porifera are cosmopolitan in their geographical distribution. Their occurrence in any quarter of the globe is subject only to the restrictions imposed by the peculiar conditions necessary for their existence in each case, such as, for instance, their bathymetrical distribution, presently to be discussed. Even the freshwater sponges, in spite of the discontinuous nature of their habitat, seem to occur in the lakes and rivers of all countries. In the latter case, the gemmules afford an important means of distribution on account of their resistance to external vicissitudes and the ease with which, in many cases, they can be transported by winds. In marine sponges the larvae are probably often carried great distances by currents, and in some cases gemmules, or other non-sexual reproductive bodies, may also play a part in their dispersal.

Although no group or family of sponges appears to be limited entirely to any particular region, yet many are found more abundantly in certain regions of the globe than elsewhere, and may be said to characterise these areas. Thus in the Hexactinellids a far larger number of species are recorded from the Pacific than from the Atlantic or Indian Oceans; this is true both of *Lyssacina* and *Dictyonina*; but while in the case of the former the south temperate zone is the richest and the north temperate zone the poorest in species, the *Dictyonina* reach their richest development in the tropical zone (Schulze). In the Demospongiae, the *Keratosa*, a group to which warm and shallow waters seem to be most congenial, are most abundant in southern and antarctic regions (Lendenfeld). The *Monaxonida*, though a widely spread and very cosmopolitan group, are most abundant in the Indo-Australian region, a fact true especially of the very populous sub-families of the *Chalininae* and *Ectyoninae*. *Tedania* and its

allies, on the other hand, are more characteristic of the Patagonian region (Ridley and Dendy); while the higher systematic groups of sponges have the widest possible distribution, the range of individual species is often very restricted, though certain forms may be of widespread occurrence. Instances of the latter are seen in some generalised forms, such as *Halichondria panicea*, *Suberites carnosus*, and many others amongst Monaxonida. The species inhabiting deep water occur, as a rule, over wider areas than those restricted to the shore-line.

The classes of Porifera are better characterised by their bathymetrical distribution than by their geographical habitat. Speaking generally, it may be said that the Calcarea and Monaxonida are shore forms, inhabiting the highest littoral zone, and flourishing between tide marks; the Choristida, amongst Tetractinellids, and the Keratosa are most abundant just below tide marks, down to about 50 fathoms; the Lithistida characterise a slightly deeper belt, from 100 to 150 fathoms; while the Hexactinellids are typical inhabitants of deep water, the Dictyonina occurring in moderate depths, near the coast, and the Lyssacina in the abyssal regions far from the coast. In every case, however, the limits of these generalisations are overstepped by particular species. Thus *Thenea muricata* (Choristida) has been recorded from 1913 fathoms (Wright), and many Monaxonida have spread down to great depths, as, for example, *Cladorhiza longipinna* (R. and D.) from 3000 fathoms. It has already been pointed out as an interesting fact that the influence of an abyssal habitat upon these characteristic littoral forms, is to cause them to exchange their irregular body form for a symmetrical mode of growth, which is clearly secondary and newly acquired.

The geological record of the Porifera is largely dependent, as might have been expected, upon the nature of the skeleton. In each group we find those forms especially represented by fossils in which a rigid and coherent framework has been evolved; for instance, amongst Calcarea, the Pharetronidae; amongst Hexactinellids, those with a dictyonal framework; and amongst Demospongiae, the Lithistida. Since in each case these are the least primitive examples of the groups to which they belong, Palaeontology affords us but little help in unravelling the phylogenetic connections of the groups of Porifera. We know nothing of the past history or distribution of the more primitive groups, such as the Ascons or the Carnosa. The most ancient sponge known, however, namely, *Protospongia* from the Cambrian, is characterised by triaxon spicules of the most primitive and unmodified type, and the early Palaeozoic forms classed by Hinde as Octactinellida and Heteractinellida perhaps represent offshoots from a very early and primitive stock, which have not left descendants persisting to the present day. On the other hand, a remarkable

feature of the forms mentioned is the relatively very large size of their spicules, which is probably not a primitive characteristic.

In general the Palaeontological record shows the extreme antiquity of the chief types of sponges, and their wide occurrence at all periods of the world's history, but is far from supplying links to connect the branches of the phylogenetic tree. We notice further that the forms most abundant as fossils are those which are now characteristic of deep water; but it is not necessarily to be inferred from this that the fossil forms were also inhabitants of the abyss.

VI. THE AFFINITIES AND PHYLOGENY OF SPONGES.

The theoretical questions which are suggested by a study of the group of sponges, fall naturally under two headings. First, we may consider sponges in general in their relation to other classes of living beings. We are then confronted with the question—what are the affinities of the simple and primitive sponge individual with other animals? Secondly we have to deal with those questions of which the range is limited and restricted within the phylum itself—that is to say, the evolution of sponges in general, and the pedigree and phylogenetic relations of the principal groups.

(a) *Position of Sponges in the Animal Kingdom.*—The most conflicting opinions have been, and still are, held upon this point. Up to the middle of the present century it was still disputed whether sponges were animals or plants. The discovery of cilia in them by Dujardin and Dobie was considered a decisive proof of their animal nature, but their systematic position still remained a matter of controversy. By Dujardin, Lieberkühn, Carter, James-Clark, and Savile-Kent, they were regarded as Protozoa, but with the progress of knowledge such a view has become incompatible with any rational definition that could be framed to separate the Protozoa from the higher animals. Modern authors are divided, in the first place, as to whether the sponges are to be regarded as Enterozoa, or as an independent phylum, distinct both from the Protozoa and from the Enterozoa (Bütschli, Sollas, and formerly Delage [2]). Those who regard them as Enterozoa are further divided in opinion, especially as regards the homologies of the two primary germ layers. Balfour, whom at the present time Maas and Delage follow, considered them as composed of ectoderm and endoderm, homologous with the similarly named layers in Coelentera, but in sponges reversed in position at the metamorphosis; Heider, Götte, and Nöldeke also consider that sponges have nothing in common above the gastrula stage, and the two latter believe that the sponge body is developed from the endoderm alone. On the other hand, Leuckart and Haeckel regard sponges as true Coelentera, composed of the same two primary germ layers, and built up on the same

architectural plan ; and Schulze, whom most authors follow, places the *Porifera* as a subdivision of the Coelentera, marked off by the possession of a distinct mesoderm, and the absence of nematocysts or tentacles from the remainder of the Coelentera or *Cnidaria*.

We have then three views to discuss, each of which is based upon a distinct theory of sponge genealogy : first, that sponges are descended from a Protozoon ancestor distinct from that of other Metazoa ; secondly, that they have a common ancestry with other Metazoa, as far as the diploblastic stage of development, and are therefore composed of the same two primary germ layers, but that after this stage they have proceeded along a distinct and independent line of evolution ; and thirdly, that they have a common ancestry with the Coelentera, both being descended from a gastrula-like progenitor with a body wall composed of ectoderm externally and endoderm internally. The sponges would then be a modification of the Coelenterate ancestor in one direction, the *Cnidaria* in another.

In considering these views we may take the last first, as being the most easy to refute, although still that most generally adopted. The result of recent embryological work has been to completely undermine the Coelenterate theory of sponge affinities, by demonstrating that at the metamorphosis the germinal layers become reversed in position, in a manner not suspected by those who first put forward this view. The Coelenterate theory assumes that sponges are composed developmentally of the same two germinal layers as the Coelentera, which also have the same architectural relations in the adult. The reversal of the layers makes it impossible, however, to extend the comparison to *both* the larvae and the adults. For if the comparison starts from the larvae, then the adult sponges are composed of endoderm externally and ectoderm internally. If, on the other hand, the adults are compared, and their constituent layers homologised, then the larvae of sponges are quite anomalous, consisting of an endoderm surrounding completely, or very largely, the ectoderm. Since the Coelenterate theory has become quite untenable at the present day, at least in a strict phylogenetic sense, we have to choose between one of the two remaining views : either that sponges have a separate descent from the Protozoa, *i.e.* from the Choanoflagellata, an idea which has suggested the term *Parazoa*, applied to them by Sollas ; or that they are Enterozoa, in which the two primary germ layers have become reversed in position, a view expressed in the name *Enantioderma s. Enantiozoa*¹ coined for them by Delage (1898 [3]).²

¹ From the Greek *ἐναντιος*, inside out.

² The theory of Götze and Nöldeke that sponges are developed from the endoderm alone, was founded on mistaken observations upon the development of *Spongilla*, and at the present day is lacking in any basis of fact.

To obtain constructive evidence of a convincing nature in favour of either of these views is a matter of extreme difficulty, if not impossible. On the side of the Choanoflagellate ancestry we may urge the invariable presence of collar cells and their remarkable resemblance to Choanoflagellata (see above, p. 53). The theory of Enterozoic affinities of sponges, on the other hand, is based upon their sexual reproduction and the resemblance of the early developmental stages, culminating in a two-layered, planula-like larva, to those of other Metazoa. The latter theory seems, therefore, at first sight, to stand upon a wider basis than the former, but a closer scrutiny leads to the conclusion that the supposed Enterozoic characters of sponges are far from being of a very diagnostic nature. In the first place, sexual reproduction by means of ova and spermatozoa is of widespread occurrence in plants as well as animals. Secondly, the type of segmentation seen in any ovum depends, as is well known, largely on its constitution, and in so far may admit of explanation by purely physical laws. And finally, as regards the germinal layers, the subsequent fate of these layers in the sponge embryo makes it very difficult to homologise them with those of other Metazoa.

While, therefore, the characters that connect the sponges with the Enterozoa are of rather a shadowy and vague nature, the possession of collar cells stands out, at present, as a sharply defined and very diagnostic feature in their organisation which links them to the Choanoflagellata, and this view receives indirect support from the many anomalies of sponge development which make it very difficult to bring them into line with other animals.

If from the basis of a Choanoflagellate ancestry we try to reconstruct the past history and evolution of the sponge phylum by the help of the stages seen in embryology, we find the simplest condition typified in the larvae of Ascons. The larva of *Clathrina* before immigration has commenced may be regarded as a Protozoon colony composed of nutritive zooids, together with a small number specialised for reproduction (cf. Figs. 57, 1, and 58, 1). Such colonies are seen in the Volvocineae and in *Proterospongia* (Savile-Kent). In the sponge ancestor the nutritive zooids were doubtless provided each with a collar and flagellum; in the sponge larva the flagellated cells serve during the free swimming stage only for locomotion, and their nutritive function is in abeyance, hence the collar is not developed on them until after the metamorphosis. As time went on a third class of cell was developed by modification of the nutritive zooids, as occurs in all sponge larvae. These new elements may have had at first a digestive and distributive function, or they may have been skeletogenous, or finally, they may have simply been a modified form of flagellated cell, as exemplified in the larva of *Oscarella*, and specialised perhaps for locomotion rather than nutrition. In any case the non-reproductive zooids, at first all alike, became subdivided into a specially nutritive set, retaining the primitive characters, and another set specialised

in other directions. The former remained at the surface, the latter tended to migrate into the interior.

Next followed the very obscure portion of the phylogenetic history in which the ancestor became fixed, and underwent changes which resulted in the nutritive collar cells becoming placed in the interior to form the gastral layer, while the other cells came to surround them and form the dermal layer. Although these two events, the fixation and the reversal of the layers, doubtless stand in close relation to one another, it is difficult to say which preceded the other, or to attempt to follow this period of the evolution in detail. It is represented in ontogeny by the metamorphosis, which, like all similar stages throughout the animal kingdom, evidently represents a large and important series of phylogenetic stages compressed into a very short time, and much modified in nature. When once the metamorphosis is past, the subsequent pupal stages are not difficult to interpret. It has already been pointed out that the flattened pupa formed by metamorphosis of the larva of *Clathrina* may be regarded as a very simple type of sponge in a state of extreme contraction. Its further histogenetic development, which in ontogeny takes place in the contracted condition, or during the gradual process of expansion, gives us a clue to understanding how in phylogeny the calcareous *Olythus* was evolved from the simple *Protolythus*, the ancestor of all sponges.

The Choanoflagellate theory of sponge ancestry may be said therefore to afford a simple interpretation of all stages of the embryology, with the exception of the metamorphosis, a portion of their life-history of which the significance still remains very obscure. We may console ourselves, however, with the thought that the metamorphosis is equally, if not more, difficult to interpret from a phylogenetic point of view on the Enterozoic theory, and that it becomes absolutely unintelligible from any point of view if the Coelenterate theory be adopted.

(b) *The Phylogeny of Sponges.*—Three main lines of descent and evolution can be recognised in sponges generally, represented by the Calcarea, the Hexactinellida, and the Demospongiae respectively. In the former we have a very distinct stock, with no transitions to other forms. The Hexactinellids, on the other hand, have in the siliceous nature of their skeleton a feature which links them with the Demospongiae, but it is open to discussion whether this peculiarity is inherited by both from a common ancestor with a siliceous skeleton, or has been independently acquired.

Haeckel believes the common ancestor of all sponges to have been a form which inhabited the deep sea, and was provided with a pseudo-skeleton of foreign bodies, consisting chiefly of the skeletons of Radiolaria, Foraminifera, and other pelagic animals which were continually showering down upon it. This primitive sponge next acquired the power of dissolving the siliceous and calcareous matter which it took up, and depositing the mineral substance anew in the form of spicules in the tissues. Some sponges, which lived in Globigerina ooze, acquired in this way a calcareous skeleton; others living in Radiolarian ooze acquired a siliceous skeleton.

The consequence was the evolution of sponges along two lines, characterised each by the material composing the supporting framework of the body.

Whatever may have been the first origin of sponge skeletons, the evolution of the siliceous sponges shows two distinct lines of evolution. In Hexactinellids the starting-point was a form of simple structure with triaxon spicules. The Demospongiae may be referred back, similarly, to a primitive Rhagon form with tetraxon spicules. In both cases the form of spicule may be explained as an adaptation to the canal system and architecture of the primitive sponge (Schulze). The primitive hexactines of the triaxon type are of the form best suited to the elongate, thimble-shaped chambers, and the loose trabecular structure of a simple Hexactinellid, while the tetraxon spicule fits the closely packed rounded chambers and the denser texture of the body wall of a *Plakina*-like ancestor. The question arises whether the two types of body structure were evolved before or after the sponge had acquired a siliceous skeleton of some kind. It is possible that a remote, ancestral Myxosponge, with flagellated chambers opening into a gastral cavity, secreted siliceous concretions and sclerites, which became spicules of a more or less irregular polyaxon form, and that, as the canal system of this sponge developed in one or the other direction, the polyaxon spicules became adapted to its structure and gradually settled down, so to speak, into the two types represented by the triaxon and tetraxon megascleres respectively. If this be so, we might expect to find other lines of sponge descent, in which the primitive polyaxon sclerite had given rise to the other types of spicule, and such forms are perhaps represented by the Palaeozoic sponges placed by Hinde in the two groups named by him Octactinellida and Heteractinellida. On this view we may recognise a class Silicea, of equal phylogenetic value with the Calcarea, and divisible into two branches, the Triaxonia or Hexactinellids and the Tetraxonia or Demospongiae. It remains to consider briefly how the various groups of non-calcareous sponges are to be distributed along these two lines of descent.

The most primitive Demospongiae are to be found in the order Carnosa, and particularly in the family *Plakinidae*. *Plakina monolopha* is but little advanced beyond the primitive Rhagon type, and its spicules are of small size, and for the most part of simple tetraxon form. The progressive complications found in other species of the same genus and in other genera of the Carnosa lead on to the typical Tetractinellids with a well-developed cortex, and with tetractines showing a corresponding differentiation between three tangential rays situated in the cortex and an enlarged ray directed radially; in other words, with triaenes. The Lithistida are to be considered as developed from primitive Tetractinellids, in which some of the tetractines become encrusted and enveloped by secondary deposits of silica to form the desma, with consequent atrophy and reduction of the primitively tetraxon crepis, as well of the free triaenes; all stages of this evolution being still preserved in different members of the group.

From a corticate Choristid with a radiate skeleton the step to *Tethya* and allied forms is not great. The triaenes are replaced by monaxons, orientated in a similar manner to the rhabdomes of the triaenes, and doubtless corresponding to them. By reduction of the tetraxons the sponge has now become a Monaxonid, the starting-point of a new evolutionary series. While many Monaxonida, especially of the order Hadromerina, differ little from typical Choristida except in the absence of tetraxon spicules, others by reduction or disappearance of the cortex, absence of the characteristic asters amongst the microscleres, shortening and diminution of the monaxon megascleres, and loss of their radiate arrangement, acquire a type of structure which in the end terms of the series is of a very distinct character. While the Hadromerina retain, as an order, many marks of Tetractinellid affinities, all traces of the latter become obliterated more or less completely in the Halichondrina, with their reticulate type of skeleton, held together very often by an element which was absent or very inconspicuous in the Hadromerina and Tetraxonida, namely, spongin.

The Halichondrina in their turn are the starting-point of an evolution in yet another direction, in which the spicules become gradually lost and replaced by spongin, which ultimately comes to make up the whole skeleton. The transitions between the Halichondrina and Keratosa are numerous and gradual, and, as already pointed out above (p. 139), the evolution of a so-called horny sponge has probably taken place in more than one family of Halichondrina, and perhaps even more than once within the limits of the same family. So inseparable are the Keratosa, or rather the Dictyoceratina, from the Halichondrina in a natural classification that it has been proposed by Vosmaer and others to unite them in one group *Cornucuspungiae*, and so separate them from the other Demospongiae which, in their turn, are to be united in one class *Spiculispungiae*, comprising the Tetraxonida and Hadromerina. This arrangement, however, is open to just the same objections as that which it is intended to replace, namely, that it introduces sharp cleavages where none naturally exist, and for practical purposes it is less convenient than the frankly artificial classification into Tetraxonida, Monaxonida, and Keratosa.

It is seen that from the most primitive Tetraxonida to the typical horny sponges we find an *uninterrupted* series of gradations, and though it might be possible to link the various forms together along lines different from those which have been traced above, it is not possible to introduce sharp distinctions between them. On the other hand, in the Keratosa themselves we come perhaps for the first time to a discontinuity in the chain of forms. The two orders of the Keratosa seem to have little in common except the material of the skeleton, and Lendenfeld has sought to bring the Dendroceratina near to the Hexactinellids, on the supposition that they represent

an evolutionary series in which the siliceous material of the triaxon spicule has become replaced by spongin, giving rise to horny spicules, combined with a dendritic horny skeleton, as in *Darwinella*. Further steps in this direction would lead to loss of the horny spicules, as seen in the other Dendroceratina; while finally, the Halisarcidae are supposed to arise by complete suppression of the entire horny skeleton. However interesting and suggestive this theory may be, it cannot be said, in the present state of our knowledge, to be more than a guess. It is not clear how the alleged Hexactinellid ancestor acquired its dendritic horny skeleton, and it is just as easy to take the *Halisarcidae* as the starting-point of the series, to derive the dendritic skeleton from an upgrowth of a basal plate of spongin, and to regard the horny spicules, present in a single genus, as originating by discontinuous secretion of spongin in a form already provided with a dendritic skeleton.

While, in the Myxospongida, the affinities of the *Halisarcidae* are uncertain and in need of further elucidation, the *Oscarellidae*, on the other hand, seem to stand very near the *Plakinidae*. *Oscarella* scarcely differs from the simpler species of *Plakina* except in the absence of any skeleton, and there is no evidence whatever that it is degenerate in this respect. *Oscarella* may be regarded therefore as in many respects the most primitive Demosponge, representing more than any other the simple Rhagon ancestor of the group. Since, on the other hand, it seems to have little affinity with any Hexactinellids, it points to the siliceous skeleton having been independently evolved in the ancestors of the Triaxonia and Tetraxonia respectively.

The Hexactinellids, unlike the Demospongiae, are a compact and homogeneous group of very uniform structure, presenting no special phylogenetic difficulties. The starting-point is a simple Rhagon-like form, as described above, from which all the known types are easily derived.

The phylogeny of the Calcarea has already been briefly discussed, and it has been seen that the two families of the Homocoela represent the two main divergent branches of the genealogical tree. It is not possible at present, however, to trace these branches upwards through the grade Heterocoela, until the latter have been further studied from this point of view.

LITERATURE OF THE PORIFERA.

The following list of references comprises, in the first place, those memoirs or monographs which deal with some sponge question or group in a comprehensive manner, and contain exhaustive references to the literature; and, in the second place, works of very recent date, which supplement and extend the larger treatises. Many important memoirs are, therefore, not cited separately, as they are to be found quoted by all authors; such as, for instance, in morphology, histology, and development, the classical memoirs of Carter, Lieberkühn,

Schulze, Metschnikoff, Barrois, Keller, Schmidt, and many others; in physiology, Lieberkühn, Metschnikoff, Lendenfeld, etc.; for the classification and system Gray, Bowerbank, Schmidt, Topsent, Lendenfeld, and Breitfuss; and in palaeontology, the works of Hinde and Zittel. Full bibliographies are given by Vosmaer [29 and 30], Lendenfeld [9], Rauff [19], and Weltner [31], and references to recent literature will be found in the *Zoological Record*, published by the Zoological Society of London, and in the *Bibliographia Zoologica*, edited by Victor Carus, and published with the *Zoologischer Anzeiger* (Leipzig, W. Engelmann).

1. *Bidder*. The Skeleton and Classification of Calcareous Sponges. (Proc. Roy. Soc., 64, 1898, pp. 61-76.)
2. *Delage*. Embryogénie des Eponges. (Arch. Zool. Exp. (2), x, (1892), pp. 345-498, pls. xiv.-xxi.)
3. — Sur la place des Spongiaires dans la Classification. (C. R. Ac. Sci. Paris, vol. cxxvi. (1898), pp. 545-548.)
4. *Dendy*. Monograph of the Victorian Sponges I. (Tr. Roy. Soc. Victoria, III. (1891), pp. 1-81, xi. pls.)
5. — Studies on the Comparative Anatomy of Sponges, V. *Calcarea Heterocœla*. (Quart. Journ. Mic. Sci., N.S. vol. xxxv. (1893), pp. 159-257, pls. x.-xiv.)
6. *Döderlein*. Ueber die Lithoninæ. (Zool. Jahrb., Abth. f. Syst. etc., x, (1897), pp. 15-32, pls. ii.-vi.)
7. *Haeckel*. Die Kalkschwämme. (3 vols. Berlin, 1872.)
8. — Deep Sea Keratosa. (Challenger Reports, Zool., vol. xxxii. 1869.)
9. *Lendenfeld*. Monograph of the Horny Sponges. (London, 1889.)
10. *Loisel*. Contribution à l'histo-physiologie des éponges. (Journ. de l'anat. et de la physiol., xxxiv. (1898), pp. 1-43 and 186-234, pls. i. and v.)
11. *Maas*. Embryonal-Entwicklung, etc., der Cornacuspongien. (Zool. Jahrb., Abth. f. Anat., etc., vii. pp. 331-448, pls. xix-xxiii.)
12. — Ueber die erste Differenzierung von Generations und Somazellen bei den Spongien. (Verh. deutsch. Zool. Ges., 1893, pp. 27-35.)
13. — Die Keimblätter der Spongien, etc. (Zeitschr. f. w. Zool., lxiii. (1898), pp. 665-679, pl. xli.)
14. — Die Entwicklung der Spongien. (Zool. Centralblatt V., 1898, pp. 581-599.)
15. — Ueber Reifung und Befruchtung bei Spongien. (Anat. Anzeiger, 1899.)
16. *Minchin*. The Position of Sponges in the Animal Kingdom. (Science Progress, N.S. I. (1897), pp. 426-460.)
17. — Materials for a Monograph of the Ascons I. (Quart. Journ. Mic. Sci., N.S. xl, 1898, pp. 469-587, pls. xxxviii.-xlii.)
18. *Foltjaff*. Calcarea. (Challenger Reports, Zool., vol. viii., 1883.)
19. *Rauff*. Palæospongiologie. (Palæontographica, xl. pp. 1-346, pls. i.-xvii.; and xli. pp. 223-272, pls. xx.-xxvi.)
20. *Ridley and Dendy*. Monaxonida. (Challenger Reports, Zool., vol. xx.)
21. *Schulze*. Hexactinellida. (Challenger Reports, Zool., vol. xxi.)
22. — Symmetrieverhältnisse bei Hexactinelliden-Nadeln. (Verh. deutsch. Zool. Ges., 1897, pp. 35-37.)
23. — Zur Histologie der Hexactinelliden. (Sitzber. Akad. Wiss., Berlin, xiv., 1899, pp. 198-209.)

24. *Schulze*. Amerikanische Hexactinelliden, etc. (Jena, Gustav Fischer, 1899, text and atlas.)
25. *Sollas*. Tetractinellida. (Challenger Reports, Zool., vol. xxv.)
26. *Topsent*. Classification des Halichondriina. (Mém. Soc. Zool. France, viii., 1894, pp. 5-22.)
27. — Étude monographique des spongiaires de France. I. Tetractinellida, II. Carnosa. (Arch. Zool. Exp. (3), ii. 1894, pp. 259-400, pls. xi-xvi., and (3), iii. 1895, pp. 493-590, pls. xxi-xxiii.)
28. — Classification des Hadromerina. (Arch. Zool. Exp. (3), vi. 1898, pp. 91-116.)
29. *Vosmaer*. Spongien. (Bronn's Thierreich, ii. 1887.)
30. — and *Pekelharing*. Observations on Sponges. (Verh. d. k. Acad. v. Wet., Amsterdam, (2), vi. 3.)
31. *Weltner*. Spongillidenstudien i., ii., iii. (Arch. f. Naturgesch, 1893, pp. 209-284, pls. viii., ix., and 1895, pp. 114-144.)
32. *Zittel*. Palaeozoologie, Bd. I. (Munich and Leipzig, 1876-1880.)
33. *Zytkoff*. Entwicklung der Gemmulä bei *Ephydatia fluviatilis*. (Bull. Soc. Imp. Nat., Moscow, 1892, pp. 1-16, pls. i., ii.)
- Addendum to Bibliography—*
34. *Evans*. The Structure and Metamorphosis of the Larva of *Spongilla lacustris*. (Quart. Journ. Micr. Sci., n.s. 42, 1899, pp. 363-476, pls. 35-41.)

ABBREVIATIONS OF AUTHORS' NAMES.

Bill., *Billings*. Boc., *de Bocage*. Bwk., *Bowerbank*. Crtr., *Carter*. D., *Dendy*. Defr., *DeFrance*. Död., *Döderlein*. d'Orb., *d'Orbigny*. Duch. et Mich., *Duchassaing et Michelotti*. Duj., *Dujardin*. Dun., *Dunikowski*. Dyb., *Dybowski*. Eichw., *Eichvall*. Et., *Etallon*. Fabr., *Fabricius*. F. E. S., *F. E. Schulze*. Flem., *Fleming*. From., *Fromentel*. Goldf., *Goldfuss*. H., *Haekel*. Han., *Hanitsch*. Hanc., *Hancock*. Iij., *Iijima*. J. Cl., *James-Clark*. Johnst., *Johnston*. L., *Linnaeus*. Lam., *Lamarek*. Lamx., *Lamouroux*. Ldf., *Lendenfeld*. Mant., *Mantell*. Mich., *Michelin*. Mont., *Montagu*. Murch., *Murchison*. Ndo., *Nardo*. Norm., *Norman*. O. S., *Oscar Schmidt*. Pall., *Pallas*. Park., *Parkinson*. Peng., *Pengelly*. Pol., *Poléjaeff*. Pom., *Pomel*. Qst., *Quenstedt*. R., *Ridley*. R. and D., *Ridley and Dendy*. Rff., *Rauff*. Roem., *Roemer*. Rss., *Reuss*. S. K., *Savile-Kent*. Schlüt., *Schlüter*. Soll., *Sollas*. Steinm., *Steinmann*. Stew., *Stewart*. Stueck., *Stuckenberg*. Stutchb., *Stutchbury*. Tops., *Topsent*. Tschern., *Tschernyschew*. Vejd., *Vejdowsky*. Vosm., *Vosmaer*. Walc., *Walcott*. Welt., *Weltner*. W. Th., *Wyville-Thomson*. Z., *Zittel*.

ADDENDUM.

Since the above chapter was in print a remarkable type of calcareous sponge has been discovered by Dr. Willey. It was found by him growing on dead coral in Sandal Bay, Lifa, Loyalty Islands (Western Pacific). A description of this organism under the name *Astroclera Willeyana* will shortly be published in Dr. Willey's *Zoological Results*, Part IV., by Mr. J. J. Lister, to whose kindness we are indebted for the following description, compiled from advance proof-sheets of his work, as well as for the two figures here given (Fig. 97, A and B).

The four specimens obtained of this sponge were cylindrical in form,

about 10 mm. in height by 5 mm. in breadth. The openings of the canal system are confined to the upper surface (Fig. 97, *A*; cf. *Tentorium*, Fig. 31).

The skeleton of *Astrosclera* is composed, not of spicules, which are entirely wanting, but of calcareous *spherules*, which arise in cells of the dermal layer near the upper surface. Each spherule is deposited within a single cell, and is from the first composed of radially arranged crystalline fibres. Its form is at first spherical, but by further increase in size adjacent spherules come into contact, and the interspaces between them become completely filled in by continued deposition of the calcareous

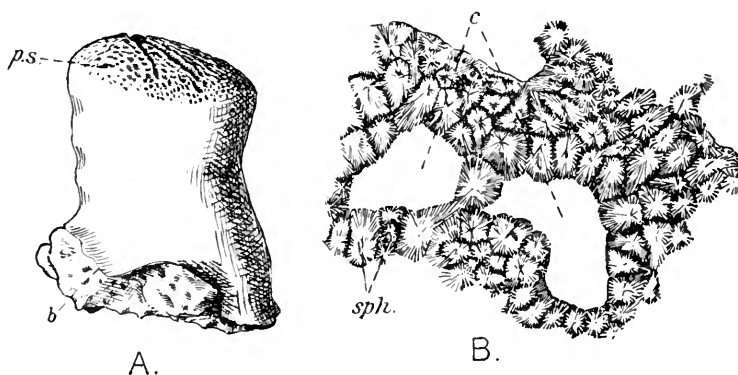

FIG. 97.

Astrosclera Willeyana, Lister. *A*, the sponge magnified about three diameters; *p.s.*, upper surface carrying the openings of the canal system; *b*, base of attachment. *B*, section of the skeleton; *sph.*, spherules; *c*, canals. (Drawings by Mr. J. J. Lister.)

substance, to the exclusion finally of the soft parts. The spherules thus acquire a polyhedral form (Fig. 97, *B*, *sph.*), and by their union build up a solid calcareous skeleton without any admixture of soft parts, but traversed by canals in which are lodged the soft tissues and the canal system of the sponge (Fig. 97, *B*, *c*). In the basal (older) part of the sponge the canals became obliterated, apparently by extension inwards of the spherules forming their wall; just as in pedunculate sponges the canal system is wanting in the stalk.

The spherules are composed of aragonite, and contain an organic basis which has the same staining reactions as that of the spicules of *Calcarea*.

The canal system is of a leuconoid type with small spherical ciliated chambers opening into branched canals. There is no large central gastral cavity, but a number of excurrent canals [which perhaps represent gastral cavities reduced in size] run vertically upwards to open on the upper surface, alternating with incurrent canals similar in appearance and arrangement. Some ova and larvae were observed, the latter apparently of a parenchymula type.

The affinities of this curious organism are very doubtful. It is unquestionably a sponge, and the material of its skeleton is carbonate of

lime, but the fact that it is in the form of aragonite may indicate that *Astrosclera* is genetically distinct from the true Calcarea, in which the skeleton is invariably calcite. On the other hand, it is possible that the spherules have in the course of phylogeny replaced a skeleton of calcite spicules originally present. In some Pharetrones a similar skeleton of spherules is known (Zittel), but in such cases the spherules are generally regarded as a secondary formation due to recrystallisation of the lime during fossilisation. "Under these circumstances it seems better to class *Astrosclera* as the type of a new family *Astroscleridae*, possibly allied to the Pharetrones, but certainly without close affinity with any other known group of sponges" (Lister).

A larger specimen of the same genus and probably of the same species of sponge has recently (November 1899) been detected by Mr. Kirkpatrick of the British Museum (Natural History) in a collection of marine organisms dredged at Funafuti (Gilbert Islands).

INDEX

To names of Classes, Orders, Sub-Orders, and Genera ; to technical terms ; and to names of Authors discussed in the text.

- Acanthascinae*, diagnosis and genera, 122
Acanthascus, 122
Acanthactinella, 123
Acanthella, 153
Acanthin, 43
Acanthodictya, 123
Acanthometridae, 43
Acanthorrhaphis, 153
Acanthosaccus, 122
Acarinus, 138, 152
acerate spicules, 101
Acerrochalina, 151
Acheliderma, 152
Aciculina, 78, 146
— diagnosis and classification, 150
Aciculites, 149
acrepid, 135
actinoblast, 40, 107
aesthacytes, 47
Agelas, 152
alate spicules, 102
Alectona, 151
Alyol, 148
Ammoconia, 154
Ammoconidae, diagnosis and genera, 154
Ammolyntus, 154
Amnosolenia, 154
amoebocytes, 28, 58, 62, 72, 85, 120
amoeboid movement in collencytes, 52
Amorphinopsis, 153
amphiaser, 134
Amphiasarella, 152
amphiblastula, 75, 81, 145
Amphibleptula, 149
amphidisc, 138
Amphidiscophora, 121 (footnote)
— diagnosis and classification, 122, 123
amphidiscs, 65, 117
Amphilectus, 152
Amphispongia, 123
Amphispongiidae, 123
amphitriaene, 134, 146
Amphius, 150
Amphinte, 110
Amphoriscidae, diagnosis and genera, 110
Amphoriscus, 110
Anamixilla, 110
anatriaene, 133
Ancorina, 148
Anisoxya, 150
Anomocladidae, 149
Anomocladinae, 149
Anomoclonella, 149
Anomoclonellidae, 149
Anoplia, diagnosis and classification, 149, 150
Antares, 148
Anthastra, 148
aphodal type of canal system, 35, 130
aphodus, 34, 127
Aphorme, 122
Aphrocallistes, 124
apical formative cell, 107
— ray, 101
Aplysilla, 44, 64, 78, 154
Aplysillidae, 141, 144, 153
— diagnosis and genera, 154
Aplysina, 26, 154
Aplysinidae, diagnosis and genera, 154
apopyles, 33
aragonite, 167
archaeocytes, 31, 57, 62, 63, 69, 73, 75, 80, 83, 84
Archaeoscyphia, 149
Archaeoscyphidae, 149
arenaceous sponges, 42, 144
Artemisina, 152
articulated tubar skeleton, 105
Ascallis, 110
Ascandra, 54, 55, 94, 100, 110
Ascelta, 109, 110
Asconema, 7, 122
Asconematidae, diagnosis and genera, 122
Ascons, 7, 31, 51, 59, 64, 85, 89, 90, 92, 109, 110, 157, 160
Ascyssa, 109, 110
aster, 117, 134
Asteractinella, 156
Asteropus, 150
Astroespongia, 154
Astrobolus, 150
Astrocladia, 149
Astroconia, 123
Astromimus, 151
Astropeplus, 150
Astrophora, diagnosis and classification, 147, 148
Astrosclera, 166
Astroseridae, 168
Stylomanon, 150
Astylospongia, 150
Astylospongiidae, 150
Atractosella, 153
attachment, mode of, in sponges, 2
Aulascus, 122
Aulaxinia, 148
Aulena, 152
Auleta, 153
Aulocylis, 122
Aulochone, 122
Aulocopidae, diagnosis and genera, 149
Aulocopium, 149
Aulocystis, 120, 124
Aulosaccus, 122
autodermalia, 118
autophya, 37

- autoskeleton, 37
 axes (geometric) of spicules, 37
 axial cross, 116, 118
Axinella, 81, 153
Axinellidae, 138, 140, 145, 151
 — diagnosis and genera, 152, 153
 Axinellid type of skeleton, 140
 axis (organic) of spicules, 40, 100
Axoniderma, 152
Acosuberites, 151
Azorica, 149
Azoriciidae, 148, 150
 — diagnosis and genera, 149

Bajulus, 154
 Balfour, 158
 Barrois, 76 (footnote), 80, 165
 basal formative cell, 107
 — ray, 101
 basalia, 118
Bathydorus, 122
Bathyziphus, 124
Batzella, 152
Becksia, 124
 Bidder, 55, 57, 87, 102, 109
Bicunna, 152
 bionomics, 88
Blastinia, 111
 blastogenesis, 73, 80
 blastomeres, 65, 68, 80, 83
 blastula, 68, 78
Bolidium, 150
Bolospongia, 149
 boring sponges, 88
 Bowerbank, 165
Brachiospongia, 123
Brachiospongiidae, 123
 Breittfuss, 165
Bubarinae, diagnosis and genera, 152
Bubaris, 152
 budding, 17, 63, 64, 90
 Bütschli, 158

Cacochalina, 151
Cacospongia, 153
Catathiscus, 124
 Calcarea, 1, 3, 24-27, 40, 41, 43, 46, 47, 50, 51, 53, 91, 92-111, 157, 161, 162, 164, 166
 calcareous spicules, 40, 100
 — origin of, 161
 Calcaronea, 109
Calcinea, 109
Callipelta, 149
Callodictyon, 124
Callodictyonidae, 124
Callopegma, 148
Calthropella, 147
 calthropes, 132, 135
Calycosaccus, 122
Calycosoma, 122
Calymmatina, 149
Camerospongia, 124
Camirus, 148
 canal system, 85
 — defined, 31
 — general account of, 31-37
 — of Calcarea, 92
 — of Demospongiae, 125-130
 — of Heterocoela, 96-100
 — of Hexactinellida, 111-116
 — of Homocoela, 92-96
 candelabrum, 134
 Carnosa, 1, 157, 162
 — diagnosis and classification, 146, 147
Carpospongia, 150
 Carter, 49, 56, 85, 86, 89, 158, 164
Carterospongia, 153
Carterius, 152
Caryomanon, 150
Caryospongia, 150
Casearia, 124
Casterella, 149
Caulocalyx, 122
Caulophacus, 7, 36, 116, 122
 cellulæ sphéruleuses, 49, 59, 144
Celyphia, 111
 cement (siliceous) uniting spicules, 41
 central cells, 76
 centrotriaene, 134
Cephalites, 125
Ceraochalina, 151
Cerberis, 152
Cerelasma, 142
Chalina, 151
Chalininae, 156
 — diagnosis and genera, 151
 Chalinine type of skeleton, 140
Chalinula, 80, 151
 chamber layer, 112
 chambers, flagellated, 32
Characella, 147
Chaunoptectella, 122
 chela, 138
Chenendepora, 150
Chiastoclonella, 149
Chiastoclonellidae, 149
 chlorophyll, 25
 choanocytes, 27, 53, 62, 121
 Choanoflagellata, 27, 53, 62, 89, 159, 160
 choanosome, 128
 chondrenchyma, 52
Chondrilla, 147
Chondrocladia, 152
Chondropsis, 152
Chondrosia, 145, 147
Chondrosidae, 145, 147
 chone, 36, 129
Chonelasma, 124
Chonella, 150
 Choristida, 135, 157, 163
 — diagnosis and classification, 147, 148
Chrotella, 147
Cinachyra, 147
Cinciderma, 124
Cioculypta, 153
 circulation, 86
Cladocroce, 152
Clauopeltidae, diagnosis and genera, 149
 cladome, 132
Cladorhiza, 152
 cladus, 132
Clathria, 152
Clathrina, 20, 27, 56, 58, 69, 73, 75, 82, 90, 110, 160, 161
 — budding, 64
 — colours of, 25
Clathrinidae, 7, 48, 53, 93-95, 100, 103, 104, 107-110, 119, 145
 — diagnosis and genera, 110
Clathriodendron, 152
Clathriopsamma, 152
Claviscopulia, 123
 clavula, 117
 Clavularia, diagnosis and classification, 123
 Clavulina, 42, 78, 140, 146
 — diagnosis and classification, 151
Climacospongia, 153
Cliona, 67, 78, 80, 151
Clionidae, 88
 — diagnosis and genera, 151
 cloacal cavity, 35
 — skeleton, 136
 clone, 134

- Cnemidiastrum*, 150
Coelocorypha, 150
Coeloptychidae, 124
Coeloptychium, 124
Coeloscyphia, 125
collar, 27, 54, 55, 121
— cells, 27, 53, 121
collenchyma, 52
collencytes, 52, 62, 120
Collinella, 148
collum, 54
colony, modifications of, in
sponges, 5, 16
Colospongia, 111
colours of sponges, 24
Cometella, 151
comitalia, 119
connecting fibres, 141
connective tissue, 51, 81
Conocoelia, 111
consistency of sponges, 26
contractile cells, 44
— vacuoles in collar cells,
54
contractility, 4, 29, 30, 87
conuli, 141
Coppatias, 150
Coppatiidae, diagnosis and
genera, 150
Corallistes, 149
Corallistidae, 148, 150
— diagnosis and genera,
149
Cornacuspongiae, 78, 146,
163
Cornulum, 152
cortex, 32, 97, 105, 129,
136, 162
cortical skeleton, 105
Corticella, 147
Corticidae, 134
— diagnosis and genera,
147
Corticium, 147
Corynella, 111
Coscinoderma, 153
Coscinopora, 124
Coscinoporidae, diagnosis
and genera, 124
Craniella, 67, 147
Crateromorpha, 122
Craticularia, 124
crepis, 134, 162
Crispispongia, 111
Crustacea in sponges, 88
cuticle, 42, 44
cuticular secretion of
spongin, 141
— secretions, 41, 43
cuttings, propagation of
sponges by, 64
Cyathophycus, 123
Cydonium, 148
Cylindrophyma, 149
Cypellia, 124
Cyrtaulon, 124
cystenichyme, 52
cystencytes, 52, 62
Cystispongia, 124
cytoplasm of collar cells,
54
Dactylocalyx, 124
Daedalopelta, 149
Damiria, 151
Darwinella, 43, 140, 141,
154, 164
deep sea, influence of life
in, 23
Delage, 49, 82, 158, 159
Demospongiae, 1, 24, 26,
37, 40, 46, 47, 52, 78, 91,
125-154, 156, 157, 161-
164
— canal system, 125-130
— classification, 146-154
— embryology, 78-81
— phylogeny, 161-164
— skeleton, 130-144
Dendoricinae, diagnosis and
genera, 152
Dendoryx, 152
Dendrilla, 141, 154
dendritic sponges, 22
— type of skeleton, 141,
164
Dendroceratina, 1, 78, 145,
146, 153, 163
— diagnosis and classifica-
tion, 154
Dendroclonella, 149
Dendropsis, 153
Dendy, 76 (footnote), 110,
157
Dendya, 94
Dercitus, 147
dermal epithelium, 27, 42,
43, 81
— layer, 27, 84
— membrane, 97, 112, 120,
127
— pores, 127
dermalia, 118
desma, 41, 62, 134
Desmacella, 152
Desmacidon, 152
Desmacidouidae, 152
desmacytes, 52, 62
Desmanthidae, 148
— diagnosis and genera,
149
Desmanthus, 149
Deszö, 67
diactinal, 38, 116
— spicules, 137
diaene, 133
Dialytina, 109, 111
— diagnosis and genera,
110
diapedesis, 69
Diaplectia, 111
dichotriaene, 134
Dietyocalyx, 122
Dietyoceratina, 1, 46, 80,
140, 146, 163
— diagnosis and classifica-
tion, 153
dictyonalia, 119
Dietyonella, 153
Dietyonina, 1, 8, 119, 121
(footnote), 156, 157
— diagnosis and classifica-
tion, 123-125
Dietyophyton, 123
Dietyospongidae, 123
digestion, 86
dilophous, 134
diplodal type of canal
system, 35, 130
Diplodictyum, 124
Dirrhopalum, 152
discocasters, 120
Discodermia, 148
discohexactine, 117
discohexaster, 117
Discostroma, 150
distribution, 86
Disyringa, 3, 13, 36, 125,
148
Diatrienella, 147
diverticula, 7, 32, 90, 93,
96, 104
division of collar cells, 56
Dobie, 56, 158
Dorylesmia, 149
Dorypleres, 150
Dotona, 151
Dragmastra, 148
Dujardin, 89, 158
Ebner, 101
echinating spicules, 140
Echinoclathria, 152
Echinodictyum, 152
Echinonema, 152
Ecionema, 148
ectochone, 129
ectoderm, 81, 82, 158,
159
ectosome, 128
Ectyoninae, 156
— diagnosis and genera,
152

- Ectyonine type of skeleton, 140
- Ectyonopsis*, 152
- Eilhardia*, 9, 110
- Elasmocoelia*, 111
- Elasmostoma*, 111
- elastic fibrils, 49
- embryology, 67
- Enantioderma, 159
- Enantiozoa, 159
- endochone, 129
- endogastral networks, 48, 96
- endoderm, 62, 73, 81, 158, 159
- Eospongia*, 150
- Epallax*, 150
- Ephydatia*, 152
- Epistomella*, 150
- epithelium, 27
- Erylina*, diagnosis and genera, 148
- Erylus*, 148
- Esperella*, 88, 152
- Esperellinae*, diagnosis and genera, 152
- Esperia*, 152
- Esperiopsis*, 23, 152
- Etheridgia*, 124
- euaster, 134, 135, 138, 155
- Euasterina*, diagnosis and genera, 148
- Euastrosa*, 147
- Eubrochus*, 124
- Eudea*, 111
- Eudictyum*, 122]
- Eumastia*, 151]
- Euplectella*, 6, 37, 41, 64, 116, 120, 122
- Euplectellidae*, diagnosis and genera, 121, 122
- Euplectellinae*, diagnosis and genera, 122
- Euplocalia*, 110
- Eurete*, 124
- Euretidae*, diagnosis and genera, 124
- Euryplegma*, 7, 23, 115, 122
- eurypylous type of canal system, 34, 99, 130
- Eusiphonella*, 111
- Euspongia*, 20, 153
- Euspongillinae*, diagnosis and genera, 151
- Eutaxicladinae*, 150
- Euzittelia*, 111
- Evans, 42, 53, 83, 138
- excretion, 87
- excurrent canals, 33, 81, 99, 113, 126
- duct, 97
- exhalant canals, 33
- exoderm, 62
- Fan-shaped sponges, 22
- Farrea*, 119, 123
- Farreidae*, diagnosis and genera, 123
- fertilisation of ovum, 61
- fibrils of spongin, 42
- fibrillae of spongin, 42, 49, 142
- Ficulina*, 151
- Fiedler, 58, 60
- Fieldingia*, 124
- filaments, of *Hircinia*, etc., 142
- Filiferae, 143
- first type of canal system, 31, 32
- fixation of sponges, 2
- flabellate sponges, 22
- flagella, 87
- flagellated cells, 69, 76, 78, 80, 84
- chambers, 32, 90
- flagellum, 27, 54, 85, 121
- flat epithelium, 27, 42, 81, 120
- flesh spicules, 39, 100, 137
- floricome, 117
- Fol, 143
- Forcepia*, 152
- formative cells, 107
- Fusifera*, 152
- Ganin, 82
- Garstang, 88
- gastral actinoblast, 108
- cavity, 3, 35, 71, 81
- layer, 27, 53
- membrane, 112
- ray, 101
- ray, formation of, 108
- skeleton, 105
- gastralia, 119
- Gastrophanella*, 149
- Gelliodes*, 152
- Gellioidinae*, diagnosis and genera, 152
- Gellius*, 151
- gemmule, 65
- Geodia*, 148
- Geodidae*, diagnosis and genera, 148
- Geodina*, diagnosis and genera, 148
- Geodites*, 148
- glandular cells, 138
- epithelium, 27, 42, 46
- Gomphostegia*, 152
- gonocytes, 60, 62
- Götte, 82, 158, 159
- Grantessa*, 110
- Grantia*, 9, 47, 110
- Grantidae*, diagnosis and genera, 110
- Gray, 165
- Guettardia*, 124
- Guitarra*, 152
- Habrodictyum*, 122
- Hadromerina, 1, 146, 163
- diagnosis and classification, 150, 151
- Haeckel, 26 (footnote), 37, 51, 62-64, 89, 96, 101, 109, 142, 143, 158
- Halichondria*, 56, 88, 151, 157
- Halichondrina, 1, 78, 80, 140, 146, 163
- diagnosis and classification, 151-153
- Haliconemia*, 153
- Halicometes*, 151
- Haliscarca*, 44, 79, 82, 145, 154
- Haliscaridae*, 146, 153, 164
- diagnosis and genera, 154
- Hamacantha*, 152
- Hanigera*, 152
- Haplistion*, 153
- Haploscleridae*, 144
- diagnosis and genera, 151
- Heider, 158
- Hemiasterella*, 150
- Hertwigia*, 122
- Hertwigidae*, diagnosis and genera, 122
- heteractinal spicules, 155
- Heteractinellida, 154, 155, 157, 162
- diagnosis and classification, 156
- Heterocoela, 1, 8, 75, 109, 164
- canal system, 96-100
- diagnosis and classification, 110
- skeleton of, 105
- heterogeneous spongin fibres, 141
- Heteromeyenia*, 152
- Heteropegma*, 100, 109, 110
- Heterophymia*, 149
- Heteropia*, 110
- Heteropidae*, diagnosis and genera, 110
- Heterorrhaphidae*, 151, 152
- Heterostinia*, 149

- Heteroxya*, 150
 Hexaceratina, 146, 153, 154
 hexactinal, 38, 116
Hexactinella, 124
 hexactines, origin of, 162
 Hexactinellida, 91, 111-125,
 156, 157, 161-164
Hexadella, 145, 154
 Hexactinellids, 40
 hexaster, 117
 Hexasterophora, diagnosis
 and classification, 121,
 122
Higginsia, 153
Himatella, 111
 Hinde, 154, 157, 162, 165
Hindia, 150
Hindiadae, 150
Hircinia, 142, 153
 hispid cortical skeleton,
 105
 — dermal skeleton, 136
 hispidating spicules, 136
 histocytes, 62, 73, 84
Histoderma, 152
 histogenesis, 73, 80
 histology, 43-63
 — of *Olynthus*, 27
Holascinae, 119
 — diagnosis and genera,
 122
Holascus, 119, 122
Holasterella, 123
Holcospongia, 111
 holoblastic segmentation,
 67, 68
Holodictyon, 149
Holopsamma, 154
Holoxea, 150
Homaedictya, 152
Homandra, 110
Homasterina, diagnosis and
 genera, 148
 Homocoela, 1, 109, 164
 — canal system, 92-96
 — diagnosis and classifica-
 tion, 110
 — skeleton of, 103-105
 homogeneous spongin fibres,
 140
Homorrhaphidae, 151
 Hoplophora, diagnosis and
 classification, 148, 149
 Hundeshagen, 42
Hyalascus, 122
Hyalonema, 41, 123
Hyalonematidae, 113, 115,
 117, 119, 121 (footnote)
 — diagnosis and genera,
 123
Hyalonematinae, 123
 Hyalospongiae, 1
Hyalostelia, 123
Hyalostylus, 122
Hyalotragos, 150
 Hydrozoa in sponges, 88
Hymedesmia, 151
Hymeniacidon, 153
Hymenaphia, 152
Hymenhabdia, 152
 hypodermalia, 119
 hypophare, 126
Ianthella, 141, 154
 immigration, 69, 75
 impersonal condition, 21,
 91, 125
 incrusting sponges, 22
 incurrent canals, 32, 97,
 127
 individuality, 89
 — loss of, 20, 91, 125
 Inermia, diagnosis and
 classification, 124, 125
 inhalant canals, 32
Inobolia, 111
 intercanal system, 93, 96
 intracellular spongin, 50
Iophon, 152
Iotrochota, 152
 irregular type of skeleton,
 135
Ischadites, 123
Isops, 148
Isoraphinia, 149
 James-Clark, 54, 62, 89,
 158
Jerea, 149
Jereica, 150
Jorunna, 88
Joyeucia, 152
Kaliapsis, 148
Kalpinella, 149
Kalykteron, 152
Kazania, 150
 Keller, 43, 120, 137, 165
 Keratosa, 1, 3, 24, 26, 78,
 80, 139, 145, 146, 156,
 157, 163
 — diagnosis and classifica-
 tion, 153, 154
 — skeleton of, 140-144
 Kirkpatrick, 168
 Körnerzellen, 76 (footnote)
 Krukenberg, 26, 42
Lamontia, 110
 Lankester, 59
Lanuginella, 122
Lanuginellinae, diagnosis
 and genera, 122
 larva, 69, 73, 78, 89, 160
 larvae of Demospongiae,
 144
Lasiocladia, 153
 lateral ray, 101, 105
Latrunculia, 151
Laxosuberites, 151
Lecanella, 149
Lefroyella, 124
Leiodermatium, 149
Leiodorella, 150
Lelapia, 106, 110
 Lendenfeld, 44 (footnote),
 46, 47, 57 (footnote), 116,
 141, 142, 156, 163, 165
Leptophragma, 124
Leptosia, 152
Lessepsia, 152
Leucandra, 19, 48, 99, 110
Leucascus, 110
Leucilla, 99, 110, 113
 Leuckart, 62, 158
 leuconoid type of canal
 system, 98-100, 167
 Leucons, 90, 92, 96, 109,
 113
Leucopsacinae, diagnosis
 and genera, 122
Leucopsacus, 122
Leucosolenia, 17, 51, 56,
 110
Leucosoleniidae, 7, 48, 64,
 75, 93, 94, 100, 101, 104,
 105, 107, 145
 — diagnosis and genera,
 110
Leucyssa, 110
Limosinion, 125
 Lieberkühn, 85, 86, 89,
 158, 164
 lipogastry, 4
 lipostony, 4
Lissodendoryx, 152
 Lister, 166, 168
 Lithistida, 41, 134, 135,
 157, 162
 — diagnosis and classifica-
 tion, 148-150
Lithonia, 109
Lithoninae, diagnosis and
 genera, 111
 Loisel, 49, 59, 86, 87, 89,
 143, 144
 lophocalthrop, 134
Lophocalyx, 64, 122
 lophotriaene, 134
Lubomirskia, 151
Lufaria, 154
Lyidium, 149

- Lymanorea*, 111
Lyssacina, 1, 3, 116, 119, 156
 — diagnosis and classification, 121-123

Maas, 49, 57, 80-82, 96, 107, 144
Macandrewia, 149
 macromeres, 80
Macandrospongiae, diagnosis and genera, 124
Magog, 150
Malacosaccus, 122
 maltha, 51
 Mantell, 7
 mantle of spongo blasts, 46, 141
Margaritella, 124
 marginalia, 118
 Marshall, 142
Marshallia, 124
 massive sponges, 22
 Masterman, 57
Mastusia, 149
 maturation of ovum, 61
Megalithista, 149
 Megamorina, 149
 megascleres, 100, 130, 137
 — definition of, 39
Meliiderma, 152
Mellittonidae, diagnosis and genera, 124
Melloumypha, 122
Melonanchora, 152
Melonella, 149
 membrana reticularis, 121
Menanetia, 151
 Merejkowsky 44 (footnote)
 mesoderm, 63, 73, 81, 85
 mesogloea, 51, 86
 mesotriaenes, 146
 metamorphosis, 69, 81, 84
 Metschnikoff, 73, 80, 82, 85, 86, 165
Metschnikowia, 151
Meyenia, 152
Meyeninae, diagnosis and genera, 151, 152
 microcalthrops, 134
Microcionia, 152
 micromeres, 80
 microrhabdus, 134, 135
 microscleres, 100, 130, 137, 138
 — definition of, 39
 Microsclerophora, diagnosis and classification, 147
 Microtriaenosa, diagnosis and classification, 146, 147
Microtylotella, 152

 Miklucho-Maclay, 64
 Minchin, 57
 monactinal spicules, 38, 116, 137
 monaene, 133
Monakidae, 123
Monanchora, 152
 monaxon spicules, 38, 116, 133, 137, 163
 Monaxonida, 1, 3, 23, 24, 26, 80, 145, 146, 156, 157, 163
 — diagnosis and classification, 150-153
 — skeleton of, 137-140
 Monoceratina, 153
 monocrepid, 135
Monocrepidium, 149
 monolophous, 134
 morphogenesis, 73, 81
 multipolar immigration, 75
Myliusia, 124
 myocytes, 44, 62, 144
Myriastrea, 148
Myrmecium, 111
Myzilla, 152
 Myxospongia, 1, 26, 52, 145, 146, 164
 — diagnosis and classification, 154

Nematrinion, 149
Neopeltidae, diagnosis and genera, 149
Neopeltis, 149
Neosiphonia, 148
 nephrocytes, 57
 nervous system in sponges, 46, 87
 networks in gastral cavity, 48, 96
Nipterella, 150
 Nölkeke, 83, 158, 159
 non-articulated tubar skeleton, 105
 Nudibranchs, feeding on sponges, 88
 nutrition, 85

Oceanapia, 152
 octactinal spicules, 155
 Octactinellida, 154, 155, 157, 162
 — diagnosis and classification, 156
Oculispongia, 111
 odour of sponges, 26
 Oligosilicina, diagnosis and classification, 147
 Olynthus, 3, 7, 8, 64, 90, 92, 103, 104, 126, 161

 Olynthus, anatomy and histology, 26
Onchocladinae, 149
Oncosella, 123
 oögenesis, 61
Ophirhaphidites, 148
Ophlitaspongia, 152
Ophrystoma, 124
 organic axis of spicules, 40, 100
 organogeny, 81
 orthotriaene, 133
Oscarella, 44, 49, 64, 127, 145, 147, 154, 160, 164
Oscarellidae, 146, 164
 — diagnosis and genera, 154
 oscular rim, 27, 93
 — tubes, 93
 osculum, 3, 27, 35, 72, 85, 87
 ostia, 33, 36, 48, 85, 97, 127, 129
 overgrowth, 71
 oxeote spicules, 101, 137
 oxyaster, 134
 oxyhexactine, 117
 oxyhexaster, 117

Pachastrella, 147
Pachastrellidae, diagnosis and genera, 147
Pachinion, 150
Pachychalina, 151
Pachymatisma, 148
Pachypoterion, 149
Pachyteichisma, 125
Pachylitodia, 111
Palaeomanon, 150
Palaeosaccus, 123
 palpoils, 47
Papyrula, 148
 Parazoa, 159
 parenchyma, 31, 51, 85, 120
 parenchymal skeleton, 106, 119
 parenchymalia, 119, 167
 parenchymula, 69, 75, 80, 145
 parietal gaps, 37, 116
Parmula, 152
 parthenogenesis, 67
Pattersonia, 123
Pattersonidae, 123
 peduncle, 3
 peduncular skeleton, 105
 pedunculate sponges, 4
 Pektel'haring, 55, 57, 85, 87
 pelagic larvae, 73
Pellina, 151

- Pemmatites*, 150
Penares, 148
 pentactinal, 38, 116
Perichara, 110
Periphragella, 124
 peristomial skeleton, 105
Peronella, 111
Peronidella, 111
 person, modifications of, in sponges, 5
 Perty, 89
Petronica, 149
Petrosia, 151
Petrostroma, 100, 106, 109, 111
 phagocytes, 58, 62, 85
 phagocytosis, 82, 83
Phakellia, 23, 153
Pharetronidae, 106, 109, 157, 168
 — diagnosis and genera, 110
Pharetrospongia, 111
Phelloderma, 152
Pheronema, 123
Phloedictinae, diagnosis and genera, 152
Phlyctenium, 125
Pholidocladia, 149
Phoriospongia, 152
Phormosella, 123
Phyllospongia, 153
Phymaplectia, 149
Phymatella, 148
Physcaphora, 148
 physiology, 85
Pilochrota, 148
 pinacocytes, 44, 62
 pinulus, 117
Placonella, 149
Placoplegma, 122
Placortis, 147
Placospongia, 148
Placospongiidae, 133, 145
 — diagnosis and genera, 148
Placotrema, 124
Plakina, 78, 82, 126-129, 145, 147, 162
Plakinastrella, 147
Plakinidae, 162
 — diagnosis and genera, 147
Plakinolopha, 147
 planula, 82
 plasmodium, 41
Platychnonia, 150
Plectispa, 152
Plectoderma, 123
Plectospongiadae, 123
Pleroma, 149
Pteronidae, diagnosis and genera, 149
 pleuralia, 118
Pleurope, 124
Pleurostoma, 124
Plinthosella, 149
Plocamia, 152
Plocoscyphia, 124
 plumicome, 117
Plumohalichondria, 152
 plumose fibres, 140
Pocillon, 152
Pocillastra, 147
Poecilocladinidae, 149
Poeciloscleridae, 138, 145
 — diagnosis and genera, 152
 Poléjaeff, 60, 100, 105, 109, 142
Polejna, 110
Poliopogon, 7, 119, 123
Pollakidae, 123
 polyaxon, spicules, 39, 132, 134
Polyblastidium, 125
Polyjerea, 149
Polylophus, 122
Polymastia, 151
Polymastiidae, diagnosis and genera, 151
Polysteganinae, 111
 pores, 3, 27, 35, 85
 — formation of, 72
Poritella, 149
Porochonia, 124
Porocypellia, 124
 porocytes, 27, 28, 48, 62, 71, 85, 108, 144
Porospongia, 124
Porospongiinae, 124
 posterior granular cells, 69, 71, 73
 — ray, 101, 105
Potamolepsis, 152
Poterion, 151
Pozziella, 152
 primary cell differentiation, 73
 — spicules, 40, 131
 principal fibres, 141
 principalia, 119
Prophysema, 154
 prosodus, 35, 49, 127
 prosopyles, 33, 48, 126, 127
 prostalia, 118
Prosuberites, 151
Protachilleum, 150
Proteleia, 138, 151
Proterospongia, 160
 Protolynthus, 31, 161
Protospongia, 123, 157
Protospongiadae, 123
Protosycon, 111
 protriaene, 133
Psammastra, 148
Psammina, 154
Psamminiidae, 142
 — diagnosis and genera, 154
Psammoclema, 154
Psammopenema, 142, 154
 pseudoderm, 95, 97, 104
 pseudogaster, 23, 95, 116
 pseudopodia, 71
 — in collencytes, 52
 pseudopore, 95, 97
 pseudosculum, 23, 95
 pseudoskeleton, 37
Pseudosuberites, 151
Purisiphonia, 124
Pycnopegma, 149
 pylocyte, 48
Pyrgochonia, 150
Pyritonema, 123
Pytheas, 152
 quadriradiate spicules, 101
 — formation of, 107, 108
Quasilina, 151
Rachella, 147
Racodiscula, 148
 radial tubes, 96
 radiate type of skeleton, 135, 140
 Radiolaria, 43
Ragadinia, 149
Raphidonema, 111
Raphidophlus, 152
Raphisia, 151
Raspailia, 153
 Rauff, 109, 134, 165
Raufia, 111
Receptaculites, 123
Receptaculitidae, 123
Regadrella, 6, 122
 regular triradiates, 101
Reniera, 59, 67, 144, 151
Renierinae, diagnosis and genera, 151
 Renierine type of skeleton, 140
Reniochalina, 151
 reticulate type of skeleton, 140, 141
Rhabdasterinu, diagnosis and genera, 148
Rhabderemia, 152
 rhabdi, 137
Rhabdocalyptus, 122
Rhabdodictyum, 122
 rhabdome, 132, 163
Rhabdoplectella, 122
Rhabdosa, 149
 rhabdus, 116, 133

- Rhagon, 64, 125, 135, 164
Rhaphidistia, 150
Rhaphidurus, 151
Rhaxella, 148
Rhizacinella, 151
Rhizochalina, 152
 Rhizomorina, 148-150
Rhizopoterion, 125
Rhopalospongia, 149
Ridleya, 151
 Ridley, 157
Rimella, 148
 Roemer, 155
 root tuft, 3, 41, 88, 118
 rosette, 117
 — cells, 80
Rossella, 122
Rossellidae, diagnosis and
 genera, 122
Rossellinae, diagnosis and
 genera, 122
Rostanga, 88

Saccocalyx, 122
 sagittal triradiates, 101
Semus, 147
 sanidaster, 134
Sanidasterina, diagnosis
 and genera, 148
Sanidastrella, 148
 sarcoenchyma, 52
 Savile-Kent, 55, 89, 158
Sceptrintus, 151
Schaudinnia, 121, 122
Schizorhabdus, 125
 Schmidt, 143, 165
 Schulze, 42, 44 (footnote),
 52, 62, 64, 76 (footnote),
 111, 120, 121, 127, 135,
 143, 156, 159, 162, 165
Scleritoderma, 149
Scleritodermidae, diagnosis
 and genera, 149
 scleroblasts, 27, 39, 47, 53,
 62, 107, 120
Sclerochalina, 151
Sclerokalia, 124
Scleroplegma, 124
Sclerothamnus, 124
Scolopes, 150
 scopula, 117, 118
Scopularia, diagnosis and
 classification, 123, 124
Scyphidium, 122
Scytalia, 149
 second type of canal
 system, 32
 secondary cell differentia-
 tion, 73
 — spicules, 40, 131, 134
 — symmetry, 23
 segmentation of ovum, 67,
 68, 73
Seiriola, 148
Seliscothoa, 150
Semisuberites, 151
Semperella, 123
Semperellinae, 123
 sensitiveness, 87
 sessile sponges, 4
Sestrocladia, 125
Sestrodictyon, 124
Sestrostomella, 106, 111
Setidium, 149
 sheath of spicule, 40, 100
Sideroderma, 152
 sieve membrane of osculum,
 27
 sigma, 138
 sigmaspire, 134
Sigmatella, 152
Sigmatophora, diagnosis
 and classification, 147
Sigmaxinella, 153
 Silicea, 162
 siliceous spicules, 40
 — spicules, origin of, 161
Siphonia, 13, 148
Siphonidium, 149
Siphonochalina, 151
 skeletal spicules, 39, 100,
 137
 skeletogenous cells, 85
 — layer, 46
 — stratum, 31, 51, 62, 71
 skeleton, 27
 — in general, 37-43
 — of Calcarea, 100-107
 — of Demospongiae, 130-
 144
 — of Hexactinellids, 118-
 120
 — of Keratosa, 140-144
 — of Monaxonida, 137-140
 — of Tetraxonida, 130-137
 — origin of, 161
 smooth cortical skeleton,
 105
 Sollas, 44, 47, 52, 58, 135,
 148, 158, 159
Sollasella, 153
 Sollas's membrane, 56
Spanioplton, 152
 spermatocyst, 60
 spermatocyte, 60
 spermatogenesis, 60
 spermatogonium, 60
 sphaeraster, 134
Sphaerospongia, 123
Sphaerotylus, 151
Sphenaulax, 124
Sphenophorina, 110
 spherule, 167
 sphincter, 27, 36, 46, 48
Sphinctrella, 147
 spicular system, 40
 spicule, definition of, 41
 spicules, 27, 71
 — calcareous, 40, 100
 — development of, 40
 — formation of, in Calcarea,
 107, 108
 — morphology of, 37
 — of *Darwinella*, 141
 — of Hexactinellids, 116-
 118
 — of Monaxonida, 127,
 138
 — of Octactinellida and
 Heteractinellida, 155
 — of Tetraxonida, 131-135
 — organic axis of, 40, 100,
 116, 118, 167
 — origin of, 161
 — sheath, 40, 100
 — siliceous, 40
Spiculispongiae, 146, 163
Spinosella, 151
Spiractinella, 123
Spirastrella, 43, 151
Spirastrellidae, diagnosis
 and genera, 151
Spiroxya, 150
Spongelia, 154
Spongellidae, 142, 144
 — diagnosis and genera,
 153, 154
Spongicola, 88
Spongidae, diagnosis and
 genera, 153
Spongilla, 42, 51, 53, 56,
 58, 61, 80, 82, 86, 89,
 151, 159
Spongillinae, 1, 25, 65, 67,
 137, 138
 — diagnosis and genera,
 151, 152
 spongin, 138, 163
 — chemical nature, 41
 — fibres, 26
 spongoblasts, 42, 46, 62
 138, 141
 spongoclasts, 141
Spongodiscus, 149
 spongophare, 126
Spongosorites, 150
 spongozoon, 89
Sporadopyle, 124
Sporadoscincia, 125
 sporaster, 134
Stachyspongia, 150
 stalk, 3
Stannarium, 154

- Stannoma*, 154
Stannomidae, 142, 143
 — diagnosis and genera, 154
Stannophyllum, 154
 statocytes, 60, 62, 65
Stauractinella, 123
Stauracalyptus, 122
Stauroderma, 124
Staurodermidae, 124
Stauroderminae, 124
Stauronema, 124
Stelletta, 43, 128, 148
Stellettidae, diagnosis and genera, 148
Stelligera, 153
Stellispongia, 111
Stelospongos, 142, 153
Stephanoscyphus, 88
 sterraster, 134
Sterrostrua, 148
 Stewart, 47
Stichophyma, 150
 stomions, 127
Stranbergia, 111
 streptaster, 134, 138
Streptasteridae, diagnosis and genera, 150
Streptastrosa, 147
 stronglyote, 137
Stryphnus, 148
Stuckenbergia, 149
 style, 133
Stylocordyla, 151
Stylocordylidae, diagnosis and genera, 150, 151
Stylostichon, 152
Stylotella, 152
Stylotrichophora, 152
 stylus, 116, 137
 subcortical crypt, 129
 subdermal cavities, 128
 — trabecular layer, 112
Suberites, 88, 151, 157
Suberitidae, 140
 — diagnosis and genera, 151
Suberotelites, 152
 subgastral trabecular layer, 112
Sulcastrella, 148
Sycantha, 110
Sycetta, 110
Sycettidae, 111
 — diagnosis and genera, 110
Sycon, 8, 27, 48, 55, 56, 61, 76, 77, 81, 82, 100, 103, 107, 110
 syconoid type of canal system, 96, 97
Sycons, 90, 92, 96, 109
Syculmis, 110
Sycyssa, 110
 symmetry, secondary, 23
Sympagella, 122
Sympyla, 149
 synapticula, 119
 synceyitium theory, 62
 synocils, 47
Synopella, 111
Synops, 148
Syringella, 153
Toegeria, 122
Toegerinae, diagnosis and genera, 122
Tedania, 152, 156
Teganium, 123
Teichonella, 110
Tentorium, 13, 20, 36, 151, 167
Terpios, 151
 tertiary cell differentiation, 73
Tethya, 64, 67, 150
Tethyidae, 133, 138
 — diagnosis and genera, 150
Tethyopsilla, 147
Tethyopsis, 148
Tethyorrhaphis, 150
Tetilla, 127, 128, 147
Tetillidae, diagnosis and genera, 147
Tetracladidae, diagnosis and genera, 148
 tetracrepid, 135
 tetractinal, 38, 116
 tetractine, 132
 Tetractinellida, 1, 3, 78, 132, 146, 157
 — diagnosis and classification, 147-150
 tetralophous, 134
Tetranthella, 153
 tetraxon spicules, 38, 132
 — spicules, origin of, 135, 162
 Tetraxonia, 162, 164
 Tetraxonida, 1, 145, 146, 163
 — diagnosis and classification, 146-150
 — skeleton, 130-137
Thalamopora, 111
Thamnospongia, 149
Thecaphora, 151
Thecosiphonia, 149
Thenca, 147, 157
Thencidae, diagnosis and genera, 147
Theonella, 148
 thesocytes, 58, 59, 62
 third type canal system, 33
Tholasterella, 156
Thoosa, 151
Thorecta, 154
Thrinacophora, 153
Thrombus, 147
Thymosia, 147
 tokocytes, 58, 59, 62, 83
 Topsent, 49, 59, 65, 67, 127, 144, 165
 tornote, 137
Toulminia, 124
 toxa, 138
Toxoachalina, 151
 trabeculae, 112, 120
Trachya, 150
Trachycaulus, 122
Trachycladus, 150
Trachysimia, 111
Trachysycon, 148
Trachytetania, 152
Tragosia, 153
Trenadictyon, 124
Tremaulidium, 149
Tremodictyidae, diagnosis and genera, 124
Tretolophus, 149
 triactinal, 38
 — spicules, 101
 triaene, 132, 135
 triaenes, 162, 163
Triacnosa, 148
 triaxon spicules, 38
 — origin of, 162
 Triaxonia, 111, 162, 164
Tribrachion, 13, 148
Trichasterina, 122
Trichospongia, 153
Trichostemma, 151
Trikentron, 138, 153
 trilophous, 134
 tripods, 104
Triptotemus, 147
 triradiate spicules, 101
 — spicules, formation of, 107
Trochobolus, 125
Trochospongilla, 151
 trophocytes, 58, 62
Tuba, 151
 tubar skeleton, 105
 — system, 93
Tubella, 152
Tuberella, 150
 tuning-fork spicules, 106
Turonina, 149
 tylhexactine, 117
Tylosigma, 152

- | | | |
|--|--|--|
| tylostyle, 137
tylote, 137
<i>Typton</i> , 88

<i>Uncinataria</i> , diagnosis and
classification, 123, 124
uncinata, 117
undergrowth, 71
unipolar immigration, 75
<i>Uruguaya</i> , 152
<i>Ute</i> , 9, 110
<i>Utella</i> , 110

Vasseur, 64
vegetative reproduction, 63 | <i>Velinea</i> , 154
<i>Ventriculites</i> , 3, 7, 125
<i>Ventriculitidae</i> , 125
<i>Verongia</i> , 154
<i>Verrucocoelia</i> , 124
<i>Verruculina</i> , 150
<i>Verticillites</i> , 111
<i>Vetulina</i> , 149
<i>Vibulinus</i> , 153
<i>Vitrollula</i> , 122
<i>Vomerula</i> , 152
Vosmaer, 55, 57, 85, 87,
163, 165
<i>Vosmaeria</i> , 110, 153
<i>Vosmaeropsis</i> , 110 | <i>Walleria</i> , 122
wandering cells, 28, 31
Weltner, 165
Willey, 166
Wright, 157

xenophya, 37
<i>Xenospongia</i> , 151

yolk granules, 65, 83
<i>Yvesia</i> , 152

Zittel, 165, 168
zoa impersonalia, 91
zygosis, 137 |
|--|--|--|

CHAPTER IV

THE HYDROMEDUSAE.¹

CLASS HYDROMEDUSAE.

- Order 1. **Anthomedusae.**
- ,, 2. **Leptomedusae.**
- ,, 3. **Trachomedusae.**
- ,, 4. **Narcomedusae.**
- ,, 5. **Hydrocorallinae.**
- ,, 6. **Siphonophora.**
- Sub-Order 1. **Disconectae.**
- ,, 2. **Calyconectae.**
- ,, 3. **Physonectae.**
- ,, 4. **Auronectae.**
- ,, 5. **Cystonectae.**

THE organisms which are dealt with in this chapter and the next under the class-names Hydromedusae and Scyphomedusae were, until quite lately, regarded as being so much more closely allied to each other than to any other class of the animal kingdom that they were grouped together under the name Hydrozoa (a name due originally to Huxley), in contrast to the other great division of Coelentera, the Anthozoa. It has, however, become increasingly probable that, near akin as are Scyphomedusae to Hydromedusae, their race-history indicates a yet closer relationship to Anthozoa: the term Hydrozoa has therefore been dropped altogether for the purposes of the present work, although the further step of uniting Scyphomedusae and Anthozoa under the class-name Scyphozoa (as some suggest) has not been taken.

DEFINITION.—Hydromedusae are Coelentera, which typically present two main forms of individuals—the non-sexual hydroid and the sexual medusoid (gonophore); in this case the life-history exhibits an alternation of generations, in which the hydroid produces the medusoid by lateral budding, and the fertilised eggs of the

¹ By G. Herbert Fowler, B.A., Ph.D.

medusoid develop into a hydroid. In other cases the medusoid may develop directly from an egg-cell, or may be budded from another medusoid. No gastric ridges or filaments occur in either hydroid or medusoid. The sexual cells lie typically on radii of the first order, and are always (?) primarily derived from ectoderm cells. The medusoids are characterised by the possession of a muscular non-vascular velum, and have as sense organs ocelli, otocysts, or tentaculocysts.

THE DIBLASTULA AND THE EMBRYONIC LAYERS.—The single form of Hydromedusan cell, which was excepted above as being capable of independent existence, is called the egg or *ovum*. If duly fertilised the ovum shortly splits into two cells, which in their turn divide again; this process of division, or segmentation of the ovum, is continued until ultimately, by one path or another, an embryo has been built up which consists of numerous cells, arranged in two layers round a central cavity. To an embryo of this kind the name *diblastula* (gastrula) has been given (Fig. 2). These two layers of cells, however complex may be the ultimate form of the adult organism, are the chief constituent tissues of all Hydromedusae, as was shown by Huxley so long ago as 1849.

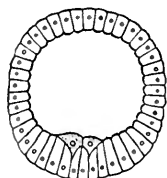

FIG. 1.

1.—Section through a blastula; the single layer of cells surrounds a cavity, the blastocoele. At the lower pole two cells of the future endoderm have been budded into the blastocoele.

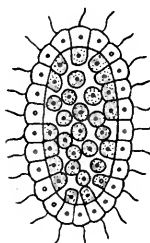

FIG. 2.

2.—Section through a diblastula (gastrula). The cells of the future ectoderm are ciliated; by their proliferation a number of cells, the future endoderm, have been budded into the blastocoele, which they nearly fill.

To the outer layer or skin has been assigned the name *ectoderm*; the inner layer which lines the central cavity or *coelenteron* has been termed the *endoderm*. Between the ectoderm and the endoderm is deposited later a gelatinous secretion, the non-cellular *mesogloea*, into which cells from either of the two primary layers may wander. From these simple elements — ectoderm, mesogloea, and endoderm lining the coelenteron—all the varied and beautiful forms of the Hydromedusae are moulded.

GENERAL DESCRIPTION OF THE HYDROID AND OF THE MEDUSOID.

—In no group of the animal kingdom is polymorphism carried to a greater extent than in the Hydromedusae, yet, upon morphological analysis, the numerous forms which individuals exhibit are apparently all referable to modifications of one or other of two main types—the Hydroid and the Medusoid.

The HYDROID (hydriform person, hydranth, trophozoid) is represented in a simple form by the genus *Hydra*, from which it derives its name. This presents (Figs. 3, 4, B and C) a tubular

body consisting of ectoderm, mesogloea, and endoderm, at one end of which is a mouth, situated on a slight eminence (the *hypostome*); through the mouth the internal cavity (*coelenteron*) communicates with the outer world. Round the mouth are placed *tentacles*, which are hollow outgrowths of the body, their cavity being part of the coelenteron.

In the hydroid thus composed the elements of the original diblastula are not far to seek: the primary two layers, ectoderm

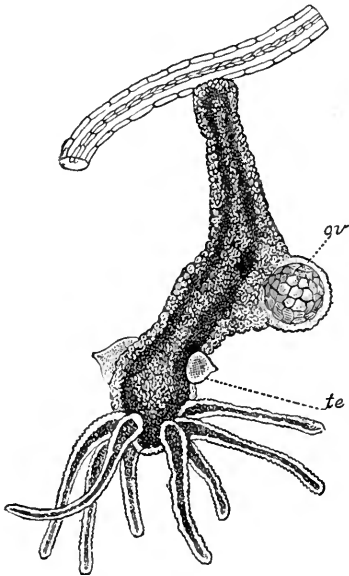

FIG. 3.

3.—*Hydra viridis*, attached to a piece of weed. *ov*, ovary; *te*, testis.

4.—Diagram exhibiting the plan of structure of hydroids. *A*, hydroid with wide disc, manubrium, and solid tentacles (Tubularian); *B*, hydroid with narrow disc and hollow tentacles (Hydra); *C*, transverse section of the body of a hydroid. All the figures show from without inwards ectoderm (strongly hatched), mesogloea (a thick black line), and endoderm (lightly hatched), surrounding the coelenteron.

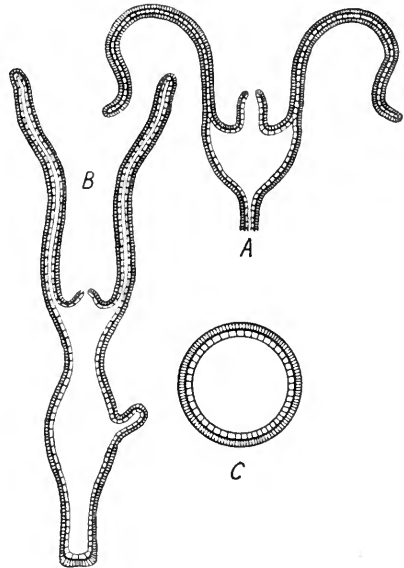

FIG. 4.

and endoderm, and the coelenteron, are still represented. The secretion of a mesogloea, the perforation of a mouth, and the outgrowth of tentacles, are the main morphological differences between embryo and adult hydroid.

Hydroids are either solitary or colonial. The solitary forms, such as *Hydra*, are capable of reproduction by a process of budding (Braem, 15; Seeliger, 16), (Fig. 4, *B*), in which a part of the body wall, enclosing coelenteric cavity, protrudes laterally; this elongates and forms a mouth and tentacles at its distal end; the little *Hydra*, thus produced, becomes constricted off by an ingrowth of cells, which seal up both its central end and the body wall of the parent.

A process of budding, similar in character but not followed by a separation of progeny from parent, results in the production of colonial forms (Figs. 16 to 20); in the colony thus formed, the

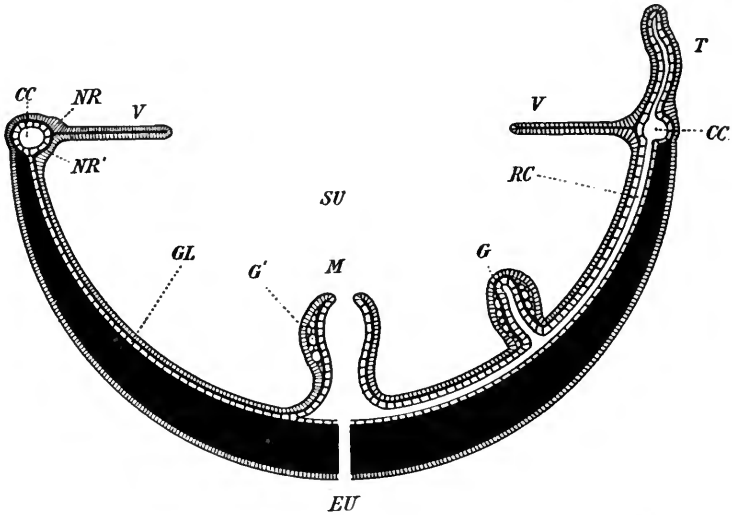

FIG. 5.

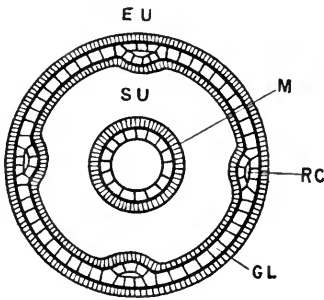

FIG. 6.

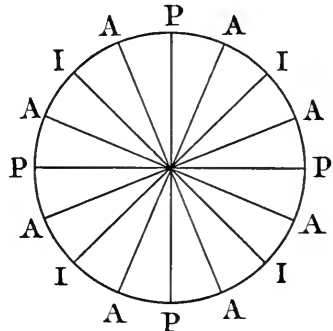

FIG. 7.

5.—Section of a medusoid, placed mouth upwards for comparison with a hydroid (Fig. 4). The right half of the section is taken along a radial canal, the left half between two radial canals. *CC*, circular canal; *EU*, exumbrellar surface; *G*, gonad or generative cells lying in the ectoderm of a process of the subumbrellar body wall (characteristic of Leptomedusae); *G'*, gonad lying in the ectoderm of the manubrium (characteristic of Anthomedusae); *GL*, gastral lamella; *M*, manubrium; *NR*, the outer, and *NR'*, the inner parts of the nerve ring; *RC*, radial canal; *SU*, subumbrellar cavity; *T*, tentacle; *V*, velum. Body layers represented as in Fig. 4.

6.—Section of a medusoid, at right angles to Fig. 5. Letters as in Fig. 5; body layers as in Fig. 4.

7.—Diagram showing the chief radii of a medusoid. *P*, perradii (the first four radii accentuated in development); *I*, interradii; *A*, adradial.

coelenteron of each hydroid communicates with those of all the other hydroids through the tubular *coenosarc* or common tissues.

The coenosarc generally consists of a branching vertical stem (the *hydrocaulus*), springing from a branching horizontal stolon (the *hydrorhiza*), by which attachment is effected to some foreign body. A transverse section of either hydrocaulus or hydrorhiza typically presents the same ectoderm, mesogloea, and endoderm lining coelenteron, as are exhibited by a section of a Hydra or of its tentacle (Fig. 4, C). Theoretically, in the Anthomedusae an axial stem or branch is only the much elongated body of the terminal hydroid of that stem or branch; but as in practice it is often difficult to allot the parts correctly, the tubular stems and branches are treated as coenosarc or tissues common to the colony.

The coenosarc is generally invested by a horny coat, the *perisarc*, formed as a secretion by the ectoderm cells; this in some cases expands into a *hydrotheca* (Fig. 17) at the base of each hydroid, in others (Fig. 16) it ceases abruptly at that point.

Hydroids are formed either as buds from other hydroids, or as buds from the coenosarc, or directly from a fertilised ovum; they are generally fixed, sterile, and nutritive.

The MEDUSOID (medusiform person, gonozooid, gonophore) exhibits all the parts of a hydroid, but in slightly altered relations. It is generally bell-shaped (Figs. 5, 25, 33), the clapper of the bell being formed by a projection (the *manubrium*), at the end of which is the mouth. The bell itself is often termed the *umbrella*; its oral or concave face is styled the *subumbral*, and its aboral or convex face the *exumbral* surface. From the lip of the bell or umbrella a shelf (the *velum*) projects inwards, and the *tentacles* hang downwards. The mouth opens through the manubrium into an expanded *gastric cavity*; from this four *perradial canals* lead to the lip of the bell and there open into a *circular canal* which runs round its circumference.

Although the relation of this organism to the hydroid is not obvious at first sight, a comparison of Figs. 4 and 5 will make it clear. The elongated hypostome of the hydroid corresponds to the manubrium of the medusoid; the tubular body of the hydroid, if expanded radially outwards in every direction, would represent the bell-shaped body of the medusoid; the tentacles would be carried outwards by this expansion, but would remain as a circlet round the hypostome (manubrium).

While the outward form of the medusoid is thus referable to that of the hydroid, the coelenteron of the former is not of the simple nature which is presented by that of Hydra; the endoderm is no longer uniformly the lining of the coelenteron, but forms a solid cup-shaped plate (the *gastral* or *endoderm lamella*), lying in the wall of the umbrella between the gastric cavity and the circular canal, except along certain lines which have been already cited as the radial canals (Figs. 5, 6). The coelenteron thus consists of the following regions, manubrial cavity, gastric cavity, radial

canals, circular canal, and sometimes tentacular canals; the endoderm, in addition to forming the lining of these cavities, forms the endoderm lamella, and sometimes a solid tentacular core.

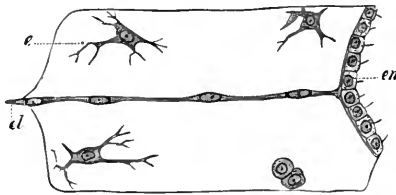

FIG. 7 bis.—Part of a section of *Aurelia*, showing *e*, amoeboid cells in the mesogloea; *el*, endoderm of gastral lamella; *en*, endoderm lining gastric cavity. (From Lankester, after Hertwig).

The *perradial* canals lie in the first four radii (Fig. 7) which are accentuated in the development of the medusoid; other four radiating canals may be similarly formed between these, which with them divide the umbrella into eight equal parts; they are termed *interradial*.

A further set of eight radiating canals is sometimes developed between perradial and interradial canals, and is termed *adradial*.

The exumbrel mesogloea is generally greatly thickened and adds firmness to the bell.

When medusoids are attached to a hydroid colony, the perisarc in some cases expands into a *gonotheca* for their protection (Fig. 17); in other cases it is absent (Fig. 16).

Medusoids are formed either as buds from hydroids or from hydroid coenosarc, or as buds from other medusoids, or directly from the fertilised ovum. They are typically free swimming and fertile, and are often incapable of taking food.

HISTOLOGY OF THE HYDROID (Figs. 8 to 10) (Jickeli, 17; v. Lendenfeld, 18).—The *ectoderm* is generally composed of a single layer of cells, and includes several varieties of cell forms. Of these the most prominent are the large *epithelio-muscular cells*, the inner ends of which give off contractile fibres in a direction parallel to the long axis of the body; these fibres, which frequently exhibit striations, are attached to the mesogloea, and the movements of the body are largely effected by their means. In some cases a gradual diminution can be traced in the size of the cell body, and a corresponding increase in the size of the muscular fibre; this leads to a deep-lying muscle cell, no longer epithelial, comparable to the smooth muscle cell of Triploblastica (Fig. 8, 1-3). The possession of a stiff sensory filament, the palpoecil, characterises the *sense cells*. Other cells, provided with a similar filament, the *cnidocil*, are termed *cnidoblasts*, and secrete in the interior of the cell body the *nematocyst*, a weapon of offence and defence. This consists (Figs. 8⁶, 9) of a vesicle, often with double walls, filled with fluid, the neck of which is barbed and then drawn out into a long and extremely fine tubular filament, at the tip of which the tube probably opens to the exterior. When in the cell, the *nematocyst* has a different appearance; the filament, barbs, and

neck, are formed and lie inside the vesicle, and are everted only by pressure upon its walls. Two kinds of nematocyst, a larger and a smaller, are generally present, and exhibit some differences of detail. *Gland cells* and *pigment cells* are not uncommon. Multi-polar *ganglion cells*, lying beneath the surface of the ectodermal epithelium, have been detected in numerous species. The smaller *interstitial cells*, of irregular form, which fill the interspaces between

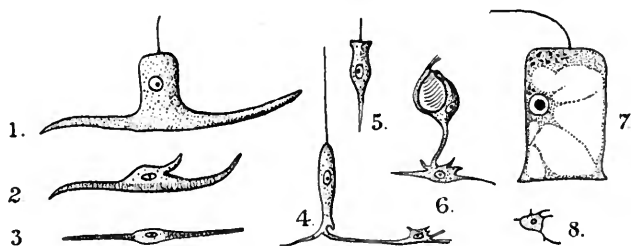

FIG. 8.

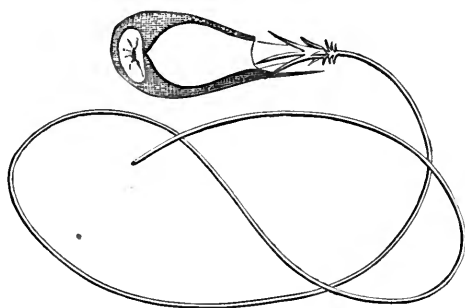

FIG. 9.

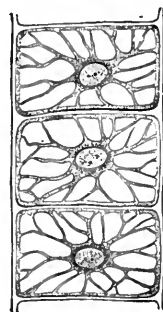

FIG. 10.

8.—Types of Hydromedusan cells, after von Lendenfeld and Schulze. 1, epithelio-muscular cell, with palpocil and contractile processes; 2, 3, muscular cells showing the transition from the epithelioid to the fibrous condition; 4, sense cell with palpocil, connected by nerve fibre with ganglion cell; 5, supporting cell with palpocil; 6, cnidoblast, with three cnidocils, enclosing a nematocyst, and connected by nerve fibre with ganglion cell; 7, endoderm cell with cilium; the protoplasm is vacuolated and contains (?) food particles; 8, amoeboid cell from mesogloea.

9.—Cnidoblast with cnidocil and nematocyst; the thread and barbs of the latter have been everted. (After Schulze.)

10.—Vacuolated endoderm cells of "cartilaginous" consistence from the axis of the tentacle of *Cunina*. (From Gegenbaur's *Elements of Comparative Anatomy*.)

the others, are apparently differentiated as required into the more specialised cell forms already mentioned.

The *endoderm* is also generally composed of a single layer of cells, and is ciliated; there is generally one cilium on each cell, which is capable of withdrawal. The larger cells of the endodermal epithelium are essentially *digestive cells*, but are in many cases also provided with short contractile fibres which lie on the mesogloea

in a direction at right angles to the long axis of the body and to the contractile fibres of the ectoderm. The cells are often amoeboid at the outer or free end, and contain vacuoles filled with an albuminous fluid. Particles of food-matter and masses of (?) excretory matter are often to be detected in the protoplasm. Among these larger cells are often intercalated *gland cells*, which appear to secrete a digestive fluid. *Ganglion cells* and *pigment cells* occur; but though nematocysts have been detected in endoderm cells, it is still doubtful whether they are formed in them or not.

Where they form the axial core of a solid tentacle, the endoderm cells become vacuolated and "cartilaginous" in consistence, resembling the notochordal cells of Chordata (Fig. 10).

The *mesogloea* forms a thin lamina everywhere between ectoderm and endoderm cells and gives by its stiffness a certain rigidity to the body. It is often apparently laminated. Although itself incapable of contraction, it is greatly thickened and shortened, on the contraction of the body, by the muscular fibres of the ectoderm and endoderm.

HISTOLOGY OF THE MEDUSOID.—The *ectoderm* appears over the greater part of the umbrella as a layer of much flattened cells, but is cubical on the velum and manubrium. *Epithelio-muscular cells*, like those of the hydroid, occur also in the medusoid, but *sub-epithelial muscle cells* are here more common; they are either scattered, or grouped in trabeculae, and in some cases become embedded in the mesogloea. The ectodermal muscle fibres may have either a circular or longitudinal trend, unlike those of the hydroid.

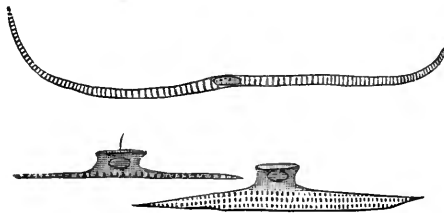

FIG. 10a.—Muscular cells of medusae (*Lizzia*). The uppermost is a purely muscular cell from the subumbrella; the two lower are epithelio-muscular cells from the base of a tentacle; the upstanding nucleated portion forms part of the epidermal mosaic on the free surface of the body. (From Lankester, after Hertwig.)

On the manubrium circular musculature is well developed; longitudinal fibres also occur on it, which are continued centrifugally outwards, radiating over the subumbral surface towards the lip of the bell. The subumbrella possesses also circular fibres; the exumbrella has little or no musculature.

Strongly developed circular fibres characterise the edge of the bell and the velum; by their agency the contraction and consequent progression of the bell are chiefly effected. The tentacles are highly contractile, and are provided with strong longitudinal muscles. *Sensory cells*, which are elongated and columnar, and are provided with palpcils, are well developed at the bases of the

tentacles. Subepithelial *ganglion cells* and *nerve fibrillae* form a scattered plexus in the ectoderm in connection with sensory and muscle cells, especially on the subumbrella; they are concentrated at the lip of the bell into a *nerve ring*, which is divided by the insertion of the velum into outer and inner portions, connected by nerve fibrils through the mesogloea.

Connected with the nerve ring are the *sense organs* (Hertwig, 19; Eimer, 20) or special aggregations of sense cells. They are referable to four chief types.

1. *Ocelli* or eye spots are generally found at the bases of tentacles. In their simplest form they consist of a few sense cells between which are scattered a few pigment cells; in their complete development, the sensory and pigment cells are grouped into a definite organ of subspherical shape (Fig. 11), which projects above the general surface, and may secrete a cuticular lens (*Lizzia*). The whole structure is ectodermal.

2. *Otocysts* are found under two chief forms: (*a*) in the simpler of these the organ consists of an open subumbrel pit at the base of the velum, the cells of which secrete each an otolith of organic and calcareous nature (*Mitrocoma*); (*b*) in the more complex type the pit becomes converted into a closed vesicle, containing one or more otolithic cells, which are usually supported on sensory hairs. The whole structure is ectodermal, and may occur either on or between tentacles (Figs. 12, 13).

3. *Cordyli* (Brooks, 21) are exumbrel structures, placed between tentacles, which consist of a core of vacuolated endoderm cells covered by flattened ectoderm. It is possible that they represent a modification of a tentacle, less complete than, but analogous to, the modification which has produced the next form of Hydro-medusan sense organ (Fig. 15).

4. *Tentaculocysts*, which are apparently tentacles modified for the better perception of auditory vibrations, and are placed exumbrellally, consist essentially of a club-shaped structure, clothed externally by ectoderm; they contain an axial core of endoderm cells, the outermost (one or more) of which secretes an otolith. The club thus formed either projects freely from an eminence composed of

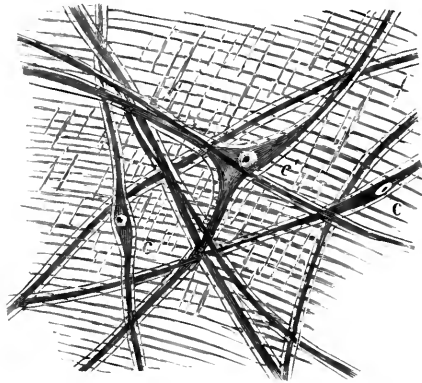

FIG. 10b.—Scattered nerve-ganglion cells from the subumbrella of *Aurelia*. (From Lankester, after Schäfer.)

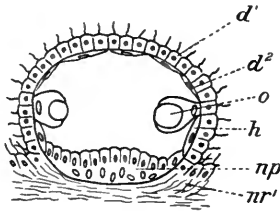

FIG. 13.

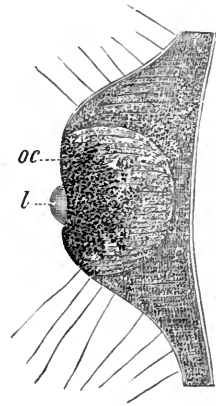

FIG. 11.

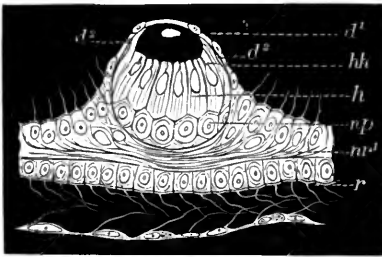

FIG. 12.

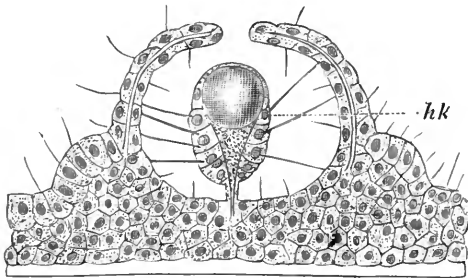

FIG. 14.

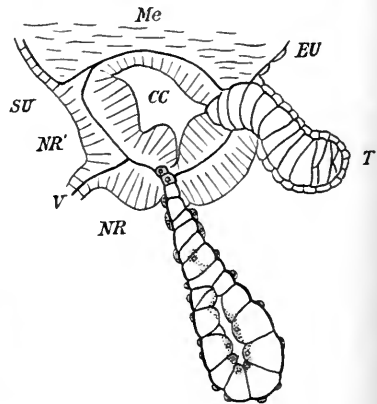

FIG. 15.

11.—Ocellus of *Lizzia Koellikeri*. *oc*, pigmented ectodermal cells; *l*, lens.

12.—Otocyst of *Phialidium*. *d*¹, superficial layer of ectoderm; *d*², deep layer of ectoderm; *h*, auditory cells of ectoderm; *hh*, auditory hairs; *np*, nerve body; *nr*¹, upper nerve ring; *r*, endoderm cells of the circular canal. The otolith cavity is seen above *h*. (Figs. 11, 12, from Lankester, after Hertwig.)

13.—Otocyst of *Euchilota*. *o*, otolith; remaining letters as Fig. 12. (After Hertwig.)

14.—Simple tentaculo-cyst of one of the Trachomedusae (*Rhopalonema velatum*). The process carrying the otolith or concretion *hk*, formed by endoderm cells, is enclosed by an upgrowth forming the "vesicle," which is not yet quite closed in. (From Lankester, after Hertwig.)

15.—Optical section of a cordylus or sense club; the surrounding structures are only roughly indicated. *CC*, circular canal; *EU*, exumbrel surface; *Me*, mesogloea; *NR*, the outer, *NR'*, the inner parts of the nerve ring; *SU*, subumbrel surface; *T*, tentacle; *V*, velum. (After Brooks.)

sensory cells provided with long sensory hairs (Cunina), or becomes surrounded by a closed vesicle, a stage in the formation of which is shown in Fig. 14; the club is supported in position by long sense hairs, and the vesicle filled with fluid (Rhopalonema). The endoderm, in secreting the otolith, has here a definite sensory function, which is confined to the ectoderm in ocelli and otocysts.

Gland cells, pigment cells, cnidoblasts, and supporting or *interstitial cells* are of constant occurrence; the cnidoblasts are especially well developed on the tentacles.

The *endoderm* has much the same characters as in the hydroid. The *mesogloea* is often extremely thick, especially on the exumbrel surface. Although it is essentially a non-cellular layer, but is rather an inert secretion by ectoderm and endoderm, when well developed, it often contains amoeboid wandering cells (Fig. 8^s), and elongated muscle cells, both in all probability migrants from the ectoderm. It is firm and jelly-like, and often shows a fibrillated structure.

The *ova* and *spermatozoa* are, with rare exceptions, of the type usual in the Animal Kingdom.

ORDER 1. Anthomedusae (*Gymnoblastera*).

DEFINITION.—Hydromedusae with a regular alternation (metagenesis) of a sterile hydroid generation with a sexual generation of medusoids or other gonophores. The perisarc does not form hydrothecae into which the hydroids are completely retractile, nor rigid permanent gonothecae. The sense organs of the medusoids are ocelli. The generative organs lie in the wall of the manubrium.

The HYDROID is colonial and fixed (*Bougainvillea*); or is non-colonial, and then is either fixed (*Myriothela*) or free (*Hydra*). The *hypostome* is conical or truncated, rarely trumpet-shaped (*Eudendrium*). The *tentacles* are hollow (*Hydra*) or, more usually, solid (*Bougainvillea*); they are rarely absent (*Microhydra*). They are irregularly scattered (*Hydra*), or form a circlet (*Bougainvillea*), or even two circlets (*Tubularia*) round the mouth. They never have a pore at the tip, and are rarely branched (*Cladocoryne*) or webbed. They are filiform (*Hydra*) or capitate (*Coryne*); in the former case the nematocysts are chiefly concentrated in scattered wart-like batteries; in the latter case in the head. The *coelenteron* of the hydroid is sometimes nearly divided into two by a constriction (*Tubularia*). Lobes (*Tubularia*) or villi (*Myriothela*) may project into it from the body wall.

A *hydrorhiza* (Figs. 16 to 20) is generally more or less developed in the fixed forms, whether single (*Myriothela*) or

colonial (Bougainvillea); but may be replaced by filiform processes (Corymorpha); it is, of course, absent in the motile forms (Hydra). In the colonial forms it gives rise to one or more simple (Perigonimus) or branching (Bougainvillea) *hydrocauli*. The coenosarc of both hydrocaulus and hydrorhiza generally forms a single tube.

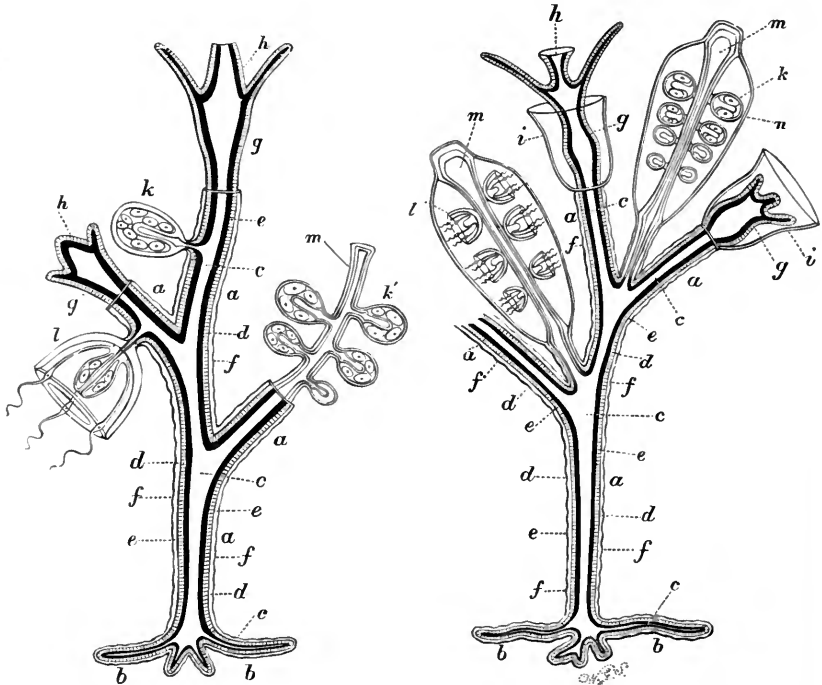

FIG. 16.

FIG. 17.

16.—Diagram showing possible modifications of persons of a Gymnoblasic Hydromedusa. *a*, hydrocaulus (stem); *b*, hydrorhiza (root); *c*, coelenteron; *d*, endoderm (thick black line); *e*, ectoderm (hatched); *f*, perisarc (thin black line); *g*, hydroid expanded; *g'*, hydroid contracted; *h*, hypostome, bearing mouth at its extremity; *k*, degenerate medusoid (sporosac) springing from the hydrocaulus; *k'*, sporosac springing from *m*, a modified hydroid (blastostyle); the genitalia are seen surrounding the spadix; *l*, medusoid; *m*, blastostyle. (After Allman.)

17.—Diagram showing possible modifications of the persons of a Calyptoblasic Hydromedusa. Letters *a* to *k* same as in Fig. 16. *i*, the horny cup or hydrotheca of the hydroid; *l*, medusoid springing from *m*, a modified hydroid (blastostyle); *n*, the horny case or gonotheca enclosing the blastostyle and its buds. This and the hydrotheca *i* give origin to the name Calyptoblastea. (After Allman.)

The tubes of the hydrorhiza are generally distinct from one another, although they are often connected by cross-tubes into a loose meshwork. In *Podocoryne*, however, such a meshwork occurs only at the growing points of the colony; in the more central parts the tubes increase in number and anastomose so freely as to appear

to form a solid crust; this crust is in reality composed of separate coenosarc tubes, each surrounded by perisarc. If, instead of the perisarc of adjacent tubes becoming adherent or continuous, its formation were suspended until the ectoderm of adjacent tubes had become confluent, we should arrive at the condition presented by the central parts of *Hydractinia* (Collcutt, 26); towards the edge of the colony this genus has the same structure as the central parts of *Podocoryne*; at the growing edge both have a loose hydrorhiza of the usual type.

The tubes of the hydrocaulus are generally distinct, but in some cases the stem of the colony is "fascicled" or formed of closely apposed or adherent hydrocauli (*Eudendrium*). Just as this is a modification comparable to the adherent hydrorhizal tubes of *Podocoryne*, so the confluent ectoderm of numerous hydrocauli in *Ceratella* (Spencer, 27) is comparable to the central hydrorhiza of *Hydractinia*. A further complication is introduced in the hydrocaulus of *Corydendrium*, owing to the fact that the young buds, instead of breaking through the perisarc and growing outwards as is usual, grow upwards for some distance inside it and surround themselves by secondary perisarc (Weismann, 10).

A space generally lies between the ectoderm, and the perisarc of hydrocaulus or hydrorhiza which it secreted; strands of protoplasm or elongated ectoderm cells may cross this space.

The *perisarc* is rarely absent (*Hydra*); it generally forms a complete investment of hydrorhiza and hydrocaulus, and is sometimes prolonged over the body of the hydroid as a sort of hydrotheca (some *Bougainvillea*), into which the entire hydroid cannot be withdrawn. The perisarc is generally a cuticular secretion of a horny character, but may be formed of adventitious particles held together by a secretion (*Perigonimus*); in both cases the secretion is formed by the activity of the ectoderm cells. A horny perisarc is usually smooth, but may be annulated at the origin of each branch (*Cordylophora*) or uniformly annulated throughout its length (*Coryne*). A horny perisarc generally exhibits a concentrically laminated structure,

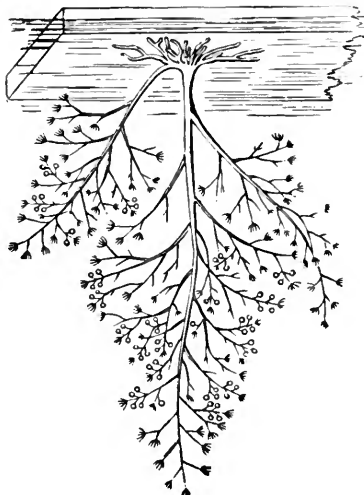

FIG. 18.—Colony of *Bougainvillea* (nat. size) attached to a piece of floating timber. (After Allman.)

and can be thickened by the addition of layers from without inwards. It can be reabsorbed by the agency of the ectoderm cells which secreted it; this occurs when a new bud grows outwards from the coenosarc.

POLYMORPHIC MODIFICATIONS OF THE HYDROID.—A *blastostyle* (Fig. 16, *m*) is a hydroid which exhibits a greater or less simplification of structure, in correlation with its special function of giving origin to medusoids by budding. It may have a few small tentacles

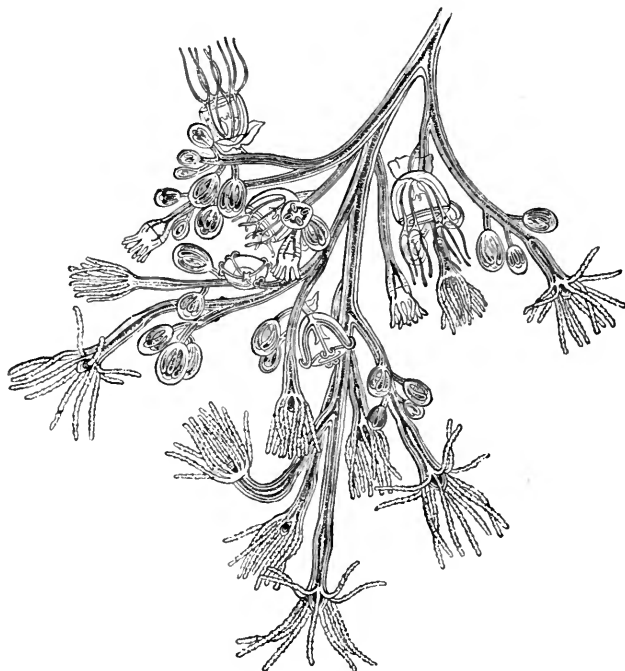

FIG. 19.—Portion of colony of *Bougainvillea* magnified.
(From Lubbock, after Allman.)

(Podocoryne), or the tentacles may be reduced to mere knobs (*Hydractinia*, Fig. 22, *b*) or absent (*Eudendrium*). The mouth is very small or absent. There seems to be no reason to deny the name *blastostyle* to the elongated tubes which spring from the hydroid of *Tubularia*, each of which buds numerous medusoids (Fig. 24, *b*). The *blastostyle* may spring from the *hydrorhiza* (*Podocoryne*), from the *hydrocaulus* (most *Eudendrium*), or from the hydroid (*Tubularia*).

A *false blastostyle* (Allman, 1; Weismann, 10) is formed by the

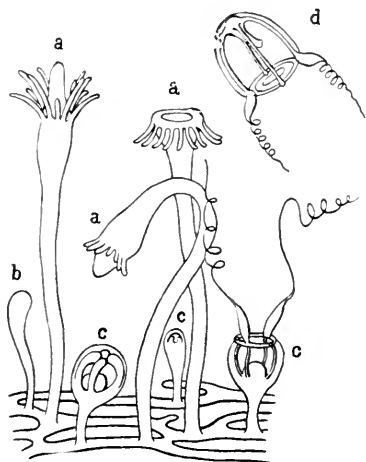

FIG. 20.

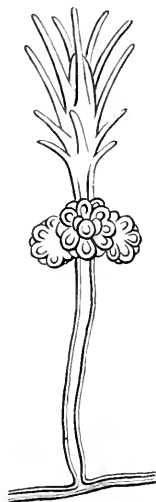

FIG. 21.

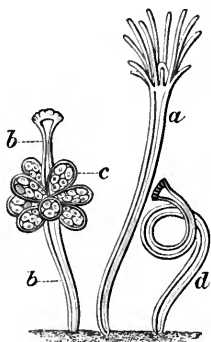

FIG. 22.

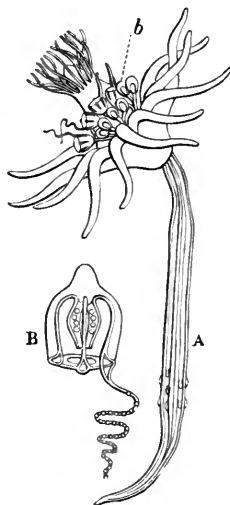

FIG. 23.

20.—Part of colony of *Perigonimus*; the thin perisarc not shown. The zooids spring from a hydrorhiza. *a*, hydroids in different phases of expansion; *b*, developing hydroid; *c*, stages in development of medusoid; *d*, free medusoid. (After Allman.)

21.—Diagram of *Clava*, showing a hydroid surrounded by a verticil of degenerate medusiform persons (sporosacs). (After Allman.)

22.—Diagram of *Hydractinia*, showing four forms of persons. *a*, hydroid; *b*, modified hydroid, or blastostyle, bearing *c*, degenerate medusiform persons or sporosacs; *d*, modified hydroid situated at the margin of the colony (dactylozooid). (After Allman.)

23.—Diagram of *Corymorpha*, a hydroid with a double circle of tentacles. *A*, the hydroid; *b*, medusoids, budded on its disc. *B*, the free medusoid, with one tentacle; the generative cells are indicated in the wall of the manubrium. (After Allman.)

absorption of the tentacles and the diminution in length of an ordinary hydroid which has begun to bud medusoids (Eudendrium).

A *dactylozoid* is a hydroid which exhibits modifications correlated with its special functions of catching prey. It is elongated, and capable of very active movements, and is either devoid of tentacles (Podocoryne), or provided with short knobs highly charged with nematocysts (Hydractinia, Fig. 22, *d*). The *cnidophore* of Eudendrium racemosum appears to belong to the category of dactylozooids, from which it differs merely in growing from the body of a hydroid, and not from the hydrorhiza (Weismann, 10).

The MEDUSOID (Fig. 25) is generally conical or hemispherical, in contrast to the next order; the *velum* is broad and muscular. The *manubrium* is generally circular; the mouth is sometimes surrounded by four perradial lobes (Tiara) or four simple or branching capitate "oral tentacles" (Bougainvillea). The marginal *tentacles* are rarely rudimentary (Amalthea); when present they are generally

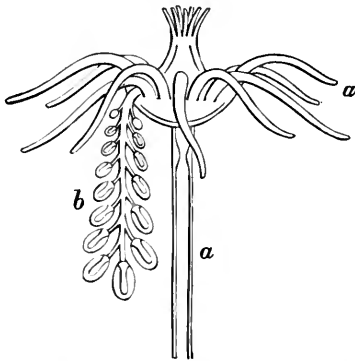

FIG. 24.—Diagram of *Tubularia*. *b*, degenerate medusoids budded from a blastostyle. (After Allman.)

hollow; they number one (Corymorpha), two (Perigonimus), or six (Clavatella), but are generally only four in number and placed at the ends of the perradial canals. Interradial tentacles may also be present (Podocoryne), or very numerous tentacles arranged in four perradial groups (Bougainvillea); even hundreds may be present (Callitiara), arranged apparently without reference to special radii. Their bases are generally surrounded by a thickened bulb of ectoderm, containing sensory cells and numerous cnidoblasts.

The *sense organs* of the Anthomedusae are *ocelli*. These consist either of a few pigment cells, hardly grouped into an organ (Euphysa), or of pigment cells grouped into a definite retina, which possesses (Lizzia, Fig. 11) or lacks (Sarsia) a lens.

They are placed on the bulb of the tentacle, and are generally on its exumbrel face, but are on the subumbrel face in genera which normally carry their tentacles reflexed (Lizzia).

The *gastric cavity* generally lies in the bell, but may be situated at the root of the manubrium (Lar). It often exhibits a prolongation upwards into the substance of the mesogloea of the exumbrella, a relic of the endoderm of the coenosarcal tube by

which its coelenteron originally communicated with that of the colony from which it was budded.

The *radial canals* are generally four in number, and are then perradial; but four interradial canals are also developed in some cases (*Cladonema*). Six are normally presented by *Clavatella* (= *Eleutheria*). In *Lar* (= *Willsia*) six are also present, which bifurcate twice; there are thus twenty-four openings into the circular canal.

The generative cells (gonads) lie in the wall of the manubrium, between the ectoderm and the mesogloea, or in the ectoderm itself; they rarely reach on to the subumbrella (*Nemopsis*). They are

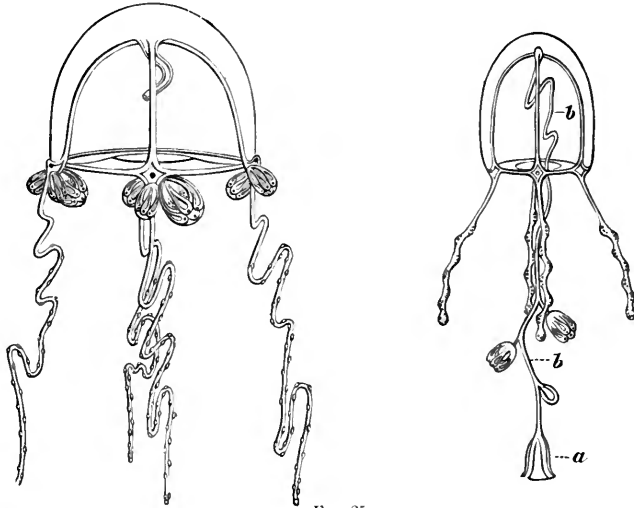

FIG. 25.

Diagrams of the medusoids of two species of "*Sarsia*," the one budding medusoids from the manubrium, the other from the ends of the radial canals. (After Allman.)

cylindrically arranged (*Sarsia*), or are broken up into four or eight bands. In *Lar* they are six in number, and lie on the walls of the six-rayed gastric cavity in the manubrium. The sexes are separate.

FORMATION OF THE MEDUSOID BY GEMMATION.—A medusoid of the type indicated above is either budded (*a*) from a hydroid (*Syncoryne*), or from a blastostyle (*Tubularia*), or from the hydrocaulus (*Bougainvillea*), or, with the intermediation of a short stem, from the hydrorhiza (most *Perigonimus*), or (*b*) from a medusoid (*Sarsia*), either from the manubrium (Fig. 25), or from the margin of the bell, at the end of the perradial canals (*Codonium*). Although in many cases medusoids have not been traced to hydroids, no medusoid of this group has been found to develop directly from the ovum.

If, as seems probable, the product of the fertilised ovum of the Anthomedusae is always a hydroid, there is an invariable alternation of an asexual generation (the hydroid) with a sexual generation (the medusoid); this alternation of generations, or metagenesis (Brooks, 14), is not disturbed by the fact that the sexual generation may in a few cases reproduce asexually (Sarsia).

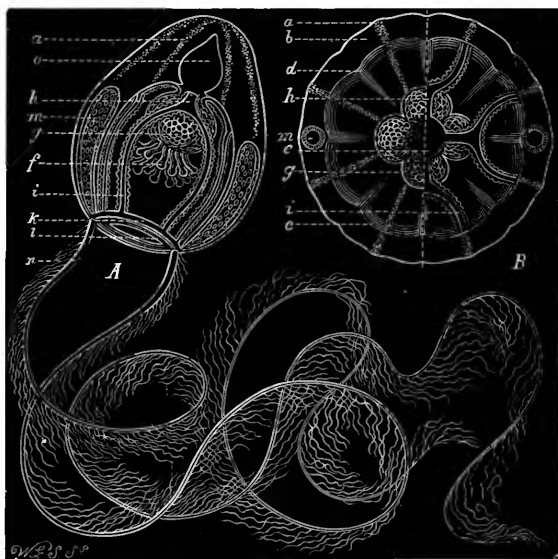

FIG. 26.

Ctenaria Ctenophora (Haeckel), one of the Anthomedusae, presenting a curious resemblance to the *Ctenophora*. *A*, lateral view of the entire medusa; *B*, two horizontal views, that to the left representing the surface of the aboral hemisphere, that to the right a section passing nearly equatorially. *a*, the eight adradial rows of thread cells, corresponding in position to the eight ctenophoral zones of Pleurobrachia; *b*, jelly of the umbrella; *c*, circular muscle of the subumbrella; *d*, longitudinal muscles of the subumbrella; *e*, stomachal dilatation of the enteric cavity; *f*, the sixteen oral tentacles; *g*, the four perradial generative glands in the stomach wall (manubrium); *h*, the four perradial primary radiating canals; *i*, the eight adradial bifurcations of the preceding; *k*, ring canal in the margin of the umbrella; *l*, velum; *m*, the two lateral tentacle pouches; *n*, the two lateral unilaterally fringed tentacles; *o*, the apical gastric cavity above the stomach. The canal system, with its four primary and eight secondary rami, resembles that of Pleurobrachia. The mouth of the latter may be homologous with the margin of the umbrella of the former, and the mouth of *Ctenaria* homologous with the junction of the so-called funnel of Pleurobrachia with its so-called digestive cavity. This last may be the homologue of the subumbrellar cavity of *Ctenaria*. The apical opening or openings of the funnel of *Ctenophora* suggest the stalk canal of medusae, whilst the agreement between the tentacles and their pouches in *Ctenaria* and Pleurobrachia is complete. Cf. p. 14, *infra*. (After Haeckel.)

The method of formation of a medusoid (Weismann, 10) varies in detail in different genera, but the following account of *Bougainvillea* may be taken as typical. A rapid proliferation of cells at the apex of a simple bud (Fig. 27, I) results in the production of a lens-shaped mass of cells; this sinks below the level of the superficial ectoderm, pressing the endodermal wall in front of it into the shape of a cup. This mass of ectoderm is termed the ento-

codon, and a cavity which appears in its interior is the rudiment of the subumbrellar cavity (Fig. 27, II). It is followed by an invagination of the superficial ectoderm, between which and itself mesogloea is deposited; the wall between the two cavities is the future velum (Fig. 27, III). Growth of the subumbrellar cavity results in an approximation of the endodermal walls of the coelenteron; they ultimately fuse into an endodermal lamella (Fig. 27, IV) except where the circular and radial canals are to lie (Fig. 6). An upgrowth of the manubrium from the floor of the subumbrellar cavity, the formation of the tentacles, and the perforation of

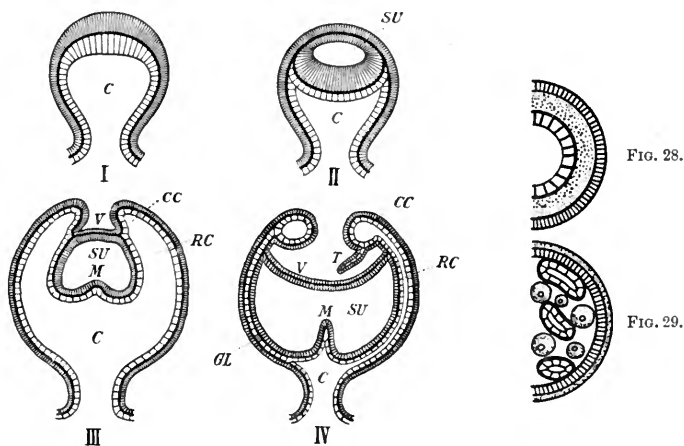

FIG. 27.

27.—Diagrams of sections of four stages in the development of a medusoid by gemmation. I. The original bud of ectoderm, mesogloea, and endoderm. II. The entocodon has been formed; a cavity—the future subumbrellar cavity—has appeared in its interior; it has pressed the endoderm into the shape of a cup. III. The growth of the entocodon inwards is followed by an invagination of ectoderm, the wall between the two is the future velum. IV. The entocodon has formed the subumbrellar cavity, the manubrium projects upwards into it. The thin walls of the bell show a radial canal on the right side (perradial section), and the gastral lamella on the left side (adradial section). A solid tentacle is forming at the base of the radial canal. The thin layer of perisarc has been omitted. *C*, coelenteron; *CC*, circular canal; *GL*, gastral lamella; *M*, manubrium; *RC*, radial canal; *SU*, entocodon = subumbrellar cavity; *T*, tentacle; *V*, velum.

28.—Diagram of half-section of sporosac of male *Endendrium*, showing from without inwards ectoderm, spermatozoa, mesogloea, endoderm lining coelenteron.

29.—Diagram of half-section of sporosac of female *Cordylophora*, showing gelatinous layer, ectoderm, ova lying among coelenteric tubes of mesogloea and endoderm.

velum and manubrium, complete the essential formation of the medusoid; a constricting ingrowth at the attached end results in the separation of the medusoid from the parent.

Medusoids are essentially devoted to the carriage of the generative cells and the dissemination of the species; the latter is achieved by the free-swimming or floating habit of the organism, which is rarely known to creep, temporarily (*Cladonema*) or permanently (*Clavatella*).

POLYMORPHIC MODIFICATIONS OF THE MEDUSOID.—In many cases the gonophore, or bearer of the generative cells, has not the complicated structure of the medusoid, but one far simpler; the simpler conditions are probably not phases in the evolution of a more complex type, but, contrariwise, have been attained by the reduction of the higher organisation. Every stage in this process of simplification is represented among the Anthomedusae, until in Hydra, the final term of the series, nothing remains of the highly organised medusoid except the generative cells. The following types (Weismann, 10) indicate the gradual abandonment of complexity of structure:—

1. The gonophore has the general form of a medusoid, but is never freed. The ocelli are always wanting, the velum and mouth generally, the tentacles sometimes; but the subumbral cavity, the manubrium, and the radial canals are developed (Tubularia). 2. The gonophore is arrested at an early stage in the development of the medusoid, corresponding roughly to Fig. 27, III. The entocodon and subumbral cavity are developed, but the latter never opens to the exterior, and no radial canals are traceable. The manubrium is only slightly indicated (male Clava). 3. The gonophore develops no entocodon. (a) In some cases the endoderm lamella is nevertheless formed, combined with a few immigrant ectoderm cells (Coryne); (b) in other cases the endoderm lamella is not developed, and a section to the centre shows merely ectoderm, generative cells, mesogloea, endoderm lining coelenteron (Fig. 28). This type of gonophore is termed a *sporosac*, and is very commonly found among Anthomedusae. The endodermal core (sometimes termed the *spadix*) may be straight (male Eudendrium, in which the sporosac is ampullated), or may be curved round the generative cells (female Eudendrium), or form anastomosing branches (Cordylophora, Fig. 29). 4. The generative cells are developed in the ectoderm of the body of the hydroid, and no trace of a medusoid is recognisable (Hydra, Fig. 3).

In a few instances a thin and temporary gelatinous capsule invests the gonophore, whether a medusoid (Bougainvillea) or a sporosac (Cordylophora).

ORIGIN OF THE GENERATIVE CELLS.—Approximately parallel to these modifications, and probably correlated with them, is a gradual alteration in position of the spot at which the generative cells are differentiated in various genera; this is apparently attributable to a necessity for the production and maturation of these cells as early as possible, and may be termed a process of acceleration. In the medusoid the generative cells are both formed, and ripen, in the manubrium; in the first stage of acceleration they are formed in the entocodon, and ripen in that part of it which ultimately becomes the manubrium (Tubularia). In the second

stage they appear in the bud of the gonophore at an early phase of its development; in the female Podocoryne, for instance, they have been first noticed in the endoderm of the bud, and migrate into the ectoderm of the manubrium through the mesogloea; in Coryne, where no entocodon is formed, they both appear and ripen in the endoderm of the sporosac. In the third stage they first appear in the tissues of the hydroid, blastostyle, coenosarc, or hydrorhiza, from which the gonophore will ultimately be budded; in Hydractinia, for example, they are first noticeable in the ectoderm of the blastostyle (Collcutt, 26), and migrate along the endoderm into the sporosac, breaking through the mesogloea to ripen in the ectoderm. In the female Eudendrium racemosum their wanderings are still more complex. They are formed in the ectoderm of a main hydroid, migrate into the ectoderm of a lateral hydroid, thence into the endoderm, first of the blastostyle, then of the sporosac, and ultimately break through into the ectoderm of the sporosac. Although in many cases the generative cells are only recognisable for the first time in the endoderm, it is probable that they are in all cases originally ectodermal cells, which may or may not migrate into the endoderm; in almost every instance they ripen in the ectoderm. The whole question is dealt with by Weismann (10).

There is thus evidence that a marked change is in progress among the Anthomedusae; the alternation of the fixed nutritive hydroid with the sexual free-swimming medusoid is being gradually abandoned; the medusoid, the function of which was to form, ripen, and disseminate the generative cells, is being replaced by the sporosac, in which they merely ripen; their formation is becoming a function of the colony or of the hydroid. Curiously enough, in one genus, Dicoryne, which forms sporosacs of the simplest type on a blastostyle, there occurs an apparent reversion to the old method of dispersal of the species, for the sporosac becomes constricted off from the blastostyle, and swims freely by means of strong cilia (Allman, 1).

ASEXUAL REPRODUCTION. — In *gemmation*, which is the rule among hydroids, both ectoderm and endoderm form a hollow lateral protrusion of the body or coenosarc; this absorbs a window in the perisarc where necessary, and either by the development of mouth and tentacles becomes a new hydroid, or in the manner already sketched (pp. 18, 19) is converted into a medusoid or a sporosac.

Gemmation from a medusoid appears to be of a similar "laminar" character, and to follow the lines sketched on pp. 18, 19; its product is always a medusoid.

Fission is rare among hydroids; it may be transverse (Protohydra) or longitudinal (Polypodium). It has not been shown to occur among medusoids in this group.

SEXUAL REPRODUCTION.—As a rule the female generative cells (ova) and the male cells (spermatozoa) are formed in different colonies; they sometimes occur on different individuals of the same colony (Dicoryne), or on the same blastostyle (Myriothela); they rarely occur in the same individual (Hydra).

In some cases there is but one *ovum* in each gonophore (Eudendrium); more commonly, one cell at a time, out of many "potential ova," is fertilised and develops, the remainder serving as its food (Tubularia). The *spermatozoa* are always extremely numerous. They escape by rupture of the tissues of the parent, and swim freely in the water. In most medusoids the ova are discharged in the same manner; in most sporosacs and sessile gonophores the ova are fertilised by spermatozoa, which penetrate to them through the tissues. Segmentation of the ovum generally produces a *blastula* (Fig. 1), a larva consisting of a single layer of cells arranged round a central cavity, the *blastocoele*. By karyokinetic cell division fresh cells are budded from the outer layer into the blastocoele, which they ultimately obliterate. This process is the formation of a *diblastula* (gastrula) by delamination (Fig. 2); the outer cells are the future ectoderm, the inner mass will give rise to the endoderm. The ectoderm becomes ciliated, the *diblastula* elongates into the larval form termed a *planula*; at this stage it generally leaves the parent and swims freely in search of an appropriate site. To this it affixes itself, and sends out rooting processes (hydrorhiza). A *coelenteron* becomes excavated in its interior; and the appearance of mouth and tentacles, and the differentiation of cell forms, convert it into a hydroid. In some cases the larva is not freed from the parent till this stage (actinularva of Tubularia). In Hydra the ectoderm of the *diblastula* secretes horny protective coatings, in which it passes a long resting stage at the bottom of a pond; a ciliated *planula* stage does not occur in its history.

In some cases the *planula*, instead of developing mouth and tentacles, grows after fixation into a branching hydrorhiza, and gives origin to hydroids by gemmation (Mitrocoma—Metschnikoff, 13).

ORDER 2. Leptomedusae (*Calyptoblastea*).

DEFINITION.—Hydromedusae with a regular alternation (metagenesis) of a sterile hydroid generation with a sexual generation of medusoids or other gonophores. The perisarc typically forms hydrothecae into which the hydroids are completely retractile, and rigid permanent gonothecae which completely envelop the blastostyles and gonophores. The chief sense organs of the medusoids are ocelli and otocysts; the otoliths are the products of ectoderm cells. The generative organs lie on the radial canals.

The HYDROID is generally colonial, and has a trumpet-shaped *hypostome*. The *tentacles* form a single circlet; they have a solid endodermal axis, and are filiform; they are rarely webbed (*Campanularia flexuosa*). The *hydrorhiza* is generally well developed and gives origin to simple (*Lafoea*) or branching (*Obelia*) hydrocauli. The tubes of the *hydrocaulus* are generally distinct from one another (monosiphonic); but several hydrocauli, each bearing hydroids or branches, may be closely bound into a compound or polysiphonic stem with greater or less confluence of the ectoderm (*Aglaophenia*). The hydrocaulus may be strengthened by the apposition of a second hydrocaulus which bears no hydroids, the perisarc of the two being continuous, except for occasional points at which the ectoderm of the two becomes confluent (*Anisicola halecioides*—Jickeli, 31).

Very exceptionally, numerous hydrocauli may be clustered round a central hydrocaulus; of these the central one gives origin to the hydroids and to the smaller branches; the accessory ones communicate occasionally with each other and with the central one, and give origin to the nematophores (*Plumularia procumbens*). A still more complex and unique condition, but one apparently deducible from the last instance, is presented by *Clathrozoön*; the accessory hydrocauli, surrounded by perisarc, anastomose so freely that each stem appears to be made up of a mass of irregularly branching tubes, several of which communicate with the coelenteron of each hydroid. This arrangement at first sight suggests an Alcyonarian or a perforate Madreporarian rather than a Hydromedusan (Spencer, 32).

A *perisarc* is always present as a complete investment of *hydrorhiza* and hydrocaulus; it generally has the same substance and structure as in Anthomedusae. It almost invariably expands at the base of each hydroid as a rigid *hydrotheca*, of variable form in different genera, into which the entire hydroid can withdraw itself (Figs. 30, 31); this is occasionally absent (*Campanopsis*).

The edge of the hydrotheca is often toothed; on the retraction of the hydroid, these teeth may fold inwards to form a conical operculum which closes the orifice of the hydrotheca (*Calycella*). There is sometimes only a single plate serving as operculum (*Diphasia*), or none at all (*Halecium*).

The hydrocaulus may carry only one hydrotheca (*Clytia*); more commonly it bears a large number; it may give off branches (*rami*, *pinnae*), on which the hydroids are borne; or the *rami* may bear branchlets (*ramuli*, *hydrocladia*) to which the hydroids are limited. Hydroids are occasionally borne on a blastostyle which carries also a medusoid (female *Halecium*).

The hydroids and hydrotheca are often confined to one plane on the branch, lying either on one side only of the hydrocaulus

(Plumularia), or both sides; in the latter case, the hydroids lie in pairs, right and left, opposite to one another (Diphasia), or lie singly, alternating on right and left sides (Obelia). They are stalked (Obelia), or sessile on the hydrocaulus (Plumularia). The perisarc of hydrocaulus and hydrotheca may be either smooth or annulated. While in the Anthomedusae the topmost hydroid of a stem or branch is the oldest, and buds the remainder of the hydroids (or branches) laterally, in the Leptomedusae the formation of new hydroids takes place at the apex of each branch, and the topmost hydroid is therefore the youngest.

POLYMORPHIC MODIFICATIONS OF THE HYDROID.—A *blastostyle* is very commonly developed, which is devoid of mouth and tentacles; the ectoderm at its apex is generally thickened into a special organ, the opercular plate (Figs. 35, 36). Dactylozooids are represented in this group by the *nematophores* (machopolyps), specially modified hydroids provided with hydrothecae (Fig. 30). They are occasionally much elongated and capitate, growing out for some distance from hydrocaulus and hydrorhiza (Ophiodes); but more commonly they are short and nearly sessile. In many cases two are placed above each hydroid, and one below it (Aglaophenia, Fig. 31); sometimes they are scattered without symmetrical reference to the hydroids (Plumularia), and are often specially concentrated round the gonophores (Aglaophenia). They are tentacle-like, with a solid endodermal axis, and are generally provided with a capitulum of cnidoblasts (Plumularia); but in some cases the cnidoblasts are replaced by cells which secrete adhesive globules. When both cnidoblasts and adhesive globules occur in the same species, only the nematophores with cnidoblasts are advanced when the colony is disturbed; when undisturbed only those which form adhesive globules are protruded (von Lendenfeld, 33; Wagner, 29).

The **MEDUSOID** (Figs. 32, 33) is generally much flatter than in the Anthomedusae, its bell less rigid, and its *velum* smaller and weaker. The *manubrium* is generally short, rarely absent (Staurostoma); the *mouth* is usually four-lobed, but very numerous accessory lobes are sometimes developed (Polycanna).

The *marginal tentacles* are as a rule hollow, rarely solid (Obelia). There may be but two of them (Dissonema); generally they are four in number, and perradial in position, or become eight in number on the addition of four interradial tentacles (Eucope). They may increase in number with radial regularity until they amount to hundreds (Aequorea). Their bases are usually expanded into a bulb like those of Anthomedusae.

Among the marginal tentacles are placed in many cases *marginal cirrhi*, which are shorter than the tentacles, and have a solid endodermal axis (Laodice). They are highly contractile, often coiled spirally, and provided with a terminal battery of

cnidoblasts. On the outer edge of the bell are also found in some

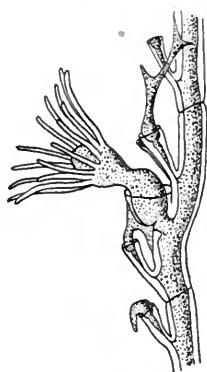

FIG. 30.

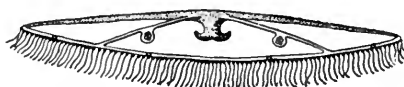

FIG. 32.



FIG. 31.

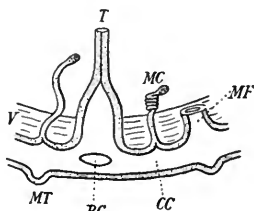

FIG. 34.

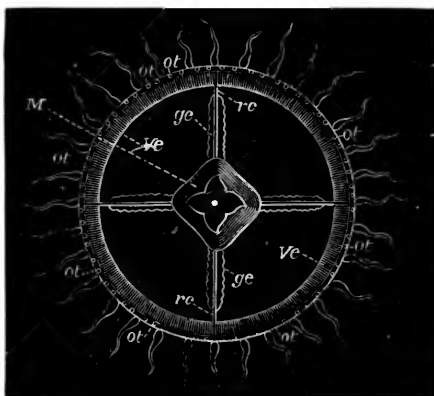

FIG. 33.

30.—Small portion of a hydrocladium of a Plumularian hydroid. Between two annulations of the hydrocladium lie (a) a hydroid projecting from its hydrotheca; (b) above it two lateral nematophores (modified hydroids), one of which is expanded; (c) below it a single median nematophore, also expanded, and spreading over the hydrotheca. (After Allman.)

31.—Perisarc of a small portion of a hydrocladium of *Aglaophenia flicula*, viewed at right angles to the plane of Fig. 30, showing between each two annulations of the hydrocladium, one hydrotheca, two lateral and one median semitubular thecae for nematophores. (After Allman.)

32.—Diagram of the flattened medusoid of *Obelia*, showing two of the four perradial canals with the pendent gonads, four of the eight adradial otocysts.

33.—View of the oral surface of one of the Leptomedusae (*Irene pellucida*, Haeckel), to show the numerous tentacles and the otocysts. *ge*, genital glands; *M*, manubrium; *ot*, otocysts; *rc*, the four radiating canals; *Ve*, the velum. (From Lankester.)

34.—Part of the edge of the bell of a Leptomedusan. *CC*, circular canal; *MC*, marginal cirrus; *MF*, marginal funnel; *MT*, marginal tubercle; *RC*, opening of radial into circular canal; *T*, tentacle (cut short); *V*, velum. (Modified from Haeckel.)

genera *marginal tubercles*, slight prominences on the body wall, generally containing a prolongation of the coelenteron, often

pigmented and provided with cnidoblasts (Octorchis). They are often placed opposite to the *marginal funnels* (subumbral papillae), which lie on the subumbral surface above the velum; these are conical prominences with an excretory pore at the apex, through which fluid has been seen to be ejected from the circular canal (Octorchis). These three structures are shown in Fig. 34.

The *sense organs* are ocelli, otocysts (marginal vesicles), and cordyli (marginal clubs); their arrangement has been utilised for purposes of classification.

The *ocelli* are generally placed on the tentacle bulbs, but may occur also at the bases of the marginal cirrhi, or of the cordyli; they may be dotted, in number several hundreds, along the margin of the bell (Orchistoma). They are rarely provided with a lens.

The *otocysts* are placed at the base of the velum; they are at least eight in number, and are then adradial in position (Obelia). They are often numerous, and may be reckoned by hundreds (Polycanna). The *cordyli* are indefinitely scattered, and are generally numerous.

The *gastric cavity* is simple, and is excavated in the bell. The *radial canals* are often four in number, and perradial in position (Eucope); to these four interradial canals may be added (Melicertum); fresh canals may be added till the number amounts to about 200 (Orchistoma). The canals occasionally branch after leaving the gastric cavity; in this case only the perradial canals may reach the circular canal, the branches ending blindly (Staurodiscus); or the branches also may open into the circular canal (Berenice).

The *generative cells* in the medusoid lie on the subumbral wall of the radial canals, rarely reaching back to the gastric cavity or on to the manubrium. They form either one central, or two lateral flat bands along the course of the canal (Fig. 33); or in many cases lie in special pouches on the canals (Fig. 32). They occur on the four perradial canals, or on both perradial and interradial canals; in species with branching radial canals they may lie on the branches also. As in the Anthomedusae, they are placed between the ectoderm and the mesogloea, or in the ectoderm itself. The sexes are separate.

The method of FORMATION OF THE MEDUSOID is of the type already described in Anthomedusae. The medusoid may be budded from the hydrocaulus (Campanulina) or, more commonly, from a blastostyle. Although even fewer medusoids have been traced to their hydroids in this group than in the Anthomedusae, no medusoid has been observed to develop directly from the ovum, and it is probable that a regular alternation of generations or metagenesis is the invariable rule.

POLYMORPHIC MODIFICATIONS OF THE MEDUSOID.—The simpli-

fication of the gonophore, the reduction of the high organisation of the free-swimming medusoid, is as noticeable in the Leptomedusae as in the Anthomedusae.

1. The gonophore retains certain medusoid structures, such as the radial and circular canals and the tentacles, but the mouth is never perforated, and the organism never freed (Gonothyraea). In this, and in many far simpler gonophores of the Leptomedusae, the ectoderm of the blastostyle is multilaminar; the inner layer gives rise to the entocodon and the exumbrial ectoderm of the gonophore; the outer layers, separated from the inner by a space, form a more or less complete sheath of the gonophores, and appear also as irregular strands (*gubernaculum*, Fig. 36) between the blastostyle and the perisarc of the gonotheca. 2. The gonophore develops entocodon, manubrium, and radial canals, but is devoid of velum and tentacles (? *Laomedea repens*). 3. The gonophore develops no entocodon; the ectoderm is multilaminar; traces of an endoderm lamella are indicated (female *Sertularia pumila*), or are entirely absent (*Aglaophenia*). 4. No trace of the gonophore remains; the generative cells are borne directly on the blastostyle (male *Sertularella polyzonias*).

In these simplified gonophores the generative cells frequently lie in the manubrium, as in the Anthomedusae, but not in the position of the radial canals, as is the case with the free-swimming medusoids of this group. The gonophore or the blastostyle may grow directly from the hydrocaulus (*Campanulina*); most commonly they arise from the axil between a hydrotheca and the hydrocaulus or hydrocladium (*Halecium*), or in the centre of a hydrocladium (*Aglaophenia*). They may spring directly from the hydrorhiza (*Coppinia*).

THE GONOTHECA AND PHYLACTOCARP.—In most cases the gonophore, or the blastostyle and gonophore, are enclosed in a rigid, horny capsule, continuous with the perisarc, and termed the *gonotheca* (Fig. 35). This is generally oval, or shaped like a flask or an amphora; and is either smooth (*Obelia*), spinose (*Plumularia*), or annulated (*Campanularia*). It encloses either a medusoid (*Campanulina*), or a blastostyle carrying medusoids (*Obelia*), or a sporosac (male *Halecium*), or a blastostyle carrying sporosacs (male *Plumularia*). It is frequently provided with a hinged operculum (*Plumularia*).

The modifications connected with the gonophore and gonotheca vary greatly in different genera and species, and even in different sexes of the same species; only a few of their types can be sketched here.

1. In *Gonothyraea*, as already mentioned, a hardly disguised medusoid is developed; each gonophore, when nearly mature, migrates up the blastostyle and projects beyond the mouth of the

gonotheca, seated upon a peduncle continuous with the opercular plate. This type of gonophore has been termed a *meconidium*.

2. In *Calycella lacerata* a blastostyle and gonophore at first lie inside a gonotheca of the usual type; the gonophore when nearly mature migrates up the blastostyle, and projecting beyond the mouth of the gonotheca, secretes a spherical gelatinous cyst, the *acrocyst*, in which it completes the maturation of the generative cells. In *Sertularia pumila* the gonophore, having formed the acrocyst as above described, withdraws again into the gonangium, leaving the ova behind to develop (Fig. 36).

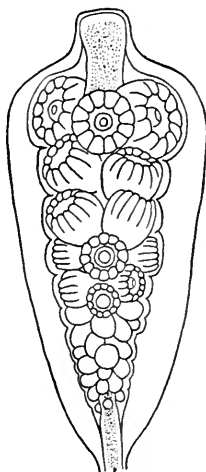

FIG. 35.

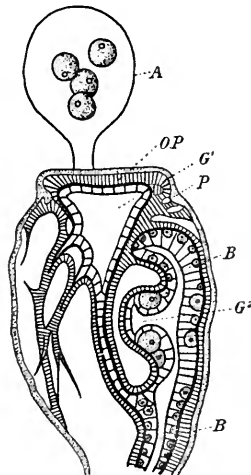

FIG. 36.

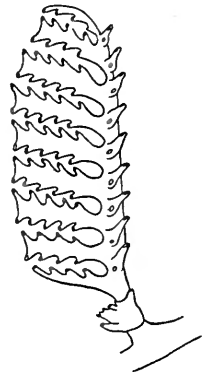

FIG. 37.

35.—Gonotheca of *Obelia*. From the central blastostyle are budded numerous gonophores, each of which becomes a free-swimming medusoid. (After Allman.)

36.—Diagrammatic section of the gonophore of *Sertularia pumila*. *A*, the acrocyst, containing ova; *B*, coelenteron of the blastostyle; *G*¹, the first gonophore (sporocyst), which has formed, and retired from, the acrocyst, connected with the perisarc on the left by strands of tissue (gubernacula); *G*², the second gonophore at an early stage of formation on the blastostyle; *OP*, opercular plate, an expansion at the distal end of the first gonophore; *P*, perisarc of the gonotheca. (After Weismann.)

37.—Phylactocarp (corbula) of *Aglaophenia attenuata*, side view. At the point of origin of the phylactocarp from the hydrocladium is a hydrotheca with the usual three nematophores; the phylactocarp itself is composed of ribs carrying numerous nematophores; the ribs figured arch over to meet those of the other side, and cover the gonophores (not shown in the figure). (After Allman.)

3. In *Sertularia rosacea*, in which the gonophore is also borne on a blastostyle, the opercular plate sends out eight hollow arms, consisting of the usual body layers; these, projecting outwards beyond the mouth of the gonotheca, secrete eight flat spines which bend inwards to serve as a *marsupium* for the reception and protection of the acrocyst.

4. Another method of protection for the gonophore is found

in the family Plumularidae, where the modification of a hydrocladium results in the formation of a special organ termed the *phylactocarp*, the complexity and completeness of which vary greatly in different genera and species. (a) All the hydroids of a hydrocladium may be suppressed and replaced by gonophores (or blastostyles), which are guarded by the usual median and lateral nematophores (*Lytocarpus*). (b) The hydroids, instead of being sessile in the centre of the axis of the hydrocladium, project laterally outwards, their central position being occupied by the gonophores; the peduncles on which the hydroids project are produced each into a long rib (homologous, according to Allman, with an elongated median nematophore), which bears numerous lateral nematophores. These ribs arch slightly over the gonophores (*Acanthocladium*). (c) All the hydroids of the hydrocladium, except one or two nearest to the hydrocaulus, are suppressed; the ribs of nematophores, formed as described under (b), arch completely over the gonophores, forming what is termed an open *corbula* (*Aglaophenia attenuata*, Fig. 37). (d) In a further stage, deducible from the last, the ribs join to form a complete investment of the gonophores, except for one (*Aglaophenia filicula*) or several (*A. Macgillivrayi*) apertures. In this manner the simple hydrocladium becomes converted into a closed corbula.

ORIGIN OF THE GENERATIVE CELLS.—The general description of the origin and migration of the generative cells in Anthomedusae applies also to this group, but the changes there mentioned as affecting the structure and functions of the gonophore, and the acceleration of the formation of the generative cells, are even more marked in the Leptomedusae. In most cases the cells, although in all probability migrants from the ectoderm, are first noticeable in the endoderm; only rarely are they confined throughout to the ectoderm (male *Campanularia*). They may make their first appearance on the manubrium and migrate on to the radial canals of the medusoid, in which case they are probably always ectodermal in position (*Obelia*); or they may appear in the endoderm of the blastostyle (male *Campanularia*), of the hydrocaulus (*Gonothyraea*), or of its lesser branches (female *Campanularia*). When a free-swimming medusoid is not present, they migrate from their place of formation into the gonophore, and generally penetrate through the mesogloea into the ectoderm of the rudimentary manubrium or of the sporosac, as in the Anthomedusae; they rarely ripen in the endoderm (*Sertularella*). For the whole question see Weismann (10).

ASEXUAL REPRODUCTION.—*Gemmation* is of the same laminar character in hydroids of the Leptomedusae as in those of the Anthomedusae. In the gemmation of gonophores from a blastostyle, it frequently happens that the ectoderm is multilaminar;

the entocodon and exumbrial ectoderm of the gonophore are then developed from the inner layer, the outer layers remaining as cups or strands of blastostylar ectoderm (Fig. 36) between the gonophore and the perisarc of the gonotheca (*gubernaculum*). Gemmation from a medusoid has rarely been noted (*Thaumantias*—Sars, 36).

Fission in hydroids has occasionally been observed under a curious form; a small piece of coenosarc at the end of a growing branch becomes nipped off from the colony, and gives origin to a hydrorhiza, from which a new colony is produced by gemmation (*Schizocladium*—Allman, 1). In medusoids fission is very rare (*Euclope*—Lang, 34; Brooks, 35).

SEXUAL REPRODUCTION.—The male and female cells are as a rule borne upon separate colonies, but both may occur in different gonophores on the same colony (*Diphasia fallax*). Both have even been recognised in the same gonophore, but in this case the male cells alone come to maturity (*Gonothyraea*). One or more ova may be present in each gonophore; when the potential ova are numerous, one, or one at a time, generally matures at the expense of the rest.

The general outline of development indicated above as occurring in the Anthomedusae holds good also for this group.

ORDER 3. *Trachomedusae*.

DEFINITION.—Hydromedusae in which the medusoid develops directly from the ovum (hypogenesis); no alternation of hydroid and medusoid generation occurs. The chief sense organs are tentaculocysts, with endodermal otoliths, generally enclosed in vesicles. The generative organs lie on the radial canals.

The bell of the MEDUSOID in this group (Figs. 38, 39) is generally hemispherical, with a thick mesogloea (*Geryonia*), but is sometimes thin, and conical or prismatic (*Aglantha*); it is always of firm consistence and is provided with a strong *velum*. The edge of the bell is provided with a special *ring of cnidoblasts*, with the usual *nerve ring*, and in some cases with spiral *marginal cirrhi*, but the marginal tubercles and funnels of the *Leptomedusae* are not represented. Suckers are rarely developed on the edge of the bell (*Pectanthis*).

The primary or perradial *tentacles* are solid, with a cartilaginous endodermal axis; between them are often developed interradially secondary tentacles, which are also solid; both primary and secondary tentacles may be either lost or retained, and replaced or supplemented by tertiary hollow tentacles. The tentacles are tipped by a sucker in a few genera (*Pectanthis*).

In a few cases the perradial tentacles are alone developed, either four (*Liriope*) or six (*Geryonia*) in number. To these may

be added either four (*Sminthonema*) or six (*Geryones*) interradial tentacles. By further additions they may amount to more than a hundred (*Olindias*); in *Pectanthis* they form sixteen bundles.

The tentacles are often arranged in two or more rows in such a manner that some take origin, not from the extreme margin of the bell, but at a little distance from it on the exumbrel surface; the endodermal axis of the tentacle still retains connection with the more central endoderm, by bending inwards through the thick exumbrel mesogloea. This bent axis, together with bands of cnidoblasts, which run from the marginal ring already mentioned to the point of attachment of the tentacle, give rise to the characteristic mantle rivets or *peronia*.

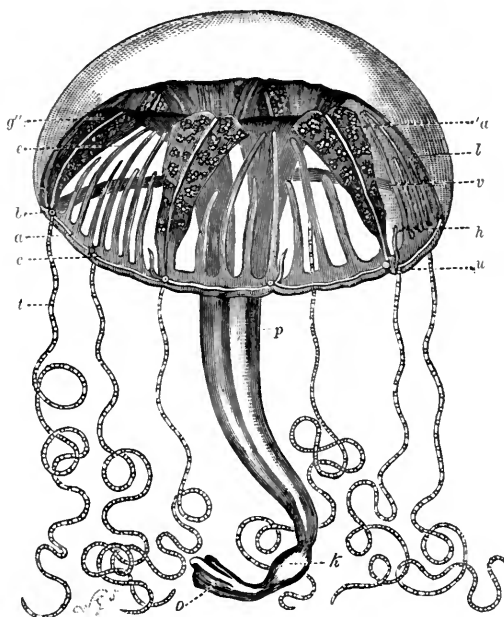

FIG. 38.

Carmarina (Geryonia) hustata (after Haeckel). *a*, nerve and endidoblast ring; *a'*, radial nerve and canal; *b*, tentaculocyst; *c*, circular canal; *e*, blind centripetal canal; *g''*, ovary; *h*, peronium or cartilaginous process ascending from the cartilaginous margin of the disc centripetally in the outer surface of the jelly-like disc; six of these are perradial, six interradial, corresponding to the twelve solid larval tentacles, resembling those of *Cunina*; *l*, dilatation (stomach) of the pseudo-manubrium; *l*, jelly of the disc; *p*, pseudo-manubrium; *t*, tentacle (hollow and tertiary, *i.e.* preceded by six perradial and six interradial solid larval tentacles); *u*, cartilaginous margin of the disc covered by thread cells; *v*, velum. (From Lankester.)

The *musculature* of the bell is of the usual type, except for the great development of radial muscle bands along the course of the radial canals through the subumbrella and pseudo-manubrium.

In two out of the four families into which this group is divided (*Petasiidae*, *Trachynemidae*) the general relations of parts of the medusoid are of the type already familiar (Fig. 5); but in the other two (*Aglauridae*, *Geryonidae*) the *gastric cavity* does not lie in the subumbrella, but is situated at the distal end of the apparent "manubrium"; the latter is really a prolongation of the subumbrella, solid except for the radial canals, and may be termed a *pseudo-manubrium*. The *mouth* is generally surrounded by four

(Aglantha) or six (Geryonia) short perradial lappets; in the Petasidae and Trachynemidae it opens through the short manubrial cavity into the subumbrel gastric cavity; in the Aglauridae and Geryonidae it opens directly into the gastric cavity of the pseudo-manubrium. The *perradial canals* which lead from the

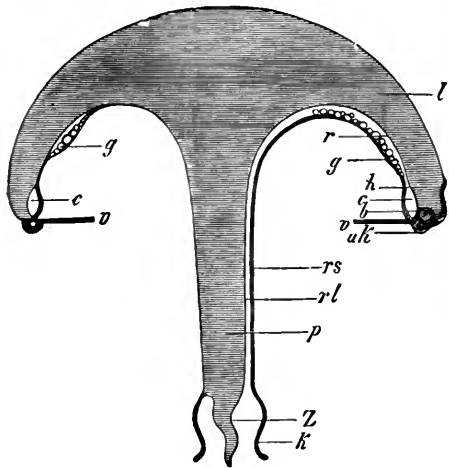

FIG. 39.

Diagrammatic vertical section of *Carmarina hastata*, passing on the right through the whole length of a perradial canal, and on the left through the outspread lobe of an ovary, a lateral extension of a similar canal. *l*, mesogloea of the disc and pseudo-manubrium; *r*, perradial canal; *rs*, its outer, *rl*, its inner wall; *g*, generative cells; *k*, gastric cavity; *Z*, tongue-like process; *h*, peronium; *c*, circular canal; *uk*, cartilaginous marginal ring. (From Lankester, after Gegenbaur.)

(Aglaura). The cells are arranged in bands, which are flat and do not project on the subumbrel surface (Geryonia), or in sacs which depend into the bell cavity from the subumbrella (Aglantha), or from the pseudo-manubrium (Aglaura). In the Pectyllidae the sacs are perradial and interrarial in position, and are each divided into two, and supported by a lamina which passes across the bell cavity from the manubrium to the radial canals (*mesogonia*); these laminae do not appear to have any relation to the mesenteries of Scyphomedusae. The sense organs are ocelli and tentaculocysts. *Ocelli* are comparatively rare in this group; when present they are generally simple pigment specks, and only occasionally possess a lens (Olindias?). The *tentaculocysts* are primarily superficial, four in number, and perradial in position (Petasus). By their displacement and by the intercalation of others there come to be, in many cases, eight (Marmanema) or twelve (Geryonia) nearly perradial and interrarial tentaculocysts, or sixteen adradial (Rhopalonema). In Olindias there are between one and two hundred of

the gastric cavity are four (Liriope) or six (Geryonia); to these *interrarial canals* are often added; both open as usual into a *circular canal*. From the latter, in old specimens of many species, blind *centripetal canals* grow backwards towards the apex of the bell, but never reach the gastric cavity (Geryonia); their number varies, but may amount to twenty-seven between every two radial canals (Olindias).

The *generative cells* are formed on the underside of the radial canals, either in their course through the subumbrella (Geryonia) or through the pseudo-manubrium

these organs. By a secondary growth they become, in many cases, enclosed by an overgrowth of ectoderm, so that they lie in sacs, which either project on the surface (*Trachynema*) or are sunk in the mesogloea (*Geryonia*).

SEXUAL REPRODUCTION.—(No form of asexual reproduction is known among *Trachomedusae*.) The sexes are separate, the product of the fertilised ovum is always a medusoid. Segmentation of the ovum is complete; the endoderm is formed by delamination from the ectoderm. The secretion of mesogloea between ectoderm and endoderm is considerable, except at one pole of the spherical larva, the pole where the mouth is pierced and the tentacles are formed. At this stage the organism presents some resemblance to a hydroid larva, but its conversion to the adult form is achieved by continuous metamorphosis, consisting chiefly in a flattening of its spherical outline and an assumption of the characteristic bell-shape of the adult. The originally simple coelenteron is converted into the canal system of the adult by fusion of the endoderm, except along certain lines, forming an endoderm lamella of the usual type.

ORDER 4. *Narcomedusae*.

DEFINITION.—Hydromedusae in which the medusoid form (with one exception) develops directly from the ovum (hypogenesis); no alternation of hydroid and medusoid generation occurs. The chief sense organs are tentaculocysts with endodermal otoliths, never enclosed in vesicles. The generative organs lie on the subumbra floor of the gastric cavity or gastric pouches.

The bell of the **MEDUSOID** (Figs. 40, 41) is generally flattened, and provided with a strong *velum*; the mesogloea is thick and extremely tough. The bell is furrowed and its edge incised into a series of lappets, by the *peronia*, which, as in the *Trachomedusae*, radiate from the exumbra origins of the tentacles outwards to the circumference, marked by a stripe of cnidoblasts from the marginal ring. The edge of the bell being thus incised, the *marginal nerve ring* and *ring of cnidoblasts* are festooned to a greater or less extent round the lappets, instead of forming the unbroken circle which is generally characteristic of the groups already described.

The four primary *tentacles* are always placed perradially; they are retained throughout life (*Cunantha*), or two of them are dropped (*Aeginella*), or four interradial tentacles are added (*Aegineta*); many forms however develop more (*Solmaris*). They are always solid, and are placed in most cases on the exumbrella at some distance from the margin, their endodermal axis penetrating far into the mesogloea; they retain, however, an endodermal connection with the circular or festoon canal or with the gastric

cavity, and an ectodermal connection of cnidoblasts and sense cells with the two marginal rings, thus forming the characteristic *peronia*. The sense organs are always free *tentaculocysts* at the margin of the bell; they are never closed as in the Trachomedusae; originally they are always four in number and interradial in position; this number may be retained throughout life (Cunantha), but by later additions they may become extremely numerous (Cunina). The otoliths are secreted by one or more endoderm cells in each tentaculocyst; they are generally crystalline, occasionally spherical. Stripes of cnidoblasts, like that of the peronium, which run from their bases up on to the exumbrella, form the characteristic *otoporpa*e. The cavity of the subumbrella is small, when compared with that of previously described groups,

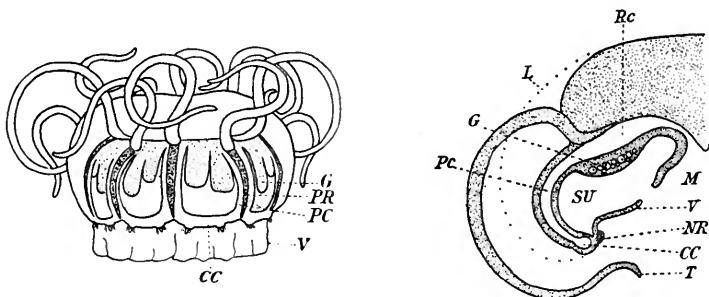

FIG. 40.

FIG. 41.

40.—*Aeginura myosura*, a species with eight tentacles and sixteen tentaculocysts; letters as in Fig. 41. (After Haeckel.)

41.—Half-section of *Cunina*. CC, circular canal; G, gonad; L, dotted outline of lappet; between each pair of lappets lies a peronium and a tentacle; M, mouth; NR, nerve ring; PC, peronial canal; Rc, radial canal; T, tentacle, the root of which penetrates to the radial canal; V, velum. (After Haeckel.)

owing to the great development of the gastric cavity; and its musculature is far weaker.

The COELENTERON in most members of this group differs somewhat from the type already familiar. The *manubrium* is generally absent, the mouth opening directly into the gastric cavity; it is, however, sometimes present, though short (*Cunina*). The *gastric cavity* is large, and occupies almost the whole of the subumbrellar aspect. In the *Cunanthidae*, the *radial canals* are short, broad, and shallow pouches, extending as far only as the base of each tentacle; at this point each canal is split by the peronium into two *peronial canals* which, after a short radial course, turn round the edge of the bell in festoons to form the *circular* or *festoon canal*. In the *Peganthidae* and *Aeginidae* the conditions are much the same as in the *Cunanthidae*, but the radial canals are practically suppressed; the peronial and festoon canals remain. In most members of the Sol-

maridae, the radial, peronial, and festoon canals are suppressed, being represented only by solid cords of endoderm cells.

The arrangement of the generative organs varies considerably; they are always developed from the subumbrel wall of the coelenteron, but may form either a continuous ring (*Solmaris*), or radial pouches (*Cunina*); the radii in which they lie are specifically, not generically, characteristic.

REPRODUCTION.—In some cases the development of the medusoid from the fertilised ovum follows along the lines of a continuous metamorphosis, the diblastula becoming gradually converted into the form of the adult medusa (*Aeginopsis mediterranea*). In *Cunocantha octonaria* the diblastula becomes parasitic on an Anthomedusan (*Turritopsis*); and both it, and buds formed from it, gradually assume the adult form by a continuous metamorphosis. The life-histories of some other forms cannot be said to be as yet fully understood; in *Cunina parasitica* the diblastula is parasitic on *Geryonia hastata*; its buds become Narcomedusae of a somewhat Solmaridan type, but the planula does not itself develop into a medusa; there is thus here an apparent alternation of at least two different generations. In *Cunina proboscidea* a form of asexual reproduction termed sporogony has been described; neutral amoeboid cells, neither ova nor spermatozoa, wander from the generative organs into the endoderm and mesogloea, and develop into medusae (Metschnikoff, 13; Brooks, 14; Maas, 44).

ORDER 5. Hydrocorallinae.

DEFINITION.—Colonial metagenetic Hydromedusae with a calcareous skeleton, into which the gastrozooids and dactylozooids can be retracted. The skeleton is perforated by coenosarcal tubes, on which the gonophores are generally formed.

The Hydrocorallinae (Moseley, 37) are colonial and trimorphic and secrete without exception a massive (*Millepora*) or branching (*Allopora*) calcareous skeleton, the *coenenchyme* (*coenosteum*). The relations of this skeleton are best understood by the conception of a branching and anastomosing hydrorhiza, the ectoderm of which secretes, not a horny perisarc, but calcareous trabeculae which fill all the interspaces between the tubes of soft tissue. The surface of the coenenchyme is either pitted with pores of two or more kinds, *gastropores* and *dactylopores*, into which the gastrozooids and dactylozooids can be withdrawn (*Millepora*, Fig. 42), or is produced into spouts (*Spinipora*) or cups (*Stylaster*) for the same purpose. The pores may be scattered, or may be arranged in definite *systems*, in which the dactylozooids are in lines parallel to, and on each side of, a line of gastrozooids (*Distichopora*), or in circles round the gastrozooids (*Stylaster*), Fig. 43, *b* and *c*. A circular system

(*cyclosystem*) may be protected by a calcareous flange (*Cryptohelia*); in some cases calcareous laminae between the dactylozooids of a cyclosystem simulate the arrangement of septa in an Anthozoan theca (*Allopora*). In branching forms the whole thickness of the branch is often permeated by coenosarcal tubes; in massive forms the living tissues are confined to the circumference, and by secreting plates of coenenchyme behind them as they grow peripherally outwards, give rise to *tabulae* below the zooids. Calcareous brush-like *styles* rise in some instances from the *tabulae* of both gastropores and dactylopores (*Stylaster*), or in the gastropores only

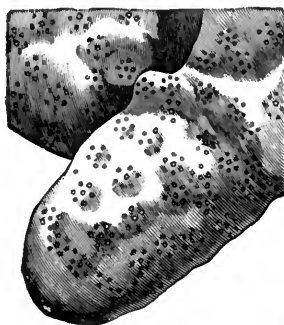

FIG. 42.

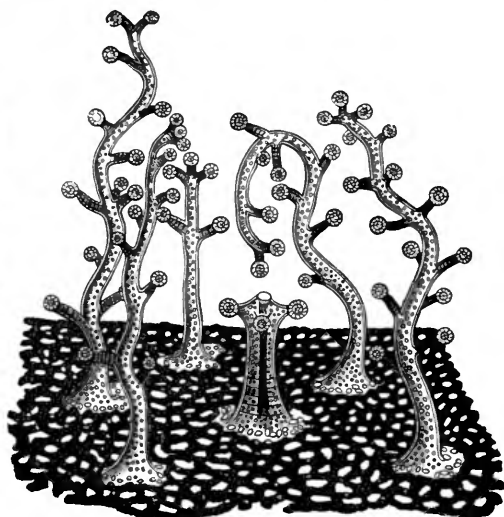

FIG. 43.

42.—Portion of the calcareous corallum of *Millepora nodosa*, showing the cyclical arrangement of the pores occupied by the hydroids. Twice the natural size. (From Moseley.)

43.—Enlarged view of the surface of a living *Millepora*, showing five dactylozooids surrounding a central gastrozooid. (From Moseley.)

(*Distichopora*). Special pits for the reception of the gonophores may occur in the coenenchyme, and are termed *ampullae*.

The *coenosarc* is covered by a superficial sheet of ectoderm which is provided with very large nematocysts. This sheet, which is perhaps composed of two layers, rests partly on spines of the skeleton, partly on the blind ends of the coenosarcal tubes, and in retraction is continued downwards as a lining to the pores; here it becomes continuous with the ectoderm of the zooids, and appears to form a circular operculum over them when retracted completely. Elsewhere than in this sheet, ectoderm, mesogloea, and endoderm bear to one another the relations usual in Hydrozoa.

The hydroids (Fig. 43) are of two kinds. The *gastrozooids*, the

nutritive zooids of the colony, may possess capitate tentacles (*Millepora*), generally four, six, or twelve in number, or may be entirely devoid of tentacles (*Astylus*). The endoderm cells near their mouths are swollen and secretory. The *dactylozooids* are generally devoid of mouths, and either have (*Millepora*) or lack (*Stylaster*) capitate tentacles; their endoderm cells are not enlarged. In some genera two kinds of dactylozooids are distinguishable by size and position (*Spinipora*).

Both forms of hydroid have strong retractor muscles, and

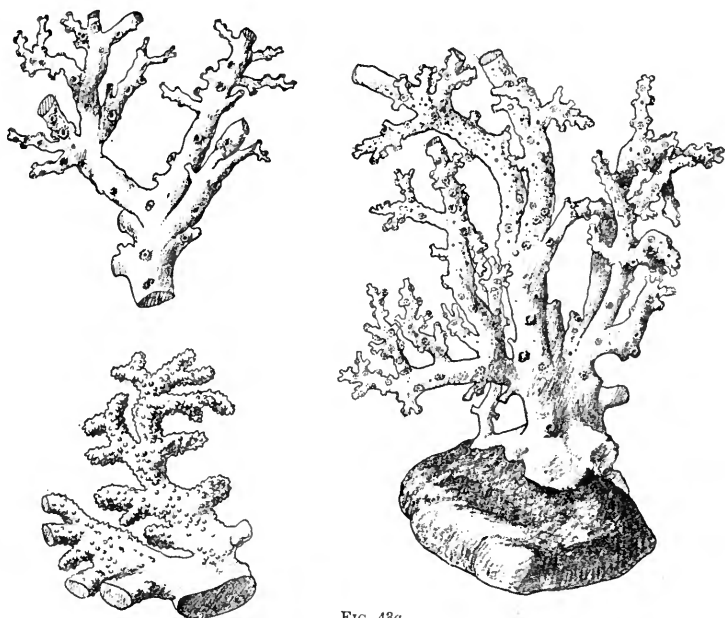

FIG. 43a.

Skeletons of *Allopora* (upper left hand), *Errina* (lower left hand), and *Stylaster* (right hand).

large complex nematocysts; they are composed of the usual body layers, and are connected at their bases with the tubular coenosarc by radiating tubes.

The structure of the *gonophores* (Hickson, 38) varies considerably in different genera, but is apparently in all cases referable to a simplification of the medusoid type, such as has been sketched in *Anthomedusae* (p. 20). The gonophore is not known to be ever freed; it develops neither velum, tentacles, mouth, nor sense organs; a manubrium is not invariably present. In *Millepora Murrayi* the gonophore is formed at the apex of a dactylozooid (cf. *Limnocodium*, *Scyphistoma*), in the other forms hitherto investigated it is formed

on the course of the coenosarcal canals, and often lies in a special pit of the coenenchyme, termed the *ampulla*. An entocodon is not formed in the usual way; instead of this, which is an ectodermal downgrowth to be hollowed out eventually into the subumbrellar cavity, the body wall at the sides of the generative cells grows upwards, and arches over the manubrium to form the same cavity (Millepora). All traces of medusoid structure are lost in some cases (male Distichopora). Radial canals may be entirely absent

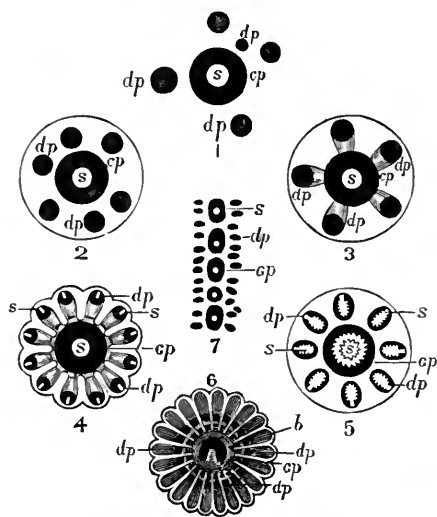

FIG. 43b.

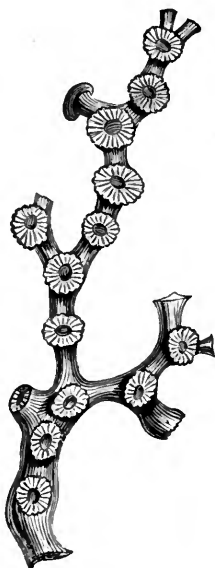

FIG. 43c.

43b.—Diagrams illustrating the successive stages in the development of the cyclosystems of the Stylasteridae. 1, *Sporodopora*; 2, 3, *Allopora*; 4, 5, *Stylaster*; 6, *Astylus subviridis*; 7, *Distichopora coccinea*. s, style; dp, dactylopore; gp, gastropore; b, in fig. 6, inner horseshoe-shaped mouth of gastropore. (After Moseley, from Lankester.)

43c.—Portion of the corallum of *Astylus subviridis* (one of the Stylasteridae), showing cyclosystems placed at intervals on the branches, each with a central gastropore and zone of slit-like dactylopores. (After Moseley, from Lankester.)

(Millepora), or may be present in varying numbers (twelve in female *Distichopora*).

REPRODUCTION.—Asexual gemmation of hydroids is apparently of the usual laminar character. The development of the sexually-produced embryo has not been traced.

ORDER 6. Siphonophora.

DEFINITION.—Colonial free-swimming Hydromedusae with numerous polymorphic modifications of both hydroid and

medusoid, and a metagenetic life-history. Gonophores rarely freed, generally sessile.

The Siphonophora (for the literature of which Haeckel, 39; Chun, 40, 41; and Schneider, 42; should be consulted) are invariably free-swimming, colonial, and polymorphic. Just as the planula in some Anthomedusae does not itself develop into a hydroid, but becomes a budding hydro-rhiza, so in all probability, in this group (a part at least of), the planula is to be regarded as itself giving origin to the coenosarc, and as budding numerous individuals of varying form and function. The composition of the colony is very different in the different families, but is generally a combination of some of the following hydroid or medusoid individuals.

POLYMORPHIC MODIFICATIONS OF THE HYDROID:—

1. The *gastrozooid* (siphon, polypite) has a large mouth, and is provided with nematocysts; at or near its base is usually placed a single *tentacle* (Figs. 44, *e*; 51, *G*). The tentacle is generally extremely long and contractile; it is tubular, and is either itself provided with batteries of nematocysts (Apolesia), or bears a large number of fine lateral threads or *tentilla*, carrying numerous nematocysts (Forskålea). The latter can sometimes be spirally retracted into a protective cup or *involutrum* (Agalmopsis). In some cases no tentacle is developed (Velella). The endoderm of the gastrozooid is generally pigmented, and often projects as villi into the coelenteron.

2. The *dactylozooid* (hydrocyst, palpon) is generally devoid of a mouth, and provided liberally with nematocysts. The *palpacle* or tentacle of the dactylozooid is never branched, and generally grows on or near the base (Figs. 44, *g, h*; 51, *D, T*). No tentacle is developed in some cases (Velella). To such an extent are the

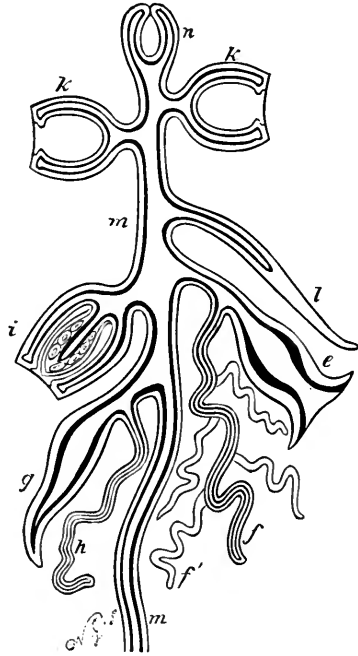

FIG. 44.

44.—Diagram showing possible modifications of medusoids and hydroids of a colony of Siphonophora. *n*, pneumatophore; *k*, nectophores (swimming bells); *l*, hydrophyllium (covering piece); *i*, generative medusoid; *g*, dactylozooid with attached tentacle, *h*; *e*, gastrozooid, with branched grappling tentacle, *f*; *m*, stem or corn. The thick black line represents endoderm, the thinner line ectoderm. (After Allman.)

modifications of polymorphism carried in this group, that it is sometimes impossible to form an opinion as to whether a particular structure is to be regarded as tentacle or dactylozoid.

3. The *blastostyle* (gonostyle, sexual palpon or siphon) which produces sexual medusoids by gemmation, is generally devoid of a mouth, but not invariably (Velella—Fig. 48, *BL*). It develops no tentacles. The blastostyle sometimes branches into a *gonodendron* (Physalia), (Fig. 51).

POLYMORPHIC MODIFICATIONS OF THE MEDUSOID :—

4. The *sexual medusoid* is set free from the colony (♀ Physalia, Velella) or remains fixed (♂ Physalia). It may have the typical structure of the Anthomedusan medusoid (Velella), or may exhibit the various stages of arrest in development already described (p. 20). Even when arrested at an early stage it is sometimes freed, and swims by means of cilia (♂ Forskålea); more often it is a permanently fixed sporosac (♂ Physalia). The medusoid is budded from a blastostyle (Velella, Fig. 48), from the coenosarc (Agalmopsis), or from the pedicle of the gastrozoid (Diphyes, Fig. 47). Most colonies of Siphonophora are hermaphrodite, and in some cases so also are the gonodendra (Physalia); the medusoids are either male or female.

5. The *nectophore* (nectocalyx, nectozoid) is a medusoid devoid of tentacles, manubrium, and mouth, but retaining the characteristic velum, circular, and radial canals (Figs. 44, *k*; 45, *m*; 46, *NN''*). The musculature is well developed. The nectophore has a locomotor function.

6. The *hydrophyllium* (bract, phyllozoid) is a shield-shaped medusoid, of protective function (Figs. 44, *l*; 47, *H*). It consists typically of a somewhat curved plate of thick mesogloea, covered externally by ectoderm, and containing a solid endodermal core (*phyllocyst*). Its medusoid origin may be inferred from a few species in which it retains a structure intermediate between that of medusoid and typical hydrophyllium; in Athoria, for example, its apex is excavated into a rudimentary subumbral cavity with minute circular and radial canals, and four knobs representing rudimentary tentacles.

7. The *pneumatophore*, an apical air sac of hydrostatic function, appears under two quite distinct forms.

(a) In the Physonectae and Cystonectae, it is probably a highly specialised medusoid, the exact homologies of which are obscure (Figs. 44, *n*; 45, *a'*; 49, *PN*). It is formed typically as a swelling at the upper end of the coenosarc, into which in the course of development an entocodon pushes its way. The ectodermal cavity thus produced is distinguishable into two regions—a central part, the air gland, secretes a gas which passes through a pylorus into a distal part, the air sac, lined by a chitinous

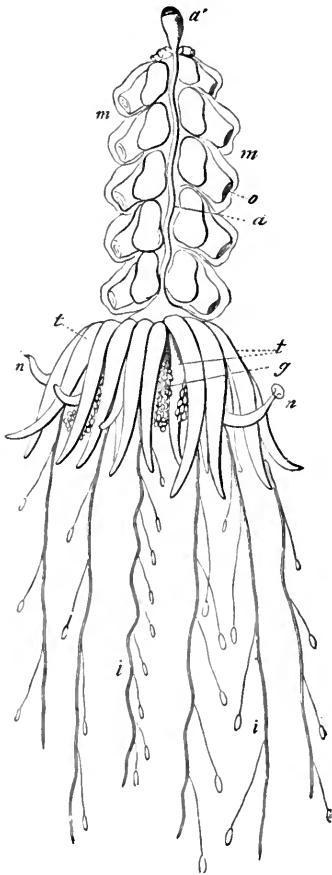

FIG. 45.

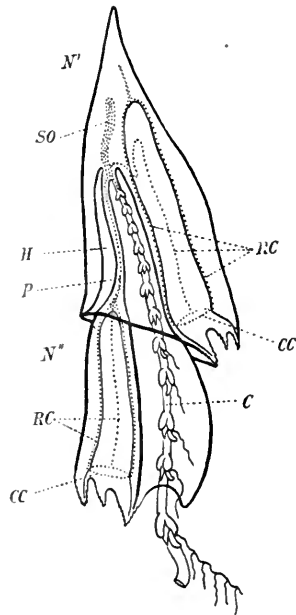

FIG. 46.

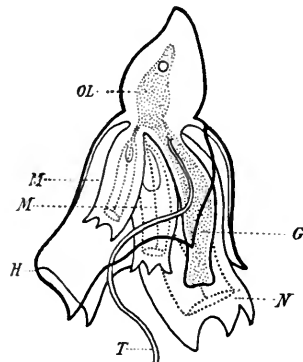

FIG. 47.

45.—*Physophora hydrostatica*. *a*, stem or corn of the colony; *a'*, pneumatophore (air-bladder); *m*, nectophore; *o*, orifice formed by the margin of the umbrella; *t*, hydrophyllia; *n*, gastrozooid; *i*, tentacles; *g*, sporosacs. (From Gegenbaur.)

46.—Diagram of the structure of a Diphyid. *C*, coenosarc carrying cornidia; *CC*, circular canal of nectophore; *H*, hydroecium; *N'*, upper, and *N''*, lower, nectophore; *P*, pedicle of lower nectophore; *RC*, radial canals of nectophore; *SO*, somatocyst. (Modified from Haeckel.)

47.—Diagram of the structure of an Ersaeome (free monogastric generation of a Diphyid). *G*, gastrozooid; *H*, hydrophyllium; *M*, sexual medusoids; *N*, nectophore; *OL*, oleocyst; *T*, tentacle of gastrozooid. (Modified from Haeckel.)

secretion. Between the air gland and the outer wall of the pneumatophore lie in many cases radial pouches and septa of varying number, which perhaps correspond to the radial canals of a medusoid. The air sac may be closed (most Physonectae) or open by a pore to the exterior (most Cystonectae).

(b) In the Disconectae the pneumatophore is at first a single chitinous chamber; round this are added concentrically and in one plane chitinous tubes of varying number, which communicate with each other, and with the central chamber, by pores in their walls, and in some places open also to the exterior. The chitinous plate thus composed may bear a crest or sail, set at right angles to the plane of the plate, but obliquely to its longer axis (Velella), and is covered on all sides by the ectoderm which secretes it. Air tubes or tracheae from the pneumatophore penetrate the centradenia. There is reason for supposing that the pneumatophore even in the Disconectae is derived from a highly modified medusoid (Figs. 48, *PN*; 50).

8. The *aurophore* is perhaps also a highly modified medusoid, characteristic of the Auronectae; it is placed at the side of the pneumatophore, is ovoid in shape, and is traversed by a minute canal which leads from the cavity of the pneumatophore to the exterior. Round this canal lies the *pistillum*, a mass of muscle enveloped in a strong chitinous tube; external to this lie successively ectoderm, mesogloea perforated by branching endodermal tubes, and the superficial ectoderm (Figs. 48*b*, 48*c*). The function and homologies of the aurophore are most obscure (Fewkes, 43).

TYPES OF SIPHONOPHORE COLONIES:—

The polymorphic individuals above described are very differently combined in the different sub-orders of the Siphonophora.

(a) In the Disconectae (Fig. 48) a single gastrozoid is surrounded by numerous blastostyles, and, beyond these, by numerous dactylozoids. They all spring from a mass of coenosarc which underlies the pneumatophore, composed of ectoderm, mesogloea, and ramifying endodermal tubes; the cells of the latter are apparently in some places renal, in others hepatic, in function; the whole structure is termed the *centradenia*, and is perforated by *tracheae*. The coenosarc entirely envelops the pneumatophore, and projects laterally for some distance beyond it; at its edge runs a circular canal.

(b) In the Calyconectae (Figs. 46, 47) no pneumatophore is developed. There are one or two, rarely more, large nectophores, the uppermost of which has on one side either an open groove (Cymbonectes) or a tube closed at the upper end (Diphyes)—the *hydroecium* or infundibulum, lined by ectoderm. From the upper end of this cavity spring both the pedicle of the second nectophore when present, and the long tubular coenosarc (Diphyes, Fig. 46); or the nectophores

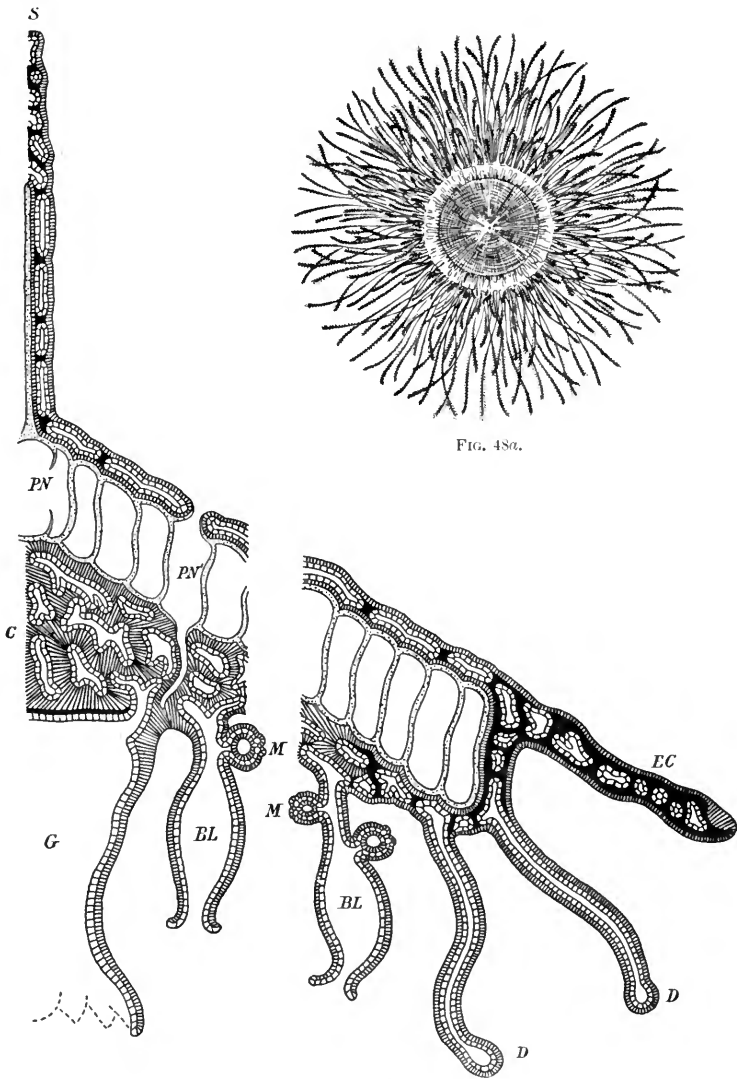

FIG. 48a.

FIG. 48.

48.—Diagram of the structure of *Velella*, showing the central and peripheral thirds of a half-section of the colony, the middle third being omitted. The ectoderm is indicated by close hatching, the endoderm by light hatching, the mesogloea by thick black lines, the horny skeleton of the pneumatophore and sail by dotting. *BL*, blastostyle; *C*, centradenia; *D*, dactylozoid; *EC*, edge of colony, prolonged beyond the pneumatophore; *G*, cavity of the large central gastrozoid; *M*, medusoids attached to blastostyles; *PN*, primary central chamber, and *PN'*, a concentric chamber of the pneumatophore, the former showing the opening into the second chamber, the latter showing an opening to the exterior, and a "trachea"; *S*, sail.

48a.—*Porpita* from the aboral aspect, showing the pneumatophore, and expanded dactylozoids. (After Agassiz.)

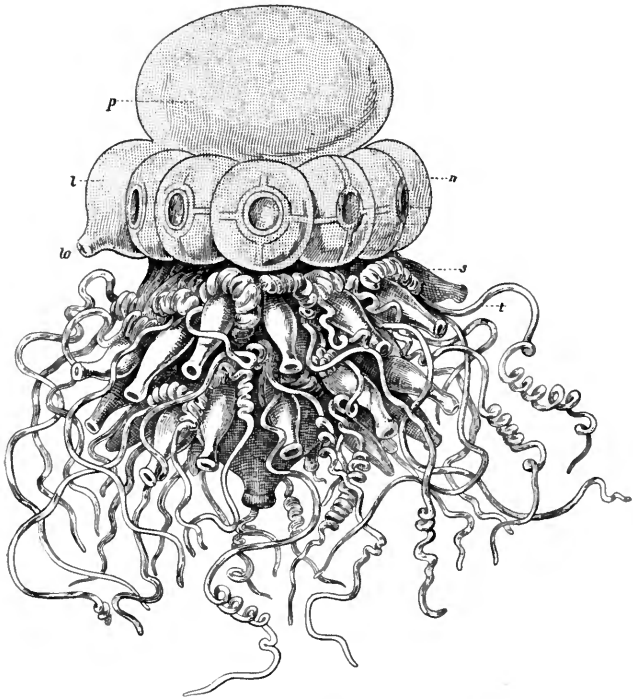

FIG. 48b.—*Stephalia corona*, a young colony. (After Haeckel.)

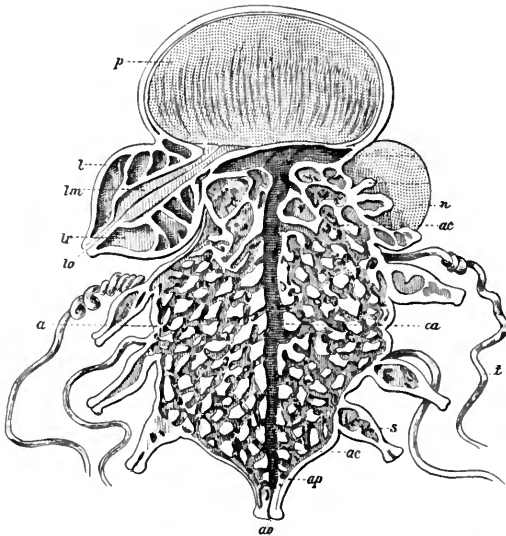

FIG. 48c.—*Stephalia corona*, colony in section. (After Haeckel.) *ao*, mouth of the primary gastrozooid, the cavity of which is continuous with the axial canal (*ca*) and the canal plexus (*ac*) of the colony. The large pneumatophore (*p*) is surrounded by a ring of nectophores (*n*), from among which projects the large aurophore (*l*), from among which projects the large aurophore (*l*), the opening of the aurophore (*lo*) leads through the pistillum (*lm*) into the cavity of the pneumatophore; (*s*), secondary gastrozooids with (*t*) tentacles.

are attached side by side, leaving an incomplete hydroecium between them (Praya); or the hydroecium is altogether absent (Galeolaria). It serves essentially as a protective canal, into which the coenosarc may be withdrawn. The coenosarc is extremely long, tubular, and contractile; its endoderm is continued upwards beyond the hydroecium as the blind *somatocyst* (acrocyst), the upper end of which usually secretes an oil globule, presumably of hydrostatic function (*oleocyst*). The coenosarc carries either a *cormidium*, or numerous cormidia at regular intervals separated by free internodes; they are aggregations of individuals, which may in some cases become freed from the colony. They generally appear under one or other of two main forms—Eudoxomes, which consist typically of hydrophyllium, gastrozoid with tentacle, and one or more medusoid gonophores; or Ersaeomes, in which typically a nectophore is added to the persons which occur in the Eudoxome. In some cases hydrophyllia are absent; in others more than one gastrozoid is present in each cormidium (Apolesia).

(c) In the Physonectae (Fig. 45) the coenosarc is generally long and tubular, and carries at its apex a small pneumatophore; below this generally occur series of nectophores followed by series of hydrophyllia; but either may be developed without the other; these are followed by the cormidia. There may be only a single gastrozoid (Athoria); generally they are numerous. Dactylozooids are generally present, each provided with a simple palpacle; sometimes they have an oral opening, and appear to serve for excretion (*cystons*). The cormidia are generally ordinate, with free internodes, but are rarely scattered irregularly along the stem (Forskålea). Each cormidium is composed typically of a gastrozoid with a branched tentacle, one or more hydrophyllia, blastostyles, gonophores, and cystons.

(d) In the Aurnectae (Figs. 48a, 48b) a small and highly modified sub-order, the coenosarc is short and very thick, and is traversed by anastomosing canals. It is covered above by a large pneumatophore, provided "dorsally" with an aurophore; below this lies a corona of nectophores. The lower part of the coenosarc is covered by cormidia more or less ordinate in arrangement, each consisting primarily of a gastrozoid with tentacle, a branched gonodendron, and a palpon (dactylozoid).

(e) In the Cystonectae (Fig. 49) a large pneumatophore is also developed, but the family is distinguished by the complete absence of nectophores and hydrophyllia. The coenosarc is long and tubular (Rhizophysa), or short and wide (Physalia); in the former case the cormidia are generally ordinate, in the latter they are arranged in a multiple series along the ventral side of the trunk; they consist typically of one or more tentaculate gastrozooids, of gonodendra, and dactylozooids.

REPRODUCTION.—The asexual reproduction of this group is apparently of the usual laminar type: medusoids, nectophores,

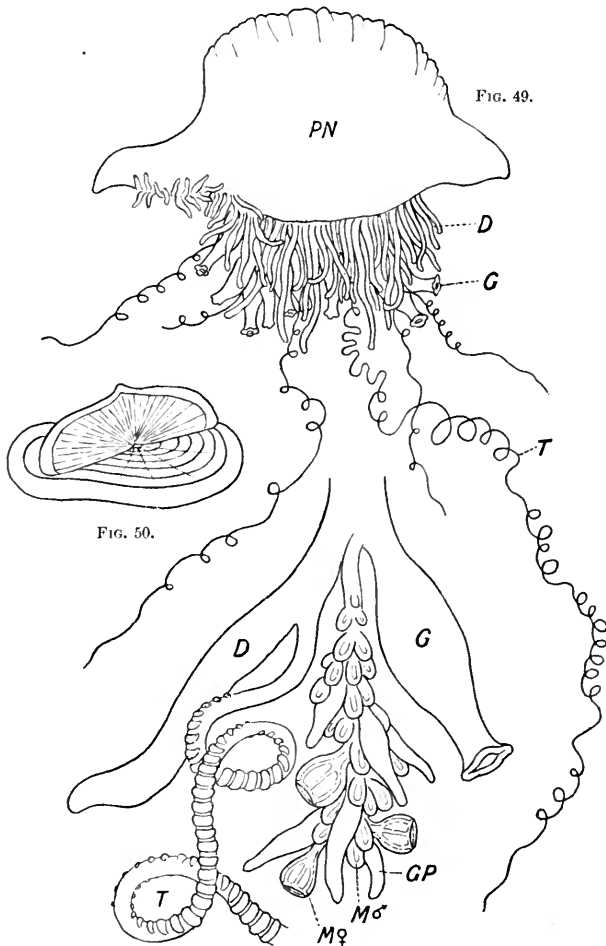

FIG. 50.

FIG. 51.

49.—Diagram of *Physalia* (modified from Cuvier and Haeckel).

50.—Upper surface of *Veella*, showing pneumatophore and sail (after Cuvier).

51.—Cormidium of *Physalia*, with a gonodendron (modified from Haeckel).

D, dactylozooid; *G*, gastrozooid; *GP*, gonopalpon or dactylozooid on the gonodendron; *M♀*, female medusoid, ultimately freed; *M♂*, male sporosac; *PN*, pneumatophore; *T*, tentacle (palpate) of dactylozooid or palpon.

and (sometimes) hydrophyllia are formed after the manner sketched on p. 20. The development of the fertilised ovum is known only

from observations on a few forms which are too widely different to allow of a general developmental scheme being as yet laid down. A planula is apparently always formed; the first individual budded from it may be a pneumatophore (*Halistemma*), nectocalyx (*Epibulia*), or hydrophyllium (*Agalma*). The coenosarc may be a lateral extension of the first gastrozoid (*Cystonectae*), or may be its elongated stem (? *Physophoridae*, *Calyconectae*).

APPENDIX TO HYDROMEDUSAE. No. I.

Limnocodium and Limnocnida.

These are two freshwater medusae, the first-named known only from the Victoria Regia Tank of the Royal Botanic Society in London, the

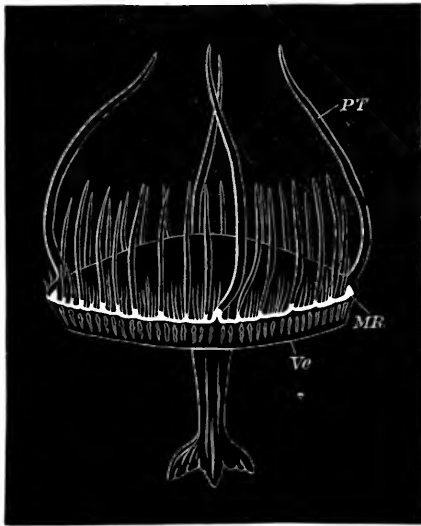

FIG. 52.



FIG. 53.

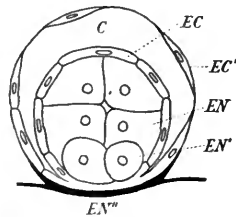

FIG. 54.

52.—*Limnocodium*, as seen floating, $\times 5$. *MR*, marginal nerve and endoblast ring; *Ve*, velum; *PT*, perradial tentacle. (After Lankester.)

53.—Polyps of *Limnocodium* on weed (after A. G. Bourne).

54.—Diagram of the sense organs of *Limnocodium* and *Limnocnida*. *C*, cavity of the vesicle, which in *Limnocodium* is continued as a canal into the velum; *EC*, ectoderm of the sense organ; *EN*, refringent endoderm cells of the sense organ; *EN'*, granular endoderm cells of the sense organ; *EN''*, position of endoderm of the circular canal. (After Lankester and Günther.)

second known only from Lake Tanganyika. They undoubtedly belong to the Hydromedusae, and to different orders of the class, but it is still a matter of difficulty to assign them to any of the existing orders.

Limnocnida (Fig. 55) presents points of resemblance both to Anthomedusae and to Narcomedusae. It shares the manubrial position of its generative organs with both these orders; but in the shortness of the

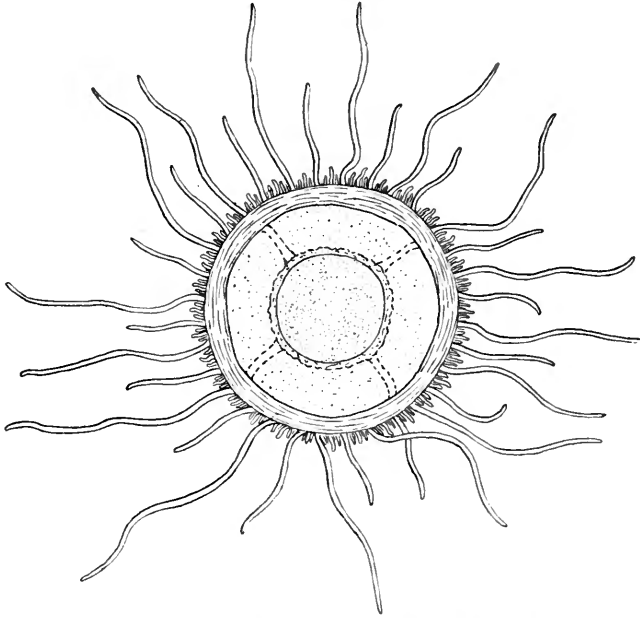

FIG. 55.—Limmocnida from the oral surface (after Günther).

manubrium and shallowness of the gastric cavity, it strangely resembles many Cuninae, and in budding from the manubrium, it approaches the Anthomedusae. No hydroid stage has been observed in its life-history.

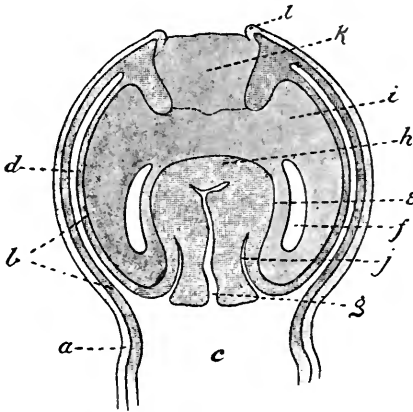

FIG. 55a.—Diagram of the gemmation of the medusoid of *Limmocodium*. *a*, external ectoderm; *b*, endoderm of the radial canals; *c*, coelenteron of the hydroid; *d*, cavity of radial canal; *e*, ectoderm of manubrium; *f*, rudiment of subumbrellar cavity; *g*, cavity of manubrium; *h*, endoderm of manubrium, with blind canals (*i*); *k*, ectoderm of entocodon. (After Fowler.)

Limmocodium, on the other hand, resembles more closely Leptomedusae and Trachomedusae (Figs. 52, 53). Its generative organs, of which the male only have been observed, are placed on the radial canals, as in both these orders; but it has a hydroid stage, a thing not known in any Trachomedusan, known not to occur in many Trachomedusae, and probably universal among Leptomedusae; yet the firm character of the

bell and tentacles suggest Trachomedusan affinities.

The continuation of the tentacles along the exumbrel surface into a "root," which occurs in both of the freshwater genera, although not quite of the character known in Trachomedusae and Narcomedusae, is nevertheless suggestive, and the presence of something corresponding to peronia points in the same direction.

As regards the character of the sense organs, which are of great diagnostic value throughout the class, Limnocodium and Limnocnida agree with each other in possessing similar organs, of a type not known in any other Hydromedusan. These organs (Fig. 54) resemble tentaculocysts in possessing an endodermal axis, but differ from them in position and in not secreting an otolith; they lie each in a closed vesicle lined by ectoderm and surrounded by mesogloea. The vesicle in Limnocnida is situated in the exumbrel nettle-ring at the base of the velum, and in Limnocodium, in the base of the velum itself, into which latter it is continued as a long canal. It may perhaps be eventually shown that a modification of cordyli in one direction has resulted in the production of these organs, in another in the formation of tentaculocysts.

Microhydra and Protohydra.

These two forms of uncertain position need only brief mention. They agree with the hydroid of Limnocodium in the absence of tentacles. While *Microhydra* (Ryder, 24) reproduces by lateral

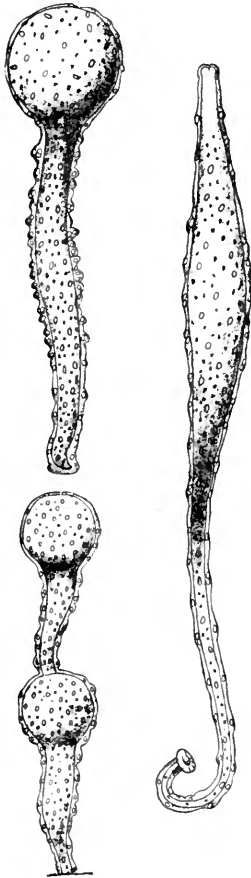

FIG. 55b.

Protohydra Leuckartii, expanded, contracted, and in strobilation (after Greef).

gemmation, *Protohydra* (Greef, 24a) undergoes a process of transverse strobilation.

Tetraplatia (Tetrapteron) volitans.

This remarkable organism (Viguier, 47) of marine habitat has been recorded by four observers only.

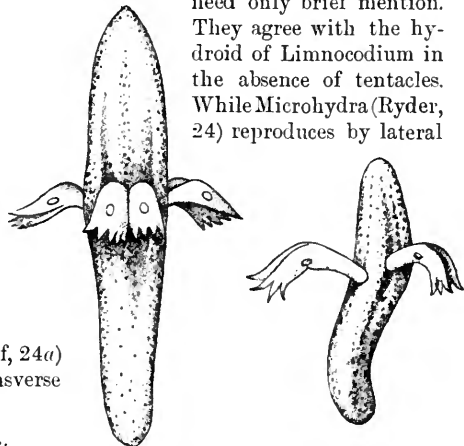

FIG. 55c.

Tetraplatia volitans (after Viguier).

It is of elongate form, with a mouth at the lower pole. In section it is somewhat square for the greater part of its length, but nearly midway between the oral and aboral pole the body is constricted by a groove; at this point the tissues of the four angles of the square section are continued across the constricting groove as flying buttresses. In the groove and between the buttresses spring four bilobed paddles or wings, each lobe carrying an otocyst. The ectoderm is ciliated and provided with nematocysts. The coelenteron, otherwise simple, is continued through the buttresses; the endoderm of the paddles is solid. While the nematocysts and otocysts undoubtedly place this form with Hydrozoa, its exact position has yet to be determined. Nothing is known of its development.

APPENDIX TO HYDROMEDUSAE. No. II.

Graptolithidae.

The forms generally included in this class are known only in a fossil state, and are divided into three orders, which possibly bear but little genetic affinity to one another.

ORDER 1. *Dendroidea*. These forms often exhibit a marked resemblance to Sertularian colonies (*Dendrograptus*). The zooids appear to have been often dimorphic; in *Dictyonema rarum* each branch presents a common canal, from which are given off pairs of dimorphic thecae opening in opposite directions (? hydrotheca and gonotheca).

ORDER 2. *Graptoloidea*. These forms possess also a tubular skeleton with a common canal, and thecae of an apparently Sertularian type. The stem is stiffened by a solid axis (*virgula*) which lies in a groove of the perisarc. The theca of the primary zooid (*sicula*) does not increase continuously in length. In this group also there appears to have existed a dimorphism, pear-shaped capsules (*Dawsonia*, Fig. 56⁶) being often found close to or attached to a Graptoloid. The sicula when perfect exhibits two regions—a smaller, slighter, embryonic chamber, continuous with which is a stronger, larger, and darker chamber; the mouth of the latter is generally provided with a spine.

SUB-ORDER 1. *Monoprionidae* (Fig. 56^{1 to 3, 5}). The thecae in this sub-order are arranged on one side of the axis only. The sicula may face either in the same direction as the mouths of the other thecae (*Monograptidae*, *Leptograptidae*) or in the opposite direction (*Dichograptidae*, *Dicranograptidae*). The second theca is budded from the sicula, the third from the second, and so forth, a common canal placing the thecae in communication with one another.

SUB-ORDER 2. *Diprionidae* (Fig. 56^{4, 7}). The thecae in this group are arranged on two or four radii from the axis. These forms are linked with the Monoprionidans by (a) *Dicranograptus*, the colony of which is at first Diprionidan, and later bifurcates into two Monoprionidan stems, and by (b) *Dimorphograptus*, in which the stem is at first Monoprionidan, then Diprionidan. The colony may exhibit two (*Diplograptidae*) or four (*Phyllograptidae*) rows of thecae; the virgula is centrally placed, and each row of thecae generally has a separate common canal of communication

between its members, the canals communicating below with each other and with the sicula. The sicula faces in a direction opposite to that of the other thecae.

There is some ground, at present most insecure, for the belief that, in both Monopriionidae and Dipriionidae, the individual stems were united into colonies, and sprang from a central mass, the sicula being at the distal end of each stem. The Graptoloids range from the Lower Arenig beds up to the Silurian inclusive, and it would appear from their distribution that

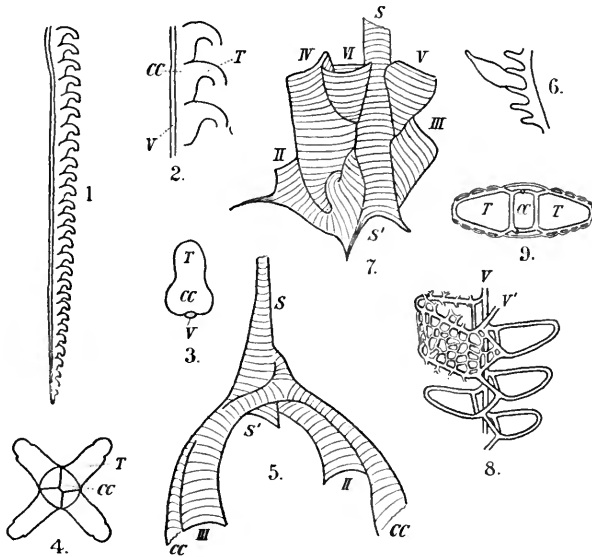

FIG. 56.

Diagrams illustrating the structure and development of Graptolites. 1, *Monograptus pridon* (after Nicholson); 2, longitudinal, and 3, transverse sections of *Monograptus pridon*; 4, transverse section of *Phyllograptus*; 5, base of colony of *Didymograptus minutus*, a two-branched Monopriionidan (after Wiman); 6, *Graptolites* with supposed gonangium (*Dawsonia*) in place (after Hoernes); 7, base of colony of *Diplograptus* (after Wiman); 8, part of colony of *Retiolites*, the perisarcal meshwork has been left on one theca only (after Holm); 9, transverse section of *Retiolites*, showing two thecae, the common canal, and the perisarcal meshwork growing out from the lip of each theca. CC, common canal; S, sicula; S', mouth of sicula; T, theca; V, virgula; V', zigzag virgula of *Retiolites*; II, III, IV, etc., indicate successively formed thecae, S being the first formed.

the Dipriionidan forms are the older, the Monopriionidan forms having arisen by the suppression of a row of thecae.

ORDER 3. *Retioloidea* (Fig. 56^{8,9}). This group, which is well developed in the Ordovician rocks, includes Graptolites which have no true sicula, but are characterised by the periderm forming an open meshwork. The thecae are generally arranged in two series; one or two virgulæ may be developed.

CLASSIFICATION AND LIST OF THE GENERA OF
HYDROMEDUSAE.

It is not at present possible to furnish a satisfactory classification of the Anthomedusae and Leptomedusae. The systems of Hincks and of Allman are based on hydroid structure, that of Haeckel on medusoid structure; our knowledge of the ontogenetic connection between individual hydroids and medusoids is at present so small that any attempt to combine the two systems must necessitate failure. The double systems, hydroid and medusoid, are therefore here given separately; where practicable, each generation has the corresponding generation appended in brackets; but even in the few cases here cited, the assignment of hydroid to medusoid, and contrariwise, is often a matter of inference rather than of proof. No attempt has been made in the present article at a critical treatment of the current systems. The chief authorities utilised in this classification are Allman (2), Haeckel (4, 39), Hincks (7), Moseley (37). Another system of the Anthomedusae is to be found in Vanhöffen's *Versuch einer natürlichen Gruppierung der Anthomedusen*, Zool. Anz. xiv. 1891. Several genera are thrown together and medusoids assigned to hydroids on the authority of Browne's *British Hydroids and Medusae* (Proc. Zool. Soc. 1896).

NOTE. + unites various hydroid genera attributed to the same medusoid genus, or various medusoid genera attributed to the same hydroid genus.

[] Square brackets indicate the corresponding medusoid genus in the hydroid scheme, or the corresponding hydroid genus in the medusoid scheme.

= indicates a synonym.

S indicates a sessile genophore, in contrast to a free-swimming medusoid.

CLASSIFICATION OF HYDROMEDUSAE.

ORDER I. **Anthomedusae = Gymnoblastea.** (For definition, see p. 11.)

(a). **Medusoid Scheme.**

FAMILY 1. CODONIDAE. Genera—*Codonium*, Hkl., + *Sarsia*, Lesson, + *Syndictyon*, A. Agass., [*Syncoryne*]; *Ectopleura*, L. Agass., [*Ectopleura*]; *Dipurena*, M'Crady, = *Slabberia*, Forbes; *Bathycodon*, Hkl.; *Dicodonium*, Hkl.; *Dinema*, v. Bened., [*Perigonimus*]; *Steenstrupia*, Forbes, + *Hybocodon*, L. Agass., = *Amphicodon*, Hkl., = *Diplura*, Allm., + *Amalthaea*, O. Schmidt, [*Corymorpha*]; *Euphysa*, Forbes, [*Halatractus*]; *Globiceps*, Ayres, [*Pennaria*]. FAMILY 2. TIARIDAE. Genera—*Protiara*, Hkl.; *Modeeria*, Forbes; *Corynetes*, M'Crady, [*Halocaris*]; *Amphinema*, Hkl., [? *Perigonimus*]; *Codonorchis*, Hkl.; *Stomotoca*, L. Agass.; *Pandaea*, Less.; *Conis*, Brandt; *Tiara*, Less., [*Perigonimus*]; *Turris*, Less., [*Turris* = *Clavula*]; *Catablema*, Hkl.; *Turritopsis*, M'Crady, = *Callitiara*, Hkl. FAMILY 3. MARGELIDAE. Genera—*Cytaeis*, Esch., = *Margellium*, Hkl., + *Cubogaster*, Hkl., + *Dysmorphosa*, Phil., + *Lizzia*, Forb. (pars.), [*Podocoryne*]; *Cytandraea*, Hkl., [*Rhizocline*]; *Lizusa*, Hkl.; *Lizzella*, Hkl.; *Thamnitis*, Hkl.; *Thamnostylus*, Hkl.; *Thamnostoma*, Hkl.; *Limnocea*, Péron; *Margelis*, Steenstr., + *Hippocrene*, Mertens, [*Bougainvillea*]; *Nemopsis*, L. Agass.; *Rathkea*, Brandt.

FAMILY 4. CLADONEMIDAE. Genera—*Pteronema* (? a Codonid), Hkl.; *Zanclaea*, Gegenb.; *Gemmaria*, M'Crady [*Gemmaria*]; *Eleutheria*, Quatref., [*Clavatella*]; *Ctenaria*, Hkl.; *Dendronema*, Hkl.; *Cladonema*, Duj., [*Cladonema* = *Stauridium*] (? a Codonid); *Willsia*, Forbes, [*Lar*].

(b). **Hydroid Scheme.**

FAMILY 1. CLAVIDAE. Genera—*Clava*, Gmel. [S]; *Rhizogeton*, A. Ag. [S]; *Cordylophora*, Allm. [S]; *Tubiclava*, Allm. [S]; *Merona*, Norm. [S].
 FAMILY 2. TURRIDAE. Genera—*Turris*, Less., = *Clavula*, Str. Wright, [*Turris*]; *Campaniclava*, Allm. [S]; *Corydendrium*, van Ben. [?]; *Dendroclava*, Weismann, [*Dendroclava*] (? Pandaeid).
 FAMILY 3. CORYNIDAE. Genera—*Coryne*, Gärtn. [S]; *Actinogonium*, Allm. [S]; *Syncoryne*, Ehrenb. (pars.), [*Codonium* + *Sarsia* + *Syndictyon*]; *Gymnocoryne*, Hincks [?]; *Corynetes*, M'Crady, [*Corynetes* = *Halocaris*]; *Gemmaria*, M'Crady, [*Gemmaria*]; *Sphaerocoryne*, Pictet [?].
 FAMILY 4. BOUGAINVILLIIDAE. Genera—*Bougainvillea*, Less., [*Margelis* + *Hippocrene*]; *Perigonimus*, M. Sars., [*Dinema* + ? *Amphinema*]; *Bimeria*, S. Wright [S]; *Dicoryne*, Allm. [S]; *Stylactis*, Allm. [S]; *Garveia*, S. Wright [S]; *Wrightia*, Allm., = *Atractylis*, S. Wright [S]; *Hydranthea*, Hincks [S]; *Heterocordyle*, Allm. [S]; *Cionistes*, S. Wright [S]; *Stylactella*, Hkl. [?].
 FAMILY 5. EUDENDRIDAE. Genus—*Eudendrium*, Ehrenb. pars. [S].
 FAMILY 6. PENNARIIDAE. Genera—*Pennaria*, Goldf., [*Globiceps*]; *Stauridium*, Duj., [*Cladonema*]; *Halocordyle*, Allm., [*Halocordyle*]; *Vorticlava*, Alder [?]; *Heterostephanus*, Allm., [*Heterostephanus*]; *Acharadria*, S. Wright [?]; *Tiarella* [*Tiarella*].
 FAMILY 7. CLAVATELLIDAE. Genus—*Clavatella*, Hincks, [*Eleutheria*].
 FAMILY 8. CLADOCORYNIDAE. Genus—*Cladocoryne*, Rotch [?].
 FAMILY 9. TUBULARIIDAE. Genera—*Tubularia*, Linn. pars. [S]; *Ectopleura*, A. Agass., [*Ectopleura*].
 FAMILY 10. MYRIOTHELIDAE. Genus—*Myriothela*, M. Sars [S].
 FAMILY 11. HYDRACTINIIDAE. Genus—*Hydractinia*, v. Bened. [S].
 FAMILY 12. PODOCORYNIDAE. Genera—*Podocoryne*, M. Sars, pars., [*Cytaeis* + *Cubogaster* + *Dysmorphosa* + *Lizzia* (pars.)]; *Corynopsis*, Allm., [*Corynopsis*].
 FAMILY 13. CORYMORPHIDAE. Genera—*Corymorpha*, M. Sars, pars., [*Steenstrupia* + *Hybocodon* = *Amphicodon* = *Diplura* + *Amalthea*]; *Halatractus*, Allm., [*Euphysa*].
 FAMILY 14. MONOCAULIDAE. Genus—*Mono-caulus*, Allm. [S].
 FAMILY 15. HYDROLARIDAE. Genus—*Lar*, Gosse, [*Willsia*, vulgo *Willia*].
 FAMILY 16. MONOBRACHIIDAE. Genus—*Mono-brachium*, Merej. [?].
 [FAMILY SPONGICOLIDAE. Genera—(*Spongicola*, F. E. Schulze, = *Stephanoscyphus*, Allm., is probably a Scyphistoma).]
 FAMILY 17. HYDRIDAE. Genus—*Hydra*, Linn. [S].
 FAMILY 18. MYRIONEMIDAE. Genus—*Myrionema*, Pictet.
 FAMILY 19. CERATELLADAE. Genera—*Ceratella*, Gray [S]; *Dehitella*, Gray [S].
 INCERTAE SEDIS—*Protohydra*, Greef; *Microhydra*, Potts.; *Haleremita*, Schaudinn; *Acaulis*, Stimps.

ORDER 2. **Leptomedusae = Calyptoblastea.** (For definition, see p. 22.)

(a). **Medusoid Scheme.**

FAMILY 1. THAUMANTHIDAE. Genera—*Tetranema*, Hkl.; *Dissonema*, Hkl.; *Octonema*, Hkl.; *Thaumantias*, Esch., [*Campanularia*, etc.] has

exploded into numerous genera; *Staurostoma*, Hkl.; *Laodice*, Less., [*Lafoea*]; *Melicertella*, Hkl.; *Melicertissa*, Hkl.; *Melicertum*, A. Agass. [*Melicertum*]; *Melicertidium*, Hkl.; *Orchistoma*, Hkl.; *Halmomises*, v. Kenn. FAMILY 2. CANNOTIDAE. Genera—*Staurodiscus*, Hkl.; *Gonytnema*, A. Agass.; *Ptychogena*, A. Agass.; *Staurophora*, Brandt; *Polyorchis*, A. Agass.; *Cannota*, Hkl.; *Dyscannota*, Hkl.; *Berenice*, Pér. et Lesueur; *Dipleurosoma*, Boeck, = *Ametrangia*, Allm.; *Dicranocranna*, Hkl.; *Toxorthis*, Hkl.; *Willetta*, Hkl.; *Willsia* (vulgo *Willia*, formerly classed here, but an Anthomedusan), Forbes; *Proboscidactyla*, Brandt; *Cladocanna*, Hkl. FAMILY 3. EUCOPIIDAE. Genera—*Eucopium*, Hkl., [*Clytia*]; *Saphenella*, Hkl.; *Eucope*, Gegenb., [? *Campanularia* + ? *Clytia*]; *Obelia*, Pér. Lesueur, [*Obelia*]; *Tiaropsis*, L. Agass.; *Euchilota*, M'Crady, = *Thaumantias* (pars), = *Laodice* (pars); *Phialum*, Hkl.; *Phialis*, Hkl.; *Mitrocomium*, Hkl.; *Epenthesis*, M'Crady, [*Clytia*]; *Mitrocomella*, Hkl.; *Phialidium*, Leuck., = *Thaumantias* (pars.), [*Campanulina*]; *Mitrocoma*, Hkl.; *Eutimium*, Hkl.; *Eutima*, M'Crady; *Saphenia*, Esch.; *Eutimeta*, Hkl.; *Eutimalphes*, Hkl.; *Octorchidium*, Hkl.; *Octorchis*, Hkl.; *Octorchandra*, Hkl.; *Irenium*, Hkl.; *Irene*, Esch.; *Tima*, Esch., [*Tima*]. FAMILY 4. AEQUORIDAE. Genera—*Octocanna*, Hkl.; *Zygocanna*, Hkl.; *Zygocannota*, Hkl.; *Zygocannula*, Hkl.; *Halopsis*, A. Agass.; *Aequorea*, Pér. Les.; *Rhegmatodes*, A. Agass.; *Stomobrachium*, Brandt; *Staurobrachium*, Hkl.; *Mesonema*, Esch., = *Zygodactyla*, Brandt, [*Zygodactyla*]; *Polycanna*, Hkl., [*Campanulina*].

(b). Hydroid Scheme.

FAMILY 1. CAMPANULARIIDAE. Genera—*Campanularia*, Lamk., [*Thaumantias* (pars)]; *Lovenella*, Hincks [?]; *Obelia*, Pér. Les. [*Obelia*]; *Thyrosocyphus*, Allm. [?]; *Hypanthea*, Allm. [S]; *Calycella*, Hincks [S]; *Lytoscyphus*, Pictet [?]; *Gonothyraea*, Allm. [S]; *Clytia*, Lamx., [*Eucope* (pars), + *Epenthesis*]; *Campanulina*, v. Bened., = *Laomedea*, Lamx., [*Phialidium* + *Polycanna*]; *Opercularella*, Hincks [S]; *Calamphora*, Allm. [S]; *Hebella*, Allm. [?]; *Hatisiphonia*, Allm. [S]; *Zygodactyla*, Brandt, [*Zygodactyla* = *Mesonema*]; *Leptoscyphus*, Allm. [?]; *Obelaria*, Hartlaub [S]. FAMILY 2. PERISIPHONIIDAE. Genera—*Perisiphonia*, Allm. [?]; *Cryptolaria*, Busk [?]; *Lafoea*, Agass., [*Laodice*]; *Lictorella*, Allm. [?]; *Cuspidella*, Hincks [?]; *Filellum*, Hincks [?]. FAMILY 3. HALECIDAE. Genera—*Halecium*, Oken [S]; *Diplocyathus*, Allm. [?]; *Ophiodes*, Hincks [S]; *Hydrella*—[S]; *Haloikema*, Bourne [?]. FAMILY 4. SERTULARIIDAE (gonophores sessile throughout). Genera—*Sertularia*, Linn. pars.; *Diphasia*, L. Agass.; *Thuiaria*, Flem.; *Desmoscyphus*, Allm.; *Sertularella*, Gray; *Hydrallmania*, Hincks; *Hypopyxis*, Allm.; *Staurotheca*, Allm.; *Dictyocladium*, Allm. FAMILY 5. AGLAOPHENIIDAE (gonophores probably sessile throughout). Genera—*Aglaophenia*, Lamouroux; *Acanthocladium*, Allm.; *Lytocarpus*, Kirchenp.; *Streptocaulus*, Allm.; *Diplocheilus*, Allm.; *Cladocarpus*, Allm. FAMILY 6. HALICORNARIIDAE (gonophores probably sessile throughout). Genera—*Halicornaria*, Busk, pars.; *Azygoplon*, Allm. FAMILY 7. IDIIDAE. Genus—*Idia*, Lamouroux [S]. FAMILY 8. GRAMMARIIDAE. Genus—*Grammaria*, Stimps., = (?) *Salacia*, Lamouroux [?]. FAMILY 9. SYNTHECIDAE. Genera—*Synthecium*, Allm. [?]; *Thecocladium*,

Allm. [?]. FAMILY 10. PLUMULARIIDAE (gonophores probably sessile throughout). Genera—*Plumularia*, Lamk. pars.; *Antennularia*, Lamk.; *Acanthella*, Allm.; *Schizotricha*, Allm.; *Sciurella*, Allm.; *Polyplumaria*, G. O. Sars; *Heteroplou*, Allm.; *Nemertesia*. FAMILY 11. CALICARPIDAE. Genera—*Calicarpa* [?]; *Hippurella*, Allm. [?]. FAMILY 12. HYDROCERATINIDAE. Genus—*Clathroozon*, Spencer [?]. INCERTAE SEDIS—*Trichydra*, S. Wright [?]; *Coppinia*, Hassall [?].

ORDER 3. **Trachomedusae.** (For definition, see p. 30.)

FAMILY 1. PETASIDAE. Genera—*Petatus*, Hkl.; *Dipetatus*, Hkl.; *Petasata*, Hkl.; *Petachnum*, Hkl.; *Aglauropsis*, F. Müll.; *Gossea*, L. Agass.; *Obindias*, F. Müll. FAMILY 2. TRACHYNEMIDAE. Genera—*Trachynema*, Gegenb.; *Marmanema*, Hkl.; *Rhopalonema*, Gegenb.; *Pectyllis*, Hkl.; *Pectis*, Hkl.; *Pectanthis*, Hkl.; *Homoeonema*, Maas; (?) *Pantachogon*, Maas. FAMILY 3. AGLAURIDAE. Genera—*Aglantha*, Hkl.; *Aglaura*, Pér. Les.; *Agliscra*, Hkl.; *Stauraglaura*, Hkl.; *Persa*, M^cCrady. FAMILY 4. GERYONIDAE. Genera—*Liriantha*, Hkl., = *Liriope*, Less.; *Glossocoelus*, Hkl.; *Glossocodon*, Hkl.; *Geryones*, Hkl.; *Geryonia*, Pér. Les.; *Carmaris*, Hkl.; *Carmarina*, Hkl.

ORDER 4. **Narcomedusae.** (For definition, see p. 33.)

FAMILY 1. CUNANTHIDAE. Genera—*Cunantha*, Hkl.; *Cunarcha*, Hkl.; *Cunoctantha*, Hkl.; *Cunoctona*, Hkl.; *Cunina*, Esch.; *Cunissa*, Hkl. FAMILY 2. PEGANTHIDAE. Genera—*Polycolpa*, Hkl.; *Polyzenia*, Esch.; *Pegusia*, Pér. Les.; *Pegantha*, Hkl. FAMILY 3. AEGINIDAE. Genera—*Aegina*, Esch.; *Aeginella*, Hkl.; *Aegineta*, Gegenb.; *Aeginopsis*, Brandt; *Aeginura*, Hkl.; *Aeginodiscus*, Hkl.; *Aeginodorus*, Hkl.; *Aeginorhodus*, Hkl. FAMILY 4. SOLMARIDAE. Genera—*Solmissus*, Hkl.; *Solmundus*, Hkl.; *Solmundella*, Hkl.; *Solmoneta*, Hkl.; *Solmaris*, Hkl.

ORDER 5. **Hydrocorallinae.** (For definition, see p. 35.)

FAMILY 1. MILLEPORIDAE. Genus—*Millepora*, Linn. FAMILY 2. STYLASTERIDAE. Genera—*Sporadopora*, Moseley; *Pliobothrus*, Pourtal.; *Errina*, Gray; *Distichopora*, Lamk.; *Labiopora*, Moseley; *Spinipora*, Moseley; *Allopora*, Ehrenb.; *Stylaster*, Gray; *Stenohelia*, S. Kent; *Conopora*, Moseley; *Cryptohelia*, M. E. and H.; *Astylus*, Moseley.

ORDER 6. **Siphonophora.** (For definition, see p. 38.)

SUB-ORDER 1. DISCONNECTAE.

Definition.—Siphonophora with an apical chambered pneumatophore, without nectophores or bracts. The individuals are confined to the lower surface of the pneumatophore, and are a single central gastrozoid, surrounded by concentric girdles of blastostyles and dactylozooids.

FAMILY 1. DISCALIDAE. Genera—*Discalia*, Hkl.; *Disconalia*, Hkl.

FAMILY 2. PORPITIDAE. Genera—*Porpalia*, Hkl.; *Porpema*, Hkl.; *Porpitella*, Hkl.; *Porpita*, Lamk. FAMILY 3. VELELLIDAE. Genera—*Rataria*, Esch.; *Velella*, Lamk.; *Armenista*, Hkl.

SUB-ORDER 2. CALYCONECTAE.

Definition.—Siphonophora without pneumatophore, with one or more nectophores. The coenosarc is elongated and tubular, and carries the cormidia which may become freed as Eudoxomes or Ersaeomes (= Monogastricae).

FAMILY 4. MONOPHYIDAE. Genera—*Monophyes*, Claus; *Sphaeronectes*, Huxl.; *Cymbonectes*, Hkl.; *Muggiaea*, Busch; *Cymba*, Esch.; *Doramasia*, Chun; *Halopyramis*, Chun. FAMILY 5. DIPHYIDAE. Genera—*Praya*, Blainv.; *Lilyopsis*, Chun; *Galeolaria*, Lesneur; *Diphyes*, Cuv.; *Mitrophyes*, Hkl.; *Diphyopsis*, Hkl.; *Abyla*, Quoy Gaim.; *Bassia*, Quoy Gaim.; *Calpe*, Quoy Gaim.; *Amphicaryon*. FAMILY 6. STEPHANOPHYIDAE. Genus *Stephanophyes*, Chun. FAMILY 7. DESMOPHYIDAE. Genera—*Desmalia*, Hkl.; *Desmophyes*, Hkl. FAMILY 8. POLYPHYIDAE. Genera—*Hippopodius*, Quoy Gaim.; *Polyphyes*, Hkl.; *Vogtia*, Köll.

[FAMILY EUDOXIDAE (includes free Eudoxomes of other genera, the names of which are included in square brackets). Genera—*Diplophysa*, Gegenb., [*Sphaeronectes*]; *Eudoxella*, Hkl., [*Praya*]; *Cucubalus*, Quoy Gaim., [*Muggiaea*]; *Cucullus*, Quoy Gaim., [*Diphyes*]; *Cuboides*, Quoy Gaim., [*Cymba*]; *Amphirrhoa*, Blainv., [*Abyla*]; *Sphenoides*, Huxl., [*Bassia*]; *Aglaisma*, Esch., [*Calpe*]. FAMILY ERSAEIDAE (includes free Ersaeomes of other genera, the names of which are included in square brackets). Genera—*Ersaea*, Esch., [*Diphyopsis*]; *Lilaea*, Hkl., [*Lilyopsis*].]

SUB-ORDER 3. PHYSONECTAE.

Definition.—Siphonophora with an apical pneumatophore, followed by one or more coronae of nectophores or bracts, without aurophore. The coenosarc is elongated and tubular, and carries the cormidia.

FAMILY 9. CIRCALIIDAE. Genus—*Circalia*, Hkl. FAMILY 10. ATHORIIDAE. Genera—*Athoria*, Hkl.; *Athoralia*, Hkl. FAMILY 11. APOLEMIIDAE. Genera—*Dicymba*, Hkl.; *Apolemia*, Esch.; *Apolemopsis*, Brandt. FAMILY 12. AGALMIDAE. Genera—*Stephanomia*, Pér. Les.; *Crystallodes*, Hkl.; *Phyllophysa*, L. Agass.; *Agalma*, Esch.; *Anthemodes*, Hkl.; *Cuneolaria*, Eysenh.; *Halistemma*, Huxl.; *Cupulita*, Quoy Gaim.; *Agalmopsis*, M. Sars; *Lychnagalma*, Hkl. FAMILY 13. FORSKÅLIDAE. Genera—*Strobalia*, Hkl.; *Forskålea*, Köll.; *Forskåliopsis*, Hkl.; *Bathyphysa*, Studer. FAMILY 14. NECTALIDAE. Genera—*Nectalia*, Hkl.; *Sphyrophysa*, L. Agass. FAMILY 15. DISCOLABIDAE. Genera—*Physophora*, Forsk.; *Discolabe*, Esch.; *Stephanospira*, Gegenb. FAMILY 16. ANTHOPHYSIDAE. Genera—*Rhodophysa*, Blainv.; *Melophysa*, Hkl.; *Athorybia*, Esch.; *Anthophysa*, Mertens.

SUB-ORDER 4. AURONECTAE.

Definition.—Siphonophora with an apical pneumatophore, followed by coronae of nectophores, and carrying an aurophore. Individuals con-

fined to the lower surface of the colony, including numerous gastrozooids.

FAMILY 17. STEPHALIDAE. Genera—*Stephalia*, Hkl.; *Stephonalia*, Hkl. FAMILY 18. RHODALIIDAE. Genera—*Auralia*, Hkl.; *Rhodalia*, Hkl.; *Angelopsis*, Fewkes.

SUB-ORDER 5. CYSTONECTAE.

Definition.—Siphonophora with an apical hollow pneumatophore, without nectophores or bracts. Gastrozooids generally numerous, arranged either on the lower side of the pneumatophore, or on a long tubular coenosarc.

FAMILY 19. Cystalidiae. Genus—*Cystalia*, Hkl. FAMILY 20. RHIZOPHYSIDAE. Genera—*Aurophysa*, Hkl.; *Cannophysa*, Hkl.; *Linophysa*, Hkl.; *Nectophysa*, Hkl.; *Pneumophysa*, Hkl.; *Rhizophysa*, Pér. Les.; *Pterophysa*, Studer; *Pleurophysa*, Fewkes. FAMILY 21. SALACIIDAE. Genus—*Salacia*, Hkl. FAMILY 22. EPIBULIDAE. Genera—*Epibulia*, Esch.; *Angela*, Less. FAMILY 23. PHYSALIIDAE. Genera—*Alophota*, Brandt; *Arethusa*, Hkl.; *Physalia*, Lamk.; *Caravela*, Hkl.

Incertae sedis.

(Hydromedusae which are not referable to any known order of the group.)

Limnocodium, Allm.; *Limnocnida*, Günth.; *Protohydra*, Greef; *Microhydra*, Potts; *Tetraplatia*, Busch.

LITERATURE OF HYDROMEDUSAE.

As far as possible only one paper on each special subject has been cited, in which the student will find references to the earlier literature.

The general subject :—

1. *Allman*. Monograph of the Gymnoblasic or Tubularian Hydroids, 1871-72.
2. *Allman*. Chall. Rep. Zool. vii. (Hydroidea, pt. i.); xxiii. (Hydroidea, pt. ii.).
3. *Chun*. Bronn's Klassen und Ordnungen des Thierreichs. Coelenterata, 1889 (in progress).
4. *Haeckel*. System der Medusen, 1879-80.
5. *Haeckel*. Chall. Rep. Zool. iv., Deep Sea Medusae, 1882.
6. *Hertwig*. Organismus der Medusen. Denkschr. Gesell. Jena, ii. 1878.
7. *Hincks*. British Hydroid Zoophytes, 1868.
8. *Jackson*. Forms of Animal Life, pp. 745-780, 1888.
9. *Lankester*. Encyclopaedia Britannica, ed. ix., article "Hydrozoa," 1881.
10. *Weismann*. Entstehung der Sexualzellen bei den Hydromedusen, 1883.

Embryology :—

11. *Balfour*. Treatise on Comparative Embryology, 1880-81.
12. *Korschelt* and *Heider*. Text-book of the Embryology of Invertebrates. Eng. trans., 1895-99.
13. *Metschnikoff*. Embryologische Studien an Medusen, 1886.

Special subjects :—

- | | |
|---|------------------------------------|
| 14. <i>Brooks</i> . (Life History of Hydromedusae.) Mem. Bost. Soc. N. H. iii., 1886. | } Metagenesis. |
| 15. <i>Braem</i> . (Ueber d. Knospung bei mehrschichtige Thieren.) Biol. Centr. xiv., 1894. | |
| 16. <i>Seeliger</i> . (Verhalten d. Keimblätter b. d. Knospung d. Coelenteraten.) Zeit. wiss. Zool. lviii., 1894. | } Gemmation of hydroid. |
| 17. <i>Jickeli</i> . (Der Bau der Hydroidpolypen, I.) Morph. Jahrb. viii., 1882. | |
| 18. <i>Von Lendenfeld</i> . (Ueber Coelenteraten der Südsee, I.) Zeit. wiss. Zool. xxxvii., 1882. | } Histology. |
| 19. <i>Hertwig, O. and R.</i> Nervensystem und Sinnesorgane der Medusen, 1878. | |
| 20. <i>Eimer</i> . Die Medusen . . . auf ihr Nervensystem untersucht, 1878. | } Nervous system and sense-organs. |
| 21. <i>Brooks</i> . (The Sense Clubs or Cordyli of Laodice.) Journ. Morph. x., 1895. | |
| 22. <i>Driesch</i> . (Tectonische Studien an Hydroid-polypen.) Jen. Zeitschr. xxiv-v., 1889-91. | } Architecture of colony. |
| 23. <i>Nutting</i> . (Notes on the Reproduction of Plumularian Hydroids.) Amer. Nat. xxix., 1895. | |

Special groups and genera :—

- | | |
|---|----------------------|
| 24. <i>Ryder</i> . (Development and Structure of Microhydra Ryderi.) Amer. Natur., 1885. | } Microhydra. |
| 24a. <i>Greef</i> . (Eine Marine Stammform der Coelenteraten.) Zeit. wiss. Zool. xx., 1870. | |
| 25. <i>Hardy</i> . (Histology and Development of Myriothela.) Quart. Journ. Micr. Sci. xxxii., 1891. | } Myriothela. |
| 26. <i>Collcutt</i> . (Structure of Hydractinia echinata.) Quart. Journ. Micr. Sci. xl., 1897. | |
| 27. <i>Spencer</i> . (Structure of Ceratella fusca.) Trans. R. Soc. Victoria, 1891. | } Ceratella. |
| 28. <i>Haeckel</i> . Deep Sea Keratosa. Chall. Rep. Zool. xxxii. | |
| 29. <i>Wagner</i> . (Organisation des Monobrachium Parasiticum.) Zool. Anz. xii., 1889. | } Monobrachium. |
| 30. <i>Ussow</i> . (Eine neue Form von Süßwasser-Coelenteraten.) Morph. Jahrb. xii., 1887. | |
| 31. <i>Jickeli</i> . (Der Bau der Hydroid-polypen, II.) Morph. Jahrb. viii., 1882. | } Anisicola. |
| 32. <i>Spencer</i> . (A New Family of Hydroidea.) Tr. R. Soc. Victoria, 1890. | |
| 33. <i>Von Lendenfeld</i> . (Ueber Coelenteraten der Südsee, III.) Zeit. wiss. Zool., xxxviii., 1883. | } Nematophores. |
| 34. <i>Lang, Arn</i> . (Gastroblasta Raffaeli.) Jen. Zeitsch. xix., 1886. | |
| 35. <i>Brooks</i> . (The Life History of Epentthesis M'Cradyi.) Stud. Biol. Lab. Johns Hopkins Univ. iv., 1888. | } Eucope in fission. |
| 36. <i>Sars, M.</i> Beskriv. og Jagttag., 1835. | |

} Thaumantias budding.

37. *Moseley*. (Corals.) Chall. Rep. Zool. ii. 1881.
38. *Hickson*. (Development of *Distichopora violacea*.) } Hydrocorallinae.
 Quart. Journ. Micr. Sci. xxxv., 1893.
39. *Haeckel*. (Siphonophora). Chall. Rep. Zool. xxviii., 1888.
40. *Chun*. (Die Canarischen Siphonophoren, I., II.) Abb. } Siphonophora.
 senck. Ges. v., 1891-92.
41. *Chun*. (Bau u. morph. Auffassung d. Siphonophoren.) }
 Verh. deutsch. zool. Ges., 1897.
42. *Schneider*. (Mitth. ü. Siphonophoren.) Zool. Jahrb. }
 (Anat. Ontog.), ix., 1896.
43. *Fewkes*. (On *Angelopsis*.) Ann. Mag. N. H. (6), iv., } Auronectae.
 1889.
44. *Maas*. (Bau. u. Entwickl. d. Cuninenknospen.) Zool. } Cunina-buds.
 Jahrb. (Anat. Ont.), v., 1892.
45. *Günther*. (Minute Anatomy of *Limnocodium*.) Quart. } Limnocodium.
 Journ. Micr. Sci. xxxv., 1894.
46. *Günther*. (Anatomy of *Limnocnida Tanganyicae*.) } Limnocnida.
 Quart. Journ. Micr. Sci. xxxvi., 1894.
47. *Vigier*. (Animaux inf. de la Baie d'Alger, IV.) } Tetraplatia.
 Arch. zool. exp. gén. (2), viii., 1890.
48. *Holm*. (Gotland's Graptoliter.) Bih. Svenska Ak. } Graptolitidae.
 Handl. xvi., 1890.
49. *Wiman*. Bull. geol. Inst. Upsala, 1893.

CHAPTER V.

THE SCYPHOMEDUSAE.¹

CLASS SCYPHOMEDUSAE.

- Order 1. **Stauromedusae.**
- „ 2. **Peromedusae.**
- „ 3. **Cubomedusae.**
- „ 4. **Discomedusae.**
- Sub-Order 1. **Cannostomae.**
- „ 2. **Semostomae.**
- „ 3. **Rhizostomae.**

DEFINITION.—Coelenterata which typically present two main forms of individuals—the non-sexual scyphistoma (hydroid) and

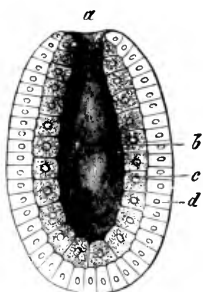

FIG. 1.

Longitudinal section of a diblastula (gastrula), formed by invagination of a simple blastula at one pole. *a*, orifice of invagination (blastopore); *b*, coelenteron; *c*, endoderm; *d*, ectoderm. (After Gegenbaur, from Lankester.)

the sexual medusoid; in this case the life-history presents an alternation of generations in which the scyphistoma produces the medusoid by transverse strobilation, and the sexual cells of the medusoid develop into a scyphistoma. In other cases the medusoid may develop directly from the sexual cells. Gastric ridges (taeniolae or mesenteries) occur in both scyphistoma and medusoid, gastric filaments (phacellae) in the medusoid. The sexual cells lie typically in interradial lines, and are developed from endoderm. The medusoids are devoid of a velum; a velarium is sometimes present; the sense organs are tentaculocysts and cordyls.

In the Scyphomedusae, as in the Hydro-medusae, but by a different path, the segmentation of the fertilised ovum produces a larva of the diblastula type (cf. p. 2), the endoderm of which is formed by invagination, and not by delamination from the ectoderm. From this diblastula may grow either of two forms of individual—the hydroid or the medusoid.

¹ By G. Herbert Fowler, B.A., Ph.D.

The Scyphomedusan hydroid or *scyphistoma* (Fig. 6) is, comparatively speaking, insignificant in size and monotonous in structure; it is known only among Ephyroniae (Discomedusae), and will be described under that group.

The *medusoid* (Figs. 4, 8) is, roughly speaking, of the same type as that of the Hydromedusae—manubrium, tentacles, exumbrel and subumbrel surfaces are of the same general character; but the velum is absent, its place being sometimes taken by the *velarium*; the latter may be either the inflected edge of the bell (*Aurelia*), or a definite subumbrel outgrowth containing coelenteric canals (*Charybdaea*), but in neither case agrees with the Hydromedusan velum in position or in structure. The gastric cavity exhibits four pouches, from which or from between which lead the radial canals; the latter are separated by an endoderm lamella in the essentially medusoid forms.

In the more scyphistomoid forms (Fig. 2¹) strong plates or pillars of mesogloea run from body wall to stomodaeum, forming the *taeniolae* or *mesenteries*, into which ectodermal pits (*subumbrel funnels*, subgenital pits) of varying depth penetrate from the oral surface. The mesenteries do not appear in all cases to be formed by endodermal concrescence.

The canals are often numerous; they frequently branch, and sometimes anastomose; they open into a circular canal at the edge of the bell. Gastric filaments (*phacellae*), interradially placed, are characteristic of this group of organisms. The generative organs are interradial or adradial in position, and are derived from endoderm cells.

ORDER 1. **Stauromedusae.**

DEFINITION.—Scyphomedusae which are devoid of tentaculocysts, but in some cases have in their place marginal anchors. The tentacles are perradial and interradial in position. The body is more scyphistomoid than medusoid, exhibiting a stomodaeum suspended by four mesenteries, between which lie the four broad perradial pouches. There is no alternation of generations.

The Stauromedusae (Figs. 2, 3) are hypogenetic; the single form of individual presents features intermediate between those of hydroid (scyphistomoid) and medusoid forms. It is either purely free-swimming (*Tessera*), or has the power of temporary fixation (*Haliclystus*) by the aboral pole.

The organism is goblet-shaped, with a narrow stem which ends conically (*Tessera*), or in a disc (*Haliclystus*) which can be used for adherence to a solid object. The *manubrium* is well developed, but no velum is present. The edge of the bell is either (1) simple, and provided with four perradial and four interradial *tentacles*

(Tessera), to which eight adradial (Tesserantha) or even more may be added; or else (2) is divided by incisions into eight hollow adradial lappets; on each lappet is seated a bunch of capitate tentacles, and between the lappets lie perradial and interradial marginal anchors or *colletocystophores* (Halicystus, Fig. 3), which are, however, absent in some genera (Lucernaria). The marginal anchors are modified and shortened tentacles, at the base of each

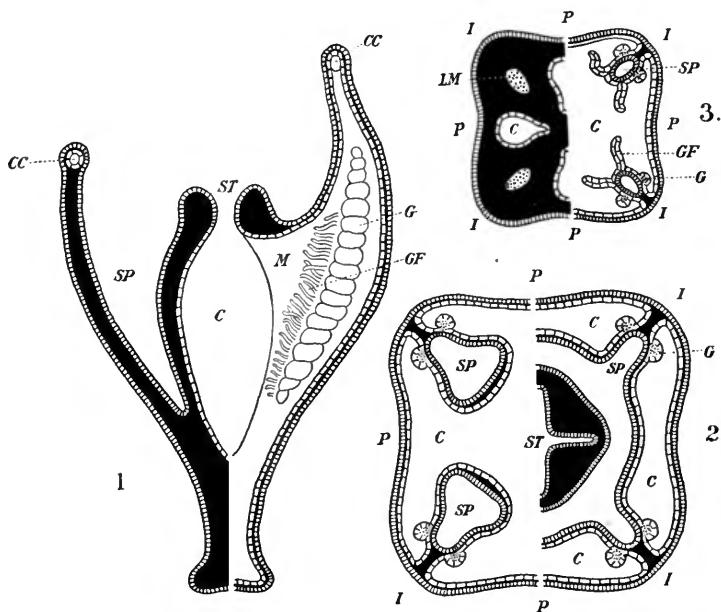

FIG. 2.

Diagrams illustrating the structure of *Lucernaria*. 1, longitudinal section; the right half passes along an adradius, just missing a mesentery, which is shown in thin outline and carries gastric filaments and generative organs; the left half passes along an interradius and shows the course of a subumbrel pit deep into the substance of the mesentery. 2, transverse section; the right half at the level of the stomodaemum, the left half a little below that level, and through the upper part of the subumbrel pits. 3, transverse section; the right half through the lower part of the subumbrel pits, the left half through the base of the animal where the four mesenteries fuse, centrally dividing the coelenteron into four pouches. In all three figures ectoderm is strongly hatched, endoderm lightly hatched, mesogloea black. *C*, coelenteron; *CC*, circular canal; *G*, genital organ; *GF*, gastric filament; *I*, interradius; *LM*, ectodermal longitudinal muscle band, continued aborally into the mesogloea; *M*, mesentery; *P*, perradius; *SP*, subumbrel pit; *ST*, stomodaemum.

lies a pad of nematocysts and adhesive cells. No organs of special sense are developed in this group.

The mouth, which is often frilled, leads into a tube, which is probably a *stomodaemum*, or invagination of ectoderm. At the bottom of the stomodaemum lies the *gastric cavity*, which is imperfectly divided into four *perradial chambers*, homologous with the perradial canals of *Hydromedusae*, by four interradial *mesenteries* or partitions

(taeniolae); these are projections of mesogloea and endoderm from the exumbrel body wall towards the centre of the cavity. The coelenteron, thus divided, extends into the adradial lappets of the edge of the bell. In most forms the mesenteries, which have a free edge in the more central parts of the organism, become attached to the subumbrel wall in the oral region, and are also continued into the lappets; they are, however, prevented from reaching the extreme lip of the bell by a *circular canal*. In other forms (Tessera) the mesenteries project but little from the exumbrellar wall and have only a very short attachment to the subumbrella; the circular sinus is therefore very large. In many forms a pouch of the ectoderm of the subumbrella, the interradial or *subumbrel funnel*, penetrates far into each mesentery.

From the mesenteries grow the gastric filaments (*phacellae*); of these there are four only, interradially placed (Tessera); or they may be present in considerable numbers along both sides of each mesentery (Halicystus). In some cases the four mesenteries fuse aborally in the centre of the gastric cavity.

A well-developed *circular muscle* runs round the edge of the bell in all forms. Of the *longitudinal muscles*, the most marked are the eight perradial and interradial bands, of which the latter lie immediately under the ectoderm of the subumbrel funnels, and are continued deep into the substance of the mesogloea of the mesentery aborally.

The sexes are separate. The *generative organs* are interradial, and are horseshoe-shaped (Tessera), or are split by growth of the mesenteries into bands at their sides (Halicystus).

Little is known of the reproduction of this group. The blastula is apparently converted into the diblastula by a process intermediate between delamination and true invagination.

ORDER 2. Peromedusae.

DEFINITION.—Scyphomedusae with four interradial tentaculocysts; the tentacles are perradial and adradial in position. Four mesenteries suspend the stomodaeum, and being attached to the body wall at two points only, divide the peripheral coelenteron into two large circular sinuses (confluent radial pouches). There is no alternation of generations.

The Peromedusae (Fig. 4) are medusiform, and bear a strong resemblance to the Tesseridae among Stauromedusae. The bell is conical and carries a well-developed *manubrium*; no velum is present, but a slight projection of the circular muscle subumbrellally constitutes the *velarium*. The edge of the bell has a complicated structure; it generally exhibits either four perradial tentacles, four tentaculocysts on interradial lappets or *pedalia*, and eight adradial lappets

or pedalia (Pericolpa); or four interradial tentaculocysts, four perradial and eight adradial tentacles on pedalia, and sixteen subradial pedalia (Periphylla). The *tentacles* are long and hollow; the *tentaculocysts* are short, and present on the oral face a crescentic pad of pigmented sense cells, a median ocellus, and a stalked sense club with otoliths; on the aboral face lies a pair of ocelli.

The mouth leads into a long tube, probably a *stomodaeum*, which opens below into the *gastric cavity*. The latter is, as in Stauro-medusae, imperfectly divided into four perradial chambers by four interradial *mesenteries*, which are invaded by four interradial *funnels* of the subumbrella. The mesenteries are attached to the exumbrel body wall only in the most aboral quarter of the bell, and again at a point just below the union of stomodaeum and gastric cavity; there are thus left two large *circular sinuses*, one round the subumbrel funnels, the other round the edge of the bell. In the pedalia at the edge of the bell the circular sinus is

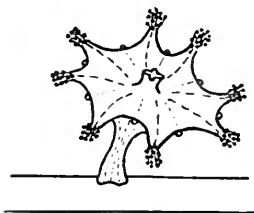

FIG. 3.

3.—*Halicystus*, temporarily attached to a piece of weed, showing eight bunches of capitate tentacles and eight colletocystophores.

4.—*Periphylla mirabilis* (after Haeckel). The division of the exumbrel surface into pedalia is well shown. *a*, tentaculocyst (interradial); *b*, subradial pedalia; four perradial and eight adradial tentacles are present.

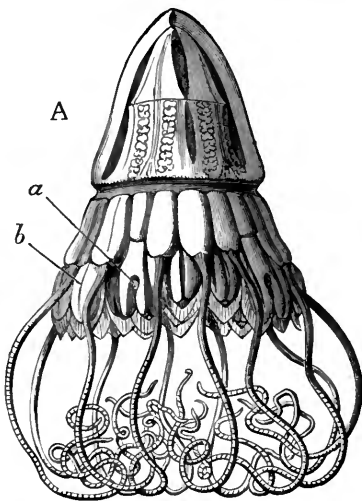

FIG. 4.

further subdivided into eight, sixteen, or more pouches by fusion of exumbrel and subumbrel walls. The *phacellae* are developed at the sides of the mesenteries; the *generative organs* form eight horseshoe-shaped glands, placed adradially.

Nothing is known of the development of this group.

ORDER 3. Cubomedusae.

DEFINITION.—Scyphomedusae with four perradial tentaculocysts; the tentacles are interradial in position. Four laminar mesenteries divide the peripheral coelenteron into four broad perradial pouches. There is no alternation of generations.

The Cubomedusae (Fig. 5) are medusiform only. The umbrella is square in section and rounded above; a broad *velarium*, containing endodermal canals and suspended by four perradial *frenulae*, or thickenings of the subumbrella, is present in many forms (*Charybdaea*), but is sometimes absent (*Procharagma*) or slightly developed (*Procharybdis*). The *manubrium* is four-square, its angles lying perradially. Four interradial *tentacles*, long, hollow, and cylindrical, are always present; they are generally seated on lappets (*pedalia*), which in some cases carry numerous additional tentacles (*Chirodopus*).

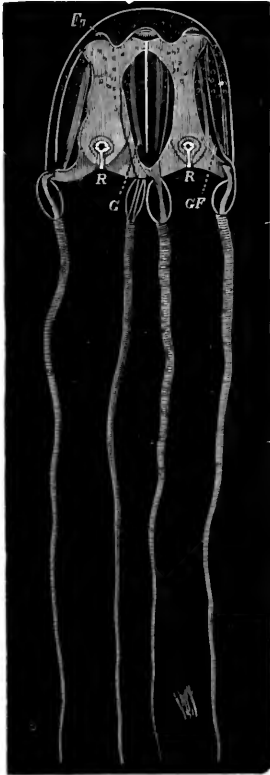

1.



2.

FIG. 5.

Charybdaea marsupialis (after Claus). 1. The four annulated tentacles are seen depending from the four lappets placed at the four corners of the quadrangular umbrella. These are interradial. Two of the four perradial gastric pouches, representing radial canals, are seen of a pale tint. *Fg*, gastral filaments (interradial); *R*, the modified perradial tentacles forming tentaculocysts; *G*, corner ridge facing the observer and dividing adjacent pouches of the umbrella; *GF*, position of one of the genital bands. 2. View of the margin of the umbrella of *Charybdaea marsupialis* (natural size, after Claus). At the four corners are seen the lappets which support the long tentacles, and in the middle of each of the four sides is seen a tentaculocyst; *Vel*, the vascular velarium, with its branched vessels.

The nervous system is well developed, consisting of a sub-umbrellar *nerve ring*, and of four larger perradial and four smaller interradial *ganglia*, from which nerves pass to the sense organs, muscles, and tentacles. The sense organs are *tentaculocysts*, they are always four in number and perradial in position, and lie in sense pits on the exumbrella. In *Charybdaea* each consists of a short stalk, the head of which carries a terminal otocyst with numerous crystalline otoliths, two median and two pairs of lateral ocelli.

The tube of the manubrium leads into a short *gastric cavity*; from this four broad shallow *perradial canals* or pouches, separated by narrow interradial *mesenteries*, lead to the *circular canal* at the edge of the bell. This canal is further subdivided by fusion of its exumbral and subumbral walls into pouches, eight (*Charybdaea*) or sixteen (*Chirodromus*) in number; from these lead the canals of the tentacles and velarium. The mesenteries are traversed by an endoderm lamella, and carry interradial *phacellae* at their

FIG. 5a.

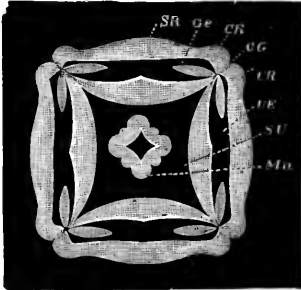

1.

1. Horizontal section through the umbrella and manubrium of *Charybdaea marsupialis* (modified from Claus); *Ma*, manubrium; *SR*, side ridge (perradial); *CR*, corner ridges, separated by *CG*, the interradial corner groove; *Ge*, the genital lamellae in section, projecting from the interradial angles on each side into *UE*, the radial canals of the umbrella; *SU*, the subumbral space. 2. Vertical sections of *Charybdaea marsupialis*, to the left in the plane of an interradius, to the right in the plane of a perradius; *Ma*, manubrium; *EAc*, gastric cavity; *Gh*, gastral filaments (*phacellae*); *CG*, corner groove; *SR*, side ridge; *EnL*, endoderm lamella (line of concrescence of the walls of the enteric cavity of the umbrella, whereby its single chamber is broken up into four pouches); *Ge*, line of attachment of a genital band; *EU*, circular canal, giving origin to *TCa*, the tentacular canal; *Ve*, velarium; *Fr*, frenum of the velum; *Tc*, tentaculocyst. (From Lankester.)

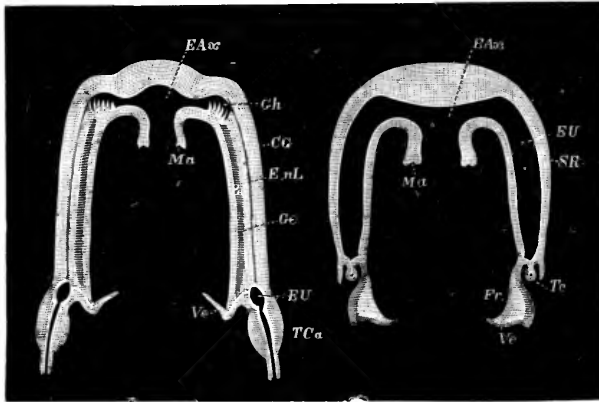

2.

aboral ends. In a few cases eight *adradial arms* carrying digitate filaments grow out from the exumbral body wall, and hang free in the radial canals (*Chirodromus*). As in *Haliclystus*, the *generative organs* grow out from the sides of the interradial mesenteries, and form leaf-shaped projections into the radial canals.

Practically nothing is known of the development of this group.

ORDER 4. Discomedusae.

DEFINITION.—Scyphomedusae with four perradial and four interradial (sometimes more) tentaculocysts. The radial canals are either broad pouches or fine canals, and are often very

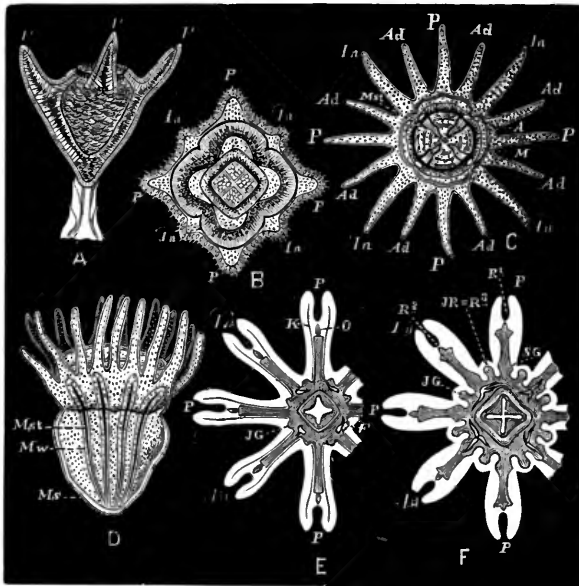

FIG. 6.

Later development of *Chrysaora* and *Aurelia* (after Claus). *A*, scyphistoma of *Chrysaora*, with four perradial tentacles and horny basal perisarc. *B*, oral surface of later stage of scyphistoma of *Aurelia*, with commencement of four interradial tentacles. The quadrangular mouth is seen in the centre; the outline of the stomach wall, seen by transparency around it, is nipped in four places interradially to form the four gastric ridges. *C*, oral surface of a sixteen-tentacled scyphistoma of *Aurelia*. The four gastric interradial ridges are seen through the mouth. *D*, first constriction of the *Aurelia* scyphistoma to form the pile of ephyrae or young medusae (see Fig. 7). The single ephyra carries the sixteen scyphistoma tentacles, which will atrophy and disappear. The four longitudinal gastric ridges are seen by transparency. *E*, young ephyra just liberated, showing the eight bifurcate arms of the disc and the interradial single gastral filaments. *F*, ephyra developing into a medusa by the growth of the adradial regions. The gastral filaments have increased to three in each of the four sets. *A*, margin of the mouth; *Ad*, adradial radius; *F*, gastral filament; *In*, interradial radius; *JG*, adradial gastral canal; *JR*=*R*³, adradial lobe of the disc; *K*, lappet of a perradial arm; *M*, stomach wall; *Mst*, muscle of the mesentery; *Mw*, mesentery; *Ms*, mesoderm; *O*, tentaculocyst; *P*, perradial radius; *R*², interradial radius; *R*³, adradial radius; *SG*, commencement of circular canal.

numerous; they are not separated from each other by laminar mesenteries, and a well-marked endoderm lamella unites them. Development showing alternation of an asexual scyphistomoid with a sexual medusoid generation.

The Discomedusae are probably all a metagenetic hydroid-like form alternating with a sexual medusoid generation. In

structure the "hydroid" differs considerably from that of the Hydromedusae, and is for distinction termed the *Scyphistoma* (scyphula).

STRUCTURE OF THE SCYPHISTOMA.—The gastrula, formed by invagination from the blastula, having been converted into a closed sac by coalescence of the lips of the blastopore, affixes itself to a solid object, and a mouth is formed by an ingrowth of ectoderm or *stomodaeum*, which perforates to the endodermal coelenteron. The appearance of four perradial tentacles is followed by the formation of four interradial, and these by eight adradial tentacles; all sixteen tentacles are solid. In some cases more than sixteen are developed. To this fixed tentaculate organism is applied the name *Scyphistoma* (Figs. 6, *A, B, C, D*; 7). In some cases it secretes a perisarc (Chrysaora).



FIG. 7.

Strobilating scyphistoma of *Aurelia* (from Shipley, after Haeckel). 1, unconstricted base of scyphistoma; 2, site of tentaculocyst; 3, adradial tentacle; 4, marginal guard lappet of future tentaculo-cyst.

Internally the organism presents considerably greater complexity of structure than the hydroid type of Hydromedusae, being built essentially on the same plan as *Haliclystus* among *Stauromedusae*. It has four interradial mesenteries (*taeniolae*), which have a free edge projecting into the gastric cavity below, but are attached in the oral region to the stomodaeum and subumbrella; they are invaded for a short distance by ectodermal *subumbrel funnels*, the muscle cells of which run deep into the mesogloea. *Phacellae* or gastric filaments are not developed, but the thickened edge of the mesentery is probably digestive in function, as in the *Anthomedusae*.

The *Scyphistoma* multiplies (*a*) by stolonar gemmation from creeping horizontal stolons; (*b*) by lateral gemmation, the buds, which are pushed out horizontally, bending vertically downwards, becoming attached to a solid object, and detached from the parent; (*c*) by strobilation.

STROBILATION AND GROWTH OF THE EPHYRA.—The process of strobilation is apparently seasonal. A series of transverse circular furrows constrict the upper or oral part of the *Scyphistoma* (Fig. 7). In the uppermost of the seg-

ments thus indicated, eight bifid lobes grow outwards, each lobe carrying with it the attachment of either a perradial or interradial tentacle. The bases of these tentacles are stated to be converted into the tentaculocysts of the adult medusoid, the eight adradial

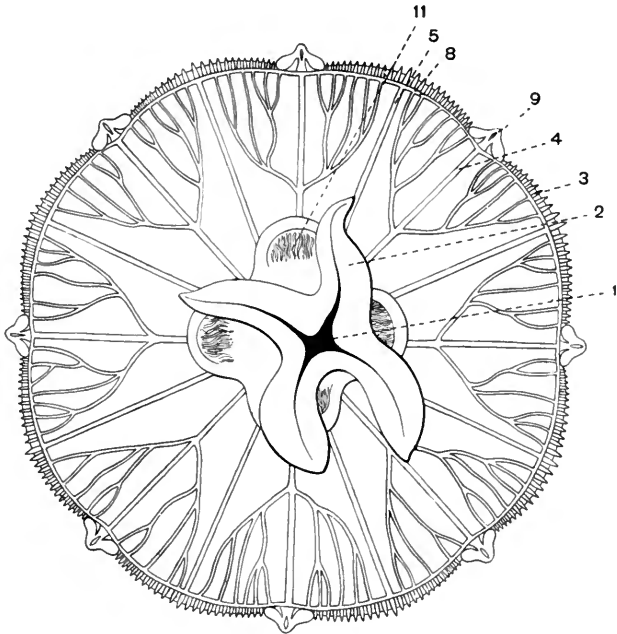

FIG. 8.

Aurelia aurita, from the oral surface. 1, mouth; 2, perradial oral arms; 3, marginal tentacles; 4, perradial branching canal; 5, adradial straight canal; 8, circular canal; 9, tentaculocyst; 11, interradial gastric filaments and generative organs. The subgenital pits are not shown in the drawing; the oral arms have been slightly twisted out of their perradial position. (From Shipley, after Claus.)

tentacles disappearing altogether. A prolongation of the coelenteron, which will form the axis of the future perradial and interradial canals of the adult, runs out into each lobe. At about this stage the entire segment becomes constricted off from the Scyphistoma, and leads a free-swimming existence as an *Ephyra*, the larval form of the future medusoid. Of the lower segments of the Scyphistoma, some, if not all, may also put out sixteen tentacles, and all become constricted off as *Ephyrae*. The basal unconstricted part of the Scyphistoma is stated to become again tentaculate, and to remain quiescent till the next season, when the process of strobilation is repeated.

In the *Ephyra* (Fig. 6, *E*, *F*) the adradial spaces between the lobes gradually fill up by centrifugal growth of the disc, and eight

adradial canals grow into them. The mesenteries lose their attachment to the body wall and are probably converted into phacellae.

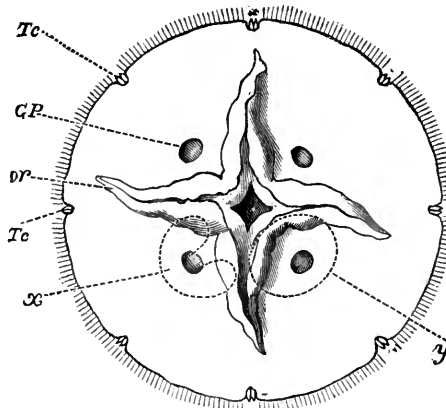

FIG. 9



FIG. 10.

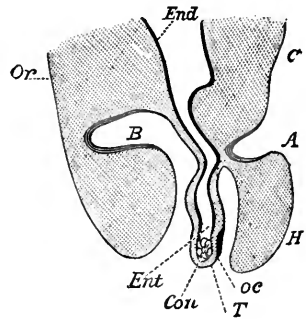

FIG. 11.

9.—Surface view of the subumbrellar or oral aspect of *Aurelia aurita*, to show the position of the openings of the subgenital pits, *GP*. In the centre is the mouth, with four perradial arms corresponding to its angles, *or*. The four subgenital pits are seen to be interradial. *x*, indicates the outline of the roof (aboral limit) of a subgenital pit; *y*, the outline of its floor or oral limit, in which is the opening; *Tc*, tentaculocyst. (After Lankester.)

10.—Tentaculocyst of *Aurelia aurita* from the oral aspect. *CC*, circular canal; *H*, the aboral hood; *L*, the protective lateral lappets; *T*, tentacles; *Tc*, tentaculocyst, carrying an ocellus, and a terminal mass of otoliths; *TC*, endodermal canal of the tentaculocyst; *V*, the "velarium," or thin edge of the bell. The outline of the endodermal canals is dotted.

11.—Tentaculocyst of *Aurelia aurita* (longitudinal section). *A*, superior or aboral olfactory pit; *B*, inferior or adoral olfactory pit; *H*, bridge between the two marginal lappets; *T*, tentaculocyst; *End*, endoderm; *Ent*, endodermal canal continued into the tentaculocyst; *Con*, endodermal concretion (auditory); *oc*, ectodermal pigment (ocellus). The drawing represents a section, taken in a radial vertical plane so as to pass through the long axis of the tentaculocyst. (After Ehner.)

Concrescence of the exumbrellar and subumbrellar endoderm of the coelenteron into a gastral lamella ultimately gives rise to the complicated system of gastric pouches and canals of the adult.

DESCRIPTION OF THE MEDUSOID.—The umbrella is generally more or less flattened, and frequently exhibits externally a coronary furrow which marks off the lappets near the edge of the bell. The exumbrella is often variously marked by aggregations of pigment cells and nematocysts. Throughout the group are recognisable in connection with the edge of the bell, or just above it on the exumbrel surface, at least eight tentaculocysts and sixteen marginal lappets, inherited from the Ephyra.

The *tentaculocysts* (Figs. 10, 11) rarely exceed eight in number, but twelve (Polyclonia) or even sixteen or thirty-two may occur. They lie in incisions at the edge of the umbrella between two lappets, which are, or are parts of, the guard lappets of the eight-rayed Ephyra; they are often protected on the exumbrel aspect by the development of a guard plate (Nausithoe). Each consists of a short stalk, the base of the Ephyra tentacle, with a terminal endodermal mass of crystalline otoliths, covered externally by ectodermal sense cells with long sense hairs; on the exumbrel aspect and proximal end of the stalk lies an ectodermal ocellus. Near the base of the oral aspect of the stalk lies an ectodermal sense pit, and a second sense pit is placed above the whole structure on the exumbrel surface of the guard plate.

In addition to the sixteen *marginal lappets* of the Ephyra, which lie at the sides of and protect the tentaculocysts, the filling up of the eight adradial spaces between the eight primary Ephyralobes results in the production of at least eight secondary marginal lappets, which by fission and intercalation may be very largely increased in number.

The *tentacles* vary considerably in the different sub-orders. In the Cannostomae they are short and solid; in the Semostomae they are long and hollow; they are absent in the Rhizostomae. They may be eight (Pelagia), twenty-four (Chrysaora), or even more numerous (Cyanea).

The *subumbrel cavity* is generally shallow, and no true velum is developed; although the edge of the bell may in a few instances form a thin *velarium* (Aurelia), it bears a different relation to the nervous system, and is never inflected inwards. The subumbrel surface is in most cases perforated by the openings of the four *subgenital pits*. These are chambers (Fig. 9) excavated in the thickness of the subumbrel wall, lined by ectoderm, and lying interradially immediately under the generative organs, but not communicating with the coelenteron; they correspond to, and are perhaps in some cases formed directly from, the subumbrel funnels of the Scyphistoma. In a few forms all four pits become confluent centrally, the four openings persisting (Cannorhiza, Figs. 12, 13). The *manubrium* is well developed, but assumes different forms in the different sub-orders; in Cannostomae it is a simple tube, crucial in

section, with perradial angles, and in some cases provided with short perradial lappets (Palephyra). In the Semostomae these lappets are drawn out into long perradial oral arms (Aurelia) with a median groove, often guarded by frilled edges (Pelagia); the arms may take origin almost directly from the subumbrella, or may spring from a fairly long manubrium. Very rarely each arm bifurcates once (Aurosa). In both these sub-orders a crucial

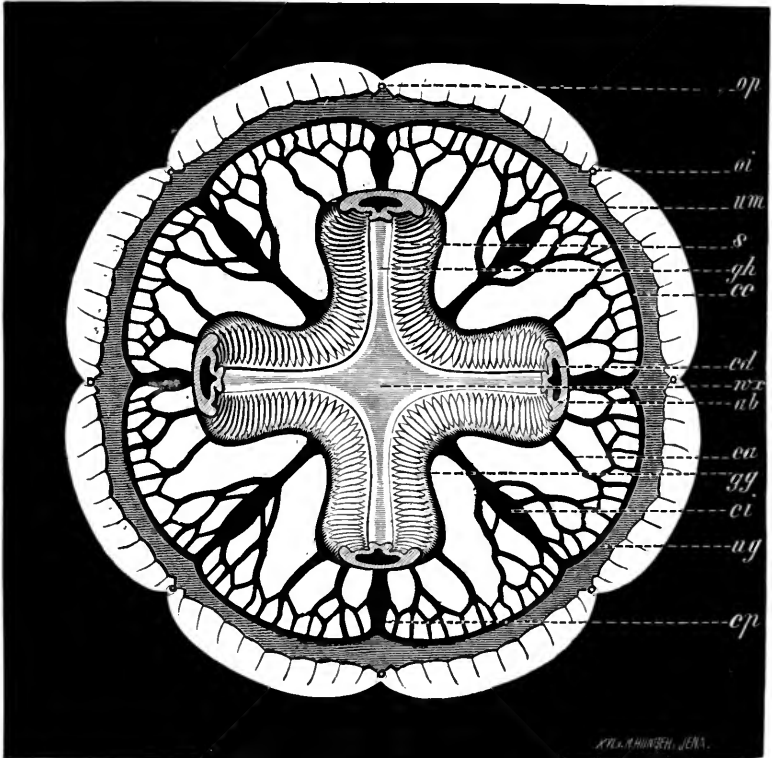

FIG. 12.

Diagram of *Cannonhiza* from the subumbrellar aspect, the arm disc with the eight oral arms having been removed. (From Haeckel.)

mouth is placed in the centre of the manubrium between the bases of the arms. In the Rhizostomae, a Semostoman stage apparently occurs in the development, and is followed by an incomplete concrescence of the frilled edges of the bifurcated arms over the median groove and the mouth; thus, instead of a central mouth, numerous small suctorial openings, numbering often hundreds, are formed along the edges of the arm, which open by short tubes into

eight *brachial canals*, the grooves of *Semostomae* (Fig. 13); these canals unite into a manubrial cavity, which may either open directly into the gastric cavity (*Rhizostoma*), or, owing to the encroachment of the subgenital pits and the diagonal fusion across its opening of the four strong pillars which support the bases of the arms, may communicate with the gastric cavity only by four *perradial pillar canals* (*Cannorhiza*, Figs. 12, 13).

The *gastric cavity* of the *Discomedusae* is generally broad and

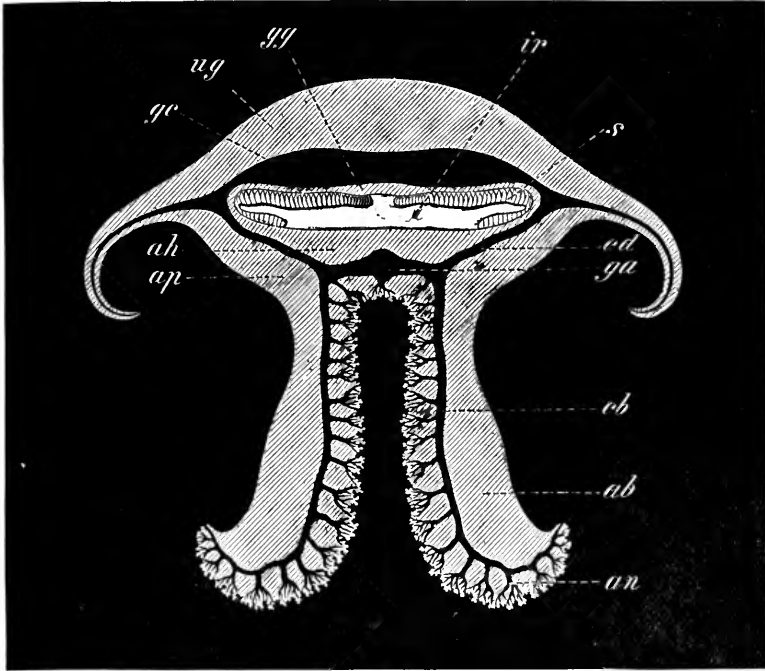

FIG. 13.

Diagram of a longitudinal section of *Cannorhiza*.

Lettering for both figures: *ah*, adradial arm in Fig. 13; *ah*, mass of tissue formed by the concrescence of the arm pillars; *an*, suctorial mouths along the "oral" faces of the arms; *ap*, perradial arm pillar; *cb*, brachial canal, formed by concrescence of its lips over the brachial groove of *Semostomae*; *cc*, circular canal; *cd*, arm-pillar canal; *ci*, interrarial canal; *cp*, perradial canal; *ga*, chamber formed by the union of the brachial canals—the site of the mouth of *Semostomae* is immediately under the end of the reference line; *gc*, gastric cavity, cut off from *ga* by the encroachment of the four subgenital pits and their union into the subgenital porticus; *gg*, *gh*, gastro-genital membrane, composed above of endoderm lining the gastric cavity and forming the generative organs, below of ectoderm lining the subgenital porticus, with mesogloea between the two; *ir*, the subgenital porticus—the centrally confluent subgenital pits, lined by ectoderm; *oi*, interrarial, and *op*, perradial, otocysts; *s*, endodermal generative organs on floor of gastric cavity; *um*, margin of umbrella. (From Haeckel.)

shallow, and exhibits four interrarial pouches, separated by the four perradial arm pillars, strong ridges of thick mesogloea which are continued into and support the arms. From these four

pouches run the radial canals, the arrangement of which falls under two main types. In the one type sixteen very broad and shallow pouches (perradial, interrarial, and adradial) pass to the edge of the bell and end blindly (Pelagia); each may bifurcate, and may give off short caeca, which never anastomose. In the second type narrow canals are formed, primarily to the number of sixteen, which may remain simple (Floscula) or branch (Aurelia) and anastomose (Leptobrachia); the number of canals may

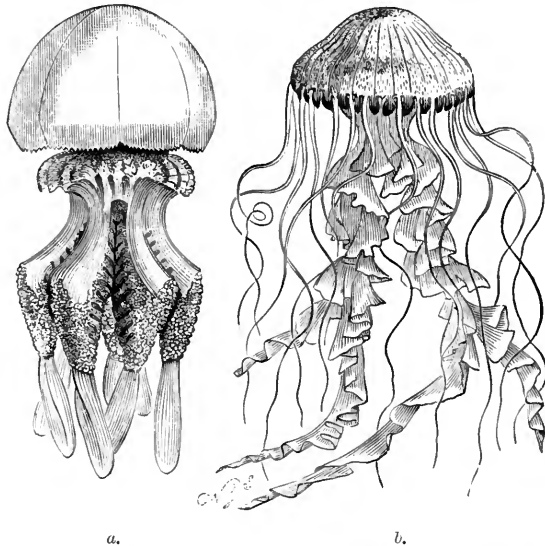

FIG. 14.—a, *Rhizostoma pulmo*; b, *Chrysaora hyoscilla*. (From Lankester.)

amount to thirty-two or sixty-four. In this second type the radial canals open into a circular canal. As in the Hydromedusae, the whole system of radial canals and pouches is produced by a concrescence of exumbrel and subumbrel endoderm, traces of which generally persist throughout life as an endoderm lamella.

The *phacellae* are of the usual character, and interradially placed; they may be only four in number, but are generally very numerous.

The *generative organs* are typically four in number and interrarial in position, and are formed from the subumbrel endoderm either of the gastric cavity or of the radial pouches. In some Cannostomae they become secondarily divided so as to form eight adradial organs (Nausicaa). They are primitively horseshoe-shaped thickenings of the endoderm, either convex centrally (Palephyra), or concave centrally (Aurelia); they may become folded (Pelagia), or thrown into lappets (Chrysaora), and may either be evaginated

as pouches which project on the subumbra surface into the subumbra cavity (Cyanea), or hang freely into the gastric cavity or radial pouches (Rhizostoma). The sexes are separate, except in *Chrysaora*; in this genus some individuals are first male, then hermaphrodite, and finally female only, the ova being confined to the interradial generative organs, the spermatozoa occurring irregularly at any point in the endoderm; other individuals are unisexual throughout life.

CLASSIFICATION AND LIST OF GENERA OF SCYPHOMEDUSAE.

The chief authority for this classification is Haeckel (6); other attempts are to be found in Claus, *Ueber die Classification der Medusen* (Arb. Zool. Inst. Wien, vii. 1888), and Vanhöffen, *Zur System der Scyphomedusen* (Zool. Anz. xiv. 1891).

ORDER 1. **Stauromedusae.** (For definition, see p. 61.)

FAMILY 1. TESSERIDAE. Genera—*Tessera*, Hkl.; *Tesserantha*, Hkl.; *Depastrella*, Hkl.; *Depastrum*, Gosse; *Tesseraria*, Hkl. FAMILY 2. LUCERNARIIDAE. Genera—*Halicystus*, Clark; *Lucernaria*, O. F. Müll.; *Halicythus*, Clark; *Craterolophus*, Clark; *Lucernosa*, Antipa. FAMILY 3. CAPRIIDAE. Genus—*Capria*, Antipa.

ORDER 2. **Peromedusae.** (For definition, see p. 63.)

FAMILY 1. PERICOLPIDAE. Genera—*Pericolpa*, Hkl.; *Pericrypta*, Hkl. FAMILY 2. PERIPHYLLIDAE. Genera—*Peripalma*, Hkl.; *Periphylla*, Steenstr.; *Periphema*, Hkl.

ORDER 3. **Cubomedusae.** (For definition, see p. 64.)

FAMILY 1. CHARYBDEIDAE. Genera—*Procharagma*, Hkl.; *Procharybdis*, Hkl.; *Charybdaea*, Pér. Les.; *Tamoya*, F. Müll. FAMILY 2. CHIRODROPIDAE. Genera—*Chiropsalmus*, L. Agass.; *Chirodopus*, Hkl.

ORDER 4. **Discomedusae.** (For definition, see p. 67.)

SUB-ORDER 1. CANNOSTOMAE.

Definition.—The mouth is simple and devoid of arms. The tentacles are solid and generally short.

FAMILY 1. EPHYRIDAE (in many cases probably larval forms). Genera—*Ephyra*, Pér. Les.; *Palephyra*, Hkl.; *Zonephyra*, Hkl.; *Nausicaa*, Hkl.; *Nausithoe*, Köll.; *Nauphanta*, Hkl.; *Atolla*, Hkl.; *Collaspsis*, Hkl. FAMILY 2. LINERGIDAE. Genera—*Linerges*, Hkl.; *Linantha*, Hkl.; *Liniscus*, Hkl.; *Linuche*, Esch.

SUB-ORDER 2. SEMOSTOMAE.

Definition.—The mouth is provided with four oral arms. The tentacles are hollow, and generally long.

FAMILY 3. PELAGIDAE. Genera—*Pelagia*, Pér. Les.; *Chrysaora*, Pér. Les.; *Dactylometra*, L. Agass. FAMILY 4. CYANEIDAE. Genera—*Procyanea*, Hkl.; *Medora*, Couthouy; *Stenoptycha*, L. Agass.; *Desmonema*, L. Agass.; *Drymonema*, Hkl.; *Cyanea*, Pér. Les.; *Patera*, Less.; *Melusina*, Hkl. FAMILY 5. FLOSCULIDAE. Genera—*Floscula*, Hkl.; *Floresca*, Hkl. FAMILY 6. ULMARIDAE. Genera—*Ulmaris*, Hkl.; *Umbrosa*, Hkl.; *Undosa*, Hkl.; *Sthenonia*, Esch.; *Phacellophora*, Brandt; *Aurelia*, Pér. Les.; *Aurosa*, Hkl.; *Auricoma*, Hkl.

SUB-ORDER 3. RHIZOSTOMAE.

Definition.—The mouth is obliterated by the central fusion of the four bifurcated oral arms, and is functionally replaced by numerous sucking mouths on their "oral" aspect; tentacles are absent.

FAMILY 7. TOREUMIDAE. Genera—*Archirhiza*, Hkl.; *Toreuma*, Hkl.; *Polyclonia*, L. Agass.; *Cassiopeja*, Pér. Les.; *Cephea*, Pér. Les.; *Polyrhiza*, L. Agass. FAMILY 8. PILEMIDAE. Genera—*Toxoclytus*, L. Agass.; *Lychnorhiza*, Hkl.; *Phyllorhiza*, L. Agass.; *Eupilema*, Hkl.; *Pilema*, Hkl.; *Rhopilema*, Hkl.; *Brachiolophus*, Hkl.; *Stomolophus*, L. Agass.; *Nectopilema*, Fewk. FAMILY 9. VERSURIDAE. Genera—*Haplorhiza*, Hkl.; *Cannorhiza*, Hkl.; *Versura*, Hkl.; *Crossostoma*, L. Agass.; *Cotylorhiza*, L. Agass.; *Stylorhiza*, Hkl.; *Loborhiza*, Vanhöffen. FAMILY 10. CRAMBESSIDAE. Genera—*Crambessa*, Hkl.; *Mastigias*, L. Agass.; *Eucrambessa*, Hkl.; *Thysanostoma*, L. Agass.; *Himantostoma*, L. Agass.; *Leptobrachia*, Brandt; *Leonura*, Hkl.; *Cramborhiza*, Hkl.

LITERATURE OF SCYPHOMEDUSAE.

1. *Clark*. (Lucernariae and their Allies.) Smithsonian Contrib. to Knowledge, 242. 1878.
2. *Claus*. (Studien. ü. Polypen u. Quallen der Adria.) Denkschr. Akad. Wien, 1877.
3. *Ibid.* (Unters. ü. Charybdæa marsupialis.) Arb. Zool. Inst. Wien, 1878.
4. *Ibid.* Unters. ü. d. Organismen u. Entwickl. d. Medusen, 1883.
5. *Ibid.* (Entwickl. d. Scyphostoma.) Arb. Zool. Inst. Wien, ix., x., 1891-93.
6. *Haeckel*. System der Medusen, 1879-80.
7. *Ibid.* (Deep Sea Medusae.) Chall. Rep. Zool. iv., 1882.
8. *Hertwig*. (Organismus der Medusen.) Denkschr. Ges. Jena, ii., 1878.
9. *Ibid.* Nervensystem und Sinnesorgane der Medusen, 1878.
10. *Hesse*. (Nervensyst. u. Sinnesorgane von Rhizostoma.) Zeit. wiss. Zool. ix., 1895.
11. *Jackson*. Forms of Animal Life, pp. 780-790, 1888.
12. *Lankester*. Encyclopaedia Britannica, ed. ix., Article Hydrozoa, 1881.
13. *Schewiakoff*. (Beitr. z. Kenntniss d. Acalephenauges.) Morph. Jahrb. xv., 1889.

INDEX

To names of Classes, Orders, Sub-Orders, and Genera ; and to technical terms.

- Abyla*, 56
Acanthella, 55
Acanthocladium, 29, 54
Acaulis, 53
Acharadria, 53
 acrocyst, 28, 45
Actinogonium, 53
 actinula larva, 22
 adradial canals, 6
 adradial, 4 (Fig. 7)
Aegina, 55
Aeginella, 33, 55
Aegineta, 33, 55
 Aeginidae, 55
Aeginodiscus, 55
Aeginodorus, 55
Aeginopsis, 35, 55
Aeginorhodus, 55
Aeginura, 34, 55
Aequorea, 24, 54
 Aequoridae, 54
Agalma, 47, 56
 Agalmidae, 56
Agalmopsis, 39, 40, 56
Aglaïsna, 56
Aglantha, 30, 32, 55
Aglaophenia, 23-25 (Fig. 31), 27, 28 (Fig. 37), 29, 54
 Aglaopheniidae, 54
Aglaura, 32, 55
 Aglauridae, 55
Aglauropsis, 55
Aglicera, 55
Allopora, 35-37 (Fig. 43a), 38, 55
Alophota, 57
 alternation of generations, 18
Amalthea, 16, 52
Ametrangia, 54
Amphicaryon, 56
Amphicodon, 52
Amphinema, 52
Amphirrhoa, 56
 ampullae (medusoid), 36, 38
Angela, 57
Angelopsis, 57
Anisicola, 23
Antennularia, 55
Anthemodes, 56
 Anthomedusae, 11-22, 52
Anthophysa, 56
 Anthophysidae, 56
Apolemia, 39, 45, 56
 Apolemiidae, 56
Apolemopsis, 56
Archirhiza, 76
Arethusa, 57
Armenista, 56
Astylus, 37, 38 (Fig. 43a), 55
Athoralia, 56
Athoria, 40, 45, 56
 Athoriidae, 56
Athorybia, 56
Atolla, 75
Atractylis, 53
Auralia, 57
Aurelia, 6 (Fig. 7bis), 9 (Fig. 10b), 61, 67, 70, 76
Auricoma, 76
 Auronectae, 56
 aurophore, 42
Aurophysa, 57
Aurosa, 72, 76
Azygoplou, 54

Bassia, 56
Bathycodon, 52
Bathypphysa, 56
Berenice, 26, 54
Bimeria, 53
 blastocoele, 22
 blastostyle, 14
 blastula, 2, 22
Bougainvillea, 11-14 (Fig. 19), 16-19, 20, 53
 Bougainvillidae, 53
 brachial canal, 73
Brachiolophus, 76
 bract, 40
 budding of hydroid, 3, 4
 — of medusoid, 17-19

Calanphora, 54
Calicarpa, 55
 Calicarpidae, 55
Callitara, 16, 52
Calpe, 56
Calycella, 23, 28, 54
 Calyconectae, 56
Calyplostastea, 53
Campaniclava, 53
Campanopsis, 23
Campanularia, 23, 27, 29, 54
 Campanularidae, 54
Campanulina, 26, 27, 54
Cannophysa, 57
Cannorhiza, 71-73, 76
 Cannostomae, 75
Cannota, 54
 Cannotidae, 54
Capria, 75
 Capriidae, 75
Caravella, 57
Carmarina. See *Geryonia*
Carmaris, 55
Cassiopeja, 76
Cutablenna, 52
 centradenia, 42
 centripetal canals, 32
Cephea, 76
Ceratella, 13, 53
 Ceratelladae, 53
Charybdaea, 61, 65, 66, 75
 Charybdeidae, 75
 Chirodropidae, 75
Chirodropus, 65, 66, 75
Chiropsalmus, 75
Chrysaora, 67 (Fig. 6), 68, 71, 74 (Fig. 14b), 75, 76
Cionistes, 53

- Circalia*, 56
 Circaliidae, 56
 circular canal, 5
 cirrhi, 24
Cladocanna, 54
Cladocarpus, 54
Cladocoryne, 11, 53
 Cladocorynidae, 53
Cladonema, 17, 19, 53
 Cladonemidae, 53
Clathrozoön, 23, 55
Clava, 15 (Fig. 21), 20, 53
Clavatella, 16, 17, 19, 53
 Clavatellidae, 53
 Clavidae, 53
Clavula, 53
Clytia, 23, 54
 cnidoblasts, 6
 cnidocil, 6
 cnidophore, 16
 Codonidae, 52
Codonium, 17, 52
Codonorchis, 52
 coelenteron, 2
 coenenchyme, 35
 coenosarc, 4
 coenosteum, 35
Collaspis, 75
 colletocystophore, 62
 colony formation, 4
Conis, 52
Conopora, 55
Coppinia, 27, 55
 corbula, 29
Cordylophora, 13, 18 (Fig. 29), 20, 53
 cordylus, 9
 cormidium, 45
Corydendrium, 13, 53
Corymorpha, 12, 15 (Fig. 23), 16, 53
 Corymorphidae, 53
Coryne, 11, 13, 20, 21, 53
Corynetes, 52, 53
 Corynidae, 53
Corynopsis, 53
Cotylorhiza, 76
Crambessa, 76
 Crambessidae, 76
Cramborhiza, 76
Craterolophus, 75
Crossostoma, 76
Cryptohelia, 36, 55
Cryptolaria, 54
Ctenaria, 18 (Fig. 26), 53
Cubogaster, 52
Cuboides, 56
 Cubomedusae, 64, 75
Cucubalus, 56
Cucullus, 56
Cunantha, 33, 34
 Cunanthidae, 55
Cunarcha, 55
Cuneolaria, 56
Cunina, 7 (Fig. 10), 11, 34, 35, 55
Cunissa, 55
Cunoctantha, 35, 55
Cunoctona, 55
Cupidita, 56
Cuspidella, 54
Cyanea, 71, 75, 76
 Cyaneidae, 76
 cyclosystem, 36
Cymba, 56
Cymbonectes, 42, 56
Cystalia, 57
 Cystaliidae, 57
 cyston, 45
 Cystonectae, 57
Cytaeis, 52
Cytandraea, 52
Dactylometra, 76
 dactylopore, 35
 dactylozooid, 16
Dawsonia, 50
Dehitella, 53
Dendroclava, 53
Dendrograptus, 50
 Dendroidea, 50
Dendronema, 53
Depastrella, 75
Depastrum, 75
Desmalia, 56
Desmonema, 76
Desmophyes, 56
 Desmophyidae, 56
Desmoscyphus, 54
 diblastula, 2, 22, 60 (Fig. 1)
 Dichograptidae, 50
Dicodonium, 52
Dicoryne, 21, 22, 53
Dicranocranna, 54
 Dicranograptidae, 50
Dictyocladium, 54
Dictyonema, 50
Dicymba, 56
 digestive cells, 7
Dimorphograptus, 50
Dinema, 52
Dipetasus, 55
Diphasia, 23, 24, 30, 54
Diphyes, 40, 42, 56
 Diphyidae, 56
Diphyopsis, 56
Dipleurosoma, 54
Diplocheilus, 54
Diplocyathus, 54
 Diplograptidae, 50
Diphysa, 56
Diplura, 52
 Diprionidae, 50
Dipurena, 52
Discalia, 55
 Discalidae, 55
Discolabe, 56
 Discolabidae, 56
 Discomedusae, 67, 75
Disconalia, 55
 Disconnectae, 55
Dissonema, 24, 53
Distichopora, 35, 36, 38, 55
Doramasia, 56
Drymonema, 76
Dyscannota, 54
Dysmorphosa, 52
 ectoderm, 2
 — of hydroid, 6, 7
 — of medusoid, 8
Ectopleura, 52, 53
Eleutheria, 17, 53
 endoderm, 2
 — of hydroid, 7, 8
 — of medusoid, 11
 — lamella, 5
 entocodon, 18
Epenthesis, 54
 Ephyra, 68, 70, 75
 Ephyridae, 75
Epibulia, 47, 57
 Epibulidae, 57
 epithelio-muscular cells, 6
Errina, 37 (Fig. 43a), 55
Ersaea, 56
 Ersaeidae, 56
 Ersaeome, 41 (Fig. 47), 45
Euchilota, 10 (Fig. 13), 54
Eucope, 24, 26, 54
 Eucopidae, 54
Eucopium, 54
Eucrambessa, 76
 Eudendriidae, 53
Eudendrium, 11, 13, 14, 16, 18 (Fig. 28), 20-22, 53
Eudozella, 56
 Eudoxidae, 56
 Eudoxome, 45
Euphysa, 16, 52
Eupilema, 76
Eutima, 54
Eutimalphes, 54
Eutineta, 54
Eutimium, 54
 exumbrel (adj.), 5
 false blastostyle, 14
 festoon canal, 34
Fillellum, 54
 fission, in hydroids, 21, 30
 — in medusoids, 30

- Floresca*, 76
Floscula, 74, 76
 Flosculidae, 76
Forskålea, 39, 40, 45, 56
 Forskålidae, 56
Forskålopsis, 56
freaula, 65

Galeolaria, 45, 56
 ganglion cells, 7
Garveia, 53
 gastral lamella, 5
 gastric cavity, 5
 gastropore, 35
 gastrozoid, 36
 gastrula, 2, 22
Gemmaria, 53
 gemmation. See budding
 generative cells, 11
 — origin and migration in
 Hydromedusae, 20, 21
 — in Leptomedusae, 29
Geryones, 31, 55
Geryonia, 30-33, 35, 55
 Geryonidae, 55
Globiceps, 52
Glossocodon, 55
Glossoconus, 55
 gonodendron, 40
 gonophore, 5
 gonostyle, 40
 gonotheca, 6, 27
Gonothyræa, 27, 29, 54
 gonozoid, 5
Gononema, 54
Gossea, 55
Grammaria, 54
 Grammariidae, 54
 Graptolithidae, 50, 51
 Graptoloidea, 50
 gubernaculum, 27, 30
 Gymnoblaster, 52
Gymnocoryne, 53

Halatractus, 53
 Haleciidae, 54
Halecium, 23, 37, 54
Haleremita, 53
Halicystus, 61-64 (Fig. 3),
 75
Halicornaria, 54
 Halicornariidae, 54
Halicynthus, 75
Halispiphonia, 54
Halistemma, 47, 56
Halmomises, 54
Halocordyle, 53
Haloikema, 54
Halopsis, 54
Halopyramis, 56
Haplorhiza, 76

Hebella, 54
Heterocordyle, 53
Heteropton, 55
Heterostephanus, 53
Himantostoma, 76
Hippocrene, 52
Hippopodius, 56
Hippurella, 55
Homoenema, 55
Hybocodon, 52
Hydra, 2, 3, 11-13, 20, 22,
 53
Hydractinia, 13, 14, 15
 (Fig. 22), 16, 21, 53
 Hydractiniidae, 53
Hydrallmania, 54
 hydranth, 2
Hydranthea, 53
Hydrella, 54
 Hydridae, 53
 hydrocaulus, 5
 Hydroceratinidae, 55
 hydrocladia, 23
 Hydrocorallinae, 35-38, 55
 hydrocyst, 39
 hydroecium, 42
 hydroid, 2-5
 — histology, 6-8
 Hydrolaridae, 53
 hydrotheca, 5
 Hydromedusae, 1
 hydrophyllium, 40
 hydrorhiza, 5
 Hydrozoa, 1
Hypanthea, 54
Hypopyxis, 54
 Hypostome, 3

Idia, 54
 Idiidae, 54
 infundibulum, 42
 interradian canals, 6
 interradian, 4 (Fig. 7)
 interstitial cells, 7
 involucre, 39
Irene, 25 (Fig. 33), 54
Irenium, 54

Labiopora, 55
Lafoea, 23, 54
Laodice, 24, 54
Laomedea, 27, 54
Lar, 16, 17, 53, 54
 lens, 9
Leonura, 76
Leptobrachia, 74, 76
 Leptograptidae, 50
 Leptomedusae, 22-30, 53
Leptoscyphus, 54
Lictorella, 54
Lilæa, 56

Lilyopsis, 56
Linnocœa, 52
Linnocnida, 47-49
Linnocodium, 47-49
Linantha, 75
Linerges, 75
 Linergidae, 75
Liniscus, 75
Linophysa, 57
Linuche, 75
Liriantha, 55
Liriopæ, 30, 32, 55
Lizusa, 52
Lizzella, 52
Lizzia, 10 (Fig. 11), 16, 52
Loborhiza, 76
Lovénella, 54
Lucernaria, 62, 75
 Lucernariidae, 75
Lucernosa, 75
Lychnagalma, 56
Lychnorhiza, 76
Lytocarpus, 29, 54
Lytoscyphus, 54

 machopolypts, 24
 manubrium, 5
 Margelidae, 52
Margelis, 52
Margellium, 52
 marginal cirrhi, 24
 — funnels, 26
 — tubercles, 25
Marmanema, 32, 55
 marsupium, 28
Mastigias, 76
 meconidium, 28
Medora, 76
 medusoid, 5
 — histology of, 8-11
Melicertella, 54
Melicertidium, 54
Melicertissa, 54
Melicertum, 26, 54
Melophysa, 56
Melusina, 76
Merona, 53
 mesentery, 61
 mesogloea, 2
 — of hydroid, 8
 — of medusoid, 11
 mesogonium, 32
Mesonema, 54
 metagenesis, 18
Microhydra, 11, 49, 53
Millepora, 35-38, 55
 Milleporidae, 55
Mitrocoma, 22, 54
Mitrocomella, 54
Mitrocomium, 54
Mitrophyes, 56



- Modeeria*, 52
 Monobrachiidae, 53
Monobrachium, 53
 Monocaulidae, 53
Monocaulus, 53
 Monogastricae, 56
 Monograptidae, 50
Monophyes, 56
 Monophyidae, 56
 Monoprioidae, 50
 monosiphonic (adj.), 23
Muggiaea, 56
Myrionema, 53
 Myrionemidae, 53
Myriothela, 11, 22, 53
 Myriothelidae, 53

 Narcomedusae, 33-35, 55
Nauphanta, 75
Nausicaa, 74, 75
Nausithoe, 71, 75
Nectalia, 56
 Nectalidae, 56
 nectocalyx, 40
 nectophore, 40
Nectophysa, 57
Nectopilema, 76
 nectozoid, 40
 nematocyst, 6
 nematophores, 24
Nemertesia, 55
Nemopsis, 17, 52

Obelaria, 54
Obelia, 23-25 (Fig. 32),
 26-28 (Fig. 35), 29, 54
 ocellus, 9
Octocanna, 54
Octonema, 53
Octorchandra, 54
Octorchidium, 54
Octorchis, 26, 54
 oleocyst, 45
Olindias, 31, 32, 55
Opercularella, 54
Ophiodes, 24, 54
Orchistoma, 26, 54
 otocyst, 9
 otolith, 9
 otoporpa, 34

Palephyra, 72, 74, 75
 palpacle, 39
 palpoil, 6
 palpon, 39
Pandaea, 52
Pantachogon, 55
Patera, 76
Pectanthis, 30, 31, 55
Pectis, 55
Pectyllis, 55

 pedalia, 63
Pegantha, 55
 Peganthidae, 55
Pegasia, 55
Pelagia, 71, 72, 74, 76
 Pelagidae, 76
Pennaria, 53
 Pennariidae, 53
Pericolpa, 64, 75
 Pericolpidae, 75
Pericrypta, 75
Perigonimus, 12, 13, 15
 (Fig. 20), 16, 17, 53
Peripalma, 75
Periphema, 75
Periphylla, 64, 75
 Periphyllidae, 75
 perisarc, 5
Perisiphonia, 54
 Perisiphoniidae, 54
 Peromedusae, 63, 75
 peronia, 31, 34
 perradial canals, 6
 perradii, 64 (Fig. 7)
Persa, 55
Petachnum, 55
Petasata, 55
 Petasidae, 55
Petasus, 32, 55
 phacella, 61
Phacellophora, 76
Phialidium, 10 (Fig. 12), 54
Phialis, 54
Phialum, 54
 phylactocarp, 29
 phyllocyst, 40
 Phyllograptidae, 50
Phyllophysa, 56
Phyllorhiza, 76
 phyllozoid, 40
Physalia, 40, 45, 46 (Figs.
 49, 51), 57
 Physaliidae, 57
 Physonectae, 56
Physophora (Fig. 45), 41,
 56
Pilema, 76
 Pilemidae, 76
 pillar canal, 73
 pinnae, 23
 pistillum, 42
 planula, 22
Pleurophysa, 57
Ptiobothrus, 55
Plumularia, 23, 24, 27, 55
 Plumulariidae, 55
 pnenmatophore, 40
Pneumophysa, 57
Podocoryne, 12, 14, 16, 21,
 53
 Podocorynidae, 53

Polycanna, 24, 26, 54
Polyclonia, 71, 76
Polycolpa, 55
 polymorphism, Antho-
 medusae, 14-16, 20, 21
 — Leptomedusae, 24, 26-
 29
Polyorchis, 54
Polyphyes, 56
 Polyphyidae, 56
 polypite, 39
Polyplumaria, 55
Polypodium, 21
Polyrhiza, 76
 polysiphonic (adj.), 23
Polycenia, 55
Porpalia, 56
Porpema, 56
Porpita, 43 (Fig. 48a), 56
Porpitella, 56
 Porpitiidae, 56
Praya, 45, 56
Proboscidactyla, 54
Procharagma, 65, 75
Procharybdis, 65, 75
Procyanea, 76
Proticara, 52
Protohydra, 21, 49, 53
 pseudo-manubrium, 31
Pteronema, 53
Pterophysa, 57
Ptychogena, 54

 radii, 4 (Fig. 7)
 rami, 23
 ramuli, 23
Rataria, 56
Rathkea, 52
 Retioloidea, 51
Rhegmatodes, 54
Rhizogeton, 53
Rhizophysa, 45, 57
 Rhizophysidae, 57
Rhizostoma, 74 (Fig. 14a)
 75
 Rhizostomae, 76
Rhodalia, 57
 Rhodaliidae, 57
Rhodophysa, 56
Rhopalonema, 10 (Fig. 14),
 11, 32, 55
Rhopilema, 76

Salacia, 54, 57
 Salaciidae, 57
Saphenella, 54
Saphenia, 54
Sarsia, 16, 17 (Fig. 25), 52
Schizocladium, 30
Schizotricha, 55

- Sciurella*, 55
 scyphistoma, 61, 68
 Scyphomedusae, 60-76
 Scyphozoa, 1
 scyphula, 68
 Semostomae, 76
 sense cells, 6
 — organs, 9-11
Sertularella, 27, 29, 54
Sertularia, 27, 28 (Fig. 36), 54
 Sertulariidae, 54
 sicula, 50
 siphon (siphonophora), 39
 Siphonophora, 38-47, 55
Slabberia, 52
Sminthonema, 31
 Solmaridae, 55
Solmaris, 33, 35, 55
Solmissus, 55
Solmoneta, 55
Solmundella, 55
Solmundus, 55
 somatocyst, 45
 spadix, 20
Sphaerocoryne, 53
Sphaeronectes, 56
Sphenoides, 56
Sphyrophysa, 56
Spinipora, 35, 37, 55
Spongicola, 53
 Spongicolidae, 53
Sporadopora (Fig. 43b), 38, 55
 sporosac, 20
Stauraglavra, 55
Stauridium, 53
Staurobanchium, 54
Staurodiscus, 26, 54
 Stauromedusae, 61, 68, 75
Staurophora, 54
Staurostoma, 24, 54
Staurotheca, 54
Steenstrupia, 52
Stenohelia, 55
Stenoptycha, 76
Stephalia, 45, 57
 Stephalidae, 57
Stephanomia, 56
Stephanophyes, 56
 Stephanophyidae, 56
Stephanoscyphus, 53
Stephanospira, 56
Stephonalia, 57
Sthenonia, 76
Stomobranchium, 54
Stomolophus, 76
Stomotoca, 52
Streptocaulus, 54
Strobalia, 56
Stylactella, 53
Stylactis, 53
Stylaster, 35-37, 55
 Stylasteridae, 55
 style (calcareous), 36
Stylorhiza, 76
 subgenital pit, 61, 71
 subumbrel (adj.), 5
 — funnel, 61
 — papillae, 26
Syncoryne, 17, 53
Syndictyon, 52
 Synthecidae, 54
Syntheticium, 54
 tabulae, 36
 taeniolae, 61
Tamoya, 75
 tentacle, 3
 tentaculocyst, 9, 70 (Figs. 10, 11), 71
 tentillum, 39
Tessera, 61-63, 75
Tesserantha, 62, 75
Tesseraria, 75
 Tesseridae, 75
Tetranema, 53
Tetraplatia, 49
Tetrapteron, 49
Thamnitis, 52
Thamnostoma, 52
Thamnostylus, 52
Thaumantias, 30, 53, 54
 Thaumantidae, 53
Theocladium, 54
Thuiaria, 54
Thyroscyphus, 54
Thysanostoma, 76
Tiara, 16, 52
Tiarella, 53
Tiaridae, 52
Tiaropsis, 54
Tina, 54
Toreuma, 76
 Toreumidae, 76
Toxoclytus, 76
Toxorchis, 54
 tracheae, 42
 Trachomedusae, 30-33, 55
Trachynema, 33, 55
 Trachynemidae, 55
Trichydra, 55
 trophozoid, 2
Tubiclava, 53
Tubularia, 11, 14, 16 (Fig. 24), 17, 20, 22, 53
 Tubulariidae, 53
 Turridae, 53
Turris, 52, 53
Turritopsis, 35, 52
 Ulmaridae, 76
Ulmaris, 76
 Umbrella, 5
Umbrosa, 76
Undosa, 76
 velarium, 61
Veella, 39, 40, 42, 43 (Fig. 48a), 46 (Fig. 50), 56
 Velellidae, 56
 velum, 5
Versura, 76
 Versuridae, 76
 virgula, 50
Vogtia, 56
Vorticlava, 53
Willetta, 54
Willsia. See *Lar*
Wrightia, 53
Zanclea, 53
Zonephyra, 75
Zygocanna, 54
Zygocannota, 54
Zygocannula, 54
Zygodactyla, 54

CHAPTER VI.

THE ANTHOZOA.¹

CLASS ANTHOZOA.

SUB-CLASS 1. ALCYONARIA.

GRADE A. PROTALCYONACEA (no Orders).

GRADE B. SYNALCYONACEA.

- Order 1. **Stolonifera.**
- „ 2. **Alcyonacea.**
- „ 3. **Pseudaxonia.**
- „ 4. **Axifera.**
- „ 5. **Stelechotokea.**
- „ 6. **Coenothecalia.**

SUB-CLASS 2. ZOANTHARIA.

GRADE A. PARAMERA.

- Order 1. **Cerianthidea.**
- „ 2. **Antipathidea.**
- „ 3. **Zoanthidea.**
- „ 4. **Edwardsiidea.**
- „ 5. **Proactinia.**

GRADE B. CRYPTOPARAMERA.

Order 6. **Actiniidea.**

Sub-Order 1. **Malacactinia.**

„ 2. **Scleractinia (= Madreporaria).**

Section 1. **Aporosa.**

- „ 2. **Fungacea.**
- „ 3. **Perforata.**

THE animals which we now class together as Anthozoa have been familiar to naturalists from the days of antiquity, but our knowledge of their true nature and affinities is of comparatively recent date. To this day we are far from being able to give a satisfactory account of the relationships of the different groups comprised in the class.

¹ By G. C. Bourne, M.A.

To the earliest authors of antiquity the larger and more striking members of the Anthozoa were partly animal, partly vegetable productions, and hence they were known as zoophytes (*ζωόφυτα*), a name which is still in popular use. But many of the Anthozoa, particularly those which have conspicuous horny or calcareous skeletons, were for a long time regarded as mineral products, or in some cases were fancifully supposed to have the double nature of plants and minerals. The popular conception of coral was expressed by Ovid in the fourth book of the *Metamorphoses*.—

nunc quoque corallii eadem natura remansit ;
 duritiam tacto capiunt ut ab aere, quodque
 vimen in aequore erat, fiat super aequore saxum.

It is true that Aristotle had long before this recognised the animal nature of the ordinary sea-anemones or Actinians, which he described sometimes under the name of "Cnidæ," sometimes of "Acalephæ"; the Medusæ were also included by him under the same name. Aristotle's observations on Actinians and Medusæ are given in the sixth chapter of the fourth book of the *Historia animalium*, and it was long before any substantial addition was made to them. Theophrastus, a pupil of Aristotle, regarded the precious coral of commerce as a mineral which, because of its red colour, was comparable to haematite; but the Gorgonians he considered to be plants. Several of the authors of antiquity fell into the same error of regarding different forms of Anthozoa as plants; and Pliny, who was acquainted with a considerable number of them, describes some as plants, some as minerals, and others as occupying an intermediate position between the animal and vegetable kingdoms. "Equidem et his inesse sensum arbitrator quæ neque animalium neque fructicum sed tertiam quamdam ex utroque naturam habent; urticis dico et spongiis" (*Historia naturalis*, lib. ix. ch. 68).

Amongst the species described by Pliny are several Gorgonians and two forms which he described as marine plants under the names of "Isis crinis" and "Charitoblepharon." They may have been Antipatharia or Pennatulids.

From the days of Pliny until the sixteenth century no addition was made to the knowledge of the Anthozoa. But we find that the encyclopaedists described and figured Actinians as animals. Rondelet (1534) and Belon (1551) described them in their works *de piscibus marinis*, and their statements were accepted and repeated by Wotton (1552), Conrad Gesner (*de aquatilibus*, 1558), Aldrovandus (*Animalia exsanguia, Zoophyta*, 1606), and John Johnston (*de exsanguibus aquaticis*, 1657). But the prevailing error which regarded the colonial forms as plants, led to the Anthozoa being chiefly studied by botanists. Lobel, for instance, in 1591 gave drawings

of six species which are recognisable as (1) *Madrepora oculata*; (2) *Dendrophyllia ramea*; (3) *Corallium rubrum*; (4) *Antipathes*; (5) and (6) *Gorgonians*.

Theodore Tabernaemontanus extended the error and figured amongst marine plants, not only the precious red coral and some Gorgonians, but also an Actinian, thus taking a step backwards from the position already gained by Aristotle. Similarly we find Gorgonians and Corals described as plants by Tournefort and Ferrante Imperato. All these authors seem to have been acquainted only with the dry condition of Corals and Gorgonians. The first step in advance was made by Paul Boccone, who, in the seventeenth century, conceived the idea of accompanying the coral divers on their expeditions from Messina in order to study corals in the fresh condition. He showed that the branched axis which forms the major part of the red coral is covered in the fresh condition with a soft tissue, and he discerned in this tissue the radiate pores of the retracted polyps. He combated the view that the coral was a plant, but fell into the still graver error of explaining their nature to be that of a simple stony concretion. Similar investigations were undertaken at a later date by the Comte de Marsilli, and by an Englishman named Shaw, both of whom regarded corals as plants, and their views were adopted in full by the illustrious Réaumur.

The discovery of the true nature of Corals and Gorgonians is due to Jean André de Peyssonel, a native of Marseilles, who made a number of observations on corals on the coast of Barbary, and kept several forms alive in aquaria. He saw the expanded polyps, and recognised their true nature, and he made some observations on their anatomy: "Je fis fleurir le corail dans des vases pleins d'eau de mer et j'observais que ce que nous croyions être la fleur de cette prétendue plante n'était, au vrai, qu'une insecte semblable à une petite ortie ou poulpe. Cette insecte s'épanouit dans l'eau et se ferme à l'air, ou lorsque je versais des liqueurs acides, ou que je le touchais avec la main j'avais le plaisir de voir remuer les pattes ou pieds de cette ortie."

Peyssonel's observations were laid before the Academy of Sciences of France in 1727, but his views were strongly opposed by Réaumur, whose authority was sufficient to condemn them. It was not till 1751 that they found full expression and acceptance at the hands of the Royal Society of London, and were fully published in London under the title of *Traduction d'un article des Transactions Philosophiques sur le Corail*. In the meantime Trembley had made his classical researches on Hydra, and had communicated them to Réaumur, who in company with Bernard de Jussieu repeated Trembley's observations, and discovered on the coasts of Normandy living and expanded Alcyonarians, covered with

multitudes of little polyps like those which Trembley had described. After this there was no resisting Peyssonel's opinion, and the name of polyps was given by Réaumur to the Hydra, to Corals, and Actinians alike, because of their fancied resemblance to the "Poulpe" or Octopus; because, as he said, "leurs cornes sont analogues aux bras de l'animal de mer qui est en possession de ce nom."

The discovery of the animal nature of corals attracted many naturalists to the study of the Anthozoa, and considerable works on the group were published by Ellis (21), Cavolini, and Esper (*Die Pflanzenthiere*, Nuremberg, 1791). The works of these authors contained many errors. No distinction was made between Hydroid polyps, Polyzoa, Corals, Sponges, and even Ascidians. The separation of the last named was due to Savigny. Neither Cuvier, Lamarck, or Lamouroux dealt with the anatomy of "polyps," but founded their systems on the characters of the skeletons or polyparies. It was Milne-Edwards who, in conjunction with Audouin, first demonstrated in 1828 that Flustra and its allies are distinguished from the Actinians and Coral polyps by the possession of a separate mouth and anus, and that the sponges form a separate group characterised by the absence of polyps. In 1830 Vaughan, Thompson, and in 1834 Ehrenberg, finally separated Flustra and its allies under the names Polyzoa and Bryozoa, but the Hydrozoa were still confounded with the Anthozoa, and it required some years of labour on the part of Sars, Dujardin, von Siebold, P. van Beneden, and Desor in order to effectually separate the two groups. The anatomy and classification of the group thus purged of intruders were placed on a firm basis by the classical works of Dana, and of Milne-Edwards and Haime (1857), and in more recent years the studies of de Lacaze-Duthiers, Kowalevsky, G. von Koch, and E. B. Wilson on development, of A. Agassiz, Moseley, G. von Koch, and others on the comparative anatomy, and O. and R. Hertwig on the histology of many forms of Anthozoa have gone far to render our knowledge of the group more exact, though, as yet, far from complete.

The Anthozoa, whose history has been shortly considered, form a class of the phylum Coelentera. Leaving the Porifera and Ctenophora out of consideration, as possessing structural and embryonic features which separate them somewhat sharply from the remainder of the Coelentera, the fundamental morphological concept of a Coelenterate animal is a polyp or zooid.

The term polyp, as has been shown above, is due to a fancied resemblance between the coelenterate individual and the Poulpe or Polypus, as the common Octopus was popularly named in France. In spite of its fanciful origin, the term has come into general use,

but it is much less convenient for practical purposes than the term zooid, which is applied to the individuals which compose colonial organisms in several other groups in the animal kingdom. There is no inconvenience in applying the same general term to the individual members of different groups, if it is clearly understood at the outset that there are several kinds of zooids, differing from one another in important anatomical features, and if we bear in mind that the term is more particularly applicable to the asexually produced individuals composing a colony, but may also be transferred to individuals, similar to the colonial forms in all respects, except that they do not form colonies. Throughout this chapter, the term zooid will be employed instead of the older term polyp, to designate an Anthozoan individual. It is true that Kölliker has used the term, in a special and limited sense, in describing certain Anthozoa, but his special use of the term is unwarrantable, and will be referred to further on.

A Coelenterate zooid is an animal consisting of a hollow sac of various form—columnar, spherical, or disc shaped. The cavity of the sac, known as the coelenteron, is the only cavity of the body, and communicates with the exterior by an opening, the mouth, which serves the double purpose of admitting food into the cavity of the sac, and of expelling undigested matter; and in the Anthozoa the reproductive elements. There is rarely a second aperture at the end of the body furthest from the mouth opening. A vertical line passing through the centre of the mouth is the principal axis of the coelenterate body, the secondary axes being disposed radially with regard to the principal axis, though, as will be seen further on, there are many cases in which the primitive radial symmetry is replaced by a more or less well-defined, bilateral symmetry. Around the mouth, but placed at some little distance from it, is a circlet of tentacles disposed radially with regard to the principal axis. The space between the mouth and tentacles is known as the peristome. The tentacles may be solid or hollow; when hollow, their cavities are prolongations of the coelenteron.

The walls of the sac-like body, and also the tentacles and peristome are always composed of three layers of tissue, of which two, the external layer or ectoderm, and the internal layer or endoderm, are always cellular, and are coextensive and identical with the epiblast and hypoblast of the embryo.

The third layer, lying between the ectoderm and endoderm, varies considerably in structure and importance in different groups of the Coelentera. Typically, it is not a cellular layer, but is of gelatinous consistency, and is formed as a sort of secretion from the ectoderm; in some cases the endoderm also takes a share in its formation. After treatment with reagents, the middle layer

may show a fibrillar structure, which, in many cases, is undoubtedly an artifact. It may be homogeneous and devoid of all trace of structure, or it may contain numerous cells, which are either branched, nucleated, so-called connective tissue cells; nerve cells and fibres, muscular fibres, or cells in which calcareous skeletal

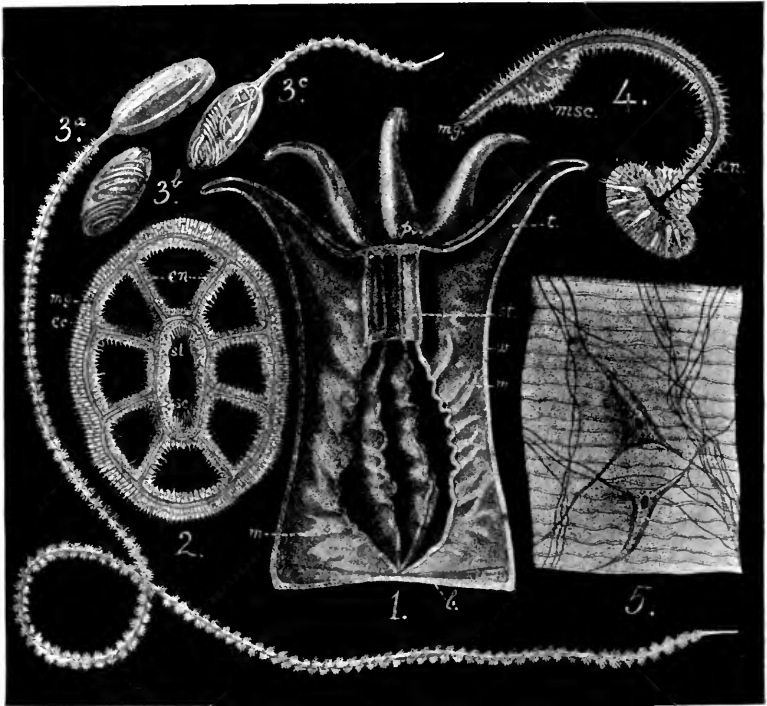

FIG. 1.

- 1.—Diagrammatic longitudinal section through a typical Anthozoan zooid. *w*, body wall; *ps*, peristome; *b*, base; *t*, tentacles; *st*, stomodaeum; *m*, mesentery.
- 2.—Diagrammatic transverse section through a typical Anthozoan zooid in the region of the stomodaeum. *ec*, ectoderm; *en*, endoderm; *mg*, mesogloea; *sc*, sulcus; *sl*, sulculus.
- 3a.—Nematocyst of *Corynactis viridis*, fully everted. 3b. The same, before eversion. 3c. The same, partly everted.
- 4.—Section through a typical Anthozoan mesentery with its mesenterial filament. *en*, endoderm; *mg*, mesogloea; *msc*, muscle banner with supporting plications of the mesogloea.
- 5.—Portion of the muscular layer of *Anemonia sulcata* showing the nerve plexus and ganglion cells. (1-4 original; 5 after O. and R. Hertwig.)

spicules are developed. All these cells or cell-products are intrusive, and are derived from one or other of the two primary limiting layers comparatively late in life. There is no third embryonic layer or mesoblast in the Coelentera, and for this reason, the terms mesoblast and mesoderm being synonymous, their middle layer is called the mesogloea, whether it be structureless

and homogeneous, or whether it contain intrusive cells imbedded in a homogeneous matrix.

Intimately connected with the absence of a mesoblast is the absence of all those cavities and structures which, in the higher metazoa, are lined by or formed from the mesoblast. There are no coelomic spaces in the Coelentera, no haemal or blood spaces, no specialised respiratory or nephridial systems. The musculature is derived either from the ectoderm or from endoderm, or in cases in which mesogloecal muscles may be spoken of, their origin from one or other of these layers is apparent. The same may be said of the skeletal tissues.

The Anthozoan zooid, whilst possessing the general features enumerated above, differs from other Coelenterate zooids in some important particulars.

The mouth in such an animal as *Hydra* opens directly into the coelenteron, and the external ectoderm passes into the endoderm at its lips. In the Anthozoan zooid the mouth does not open directly into the coelenteron, but into a shorter or longer tube, which projects into the coelenteron and opens into it below. This tube is formed in the course of development as an invagination of the ectoderm, and is therefore a stomodaeum. It is seldom round, more generally compressed from side to side, so as to be oval or slit-like in transverse section.

At either one or at both ends of the oval there is a groove, the cells lining which are furnished with specially long cilia. When only one groove is present, it is termed the sulcus (siphonoglyphe of Hickson), where two grooves are present—one is termed the sulcus and the other the sulculus. The elongation of the mouth and stomodaeum confers a bilateral symmetry on the Anthozoan zooid, which is extended to other organs of the body. One may speak of a sulcar and a sulcular aspect of the body in cases in which two grooves are present, and of a sulcar and asulcar aspect in cases in which only one groove is present. These terms are preferable to the older terms "ventral" and "dorsal," which cannot properly be applied to the Anthozoa, since they have nothing corresponding to the ventrum and dorsum of higher animals. It must be understood that, throughout this chapter, the sulcar surface corresponds to the ventral surface of other authors, the asulcar or sulcular surface to the dorsal. The terms sulcus and sulculus and the corresponding adjectives are due to Haddon (33).

It is obvious from this description that the mouth of *Hydra* and its allies does not correspond morphologically with what is usually called the mouth, but rather with the inferior opening of the stomodaeum of the Anthozoan zooid; this being the region in both groups at which the ectoderm passes into the endoderm.

The Anthozoan zooid is further characterised by the following anatomical features:—The coelenteron is not a simple cavity, as in the Hydroid zooid, but is divided by a number of radial folds of tissue into a corresponding number of radial chambers. These radial folds of tissue are called mesenteries, or by German authors,

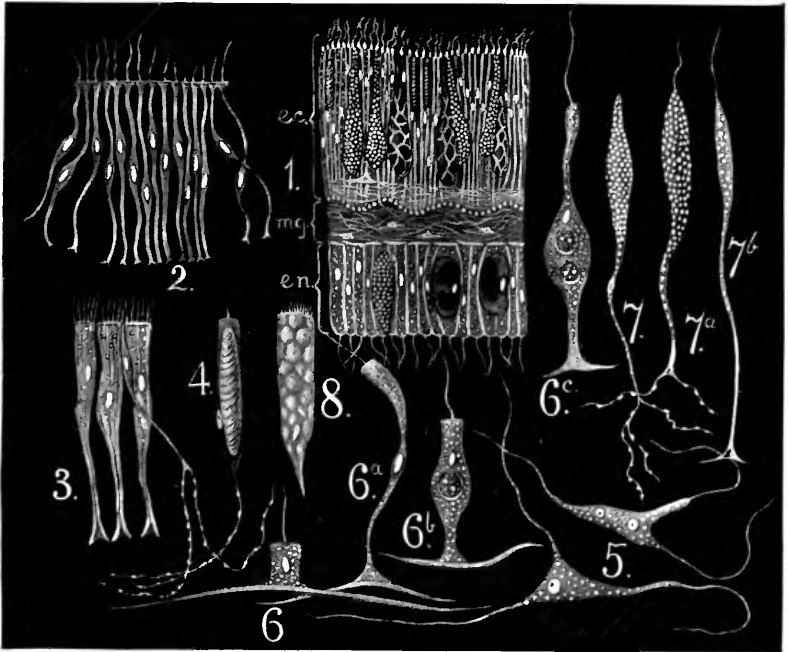

FIG. 11.

1.—Section through the stomodaeum of *Adamsia rondeletii*. Diagrammatic. *ec*, ectoderm showing elongate ciliated epithelial cells, two kinds of gland cells, and nematocysts. Beneath the ectoderm is a layer of nerve fibrils. *mg*, mesogloea, containing fibrils and a few stellate cells; *en*, endoderm composed of columnar ciliated cells and containing two kinds of gland cells.

2.—Ectoderm cells from the body wall of *Corynactis viridis*, partly isolated.

3.—A portion of epithelium from the tentacle of *Anemonia sulcata*, consisting of three supporting cells and one sense cell.

4.—A cnidoblast with enclosed nematocyst from the tentacle of *Anemonia sulcata*.

5.—Two ganglion cells from the ectoderm of the peristome of *Anemonia sulcata*.

6.—An epithelio-muscular cell from the extended tentacle of *Adamsia rondeletii*. *6a*. The same from a contracted tentacle. *6b* and *6c*. Endoderm cells with symbiotic zooxanthellae from the tentacle of *Anemonia sulcata*.

7, *7a*, *7b*.—Two gland cells from the stomodaeum of *Anemonia sulcata*. *7b*. A flagellate cell from the same species.

8.—A gland cell from the stomodaeum of *Anemonia sulcata*. (2 original; all the others after O. and R. Hertwig.)

sarcosepta or simply septa. There is no objection to the use of the term sarcoseptum, but the term septum must be avoided, because it denotes a distinct set of structures in one of the groups of the Anthozoa. In this chapter the term mesentery will always

be employed. The position and relations of the mesenteries in an ideal Anthozoan zooid may be understood by reference to Fig. I. 1 and 2. Each mesentery is attached by its upper margin to the peristome, by its outer margin to the body wall, and by its lower margin to the basal disc. Typically it is attached by the upper part of its inner margin to the stomodaeum, but below the stomodaeum it ends in a free edge, on which is placed a thickening known as the mesenterial filament. A mesentery consists of a middle layer of mesogloea, covered on both faces with a layer of endoderm. The mesenterial filament is often ectodermic in origin. The gonads or reproductive organs are borne on the mesenteries, the germinal cells being derived from the endoderm. The Anthozoa, like all the other Coelenterates, are provided with special offensive weapons in the form of cnidae or nematocysts. The nematocysts of the Anthozoa are in many cases rendered complex by the presence of numerous spines on the whole length of the eversible thread. In the nematocyst of *Corynactis*, shown in Fig. I. 3, the spines are arranged in a double spiral. The nematocysts of the *Acyonaria*, on the other hand, are generally simple, small, and devoid of spines (Fig. IV. 8).

The histology of the Anthozoa has been studied with some care in the case of particular groups, especially in the Actiniae by O. and R. Hertwig (40). In these forms the ectoderm consists of three not very clearly defined layers: (a) The epithelial layer; (b) the nervous layer; (c) the layer of muscular fibres.

Four elements are distinguishable in the epithelial layer. The preponderating elements are the elongate, almost thread-like, ciliated cells, whose characters may be studied in Fig. II. 1, 2, and 3. 3 represents cells from the tentacle of *Anemonia sulcata*, and it will be observed that each bears a tuft of fine and short cilia at its broader peripheral end. 2 represents partly isolated cells from the ectoderm of the body wall of *Corynactis viridis*. In this case each attenuated cell bears a single flagellum at its outer extremity. Similar cells are found on the mesenterial filaments of *Sagartia parasitica* and other forms.

Amongst the ciliated epithelial cells are found sense cells, one of which is shown in Fig. II. 3. They occur chiefly on the peristome and the tentacles. Each sense cell bears a single stiff hair at its peripheral extremity, and internally ends in several very fine varicose fibrillae, which are continuous with the fibrils of the nerve layer.

The third element of the ectoderm is the cnidoblast shown in Fig. II. 4. Each cnidoblast forms, as an entoplasmic product, a single nematocyst. It is provided at its peripheral extremity with a single stiff hair or cnidocil, and internally it ends in a fibre which branches to form numerous fibrillae like those of a

sense cell. The fourth elements of the epithelial layer are the gland cells, most abundant in the stomodaeum and on the mesenterial filaments. They are of two kinds, as shown in Fig. II. 7 and 8.

The nervous layer of the ectoderm, shown in Fig. II. 1, consists of a plexus of extremely fine fibrillae, giving in transverse section a punctate appearance. In the depth of the fibrillar layer are found, most abundantly at the bases of the tentacles, bipolar and multipolar ganglion cells. These last lie directly on the muscular layer, and are figured in Fig. I. 5, and in Fig. II. 5. The muscular layer lies directly on the mesogloea. It is composed of very long and fine fibres, each of which bears about the middle of its length a small mass of granular protoplasm, in the midst of which lies the nucleus.

The endoderm consists chiefly of epithelio-muscular cells, such as are represented in Fig. II. 6. Each epithelio-muscular cell is somewhat quadrangular in form in the extended condition of the animal; its free extremity is somewhat rounded and bears a single long flagellum. Internally it rests upon a long and narrow muscular fibre, which runs at right angles to it. The epithelio-muscular cells of the endoderm contain yellow or green spherical bodies which are symbiotic, unicellular algae, the so-called zooxanthellae or zoochlorellae. In addition nervous and glandular elements are found in the endoderm.

The mesogloea of the Actinians consists of fine fibres imbedded in a homogeneous matrix. Between the fibres lie numerous small branched or spindle-shaped cells, the so-called connective tissue cells. In many Actinians muscular elements are imbedded in the mesogloea.

The reader will be able to get a good general idea of the histological elements of the Anthozoa by studying Figs. I. and II. For further details he should refer to the work of O. and R. Hertwig (40). But it must be remembered that in the Anthozoa histological differentiation reaches its highest point in the Actinians. In the other groups the elements are simpler.

The Anthozoa are divisible into two great sub-classes, sharply marked off from one another by definite anatomical characters. These are the Alcyonaria, sometimes called the Octactinia, and the Zoantharia, sometimes called the Hexactinia. The last name should be avoided.

ALCYONARIA—FIRST SUB-CLASS OF THE ANTHOZOA.

The Alcyonarian zooid is distinguished by the following characters:—

There are always eight, and never more nor less than eight

tentacles, which are always hollow and pinnate, the cavities of the tentacles extending into the pinnae.

There are eight mesenteries, all of which are attached to the stomodaeum, and may therefore be called complete. There is but one longitudinal, ciliated groove in the stomodaeum, which will be called the sulcus, though it is not certain whether the groove in the stomodaeum of the Alcyonarian is homologous with the sulcus of the Zoantharian zooid. The probability is that it is homologous.

The mesenteries are provided with well-developed retractor muscles, supported on folds or plaits of the mesogloea, which look like branched processes in transverse section, and form the so-called muscle banners. The arrangement of the muscle banners of the Alcyonaria is characteristic. They are all situated on the sulcar aspects of the mesenteries (Fig. IV. 1).

Each mesentery is provided with a mesenterial filament; but two mesenteries, namely, the asulcar pair, are longer than the rest, and have a different form of filament. It has been shown by E. B. Wilson (97) that the asulcar mesenterial filaments are derived from the ectoderm, the remainder from the endoderm. For the structure of the asulcar and other mesenterial filaments, see Fig. IV. 5 and 6.

The only exceptions to this structure are found in the arrested or modified zooids which occur in many of the colonial Alcyonaria. In these the tentacles are stunted or suppressed, and the mesenteries are ill-developed, but the sulcus is unusually large, and is provided with specially long cilia. Such specialised zooids are distinguished as siphonozooids, and their function is to drive currents of water through the complex canal systems of the colonies to which they belong (see Fig. XII. 4).

Many forms of Alcyonaria have siphonozooids in addition to the ordinary zooids (sometimes called autozooids), and are therefore dimorphic; but the character is of no systematic value, for



FIG. 111.

1.—A typical Alcyonarian zooid showing the eight pinnate tentacles, *t*; the two long asulcar mesenteries, *m*¹ and the six shorter mesenteries, *m*². (Original.)

2.—Spicules of *Alcyonium digitatum*.

we find dimorphism occurring in individual species of many families which in other respects are widely separated from one another. Only in one group, the Pennatulacea, is dimorphism of constant occurrence.

Much attention has been paid to the skeleton of the Alcyon-

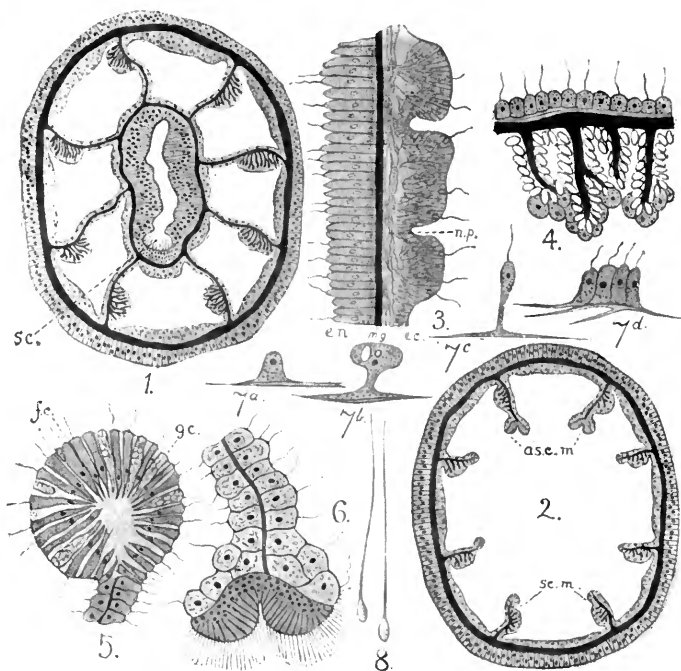

FIG. IV.

- 1.—Transverse section through the stomodaeum of *Funiculina quadrangularis*. *sc*, sulcus.
- 2.—Transverse section of the same species below the level of the stomodaeum. *scm*, sulcar mesenteries; *ascm*, asulcar mesenteries.
- 3.—Longitudinal section of a tentacle of *Alcyonium digitatum*. *ec*, ectoderm with ectodermic nerve plexus; *mg*, mesogloea; *en*, endoderm.
- 4.—Transverse section through a portion of a mesentery of *Alcyonium digitatum*, showing the large retractor muscle fibres borne on branched processes of the mesogloea, and the delicate protractor muscles on the opposite face of the mesentery.
- 5.—Transverse section through one of the sulcar mesenterial filaments of *Alcyonium digitatum*, showing the gland cells, *gc*, and the flagellate cells, *fc*.
- 6.—Transverse section through an asulcar filament of the same species, showing the open groove lined by elongate ciliated ectoderm cells.
- 7, 7a, 7b, 7c, 7d.—Myoepithelial cells from the endoderm of *Alcyonium digitatum*.
- 8.—Two nematocysts of *Alcyonium digitatum*. (1 and 2 original; the rest after Hickson.)

aria, but for taxonomic purposes it is of subordinate value. A calcareous skeleton is present in all, with the exception of Proto-caulon, Cornularia, some species of Clavularia, and Monoxenia, and it is possible that spicules so minute as to have been overlooked are present in these forms. The calcareous skeleton

usually consists of spicules, which may be fusiform, club-shaped, cross-shaped, or discoid; they are seldom smooth, but generally covered with spines or warty projections. They are developed within ectodermal cells, and are therefore entoplasmic products. Most commonly the spicule-forming cells pass out of the ectoderm and are imbedded in the mesogloea, but Bourne (9) has shown that in the genus *Xenia* the spicule-forming cells remain in the ectoderm; this is also the case in some members of the genus *Clavularia*. In one Alcyonarian (*Heliopora coerulea*) the calcareous skeleton is not spicular but lamellar, like that of Madreporarian corals; it is formed by a special layer of cells called calicoblasts, derived from the ectoderm.

An organic horny skeleton is frequently present, either in the form of an external horny investment (*Cornularia*), or of an internal axis, as in *Pennatula*, *Gorgonia*, and others; or there may be a half horny half calcareous axis, as in *Isis*; or there may be an axis formed of calcareous spicules imbedded in horny substance, as in many *Pseudaxonia*.

The development of the Alcyonaria has been studied by Kowalevsky and Marion (69), E. B. Wilson (96), and von Koch (61). The segmentation of the ovum is complete, and results in the formation of a solid morula. Wilson has shown that in *Renilla* the ovum divides at once into many, usually sixteen, blastomeres. As neither von Koch nor Kowalevsky and Marion found earlier stages of segmentation, this exceptional mode of division may possibly be the rule amongst the Alcyonaria. After repeated subdivision of the blastomeres of the sixteen cell stage, the solid mass of cells is divided into two layers—an external ectoderm and a central mass, the primitive endoderm. The coelenteron is formed by the dissolution and absorption of the central cells of the endodermic mass, the disintegrated cells being engulfed by and serving as nourishment for the more peripheral cells which become the definitive endoderm. There is no gastrula stage in *Clavularia*, *Gorgonia*, or *Renilla*, though Haeckel has described a gastrula in the case of *Monoxenia*. The embryo, at the time of the formation of the coelenteron, becomes pear-shaped, the ectoderm cells become columnar and acquire cilia, and the larval stage known as a planula is reached. The planula escapes from the cavity of the parent zooid, in which the earlier stages of development have proceeded, and swims freely in the water by means of its cilia. There is, as yet, no communication between the coelenteron and the exterior. After a free existence of shorter or longer duration, the embryo fixes itself by one end of its elongate body, and a stomodaeum is formed at its opposite extremity by invagination of the ectoderm. At the bottom of the invagination a perforation places the coelenteron in communication with the exterior. The

mesenteries are formed as eight radial folds of the endoderm, which arise simultaneously at the oral end of the embryo at the time of the formation of the stomodæal invagination. The tentacles are formed as eight outgrowths surrounding the mouth, simple at first, but soon acquiring lateral pinnules. The embryo is now a zoid, and after a period of growth it gives off *solenia*, and from these buds are produced, or in more differentiated colonies an axis and other structures characteristic of particular groups are

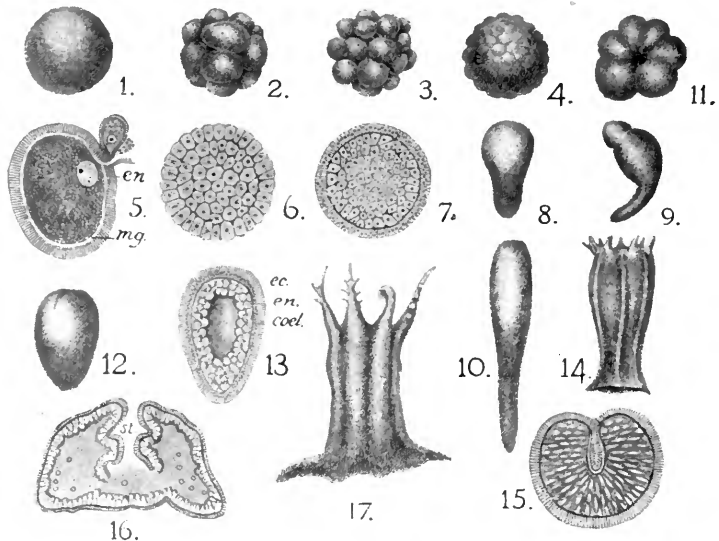

FIG. V.

Developmental phases of *Gorgonia Cavolinii*, after G. von Koch. 1. A mature ovum. 2-4 Progressive stages of segmentation. 5. Section through a mature and an immature ovum in their follicles. *en*, endoderm; *mg*, mesogloea. 6. Section of an embryo of the same stage as 4. 7. Section of a later stage showing the commencing disintegration of the central cells of the endoderm, and the columnar ectoderm. 8, 9, and 10. Planulae in different stages of contraction. 11. A larva viewed from the oral surface to show the first traces of the mesenteries. 12. The same viewed from the side. 13. Longitudinal section through a planula of about the same stage as 8, showing the coelenteron, *coel*, the endoderm, *en*, and the ectoderm, *ec*. 14. A young zoid with simple tentacles. 15. Vertical section of a free larva with stomodæal invagination. 16. Vertical section of an older fixed larva showing stomodæum, *st*, opening into the coelenteron. 17. A young zoid with pinnate tentacles.

developed in connection with it. The development of the mesogloea has been most carefully studied in *Renilla* by Wilson (96). In an embryo of eight hours there is a delicate membrane lying between the ectoderm and endoderm, on which the ectoderm cells are planted, as on a basement membrane. This is the first sign of the mesogloea, but the bulk of it is formed at a later stage by deliquescence of the lower ends of the ectoderm cells and their conversion into a gelatinoid substance. Spicules are formed in rounded interstitial cells, which in the embryo occupy the deeper

parts of the ectoderm, but in most Alcyonaria subsequently become situated in the mesogloea. Fig. V. represents the principal developmental phases of *Gorgonia Cavolinii*, as figured by von Koch.

The sub-class Alcyonaria comprises many and highly diversified forms, yet, as has been seen, the anatomy of the zooids is remarkably constant throughout the group. The diversity of form is chiefly due to the manner in which the zooids are aggregated together to form colonies, and the mode of aggregation is due, in the first place, to the mode of asexual reproduction by budding. The form and nature of the skeleton and the mode of aggregation of the zooids are largely interdependent, and must be taken together as a basis of classification, the larger groups being defined chiefly by the mode of aggregation, and their subdivisions by the character of the skeleton. The difficulties of classification are, however, considerable. The characters on which reliance is placed are so inconstant, and shade so imperceptibly into one another, that it is in many cases impossible to say where one group ends and another begins.

Nearly all the Alcyonaria are colonial, but a few solitary forms have been described, and these may conveniently be placed in a separate grade under the name of *Protalcyonacea* (Protalcyonaria, Hickson), the colonial forms forming a second grade, *Synalcyonacea*.

GRADE A. PROTALCYONACEA.

The Protalcyonacea are solitary Alcyonarian zooids, having the structural features common to the individual zooids of the sub-class. They do not form colonies by gemmation. The grade contains a single family, the *Haimeidae*, which contains three genera.

Family *Haimeidae*, M. Edw. *Haimea funebris*, M. Edw. from the coast of Algeria. *H. hyalina*, Kor. and Danielsen, from Norway. *Hartea elegans*, P. Wright (Fig. VI.), from the Irish coast. *Monoxenia Darwinii*, Haeckel, from the Red Sea.

It may be doubted whether all or any of the Protalcyonacea cited above are adult forms; possibly they are the young forms of colonies. The reproductive cells are neither figured nor described

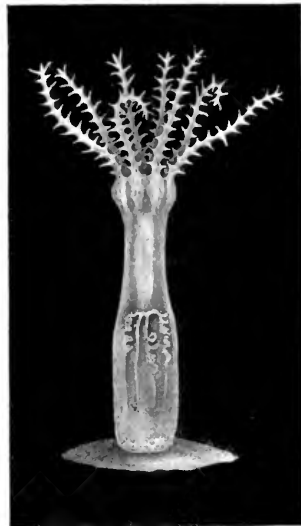

FIG. VI.

Hartea elegans, an example of the Protalcyonacea. (After P. Wright.)

in *Haimea* and *Hartea*. Haeckel describes and figures the ovaries of *Monoaxenia*, but his account leaves much to be desired.

GRADE B. SYNALCYONACEA.

The Synalcyonacea are all colonial. The colony originates from a mother zooid, which gives off hollow diverticula from its base or from its lateral walls. From these diverticula buds are formed, which grow into new zooids, and these again give off diverticula. In this manner colonies of complex character are formed.

It is characteristic of the Synalcyonacea that buds are never formed directly from the mother zooid, nor yet from the daughter zooids; they are always formed on tubular outgrowths of the zooids, which have variously been named stolons, nutritive canals, endodermic canals, etc. The name stolon is the least cumbersome, but it has been applied not only to the canals but also to structures composed of many canals united together, and its connotation is so vague as to be misleading in the extreme. Throughout this chapter the canals, lined by endoderm, which are given off as diverticula from the coelentera of the zooids comprising a colony, will be described as *solenia*, from the Greek *σωλήνιον*, a little pipe or conduit. The name stolon will be applied to the root-like outgrowths by which many Synalcyonacea are fixed to stones, corals, and other surfaces; and following Hickson, the name will be extended to the membranous expansions which are formed by the union of many flattened, root-like outgrowths.

It must be borne in mind that the cavities of Alcyonarian zooids never communicate directly with one another, but always by means of solenia; these may be long, much branched, anastomosing passages, or they may be so much reduced that the zooids seem at first sight to be in direct communication. Closer inspection, however, will always demonstrate the intervention of solenia.

The simplest form of budding, giving rise to the simplest form of colony, is found in the genus *Cornularia*. In this genus we find (on the authority of von Koch [54]) that the mother zooid gives off from its base a simple, radiciform outgrowth or stolon, which is composed of a single solenium. At a longer or shorter distance from the mother zooid, a daughter zooid is formed as a bud on the stolon. This gives off new stolons, and these branching and anastomosing with one another may form a network, adhering to stones, corals, Gorgonians, and other objects, from which zooids arise at intervals.

A further differentiation is found in the genus *Clavularia*. The colony resembles *Cornularia* in form and in habit of growth, but

each stolon contains, not one, but several solenia, which branch and anastomose with one another. In many Clavulariae the stolons are flattened and band-like, and anastomose freely with one another so as to form a close meshwork; and this process of fusion and anastomosis being carried still further, the stolons form a close feltwork, which, like a membrane, adheres to the surface of attachment. In all these forms the stolons and the solenia which they contain are, with one exception, given off from the basal region only of the zooid, and the zooids appear to, and do in fact, stand upon the meshwork or feltwork of stolon tubes.

A further differentiation is established when, as in Sarcodictyon, the solenia are not confined to the base, but are also given off from the lateral walls of the proximal extremity of the zooid. In such a case, fusion of the walls of adjacent solenia gives rise to a cushion-like thickening at the base of each zooid.

In Sympodium the zooids are frequently crowded together to form dense tufts, and in such tufts (Pseudobushes of von Koch) the cushion-like thickenings surrounding the bases of the zooids become fused together so as to form a crust, in which numerous solenia ramify. The proximal portions of the cavities of the individual zooids extend through the thickness of the crust.

By further differentiation along the same lines, the colonial forms characteristic of the Xenidiidae and Alcyonidae are arrived at. In the Xenidiidae the zooids are crowded together to form bundles; the surface of attachment is relatively small, and the fused proximal portions of the zooids assume the character of a stout stem, from the flat summit of which the distal portions of the zooids project.

In the Xenidiidae the zooids are not very intimately fused together in each bundle. Each zooid and each solenium is typically limited by three layers—endoderm, mesogloea, and ectoderm—passing from within outwards. In *Xenia* the zooid bundles are formed chiefly by fusion of the ectoderm of adjacent zooids and their solenia, the mesogloea of each remaining distinct. In *Heteroxenia* the mesogloea takes a share in the fusion. In the Alcyonidae the fusion of the mesogloea layers is complete. The colonies form lobose, generally bluntly branching masses, from the whole surface of which the distal moieties of the zooids, when fully expanded, project. The fused mesogloea forms a thick mass, honeycombed by the



FIG. VII.

Clavularia celebensis, Hickson.

solenia, containing spicules and spicule-forming cells, and into this mass the proximal moieties of the zooid cavities extend. This line of differentiation culminates in the Nephthyidae.

Starting again from the Cornulariidae, we get another line of differentiation, culminating in the Pseudaxonia. As in the first case a fusion of cushion-like thickenings at the bases of the zooids results in the formation of a stout, crustaceous coenenchyme. But the vertical growth of the colony, instead of being arrived at by elongation of the individual zooids and their aggregation into bundles, is effected by the upgrowth of the creeping coenenchymatous expansion, which deserts the surface of attachment and expands in the water. In this condition one surface of the colony represents the attached surface of an encrusting form and is sterile, the other face bears the exsert distal moieties of the zooids. For mechanical reasons the colony does not retain its flattened form, but becomes rolled up like a paper spill; the sterile portion forms the interior of a hollow cylinder, and the fertile portion is external. By the excessive development of spicules on the internal (primitively attached) surface, the colony becomes differentiated into a softer cortical layer and a denser axial mass, both being penetrated by numerous solenia. The axial mass, hollow at first, becomes solidified in higher forms, and then it may either consist of closely interlocked but distinct spicules, imbedded in a mesogloal matrix which is penetrated by solenia, as is the case in the Briareidae, or the axis may consist of closely interlocking spicules, imbedded in a mesogloal matrix which is surrounded but not penetrated by solenia, as in the Sclerogorgiidae, or the spicules may be fused together so as to form a dense calcareous axis which is not penetrated by solenia, as in the Corallidae.

A third line of differentiation gives rise to the division Axifera. In this case the vertical extension of the colony is effected by the formation of a horny secretion between the primitively crustaceous colony and the surface of attachment. The horny secretion, growing rapidly in thickness by the superimposition of new layers, raises the colony up in the water, and presently, by continual growth at the summit, the horny matter, which at first was basal, comes to form an axis, supporting the colony by which it is encrusted like a tree by its bark. The axis may branch in various ways, and may become partly calcified, and thus we get the various forms of the Dasygorgiidae, Isidae, Primnoidae, and Gorgoniidae.

A fourth line of differentiation leads to the Pennatulidae. The starting-point from the Cornularian ancestor is probably to be found in the genera *Telesto* and *Coelogorgia*. In this case vertical extension is attained by the extreme elongation of a single zooid which, as it grows upwards, gives off solenia from

all parts of its lateral walls, with the exception of a short region immediately beneath the tentacles. These solenia ramify in a much thickened mesogloal layer which is further strengthened by the development of calcareous spicules, and lateral buds, which appear to be direct offshoots from the elongated mother zooid, are formed from the solenia. Some of the daughter zooids may in turn become elongated and give rise to lateral buds, and so an arborescent colony is formed, as in *Coelogorgia*. In the Pennatulids the cavity of the mother zooid early becomes divided by a longitudinal partition into two halves, and an axis of peculiar wood-like texture is formed in the partition. The greatly enlarged and elongated body of the mother zooid serves as the stem of the colony. In the lowest Pennatulacea the daughter zooids are irregularly distributed over the stem, in the higher forms they become symmetrically disposed with regard to the stem, and tend to form rows, the members composing which are fused together to form leaflets or pinnae.

A fifth line of differentiation is found in the Helioporidae. In these the solenia are not given off from the base, but ringwise at about the middle of the length of the zooid, and immediately beyond the zooid they anastomose so as to form a regular meshwork. From the nodes of the meshwork vertical solenial downgrowths are formed, and a dense calcareous lamellar skeleton is formed from the ectoderm clothing the whole. *Heliopora*, the single living representative of the family, is a peculiar and aberrant member of the Alcyonaria, and will be described in detail further on.

The Synalcyonacea, according to the lines of divergence which have been sketched out above, may be divided into six orders whose relations may be expressed as follows:—

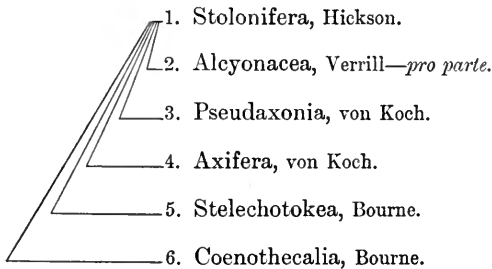

We shall now proceed to review these several orders of the Synalcyonacea.

ORDER 1. *Stolonifera*, Hickson.

Characters—Colonial Alcyonaria with a root-like or membranous stolon. Zooids either entirely free from one another except at their bases, or con-

nected by horizontal solenia or by lateral stolons or platforms containing solenia. Skeleton either horny or calcareous; when calcareous spicular.

FAMILY 1. CORNULARIIDAE. The zooids are united only by their bases. Genera—*Cornularia*, Lamarck. Without spicules. The stolons are single solenia. The proximal parts of the zooids and stolons protected by a horny sheath. *Clavularia*, Quoy and Gaim., spicular calcareous skeleton present. Zooids free, borne on a membranous or retiform creeping stolon which includes many anastomosing solenia. [*Clavularia viridis*, Quoy and



FIG. VIII.

Clavularia viridis, Quoy and Gaim., var. *Syringoporoides*, showing the lateral connecting stolons. (After Hickson.)

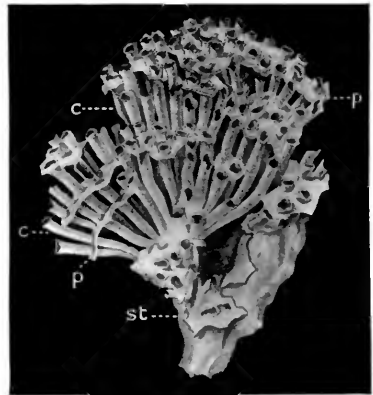

FIG. IX.

Skeleton of a young colony of *Tubipora purplea*, growing on a piece of dead coral. *st*, stolon; *cc*, corallites; *pp*, platforms. (After Hickson.)

Gaimard, occurs in two varieties. The one variety has all the characters of the genus, but the second variety, described and figured by Hickson (44 and 45), differs from all other members of the genus in that the zooids are connected at varying heights above the basal stolons by tubular connecting stolons containing solenia, and consequently it bears a close resemblance to *Syringopora* (comp. Fig. VIII. with Fig. X. 7). The character in question, if of constant occurrence, would warrant the placing of *C. viridis* in a new genus allied to the *Syringoporidae* and *Tubiporidae*. As it is, the character must be regarded as accidental rather than essential, but is of importance as indicating the affinities of the last-named families with the *Cornulariidae*.] *Sarcodictyon*, Forbes, like *Clavularia*, but the zooids are wholly retractile within cushion-like thickenings of their bases. *Sympodium*, Ehrb., the crustaceous stolon is thickened

locally, so that the proximal portions of the zooid cavities are sunk in a coenenchyma. FAMILY 2. SYRINGOPORIDAE. Genus—*Syringopora*, Goldfuss. This extinct genus resembles *Clavularia viridis*; the cavities of the zooids are divided by cup-shaped transverse partitions called tabulae (Fig. X. 7). FAMILY 3. TUBIPORIDAE. Genus—*Tubipora*, Linnaeus. The zooids

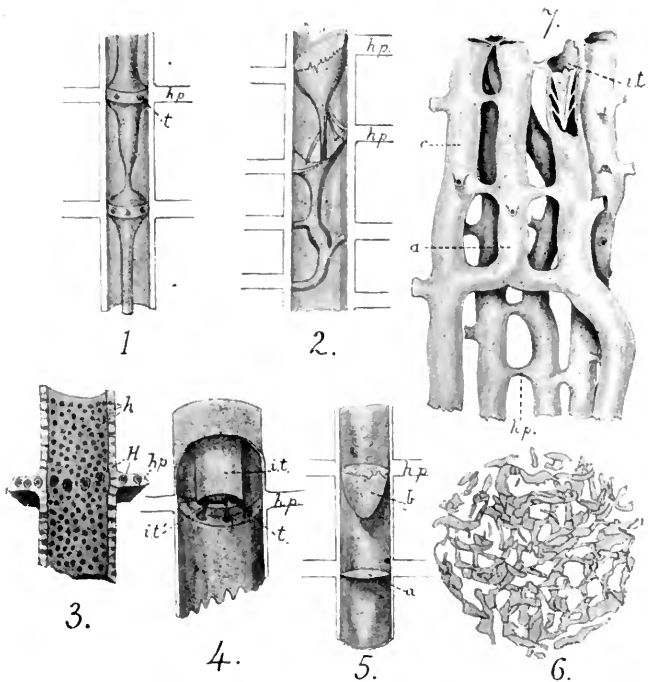

FIG. X.

1.—Diagram of the structure of a corallite of *Tubipora purpurea*, showing the tabulae in the form of axial tubes. *hp*, horizontal platforms; *t*, solenia.

2.—A similar diagram, showing complicated tabulae.

3.—View of the inner surface of a corallite of *T. purpurea*, showing the numerous lacunae, *h* in the walls of the corallite, and in the region of the node the larger perforations, *H*, through which solenia pass into the platforms.

4.—Diagram showing two tabulae broken across where one tabula (*it*) runs inside another tabula (*it*).

5.—Diagram showing simple, flat, or cup-shaped tabulae.

6.—Portion of the edge of a growing tabula, showing how the corallum is formed by the union of spicules.

7.—Portion of a colony of *Syringopora ramulosa*, showing the transverse connections between the corallites which correspond to the solenia in the platforms of *Tubipora*; *it*, a tabula. (After Hickson.)

are elongate, ranged side by side, and spring from a calcareous encrusting stolon. The proximal part of each zooid is stiffened to form a firm calcareous calyx, the corallite, into which the distal part can be retracted. The cavity of each corallite is divided by transverse, calcareous partitions of various form—tabulae. The individual zooids are united with one

another by horizontal, calcareous lamellae or platforms, springing from the levels of the tabulae and penetrated by branching solenia. New zooids are formed by budding from the solenia of the platforms.

FAMILY 4. FAVOSITIDAE. The colony is basaltiform, composed of numerous polygonal zooid tubes closely packed together. Tabulae present and the walls of adjacent zooid tubes communicate by solenia. Genera — *Favosites*, Lamarck; *Syringolites*, Hinde; *Stenopora*, King.

FAMILY 5. COLUMNARIIDAE. This family of extinct corals, comprising

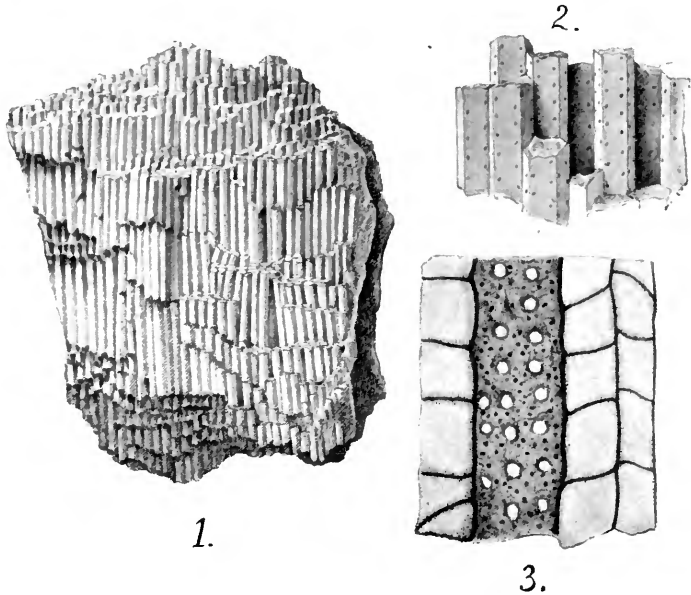

FIG. XI.

- 1.—*Favosites gothlandica*, a colony about one-half natural size from the Upper Silurian.
 2.—A portion of the same colony magnified, showing the closely apposed corallites and the perforations, solenia, placed at regular intervals on their walls, alternating with one another.
 3.—Portion of a longitudinal section of *Favosites gothlandica*, showing the tabulae, solenia, and the minute lacunae in the walls of the corallites. Magnified.
 All the figures original.

the genus *Columnaria* (Goldfuss), may provisionally be placed among the Autothecalia. See Bourne (9).

The fossil forms of the Autothecalia were at one time placed along with the Helioporidae and some Madreporarian corals in a group Tabulata. Hickson (42) has clearly demonstrated the relations of Tubipora to Syringopora, Syringolites, and Bourne has shown that *Favosites* must be ranked with these forms rather than with the Helioporidae. There is a great resemblance between the extinct *Syringopora* and the living *Clavularia viridis*, and Hickson may be held to have established that *Syringopora*, *Tubipora*, and their allies have been derived from a Cornu-

larian ancestor resembling *C. viridis*. The structure of Tubipora and Favosites is shown in Figs. IX., X., and XI.

ORDER 2. *Alcyonacea*, Verrill (*pro parte*).

Characters—The colony consists of bunches of elongate, cylindrical zooids which, in their proximal portions, are connected together by numerous anastomosing solenia, and are compacted into a fleshy mass, the coenenchyma, by fusion of their own walls and those of the solenia.

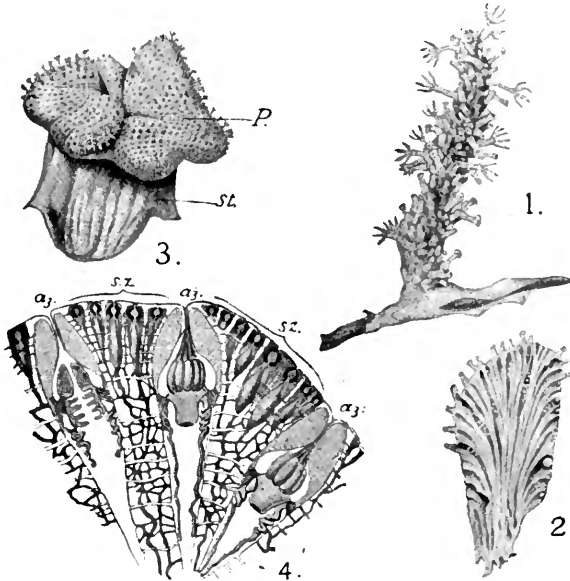

FIG. XII.

- 1.—A small colony of *Alcyonium palmatum*, Pallas, with expanded zooids. (Original.)
- 2.—Vertical section through a small colony of *Alcyonium digitatum*, Linn., showing the elongated zooid cavities. (Original.)
- 3.—A colony of *Sarcophyllum pulmo*, Esper, showing the pileus, *P*, bearing zooids, and the barren stem, *st*. One-half natural size. (Original.)
- 4.—Diagrammatic vertical section through a portion of a colony of *Sarcophyllum pulmo*, showing the retracted autozooids, *az*, and the siphonozooids, *sz*, connected by a network of solenia. (After Moseley.)

The coenenchyma thus forms a stem, sometimes branched, from the surface of which the free portions of the zooids project.

FAMILY 1. XENIDAE, Gray (*pro parte*). The zooids are not retractile. Spicules in the form of minute, feebly calcareous discs, often confined to the ectoderm. The colony consists of a stout, fleshy, sterile stem, sometimes bearing short lobose branches, on the expanded upper surface of which the free moieties of the zooids are borne. Genera—*Xenia*, Savigny. Colony monomorphic. *Heteroxenia*, Kölliker. Colony dimorphic, bearing autozooids and siphonozooids. FAMILY 2. ALCYONIDAE, Verrill. The colony a fleshy stock, sometimes simple and lobose, sometimes irregularly

branching, the extreme basal portion of the stock generally devoid of zooids and forming a stem. Zooids elongate, imbedded in coenenchyma up to the stomodæal region, which is completely retractile within the lower portion. Spicules mesogloæal, of various form, commonly fusiform, and furnished with spines and warty projections. Genera—(a). Monomorphic forms. *Alcyonium*, Linnaeus; *Paralcyonium*, M. Edw.; *Sarakka*, Danielssen. (β). Dimorphic forms. *Sarcophyton*, Lesson; *Lobophytum*, Marenzeller; *Anthomastus*, Verrill; *Nannodendron*, Danielssen. FAMILY 3. NEPHTHYIDÆ. The zooids form upright colonies, consisting of a more

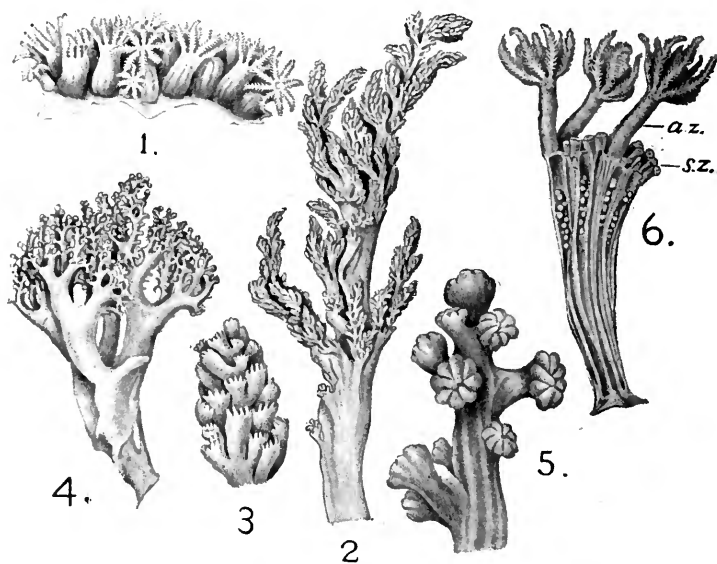

FIG. XIII.

- 1.—*Clavularia coerulea*, Ehrb. A Clavularian colony with a membranous stolon.
- 2.—*Ammothea arborea*, Forsk. A member of the sub-family Spongodinae.
- 3.—A group of zooids of the same, magnified.
- 4.—*Lemnalina nitida*, Verrill. A member of the sub-family Siphonogorginae.
- 5.—A terminal branchlet of the same, magnified.
- 6.—*Heterozenia elizabethae*, Köll. A colony divided vertically to show the elongate cavities of the autozooids, az, between the exsert portions of which are siphonozooids, sz.

or less sterile trunk, and variously ramified branches bearing terminal zooids or clusters of zooids. The tentacular region of the zooid is not retractile into the gastral region, but the tentacles, when at rest, are simply folded over the oral disc. The wide canals which run longitudinally in the stem and larger branches are continuations of the cavities of the principal zooids of the clusters. There are two sub-families. 1. SPONGODINÆ. The partitions between the stem canals contain few or no spicules. Genera—*Nephthya*, Savigny. The zooid heads beset with long and large, but not projecting spicules. *Spongodes*, Lesson. The zooid heads protected by projecting tufts of long spicules.

Ammothea, Savigny. The zooid heads soft, containing few and small or no spicules. *Eunephtya*, Verrill; *Voeringia*, Danielssen; *Fulla*, Danielssen; *Barathrobius*, Danielssen; *Gersemia*, Danielssen; *Gersemiopsis*, Danielssen; *Drifa*, Danielssen; *Duva*, Kor. and Danielssen.

2. SIPHONOGORGINAE. Abundant spicules present in the partition walls of the stem canals, giving stiffness and consistency to the colony. Genera—*Siphonogorgia*, Kölliker; *Paranephtya*, Wright and Studer. *Scleronephtya*, Wright and Studer; *Chironephtya*, Wright and Studer; *Lemnalina*, Gray.

ORDER 3. *Pseudaxonia*, G. von Koch.

Characters—Synalcyonacea forming upright branched colonies. The zooid cavities short, the zooids imbedded in a coenenchyma containing ramifying solenia and numerous spicules. The coenenchyma differentiated into a cortical and a medullary portion, the latter containing spicules different from those of the cortex, densely crowded together and sometimes cemented together to form a supporting axis.

FAMILY 1. BRIAREIDAE. The medullary substance consists of closely packed but separate spicules. There are two sub-families. 1. BRIAREINAE. The medullary mass is penetrated by solenia. Genera—*Solenocaulon*, Gray; *Leucoella*, Gray; *Semperina*, Kölliker; *Suberia*, Studer; *Anthothela*, Verrill; *Paragorgia*, M. Edwards; *Briareum*, Blainville. 2. SPONGIODERMINAE. The medullary mass is devoid of solenia. Genera—*Spongioderma*, Kölliker; *Titanideum*, Agassiz; *Ilicigorgia*, Ridley. FAMILY 2. SCLEROGORGIDAE. The medullary mass forms a distinct axis consisting of closely packed elongate spicules with dense horny sheaths. The axis does not contain solenia, but is surrounded by longitudinal canals, *i.e.* by large solenia which are connected with the zooid cavities by smaller ramifying solenia. Genera—*Suberogorgia*, Gray; *Keroeides*, Wright and Studer. FAMILY 3. MELITODIDAE. The medullary mass forms a distinct axis, which exhibits alternate calcareous and horny segments. The former (internodes) consist of fused calcareous spicules surrounded by a trace of horny substance; the latter (nodes) consist of horny substance containing few, separate, calcareous spicules. Genera—(a). The axis penetrated by solenia. *Melitodes*, Verrill; *Mopsella*, Gray. (b). The axis not penetrated by solenia. *Wrightella*, Gray; *Parisis*, Verrill. FAMILY 4. CORALLIDAE. The axis is a dense, calcareous mass formed by fusion of spicules. Genera—*Corallium*, Lamarck; *Pleurocorallium*, Gray.

Corallium rubrum, the precious red coral of commerce, is found in the Mediterranean sea, chiefly on the coasts of Africa, but also in the neighbourhood of Sardinia and Corsica, and at some places on the littoral of Italy and Provence. It has, from time immemorial, been the object of an extensive fishery, on account of the value of its hard, red, calcareous axis, for the manufacture of jewellery and ornaments. The colonies are found attached to rocks at depths varying from 15 to 120 fathoms. The fishermen use a special form of tangle to procure it. From its beauty and importance as an article of commerce, the red coral has attracted the attention of zoologists from an early period. De Lacaze Duthiers (70) has written an exhaustive and beautifully illustrated memoir on this

species which the reader should consult for details of the anatomy and development.

Although von Koch, some years since, demonstrated the essential difference between the Pseudaxonia and the Gorgonians or true Axifera, many subsequent authors, although they have accepted von Koch's conclusions, have persisted in bringing the two groups together in the order Gorgonacea. It is evident, from what has been said above, that the Pseudaxonia and the Axifera form two distinct lines of descent, diverging from a common Cornularia-like ancestor, and therefore they must be classed as two distinct branches of the order Synalcyonacea. The sole reason for uniting the two branches in one order is that the higher forms of the two show a remarkable superficial resemblance to one another, a resemblance which is the more remarkable from the parallelism of forms like *Melitodes* and *Isis*, both of which, though belonging to widely separate families, have an axial skeleton composed of alternate horny and calcareous segments. The resemblance, striking though it may be on superficial examination, disappears on closer comparison.

But whilst there is ample justification for keeping the two groups apart, it is not suggested that the line of descent attributed to the Pseudaxonia is beyond criticism. Whilst it is quite possible, and may seem probable, that *Leucoella* and *Solenocaulon* are on the direct line of descent of the higher forms of the Pseudaxonia, there is nothing that can be urged against the view put forward by Klunzinger (49) that the Briareidae are descended from forms like the Siphonogorginae, the medullary mass being formed by excessive development of spicules in the partitions separating the stem-canals. The majority of the Pseudaxonia are monomorphic, but dimorphism occurs sporadically in the genera *Paragorgia* and *Corallium*.

ORDER 4. *Axifera*, von Koch.

Characters—Synalcyonacea, forming colonies consisting of a coenenchymatous rind investing a horny or calcified axis. The axis may be horny, or composed of a calcified, horny substance, or may consist of alternate segments of calcified and horny substance; it never contains solenia, and is never formed of fused spicules. The coenenchyme completely invests the axis, and contains solenia and calcareous spicules imbedded in the mesogloea.

The Axifera (or Gorgonacea) have been the subject of an admirable memoir by G. von Koch (61), to which the reader should refer for morphological and embryological details. The characteristic feature of the group is the axis, which is horny, or consists of a horny basis impregnated with salts-of-lime. It is surrounded by a definite epithelium, which is ectodermic, and is derived from the basal ectoderm of the mother zooid of the colony. The mother zooid secretes at its base a horny plate, which lies between the basal ectoderm and the surface of attachment. This is the primordium of the axis. It rapidly increases in thickness, and forms a short column, rounded at the upper end. This column projects upwards into the coelenteron of the mother zooid, carrying before it the three layers, ectoderm, mesogloea, and endoderm.

It always lies eccentrically in the coelenteron, and becomes fused partly with the body wall, partly with the neighbouring mesenteries. Before the axis has reached the level of the stomodaeum, the surrounding parts of the primitive coelenteron become differentiated, and take on the characters of solenia, which, as growth proceeds, become more differentiated and distinct. At a later stage the distal moiety of the zooid is separated by a constriction from the moiety which surrounds the axis, and thus comes to look like an appendage of the stem. The first daughter zooid is formed as an outgrowth of a solenium on the side of the axis opposite

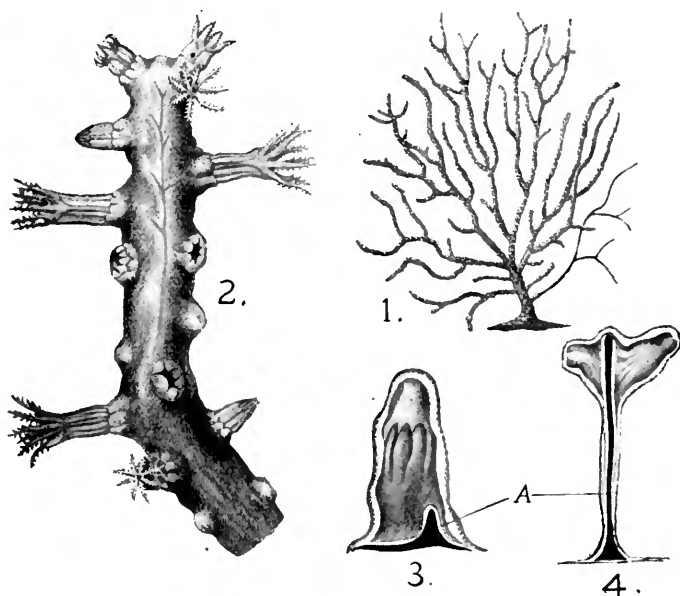

FIG. XIV.

- 1.—A colony of *Gorgonia Cavolini*, von Koch. One-quarter natural size.
 - 2.—Extremity of a branch of *Gorgonia Cavolini*, showing zooids in various stages of contraction. Magnified.
 - 3.—Optical section through the mother zooid of a colony of *Gorgonia Cavolini*, showing the formation of the axis, *A*, as a secretion of the basal ectoderm.
 - 4.—Optical section through an older stage with two zooids. *A*, axis.
- All the figures after G. von Koch.

to the zooid already formed, and successive zooids are formed in the same manner, alternately on either side of the axis. In the fully grown colony the cortex or coenenchyme consists of a thickened mesogloea, in which lie solenia, whose course is mainly longitudinal, *i.e.* parallel to the axis. In the smaller branches of some forms eight solenia are present, which probably represent the eight inter-mesenterial chambers of the primary zooid. In the main stem the number is usually greater. The solenia, both in stem and branches, anastomose freely with one another,

From this description it is clear that the relation of the zooid cavities to the axis is much more intimate in the Axifera than in the Pseudaxonia.

FAMILY 1. DASYGORGIDAE. Colonies simple or branched. Axis horny and calcified. Zooids large, placed far apart, non-retractile, infolding their tentacles over the oral disc when at rest. Spicules smooth, needle-like or fusiform. Genera—*Dasygorgia*, Verrill; *Chrysogorgia*, Duchassaing and Michelotti.

FAMILY 2. ISIDAE. The axis consists of alternate horny and calcareous segments, the calcareous matter being amorphous. There are three sub-families. 1. CERATOISIDINAE. Spicules in the form of smooth needles. Genera—*Bathygorgia*, P. Wright; *Ceratoisis*, P. Wright; *Callisis*, Verrill; *Acanella*, Gray; *Isidella*, Gray; *Sclerisis*, Studer. 2. MOPSEINAE. Spicules in the form of dentate scales. Genera—*Mopsea*, Lamouroux; *Primnoisis*, Wright and Studer; *Acanthoisis*, Wright and Studer. 3. ISIDINAE. Zooids retractile in a thick coenenchyme; spicules stellate, warty. Genus—*Isis*, Linnaeus.

FAMILY 3. PRIMNOIDAE. Axis horny, calcified. Zooids with a calycine moiety stiffened by calcareous scales. Tentacular moiety retractile within the calyx, the opening of which can be closed by an operculum of eight scales. SUB-FAMILY—CALLOZOSTRINAE. Genus—*Callozostrom*, P. Wright. SUB-FAMILY—CALYPTROPHORINAE. Genus—*Calyptrophora*, Gray.

SUB-FAMILY—PRIMNOINAE. Genera—*Primnoa*, Lamouroux; *Stachyodes*, Wright and Studer; *Calypterinus*, Wright and Studer; *Stenella*, Gray; *Thouarella*, Gray; *Amphilaphis*, Wright and Studer; *Plumarella*, Gray; *Primnoella*, Gray.

FAMILY 4. MURICEIDAE. Axis horny; zooids divided into three regions—a proximal calycine, a median retractile, and a tentacular non-retractile. Tentacles at rest infolded, provided at their bases with an armour of stout spicules, forming a false operculum. There are twenty-three genera of Muriceidae, the best known being *Acanthogorgia*, Gray; *Paramuricea*, Kölliker; *Villogorgia*, Duch. and Mich.; *Bebryce*, de Phillipi; *Acis*, Duch. and Mich.; *Eumuricea*, Verrill.

FAMILY 5. PLEXAURIDAE. Axis horny or horny and calcified; zooids partially or wholly retractile, without opercula. Genera—*Eunicea*, Lamouroux; *Plexaura*, Lam.; *Plexaurella*, Kölliker; *Psammogorgia*, Verrill; *Eunicella*, Verrill; *Platygorgia*, Studer.

FAMILY 6. GORGONIDAE. Colonies erect, branched, usually in one plane. Zooids bilaterally or biradially disposed on stem and branches; retractile. Spicules small, fusiform. Genera—*Gorgonia*, Linnaeus; *Eugorgia*, Verrill; *Platycaulos*, Wright and Studer, *Lophogorgia*; M. Edwards; *Stenogorgia*, Verrill; *Callistephanus*, Wright and Studer; *Swiftia*, Duch. and Mich.; *Danielssenia*, Grieg; *Xiphogorgia*, M. Edw.; *Hymenogorgia*, Valenciennes; *Phycogorgia*, Val.

ORDER 5. Stelechotokea.

Under this name are (here for the first time) included all those Synalcyonacea in which a much elongated mother zooid forms the stem or axis of the colony, the daughter zooids being borne as lateral buds upon the stem. The colonies are erect, simple, or branched, or may be plumose. When they are branched, secondary zooids, developed as buds from the stem or mother zooid, form the axes of the branches, and tertiary zooids are budded off on each side of them. The secondary and tertiary zooids, though

they appear to be borne directly by the mother zooid, do not communicate directly with the cavity of the latter, but secondarily by means of solenia, which ramify in the greatly thickened mesogloea of the walls of the mother zooid. The branch thus defined includes forms which have hitherto been classified with the Cornulariidae, and are, in truth, not easily separable from that family. But they exhibit, in their mode of budding and in the disposition of the secondary zooids around a central zooid, characters which mark them off distinctly from their nearest

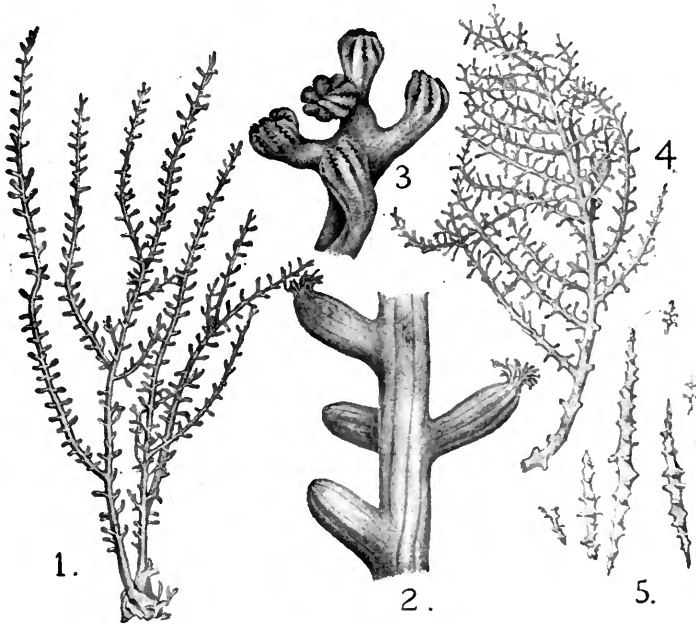

FIG. XV.

- 1.—Portion of a colony of *Carijoa arborea*, Wright and Studer. About one-third natural size.
 - 2.—Portion of stem of *Telestia arborea*. Magnified, showing the zooids.
 - 3.—Extremity of branch of *Coelogorgia*. Magnified, showing the zooids.
 - 4.—*Coelogorgia palmosa*, M. Edw. Portion of a colony about one-third natural size.
 - 5.—Spicules of *Coelogorgia*.
- (1 and 2 after Wright and Studer; 3 to 5 original.)

Cornularian allies, and they appear to lead on to the well-defined group of the Pennatulacea.

SECTION 1. Asiphonacea. *Characters*—Colony erect, simple, or branching, consisting of an elongated, axial zooid with thickened walls containing solenia, from which secondary zooids are formed. Skeleton in the form of dentate discs or warty spindles; a horny or calcified axis absent. The cavity of the axial zooid is not divided by a partition.

FAMILY 1. TELESTIDAE. From a membranous or ramifying stolon individual Clavularia-like zooids, the body walls of which contain solenia, arise. Certain of these grow out to form long zooid tubes, or axial zooids,

and from their walls lateral zooids are given off. Genera—*Telesto*, Lamouroux. The colony is low and only slightly ramified. Spicules in the form of broad dentate discs or ramified and irregular. *Carijoa*, F. Müller. The colonies form tall ramified masses. The axial zooids large, lateral zooids minute. Spicules rod-like with few spines cemented together by a horny substance. [Telesto is usually placed among the Cornulariidae, which it resembles in many respects, in the ramifying or membranaceous stolon, and in the manner in which isolated zooids arise from the stolon. But it differs from them in the manner of budding from axial zooids. The same character removes it from the Stolonifera, as defined above, though the presence of a stolon suggests its inclusion in that group. It must in any case be regarded as a link between the Stolonifera, especially the Cornulariidae, and the next family.] FAMILY 2. COELOGORGIDAE. The colony arborescent, attached by stolon-like processes. The stem formed by an axial zooid, with thickened coenenchymatous walls. Branches formed by axial zooids of the second order, and branchlets by axial zooids of the third order, borne either on two sides or in spirals by the main stem. Spicules straight or curved, bearing lateral processes. Genus—*Coelogorgia*, M. Edwards.

SECTION 2. Pennatulacea. *Characters*—The colony consists of more or less numerous lateral zooids borne by a much elongated axial zooid. The colony is free (except in Gondul), and the axial zooid forms a scapus or stem, which is again subdivided into a proximal calamus or peduncle, sunk into the sand or mud and destitute of zooids, and a distal rachis which bears two kinds of zooids—autozooids and siphonozooids. Thus the colonies are always dimorphic. Early in development the cavity of the axial zooid is divided into two by a longitudinal partition. The majority of the Pennatulacea have an axis which is composed of a calcified horny substance and is generally described as having a willowy texture. When it is present it runs along the middle of the septum dividing the cavity of the axial zooid, and two additional stem canals are formed as cavities in the septal tissue on either side of the axis, making four stem canals in all. The mesogloea of the stem is much thickened and is penetrated by numerous solenia which communicate on the one hand with the stem canals, on the other hand with the coelentera of the autozooids and siphonozooids borne on the rachis. The endodermic musculature is largely developed, especially in the stem where it forms, in the higher members of the group, an external longitudinal and an inner circular layer.

The higher members of the Pennatulacea have a distinct bilateral symmetry, due to the zooids being borne like the barbs of a feather on two sides of the rachis only, leaving a sterile band on the two remaining sides. Hence four surfaces may be distinguished, named by Kölliker the dorsal and ventral sterile surfaces, and the two lateral zooid-bearing surfaces. The names dorsal and ventral are in themselves objectionable, and Kölliker's application of them was unfortunate, for Jungersen (48) has shown that the so-called ventral side of the Pennatulid colony is, in fact, the asulcar, or as it is frequently called, the *dorsal* aspect of the terminal zooid. It is evident that the arbitrary use of the terms dorsal

and ventral leads to confusion, and to avoid ambiguity the following terms will be applied to the several regions into which the rachis of the bilaterally symmetrical Pennatulacea may be divided:—The face of the rachis which is sterile and coincides with the asulcar aspect of the terminal zooid, *i.e.* with the ventral surface of Kölliker, will be called the *prorachis*. The opposite face, equivalent to Kölliker's dorsal surface, is the *metarachis*. The two remaining faces, the lateral surfaces of

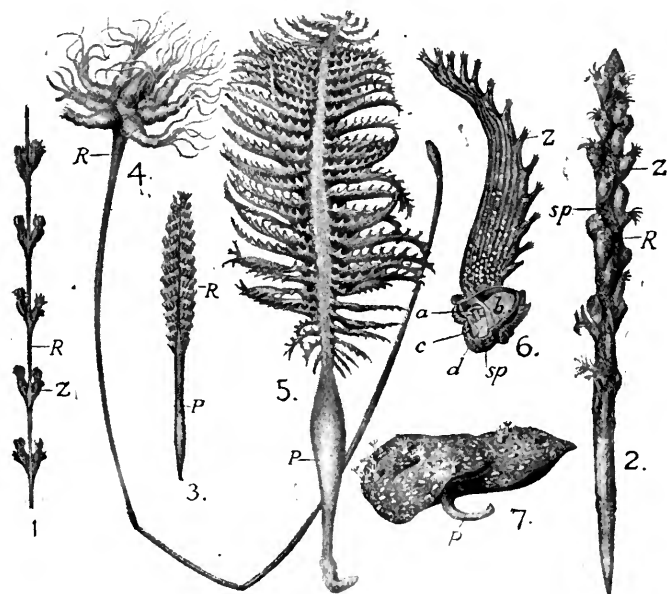

FIG. XVI.

- 1.—*Virgularia Bromleyi*, Köll., from the prorachial aspect.
 2.—*Kophoblemnon Burgeri*, Herklots; metarachial aspect.
 3.—*Stachyptilum Macleari*, Köll.; metarachial aspect.
 4.—*Umbellula Carpenteri*, Köll.; metarachial aspect.
 5.—*Pennatula phosphorea*, Linn.; metarachial aspect.
 6.—Section of the rachis of *Pennatula phosphorea* bearing a single pinna. *a*, axis; *b*, metarachial; *c*, prorachial; *dd*, pararachial stem canals; *sp*, siphonozooids; *z*, autozooids.
 7.—*Renilla reniformis*, Pallas. (1 to 4 after Kölliker, 5 to 7 original.) In all the figures. *R*, rachis; *P*, peduncle; *sp*, siphonozooids; *z*, zooids.

Kölliker, are the *pararachides*. Milnes Marshall (77) has shown that the symmetry of the lateral, or as we may now call them, pararachial zooids, bears a definite relation to the symmetry of the colony. The asulcar aspect of each zooid is turned towards the stem, and therefore may be called axial, the sulcar aspect is turned away from the stem and is therefore abaxial. When, as is the case in *Pennatula* and *Pteroeides*, several elongated zooids are fused together side by side to form leaflets or pinnae, these are always situate on the pararachides and are inserted diagonally on those surfaces. Hence in each leaflet two surfaces may be distinguished—an axial, turned towards the rachis, and an abaxial,

turned away from it. There are also three edges in each pinna—a basal, attached to the rachis; a lower, destitute of zooids; and an upper, more or less convex, bearing zooids. The axis of the Pennatulacea, when present, is entirely enclosed within the tissues and is surrounded by an epithelium. There is not sufficient evidence to show from what layer this epithelium is derived, but the evidence, as far as it goes, points to its being of endodermic origin. The development of Renilla has been

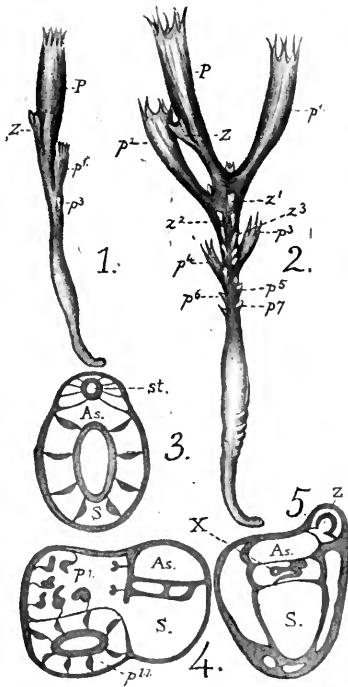

FIG. XVII.

1.—A young colony of *Pennatula phosphorea* seen from the right side. *P*, the calyx of the mother zooid; *Z*, the first siphonozooid; *p*¹, the first lateral autozooid formed as a bud from *P*; *p*³, the third lateral autozooid.

2.—A somewhat older colony seen from the asulcar aspect. *z*¹, *z*², lateral siphonozooids formed at the bases of *p*¹, *p*², the first and second lateral autozooids; *p*³–*p*⁷, successively formed lateral autozooids.

3.—Diagrammatic section through the terminal autozooid and siphonozooid of a young colony of *Pennatula phosphorea*. *S*, sulcar intermesenterial chamber; *As*, asulcar chamber; *st*, stomodaeum of siphonozooid.

4.—A section of the same colony through the autozooid, in 2. *S*, sulcar chamber of the axial zooid; *As*, asulcar chamber; the two are separated by the transverse partition, in which two lateral canals (stem canals) are being formed; *p*¹, *p*¹¹, lateral autozooids.

5.—A section somewhat lower down. The axis *X* is being formed in the partition between the two lateral chambers; *Z*, a siphonozooid. (All the figures after Jungersen.)

thoroughly studied by E. B. Wilson (96), whose memoir should be consulted by the reader; but Renilla has no axis, and Jungersen was unable to obtain stages of *Pennatula phosphorea* young enough to throw light upon the question. The growth of the peduncular septum in Renilla has been fully described by Wilson, and the same mode of development apparently holds good for Pennatula. It arises as a double fold of endoderm containing a delicate lamina of mesogloea at the basal end of a larva of forty hours. This fold grows rapidly upwards and becomes continuous with the asulcar mesenteries at the point where these unite, as they do in Renilla, with the asulco-lateral pair. Thus the coelenteron of the mother zooid is early divided into two cavities by a transverse partition which separates the asulcar portion of the coelenteron from the sulcar portion containing the mesenteries. The lower or proximal portion of the mother zooid becomes, in course of growth,

enormously larger than the distal portion, and forms the peduncle and rachis of the colony, its cavity being divided by the septum into a prorachidial (asulcar or ventral of Kölliker) and a metarachidial (sulcar or dorsal of Kölliker) chamber. The distal portion of the mother zooid becomes at an early period nothing more than a relatively minute appendage upon the upper part of the stem which has been developed from it. At the base of the distal or calycine portion of the mother zooid, a bud, formed on the asulcar side, forms the first or terminal siphonozooid. The lateral zooids are formed as buds on either side of the terminal zooid, and as each is developed a siphonozooid is formed at its base. The pinnae are formed by the development of secondary buds at the bases of the primary pararachidial autozooids. In the course of growth the proximal portions of the rows of autozooids so formed become fused together, the distal ends remaining free and forming small calices, strengthened by a crown of eight points formed by spicules, and the tentacular portions of the zooids are retractile within the calices.

The development of the Pennatulid colony and the formation of the peduncular septum will best be understood by a study of Fig. XVII. The existing families of the Pennatulaceae appear to have diverged from an ancestral form resembling *Protocaulon molle*. The lines of divergence may be briefly indicated as follows:—From an original form in which simple sessile autozooids, each with a siphonozooid at its base, were borne on either side of an axial zooid, differentiated into peduncle and rachis. (1) The autozooids have become more numerous, have encroached on the whole surface of the rachis, and the siphonozooids, multiplying in number, have filled up the spaces between the autozooids. Such a condition is found in the Veretillidae, in which a bilateral symmetry is replaced by a radial symmetry. (2) The autozooids, whilst increasing in number, are confined to two opposite aspects of the rachis, and there form, at first indistinct, afterwards distinct rows. The siphonozooids also increase in number, and lying between the bases of the autozooids, occupy the remainder of the pararachidial surfaces. From this condition, realised in the Funiculinidae, differentiation proceeds in two directions. (a) The autozooids are confined to the upper part of the rachis, and are finally grouped in an umbel at its summit, the remainder of the rachis bearing siphonozooids only on the pararachides, e.g. the Umbellulidae. (β) The autozooids are disposed in oblique rows on the pararachides, and their proximal portions are fused so as to form leaf-like appendages of the rachis or pinnules. In the family Virgularidae the autozooids are short and the pinnules are small and inconspicuous, in the Pennatulidae the autozooids are much elongated and form conspicuous pinnules. The family Göndulidae is derived from the Pennatulidae by suppression of the peduncle, the colony, consisting of rachis and pinnules, being fixed by the proximal end of the rachis. The family Renillidae appears to have branched off from the Umbellulid stem; the peduncle is short, the rachis is much expanded and forms a kidney-shaped expansion, bearing on its upper surface numerous irregularly distributed autozooids, amongst which are situated groups of siphonozooids. The following classification of the Pennatulacea is founded on Kölliker's work, but is

modified to exhibit the relations sketched out above, and to harmonise with the grouping of the other branches of the Alcyonaria :—

SUB-SECTION A. Rachis without pinnules, autozooids sessile, disposed on both sides of the rachis in single series or in indistinct rows.

FAMILY 1. PROTOCAULIDAE. Autozooids sessile, without calices, disposed alternately on each side of the rachis in a single row. Spicules absent.

Genus—*Protocaulon*, Kölliker. FAMILY 2. PROTOPTILIDAE. Autozooids sessile, with calices, disposed alternately on each side of the rachis in a single row. A single siphonozooid at the base of each autozooid.

Spicules present. Genera—*Protoptilum*, Kölliker; *Lygomorpha*, Koren and Danielssen; *Microptilum*, Köll.; *Leptoptilum*, Köll.; *Trichoptilum*, Köll.;

Scleroptilum, Köll. FAMILY 3. KOPHOBELEMNONIDAE. Rachis longer than peduncle, cylindrical, bearing on the parachides retractile autozooids in indistinct rows. Siphonozooids numerous. Spicules present.

Genera—*Kophobelemnion*, Absjörnsen; *Sclerobelemnion*, Köll.; *Bathyptilum*, Köll. FAMILY 4. UMBELLULIDAE. Rachis short, bearing autozooids at its distal end only, where they are frequently grouped into an umbel.

Siphonozooids scattered over the parachides. Genus—*Umbellula*, Lam.

SUB-SECTION B. Rachis without pinnules. Autozooids sessile, borne on the parachides in distinct rows.

FAMILY 5. ANTHOPTILIDAE. The autozooids without calices. Genus—*Anthoptilum*, Köll. FAMILY 6. FUNICULINIDAE. The autozooids have calices.

SUB-FAMILY—FUNICULININAE, with prorachidial siphonozooids. Genera—*Funiculina*, Lam.; *Halipterus*, Köll. SUB-FAMILY—STACHYPTILIDAE, without prorachidial siphonozooids. Genus—*Stachyptilum*, Köll.

SUB-SECTION C. Rachis with pinnules formed by fused rows of autozooids borne on the parachides.

FAMILY 7. VIRGULARIDAE. Pinnules small. SUB-FAMILY—VIRGULARINAE. Pinnules without a calcareous plate. Genera—*Virgularia*, Lam.;

Scytilium, Herklots; *Pavonaria*, Köll. SUB-FAMILY—STYLATULINAE. Pinnules with a calcareous plate. Genera—*Stylatula*, Verrill;

Dubenia, Kor. and Dans.; *Acanthoptilum*, Köll. FAMILY 8. PENNATULIDAE. Pinnules large. SUB-FAMILY—PENNATULINAE. Siphonozooids on prorachis, metarachis, and parachides, but not on pinnules. Genera—*Pennatula*, Lam.;

Leioptilum, Verrill; *Ptilosarcus*, Gray; *Halisceptrum*, Herklots. SUB-FAMILY—PTEROEIDIDAE. Siphonozooids on the pinnules. Genera—*Pteroeides*, Herklots; *Godefroyia*, Köll.;

Sarcophyllum, Köll. FAMILY 9. GÖNDULIDAE. Peduncle absent; colony attached by proximal end of rachis. Genus—*Göndul*, Kor. and Dan.

SUB-SECTION D. Autozooids sessile, disposed over the whole surface of the rachis, which therefore has no pro-, meta-, and parachides, and the symmetry of the colony is radial.

FAMILY 10. VERETILLIDAE. SUB-FAMILY—CAVERNULARINAE. Spicules elongate. Genera—*Cavernularia*, Valenciennes; *Stylobelemnion*, Köll.

SUB-FAMILY—LITUARINAE. Spicules short. Genera—*Lituaria*, Val.; *Veretillum*, Cuvier; *Policella*, Gray; *Clavella*, Gray.

SUB-SECTION E. The rachis forms a broad reniform expansion bearing autozooids and siphonozooids on its surface. Axis absent.

FAMILY 11. RENILLIDAE. Genus—*Renilla*, Lam.

ORDER 6. Coenothecalia.

Characters—Synalcyonacea with a calcareous skeleton composed of lamellae of calcite forming a dense corallum resembling that of the

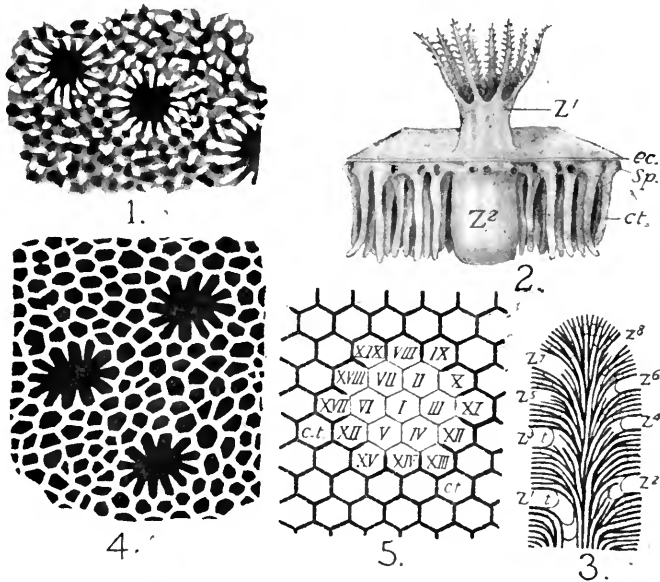

FIG. XVIII.

1.—Surface view of a portion of a fully grown colony of *Heliopora coerulea*, Pall., showing two calices with their pseudosepta; the openings of the coenenchymal tubules, the superficial echinulations, and the shallow canals between them in which the superficial network of solenia lies in the living condition.

2.—A single zooid with the adjacent soft tissues of *Heliopora coerulea*, as seen after removal of the skeleton by decalcification; semidiagrammatic. Z^1 , the distal retractile moiety of the zooid, bearing eight pinnate tentacles; Z^2 , the proximal calicular moiety of the same; *ec*, the continuous sheet of ectoderm which clothes the surface of the colony; *sp*, the superficial network of solenia lying directly beneath the ectoderm; *ct*, coenenchymal tubules.

3.—Diagram illustrating the mode of growth and architecture of a colony of *Heliopora*. Z^1 , calyx of mother zooid; Z^2 , Z^3 , etc., calices of daughter zooids successively formed amongst the coenenchymal tubules; *tt*, tabulae.

4.—Surface view of a tangential section through the surface of a colony of *Heliolites porosus*, Goldfuss, showing three calices, each with twelve pseudosepta imbedded in a coenenchyme consisting of numerous vertical coenenchymal tubules (solenia) of approximately hexagonal shape.

5.—Diagram illustrating the essential structure of the corallum in *Heliopora* and *Heliolites*. *Ct*, coenenchymal tubules, the walls of each of which are composed of twelve separate laminae, which take a share in the composition of the walls of six adjacent tubules. In the centre of the figure a calicular cavity is indicated formed by the arrest, complete or partial, of a group of nineteen coenenchymal tubules numbered 1-xix. The outlines of the arrested tubules are indicated by dotted lines.

imperforate Madreporaria, and developed from a specialised layer of ectoderm cells (calicoblasts). The corallum exhibits a number of larger calices, provided with a variable number of radial pseudosepta, sunk in a coenenchyme composed of numerous closely set vertical tubules, with calcareous walls, which are disposed vertically to the surface of the

corallum. Both calices and coenenchymal tubules are closed below by transverse calcareous partitions or tabulae. The walls of the calices and coenenchymal tubules are not separate and independent, but the calcareous lamellae forming the walls of one tubule enter into the composition of the walls of adjacent tubules, and the calyx walls and the pseudosepta are formed by the walls of adjacent coenenchymal tubules. The colony consists of zooids and solenia. The zooids exhibit a proximal moiety imbedded in the calyx and a distal moiety which can be invaginated within the calcine portion. Solenia are given off radially from the level where these two regions pass into one another, and anastomose with one another to form a more or less regular superficial network, which covers the surface of the corallum. From the nodes of the network blind solenial downgrowths project vertically into the coenenchyme, each occupying a coenenchymal tubule.

The Coenothecalia are represented by a single living genus *Heliopora*, but the group was more largely represented in Palaeozoic times. *Heliolites* from the Silurian and Devonian is closely allied to *Heliopora*. The presence of septiform radial lamellae in the calycles was long regarded as a reason for placing *Heliopora* and *Heliolites* among the Zoantharia, but Moseley (80) demonstrated the typical Alcyonarian structure of the zooids of *Heliopora*, and subsequent investigations have shown that this genus, with others which have a similar structure of corallum, must be placed in a separate branch of the Alcyonaria. For details of the anatomy of *Heliopora* the reader is referred to Moseley's memoir, and to Bourne (9).

Fig. XVIII. 2 shows the relations of the soft parts of the Helioporidae colony, and 5 shows how the walls of each coenenchymal tubule are formed of twelve pieces common to that and the six adjacent tubules, the calyx being formed by the arrest in growth of a group of seven central tubules and the partial arrest of twelve peripheral tubules, the walls of which give rise to the pseudosepta. The most remarkable features in *Heliopora*, in addition to the laminar calcareous corallum, are the limitation of the solenial outgrowths to the middle region of the zooid, and the formation of vertical tubular downgrowths from the solenial meshwork, forming the so-called coenenchymal tubules. These were originally considered to be extremely degenerate siphonozooids, but they have no traces of zooidal structure, and must rather be considered to be a specialised part of the solenial system, associated with the peculiar form of the corallum.

FAMILY 1. HELIOPORIDAE. Colonies forming broad, upright, lobed, or digitate masses flattened from side to side, of a blue colour. Calices with (usually) fifteen pseudosepta. The coenenchymal tubules do not branch, but new tubules are intercalated between those previously existing. Genus—*Heliopora*, Pallas. From tropical seas in shallow water. FAMILY 2. HELIOLITIDAE. Colonies forming spheroidal masses, rarely lobate. Calices with twelve pseudosepta. Coenenchymal tubules more or less regularly hexagonal. Coenenchymal tubes branch dichotomously. Genera—*Heliolites*, Dana. From the Lower and Upper Silurian, and the Devonian. *Plasmopora*, M. Edw. and Haime. Silurian. *Propora*, M. Edw. and Haime. Upper Silurian. *Lyellia*, Edw. and Haime. Upper Silurian. FAMILY 3. THECIDAE. Colonies forming laminar expansions.

Calices with few, not more than nine, irregular pseudosepta. Coenenchymal tubules small, numerous, polygonal. Genus—*Thecia*, M. Edw. and Haime. From the Wenlock limestone. FAMILY 4. CHAETETIDAE. Corallum massive, consisting of long, prismatic, closely contiguous corallites, with common walls. No coenenchymal tubules. Genus—*Chaetetes*, Fischer. From the Carboniferous. The family Monticuliporidae may provisionally be placed here. For a full account of the fossil so-called tabulate corals the reader should consult Nicholson's works (83 and 84).

ZOANTHARIA—SECOND SUB-CLASS OF THE ANTHOZOA.

The Zoantharian zooid is distinguished from the Alcyonarian zooid by the following characters:—

The tentacles are usually simple, more rarely compound or foliaceous, either only six or more than eight in number, and never provided with lateral pinnules. As a rule each tentacle, which is always hollow, is placed over an intermesenterial space. The mesenteries vary very much in number, and in the disposition of their longitudinal retractor muscles, but these never have the arrangement characteristic of the Alcyonaria. Each mesentery is provided with a mesenterial filament, commonly of a trefoil shape in section, the median lobe richly provided with gland cells and nematocysts, the two lateral lobes without these structures, but richly ciliated. The median lobe is derived from the ectoderm, the lateral lobes from the endoderm. There are commonly two ciliated grooves in the stomodaeum, named respectively the sulcus and sulculus; when one only is present it is named the sulcus. The musculature is highly developed, especially on the mesenteries, and the histological differentiation of the tissues is greater than in the Alcyonaria. A skeleton may be absent or present; when present it is calcareous or horny, but is never in the form of spicules, as in the Alcyonaria, and is always developed on the surface of a special layer of ectoderm cells, which never wander into the mesogloea.

The Zoantharia may be simple or colonial; among colonial forms dimorphism is of uncommon occurrence.

It has been shown that in the sub-class Alcyonaria the anatomy of the zooids, the individual members of which the colonies are composed, is remarkably constant, and therefore the modes of budding, and the architecture of the colonies resulting from those different modes were selected as the primary characters of taxonomic value. It has been possible to show, with greater or less certainty, that the highly differentiated and complex members of the higher groups may be derived from a common *Cornularia*-like ancestor, and the existence of a number of intermediate forms has made it possible, in the case of nearly every group, to trace the probable lines of divergence from the parent stock. In the

Zoantharia the case is very different. The zooids present great diversities of anatomical structure, even whilst their external features show strong superficial resemblance to one another. We have to deal with a heterogeneous instead of a homogeneous assemblage of organisms; and in spite of the labours of many excellent investigators, we are still unprovided with a clue which shall enable us to trace out the lines of descent of the principal groups into which the sub-class must be divided. The difficulties of classification are consequently great, and the arrangement here adopted must be regarded as wholly provisional, though pains have been taken to make it as fully as possible representative of the actual state of our knowledge.

The type form of the Zoantharia is the ordinary sea-anemone, of which *Actinia equina*, Linn. (= *A. mesembryanthemum*, Ellis and Sol.), the common red anemone of our English coasts, is an excellent example.

In a common *Actinia* the zooid is solitary and does not produce colonies by asexual generation. The animal has the form of a hollow cylinder, one end of which, the base, is fixed to a rock or to some other surface of attachment; at the opposite end is the mouth, surrounded by tentacles, which are arranged in several circles. The following regions are easily distinguished:—The peristome, or space between the mouth and the bases of the tentacles, the column or body wall, and the basal disc. The mouth is situated in the centre of the peristome. It is elongate and slit-like, and surrounded by somewhat tumid lips. In the living animal the middle portion of the slit is commonly kept closed by apposition of the lips, the two ends being open. The tentacles are situated on the periphery and margin of the peristome; they are simple, digitiform outgrowths of the peristome, retractile, hollow, their cavities communicating below with the intermesenterial spaces of the coelenteron. Each has a small aperture at its extremity. They are numerous; as many as 192 in adult specimens, subequal in size, arranged in four cycles of 6, 6, 12, 24, 48, 96. They bear a definite relation to the number of mesenteries (see Fig. XIX. 1). The margin of the peristome is studded with several, usually twenty-four, coloured vesicles, which are batteries of nematocysts.

The mouth opens into a tolerably long stomodaeum which, like the mouth itself, is flattened from side to side. At each end of the stomodaeum is a longitudinal groove, lined by specialised ectoderm cells bearing long cilia. One of these grooves is termed the sulcus, the other the sulculus, but they do not differ in size or structure, nor is there any means of determining how the names shall be applied to the two grooves in any individual specimen. The mesenteries are numerous, corresponding in number to the

tentacles. They are arranged in couples,¹ the members of each couple being recognisable by the arrangement of their longitudinal retractor muscles. These are attached to plaited folds of the mesogloea and form the so-called muscle banners. They are so disposed that the muscle banners of each mesenterial couple are *vis à vis*, with the exception of two mesenterial couples situated

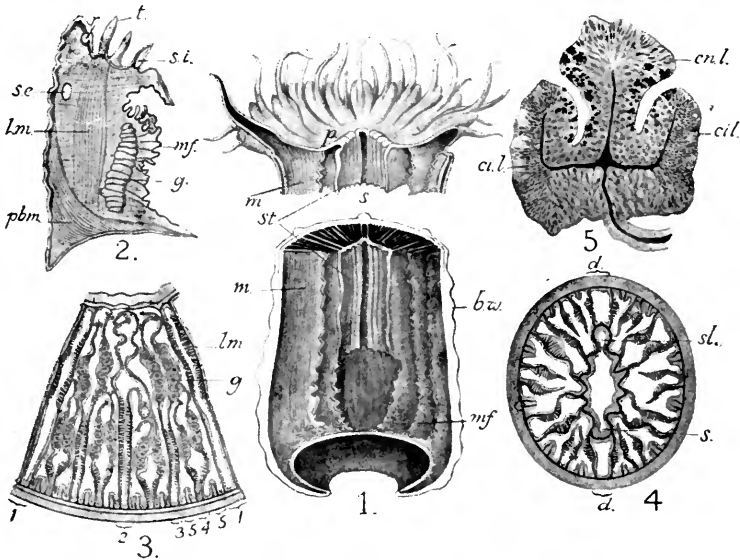

FIG. XIX.

1.—Diagrammatic longitudinal section through an Actinian, *Actinauge Richardi*, to show the general anatomy of the zooid. *bw*, body wall; *st*, stomodaeum; *s*, sulcus; *p*, peristome; *mm*, mesenteries; *mf*, mesenterial filament. (After Haddon.)

2.—A mesentery of *Tealia crassicornis*. *t*, tentacles; *g*, gonads; *r*, Rötteken's or circular muscle; *si*, internal; and *se*, external stomata; *mf*, mesenterial filament; *lm*, longitudinal retractor muscle; *pbm*, parieto-basilar muscle. (After O. and R. Hertwig.)

3.—Transverse section between two couples of primary mesenteries of *Adamsia Rondoletii*. 1, 2, 3, 4, and 5, primary, secondary, tertiary, quaternary, and quinary mesenteries. *lm*, muscle banners; *g*, gonads. (After O. and R. Hertwig.)

4.—Transverse section through the stomodaeal region of *Adamsia diaphana*. *s*, sulcus; *sl*, sulculus; *dl*, the two couples of directive mesenteries. (After O. and R. Hertwig.)

5.—Section through mesenterial filament of *Actinia equina*. *cnl*, cnido-glandular lobe; *cil*, ciliated lobes. The animal had been fed with powdered carmine, the particles of which have been ingested by the cells lying between the cnido-glandular and ciliated lobes, and are represented by the black masses. (Original.)

at the two ends of the long axis of the stomodaeum. In these, which are called the directive mesenterial couples, the muscle banners are turned away from one another.

Mesenteries are complete or incomplete. A complete mesentery is attached by the upper part of its inner margin to the stomodaeum, an incomplete mesentery is not. The free edge of each mesentery

¹ It is convenient when speaking of the adult arrangement of the mesenteries to use the word "couple," when of their developmental sequence to use the word "pair."

is thickened to form a mesenterial filament; in complete mesenteries the filament commences at the stomodaeum, and ends at a short distance from the insertion of the mesentery on the basal disc; in incomplete mesenteries the filament commences some little way below the insertion of the mesentery on the peristome, and ends below in a similar manner. In the upper and lower parts of their courses the mesenterial filaments are straight, but their middle portions are thrown into a number of coils, the mesentery itself being plaited in a corresponding manner. The structure and histology of a filament differs in different parts of its course. In the upper part of its length the filament is trefoil-shaped in section and has the structure shown in Fig. XIX. 5. The central lobe is the cnido-glandular tract (*Nesseldrüsenstreif* of German authors), the lateral lobes are the ciliated tracts (*Flimmerstreifen*). In the middle of the filament the cnido-glandular lobe disappears, the two ciliated tracts remaining; and in the lower portion of the filament the ciliated tracts disappear, the median cnido-glandular lobe re-appearing and forming the whole of the filament. Acontia are filamentous offsets from the lower edge of the mesentery, having the same general histological structure as mesenterial filaments. They are characteristic of the family Sagartidae.

The gonads are borne on the mesenteries, forming band-like thickenings on that part of each mesentery which lies internal to the longitudinal retractor muscles and below the level of the stomodaeum. *Actinia equina* is dioecious, as are many other Actinians, but some members of the group appear to be monoecious.

The radial chambers into which the coelenteron is divided by the mesenteries communicate with one another, not only by way of the axial space into which they all open, but also by perforations in the mesenteries themselves; these are mesenterial stomata. In Actinia the stomata are found in the uppermost inner angles of the complete mesenteries, close beneath the mouth, and are probably the result of incomplete union of the mesentery with the stomodaeum. They are known as internal stomata.

In some other Actiniae, e.g. *Tealia crassicornis* and *Actinoloba dianthus*, external stomata are present. These are circular openings situated in the upper third of each mesentery, nearer to the body wall than to the peristome, but separated by a space from both. Those genera which have external stomata also possess a strong circular muscle band which runs right round the body just beneath and outside of the outermost circlet of tentacles. This muscle band, consisting of an axis of mesogloea thrown into folds along which muscle fibres are arranged, projects into the coelenteron, and is attached to the body wall by a thin sheet of tissue. It is known as Röttcken's muscle.

In Actinia the coelenteron communicates with the exterior by

the mouth, and by the pores at the tips of the tentacles. In the family Sagartidae there are in addition perforations in the lower third of the body wall called cinclides through which the acontia are protruded. In *S. parasitica* each cinclis is placed on the summit of one of the warty tubercles scattered over that region of the body. The histology of the Actiniae has been studied with great care by O. and R. Hertwig (40), to whose work the reader should refer for details. The general features of the histology have already been given on p. 9. The general anatomical features of an Actinian zooid may be studied in Fig. XIX. 1. 2 shows the structure of a mesentery and the arrangement of its musculature. 3 and 4 show the order and relations of the mesenteries.

The mesenteries are the most important organs of the Zoantharian zooid, and it is of great importance that their arrangement and order of succession should be thoroughly understood, since they afford the only characters which have hitherto been found to be of definite taxonomic value. The arrangement of the mesenteries in a typical Actinian is shown in Fig. XIX. 4. As has already been stated, they are arranged in couples, the muscle banners of each couple are turned towards one another, except in the two couples of directive mesenteries (*dl*) whose muscle banners face outwards. The following points must be noted over and above the situation of the longitudinal muscles and the position of the directive mesenteries:—

(a) The mesenteries are arranged in cycles: six couples in the first cycle, six couples in the second, twelve couples in the third, twenty-four in the fourth, and so on. Mesenteries of the same cycle are of the same size and (with the exceptions mentioned hereafter) were formed at the same time. The mesenteries first formed, the primaries, are as a rule the largest; the secondaries are next in size; the tertiaries smaller than the secondaries, and so forth. The two couples of directive mesenteries belong to the first cycle.

(b) Any two mesenteries forming a couple belong to the same cycle, and are therefore of the same size. The two mesenteries forming a couple are separated by a narrow space, an *entocoele*; the two mesenteries of adjacent couples are separated by a wider space, an *exocoele*.

(c) With the exception of the directives the longitudinal muscles of the mesenteries are always entocoealic, the transverse muscles exocoealic.

(d) New couples of mesenteries always take their origin in the exocoeles, never in the entocoeles.

It is common to find six couples of primary mesenteries in the Zoantharia. So commonly does this number occur that at one time the Zoantharia were named the Hexactiniae, in opposition to

the Alcyonarians, called the Octactiniae. It is now known that the number six is not nearly so constant as was formerly supposed, and that where it does occur, the mesenteries of the first cycle are not developed simultaneously nor in the couples which are eventually established. In fact, the six-rayed symmetry which was supposed to be so characteristic of the Zoantharia is not a primary but a secondary feature. The development of the mesenteries in a six-rayed Actinian may be said to proceed in two stages. Firstly, the six couples of primary mesenteries are formed, not simultaneously, as are the eight mesenteries of Alcyonarians, but irregularly, one after

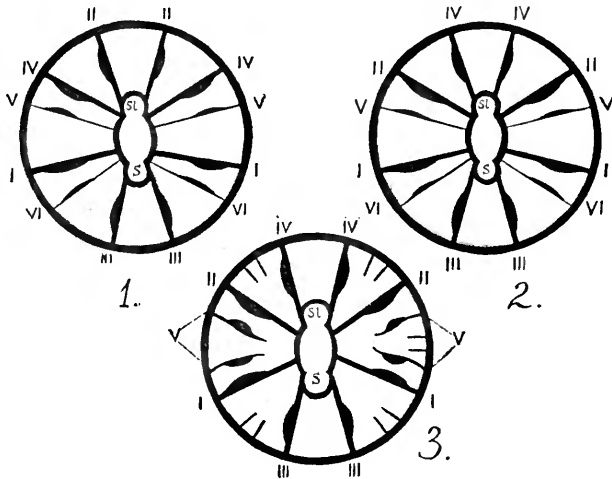

FIG. XX

1.—Diagram showing the developmental sequence of the mesenteries in *Actinia equina*, *Sagartia bellis*, and *Bunodes gemmaceus*.

2.—Shows the sequence of mesenterial development in *Rhodactis*, *Halcampa*, and *Manicina*.

3.—Shows the sequence of mesenterial development in *Aiptasia diaphana*.

In all the figures the numerals I, II, III, etc., denote the order in which the mesenteries make their appearance. The eight mesenteries first formed, the so-called "Edwardsian" mesenteries, are drawn in thick lines, those formed subsequently in thin lines. s, sulcus; sl, sulculus.

the other. This first cycle being once established, the mesenterial couples of each succeeding cycle are formed synchronously, in a regular manner, in the exocoel of the cycles previously existing.

The first cycle of six couples is formed differently in different genera. In *Actinia equina*, *Sagartia bellis*, and *Bunodes gemmaceus*, the order of succession is as follows:—

At the period when the stomodaeum is established, and the mouth has taken on an elongate shape two mesenteries are formed, marked I, I, in the diagram (Fig. XX. 1). They divide the coelenteron into a larger sulcular and a smaller sulcar chamber. It will be seen that these mesenteries originate in the neighbour-

hood of one of the stomodæal grooves, the sulcus, and are placed right and left of it. The second pair of mesenteries (II, II) arises in the larger sulcular chamber, right and left of the sulcular groove. It appears to become the sulcular directive couple of the adult. The third pair of mesenteries (III, III) arises in the smaller (sulcar) of the two original chambers, right and left of the sulcus, and forms the sulcar directive couple of the adult. A fourth mesenterial pair (IV, IV) is then formed, one mesentery in each interspace between the first and second mesenterial pairs. There is now a stage with eight mesenteries which is for a short time persistent. The number of mesenteries corresponds with the condition permanent in the Alcyonaria, but the arrangement of the muscle banners is quite different. The sulcular (II, II), sulculo-lateral (IV, IV), and sulco-lateral (I, I) mesenteries have the muscle banners on their *sulcar* faces; the sulcar mesenteries (III, III) have the muscle banners on their *sulcular* faces. In the number and arrangement of the muscles this stage exactly resembles the permanent condition in the genus *Edwardsia* (cf. Fig. XXI. 2). The six-rayed symmetry is completed by the formation of the mesenteries (V, V) in the lateral chambers, and (VI, VI) in the sulco-lateral chambers, and their muscle banners are so disposed that they form couples respectively with IV, IV, and I, I.

In the genera *Rhodactis*, *Manicina* (a Madreporarian coral), and *Halcampa*, there is an *Edwardsia* stage of eight mesenteries, but it is arrived at somewhat differently. The mesenteries second in order of formation form with the fifth the sulculo-lateral couples of the adult; the mesenteries fourth in order of formation form the sulcular directives of the adult (see Fig. XX. 2).

A third and peculiar mode of arriving at the six-rayed condition is found in *Aiptasia diaphana*, which will be best understood by reference to Fig. XX. 3. There is a stage with eight mesenteries, but the muscle banners on I, I, are turned in the direction opposite to what occurs in *Edwardsia*.

The tentacles, being placed each above an intermesenterial chamber, conform in the order of their appearance and in relative size to the succession of the mesenteries. When the six mesenterial couples are established, six tentacles, viz. those placed over the entocoeles, become larger and longer than the six remaining exocoelic tentacles; at a later stage their sizes are equalised.

It will readily be understood from this account, that the Actinian embryo is at first bilaterally symmetrical. A divisional plane passing through the sulcus and sulculus divides the body into two equal and symmetrical halves, and this symmetry is preserved till the *Edwardsia* stage with eight mesenteries is reached. With the development of the fifth and sixth pairs of mesenteries, a radial arrangement is superimposed on the primitive bilateral

symmetry, and thenceforward the radial predominates over the bilateral type, but a trace of the latter always remains in the laterally compressed stomodaeum and the two couples of directive mesenteries. This combination of bilateral and radial symmetry has been called by Boveri (10) a *biradial* symmetry.

In the genus *Edwardsia*, on the other hand, the symmetry is permanently bilateral.

The genus *Edwardsia*, of which six British species are recognised, comprises small Actinians which are rounded at the aboral extremity and live buried in the sand. The body is divisible into three regions—an upper capitulum, a median scapus, and a lower physa. The capitulum and physa are retractile within the scapus, which is usually invested by a friable cuticle. Though there are only eight mesenteries and therefore eight intermesenterial chambers, the tentacles exceed eight in number, sixteen to thirty-two are generally present. A sulcus and a sulculus are both present, and the arrangement of the muscle banners in the mesenteries has been referred to (see Fig. XXI. 1 and 2). The development of *Edwardsia* is not known, but Boveri observed in a larva in which all the eight mesenteries were present that only two of them, namely, those two corresponding to the mesenteries first developed in *Actinia*, *Bunodes*, etc., bore filaments. Thus it seems probable that they were the first developed in *Edwardsia*, and that the succession of mesenteries is the same in this genus as in the other forms, but that in *Edwardsia* the development stops short at the number eight, whilst the bilateral symmetry is still perfect; in other forms it proceeds further, and a biradial hexamerous symmetry is produced.

Seeing that most Actinians (*Aiptasia* is the exception) pass through an *Edwardsia* stage, and the development of *Edwardsia*, as far as we know it, points to the same sequence of mesenteries as in *Actinia*, it is reasonable to conclude that the latter are derived from an *Edwardsia* form. This conclusion is strengthened by the study of the genus *Halcampa*, a small anemone which, like *Edwardsia*, lives buried in the sand, and is divisible into capitulum, scapus, and physa (Fig. XXI. 3). From twelve to twenty tentacles are present (usually twelve only), and the physa is perforated by about twenty-four apertures at its apex. In *Halcampa chrysanthellum* there are in the adult six couples of perfect mesenteries, arranged on the biradial type, and in addition six couples of very small imperfect mesenteries in the exocoelae. Fig. XXI. 4 is a section through the stomodæal region. Of the twelve complete mesenteries six only bear gonads, viz. those which in order of development are I, I; II, II; III, III. Below the level of the stomodaeum the asulcar directives IV, IV, are provided with filaments and muscle banners, but the mesenteries V, V, and VI, VI, become

much reduced, have no filaments and no muscle banners (Fig. XXI. 5). Thus we find that whilst twelve primary mesenteries are present, four of these, namely, those which are absent in *Edwardsia*, lag behind the others in size and importance.

We are justified, therefore, in regarding the *Edwardsiæ* as the nearest living representatives of the ancestor of the six-rayed Actinians.

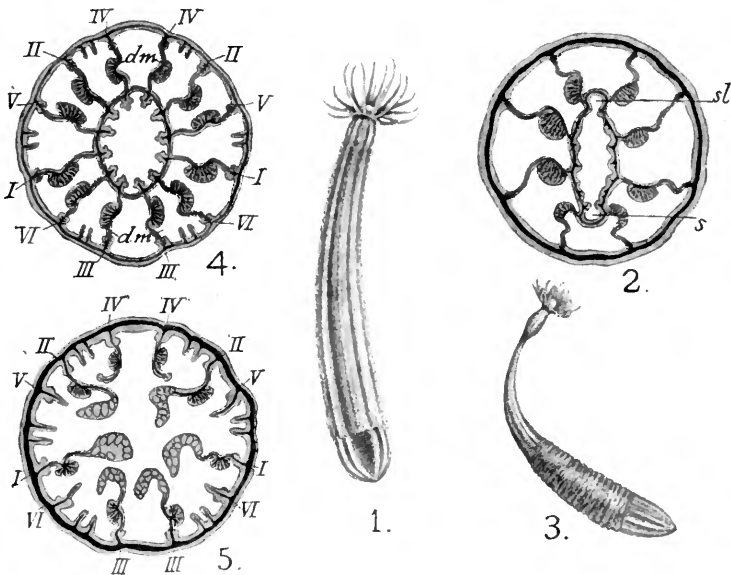

FIG. XXI.

- 1.—*Edwardsia claparedii*, Panc. (After A. Andres.)
- 2.—Transverse section through the stomodeal region of *Edwardsia*, showing the eight mesenteries, and the arrangement of the muscle banners. *s*, sulcus; *sl*, sulcus.
- 3.—*Halcampa endromitata*, Andr. (After A. Andres.)
- 4.—Transverse section through the stomodeal region of *Halcampa*, showing twelve couples of complete primary mesenteries and six couples of minute incomplete mesenteries in the exocoel. *dm*, directive mesenteries.
- 5.—Transverse section of the same species below the region of the stomodaeum, showing six fertile mesenteries—I, I; II, II; III, III; the sterile sulcular directives IV, IV', bearing filaments, and the reduced mesenteries, V, V, and VI, VI, of the first cycle.

To the group of six-rayed Actinians we must now add the large assemblage of forms, both single and colonial, which have hitherto been classed apart as the Madreporaria or stony corals. Researches made by various authors in recent years have shown that the anatomy of a Madreporarian coral, leaving the skeleton out of the question, is in all essential particulars identical with that of such a form as *Actinia equina*. H. V. Wilson has further shown (98) that in the coral *Manicina areolata* the sequence of the development of the first six pairs of mesenteries is identical with that of *Rhodactis* and *Halcampa*. Such being the case, it is no

longer possible to keep the two groups apart in a scheme of natural classification. They must be considered as belonging to an order Actiniidea, and as belonging to the same line of descent from a common Edwardsia-like ancestor. The structure of the corals will be detailed further on. Besides the biradial six-rayed Actinians there are forms which, in external characters, bear the closest resemblance to the ordinary sea-anemones. The resemblance extends to their histological characters, yet they differ considerably in the number and arrangement of their mesenteries. There is the family of Tealiidae, containing sea-anemones undistinguishable from others in external appearance. *Tealia crassicornis* and *T. tuberculata* are common on the British coasts. In these the tentacles and mesenteries are arranged not in multiples of six but of five. In *T. crassicornis* there are ten couples of complete mesenteries of equal size, two couples of which are directives. Between these are ten couples of smaller mesenteries, and again in the exocoelae between the first and second cycles twenty couples of still smaller mesenteries (see Fig. XXII. 1).

It seems difficult to connect this arrangement with the six-rayed type, but the following ingenious suggestion is given by Boveri:—The complete mesenteries numbered 1 correspond to the six couples of the first cycle in Actinia. Those numbered 1^a, the four couples which are added to the other six to make up the *apparent* first cycle of ten, belong in reality to the second cycle, but are precociously developed and intruded amongst the first cycle. The two couples of mesenteries numbered 2 are the remaining members of the second cycle, and to them are joined the eight couples of mesenteries numbered 2^a, precocious members of the real third cycle, which, when added to the two couples 2^a, make up the ten couples of the apparent second cycle. And so on for the remaining cycles.

Boveri's suggestion is not only very ingenious, but is supported by a peculiar sequence of mesenterial development observed in an undetermined larva which he suspected to be that of a Tealia. The reader is referred to his memoir (10) for details. Accepting his suggestion, we may provisionally consider the Tealiidae as an offshoot of the six-rayed Actinians.

Polyopis striata has been described by R. Hertwig. It is a small Actinian from the *Challenger* Collection, with thirty-six tentacles reduced to stomidia, and is described as having eighteen couples of mesenteries—six couples complete, of which two couples are directives, and in each of the sulco-lateral and sulculo-lateral chambers three couples of incomplete mesenteries, the middle couple being the longest (Fig. XXII. 2). According to this description we may, with Boveri, derive *Polyopis* from the normal biradial type by suppression of the mesenteries in the lateral

exocoelae. But Hertwig's description is inconsistent with his figures, in which twenty couples of mesenteries are shown, of which eight couples are complete, and the position of Polyopis must be considered doubtful for the present.

Sicyonis crassa has sixty-four mesenterial couples—sixteen com-

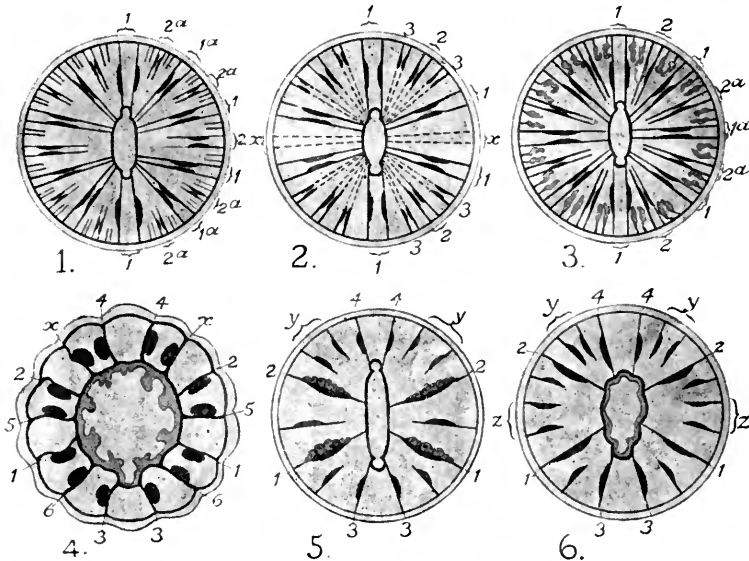

FIG. XXII.

1.—Diagrammatic transverse section through the stomodaeal region of *Tealia crassicornis*. 1, 1, primary mesenteries; 1^a, 1^a, precociously developed mesenteries of the second cycle; 2, 2, normal mesenteries of the second cycle; 2^a, 2^a, precociously developed mesenteries of the third cycle.

2.—A similar section of *Polyopis striata*. 1, 1, mesenterial couples of the first cycle; 2, 2, mesenterial couples of the second cycle; 3, 3, mesenterial couples of the third cycle; x, x, the dotted lines represent mesenterial couples figured by Hertwig, but stated in his description to be absent. If they were present they would complete the second cycle. All the mesenteries are said by Hertwig to reach the stomodaeum, but his figure represents the primaries only as complete. Hence the inner ends of the secondaries and tertiaries have been represented in dotted lines.

3.—A similar section through *Sicyonis crassa*. Numerals as in 1. There are really sixty-four mesenteries in *Sicyonis*, but to avoid crowding the figure the number has been halved.

4.—A similar section through *Scytophorus striatus*. Numerals as in Fig. XXI.; x, x, additional pair of sulculo-lateral mesenteries.

5.—*Gonaetina prolifera*. Numerals as in Fig. XXI.; y, y, two additional mesenterial couples in the sulculo-lateral chambers.

6.—*Oractis diomedeanae*. Numerals, etc., as in 5; z, z, additional mesenterial couples in the transverse chambers.

plete, sixteen incomplete forming the second cycle, and thirty-two incomplete forming the third cycle. Only the mesenteries of the third cycle bear gonads (Fig. XXII. 3). Here, Boveri suggests, the mesenterial couples numbered 1 are the true primaries, to which the two couples numbered 1^a, belonging really to the second cycle, are added, making an apparent primary cycle of eight couples. The apparent second cycle of eight couples is made up of the four

remaining members of the real second cycle 2, to which are added the four couples 2^a, and so forth. The suggestion is ingenious; it can hardly be said to be proved, but may be provisionally accepted, and the Sicyonidae may be considered as offshoots of the six-rayed Actinians. The reader will not fail to notice the resemblance between *Tealia*, *Polyopis*, and *Sicyonis*. They are clearly more nearly related to one another than the following, and are offshoots from the fully formed biradial type:—

The genus *Peachia* has no sulculus, but a large and modified sulcus with a conspicuous protuberant lip, the conchula. It has ten couples of mesenteries—six couples are complete, two couples being directives. They correspond in number and muscular arrangement to the definitive primary cycle of *Actinia*, and are doubtless homologous with them. The four remaining couples are incomplete, have no filament, and do not bear gonads, but are very muscular. One couple is found in each sulco-lateral and lateral chamber, but there are none in the sulculo-lateral chambers. *Peachia*, then, is a six-rayed Actinian with two cycles of mesenteries, but the sulculo-lateral couples of the second cycle are suppressed.

The *Monauleae* of Hertwig are represented by the single species, *Scytophorus striatus*. It has only one stomodæal groove (the sulcus), fourteen tentacles, and seven couples of mesenteries (Fig. XXII. 4).

This may easily be explained by reference to a larval *Halcampa*. The mesenteries are numbered in the order of their succession in *Halcampa*, and to the six couples of the primary cycle two mesenteries are added marked *x, x*, whose muscle banners are so disposed that they seem to form couples with the ascular directives.

Gonactinia prolifera, a remarkable form found on the coasts of Norway and recorded from Falmouth, has sixteen tentacles, a sulcus and sulculus, and sixteen mesenteries (Fig. XXII. 5). Of these eight are macromesenteries, are complete, and in the arrangement of their muscles agree with the *Edwardsia* type. The eight others are incomplete micromesenteries; there is a couple in each sulculo-lateral chamber, their muscle banners *vis à vis*; one micromesentery in each transverse and sulco-lateral chamber, their muscle banners so disposed that they face the sulco-lateral and sulculo-lateral macromesenteries and seem to form couples with them. Only the four lateral macromesenteries bear gonads, and in immature forms these are the only four which bear filaments. In this case the derivation from an *Edwardsia* form is obvious, and it may also be observed that if the upper members of the two pairs of mesenteries marked *y, y* in Fig. XXII. 5 are taken away, the arrangement and number of mesenteries resembles *Scytophorus*.

Oractis diomedae has been described by M'Murich (76). It has a sulcus but no sulculus; eight complete mesenteries are present, having an Edwardsia arrangement, and all bear gonads and mesenterial filaments. In addition there are twelve micromesenteries, whose arrangement recalls that observed in Gonactinia, but there is an additional couple in each of the transverse chambers (see Fig. XXII. 6).

From the persistence of the Edwardsian mesenteries as macromesenteries in Gonactinia and Oractis, and from the easy transition from Gonactinia to Scytophorus, it may be concluded that these forms have descended from an Edwardsia-like ancestor, diverging somewhat low down from the line of descent which led to the Hexactinian type.

All the Zoantharia hitherto considered agree in their fundamental histological characters, and in spite of the exceptions enumerated, it may be stated of them that, after the first cycle of twelve couples of mesenteries is established, new mesenterial couples are formed in the exocoelae between the couples already existing.

The remaining groups of the Zoantharia offer greater difficulties. They differ from the Actinian type both in histological characters and in the disposition and sequence of their mesenteries. There are three groups to be considered—the Zoanthidea, the Cerianthidea, and the Antipathidea.

The Zoanthidea are mostly colonial, more rarely solitary Zoantharia, without a skeleton, but encrusted externally by a coat of sandy and other adventitious particles. The colonial forms are united by basal stolons, which, like those of the Alcyonaria, contain numerous solenia. The stolons may fuse to form a membranous expansion, which again may be thickened to form a coenenchyme, in which the proximal moieties of the zooids are imbedded. The external characters of the zooids are Actinia-like. There are two circles of tentacles—an inner larger and a smaller outer circle. The large and small tentacles alternate with one another, and those of the one cycle are placed over the exocoelae, those of the other over the entocoelae, so that there are as many tentacles as mesenteries. The mesogloea differs from that of all other Zoantharia in being permeated by canals which are filled with cells of ectodermic origin. There is a sulcus, but no sulculus. The mesenteries of the Zoanthidea are bilaterally disposed in a characteristic manner.

There are two kinds of mesenteries—complete macromesenteries bearing gonads and filaments, and incomplete micromesenteries devoid of gonads and filaments. There are two couples of directives with muscle banners turned away from one another. The sulcar directives are macromesenteries, the asulcar directives micromesenteries. Between these, on either side, lie a variable

number of mesenterial couples, each couple consisting of a macro-mesentery and a micromesentery, their muscle banners *vis à vis*. In the youngest observed stages of Zoanthidea there are six macro-mesenteries and six micromesenteries, whose disposition is shown in Fig. XXIII. 3. They are numbered according to the probable order of their development. (M'urrich's (75) account is followed in preference to that of van Beneden.) It is obvious that the sequence is the same as that observed in Hexactinian larvae,

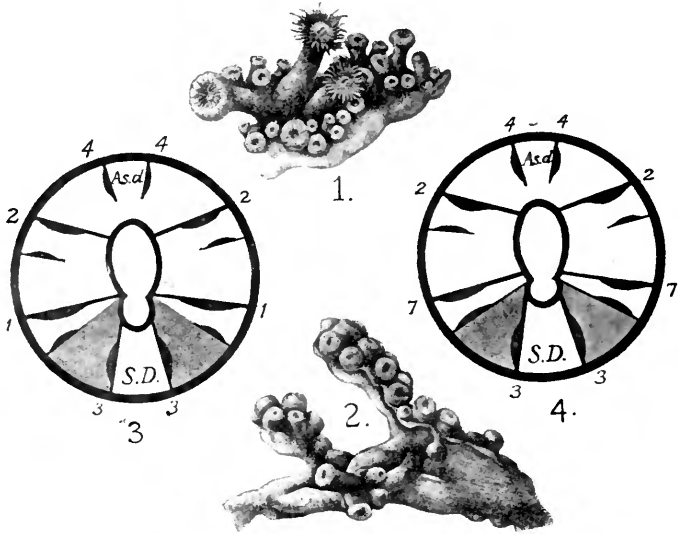

FIG. XXIII.

- 1.—*Polythoa*, sp. ? showing expanded zooids.
- 2.—*Zoanthus*, sp. ? growing on a piece of sponge showing retracted zooids springing from a membranaceous stolon.
- 3.—Diagram showing the microtypal arrangement of mesenteries in a young Zoanthid.
- 4.—Diagram showing the macrotypal arrangement. Numerals in 3 and 4 as in Fig. XXI. In both microtype and macrotype all the mesenteries succeeding the first twelve are developed in the sulco-lateral exocoel, shaded in the diagrams. *SD*, sulcar directive macromesenteries; *Asd*, asular directive micromesenteries.

the difference being that the fourth, fifth, and sixth pairs, instead of completing the cycle of twelve equal and complete mesenteries, remain incomplete and are micromesenteries. There is no doubt that the micromesenteries 4, 4, are homologous with the sulcular directives of *Edwardsia* or *Actinia*, but their arrested development as well as the absence of a sulculus suggests that the Zoanthidea have branched off from a parent form common to the *Edwardsiidea* and themselves, and are not descended from an *Edwardsia* form, as are the groups hitherto considered. Be this as it may, the subsequent development is peculiar. New mesen-

teries are formed only in the sulco-lateral exocoelae. They are formed in couples, each couple comprising a macromesentery and a micromesentery, in such wise that the former is always nearest the *sulcar* directives. The resulting arrangement is shown in Fig. XXIV. It will be observed that five of the original six pairs of mesenteries are pushed up towards the asulcar surface and there form an asulcar group, characterised by the fact that in the lateral members of the group the macromesenteries are nearest to the *asulcar* directives. Some members of the Zoanthidea show a slight modification of this arrangement, in that the mesenteries 6, 6, forming couples with 1, 1, are macromesenteries. Such a modified

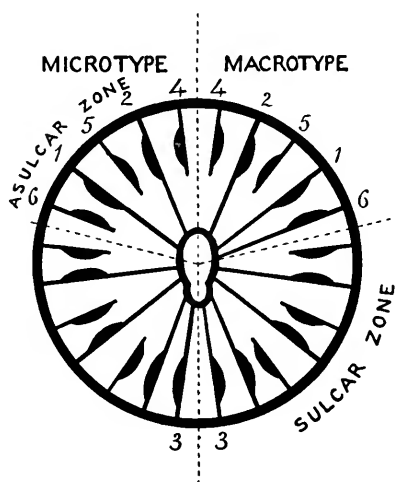

FIG. XXIV.

Diagram of the final arrangement of the mesenteries in the Zoanthaea. The left of the figure shows the microtypal, the right the macrotypal arrangement. Numerals as in Fig. XXIII. 3 and 4. The five mesenterial pairs, 1, 1; 2, 2; 4, 4; 5, 5; 6, 6, occupy the asulcar aspect of the zoid, and it is seen that in this region the macromesentery of each couple is furthest from the sulcar directives. In the remaining sulcar region the macromesentery of each couple is nearest the sulcar directives.

arrangement is known as the macrotype, the normal arrangement being called the microtype. The difference is made use of for purposes of classification.

The *Cerianthidea* form a limited group, comprising the genera *Cerianthus*, *Bathyanthus*, and *Saccanthus*. *Cerianthus* is a solitary Zoantharian, living imbedded in the sand. Its basal extremity is rounded, and provided with a terminal pore. The column is elongated, cylindrical, smooth, protected by a non-adherent case formed of a felt-work of nematocysts containing grains of sand and other bodies. The peristome is large, provided with two circlets of tentacles—marginal and labial (Fig. XXV. 1). There is a single ciliated groove in the stomodaeum, which is apparently not the sulcus but the sulculus. The mesenteries are numerous, and all but the very short pair on the side furthest from the ciliated groove are complete. The musculature of the mesenteries

is weak, the longitudinal muscles being less developed than the transverse, and there are no muscle banners. Carlgren (14) has shown that the longitudinal muscles are always found on the same face in each mesentery, namely, on the face turned away from the ciliated groove. In *Edwardsia* the opposite is the case, and it is concluded that the ciliated groove of *Cerianthus* does not

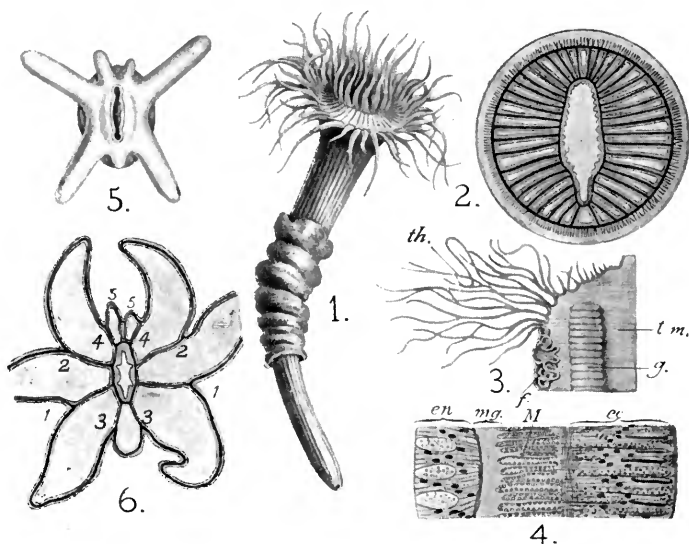

FIG. XXV.

- 1.—*Cerianthus solitarius*, Rapp.
- 2.—Transverse section through the stomodæal region of *Cerianthus*, showing the sulculus, *s*, and the arrangement of the mesenteries. (After O. and R. Hertwig.)
- 3.—Portion of a mesentery of *Cerianthus membranaceus*, showing the transverse muscles, *tm*, the filament *f*. The Acontia-like threads, *th*, borne by the upper edge of the mesentery, and *g*, the gonads. (After O. and R. Hertwig.)
- 4.—Section through the peristome of *Cerianthus membranaceus*, showing the longitudinal ectodermic muscles, *M*; *ec*, ectoderm; *mg*, mesogloea; *en*, endoderm. (After O. and R. Hertwig.)
- 5.—Oral aspect of a young *Arachnactis brachiolata*, the larva of a *Cerianthus*, with seven tentacles. (After E. van Beneden.)
- 6.—Transverse section through the stomodæal region of an older larva. The numerals indicate the order of development of the mesenteries. (After Boveri, slightly altered.)

correspond with that of *Edwardsia*, but is the sulculus, the sulcus being absent.

The pelagic larva shown from the oral surface in Fig. XXV. 5 is known as *Arachnactis brachiolata*. It is the young form of an undetermined species of *Cerianthus*. Fig. XXV. 6 is a transverse section through the stomodæal region of an older larva. It has nine tentacles—one small, median, and, according to Carlgren's orientation, ascular; six large and lateral; two of unequal size, but smaller than the lateral tentacles, occupy the sulcar region. The section shows that these correspond to as many intermesen-

terial spaces, and that, in addition, there is a median intermesenterial space on the sulcar side as yet unprovided with a tentacle. The intermesenterial spaces are formed by ten mesenteries, whose developmental sequence is expressed by the numbers 1, 1; 2, 2; 3, 3; 4, 4; 5, 5. Thus the larval *Cerianthus* passes through a stage with eight mesenteries, and these are developed in the same sequence as the first eight mesenteries of *Halcampa* and *Rhodactis*. But in the absence of muscle banners it can hardly be called an *Edwardsia* stage. The further course of development differs from anything else that has been described. New mesenteries are always developed in the sulcar chamber between the previously existing sulcar mesenteries. Thus 5, 5, are developed between 4, 4; 6, 6, will be developed between 5, 5, and so on. It results that *Cerianthus* is strictly bilaterally symmetrical, and that the members of a mesenterial pair are not contiguous, but are to be found on opposite sides of the stomodaeum. As the sequence of the first four pairs of mesenteries is identical with that of *Halcampa*, etc., it has been held by Boveri and M'Murrich that the *Cerianthidae* are derived from an *Edwardsian* stock. But the presence of longitudinal parietal ectodermic muscles must be held to separate the *Cerianthidae* from the *Edwardsia* stock, and, as in the case of the *Zoantheae*, they must be regarded as having diverged from a common ancestor of all the *Zoantharia*.

The *Antipathidea* form a well-defined group, whose relationships are very obscure. The type form, *Antipathes dichotoma*, forms arborescent colonies, consisting of numerous zooids arranged in a single series along one surface of a branched horny axis. The axis is enclosed by the soft tissues, and is surrounded by a special epithelium, which in all probability is of ectodermic origin. Only the number and arrangement of the mesenteries will be considered in this place, further details being postponed. In the *Antipatharian* zooid the peristome forms a prominent oral cone, on the summit of which the mouth is placed. It is surrounded by six tentacles, usually simple and non-retractile, but branched and retractile in the family *Dendrobrachiidae*. The stomodaeum is strongly compressed, and the zooids are so arranged on the axis that the long axis of the stomodaeum is at right angles to the axis of the colony. An ill-defined sulcus and a sulculus are present, and the tentacles corresponding to the sulcar and sulcular intermesenterial chambers are longer than the rest. In most of the genera there are ten mesenteries, which do not bear muscle banners. The genus *Leiopathes* is an exception, having twelve mesenteries. Where ten mesenteries are present, they have the arrangement shown in Fig. XXVI. 2.

The sulcar and asulcar mesenterial pairs are short; the sulco-lateral and sulculo-lateral pairs are somewhat longer, but the

lateral mesenteries which correspond with the long axis of the colony are very long, and are the only mesenteries which bear gonads. They are conveniently distinguished as the reproductive mesenteries. The development of the Antipathidea is unknown, and it is therefore impossible to say what is the sequence of the mesenteries; but it seems probable, from a comparative study of the existing genera, that the sequence conforms to the Edwardsio-Actinian type. The tentacles are placed over the sulcar

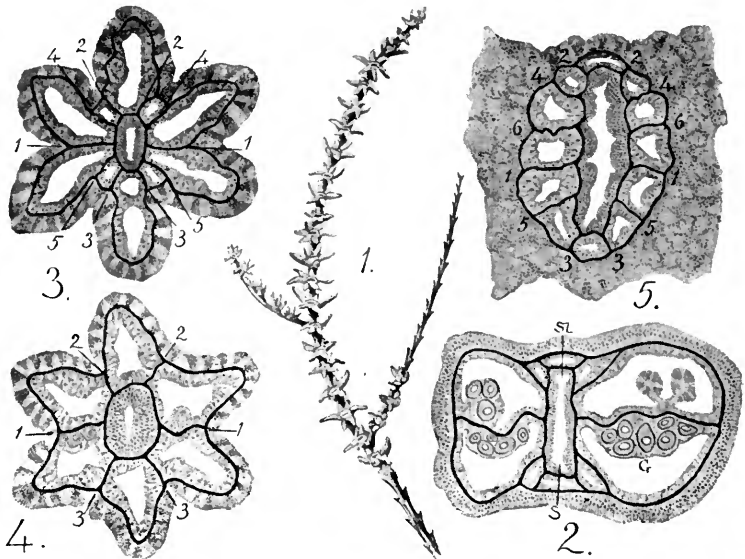

FIG. XXVI.

- 1.—Portion of a colony of *Antipathes dichotoma*.
- 2.—Transverse section through the oral cone of *Antipathella subpinnata*. *s*, sulcus *sl*, sulculus; *g*, gonads.
- 3.—Transverse section through the upper part of the oral cone of *Antipathella minor*. The numerals indicate the probable order of succession of the mesenteries.
- 4.—A section somewhat lower down from the same specimen. Only three pairs of mesenteries are present.
- 5.—Section through the oral cone of *Leiopathes glaberrima*. Six pairs of mesenteries are present, their probable order of succession being indicated by the numerals.

and sulcular chambers, and over the four chambers adjacent to the reproductive mesenteries. In *Antipathella minor* ten mesenteries are present in the oral cone, but lower down four of them disappear, leaving six mesenteries only, which, as Fig. XXVI. 3 and 4 show, are the sulcar and sulcular pairs and the reproductive mesenteries. Assuming that the more persistent mesenteries are the oldest, and that the great reproductive mesenteries correspond in order of appearance, as they do in position, to the mesenteries 1, 1, in the Actinian larva, we may number the two remaining pairs 2, 2,

3, 3, and we get a form with six mesenteries whose sequence corresponds to the sequence of the first six mesenteries in *Actinia equina*. But we can go no further. If the mesenteries marked 4, 4, in 3 were found to be developed before those marked 5, 5, we should get an eight-rayed stage similar in all respects to the Edwardsia stage in Actinia, except for the absence of muscle banners.

Leiopathes glaberrima has twelve mesenteries in the oral cone. Below the level of the stomodaeum only six are present. Study of serial sections shows that the mesenteries die out in the following order:—Firstly, those marked 6, 6, in Fig. XXVI. 5; secondly, those marked 5, 5; thirdly, those marked 4, 4. It will be observed that the additional pair of mesenteries is the first to disappear, and that the pair which is presumably fourth in order of development outstays the pair which was presumably developed fifth. In the absence of further evidence it may be conjectured that the first four pairs of mesenteries are formed in the Antipatharia in the same sequence as in the case of Actinia, and that therefore an Edwardsia stage of development may be assumed. It would follow that the normal number of ten, characteristic of the Antipatharia, is arrived at by the development of a single mesentery in each sulco-lateral chamber; and where twelve mesenteries are present, as in *Leiopathes*, an additional mesentery is formed on each side between the sulco-lateral and reproductive mesenteries, the arrangement of the last two pairs differing from that in *Actinia equina*.

It may be concluded that the existing Zoantharia are derived from a bilateral ancestral form which was provided with no more than eight mesenteries. In this form there was probably no sulcus and no sulculus, and muscle banners were absent. It was, therefore, antecedent to the Edwardsia form, and probably enough was the common ancestor of the Alcyonaria and Zoantharia. From this parent form the Cerianthidea, the Zoanthidea, the Antipathidea, and the Edwardsiidea diverged. From the Edwardsiidea may be derived all the other recent Zoantharia. The Oractidae, Gonactinidae, and Monaulidae appear to have diverged early from the Edwardsian stem, which was continued into the Actinian series which, from its disguised bilateral symmetry, may be called the Cryptoparamera. This gave rise to two main branches: (1) Forms with a stony skeleton, the Scleractineae, equivalent to the Madreporaria of previous authors, and (2) the Malacactineae, equivalent to the Actiniaria of previous authors. From the Malacactineae the aberrant families of the Polyopidae, Sicyonidae, and Tealiidae were derived. These relationships are expressed in the following table:—

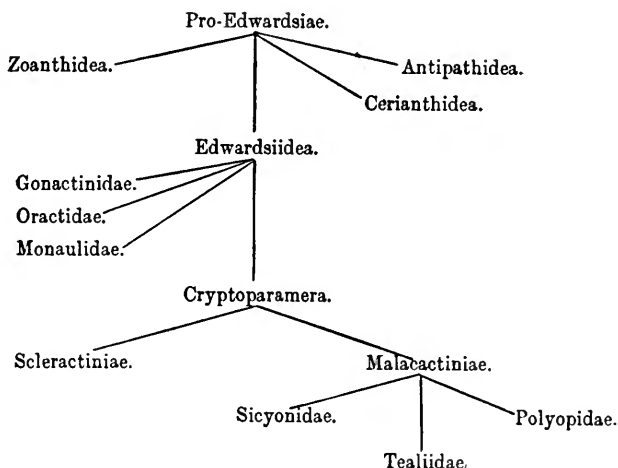

Whether or no the pro-Edwardsiidae were developed from a cruciform, *i.e.* a four-rayed ancestor, is a matter of conjecture. The Rugosa, a heterogeneous group of Palaeozoic corals, are sometimes known as the Tetracoralla because of the characteristic quadripartite symmetry which they exhibit. In such a form as *Stauria* there are four principal septa, placed at right angles to one another, and several secondary septa arranged in four systems, those in each system inclining towards a primary septum. A different arrangement of the secondary septa obtains in such forms as *Streptelasma*, but the quadripartite symmetry is again conspicuous. It is tempting to suppose that the four principal septa stood between four primary mesenteries, which were homologous with the two pairs first developed in recent Zoantharia. This would indicate a quadripartite ancestor for the Zoantharia, possibly for all the Anthozoa. But in the present state of our knowledge such inferences must be received with caution. The most that can be said, is that microscopic examination of palaeozoic corals shows that their skeletons are built up on the same plan as those of recent corals, and that it may legitimately be inferred that the correspondence in structure of the hard parts is evidence of a correspondence in the structure of the soft tissues which gave rise to them. The work of Pratz (104), von Koch (102), Quelch (86), and Ogilvie (103) has resulted in the breaking up of the old group of the Rugosa, many members of which are now included amongst families to which recent Scleractineae belong.

The Zoantharia may be classified as follows :—

GRADE I.—PARAMERA.

The primitive bilateral symmetry of the zooid is retained, or at most is partially obscured by the secondary development of mesenteries in a limited number of the primary intermesenterial chambers.

ORDER 1. *Cerianthidea*.

Solitary Zoantharia paramera without a skeleton. The mesenteries are numerous, arranged symmetrically in pairs, each member of a pair on opposite sides of the stomodaeum. The mesenteries devoid of muscle banners. A sulculus present but no sulcus. Musculature chiefly in the form of longitudinal ectodermal muscles supported by processes of the mesogloea of the column.

FAMILY CERIANTHIDAE. Genera—*Cerianthus*, Dell. Chiaje; *Bathyanthus*, Andres; *Saccanthus*, M. Edw.

ORDER 2. *Antipathidea*.

Colonial Zoantharia paramera with a spinose, horny, usually branching axial skeleton on which the zooids are seated. Six tentacles, of which two corresponding to the ends of the long axis of the stomodaeum are usually larger than the others. Six primary mesenteries always present; in most forms four others are developed, one in each sulco-lateral and sulculo-lateral chamber, making ten. The two mesenteries at right angles to the long axis of the stomodaeum are greatly developed, and alone bear gonads. Muscle banners absent.

FAMILY 1. ANTIPATHIDAE. The individual zooids have six simple non-retractile tentacles, which may be radiately arranged or in two rows of three each. Axis spinose and with a central canal. Ten mesenteries are present. SUB-FAMILY—CIRRHIPATHINAE. The zooids are radiately arranged on all sides of the axis. Genus—*Cirrhopathes*, Blainville. SUB-FAMILY—ANTIPATHINAE. The zooids are borne in linear series on one side of the axis. The transverse axis of the zooid tends to be elongated in the direction of the long axis of the stem and branches. Genera—*Antipathes*, Pallas; *Stichopathes*, Brook; *Antipathella*, Brook; *Aphanipathes*, Brook; *Tylopathes*, Brook; *Pteropathes*, Brook; *Parantipathes*, Brook. SUB-FAMILY—SCHIZOPATHINAE. Zooids much elongated in the transverse axis. On either side the two chambers adjacent to the reproductive mesenteries are separated by a partition from the rest of the zooid, which thus appears to be divided into three parts—two reproductive and one gastral. Each division bears two tentacles. Genera—*Schizopathes*, Brook; *Bathypathes*, Brook; *Taxipathes*, Brook; *Cladopathes*, Brook. The last-named genus has only six mesenteries.

Note.—The Schizopathinae have been described by Brook as dimorphic, but there is no division of labour accompanied by structural differentiation amongst the zooids, and therefore there is no dimorphism. The zooids are all alike; each zooid is greatly modified in connection with the greatly developed gonadial mesenteries, but there is no division into

sterile and fertile, gastrozooids and gonozooids. It is easy to trace the steps which have led to the specialised Schizopathinae. Antipathes is a nearly radial form, the reproductive mesenteries but little longer than the others, and the zooid is scarcely elongated in the transverse axis. In Parantipathes the reproductive mesenteries are very long, the zooid is much elongated in the transverse axis, and the two pairs of tentacles belonging to the paragonadial chambers are shifted away from the oral cone. The formation of incomplete septa dividing the paragonadial chambers from the remainder completes the Schizopathine condition.

FAMILY 2. LEIOPATHIDAE. Twelve mesenteries are present in the oral cone. Genus—*Leiopathes*, Gray. FAMILY 3. DENDROBRACHIIDAE. Axis formed by several longitudinal lamellae arranged round a central rod; no central canal. Tentacles retractile, pinnate. Genus—*Dendrobrachia*, Brook.

ORDER 3. Zoanthidea.

Zoantharia paramera, mostly colonial, rarely solitary. Without a skeleton, but often encrusted by sand. A sulcus is present, but no sulculus. Mesenteries numerous, of two kinds, fertile macromesenteries and sterile micromesenteries. The sulcar directives are macromesenteries; the asulcar directives are micromesenteries. In the remaining mesenteries each macromesentery forms a couple with a micromesentery (one couple excepted in *Macrotypa*), their well-developed retractor muscles being *vis à vis*. After the first twelve mesenteries are established, new mesenteries are formed only in the sulco-lateral chambers. Mesogloea permeated by ectodermic canals.

FAMILY 1. ZOANTHIDAE. Division 1. *Microtypa*. The sixth primary mesenteries are micromesenteries. Genera—*Zoanthus*, Cuvier; *Mammilifera*, Lesueur; *Corticifera*, Lesueur. Division 2. *Macrotypa*. The sixth primary mesenteries are macromesenteries. Genera—*Epizoanthus*, Verrill; *Palythoa*, Lam.

FAMILY 2. SPHENOPIDAE. Solitary Zoantheae with rounded aboral extremity. Genus—*Sphenopus*, Steenstrup.

ORDER 4. Edwardsiidea.

Free solitary Zoantharia paramera with eight mesenteries and sixteen to thirty-two tentacles. Body divided into capitulum, scapus, and physa. Without a skeleton. Sulcus and sulculus present. Retractor muscles of mesenteries well developed, placed on the asulcar aspect of the sulcar directives, on the sulcar aspect of the remaining mesenteries.

Genus—*Edwardsia*, Quatrefages.

ORDER 5. Proactiniae.

Zoantharia paramera in which a variable number of mesenteries is added to the eight Edwardsian mesenteries. The bilateral symmetry of the *Edwardsia* form is retained. No skeleton.

FAMILY 1. GONACTINIDAE. Sulcus and sulculus present. Eight Edwardsian macromesenteries and eight micromesenteries. The sulcar and sulcular macromesenteries are sterile, the four remaining macromesenteries are fertile, and form couples with four micromesenteries. Of the four remaining micromesenteries there is a couple in each sulculo-lateral chamber. Genus—*Gonactinia*, Sars; *Gonactinia prolifera* reproduces itself asexually by strobilisation. FAMILY 2. ORACTIDAE. No sulculus. Mesenteries as in Gonactinia, with an additional couple of micromesenteries in the transverse chambers. Genus—*Oractis*, M'Murich. FAMILY 3. MONAULIDAE. Sulculus absent. Fourteen tentacles and fourteen complete mesenteries arranged as in Gonactinia, but the sulculo-laterals are absent. Genus—*Scytophorus*, Hertwig.

GRADE II.—CRYPTOPARAMERA.

Zoantharia in which the primary bilateral symmetry is obscured by radial development of the second and succeeding cycles of mesenteries.

ORDER 6. Actiniidea.

Colonial or solitary Zoantharia cryptoparamera, with or without a skeleton. Sulcus and sulculus both present (with rare exceptions). Mesenteries arranged in cycles. Each cycle consisting usually of twelve couples of equal size. Typically a couple of new mesenteries is formed in each exocoel formed by previously existing cycles. The muscle banners of the sulcar and sulcular directive mesenteries are turned away from one another; in all other couples they are *vis à vis*. Tentacles equal in number to the mesenteries, one over each endocoel and exocoel.

SUB-ORDER 1. MALACACTINIAE. Solitary Actiniidea or very rarely forming colonies. Without a skeleton.

GROUP A. HEXACTINIAE.

FAMILY 1. ILYANTHIDAE. Free Malacactiniae, not adhering by a basal disc. Aboral end of body rounded. SUB-FAMILY—HALCAMPINAE. Tentacles twelve. Mesenteries twenty-four—six couples complete, six couples incomplete. Genus—*Halcampa*, Gosse. SUB-FAMILY—ILYANTHINAE. Genus—*Ilyanthus*, Forbes. SUB-FAMILY—PEACHINAE. Tentacles twelve. Mesenteries twenty; six primary couples complete, fertile; four secondary couples, the sulculo-lateral couples being absent. A single conchula present. Genus—*Peachia*, Gosse.

FAMILY 2. ACTINIDAE. Malacactiniae with an adherent basal disc. Tentacles simple, uniform, arranged in cycles on periphery of peristome, one tentacle over each exocoel and endocoel. SUB-FAMILY—ANTHEINAE. Marginal tubercles present. No circular muscle. No acontia. Genera—*Actinia*, Browne; *Anemonia*, Risso; *Comactis*, M. Edw. SUB-FAMILY—SAGARTINAE. Circular muscle present. Acontia present. Primary mesenteries alone complete, and are sterile. Division A. Circular muscle endodermal. Genus—*Actinoloba*, Blainville. Division B. Circular muscle

mesogloea. Genera—*Sagartia*, Gosse; *Calliactis*, Verrill; *Cereus*, Oken; *Phellia*, Gosse; *Chondractinia*, Lütken; *Hormathia*, Gosse; *Chitonactis*, Fischer; *Actinauge*, Verrill; *Adamsia*, Forbes; *Aiptasia*, Gosse. SUB-FAMILY—BUNODINAE. Circular muscle present. No acontia. The column covered with tubercles. Genera—*Bunodes*, Gosse; *Aulactinia*, Verrill; *Cladactis*, Panceri. SUB-FAMILY—PARACTININAE. Circular muscle mesogloea. Many perfect mesenteries. Genera—*Paractis*, Andres; *Paractinia*, Andres; *Paranthus*, Andres. SUB-FAMILY—ANTHEOMOR-

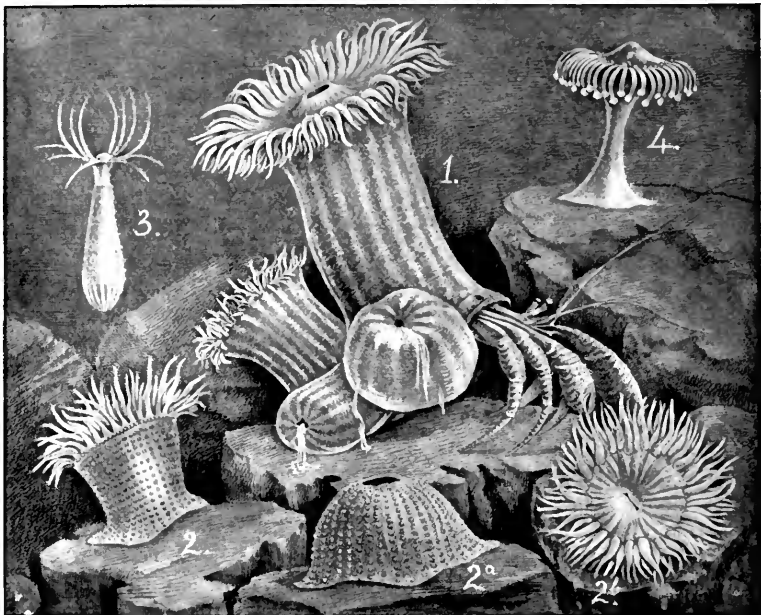

FIG. XXVII.

1.—*Adamsia Rondletii*, D. Ch. (= *Sagartia parasitica*).2, 2a, 2b, *Bunodes rigidus*, Andres.4.—*Corynactis viridis*, Allman.3.—*Octophellia timida*, Andres.

PHINAE. No circular muscle. Complete mesenteries numerous. All the mesenteries fertile. Genus—*Antheomorpha*, Hertwig. FAMILY 3. CORALLIMORPHIDAE. Tentacles arranged in a double corona, one corona marginal and principal, the other intermediate and accessory. Mesenteries slightly differentiated, all fertile. No circular muscle. SUB-FAMILY—CORALLIMORPHINAE. Genus—*Corallimorphus*, Moseley. SUB-FAMILY—CORYNACTINAE. Genera—*Corynactis*, Allmann; *Capnea*, Forbes. (In *Corynactis viridis* the bases of the zooids are confluent, so that they adhere to form a colony.) SUB-FAMILY—DISCOSOMINAE. Genus—*Discosoma*, Leuck. FAMILY 4. LIPONEMIDAE. Marginal tentacles trans-

formed by retrograde formation into short tubes or stomidia. Genera—*Polystomidium*, Hertwig; *Polysiphonia*, Hertwig. FAMILY 5. AMPHIANTHIDAE. Malacactineae embracing by their bases stems of Gorgonidae; with shortened sagittal and elongated transverse axis, circular muscle mesogloea. Primary septa alone complete, but sterile. Genera—*Stephanactis*, Hertwig; *Amphianthus*, Hertwig; *Gephyra*, von Koch. (Possibly the genus *Savaglia* with twenty-four tentacles and twenty-four mesenteries must be placed here. It was formerly classed among the Antipatheae.) FAMILY 6. DENDRACTIDAE. Some or all of the tentacles ramified or foliaceous. SUB-FAMILY—RHODACTINAE. Genera—*Rhodactis*, M. Edw.; *Taractea*, Andres. SUB-FAMILY—PHYMANTHINAE. Genera—*Phymanthus*, M. Edw.; *Triactis*, Klunz. SUB-FAMILY—PHYLLACTINAE. Genus—*Phyllactis*, M. Edw. SUB-FAMILY—CRAMBACTINAE. Genus—*Crambactis*, Haeckel. SUB-FAMILY—CRYPTODENDRINAE. Genus—*Cryptodendron*, Klunz. FAMILY 7. THALASSIANTHIDAE. The disc is covered with peculiar appendages, which are not tentacles, and are termed fronds. Each frond is villose, pinnate, or tubercular. SUB-FAMILY—THALASSIANTHINAE. Genera—*Thalassianthus*, Leuck; *Actineria*, Blainv.; *Megalactis*, Ehrb.; *Actinodendron*, Ehrb. SUB-FAMILY—SARCOPHIANTHINAE. Genus—*Sarcophianthus*, Lesson.

GROUP B.

Malacactineae in which precocious development of the secondary and succeeding cycles of mesenteries obscures the hexamerous arrangement.

FAMILY 1. TEALIIDAE. Genus—*Tealia*, Gosse. FAMILY 2. POLYOPIDAE. Genus—*Polyopsis*, Hertwig. FAMILY 3. SICYONIDAE. Genus—*Sicyonis*, Hertwig.

For the characters of these three families, see p. 46.

The classification of the Malacactineae given above must be considered provisional. As far as possible the lines laid down by Hertwig (41) have been followed, as his classification is based on anatomical characters. But the anatomy of many forms is still undescribed, and where anatomical characters are wanting the arrangement of Andres (1) has been followed.

SUB-ORDER 2. SCLERACTINIAE (= MADREPORARIA). Actinideae provided with a calcareous skeleton secreted by cells called calicoblasts, which actually are or represent the basal ectoderm.

The anatomy of the soft parts of any Scleractinian resembles, in essential points, that of an Actinia. There are complete and incomplete mesenteries arranged in cycles, the sequence of numbers being usually 12, 12, 24, 48, etc., as in Hexactiniae. Usually two couples of directive mesenteries are present, but in a few forms (*Mussa*, *Lophohelia*, and *Euphyllia*) there are no directives. For a detailed account of the anatomy of such corals as have been studied, the reader is referred to the works of von Koch (51, 57,

58, 59, 63); von Heider (38); Fowler (23-26); Bourne (6 and 7); and Ogilvie (103).

The relations of the zooid to the skeleton may be studied in Fig. XXVIII., which represents a diagrammatic longitudinal section through a Turbinolid coral. A quadrant is cut out on the left side to further display the anatomy. In the skeleton of a typical solitary coral—the common Devonshire cup-coral, *Caryophyllia Smithii*, is a good example—the following parts are to be dis-

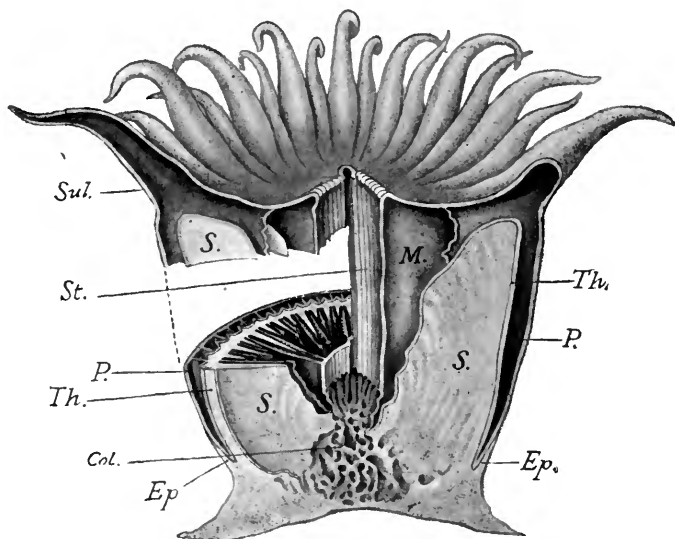

FIG. XXVIII.

Diagram illustrating the relation of the soft tissues to the corallum in a solitary aporose coral. *St.*, stomodaeum; *Sul.*, sulcus; *M.*, mesenteries; *Th.*, theca; *S.*, septa; *Col.*, columella; *Ep.*, epitheca; *P.*, edge-zone.

tinguished:—(1) The basal plate, between the zooid and the surface of attachment. (2) The *septa*, radial calcareous laminae reaching from the periphery to near or quite to the centre of the calycle. (3) The *theca* or wall, which, in many corals, is not an independent structure, but is formed by the conjoined peripheral ends of the septa. (4) The *columella*, a structure which occupies the axis of the corallite, and may be solid or trabeculate. If it arises from the base, it is termed essential; if formed by the union of trabeculae from the septa, it is termed unessential. (5) The *costae*, longitudinal ribs or rows of spines on the outer surface of the theca. True costae always correspond to the septa, and are in fact the peripheral ends of the latter. (6) *Epitheca*, an offset of the basal plate which surrounds the base of the theca in a ring-like manner. (7) *Pali*, laminae which extend upwards from

the bottom of the calyce and project between the inner edges of certain septa and the columella. In addition to these parts, other structures are found in the skeletons of certain corals. *Dissepiments* are oblique calcareous partitions stretching from septum to septum, and closing the interseptal loculi below (see Fig. XXXI. 2). The whole system of dissepiments in any given calyx is often called *endotheca*. *Synapticula* are calcareous bars uniting adjacent septa (Fig. XXXI. 3). *Tabulae* are stout horizontal partitions traversing the whole space within the calyce.

Though the skeleton or corallum of the Scleractinia appears to lie within the zooid, it is morphologically external to it, as is best shown by its developmental history, which has been studied by G. von Koch in *Astroides calicularis* (55) and in *Caryophyllia*

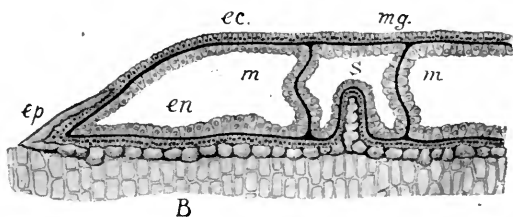

FIG. XXIX.

Radial section of the larva of *Astroides calicularis*, which has fixed itself on a piece of cork. *ec*, ectoderm; *en*, endoderm; *mg*, mesogloea; *mm*, mesenteries; *S*, septum; *B*, basal plate, formed of ellipsoids of carbonate of lime secreted by the basal ectoderm; *ep*, epitheca. (After G. von Koch.)

cyathus (105), and by H. V. Wilson in *Manicina areolata* (98). The larvae of *Astroides* are at first ciliated and free-swimming, and do not acquire a corallum until they fix themselves. The first trace of the corallum appears as a ring-shaped plate of calcareous tissue situated between the basal ectoderm and the surface of attachment. It is composed of calcium carbonate in the form of numerous spheroidal masses of concentric structure, each mass built up of numerous rhombic crystals. Von Koch states definitely that the calcareous nodules are formed as a secretion product of the ectoderm, and he gives figures which fully bear out his assertion (Fig. XXIX.) Wilson, as far as he has traced the development of the corallum in *Manicina*, confirms von Koch's statement. Von Heider, however, holds that the calcareous crystals are formed *within* ectodermic cells, as are the spicules of *Alcyonaria*, but his proofs are not satisfactory.¹ The further development of the corallum is effected by the completion and increase in size of the

¹ Since this was written, Dr. Maria M. Ogilvie has expressed herself strongly in favour of von Heider's opinion. The subject requires reinvestigation, but it must be said that Ogilvie's evidence is not strong enough to overthrow the positive embryological observations of von Koch and H. V. Wilson. (The writer has since shown that von Koch's views are correct and that no true spicules, formed within cells, occur in the Scleractinia.—*Quart. Jour. Micr. Sci.* vol. xli.)

basal plate, and the formation of the septa. The first traces of the septa are radially disposed folds of endoderm, on the basal disc, one fold in each endocoele and exocoele. As twelve mesenteries are present, twelve septa are formed simultaneously. Beneath each fold the ectoderm becomes detached from the surface of the basal plate, and is folded inwards conformably with the endoderm, so that ridges composed of all three layers project into the coelenteron. Between the limbs of the ectodermic folds calcareous nodules are formed, and these fuse together to form the septa. The septa soon fuse with the basal plate, and each primary septum becomes forked at its peripheral end, so that, when viewed from above, it has the shape of a Y. At a later stage the septa form relatively high but thin radial plates, over each of which the three layers—ectoderm, mesogloea, endoderm—are folded. They increase in size, their peripheral ends branch, and eventually the branches of adjacent septa unite with one another to form a porous theca. At the same time their central ends unite and form a trabecular columella. Whilst the septa are being formed, and are becoming united to form a theca, a secretion of carbonate of lime from the wall of the young zooid, at the point where basal disc passes into body wall, gives rise to a thin lamina which is continuous with the basal plate. This is the epitheca; at first it is separate from the theca, but at a subsequent period is united to it by processes. Of the twelve septa first formed six, viz. the exocoelic septa, grow faster than the others, and thus there appear to be two cycles of alternately larger and smaller septa, six in each cycle. From the foregoing account, it is evident that the corallum is formed from the basal ectoderm, and that it is, as it were, *pushed up from below into the cavity of the zooid*, each part of the corallum carrying before it the three layers—ectoderm, mesogloea, and endoderm. Further, it is evident that the theca in *Astroides* is not an independent structure, but is formed by the coalescence of the peripheral ends of the septa. In *Caryophyllia*, however, the theca is formed independently of the septa. The development explains a feature present in many *Scleractinia*e. The soft tissues of the zooid extend outside the theca, and invest it to a greater or less extent. This extrathecal extension of the soft tissues is shown in Fig. XXVIII. *P*. A section through this region shows that the extrathecal soft tissues enclose a cavity which is a part of the coelenteron, and, like the latter, is divided into chambers by partitions, which are the peripheral parts of the mesenteries. The extrathecal soft tissues will be called the *edge-zone*. The extent of the edge-zone and its relations to the intracalicular part of the zooid will easily be understood after a study of Fig. XXVIII., and a transverse section through the upper part of a zooid is shown in Fig. XXXI. 1,

from which it will be seen that the theca appears to cut the mesenteries in two. It will also be noticed that, in an aporose coral such as is shown in Fig. XXX. 2 and 4, the only communication between the cavities in the edge-zone and the remainder of the intermesenterial spaces is by way of the lip of the calice,

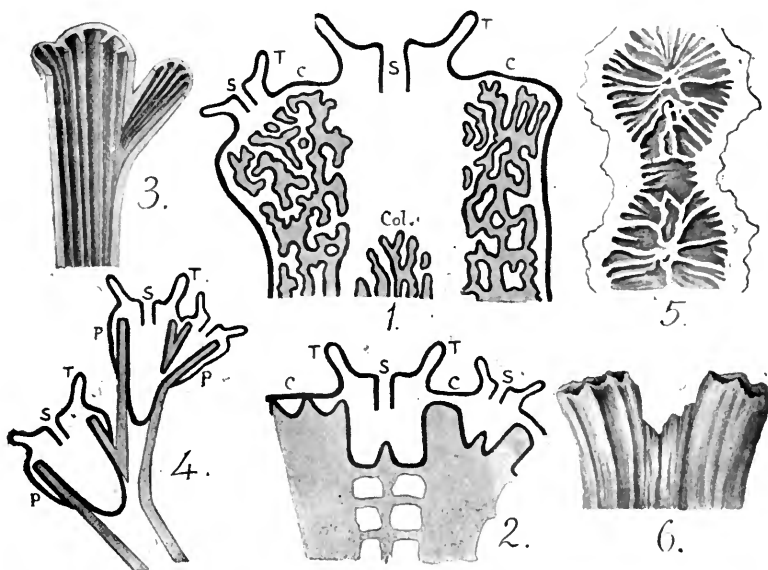

FIG. XXX.

1.—*Astroides calicularis*. Schematic longitudinal section through a zooid and a bud, showing the relations of the soft tissues to the corallum. In this, and in figures 2 and 4, the thick black line represents the soft tissues, the corallum is gray. The sections are much simplified, the mesenteries, etc., being omitted. S, stomodaeum; T, tentacles; C, coenosarc; Col, columella.

2.—A similar section through a single zooid and bud of *Stylophora digitata*. On the left of the figure the coenosarc is seen to be supported on echinulations of the coenenchyme.

3.—A diagram illustrating the process of asexual reproduction by unequal division.

4.—Schematic longitudinal section through three corallites of *Lophohelia prolifera*. In the upper part of the figure the larger zooid is seen to be in connection with the smaller zooid formed from it by division both internally and externally by way of the edge-zone. The lowest zooid has lost all organic connection with the other members. P, edge-zone; other letters as in 1.

5.—A section through a dividing calice of *Mussa*, showing the union of two septa in the plane of division and the origin of new septa at right angles to them.

6.—Side view of the upper part of the specimen shown in 5. (4 original, the rest after G. von Koch.)

but in the perforate coral the theca is permeated by numerous anastomosing canals lined by endoderm, which place the cavities of the edge-zone in communication with the central coelenteron.

According as these canals are absent or present, the Scleractiniae are classified as Aporosa or Perforata, and the anatomical character in question is sufficiently definite to afford a basis of classification. There are, however, some corals which cannot be placed in either of these groups.

There are both solitary and colonial Scleractiniae, and both solitary and colonial forms occur in the two groups Aporosa and Perforata. The colonial forms are produced by asexual reproduction either by gemmation or division, the resulting individuals remaining in connection with one another. Several of the solitary Scleractiniae reproduce themselves asexually by discontinuous budding or division. *Blastotrochus nutrix*, a member of the family Flabellidae, produces lateral buds on the theca, which after a time drop off, and a new bud may be formed from the scar of the old one. Some species of Flabellum reproduce themselves asexually by transverse fission. *Rhodopsammia parallela* and *R. socialis*, perforate corals, bear marginal and lateral buds which may detach themselves. In the genus *Fungia*, the discoid free adult forms are asexually produced from an attached parent stock termed the trophozoid, and the adult individuals may multiply themselves by transverse fission.

In the formation of colonies by asexual reproduction, the distinction between gemmation and division must be borne in mind. In the former case the young zooid, with its corallum, arises wholly outside of the cavity of the calyx of the parent zooid, and the component parts of the young corallum, theca, septa, columella, etc., are formed anew in every individual produced. In division a constriction divides a zooid into two or more equal or unequal parts, and the component parts of the two (or more) coralla so produced are severally derived from the corresponding parts of the dividing corallum.

Gemmation in the colonial Aporosa and Perforata always proceeds from the soft tissues which clothe the outside of the theca, *i.e.* from the edge-zone or its derivatives. In the case of an aporose coral a bud is formed on the edge-zone, and develops into a new zooid with its corallum. The cavity of the latter does not communicate directly with the cavity of the parent, but organic connection between parent and offspring is effected by means of the edge-zone. As growth proceeds, and parent and bud become separated further from one another, the sheet of soft tissues connecting the two loses the characters shown in Fig. XXXI. 1, *A*, the peripheral continuations of the mesenteries are no longer present, and there is found instead a sheet of tissue resting upon projecting spines of the corallum, between which run canals lined by endoderm, the last-named serving as the means of communication between zooid and zooid (see Fig. XXXI. 1, *B*). Such a sheet of soft tissue, devoid of the peripheral continuations of the mesenteries, and bridging over the spaces between the zooids, may be called the *coenosarc*. The layer of calicoblasts on the lower surface of the coenosarc gives rise to a secondary deposit of carbonate of lime, which more or less fills up the spaces

between individual corallites, and is distinguished as coenenchyme. The individual corallites may be wholly immersed in coenenchyme, in which case the whole of the soft tissues connecting the zooids have the character of coenosarc; or, as in *Galaxea*, Fig. XXXIII. 5, the corallites may be only partially immersed in coenenchyme, in which case the soft tissues on the outside of the projecting

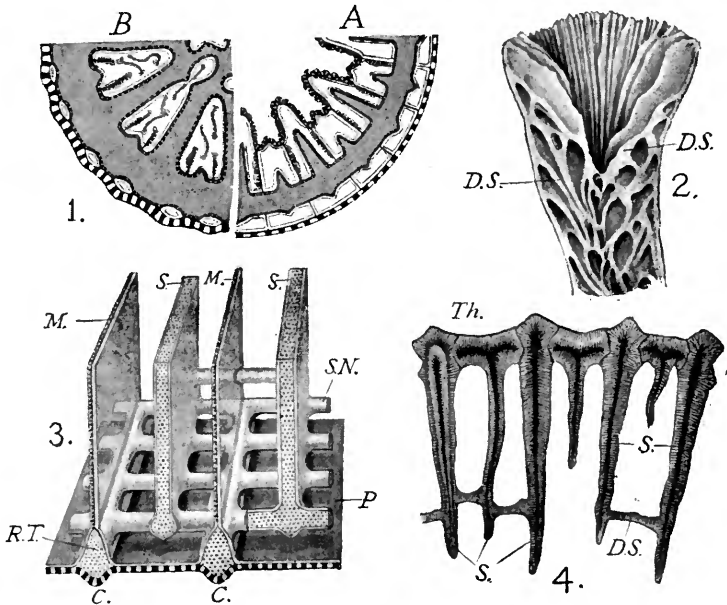

FIG. XXXI.

1.—Diagrammatic transverse section through two quarters of a zooid of *Amphihelia ramea*. *A*, through the theca in the region of the tentacles, showing the peripheral ends of the mesenteries in the cavity of the perisarc. *B*, below the stomodaem, showing the external canals between the body wall and corallum. Ectoderm blocked black and white, corallum shaded. (After G. H. Fowler.)

2.—Vertical section through a corallite of *Euphyllia*, showing the dissepiments, *DS*. (Original.)

3.—Diagrammatic representation of the relations of septa, *SS*; mesenteries, *MM*; costae, *CC*; and body wall, *P*, in *Stephanophyllia formosissima*, in a small cube cut out of the base of the zooid; *RT*, radial trabeculae; *SN*, synapticala. Ectoderm blocked black and white; corallum dotted. (After Fowler.)

4.—Part of a section through a corallite of *Euphyllia*, showing the formation of the theca, *Th*, from the peripheral ends of the septa; *SS*, dissepiments. (Original.)

distal moieties of the corallites have the characters of edge-zone, whilst the spaces between the corallites are covered with coenosarc, the latter shading imperceptibly into the former. For a full description of these relations the reader is referred to Fowler's Memoirs (22-26).

Budding takes place in an analogous manner in perforate corals, but the relations between edge-zone and coelenteron, referred to

above, induce modifications in the process. The canal system which permeates the porous theca becomes much extended, and, as it extends, calcareous tissue is deposited between the network of canals, so that the theca appears to be enormously thickened. But the mesenteries do not share in this extension, and so the edge-zone proper—that is to say, the soft tissue which is external to the calyx, and is supported on prolongations of the mesenteries—

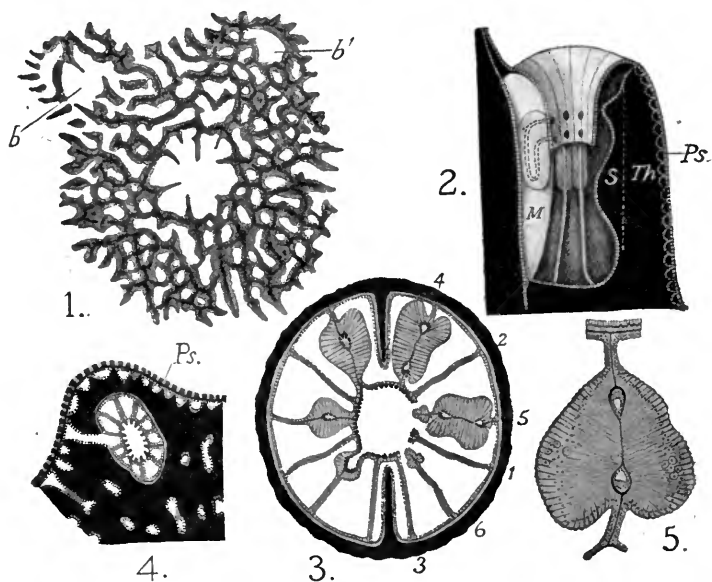

FIG. XXXII.

1.—Section through a branchlet of *Madrepora*, sp. ? showing an axial zooid with septa, the surrounding coenenchyme, and two buds, *b*, *b'*.

2.—Diagram of a longitudinal section of *Madrepora durvillei*, showing the perforations in the stomodaeum leading into canals hollowed out in the mesenteries. *M*, mesentery; *S*, septum; *Th*, theca; *Ps*, perisarc.

3.—Diagram of the various forms and conditions of the mesenteries in a zooid of *Madrepora durvillei*. The mesenteries numbered 1, 1; 2, 2; 3, 3, and bear no filament and are simple; the remainder are modified, and bear filaments below the level of the stomodaeum.

4.—Diagram of a transverse section of a zooid of the same species. *Ps*, perisarc.

5.—Transverse section of a modified mesentery of *M. durvillei*, passing through two arms of the stomodaeal canal. The thickened endoderm of the modified mesentery is clearly seen. (1 original; the rest after Fowler.)

becomes limited to the neighbourhood of the mouth of the calyx. The rest of the coral is clothed with a coenosarc in which no traces of the mesenteries are discoverable. From this coenosarc buds arise which grow into zooids whose cavities are permanently connected with the cavities of the other zooids composing the colony by means of the system of canals just spoken of, as well as by the canals of the coenosarc (see Fig. XXX. 1, and Fig. XXXII. 1, 4). It is clear that in the perforate corals the spongy tissue

in which the calicles lie is in its origin a thecal structure, and that it is impossible to say where the theca of one corallite ends and that of another begins. In aporose corals, on the other hand, the theca is a well-defined structure, and the calcareous tissue in which the corallites are imbedded is a secondary deposit of entirely different origin.

In the formation of colonies by division a distinction must be made between equal and unequal division, though the two processes merge into one another. The process of equal division is well illustrated by Mussa (Fig. XXX. 5, 6). The zooid, previously subcircular in section, becomes elongated in the direction of the long axis of the mouth, and at the same time the tentacles, mesenteries, and septa increase in number. A constriction, at right angles to the long axis of the mouth, involves first the mouth, then the peristome, and finally the calyx itself, so that the zooid and its corallite, previously single, becomes divided into two. The part played by the septa and theca will be best understood by a study of Fig. XXX. 5. After division the two corallites grow upwards; at first their zooids are united by a bridge of soft tissue or edge-zone, but as they grow further and further apart this continuity is broken, each corallite is clothed externally to a greater or less extent by its proper edge-zone, and, as the interseptal loculi become closed below by dissepiments, all organic connection between the two zooids is eventually lost, though the corallites remain attached to one another. There are, however, forms not far removed from Mussa in which the corallites are closely apposed after division, the continuity of the edge-zone is not broken, and growth leads to the formation of a coenosarc which, as in the case of colonies produced by gemmation, gives rise to a coenenchyme filling up the spaces between the corallites. The complex Mæandrine corals are produced by incomplete division which involves the mouth, and to some extent the peristome, but does not extend to the calyx. Repetition of this incomplete division gives rise to long Mæandrine channels, each containing numerous zooid mouths.

Unequal division may be studied in *Lophohelia prolifera* and allied forms, and the process is illustrated in Fig. XXX. 3, 4. Instead of the whole calyx undergoing division, a small portion of it is constricted off to form a young zooid which, in its earliest stage, looks like a bud on the margin of the calyx. Reference to 3 shows, however, that the process of unequal division differs from that of gemmation in that, in the former, the theca, septa, and columella of the young zooid are directly formed from corresponding structures in the parent. As growth proceeds, the smaller or daughter calyx becomes more and more separate from the larger or parent calyx, and eventually it looks like a lateral bud

borne by the latter, the cavities of the two being still in free communication below. As a rule, this communication is eventually cut off by a secondary deposit of calcareous tissue, and then the two zooids are united only by their confluent edge-zones. But as growth proceeds this union also is broken, and the zooids in the older parts of the colony are isolated, and have no organic connection with one another (see Fig. XXX. 4).

The classification here adopted is based upon Martin Duncan's revision of the Madreporaria (79), with the modifications introduced by Quelch (86). It cannot be pretended that it is a natural or a satisfactory classification, yet it is the best which can be offered in the present state of our knowledge. Other systems have been proposed, but they have not stood the test of criticism, and have been ephemeral. Milne-Edwards and Haime divided the Scleractineae into five sections—Aporosa, Perforata, Rugosa, Tabulata, and Tubulosa. The two last named have long since been broken up and their families distributed, some among the Alcyonaria, others among the Aporosa. The Rugosa, also termed the Tetracoralla, held their ground for a long time; but it has been shown that the structure of the skeleton of the rugose corals does not differ from that of recent corals, and the tetrameral symmetry, which so many of them exhibit, is to be considered of less importance, since it has been shown that a hexamerall symmetry is by no means characteristic of recent corals. Moreover, the tetrameral symmetry is an inconstant feature in Rugosa. The discovery of *Moseleya latistellata*, a reef coral from Wednesday Island, Torres Straits, leaves no doubt as to the close relationship of the Astreaeidae to the Cyathophyllidae. *Moseleya* is a compound coral with polygonal calicles, a thin epitheca, a rudimentary theca, and the cavity of the calicle is filled up nearly to the margin by tabulae separated by an abundant dissepimental endotheca. The septa in adult calicles are numerous and give no indication of a hexamerall arrangement, but in young calicles a tetrameral symmetry is distinctly visible, owing to the cruciate arrangement of four larger septa. *Moseleya* shows decided affinities on the one hand to a typical Astreaeid, such as *Prionastraea*; on the other hand to a Cyathophyllid, such as *Cyathophyllum regium*, and it cannot be doubted that the Cyathophyllidae and the forms allied to them can no longer be classified apart as Rugosa, but must be placed along with or close to the Astreaeidae.

There is some doubt as to the distinctness of the sections Aporosa and Perforata of M. Edwards and Haime. The anatomical features on which the division is based have been referred to above, but there are corals ranked among the Aporosa in which the theca is perforated by a few canals, and amongst the Perforata there is every grade between trabeculate and spongiöse theca and septa

and a comparatively compact structure, the septa being aporose and the theca and coenenchyme traversed by a sparse canal system. The distinctness of the section Fungacea may also be called into question. The characteristic of the group is the presence of synaptacula, which are transverse calcareous bars uniting adjacent septa. But such transverse bars are to be found in many corals not included among the Fungacea, e.g. in *Stephanophyllia formosissima*, Mich., and in some other Eupsammidae. Fungia, the type of the Fungacea, is regarded by some authors as a perforate coral; but it must not be forgotten that in its young state it is aporose, and has all the characters of a typical Turbinolid, synaptacula being developed only as the lip of the calyx expands to form the characteristic fungiform disc. This indicates a close relationship between the Fungidae and the Turbinolidae. On the other hand, the Plesioporitidae, now included amongst the Fungacea, are perforate corals, and if the divisions Aporosa and Perforata are of any value, they are clearly out of place. The following classification, then, is to be regarded as provisional and likely

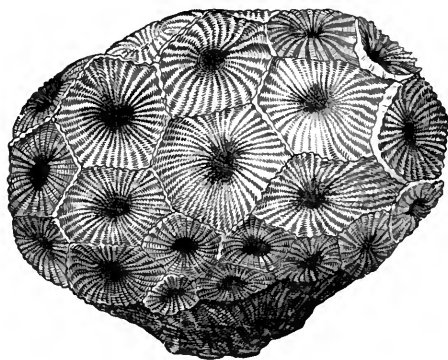

FIG. XXXIII.

Cyathophyllum hexagonum, Goldfuss, from the Devonian chalk of Gerolstein. Nat. size (from Zittel's *Grundzüge der Palaeontologie*).

to be supplanted at no distant date by an entirely new arrangement. The sub-section Scleractiniae is very rich in genera and species; Duncan enumerates 343 genera, without taking account of the Rugosa. In this place only the more important and familiar genera will be cited, and the reader in search of further details is referred to Duncan (19), Quelch (86), Moseley (82), and to the British Museum Catalogues of Madreporaria by Brook (12) and Bernard (13).

[Since this article was written and in proof the work of Dr. Maria Ogilvie has been published. As a result of an extensive study of the microscopic characters of recent and extinct corals she divides the Scleractineae into two sections—*Zaphrentoidea* or *Haplophracta* and *Cyathophylloidea* or *Pollaplophracta*. The first section is divided into the sub-sections *Coenenchymata* (families *Poritidae*, *Madreporidae*, *Pocilloporidae*, *Oculinidae*) and *Murocorallia* (families *Zaphrentidae*, *Turbinolidae*, *Amphistraeidae*, *Stylinidae*).

The second section is divided into the sub-sections *Septocorallia* (families *Cyathophyllidae*, *Astraeidae*, *Fungidae*) and *Spinocorallia* (family *Eupsammidae*). Whilst recognising the value and suggestiveness of Miss Ogilvie's work, her classification cannot be adopted here, for it is open to serious criticism. The grounds for removing the Eupsammidae from the other Perforata seem to be scarcely sufficient. The sub-section Coenenchymata appears artificial. The Murocorallia are defined as corals which have a well-built theca, whose fibrous elements are set in a direction at right angles to those of the septa. In this group are included the Turbinolidae, and it is more than doubtful whether it can be predicated of all members of this group that they have a theca separate from the septa. Von Koch has recently shown (102) that the theca is an independent structure in the larval Caryophyllia, but as growth proceeds the distinction between the two becomes lost, and a section through an adult Caryophyllia shows that the septa are thickened and in contact at their peripheral ends, thus forming, in the upper moiety of the calyx, at any rate, a so-called pseudotheca, such as would characterise the group Septocorallia. For a discussion of the question as to the relations between theca and septa the reader should refer to the excellent memoir of von Koch (102).]

SECTION I. APOROSA.

Simple or colonial Scleractineae with solid theca and septa not perforated by canals; the theca may be epithecate. In colonial forms the zooids may be separate from one another, or, if in organic continuity, their cavities communicate only by means of superficial canals in the coenosarc. FAMILY 1. ZAPHRENTIDAE. Solitary palaeozoic Scleractineae with an epithecal wall. Septa well developed, arranged pinnately with regard to four principal septa, the main- and counter-septa. Tabulae present. Vesicular endotheca absent or scanty. No columella. Genera — *Zaphrentis*, Rafinesque and Clifford; *Amplexus*, M. Edw. and H.; *Omphyma*, Raf. and Clifford; *Streptelasma*, Hall (Figs. XXXIV. and XXXV.), etc. FAMILY 2. TURBINOLIDAE. Solitary Scleractineae, or forming colonies by gemmation from the bases of the parent zooids or from a stolon-like expansion from the base of the parent zooid. Septa radial not pinnate. Interseptal loculi open to the base, i.e. without tabulae or dissepiments. SUB-FAMILY 1. FLABELLINAE. The wall is epithecate. Genera — *Flabellum*,

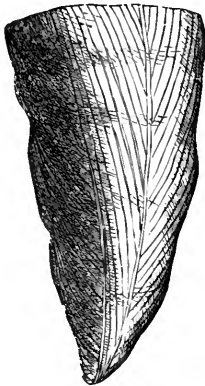

FIG. XXXIV.

Streptelasma corniculatum, Hall, from the lower Silurian chalk of Cincinnati. Nat. size (from Zittel).

Lesson; *Duncania*, Pourtales; *Schizocyathus*, Pourtales; *Rhizotrochus*, M. Edw. and H.; *Pleurocyathus*, Moseley; *Desmophyllum*, Ehrenb.;

Blastotrochus, M. Edw. and H. ; *Placocyathus*, M. Edw. The existence of an epithecate wall, with which is correlated the absence of a perisarc is sufficient to separate the Flabellinae from other Turbinolidae, and the same feature brings them into relationship with the Zaphrentidae. Further researches may lead to the inclusion of several forms now classed as Turbinolinae amongst the Flabellinae. *Flabellum variable* and *Placotrochus laevis* reproduce themselves asexually by a process of strobilisation, and *Blastotrochus nutrix* gives rise to lateral deciduous buds (see Semper, 91). SUB-FAMILY 2. TURBINOLINAE. GROUP 1. SIMPLICES. The zooids solitary. Genera—*Smilotrochus*, M. Edw. and H. ; *Turbinolia*, M. Edw. and H. ; *Trochocyathus*, M. Edw. and H. ; *Caryophyllia*, Lamarck ; *Stephanotrochus*, Moseley. GROUP 2. GEMMANTES. Colonies are formed by gemmation from the bases of the parent zooids. Genera—*Cocnocyathus*, M. Edw. (Recent and Tertiary) ; *Gemmulatrochus*, Duncan. GROUP 3. REPTANTES. Buds are formed from a stolon-like expansion of the base

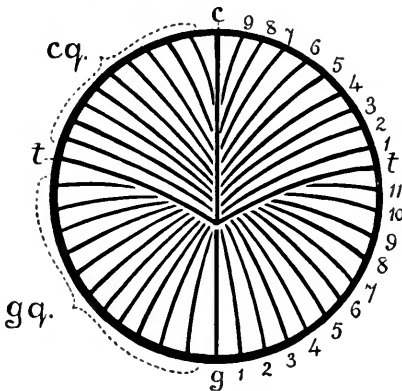

FIG. XXXV.

Schematic representation of the calyx of a Zaphrentid seen from below. *c*, main septum; *g*, counter-septum; *t*, transverse septa; *cq*, chief quadrant; *gq*, counter quadrant. The numbers indicate the order in which the septa are formed. In the chief quadrants the secondary septa radiate from the chief septum, the most recently formed lying nearest to the transverse septa, the oldest nearest to the chief septum. In the counter quadrants the secondary septa radiate from the transverse septa, and the most recently formed are nearest to the counter septum.

of the parent zooid. Genera—*Polycyathus*, Duncan ; *Agelecyathus*, Duncan. FAMILY 3. OCULINIDAE. Aporosa, forming irregular branching colonies. Asexual multiplication by mural budding. The walls of the corallites increase in thickness exogenously, the thickening (coenenchyme) being due to the activity of the calicoblastic layer of the edge-zone. Genera—*Neohelia*, Moseley ; *Lophohelia*, M. Edw. and H. ; *Oculina*, M. Edw. and H. ; *Stylophora*, M. Edw. and H. ; *Madracis*, M. Edw. and H. FAMILY 4. POCILLOPORIDAE. Colonial Aporosa with tabulae. Two larger septa, axial and abaxial, are present, and traces of ten smaller septa. Genera—*Pocillopora*, Lamarck ; *Seriatopora*, Lamarck. For an account of these two genera see Moseley (81) and Fowler (25). In *Seriatopora subulata* there are twelve mesenteries, of which those corresponding to 1, 1 ; 2, 2 ; 3, 3 ; 4, 4 in *Rhodactis* and *Manicina* (see above, p. 43) are longer than the others, but only 1, 1 bear filaments. FAMILY 5. ASTRAEIDAE. Simple or colonial Aporosa with dissepimental or vesicular endotheca ; with or without tabulae. A solid intercalicular coenenchyme rarely developed. An epitheca surrounds the base of massive and Meandroid

forms, but only surrounds individual corallites in simple or branching forms. SUB-FAMILY I. ASTRAEINAE. A. Simplicis. Genera—*Trochomilia*, M. Edw. and H.; *Placosmilia*, M. Edw. and H., etc. B. Reptantes. Genera—*Cylicia*, M. Edw. and H.; *Astrangia*, M. Edw. and H. C. Gemmantes. Genera—*Cladocora*, M. Edw. and H.; *Goniocora*, M. Edw. and H. (Trias, Lias, and Oolite), etc. D. Caespitosae. Genera—*Eusmilia*, M. Edw. and H.; *Mussa*, Oken. E. Confluentes. Genera

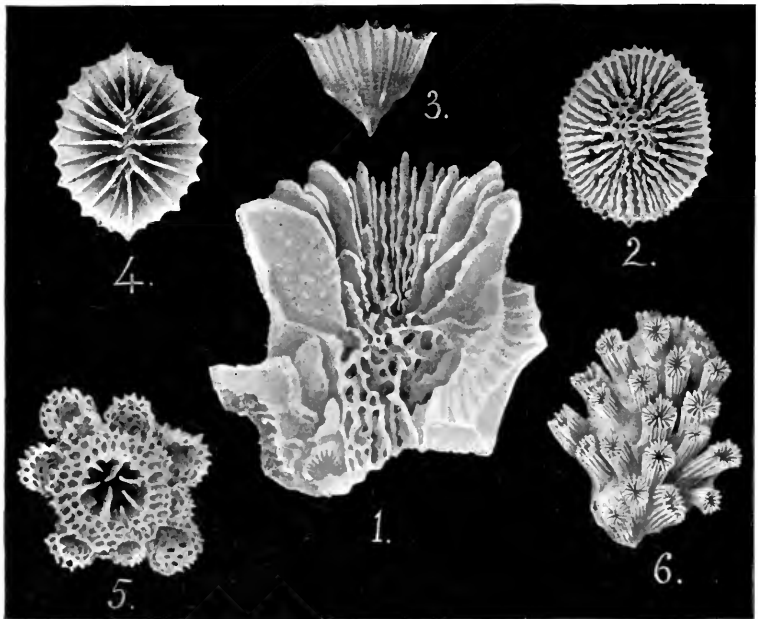

FIG. XXXVI.

- 1.—Vertical section through the corallum of *Caryophyllia Smithii*, showing the theca, septa, pali, columella.
- 2.—View of an individual of the same species from above.
- 3.—*Flabellum patagonicum*, a specimen viewed from the side.
- 4.—The same viewed from above.
- 5.—Enlarged view of an axial calicle, with surrounding calicles, from a branchlet of *Madrepora*. The perforate character of the theca and coenenchyme is well seen.
- 6.—View of a portion of a colony of *Galaxea laprousiana*, showing corallites projecting from an abundant peritheca.

—*Euphyllia*, M. Edw. and H.; *Diploria*, M. Edw. and H.; *Manicina*, Ehrb.; *Mwandrina*, Lam.; *Coeloria*, M. Edw. and H.; *Hydnophora*, M. Edw. and H. F. Agglomeratae fissiparantes. Genera—*Favia*, Oken; *Goniastrea*, M. Edw. and H. G. Agglomeratae gemmantes. Genera—*Heliastrea*, M. Edw. and H.; *Echinopora*, Dana; *Galaxea*, Oken; *Isastrea*, M. Edw. and H. (Trias, Cretaceous, Miocene); *Merulina*, Ehrb. For a fuller account of the Astreaeinae see Duncan (19). Ogilvie (84a) has recently broken up the Astreaeinae, separating the Eusmilinae, M. Edw. and H., from them and placing the Trochosmiliacea, M. Edw. and H.,

among the Turbinolidae; Euphyllia and Rhipidogyra and their allies form a new family, the Amphistraeidae; Galaxea is placed in Klunzinger's family, the Stylinidae. See her paper, pp. 159-167. SUB-FAMILY 2. CYATHOPHYLLINAE. Solitary and colonial Astreaeidae, never Maendroid. Tabulae and vesicular endothea present. Genera—*Moseleya*, Quelch; *Cyathophyllum*, Goldfuss (Devonian, Carboniferous, and Permian). SUB-FAMILY 3. STAURINAE. The septa show a marked tetrameral arrangement. No columella. Genus—*Stauria*, M. Edw. (Upper Silurian). SUB-FAMILY 4. CYSTIPHYLLIDAE. Septa rudimentary; calices filled with vesicular endothea. Genera—*Cystiphyllum*, Lonsdale (Silurian and Devonian); *Michelinia*, de Kon. (Carboniferous). In the sub-family *Goniophyllinae* the calyx is provided with a movable calcareous operculum. Genera—*Goniophyllum*, M. Edw. and H. (Silurian); the operculum formed of four paired pieces, attached to the four sides of the lip of the calyx and reaching with their pointed ends to the centre. *Rhizophyllum*, Lindstrom (Silurian); the operculum simple, semicircular, with a median ridge on its inner face, and numerous striae parallel to it. *Calceola*, Lam.; the operculum thick with a stout median septum and numerous feebly developed secondary septa.

Following Quelch the Cystiphyllidae are here placed with the Astreaeidae. Ogilvie, whilst remarking on their affinities with the Astreaeidae, places the Cystiphyllidae in the same group as the Eupsammidae under the name *Spinocorallia*, loc. cit. pp. 324, 325.

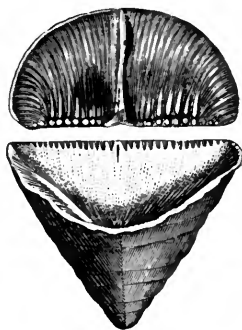

FIG. XXXVII.

Calceola sandalina, Lam.,
from the Devonian of the Eifel.
Nat. size (from Zittel).

SECTION 2. FUNGACEA.

Solitary or colonial Scleractinia. Septa united by synapticula, which cross the interseptal loculi and perforate the mesenteries.

FAMILY 1. PLESIOFUNGIDAE. Colonial or simple Fungacea. Septa generally solid and imperforate; united by synapticula. Genera—*Siderastraea*, Blainv.; *Thamnastraea*, Lesauvage; *Lophoseris*, M. Edw. and H.; *Agaricia*, Lamarck. FAMILY 2. FUNGIDAE. Simple or colonial Fungacea; usually depressed or discoid. Theca more or less synapticulate. GROUP 1. Solitary Fungidae. Genera—*Fungia*, Dana; *Diafungia*, Duncan; *Micrabacia*, M. Edw. and H. The young form of *Fungia* is fixed, and either solitary or colonial, resembling in all its characters a turbinolid, such as *Caryophyllia*. The fixed form developed from the ovum is called a trophozooid. The free discoid adult, or anthocyathus is formed by the expansion of the upper part of the calicle of the trophozooid. When this has acquired a disc shape, and its septa are united by synapticula, it is detached from the pedicle (*anthocaulus*) formed by the rest of the trophozooid, and is set free as an adult *Fungia*. Three or four anthocyathi may be formed in succession from one trophozooid. For details the reader should refer

to Stutchbury (93), Semper (91), and Bourne (8). GROUP 2. Colonial Fungidae. Genera—*Halomitra*, Dana; *Cryptabacia*, M. Edw. and H.; *Herpolitha*, Eschholtz. FAMILY 3. CYCLOSERIDAE. Simple or colonial Fungacea, in which the wall is not perforated. Genera—*Trochoseris*, M. Edw. and H.; *Cycloseris*, M. Edw. and H.; *Bathyaectis*, Moseley; *Psammoseris*, M. Edw. and H.; *Podoseris*, Duncan; *Cyathoseris*, M. Edw. and H. (Cretaceous and Eocene); *Mycedium*, Oken; *Leptoseris*, M. Edw. and H.; *Stephanaria*, Verrill. FAMILY 4. ANABACIADAE. Genus—*Anabacia*, d'Orb. FAMILY 5. PLESIOPORITIDAE. Septa trabeculate and perforate. Genera—*Leptophyllia*, Reuss. (Jurassic and Cretaceous); *Cycloletes*, Lamk. (Jurassic and Cretaceous); *Mæandroseris*, Rousseau (Recent). This classification of the Fungacea can hardly be considered satisfactory, and requires revision after an extended study of the anatomy and development of different forms. The characteristic of the group is the presence of synapticala, but this would lead to the inclusion of the genus *Stephanophyllia*, Mich., which has been shown by Fowler (26) to possess true synapticala. The Fungacea, as above classified, are connected with the Aporosa, on the one hand, through the Plesiofungidae, and with the Perforata, on the other hand, through the Plesioporitidae. But it should not be forgotten that the young Fungia is a typical Aporose coral, and it is probable that the Fungacea will have to be broken up into two groups, which will belong respectively to the Aporosa and the Perforata, the presence of synapticala being a character of insufficient importance to justify the formation of a section Fungacea.

SECTION 3. PERFORATA.

Scleractinia with a corallum composed chiefly or wholly of porous coenenchyma. The coelentera of the zooids composing a colony communicate by means of coenenchymal canals.

FAMILY 1. EUPSAMMIDAE. Simple or colonial Perforata; septa in several cycles; the principal cycles imperforate. Genera—*Stephanophyllia*, Michelin; *Leptopenus*, Moseley; *Balanophyllia*, S. Wood; *Eupsammia*, M. Edw. and H.; *Heteropsammia*, M. Edw. and H.; *Dendrophyllia*, M. Edw. and H.; *Astroides*, Blainv.; *Rhodopsammia*, Verrill. FAMILY 2. MADREPORIDAE. Colonial Perforata with abundant coenenchyma, scarcely distinct from walls of corallites. Septa often porous and reduced. Genera—*Madrepora*, Linn.; *Turbinaria*, Oken; *Astraeopora*, Blainv.; *Montipora*, Quoy and G.; *Anacropora*, Ridley. The genus *Madrepora* is exceedingly rich in species. For an account of the Madreporidae, see Brook (12). FAMILY 3. PORITIDAE. Colonial Perforata with trabeculate septa. Genera—*Porites*, M. Edw. and H.; *Synaræa*, Verrill; *Goniopora*, Quoy and G.; *Rhodaræa*, M. Edw. and H.; *Alveopora*, Quoy and Gaim., etc.

LITERATURE OF THE ANTHOZOA.

1. *Andres, A.* Fauna u. Flora des Golfes von Neapel, ix. 1884. (Actinien.)
2. *Beneden, E. van.* Arch. de Biol. x. 1890, p. 485. (Larval Zoanthæe.)
3. *Ibid.* Bull. de l'Acad. Roy. de Belg. (3), xxi. 1891, p. 179. (Arachnactis.)

4. *Blainville*. Manuel d'Actinologie. Paris, 1834.
5. *Blochmann and Hilger*. Morph. Jahrb. xiii. 1888, p. 385. (Gonactinia.)
6. *Bourne, G. C.* Quart. Jour. Micr. Sci. xxvii. 1887, p. 359. (Fungia.)
7. *Ibid.* Q. J. M. S. xxviii. 1888, p. 21. (Mussa and Euphyllia.)
8. *Ibid.* Trans. Roy. Dubl. Soc. v. 1893, p. 205. (Develpt. of Fungia.)
9. *Ibid.* Phil. Trans. clxxxvi. 1895, p. 455. (Heliopora and Xenia.)
10. *Boveri, Th.* Zeit. Wiss. Zool. xlix. 1890, p. 461. (Develpt. and Phylogeny of Zoantharia.)
11. *Brook, G.* Challenger Reports, Zool. xxxii. 1889. (Antipatharia.)
12. *Ibid.* Catalogue of Madreporarian Corals in Brit. Museum, vol. i. 1893. (Madrepora.)
13. *Bernard, H. M.* Cat. Madrep. Corals, Brit. Mus. ii. 1896. (Turbinaria Astraeopora.)
14. *Carlson, O.* Oversigt af. K. Vet. Akad. Förhandlingar, 1891-93. (Edwardsia and Ceriantheae.)
15. *Dana, J. D.* United States Exploring Expedition, Zoophytes. Philadelphia, 1846.
16. *Ibid.* Corals and Coral Islands. New York, 1872. 2nd Ed. Lond. 1885.
17. *Dixon, G. F. and Y.* Sci. Proc. Roy. Dub. Soc. vi. 1889, p. 310.
18. *Danielsen, D. C.* Report of Norwegian, N. Atlantic Exped. Zool. xix. 1890. (Actinidae.)
19. *Duncan, P. M.* Jour. Linn. Soc. xviii. 1885, p. 1. (Classification of Madreporaria.)
20. *Ehrenberg, C. G.* Die Korallthiere des rothen Meeres. Abh. d. k. Akad. Berlin, 1832.
21. *Ellis, J.* The Natural History of many curious and uncommon Zoophytes. Lond. 1786.
22. *Erdmann, A.* Jenaische Zeitsch. xix. 1886, p. 430. (Zoantheae.)
23. *Fowler, G. H.* (The Anatomy of the Madreporaria, i.) Quart. Jour. Micr. Sci. xxv. 1885, p. 577.
24. *Ibid.* Q. J. M. S. xxvii. 1887, p. 1.
25. *Ibid.* Q. J. M. S. xxviii. 1888, p. 1.
26. *Ibid.* Q. J. M. S. xxviii. 1888, p. 413.
27. *Ibid.* Q. J. M. S. xxx. 1890, p. 405.
28. *Genth.* Z. Wiss. Zool. xvii. 1867, p. 429. (Solenocaulon.)
29. *Gosse, P. H.* Actinologia britannica. Lond. 1860.
30. *Haacke, W.* Jenaische Zeitschrift, xiii. 1879, p. 269. (Blastology of Corals.)
31. *Häckel, E.* Arabische Korallen. Berlin, 1875.
32. *Haddon, A. C.* Sci. Proc. Roy. Dublin Soc. v. 1886, p. 1. (Halcampa.)
33. *Ibid.* Sci. Trans. Roy. Dublin Soc. iv. 1888, p. 297. (Revision of Actiniac.)
34. *Ibid.* Sci. Proc. Roy. Dub. Soc. 1892, p. 127. (Larval Euphyllia.)
35. *Haimé, J.* Ann. Sci. Nat. (4), i. 1854, p. 341. (Cerianthus.)
36. *Heider, A. von.* Sitz. d. Kais. Akad. Wien. lxxv. 1877.
37. *Ibid.* Sitz. d. Kais. Akad. Wien. lxxix. 1879. (Cerianthus.)
38. *Ibid.* Zeit. Wiss. Zool. xlv. 1886, p. 152. (Astroides, Dendrophyllia.)
39. *Herdman, W. A.* Proc. Roy. Phys. Soc. Edinb. viii. 1885, p. 31. (Sarcodictyon.)
40. *Hertwig, O. and R.* Die Actinien, Jena, 1879; also Jenaische Zeitschrift, xiii. 1879, p. 457.
41. *Hertwig, R.* Challenger Reports, Zool. vi. 1882; and xxvi. 1888. (Malactinia, Zoantheae.)

42. *Hickson, S. J.* Quart. Jour. Micr. Sci. xxiii. 1883, p. 556. (Tubipora.)
43. *Ibid.* Phil. Trans. clxxiv. 1883, p. 693. (Sulcus of Alcyonarians.)
44. *Ibid.* Proc. Roy. Soc. No. 243, 1886, p. 322.
45. *Ibid.* Trans. Zool. Soc. Lond. xiii. 1894, p. 325. (Alcyonaria stolonifera.)
46. *Ibid.* Quart. Jour. Micr. Sci. xxxvii. 1895, p. 343. (Alcyonium.)
47. *Johnston, G.* A History of British Zoophytes, Edinb. 1838. 2nd Edition, 1847.
48. *Jungersen, H. F. E.* Zeit. Wiss. Zool. xlvii. 1888, p. 626. (Develpt. of Pennatula.)
49. *Klunzinger, C. B.* Die Korallthiere des Rothes Meeres. Berlin, 1877.
50. *Koch, G. von.* Anat. der Orgelkoralle. (Tubipora.) Jena, 1874.
- 50a. *Ibid.* Festschrift für Gegenbauer, 1896.
- 50b. *Ibid.* Mitth. Zool. Stat. Neapel. xii. 1897, p. 754.
51. *Ibid.* Jenaische Zeitschr. xi. 1877, p. 375. (Stylophora.)
52. *Ibid.* Morph. Jahrb. iv. 1878, p. 74. (Gephyra Dohrnii.)
53. *Ibid.* Morph. Jahrb. v. 1880, p. 355. (Cerianthus, Zoanthus.)
54. *Ibid.* Morph. Jahrb. vii. 1882, p. 467. (Telesto.)
55. *Ibid.* Mitt. Zool. Stat. Neapel. iii. 1882, p. 281. (Develpt. of Astroides.)
56. *Ibid.* Palaeontographica, xxix. 1883, p. 329. (Asexual Reproduction in Recent and Fossil Corals.)
57. *Ibid.* Morph. Jahrb. xii. p. 154. (Relations of hard to soft parts in Madreporaria.)
58. *Ibid.* Morph. Jahrb. xiv. 1888, p. 330. (Flabellum.)
59. *Ibid.* Morph. Jahrb. xv. 1889, p. 10. (Caryophyllia.)
60. *Ibid.* Zool. Jahrb. v. 1891, p. 76. (Sympodium.)
61. *Ibid.* Fauna und Flora des Golfes des Neapels, xv. 1887. (Die Gorgoniden.)
62. *Ibid.* Festschrift der teknischen Hochschule zu Darmstadt, 1886. (Antipathes.)
63. *Ibid.* Kleinere Mittheilungen über Anthozoen, Morph. Jahrb. xv., xvi., xvii. xviii.
64. *Kölliker, A. von.* Icones histiologicae. Leipzig, 1863.
65. *Ibid.* Die Pennatuliden, Abhand. d. Leukenb. Naturf. Gesell. vii.
66. *Ibid.* Challenger Reports, Zoology, i., Pennatulids, 1880.
67. *Korn and Danielssen.* Nye Alcyonider, etc. Bergen, 1883.
68. *Ibid.* Norske Nordhavs-Expedition, Alcyonida, 1887.
69. *Kowalevsky and Marion.* Ann. Mus. Hist. Nat. Marseille, i. 1883. (Develpt. of Clavularia.)
70. *Lacaze-Duthiers, H. de.* Hist. Nat. du Corail. Paris, 1864.
71. *Ibid.* Arch. Zool. Expér. et gén. i. 1872; and ii. 1873. (Development.)
72. *Lamouroux.* Exposition Méthodique des genres de l'ordre des Polypiers, Paris, 1821.
73. *M'Murich, J. P.* Johns Hopkins Univ. Circ. viii. No. 70. (Edwardsia stage in Hexactinians.)
74. *Ibid.* Journ. Morph. iv. 1891, p. 131. (Cerianthus.)
75. *Ibid.* Journ. Morph. iv. 1891, p. 303. (Succession of Mesenteries in Zoantharia.)
76. *Ibid.* Journ. Morph. v. 1892, p. 125. (Phylogeny of Anthozoa.)
77. *Marshall, A. M.* Trans. Roy. Soc. Edinb. xxxii. 1887, p. 140. (Pennatulacea.)
78. *Marshall, A. M., and Fowler, G. H.* Trans. Roy. Soc. Edinb. xxiii. 1888, p. 453.

79. *Milne-Edwards, H., and Haime.* Hist. Nat. des Coralliaires, Paris, 1857, 3 vols.
80. *Moseley, H. N.* Phil. Trans. clxvi. 1876, p. 91. (*Heliopora* and *Sarcophytum*.)
81. *Ibid.* Quart. Jour. Micr. Sci. xxii. 1882. (*Seriatopora*, *Pocillopora*.)
82. *Ibid.* Challenger Reports, Zool. ii. 1881. (Deep Sea Corals.)
83. *Nicholson, H. A.* Palaeozoic Tabulate Corals, Edinb. 1879.
84. *Ibid.* The Genus *Monticulipora*, Edinb. 1881.
- 84a. *Ogilvie, M. M.* Phil. Trans. clxxxvii. 1896, p. 83.
85. *Ortmann, A.* Zeit. Wiss. Zool. l. 1890, p. 278. (Formation of Colonies in *Madreporaria*.)
- 85a. *Pratz, E.* Palaeontographica, xxix. 1882. (Structure and Relationships of Extinct Corals.)
86. *Queleh, J. J.* Challenger Reports, Zool. xvi. 1886. (Reef Corals.)
87. *Quoy and Gaimard.* Voyage de l'Astrolabe, 1834.
88. *Ridley, S. O.* Rep. Zool. Collect. H.M.S. *Alert*, *Alcyonaria*, p. 356.
89. *Sars, M.* Fauna littoralis Norvegiae, 1846, p. 28. (*Arachnactis*.)
90. *Schneider and Rotteken.* Ann. Mag. Nat. Hist. (4), vii. 1871, p. 437. (Transl.)
91. *Semper, C.* Zeit. Wiss. Zool. xxii. 1872, p. 235. (Alternation of Generations in Corals.)
92. *Studer, Th.* Monatsb. d. k. Preuss. Akad. Wiss. 1875, p. 668. (*Solenocaulon*.)
93. *Stutchbury.* Trans. Linn. Soc. 1830, p. 494. (Asexual Reproduction of *Fungia*.)
94. *Verrill.* Amer. Jour. Arts and Sciences, xlv. 1868, p. 415; and numerous papers in succeeding numbers.
95. *Vogt, C.* Arch. de Biologie, viii. 1888. (*Cerianthus*.)
96. *Wilson, E. B.* Phil. Trans. clxxiv. 1883, p. 723. (Develpt. of *Renilla*.)
97. *Ibid.* Mitth. Zool. Stat. Neapel. v. 1884, p. 1. (Mesenterial Filaments of *Alcyonaria*.)
98. *Wilson, H. V.* Journal of Morphology, ii. 1888, p. 191. (Develpt. of *Manicina*.)
99. *Wright, P. S.* Proc. Roy. Phys. Soc. Edinb. ii. 1859, p. 91. (*Peachia*.)
100. *Ibid.* Quart. Jour. Micros. Sci. v. 1865, p. 213. (*Hartea*.)
101. *Wright, P. S., and Studer, Th.* Challenger Reports, Zoology, xxxi. (*Alcyonaria*), 1889.

ADDENDUM.

Since this article was written, the author has studied the structure and formation of the calcareous skeleton in a number of different genera of Anthozoa with the view of deciding the question whether the skeleton of the Scleractiniae is composed of entoplasmic spicules as von Heider and Ogilvie assert, or whether it is an ectoplasmic product as described by von Koch. The results of these investigations may be briefly summed up as follows:—In all the Alcyonaria except *Heliopora* the calcareous skeleton consists of spicules, a "spicule" being the entoplasmic product of a single cell or of a coenocyte. The spicule is covered by a sheath of organic substance, and its axis is traversed by an organic thread or bundle of threads from which other organic threads radiate outwards and are

attached to the spicule sheath. The inorganic constituents of the spicule show a complex, fibro-crystalline structure, the component crystalline fibres always being oriented in a definite manner with regard to the organic threads. In *Heliopora* the skeleton is not spicular but lamellar, resembling in structure that of the Scleractinian corals. It is not formed of a number of fused spicules, but is secreted by a special layer of cells derived from the ectoderm and called calicoblasts. The calicoblasts are separated from the corallum by a fine membrane. At intervals in the layer of calicoblasts and lying among them are peculiar structures which will be called *desmocytes*. These are wedge-shaped bodies, with their narrower ends attached to the mesogloea, their broader ends attached to the corallum. They exhibit a faint but distinct longitudinal striation, which is not due to the presence of needles of carbonate of lime. The desmocytes are most abundant in the older parts of the colony, and are absent or only represented by early stages of development in those parts where coral growth is most active. There can be no doubt that the desmocytes of *Heliopora* are homologous with the similar structures in Scleractinian corals, discovered by von Heider and called by him calicoblasts. After examination of a large number of Scleractiniae the present writer found that (1) the corallum is everywhere clothed by a layer of cells either rounded, columnar, or fused together, which form the true calicoblastic layer; (2) that the calicoblastic layer is separated from the corallum by a fine membrane; (3) that desmocytes (von Heider's calicoblasts) occur at widely separated intervals in the calicoblastic layer, except along the lines of insertion of the mesenteries, where they are numerous and closely crowded together; (4) that each desmocyte is the product of a single cell; (5) that the striations of the desmocytes are not due to the presence of spicules of carbonate of lime as von Heider supposed, since they give none of the optical effects of crystals; (6) that desmocytes do not occur in the regions of most active coral growth. The conclusion arrived at is that the desmocytes, both in *Heliopora* and the Scleractiniae, have no share in coral formation, but serve, as Fowler suggested, to attach the soft tissues to the corallum. A study of the costal spines of *Madrepora rosacea* showed that the carbonate of lime secreted by the calicoblasts is deposited in the form of minute crystals on the far side of the limiting membrane which separates the calicoblasts from the corallum. These minute crystals are oriented conformably to the crystalline structure of the previously existing corallum, and eventually become merged into its structure. Thus von Koch's view that the corallum is secreted by the calicoblastic layer derived from the ectoderm is shown to be correct (see *Quart. Jour. Micro. Sci.* vol. xli. 1899, p. 449).

INDEX

To names of Classes, Orders, Sub-Orders, and Genera ; to technical terms ; and to names of Authors discussed in the text.

- Acalephae*, 2
Acanella, 28
Acanthogorgia, 28
Acanthoisis, 28
Acanthoptilum, 34
Acis, 28
acontia, 41
Actinauge, 60
Actinaria, 61
Actinia, 42, 59
Actinidae, 59
Actiniidea, 46, 59
Actinodendron, 61
Actinoloba, 59
Adamsia, 60
Agaricia, 75
Agassiz, A., 4
Agelecyathus, 73
Aiptasia, 43, 60
Alcyonacea, 19, 23
Alcyonaria, 10
Alcyonidae, 17, 23
Alcyonium, 24
Aldrovandus, 2
Alveopora, 76
Ammothea, 25
Amphianthidae, 61
Amphianthus, 61
Amphilaphis, 28
Amplexus, 72
Anabacia, 76
Anabaciadae, 76
Anacropora, 76
Anemonia, 59
Antheinae, 59
Antheomorpha, 60
Antheomorphinae, 60
anthocaulus, 75
anthocyathus, 75
Anthomastus, 24
Anthoptilidae, 34
Anthoptilum, 34
Anthothela, 25
Anthozoa, 2
Antipathella, 54, 57
Antipathes, 53, 57
Antipathidae, 57
Antipathidea, 53, 57
Antipathinae, 57
Aphanipathes, 57
Aporosa, 65, 72
Arachnactis, 52
Aristotle, 2
asexual reproduction in
 corals, 66
Asiphonacea, 29
Astracidae, 70, 73
Astracinae, 74
Astraeopora, 76
Astrangia, 74
Astroides, 76
 — development of, 63
Audouin, 4
Aulaciniu, 60
autozoid, 11, 30
Azifera, 18, 19, 26
axis, of Pennatulids, 30
 — development of, 32

Balanophyllia, 76
Barathrobium, 25
basal disc, 33
 — plate, 62
Bathyactis, 76
Bathyanthus, 57
Bathygorgia, 28
Bathypathes, 57
Bathyptilum, 34
Bebruce, 28
Belon, 2
Beneden, P. J. van, 4
 — *E. van*, 50, 52
Bernard, 71
bilateral symmetry, 43
biradial symmetry, 44
Blastotrochus, 66, 73
Boccone, 3
Bourne, 22, 62, 76
Boveri, 44, 46, 47
Briareidae, 18, 25
Briareinae, 25
Briareum, 25
Brook, 57, 71
 budding, 16, 67
Bunodes, 42, 60
Bunodinae, 60

calamus, 30
calcareous skeleton, 12
Calceola, 75
calicoblast, 66
Calliactis, 60
Callisis, 28
Callistephanus, 28
Callozostrinae, 28
Callozostron, 28
Calypterus, 28
Calyptophora, 28
Calyptrophorinae, 28
canal system, 68
capitulum, 44
Capna, 60
Carijoa, 30
Carlgren, 52
Caryophyllia, 62, 63, 72
Cavernularia, 34
Cavernularinae, 34
Cavolini, 4
Ceratoisulinae, 28
Ceratoisis, 28
Cereus, 60
Cerianthidea, 51, 57
Cerianthus, 51, 57
Chaetetes, 37
Chaetetidae, 37
Chironephytha, 25
Chitonactis, 60
Chondractinia, 60
Chrysoyorgia, 28
cinclides, 41
Cirrhopathes, 57
Cirrhopathinae, 57
Cladactis, 60
Cladocora, 74
Cladopathes, 57

- Clavella*, 34
Clavularia, 20
 cnidoblasts, 9
 coelenteron, 5
Coelogorgia, 18, 30
Coelogorgiidae, 30
Coeloria, 74
Coenenchymata, 71
 coenenchyme, 67
Coenocyathus, 73
 coenosarc, 66
Coenothecalia, 19, 35
columnella, 62
 column, in *Zoantharia*, 38
Columnaria, 22
Columnariidae, 22
Comactis, 59
 conchula, 48
Corallidae, 18, 25
Corallimorphidae, 60
Corallimorphinae, 60
Corallimorphus, 60
Corallinum, 25
Cornularia, 20
Cornulariidae, 20
Corticifera, 58
Corynactinae, 60
Corynactis, 60
 costae, 62
Crambactinae, 61
Crambactis, 61
Cryptabacia, 76
Cryptodendrinae, 61
Cryptodendron, 61
Cryptoparamera, 59
 Cuvier, 4
Cyathophyllidae, 70
Cyathophyllinae, 75
Cyathophylloidea, 71
Cyathophyllum, 70, 75
Cyathoseris, 76
 cycles, of mesenteries, 42
Cyclolites, 76
Cycloseridae, 76
Cycloseris, 76
Cylicia, 74
Cystiphyllidae, 75
Cystiphyllum, 75
- Dana, 4
Danielssenia, 28
Dasygorgia, 28
Dasygorgiidae, 18, 28
Dendractidae, 61
Dendrobrachia, 58
Dendrobrachiidae, 53, 58
Dendrophyllia, 76
Desmophyllum, 72
 Desor, 4
 development, of *Alcyonaria*, 13
- Diapungia*, 75
 dimorphism, 11
Diploria, 74
Discosoma, 60
Discosominae, 60
 Dissepiments, 63
 division, in *Scleractinia*, 66
 dorsum, 7
Drifa, 25
Dubenia, 34
 Duncan, 70, 71
Duncania, 72
Duva, 25
- Echinopora*, 74
 ectoderm, 5
 edge-zone, 64
Edwardsia, 44, 58
Edwardsiidea, 58
 Ehrenberg, 4
 Ellis, 4
 endoderm, 5
 endotheca, 63
 entocoele, 41
 epitheca, 62
 epithelio-muscular cells, 10
Epizoanthus, 58
 equal division, 69
 Esper, 4
Eugorgia, 28
Eumuricea, 28
Eunephtya, 25
Eunicea, 28
Eunicella, 28
Euphyllia, 74
Eupsammia, 76
Eupsammidae, 71, 76
Eusmilia, 74
 exocoele, 41
- Favia*, 74
Favosites, 22
Favositidae, 22
Flabellinae, 72
Flabellum, 72, 73
 Fowler, 62
Fulla, 25
Fungacea, 71, 75
Fungia, 66, 71, 75
Funiculina, 34
Funiculinidae, 33, 34
- Galaxea*, 67, 74
 ganglion-cells, 10
 gemmation, 66, 69
Gemmulatrochus, 73
Gephyra, 61
Gersemia, 25
Gersemiopsis, 25
 Gesner, 2
 gland-cells, 10
- Godefroyia*, 34
Gonactinia, 48, 59
Gonactinidae, 59
 gonads, 40
Göndül, 34
Göndulidae, 33, 34
Goniastrea, 74
Goniocora, 74
Goniophyllinae, 75
Goniophyllum, 75
Goniopora, 76
Gorgonia, 28
 — development of, 14
Gorgonidae, 18, 28
- Haddon, 7
 Haime, 4, 70
Haimea, 15
Haineidae, 15
Halcampa, 43, 44, 59
Halcampinae, 59
Halipterus, 34
Halisceptrum, 34
Halomitra, 76
Haplophracta, 71
Hartea, 15
 Heider, A. von, 62
Heliastraea, 74
Heliolites, 36
Heliolitidae, 36
Heliopora, 36
Helioporidae, 19, 36
Herpetolitha, 76
 Hertwig, O., 4
 Hertwig, R., 4
Heteropsanmia, 76
Heterozenia, 17, 23
Hexactinia, 10
Hexactiniae, 59
 Hickson, 22
Hydnophora, 74
Hymenogorgia, 28
- Ilicigorgia*, 25
Ilyanthidae, 59
Ilyanthinae, 59
Ilyanthus, 59
 Imperato, 3
Isastraea, 74
Isidae, 18, 28
Isidella, 28
Isidinae, 28
Isis, 28
- Johnston, J., 2
 Jungersen, 30
- Keroeides*, 25
 Klunzinger, 26
 Koch, G. von, 4, 26, 61
 Kölliker, A. von, 5

- Kophobolemnon*, 34
Kophobolemnoidae, 34
 Kowalevsky, 4

 Lacaze-Duthiers, H. de, 4, 25
 Lamarck, 4
 Lamouroux, 4
Leiopathes, 53, 55, 58
Leiopathidae, 58
Leioptilum, 34
Lemnalìa, 25
Leptopenus, 76
Leptophyllia, 76
Leptoptilum, 34
Leptoseris, 76
Leucoella, 25
Liponemidae, 61
Lituaria, 34
Lituarinae, 34
 Lobel, 2
Lobophytum, 24
Lophogorgia, 28
Lophohelia, 69, 73
Lophoseris, 75
Lyellia, 36
Lygomorpha, 34

 M'Murrich, 49, 50
 macromesenteries, 48, 49
Macrotypa, 58
 macrotype, 51
Madracis, 73
Madrepora, 76
Madreporaria, 45
Madreporidae, 76
Mæandrina, 74
Mæandroseris, 76
Malacactiniae, 55, 59
Mammilifera, 58
Mauicina, 43, 45, 63, 74
 Marsilli, 3
Megalactis, 61
Melitodes, 25
Melitodidae, 25
Merulina, 74
 mesenterial filaments, 9, 37, 40
 mesenteries, 8
 — in *Acyouaria*, 11
 — in *Antipathidea*, 54
 — in *Cerianthidea*, 53
 — in *Zoantharia*, 37-39, 41
 — in *Zoanthidea*, 51
 mesogloea, 6, 10
 metarachis, 31
Michelinia, 75
Micrubacia, 75
 micromesenteries, 48, 49
Microptilum, 34

Microtypa, 58
 microtype, 51
 Milne-Edwards, 4, 70
Monaulæae, 48
Monaulidae, 59
Monoxenia, 15
Monticuliporidae, 37
Montipora, 76
Mopsea, 28
Mopseinae, 28
Mopsella, 25
 Moseley, 4, 36, 71
Moseleya, 70, 75
Muriceidae, 28
Murocorallia, 71
 muscle-banners, 11, 39
 muscular layer, 9
Mussa, 69, 74
Mycelium, 76

Nannodendron, 24
 nematocysts, 9
Neohelia, 73
 nephridia, 7
Nephtya, 24
Nephtyidae, 18, 24
 nervous layer, 9

Octactiniae, 10
Oculina, 73
Oculinidae, 73
 Ogilvie, Miss, 56, 62, 71, 74, 75
Omphyma, 72
Oractidae, 59
Oractis, 49, 59
 Ovid, 2

Pali, 62
Palythou, 58
Paractinia, 60
Paractininae, 60
Paractis, 60
Paragorgia, 25
Paralcyonium, 24
Paramera, 57
Paramuricea, 28
Paranephtya, 25
Paranthus, 60
Parantipathes, 57
Pararachides, 31
Parisis, 25
Pavonaria, 34
Peachia, 48, 59
Peachiinae, 59
Pennatulæ, 34
Pennatulacea, 30
Pennatulidae, 18, 33, 34
Pennatulinae, 34
Perforata, 65, 76
 peristome, 38

 Peyssonel, 3
Phellia, 60
Phycogorgia, 28
Phyllactinæ, 61
Phyllactis, 61
Phymanthidae, 61
Phymanthus, 61
 physa, 44
 pinnae, 31
Placocyathus, 73
Placosmilia, 74
Placotrochus, 73
Plasmopora, 36
Platycalcos, 28
Platyogorgia, 28
Plesiogungidae, 75
Plesioporitidae, 71, 76
Pleurocorallium, 25
Pleurocyathus, 72
Plexaura, 28
Plexaurella, 28
Plexauridae, 28
 Pliny, 2
Plumarella, 28
Pocillopora, 73
Pocilloporidae, 73
Poloseris, 76
Policella, 34
Pollaplophracta, 71
Polycyathus, 73
Polyopidae, 61
Polyopsis, 46, 61
 polyp, 4
Polysiphonia, 61
Polystomidium, 61
Porites, 76
Poritidae, 76
 Pratz, 56
Primnoa, 28
Primnoella, 28
Primnoidae, 18, 28
Primnoinae, 28
Prinnois, 28
Prionastrea, 70
Proactininae, 58
Propora, 36
 prorachis, 31
Protalcyonacea, 15
Protocaulidae, 34
Protocaulon, 33, 34
Protoptilidae, 34
Protoptilum, 34
Psammogorgia, 28
Psammoseris, 76
Pseudaxonia, 18, 19, 25
Pteroeides, 34
Pteroeididae, 34
Pteropathes, 57
Ptilosarcus, 34

 Quelch, 56, 70, 71, 75

- Réaumur, 3
 relationships of Zoantharia, 55, 56
Renilla, 13, 14, 34
Renillidae, 33, 34
 respiratory system, 7
Rhizophyllum, 75
Rhizotrochus, 72
Rhodactinae, 61
Rhodactis, 43, 61
Rhodarea, 76
Rhodopsammia, 66, 76
 Rondelet, 2
 Rötteken's muscle, 40
Rugosa, 56
- Saccanthus*, 57
Sagartia, 42, 60
Sagartinae, 59
Sarakka, 24
Sarcodictyon, 17, 20
Sarcophianthidae, 61
Sarcophianthus, 61
Sarcophyllum, 34
Sarcophyton, 24
 Sars, 4
Savaglia, 61
 Savigny, 4
 scapus, 30, 44
Schizocyathus, 72
Schizopathes, 57
Schizopathinae, 57
Scleractinia, 55, 61
Sclerisis, 23
Scleroblemnon, 34
Sclerogorgia, 25
Sclerogorgiidae, 18, 25
Scleronephyta, 25
Scleroptilum, 34
Scytalium, 34
Scytophorus, 48, 59
 Semper, 76
Semperina, 25
 sense-cells, 9
 septa, 8, 62
Septocorallia, 72
Seriatorpora, 73
 Shaw, 3
Sicyonidae, 61
Sicyonis, 47, 61
Siderastraea, 75
 Siebold, C. von, 4
 siphonoglyphe, 7
Siphonogorgia, 25
Siphonogorginae, 25
 siphonozooids, 11, 30
 skeleton, 13, 37
- Smilotrochus*, 73
 solenia, 14, 16
Solenocaulon, 25
Sphenopidae, 58
Sphenopus, 58
Spongioderma, 25
Spongioderminae, 25
Spongodes, 24
Spongodinae, 24
Stachyodes, 28
Stachyptilidae, 34
Stachyptilum, 34
Stauria, 56, 75
Staurinae, 75
Stelechotokea, 19, 28
Stenella, 23
Stenogorgia, 28
Stenopora, 22
Stephanactis, 61
Stephanaria, 76
Stephanophyllia, 71, 76
Stephanotrochus, 73
Stichopathes, 57
Stolonifera, 19
 stomodaeum, 7, 38
Streptelasma, 56, 72
 Stutchbury, 76
Stylatula, 34
Styloblemnon, 34
Stylophora, 73
Suberia, 25
Suberogorgia, 25
 sulculus, 7, 37
 sulcus, 7, 11, 37
Swiftia, 28
Sympodium, 17, 20
Synalcyonacea, 15
 synaptacula, 63
Synarava, 76
Syringolites, 22
Syringopora, 21
Syringoporidae, 21
- Tabernaemontanus, 3
 tabulae, 63
Taractea, 61
Taxipathes, 57
Tealia, 46, 61
Tealiidae, 61
Telestidae, 29
Telesto, 18, 30
 tentacles, 5, 37
Tetracoralla, 56
Thalassianthidae, 61
Thalassianthinae, 61
Thalassianthus, 61
Thamnastraea, 75
- theca, 62
Thecia, 37
Thecidae, 36
 Theophrastus, 2
Thouarella, 28
Titanideum, 25
 Tournefort, 3
 Trembley, 3
Triactis, 61
Trichoptilum, 34
Trochocyathus, 73
Trochoseris, 76
Trochosmilia, 74
 trophozooid, 66, 75
Tubipora, 21
Tubiporidae, 21
Turbinaria, 76
Turbinolia, 73
Turbinolidae, 71, 72
Turbinolinae, 73
Tylopathes, 57
- Umbellula*, 34
Umbellulidae, 33, 34
 unequal division, 69
- Vaughan-Thompson, 4
 ventrum, 7
Veretillidae, 33, 34
Veretillum, 34
Villogorgia, 28
Virgularia, 34
Virgulariidae, 33, 34
Virgularinae, 34
Voeringia, 25
- Wilson, E. B., 4
 Wilson, H. V., 63
 Wotton, 2
Wrightella, 25
- Xenia*, 17, 23
Xeniidae, 17, 23
Xiphigorgia, 28
- Zaphrentidae*, 71, 72
Zaphrentis, 72
Zaphrentoidea, 71
 Zoantharia, 37
Zoanthidae, 58
Zoanthidea, 49, 58
Zoanthus, 53
 zoochlorellae, 10
 zooid, 5
 zoophytes, 2
 zooxanthellae, 10

CHAPTER VII.

THE CTENOPHORA.¹

CLASS CTENOPHORA.

SUB-CLASS 1. TENTACULATA.

- Order 1. **Cydippidea.**
- " 2. **Lobata.**
- " 3. **Cestoidea.**
- " 4. **Platyctenea.**

SUB-CLASS 2. NUDA.

- Order 5. **Beroidea.**

UNDER the name Ctenophora is comprised a small assemblage of organisms, pelagic in habit, characterised by a well-marked biradial symmetry, the possession of rows of swimming plates formed of modified cilia, and a transparent gelatinoid body. The majority of authors classify the Ctenophora as an aberrant group of the Coelentera, the architecture of the body being compared with that of a Hydromedusa; on the other hand, several authors have claimed affinities between the Ctenophora and Turbellarian worms. It will be most convenient to describe the structure and development of a typical form of the group, and to discuss its phylogeny afterwards.

Though the Ctenophora are universally distributed and are especially abundant in warm seas, they were not recognised until 1671, and then they were observed, not in warm or temperate seas, but in the neighbourhood of Spitzbergen by a ship's surgeon named Friedrich Martens. Nearly a century later, in 1756, they were again discovered at Jamaica by Patrick Brown, and two species were included in the tenth edition of the *Systema Naturae* under the names *Volvox beroë* and *Volvox bicaudatus*. Since the beginning of the present century Ctenophora have been found and studied in all quarters of the globe. They attracted the

¹ By G. C. Bourne, M.A.

attention of the earlier zoological circumnavigators, Peron, Lesueur, Quoy, Gaimard, and Chamisso; and in 1829 Eschscholtz assigned to them the systematic position near the Medusae, which they have retained ever since. After Eschscholtz the Ctenophora were studied by many observers, particularly by Leuckhart, Kölliker, Gegenbauer, Fol, L. Agassiz, and Allman, and lately they have been more closely studied by Kowalevsky, A. Agassiz, Metschnikoff, and especially by Chun, whose monograph, forming the first volume of the *Fauna and Flora of the Gulf of Naples*, is the standard treatise on the subject.

The fundamental structure of the Ctenophora may conveniently be studied in two species, which may be procured in abundance off the English coasts in the spring, summer, and autumn months, *Pleurobrachia pileus*, Fabr. (= *P. rhodactyla*, Agassiz), and *Hormiphora plumosa*, Agassiz.

The body is ovoid, and in *Hormiphora* it tapers somewhat towards one end, on which is placed a wide aperture compressed from side to side; this is the mouth. At the opposite end of the body is a shallow depression containing a sense organ of characteristic structure. The line connecting mouth and sense organ is the chief axis of the body; the extremity, at which the mouth is placed, is distinguished as the oral pole, the opposite extremity as the aboral or sensory pole.

The surface of the body is beset with eight meridional rows of modified ectoderm, bearing very long cilia, fused together and so disposed as to form a series of swimming plates called combs or ctenes. The meridional rows are termed ribs or costae, and they divide the body into octants. In both *Hormiphora* and *Pleurobrachia* they begin at some little distance from the aboral pole, in *Hormiphora* they extend downwards over about two-thirds of the body, in *Pleurobrachia pileus* they reach downwards nearly to the mouth. On either side of the body, in an interspace between two costae, is a pouch leading into a considerable cavity hollowed out in the gelatinous body. From each pouch projects a tentacle, a long solid filament furnished with numerous accessory filaments.

The mass of the body is composed of a gelatinous substance, so transparent that the main features of the internal anatomy may be studied without dissection. The mouth leads into a tolerably spacious sac which, like the mouth itself, is compressed from side to side. This sac, usually called the stomach, is developed as a secondary invagination of the epiblast, and is therefore a *stomodaeum*. It extends upwards for some two-thirds of the way towards the aboral pole, and there opens by a small orifice into a second sac, the *infundibulum*, which is also compressed from side to side, but in a plane at right angles to the first. Following Claus's

terminology (9), the plane in which the stomodaeum is compressed will be called the *sagittal*, that in which the infundibulum is compressed the *transverse* plane. As the tentacles lie at either end of the transverse plane, the latter is sometimes called the tentacular plane.

As the whole plan of the Ctenophoran body is dominated by these two planes lying at right angles to one another, it will be convenient to refer the position of other organs to them. Accord-

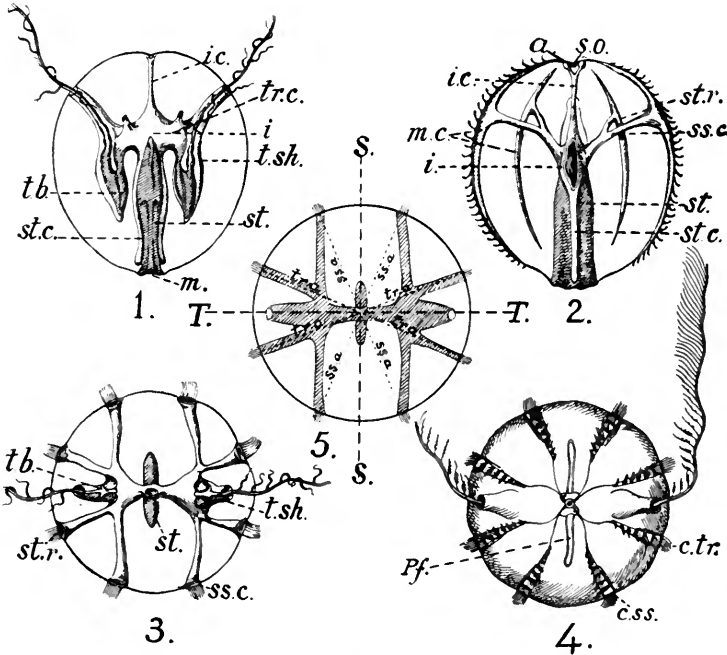

FIG. 1.—All the figures are of *Pleurobrachia pileus*.

1.—The animal has been cut in half vertically rather than to one side of the transverse plane *st*, stomodaeum; *i*, infundibulum; *ic*, infundibular canal; *stc*, stomodaeal canals; *trc*, transverse canal, on which are seen the cut ends of the secondary canals; *tb*, tentacle base; *tsh*, tentacle sheath.

2.—The animal has been similarly cut in half in the sagittal plane. *a*, sub-sensory ampullae; *mc*, meridional canals; *ssa*, sub-sagittal and, *str*, sub-transverse gastrovascular canals.

3.—View of the gastrovascular system in an animal cut across just above the level of the infundibulum. Lettering as before.

4.—View of the aboral aspect of *Pleurobrachia* showing the central otolith mass, the polar fields, *Pf*; the four ampullae and two excretory openings, the eight ciliated furrows, the costae and the fringed tentacles; *c.ss*, sub-sagittal and, *c.tr*, sub-transverse costae.

5.—Diagram illustrating the symmetry of a cydippiform Ctenophore. *SS*, sagittal axis; *TT*, transverse axis; *ssa*, sub-sagittal radii; *tra*, sub-transverse radii.

ingly, organs which are adjacent to the sagittal plane will be called *sub-sagittal*, those which are adjacent to the transverse plane will be called *sub-transverse*.

The infundibulum is lined by endoderm, and is the true

enteron, though the process of digestion is, for the most part, carried on in the stomodaeum, which is provided in its upper portion with a pair of longitudinal thickenings, the stomodæal folds, serving to increase its surface. The products of digestion pass into the infundibulum, and are thence distributed to all parts of the body by canals which, taken collectively, constitute the gastrovascular system. The gastrovascular canals, like the infundibulum, are lined with endoderm.

We may conveniently distinguish two sets of canals—vertical and horizontal. The vertical canals consist of a pair running mouthwards, and a single axial vessel passing towards the aboral pole. The former are blind diverticula running down, one on each flattened side of the stomodaeum, and ending in the neighbourhood of the mouth (Fig. I. 1, 2, *etc.*). The aboral vessel runs straight towards the sense organ, bifurcates at a short distance below it, and each branch again divides to form a pair of small sacs or ampullae which lie immediately below the ectoderm, and underneath the aboral sense organ. Each of the ampullae lies in one of the angles formed by the intersection of the sagittal and transverse planes. Two of them are closed sacs, but two, lying diagonally opposite to one another, open to the surface by small pores in the neighbourhood of the polar fields. It is a rule, without exception, in the Ctenophora that, if the animal is viewed from the sagittal aspect, the ampulla farthest from the spectator on the left, and the one nearest to him on the right, open by these so-called excretory pores (Fig. I. 4, and Fig. II. 1, *exp.*).

The horizontal gastrovascular canals serve to place the infundibulum in connection with the bases of the tentacles, and with the eight meridional canals which run immediately beneath the costae. A single pair of wide vessels, lying in the transverse plane, starts from the infundibulum at the level of its opening into the stomodaeum. Each transverse vessel, after a short course, bifurcates at a wide angle, and its branches again divide, forming on either side of the body four canals, two of which are sub-sagittal and two sub-transverse (Fig. I. 3, 5). Each canal passes direct to a costa, and beneath it is produced orally and aborally into a long diverticulum which lies immediately below the costa and ends blindly, forming the sub-costal meridional canal. The gonads are developed on the walls of these sub-costal canals.

The space between the stomodaeum, gastrovascular system, and body walls is occupied by a gelatinoid substance, in which are imbedded numerous muscle fibres, whose structure and arrangement will be described further on.

The sensory organ at the aboral pole consists of a shallow depression of the ectoderm, lined by a modified and probably sensory epithelium. Within many of the epithelial cells are formed cal-

careous sphaeroids (otoliths); and, according to Samassa (21), when the otoliths are fully formed, they are ejected, still surrounded by the remnants of the cells in which they were formed, and become aggregated together to form a mulberry-like mass. The otolith mass is supported by four "balancers," delicate lamellae of peculiar shape formed by fused cilia. The whole structure, sensory pit and otolith mass, is covered over and protected by a transparent dome formed by fused cilia (see Fig. II. 1, 2). The four balancers lie in the angles of intersection of the sagittal and

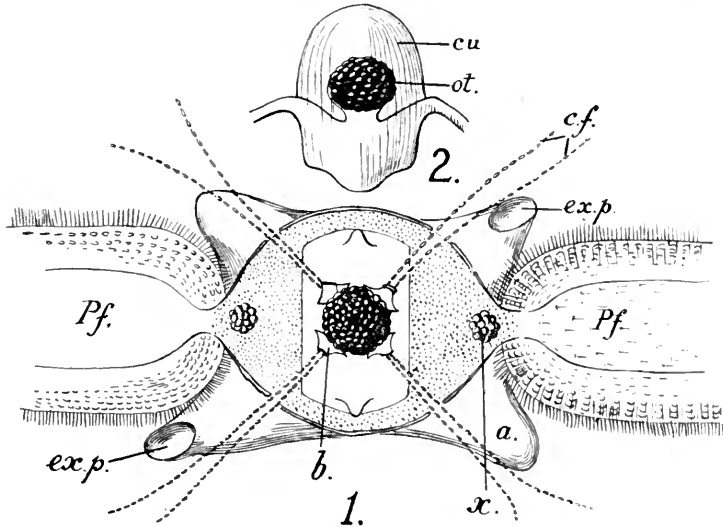

FIG. 11.

1.—Surface view of the sense organ of *Hormiphora plumosa*. *Pf*, polar fields; *a*, ampullae; *xp*, excretory pores; *x*, groups of gland cells; *cf*, ciliated furrows. (After Chun.)
 2.—The same seen from the side. *ot*, otolith mass; *cu*, cupule formed of fused cilia.

transverse planes; from the base of each of them two rows of ciliated furrows run outwards to end in the uppermost comb of each costa. The sensory pit is produced on either side, in the sagittal plane, into an elongated band-like ciliated tract. These tracts are known as the polar fields (Fig. I. 4, and Fig. II. 1, *Pf*), and it was supposed that they served as olfactory organs, but Samassa (21) states that they are nothing more than tracts of simple ciliated epithelium, devoid of sensory cells, so their function remains unknown. Samassa denies the existence of any nervous structures beyond those already mentioned; but Hertwig (13), whose observations have recently been confirmed by Bethe (5), describes a sub-epithelial nerve plexus similar to that which occurs in Medusae.

In the majority of the Ctenophora locomotion is effected solely through the action of the combs of the costae. Only in the much modified family of the Cestidae is the ciliary action supplemented by sinuous movements of the elongated, band-like body.

A costa is made up of a number of short transverse rows of modified ectoderm cells, bearing exceedingly long cilia. The cilia are fused together to form the swimming plate or comb. The basis of each comb is a cushion composed of large columnar cells; these cells have broad bases and narrower ends, so that they converge together (Fig. III. 5). According to Samassa, the ciliated cells of one comb are in direct organic continuity with those of the next succeeding comb by means of branched processes of the bases of the cells, which processes traverse the intervening space, and admit of stimuli being conducted from comb to comb (Fig. III. 4). The cilia are borne on the narrower ends of the columnar cells, and are fused to form a plate which is bent downwards at a tolerably sharp angle at a short distance from the surface. When in action the comb is straightened out so as to give a sharp stroke in an upward—that is, in the aboral—direction, and then it swings slowly back to the bent position of rest. The combs of each costa contract in succession from the aboral towards the oral pole, their successive action giving rise to the appearance of a wave travelling in the same direction. It follows that the action of the combs drives the animal through the water mouth forwards, its progress being just the opposite to that of a Medusa. The activity of the combs of each costa is directed and controlled by the aboral sense organ. The structure of the latter shows it to be an organ of balance. If the Ctenophore be tilted over to one side the otolith mass bears down upon the balancer of that side, and the impulse thus originated is transmitted from cell to cell of the ciliated furrows till it reaches the first combs of the costae to which the furrows are distributed. These combs immediately contract, and the stimulus is conveyed from comb to comb by means of the processes of the ectoderm cells described above. Thus the ciliated furrows function as nerves, though they do not contain nerve fibres or nerve ganglion cells, and the transmission of stimuli is effected by simple cell contact. It must be borne in mind, however, that there is also a sub-epithelial nerve plexus with ganglion cells and nerve fibrils, though the latter are not known to be connected with the aboral sense organ.

The tentacles of the Ctenophora serve for the capture of prey, and are not used in locomotion. They are most fully developed in the Cydippidae (*Hormiphora* and *Pleurobrachia*); are present, though much modified, in the Cestidae and Lobatae, but are absent in the Beroidae. In *Pleurobrachia* and *Hormiphora* the tentacle, consisting of a tentacular base and the tentacle proper, is retractile

within the tentacle sheath, a wide sac-like invagination of the ectoderm. The tentacular base is the broad proximal extremity of the tentacle, and is inserted on the inner or axial side of the tentacular sheath. It is penetrated by a pair of saccular cavities which are prolongations of the transverse gastrovascular canals.

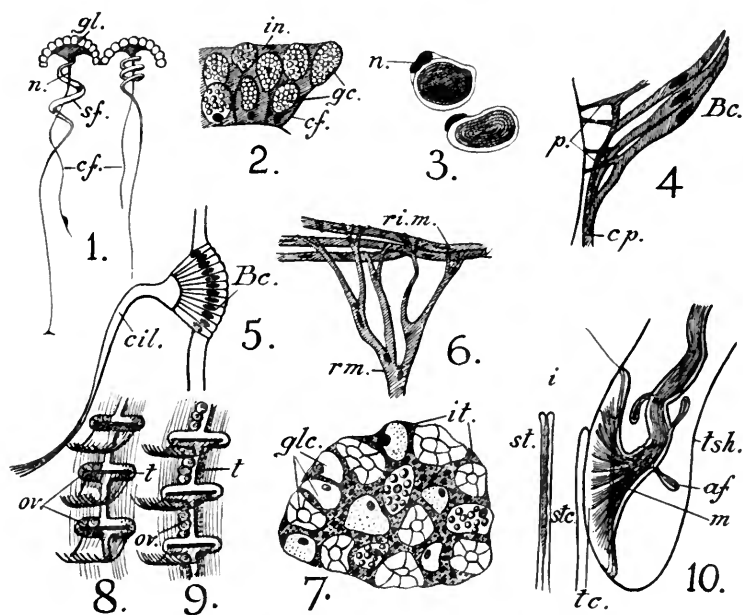

FIG. III.

1.—Two lasso-cells (after Samassa). *gl.*, glandular portion of lasso-cell; *cf.*, central filament; *sf.*, spiral filament; *n.*, nucleus of central filament.

2.—Section through the epithelium of the base of a tentacle of *Hormiphora*, showing the development of the lasso-cells from, *gc.*, gland cells and, *cf.*, filaments formed from, *in.*, the interstitial tissue.

3.—Two otoliths of *Beroë* (after Samassa). *n.*, nucleus.

4.—Section through the ectoderm cushion at the base of a comb. *Bc.*, basal cells of the comb; *p.*, their processes; *cp.*, connecting process going to the next comb. (After Samassa.)

5.—Diagrammatic section through a comb. *Bc.*, basal cells; *cil.*, plate formed of fused cilia. (After Chun.)

6.—Attachment of the radial muscles, *rm.*, to the stomodaeal sphincter muscles, *rim.*, in *Beroë*. (After Samassa.)

7.—Epithelium of *Cestus veneris*, showing gland cells, *glc.*, in various stages of development imbedded in a coenocytal interstitial tissue, *it.*

8.—Diagram showing the position of the ovaries, *ov.*, and the spermaries, *t.*, in the hypotential diverticula of the meridional canals in *Eucharis multicornis*, and in *Bolina alata*.

9.—Diagram showing the position of the ovaries and spermaries in *Deiopea kaloktenota* and *Bolina hydatina*.

10.—Diagram of the tentacle base of *Hormiphora plumosa*, after Chun. *i.*, infundibulum; *st.*, stomodaeum; *stc.*, stomodaeal canal; *tc.*, tentacular canal; *af.*, accessory filament; *m.*, muscles; *tsh.*, tentacle sheath.

The partition between the tentacular canals is called the tentacle stem; it contains muscles which converge from the wall of the tentacle sheath to the tentacle itself, where they form a solid axial

cord, from which muscular slips are given off to the accessory filaments. The tentacle itself is a solid, muscular, and exceedingly extensile filament (Fig. III. 10). The accessory filaments are simple and thread-like in *Pleurobrachia*, but in *Hormiphora* certain of them are thickened and furnished with digitiform appendages which, from their supposed resemblance to a minute Eolis, are often called eolidiform appendages. The whole surface of the tentacle and its accessory filaments is covered by densely crowded "lasso-cells," structures characteristic of the Ctenophora, which will be described in detail further on.

The musculature of the Ctenophora is wholly derived from the mesoblast, and there are no epithelio-muscular cells. The muscle fibres are for the most part much branched, and are not grouped into bundles except at the bases of the tentacles, in the tentacles themselves, and in the regions of the mouth and aboral sensory organ, where they form sphincters. There is a well-marked layer of musculature under the body wall, consisting of an external layer of longitudinal, and an internal layer of transverse fibres. A similar musculature invests the stomodaeum and the gastrovascular canals. The gelatinous substance of the body is traversed by numerous fibres, whose general direction is radial, from the stomodaeum and gastrovascular system to the body wall.

The histology of the Ctenophora has been carefully studied by Samassa (21), to whose paper the reader is referred for details. The epithelium of the body is peculiar, being formed of large gland cells lying in an interstitial tissue, in which many nuclei, but no cell boundaries, are to be distinguished. In the neighbourhood of the aboral sense organ, the ciliated ridges and the costae, the gland cells become smaller and less numerous, and the interstitial tissue is replaced by a simple cubical epithelium. The most characteristic histological feature of the Ctenophora is the presence of the lasso-cells (Fig. III. 1, 2). Each lasso-cell has the shape of a hemispherical cup, the convexity turned outwards and covered with minute sticky papillae. To the inner concave side are attached two filaments: the one an exceedingly fine central protoplasmic thread, in the upper part of which a much attenuated nucleus can generally be distinguished. The other is a contractile fibre thicker than the first, attached like it to the centre of the convex surface of the cup, and coiled in the first part of its course in a close spiral. Eventually the spiral thread tapers off into a fine filament, which, according to Chun, is attached to the muscle fibres forming the axis of the tentacle. The lasso-cells lie close together, forming a complete investment for the tentacle, with only very sparse interstitial tissue between. When any foreign body comes into contact with the tentacle, the lasso-cells adhere to it by their sticky convex surfaces, are withdrawn from the surface,

and the object is held fast by the spiral thread which remains attached to the tentacle.

According to Samassa, the lasso-cells are formed from two cell elements. The hemispherical cup is the product of a metamorphosed gland cell, the nucleus of which may often be distinguished in the convexity of the cup near the point of attachment of the spiral thread. The straight, thread-like filament and the spiral, contractile filament are formed from an elongate cell, which is apparently a metamorphosed interstitial cell. If Samassa's account is correct, it is obvious that there is no homology between the lasso-cell, composed as it is of two metamorphosed cells, and the nematocyst which is the entoplasmic product of a single cell.

All the Ctenophora are monoecious, the ova and spermatozoa being formed from the endodermic epithelium lining the sub-costal meridional canals. The ova are developed on one side, the spermatozoa on the other side of each canal. In the sub-sagittal canals the ova are borne on the sides nearest to the sagittal plane, in the sub-transverse canals they are borne on the sides nearest to the transverse plane. In *Pleurobrachia* and *Hormiphora*, as in the Cydippidae generally, the ovaries and spermaries are simply paired outgrowths from the walls of the meridional canals, and extend as two long bands throughout the entire length of each. As a rule, all the eight meridional canals bear gonads in the Ctenophora, but in *Euchlora rubra* and *Charistephane fugiens* the gonads are formed only in the four sub-transverse canals. In the Lobatae and Beroidae the gonads, whilst occupying the typical position, are somewhat modified in detail. In the former group the meridional canals are produced laterally to form diverticula underlying each comb. In *Eucharis multicornis* and *Bolina alata* the ova and spermatozoa are found in these diverticula only, but in *Deiopea* and *Bolina hydatina* the diverticula are sterile, the reproductive cells being confined to the sections of the meridional canals which lie between successive combs (Fig. III. 8 and 9). In the Beroidae the meridional canals are produced laterally into short, branched diverticula in which the sexual cells are developed (Fig. X.).

The ova in most cases are deposited singly and are fertilised in the sea-water. The breeding season in Northern seas lasts through the summer months, in the Mediterranean throughout the year. The ovum is centrolecithal, consisting of an inner vacuolated mass surrounded by a layer of granular protoplasm. It is enveloped by a vitelline membrane rather widely separated from the surface of the egg, the space between being filled with a gelatinous substance.

The most interesting feature in the development of the Ctenophora is the formation of a definite mesoblast. We owe this important discovery to Metschnikoff (18), whose observations

have been confirmed in all essential particulars by the unpublished researches of Mr. T. H. Riches. The segmentation is holoblastic. By three successive meridional cleavages the ovum is divided into eight blastomeres, in each of which the granular protoplasm is aggregated at one pole, the vacuolar deutoplasm at the other pole (Fig. IV. 2). By an equatorial division a portion of the granular protoplasm is next segmented off from the upper pole of each blastomere, the embryo now consisting of eight upper protoplasmic micromeres and eight large inferior macromeres (3). The succeeding divisions lead to increase of the number of micromeres which are formed partly by continued budding off of small cells from the four macromeres, partly by division of the eight micromeres first formed. When some thirty to fifty micromeres are present the macromeres cease to bud off fresh micromeres and themselves divide. Reference to Fig. IV. 4 shows that the eight macromeres are not all of equal size. There are four larger macromeres, median and inferior, and four smaller macromeres, lateral and superior. The median macromeres divide first, the lateral somewhat later, and this sequence is followed through the succeeding steps of development. In the next stage (6) the embryo is ring-shaped, consisting of a circlet of sixteen macromeres surrounding a central cavity widely open both above and below. On one aspect, which we may at once call the aboral aspect, the macromeres are covered over by the continually increasing cap of micromeres. The micromeres at this stage show a four-rayed symmetry, and on the aboral aspect they surround a cross-shaped opening, the pseudoblastopore, erroneously described by Chun (6) as the blastopore. The micromeres spread more and more over the surface of the macromeres and extend towards the lower surface. The next stage leads to the formation of the mesoblast. The nuclei of the sixteen macromeres, which at first were situated near the aboral pole, travel towards the opposite pole (7). The micromeres meanwhile have increased in number, the size of the pseudoblastopore is decreased, and there is at the lower pole a roughly quadrilateral area bounded by micromeres which is the true blastopore. Next follows a fresh division of the macromeres; first the eight median, later the eight lateral macromeres bud off each a small cell at the blastoporic pole, thus there is formed a median group of sixteen cells, which are the mesoblast. The three germ layers are now established. The micromeres form the epiblast, the macromeres the hypoblast, and the sixteen cells above mentioned are the mesoblast. Thus far the embryo has been formed by epibolic growth of the epiblast over the hypoblast. This is now succeeded by a process of embolism. The macromeres are rotated in such a manner that their previously lower ends face inwards, their previously upper ends face out-

wards. As a result of this change of position a central cavity, the enteron, is formed, and the mesoblast cells are carried

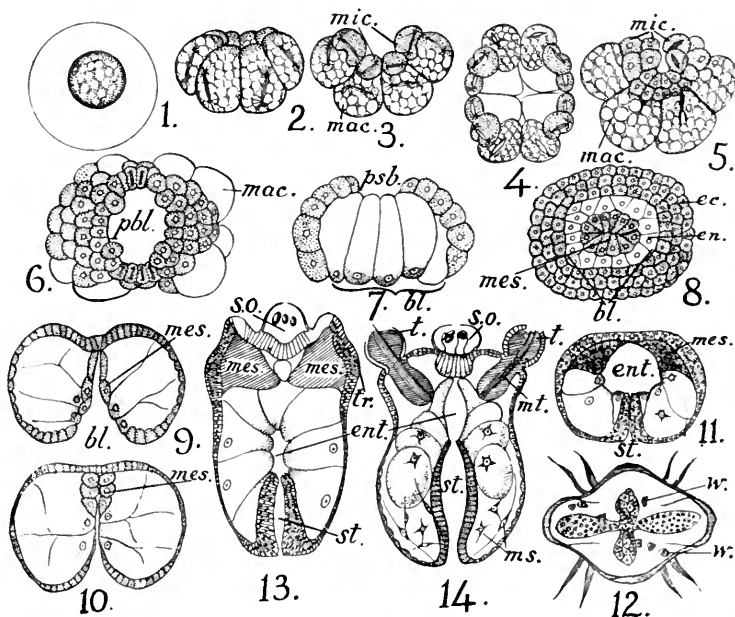

FIG. IV.—Development of *Callianira bialata* (after Metschnikoff).

- 1.—Ovum surrounded by the vitelline membrane.
- 2.—Stage with eight blastomeres.
- 3.—Side view of a stage with sixteen blastomeres, eight larger macromeres, *mac*, and eight smaller micromeres, *mic*.
- 4.—A similar stage viewed from above.
- 5.—Side view of a later stage; the micromeres have increased in number, and the macromeres are beginning to divide.
- 6.—Aboral surface of an older embryo. The micromeres form a four-rayed plate, covering the upper surfaces of the macromeres and surrounding a cross-shaped cavity, the pseudo-blastopore, *pbl*.
- 7.—Vertical section of the same embryo as the preceding, showing the large macromeres covered by the micromeres, except in the regions of blastopore, *bl*, and pseudo-blastopore, *psb*. The nuclei of the macromeres are now at the blastoporic pole.
- 8.—Oral surface of an older embryo. *bl*, blastopore; *mes*, mesoblast plate; *ec*, ectoderm; *en*, endoderm.
- 9.—Vertical section of an older embryo showing invagination. *mes*, mesoblast; the pseudo-blastopore is closed.
- 10.—An embryo somewhat older than 9.
- 11.—A later stage showing the stomodaeum, *st*, the enteron, *ent*, and the mesoblast, *mes*, which is spreading out as a plate on either side beneath ectodermic thickenings, which are the primordia of the tentacles.
- 12.—Aboral view of a somewhat later stage, showing the cross-shaped mesoblast plate. *w*, wandering cells of the mesoblast.
- 13.—Vertical section in the transverse plane of an embryo in the same stage as 12. *so*, sense organ; *mes*, mesoblast; *tr*, primordium of the tentacle; *ent*, enteron; *st*, stomodaeum.
- 14.—A later stage. *tt*, tentacles; *mt*, contractile muscles of the tentacles formed from the mesoblast; *ms*, mesenchymatous cells derived from the wandering cells of the mesoblast shown in 12.

upwards from the blastoporic towards the pseudo-blastoporic pole (9). According to Riches, the pseudo-blastopore is closed before

invagination by concrescence of the epiblast at the upper pole, and the embryo is now a gastrula (10). A secondary invagination of the ectoderm gives rise to a stomodaeum, and the mesoblast cells travel to the aboral pole and spread out beneath the ectoderm to form a plate of cells from which all the muscles of the body are eventually developed. The tentacles are first seen as thickenings of the ectoderm in the transverse plane, to which two plates of mesoblast attach themselves. The mesoblast plates extend not only in the transverse, but also in the sagittal plane, so that a cross-shaped figure is formed, the exact significance of which is not known (12). It is supposed by some that it is an indication of the existence of sagittal tentacles in the ancestral Ctenophore. The sense body is formed from an epiblastic thickening at the aboral pole. The further stages of development can be understood by reference to Fig. IV. 13, 14, and the reader is referred to Metschnikoff's and Chun's works for details.

All the Ctenophora reproduce themselves sexually. There is no alternation of generations. In the Cydippidae and Beroidae development is direct, but in the Lobatae and Cestidae there is a metamorphosis. The larvae of these forms are cydippiform and only gradually acquire their adult characters. In connection with this metamorphosis a peculiar sequence of juvenile fertility, adolescent sterility, and adult fertility has been observed in the Lobatae, and has been named by Chun, its discoverer, *Dissogony*. In the warm months the cydippiform larvae of *Eucharis multicornis* and *Bolina hydatina*, as soon as they have escaped from the egg membranes, and whilst they are only some $\cdot 5 - \cdot 2$ mm. in diameter, become sexually mature and develop ova and spermatozoa in the four sub-sagittal meridional canals. The ova are fertilised and give rise to fresh cydippiform larvae. In the parent larva, after a brief period of sexual activity, the gonads degenerate and a barren period succeeds, during which the larva goes through a complicated metamorphosis. At the end of the metamorphosis the animal, now much larger and indued with the full characters of a lobate Ctenophore, becomes a second time sexually mature, gonads being developed in all the eight meridional canals (see Chun, 8).

With few exceptions zoologists, since the time of Eschscholtz, have been agreed in ranking the Ctenophora as a class of the Coelentera, although much evidence has been brought forward of late years to show that they have decided affinities with Platyhelminthes, particularly with the Polyclada (see Lang, 17). The polyclad affinities of Ctenophora are regarded as tending to prove that the Polyclada are descended by way of the Ctenophora, or, at least, by way of a Ctenophore-like ancestor, from the Coelentera. Such an argument implies that the Ctenophora are indubitably Coelentera.

The characters of the Ctenophora which are relied on as evidence of their Coelenterate nature are as follows:—1. The existence of a gastrovascular system, and the absence of a separate body cavity or coelom. 2. The general shape and architecture of the body, its radial symmetry, and the existence of an abundant gelatinous material between the two primary layers—the ectoderm and endoderm. 3. The presence of tentacles, which are likened to those of a Medusa. 4. The position of the gonads, and the derivation of the sexual cells from the endoderm. 5. The existence of a sub-epithelial nerve plexus resembling that of Medusae. 6. The supposed homology between lasso-cells and nematocysts. 7. The absence of nephridia. In a more special manner it has been sought to compare the Ctenophore directly with a Medusa or with an Anthozoan zooid. Thus the general surface of the Ctenophoran body has been homologised with the exumbrellar surface of a Medusa; the stomodaeum with the sub-umbrellar cavity; the gelatinous mesoderm of the one with the mesogloea of the other; the gastrovascular canals with the radial canals; the Ctenophoran tentacles with the marginal tentacles of the Medusa. These homologies appeared at one time to be established beyond all cavil by the discovery of *Ctenaria ctenophora*, a Cladonemid Anthomedusa, described by Haeckel (12) as a form directly intermediate between the Hydromedusae and the Ctenophora.¹ *Ctenaria* (see Fig. V.) is an ovoid Anthomedusa, with a relatively small sub-umbrellar cavity, the aperture of which is still further diminished by the velum. The mouth opens at the end of a manubrium, and is surrounded by a circlet of sixteen oral tentacles. The gastral cavity is divided by a constriction into an upper and a lower moiety, the former of which is homologised with the infundibulum of Ctenophora. From the lower moiety four perradial gastrovascular canals are given off, each of which bifurcates to form two adradial canals. The eight adradial canals thus formed are connected round the margin of the umbrella by a ring canal. There are two perradial marginal filamentous tentacles beset with accessory filaments. At the base of each tentacle is a pocket-like cavity in the exumbrella, lined by batteries of nematocysts; it is doubtful whether the tentacles are retractile within these pouches. On the surface of the exumbrella are eight adradial meridional ridges, made up of nematocyst batteries. There is no apical sense organ, and the gonads are borne, as in all Anthomedusae, on the manubrium. The resemblance of *Ctenaria* to the Ctenophora is quite superficial. One has only to compare the eight nematocyst stripes of the one with the highly specialised ciliated costae of the other to see their

¹ "Eine neue höchst interessante pacifische Form, *Ctenaria ctenophora*, welche ich als eine unmittelbare Uebergangsform von Gemmaria-ähnlichen Anthomedusen zu Cydippe-ähnlichen Ctenophoren auffassen muss."

essential difference, and, for the rest of it, nematocysts do not occur in the Ctenophora.¹ The sub-umbrella cannot be compared either in its development or in its adult relations to a stomodaeum. There is a superficial resemblance between the gastro-vascular system of the two forms, but even if we pass over the absence of anything representing the manubrium and oral tentacles in Ctenophora, we find an essential difference in that the endoderm lamella, in which the radial canals of the Anthomedusan are

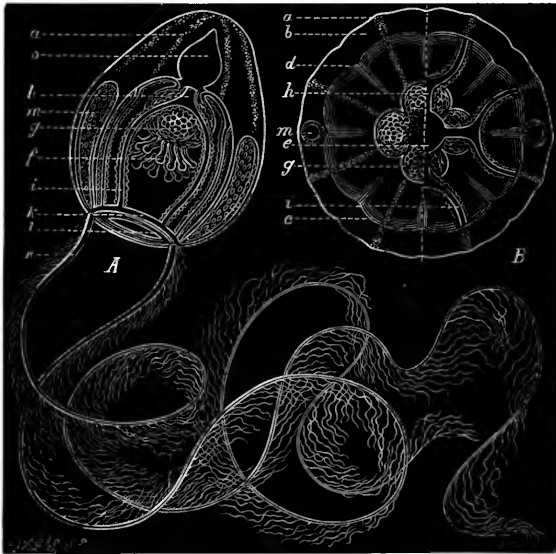

FIG. V.

Ctenaria ctenophora, Haeckel. A, side view; B, two horizontal views, that to the left representing the surface of the aboral hemisphere, that to the right a section passing nearly equatorially. *a*, the right adradial ridges of nematocysts; *b*, mesogloea of the umbrella; *c*, circular muscle of the umbrella; *d*, longitudinal muscles of the umbrella; *e*, the gastral cavity; *f*, the sixteen oral tentacles; *g*, the four perradial gonads borne on the manubrium; *h*, the four perradial gastrovascular canals; *i*, the eight adradial bifurcations of the preceding; *k*, ring canal at the umbrellar margin; *l*, velum; *m*, pocket-like cavities in the exumbrella situated at the bases of the tentacles and lined with nematocysts; *n*, the tentacles; *o*, the upper moiety of the gastral cavity, called by Haeckel the infundibulum.

hollowed out, is entirely unrepresented in the Ctenophora. Nor is there any ring canal in the latter group. The tentacles of *Ctenaria* are lined by endoderm, their musculature is epithelial; the tentacles of Ctenophora have a solid axial cord of muscular fibres derived from mesoblast. The sub-tentacular pouches of *Ctenaria* correspond neither in position nor in their relations to the tentacles to the tentacular sheaths of Ctenophores, and the existence of such nematocyst pouches, as well as the existence of only a single pair of perradial tentacles, is paralleled in other

¹ With one exception.

Medusae which are not endowed with superficial Ctenophore-like characters. The so-called infundibulum of *Ctenaria* proves to be a brood pouch similar to that in the allied *Eleutheria*, and the Medusa is devoid of any trace of the aboral sense organ so characteristic of the Ctenophore. The position of the gonads is also different in the two forms. The gelatinous tissue and the musculature of the Ctenophora are mesoblastic, in the Anthomedusan they are ectodermal in origin. Add to this the fact that the locomotion of the Ctenophora is essentially ciliary, that of the Medusae muscular, that the symmetry of the one group is radial, whilst in the other it is biradial, and it must be conceded that the Medusoid affinities of the Ctenophora are untenable.

A comparison of the Ctenophora with the Anthozoa offers more satisfactory grounds of homology. The ciliated ectoderm of the Anthozoa might possibly be the antecedent of the specialised ciliated bands which form the costae of the Ctenophora. The stomodaeum of the Ctenophora and Anthozoa may fairly be homologised. In both cases it is compressed in a plane which is known as the sagittal plane, and in both cases the gastrovascular system exhibits a biradial symmetry with regard to that plane. Further evidence is afforded by the comparison of developmental stages. In both the Anthozoa and the Ctenophora there is a stage in which the gut is produced into four saccular pouches, so that the embryo has a four-rayed symmetry. This condition, which is typical in the Ctenophora, is best seen in the young *Arochnactis* amongst the Anthozoa, but may also be distinguished in the larvae of Actinidae. It would be idle to deny the significance of these features, but it must be recollected that the Ctenophora have many features peculiar to themselves. The costae and their combs, though doubtless a specialisation of a primitively uniformly ciliated surface, are characteristic of Ctenophora; so is the aboral sense organ, to which there is no parallel in Anthozoa. The solid muscular tentacles of the Ctenophores cannot be homologised with the hollow tentacles of the Anthozoan. There is no epithelio-muscular system in Ctenophora, and the musculature differs both in origin and in structure from that of Anthozoa, and indeed all other Coelentera. The nematocysts so characteristic of Coelentera are replaced in Ctenophora by the lasso-cells, structures of an entirely different nature.

Finally, there are those who would question whether any animals possessing a mesoblast can properly be called Coelentera. The Coelentera, as originally defined by Leuckart, are animals in which there is no body cavity or coelom separate from the digestive cavity or enteron; the two being represented by a single cavity, the gastrovascular cavity or coelenteron. According to this definition the Ctenophora are certainly Coelentera. In

typical Coelentera one or other of the two primary layers, ectoderm or endoderm, retains the functions which in Coelomata are handed over to mesoblast. Hence we find epithelio-muscular cells derived chiefly from ectoderm in Hydrozoa, chiefly from endoderm in Anthozoa. The researches of Metschnikoff, confirmed by Samassa, have shown that a mesoblast is formed in the Ctenophora, that there is no epithelio-muscular system, but that the musculature is wholly derived from the mesoblast. At the same time it must be duly borne in mind that "mesoblast" is nothing more than an embryological segregation of those cells derived in Coelentera or Diploblastic animals from one or both of the primary germ layers which are in Coelomata destined to give rise to the coelom and the tissues of its walls. Greater weight must be attached to the presence of the gastrovascular system in Ctenophora than to the embryonic exhibition of "a mesoblast."

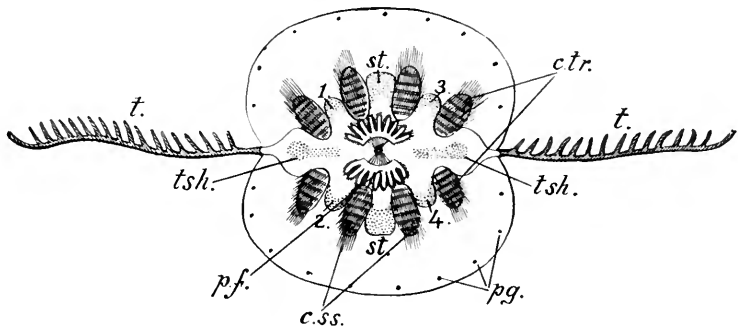

FIG. VI.

Ctenoplana Kowalevskii, Korotneff (after Willey). *tt*, tentacles; *tsh*, tentacle sheaths; *ctr*, sub-transverse costae; *c.ss*, sub-sagittal costae; *st*, "stomach" (? stomodaeum), 1, 2, 3, 4, the four principal lobes of the infundibulum; *pf*, sensory tentacles representing the polar fields; *pg*, pigment spots.

The affinities of the Ctenophora with the Polyclada remain to be considered. These affinities, first suggested by Selenka on embryological grounds, were rendered more probable by the discovery of *Coeloplana Metschnikoffii*, a form supposed to be intermediate between Planarians and Ctenophora, and were urged with considerable force by Lang (17). The discovery of *Ctenoplana Kowalevskii*, an animal allied to *Coeloplana*, by Korotneff (14) served to confirm this view.

Ctenoplana has recently been rediscovered by Willey (22), who has given a more exact account of its habits and anatomy than Korotneff was able to do. It is a Ctenophore, flattened so much that the principal axis joining mouth and sense organ is extremely short. Hence one can distinguish a dorsal or aboral

and a ventral or oral surface. It has eight very short ribs with the characteristic combs, which can be withdrawn into or evaginated from pouch-like cavities in the body wall. There is a single pair of pinnate tentacles retractile within tentacle sheaths; the tentacles are solid and muscular. In the centre of the aboral surface of the body is a sense organ, consisting of an otolith mass suspended by stiff cilia, and two crescentic rows of ciliated tentacles or papillae, which are evidently homologous with the polar fields, and recall the lappet-like processes of the edge of the polar fields of the Beroidae (Fig. X. *pf*). The mouth is circular and leads into a "stomach," which is compressed in the sagittal plane; it is not known whether the "stomach" is a stomodaeum. An infundibular vessel passes from the aboral end of the stomach towards the sense organ, which it embraces without opening to the exterior. From each of the two flattened sides of the stomach a narrow canal, lying in the transverse plane, leads into a pair of saccular lobes, and from these numerous diverticula are given off forming a peripheral canal system. These peripheral canals may be compared with the canals of the lobes of Lobatae. The testes are situated at the bases of the two saccular lobes at either end of the main transverse canal of the gastrovascular system, and they have ducts which open to the exterior just below the costae. The ovaries have not been observed. *Ctenoplana* either swims by means of its combs, or crawls on the bottom by its ventral surface. It can also attach itself, like a Planarian, ventral surface uppermost, to the surface film of the water. Its body is thickened in the transverse plane, and the sagittal margins are produced into two thin rounded lobes. In swimming the lobes are folded together like the leaves of a book. It should be noticed that the lobes of *Ctenoplana* correspond in position with those of the Lobatae. The ventral surface of *Ctenoplana* is ciliated, but, excepting for the costae and sensory tentacles, there are no cilia on the dorsal surface.

Unfortunately we have only a meagre account of the anatomy of *Coeloplana*. It appears, in general, to resemble *Ctenoplana*, but has no costae, and the whole surface of the body is uniformly ciliated. Both *Ctenoplana* and *Coeloplana* have been said to exhibit remarkable Planarian affinities because of their dorso-ventrally flattened bodies, their crawling habits, and the ciliation of the ectoderm, partial in the case of *Ctenoplana*, complete in the case of *Coeloplana*. Not much weight can be attached to these characters. Habit is a very insecure guide to affinity. One of the Cydippidae, *Lampetia pancerina*, crawls on its oral surface, everting the stomodaeum so as to form a broad creeping surface. The flattened bodies of *Ctenoplana* and *Coeloplana* are clearly correlated with the adoption of the creeping habit already foreshadowed in *Lampetia*.

A tendency towards dorso-ventral compression is not unknown in typical Ctenophora, for in *Deiopea* (Fig. VIII.) the main axis is considerably shortened and the sagittal axis lengthened by the development of the lobes. *Ctenoplana* is an undoubted Ctenophore modified as a result of the assumption of creeping habits. It still retains the power of swimming, and has not lost the typical Ctenophoran costae. *Coeloplana* is still more modified and has lost the costae. The features in which *Ctenoplana* differs most from Ctenophora are: the absence of meridional sub-costal canals, and as a consequence the development of gonads in a more proximal part of the gastrovascular system; the presence of genital ducts and the presence of a peripheral canal system, which, however, is paralleled in the Beroidae and Lobatae. Whilst there can be no

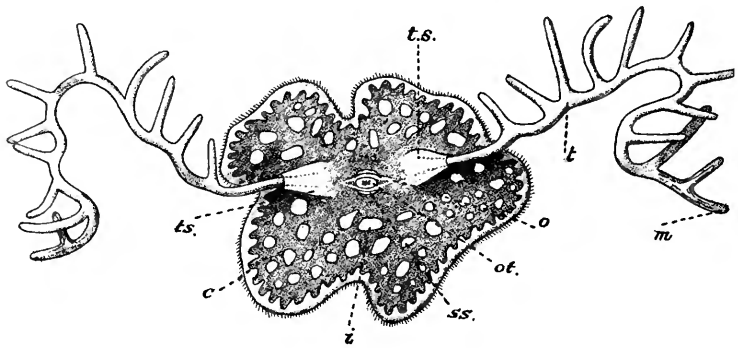

FIG. VII.

Coeloplana Metschnikowii (slightly altered from Kowalevsky). *o*, mouth; *d*, cavity of the digestive canal; *i*, islets of tissue; *c*, circular canal; *d'*, one of the four diverticula of the digestive canal; *ss*, caecal offsets of the digestive canal, terminating in crescentic enlargements about the otolith sac; *ot*, vesicle with a group of otoliths; *ts*, tentacle sheaths; *m*, muscular fibre of tentacles.

doubt that *Ctenoplana* is a Ctenophore, and not very distantly related to the other members of the group, it is a question whether it is a primitive or a much specialised form. Willey (22) is decidedly of the opinion that it is primitive. He sees in it the representative of the littoral ancestor from which both the pelagic Ctenophora and the Platyhelminthes have been derived. In point of fact we have no evidence as to whether *Ctenoplana* or *Coeloplana* are primitive or derived forms; such evidence can only be furnished by their development and larval history, which are unknown. If *Ctenoplana* should prove to have a cydippiform larva like the Cestidae and Lobatae, then there can be no doubt that it is a derived form; if it should prove to have a direct development without a metamorphosis, then the probability will be that it is a primitive form. In the present state of our knowledge it cannot be said that the existence of *Ctenoplana* and *Coeloplana* gives any

satisfactory evidence of the relationship of Platyhelminthes to Ctenophora, still less of the descent of the former group from the latter. The most that can be said is that *Ctenoplana* and *Coeloplana* afford an interesting suggestion as to how the Polyclada might conceivably have been derived from a Ctenophore-like ancestor. But whilst we decline to attach very much importance to the resemblance between *Ctenoplana* and the Polyclada, we cannot ignore other points of resemblance between the Ctenophora and the Platyhelminthes. The earlier stages of segmentation, the formation of the gastrula, the outgrowth of the primitive mesoderm cells into four mesodermal bands placed crosswise, and the formation of the mesenchymatous mesoderm from these bands, are features in which the young Polyclad resembles the young Ctenophore in a remarkable degree. The gelatinous mesoderm of Ctenophora, with its layers of longitudinal, transverse, and radiating branched muscle fibres, most nearly resembles the mesenchyme of Turbellarian worms, and the ciliated larvae of many Platyhelminthes, more particularly the *Pilidium* larva of Nemertines and the larva of *Stylochus pilidium*, with its uniform coat of cilia, its aboral sense organ, its stomodaeum or pharynx, and its enteron lined with endoderm cells, are most suggestive of the hypothetical ancestor from which both the Turbellaria and the Ctenophora may have originated. The conclusion is that the Turbellaria, the Nemertines, and the Ctenophora are descended from a common ancestor which is most nearly represented by the larva of *Stylochus*. Such an ancestor would be spherical or hemispherical in shape, would have an aboral sense organ consisting of a plate of thickened ectoderm provided with long stiff cilia. The line joining mouth and sense organ would be the chief axis of the body. The digestive tract would consist of a stomodaeum and a more or less spacious sacculated enteron, and would be surrounded by a mesenchymatous tissue consisting of a gelatinous matrix traversed by branched muscular fibres, derived from a special germ layer, the mesoblast. Such an ancestor would itself be a Coelenterate and have been derived from a Coelenterate ancestor, and very probably from a form resembling the early larvae of Actinians.

The Ctenophora are classified as follows :—

CLASS CTENOPHORA.

SUB-CLASS I. TENTACULATA. With tentacles.

ORDER I. *Cydippidea*, Lesson.

Ctenophora of spherical, cylindrical, or compressed form, with two simple or branched tentacles retractile within tentacular sheaths. The meridional and stomodaeal canals end blindly, and are not produced into a peripheral canal system.

BOLINIDAE. Sagittal lobes of moderate size; lobular canals simple; auricles short. Genera—*Bolina*, Mertens; *Bolinopsis*, L. Agassiz; *Hapalia*, Eschscholtz. **FAMILY 3. DEIOPEIDAE.** Body much compressed; lobes of moderate size, with lobular vessels more complicated than in Bolinidae; auricles short; costae comprise very few, but very broad combs. Genus—*Deiopea*, Chun. **FAMILY 4. EURHAMPHAEIDAE.** Two wing-like projections at the aboral pole in which the sub-tentacular costae and meridional vessels are produced. Genus—*Eurhamphaea*, Gegenbauer. **FAMILY 5. EUCHARIDAE.** Lobes large, with complex lobular canals; body covered with elongate touch-papillae; a main tentacular filament present, as well as accessory filaments; above the tentacle bases are a pair of openings which lead into elongate blind sacs lying in the sagittal plane and ending blindly in the neighbourhood of the infundibulum. Genus—*Eucharis*, Eschscholtz. **FAMILY 6. MNEMIDAE.** Lobes large; the lobes and auricles spring from near the level of the infundibulum; auricles long and ribbon-like. Genera—*Mnemia*, Eschscholtz; *Alcinoe*,

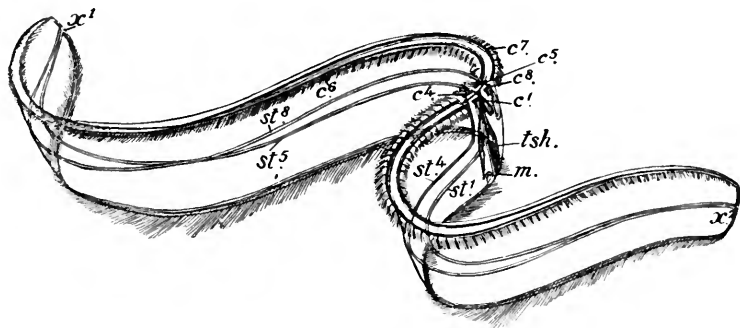

FIG. IX.

Cestus veneris, Lesueur. *m.*, mouth; *tsh.*, tentacle sheath; *c1*, *c4*, *c5*, *c6*, the four rudimentary sub-transverse costae; *c2*, *c3*, *c6*, *c7*, the four large sub-sagittal costae; *st1*, *st4*, *st5*, *st8*, the four sub-transverse, meridional canals which communicate at *x1*, *x2*, with the sub-sagittal canals.

Rang.; *Mnemiopsis*, L. Agassiz. **FAMILY 7. CALYMMIDAE.** Body much compressed; lobes large, springing from the level of the infundibulum; costae nearly horizontal. Genus—*Calymma*, Eschscholtz. **FAMILY 8. OCYROIDAE.** Lobes of great length, with relatively small attachments to the body; costae horizontal. Genus—*Ocyroë*, Rang.

ORDER 3. Cestoidea, Lesson.

Ctenophora so much compressed in the infundibular plane as to be band-like. The sub-sagittal costae extend over the whole length of the aboral surface; the sub-transverse costae rudimentary. The sub-transverse meridional canals run down the middle of the band-like body and unite with the ends of the long sub-sagittal and stomodæal canals. Tentacle sheath and tentacle basis present, but no main tentacle; accessory tentacles lie in four tentacular grooves which extend, on the oral surface, from the mouth to the extremities of the band-like body. Gonads developed only in the sub-sagittal canals. **FAMILY CESTIDAE.** Genera—*Cestus*, Lesueur; *Vexillum*, Fol.

ORDER 4. *Platyctenea*.

Ctenophora of creeping habit ; the body flattened in the principal axis so that a dorsal can be distinguished from a ventral surface. No meridional sub-costal canals, but a system of anastomosing peripheral vessels. Costae, when present, retractile within ectodermal pouches. Genera—*Ctenoplana*, Korotneff, costae present ; *Coeloplana*, Kowalevsky, costae absent ; the whole surface ciliated.

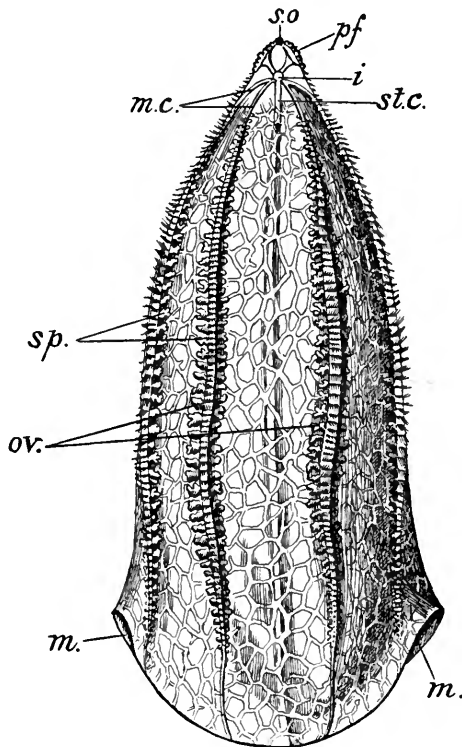

FIG. X.

Beroë Forskalii, Chun, from the sagittal aspect. *m*, mouth ; *i*, infundibulum ; *so*, sense organ ; *pf*, papilliform processes of the polar fields ; *st.c.*, stomodaeal canal ; *m.c.*, meridional canals ; *ov.*, ovaries ; *sp.*, spermaries. The peripheral canal system is seen extending over the entire surface.

SUB-CLASS 2. NUDA. Tentacles absent.

ORDER *Beroidea*, Lesson.

FAMILY BEROIDAE. Elongate, conical, or ovoid Ctenophora compressed in the infundibular plane, with wide mouth and spacious stomodaeum. The otolith mass is uncovered, the polar fields surrounded by

branched papillae. Tentacles and tentacle sheaths absent. The meridional canals unite with the stomodæal canals in the region of the mouth and send out diverticula, which anastomose to form a peripheral network of canals extending all over the body. Genus—*Beroë*, Brown.

LITERATURE OF THE CTENOPHORA.

1. *Agassiz, A.* Mem. Amer. Acad. Arts and Sciences, x. 1874, p. 357. (Embryology.)
2. *Ibid.* Illust. Catal. Mus. Comp. Anat. Harvard, ii., North American Acalephæ, 1865.
3. *Agassiz, L.* Mem. Amer. Acad. Arts and Sciences, iv. 1850, p. 313. (Beroïd Medusæ of Massachusetts.)
4. *Allman, J.* Edinburgh New Philosophical Journal, N.S. xv. 1862, p. 285.
5. *Bethe, A.* Biologisches Centralblatt, xv. 1895, p. 140. (Sub-epithelial Nerve Plexus.)
6. *Chun, C.* Die Ctenophoren des Golfes von Neapel. Fauna und Flora des Golfes von Neapel, vol. i. 1880.
7. *Ibid.* Bronn's Thier-reichs, Bd. ii. Abth. 2, Coclenterata, 1889-1892, p. 139.
8. *Ibid.* Festschrift zum 70^{ten} Geburtstage Rudolf Leuckarts, 1892, p. 77. (Dissogony.)
9. *Claus, C.* Arbeit. Zool. Inst. Wien. vii. 1886, p. 23. (*Deiopea*, Symmetry of Ctenophora.)
10. *Eschscholtz, Fr.* System der Acalephen. Berlin, 1829.
11. *Gegenbauer, C.* Arch. f. Naturgeschichte, Jahrg. 22, Bd. i. 1856, p. 162.
12. *Haeckel, E.* Sitz. der Jenaischen Gesellsch. f. Med. u. Naturwiss. Jahrg. 1879, p. 70.
13. *Hertwig, R.* Jenaische Zeitschrift, xiv. 1880, p. 313. (Anatomy and Histology.)
14. *Korotneff, A.* Zeit. Wiss. Zool. xliii. 1886, p. 242. (*Ctenoplana*.)
15. *Kowalevsky, A.* Mem. Acad. St. Pétersbourg, Sér. 7, tome x. 1866. (Development.)
16. *Ibid.* Zool. Anzeiger, 1880, p. 140. (*Coeloplana*.)
17. *Lang, A.* Die Polycladen. Fauna u. Flora Neapel, xi. 1884.
18. *Metschnikoff, E.* Zeit. Wiss. Zool. xlii. 1885, p. 648. (Development.)
19. *Mertens, H.* Mem. Acad. St. Pétersbourg, Sér. 6, tome ii. 1833, p. 479.
20. *Rang.* Mem. Soc. Nat. Hist. Paris, iv. 1828, p. 168.
21. *Samassa, P.* Arch. Mikros. Anatomie, xl. 1892, p. 157. (Histology.)
22. *Willey, A.* Quart. Jour. Micr. Sci. xxxix. 1896, p. 323. (*Ctenoplana*.)

INDEX

To names of Classes, Orders, Sub-Orders, and Genera ; to technical terms ; and to names of Authors discussed in the text.

- aboral pole, 2
 Actinians, 19
 Agassiz, A., 2
 Agassiz, L., 2
Alcinoë, 21
 Allman, 2
 ampullae, 4
 Anthomedusae, 13
 Anthozoa, 15
Arachnactis, 15
 axis, 2

 balancers, 5
 balancing organ, 6
Beroë, 23
Beroidea, 6, 22
 Bethe, 5
 blastopore, 10
Bolina, 9, 12, 21
Bolinidae, 21
Bolinopsis, 21
 breeding season, 9
 Brown, P., 1

Callianira, 20
Callianirinae, 20
Calymma, 21
Calymmnidae, 21
Cestidae, 6, 21
Cestoidea, 21
Cestus, 21
 Chamisso, 2
Charistephane, 9, 20
 Chun, 2, 8, 10, 12
 Coelentera, 12, 16
Coeloplana, 16-19, 22
 combs, 2, 6, 17
 costae, 2, 6
Ctenaria, 13, 14
 ctenes, 2
Ctenoplana, 16-19, 22
Cydippidae, 6
Cydippidea, 19

Deiopea, 9, 17, 21
Deiopeidae, 21
 development, 9-12
Dissogony, 12

Eleutheria, 15
 embole, 10
 embryo, 10
 enteron, 4, 19
 eolidiform appendages, 8
 epiblast, 10
 epithelium, 8
 Eschscholtz, 2
Eucharidae, 21
Eucharis, 9, 12, 21
Euchlora, 9, 20
Euplokamis, 20
Euramphaea, 21
Euramphaeidae, 21
 excretory pores, 4

 Fol, 2

 Gaimard, 2
 gastrovascular canals, 4
 — cavity, 15
 gastrula, 12
 Gegenbauer, 2
 gelatinous matrix, 8
 gland cells, 8
 gonads, 4, 9

 Haeckel, E., 13
Hapalia, 21
 Hertwig, R., 5
 histology, 8
Hormiphora, 2, 20
 hypoblast, 10

Infundibulum, 2
 interstitial tissue, 8

 Kölliker, 2

 Korotneff, 16
 Kowalevsky, 2

Lampetia, 17, 20
 Lang, A., 12, 16
 larvae, 12
 lasso-cells, 8
 Lesueur, 2
Lesueuria, 20
Lesueviridae, 20
 Leuckart, 2, 15
Lobatae, 6, 20
 locomotion, 6
Lophoctenia, 20

 macromeres, 10
 Martens, F., 1
 Medusae, 13
Mertensidae, 20
Mertensinae, 20
 mesenchyme, 19
 mesoblast, 9, 10
 metamorphosis, 12
 Metschnikoff, 2, 9, 16
 micromeres, 10
Mnemia, 21
Mnemiidae, 21
Mnemiopsis, 21
 mouth, 2
 musculature, 8

 Nemertines, 19
 nephridia, 13
 nerve stimuli, paths of, 6
 nervous system, 5
Nuda, 22

Ocyroë, 21
Ocyroidae, 21
 oral pole, 2
 otoliths, 5
 ova, 9

- | | | |
|---|---|---|
| Peron, 2
Pilidium, 19
Planarians, 16
<i>Platyctenea</i> , 22
Platyhelminthes, 12, 18, 19
<i>Pleurobrachia</i> , 2, 20
<i>Pleurobrachiidae</i> , 20
polar fields, 5
Polyclada, 12, 16, 19
pseudoblastopore, 10

Quoy, 2

ribs, 2, 17
Riches, T. H., 10, 11 | sagittal plane, 3
Samassa, 5, 6, 8, 9, 16
Selenka, 16
sense organ, 2, 4, 6, 12
spermatozoa, 9
stomach, in <i>Coeloplana</i> , 17
stomodaeum, 2, 12, 19
Stylochus, 19
sub-costal canals, 4
sub-sagittal canals, 4
— organs, 3
sub-transverse canals, 4
— organs, 3

tentacle sheath, 7 | tentacle stem, 7
tentacles, 2, 6, 12
tentacular base, 6
— filaments, 8
— plane, 3
<i>Tentaculata</i> , 19
transverse plane, 3
— vessels, 4
Turbellaria, 19

<i>Vexillum</i> , 21
<i>Volvox</i> , 1

Willey, 16, 18 |
|---|---|---|

