



3 1761 07547020 3

USEFUL DATA

CORRUGATED BAR COMPANY, INC.

BUFFALO



A. E. Nourse
Jan. 1920

1205



USEFUL DATA

ON

REINFORCED CONCRETE BUILDINGS

FOR THE

DESIGNER AND ESTIMATOR

BY THE

ENGINEERING STAFF

OF THE

CORRUGATED BAR COMPANY, INC.



PRICE, \$2.50

CORRUGATED BAR COMPANY, INC.

1) BUFFALO, N. Y.

2) 1919

Copyright, 1919, by
CORRUGATED BAR COMPANY, INC.
BUFFALO, N. Y.



PREFACE

FOR more than 25 years we have been engaged in the design and development of reinforced concrete construction. During this period we have had occasion to publish technical data from time to time of interest to the engineer, the architect and the contractor. As a result of these publications we find there is a growing demand for a compilation of data relating to the design of reinforced concrete buildings. A number of comprehensive treatises have been published to meet this demand, but they deal generally with method and theory of design rather than with quantitative results.

It is not intended, nor is it expected, that this handbook can take the place of any of the excellent textbooks on concrete design or replace the services of the designing engineer. It is hoped that it will supplement the works of reference and as far as possible eliminate the manual labor involved in the repeated application of formulas and diagrams to the determination of the dimensions of a structure. It is the further aim of the book to give under one cover all of the data needed by the busy engineer or estimator in meeting the everyday problems in concrete building design, or briefly to place in his hands designing information that in a measure parallels the familiar handbook of the structural steel manufacturer.

Until such time as a national building code may be adopted, there will be recognized the impossibility of preparing a thoroughly satisfactory set of reinforced concrete standards so that we have of necessity confined ourselves to stress combinations most widely accepted and within these limits to give a satisfactory range of working values,—values that give the “answer,” without further resort to calculation, when the conditions of the problem are known.

Several of the more comprehensive publications on reinforced concrete contain some excellent diagrams that greatly facilitate the designer's work. A few of these diagrams have been incorporated in the present volume and due acknowledgment for their use is hereby made to the work of Messrs. Turneure & Maurer entitled “Principles of Reinforced Concrete Construction” and to “Reinforced Concrete Construction,” by George A. Hool, S. B., Professor of Structural Engineering, University of Wisconsin. Further acknowledgment is also made to those members of our organization who so ably assisted in the compilation of the data and to their efforts is due what measure of success may attend the publication of this volume.

CORRUGATED BAR COMPANY, INC.

Buffalo, N. Y., March 15, 1919.

1877

The first part of the report is devoted to a general
 description of the country and its resources. It
 is followed by a detailed account of the
 various industries and occupations of the
 people. The third part of the report
 contains a list of the principal towns and
 villages, with a description of each. The
 fourth part of the report is a list of the
 principal rivers and streams, with a
 description of each. The fifth part of the
 report is a list of the principal mountains
 and hills, with a description of each. The
 sixth part of the report is a list of the
 principal lakes and ponds, with a
 description of each. The seventh part of
 the report is a list of the principal
 forests, with a description of each. The
 eighth part of the report is a list of the
 principal minerals, with a description of
 each. The ninth part of the report is a
 list of the principal animals, with a
 description of each. The tenth part of the
 report is a list of the principal plants, with
 a description of each. The eleventh part of
 the report is a list of the principal
 birds, with a description of each. The
 twelfth part of the report is a list of the
 principal insects, with a description of each.

FORMULAS FOR REINFORCED CONCRETE DESIGN

It is recognized by all authorities on the design of reinforced concrete structures, that the common theory of flexure does not apply for wide ranges of stress. For stresses in excess of those commonly used in design the relation between stress and deformation is not uniform and this divergence becomes more pronounced as the stress increases. Under these conditions the parabola is the curve which most nearly expresses the relation between stress and deformation and is the relation which should be used in the discussion of experimental or test data to obtain accuracy of results.

In the design of structures, however, the stresses used are low, a condition for which it can safely be assumed that the deformation of any compression fibre in a beam is proportional to its distance from the neutral axis. The error in this assumption is small and is on the side of safety.

The formulas which follow are for working loads and assume a straight line variation of stress to deformation of concrete in compression. Tension in the concrete is neglected.

*STANDARD NOTATION

(a) Rectangular Beams.

The following notation is recommended:

f_s = tensile unit stress in steel.

f_c = compressive unit stress in concrete.

E_s = modulus of elasticity of steel.

E_c = modulus of elasticity of concrete.

$$n = \frac{E_s}{E_c}$$

M = moment of resistance, or bending moment in general.

A_s = steel area.

b = breadth of beam.

d = depth of beam to center of steel.

k = ratio of depth of neutral axis to depth d .

z = depth below top to resultant of the compressive stresses.

j = ratio of lever arm of resisting couple to depth d .

jd = $d - z$ = arm of resisting couple.

$$p = \text{steel ratio} = \frac{A_s}{bd}$$

(b) T-Beams.

b = width of flange.

b' = width of stem.

t = thickness of flange.

(c) Beams Reinforced for Compression.

A' = area of compressive steel.

p' = steel ratio for compressive steel.

f_s' = compressive unit stress in steel.

C = total compressive stress in concrete.

* From: Transactions of Am. Soc. of C. E. Vol. LXXXI, December, 1917.

- C' = total compressive stress in steel.
 d' = depth to center of compressive steel.
 z = depth to resultant of C and C' .

(d) **Shear, Bond and Web Reinforcement.**

- V = total shear.
 V' = total shear producing stress in reinforcement.
 v = shearing unit stress.
 u = bond stress per unit area of bar.
 o = circumference or perimeter of bar.
 Σo = sum of the perimeters of all bars.
 T_s = total stress in single reinforcing member.
 s = Horizontal spacing of reinforcing members.

(e) **Columns.**

- A = total net area.
 A_s = area of longitudinal steel.
 A_c = area of concrete.
 P = total safe load.

FORMULAS

(a) **Rectangular Beams.**

Position of neutral axis,

$$k = \sqrt{2pn + (pn)^2} - pn. \quad (1)$$

Arm of resisting couple,

$$j = 1 - \frac{1}{3}k. \quad (2)$$

[For $f_s = 15,000$ to $16,000$ and $f_c = 600$ to 650 , j may be taken at $\frac{7}{8}$.]

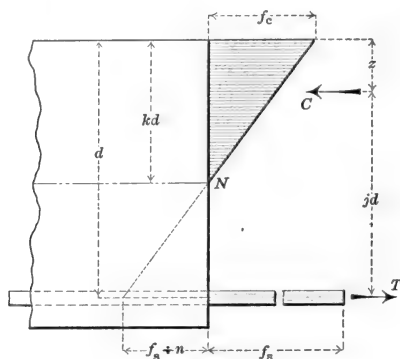

FIG. 1.

Fiber stresses,

$$f_s = \frac{M}{A_s j d} = \frac{M}{p j b d^2} \quad (3)$$

$$f_c = \frac{2M}{j k b d^2} = \frac{2p f_s}{k} \quad (4)$$

Steel ratio, for balanced reinforcement,

$$p = \frac{1}{2} \frac{1}{\frac{f_s}{f_c} \left(\frac{f_s}{n f_c} + 1 \right)} \quad (5)$$

(b) T-Beams.

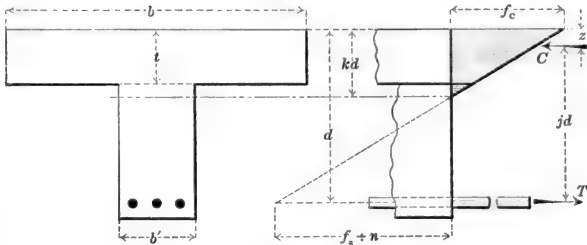

FIG. 2.

Case I. When the neutral axis lies in the flange, use the formulas for rectangular beams.

Case II. When the neutral axis lies in the stem.

The following formulas neglect the compression in the stem.

Position of neutral axis,

$$kd = \frac{2ndA_s + bt^2}{2nA_s + 2bt} \quad (6)$$

Position of resultant compression,

$$z = \frac{3kd - 2t}{2kd - t} \cdot \frac{t}{3} \quad (7)$$

Arm of resisting couple,

$$jd = d - z. \quad (8)$$

Fiber stresses,

$$f_s = \frac{M}{A_s jd} \quad (9)$$

$$f_c = \frac{Mkd}{bt \left(kd - \frac{1}{2}t \right) jd} = \frac{f_s}{n} \cdot \frac{k}{1-k} \quad (10)$$

(For approximate results the formulas for rectangular beams may be used.)

The following formulas take into account the compression in the stem; they are recommended where the flange is small compared with the stem:

Position of neutral axis,

$$kd = \sqrt{\frac{2ndA_s + (b-b')t^2}{b'} + \left(\frac{nA_s + (b-b')t}{b'} \right)^2} - \frac{nA_s + (b-b')t}{b'} \quad (11)$$

Position of resultant compression,

$$z = \frac{\left(kdt^2 - \frac{2}{3}t^3 \right) b + \left[(kd-t)^2 \left(t + \frac{1}{3}(kd-t) \right) \right] b'}{t(2kd-t)b + (kd-t)^2 b'} \quad (12)$$

Arm of resisting couple,

$$jd = d - z \quad (13)$$

Fiber stresses,

$$f_s = \frac{M}{A_s jd} \quad (14)$$

$$f_c = \frac{2Mkd}{[(2kd - t)bt + (kd - t)^2 b']jd} \quad (15)$$

(c) Beams Reinforced for Compression.

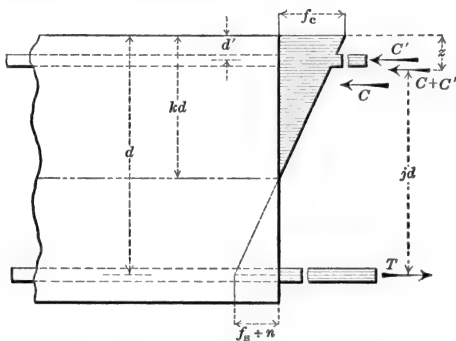

FIG. 3.

Position of neutral axis,

$$k = \sqrt{2n \left(p + p' \frac{d'}{d} \right) + n^2 (p + p')^2} - n(p + p') \quad (16)$$

Position of resultant compression,

$$z = \frac{\frac{1}{3}k^3d + 2p'nd' \left(k - \frac{d'}{d} \right)}{k^2 + 2p'n \left(k - \frac{d'}{d} \right)} \quad (17)$$

Arm of resisting couple,

$$jd = d - z \quad (18)$$

Fiber stresses,

$$f_c = \frac{6M}{bd^2 \left[3k - k^2 + \frac{6p'n}{k} \left(k - \frac{d'}{d} \right) \left(1 - \frac{d'}{d} \right) \right]} \quad (19)$$

$$f_s = \frac{M}{pjbd^2} = nf_c \frac{1-k}{k} \quad (20)$$

$$f_s' = nf_c \frac{k - \frac{d'}{d}}{k} \quad (21)$$

(d) Shear, Bond, and Web Reinforcement.

For rectangular beams,

$$v = \frac{V}{bjd} \quad (22)$$

$$u = \frac{V}{jd \cdot \Sigma o} \quad (23)$$

(For approximate results j may be taken at $\frac{7}{8}$.)

The stresses in web reinforcement may be estimated by means of the following formulas:

Vertical web reinforcement,

$$T_s = \frac{V's}{jd} \quad (24)$$

Bars bent up at angles between 20 and 45 deg. with the horizontal and web members inclined at 45 deg.,

$$T_s = \frac{3 V's}{4 jd} \quad (25)$$

In the text of the report it is recommended that two-thirds of the external vertical shear (total shear) at any section be taken as the amount of total shear producing stress in the web reinforcement. V' therefore equals two-thirds of V .

The same formulas apply to beams reinforced for compression as regards shear and bond stress for tensile steel.

For T-Beams,

$$v = \frac{V}{b'jd} \quad (26)$$

$$u = \frac{V}{jd \cdot \Sigma o} \quad (27)$$

[For approximate results j may be taken at $\frac{7}{8}$.]

(e) Columns.

Total safe load,

$$P = f_c(A_o + nA_s) = f_c A [1 + (n-1)p] \quad (28)$$

Unit stresses,

$$f_o = \frac{P}{A[1 + (n-1)p]} \quad (29)$$

$$f_s = n f_o \quad (30)$$

EXPLANATION OF THE USE OF DESIGNING DIAGRAMS

Rectangular beams or slabs, reinforced for tension only, may readily be designed by the aid of Diagram 1, page 16. This diagram assumes a value for E_c of 2,000,000 or $n=15$, which is recommended for the design of beams and slabs.

Example 1.—Given a beam having a span of 24 ft. simply supported, to carry a load of 4,000 lb. per ft. including estimated dead load; $f_c=650$, $f_s=16,000$, $E_c=2,000,000$, $n=15$. Determine size of beam required.

$$M = \frac{(4,000)(24)(24)}{8} = 288,000 \text{ ft. lb.} = 3,456,000 \text{ in. lb.}$$

On Diagram 1, page 16, find the intersection of curves for $f_s=16,000$ and $f_c=650$ and read $K = \frac{M}{bd^2} = 107.5$ and $p = 0.77\% = 0.0077$

$$bd^2 = \frac{M}{K} = \frac{3,456,000}{107.5} = 32,150$$

Assuming $b=24$ in., $d = \sqrt{\frac{M}{bK}} = \sqrt{\frac{3,456,000}{(24)(107.5)}} = 36.6$

$$A_s = pbd = (0.0077)(24)(36.6) = 6.76 \text{ sq. in.}$$

It will be noted that by selecting a value for either b or d the problem may be completely solved. This selection may be governed by the relative cost of steel and concrete or may be limited by clearance.

Care should always be taken to ascertain if the section selected to resist bending moment is satisfactory in shear. In the example:

$$V = \frac{(4,000)(24)}{2} = 48,000 \text{ lb.}$$

$$v = \frac{V}{bjd} = \frac{48,000}{(24)\left(\frac{7}{8}\right)(36.6)} = 62.5 \text{ lb. per sq. in.}$$

It will be noted that j has been taken as $\frac{7}{8}$, which is sufficiently close when used in calculations for bond and shear stresses. The result indicates web reinforcement would be required, for a limit of 40 lb. per sq. in. shear on the concrete.

Example 2.—Given a beam of 20 ft. span having fixed ends and carrying a total load of 1,000 lb. per ft.; $b=10$ in., $d=18$ in., $A_s=2.20$ sq. in. and $n=15$. Find f_s , f_c , j and k .

$$M = \frac{(1,000)(20)(20)(12)}{12} = 400,000 \text{ in. lb.}$$

$$K = \frac{M}{bd^2} = \frac{400,000}{(10)(18)(18)} = 123.5$$

$$p = \frac{A_s}{bd} = \frac{2.20}{(10)(18)} = 0.0122$$

On Diagram 1 find the intersection of $K=123.5$ and $p=1.22$ and read $f_s=11,900$, $f_c=650$. On the upper portion of the diagram for $p=1.22$ find $j=0.846$ and $k=0.452$.

T-Beams. In the design and investigation of T-beams Diagrams 2, 3 and 4, pages 17, 18 and 19 will be found useful. These diagrams apply only when the neutral axis falls below the under side of the flange of the T-beam. When the neutral axis falls above, the diagrams for rectangular beams apply.

Diagram 2 can be used only when the area of steel is such that f_s is 16,000 and Diagram 3 when f_s is 18,000. From these diagrams, for any assumed value of d and for fixed values of M , t and b , we may obtain j for determining the steel area required and also the value of f_c . If f_c is fixed, knowing M and t , we may find the value of b or d , by assuming one of them, and obtain the corresponding steel area. It should be borne in mind that b must not exceed code or specification limits.

Diagram 4 gives values of k and j for T-beams and is useful in checking steel and concrete stresses, the dimensions and reinforcement being known.

Example 1. Given a T-beam having a span of 24 feet, freely supported, to carry a total load of 2,000 lb. per foot, $t=5$ in., $b=30$ in., $f_s=16,000$, $f_c=650$, $n=15$, $v=120$.

$$M = \frac{(2,000)(24)(24)(12)}{8} = 1,728,000 \text{ in. lb.}$$

$$V = \frac{(2,000)(24)}{2} = 24,000 \text{ lb.}$$

Assuming a width of stem of 10 in. we find from shear considerations,

$$d = \frac{V}{vjb'} = \frac{24,000}{(120)\left(\frac{7}{8}\right)(10)} = 22.85 \text{ in.}$$

$$\text{then } \frac{t}{d} = \frac{5}{22.85} = 0.219$$

From Diagram 2 trace upward from the value of $\frac{t}{d}=0.219$ to intersection with the curve for $f_c=650$ and read $\frac{M}{bd^2}=92.0$. Substituting for M and d the values given above we find

$$\frac{1,728,000}{(b)(22.85)(22.85)} = 92.0$$

$$b = 35.8 \text{ in.}$$

This exceeds the fixed dimension of 30 in. for b so that it becomes necessary to assume a new value for d . Try $d=26$ in.

$$\text{then } \frac{t}{d} = 0.192$$

and from Diagram 2

$$\frac{M}{bd^2} = 86.0$$

$$b = 29.7 \text{ in.}$$

This value is sufficiently close so as to require no further revision.

To find the area of steel required first obtain j from the right-hand side of Diagram 2 by tracing upward from $f_c=650$ to intersection of $\frac{M}{bd^2} = 86.0$ and read $j=0.913$

$$\text{then } A_s = \frac{M}{jdf_s} = \frac{1,728,000}{(0.913)(26)(16,000)} = 4.55 \text{ sq. in.}$$

Example 2. Given a T-beam of 20 ft. span, ends freely supported, $t=4$ in., $d=20$ in., $b=30$ in., $A_s=4.0$ sq. in. Find the total load per foot this beam will carry when $n=15$ and f_s and f_c are not to exceed 16,000 and 650 pounds per square inch, respectively,

$$p = \frac{A_s}{bd} = \frac{4.0}{(20)(30)} = 0.00667 = 0.667\%$$

$$\frac{t}{d} = \frac{4}{20} = 0.2$$

On the left of Diagram 4 from the intersection of $\frac{t}{d}=0.2$ and $p=0.667\%$ read $k=0.40$ and on the right from the intersection of $p=0.667\%$ and $k=0.40$ read $j=0.912$
 $M_s = A_s f_s j d = (4.0)(16,000)(0.912)(20) = 1,167,360 \text{ in. lb.}$

$$\begin{aligned} M_o &= f_c \left(1 - \frac{t}{2kd}\right) b t j d \\ &= 650 \left(1 - \frac{4}{(2)(0.40)(20)}\right) (30)(4)(0.912)(20) = 1,067,040 \text{ in. lb.} \end{aligned}$$

The resisting moment of the concrete, being less than that of the steel, will govern the carrying capacity of the beam. Equating the external moment ($M = \frac{1}{8} w l^2$) in inch pounds to the resisting moment of the concrete and solving for w we find

$$w = \frac{8M}{l^2} = \frac{(8)(1,067,040)}{(12)(20)(20)} = 1,778 \text{ lb. per ft.}$$

Beams Reinforced for Compression. It is sometimes desirable or necessary to place reinforcement in the compression side of a beam in order to maintain the concrete stress within safe limits. Continuous beams of T section are frequently deficient in concrete area at the supports, where due to the reversal of moment, the stem is in compression. When the stress in the concrete at this point exceeds that specified, the straight bars in the bottom of the beam may be carried through the support and utilized as compressive reinforcement.

A continuous T-beam has the following dimensions:

$$t = 6 \text{ in.}, b = 30 \text{ in.}, d = 34 \text{ in.}, b' = 14 \text{ in.}$$

The negative moment is 2,400,000 in. lb. It will be assumed that the working stress in the concrete at the center of the beam is 650 pounds per square inch which may be increased 15% at the support, in accordance with recommendations of the Joint Committee, so that the value at this point is 747 pounds per square inch, steel stress 16,000 pounds per square inch. Determine the amount of compression steel required.

In the top for tension,

$$A_s = \frac{2,400,000}{(16,000) \left(\frac{7}{8}\right) (34)} = 5.04 \text{ sq. in.}$$

$$K = \frac{M}{bd^2} = \frac{2,400,000}{(14)(34)(34)} = 148$$

Entering Diagram 1 with $K=148$, we find, for $f_s=16,000$, that $f_c=805$. The reduc-

tion of f_c to 747 will then be $\frac{805 - 747}{747} = 7.76\%$. Entering Diagram 5, on the left margin, with 7.76 and moving to the right to the "concrete curve," thence downward, the amount of compressive steel to effect the reduction in f_c is found to be 0.20% or $(14)(34)(0.002) = 0.95$ sq. in.

Combined Bending and Direct Stress. In the design of columns, arch rings, etc., the resultant of the external forces does not always coincide with the center of gravity of the cross section of the member. In such cases consideration must be given to the combined action of bending and direct stress. For reinforced concrete members the general formula for extreme fibre stress where compression exists over the entire section, is

$$f_c = \frac{W}{A + (n-1) p_o A} + \frac{My}{I_o + n I_s}$$

W = Total direct load.

$$p_o = \text{Percentage of reinforcement} = \frac{A_s}{A}$$

y = Distance from center of gravity of section to extreme fibre.

I_o = Moment of inertia of concrete section about the gravity axis

I_s = Moment of inertia of steel area about the gravity axis.

The other symbols are as given in the standard notation, pages 5 and 6.

It is in the case of rectangular sections with symmetrical reinforcement, that we most frequently meet with problems involving bending and direct stress and Diagrams 6, 7, 8a and 8b, will be found to greatly facilitate the solution of such problems.

In the case of a homogeneous material no tension exists on the cross section when the resultant falls within the middle third. For a concrete section reinforced with steel bars the conditions are altered somewhat and the resultant may fall slightly outside the middle third without producing tension on the section. In those cases where compression exists over the whole section Diagram 6 may be employed, but where there is tension over part of the section Diagrams 7 and 8a or 8b should be used.

Case I. No Tension on the Cross Section. Consider a column 18 inches square, reinforced with 4-1 in. square bars, carrying a load of 150,000 lb. concentrated 1 in. from the center of the column. Find the maximum unit stress in the concrete.

$$\text{Percentage of reinforcement, } p_o = \frac{A_s}{bt} = \frac{4}{(18)(18)} = 1.23\%$$

$$\text{The eccentricity } x_o = 1 \text{ in.}$$

$$\text{and } \frac{x_o}{t} = \frac{1}{18} = 0.0555$$

Entering Diagram 6 with $\frac{x_o}{t} = 0.0555$, tracing vertically to $p_o = 1.23\%$ and then to the left margin find $K' = 1.09$, a factor by which the average unit stress must be multiplied to find the maximum unit stress.

$$\text{Max. } f_c = \frac{W}{bt} K' = \frac{150,000}{(18)(18)} (1.09) = 505 \text{ lb. per sq. in.}$$

To obtain the minimum concrete unit stress we know that the minimum is as much below the average as the maximum is above. In this example the average concrete unit

stress is $\frac{150,000}{[(18)(18) - 4] + (15)(4)} = 394$ lb. per sq in. Thus the minimum unit stress is $394 - (496 - 394) = 292$ pounds per square inch.

Case II. Tension on the Cross-Section. Suppose the column of *Case I* had an applied moment of 800,000 in. lb. in addition to an axial load of 100,000 lb. Then

$$x_o = \frac{M}{W} = \frac{800,000}{100,000} = 8 \text{ in.}$$

$$\frac{x_o}{t} = \frac{8}{18} = 0.444$$

As before $p_o = 1.23\%$ entering Diagram 7 with $\frac{x_o}{t} = 0.444$, tracing vertically to $p_o = 1.23\%$, then to the left margin, $k = 0.60$. Now entering Diagram 8a with this value of k and tracing to $p_o = 1.23\%$, the value of F is found to be 0.139. Then

$$\text{Max. } f_c = \frac{M}{Fbt^2} = \frac{800,000}{(0.139)(18)(18)(18)} = 987 \text{ pounds per sq. in.}$$

This resulting fibre stress is larger than is usually permitted and would necessitate a redesign of the column section in order to reduce the stress to the limit allowable.

VALUES OF p , k , j AND K FOR VARIOUS COMBINATIONS OF STEEL AND CONCRETE STRESSES

FOR RECTANGULAR BEAMS AND SLABS. $n=15$

$$K = \frac{1}{2} f_c k j \text{ or } p f_s j$$

$$j = 1 - \frac{k}{3}$$

$$p = \frac{f_c k}{2 f_s}$$

$$k = \frac{1}{1 + \frac{f_s}{m f_c}}$$

14,000																
f_s	500	550	600	650	700	750	800	850	900	950	1000	1100	1200	1300	1400	1500
f_c	0.0062	0.0073	0.0084	0.0095	0.0107	0.0119	0.0132	0.0145	0.0158	0.0171	0.0185	0.0213	0.0241	0.0270	0.0300	0.0330
p	0.3488	0.3708	0.3913	0.4105	0.4286	0.4455	0.4615	0.4766	0.4909	0.5044	0.5173	0.5410	0.5625	0.5821	0.6000	0.6164
k	0.8838	0.8764	0.8696	0.8632	0.8571	0.8515	0.8462	0.8411	0.8364	0.8319	0.8276	0.8197	0.8125	0.8060	0.8000	0.7945
j	77.07	89.37	102.1	115.2	128.6	142.2	156.2	170.4	184.8	199.3	214.1	243.9	274.2	305.0	336.0	367.3
K																
16,000																
f_s	500	550	600	650	700	750	800	850	900	950	1000	1100	1200	1300	1400	1500
f_c	0.0050	0.0058	0.0068	0.0077	0.0087	0.0097	0.0107	0.0118	0.0129	0.0140	0.0151	0.0175	0.0199	0.0223	0.0248	0.0274
p	0.3191	0.3402	0.3600	0.3786	0.3962	0.4128	0.4286	0.4435	0.4576	0.4711	0.4839	0.5077	0.5294	0.5493	0.5676	0.5844
k	0.8936	0.8866	0.8800	0.8738	0.8679	0.8624	0.8571	0.8522	0.8475	0.8430	0.8387	0.8308	0.8235	0.8169	0.8108	0.8052
j	71.29	82.95	95.04	107.5	120.4	133.5	146.9	160.6	174.5	188.6	202.9	232.0	261.6	291.7	322.1	352.9
K																
18,000																
f_s	500	550	600	650	700	750	800	850	900	950	1000	1100	1200	1300	1400	1500
f_c	0.0041	0.0048	0.0056	0.0063	0.0072	0.0080	0.0089	0.0098	0.0107	0.0117	0.0126	0.0146	0.0167	0.0188	0.0209	0.0232
p	0.2941	0.3143	0.3333	0.3514	0.3684	0.3846	0.4000	0.4146	0.4288	0.4419	0.4545	0.4783	0.5000	0.5200	0.5385	0.5556
k	0.9020	0.8952	0.8889	0.8829	0.8772	0.8718	0.8667	0.8618	0.8571	0.8527	0.8485	0.8406	0.8333	0.8267	0.8205	0.8148
j	66.32	77.37	88.88	100.8	113.1	125.7	138.7	151.9	165.4	179.0	192.8	221.1	250.0	279.4	309.3	339.5
K																
20,000																
f_s	500	550	600	650	700	750	800	850	900	950	1000	1100	1200	1300	1400	1500
f_c	0.0034	0.0040	0.0047	0.0053	0.0060	0.0068	0.0075	0.0083	0.0091	0.0099	0.0107	0.0124	0.0142	0.0160	0.0179	0.0199
p	0.2727	0.2920	0.3103	0.3277	0.3443	0.3600	0.3750	0.3893	0.4030	0.4161	0.4286	0.4521	0.4737	0.4937	0.5122	0.5294
k	0.9091	0.9027	0.8966	0.8908	0.8852	0.8800	0.8750	0.8702	0.8657	0.8613	0.8571	0.8493	0.8421	0.8354	0.8293	0.8235
j	61.98	72.49	83.46	94.87	106.7	118.8	131.3	144.0	157.0	170.2	183.7	211.2	239.3	268.1	297.3	327.0
K																

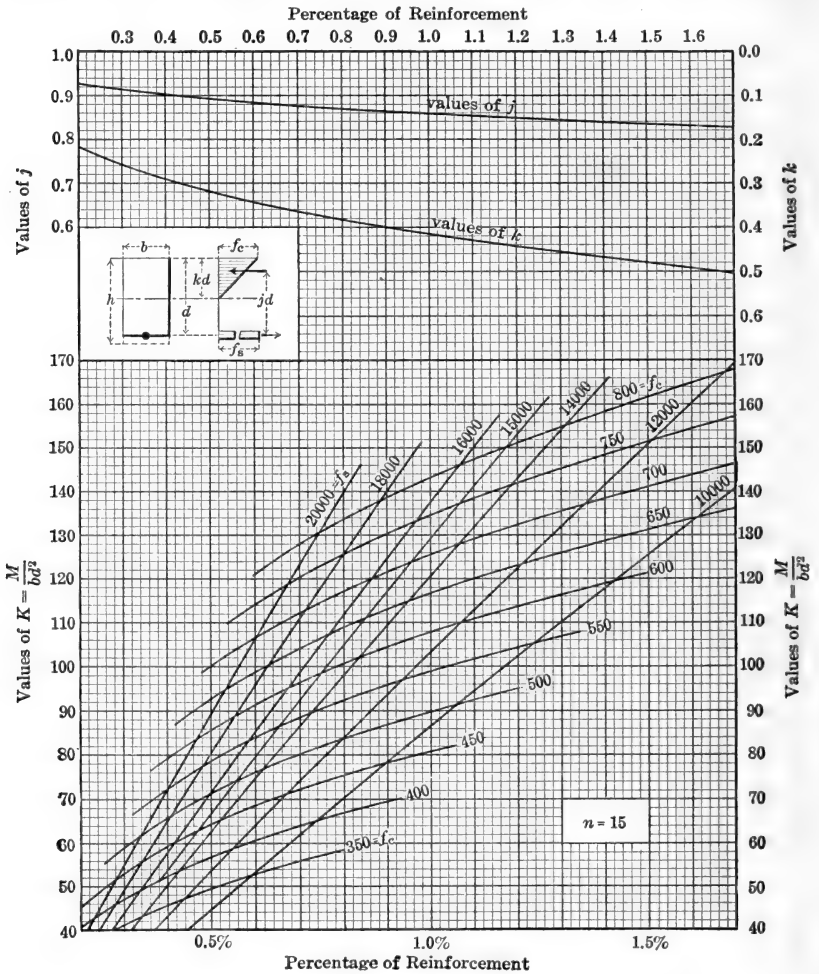

DIAGRAM 1

Coefficients of resistance K and values of j and k for rectangular beams.

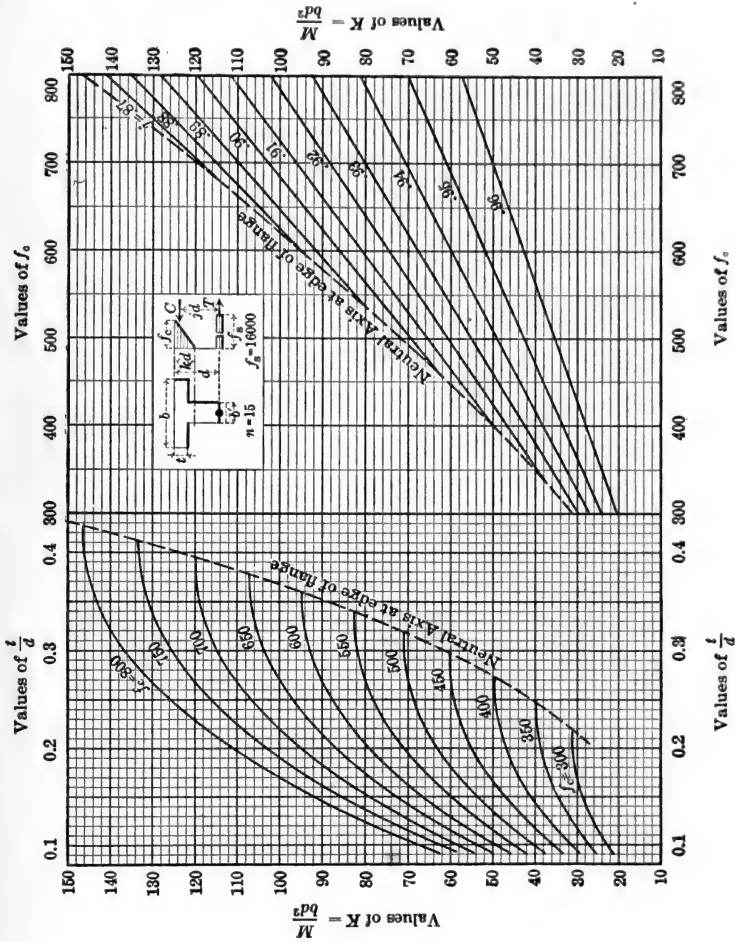

DIAGRAM 2

Coefficients of resistance K and values of j for T-beams when $n = 15$ and $f_s = 16,000$.

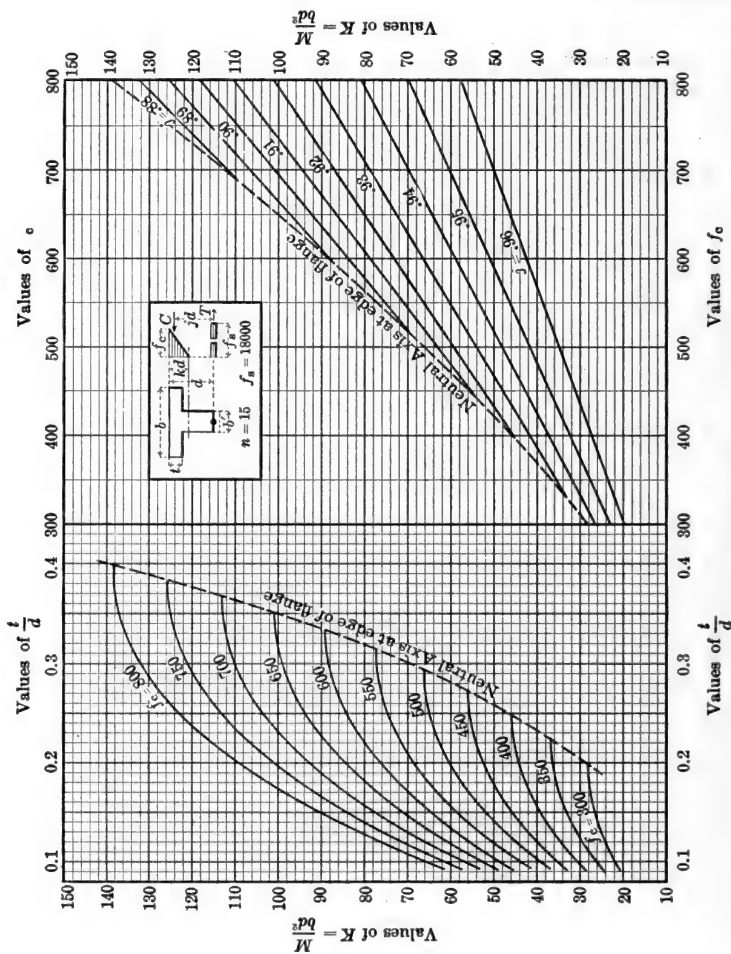

DIAGRAM 3

Coefficients of resistance K and values of j for T-beams when $n = 15$ and $f_s = 18,000$.

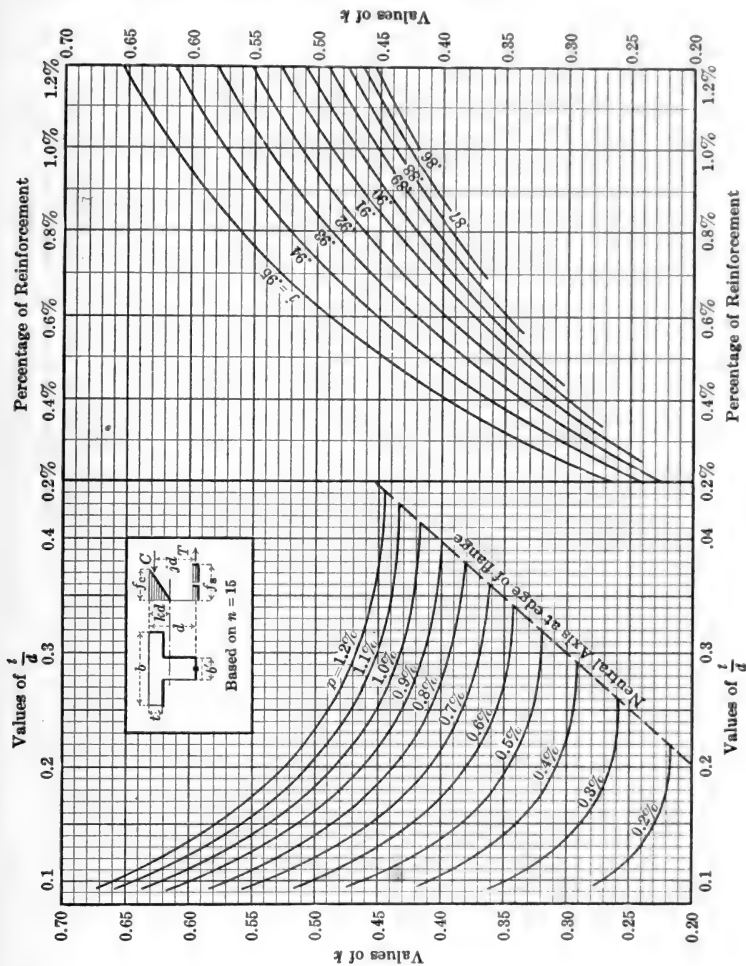

DIAGRAM 4

Values of k and j for T-beams.

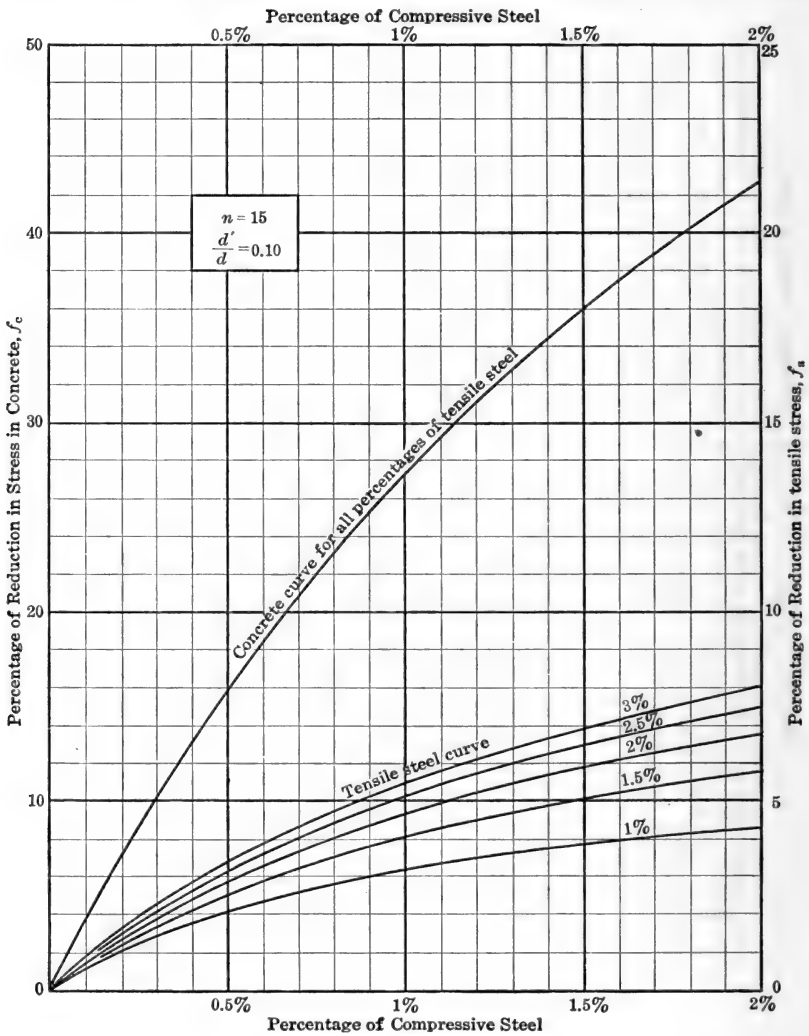

DIAGRAM 5

Compressive reinforcement of beams.

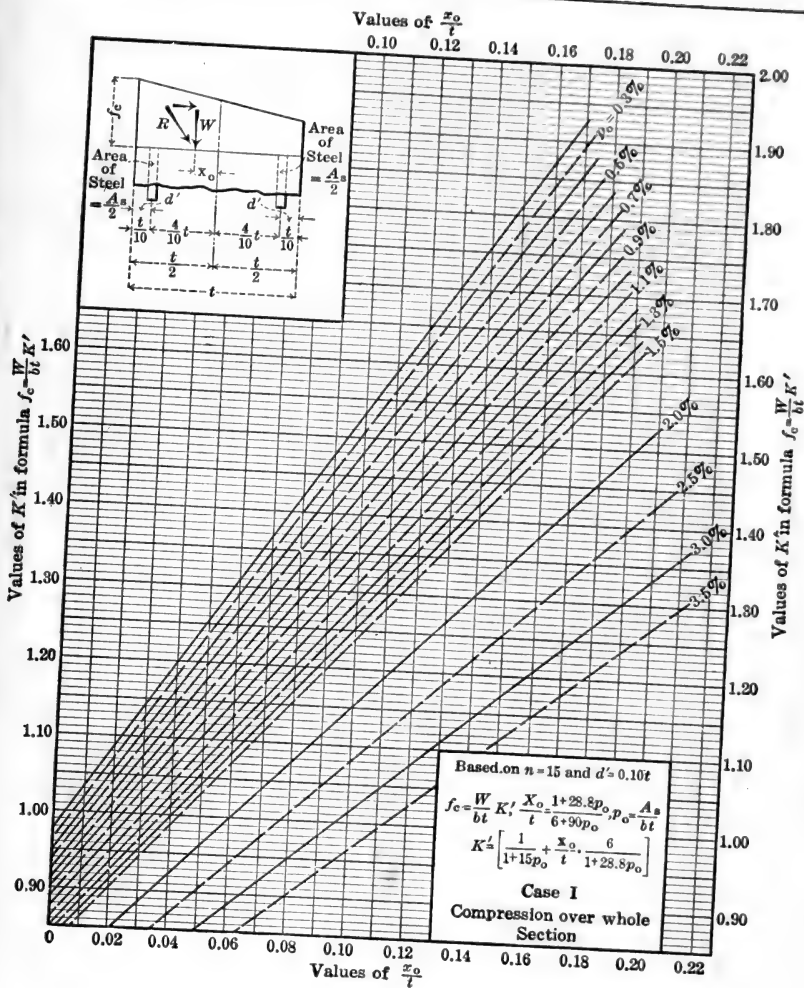

DIAGRAM 6

Bending and direct stress.

Values of K' , a factor by which the average stress is multiplied to obtain the maximum fibre stress.

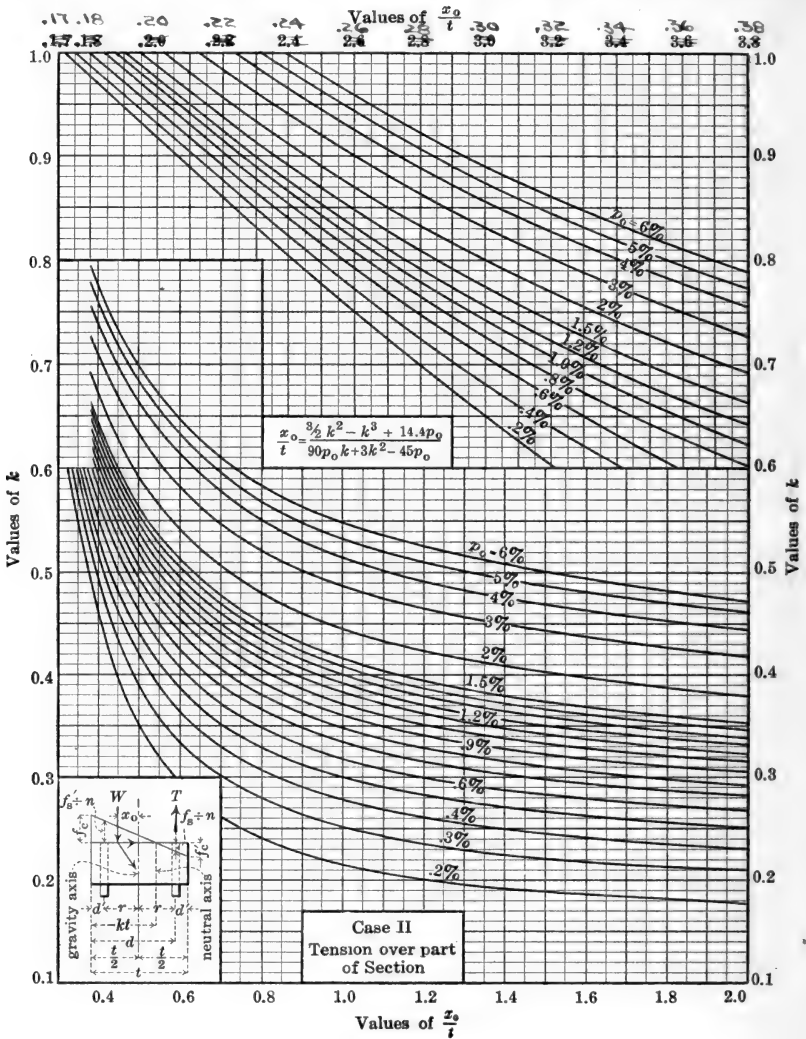

DIAGRAM 7

Bending and direct stress.

Values of k , the ratio of distance of neutral axis from extreme fibre to total thickness or depth, t .

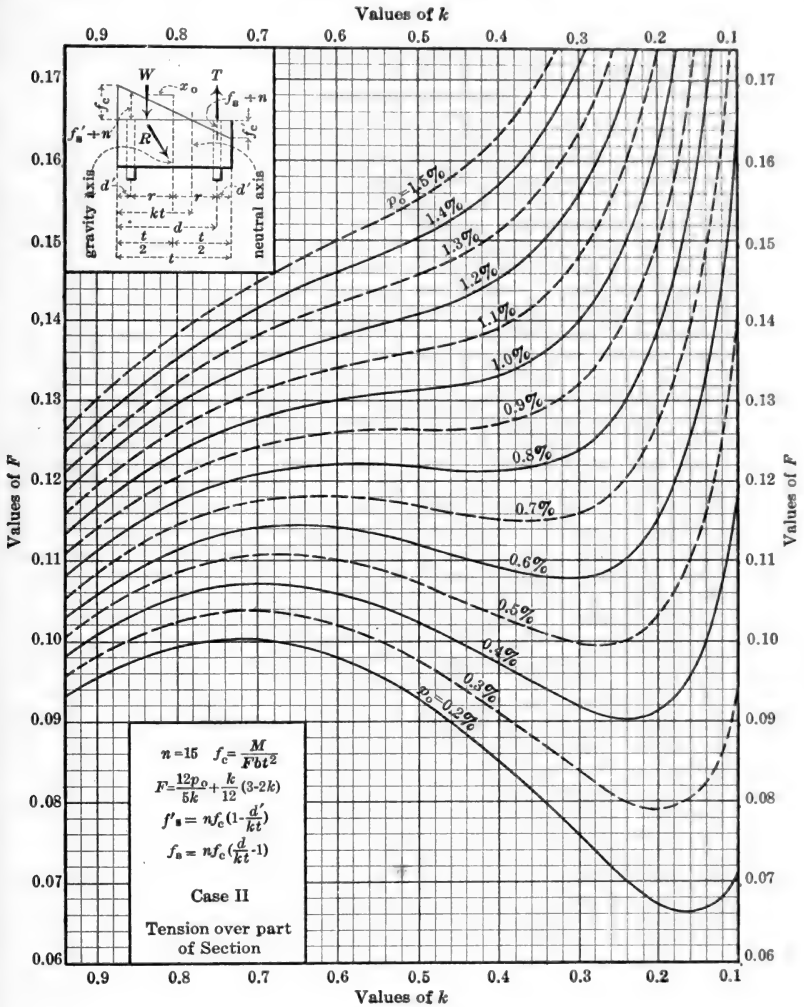

DIAGRAM 8a

Bending and direct stress.

Values of coefficient F in formula for obtaining extreme fibre stress $f_c = \frac{M}{Fbt^2}$

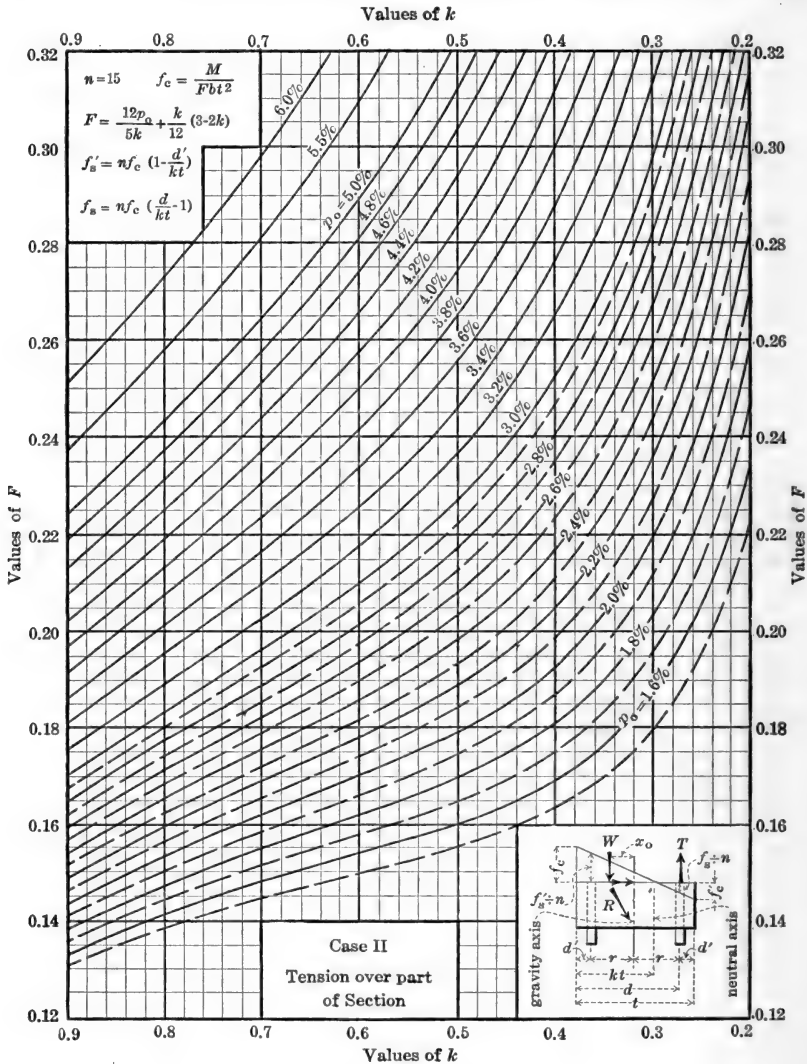

DIAGRAM 8b

Bending and direct stress.

Values of coefficient F in formula for obtaining extreme fibre stress $f_c = \frac{M}{Fbt^2}$

USEFUL DATA

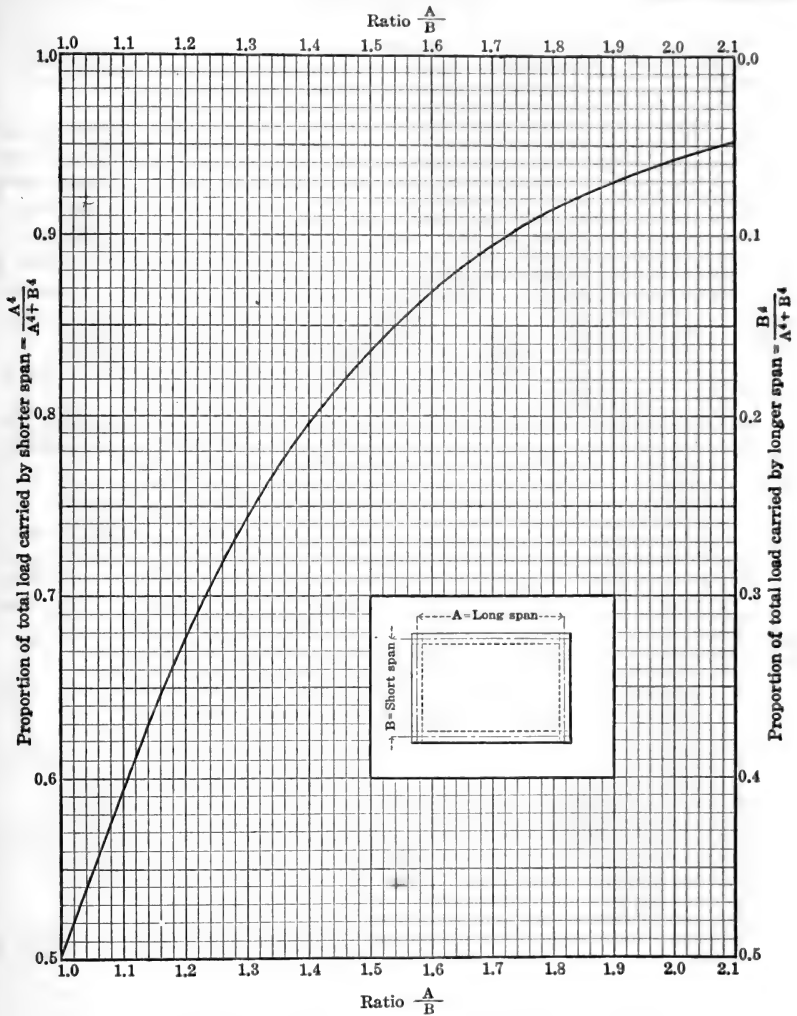

DIAGRAM 9

Curve showing distribution of load for rectangular slabs supported at the four edges.

GENERAL FORMULAS FOR BEAMS

REACTIONS, BENDING MOMENTS, SHEARS AND DEFLECTIONS
CAUSED BY VARIOUS APPLIED LOADS

The classes of beam loading given on the following pages cover the majority of cases occurring in reinforced concrete design. The formulas may be applied to a beam of any material, although it should be noted that those for deflection and maximum safe load require modification for use in connection with reinforced concrete beams.

In the application of deflection and maximum load formulas to reinforced concrete beams account must be taken of the fact that the moment of inertia of the section and the modulus of elasticity of the material enters into the computations, thereby introducing elements of uncertainty that do not exist in the case of homogeneous beams, at least not within the limits of working stresses. Bearing this fact in mind it will be necessary to make certain assumptions before applying these formulas. These assumptions may be stated briefly as follows:

1. The moment of inertia is considered substantially uniform throughout the length of the beam, and shall be taken as that of the section of the beam at the center of the span.

2. The section shall be considered intact from top of beam to center of steel.

3. The modulus of elasticity of the concrete shall be taken as the average or secant modulus up to the working compressive stress.

For such a beam the moment of inertia of a section is the moment of inertia of the concrete about the neutral axis plus n times the moment of inertia of the steel about the same axis, or

$$I = I_c + nI_s$$

$$= \frac{bd^3}{3} \left[k^3 + (1-k)^3 + 3np(1-k)^2 \right] \text{ for rectangular beams.}$$

$$= \frac{bd^3}{3} \left[k^3 - \left(1 - \frac{b'}{b}\right) \left(k - \frac{t}{d}\right)^3 + \frac{b'}{b} (1-k)^3 + 3pn(1-k)^2 \right] \text{ for T-beams}$$

The value of the modulus of elasticity to use in the deflection formula is that of the concrete, or

$$E = E_c = \frac{E_s}{n}$$

It is recommended, from the consideration of test data, that 8 or 10 be used for n to secure fair agreement between computed and measured deflection. A more complete discussion of the subject of deflection of reinforced concrete beams will be found in "Principles of Reinforced Concrete Construction" by Turneure and Maurer.

The maximum safe load formula given in the following cases applies only to homogeneous beams. To obtain the maximum safe load for a reinforced concrete beam, equate the maximum external moment to the internal resisting moment of the section and solve for W . For example, in the case of a uniformly loaded rectangular beam supported at the ends, $M_m = \frac{wl^2}{8}$ and the resisting moment of the section is Kbd^2 ,

$$\text{then } W_m = \frac{8Kbd^2}{12l^2}$$

Values of K may be obtained from Diagrams 1, 2 and 3.

NOTATION. The following notation has been adopted in the formulas:

- P, p = Concentrated loads in pounds. $\omega \text{ or } \text{or } \text{or}$
- w = Superimposed load in pounds per ~~foot~~ length of beam or slab.
- W = Superimposed load supported by beam or slab in pounds.
- l = Length of beam in feet.
- L = Length of beam in inches.
- R_1, R_2 = Reactions at supports of beam, in pounds.
- V_x = Total transverse shear in pounds, at distance x .
- V_m = Total maximum transverse shear in pounds.
- M_m = Maximum positive external bending moment in foot-pounds.
- M'_m = Maximum negative external bending moment in foot-pounds.
- x_0 = Distance in feet to point of zero shear, or to M_m .
- $\omega \text{ or } \text{or } \text{or}$ W_m = Maximum safe load in pounds per ~~foot~~ length of beam or slab for load distribution indicated in each case.
- P_m = Maximum safe concentrated load in pounds.
- f = Working unit-stress in flexure, in pounds per square inch. (This does not apply to reinforced concrete beams.)
- I = Moment of inertia of cross-section in inches⁴.
- S = Section modulus of cross-section in inches³.
(This does not apply to reinforced concrete beams.)
- D = Maximum deflection in inches.
- y = Distance in feet to point of maximum deflection D .

1. Cantilever Beam. Concentrated load.

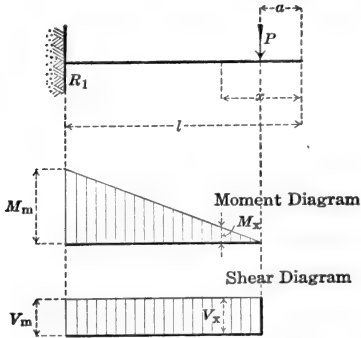

$$R_1 = P$$

$$V_x = P = V_m$$

$$M_x = P(x-a)$$

$$M_m = P(l-a)$$

$$P_m = \frac{fS}{12(l-a)}$$

$$D = \frac{P}{6EI}(2L^3 - 3aL^2 + a^3) \text{ (Right end)}$$

$$D_a = \frac{P}{3EI}(L-a)^3 \text{ (At load P)}$$

2. Cantilever Beam. Uniformly distributed load.

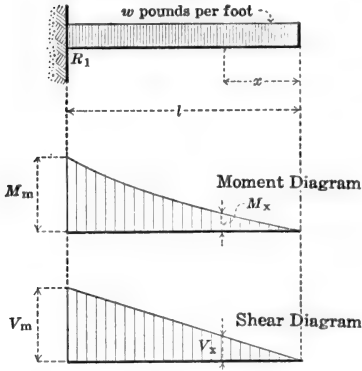

$$R_1 = W = wl = V_m$$

$$V_x = wx$$

$$M_x = \frac{wx^2}{2}$$

$$M_m = \frac{wl^2}{2} = \frac{Wl}{2}$$

$$w_m = \frac{fS}{6l^2}$$

$$D = \frac{wL^4}{8EI}$$

3. Cantilever Beam. Load increasing uniformly to fixed end.

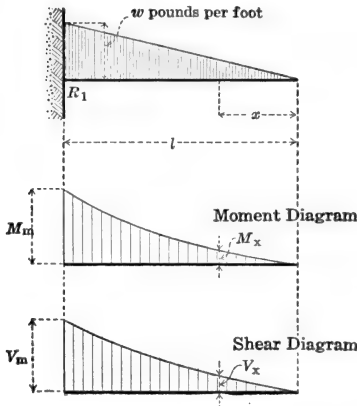

$$R_1 = W = \frac{wl}{2} = V_m$$

$$V_x = \frac{wx^2}{2l}$$

$$M_x = \frac{wx^3}{6l}$$

$$M_m = \frac{wl^2}{6} = \frac{Wl}{3}$$

$$w_m = \frac{fS}{2l^2}$$

$$D = \frac{wL^4}{30EI}$$

4. Cantilever Beam. Load increasing uniformly to free end.

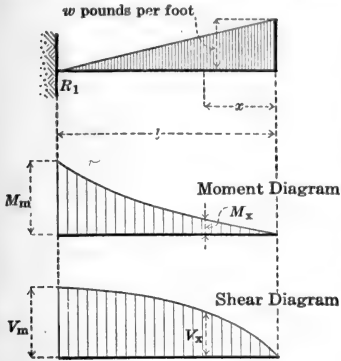

$$R_1 = W = \frac{wl}{2} = V_m$$

$$V_x = \frac{wx}{2l}(l-x) = \frac{wx}{2l}(2l-x)$$

$$M_x = \frac{wx^2}{6l}(3l-x)$$

$$M_m = \frac{wl^2}{3} = \frac{2Wl}{3}$$

$$w_m = \frac{fS}{4l^2}$$

$$D = \frac{11}{120} \frac{wL^4}{EI}$$

5. Beam Supported at Ends. Concentrated load near one end.

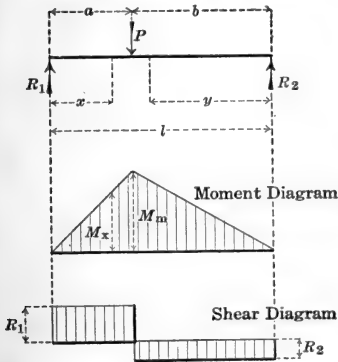

$$R_1 = \frac{Pb}{l} \quad R_2 = \frac{Pa}{l}$$

$$V_m = R_1 \text{ when } a < \frac{l}{2}$$

$$M_x = \frac{R_1 x}{l} = \frac{Pbx}{l}$$

$$M_m = M_p = \frac{Pab}{l}$$

$$D = \frac{P(L-b)}{3EIL} \left[\frac{b}{3}(2L-b) \right]^{\frac{3}{2}}$$

$$y = \frac{1}{3} \sqrt{3b(l+a)} \quad a < b \text{ and on same side of load.}$$

6. Beam Supported at Ends. Concentrated load at center.

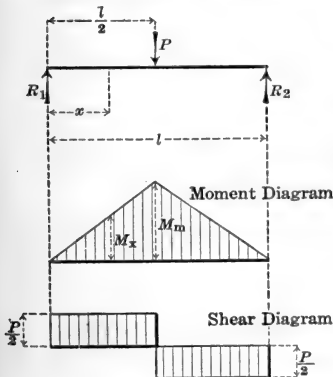

$$R_1 = R_2 = \frac{P}{2} = V_m$$

$$M_x = \frac{Px}{2}$$

$$M_m = \frac{Pl}{4}$$

$$P_m = \frac{fS}{3l}$$

$$D = \frac{PL^3}{48EI}$$

$$y = \frac{l}{2}$$

7. **Beam Supported at Ends.** Two unequal and unsymmetrical concentrated loads

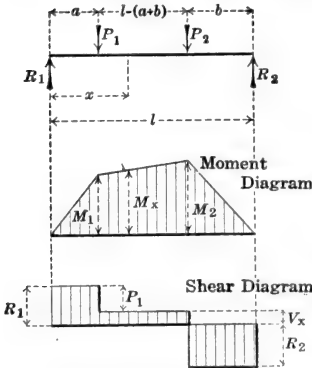

$$R_1 = \frac{1}{l} \left[P_1(l-a) + P_2b \right]$$

$$R_2 = \frac{1}{l} \left[P_1a + P_2(l-b) \right]$$

$$V_x = R_1 - P_1$$

$$V_m = \text{Maximum Reaction.}$$

$$M_x = P_1 \frac{a}{l} (l-x) + P_2 \frac{bx}{l}$$

$$M_1 = R_1a = \frac{a}{l} \left[P_1(l-a) + P_2b \right]$$

$$M_2 = R_2b = \frac{b}{l} \left[P_1a + P_2(l-b) \right]$$

$$M_m = \text{Greater of } M_1 \text{ and } M_2$$

8. **Beam Supported at Ends.** Two equal unsymmetrical concentrated loads.

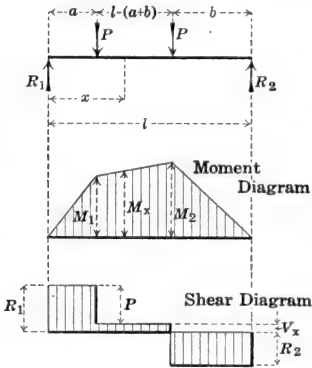

$$R_1 = \frac{P}{l} (l-a+b)$$

$$R_2 = \frac{P}{l} (l-b+a)$$

$$V_x = R_1 - P$$

$$V_m = \text{Maximum Reaction}$$

$$M_x = \frac{P}{l} (al - ax + bx)$$

$$M_1 = R_1a = \frac{Pa}{l} (l-a+b)$$

$$M_2 = R_2b = \frac{Pb}{l} (l-b+a)$$

$$M_m = \text{Greater of } M_1 \text{ and } M_2$$

$$P_m = \frac{flS}{12b(l-b+a)} \text{ (when } b > a)$$

9. **Beams Supported at Ends.** Two equal symmetrical concentrated loads.

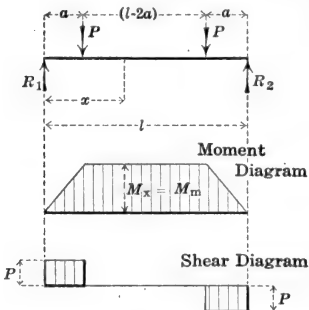

$$R_1 = R_2 = P = V_m$$

$$V_x = 0$$

$$M_x = M_m = Pa$$

$$P_m = \frac{fS}{12a}$$

$$D = \frac{Pa}{24EI} (3l^2 - 4a^2)$$

At center.

When $a = \frac{l}{3}$

$$M_x = M_m = \frac{Pl}{3}$$

$$P_m = \frac{3fS}{12} = \frac{fS}{4}$$

$$D = \frac{23}{648} \frac{PE}{EI}$$

10. **Beam Supported at Ends.** Three unequal unsymmetrical concentrated loads.

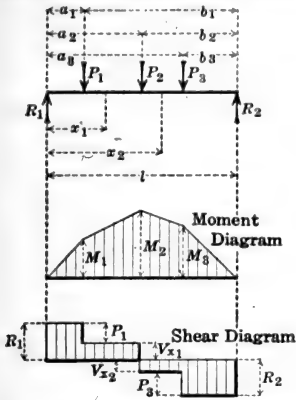

$$R_1 = \frac{\sum P b}{l} \quad R_2 = \frac{\sum P a}{l}$$

$$V_{x_1} = R_1 - P_1 \quad V_{x_2} = R_1 - P_1 - P_2$$

$$V_m = \text{Greater Reaction}$$

$$M_1 = \frac{a_1}{l} \sum P b \quad M_2 = \frac{a_2}{l} \sum P b - P_1(a_2 - a_1)$$

$$M_3 = \frac{b_3}{l} \sum P a$$

$$M_m = \text{Greatest of } M_1, M_2, \text{ and } M_3$$

$$= M_1 \text{ if } P_1 > R_1$$

$$= M_2 \text{ if } P_1 < R_1 \text{ when } (P_1 + P_2) > R_1$$

$$= M_3 \text{ if } P_3 > R_2$$

11. **Beam Supported at Ends.** Three equal symmetrical concentrated loads.

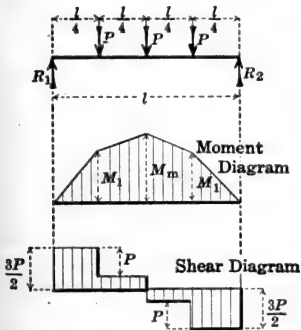

$$R_1 = R_2 = \frac{3P}{2} = V_m$$

$$M_1 = \frac{3}{8} Pl$$

$$M_m = \frac{Pl}{2}$$

$$P_m = \frac{fS}{6l}$$

$$D = \frac{19}{384} \frac{PL^3}{EI} \text{ at center}$$

12. **Beam Supported at Ends.** Uniform load partially distributed.

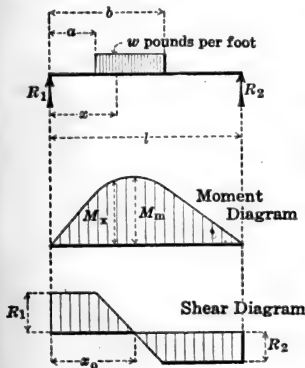

$$R_1 = \frac{w}{2l} (b-a)(2l-b-a)$$

$$R_2 = \frac{w}{2l} (b-a)(2a+b-a)$$

$$M_x = R_1 x - \frac{w}{2} (x-a)^2$$

$$x_0 = a + \frac{R_1}{w}$$

$$M_m = R_1 x_0 - \frac{w}{2} (x_0 - a)^2$$

$$w_m = \frac{fS - 12R_1 x_0}{6(x_0 - a)^2}$$

13. **Beam Supported at Ends.** Uniform load partially discontinuous.

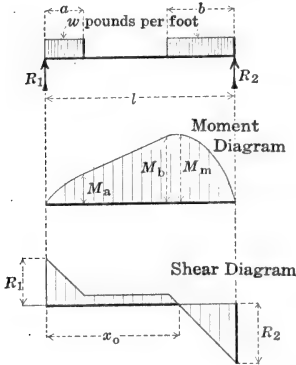

$$R_1 = \frac{w}{2l}(2al - a^2 + b^2)$$

$$R_2 = \frac{w}{2l}(2bl - b^2 + a^2)$$

$$V_m = \text{Greater Reaction}$$

$$M_a = R_1 a - \frac{wa^2}{2}$$

$$M_b = R_2 b - \frac{wb^2}{2}$$

$$x_0 = l - a - b + \frac{R_1}{w} \quad (\text{when } b > a)$$

$$M_m = \frac{R_2^2}{2w} \quad (\text{when } b > a)$$

14. **Beam Supported at Ends.** Uniformly distributed load.

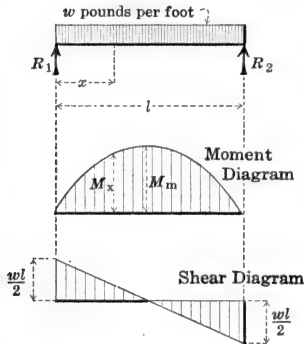

$$R_1 = R_2 = \frac{wl}{2} = V_m$$

$$M_x = \frac{wx}{2}(l-x)$$

$$M_m = \frac{wl^2}{8} = \frac{Wl}{8}$$

$$w_m = \frac{2fS}{3l^2}$$

$$D = \frac{5}{384} \frac{wL^4}{EI}$$

15. **Beam Supported at Ends.** Load increasing uniformly to center.

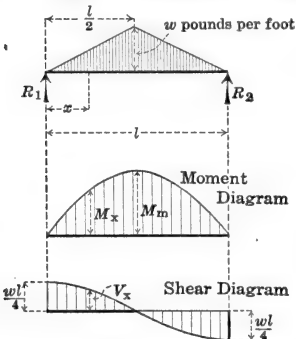

$$R_1 = R_2 = \frac{wl}{4} = V_m$$

$$V_x = \frac{w}{4l}(l^2 - 4x^2)$$

$$M_x = \frac{wx}{12l}(3l^2 - 4x^2)$$

$$M_m = \frac{wl^2}{3} \cdot \frac{wl^2}{12}$$

$$w_m = \frac{fS}{l^2}$$

$$D = \frac{wL^4}{120EI} \text{ at center}$$

16. **Beam Supported at Ends.** Load decreasing uniformly to center.

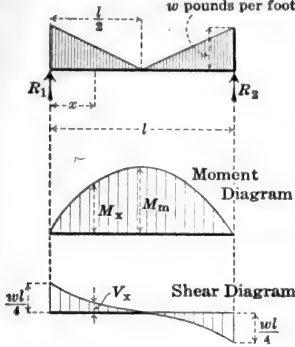

$$R_1 = R_2 = \frac{wl}{4} = V_m$$

$$V_x = \frac{w}{4l}(l-2x)^2$$

$$M_x = \frac{wx}{12l}(3l^2 - 6lx + 4x^2)$$

$$M_m = \frac{wl^2}{24}$$

$$w_m = \frac{2fs}{l^2}$$

$$D = \frac{3}{640} \frac{wL^4}{EI} \text{ at center}$$

17. **Beam Supported at Ends.** Load increasing uniformly to one end.

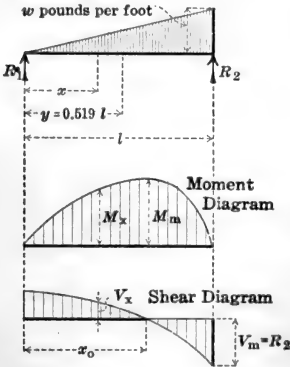

$$R_1 = \frac{wl}{6} \quad R_2 = \frac{wl}{3} = V_m$$

$$V_x = \frac{w}{6l}(l^2 - 3x^2)$$

$$M_x = \frac{wx}{6l}(l^2 - x^2)$$

$$x_0 = 0.5774 l$$

$$M_m = 0.0642 wl^2$$

$$w_m = \frac{1.3fs}{l^2}$$

$$y = 0.519 l$$

$$D = 0.00652 \frac{wL^4}{EI}$$

18. **Beam Fixed at Ends.** Load increasing uniformly to center.

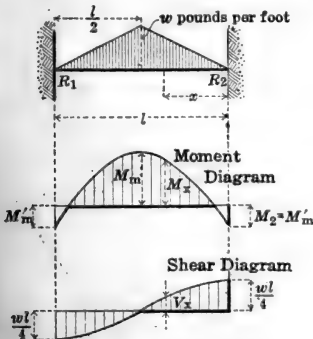

$$R_1 = R_2 = \frac{wl}{4}$$

$$V_x = \frac{wl}{4} - \frac{wx^2}{l}$$

$$M_x = M_1 + \frac{wlx}{4} - \frac{wx^3}{3l}$$

$$M_2 = M'_m = -\frac{5wl^2}{96}$$

$$M_m = \frac{wl^2}{32}$$

19. Beam Fixed at Ends. Load decreasing uniformly to center.

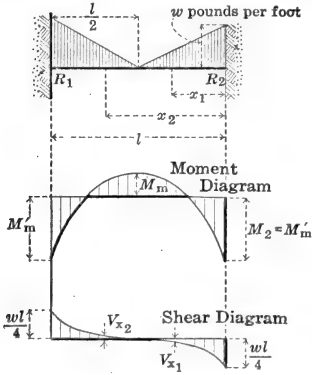

$$R_1 = R_2 = \frac{wl}{4}$$

$$V_{x_1} = -\frac{w}{4l}(l-2x_1)^2$$

$$V_{x_2} = \frac{w}{4l}(2x_2-l)^2$$

$$M_m = \frac{wl^2}{96}$$

$$M'_m = M_2 = -\frac{wl^2}{32}$$

20. Beam Supported at Ends. Uniformly distributed load plus load increasing uniformly to one end.

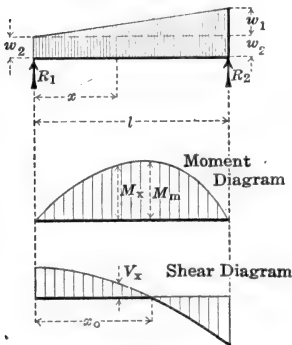

$$R_1 = \frac{w_1 l}{6} + \frac{w_2 l}{2}$$

$$R_2 = \frac{w_1 l}{3} + \frac{w_2 l}{2} = V_m$$

$$V_x = \frac{w_1}{6l}(l^2 - 3x^2) + \frac{w_2}{2}(l - 2x)$$

$$M_x = \frac{w_1 x}{24l}(l - x) + \frac{w_2 x}{6l}(l^2 - x^2)$$

$$M_m = \frac{l^2}{16}(2w_2 + w_1) \text{ Approx.}$$

$$x_0 = \text{between } 0.50 l \text{ and } 0.58 l$$

$$D = \frac{5L^4}{768EI}(w_1 + 2w_2)$$

21. Beam Fixed at One End, Supported at Other. Concentrated load.

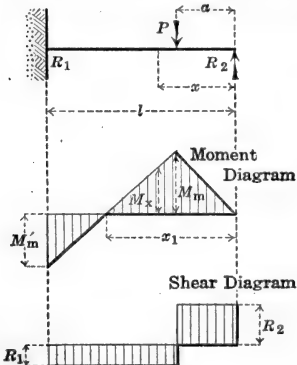

$$R_1 = \frac{P}{2l^3}(3al^2 - a^3)$$

$$R_2 = \frac{P}{2l^3}(2l^3 - 3al^2 + a^3)$$

$$M_x = R_2 x - P(x - a)$$

$$x_1 = \frac{Pa}{P - R_2}$$

$$M_m = \frac{Pa}{2l^3}(2l^3 - 3al^2 + a^3)$$

$$M'_m = \frac{P}{2l^2}(al^2 - a^3)$$

when $y = a = 0.414l$, $D = 0.0098 \frac{PL^3}{EI}$

22. Beam Fixed at One End, Supported at Other. Load increasing uniformly to fixed end.

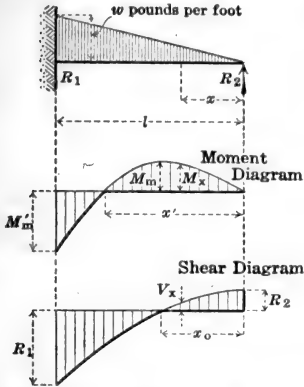

$$R_1 = \frac{4wl}{10}$$

$$R_2 = \frac{wl}{10}$$

$$V_x = \frac{wl}{10} - \frac{wx^2}{2l}$$

$$M_x = \frac{wlx}{10} - \frac{wx^3}{6l}$$

$$x_0 = 0.4474l$$

$$M_m = 0.031wl^2$$

$$M'_m = -\frac{wl^2}{15}$$

$$x' = 0.775l$$

23. Beam Fixed at One End, Supported at Other. Uniformly distributed load.

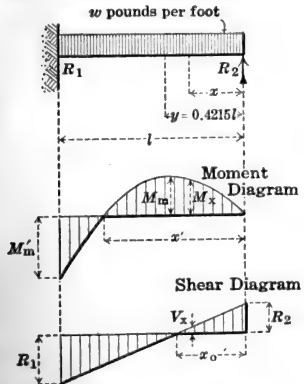

$$R_1 = \frac{5}{8}wl$$

$$R_2 = \frac{3}{8}wl$$

$$V_x = \frac{3}{8}wl - wx$$

$$M_x = \frac{wx}{8}(3l - 4x)$$

$$M_m = \frac{9}{128}wl^2$$

$$M'_m = -\frac{1}{8}wl^2$$

$$x_0 = \frac{3}{8}l$$

$$x' = \frac{3}{4}l$$

$$y = 0.4215l$$

$$D = \frac{0.0054wL^4}{EI}$$

24. Beam Fixed at Ends. Load increasing uniformly to one end.

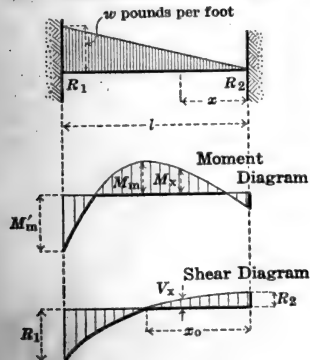

$$R_1 = \frac{7wl}{20}$$

$$R_2 = \frac{3wl}{20}$$

$$V_x = \frac{3wl}{20} - \frac{wx^2}{2l}$$

$$M_x = \frac{wlx}{30} + \frac{3wlx}{20} - \frac{wx^3}{6l} = \frac{3wlx}{20} - \frac{wl^2}{30} - \frac{wx^3}{6l}$$

$$M_1 = M'_m = -\frac{wl^2}{20}$$

$$x_0 = 0.548l$$

$$M_m = 0.0215wl^2$$

25. **Beam Fixed at Ends.** Uniformly distributed load.

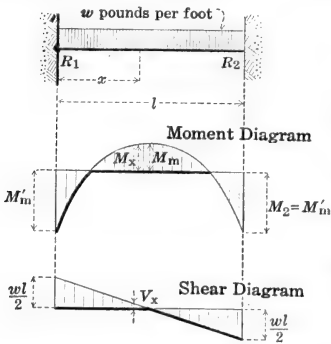

$$R_1 = R_2 = \frac{1}{2}wl$$

$$V_x = \frac{1}{2}wl - wx$$

$$M_x = \frac{w}{2}(-\frac{l^2}{6} + lx - x^2)$$

$$M_m = \frac{1}{24}wl^2$$

$$x_o = \frac{1}{2}l$$

$$M'_m = \frac{1}{12}wl^2$$

$$D = \frac{1}{384} \frac{wL^4}{EI}$$

26. **Beam Fixed at Ends.** Concentrated load at center.

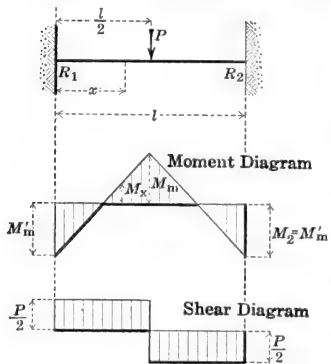

$$R_1 = R_2 = \frac{1}{2}P$$

$$V_x = \frac{1}{2}P$$

$$M_x = \frac{1}{2}P(x - \frac{1}{4}l) \text{ between } R_1 \text{ and } P$$

$$= \frac{1}{2}P(\frac{3}{4}l - x) \text{ between } P \text{ and } R_2$$

$$M_m = \frac{1}{8}Pl$$

$$x_o = \frac{1}{2}l$$

$$M'_m = \frac{1}{8}Pl$$

$$D = \frac{1}{192} \frac{PE}{EI}$$

27. **Beam Fixed at Ends.** Concentrated load.

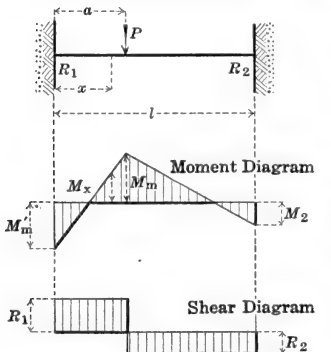

$$R_1 = P \frac{(l-a)^2 (2a+l)}{l^3}$$

$$R_2 = P \frac{a^2 (3l-2a)}{l^3}$$

$$V_x = R_1 \text{ between } R_1 \text{ and } P$$

$$V_{x_1} = R_2 \text{ between } P \text{ and } R_2$$

$$M_x = R_1 x + M'_m \text{ between } R_1 \text{ and } P$$

$$M_m = R_1 a + M'_m$$

$$M'_m = -P \frac{a(l-a)^2}{l^2}$$

$$M_2 = -P \frac{a^2(l-a)}{l^2}$$

Concentrated Moving Loads. Position for maximum moment and shear.

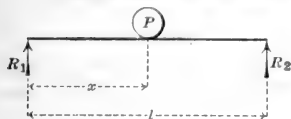

Max. V when $x=0$
 Max. M when $x = \frac{l}{2}$ | $R_1 = \frac{P}{2}$
 $V_m = R_1 = P$ | $M_m = \frac{Pl}{4}$ (at P)

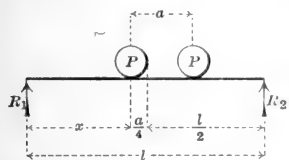

Max. V when $x=0$
 Max. M when $x = \frac{1}{4}(2l-a)$ | $R_1 = \frac{P}{2}(2l-a)$
 $V_m = R_1 = \frac{P}{l}(2l-a)$ | $M_m = \frac{P}{2l}(2l-a) \frac{Pl}{8l}$
 When a exceeds $0.586l$, use case of one load only, for M_m .

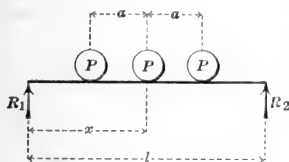

Max. V when $x=0$
 Max. M when $x = \frac{l}{2}$ | $R_1 = \frac{3}{2}P$
 $V_m = R_1 = \frac{3P}{l}(l-a)$ | $M_m = \frac{P}{4}(3l-4a)$
 When a exceeds $0.45l$, use case of two loads only, for M_m .

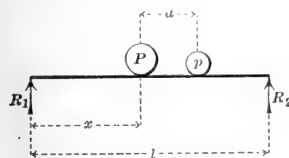

Max. V when $x=0$ | $V_m = R_1 = \frac{(l-a)}{l} \sum P$
 Max. M when $x = \frac{1}{2} \left[l - \frac{pa}{\sum P} \right]$ | $M_m = \frac{x^2}{l} \sum P$
 Maximum moment may occur under one load only.

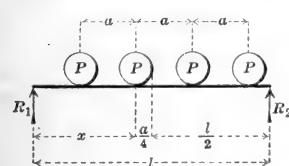

Max. V when $x=0$
 Max. M when $x = \frac{1}{4}(2l-a)$ | $R_1 = \frac{P}{l}(2l-a)$
 $V_m = R_1 = \frac{4P}{l}(l-a)$ | $M_m = \frac{Pl}{4l}(4l^2 - 8al + a^2)$
 When a exceeds $0.268l$, use case of three loads only, for M_m .

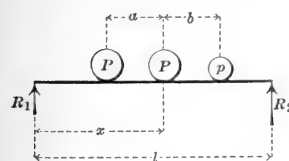

Max. V when $x=0$
 Max. M when $x = \frac{1}{2} \left[l - \frac{p(b-a)}{\sum P} \right]$ | $V_m = R_1 = \frac{l}{2} + \frac{1}{2 \sum P} (pb - Pa)$
 $V_m = R_1 = P + \left[P(l-a) + p(l-a-b) \right] \frac{1}{l}$
 $M_m = \frac{x^2 \sum P}{l} - Pa$ | Maximum moment may occur for two loads only

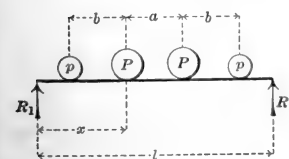

Max. V when $x=b$
 Max. M when $x = \frac{1}{4}(2l-a)$ | $V_m = R_1 = \frac{\sum P}{2l}(2l-2b-a)$
 $M_m = \frac{\sum P}{16l}(2l-a)^2 - pb$
 Maximum moment may occur for preceding case.

MOMENTS AND SHEARS FOR CONTINUOUS BEAMS

The moment factors commonly specified for continuous beams assume equal spans and uniform loads. While these factors are within safe limits for the usual conditions met with in building design, cases arise where it is advisable to investigate the actual moments and shears produced, through inequality of span and load, by the *theorem of three moments*.

This theorem may be employed in problems involving either uniform or concentrated loads or combinations of the two, but a full discussion of the theory involved would be out of place in a book of this character and, therefore, only a brief statement covering its application will be given.

In the formulas and diagrams which follow it is assumed that the moment of inertia is constant throughout the length of the beam and that the supports retain their same relative position after the beam is loaded as before.

UNIFORM LOAD

For uniform load the theorem is expressed by the formula,

$$M_1 l_1 + 2M_2(l_1 + l_2) + M_3 l_2 = -\frac{w_1 l_1^3}{4} - \frac{w_2 l_2^3}{4}$$

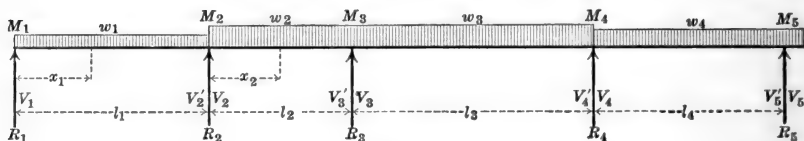

FIG. 4

The equation as written applies to the moments at the supports in span l_1 and l_2 ; by increasing all the subscripts by one it will apply to spans l_2 and l_3 and so on for as many spans as there are in the structure. It will thus be seen that there may be obtained as many equations as there are unknown moments, assuming that the moments at the first and last support are zero or their values are known. Having obtained the moments at the supports, the shears and moments at any other section of the beam may be found by the following equations.

Consider for example, spans l_1 and l_2 in Fig. 4.

$$V_1 = \frac{M_2 - M_1}{l_1} + \frac{w_1 l_1}{2}$$

$$V'_2 = V_1 - w_1 l_1$$

$$V_2 = \frac{M_3 - M_2}{l_2} + \frac{w_2 l_2}{2}$$

$$V'_3 = V_2 - w_2 l_2$$

The reaction at any support (R_1, R_2 , etc.) will be equal to the shear on its right plus that on its left with the sign reversed.

The distance to the point of zero shear, provided the shear changes sign in the span, is

$$x_1 = \frac{V_1}{w_1} \text{ for span } l_1$$

$$x_2 = \frac{V_2}{w_2} \text{ for span } l_2$$

The bending moment at this point,

$$M = M_1 + V_1 x_1 - \frac{w_1 x_1^2}{2} \text{ for span } l_1$$

$$M = M_2 + V_2 x_2 - \frac{w_2 x_2^2}{2} \text{ for span } l_2$$

If the sign of this moment is plus, it is the maximum positive moment. If the sign is minus, it is the minimum negative moment and indicates that no positive moment exists at any point of the span.

By changing the subscripts as previously mentioned the formulas may be applied to any span.

CONCENTRATED LOADS

For concentrated loads the theorem is expressed by the formula,

$$M_1 l_1 + 2M_2(l_1 + l_2) + M_3 l_2 = -\sum P_1 l_1^2 (k_1 - k_1^3) - \sum P_2 l_2^2 (2k_2 - 3k_2^2 + k_2^3)$$

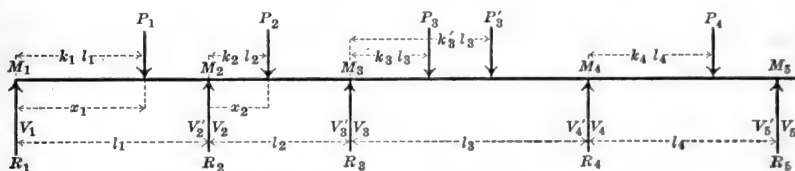

FIG. 5

Applied to spans l_3 and l_4 , Fig. 5, the formula would be written as follows:

$$M_3 l_3 + 2M_4(l_3 + l_4) + M_5 l_4 = -[P_3 l_3^2 (k_3 - k_3^3) + P'_3 l_3^2 (k'_3 - k'_3^3)] - [P_4 l_4^2 (2k_4 - 3k_4^2 + k_4^3)]$$

The shears will then be:

$$V_3 = \frac{M_4 - M_3}{l_3} + P_3(1 - k_3) + P'_3(1 - k'_3)$$

$$V'_4 = V_3 - (P_3 + P'_3)$$

$$V_4 = \frac{M_5 - M_4}{l_4} + P_4(1 - k_4)$$

$$V'_5 = V_4 - P_4$$

Knowing the moments at the supports, the shears and moments at any section may be obtained as in the case of continuous beams with uniformly distributed loads.

Careful attention must be paid to the use of the proper algebraic signs in the foregoing equations.

Equal Spans. *Uniform load over all spans:* Diagram 10, page 45, gives moment coefficients of wl^2 at critical sections of continuous beams of from two to

seven spans and Diagram 11 gives shear coefficients of wl at supports for the same case.

Example. For a beam of three spans the negative moment at the first interior support is $0.10wl^2$. The shear at the end of the middle span is $\frac{5}{10}wl$ and at the inner support of the end span it is $\frac{6}{10}wl$.

Equal Concentrated Loads on All Spans: Diagram 12, page 46, shows three cases of loading. (1) Loads at middle points. (2) Loads at third points. (3) Loads at middle and quarter points. The full irregular line is the moment curve and the broken line represents the shear line for each case of loading. The ordinates to the moment line are coefficients of Pl and the ordinates to the shear line are coefficients of P . The numerical coefficients are given at critical sections.

Example: At the central span of a five-span girder loaded at the third points, the negative moment at the adjacent support is $0.211Pl$; the positive moment at either of the loads is $0.122Pl$ and the reaction at the adjacent support is $1.93P$.

The moments and shears of any uniform load should be combined with those of the concentrated loads on the girder.

Partial Uniform Load: Diagrams 13, 14, 15 and 16, pages 47 and 48, for two and three span beams, give moment and shear coefficients that are maximum for the indicated positions of the uniform load; the ends of the beams being either free or fixed.

Unequal Spans. Uniform Load: In the design of schools, hospitals, hotels public buildings, garages and shop buildings, the layout usually involves continuous beams of unequal span. The application of the three moment theorem in such cases can best be illustrated by means of problems.

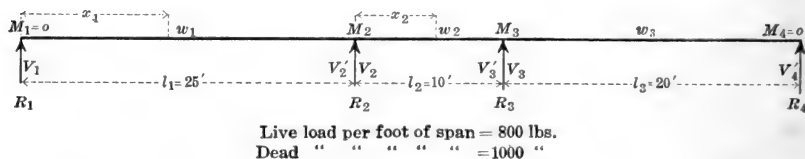
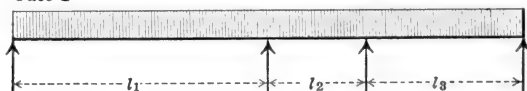

FIG. 6

Problem I. Assume a beam of three unequal spans as shown in Fig. 6, carrying a live load of 800 pounds per linear foot and a dead load of 1,000 pounds per linear foot. Find the critical moments, shears and reactions, the ends being assumed simply supported.

Case 1



Live Load on All Spans. The ends being simply supported $M_1 = M_4 = 0$. The moments M_2 and M_3 at the intermediate supports can now be found.

From page 38, $M_1 l_1 + 2M_2(l_1 + l_2) + M_3 l_2 = -\frac{w_1 l_1^3}{4} - \frac{w_2 l_2^3}{4}$
 $M_2 l_2 + 2M_3(l_2 + l_3) + M_4 l_3 = -\frac{w_2 l_2^3}{4} - \frac{w_3 l_3^3}{4}$

Substituting numerical values in these two equations:

$$\sim 70M_2 + 10M_3 = -\frac{(1,800)(25)^3}{4} - \frac{(1,800)(10)^3}{4} = -7,481,250 \dots \dots (1)$$

$$10M_2 + 60M_3 = -\frac{(1,800)(10)^3}{4} - \frac{(1,800)(20)^3}{4} = -4,050,000 \dots \dots (2)$$

Multiplying equation (1) by 6 and subtracting equation (2)

$$410M_2 = -40,837,500$$

$$M_2 = -99,604 \text{ ft. lb. and we find } M_3 = -50,899 \text{ ft. lb.}$$

Substituting in Eq. (2) $M_3 = -50,899 \text{ ft. lb.}$

From page 38, $V_1 = \frac{M_2 - M_1}{l_1} + \frac{w_1 l_1}{2}$
 $= \frac{(-99,604)}{25} + \frac{(1,800)(25)}{2} = 18,516 \text{ lb.}$

$$V'_2 = V_1 - w_1 l_1 = 18,516 - (1,800)(25) = -26,484 \text{ lb.}$$

$$V_2 = \frac{M_3 - M_2}{l_2} + \frac{w_2 l_2}{2}$$

$$= \frac{(-50,899) - (-99,604)}{10} + \frac{(1,800)(10)}{2} = 13,870 \text{ lb.}$$

$$V'_3 = V_2 - w_2 l_2 = 13,870 - (1,800)(10) = -4,130 \text{ lb.}$$

$$V_3 = \frac{M_4 - M_3}{l_3} + \frac{w_3 l_3}{2}$$

$$= \frac{-(-50,899)}{20} + \frac{(1,800)(20)}{2} = 20,545 \text{ lb.}$$

$$V'_4 = V_3 - w_3 l_3 = 20,545 - (1,800)(20) = -15,455 \text{ lb.}$$

$$R_1 = V_1 = 18,516 \text{ lbs.}$$

$$R_2 = V_2 + V'_2 = 13,870 + 26,484 = 40,354 \text{ lb.}$$

$$R_3 = V_3 + V'_3 = 20,545 + 4,130 = 24,675 \text{ lb.}$$

$$R_4 = V'_4 = 15,455 \text{ lbs.}$$

Distance from left support to point of zero shear,

$$x_1 = \frac{V_1}{w_1} = \frac{18,516}{1,800} = 10.29 \text{ ft. for span } l_1$$

$$x_2 = \frac{V_2}{w_2} = \frac{13,870}{1,800} = 7.71 \text{ ft. for span } l_2$$

$$x_3 = \frac{V_3}{w_3} = \frac{20,545}{1,800} = 11.41 \text{ ft. for span } l_3$$

$$\begin{aligned} \text{Moment at point } x_1, M &= M_1 + V_1 x_1 - \frac{w_1 x_1^2}{2} \\ &= (18,516) (10.29) - \frac{(1,800) (10.29)^2}{2} = +95,243 \text{ ft. lb.} \end{aligned}$$

This is the maximum positive moment in span l_1 for this condition of loading. Moment at point x_2 ,

$$\begin{aligned} M &= M_2 + V_2 x_2 - \frac{w_2 x_2^2}{2} \\ &= (-99,604) + (13,870) (7.71) - \frac{(1,800) (7.71)^2}{2} = -46,166 \text{ ft. lb.} \end{aligned}$$

This is the minimum negative moment in span l_2 and indicates that no positive moment exists in the span for this condition of loading, a point that is worthy of notice, as quite commonly this span is designed for positive moment only. Moment at point x_3 ,

$$\begin{aligned} M &= M_3 + V_3 x_3 - \frac{w_3 x_3^2}{2} \\ &= (-50,899) + (20,545) (11.41) - \frac{(1,800) (11.41)^2}{2} = +66,350 \text{ ft. lb.} \end{aligned}$$

If the beam is subjected to partial loading larger moments, shears and reactions may be obtained than in Case 1. The maximum values for this problem are given in the following cases when the live load is placed as shown.

Case 2

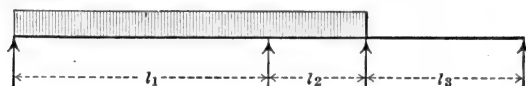

$$\begin{aligned} \text{Max. } M_2 &= -103,506 \text{ ft. lb.} \\ \text{Max. } V'_2 &= -26,640 \text{ lb.} \\ \text{Max. } V_2 &= +16,992 \text{ lb.} \\ \text{Max. } R_2 &= +43,632 \text{ lb.} \end{aligned}$$

Case 3

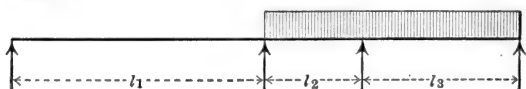

$$\begin{aligned} \text{Max. } M_3 &= -58,521 \text{ ft. lb.} \\ \text{Max. } V'_3 &= -9,465 \text{ lb.} \\ \text{Max. } V_3 &= +20,926 \text{ lb.} \\ \text{Max. } R_3 &= +30,391 \text{ lb.} \end{aligned}$$

Case 4

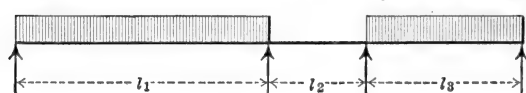

$$\begin{aligned} \text{Max. positive moment in span } l_1 &= +97,300 \text{ ft. lb.} \\ \text{Max. positive moment in span } l_3 &= +67,300 \text{ ft. lb.} \\ \text{Max. } V_1 &= +18,614 \text{ lb.} \\ \text{Max. } V'_4 &= -15,606 \text{ lb.} \\ \text{Max. } R_1 &= +18,614 \text{ lb.} \\ \text{Max. } R_4 &= +15,606 \text{ lb.} \end{aligned}$$

Case 4 also gives the position of live load for maximum negative moment at the center of span l_2 .

Problem II. Assume a beam having a long central span and two shorter end spans of equal length, as shown in Fig. 7, carrying a live load of 2,500 pounds per linear foot and a dead load of 2,200 pounds per linear foot. To find the critical moments, shears and reactions, assuming the ends simply supported.

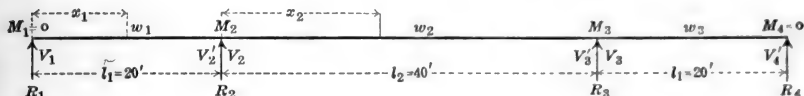

Live load per ft. of span = 2500 lb.
 Dead " " " " = 2200 "

FIG. 7

The solution of this problem involves the same procedure as that carried out in detail for Problem I, Case 1, and, therefore, the results only are tabulated below for the various cases of critical loading.

Case 1



$$M_2 = M_3 = -528,750 \text{ ft. lb.}$$

$$\text{Positive moment at point } x_1 = +44,978 \text{ ft. lb.}$$

$$\text{Positive moment at point } x_2 = +411,250 \text{ ft. lb.}$$

$$V_1 = +20,562 \text{ lbs. } V_2' = -73,438 \text{ lbs. } V_2 = +94,000 \text{ lbs.}$$

$$R_1 = 20,562 \text{ lbs. } R_2 = 167,438 \text{ lbs.}$$

Case 2



$$\text{Max. } M_2 = -544,375 \text{ ft. lb.}$$

$$\text{Max. } V_2' = -74,219 \text{ lbs.}$$

$$\text{Max. } V_2 = +95,562 \text{ lbs.}$$

$$\text{Max. } R_2 = +169,781 \text{ lbs.}$$

NOTE.—This loading gives negative reaction, $R_4 = -2,094 \text{ lb.}$

Case 3



$$\text{Max. positive moment in span } l_2 = +442,500 \text{ ft. lb.}$$

$$\text{Max. } R_2 = +169,781 \text{ lbs.}$$

NOTE.—This loading gives negative reactions R_1 and $R_4 = -2,875 \text{ lb.}$

Case 4

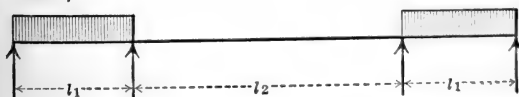

$$\text{Max. positive moment in span } l_1 = +116,294 \text{ ft. lb.}$$

$$\text{Max. } V_1 = +33,063 \text{ lbs.}$$

$$\text{Max. } R_1 = +33,063 \text{ lbs.}$$

The condition of simply supported ends assumed in Problems I and II is that which occurs when the beam frames into a brick wall. If, however, the ends frame into a column or girder, the moment at the end support will not equal zero, but will have a value depending upon the degree of fixity. This may be as large as $\frac{wl^2}{12}$ where small beams frame into heavy columns. For ordinary conditions the Joint Committee recommends a value of $\frac{wl^2}{16}$.

We will now take Problem II, Case 1, and substitute for M_1 , a value $\frac{wl_1^2}{16}$ and for M_4 , $\frac{w_3l_3^2}{16}$ and note the effect on the various moments and shears.

$$M_1 = M_4 = -\frac{wl_1^2}{16} = -\frac{(4,700)(20)^2}{16} = -117,500 \text{ ft. lb.}$$

From symmetry $M_2 = M_3$

$$M_1l_1 + 2M_2(l_1 + l_2) + M_3l_2 = -\frac{w_1l_1^3}{4} - \frac{w_3l_3^3}{4}$$

Inserting numerical values,

$$(-117,500)(20) + 120M_2 + 40M_2 = -\frac{(4,700)(20)^3}{4} - \frac{(4,700)(40)^3}{4}$$

$$160M_2 = (-9,400,000 - 75,200,000) + 2,350,000$$

$$M_2 = M_3 = \frac{(-84,600,000 + 2,350,000)}{160} = -514,063 \text{ ft. lb.}$$

$$V_1 = \frac{(-514,063) - (-117,500)}{20} + \frac{(4,700)(20)}{2} = +27,172 \text{ lb.}$$

$$V'_2 = 27,172 - (4,700)(20) = -66,828 \text{ lb.}$$

$$V_3 = \frac{(-514,063) - (-514,063)}{40} + \frac{(4,700)(40)}{2} = +94,000 \text{ lb.}$$

$$R_1 = 27,172 \text{ lb.}$$

$$R_2 = 94,000 + 66,828 = 160,828 \text{ lb.}$$

$$x_1 = \frac{27,172}{4,700} = 5.78 \text{ ft.}$$

$$\text{Moment at } x_1, M = (-117,500) + (27,172)(5.78) - \frac{(4,700)(5.78)^2}{2} = -38,955 \text{ ft. lb.}$$

$$x_2 = \frac{94,000}{4,700} = 20 \text{ ft.}$$

$$\text{Moment at } x_2, M = (-514,063) + (94,000)(20) - \frac{(4,700)(20)^2}{2} = +425,937 \text{ ft. lb.}$$

It will be noted that for Problem II, Case 1, with the ends partially restrained, negative moment exists throughout span l_1 .

USEFUL DATA

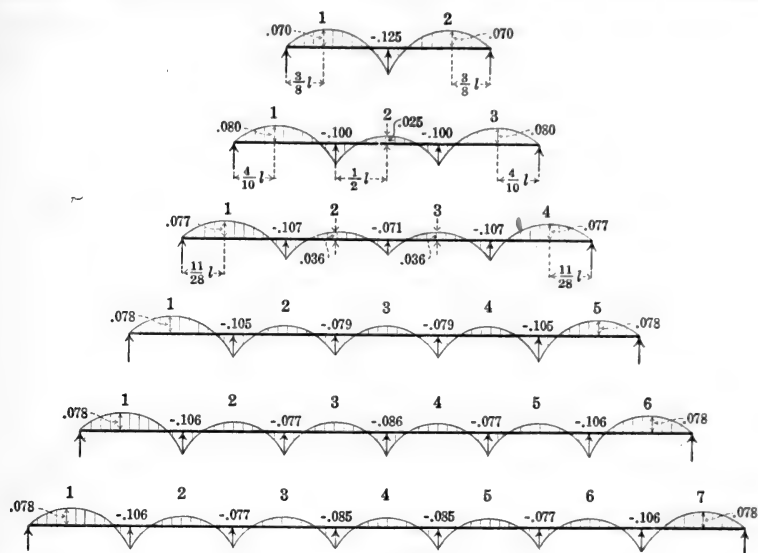

DIAGRAM 10

Moment coefficients of wl^2 for continuous beams of equal spans supported at the ends and uniformly loaded.

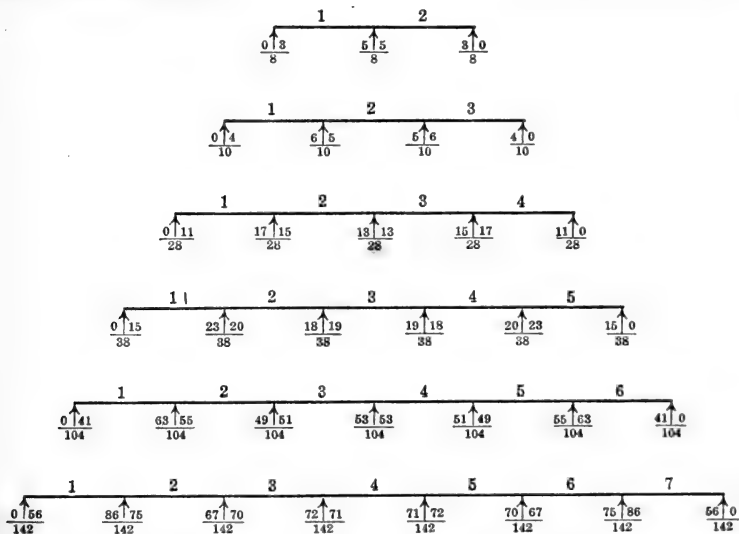
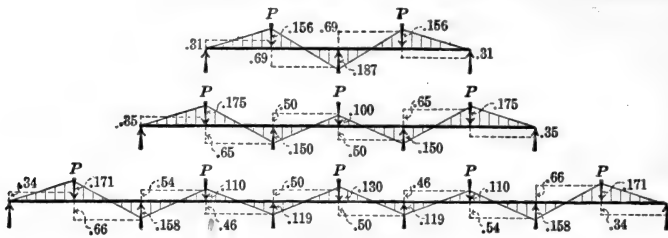
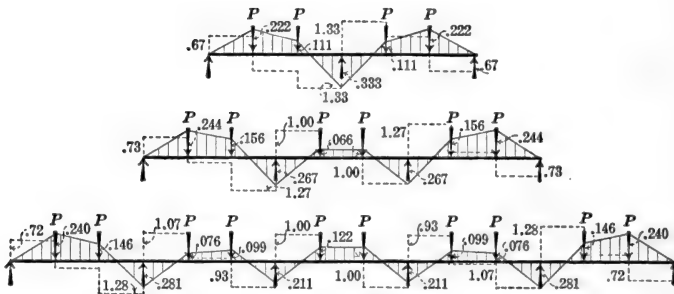

DIAGRAM 11

Shear coefficients of wl for continuous beams of equal spans supported at the ends and uniformly loaded.



Loads at Middle Points



Loads at Third Points

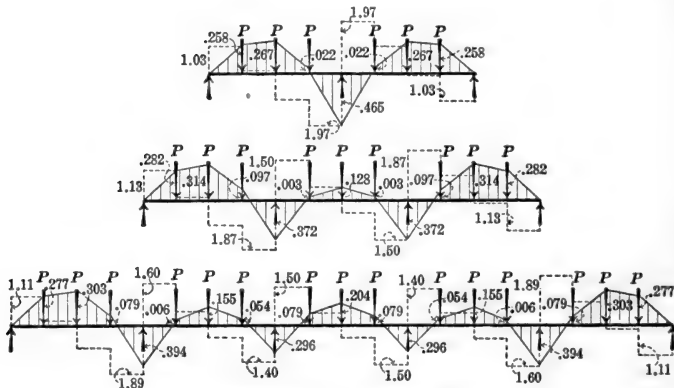

Loads at Middle and Quarter Points

DIAGRAM 12

Moment coefficient of Pl and shear coefficient of P for continuous beams of equal spans supported at the ends and loaded as indicated.

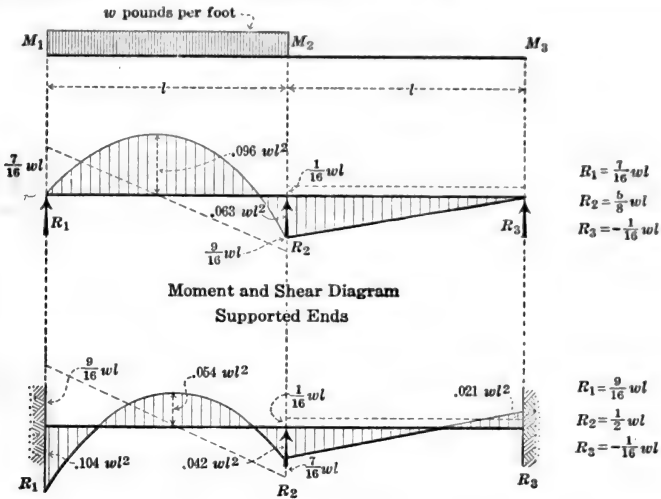

Moment and Shear Diagram
Fixed Ends

DIAGRAM 13

Moment and shear coefficients for continuous beams of two equal spans with uniformly distributed load on one span only.

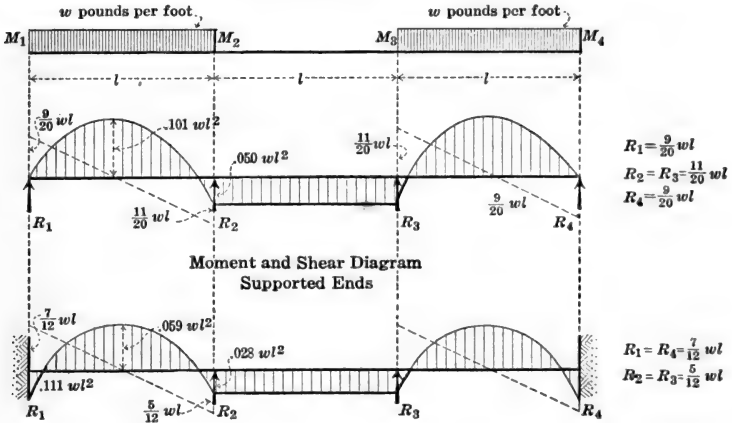

Moment and Shear Diagram
Fixed Ends

DIAGRAM 14

Moment and shear coefficients for continuous beams of three equal spans with uniformly distributed load on two end spans only.

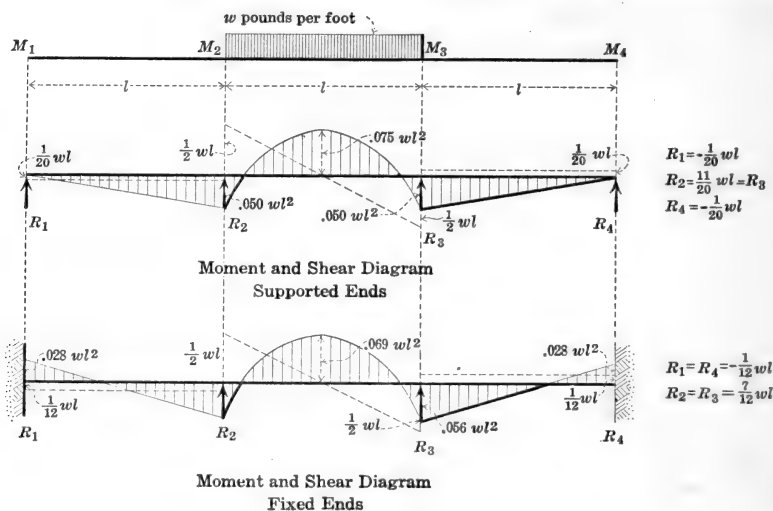

DIAGRAM 15

Moment and shear coefficients for continuous beams of three equal spans with uniformly distributed load on center span only.

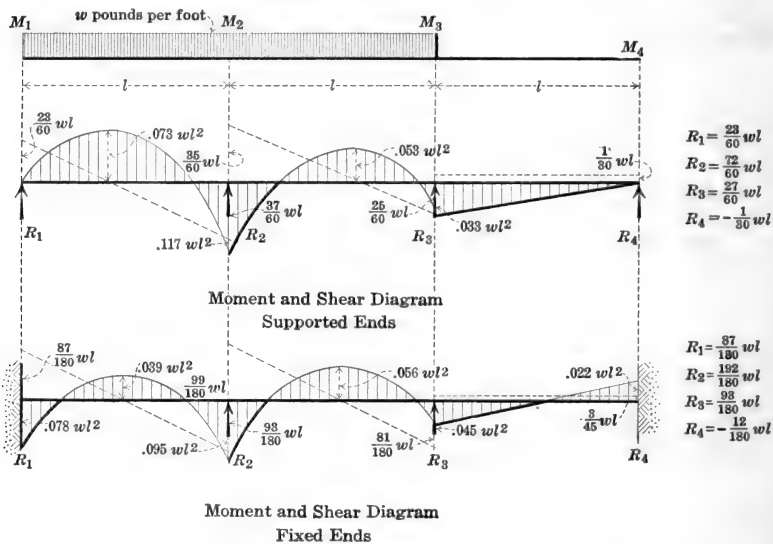

DIAGRAM 16

Moment and shear coefficients for continuous beams of three equal spans with uniformly distributed load on center and one end span only

CONTENTS OF STORAGE WAREHOUSES

Material	Weights per Cubic Foot of Space, Pounds	Height of Pile, Feet	Weights per Square Foot of Floor, Pounds	Recommended Live Loads, Pounds per Square Foot
GROCERIES, WINES, LIQUORS, ETC.				
Beans, in bags	40	8	320	250 to 300
Canned Goods, in cases	58	6	348	
Coffee, Roasted, in bags	33	8	264	
Coffee, Green, in bags	39	8	312	
Dates, in cases	55	6	330	
Figs, in cases	74	5	370	
Flour, in barrels	40	5	200	
Molasses, in barrels	48	5	240	
Rice, in bags	58	6	348	
Sal Soda, in barrels	46	5	230	
Salt, in bags	70	5	350	
Soap Powder, in cases	38	8	304	
Starch, in barrels	25	6	150	
Sugar, in barrels	43	5	215	
Sugar, in cases	51	6	306	
Tea, in chests	25	8	200	
Wines and Liquors, in barrels	38	6	228	
DRY GOODS, COTTON, WOOL, ETC.				
Burlap, in bales	43	6	258	200 to 250
Coir Yarn, in bales	33	8	264	
Cotton, in bales, compressed	18	8	144	
Cotton Bleached Goods, in cases	28	8	224	
Cotton Flannel, in cases	12	8	96	
Cotton Sheeting, in cases	23	8	184	
Cotton Yarn, in cases	25	8	200	
Excelsior, compressed	19	8	152	
Hemp, Italian, compressed	22	8	176	
Hemp, Manila, compressed	30	8	240	
Jute, compressed	41	8	328	
Linen Damask, in cases	50	5	250	
Linen Goods, in cases	30	8	240	
Linen Towels, in cases	40	6	240	
Sisal, compressed	21	8	168	
Tow, compressed	29	8	232	
Wool, in bales, compressed	48			
Wool, in bales, not compressed	13	8	104	
Wool, Worsted, in cases	27	8	216	

CONTENTS OF STORAGE WAREHOUSES

Material	Weights per Cubic Foot of Space, Pounds	Height of Pile, Feet	Weights per Square Foot of Floor, Pounds	Recommended Live Loads, Pounds per Square Foot
BUILDING MATERIALS				
Cement, Natural.	59	6	354	300 to 400
Cement, Portland	73	6	438	
Lime and Plaster	53	5	265	
HARDWARE, ETC.				
Door Checks	45			
Hinges	64			
Locks, in cases, packed	31			
Sash Fasteners	48			
Screws	101			
Sheet Tin, in boxes	278	2	556	300 to 400
Wire Cables, on reels			425	
Wire, Insulated Copper, in coils	63	5	315	
Wire, Galvanized Iron, in coils	74	4½	333	
Wire, Magnet, on spools	75	6	450	
DRUGS, PAINTS, OIL, ETC.				
Alum, Pearl, in barrels	33	6	198	
Bleaching Powder, in hogsheads	31	3½	102	
Blue Vitriol, in barrels	45	5	226	
Glycerine, in cases	52	6	312	
Linseed Oil, in barrels	36	6	216	
Linseed Oil, in iron drums	45	4	180	
Logwood Extract, in boxes	70	5	350	
Rosin, in barrels	48	6	288	200 to 300
Shellac, Gum	38	6	228	
Soda Ash, in hogsheads	62	2¾	167	
Soda, Caustic, in iron drums	88	3⅓	294	
Soda, Silicate, in barrels	53	6	318	
Sulphuric Acid	60	1⅔	100	
White Lead Paste, in cans	174	3½	610	
White Lead, dry	86	4¾	408	
Red Lead and Litharge, dry	132	3¾	495	
MISCELLANEOUS				
Glass and Chinaware, in crates	40	8	320	
Hides and Leather, in bales	20	8	160	
Hides, in bundles	37	8	296	
Paper, Newspaper and Strawboards	35	6	210	300
Paper, Writing and Calendered	60	6	360	
Rope, in coils	32	6	192	

BUILDING CODE REQUIREMENTS FOR LIVE LOAD

Structure	Baltimore	Boston	Buffalo	Chicago	Cincinnati	Indianapolis	Milwaukee	Minneapolis
Apartments	60	50	70	40	40	50	30	50
Public Rooms and Halls		100		100				
Assembly Halls			100	100	100	125		125
Fxd. Seat Auditoriums	75			100			50	
Mov. Seat Auditoriums	125						80	
Churches			100	100		125	50	
Dance Halls		200		100	150		100	
Drill Rooms		200					100	
Theaters			100	100	100	125	50	
Theater Balconies								
Theater Stairways							80	
Dwellings	60	50	40	40	40	50	30	50
Hospitals			70	50		50	30	50
Hotels	60		70	50	40	75	30	50
First Floors					100			
Corridors								
Office Rooms				50				
Manufacturing	175				150	200		
Light Manufacturing	125	125	120	100	100	100	100	100
Mercantile	125	250		100				
Retail Stores	125	125	120	100	100	100	100	100
Heavy Storehouses	250	250			150	200		
Warehouses		250	150		150	200		
Offices	75	100	70	50	50	75	40	75
First Floor	150				100	150	80	100
Corridors								
Public Buildings					100			
Schools—Class Rooms	75	60			60	100	40	100
Assembly Rooms		125	100	75			60	
Corridors							60	
Stairways							60	
Sidewalks	200				300	300	150	300
Stables, Carriage Houses, Garages	100		120	100	75	85	80	85
Stairways, General		70		100	80		60	
Fire Escapes		70						
Roofs—Slope Under 20°		40	40	25	25	30	30	50
Over 20° (Hor. Proj.)								50
Wind Pressures	30		30	20	20		30	30

BUILDING CODE REQUIREMENTS FOR LIVE LOAD

Structure	New Orleans	New York	Philadelphia	Pittsburgh	St. Louis	San Francisco	Seattle	Washington
Apartments	40		70		50	60	40	50
Public Rooms and Halls	70							75
Assembly Halls		100	120	150	100			
Fxd. Seat Auditoriums						75	75	
Mov. Seat Auditoriums						125	100	
Churches					75		75	
Dance Halls	150						100	
Drill Rooms	150						250	
Theaters					100	75	75	
Theater Balconies								
Theater Stairways							100	
Dwellings	40	40	70	70	50	60	40	50
Hospitals			70		50	60	50	
Hotels	40		70		50	60	40	50
First Floors							100	75
Corridors						125	100	75
Office Rooms								75
Manufacturing			150	200	150	250		
Light Manufacturing	125		120		100	125	125	
Mercantile	200				150			
Retail Stores	125	120	120		150	125	125	110
Heavy Storehouses			150			250		150
Warehouses	200		150	200	150	250		150
Offices	70	60	100		60	60	50	75
First Floor					100		125	
Corridors					100			110
Public Buildings	125				100			110
Schools—Class Rooms	60	75			75	75	50	75
Assembly Rooms	125						75	
Corridors						125	100	
Stairways								
Sidewalks	300	300				150		
Stables, Carriage Houses, Garages					100	75	75	
Stairways, General	70						100	
Fire Escapes	70						100	
Roofs—Slope under 20°	30	40	30	50	30	30	40	25
Over 20° (Hor. Proj.)			30			20	40	25
Wind Pressures		30	30		30	20		30

WEIGHTS OF MATERIAL

Substance	Weight, Pounds per Cubic Foot	Substance	Weight, Pounds per Cubic Foot
ASHLAR MASONRY		EARTH, ETC., EXCAVATED.	
		(CONTINUED)	
Granite, syenite, gneiss	165	Earth, dry, loose	76
Limestone, marble	160	Earth, dry, packed	95
Sandstone, bluestone	140	Earth, moist, loose	78
MORTAR RUBBLE MASONRY		Earth, moist, packed	96
Granite, syenite, gneiss	155	Earth, mud, flowing	108
Limestone, marble	150	Earth, mud, packed	115
Sandstone, bluestone	130	Riprap, limestone	80-115
DRY RUBBLE MASONRY		Riprap, sandstone	90
Granite, syenite, gneiss	130	Riprap, shale	105
Limestone, marble	125	Sand, gravel, dry, loose	90-105
Sandstone, bluestone	110	Sand, gravel, dry, packed	100-120
BRICK MASONRY		Sand, gravel, dry, wet	118-120
Pressed brick	140	EXCAVATION IN WATER	
Common brick	120	Sand or gravel	60
Soft brick	100	Sand or gravel and clay	65
CONCRETE MASONRY		Clay	80
Cement, stone, sand	144	River mud	90
Cement, slag, etc.	130	Soil	70
Cement, cinder, etc.	100	Stone riprap	65
VARIOUS BUILDING MATERIALS		MINERALS	
Ashes, cinders	40-45	Asbestos	153
Cement, Portland, loose	90	Barytes	281
Cement, Portland, set	183	Basalt	184
Lime, gypsum, loose	53-64	Bauxite	159
Mortar, set	103	Borax	109
Slags, bank slag	67-72	Chalk	137
Slags, bank screenings	98-117	Clay, marl	137
Slags, machine slag	96	Dolomite	181
Slags, slag sand	49-55	Feldspar, orthoclase	159
EARTH, ETC., EXCAVATED		Gneiss, serpentine	159
Clay, dry	63	Granite, syenite	175
Clay, damp, plastic	110	Greenstone, trap	187
Clay and gravel, dry	100	Gypsum, alabaster	159
		Hornblende	187

WEIGHTS OF MATERIAL

Substance	Weight, Pounds per Cubic Foot	Substance	Weight, Pounds per Cubic Foot
MINERALS—CONTINUED		COAL, PILED—CONTINUED	
Limestone, marble	165	Coal, peat, turf	20-26
Magnesite	187	Coal, charcoal	10-14
Phosphate rock, apatite	200	Coal, coke	23-32
Porphyry	172		
Pumice, natural	40		
Quartz, flint	165		
Sandstone, bluestone	147		
Shale, slate	175		
Soapstone, talc	169		
STONE, QUARRIED, PILED		METALS, ALLOYS, ORES	
Basalt, granite, gneiss	96	Aluminum, cast-hammered	165
Limestone, marble, quartz	95	Aluminum, bronze	481
Sandstone	82	Brass, cast-rolled	534
Shale	92	Bronze, 7.9 to 14% Sn	509
Greenstone, hornblende	107	Copper, cast-rolled	556
		Copper, ore pyrites	262
		Gold, cast-hammered	1205
		Iron, cast, pig	450
		Iron, wrought	485
		Iron, steel	490
		Iron, speigel-eisen	468
		Iron, ferro-silicon	437
		Iron, ore, hematite	325
		Iron, ore limonite	237
		Iron, ore magnetite	315
		Iron, slag	172
		Lead	710
		Lead, ore, galena	465
		Manganese	475
		Manganese ore, pyrolusite	259
		Mercury	849
		Nickel	565
		Nickel monel metal	556
		Platinum, cast-hammered	1330
		Silver, cast-hammered	656
		Tin, cast-hammered	459
		Tin, ore, cassiterite	418
		Zinc, cast-rolled	440
		Zinc, ore, blende	253
BITUMINOUS SUBSTANCES			
Asphaltum	81		
Coal, anthracite	97		
Coal, bituminous	84		
Coal, lignite	78		
Coal, peat, turf, dry	47		
Coal, charcoal, pine	23		
Coal, charcoal, oak	33		
Coal, coke	75		
Graphite	131		
Paraffine	56		
Petroleum	54		
Petroleum refined	50		
Petroleum benzine	46		
Petroleum gasoline	42		
Pitch	69		
Tar, bituminous	75		
COAL AND COKE, PILED			
Coal, anthracite	47-58		
Coal, bituminous, lignite	50-54		

WEIGHTS OF MATERIAL

Substance	Weight, Pounds per Cubic Foot	Substance	Weight, Pounds per Cubic Foot
VARIOUS SOLIDS		TIMBER—CONTINUED	
Cereal, oats, bulk	32	Maple, hard	43
Cereal, barley, bulk	39	Maple, white	33
Cereal, corn, rye, bulk	48	Oak, chestnut	54
Cereal, wheat, bulk	48	Oak, live	59
Hay and Straw, bales	20	Oak, red, black	41
Cotton, Flax, Hemp	93	Oak, white	46
Fats	58	Pine, Oregon	32
Flour, loose	28	Pine, red	30
Flour, pressed	47	Pine, white	26
Glass, common	156	Pine, yellow, long-leaf	44
Glass, plate or crown	161	Pine, yellow, short-leaf	38
Glass, crystal	184	Poplar	30
Leather	59	Redwood, California	26
Paper	58	Spruce, white, black	27
Potatoes, piled	42	Walnut, black	38
Rubber, caoutchouc	59	Walnut, white	26
Rubber, goods	94	Moisture Contents:	
Salt, granulated, piled	48	Seasoned timber 15 to 20%	
Saltpeter	67	Green timber up to 50%	
Starch	96		
Sulphur	125		
Wool	82		
		VARIOUS LIQUIDS	
		Alcohol, 100%	49
		Acids, muriatic 40%	75
		Acids, nitric 91%	94
		Acids, sulphuric 87%	112
		Lye, Soda, 66%	106
		Oils, vegetable	58
		Oils, mineral, lubricants	57
		Water, 4°C, max. density	62.428
		Water, 100°C	59.830
		Water, ice	56
		Water, snow, fresh fallen	8
		Water, sea water	64
		GASES, AIR=1	
		Air, 0°C. 760 mm.0807
TIMBER, U. S. SEASONED			
Ash, white-red	40		
Cedar, white-red	22		
Chestnut	41		
Cypress	30		
Elm, White	45		
Fir, Douglas spruce	32		
Fir, eastern	25		
Hemlock	29		
Hickory	49		
Locust	46		

WEIGHTS OF BUILDING MATERIALS

Kind	Weight in lb. per sq. ft.
FLOORS	
3/8" Maple finish floor and 7/8" Spruce under floor on 2" x 4" sleepers, 16" centers, with 2" dry cinder concrete filling	18
Cinder concrete filling per inch of thickness	7
Cement finish per inch of thickness	12
Asphalt mastic flooring 1 1/2" thick	18
3" creosoted wood blocks on 3/4" mortar base	21
Solid flat tile on 1" mortar bed	23
CEILING	
Plaster on tile or concrete	5
Suspended Metal Lath and plaster	10
ROOFS	
Five-ply felt and gravel	6
Four-ply felt and gravel	5 1/2
Three-ply ready roofing	1
Cement Tile	16
Slate, 1/2" thick	9 1/2
Sheathing, 1" thick, Yellow Pine	4
2" Book Tile	12
3" Book Tile	20
Skylight with galvanized iron frame, 3/8" glass	6

Kind	WEIGHT IN LB. PER SQ. FT.		
	Unplastered	One Side Plastered	Both Sides Plastered
WALLS			
9" Brick Wall	84	89	
13" Brick Wall	121	126	
18" Brick Wall	168	173	
22" Brick Wall	205	210	
26" Brick Wall	243	248	
4" Brick, 4" Tile Backing	60	65	
4" Brick, 8" Tile Backing	75	80	
9" Brick, 4" Tile Backing	102	107	
8" Tile	33	38	43
12" Tile	45	50	55
PARTITIONS			
3" Clay Tile	17	22	27
4" Clay Tile	18	23	28
6" Clay Tile	25	30	35
8" Clay Tile	31	36	41
10" Clay Tile	35	40	45
3" Gypsum Block	10	15	20
4" Gypsum Block	12	17	22
5" Gypsum Block	14	19	24
6" Gypsum Block	16	21	26
2" Solid Plaster			20
4" Solid Plaster			32
4" Hollow Plaster			22

MASONRY

Kind	Weight in lb. per cu. ft.	Kind	Weight in lb. per cu. ft.
Concrete, cinder	110	Mortar rubble, sandstone	130
Concrete, stone	140 to 150	Mortar rubble, limestone	150
Concrete, reinforced stone	150	Mortar rubble, granite	155
Brick masonry, soft	100	Ashlar sandstone	140
Brick masonry, common	125	Ashlar limestone	160
Brick masonry, pressed	140	Ashlar granite	165

FLOORS AND ROOFS—WITH EXPLANATION OF TABLES

Types. The selection of the best type of floor and roof construction depends upon the spans, loads to be carried, character of the building and local conditions. Buildings readily divide themselves into two general groups,—those primarily for the housing of people, and those for warehousing and industrial purposes.

In structures of the first group, comprising office and public buildings, schools, hospitals, hotels, apartments, dwellings and garages the majority of the spans are long and the loads light (40 to 125 pounds per square foot). Such conditions require a greater depth of slab, to avoid undue deflection, than would be demanded for strength alone, and the problem is usually solved through the use of a concrete ribbed floor employing clay or composition tile, metal or wood forms of whatever depth may be necessary. In the case of clay or composition tile they always remain a part of the permanent floor and may be said to represent the best type of form or filler for concrete ribbed slabs; they add stiffness and strength to the construction and in no way detract from its fireproofness. To reduce the cost, however, metal forms are frequently used and may be of either the removable or permanent type. Permanent metal forms are of light gauge steel sheets, stiffened transversely by corrugations, to enable them to withstand the loads and impacts of service; they add nothing to the structural efficiency of the floor and, in fact, may damage the concrete through expansion of the exposed metal in case of fire. For this reason, if metal forms are used, those of a removable type would seem the proper selection.

For buildings in the warehouse and industrial group the loads usually vary from 125 to 500 pounds per square foot. Where the panels are square, or approximately so, the flat slab type of floor presents the utmost advantages structurally and economically. If, however, the ratio of length of short to long side of panel exceeds $1:1\frac{1}{8}$, a beam and girder floor with solid concrete slabs should generally be used.

Treatment. All beams, including the ribs in concrete ribbed slabs, may be classed under one of two types—rectangular or T-section. In rectangular beams, the concrete above the neutral axis within the limits of the width of the beam must resist the total compressive stress (assisted in special cases by additional steel in the compression area); whereas, in the T-section beam the flange, when built monolithically with the web, materially increases the compressive resistance of the beam and consequently its carrying capacity.

The tables of safe loads for ribbed slabs, continuous or partially continuous, are based on a length of span equal to the distance center to center of supports, with the condition that the tile or form, as the case may be, shall extend to within not less than twelve inches of the center of support as indicated by the illustrations at the head of the tables. The critical section for bending is usually at this point and as the ratio between the bending moment here and at the center of span varies with each change of span, it would be uneconomical to maintain a constant steel area for each fixed depth of slab on all spans. In these tables the proper steel area for each depth and span length is given.

Load and Moment Conditions. The carrying capacity of beams and slabs is dependent upon the condition of fixity at the supports and the stresses allowed in the

steel and concrete. The safe load tables, pages 61 to 106 inclusive, have been prepared on the basis of two different stress combinations and for moments of $\frac{wl^2}{8}$, $\frac{wl^2}{10}$ and $\frac{wl^2}{12}$. The governing conditions are stated in the heading of each table.

It is important to note that in the case of ribbed slabs or of T-beams continuous over supports, that the critical compressive stress usually occurs at the supports where the flange is in tension and the stem of the beam is in compression, thereby resolving the problem into that of a beam of rectangular section. However, as only a short section of the beam is under maximum compression at this point it is considered entirely permissible to employ a higher unit stress in the concrete here than at the center of span. This feature has been carefully considered in preparing the tables for continuous or semi-continuous ribbed slabs and T-beams and the maximum fibre stress in the concrete at supports has been held to a value not exceeding 15% greater than the fibre stress noted in the table. This is in accordance with the recommendations of the Joint Committee on Concrete and Reinforced Concrete.

In the case of T-beams continuous over supports the straight bars in the bottom of the beam are considered to act as compressive reinforcement and should be carried past the face of the support a sufficient distance to develop their stress in bond.

Shear. After selecting from the tables the proper slab or beam to be used for any particular load, special attention should be given to the shear reinforcement required. For the solid concrete slabs the loads given produce shears of less than forty pounds per square inch on the area bjd . For the concrete ribbed slabs loads to the left of the heavy stepped line produce shears in excess of ninety pounds per square inch on bjd and vertical stirrups should be used in addition to the bent up bars in the ribs.

In the case of the beam tables, to satisfy the majority of code requirements, stirrups will have to be provided. Particular attention is called to the fact that all loads to the left of the heavy stepped line produce shears in excess of 120 pounds per square inch on bjd .

Fireproofing. In preparing the tables the depth of fireproofing under the reinforcement was taken at $\frac{3}{4}$ in. for solid and ribbed slabs and $1\frac{1}{2}$ in. for beams. As the fireproofing determines the effective depth for any given slab or beam it will be necessary to increase or reduce the table load should a change be made in the amount of fireproofing. This may be effected by multiplying the sum of the superimposed and dead loads of the table by the square of the ratio of the new effective depth to the given effective depth. This gives the new total load from which should be deducted the dead load in order to obtain the new superimposed load.

The following examples illustrate the use of the tables:

Solid Concrete Slabs. Given a floor layout consisting of solid concrete slabs, continuous over beams spaced 12'-0" in the clear. The floor to carry a live load of 150 pounds per square foot, a wood finish on sleepers embedded in 2 inches of cinder concrete and a plastered ceiling; the finish and plaster weighing together 25 pounds per square foot, giving a total superimposed load of 175 pounds per square foot. The stress in the steel not to exceed 16,000 pounds per square inch and in the concrete 650 pounds per square inch.

The table on page 63 for slabs continuous over supports and based on the specified unit stresses shows that a 6½-inch slab reinforced with ⅝" round bars, 7½ inches on centers, will carry 178 pounds per square foot.

Concrete Ribbed Slabs—Clay Tile Fillers: Given a floor of 22'-0" span, non-continuous. This floor is to carry a live load of 70 pounds per square foot, a wood floor on cinder concrete fill and a plastered ceiling; the finish and plaster weighing together 27 pounds per square foot, thus giving a total superimposed load of 97 pounds per square foot. Steel stress 16,000 pounds per square inch and concrete 650 pounds per square inch.

The table on page 67 for non-continuous slabs shows that a 10"+2½" slab with 1.15 square inches of steel in each rib will carry 106 pounds per square foot and a 12"+2" slab with 1.04 square inches of steel will carry 112 pounds per square foot. If the 10"+2½" slab is selected the area of steel called for in the table may be reduced in the ratio of actual total load per square foot to the total carrying capacity per square foot or,

$$\text{New steel area} = (1.15) \left(\frac{97+87}{106+87} \right) = 1.10 \text{ sq. in. per rib.}$$

This area may be secured by using 1¼" rounds and 1⅝" rounds in alternate ribs or 2¾" squares in each rib. If the 12"+2" slab is used the table area of 1.04 square inches may be similarly reduced to 0.96 square inch and a 1⅝" round bar placed in each rib.

Concrete Ribbed Slabs—Steel or Wood Forms. Consider a floor slab of 21'-0" span continuous on one end only. The floor is to carry a live load of 80 pounds per square foot, a wood floor on cinder concrete fill weighing 18 pounds per square foot and a ceiling of plaster on metal lath weighing 10 pounds per square foot, giving a total superimposed load of 108 pounds per square foot.

The table on page 74 gives for a 12"+3" slab reinforced with 1.30 square inches of steel in each rib a carrying capacity of 122 pounds per square foot. As this is in excess of the requirements the table area of steel may be reduced as in the previous example and an area of 1.20 square inches used. This area is secured by using 2-⅞" round bars in each rib.

Tebeams,—Continuous over supports. Determine size and reinforcement of a beam in a floor construction assuming the span to be 22 feet, the superimposed load 200 pounds per square foot, the floor slab 4½" thick and the distance center to center of beams as 7'-0". The beam is continuous over supports and the unit stresses employed are to be as follows: f_s , 16,000; f_c , 650; and v , 120. Haunches are not to be used at the ends of the beams. This represents the type of beam usually encountered in building construction commonly referred to as a T-beam, but due to the continuity at supports its capacity must necessarily be rated on the section of the web of the beam rather than upon the T-section at center of span.

From the data given the total load per square foot of floor, including the weight of the slab, is found to be 256 pounds per square foot, or 1,792 pounds per linear foot of beam. By referring to the table on page 98 it will be found that a 10" x 26" beam reinforced with 4-1" round bars will carry, exclusive of the weight of beam, 1,927 pounds, which from a practical standpoint fulfills the conditions of the problem.

If it is required to maintain a minimum depth of beam it will be found that a 14" x 22" beam, reinforced with 6- $\frac{7}{8}$ " round bars will carry the load. It will be noted, however, that the shallower beam requires more steel and concrete.

To determine the number of stirrups required for the 10" x 26" beam, find the end shear.

$$v = \frac{(2,062) \left(\frac{22}{2}\right)}{\left(\frac{7}{8}\right) (10) (23)} = 113 \text{ lb. per sq. in.}$$

From the table on page 107 for an end shear of 120 pounds per square inch a 10-inch beam of 22 foot span requires 20- $\frac{3}{8}$ " round stirrups, and for an end shear of 100 pounds per square inch, 14- $\frac{3}{8}$ " round stirrups. As the actual end shear is 113 pounds per square inch, by interpolation, 18- $\frac{3}{8}$ " round stirrups will be sufficient.

In the tables which follow the endeavor has been made to give a fairly wide range of values from which to make the desired selection of size of member and reinforcement required, so that knowing the load and span the designer may enter the tables and choose the beam or slab which best meets the needs of his particular case, much as he would select a beam from a safe load table in a structural steel handbook.

SOLID CONCRETE SLABS—SIMPLE SPANS

Bending Moment

$$M = \frac{1}{8} w l^2$$

Unit Stresses
f_s, 16,000
f_c, 650

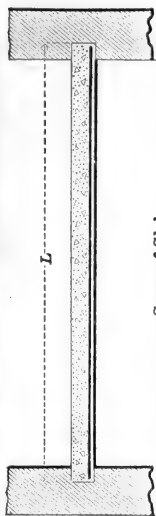

Span of Slab

No. of Reinforcing Bars	Size of Bars	SPAN OF SLAB IN FEET																															
		4	4 1/2	5	5 1/2	6	6 1/2	7	7 1/2	8	8 1/2	9	9 1/2	10	10 1/2	11	11 1/2	12	12 1/2	13	13 1/2	14	14 1/2	15	15 1/2	16	16 1/2	17	17 1/2	18			
3	37 3/8	191	143	109	83	64	49	37																									
3 1/2	44 3/8	311	236	183	144	114	90	72	57	45	35																						
4	50 1/2	434	333	260	206	165	133	108	88	71	57	46	36																				
4 1/2	56 1/2	585	451	354	284	230	188	154	126	105	86	71	58	47	37																		
5	62 1/2	784	607	480	386	314	258	214	179	150	125	105	88	73	61	50	40	32															
5 1/2	69 5/8	988	766	608	490	401	331	276	232	195	165	140	118	100	84	71	59	49	39	31													
6	75 5/8	963	766	621	510	423	355	299	254	216	185	158	136	116	99	84	71	60	50	41	32												
6 1/2	81 5/8	916	743	611	509	428	362	308	264	226	195	168	145	125	107	92	78	66	56	46	37	30											
7	87 5/8	926	764	638	538	458	392	338	291	253	219	191	166	145	126	109	94	81	69	59	49	41	33										
7 1/2	94 5/8	907	758	641	546	469	404	351	305	266	233	204	178	156	136	119	104	90	77	66	56	47	38										
8	100 3/4	848	717	612	526	454	394	344	300	263	231	203	178	156	137	120	104	90	78	66	56	47	38	30									
8 1/2	106 3/4	974	825	705	607	525	457	399	350	308	271	239	210	186	164	144	126	110	96	83	72	61	52	43	35								
9	112 3/4	950	813	701	608	531	464	408	360	318	282	249	221	196	174	153	135	119	104	91	79	68	58	49									
9 1/2	119 3/4	933	806	700	612	537	473	417	370	329	292	260	231	206	183	162	144	127	112	98	86	74	64										
10	125 7/8	904	786	688	617	546	484	432	386	344	309	277	249	224	201	180	162	145	130	116	103	91											

Safe Superimposed Load in Pounds per Square Foot

SOLID CONCRETE SLABS—END SPANS

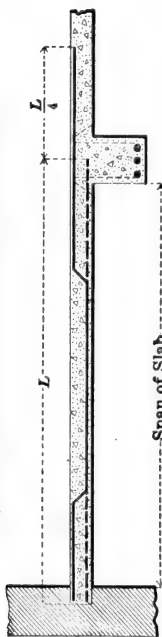

Bending Moment

$$M = \frac{1}{10}wl^2$$

Unit Stresses
 f_s , 16,000
 f_c , 650

Thickness of Slab	RD. BARS	SPAN OF SLAB IN FEET																																
		4	4½	5	5½	6	6½	7	7½	8	8½	9	9½	10	10½	11	11½	12	12½	13	13½	14	14½	15	15½	16	16½	17	17½	18				
3	37 ¾	248	188	145	113	89	71	56	44	34	26																							
3½	44 ¾	400	307	240	191	153	124	101	82	67	54	44	35																					
4	50 ½	555	428	337	270	219	179	147	122	101	84	69	57	47	38	30																		
4½	56 ½	745	578	458	369	300	248	206	172	145	122	103	86	72	61	50	41	33																
5	62 ½	774	615	498	408	338	284	239	202	172	147	125	107	91	78	66	55	46	38	31														
5½	69 ¾	777	630	518	431	363	307	261	223	192	165	142	123	106	91	77	66	56	47	39	31	25												
6	75 ¾	794	656	548	462	392	336	289	250	217	188	164	143	124	108	93	81	69	59	50	42	34	28											
6½	81 ¾	784	655	554	472	405	350	303	264	230	201	176	154	135	118	103	90	78	67	57	48	41	33											
7	87 ¾	695	594	512	443	387	337	296	260	229	203	179	158	139	124	108	95	83	72	62	53	45	38	31										
7½	94 ¾	707	610	529	462	405	356	314	278	246	219	194	172	153	136	120	106	93	82	71	62	53	45											
8	100 ¾	682	593	518	455	400	354	314	278	248	220	196	174	155	138	122	108	95	84	73	63	54												
8½	106 ¾	684	598	526	464	412	365	325	290	259	232	207	185	165	148	131	117	103	91	80	70													
9	112 ¾	691	609	538	478	425	380	339	304	273	244	220	197	177	159	142	127	113	100	88														
9½	119 ¾	701	621	552	492	441	395	355	319	286	258	232	209	188	170	152	137	122	109															
10	125 ¾	698	621	555	497	446	401	362	326	295	266	241	217	196	177	159	143	129																

Safe Superimposed Load in Pounds per Square Foot

SOLID CONCRETE SLABS—CONTINUOUS OVER SUPPORTS

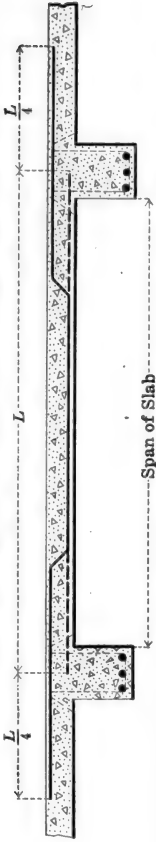

Bending Moment

$$M = \frac{1}{12} w l^2$$

Unit Stresses
 $f_s, 16,000$
 $f_c, 650$

R. D. BARS		SPAN OF SLAB IN FEET																																				
Slab Thickness	Slab Width	Bar Size	Space	Safe Superimposed Load in Pounds per Square Foot																																		
in.	lb.	in.	in.	4	4½	5	5½	6	6½	7	7½	8	8½	9	9½	10	10½	11	11½	12	12½	13	13½	14	14½	15	15½	16	16½	17	17½	18						
3	37	¾	7	304	233	181	143	115	92	74	60	48	39	30																								
3½	44	¾	5½	489	377	297	238	193	158	130	107	89	74	61	50	41	33																					
4	50	½	8½	677	524	414	334	273	225	187	156	131	111	93	79	66	55	46	38	31																		
4½	56	½	7½	560	453	371	308	258	218	184	157	134	115	98	83	71	61	51	43	35																		
5	62	½	6½	609	502	419	352	299	255	219	188	163	141	122	106	91	79	68	58	49	41	34	28															
5½	69	⅝	9					636	531	449	382	327	282	244	212	185	161	141	123	107	93	81	70	60	51	44	36	30										
6	75	⅝	8							569	486	419	362	315	275	241	211	186	163	144	127	112	98	86	75	65	56	48	41	34								
6½	81	⅝	7½								584	503	436	380	333	293	258	228	201	178	158	140	124	110	96	85	74	65	56	48	41	34						
7	87	⅝	6½									631	549	490	422	373	329	293	260	232	207	185	165	147	131	117	104	92	81	72	63	55						
7½	94	⅝	6										574	504	446	396	352	315	281	252	226	202	182	162	146	130	117	104	93	82	73							
8	100	¾	8½											565	500	445	396	354	317	284	255	230	207	185	167	150	135	120	108	96	85							
8½	106	¾	8											579	515	459	412	369	332	299	270	243	219	198	178	171	145	130	117	105								
9	112	¾	7½													596	534	478	430	388	350	316	286	259	235	212	193	174	158	142	129							
9½	119	¾	7															552	497	449	406	368	334	303	276	250	228	207	188	171	155							
10	125	⅞	9																	561	506	459	417	379	344	314	285	261	237	217	179	180						

SOLID CONCRETE SLABS—SIMPLE SPANS

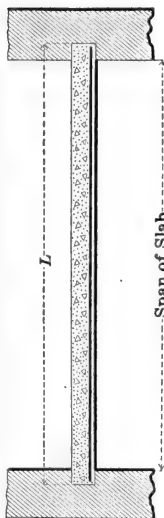

Bending Moment

$$M = \frac{1}{8}wl^2$$

Unit Stresses
 f_s , 18,000
 f_c , 700

Thickness of Slab	RD. BARS	SPAN OF SLAB IN FEET																															
		4	4½	5	5½	6	6½	7	7½	8	8½	9	9½	10	10½	11	11½	12	12½	13	13½	14	14½	15	15½	16	16½	17	17½	18			
3	37 ¾	202	152	116	89	69	54	41	31																								
3½	44 ¾	327	249	194	152	121	97	77	61	49	38	29																					
4	50 ½	461	354	277	220	177	144	117	95	78	63	51	41	32																			
4½	56 ½	622	479	378	302	246	208	165	137	113	94	77	64	52	42	33																	
5	62 ½	824	638	505	406	332	273	227	190	159	134	113	95	80	66	55	45	36															
5½	69 ½	840	668	540	443	367	307	259	219	186	158	135	115	98	83	70	59	49	40	32													
6	75 ½	813	659	542	451	379	320	272	232	199	171	147	126	108	93	79	67	56	47	38													
6½	81 ½	791	651	542	457	387	330	283	244	211	183	158	136	118	102	87	75	63	53	44	36												
7	87 ½	808	676	571	486	417	359	311	270	235	205	179	157	135	119	104	90	77	66	56	47	39	31										
7½	94 ½	800	677	578	496	429	372	324	284	248	218	191	168	147	128	113	98	85	74	63	53	44	36										
8	100 ¾	907	769	657	566	489	426	372	326	286	252	222	196	172	152	133	117	102	89	77	66	56	47	39	31								
8½	106 ¾	883	756	651	564	492	430	379	333	296	260	230	204	180	159	141	124	109	95	83	71	61	52	43									
9	112 ¾	867	748	650	568	498	439	387	343	304	270	240	214	190	169	149	132	117	103	90	78	68	58										
9½	119 ¾	855	743	650	571	504	446	396	352	314	280	250	223	199	177	158	140	124	109	96	84	73											
10	125 ¾		859	752	662	586	520	462	412	369	330	294	265	238	213	191	170	153	135	121	107	94											

Safe Superimposed Load in Pounds per Square Foot

SOLID CONCRETE SLABS—END SPANS

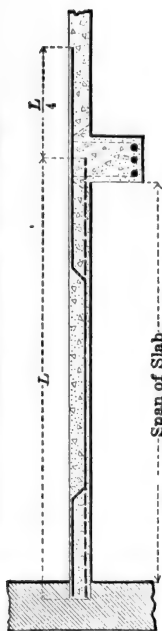

Bending Moment

$$M = \frac{1}{10} w l^2$$

Unit Stresses
 f_s , 18,000
 f_c , 700

Span of Slab in.	Rd. Bar	in.	SPAN OF SLAB IN FEET																Unit Stresses																
			Safe Superimposed Load in Pounds per Square Foot																	f_s , 18,000	f_c , 700														
			4	4½	5	5½	6	6½	7	7½	8	8½	9	9½	10	10½	11	11½				12	12½	13	13½	14	14½	15	15½	16	16½	17	17½	18	
3	37	¾	262	199	155	121	96	76	61	48	38	29																							
3½	44	¾	420	323	253	201	162	132	107	88	72	59	48	38	30																				
4	50	½	589	455	359	288	234	192	158	132	110	91	76	63	52	43	34																		
4½	56	½	614	486	392	321	265	221	185	156	132	111	94	80	67	56	46	38	31																
5	62	½	647	524	431	358	300	253	215	183	157	133	115	98	84	72	61	51	43	35															
5½	69	½	692	571	476	401	340	291	250	215	186	161	140	121	105	91	78	67	58	48	40	33													
6	75	½	696	582	491	419	359	309	267	232	202	177	154	135	117	102	89	77	66	57	48	40	33												
6½	81	½	699	591	505	434	375	325	284	248	218	191	168	148	130	114	100	87	75	65	56	47	40	33											
7	87	½	735	629	543	471	410	359	316	278	245	217	193	171	151	134	118	104	92	80	70	61	52	42	37										
7½	94	½	746	644	560	490	429	378	334	296	263	234	208	185	165	147	130	116	102	90	79	69	60	52											
8	100	¾	731	636	557	490	432	383	340	302	269	240	215	192	171	153	136	121	108	95	84	73	64												
8½	106	¾	732	642	565	500	443	395	352	314	282	252	226	203	182	163	146	130	116	103	91	81													
9	112	¾	738	650	576	512	456	408	365	328	295	265	239	214	194	174	156	140	126	112	100														
9½	119	¾	744	660	587	524	470	422	379	342	308	278	251	227	205	185	167	150	135	121															
10	125	¾	763	681	610	547	492	443	400	362	328	297	270	244	222	201	182	165	149																

Solid Concrete Slabs

SOLID CONCRETE SLABS—CONTINUOUS OVER SUPPORTS

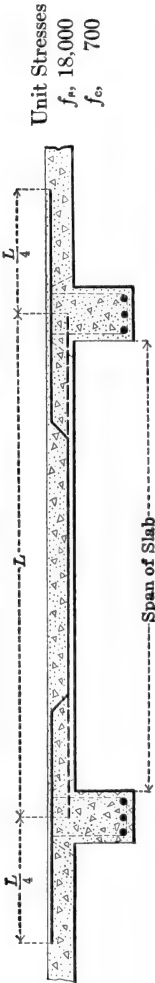

Bending Moment

$$M = \frac{1}{12} w l^2$$

Span in.	RD. BARS	SPAN OF SLAB IN FEET																	Unit Stresses f_s , 18,000 f_c , 700													
		4	4½	5	5½	6	6½	7	7½	8	8½	9	9½	10	10½	11	11½	12		12½	13	13½	14	14½	15	15½	16	16½	17	17½	18	
3	37 ¾	322	247	193	153	123	99	80	65	53	42	34																				
3½	44 ¾	513	396	312	251	204	167	138	114	95	79	66	55	45	37																	
4	50 ½	556	441	356	291	240	200	168	142	120	102	86	73	60	51	43	35															
4½	56 ½	594	482	396	329	276	233	198	169	145	124	107	91	78	67	57	48	40	33													
5	62 ½	641	529	442	372	316	270	232	200	173	151	131	113	99	86	74	64	55	46	39	32											
5½	69 ½																															
6	75 ½																															
6½	81 ½																															
7	87 ½																															
7½	94 ½																															
8	100 ¾																															
8½	106 ¾																															
9	112 ¾																															
9½	119 ¾																															
10	125 ¾																															

CLAY TILE RIBBED SLABS—SIMPLE SPANS

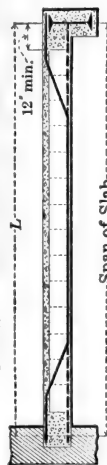

Bending Moment

$$M = \frac{1}{8} w l^2$$

Unit Stresses
 f_s , 16,000
 f_c , 650

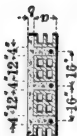

a+b in.	Weight of Slab per sq. ft. lb.	Steel Area in Each Rib sq. in.	SPAN OF SLAB IN FEET																																			
			10	11	12	13	14	15	16	17	18	19	20	21	22	23	24	25	26	27	28																	
4+1/2	44	0.54	120	92	70	53	40	29																														
4+2	50	0.60	155	120	92	71	55	41	30																													
5+2	55	0.72	240	189	150	120	95	76	60	47	36																											
6+2	60	0.80	330	262	211	171	139	113	92	75	60	48	38																									
8+2	70	0.91	504	405	329	270	223	185	154	129	107	89	74	60	49	39																						
8+2 1/2	76	1.05	495	404	333	277	231	194	163	138	116	97	81	67	55	44	35																					
10+2	81	0.98	455	376	313	262	221	186	157	133	112	94	79	65	53	43	33																					
10+2 1/2	87	1.15	466	390	328	278	237	201	172	147	125	106	90	75	63	51	41	32																				
10+3	94	1.30	462	391	332	284	243	208	179	153	132	112	95	81	67	56	45																					
12+2	91	1.04	591	490	410	345	293	249	212	181	155	132	112	95	80	66	54	44	34																			
12+2 1/2	97	1.23	731	608	511	433	368	315	271	233	201	173	149	129	110	94	79	67	55																			
12+3	104	1.39	593	512	437	375	323	280	242	210	182	158	136	118	101	86	73																					

Loads to left and below heavy line should not be used unless stirrups are provided.

CLAY TILE RIBBED SLABS—END SPANS

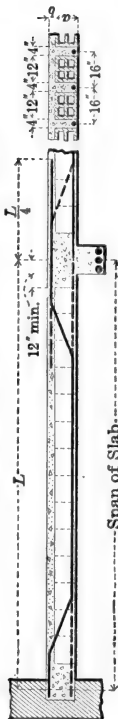

Bending Moment

$$M = \frac{1}{10}wl^2$$

Unit Stresses
 $f_s, 16,000$
 $f_c, 650$

$a + b$ in.	Weight of Slab per sq. ft. lb.	SPAN OF SLAB IN FEET																																	
		10	11	12	13	14	15	16	17	18	19	20	21	22	23	24	25	26	27	28															
		Safe Superimposed Load in Pounds per Square Foot. Steel Area in Square Inches in Each Rib in Italics																																	
4+1½	44	162	102	62	41	26																													
4+2	50	0.54	0.50	0.44	0.40	0.38	22																												
5+2	55	0.60	0.55	0.48	0.44	0.42	0.40	29	17																										
6+2	60	0.72	0.66	0.58	0.53	0.49	0.47	0.44	0.43	24																									
8+2	70	0.80	0.76	0.69	0.62	0.58	0.55	0.52	0.50	0.48	541	358	264	201	154	117	88	64	47	32	25														
8+2½	76	0.94	0.87	0.79	0.74	0.70	0.66	0.63	0.60	0.58	0.57	402	300	226	174	133	101	76	53	37	26	16													
10+2	81	1.02	0.97	0.91	0.86	0.81	0.76	0.75	0.72	0.70	0.68	0.66	0.65	0.64	581	423	326	257	201	159	126	98	76	58	41	30	19								
10+2½	87	1.02	0.95	0.90	0.85	0.82	0.79	0.75	0.73	0.71	0.69	0.68	0.67	0.66	468	360	284	222	177	140	108	84	65	47	34	23	13								
10+3	94	1.06	0.99	0.94	0.89	0.85	0.82	0.78	0.76	0.74	0.72	0.71	0.70	0.69	508	392	311	245	193	153	118	92	71	53	38	26	15								
12+2	91	1.08	1.07	1.02	0.97	0.93	0.89	0.85	0.82	0.78	0.76	0.75	0.74	0.73	636	480	385	309	249	199	159	126	102	81	65	50	37	26	15						
12+2½	97	1.10	1.10	1.05	1.00	0.96	0.92	0.88	0.85	0.83	0.81	0.80	0.79	0.78	513	413	331	267	215	172	137	112	89	71	55	41	28	17	8						
12+3	104	1.15	1.10	1.05	1.00	0.96	0.92	0.88	0.85	0.83	0.81	0.80	0.79	0.78	557	450	363	290	233	188	151	123	98	77	60	46	32	18	8						

Loads to left and below heavy line should not be used unless stirrups are provided.

CLAY TILE RIBBED SLABS—CONTINUOUS OVER SUPPORTS

Bending Moment

$$M = \frac{1}{12} w l^2$$

Unit Stresses
 f_s , 16,000
 f_c , 650

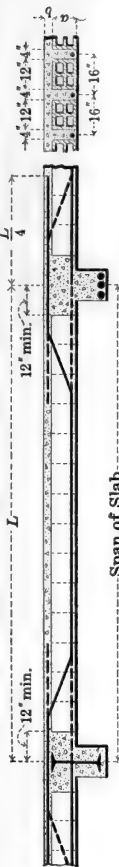

$a + b$ in.	Weight of Slab per sq. ft. lb.	SPAN OF SLAB IN FEET																				
		10	11	12	13	14	15	16	17	18	19	20	21	22	23	24	25	26	27	28		
		Safe Superimposed Load in Pounds per Square Foot. Steel Area in Square Inches in each Rib in Italics.																				
4+1½	44	204 <i>0.54</i> <i>0.50</i>	132 <i>0.44</i> <i>0.40</i>	86 <i>0.40</i> <i>0.36</i>	58 <i>0.38</i> <i>0.36</i>	40 <i>0.36</i> <i>0.36</i>	25 <i>0.36</i> <i>0.36</i>															
4+2	50	257 <i>0.60</i> <i>0.55</i>	165 <i>0.48</i> <i>0.44</i>	108 <i>0.44</i> <i>0.40</i>	75 <i>0.42</i> <i>0.38</i>	53 <i>0.40</i> <i>0.38</i>	36 <i>0.38</i> <i>0.38</i>	22 <i>0.38</i> <i>0.38</i>														
5+2	55	391 <i>0.72</i> <i>0.66</i>	257 <i>0.58</i> <i>0.53</i>	175 <i>0.49</i> <i>0.47</i>	126 <i>0.44</i> <i>0.43</i>	89 <i>0.44</i> <i>0.43</i>	66 <i>0.44</i> <i>0.43</i>	46 <i>0.44</i> <i>0.43</i>	32 <i>0.44</i> <i>0.43</i>													
6+2	60	524 <i>0.80</i> <i>0.76</i>	360 <i>0.69</i> <i>0.62</i>	260 <i>0.62</i> <i>0.58</i>	187 <i>0.58</i> <i>0.55</i>	140 <i>0.55</i> <i>0.52</i>	106 <i>0.52</i> <i>0.50</i>	79 <i>0.50</i> <i>0.46</i>	58 <i>0.48</i> <i>0.46</i>	40 <i>0.46</i> <i>0.46</i>	28 <i>0.46</i> <i>0.46</i>											
8+2	70	444 <i>0.87</i> <i>0.79</i>	331 <i>0.74</i> <i>0.66</i>	255 <i>0.66</i> <i>0.60</i>	199 <i>0.60</i> <i>0.58</i>	154 <i>0.58</i> <i>0.56</i>	120 <i>0.56</i> <i>0.54</i>	91 <i>0.54</i> <i>0.54</i>	71 <i>0.54</i> <i>0.54</i>	53 <i>0.54</i> <i>0.54</i>	40 <i>0.54</i> <i>0.54</i>	28 <i>0.54</i> <i>0.54</i>										
8+2½	76	499 <i>0.92</i> <i>0.84</i>	375 <i>0.78</i> <i>0.74</i>	288 <i>0.74</i> <i>0.70</i>	224 <i>0.70</i> <i>0.67</i>	175 <i>0.67</i> <i>0.64</i>	137 <i>0.64</i> <i>0.61</i>	106 <i>0.61</i> <i>0.59</i>	80 <i>0.59</i> <i>0.58</i>	60 <i>0.58</i> <i>0.57</i>	46 <i>0.58</i> <i>0.57</i>	34 <i>0.57</i> <i>0.57</i>										
10+2	81	414 <i>0.91</i> <i>0.86</i>	325 <i>0.81</i> <i>0.78</i>	257 <i>0.78</i> <i>0.75</i>	207 <i>0.75</i> <i>0.72</i>	167 <i>0.72</i> <i>0.68</i>	134 <i>0.68</i> <i>0.66</i>	107 <i>0.66</i> <i>0.64</i>	86 <i>0.64</i> <i>0.64</i>	66 <i>0.64</i> <i>0.64</i>	52 <i>0.64</i> <i>0.64</i>	39 <i>0.64</i> <i>0.64</i>										
10+2½	87	450 <i>0.95</i> <i>0.90</i>	358 <i>0.85</i> <i>0.82</i>	284 <i>0.82</i> <i>0.79</i>	230 <i>0.79</i> <i>0.75</i>	186 <i>0.75</i> <i>0.71</i>	157 <i>0.71</i> <i>0.69</i>	134 <i>0.69</i> <i>0.67</i>	118 <i>0.67</i> <i>0.66</i>	95 <i>0.66</i> <i>0.66</i>	74 <i>0.66</i> <i>0.66</i>	58 <i>0.66</i> <i>0.66</i>	45 <i>0.66</i> <i>0.66</i>	33 <i>0.66</i> <i>0.66</i>								
10+3	94	331 <i>0.89</i> <i>0.85</i>	257 <i>0.85</i> <i>0.82</i>	207 <i>0.82</i> <i>0.79</i>	167 <i>0.79</i> <i>0.76</i>	134 <i>0.76</i> <i>0.74</i>	107 <i>0.74</i> <i>0.72</i>	86 <i>0.72</i> <i>0.70</i>	66 <i>0.70</i> <i>0.68</i>	52 <i>0.68</i> <i>0.68</i>	39 <i>0.68</i> <i>0.68</i>											
12+2	91	389 <i>0.97</i> <i>0.93</i>	319 <i>0.89</i> <i>0.85</i>	257 <i>0.85</i> <i>0.82</i>	209 <i>0.82</i> <i>0.79</i>	170 <i>0.79</i> <i>0.76</i>	141 <i>0.76</i> <i>0.74</i>	116 <i>0.74</i> <i>0.72</i>	96 <i>0.72</i> <i>0.70</i>	79 <i>0.70</i> <i>0.69</i>	63 <i>0.69</i> <i>0.68</i>	50 <i>0.68</i> <i>0.68</i>	37 <i>0.68</i> <i>0.68</i>	26 <i>0.68</i> <i>0.68</i>								
12+2½	97	524 <i>0.92</i> <i>0.88</i>	360 <i>0.88</i> <i>0.85</i>	260 <i>0.85</i> <i>0.82</i>	187 <i>0.82</i> <i>0.79</i>	140 <i>0.79</i> <i>0.76</i>	106 <i>0.76</i> <i>0.74</i>	79 <i>0.74</i> <i>0.72</i>	58 <i>0.72</i> <i>0.70</i>	40 <i>0.70</i> <i>0.68</i>	28 <i>0.68</i> <i>0.68</i>											
12+3	104	301 <i>0.96</i> <i>0.92</i>	247 <i>0.92</i> <i>0.89</i>	202 <i>0.89</i> <i>0.85</i>	168 <i>0.85</i> <i>0.82</i>	139 <i>0.82</i> <i>0.79</i>	113 <i>0.79</i> <i>0.76</i>	93 <i>0.76</i> <i>0.74</i>	76 <i>0.74</i> <i>0.72</i>	66 <i>0.72</i> <i>0.70</i>	59 <i>0.70</i> <i>0.68</i>	43 <i>0.68</i> <i>0.68</i>	31 <i>0.68</i> <i>0.68</i>	26 <i>0.68</i> <i>0.68</i>								

Loads to left and below heavy line should not be used unless stirrups are provided.

CLAY TILE RIBBED SLABS—SIMPLE SPANS

Bending Moment
 $M = \frac{1}{8} w l^2$

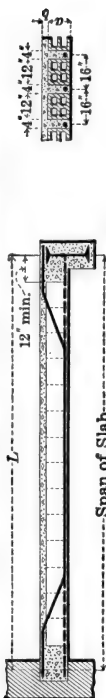

Unit Stresses
 $f_s, 18,000$
 $f_c, 700$

$a+b$ in.	Weight of Slab per sq. ft. lb.	Steel Area in Each Rib sq. in.	SPAN OF SLAB IN FEET																															
			10	11	12	13	14	15	16	17	18	19	20	21	22	23	24	25	26	27	28													
4+1 1/2	44	0.51	135	104	80	62	48	36																										
4+2	50	0.56	169	131	102	80	62	47	36																									
5+2	55	0.67	261	206	164	132	106	85	68	54	42																							
6+2	60	0.76	356	283	229	186	152	124	102	84	68	55	44																					
8+2	70	0.85	544	437	357	293	243	203	170	142	119	100	83	69	57	46																		
8+2 1/2	76	0.98	518	422	349	280	243	203	173	145	123	104	87	72	60	48	39																	
10+2	81	0.93	496	411	342	288	243	206	175	149	127	107	90	76	63	52	42	33																
10+2 1/2	87	1.09	510	428	363	308	263	225	192	166	142	122	104	88	75	62	51	42																
10+3	94	1.22	503	426	363	311	267	230	198	171	148	127	109	93	79	66	55																	
12+2	91	0.98	443	374	318	272	232	199	171	147	125	107	91	76	64	52	42																	
12+2 1/2	97	1.17	476	406	349	300	260	225	195	169	147	127	109	94	80	67																		
12+3	104	1.32	480	413	358	310	270	235	205	179	156	135	117	101	87																			

Loads to left and below heavy line should not be used unless stirrups are provided.

CLAY TILE RIBBED SLABS—END SPANS

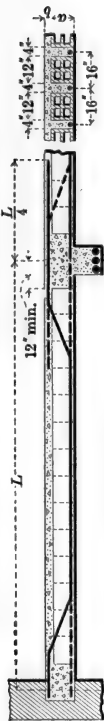

Bending Moment

$$M = \frac{1}{10} w l^2$$

Unit Stresses
 $f_b, 18,000$
 $f_c, 700$

a + b in.	Weight of Slab per sq. ft.	SPAN OF SLAB IN FEET																												
		10	11	12	13	14	15	16	17	18	19	20	21	22	23	24	25	26	27	28										
4+1½	44	179	108	70	44	26	Safe Superimposed Load in Pounds per Square Foot. Steel Area in Square Inches in Each Rib in Italics																							
4+2	50	223	137	89	59	37	23																							
5+2	55	340	219	150	105	72	52	35	21																					
6+2	60	460	313	220	158	115	85	63	42	30																				
8+2	70	566	380	279	215	165	128	97	74	53	37	26																		
8+2½	76	430	323	243	188	147	110	85	62	44	31	22																		
10+2	81	454	345	275	220	170	137	107	81	64	49	36	23																	
10+2½	87	496	381	299	241	190	151	118	91	72	56	42	28	17																
10+3	94	548	416	329	265	207	165	128	100	80	62	45	32	18																
12+2	91	579	404	332	265	216	172	138	114	93	73	56	42	31	19															
12+2½	97	440	357	286	234	187	150	123	102	81	62	48	35	23	11															
12+3	104	476	387	311	251	201	159	135	111	89	68	51	37	25	13															
		1.02	1.08	1.09	1.09	1.09	1.09	1.09	1.09	1.09	1.09	1.09	1.09	1.09	1.09	1.09	1.09	1.09	1.09	1.09	1.09									

Loads to left and below heavy line should not be used unless stirrups are provided.

100

CLAY TILE RIBBED SLABS—CONTINUOUS OVER SUPPORTS

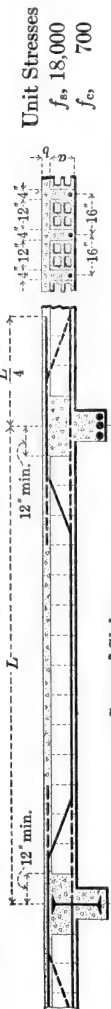
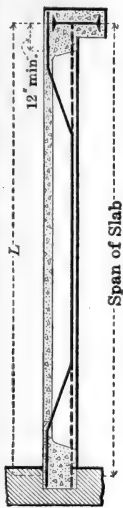

Table with columns for span (a+b in inches) and weight of slab per sq. ft. (lb.). Rows represent different slab weights (44 to 104 lb.). The table provides data for safe superimposed load, steel area, and unit stresses across various spans (10 to 28 feet).

Loads to left and below heavy line should not be used unless stirrups are provided.

RIBBED SLABS—SIMPLE SPANS



Unit Stresses
 $f_s, 16,000$
 $f_c, 650$

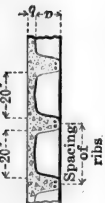

Bending Moment

$$M = \frac{1}{8} w l^2$$

Span of Slab

$a+b$ in.	Spacing of Ribs in.	Weight of slab per sq. ft. lb.	Steel area per Rib sq. in.	SPAN OF SLAB IN FEET																															
				10	11	12	13	14	15	16	17	18	19	20	21	22	23	24	25	26	27	28													
6+2	24	46	1.21	346	278	226	186	154	128	107	90	75	63	52	43	35	48	40	33	33	30	26	25	26	27	28									
6+2	25	48	1.26	344	276	224	184	152	126	105	88	73	61	50	41	33	45	37	30	30	26	25	26	27	28	28									
8+2	24	52	1.37	524	424	348	289	242	204	173	147	126	107	92	79	67	84	76	64	54	45	37	30	26	25	26	27	28							
8+2	25	55	1.43	521	422	345	286	239	201	170	144	123	104	89	76	64	84	73	62	53	44	37	30	26	25	26	27	28							
10+2	25	62	1.54	713	579	476	396	334	283	241	206	177	153	132	114	98	114	101	87	76	65	55	44	37	30	26	27	28							
10+2½	25	68	1.80	868	705	582	485	409	348	298	256	221	191	166	144	125	144	125	109	94	81	70	60	51	44	37	30	26	27	28					
10+3	25	74	2.03	827	683	572	483	411	352	304	262	228	198	174	151	132	151	132	116	101	87	76	65	55	44	37	30	26	27	28					
12+2	25	70	1.63	614	512	432	368	314	271	234	203	176	153	133	116	101	133	116	101	88	76	65	55	44	37	30	26	27	28						
12+2½	25	76	1.93	754	632	534	456	391	337	293	255	223	195	171	150	132	171	150	132	119	101	88	77	65	55	44	37	30	26	27	28				
12+3	25	82	2.17	880	735	626	533	458	397	345	301	264	232	204	180	158	204	180	158	141	123	108	94	81	70	60	51	44	37	30	26	27	28		
12+3	26	86	2.26	619	529	458	393	341	297	260	228	200	176	154	137	119	200	176	154	137	119	104	90	77	65	55	44	37	30	26	27	28			
14+3	26	96	2.40	660	567	493	429	375	329	290	256	226	199	176	156	137	290	256	226	199	176	156	137	121	104	90	77	65	55	44	37	30	26	27	28

Loads to left and below heavy line should not be used unless stirrups are provided. To resist temperature and shrinkage stresses place ¼" round rods 12" centers at right angles to the ribs in the slab.

RIBBED SLABS—END SPANS

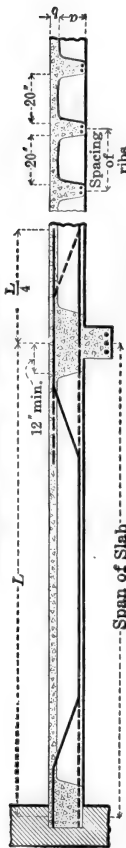

Bending Moment

$$M = \frac{1}{10}wl^2$$

Unit Stresses
 $f_s, 16,000$
 $f_c, 650$

a+b in.	Spacing of Slab Ribs per sq. ft.	Weight of Slab lb.	SPAN OF SLAB IN FEET																																																	
			10	11	12	13	14	15	16	17	18	19	20	21	22	23	24	25	26	27	28																															
6+2	24	46	277	187	131	92	66	47	32																																											
6+2	25	48	348	235	165	118	84	63	43	30																																										
8+2	24	52	481	335	233	170	129	97	72	53	39																																									
8+2	25	55	590	410	289	212	161	126	93	71	54	40																																								
10+2	25	62	639	457	340	264	210	163	130	102	80	63	48	37																																						
10+2½	25	68	499	374	288	227	176	141	111	87	69	52	40																																							
10+3	25	74	544	412	314	251	193	152	123	96	75	57	44	33																																						
12+2	25	70	660	501	388	313	244	197	162	132	106	85	68	54	42	32																																				
12+2½	25	76	541	417	336	264	214	174	140	114	91	74	58	46	35																																					
12+3	25	82	578	451	363	285	228	186	150	122	98	80	63	49	36																																					
12+3	26	86	674	528	424	335	273	224	182	149	122	100	80	64	51	39																																				
14+3	26	96	709	574	460	375	312	254	211	179	149	124	102	84	69	54	42																																			

Leads to left and below heavy line should not be used unless stirrups are provided.
To resist temperature and shrinkage stresses place ¼" round rods 12" centers at right angles to the ribs in the slab.

RIBBED SLABS—SIMPLE SPANS

Bending Moment

$$M = \frac{1}{8} w l^2$$

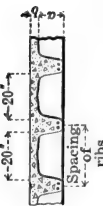
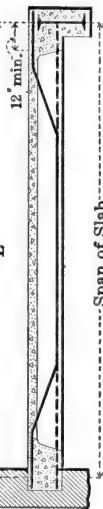

a+b in.	Spacing of Ribs in.	Weight of Slab per sq. ft. lb.	Steel Area per Rib sq. in.	SPAN OF SLAB IN FEET																								
				10	11	12	13	14	15	16	17	18	19	20	21	22	23	24	25	26	27	28						
6+2	24	46	1.13	367	296	241	198	164	138	115	97	82	68	57	48	39	32	54	46	38	60	51	43	35	26			
6+2	25	48	1.18	366	294	240	197	163	136	114	95	80	67	56	46	38	26	46	38	30	60	51	43	35	26			
8+2	24	52	1.29	559	453	372	310	260	220	187	159	137	117	101	87	74	64	54	46	38	60	51	43	35	26			
8+2	25	55	1.34	555	449	368	306	256	216	183	156	133	114	97	83	71	60	51	43	35	60	51	43	35	26			
10+2	25	62	1.45	762	619	510	425	358	304	260	223	192	166	144	125	108	94	81	70	60	60	51	43	35	26			
10+2½	25	68	1.70	754	622	521	439	374	321	276	239	208	181	157	138	120	105	91	79	69	60	51	43	35	26			
10+3	25	74	1.91	881	729	610	516	440	378	326	283	246	215	188	165	145	127	111	97	85	73	65	57	49	41			
12+2	25	70	1.55	664	556	470	400	343	296	256	223	194	170	148	130	114	99	87	75	65	57	49	41	33	25			
12+2½	25	76	1.81	804	674	571	487	419	362	315	275	241	212	186	164	144	127	111	98	86	75	65	57	49	41			
12+3	25	82	2.06	943	793	673	575	496	430	375	328	288	254	224	198	175	155	137	121	107	95	83	72	61	51			
12+3	26	86	2.14	668	570	491	425	370	323	284	249	219	194	170	150	132	117	102	88	76	65	55	45	35	25			
14+3	26	96	2.25	704	608	527	460	402	354	312	276	244	217	192	170	151	134	118	102	87	74	62	51	41	31			

Loads to left and below heavy line should not be used unless stirrups are provided. To resist temperature and shrinkage stresses place ¼" round rods 12" centers at right angles to the ribs in the slab.

RIBBED SLABS—END SPANS

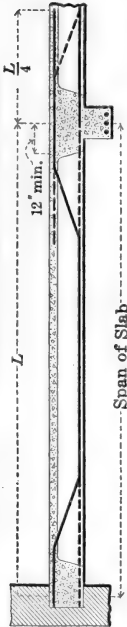

Bending Moment

$$M = \frac{1}{10}wl^2$$

Unit Stresses
 f_s 18,000
 f_c 700

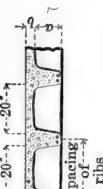

$a+b$ in.	Spacing of Slabs per sq. ft. in.	Weight of Slab per sq. ft. lb.	SPAN OF SLAB IN FEET																						
			10	11	12	13	14	15	16	17	18	19	20	21	22	23	24	25	26	27	28				
6+2	24	46	301 0.83	203 0.72	140 0.58	99 0.64	71 0.54	51 0.51	36 0.49																
6+2	25	48	365 1.03	250 0.90	176 0.80	127 0.73	91 0.67	67 0.61	50 0.58	35															
8+2	24	52	506 1.05	352 0.92	248 0.81	184 0.74	138 0.69	105 0.65	80 0.62	59 0.57	44														
8+2	25	55	614 1.81	430 1.15	308 1.02	229 0.98	173 0.86	132 0.81	104 0.78	79 0.74	60 0.71	44													
10+2	25	62	668 1.41	485 1.25	366 1.14	279 1.05	230 0.99	179 0.96	139 0.87	112 0.83	87 0.77	68	55	42											
10+2½	25	68	532 1.81	400 1.19	306 1.10	242 1.04	194 0.95	154 0.91	122 0.87	95 0.83	73 0.82	59 0.81	46												
10+3	25	74	577 1.86	440 1.25	334 1.15	265 1.09	214 0.95	168 0.91	133 0.87	105 0.86	80 0.85	65	51	38											
12+2	25	70	698 1.48	532 1.35	412 1.25	329 1.18	269 1.14	213 1.07	174 1.03	140 0.99	111 0.94	93	77	62	48	37									
12+2½	25	76	577 1.41	445 1.30	355 1.23	288 1.11	230 1.07	187 1.03	152 0.98	121 0.93	100 0.88	82	65	51	40										
12+3	25	82	619 1.46	479 1.35	380 1.27	308 1.22	246 1.15	201 1.11	164 1.07	130 1.02	109 0.99	88	71	56	43										
12+3	26	86	724 1.75	562 1.62	450 1.58	368 1.47	296 1.39	243 1.34	197 1.28	158 1.22	134 1.19	111	90	73	57	47									
14+3	26	96	753 1.85	607 1.85	498 1.75	405 1.68	335 1.59	274 1.53	225 1.46	192 1.40	162 1.33	135	114	93	76	60	46								

Leads to the left and below heavy line should not be used unless stirrups are provided.
To resist temperature and shrinkage stresses place ¼" round bars 12" centers at right angles to the ribs in the slabs.

RIBBED SLABS—CONTINUOUS OVER SUPPORTS

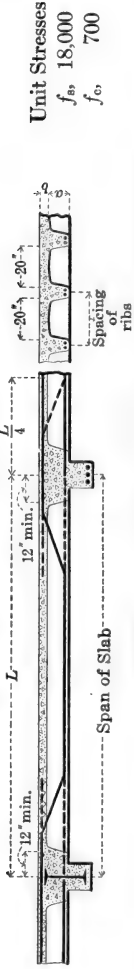

Bending Moment

$$M = \frac{1}{12} w l^2$$

<i>a</i> + <i>b</i> in.	Spacing of Ribs in.	Weight of Slab per sq. ft. lb.	SPAN OF SLAB IN FEET																																																						
			10	11	12	13	14	15	16	17	18	19	20	21	22	23	24	25	26	27	28																																				
6+2	24	46	0.83	0.72	0.64	0.58	0.54	0.51	0.49	0.46	370	128	94	70	52	36	Safe Superimposed Load in Pounds per Square Foot. Steel Area in Square Inches in each Rib in Italics																																								
6+2	25	48	1.08	0.90	0.80	0.78	0.67	0.63	0.61	0.56	448	310	221	162	119	89	69	51	40																																						
8+2	24	52	1.05	0.92	0.81	0.74	0.69	0.65	0.62	0.59	0.57	0.54	0.52	618	432	309	231	176	136	106	82	63	47	34																																	
8+2	25	55	1.31	1.15	1.02	0.98	0.89	0.81	0.78	0.74	0.71	0.68	0.65	0.64	746	527	381	286	218	170	136	106	83	64	48	37																															
10+2	25	62	1.25	1.14	1.05	0.99	0.96	0.90	0.87	0.83	0.80	0.79	0.77	0.76	0.74	594	452	348	276	227	179	146	119	94	78	62	51	39																													
10+2½	25	68	1.19	1.10	1.04	1.00	0.95	0.91	0.87	0.83	0.82	0.81	0.79	0.78	652	493	381	303	247	199	160	128	101	84	69	55	43																														
10+3	25	74	1.25	1.15	1.09	1.05	0.99	0.95	0.91	0.87	0.86	0.85	0.83	0.81	0.79	542	416	332	271	216	175	140	111	92	76	61	47	35																													
12+2	25	70	1.35	1.25	1.18	1.14	1.07	1.03	0.99	0.94	0.93	0.92	0.90	0.88	0.86	0.85	0.83	652	508	408	337	269	223	183	148	125	106	88	72	58	47	36																									
12+2½	25	76	1.30	1.23	1.18	1.11	1.07	1.03	0.98	0.97	0.95	0.93	0.91	0.89	0.86	0.85	0.83	550	441	361	291	240	197	160	136	113	94	77	65	50	39																										
12+3	25	82	1.35	1.27	1.22	1.15	1.11	1.07	1.02	1.01	0.99	0.97	0.95	0.93	0.91	0.89	0.86	0.85	0.83	591	473	388	312	258	213	172	146	123	102	83	68	53	41	30																							
12+3	26	86	1.62	1.53	1.47	1.39	1.34	1.28	1.22	1.21	1.19	1.16	1.14	1.11	1.07	1.05	1.03	1.01	0.99	0.97	0.95	693	557	459	372	309	254	208	178	151	126	105	86	72	56	44																					
14+3	26	96	1.75	1.68	1.63	1.53	1.46	1.40	1.38	1.38	1.36	1.31	1.26	1.21	1.16	1.11	1.07	1.05	1.03	1.01	0.99	0.97	0.95	747	618	504	421	348	289	250	214	182	156	131	110	91	74																				

Loads to the left and below heavy line should not be used unless stirrups are provided. To resist temperature and shrinkage stresses place ¼" round bars 12" centers at right angles to the ribs in the slabs.

RECTANGULAR BEAMS—SIMPLE SPANS

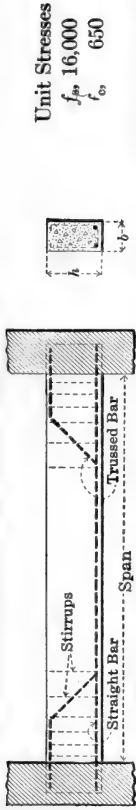

Bending Moment

$$M = \frac{1}{8} w l^2$$

Unit Stresses
 f_{st} 16,000
 f'_c 650

DIMENSIONS AND WT.			ROUND BARS				SPAN OF BEAM IN FEET																				
h	b	Weight of Section $b h$ lb. per ft.	Straight		Trussed		Safe Load in Pounds per Foot Uniformly Distributed, Including Weight of Beam																				
			No.	Size	No.	Size	6	7	8	9	10	11	12	13	14	15	16	17	18	19	20	21					
12	6	75	1	5/8	1	1/2	1273	936	717	567	459	380	318	271	234	204	179	202	232	294	262	235	212				
	8	100	1	5/8	1	5/8	1625	1193	912	721	583	483	406	346	298	260	228	293	334	331	377	410	363	324	291	262	238
	10	125	2	1/2	2	1/2	2083	1532	1174	927	750	620	521	444	383	334	293	260	232	294	262	235	212				
14	8	117	1	3/4	1	5/8	2358	1735	1327	1047	849	701	590	502	433	377	331	294	262	235	212						
	10	146	2	5/8	1	5/8	2918	2142	1640	1296	1048	868	729	621	535	466	410	363	324	291	262						
	12	175	2	5/8	2	5/8	3657	2683	2055	1624	1315	1087	913	779	671	585	513	455	406	364	329	298					
16	8	133	1	3/4	1	3/4	3200	2350	1800	1421	1149	951	799	680	587	511	450	398	355	319	288	261					
	10	167	1	7/8	1	3/4	3818	2807	2150	1700	1375	1135	955	814	701	610	538	475	424	380	344	311					
	12	200	2	3/4	1	3/4	4795	3525	2695	2130	1724	1425	1197	1020	880	766	672	596	531	477	430	390					
18	8	150	1	7/8	1	3/4	4200	3087	2362	1870	1513	1250	1050	895	771	672	591	523	467	419	378	343					
	10	188	2	5/8	2	5/8	5150	3785	2897	2290	1855	1533	1288	1098	946	825	725	642	573	514	464	421					
	12	225	2	3/4	1	7/8	6200	4550	3482	2752	2232	1842	1550	1320	1139	992	872	772	688	618	558	505					
20	14	262	2	3/4	2	3/4	7287	5354	4100	3237	2623	2167	1825	1555	1341	1169	1027	910	812	728	657	596					
	8	167	1	7/8	1	3/4	4900	3600	2758	2180	1765	1460	1225	1045	901	785	690	611	545	489	442	400					
	10	208	2	3/4	1	3/4	6230	4585	3513	2775	2243	1858	1560	1330	1145	1000	878	778	694	622	562	510					
20	12	250	2	3/4	2	3/4	7990	5873	4492	3550	2878	2375	1998	1702	1468	1279	1123	995	888	796	719	652					
	14	292	2	7/8	2	3/4	9350	6860	5255	4155	3364	2780	2337	1992	1718	1496	1315	1165	1040	932	841	763					

RECTANGULAR BEAMS—SIMPLE SPANS

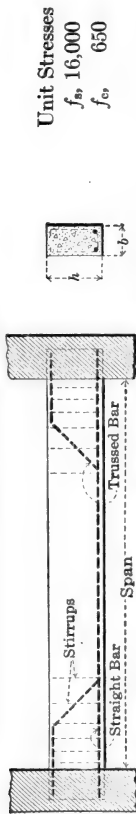

Bending Moment

$$M = \frac{1}{8} w l^2$$

Unit Stresses
 $f_s, 16,000$
 $f_c, 650$

DIMENSIONS AND WT.		ROUND BARS		SPAN OF BEAM IN FEET																								
h	b	lb. per ft.	Straight		Trussed		Safe Load in Pounds per Foot Uniformly Distributed, Including Weight of Beam																					
			No.	Size	No.	Size	10	11	12	13	14	15	16	17	18	19	20	21	22	23	24	25						
22	8	183	1	7/8	1	7/8	2252	1860	1563	1332	1150	1000	880	779	695	624	563	511	465	426	391	361						
	10	229	1	1	1	1	2885	2385	2003	1708	1472	1282	1128	998	890	799	721	655	596	545	501	462						
	12	275	2	3/4	2	3/4	3324	2747	2310	1968	1698	1479	1300	1150	1027	921	831	754	687	629	577	532						
	14	321	2	7/8	2	7/8	3912	3233	2715	2315	1995	1738	1528	1352	1207	1082	977	886	808	739	679	626						
24	8	200	1	1	1	7/8	2800	2314	1945	1657	1430	1245	1095	969	864	775	700	635	578	530	486	448						
	10	250	2	3/4	2	3/4	3551	2935	2464	2100	1812	1578	1388	1229	1097	983	887	805	734	672	616	568						
	12	300	2	7/8	1	1	4080	3375	2833	2415	2082	1813	1595	1412	1260	1130	1020	925	844	772	709	653						
	14	350	2	7/8	2	7/8	4902	4050	3405	2900	2502	2180	1915	1697	1513	1359	1227	1112	1013	926	851	785						
26	8	217	1	1	1	1	3373	2787	2342	1996	1720	1500	1318	1167	1040	935	843	765	697	638	585	540						
	10	271	2	7/8	1	7/8	4049	3345	2810	2395	2064	1800	1580	1400	1250	1121	1011	918	836	765	702	647						
	12	325	2	7/8	2	7/8	5114	4230	3550	3025	2610	2274	1996	1770	1580	1417	1280	1160	1057	966	888	818						
	14	379	2	1	2	7/8	5934	4900	4118	3510	3025	2635	2317	2053	1830	1642	1482	1345	1225	1121	1030	949						
28	8	233	1	1	1	1	3807	3145	2643	2255	1944	1692	1488	1318	1176	1055	952	864	787	720	661	610						
	10	292	2	7/8	1	1	4820	3985	3350	2853	2460	2142	1884	1670	1489	1335	1205	1093	996	911	837	771						
	12	350	2	7/8	2	7/8	5847	4830	4060	3460	2980	2600	2283	2022	1805	1620	1461	1325	1208	1105	1015	935						
	14	408	2	1	2	7/8	6722	5555	4668	3978	3430	2990	2627	2325	2077	1862	1681	1525	1390	1271	1168	1077						
30	10	312	2	1	1	1	5646	4660	3918	3340	2880	2508	2203	1952	1740	1562	1410	1280	1167	1068	980	903						
	12	375	2	1	1	1 1/8	6705	5545	4658	3970	3425	2980	2620	2320	2070	1860	1678	1521	1387	1268	1165	1073						
	14	437	2	1	2	1	7976	6593	5540	4720	4065	3545	3115	2760	2460	2210	1995	1810	1648	1508	1385	1277						
	16	500	3	7/8	2	1	8825	7300	6130	5220	4500	3925	3450	3055	2725	2445	2205	2000	1825	1670	1532	1412						

RECTANGULAR BEAMS—END SPANS

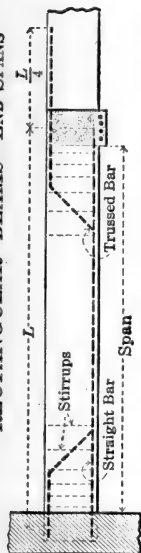

Bending Moment

$$M = \frac{1}{10}wl^2$$

Unit Stresses
 f_s , 16,000
 f_c , 650

DIMENSIONS AND WT.		ROUND BARS		SPAN OF BEAM IN FEET																	
h	b	Weight of Section $b \times h$	Straight	Trussed	Safe Load in Pounds per Foot Uniformly Distributed, Including Weight of Beam																
in.	in.	lb. per ft.	No.	Size	6	7	8	9	10	11	12	13	14	15	16	17	18	19	20	21	
12	6	75	1	1/2	1313	965	739	584	473	391	328	280	241	210	185	165	145	125	105	85	65
	8	100	1	5/8	2025	1487	1139	900	729	603	506	431	372	324	284	252	225	202	180	160	140
	10	125	2	1/2	2603	1912	1465	1157	937	775	651	555	478	416	366	324	289	260	234	212	192
14	8	117	1	5/8	2443	1795	1375	1087	880	727	611	521	449	391	344	304	272	244	220	200	180
	10	146	1	3/4	3470	2550	1952	1542	1250	1032	868	740	638	555	488	432	386	346	312	283	258
	12	175	2	5/8	4567	3355	2570	2030	1644	1359	1141	973	838	731	642	569	507	455	411	373	338
16	8	133	1	3/4	3990	2928	2242	1771	1436	1186	997	850	733	638	560	496	443	397	359	325	295
	10	167	1	7/8	5100	3745	2867	2265	1836	1518	1275	1086	936	815	716	635	566	508	458	416	381
	12	200	2	5/8	5650	4150	3180	2511	2035	1681	1412	1204	1039	905	795	704	628	564	508	461	421
18	8	150	1	3/4	4645	3410	2612	2063	1671	1381	1161	990	853	743	653	578	516	463	418	379	344
	10	188	2	5/8	6440	4730	3622	2860	2319	1915	1610	1371	1182	1030	905	802	715	642	580	525	480
	12	225	2	5/8	6500	4770	3655	2890	2340	1934	1625	1385	1193	1040	914	810	722	648	585	530	485
20	14	262	2	3/4	9100	6685	5120	4048	3279	2710	2275	1940	1672	1457	1280	1134	1011	907	820	744	670
	8	167	1	7/8	6665	4903	3750	2963	2401	1985	1667	1420	1225	1068	937	830	741	665	600	544	494
	10	208	2	5/8	7280	5350	4095	3235	2621	2165	1821	1551	1338	1165	1024	907	810	726	655	594	544
20	12	250	2	3/4	10000	7340	5618	4440	3597	2975	2500	2128	1835	1600	1405	1245	1111	996	899	816	744
	14	292	2	3/4	10422	7657	5860	4630	3752	3100	2605	2220	1914	1667	1465	1298	1158	1040	938	850	774

RECTANGULAR BEAMS—END SPANS

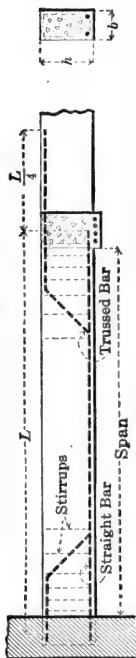

Bending Moment

$$M = \frac{1}{10} w l^2$$

Unit Stresses

$$f_s = 16,000$$

$$f_c = 650$$

DIMENSIONS AND WT.		ROUND BARS		SPAN OF BEAM IN FEET																							
h	b	Weight of Section <i>o h</i>	lb. per ft.	Straight		Trussed		Safe Load in Pounds Per Foot Uniformly Distributed, Including Weight of Beam	10	11	12	13	14	15	16	17	18	19	20	21	22	23	24	25			
				No.	Size	No.	Size																				
22	8	183	2	5/8	2	5/8	2888	2387	2007	1710	1475	1284	1129	1000	892	800	722	655	597	546	502	462					
	10	229	1	1	1	1	3606	2980	2504	2135	1841	1602	1410	1248	1112	999	901	818	745	682	626	577					
	12	275	2	3/4	2	3/4	4155	3437	2887	2460	2121	1848	1625	1440	1283	1152	1040	943	859	786	722	665					
	14	321	2	7/8	2	7/8	5231	4320	3630	3096	2668	2324	2042	1810	1614	1449	1308	1186	1080	989	908	836					
24	8	200	1	7/8	1	7/8	3109	2570	2159	1840	1586	1381	1214	1075	959	861	777	705	642	588	539	497					
	10	250	2	3/4	2	3/4	4438	3665	3080	2624	2263	1970	1732	1535	1370	1229	1110	1006	917	839	770	710					
	12	300	2	3/4	2	3/4	4592	3792	3187	2718	2342	2040	1793	1589	1417	1271	1148	1040	949	868	797	735					
	14	350	2	7/8	2	7/8	6127	5060	4257	3625	3125	2723	2395	2120	1891	1698	1531	1390	1267	1159	1063	981					
26	8	217	1	1	1	1	4216	3482	2925	2495	2150	1873	1646	1459	1300	1168	1052	956	871	797	732	675					
	10	271	2	3/4	2	3/4	4976	4110	3455	2944	2540	2211	1944	1721	1536	1379	1244	1129	1028	940	864	796					
	12	325	2	7/8	2	7/8	6392	5280	4440	3780	3260	2840	2495	2210	1972	1770	1598	1450	1320	1208	1110	1022					
	14	379	2	7/8	2	7/8	8761	7150	5900	5000	4300	3700	3200	2800	2450	2150	1900	1700	1550	1400	1280	1170	1082				
28	8	233	1	1	1	1	4759	3936	3305	2820	2430	2117	1860	1648	1470	1320	1190	1080	984	900	826	762					
	10	292	2	3/4	2	3/4	5420	4482	3767	3211	2768	2412	2120	1877	1674	1502	1357	1230	1120	1025	942	868					
	12	350	2	7/8	2	7/8	7308	6045	5080	4326	3730	3250	2855	2530	2257	2025	1829	1659	1510	1382	1270	1170					
	16	467	2	1	2	1	9518	7870	6610	5630	4858	4230	3720	3293	2940	2638	2380	2160	1969	1800	1652	1523					
30	8	312	2	3/4	2	3/4	5860	4845	4065	3470	2990	2605	2290	2028	1810	1625	1465	1330	1211	1109	1018	938					
	12	375	2	7/8	2	7/8	7890	6520	5480	4665	4025	3505	3082	2729	2435	2184	1972	1789	1630	1491	1370	1262					
	14	437	2	1	2	1	9969	8240	6925	5900	5090	4430	3895	3450	3078	2762	2492	2260	2060	1885	1730	1595					
	18	563	3	7/8	3	7/8	11824	9775	8210	7000	6035	5253	4618	4095	3650	3278	2957	2681	2443	2238	2052	1893					

RECTANGULAR BEAMS—CONTINUOUS OVER SUPPORTS

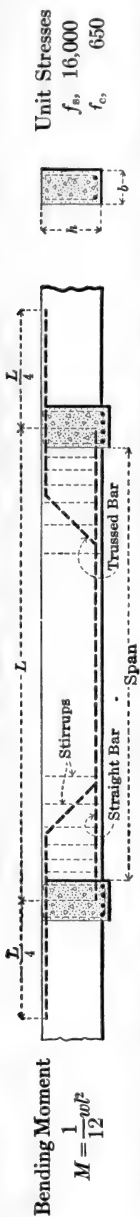

DIMENSIONS AND WT.		ROUND BARS		SPAN OF BEAM IN FEET																	
h	b	Weight of Section $b h$	Straight	Trussed	Safe Load in Pounds per Foot Uniformly Distributed, Including Weight of Beam																
in.	in.	lb. per ft.	No.	Size	6	7	8	9	10	11	12	13	14	15	16	17	18	19	20	21	
12	6	75	1	1/2	1576	1159	887	700	568	469	394	336	290	252	222	203	184	165	146	127	
	8	100	1	5/8	2432	1787	1369	1080	875	724	608	518	447	389	342	303	270	242	219		
	10	125	2	1/2	3122	2293	1760	1389	1125	930	781	666	574	500	440	389	347	312	281	255	
14	8	117	1	5/8	2935	2155	1650	1305	1056	873	734	625	539	470	413	366	326	292	264	240	
	10	146	1	3/4	4160	3060	2342	1851	1500	1240	1040	886	765	666	585	519	463	415	375	340	
	12	175	2	5/8	5480	4027	3083	2440	1973	1631	1371	1169	1008	877	771	683	610	546	493	448	
16	8	133	1	3/4	4790	3520	2693	2128	1724	1425	1195	1020	880	766	674	596	532	478	431	391	
	10	167	1	7/8	6115	4500	3444	2720	2203	1822	1530	1305	1125	980	861	762	680	611	551	500	
	12	200	2	5/8	6785	4985	3817	3015	2442	2020	1697	1446	1247	1086	955	845	754	676	610	554	
18	8	150	1	3/4	5567	4090	3133	2475	2005	1658	1391	1187	1022	891	783	694	619	555	501	455	
	10	188	2	5/8	7730	5675	4350	3438	2783	2300	1932	1647	1420	1237	1088	963	859	771	696	631	
	12	225	2	5/8	7800	5730	4390	3467	2808	2322	1950	1662	1433	1249	1098	972	866	778	702	637	
20	14	262	2	3/4	10920	8027	6150	4855	3935	3250	2732	2328	2007	1750	1537	1361	1215	1090	984	892	
	8	167	1	7/8	8005	5885	4507	3560	2881	2381	2003	1708	1472	1282	1127	998	890	799	721	654	
	10	208	2	5/8	8735	6420	4914	3883	3146	2600	2184	1862	1605	1398	1229	1089	972	871	786	714	
20	12	250	2	3/4	12000	8810	6750	5335	4317	3570	3000	2558	2205	1920	1689	1495	1335	1198	1080	980	
	14	292	2	3/4	12520	9200	7045	5560	4503	3722	3130	2665	2300	2004	1761	1560	1391	1249	1127	1022	

RECTANGULAR BEAMS—CONTINUOUS OVER SUPPORTS

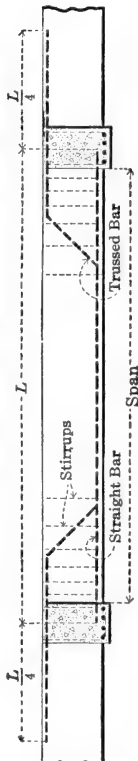

Bending Moment

$$M = \frac{1}{12}wl^2$$

DIMENSIONS AND WT.			ROUND BARS		SPAN OF BEAM IN FEET																		
h	b	Weight of Section $b \times h$	Straight	Trussed	Safe Load in Pounds Per Foot Uniformly Distributed, Including Weight of Beam																		
in.	in.	lb. per ft.	No.	Size	10	11	12	13	14	15	16	17	18	19	20	21	22	23	24	25			
22	8	183	2	$\frac{5}{8}$	3466	2865	2407	2050	1770	1540	1355	1200	1070	960	866	786	716	655	602	555			
	10	229	1	1	4328	3575	3005	2560	2208	1923	1690	1498	1336	1200	1082	981	894	818	751	692			
	12	275	2	$\frac{3}{4}$	4986	4118	3460	2950	2542	2215	1946	1724	1538	1380	1246	1130	1030	942	865	797			
	14	321	2	$\frac{7}{8}$	6277	5190	4357	3714	3203	2790	2453	2172	1939	1739	1570	1423	1297	1188	1090	1004			
24	8	200	1	$\frac{7}{8}$	3730	3085	2591	2208	1903	1658	1457	1291	1151	1033	933	845	770	705	648	597			
	10	250	2	$\frac{3}{4}$	5326	4405	3700	3153	2720	2365	2080	1843	1644	1475	1331	1208	1100	1008	925	852			
	12	300	2	$\frac{3}{4}$	6510	4560	3827	3262	2812	2450	2153	1908	1700	1527	1378	1250	1139	1042	958	882			
	14	350	2	$\frac{7}{8}$	7353	6080	5105	4350	3750	3270	2873	2544	2269	2040	1840	1669	1520	1390	1273	1178			
26	8	217	1	1	5060	4180	3517	2997	2582	2250	1978	1751	1562	1402	1265	1149	1047	956	879	810			
	10	271	2	$\frac{3}{4}$	6972	4938	4150	3535	3047	2655	2333	2066	1842	1655	1493	1355	1233	1129	1038	955			
	12	325	2	$\frac{7}{8}$	7671	6343	5327	4540	3914	3410	3000	2655	2367	2124	1918	1740	1586	1450	1332	1228			
	14	379	2	$\frac{7}{8}$	8114	6708	5640	4805	4145	3608	3170	2810	2505	2248	2030	1841	1679	1535	1410	1300			
28	8	233	1	1	5711	4725	3965	3380	2915	2540	2232	1977	1764	1582	1429	1296	1180	1080	991	915			
	10	292	2	$\frac{3}{4}$	6504	5380	4518	3850	3320	2890	2540	2250	2010	1802	1627	1476	1344	1230	1130	1041			
	12	350	2	$\frac{7}{8}$	8770	7250	6095	5195	4475	3900	3425	3035	2710	2430	2192	1990	1813	1659	1524	1405			
	16	467	2	1	11422	9440	7940	6760	5827	5077	4460	3955	3525	3164	2858	2590	2362	2160	1983	1828			
30	10	312	2	$\frac{3}{4}$	7082	5808	4880	4160	3587	3121	2747	2433	2170	1948	1758	1595	1452	1329	1220	1124			
	12	375	2	$\frac{7}{8}$	9469	7825	6570	5605	4833	4210	3700	3278	2920	2623	2365	2148	1958	1791	1645	1516			
	14	437	2	1	11964	9885	8310	7080	6100	5317	4675	4140	3690	3310	2990	2710	2470	2260	2075	1912			
	18	563	3	$\frac{7}{8}$	14189	11720	9850	8395	7240	6310	5540	4907	4375	3928	3545	3215	2930	2680	2460	2270			

RECTANGULAR BEAMS—SIMPLE SPANS

Bending Moment

$$M = \frac{1}{8}wl^2$$

Unit Stresses

$$f_t = 18,000$$

$$f_c = 700$$

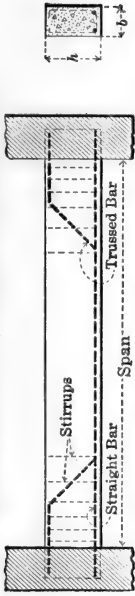

DIMENSIONS AND WT.		ROUND BARS		SPAN OF BEAM IN FEET																		
<i>h</i>	<i>b</i>	Weight of section <i>b</i> <i>h</i>	Straight	Trussed	Safe Load in Pounds per Foot Uniformly Distributed, Including Weight of Beam																	
in.	in.	lb. per ft.	No.	Size	6	7	8	9	10	11	12	13	14	15	16	17	18	19	20	21		
12	6	75	1	5/8	1370	1007	770	608	493	407	342	292	252	219	193							
	8	100	1	5/8	1770	1300	995	786	637	526	442	377	325	283	249	220	196					
	10	125	2	1/2	2249	1652	1265	1000	810	670	563	479	413	360	316	280	250	224				
14	8	117	1	3/4	2537	1862	1427	1128	913	755	634	540	466	406	356	316	282	253	228	252		
	10	146	1	3/4	3095	2272	1740	1376	1114	921	774	660	569	495	435	385	344	309	278	252		
	12	175	2	5/8	3585	2633	2017	1592	1290	1067	895	763	658	574	504	446	398	357	322	292		
16	8	133	1	3/4	3440	2525	1935	1529	1238	1022	860	732	631	550	484	428	382	343	309	281		
	10	167	2	5/8	4163	3060	2342	1851	1500	1240	1041	887	765	666	586	519	463	415	375	340		
	12	200	2	5/8	5065	3725	2850	2253	1826	1510	1268	1080	931	811	713	632	563	505	456	414		
18	8	150	1	3/4	4165	3062	2345	1855	1503	1241	1042	889	766	667	586	520	464	416	375	340		
	10	188	2	5/8	5600	4110	3147	2485	2014	1665	1400	1192	1028	895	786	697	621	558	503	457		
	12	225	2	3/4	6263	4593	3523	2780	2255	1860	1562	1331	1149	1000	879	778	695	623	563	510		
20	14	262	2	3/4	7850	5763	4415	3490	2825	2336	1963	1671	1442	1257	1103	978	872	783	706	641		
	8	167	1	7/8	5493	4038	3090	2440	1978	1635	1372	1170	1010	879	772	685	610	548	494	448		
	10	208	2	3/4	6923	5080	3890	3075	2492	2060	1730	1473	1271	1107	973	862	769	690	622	565		
20	12	250	2	3/4	7963	5850	4480	3542	2867	2372	1992	1697	1463	1275	1120	993	885	795	717	650		
	14	292	2	7/8	9530	7000	5360	4237	3428	2835	2380	2030	1750	1523	1340	1188	1058	950	857	778		

RECTANGULAR BEAMS—SIMPLE SPANS

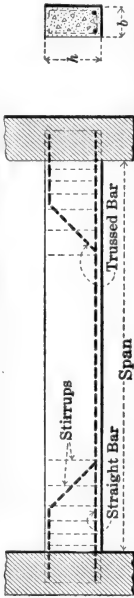

Bending Moment

$$M = \frac{1}{8} w l^2$$

Unit Stresses

$$f_s = 18,000$$

$$f_c = 700$$



DIMENSIONS AND WT.		ROUND BARS		SPAN OF BEAM IN FEET																						
<i>h</i>	<i>b</i>	Weight of Section <i>b h</i>	Straight	Trussed	Safe Load in Pounds per Foot Uniformly Distributed, Including Weight of Beam																					
in.	in.	lb. per ft.	No.	Size	10	11	12	13	14	15	16	17	18	19	20	21	22	23	24	25						
22	8	183	1	7/8	2462	2035	1711	1459	1258	1095	962	853	760	682	616	559	509	466	428	394						
	10	229	2	3/4	3074	2540	2135	1819	1568	1366	1200	1065	949	851	768	697	635	581	534	492						
	12	275	2	3/4	3690	3050	2562	2182	1882	1639	1441	1277	1140	1022	923	836	763	698	640	590						
	14	321	2	7/8	4311	3562	2992	2550	2200	1916	1684	1492	1330	1194	1078	977	890	815	748	690						
24	8	200	2	3/4	2995	2475	2080	1772	1528	1331	1170	1037	925	830	749	680	620	566	520	480						
	10	250	1	1	3636	3005	2523	2150	1855	1615	1420	1259	1122	1008	909	825	751	687	631	582						
	12	300	2	7/8	4457	3685	3097	2640	2277	1982	1742	1543	1378	1236	1115	1011	921	844	775	714						
	14	350	2	7/8	5279	4360	3667	3123	2694	2345	2062	1827	1630	1461	1320	1198	1091	998	917	845						
26	8	217	1	1	3489	2884	2424	2064	1780	1550	1363	1208	1078	967	873	792	721	660	606	559						
	10	271	2	3/4	4420	3652	3070	2620	2258	1966	1730	1530	1366	1225	1106	1004	915	836	768	708						
	12	325	2	7/8	5262	4350	3652	3115	2685	2340	2055	1822	1625	1459	1316	1193	1089	995	914	842						
	14	379	2	7/8	6085	5027	4223	3600	3103	2702	2377	2104	1877	1685	1520	1380	1257	1150	1056	974						
28	8	233	1	1	4150	3426	2880	2457	2117	1844	1620	1435	1280	1150	1038	941	857	784	720	664						
	10	292	2	7/8	4949	4090	3437	2927	2523	2200	1932	1712	1528	1370	1237	1121	1021	935	859	791						
	12	350	2	7/8	6293	5200	4362	3722	3210	2795	2458	2178	1941	1742	1572	1428	1300	1190	1092	1007						
	14	408	2	1	7291	6025	5060	4310	3720	3240	2845	2520	2248	2020	1823	1652	1507	1380	1266	1167						
30	8	312	2	7/8	5861	4845	4070	3470	2990	2607	2290	2028	1810	1625	1466	1330	1210	1110	1017	938						
	10	375	2	7/8	7100	5863	4930	4200	3623	3158	2775	2460	2190	1968	1775	1610	1467	1342	1232	1136						
	12	437	2	1	8176	6760	5680	4840	4165	3634	3195	2830	2522	2264	2043	1855	1690	1547	1420	1310						
	14	500	2	1	9283	7665	6450	5495	4738	4125	3625	3213	2865	2574	2320	2105	1920	1756	1612	1485						

RECTANGULAR BEAMS—END SPANS

Bending Moment

$$M = \frac{1}{10}wl^2$$

Unit Stresses

$$f_s, 18,000$$

$$f_c, 700$$

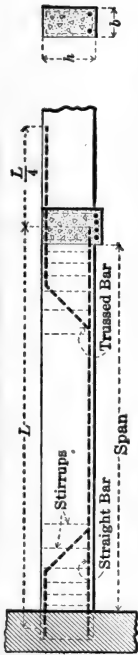

DIMENSIONS AND WT.		ROUND BARS		SPAN OF BEAM IN FEET																			
h	b	Weight of section wh	Straight		Trussed		Safe Load in Pounds per Foot Uniformly Distributed, Including Weight of Beam																
in.	in.	lb. per ft.	No.	Size	No.	Size	6	7	8	9	10	11	12	13	14	15	16	17	18	19	20	21	
12	6	75	1	1/2	1	1/2	1480	1087	832	657	533	440	370	315	272	236	208	184					
	8	100	1	5/8	1	5/8	2210	1623	1242	982	796	658	553	471	406	354	311	275	246	220	199		
	10	125	2	1/2	2	1/2	2813	2065	1582	1250	1012	837	703	600	516	450	396	350	312	280	253	230	
14	8	117	1	5/8	1	5/8	2753	2022	1550	1223	991	819	688	586	506	440	387	343	306	274	246	225	
	10	146	1	3/4	1	3/4	3868	2840	2177	1720	1393	1151	967	824	711	619	544	482	430	386	348	316	
	12	175	2	5/8	2	5/8	4917	3612	2765	2184	1770	1463	1230	1048	903	786	692	613	546	490	443	402	
16	8	133	1	3/4	1	3/4	4300	3158	2418	1910	1548	1280	1075	916	790	688	605	535	478	429	387	351	
	10	167	2	5/8	2	5/8	5610	4120	3155	2492	2020	1670	1402	1195	1030	897	789	699	624	560	505	458	
	12	200	2	5/8	2	5/8	6345	4660	3568	2820	2283	1888	1587	1352	1165	1015	892	790	705	633	571	518	
18	8	150	1	3/4	1	3/4	5215	3830	2935	2320	1879	1552	1305	1111	958	835	734	650	580	520	469	426	
	10	188	2	5/8	2	5/8	6995	5135	3935	3110	2518	2080	1750	1490	1285	1120	984	871	777	698	630	571	
	12	225	2	5/8	2	5/8	7320	5375	4115	3254	2636	2180	1831	1560	1345	1171	1030	912	814	730	659	597	
20	14	262	2	3/4	2	3/4	9808	7200	5515	4360	3531	2920	2452	2090	1802	1570	1380	1221	1090	978	883	800	
	8	167	1	7/8	1	7/8	7180	5275	4040	3190	2586	2138	1795	1530	1320	1150	1010	895	798	716	646	586	
	10	208	2	5/8	2	5/8	8195	6015	4605	3640	2949	2439	2048	1747	1505	1312	1152	1020	910	817	737	669	
20	12	250	2	3/4	2	3/4	10750	7900	6050	4775	3870	3198	2687	2290	1975	1720	1512	1340	1194	1072	968	878	
	14	292	2	3/4	2	3/4	11720	8610	6600	5210	4220	3487	2932	2500	2155	1876	1650	1461	1302	1170	1056	957	

RECTANGULAR BEAMS—END SPANS

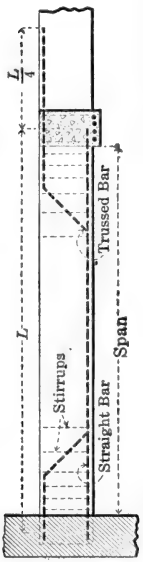

Bending Moment

$$M = \frac{1}{10}wl^2$$

Unit Stresses
 f_s , 18,000
 f_c , 700



DIMENSIONS AND WT.			ROUND BARS		SPAN OF BEAM IN FEET																			
h	b	Weight of Section bh	Straight	Trussed	Safe Load in Pounds per Foot Uniformly Distributed, Including Weight of Beam																			
in.	in.	lb. per ft.	No.	Size	10	11	12	13	14	15	16	17	18	19	20	21	22	23	24	25				
22	8	183	1	7/8	3078	2542	2137	1821	1570	1368	1202	1065	950	852	769	697	635	582	534	492				
	10	229	1	1	3883	3210	2697	2300	1981	1727	1518	1344	1200	1076	971	881	803	735	675	622				
	12	275	2	3/4	4613	3815	3207	2732	2356	2052	1803	1598	1425	1279	1155	1048	954	873	802	739				
	14	321	2	7/8	5630	4650	3910	3330	2874	2500	2200	1948	1738	1560	1408	1277	1163	1064	977	901				
24	8	200	1	7/8	3504	2900	2435	2077	1790	1560	1370	1212	1082	971	876	795	725	663	609	561				
	10	250	1	1	4545	3760	3155	2690	2320	2020	1776	1572	1402	1260	1137	1030	940	860	789	727				
	12	300	2	3/4	5169	4275	3592	3060	2640	2300	2020	1790	1597	1432	1293	1172	1070	978	898	828				
	14	350	2	7/8	6598	5455	4580	3903	3365	2933	2578	2282	2037	1828	1650	1495	1363	1248	1145	1055				
26	8	217	1	1	4531	3745	3145	2682	2313	2014	1770	1569	1400	1255	1132	1028	937	857	786	725				
	10	271	2	3/4	5524	4562	3840	3270	2820	2457	2160	1912	1707	1531	1381	1254	1142	1045	960	885				
	12	325	2	7/8	6884	5690	4780	4075	3513	3060	2690	2382	2124	1908	1722	1561	1422	1302	1195	1101				
	14	379	2	7/8	7606	6286	5280	4500	3880	3380	2970	2630	2346	2107	1902	1724	1570	1437	1320	1216				
28	8	233	1	1	5187	4290	3602	3070	2646	2305	2025	1795	1602	1438	1297	1177	1072	981	900	830				
	10	292	2	3/4	6091	5030	4230	3603	3107	2705	2380	2106	1880	1688	1522	1381	1259	1151	1057	975				
	12	350	2	7/8	7865	6500	5460	4655	4010	3498	3073	2722	2427	2180	1968	1785	1627	1489	1367	1260				
	14	408	2	7/8	8281	6845	5750	4900	4225	3680	3235	2865	2557	2295	2070	1878	1711	1565	1438	1325				
30	10	312	2	3/4	6592	5450	4575	3900	3360	2928	2575	2280	2035	1825	1648	1495	1361	1245	1143	1054				
	12	375	2	7/8	8875	7340	6160	5250	4525	3943	3465	3070	2740	2460	2220	2013	1834	1679	1540	1420				
	16	500	2	1	11603	9595	8060	6870	5920	5150	4535	4015	3580	3216	2900	2633	2400	2195	2015	1858				
	18	563	3	7/8	13300	11000	9230	7865	6785	5910	5195	4600	4105	3682	3322	3016	2748	2512	2308	2125				

RECTANGULAR BEAMS—CONTINUOUS OVER SUPPORTS

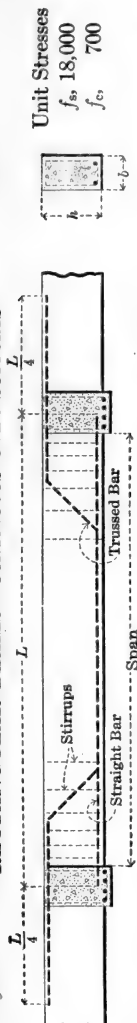

Bending Moment
 $M = \frac{1}{12} w l^2$

DIMENSIONS AND WT.		ROUND BARS		SPAN OF BEAM IN FEET																				
h	b	Weight of Section b h	lb. per ft.	Straight		Trussed		Safe Load in Pounds per Foot Uniformly Distributed, Including Weight of Beam																
				No.	Size	No.	Size	6	7	8	9	10	11	12	13	14	15	16	17	18	19	20	21	
12	6	75	1	1/2	1	1/2	1	1775	1304	998	788	639	528	444	378	326	284	250	221	197	264	238	216	
	8	100	1	5/8	1	5/8	1	2650	1948	1491	1179	955	789	663	565	487	424	373	330	294	336	304	276	
	10	125	2	1/2	2	1/2	2	3375	2480	1898	1500	1214	1004	844	719	620	540	475	420	375	336	304	276	
14	8	117	1	5/8	1	5/8	1	3307	2426	1859	1469	1190	983	826	704	607	529	465	412	367	329	297	270	
	10	146	1	3/4	1	3/4	1	4645	3411	2613	2062	1672	1382	1161	990	853	743	654	579	516	463	418	379	
	12	175	2	5/8	2	5/8	2	5900	4340	3320	2623	2125	1756	1475	1258	1084	945	830	735	656	589	531	482	
16	8	133	1	3/4	1	3/4	1	5158	3790	2900	2293	1858	1536	1290	1100	947	825	725	643	573	515	464	421	
	10	167	2	5/8	2	5/8	2	6730	4950	3790	2994	2424	2003	1684	1435	1238	1078	947	839	748	671	606	550	
	12	200	2	5/8	2	5/8	2	7600	5590	4276	3380	2739	2262	1902	1620	1398	1218	1070	947	845	759	685	621	
18	8	150	1	3/4	1	3/4	1	6260	4600	3522	2784	2255	1863	1567	1334	1150	1002	881	780	696	625	564	511	
	10	188	2	5/8	2	5/8	2	8400	6160	4718	3730	3021	2497	2098	1788	1542	1343	1180	1045	932	837	755	685	
	12	225	2	5/8	2	5/8	2	8790	6455	4940	3905	3163	2615	2200	1872	1615	1407	1237	1095	977	876	791	718	
20	14	262	2	3/4	2	3/4	2	11770	8642	6615	5230	4237	3500	2942	2505	2160	1882	1655	1465	1308	1172	1059	961	
	8	167	1	7/8	1	7/8	1	8625	6330	4850	3830	3103	2565	2157	1838	1585	1380	1212	1073	958	860	776	704	
	10	208	2	5/8	2	5/8	2	9835	7220	5530	4365	3539	2924	2458	2095	1805	1572	1382	1225	1092	980	885	802	
20	12	250	2	3/4	2	3/4	2	12900	9475	7250	5730	4644	3838	3223	2747	2370	2063	1815	1608	1433	1287	1161	1052	
	14	292	2	3/4	2	3/4	2	14066	10330	7917	6255	5064	4190	3520	3000	2585	2252	1980	1754	1565	1405	1268	1150	

RECTANGULAR BEAMS—CONTINUOUS OVER SUPPORTS

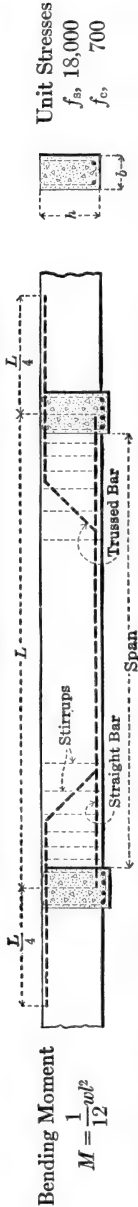

DIMENSIONS AND WT.		ROUND BARS		SPAN OF BEAM IN FEET																				
<i>h</i>	<i>b</i>	lb. per ft.	Straight	Trussed	Safe Load in Pounds per Foot Uniformly Distributed, Including Weight of Beam																			
in.	in.		No.	Size	10	11	12	13	14	15	16	17	18	19	20	21	22	23	24	25				
22	8	183	1	7/8	3693	3052	2564	2184	1884	1640	1442	1278	1140	1022	923	837	763	698	641	591				
	10	229	1	1	4660	3851	3236	2758	2377	2071	1820	1612	1438	1291	1165	1056	963	881	809	746				
	12	275	2	3/4	5536	4570	3840	3275	2822	2460	2160	1915	1708	1532	1382	1255	1142	1046	960	885				
	14	321	2	7/8	6756	5584	4695	4000	3450	3003	2640	2340	2085	1872	1690	1532	1397	1279	1172	1081				
24	8	200	1	7/8	4205	3480	2922	2490	2146	1870	1643	1457	1300	1165	1052	955	870	795	730	673				
	10	250	1	1	5455	4510	3790	3230	2785	2425	2132	1890	1685	1512	1365	1239	1128	1032	948	873				
	12	300	2	3/4	6203	5130	4310	3675	3169	2760	2424	2148	1915	1720	1551	1409	1282	1173	1078	994				
	14	350	2	7/8	7918	6544	5500	4688	4040	3520	3092	2740	2443	2193	1980	1797	1637	1498	1375	1268				
26	8	217	1	1	5437	4492	3773	3218	2774	2415	2122	1881	1678	1506	1360	1232	1122	1028	944	870				
	10	271	2	3/4	6629	5477	4600	3922	3382	2947	2590	2295	2045	1838	1659	1503	1370	1253	1151	1061				
	12	325	2	7/8	8261	6828	5740	4890	4213	3672	3228	2860	2550	2289	2064	1873	1708	1562	1435	1322				
	14	379	2	7/8	9127	7540	6340	5400	4660	4055	3565	3159	2816	2527	2280	2070	1885	1725	1585	1460				
28	8	233	1	1	6224	5145	4320	3683	3177	2765	2432	2155	1922	1725	1556	1412	1287	1177	1080	996				
	10	292	2	3/4	7310	6040	5075	4325	3730	3250	2855	2529	2256	2025	1828	1660	1510	1382	1270	1170				
	12	350	2	7/8	9439	7800	6550	5582	4815	4195	3686	3263	2912	2615	2358	2140	1949	1783	1639	1510				
	14	408	2	7/8	9937	8208	6900	5880	5067	4417	3880	3440	3084	2752	2482	2253	2052	1879	1725	1590				
30	10	312	2	3/4	7910	6540	5500	4680	4040	3520	3090	2740	2440	2192	1979	1795	1636	1497	1375	1267				
	12	375	2	7/8	10650	8800	7400	6300	5435	4730	4160	3685	3287	2950	2662	2415	2200	2014	1850	1704				
	16	500	2	1	13924	11510	9668	8240	7105	6190	5440	4818	4300	3860	3480	3160	2877	2633	2420	2227				
	18	563	3	7/8	15961	13191	11080	9440	8145	7090	6230	5518	4930	4420	3987	3618	3295	3017	2770	2552				

TEE BEAMS—SIMPLE SPANS

Bending Moment

$$M = \frac{1}{8} w l^2$$

Unit Stresses

$$f_s, 16,000$$

$$f_c, 650$$

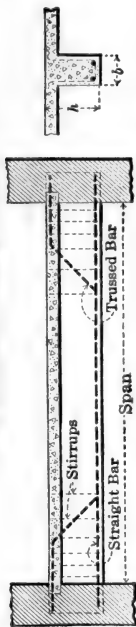

DIMENSIONS AND Wt.			Thick-ness of Flange	Width of Flange	ROUND BARS		SPAN OF BEAM IN FEET													
<i>h</i>	<i>b</i>	Weight of Section <i>w</i>			in.	in.	Straight	Trussed	10	11	12	13	14	15	16	17	18	19	20	21
in.	in.	lb. per ft.			No.	Size	Safe Load in Pounds per Foot Uniformly Distributed, Including Weight of Beam													
12	6	75	4	18	1	1	7/8	1295	1071	900	766	660	576	506						
	8	100	4	23	1	1 1/8	1	1664	1375	1156	985	849	740	650						
	10	125	4	31	2	1	1	2195	1815	1525	1300	1120	976	856						
14	8	117	4	24	1	1 1/4	1	2463	2037	1711	1457	1257	1095	963	853	761	683	616		
			4 1/2	24	1	1 1/8	1													
			5	24	2	1	1 1/8	2875	2375	1995	1700	1467	1278	1122	995	886	796	718		
16	12	175	4	36	2	1 1/8	1	3580	2960	2485	2120	1828	1591	1398	1240	1105	993	895		
			4 1/2	35	2	7/8	2													
			5	35	2	7/8	2	2954	2440	2052	1748	1508	1312	1153	1022	912	818	738	670	
16	10	167	4	32	2	1	2	3794	3136	2635	2244	1936	1686	1482	1313	1171	1051	948	860	
			5	31	2	1	2													
			6	31	3	1	2	4430	3661	3077	2621	2260	1969	1731	1532	1368	1227	1108	1005	
16	12	200	4	36	3	1	2													
			5	35	3	1	2													
			6	35	3	1	2													

TEE BEAMS—SIMPLE SPANS

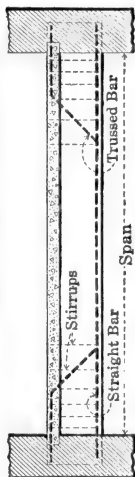

Bending Moment

$$M = \frac{1}{8}wl^2$$

Unit Stresses

$$f_s, 16,000$$

$$f_c, 650$$

DIMENSIONS AND WT.		Thick-ness of Flange	Width of Flange	ROUND BARS		SPAN OF BEAM IN FEET																			
<i>h</i>	<i>b</i>			Weight of Section <i>bh</i>	in.	lb. per ft.	in.	Trussed	Safe Load in Pounds per Foot Uniformly Distributed, Including Weight of Beam																
in.	in.	lb. per ft.	in.	lb. per ft.	No.	Size	No.	Size	12	13	14	15	16	17	18	19	20	21	22	23	24	25	26	27	
	8	150	4 5 6 7	26 24 24 24	2 1	2 7/8	2 1	2 1	2717	2315	1997	1739	1530	1355	1208	1084	978	887	808	740	679				
18	10	188	4 5 6 7	33 31 31 31	2 1	1 1/8	2 1	1	3453	2942	2538	2211	1943	1721	1535	1378	1244	1128	1028	940	864				
	12	225	4 5 6 7	40 38 37 37	3 2	1 1/8	2 1	1	4219	3595	3097	2698	2372	2100	1874	1682	1519	1378	1254	1149	1054				
	8	167	4 5 6 7	27 25 24 24	2 1	2 1	2 1	1	3458	2947	2541	2213	1945	1723	1537	1379	1245	1129	1028	941	864	797	737	683	
20	10	208	4 5 6 7	34 31 30 30	3 2	2 1	2 1	1	4380	3733	3220	2803	2463	2182	1947	1748	1577	1430	1302	1191	1094	1008	932	864	
	12	250	4 5 6 7	41 38 36 36	3 2	3 1	3 1	1	5187	4420	3811	3320	2918	2585	2305	2067	1867	1693	1543	1412	1297	1195	1105	1025	

TEE BEAMS—SIMPLE SPANS

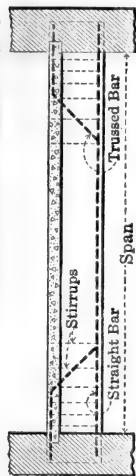

Bending Moment

$$M = \frac{1}{8} w l^2$$

Unit Stresses

$f_s, 16,000$
 $f_c, 650$

DIMENSIONS AND Wt.			ROUND BARS		SPAN OF BEAM IN FEET																						
h	b	Weight of Section lb. per ft.	Thick-ness of Flange in.	Width of Flange in.	Straight		Trussed		19	20	21	22	23	24	25	26	27	28	29	30	31	32	33	34			
					No.	Size	No.	Size																			
22	8	183	4	29	2	1 1/8	1	1750	1580	1433	1305	1194	1097	1011	934	866	806	751	702								
				24	3	1	2	2137	1929	1750	1594	1458	1340	1234	1140	1059	984	917	857								
				25	3	1 1/8	3	2625	2367	2148	1957	1790	1645	1515	1400	1300	1208	1125	1052								
24	10	250	4	37	3	1	1	2558	2308	2095	1908	1745	1602	1478	1367	1268	1178	1098	1026	961	901						
				31	3	1 1/8	3	3208	2895	2624	2391	2188	2009	1852	1712	1588	1475	1376	1286	1204	1130						
				29	3	1 1/8	3	3176	2867	2600	2369	2168	1991	1835	1696	1573	1463	1363	1274	1192	1119	1053	992				
26	12	300	4	47	3	1 1/8	3	3648	3293	2987	2721	2490	2287	2107	1948	1807	1680	1567	1462	1370	1285	1209	1140				
				39	3	1 1/8	2																				
				37	3	1 1/4	2																				

TEE BEAMS—SIMPLE SPANS

Bending Moment

$$M = \frac{1}{8} w l^2$$

Unit Stresses

f_s , 16,000

f_c , 650

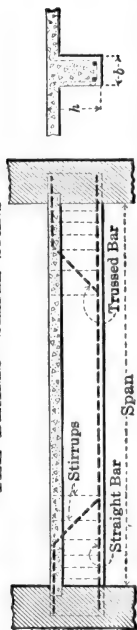

DIMENSIONS AND WT.			ROUND BARS		SPAN OF BEAM IN FEET																					
h	b	Weight of Section lb. per ft.	Thickness of Flange in.	Width of Flange in.	Straight		Trussed		25	26	27	28	29	30	31	32	33	34	35	36	37	38	39	40		
					No.	Size	No.	Size																		
28	10	292	4	44	3	1 1/8	3	1 1/8	2207	2041	1891	1758	1639	1532	1435	1347	1266	1192	1125	1064	1008	954	906			
					3	1 1/4	3	1 1/4	2477	2290	2124	1975	1841	1720	1611	1512	1422	1339	1263	1195	1131	1072	1017			
					4	1 1/8	4	1 1/8	2952	2728	2530	2352	2193	2050	1919	1800	1694	1596	1505	1424	1347	1277	1212			
					4	1 1/4	4	1 1/4	3444	3120	2832	2580	2352	2124	1908	1704	1512	1336	1176	1032	900	780	672	576	492	420
30	12	375	4	55	4	1 1/8	4	1 1/8	3065	2832	2625	2442	2275	2127	1992	1870	1754	1657	1562	1477	1398	1326	1259	1197		
					4	1 1/4	4	1 1/4	3558	3290	3051	2836	2648	2470	2313	2172	2042	1923	1816	1717	1625	1540	1462	1389		
					4	1 1/8	4	1 1/8	3612	3360	3120	2892	2680	2484	2304	2136	1980	1836	1704	1584	1476	1380	1296	1224	1164	1116
					4	1 1/4	4	1 1/4	4144	3840	3552	3280	3024	2784	2556	2340	2136	1944	1764	1596	1440	1296	1164	1044	936	840

TEE BEAMS—END SPANS

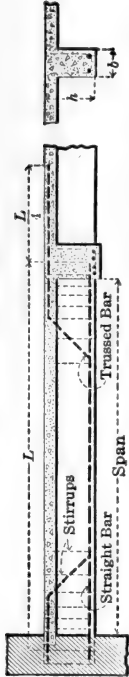

Bending Moment

$$M = \frac{1}{10} w l^2$$

Unit Stresses

$$f_s = 16,000$$

$$f_c = 650$$

DIMEN. AND WT.		ROUND BARS		SPAN OF BEAM IN FEET																					
<i>h</i>	<i>b</i>	Weight of Section <i>b</i> <i>h</i>	Straight	Trussed	10	11	12	13	14	15	16	17	18	19	20	21	22	23	24	25					
in.	in.	lb. per ft.	No. and Size	No. and Size	Safe Load in Pounds per Foot Uniformly Distributed, Including Weight of Beam																				
12	6	75	1-5/8	1-5/8	700	579	487	414	357	312	273														
	8	100	1-3/4	1-3/4	1002	828	697	593	512	446	392														
	10	125	1-7/8	1-7/8	1343	1111	933	796	687	597	525														
	12	150	2-5/8	2-5/8	1400	1158	972	828	714	622	547														
14	6	88	1-3/4	1-3/4	1202	992	834	711	612	534	470	417	371	333											
	8	117	1-7/8	1-7/8	1620	1339	1125	958	827	720	632	561	500	449											
	10	146	1-1	1-1	2061	1704	1432	1221	1052	917	805	713	637	571											
	12	175	2-3/4	2-3/4	2403	1987	1670	1423	1226	1068	939	831	742	667											
16	6	100	1-7/8	1-7/8	1800	1488	1251	1065	918	800	703	623	556	498	450	408									
	8	133	1-1	1-1	2372	1960	1647	1404	1210	1054	926	821	732	657	593	537									
	10	167	2-3/4	2-3/4	2817	2328	1957	1667	1437	1252	1101	975	870	780	704	639									
	12	200	1-7/8+1-3/4	1-7/8+1-3/4	3356	2773	2330	1986	1712	1492	1311	1161	1036	929	838	761									
18	8	150	1-1	1-1	2894	2392	2010	1712	1477	1287	1131	1002	893	802	723	657	598	547	502						
	10	188	1-7/8+1-3/4	1-7/8+1-3/4	3808	3147	2644	2253	1942	1692	1489	1317	1176	1055	952	863	787	720	661						
	12	225	2-7/8	2-7/8	4423	3656	3072	2617	2257	1966	1728	1531	1365	1225	1106	1003	914	836	768						
	14	262	1-1+1-7/8	1-1+1-7/8	5136	4250	3571	3042	2622	2285	2008	1779	1587	1425	1285	1167	1062	972	892						
20	8	167	1-1 1/8	1-1 1/8			2792	2377	2050	1786	1569	1391	1242	1114	1005	911	830	760	697	642					
	10	208	2-7/8	2-7/8			3417	2912	2510	2188	1923	1702	1518	1363	1230	1116	1017	930	854	787					
	12	250	1-1+1-7/8	1-1+1-7/8			4033	3437	2962	2583	2271	2010	1793	1609	1452	1317	1200	1098	1008	929					
	14	292	2-1	2-1			4566	3887	3354	2922	2567	2275	2029	1821	1643	1491	1358	1242	1142	1052					

TEE BEAMS—END SPANS

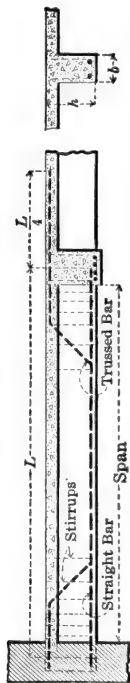

Bending Moment

$$M = \frac{1}{10} w l^2$$

Unit Stresses

$$f_b, 16,000$$

$$f_c, 650$$

DIMEN. AND WT.		ROUND BARS		SPAN OF BEAM IN FEET																	
<i>h</i>	<i>b</i>	Weight of Section <i>bh</i>	Straight	Trussed	Safe Load in Pounds per Foot Uniformly Distributed, Including Weight of Beam																
in.	in.	lb. per ft.	No. and Size	No. and Size	16	17	18	19	20	21	22	23	24	25	26	27	28	29	30	31	
8	10	183	1-1 1/8	1-1 1/8	1810	1603	1430	1283	1158	1051	957	876	804	742	686	636	591	551			
22	10	229	1-1 + 1-7/8	1-1 + 1-7/8	2448	2168	1933	1735	1566	1421	1293	1183	1087	1002	926	859	800	746			
12	12	275	2-1	2-1	2875	2546	2271	2037	1838	1669	1520	1392	1277	1177	1088	1009	939	875			
14	14	321	3-7/8	3-7/8	3296	2919	2604	2337	2109	1913	1743	1595	1465	1351	1248	1157	1076	1003			
10	20	250	1-1 + 1-7/8	1-1 + 1-7/8	2798	2477	2210	1983	1789	1624	1479	1354	1243	1146	1059	982	913	852	796	746	
12	24	300	3-7/8	3-7/8	3559	3152	2812	2524	2277	2066	1882	1722	1582	1457	1347	1250	1162	1083	1012	948	
14	30	350	2-1 1/8	2-1 1/8	4007	3550	3167	2842	2565	2326	2120	1938	1781	1642	1517	1407	1308	1220	1140	1067	
16	40	400	3-1	3-1	4700	4162	3712	3333	3008	2727	2483	2274	2087	1925	1778	1649	1533	1430	1336	1252	
10	27	271	2-1	2-1	3464	3069	2737	2456	2217	2012	1832	1677	1541	1418	1312	1217	1132	1055	985	923	
12	32	325	2-1 1/8	2-1 1/8	4283	3795	3383	3037	2742	2486	2265	2072	1902	1754	1621	1504	1398	1303	1217	1140	
14	37	379	1-1 1/4 + 1-1 1/8	1-1 1/4 + 1-1 1/8	4871	4312	3846	3452	3117	2825	2575	2355	2162	1994	1842	1708	1589	1482	1384	1297	
16	43	433	2-1 + 2-7/8	2-1 + 2-7/8	5182	4622	4148	3744	3396	3094	2831	2600	2396	2215	2054	1910	1781	1664	1558		
10	29	292	3-7/8	3-7/8	3343	3001	2708	2457	2238	2047	1879	1733	1603	1485	1382	1288	1202	1127			
12	35	350	1-1 1/4 + 1-1 1/8	1-1 1/4 + 1-1 1/8	4052	3637	3282	2977	2713	2482	2280	2101	1944	1802	1675	1562	1459	1367			
14	40	408	2-1 1/4	2-1 1/4	4633	4162	3754	3404	3102	2837	2606	2403	2221	2058	1912	1785	1667	1562			
16	46	467	3-1 1/8	3-1 1/8	5445	4887	4411	4001	3645	3335	3063	2823	2610	2420	2251	2098	1960	1836			
12	37	375	3-1	3-1	3802	3450	3146	2878	2643	2436	2252	2089	1942	1810	1691	1583					
14	43	437	2-1 + 2-7/8	2-1 + 2-7/8	4459	4044	3685	3372	3097	2854	2638	2447	2275	2121	1982	1856					
16	50	500	3-1 1/8	3-1 1/8	4934	4475	4077	3731	3427	3157	2922	2707	2517	2347	2192	2053					
18	56	563	2-1 1/8 + 2-1	2-1 1/8 + 2-1	5730	5200	4741	4333	3981	3670	3390	3144	2925	2727	2546	2386					

TEE BEAMS—CONTINUOUS OVER SUPPORTS

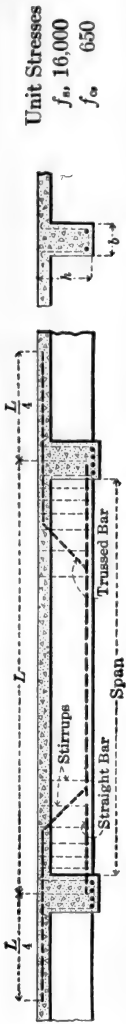

Bending Moment

$$M = \frac{1}{12} w l^2$$

DIMEN. AND WT.		ROUND BARS		SPAN OF BEAM IN FEET																								
<i>h</i>	<i>b</i>	Weight of Section <i>b h</i>	No. and Size	Trussed	10	11	12	13	14	15	16	17	18	19	20	21	22	23	24	25	Unit Stresses							
in.	in.	lb. per ft.	No. and Size		Safe Load in Pounds per Foot Uniformly Distributed, Including Weight of Beam																						<i>f_s</i>	<i>f_c</i>
6	75	1-5/8	1-5/8	Trussed	840	695	584	497	429	374	328												16,000	650				
12	8	100	1-3/4	1-3/4	1203	994	836	712	614	535	470																	
10	125	1-7/8	1-7/8	1-7/8	1612	1333	1120	955	824	716	630																	
12	150	2-5/8	2-5/8	2-5/8	1680	1390	1167	994	857	746	656																	
6	88	1-3/4	1-3/4	1-3/4	1442	1191	1001	853	735	641	564	500	445	400														
8	117	1-7/8	1-7/8	1-7/8	1944	1607	1350	1150	992	864	759	673	600	539														
14	10	146	1-1	1-1	2473	2045	1719	1465	1262	1100	966	856	764	685														
12	175	2-3/4	2-3/4	2-3/4	2884	2384	2004	1708	1472	1282	1127	998	890	800														
6	100	1-7/8	1-7/8	1-7/8	2161	1786	1501	1279	1102	960	844	748	667	598	540	490												
8	133	1-1	1-1	1-1	2846	2352	1976	1685	1452	1265	1111	985	878	788	712	645												
16	10	167	2-3/4	2-3/4	3381	2794	2348	2001	1725	1503	1321	1170	1044	936	845	767												
12	200	1-7/8+1-3/4	1-7/8+1-3/4	1-7/8+1-3/4	4027	3328	2796	2383	2054	1790	1573	1393	1243	1115	1006	913												
8	150	1-1	1-1	1-1	2871	2412	2055	1772	1544	1357	1202	1072	962	868	788	718	657	603										
18	10	188	1-7/8+1-3/4	1-7/8+1-3/4	3173	2704	2331	2031	1787	1581	1411	1266	1142	1036	944	864	793											
12	225	2-7/8	2-7/8	2-7/8	3686	3141	2708	2359	2074	1837	1638	1470	1327	1204	1097	1003	922											
14	262	1-1+1-7/8	1-1+1-7/8	1-1+1-7/8	4285	3650	3147	2742	2410	2135	1904	1710	1542	1400	1275	1166	1071											
8	167	1-1 1/8	1-1 1/8	1-1 1/8	2460	2143	1883	1669	1490	1337	1206	1093	996	912	837	771												
10	208	2-7/8	2-7/8	2-7/8	3012	2626	2308	2043	1822	1636	1476	1339	1220	1116	1025	945												
12	250	1-1+1-7/8	1-1+1-7/8	1-1+1-7/8	3555	3100	2725	2412	2152	1931	1742	1580	1440	1318	1210	1115												
14	292	2-1	2-1	2-1	4025	3507	3080	2730	2435	2185	1972	1789	1630	1491	1370	1262												

TEE BEAMS—CONTINUOUS OVER SUPPORTS

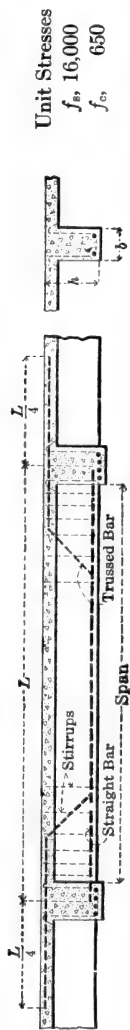

Bending Moment

$$M = \frac{1}{12} w l^2$$

DIMEN. AND WT.		ROUND BARS		SPAN OF BEAM IN FEET																Unit Stresses			
<i>h</i>	<i>b</i>	Weight of Section <i>b h</i>	Straight	Trussed	Safe Load in Pounds per Foot Uniformly Distributed, Including Weight of Beam																<i>f_s</i>	<i>f_c</i>	
in.	in.	lb. per ft.	No. and Size	No. and Size	16	17	18	19	20	21	22	23	24	25	26	27	28	29	30	31	16,000	650	
8	8	183	1-1½	1-1½	2172	1924	1716	1540	1390	1261	1149	1051	965	890	823	763	709	661					
22	10	229	1-1+1-7/8	1-1+1-7/8	2937	2602	2320	2082	1879	1705	1552	1420	1305	1202	1111	1031	960	895					
	12	275	2-1	2-1	3450	3055	2725	2445	2206	2003	1824	1670	1533	1412	1306	1211	1127	1050					
	14	321	3-7/8	3-7/8	3955	3503	3125	2805	2531	2296	2092	1914	1758	1622	1498	1389	1291	1204					
24	10	250	1-1+1-7/8	1-1+1-7/8			2652	2380	2147	1949	1775	1625	1492	1375	1271	1179	1096	1022	955	895			
	12	300	3-7/8	3-7/8			3375	3029	2733	2479	2259	2067	1898	1749	1617	1500	1395	1300	1215	1138			
	14	350	2-1½	2-1½			3800	3410	3078	2791	2544	2326	2137	1970	1821	1689	1570	1464	1368	1281			
	16	400	3-1	3-1			4455	4000	3610	3272	2980	2728	2505	2310	2134	1979	1840	1716	1603	1502			
26	10	271	2-1	2-1					2660	2415	2198	2012	1849	1702	1574	1460	1358	1266	1182	1108			
	12	325	2-1½	2-1½					3290	2983	2718	2487	2283	2105	1945	1805	1678	1564	1461	1368			
	14	379	1-1¼+1-1½	1-1¼+1-1½					3740	3390	3090	2826	2595	2393	2211	2050	1907	1779	1661	1556			
	16	433	2-1+2-7/8	2-1+2-7/8					4493	4075	3713	3397	3120	2875	2658	2465	2292	2137	1997	1870			
28	10	292	3-7/8	3-7/8							2686	2457	2255	2080	1924	1782	1659	1546	1443	1352			
	12	350	1-1¼+1-1½	1-1¼+1-1½							3256	2979	2736	2521	2333	2162	2010	1874	1751	1640			
	14	408	2-1¼	2-1¼							3723	3403	3127	2884	2665	2470	2295	2142	2000	1875			
	16	467	3-1½	3-1½							4374	4002	3676	3388	3132	2904	2701	2518	2352	2203			
30	12	375	3-1	3-1									3172	2923	2703	2506	2330	2172	2029	1900			
	14	437	2-1+2-7/8	2-1+2-7/8									3716	3425	3166	2936	2730	2545	2378	2227			
	16	500	3-1½	3-1½									4112	3789	3506	3249	3021	2816	2631	2464			
	18	563	2-1½+2-1	2-1½+2-1									4777	4404	4088	3773	3510	3272	3055	2863			

TEE BEAMS—SIMPLE SPANS

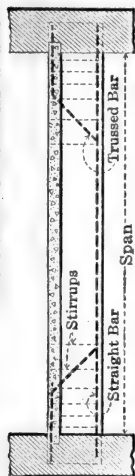

Bending Moment

$$M = \frac{1}{8} w l^2$$

Unit Stresses
 f_t , 18,000
 f_c , 700

DIMENSIONS AND WT.			Thick-ness of Flange		Width of Flange		ROUND BARS		SPAN OF BEAM IN FEET												
h	b	Weight of Section $b h$	in.	in.	in.	in.	Straight	Trussed	10	11	12	13	14	15	16	17	18	19	20	21	
in.	in.	lb. per ft.			No.	Size	No.	Size	Safe Load in Pounds per Foot Uniformly Distributed, Including Weight of Beam												
12	6	75	4	17	1	1	1	$\frac{3}{4}$	1298	1073	901	768	662	577	507						
	8	100	4	25	1	$1\frac{1}{8}$	1	1	1872	1547	1300	1108	955	831	730						
	10	125	4	30	2	1	1	$\frac{7}{8}$	2281	1885	1584	1350	1164	1014	891						
14	8	117	4	23	1	$1\frac{1}{8}$	1	$1\frac{1}{8}$	2508	2073	1741	1484	1279	1115	979	868	774	695	627		
			5	23																	
	10	146	4	30	2	1	1	$1\frac{1}{8}$	3233	2672	2245	1913	1649	1437	1263	1118	998	895	808		
16	12	175	4	37	2	1	2	1	3962	3275	2753	2347	2023	1762	1548	1371	1223	1099	991		
			5	37																	
	8	133	4	26	1	$1\frac{1}{4}$	1	$1\frac{1}{4}$	3573	2953	2481	2114	1822	1588	1395	1236	1102	990	894	811	
16	10	167	4	31	2	$1\frac{1}{8}$	1	$1\frac{1}{8}$	4374	3615	3038	2588	2232	1944	1709	1513	1350	1212	1093	992	
			5	30																	
	12	200	4	39	2	$1\frac{1}{4}$	1	$1\frac{1}{4}$	5374	4444	3734	3182	2743	2390	2100	1861	1659	1489	1344	1219	
			5	37																	
			6	37																	

TEE BEAMS—SIMPLE SPANS

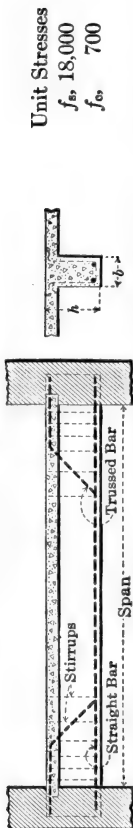

Bending Moment

$$M = \frac{1}{8} w l^2$$

Unit Stresses
 f_s , 18,000
 f_c , 700

DIMENSIONS AND WT.			ROUND BARS		SPAN OF BEAM IN FEET																						
h	b	Weight of Section $b h$	Thick-ness of Flange	Width of Flange	Straight	Trussed	Safe Load in Pounds per Foot Uniformly Distributed, Including Weight of Beam																				
in.	in.	lb. per ft.	in.	in.	No.	Size	12	13	14	15	16	17	18	19	20	21	22	23	24	25	26	27					
18	8	150	4	25	2	1	1 1/4	2849	2427	2093	1823	1602	1419	1266	1136	1025	930	847	775	712							
			5	24																							
			6	24																							
			7	24																							
18	10	188	4	32	2	1 1/4	3555	3029	2613	2275	2000	1771	1580	1419	1280	1161	1058	968	889								
			5	30																							
			6	30																							
			7	30																							
12	12	225	4	39	3	1	2	1	4363	3717	3205	2792	2454	2174	1939	1740	1570	1424	1298	1187	1090						
			5	36																							
			6	36																							
			7	36																							
20	8	167	4	27	2	1 1/4	3752	3197	2756	2401	2110	1869	1667	1496	1350	1225	1116	1021	938	864	799	741					
			5	25																							
			6	24																							
			7	24																							
20	10	208	4	34	2	1 1/4	4605	3924	3383	2947	2590	2295	2047	1837	1658	1503	1370	1253	1151	1061	981	909					
			5	31																							
			6	30																							
			7	30																							
12	12	250	4	40	3	1	2	1 1/4	5410	4610	3975	3462	3043	2696	2404	2158	1948	1766	1609	1472	1352	1246	1152	1068			
			5	37																							
			6	36																							
			7	35																							

TEE BEAMS—SIMPLE SPANS

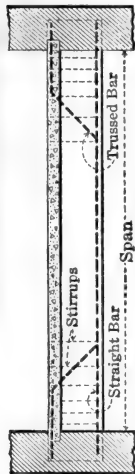

Bending Moment

$$M = \frac{1}{8} w l^2$$

Unit Stresses
 f_s 18,000
 f_c 700

DIMENSIONS AND WT.			Thick-ness of Flange		Width of Flange		ROUND BARS		SPAN OF BEAM IN FEET																	
h	b	Weight of Section $b h$	in.	in.	in.	in.	Straight	Trussed	19	20	21	22	23	24	25	26	27	28	29	30	31	32	33	34		
in.	in.	lb. per ft.					No.	No.	Safe Load in Pounds per Foot Uniformly Distributed, Including Weight of Beam																	
							Size	Size																		
22	8	183	4	6	24	24	2	1 1/8	1	1 1/4	1794	1619	1470	1339	1225	1125	1035	957	887	825	769	719				
	10	229	4	6	30	30	2	1 1/4	2	1	2239	2021	1833	1670	1528	1403	1293	1196	1109	1031	961	898				
	12	275	4	6	37	36	2	1 1/4	2	1 1/4	2679	2418	2193	1998	1828	1679	1547	1431	1327	1234	1150	1075				
24	10	250	4	6	31	30	2	1 1/4	2	1 1/8	2705	2442	2215	2019	1848	1697	1564	1446	1341	1247	1162	1086	1017	954		
	12	300	4	6	38	36	3	1 1/8	2	1 1/4	3319	2995	2716	2475	2265	2080	1917	1772	1643	1528	1424	1331	1246	1170		
			10	10	36	36																				
26	10	271	4	6	32	30	2	1 1/4	2	1 1/4	3253	2936	2662	2426	2219	2038	1879	1737	1611	1498	1396	1305	1222	1147	1078	1016
	12	325	4	6	39	37	3	1 1/8	3	1 1/8	3974	3587	3253	2964	2712	2490	2295	2122	1968	1830	1706	1594	1493	1401	1317	1241
			10	10	36	36																				

TEE BEAMS—SIMPLE SPANS

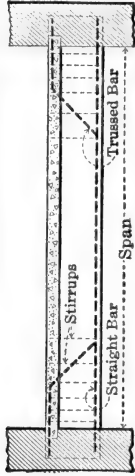

Bending Moment

$$M = \frac{1}{8} w l^2$$

Unit Stresses

$$f_b, 18,000$$

$$f_c, 700$$



DIMENSIONS AND WT.			ROUND BARS		SPAN OF BEAM IN FEET																										
h	b	in.	Thick- ness of Flange	Width of Flange	in.	Straight		Trussed		Safe Load in Pounds per Foot Uniformly Distributed, Including Weight of Beam	25	26	27	28	29	30	31	32	33	34	35	36	37	38	39	40					
						No.	Size	No.	Size																						
	10	292	4	41	3	1 1/8	3	1	2250	2080	1929	1794	1672	1563	1463	1373	1291	1215	1148	1085	1027	974	924								
28	12	350	4	49	4	1	4	1	2649	2449	2271	2112	1969	1840	1723	1617	1520	1432	1352	1278	1209	1147	1088								
	14	408	4	60	4	1 1/8	3	1 1/4	3210	2966	2750	2558	2382	2226	2085	1956	1840	1733	1635	1546	1463	1387	1317								
	10	312	4	45	3	1 1/8	3	1 1/8	2694	2491	2310	2148	2002	1871	1752	1644	1546	1457	1375	1299	1230	1166	1107	1052							
30	12	375	4	52	3	1 1/4	1	1 1/4	3120	2884	2675	2487	2318	2166	2029	1904	1790	1687	1592	1504	1424	1350	1282	1218							
	14	437	4	60	4	1 1/4	4	1	3665	3387	3141	2921	2723	2544	2383	2237	2103	1980	1870	1767	1672	1586	1505	1432							

TEE BEAMS—END SPANS

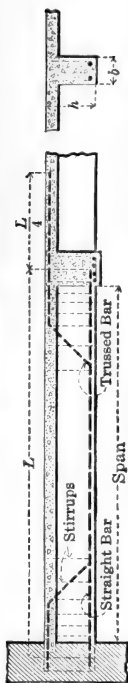

Bending Moment

$$M = \frac{1}{10} w l^2$$

Unit Stresses
 f_b , 18,000
 f_s , 700

DIMEN. AND WT.		ROUND BARS									SPAN OF BEAM IN FEET														
<i>h</i>	<i>b</i>	Weight of Section <i>w</i> /ft	Straight	Trussed	Safe Load in Pounds per Foot Uniformly Distributed, Including Weight of Beam																				
in.	in.	lb. per ft.	No. and Size	No. and Size	10	11	12	13	14	15	16	17	18	19	20	21	22	23	24	25					
12	6	75	1-5/8	1-5/8	737	651	547	466	402	350	307														
	8	100	1-3/4	1-3/4	1111	917	772	657	567	494	434														
	10	125	1-7/8	1-7/8	1442	1192	1002	853	736	641	563														
	12	150	2-5/8	2-5/8	1575	1301	1092	932	803	700	615														
14	6	88	1-3/4	1-3/4	1293	1066	895	763	657	573	504	447	398	357											
	8	117	1-7/8	1-7/8	1738	1437	1207	1029	887	772	679	602	537	482											
	10	146	1-3/4 + 1-5/8	1-3/4 + 1-5/8	2154	1780	1496	1275	1099	957	842	745	665	597											
	12	175	2-3/4	2-3/4	2579	2132	1792	1527	1316	1147	1008	892	796	714											
16	6	100	1-3/4	1-3/4	1605	1327	1115	950	819	713	627	555	495	445	402	364									
	8	133	1-7/8	1-7/8	2187	1807	1519	1294	1116	972	854	757	675	606	547	496									
	10	167	1-1	1-1	2852	2356	1981	1687	1456	1267	1115	987	881	790	712	647									
	12	200	1-7/8 + 1-3/4	1-7/8 + 1-3/4	3613	2986	2509	2138	1843	1606	1412	1250	1115	1001	903	819									
18	8	150	1-1	1-1	3173	2622	2204	1877	1619	1411	1240	1098	979	879	793	719	656	600	551						
	10	188	1-1 1/8	1-1 1/8	3984	3293	2767	2357	2032	1771	1557	1378	1230	1103	996	903	822	753	692	633					
	12	225	2-7/8	2-7/8	4802	3968	3334	2843	2450	2135	1876	1662	1482	1330	1200	1088	992	907	833						
	14	262	1-1 + 1-7/8	1-1 + 1-7/8	5566	4600	3865	3293	2840	2473	2174	1926	1717	1542	1392	1262	1150	1052	966						
20	8	167	2-3/4	2-3/4			2813	2397	2067	1801	1582	1402	1250	1122	1012	918	837	766	703	648					
	10	208	1-7/8 + 1-3/4	1-7/8 + 1-3/4			3408	2905	2505	2182	1918	1698	1516	1359	1227	1113	1015	927	852	786					
	12	250	2-7/8	2-7/8			3928	3347	2887	2514	2210	1958	1746	1567	1413	1284	1169	1068	982	905					
	14	292	2-1	2-1			4987	4249	3664	3192	2805	2485	2217	1989	1795	1628	1483	1357	1247	1149					

TEE BEAMS—END SPANS

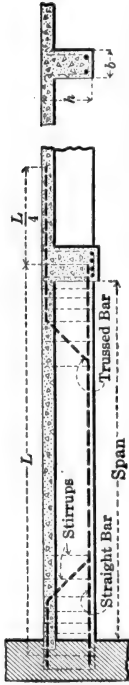

Bending Moment

$$M = \frac{1}{10} w l^2$$

Unit Stresses

$$f_b, 18,000$$

$$f_c, 700$$

DIMEN. AND WT.		ROUND BARS		SPAN OF BEAM IN FEET																																							
<i>h</i>	<i>b</i>	Weight of Section <i>b h</i>	Straight	Trussed	Safe Load in Pounds per Foot Uniformly Distributed, Including Weight of Beam																																						
in.	in.	lb. per ft.	No. and Size	No. and Size	16	17	18	19	20	21	22	23	24	25	26	27	28	29	30	31																							
22	8	183	1-1 1/8	1-1 1/8	1996	1767	1577	1415	1277	1158	1056	967	887	817	756	701	652	607																									
	10	229	2-7/8	2-7/8	2452	2172	1937	1739	1570	1423	1297	1187	1090	1004	929	861	801	747																									
	12	275	1-1 + 1-1/8	1-1 + 1-1/8	2842	2517	2243	2015	1817	1649	1502	1375	1262	1164	1076	997	927	864																									
	14	321	1-1 1/8 + 1-1	1-1 1/8 + 1-1	3522	3120	2782	2497	2254	2044	1862	1704	1565	1442	1333	1237	1150	1071																									
24	10	250	1-1 + 1-7/8	1-1 + 1-7/8	3057	2707	2415	2167	1956	1774	1617	1479	1358	1252	1157	1073	998	930	869	814																							
	12	300	2-1	2-1	3573	3167	2823	2535	2287	2075	1889	1729	1588	1464	1352	1254	1167	1088	1017	952																							
	14	350	2-1 1/8	2-1 1/8	4332	3837	3423	3072	2772	2515	2292	2097	1926	1774	1641	1522	1415	1318	1232	1154																							
	16	400	1-1 1/4 + 1-1 1/8	1-1 1/4 + 1-1 1/8	4900	4338	3871	3475	3135	2844	2592	2373	2177	2006	1854	1719	1600	1491	1392	1305																							
26	10	271	2-1	2-1	3742	3315	2957	2652	2395	2172	1979	1812	1663	1533	1417	1314	1222	1139	1065	997																							
	12	325	1-1 1/8 + 1-1	1-1 1/8 + 1-1	4355	3858	3442	3087	2788	2527	2302	2107	1935	1783	1649	1529	1422	1325	1239	1159																							
	14	379	2-1 1/8	2-1 1/8	4914	4352	3882	3485	3145	2852	2599	2378	2184	2012	1861	1726	1604	1496	1397	1309																							
	16	433	2-1 1/4	2-1 1/4	5916	5241	4675	4196	3787	3433	3129	2862	2631	2424	2242	2077	1932	1801	1683	1576																							
28	10	292	2-1	2-1	3348	3005	2712	2461	2242	2050	1883	1736	1605	1487	1383	1290	1206	1129																									
	12	350	2-1 1/8	2-1 1/8	4132	3708	3347	3036	2766	2531	2324	2142	1980	1836	1707	1592	1487	1393																									
	14	408	1-1 1/4 + 1-1 1/8	1-1 1/4 + 1-1 1/8	4712	4225	3812	3462	3154	2885	2650	2442	2258	2093	1946	1815	1696	1587																									
	16	467	2-1 1/4	2-1 1/4	5207	4674	4218	3826	3486	3189	2929	2700	2496	2314	2152	2006	1875	1756																									
30	12	375	2-7/8 + 2-3/4	2-7/8 + 2-3/4	3850	3492	3182	2911	2673	2464	2278	2112	1964	1831	1711	1602																											
	14	437	2-1 1/4	2-1 1/4	4508	4092	3729	3412	3133	2887	2667	2475	2300	2146	2004	1877																											
	16	500	2-1 + 2-7/8	2-1 + 2-7/8	5127	4654	4237	3877	3561	3282	3034	2813	2616	2438	2278	2134																											
	18	563	4-1	4-1	5787	5250	4783	4375	4018	3704	3423	3175	2950	2750	2571	2408																											

TEE BEAMS—CONTINUOUS OVER SUPPORTS

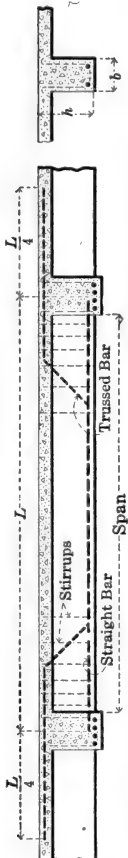

Bending Moment

$$M = \frac{1}{12} w l^2$$

Unit Stresses
 f_s , 18,000
 f_c , 700

DIMEN. AND WT.		ROUND BARS		SPAN OF BEAM IN FEET																				
h	b	Weight of Section $b h$	Straight	Trussed	10	11	12	13	14	15	16	17	18	19	20	21	22	23	24	25				
in.	in.	lb. per ft.	No. and Size	No. and Size	Safe Load in Pounds per Foot Uniformly Distributed, Including Weight of Beam																			
12	6	75	1-5/8	1-5/8	945	781	656	559	482	420	369													
	8	100	1-3/4	1-3/4	1333	1101	926	789	681	593	521													
	10	125	1-7/8	1-7/8	1731	1430	1202	1024	883	769	676													
	12	150	2-5/8	2-5/8	1890	1561	1311	1118	964	840	738													
14	6	88	1-3/4	1-3/4	1548	1279	1074	916	789	688	605	536	478	429										
	8	117	1-7/8	1-7/8	2086	1724	1449	1235	1065	927	815	722	644	578										
	10	146	1-3/4 + 1-5/8	1-3/4 + 1-5/8	2585	2136	1795	1530	1319	1149	1010	894	798	716										
	12	175	2-3/4	2-3/4	3095	2558	2150	1832	1579	1376	1210	1071	955	857										
16	6	100	1-3/4	1-3/4	1926	1592	1338	1140	983	856	752	666	594	534	482	437								
	8	133	1-7/8	1-7/8	2625	2169	1823	1553	1339	1166	1025	908	810	727	656	595								
	10	167	1-1	1-1	3422	2827	2377	2025	1747	1521	1338	1185	1057	948	855	776								
	12	200	1-7/8 + 1-3/4	1-7/8 + 1-3/4	4336	3583	3011	2566	2212	1927	1694	1500	1338	1201	1084	983								
18	8	150	1-1	1-1	2253	1943	1693	1488	1318	1175	1055	952	863	787	720	661								
	10	188	1-1 1/8	1-1 1/8	2829	2439	2125	1868	1654	1476	1324	1195	1084	987	904	830								
	12	225	2-7/8	2-7/8	3412	2940	2562	2251	1994	1778	1596	1440	1306	1190	1089	1000								
	14	262	1-1 + 1-7/8	1-1 + 1-7/8	3952	3408	2968	2609	2311	2061	1850	1670	1514	1380	1262	1159								
20	8	167	2-3/4	2-3/4	2480	2161	1899	1682	1500	1347	1215	1102	1004	919	844	778								
	10	208	1-7/8 + 1-3/4	1-7/8 + 1-3/4	3006	2618	2302	2038	1819	1631	1472	1336	1218	1113	1022	943								
	12	250	2-7/8	2-7/8	3465	3017	2652	2350	2095	1880	1696	1540	1403	1282	1179	1086								
	14	292	2-1	2-1	4397	3830	3366	2982	2660	2387	2154	1954	1780	1629	1496	1379								

TEE BEAMS—CONTINUOUS OVER SUPPORTS

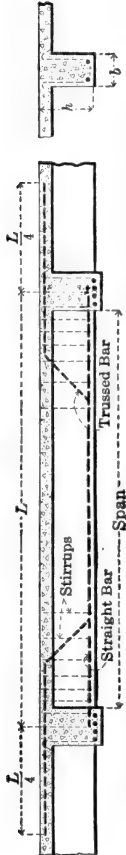

Bending Moment

$$M = \frac{1}{12} w l^2$$

Unit Stresses
 f_b , 18,000
 f_c , 700

DIMEN. AND WT.	ROUND BARS		SPAN OF BEAM IN FEET																			
	h	b	Weight of Section $b h$	Straight	Trussed	Safe Load in Pounds per Foot Uniformly Distributed, Including Weight of Beam																
	in.	in.	lb. per ft.	No. and Size	No. and Size	16	17	18	19	20	21	22	23	24	25	26	27	28	29	30	31	
22	10	8	183	1-1 1/8	1-1 1/8	2395	2121	1892	1698	1533	1390	1267	1160	1064	981	907	841	782	729			
	10	10	229	2-7/8	2-7/8	2943	2607	2325	2087	1884	1708	1557	1424	1308	1205	1115	1033	961	896			
	12	12	275	1-1 + 1-7/8	1-1 + 1-7/8	3410	3020	2692	2418	2180	1979	1803	1650	1515	1397	1291	1197	1112	1037			
	14	14	321	1-1 1/8 + 1-1	1-1 1/8 + 1-1	4226	3744	3339	2997	2705	2453	2235	2045	1878	1731	1600	1484	1380	1286			
24	10	10	250	1-1 + 1-7/8	1-1 + 1-7/8	2898	2601	2347	2129	1940	1775	1630	1502	1389	1288	1198	1116	1043	977			
	12	12	300	2-1	2-1	3388	3042	2744	2490	2267	2075	1906	1757	1623	1505	1400	1306	1220	1142			
	14	14	350	2-1 1/8	2-1 1/8	4108	3687	3327	3018	2750	2516	2311	2129	1969	1826	1698	1582	1479	1385			
	16	16	400	1-1 1/4 + 1-1 1/8	1-1 1/4 + 1-1 1/8	4645	4170	3762	3413	3110	2848	2612	2407	2225	2062	1920	1789	1671	1566			
26	10	10	271	2-1	2-1	2874	2606	2375	2174	1996	1840	1700	1577	1466	1367	1278	1197					
	12	12	325	1-1 1/8 + 1-1	1-1 1/8 + 1-1	3346	3033	2762	2528	2322	2140	1979	1835	1706	1590	1487	1391					
	14	14	379	2-1 1/8	2-1 1/8	3774	3423	3119	2854	2621	2415	2233	2071	1925	1795	1677	1571					
	16	16	433	2-1 1/4	2-1 1/4	4545	4120	3755	3435	3157	2909	2690	2492	2318	2161	2020	1891					
28	10	10	292	2-1	2-1	2690	2460	2260	2083	1926	1785	1660	1548	1447	1355							
	12	12	350	2-1 1/8	2-1 1/8	3319	3037	2789	2570	2376	2203	2049	1910	1785	1672							
	14	14	408	1-1 1/4 + 1-1 1/8	1-1 1/4 + 1-1 1/8	3785	3462	3180	2930	2710	2512	2335	2178	2035	1905							
	16	16	467	2-1 1/4	2-1 1/4	4183	3827	3515	3240	2995	2777	2582	2407	2250	2107							
30	12	12	375	2-7/8 + 2-3/4	2-7/8 + 2-3/4	3208	2957	2734	2535	2357	2197	2053	1923									
	14	14	437	2-1 1/4	2-1 1/4	3760	3465	3200	2970	2760	2575	2405	2252									
	16	16	500	2-1 + 2-7/8	2-1 + 2-7/8	4273	3938	3641	3376	3139	2926	2734	2561									
	18	18	563	4-1	4-1	4822	4445	4108	3810	3540	3300	3085	2890									

STIRRUP REINFORCEMENT FOR UNIFORMLY LOADED BEAMS



NOTE.—The table gives total number of stirrups per beam. Place one-half of number at each end of beam as indicated.

Clear Span of Beam ft.	NUMBER AND SIZE OF ROUND BAR STIRRUPS															
	For End Shear = 80 lb. per sq. in.				For End Shear = 100 lb. per sq. in.				For End Shear = 120 lb. per sq. in.				For End Shear = 140 lb. per sq. in.			
	Width of Beam in Inches		Width of Beam in Inches		Width of Beam in Inches		Width of Beam in Inches		Width of Beam in Inches		Width of Beam in Inches		Width of Beam in Inches		Width of Beam in Inches	
6	4-1/4	4-1/4	6-1/4	6-1/4	8-1/4	6-3/8	6-3/8	6-3/8	6-3/8	6-3/8	6-3/8	8-3/8	8-3/8	6-3/8	6-3/8	
7	4-1/4	6-1/4	8-1/4	8-1/4	8-1/4	6-3/8	6-3/8	6-3/8	6-3/8	6-3/8	6-3/8	8-3/8	8-3/8	8-3/8	8-3/8	
8	6-1/4	6-1/4	8-1/4	8-1/4	10-1/4	8-3/8	8-3/8	8-3/8	8-3/8	8-3/8	8-3/8	8-3/8	8-3/8	10-3/8	10-3/8	
9	6-1/4	8-1/4	8-1/4	10-1/4	10-1/4	8-3/8	8-3/8	8-3/8	8-3/8	8-3/8	8-3/8	8-3/8	8-3/8	10-3/8	10-3/8	
10	6-1/4	8-1/4	10-1/4	10-1/4	12-1/4	8-3/8	8-3/8	8-3/8	8-3/8	8-3/8	8-3/8	10-3/8	10-3/8	10-3/8	10-3/8	
11	8-1/4	8-1/4	10-1/4	10-1/4	12-1/4	8-3/8	8-3/8	8-3/8	8-3/8	8-3/8	8-3/8	10-3/8	10-3/8	12-3/8	12-3/8	
12	8-1/4	10-1/4	12-1/4	12-1/4	12-1/4	8-3/8	8-3/8	8-3/8	8-3/8	8-3/8	8-3/8	10-3/8	10-3/8	12-3/8	12-3/8	
13	8-1/4	10-1/4	12-1/4	14-1/4	14-1/4	8-3/8	8-3/8	8-3/8	8-3/8	8-3/8	8-3/8	10-3/8	10-3/8	12-3/8	12-3/8	
14	10-1/4	12-1/4	14-1/4	14-1/4	16-1/4	8-3/8	8-3/8	8-3/8	8-3/8	8-3/8	8-3/8	10-3/8	10-3/8	12-3/8	12-3/8	
15	10-1/4	12-1/4	14-1/4	16-1/4	16-1/4	8-3/8	8-3/8	8-3/8	8-3/8	8-3/8	8-3/8	10-3/8	10-3/8	12-3/8	12-3/8	
16	10-1/4	12-1/4	8-3/8	8-3/8	8-3/8	8-3/8	8-3/8	8-3/8	8-3/8	8-3/8	8-3/8	10-3/8	10-3/8	12-3/8	12-3/8	
17	10-1/4	14-1/4	8-3/8	8-3/8	8-3/8	8-3/8	8-3/8	8-3/8	8-3/8	8-3/8	8-3/8	10-3/8	10-3/8	12-3/8	12-3/8	
18	12-1/4	14-1/4	8-3/8	8-3/8	8-3/8	8-3/8	8-3/8	8-3/8	8-3/8	8-3/8	8-3/8	10-3/8	10-3/8	12-3/8	12-3/8	
19	12-1/4	14-1/4	8-3/8	10-3/8	10-3/8	10-3/8	10-3/8	10-3/8	10-3/8	10-3/8	10-3/8	12-3/8	12-3/8	14-3/8	14-3/8	
20	12-1/4	16-1/4	8-3/8	10-3/8	10-3/8	10-3/8	10-3/8	10-3/8	10-3/8	10-3/8	10-3/8	12-3/8	12-3/8	14-3/8	14-3/8	
21	14-1/4	16-1/4	10-3/8	10-3/8	10-3/8	10-3/8	10-3/8	10-3/8	10-3/8	10-3/8	10-3/8	12-3/8	12-3/8	14-3/8	14-3/8	
22	14-1/4	18-1/4	10-3/8	10-3/8	10-3/8	10-3/8	10-3/8	10-3/8	10-3/8	10-3/8	10-3/8	12-3/8	12-3/8	14-3/8	14-3/8	
23	14-1/4	18-1/4	10-3/8	12-3/8	12-3/8	12-3/8	12-3/8	12-3/8	12-3/8	12-3/8	12-3/8	14-3/8	14-3/8	16-3/8	16-3/8	
24	16-1/4	18-1/4	10-3/8	12-3/8	12-3/8	12-3/8	12-3/8	12-3/8	12-3/8	12-3/8	12-3/8	14-3/8	14-3/8	16-3/8	16-3/8	
25	16-1/4	20-1/4	10-3/8	12-3/8	12-3/8	12-3/8	12-3/8	12-3/8	12-3/8	12-3/8	12-3/8	14-3/8	14-3/8	16-3/8	16-3/8	
26	16-1/4	20-1/4	12-3/8	12-3/8	14-3/8	14-3/8	14-3/8	14-3/8	14-3/8	14-3/8	14-3/8	16-3/8	16-3/8	18-3/8	18-3/8	
27	18-1/4	20-1/4	12-3/8	14-3/8	14-3/8	14-3/8	14-3/8	14-3/8	14-3/8	14-3/8	14-3/8	16-3/8	16-3/8	18-3/8	18-3/8	
28	18-1/4	22-1/4	12-3/8	14-3/8	14-3/8	14-3/8	14-3/8	14-3/8	14-3/8	14-3/8	14-3/8	16-3/8	16-3/8	18-3/8	18-3/8	
29	18-1/4	22-1/4	12-3/8	14-3/8	14-3/8	14-3/8	14-3/8	14-3/8	14-3/8	14-3/8	14-3/8	16-3/8	16-3/8	18-3/8	18-3/8	
30	18-1/4	24-1/4	12-3/8	14-3/8	14-3/8	14-3/8	14-3/8	14-3/8	14-3/8	14-3/8	14-3/8	16-3/8	16-3/8	18-3/8	18-3/8	

FLAT SLAB TABLES

CORR-PLATE FLOORS

(PATENTED)

Flat slab floors, or floors in which beam elements are omitted and the slab supported directly on the columns, are the result of the ever-present demand for efficiency and economy of construction, particularly for buildings in the warehouse and industrial group. This demand has been met by numerous "systems" of flat slab floors, each reflecting the ideas of the designer as to the distribution of the reinforcement; some approaching the ideal distribution and still others varying widely from the mark.

The Corrugated Bar Company, Inc., has developed through its research and laboratory work, accompanied by field tests, a method of design and a system of steel distribution which it is believed meets the conditions of the problem in the most logical manner. This construction is known as Corr-Plate—a flat slab reinforced in two directions in such manner as to conform to the variation in moment that exists in a flat plate on point supports when subjected to load, and for which is claimed the following engineering advantages:

- (a) That it can be accurately designed.
- (b) That the arrangement of reinforcement in two directions, parallel to the sides of the panel, is the best arrangement to meet the stress distribution as observed in laboratory and field tests.
- (c) That the steel distribution adopted varies with the bending moment, being heaviest at the panel margin and gradually decreasing toward mid-panel.
- (d) That having no more than two layers of reinforcement at any one point the length of arm of the moment couple at any section is the greatest possible, thus affording maximum strength and stiffness for a given thickness of concrete.
- (e) The factor of safety being substantially uniform throughout, there results a saving in quantity of concrete and reinforcement.

Aside from the specific advantages claimed for Corr-Plate Floors, flat slab construction in general appeals to the owner and builder from the economic and service standpoint. The advantages may be summed up in the following brief paragraphs:

- (a) No beams or girders. This means saving in forms and by virtue of the flat ceiling, greater economy in the installation of the sprinkler system.
- (b) Saves space. From one to one and a half feet of actual free space is gained in every story. This may amount to a story height in every eight, depending upon the standard of ceiling heights used in the building. The reduction in total height of building means a saving in walls, columns, piping, stairways, elevator structure and in every item in a building that is affected by a change in story height.
- (c) Better light and ventilation. There are no beams to cast shadows or interfere with a thorough diffusion of light. Flat ceilings remove all obstacles to the free movement of air currents and to that extent assist in maintaining uniform conditions as to temperature, humidity and the removal of vitiated air.

(d) Better fire protection. The damage a concrete building sustains by fire bears a direct relation to the number of corners exposed to the action of heat and water. In this respect it is clear that the beamless floor has a decided advantage over the beam

and girder type of construction. Again, beams serve to deflect hose streams and to form pockets in the ceiling that collect and intensify heat.

(e) Speed and economy. A flat slab building may be erected in less time and with greater economy than one of the beam and girder type.

The moment factors used in the design of Corr-Plate Floors, as previously stated, are based on the result of experiment in the laboratory supplemented by tests on actual structures where steel and concrete deformations were measured and stress and moment distribution determined therefrom. The distribution of moment, and similarly of reinforcement, is given in Fig. 8, where, to avoid confusion, the distribution is given for only one set of reinforcements. The same methods are applied to the reinforcements at right angles to the ones shown. The figures in the circles are the denominators of the moment coefficient per foot width of slab for the band in which they appear; thus the positive moment per foot of width at the center of the band extending between columns is, $M = \frac{WS^2}{20}$ and the negative moment over the column for the same band is $M = \frac{WS^2}{10}$

Similarly for the remaining bands into which the panel is divided. The clear span

between the column heads in feet, is S , and w is the total dead and live load per square foot of floor. In Fig. 8, the heavy stepped line shows the practical distribution of moment while the dashed curved line shows the actual distribution as determined by experiment.

The tables on pages 110 and 111 are based on standard Corr-Plate design for stresses of $f_s = 16,000$, $f_c = 650$; and $f_s = 18,000$, $f_c = 700$, respectively, and are for square interior panels. Similar tables are given on pages 112 and 113 to meet the requirements of the Chicago Flat Slab ruling and the Final Report of the Joint Committee. The latter report is given in detail on pages 194 to 211.

The approximate weight of reinforcement per square foot of floor area is given for each span and load and includes steel required for the support of the negative moment reinforcement.

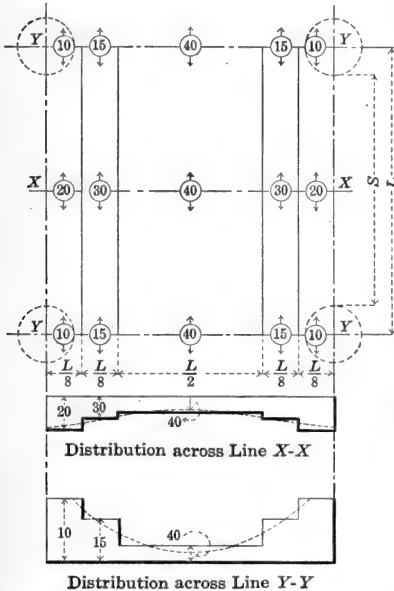
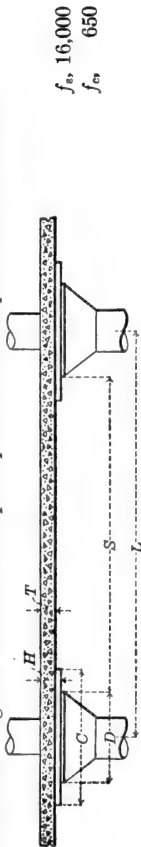

FIG. 8

FLAT SLAB FLOORS
STANDARD CORR-PLATE
Concrete Sizes and Weight of Reinforcement per Square Foot for Square Interior Panels



L	C	D	Live load 40 lb. sq. ft.			Live load 150 lb. sq. ft.			Live load 200 lb. sq. ft.			Live load 300 lb. sq. ft.			Live load 400 lb. sq. ft.			Live load 500 lb. sq. ft.																
			T	H	Weight of Slab	T	H	Weight of Slab	T	H	Weight of Slab	T	H	Weight of Slab	T	H	Weight of Slab	T	H	Weight of Slab	T	H	Weight of Slab											
ft.	ft.	in.	in.	in.	lb.	in.	in.	in.	lb.	in.	in.	in.	lb.	in.	in.	lb.	in.	in.	in.	lb.	in.	in.	lb.	in.	in.	lb.	in.	in.	lb.	in.	in.	lb.	in.	in.
15	6-0	41	5½	7½	73	1-30	6	8	79	1-84	6	8	79	2-18	7	9	92	2-58	7½	11½	102	2-92	8½	12½	114	3-04	8½	12½	114	3-04	8½	12½	114	3-04
16	6-6	43	5½	7½	73	1-33	6	8	79	2-15	6½	8½	86	2-37	7½	9½	98	2-73	8	12	108	3-16	9	13	121	3-25	9	13	121	3-25	9	13	121	3-25
17	6-9	46	5½	7½	73	1-37	6½	8½	86	2-19	7	9	92	2-56	8	11	106	2-91	8½	12½	114	3-27	9½	13½	127	3-49	9½	13½	127	3-49	9½	13½	127	3-49
18	7-3	49	6	8	79	1-43	6½	8½	86	2-46	7	9	92	2-70	8½	11½	112	2-95	9	13	121	3-49	10	14	133	3-75	9	13	121	3-49	10	14	133	3-75
19	7-9	52	6	8	79	1-52	7	9	92	2-47	7½	9½	98	2-86	8½	11½	112	3-37	9½	13½	127	3-71	10½	15½	142	3-96	9½	13½	127	3-71	10½	15½	142	3-96
20	8-0	54	6	8	79	1-65	7½	9½	98	2-65	8	10	104	2-96	9	13	120	3-37	10	14	133	3-82	11	16	148	4-27	10	14	133	3-82	11	16	148	4-27
21	8-6	57	6½	8½	86	1-79	8	10	104	2-79	8	10	104	3-25	9½	13½	127	3-61	10½	14½	139	4-16	11½	16½	154	4-40	10½	14½	139	4-16	11½	16½	154	4-40
22	8-9	60	6½	8½	86	1-89	8	10	104	3-01	8½	11½	112	3-31	10	14	133	3-85	11	16	147	4-18	12	18	162	4-63	11	16	147	4-18	12	18	162	4-63
23	9-3	62	7	9	92	1-97	8½	10½	111	3-12	9	12	119	3-52	10½	14½	140	3-98	11½	16½	154	4-51	12½	18½	168	5-04	10½	14½	140	3-98	11½	16½	154	4-51
24	9-9	65	7½	9½	98	2-09	9	11	117	3-35	9½	12½	125	3-62	10½	15½	142	4-24	12	18	162	4-64	13	19	175	5-15	12	18	162	4-64	13	19	175	5-15
25	10-0	68	8	10	104	2-17	9½	11½	123	3-47	10	13	131	3-95	11	16	148	4-48	12½	18½	168	4-76	14	20	187	5-27	11	16	148	4-48	12½	18½	168	4-76

FLAT SLAB FLOORS
STANDARD CORR-PLATE
Concrete Sizes and Weight of Reinforcement per Square Foot for Square Interior Panels



f_s , 18,000
 f_c , 700

L	C	D	Live load 40 lb. sq.ft.			Live load 150 lb. sq.ft.			Live load 200 lb. sq.ft.			Live load 300 lb. sq.ft.			Live load 400 lb. sq.ft.			Live load 500 lb. sq.ft.							
			T	H	Reinforcement	T	H	Reinforcement	T	H	Reinforcement	T	H	Reinforcement	T	H	Reinforcement	T	H	Reinforcement	T	H	Reinforcement		
ft.	ft.	in.	in.	lb.	sq.ft.	lb.	sq.ft.	lb.	sq.ft.	in.	lb.	sq.ft.	in.	lb.	sq.ft.	in.	lb.	sq.ft.	in.	lb.	sq.ft.	in.	lb.	sq.ft.	
15	6-0	41	5½	73	1.30	6	8	79	1.61	6	8	79	1.99	7	9	92	2.36	7½	11½	102	2.54	8½	12½	114	2.84
16	6-6	43	5½	73	1.22	6	8	79	1.89	6½	8½	86	2.07	7½	9½	98	2.51	8	12	108	2.77	9	13	121	2.99
17	6-9	46	5½	73	1.35	6½	8½	86	1.93	7	9	92	2.22	8	11	106	2.63	8½	12½	114	2.87	9½	13½	127	3.10
18	7-3	49	6	79	1.39	6½	8½	86	2.13	7	9	92	2.49	8½	11½	112	2.72	9	13	121	3.12	10	14	133	3.32
19	7-9	52	6	79	1.42	7	9	92	2.28	7½	9½	98	2.51	8½	11½	112	2.98	9½	13½	127	3.31	10½	15½	142	3.50
20	8-0	54	6	79	1.46	7½	9½	98	2.35	8	10	104	2.71	9	13	120	3.11	10	14	133	3.43	11	16	148	3.79
21	8-6	57	6½	86	1.59	8	10	104	2.42	8	10	104	3.01	9½	13½	127	3.21	10½	14½	139	3.59	11½	16½	154	4.03
22	8-9	60	6½	86	1.70	8	10	104	2.69	8½	11½	112	3.04	10	14	133	3.31	11	16	147	3.86	12	18	162	4.15
23	9-3	62	7	92	1.82	8½	10½	111	2.87	9	12	119	3.17	10½	14½	140	3.52	11½	16½	154	4.05	12½	18½	168	4.22
24	9-9	65	7½	98	1.89	9	11	117	2.96	9½	12½	125	3.25	10½	15½	142	3.87	12	18	162	4.22	13	19	175	4.53
25	10-0	68	8	104	1.95	9½	11½	123	3.08	10	13	131	3.43	11	16	148	4.06	12½	18½	168	4.38	14	20	187	4.76

FLAT SLAB FLOORS

CHICAGO RULING

Concrete Sizes and Weight of Reinforcement per Square Foot for Square Interior Panels

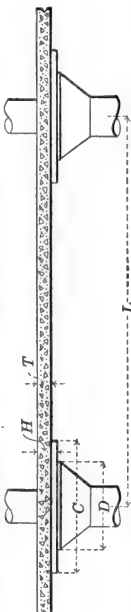

f_s , 18,000
 f_c , 700

L	C	D	Live Load 40 lb. sq. ft.			Live load 150 lb. sq. ft.			Live load 200 lb. sq. ft.			Live load 300 lb. sq. ft.			Live load 400 lb. sq. ft.			Live load 500 lb. sq. ft.													
			T	H	Reinforcement	T	H	Reinforcement	T	H	Reinforcement	T	H	Reinforcement	T	H	Reinforcement	T	H	Reinforcement	T	H	Reinforcement								
ft.	ft.	in.	in.	lb.	lb.	sq. ft.	in.	lb.	lb.	sq. ft.	in.	lb.	lb.	sq. ft.	in.	lb.	lb.	sq. ft.	in.	lb.	lb.	sq. ft.	in.	lb.	lb.	sq. ft.	in.	lb.	lb.	sq. ft.	
15	5-0	41	6	75	1.50	6	8	78	1.96	6	8½	79	2.29	5-9	6¾	9¼	90	2.69	7¾	10½	102	2.97	8½	11½	112	3.45	8½	11½	112	3.45	
16	5-6	43	6	75	1.51	6	8	78	2.16	6¼	9	82	2.46	6-3	7¼	10	96	2.83	8¼	11¼	109	3.24	9¼	12¼	122	3.54	9¼	12¼	122	3.54	
17	5-9	46	6	75	1.71	6½	8¾	85	2.19	6¾	9½	88	2.53	7-0	7¾	10½	103	3.07	9	11¾	118	3.42	9¾	12¾	128	3.79	9¾	12¾	128	3.79	
18	6-0	49	6	78	1.59	6¾	9¼	89	2.33	7	10½	92	2.75	7-3	8½	11¼	112	3.22	9½	12½	125	3.57	10½	13½	137	3.92	10½	13½	137	3.92	
19	6-6	52	6	78	1.66	7¼	9¾	95	2.46	7½	11	99	2.94	7-6	9	12	118	3.45	10	13¼	131	3.79	11	14½	144	4.21	11	14½	144	4.21	
20	6-9	54	6	78	1.79	7½	10½	98	2.59	8	11½	105	3.03	8-0	9½	12½	125	3.59	10¾	14	141	4.01	11¾	15¼	154	4.42	11¾	15¼	154	4.42	
21	7-0	57	6½	81½	84	1.85	8	11¼	105	2.81	8½	12¼	111	3.19	8-6	10	131	3.80	11¼	14¾	148	4.16	12½	16	163	4.53	12½	16	163	4.53	
22	7-6	60	6½	81½	84	1.94	8¼	11¾	108	3.04	9	12¾	118	3.39	8-9	10½	14	138	4.04	12	15½	157	4.43	13	17	170	4.84	13	17	170	4.84
23	7-9	62	7	90	2.06	8¾	12¼	114	3.10	9½	13½	125	3.51	9-0	11¼	14½	147	4.15	12½	16¼	164	4.73	13¾	17¼	180	5.15	13¾	17¼	180	5.15	
24	8-0	65	7¼	91¼	94	2.18	9	118	3.31	10	14¼	131	3.64	9-3	11¾	15½	154	4.31	13¼	17½	173	4.83	14½	19	189	5.33	14½	19	189	5.33	
25	8-6	68	7½	91½	96	2.32	9½	125	3.48	10½	14¾	137	3.86	9-6	12¼	16½	161	4.51	14	18¼	183	5.09	15¼	20	199	5.49	15¼	20	199	5.49	

FLAT SLAB FLOORS
JOINT COMMITTEE RECOMMENDATIONS
Concrete Sizes and Weight of Reinforcement per Square Foot for Square Interior Panels

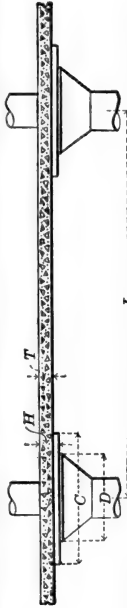

f_c 16,000
 f_s 650

L	C	D	Live load 40 lb. sq. ft.			Live load 150 lb. sq. ft.			Live load 200 lb. sq. ft.			Live load 300 lb. sq. ft.			Live load 400 lb. sq. ft.			Live load 500 lb. sq. ft.																
			T	H	Reinforcement	T	H	Reinforcement	T	H	Reinforcement	T	H	Reinforcement	T	H	Reinforcement	T	H	Reinforcement	T	H	Reinforcement											
ft.	ft.	in.	in.	in.	lb. sq. ft.	lb. sq. ft.	lb. sq. ft.	in.	in.	lb. sq. ft.	lb. sq. ft.	lb. sq. ft.	in.	in.	lb. sq. ft.	lb. sq. ft.	lb. sq. ft.	in.	in.	lb. sq. ft.	lb. sq. ft.	lb. sq. ft.	in.	in.	lb. sq. ft.	lb. sq. ft.	lb. sq. ft.	in.	in.	lb. sq. ft.	lb. sq. ft.			
156	0	41	6	6	75	1.57	6	8 1/4	79	2.60	6 1/4	9	84	3.00	7	10 1/2	94	3.43	7 3/4	11 3/4	105	3.93	8 1/2	12 3/4	115	4.33	9 1/2	14 1/2	125	4.83	10 1/2	15 1/4	136	5.15
166	5	43	6	8	79	1.52	6	8 3/4	80	2.85	6 1/2	9 3/4	88	3.07	7 1/2	11	101	3.67	8 1/4	12 1/2	112	4.38	9	13 1/2	121	4.68	9 1/2	14 1/2	118	4.46	9 1/2	14 1/2	129	4.95
176	10	46	6	8	79	1.69	6 1/2	9 1/4	87	2.97	7	10 1/4	94	3.37	8	12	108	3.94	8 3/4	13 1/4	118	4.46	9 1/2	14 1/2	129	4.95	9 1/2	14 1/2	125	4.83	10	15 1/4	136	5.15
187	3	49	6	8	79	1.93	6 3/4	9 3/4	90	3.20	7 1/2	11	101	3.38	8 1/2	12 1/2	114	4.15	9 1/4	14	125	4.83	10	15 1/4	136	5.15	9 1/2	14 1/2	125	4.83	10	15 1/4	136	5.15
197	8	52	6	8	79	2.12	7 1/4	10 1/2	97	3.41	7 3/4	11 1/2	104	3.74	8 3/4	13 1/4	118	4.54	9 3/4	14 3/4	132	4.86	10 3/4	16	145	5.40	9 1/2	14 1/2	125	4.83	10	15 1/4	136	5.15
208	0	54	6	8	79	2.30	7 1/2	11	100	3.50	8	12	108	4.10	9 1/4	14	125	4.59	10 1/2	15 3/4	142	5.27	11 1/4	17	152	5.86	9 1/2	14 1/2	125	4.83	10	15 1/4	136	5.15
218	5	57	6 1/2	8 1/2	83	2.41	8	11 3/4	107	3.68	8 1/2	12 3/4	115	4.18	9 3/4	14 3/4	132	4.90	11	16 1/2	149	5.52	12	18	162	6.03	9 1/2	14 1/2	125	4.83	10	15 1/4	136	5.15
228	10	60	6 1/2	9	86	2.60	8 1/4	12 1/4	111	3.87	9	13 1/2	121	4.43	10 1/4	15 1/2	139	5.07	11 1/2	17 1/4	155	5.97	12 1/2	18 3/4	169	6.48	9 1/2	14 1/2	125	4.83	10	15 1/4	136	5.15
239	3	62	7	9 1/2	92	2.72	8 3/4	12 3/4	117	4.10	9 1/2	14	128	4.58	10 3/4	16	145	5.35	12	18	162	6.17	13	19 3/4	176	6.55	9 1/2	14 1/2	125	4.83	10	15 1/4	136	5.15
249	8	65	7 1/4	10	96	2.85	9	13 1/4	121	4.28	9 3/4	14 3/4	132	4.76	11 1/4	17	152	5.72	12 1/2	18 3/4	169	6.38	13 1/2	20 1/2	183	6.94	9 1/2	14 1/2	125	4.83	10	15 1/4	136	5.15
2510	0	68	7 1/2	10 1/4	99	3.01	9 1/2	14	128	4.55	10 1/4	15 1/4	138	5.05	11 3/4	17 3/4	159	5.85	13	19 3/4	176	6.63	14	21 1/4	189	7.18	9 1/2	14 1/2	125	4.83	10	15 1/4	136	5.15

COLUMN TABLES

Concrete columns are usually reinforced either with vertical bars tied together at intervals by steel hoops or with vertical bars and spiral hooping. These two general types of column are referred to in the tables, pages 115 to 132, as "Tied Columns" and "Spiral Columns." These tables give safe loads in thousands of pounds for columns to meet the requirements of the New York or Chicago building codes, or the Final Report of the Joint Committee on Concrete and Reinforced Concrete.

In New York City the code recognizes but two concrete mixes for columns, viz., 1:2:4 and 1:1½:3, while Chicago and the Joint Committee permit, in addition to these two, a 1:1:2 mix. Where it is desired to hold the column size to a minimum the advantage of the richer mix is apparent.

In the matter of percentages of vertical and spiral reinforcement it will be recognized that it is not practicable to give all possible combinations that could be worked out but there is a sufficient range in each table to satisfactorily cover most requirements. Consider, for example, the spiral columns based on New York code requirements, pages 122 to 124. For each column there is given five different percentages of vertical steel and three different percentages of spiral reinforcement for each mix, thus yielding fifteen load variations for one size of column. Similarly for the balance of the column tables.

The following formulas express the requirements for safe column load for each of the three codes used:

TIED COLUMNS

$$\text{New York } P = Af_c [1 + (n - 1) p]$$

$$\text{Chicago } P = Af_c [1 + (n - 1) p]$$

$$\text{Joint Committee } P = Af_c [1 + (n - 1) p]$$

SPIRAL COLUMNS

$$\text{New York } P = f_c (A - pA) + nf_c pA + 2f_s p' A$$

$$\text{Chicago } P = Af_c (1 + 2.5 np') [1 + (n - 1) p]$$

$$\text{Joint Committee } P = Af_c [1 + (n - 1) p]$$

In the above formulas the values of f_c and n are noted in the tables. In each case p represents the percentage of vertical steel and p' the percentage of spiral. The value of f_s in the New York formula is taken at 20,000 pounds per square inch.

SQUARE TIED COLUMNS

SAFE AXIAL LOADS IN THOUSANDS OF POUNDS

NEW YORK CITY BUILDING CODE REQUIREMENTS

Ratio of Length of Column to its Side, limited to 15

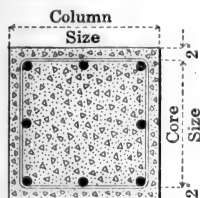

Column Size in.	Core Size in.	ROUND BAR TIES		ROUND BAR VERTICALS		1: 2: 4 Concrete $f_c = 500$ lb. per sq. in. $n = 15$	1: 1½: 3 Concrete $f_c = 600$ lb. per sq. in. $n = 12$
		Size in.	Spacing in.	No.	Size		
12	8	¼	5	4	¾	35	41
		¼	7	4	1½	38	44
		¼	9	4	5/8	41	46
		¼	11	4	¾	44	50
		¼	12	4	7/8	49	54
13	9	¼	5	4	¾	44	52
		¼	7	4	1½	46	54
		¼	9	4	5/8	49	57
		¼	11	4	¾	53	60
		¼	12	4	7/8	57	64
		¼	12	4	1	62	69
14	10	¼	7	4	1½	55	65
		¼	9	4	5/8	59	68
		¼	11	4	¾	62	72
		¼	12	4	7/8	67	76
		¼	12	4	1	72	81
		¼	12	4	1½	78	86
15	11	¼	7	4	1½	66	78
		¼	9	4	5/8	69	81
		¼	11	4	¾	73	84
		¼	12	4	7/8	77	88
		¼	12	4	1	82	93
		¼	12	6	1	93	104
16	12	¼	7	4	1½	77	92
		¼	11	4	¾	84	98
		¼	12	4	7/8	89	102
		¼	12	4	1	94	107
		¼	12	4	1½	100	113
		¼	12	6	1½	114	126
17	13	¼	9	4	5/8	93	110
		¼	11	4	¾	97	113
		¼	12	4	7/8	101	117
		¼	12	6	7/8	110	125
		¼	12	6	1	117	133
		¼	12	8	1	128	143
18	14	¼	9	4	5/8	107	126
		¼	12	4	7/8	115	134
		¼	12	4	1	120	139
		¼	12	6	7/8	123	142
		¼	12	6	1½	140	158
		¼	12	8	1½	154	171
19	15	¼	9	4	5/8	121	143
		¼	12	4	7/8	129	151
		¼	12	6	7/8	138	159
		¼	12	6	1	145	166
		¼	12	8	1	156	176
		¼	12	8	1½	168	188

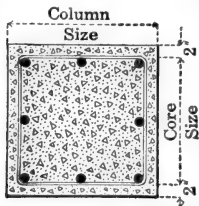

SQUARE TIED COLUMNS

SAFE AXIAL LOADS IN THOUSANDS OF POUNDS

NEW YORK CITY BUILDING CODE REQUIREMENTS

Ratio of Length of Column to its Side, limited to 15

Column Size in.	Core Size in.	ROUND BAR TIES		ROUND BAR VERTICALS		1: 2: 4 Concrete $f_c = 500$ lb. per sq. in. $n = 15$	1: 1½: 8 Concrete $f_c = 600$ lb. per sq. in. $n = 12$
		Size in.	Spacing in.	No.	Size		
20	16	¼	11	4	¾	140	165
		¼	12	4	1	150	174
		¼	12	6	1	153	177
		¼	12	8	1	162	185
		¼	12	8	1½	184	206
		¼	12	10	1½	197	219
21	17	¼	11	4	¾	157	185
		¼	12	4	1	166	194
		¼	12	6	1	177	204
		¼	12	8	1	188	215
		¼	12	8	1½	200	226
		¼	12	12	1½	228	252
22	18	¼	11	4	¾	174	206
		¼	12	6	1	187	218
		¼	12	6	1	195	226
		¼	12	8	1	206	236
		¼	12	8	1½	231	259
		¼	12	12	1½	245	273
23	19	¼	9	6	5/8	193	229
		¼	12	6	1	206	240
		¼	12	6	1½	222	256
		¼	12	10	1	235	268
		¼	12	10	1½	250	282
		¼	12	12	1½	284	314
24	20	¼	11	6	¾	219	258
		¼	12	6	1	233	271
		¼	12	6	1½	242	279
		¼	12	10	1	255	292
		¼	12	12	1½	284	319
		¼	12	16	1½	311	345
25	21	¼	11	6	¾	239	282
		¼	12	6	1	254	296
		¼	12	8	1	265	306
		¼	12	12	1	286	327
		¼	12	14	1½	318	356
		¼	12	18	1½	346	383
26	22	¼	9	8	5/8	259	307
		¼	12	8	1	276	322
		¼	12	10	1	297	342
		¼	12	12	1	308	353
		¼	12	14	1½	340	382
		¼	12	18	1½	367	409
27	23	¼	9	10	5/8	286	338
		¼	12	10	1	307	357
		¼	12	10	1	320	369
		¼	12	14	1	341	390
		¼	12	16	1½	376	422
		¼	12	20	1½	404	449

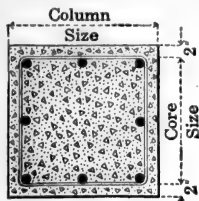

SQUARE TIED COLUMNS

SAFE AXIAL LOADS IN THOUSANDS OF POUNDS

NEW YORK CITY BUILDING CODE REQUIREMENTS

Ratio of Length of Column to its Side, limited to 15

Column Size	Core Size	ROUND BAR TIES		ROUND BAR VERTICALS		1 : 2 : 4 Concrete $f_c = 500$ lb. per sq. in. $n = 15$	1 : 1½ : 3 Concrete $f_c = 600$ lb. per sq. in. $n = 12$
		Size	Spacing	No.	Size		
28	24	¼	9	10	5/8	310	366
		¼	12	10	7/8	330	385
		¼	12	12	1	354	408
		¼	12	14	1	365	418
		¼	12	18	1½	413	463
		¼	12	22	1½	441	490
29	25	¼	9	12	5/8	338	399
		¼	12	12	7/8	363	423
		¼	12	12	1	378	437
		¼	12	14	1½	410	467
		¼	12	18	1½	438	493
		¼	12	20	1½	484	537
30	26	¼	9	12	5/8	364	430
		¼	12	12	7/8	388	453
		¼	12	12	1	404	468
		¼	12	14	1½	435	497
		¼	12	20	1½	477	537
		¼	12	22	1½	527	584
31	27	¼	9	12	5/8	390	462
		¼	12	14	7/8	424	493
		¼	12	14	1	441	510
		¼	12	16	1½	476	542
		¼	12	22	1½	518	582
		¼	12	24	1½	571	632
32	28	¼	9	14	5/8	422	499
		¼	12	14	7/8	451	526
		¼	12	14	1	469	543
		¼	12	16	1½	503	575
		¼	12	24	1½	559	628
		¼	12	26	1½	615	680
33	29	¼	9	14	5/8	450	533
		¼	12	14	7/8	479	560
		¼	12	16	1	508	587
		¼	12	18	1½	545	623
		¼	12	24	1½	587	662
		¼	12	28	1½	660	731
34	30	¼	9	16	5/8	484	572
		¼	12	16	7/8	518	604
		¼	12	18	1	549	633
		¼	12	18	1½	575	658
		¼	12	24	1½	656	734
		¼	12	30	1½	707	782
35	31	¼	9	16	5/8	515	609
		¼	12	16	7/8	548	640
		¼	12	18	1	579	670
		¼	12	20	1½	619	707
		¼	12	24	1½	686	771
		¼	12	32	1½	755	835

SQUARE TIED COLUMNS

SAFE AXIAL LOADS IN THOUSANDS OF POUNDS

CHICAGO BUILDING CODE REQUIREMENTS

Ratio of Length of Column to its Side, limited to 12

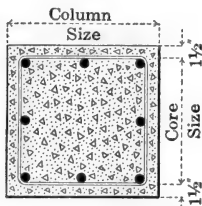
Square
Tied
Columns

Column Size	Core Size	ROUND BAR TIES		ROUND BAR VERTICALS		1: 2: 4	1: 1 1/2: 3	1: 1: 2
		Size	Spacing	No.	Size	2,000 lb. Concrete $f_c = 400$ lb. per sq. in. $n = 15$	2,400 lb. Concrete $f_c = 480$ lb. per sq. in. $n = 12$	2,900 lb. Concrete $f_c = 580$ lb. per sq. in. $n = 10$
in.	in.	in.	in.	No.	Size			
11	8	1/4	7	4		32	37	44
		3/4	9	4	3/4	35	40	46
12	9	1/4	7	4	5/8	39	45	53
		3/4	9	4	3/4	42	48	56
		1/4	10	4	7/8	46	52	60
13	10	1/4	7	4	5/8	47	54	64
		3/4	9	4	3/4	50	57	67
		1/4	10	4	7/8	53	61	71
		1/4	12	4	1	58	65	74
14	11	1/4	7	4	5/8	55	65	77
		3/4	9	4	3/4	58	67	79
		1/4	10	4	7/8	62	71	83
		1/4	12	4	1	66	75	87
15	12	1/4	7	4	5/8	64	76	90
		3/4	9	4	3/4	68	78	93
		1/4	10	4	7/8	71	82	96
		1/4	12	4	1	75	86	100
		1/4	13	4	1 1/8	80	90	104
16	13	1/4	7	4	5/8	74	88	104
		3/4	9	4	3/4	77	90	107
		1/4	10	4	7/8	81	94	111
		1/4	10	6	7/8	88	100	117
		1/4	12	6	1	94	106	123
		1/4	7	4	5/8	85	101	120
17	14	1/4	10	4	7/8	92	107	126
		3/4	12	4	1	96	111	130
		1/4	10	6	7/8	99	113	133
		1/4	13	6	1 1/8	112	125	145
		1/4	7	4	5/8	97	114	137
18	15	1/4	10	4	7/8	104	121	143
		3/4	10	6	7/8	110	127	149
		1/4	12	6	1	116	133	155
		1/4	12	8	1	125	141	163
		1/4	9	4	3/4	112	132	158
19	16	1/4	12	4	1	120	139	165
		3/4	10	6	7/8	123	142	167
		1/4	10	8	7/8	129	148	174
		1/4	13	8	1 1/8	147	165	190
		1/4	9	4	3/4	126	148	177
20	17	1/4	12	4	1	133	155	184
		3/4	12	6	1	142	164	192
		1/4	12	8	1	151	172	200
		1/4	13	8	1 1/8	160	181	209
21	18	1/4	9	4	3/4	139	165	197
		3/4	10	6	7/8	150	174	207
		1/4	12	6	1	156	179	213
		1/4	12	8	1	165	189	221
		1/4	15	8	1 1/4	185	207	239

SQUARE TIED COLUMNS

SAFE AXIAL LOADS IN THOUSANDS OF POUNDS

CHICAGO BUILDING CODE REQUIREMENTS

Ratio of Length of Column to its Side, limited to 12

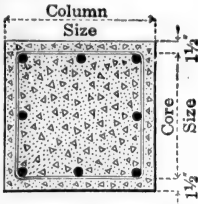

Column Size in.	Core Size in.	ROUND BAR TIES		ROUND BAR VERTICALS		1: 2: 4 2,000 lb. Concrete $f_c = 400$ lb. per sq. in. $n = 15$	1: 1 1/2: 3 2,400 lb. Concrete $f_c = 480$ lb. per sq. in. $n = 12$	1: 1: 2 2,900 lb. Concrete $f_c = 580$ lb. per sq. in. $n = 10$
		Size in.	Spacing in.	No.	Size			
22	19	7	7	6	5/8	155	183	219
		10	7	6	7/8	165	192	228
		13	6	6	1 1/8	178	205	241
		12	10	10	1	188	215	250
		13	10	10	1 1/8	200	226	261
23	20	9	6	6	3/4	175	206	246
		12	6	6	1	186	217	257
		13	6	6	1 1/8	193	223	263
		12	10	10	1	204	233	273
		13	12	12	1 1/8	227	255	294
24	21	9	6	6	3/4	191	226	270
		12	6	6	1	203	237	280
		12	8	8	1	212	245	289
		12	12	12	1	229	261	305
		13	14	14	1 1/8	254	285	328
25	22	7	8	8	5/8	207	245	294
		10	8	8	5/8	221	258	306
		12	10	10	1	238	274	322
		12	12	12	1	246	282	330
		13	14	14	1 1/8	272	306	353
26	23	7	10	10	5/8	229	270	323
		10	10	10	5/8	245	286	338
		12	10	10	1	256	296	348
		12	14	14	1	273	312	364
		13	16	16	1 1/8	301	338	390
27	24	7	10	10	5/8	248	293	350
		10	10	10	5/8	264	308	365
		12	12	12	1	283	326	383
		12	14	14	1	292	335	392
		13	18	18	1 1/8	330	371	427
28	25	7	12	12	5/8	271	320	382
		10	12	12	5/8	291	338	400
		12	12	12	1	303	350	412
		13	14	14	1 1/8	328	374	435
		13	18	18	1 1/8	350	395	456
29	26	7	12	12	5/8	291	344	411
		10	12	12	5/8	311	362	430
		12	12	12	1	323	374	441
		13	14	14	1 1/8	348	398	465
		13	20	20	1 1/8	382	429	495
30	27	7	12	12	5/8	312	370	442
		10	14	14	5/8	339	394	467
		12	14	14	1	353	408	480
		13	16	16	1 1/8	381	434	506
		13	22	22	1 1/8	414	465	537
31	28	7	14	14	5/8	338	399	477
		10	14	14	5/8	361	421	499
		12	14	14	1	375	434	512
		13	16	16	1 1/8	403	460	538
		13	24	24	1 1/8	447	502	579

SQUARE TIED COLUMNS

SAFE AXIAL LOADS IN THOUSANDS OF POUNDS

JOINT COMMITTEE RECOMMENDATIONS

Ratio of Unsupported Length of Column to its Side,
limited to 15

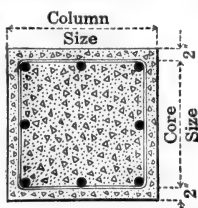

Column Size in.	Core Size in.	ROUND BAR TIES		ROUND BAR VERTICALS		1: 2: 4 2,000 lb. Concrete $f_c = 450$ lb. per sq. in. $n = 15$	1: 1½: 3 2,500 lb. Concrete $f_c = 562.5$ lb. per sq. in. $n = 12$	1: 1: 2 3,000 lb. Concrete $f_c = 675$ lb. per sq. in. $n = 10$
		Size in.	Spacing in.	No.	Size			
12	8	¼	8	4	½	34	41	48
		¼	10	4	⅝	37	44	51
		¼	12	4	¾	40	47	54
		¼	12	4	⅞	44	51	58
13	9	¼	8	4	½	41	50	59
		¼	10	4	⅝	44	53	62
		¼	12	4	¾	48	56	65
		¼	12	4	⅞	52	60	69
		¼	12	4	1	56	65	74
14	10	¼	10	4	⅝	53	64	75
		¼	12	4	¾	56	67	78
		¼	12	4	1	60	71	82
		¼	12	4	1	65	76	87
		¼	12	4	1 ⅛	70	81	92
15	11	¼	10	4	⅝	62	76	89
		¼	12	4	¾	66	79	92
		¼	12	4	⅞	70	83	96
		¼	12	4	1	74	87	101
		¼	12	6	1	84	97	110
16	12	¼	12	4	¾	76	92	108
		¼	12	4	1	80	96	112
		¼	12	4	1 ⅛	85	100	116
		¼	12	6	1 ⅛	90	106	121
17	13	¼	12	4	¾	87	106	125
		¼	12	4	⅞	91	110	129
		¼	12	6	⅞	99	117	136
		¼	12	6	1	106	124	143
		¼	12	8	1	116	134	152
18	14	¼	12	4	¾	103	125	147
		¼	12	4	1	108	130	151
		¼	12	6	⅞	111	133	154
		¼	12	6	1 ⅛	126	147	169
		¼	12	8	1 ⅛	138	159	181
19	15	¼	12	4	¾	116	141	166
		¼	12	6	⅞	124	149	174
		¼	12	6	1	131	156	181
		¼	12	8	1	141	165	190
		¼	12	8	1 ⅛	151	176	200
20	16	¼	12	4	1	135	163	192
		¼	12	6	⅞	138	166	195
		¼	12	8	⅞	145	174	202
		¼	12	8	1 ⅛	165	193	221
		¼	12	10	1 ⅛	178	205	233
21	17	¼	12	4	1	150	182	214
		¼	12	6	1	160	192	224
		¼	12	8	1	170	201	233
		¼	12	8	1 ⅛	180	212	243
		¼	12	12	1 ⅛	205	236	268

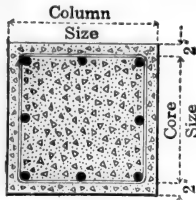

SQUARE TIED COLUMNS

SAFE AXIAL LOADS IN THOUSANDS OF POUNDS

JOINT COMMITTEE RECOMMENDATIONS

Ratio of Unsupported Length of Column to its Side,
limited to 15

Column Size	Core Size	ROUND BAR TIES		ROUND BAR VERTICALS		1: 2: 4	1: 1½: 3	1: 1: 2
		Size	Spacing	No.	Size	2,000 lb. Concrete <i>f_c</i> = 450 lb. per sq. in. <i>n</i> = 15	2,500 lb. Concrete <i>f_c</i> = 562.5 lb. per sq. in. <i>n</i> = 12	3,000 lb. Concrete <i>f_c</i> = 675 lb. per sq. in. <i>n</i> = 10
in.	in.	in.	in.	No.	Size			
22	18	1/4	12	6	3/8	169	204	241
				6	1	175	211	247
				8	1	185	221	257
				8	1 1/8	208	243	278
				12	1 1/8	221	256	291
23	19	1/4	12	6	3/8	185	225	266
				6	1 1/8	200	240	280
				10	1	219	252	291
				10	1 1/8	225	265	304
				12	1 1/4	255	294	333
24	20	1/4	12	6	1	210	254	299
				6	1 1/8	218	262	306
				10	1	230	274	318
				12	1 1/8	255	299	343
				16	1 1/8	280	324	367
25	21	1/4	12	6	1	228	277	326
				8	1	238	287	336
				12	1	258	306	355
				14	1 1/8	286	334	382
				18	1 1/8	311	359	406
26	22	3/8	12	8	3/8	248	302	356
				10	1	267	321	374
				12	1	277	331	384
				14	1 1/8	306	358	411
				18	1 1/8	331	383	435
27	23	3/8	12	10	3/8	276	335	393
				10	1	288	346	405
				14	1	307	366	424
				16	1 1/8	338	396	454
				20	1 1/8	363	421	478
28	24	3/8	12	10	3/8	297	361	425
				12	1	319	382	446
				14	1	328	392	456
				18	1 1/8	372	434	497
				22	1 1/8	397	459	521
29	25	3/8	12	12	3/8	327	396	466
				12	1	341	410	479
				14	1 1/8	369	438	506
				18	1 1/8	394	462	531
				20	1 1/4	436	503	571
30	26	3/8	12	12	3/8	350	425	500
				12	1	364	438	514
				14	1 1/8	392	466	541
				20	1 1/8	429	503	577
				22	1 1/4	474	547	620
31	27	3/8	12	14	3/8	381	462	543
				14	1	397	478	559
				16	1 1/8	428	508	588
				22	1 1/8	466	545	625
				24	1 1/4	514	593	671

SPIRAL COLUMNS

SAFE AXIAL LOADS IN THOUSANDS OF POUNDS

NEW YORK CITY BUILDING CODE REQUIREMENTS

Ratio of Length of Column to its Side or Diameter, limited to 15.

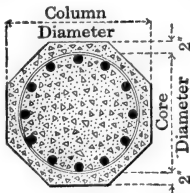

Column Diam. in.	Core Diam. in.	ROUND BAR VERTICALS		1:2:4 Concrete $f_c = 500$ lb. per sq. in. $n = 15$			1:1½:3 Concrete $f_c = 600$ lb. per sq. in. $n = 12$		
		No.	Size	$\frac{1}{4}"\phi-2"p$	$\frac{5}{16}"\phi-1\frac{1}{8}"p$	$\frac{3}{8}"\phi-1\frac{3}{4}"p$	$\frac{1}{4}"\phi-2"p$	$\frac{5}{16}"\phi-1\frac{1}{8}"p$	$\frac{3}{8}"\phi-1\frac{3}{4}"p$
16	12	4	$\frac{5}{8}$	100	124	154	111	135	165
		4	$\frac{3}{4}$	104	128	158	115	139	169
		4	$\frac{7}{8}$	109	133	162	119	143	173
		4	1	114	138	168	124	148	178
		7	$\frac{7}{8}$	122	146	175	131	155	185
17	13	4	$\frac{3}{4}$	$\frac{1}{4}"\phi-1\frac{1}{8}"p$	$\frac{5}{16}"\phi-1\frac{3}{4}"p$	$\frac{3}{8}"\phi-1\frac{5}{8}"p$	$\frac{1}{4}"\phi-1\frac{7}{8}"p$	$\frac{5}{16}"\phi-1\frac{3}{4}"p$	$\frac{3}{8}"\phi-1\frac{5}{8}"p$
		4	$\frac{7}{8}$	120	148	182	132	160	195
		5	1	124	152	187	136	165	199
		8	$\frac{7}{8}$	135	163	197	146	175	209
18	14	5	$\frac{5}{8}$	$\frac{1}{4}"\phi-1\frac{3}{4}"p$	$\frac{3}{8}"\phi-2\frac{1}{4}"p$	$\frac{1}{2}"\phi-2\frac{3}{8}"p$	$\frac{1}{4}"\phi-1\frac{3}{4}"p$	$\frac{3}{8}"\phi-2\frac{1}{4}"p$	$\frac{1}{2}"\phi-2\frac{3}{8}"p$
		5	$\frac{3}{4}$	134	168	208	149	183	223
		5	$\frac{7}{8}$	139	173	213	154	188	228
		6	1	145	179	219	159	193	233
		8	$\frac{7}{8}$	157	191	231	170	204	244
19	15	6	$\frac{5}{8}$	$\frac{1}{4}"\phi-1\frac{3}{4}"p$	$\frac{3}{8}"\phi-2"p$	$\frac{1}{2}"\phi-2"p$	$\frac{1}{4}"\phi-1\frac{3}{4}"p$	$\frac{3}{8}"\phi-2"p$	$\frac{1}{2}"\phi-2"p$
		6	$\frac{3}{4}$	151	199	238	168	216	255
		6	$\frac{7}{8}$	157	204	244	174	221	261
		7	1	164	211	251	180	227	267
		9	$\frac{7}{8}$	177	224	264	192	240	279
20	16	7	$\frac{5}{8}$	$\frac{5}{16}"\phi-2\frac{1}{2}"p$	$\frac{3}{8}"\phi-1\frac{7}{8}"p$	$\frac{1}{2}"\phi-1\frac{7}{8}"p$	$\frac{5}{16}"\phi-2\frac{1}{2}"p$	$\frac{3}{8}"\phi-1\frac{7}{8}"p$	$\frac{1}{2}"\phi-1\frac{7}{8}"p$
		7	$\frac{3}{4}$	175	227	272	194	246	291
		7	$\frac{7}{8}$	182	233	278	200	252	297
		8	1	189	241	286	208	259	304
		10	$\frac{7}{8}$	204	255	300	222	273	318
21	17	8	$\frac{5}{8}$	$\frac{5}{16}"\phi-2\frac{3}{8}"p$	$\frac{3}{8}"\phi-1\frac{3}{4}"p$	$\frac{1}{2}"\phi-1\frac{3}{4}"p$	$\frac{5}{16}"\phi-2\frac{3}{8}"p$	$\frac{3}{8}"\phi-1\frac{3}{4}"p$	$\frac{1}{2}"\phi-1\frac{3}{4}"p$
		8	$\frac{3}{4}$	197	257	309	219	279	330
		8	$\frac{7}{8}$	204	264	316	226	286	337
		8	1	213	273	325	234	294	346
		11	$\frac{7}{8}$	224	284	335	244	304	356
22	18	8	$\frac{5}{8}$	$\frac{5}{16}"\phi-2\frac{1}{4}"p$	$\frac{1}{2}"\phi-2\frac{3}{8}"p$	$\frac{1}{2}"\phi-1\frac{5}{8}"p$	$\frac{5}{16}"\phi-2\frac{1}{4}"p$	$\frac{1}{2}"\phi-2\frac{3}{8}"p$	$\frac{1}{2}"\phi-1\frac{5}{8}"p$
		9	$\frac{3}{4}$	219	283	347	243	307	371
		9	$\frac{7}{8}$	229	294	358	253	317	382
		10	1	239	304	368	263	327	391
		12	$\frac{7}{8}$	256	321	385	279	343	407
23	19	8	$\frac{3}{4}$	$\frac{5}{16}"\phi-2"p$	$\frac{1}{2}"\phi-2\frac{1}{4}"p$	$\frac{1}{2}"\phi-1\frac{5}{8}"p$	$\frac{5}{16}"\phi-2"p$	$\frac{1}{2}"\phi-2\frac{1}{4}"p$	$\frac{1}{2}"\phi-1\frac{5}{8}"p$
		10	$\frac{3}{4}$	255	321	381	282	348	408
		10	$\frac{7}{8}$	261	327	387	288	353	414
		11	1	272	338	398	298	364	424
		11	$\frac{7}{8}$	291	357	417	316	381	441
11	$1\frac{1}{8}$	307	373	433	331	397	457		

NOTE—Size and pitch of spiral wire is given at head of each group of loads for each size column.

SPIRAL COLUMNS

SAFE AXIAL LOADS IN THOUSANDS OF POUNDS

NEW YORK CITY BUILDING CODE REQUIREMENTS

Ratio of Length of Column to its Side or Diameter, limited to 15.

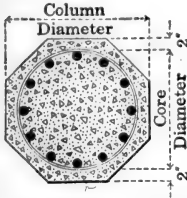

Column Diam. in.	Core Diam. in.	ROUND BAR VERTICALS		1:2:4 Concrete $f_c = 500$ lb. per sq. in. $n = 15$			1:1½:3 Concrete $f_c = 600$ lb. per sq. in. $n = 12$		
		No.	Size	$\frac{1}{16}''\phi-2''p$	$\frac{1}{16}''\phi-2\frac{1}{4}''p$	$\frac{1}{2}''\phi-2''p$	$\frac{1}{16}''\phi-2''p$	$\frac{1}{16}''\phi-2\frac{1}{4}''p$	$\frac{1}{2}''\phi-2''p$
24	20	8	$\frac{3}{4}$	275	344	419	305	374	449
		10	$\frac{3}{4}$	281	350	426	311	380	455
		10	$\frac{7}{8}$	292	361	437	321	390	466
		12	1	316	385	461	344	413	488
		12	$1\frac{1}{8}$	333	403	478	360	429	505
25	21	8	$\frac{3}{4}$	$\frac{3}{8}''\phi-2\frac{3}{8}''p$	$\frac{1}{16}''\phi-2\frac{1}{8}''p$	$\frac{1}{2}''\phi-1\frac{1}{8}''p$	$\frac{3}{8}''\phi-2\frac{3}{8}''p$	$\frac{1}{16}''\phi-2\frac{1}{8}''p$	$\frac{1}{2}''\phi-1\frac{1}{8}''p$
		10	$\frac{3}{4}$	302	378	464	335	411	497
		10	$\frac{7}{8}$	319	395	481	351	428	514
		10	1	332	408	494	363	440	526
		13	1	349	425	511	379	456	541
14	$1\frac{1}{8}$	375	451	537	404	480	566		
26	22	9	$\frac{3}{4}$	$\frac{3}{8}''\phi-2\frac{1}{2}''p$	$\frac{1}{16}''\phi-2''p$	$\frac{1}{2}''\phi-1\frac{3}{4}''p$	$\frac{3}{8}''\phi-2\frac{1}{2}''p$	$\frac{1}{16}''\phi-2''p$	$\frac{1}{2}''\phi-1\frac{3}{4}''p$
		10	$\frac{7}{8}$	332	419	516	368	455	552
		10	$\frac{7}{8}$	346	433	530	382	468	566
		10	1	359	446	543	394	481	578
		13	$1\frac{1}{8}$	395	481	579	427	514	611
15	$1\frac{1}{8}$	408	495	592	441	527	625		
27	23	10	$\frac{3}{4}$	$\frac{3}{8}''\phi-2\frac{3}{8}''p$	$\frac{1}{2}''\phi-2\frac{1}{2}''p$	$\frac{1}{2}''\phi-1\frac{3}{4}''p$	$\frac{3}{8}''\phi-2\frac{3}{8}''p$	$\frac{1}{2}''\phi-2\frac{1}{2}''p$	$\frac{1}{2}''\phi-1\frac{3}{4}''p$
		10	$\frac{7}{8}$	365	456	551	405	496	591
		10	$\frac{7}{8}$	376	467	562	415	507	601
		11	1	394	486	581	433	524	619
		13	$1\frac{1}{8}$	424	516	611	461	552	647
16	$1\frac{1}{8}$	445	537	631	481	572	667		
28	24	10	$\frac{3}{4}$	$\frac{3}{8}''\phi-2\frac{1}{4}''p$	$\frac{1}{2}''\phi-2\frac{3}{8}''p$	$\frac{1}{2}''\phi-1\frac{5}{8}''p$	$\frac{3}{8}''\phi-2\frac{1}{4}''p$	$\frac{1}{2}''\phi-2\frac{3}{8}''p$	$\frac{1}{2}''\phi-1\frac{5}{8}''p$
		10	1	395	496	606	438	540	650
		10	1	419	520	630	461	562	673
		12	1	430	531	641	471	572	683
		14	$1\frac{1}{8}$	461	563	673	501	602	713
15	$1\frac{1}{4}$	493	594	704	531	632	742		
29	25	10	$\frac{7}{8}$	$\frac{3}{8}''\phi-2\frac{1}{8}''p$	$\frac{1}{2}''\phi-2\frac{1}{4}''p$	$\frac{1}{2}''\phi-1\frac{5}{8}''p$	$\frac{3}{8}''\phi-2\frac{1}{8}''p$	$\frac{1}{2}''\phi-2\frac{1}{4}''p$	$\frac{1}{2}''\phi-1\frac{5}{8}''p$
		10	1	439	550	653	485	597	699
		10	1	452	564	666	497	609	712
		12	1	463	575	677	508	620	722
		15	$1\frac{1}{8}$	501	613	715	544	656	758
16	$1\frac{1}{4}$	534	646	748	575	687	789		
30	26	10	$\frac{7}{8}$	$\frac{3}{8}''\phi-2\frac{1}{8}''p$	$\frac{1}{2}''\phi-2\frac{1}{4}''p$	$\frac{1}{2}''\phi-1\frac{1}{2}''p$	$\frac{3}{8}''\phi-2\frac{1}{8}''p$	$\frac{1}{2}''\phi-2\frac{1}{4}''p$	$\frac{1}{2}''\phi-1\frac{1}{2}''p$
		10	1	467	581	717	518	632	768
		10	1	480	594	730	530	644	780
		12	$1\frac{1}{8}$	508	623	759	556	671	807
		16	$1\frac{1}{8}$	536	651	787	583	697	833
17	$1\frac{1}{4}$	571	685	821	615	730	866		
31	27	10	$\frac{7}{8}$	$\frac{3}{8}''\phi-2''p$	$\frac{1}{2}''\phi-2\frac{1}{8}''p$	$\frac{1}{2}''\phi-1\frac{1}{2}''p$	$\frac{3}{8}''\phi-2''p$	$\frac{1}{2}''\phi-2\frac{1}{8}''p$	$\frac{1}{2}''\phi-1\frac{1}{2}''p$
		11	1	502	631	754	557	685	809
		11	1	521	649	773	575	703	827
		12	$1\frac{1}{8}$	544	672	796	596	725	848
		18	$1\frac{1}{8}$	585	714	837	636	764	887
19	$1\frac{1}{4}$	623	752	875	672	800	923		

NOTE—Size and pitch of spiral wire is given at head of each group of loads for each size column.

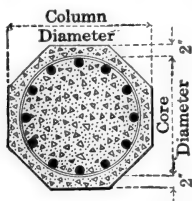

SPIRAL COLUMNS

SAFE AXIAL LOADS IN THOUSANDS OF POUNDS

NEW YORK CITY BUILDING CODE REQUIREMENTS

Ratio of Length of Column to its Side or Diameter,
limited to 15.

Column Diam. in.	Core Diam. in.	ROUND BAR VERTICALS		1:2:4 Concrete $f_c = 500$ lb. per sq. in. $n = 15$			1:1½:3 Concrete $f_c = 600$ lb. per sq. in. $n = 12$		
		No.	Size	$\frac{3}{8}''\phi-2''p$	$\frac{1}{2}''\phi-2\frac{1}{8}''p$	$\frac{1}{2}''\phi-1\frac{1}{2}''p$	$\frac{3}{8}''\phi-2''p$	$\frac{1}{2}''\phi-2\frac{1}{8}''p$	$\frac{1}{2}''\phi-1\frac{1}{2}''p$
32	28	10	$\frac{7}{8}$	532	663	793	591	722	852
		12	1	556	687	817	614	744	875
		13	$1\frac{1}{8}$	581	711	842	637	768	898
		18	$1\frac{1}{8}$	615	746	876	669	800	931
		20	$1\frac{1}{4}$	662	792	923	714	845	975
33	29	11	$\frac{7}{8}$	564	699	834	627	762	897
		13	1	589	724	859	651	786	921
		14	$1\frac{1}{8}$	615	750	885	676	810	945
		18	$1\frac{1}{4}$	672	807	942	729	864	999
		22	$1\frac{1}{4}$	707	841	976	762	896	1031
34	30	12	$\frac{7}{8}$	588	738	879	655	805	947
		14	1	614	764	905	680	830	972
		15	$1\frac{1}{8}$	641	791	933	706	856	997
		18	$1\frac{1}{4}$	692	842	983	754	904	1045
		23	$1\frac{1}{4}$	735	885	1026	794	944	1085
35	31	13	$\frac{7}{8}$	622	779	921	695	852	994
		15	1	650	807	949	721	878	1020
		15	$1\frac{1}{8}$	672	829	971	741	898	1040
		18	$1\frac{1}{4}$	722	879	1021	789	946	1088
		25	$1\frac{1}{4}$	782	939	1081	845	1003	1144
36	32	14	$\frac{7}{8}$	644	798	966	721	876	1043
		15	1	668	822	990	744	898	1065
		16	$1\frac{1}{8}$	697	851	1019	771	925	1093
		20	$1\frac{1}{4}$	757	912	1079	828	982	1150
		26	$1\frac{1}{4}$	809	963	1131	877	1031	1199
37	33	14	$\frac{7}{8}$	678	836	1007	760	918	1088
		15	$1\frac{1}{8}$	724	881	1052	803	961	1132
		16	$1\frac{1}{4}$	756	914	1085	834	991	1162
		21	$1\frac{1}{4}$	802	959	1130	876	1034	1205
		28	$1\frac{1}{4}$	860	1017	1188	931	1089	1260
38	34	14	1	727	890	1068	813	977	1155
		15	$1\frac{1}{8}$	754	918	1096	839	1003	1181
		16	$1\frac{1}{4}$	788	951	1129	870	1034	1212
		22	$1\frac{1}{4}$	839	1002	1180	919	1082	1261
		29	$1\frac{1}{4}$	899	1063	1241	976	1139	1317
39	35	14	1	758	927	1112	850	1019	1204
		15	$1\frac{1}{8}$	786	955	1140	876	1045	1230
		16	$1\frac{1}{4}$	819	988	1173	907	1077	1261
		24	$1\frac{1}{4}$	887	1056	1241	972	1141	1326
		31	$1\frac{1}{4}$	948	1117	1302	1029	1193	1383

NOTE—Size and pitch of spiral wire is given at head of each group of loads for each size column.

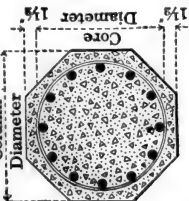

SPIRAL COLUMNS
SAFE AXIAL LOADS IN THOUSANDS OF POUNDS
CHICAGO BUILDING CODE REQUIREMENTS

Ratio of Length of Column to its Side or Diameter, limited to 12

Column Diam. in.	Core Diam. in.	ROUND BAR VERTICALS		1:2:4 (2,000 lb. Concrete) $f_c = 500$ lb. per sq. in. $n = 15$			1:1 1/2:3 (2,400 lb. Concrete) $f_c = 600$ lb. per sq. in. $n = 12$			1:1:2 (2,900 lb. Concrete) $f_c = 725$ lb. per sq. in. $n = 10$		
		No.	Size	$\frac{1}{8}''\phi-1\frac{1}{4}''p$	$\frac{1}{4}''\phi-1\frac{1}{2}''p$	$\frac{1}{2}''\phi-1\frac{3}{4}''p$	$\frac{1}{8}''\phi-1\frac{1}{4}''p$	$\frac{1}{4}''\phi-1\frac{1}{2}''p$	$\frac{1}{2}''\phi-1\frac{3}{4}''p$	$\frac{1}{8}''\phi-1\frac{1}{4}''p$	$\frac{1}{4}''\phi-1\frac{1}{2}''p$	$\frac{1}{2}''\phi-1\frac{3}{4}''p$
15	12	8	$\frac{1}{2}$	87			96			110		
		8	$\frac{3}{8}$	95			103			117		
		8	$\frac{1}{2}$	105			112			125		
		8	$\frac{3}{4}$	116			123			135		
16	13	8	$\frac{1}{2}$	98	$\frac{1}{4}''\phi-1\frac{1}{2}''p$		109	$\frac{1}{4}''\phi-1\frac{1}{2}''p$		125	$\frac{1}{4}''\phi-1\frac{1}{2}''p$	
		8	$\frac{3}{8}$	106			116			132		
		8	$\frac{1}{2}$	115			124			140		
		8	$\frac{3}{4}$	127			136			150		
17	14	8	$\frac{1}{2}$	108	$\frac{1}{4}''\phi-1\frac{3}{4}''p$	$\frac{1}{4}''\phi-1\frac{1}{2}''p$	121	$\frac{1}{4}''\phi-1\frac{1}{2}''p$	$\frac{1}{4}''\phi-1\frac{1}{2}''p$	140	$\frac{1}{4}''\phi-1\frac{1}{2}''p$	$\frac{1}{2}''\phi-1\frac{3}{4}''p$
		8	$\frac{3}{8}$	115			128			147		
		8	$\frac{1}{2}$	125			136			155		
		8	$\frac{3}{4}$	135			146			164		
18	15	8	1	148	$\frac{1}{4}''\phi-1\frac{3}{4}''p$	$\frac{1}{4}''\phi-1\frac{1}{2}''p$	161	$\frac{1}{4}''\phi-1\frac{1}{2}''p$	$\frac{1}{4}''\phi-1\frac{1}{2}''p$	175	$\frac{1}{4}''\phi-1\frac{1}{2}''p$	$\frac{1}{2}''\phi-1\frac{3}{4}''p$
		8	$\frac{5}{8}$	126	$\frac{1}{4}''\phi-1\frac{1}{2}''p$	$\frac{1}{4}''\phi-1\frac{1}{2}''p$	137	$\frac{1}{4}''\phi-1\frac{1}{2}''p$	$\frac{1}{4}''\phi-1\frac{1}{2}''p$	152	$\frac{1}{4}''\phi-1\frac{1}{2}''p$	$\frac{1}{2}''\phi-1\frac{3}{4}''p$
		8	$\frac{3}{4}$	135			148			162		
		9	$\frac{1}{2}$	150			163			184		
19	16	8	$\frac{5}{8}$	164	$\frac{1}{4}''\phi-1\frac{1}{2}''p$	$\frac{1}{4}''\phi-1\frac{1}{2}''p$	181	$\frac{1}{4}''\phi-1\frac{1}{2}''p$	$\frac{1}{4}''\phi-1\frac{1}{2}''p$	196	$\frac{1}{4}''\phi-1\frac{1}{2}''p$	$\frac{1}{2}''\phi-1\frac{3}{4}''p$
		8	$\frac{3}{4}$	141	$\frac{1}{4}''\phi-1\frac{1}{2}''p$	$\frac{1}{4}''\phi-1\frac{1}{2}''p$	158	$\frac{1}{4}''\phi-1\frac{1}{2}''p$	$\frac{1}{4}''\phi-1\frac{1}{2}''p$	170	$\frac{1}{4}''\phi-1\frac{1}{2}''p$	$\frac{1}{2}''\phi-1\frac{3}{4}''p$
		8	$\frac{1}{2}$	150			167			180		
		10	$\frac{3}{4}$	158			174			198		
20	16	10	$\frac{3}{4}$	171			186			209		
		10	1	186			200			223		
21	16	10	$\frac{3}{4}$	186			221			253		
		10	1	186			221			253		

NOTE—Size and pitch of spiral wire is given at head of each group of loads for each size column.

SPIRAL COLUMNS

SAFE AXIAL LOADS IN THOUSANDS OF POUNDS

CHICAGO BUILDING CODE REQUIREMENTS

Ratio of Length of Column to its Side or Diameter, limited to 12

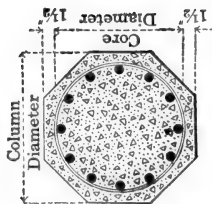

Column Diam. in.	Core Diam. in.	ROUND BAR VERTICALS		1:2:4 (2,000 lb. Concrete) $f_c = 500$ lb. per sq. in.			1:1 $\frac{1}{2}$:3 (2,400 lb. Concrete) $f_c = 600$ lb. per sq. in.			1:1:2 (2,900 lb. Concrete) $f_c = 725$ lb. per sq. in.		
		No.	Size	$n = 15$			$n = 12$			$n = 10$		
20	17	8	$\frac{5}{8}$	$\frac{1}{16}\phi-1\frac{1}{2}''p$	$\frac{1}{16}\phi-1\frac{3}{4}''p$	$\frac{3}{8}\phi-1\frac{1}{2}''p$	$\frac{1}{16}\phi-1\frac{3}{4}''p$	$\frac{3}{8}\phi-1\frac{1}{2}''p$	$\frac{1}{16}\phi-1\frac{3}{4}''p$	$\frac{3}{8}\phi-1\frac{1}{2}''p$	$\frac{1}{16}\phi-1\frac{3}{4}''p$	$\frac{3}{8}\phi-1\frac{1}{2}''p$
		8	$\frac{3}{4}$	$\frac{1}{16}\phi-1\frac{1}{2}''p$	$\frac{1}{16}\phi-1\frac{3}{4}''p$	$\frac{3}{8}\phi-1\frac{1}{2}''p$	$\frac{1}{16}\phi-1\frac{3}{4}''p$	$\frac{3}{8}\phi-1\frac{1}{2}''p$	$\frac{1}{16}\phi-1\frac{3}{4}''p$	$\frac{3}{8}\phi-1\frac{1}{2}''p$	$\frac{1}{16}\phi-1\frac{3}{4}''p$	$\frac{3}{8}\phi-1\frac{1}{2}''p$
		10	$\frac{3}{4}$	156	179	199	175	198	203	211	234	257
		10	$\frac{7}{8}$	164	190	216	183	207	218	231	241	259
		11	$\frac{7}{8}$	171	198	225	190	214	207	233	249	282
		12	1	190	219	249	207	233	228	254	282	310
22	18	8	$\frac{5}{8}$	$\frac{1}{4}\phi-1\frac{3}{4}''p$	$\frac{1}{16}\phi-1\frac{1}{2}''p$	$\frac{3}{8}\phi-1\frac{1}{2}''p$	$\frac{1}{4}\phi-1\frac{3}{4}''p$	$\frac{3}{8}\phi-1\frac{1}{2}''p$	$\frac{1}{4}\phi-1\frac{3}{4}''p$	$\frac{3}{8}\phi-1\frac{1}{2}''p$	$\frac{1}{16}\phi-1\frac{3}{4}''p$	$\frac{3}{8}\phi-1\frac{1}{2}''p$
		8	$\frac{3}{4}$	$\frac{1}{16}\phi-1\frac{1}{2}''p$	$\frac{1}{16}\phi-1\frac{3}{4}''p$	$\frac{3}{8}\phi-1\frac{1}{2}''p$	$\frac{1}{16}\phi-1\frac{3}{4}''p$	$\frac{3}{8}\phi-1\frac{1}{2}''p$	$\frac{1}{16}\phi-1\frac{3}{4}''p$	$\frac{3}{8}\phi-1\frac{1}{2}''p$	$\frac{1}{16}\phi-1\frac{3}{4}''p$	$\frac{3}{8}\phi-1\frac{1}{2}''p$
		10	$\frac{3}{4}$	176	199	244	199	220	230	241	263	291
		10	$\frac{7}{8}$	189	214	244	211	233	241	256	280	309
		12	$\frac{7}{8}$	207	233	266	226	251	261	282	302	320
		12	1	217	245	280	236	261	282	308	320	340
23	19	8	$\frac{3}{4}$	$\frac{1}{4}\phi-1\frac{1}{2}''p$	$\frac{1}{16}\phi-1\frac{1}{2}''p$	$\frac{3}{8}\phi-1\frac{1}{2}''p$	$\frac{1}{4}\phi-1\frac{1}{2}''p$	$\frac{3}{8}\phi-1\frac{1}{2}''p$	$\frac{1}{4}\phi-1\frac{1}{2}''p$	$\frac{3}{8}\phi-1\frac{1}{2}''p$	$\frac{1}{16}\phi-1\frac{1}{2}''p$	$\frac{3}{8}\phi-1\frac{1}{2}''p$
		8	$\frac{3}{4}$	$\frac{1}{16}\phi-1\frac{1}{2}''p$	$\frac{1}{16}\phi-1\frac{3}{4}''p$	$\frac{3}{8}\phi-1\frac{1}{2}''p$	$\frac{1}{16}\phi-1\frac{3}{4}''p$	$\frac{3}{8}\phi-1\frac{1}{2}''p$	$\frac{1}{16}\phi-1\frac{3}{4}''p$	$\frac{3}{8}\phi-1\frac{1}{2}''p$	$\frac{1}{16}\phi-1\frac{3}{4}''p$	$\frac{3}{8}\phi-1\frac{1}{2}''p$
		10	$\frac{3}{4}$	199	227	267	224	249	258	265	291	319
		10	$\frac{7}{8}$	206	235	267	230	257	265	286	304	333
		12	$\frac{7}{8}$	220	250	284	242	270	277	302	331	364
		12	1	248	282	321	268	299	320	357	386	427
24	21	8	$\frac{3}{4}$	$\frac{1}{4}\phi-1\frac{1}{2}''p$	$\frac{1}{16}\phi-1\frac{1}{2}''p$	$\frac{3}{8}\phi-1\frac{1}{2}''p$	$\frac{1}{4}\phi-1\frac{1}{2}''p$	$\frac{3}{8}\phi-1\frac{1}{2}''p$	$\frac{1}{4}\phi-1\frac{1}{2}''p$	$\frac{3}{8}\phi-1\frac{1}{2}''p$	$\frac{1}{16}\phi-1\frac{1}{2}''p$	$\frac{3}{8}\phi-1\frac{1}{2}''p$
		8	$\frac{3}{4}$	$\frac{1}{16}\phi-1\frac{1}{2}''p$	$\frac{1}{16}\phi-1\frac{3}{4}''p$	$\frac{3}{8}\phi-1\frac{1}{2}''p$	$\frac{1}{16}\phi-1\frac{3}{4}''p$	$\frac{3}{8}\phi-1\frac{1}{2}''p$	$\frac{1}{16}\phi-1\frac{3}{4}''p$	$\frac{3}{8}\phi-1\frac{1}{2}''p$	$\frac{1}{16}\phi-1\frac{3}{4}''p$	$\frac{3}{8}\phi-1\frac{1}{2}''p$
		10	$\frac{3}{4}$	216	252	291	244	277	282	315	342	398
		10	$\frac{7}{8}$	228	261	308	250	285	289	323	364	414
		12	$\frac{7}{8}$	236	276	329	263	299	300	335	364	395
		13	1	265	309	345	288	328	325	351	392	426
24	21	8	$\frac{3}{4}$	$\frac{1}{4}\phi-1\frac{1}{2}''p$	$\frac{1}{16}\phi-1\frac{1}{2}''p$	$\frac{3}{8}\phi-1\frac{1}{2}''p$	$\frac{1}{4}\phi-1\frac{1}{2}''p$	$\frac{3}{8}\phi-1\frac{1}{2}''p$	$\frac{1}{4}\phi-1\frac{1}{2}''p$	$\frac{3}{8}\phi-1\frac{1}{2}''p$	$\frac{1}{16}\phi-1\frac{1}{2}''p$	$\frac{3}{8}\phi-1\frac{1}{2}''p$
		8	$\frac{3}{4}$	$\frac{1}{16}\phi-1\frac{1}{2}''p$	$\frac{1}{16}\phi-1\frac{3}{4}''p$	$\frac{3}{8}\phi-1\frac{1}{2}''p$	$\frac{1}{16}\phi-1\frac{3}{4}''p$	$\frac{3}{8}\phi-1\frac{1}{2}''p$	$\frac{1}{16}\phi-1\frac{3}{4}''p$	$\frac{3}{8}\phi-1\frac{1}{2}''p$	$\frac{1}{16}\phi-1\frac{3}{4}''p$	$\frac{3}{8}\phi-1\frac{1}{2}''p$
		10	$\frac{3}{4}$	236	271	315	266	299	299	327	361	395
		10	$\frac{7}{8}$	256	294	335	285	320	327	341	376	414
		13	1	272	312	355	299	336	341	375	395	435
		14	1	291	335	380	317	356	358	387	414	469

NOTE—Size and pitch of spiral wire is given at head of each group of loads for each size column.

SPIRAL COLUMNS

SAFE AXIAL LOADS IN THOUSANDS OF POUNDS

CHICAGO BUILDING CODE REQUIREMENTS

Ratio of Length of Column to its Side or Diameter, limited to 12

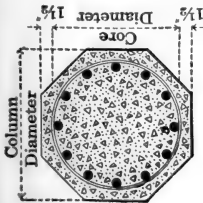

Column Diam. in.	Core Diam. in.	ROUND BAR VERTICALS		1:2:4 (2,000 lb. Concrete) f _c = 500 lb. per sq. in. n = 15				1:1 1/2:3:2,400 lb. Concrete) f _c = 600 lbs. per sq. in. n = 12				1:1:2 (2,900 lb. Concrete) f _c = 725 lb. per sq. in. n = 10				
		No.	Size	1/4"φ-1 1/8"p	3/8"φ-1 7/8"p	1/2"φ-1 3/4"p	1/2"φ-1 1/2"p	3/8"φ-1 1/8"p	1/2"φ-1 3/4"p	1/4"φ-1 3/8"p	1/2"φ-1 1/2"p	3/8"φ-1 1/8"p	1/2"φ-1 3/4"p	1/4"φ-1 3/8"p	1/2"φ-1 1/2"p	3/8"φ-1 1/8"p
25	22	9	3/4	257	300	319	363	291	330	348	389	338	377	394	434	
		10	7/8	274	319	337	384	306	348	366	352	394	352	394	450	
		11	1	289	337	354	401	320	364	384	407	409	366	409	456	
		13	1 1/8	331	386	405	461	358	407	435	456	403	456	403	456	513
		15	1 1/4	347	405	424	488	373	424	474	418	474	418	474	466	513
26	23	10	3/4	283	325	340	386	320	359	372	416	371	409	464		
		10	7/8	296	340	357	404	332	372	383	422	383	422	488		
		11	1	318	365	382	430	352	395	440	440	402	443	488		
		13	1 1/8	354	405	424	488	382	431	481	481	434	478	526		
		15	1 1/4	399	458	477	521	426	477	533	474	523	474	523	575	
27	24	10	3/4	307	355	370	417	348	393	407	467	403	448	520		
		10	7/8	326	374	391	438	374	422	428	476	428	476	520		
		12	1	349	404	421	468	386	436	482	480	440	489	533		
		14	1 1/8	387	447	464	511	420	474	524	473	524	473	524	574	
		15	1 1/4	424	491	508	552	454	513	568	506	562	506	562	614	
28	25	10	3/4	341	393	411	458	384	433	444	503	444	492	561		
		10	7/8	357	411	428	475	398	448	458	507	458	507	561		
		12	1	370	426	443	490	410	462	470	518	470	518	575		
		15	1 1/8	415	478	495	542	452	508	518	571	510	564	624		
		16	1 1/4	455	524	541	588	488	549	616	544	603	544	603	667	
29	26	10	3/4	365	423	441	488	412	465	477	532	477	530	597		
		10	7/8	380	441	458	505	426	482	493	548	493	548	597		
		12	1	414	480	497	544	457	516	520	578	520	578	630		
		15	1 1/8	447	518	535	582	487	550	607	550	607	550	610		
		17	1 1/4	488	566	583	635	525	593	655	586	651	586	651	710	

NOTE—Size and pitch of spiral wire is given at head of each group of loads for each size column.

SPIRAL COLUMNS

SAFE AXIAL LOADS IN THOUSANDS OF POUNDS

CHICAGO BUILDING CODE REQUIREMENTS

Ratio of Length of Column to its Side or Diameter, limited to 12

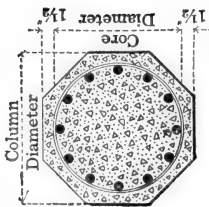

Column Diam. in.	Core Diam. in.	ROUND BAR VERTICALS		1:2:4 (2,000 lb. Concrete) $f_c = 500$ lb. per sq. in. $n = 15$			1:1 $\frac{1}{2}$:3 (2,400 lb. Concrete) $f_c = 600$ lb. per sq. in. $n = 12$			1:1:2 (2,900 lb. Concrete) $f_c = 725$ lb. per sq. in. $n = 10$		
		No.	Size	$\frac{1}{16}''\phi-2\frac{1}{2}''p$	$\frac{1}{8}''\phi-2\frac{1}{2}''p$	$\frac{1}{2}''\phi-1\frac{1}{2}''p$	$\frac{1}{16}''\phi-2\frac{1}{2}''p$	$\frac{1}{8}''\phi-2\frac{1}{2}''p$	$\frac{1}{2}''\phi-1\frac{1}{2}''p$	$\frac{1}{16}''\phi-2\frac{1}{2}''p$	$\frac{1}{8}''\phi-2\frac{1}{2}''p$	$\frac{1}{2}''\phi-1\frac{1}{2}''p$
30	27	10	$\frac{7}{8}$	391	454	540	442	500	512	570	647	
		11	1	413	479	540	462	523	531	592	677	
		12	$1\frac{1}{8}$	441	511	571	487	551	556	619	729	
		18	$1\frac{1}{4}$	490	569	641	532	609	599	667	779	
		19	$1\frac{1}{2}$	536	622	701	574	650	640	712	825	
31	28	10	$\frac{7}{8}$	416	478	576	470	528	546	605	691	
		12	1	444	511	576	496	558	571	633	722	
		13	$1\frac{1}{8}$	473	545	614	523	588	597	661	766	
		18	$1\frac{1}{4}$	514	592	667	560	631	633	701	825	
		20	$1\frac{1}{2}$	569	656	739	611	688	683	755	885	
32	29	11	$\frac{7}{8}$	447	518	626	506	572	587	648	748	
		13	1	477	552	667	533	603	613	677	781	
		14	$1\frac{1}{8}$	508	588	704	562	635	641	712	825	
		18	$1\frac{1}{4}$	575	666	756	623	704	700	778	899	
		22	$1\frac{1}{2}$	616	714	809	660	747	737	819	947	
33	30	12	$\frac{7}{8}$	480	551	663	542	609	630	695	794	
		14	1	511	587	705	571	641	657	726	829	
		15	$1\frac{1}{8}$	543	624	742	601	674	686	757	863	
		18	$1\frac{1}{4}$	603	693	822	655	735	738	815	939	
		23	$1\frac{1}{2}$	654	751	849	702	788	784	865	997	
34	31	13	$\frac{7}{8}$	515	594	718	581	656	674	747	858	
		15	1	548	632	753	612	690	703	770	886	
		18	$1\frac{1}{8}$	574	663	789	635	716	727	799	911	
		18	$1\frac{1}{4}$	634	732	831	690	778	779	864	985	
		25	$1\frac{1}{2}$	705	814	925	755	852	842	935	1028	

NOTE—Size and pitch of spiral wire is given at head of each group of loads for each size column.

SPIRAL COLUMNS
SAFE AXIAL LOADS IN THOUSANDS OF POUNDS
CHICAGO BUILDING CODE REQUIREMENTS
Ratio of Length of Column to its Side or Diameter, limited to 12

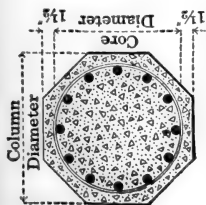

Column Diam. in.	Core Diam. in.	ROUND BAR VERTICALS		1:2:4 (2,000 lb. Concrete) $f_c = 500$ lb. per sq. in. $n = 15$			1:1.5:3 (2,400 lb. Concrete) $f_c = 600$ lb. per sq. in. $n = 12$			1:1.2 (2,900 lb. Concrete) $f_c = 725$ lb. per sq. in. $n = 10$			
		No.	Size	$\frac{3}{8}'' \phi - 2 \frac{1}{2}'' p$	$\frac{1}{2}'' \phi - 2 \frac{1}{4}'' p$	$\frac{1}{2}'' \phi - 1 \frac{1}{2}'' p$	$\frac{3}{8}'' \phi - 2 \frac{1}{2}'' p$	$\frac{1}{2}'' \phi - 2 \frac{1}{4}'' p$	$\frac{1}{2}'' \phi - 1 \frac{1}{2}'' p$	$\frac{3}{8}'' \phi - 2 \frac{1}{2}'' p$	$\frac{1}{2}'' \phi - 2 \frac{1}{4}'' p$	$\frac{1}{2}'' \phi - 1 \frac{1}{2}'' p$	
35	32	14	$\frac{7}{8}$	546	629	748	617	694	804	715	792	899	
		15	$1 \frac{1}{8}$	574	661	793	643	723	843	741	820	935	
		16	$1 \frac{1}{4}$	608	700	843	674	759	883	925	771	853	1013
		20	$1 \frac{1}{2}$	741	886	1049	739	832	955	995	834	924	1078
		26	$1 \frac{3}{4}$	741	853	966	795	895	988	995	888	982	1166
36	33	14	$\frac{7}{8}$	578	673	835	654	743	890	760	848	990	
		15	$1 \frac{1}{8}$	632	735	887	703	799	935	807	900	1035	
		16	$1 \frac{1}{4}$	671	781	958	739	839	988	841	938	1082	
		21	$1 \frac{1}{2}$	793	843	1049	788	894	998	889	992	1090	
		28	$1 \frac{3}{4}$	793	924	1049	850	966	1077	950	1060	1166	
37	34	14	$1 \frac{1}{8}$	632	728	868	711	800	929	823	910	1035	
		15	$1 \frac{1}{4}$	665	765	920	742	835	974	852	943	1078	
		16	$1 \frac{1}{2}$	705	811	981	777	875	1004	887	981	1143	
		22	$1 \frac{3}{4}$	838	881	1000	833	938	1044	940	1040	1143	
		29	$1 \frac{3}{4}$	838	964	1094	899	1011	1125	1004	1110	1220	
38	35	14	$1 \frac{1}{8}$	662	770	901	748	847	968	866	963	1080	
		15	$1 \frac{1}{4}$	695	807	952	778	881	1013	894	995	1129	
		16	$1 \frac{1}{2}$	734	853	992	813	921	1034	929	1034	1178	
		24	$1 \frac{3}{4}$	815	947	1058	888	1006	1113	1000	1113	1210	
		31	$1 \frac{3}{4}$	888	1031	1151	953	1080	1187	1064	1184	1286	
39	36	14	$1 \frac{1}{8}$	698	803	948	785	886	1016	912	1010	1136	
		16	$1 \frac{1}{4}$	740	852	999	825	928	1063	949	1050	1186	
		17	$1 \frac{1}{2}$	780	898	1063	862	970	1103	984	1089	1219	
		25	$1 \frac{3}{4}$	862	992	1103	933	1055	1155	1057	1170	1266	
		33	$1 \frac{3}{4}$	944	1087	1209	1013	1139	1247	1129	1249	1353	

NOTE—Size and pitch of spiral wire is given at head of each group of loads for each size column.

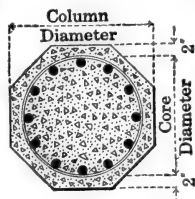

SPIRAL COLUMNS

SAFE AXIAL LOADS IN THOUSANDS OF POUNDS

JOINT COMMITTEE RECOMMENDATIONS

Ratio of Unsupported Length of Column to its Core
Diameter, limited to 10

Column Diam- eter	Core Diam- eter	ROUND SPIRAL WIRE		ROUND BAR		1: 2: 4		1: 1½: 3		1: 1: 2	
		Size	Pitch	VERTICALS		$f_c = 697.5$ lb. per sq. in. $n = 15$		$f_c = 872$ lb. per sq. in. $n = 12$		$f_c = 1,046$ lb. per sq. in. $n = 10$	
in.	in.	in.	in.	No.	Size						
16	12	¼	1 ½	4	⅝	91	110	130			
				4	¾	96	116	135			
				4	⅞	102	122	141			
				4	1	110	129	148			
				7	⅞	121	140	159			
17	13	⅝	2 ¼	4	¾	110	133	155			
				4	⅞	116	139	161			
				5	1	131	153	176			
				8	⅞	140	162	184			
				5	⅝	122	149	176			
18	14	⅝	2 ½	5	¾	129	155	182			
				5	⅞	137	163	189			
				6	1	153	179	205			
				8	1	169	195	220			
				6	⅝	141	172	202			
19	15	⅝	1 ¾	6	¾	149	180	210			
				6	⅞	159	189	219			
				7	1	177	207	237			
				9	1	192	222	251			
				7	⅝	161	196	230			
20	16	¾	2 ⅝	7	¾	171	205	240			
				7	⅞	181	216	250			
				8	1	202	236	269			
				10	1	217	251	284			
				8	⅝	182	221	260			
21	17	¾	2 ¾	8	¾	193	232	271			
				8	⅞	205	244	282			
				8	1	220	258	297			
				11	1	243	281	319			
				8	⅝	201	245	289			
22	18	¾	2 ¼	9	¾	216	260	304			
				9	⅞	230	274	317			
				10	1	254	297	340			
				12	1	269	312	355			
				8	⅝	232	281	330			
23	19	¾	2 ½	10	¾	241	290	338			
				10	⅞	256	305	353			
				11	1	282	330	378			
				11	1 ½	305	352	399			
				8	⅝	254	308	362			
24	20	¾	2	10	¾	262	316	370			
				10	⅞	278	332	385			
				12	1	311	364	417			
				12	1 ½	335	388	441			

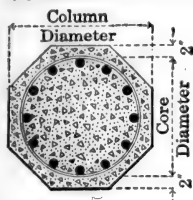

SPIRAL COLUMNS

SAFE AXIAL LOADS IN THOUSANDS OF POUNDS

JOINT COMMITTEE RECOMMENDATIONS

Ratio of Unsupported Length of Column to its Core Diameter, limited to 10

Column Diameter in.	Core Diameter in.	ROUND SPIRAL WIRE		ROUND BAR VERTICALS		1: 2: 4 2,000 lb. Concrete $f_c = 697.5$ lb. per sq. in. $n = 15$		1: 1½: 3 2,500 lb. Concrete $f_c = 872$ lb. per sq. in. $n = 12$		1: 1: 2 3,000 lb. Concrete $f_c = 1,046$ lb. per sq. in. $n = 10$	
		Size in.	Pitch in.	No.	Size						
25	21	7/16	2 3/4	8	3/4	276		336		396	
				10	7/8	300		360		419	
				10	1	318		377		436	
				13	1	341		400		459	
				14	1 1/8	378		436		493	
26	22	7/16	2 5/8	9	3/4	304		370		435	
				10	7/8	324		389		454	
				10	1	342		407		472	
				13	1 1/8	391		455		519	
				15	1 1/2	411		475		538	
27	23	7/16	2 1/2	10	3/4	333		405		476	
				10	7/8	348		420		491	
				11	1	374		445		516	
				13	1 1/8	416		486		556	
				16	1 1/8	445		515		585	
28	24	7/16	2 3/8	10	3/4	359		437		515	
				10	1	392		470		547	
				12	1	408		485		562	
				14	1 1/8	452		528		604	
				15	1 1/4	495		571		646	
29	25	7/16	2 3/8	10	7/8	401		486		570	
				10	1	419		503		587	
				12	1	434		518		602	
				15	1 1/8	488		571		654	
				16	1 1/4	534		616		698	
30	26	7/16	2 1/4	10	7/8	429		521		612	
				10	1	447		538		629	
				12	1 1/8	487		577		668	
				16	1 1/8	525		615		705	
				17	1 1/4	574		663		752	
31	27	7/16	2 1/8	10	7/8	458		557		656	
				11	1	484		582		680	
				12	1 1/8	516		614		711	
				18	1 1/8	574		671		767	
				19	1 1/4	627		723		819	
32	28	7/16	2	10	7/8	488		594		701	
				12	1	521		627		733	
				13	1 1/8	556		661		766	
				18	1 1/8	604		708		812	
				20	1 1/4	669		773		875	
33	29	1/2	2 3/4	11	7/8	525		639		753	
				13	1	560		674		787	
				14	1 1/8	597		710		821	
				18	1 1/4	676		787		899	
				22	1 1/4	724		835		945	

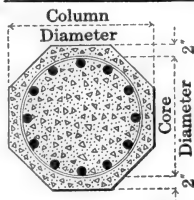

SPIRAL COLUMNS

SAFE AXIAL LOADS IN THOUSANDS OF POUNDS

JOINT COMMITTEE RECOMMENDATIONS

Ratio of Unsupported Length of Column to its Core Diameter, limited to 10

Column Diameter in.	Core Diameter in.	ROUND SPIRAL WIRE		ROUND BAR VERTICALS		1: 2: 4 2,000 lb. Concrete $f_c = 697.5$ lb. per sq. in. $n = 15$		1: 1½: 3 2,500 lb. Concrete $f_c = 872$ lb. per sq. in. $n = 12$		1: 1: 2 3,000 lb. Concrete $f_c = 1,046$ lb. per sq. in. $n = 10$	
		Size in.	Pitch in.	No.	Size	sq. in.	sq. in.	sq. in.	sq. in.		
34	30	½	2 ½	12	¾	564		685		807	
				14	1	601		722		843	
				15	1 ⅛	638		759		880	
				18	1 ¼	708		828		947	
				23	1 ¼	769		887		1005	
35	31	½	2 ¾	13	¾	603		733		863	
				15	1	641		771		900	
				15	1 ⅛	672		801		930	
				18	1 ¼	742		870		997	
				25	1 ¼	826		952		1078	
36	32	½	2 ¾	14	¾	643		782		920	
				15	1	676		814		952	
				16	1 ⅛	716		854		991	
				20	1 ¼	800		937		1073	
				26	1 ¼	873		1008		1142	
37	33	½	2 ¼	14	¾	679		826		974	
				15	1 ⅛	742		889		1035	
				16	1 ¼	788		934		1080	
				21	1 ¼	851		996		1140	
				28	1 ¼	932		1075		1219	
38	34	½	2 ¼	14	1	740		897		1053	
				15	1 ⅛	779		935		1090	
				16	1 ¼	825		980		1135	
				22	1 ¼	897		1051		1203	
				29	1 ¼	981		1133		1285	
39	35	½	2 1/8	14	1	778		945		1110	
				15	1 ⅛	817		982		1146	
				16	1 ¼	863		1028		1192	
				24	1 ¼	958		1122		1283	
				31	1 ¼	1043		1205		1365	
40	36	½	2 1/8	14	1	817		993		1168	
				16	1 ⅛	865		1040		1215	
				17	1 ¼	914		1087		1262	
				25	1 ¼	1010		1182		1353	
				33	1 ¼	1106		1276		1446	
41	37	½	2	14	1	857		1043		1228	
				16	1 ⅛	905		1090		1274	
				18	1 ¼	965		1149		1333	
				26	1 ¼	1061		1243		1425	
				35	1 ¼	1169		1349		1528	
42	38	½	2	15	1	906		1102		1298	
				17	1 ⅛	956		1151		1345	
				19	1 ¼	1019		1212		1406	
				28	1 ¼	1126		1318		1509	
				37	1 ¼	1234		1424		1613	

FOOTING TABLES

The purpose of a footing is to distribute the column load uniformly over the soil so that unequal settlements may be avoided. To accomplish this one of three general types of foundation may be used: (a) square spread footings; (b) combined spread footings; (c) spread footings supported by piles. Tables covering these three types are given on pages 136 to 142. In special cases there may be employed cantilever footings or a raft foundation extending over the entire lot area. To cover these in tabular form, however, would be difficult.

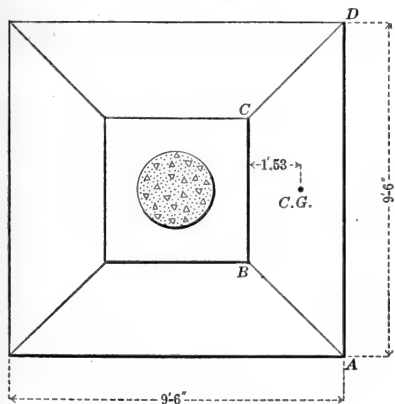
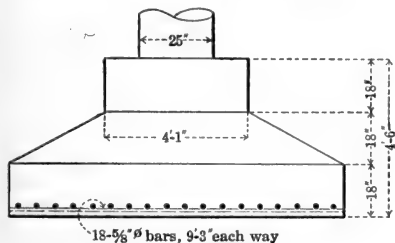

FIG. 9

The effective depth of footing is found by dividing the column load, less the net soil reaction directly under the column area, by the perimeter of the column multiplied by the unit punching shear, or $\text{Eff. depth} = \frac{500,000 - 19,000}{(25)(3.14)(120)} = 51$ in.

To the effective depth should be added 3 inches of concrete for the protection of the metal, giving a total depth of footing of 4' 6".

The area of the steel, in one direction, to resist the moment of the net soil reaction about the edge BC of the cap, is

$$A_s = \frac{\left(\frac{4.08 + 9.50}{2}\right) (2.71) (5,600) (1.53) (12)}{\left(\frac{7}{8}\right) (33) (16,000)} = 4.10 \text{ sq. in.}$$

This area is equivalent to 14—5/8" round bars.

As it is required to maintain the bond stress at 100 pounds per square inch

(assuming the use of deformed bars), the number of bars selected for moment considerations may not be sufficient to accomplish this. In this case the unit bond stress,

$$u = \frac{\left(\frac{4.08 + 9.50}{2}\right)(2.71)(5,600)}{(14)(1.965)\left(\frac{7}{8}\right)(33)} = 130 \text{ lb. per sq. in.}$$

The allowable bond stress is exceeded and it will be necessary, therefore, to increase the number of $\frac{5}{8}$ " round bars required for moment in the ratio 130/100; or a total of 18- $\frac{5}{8}$ " round bars will be needed in each direction at a uniform spacing of 6 inches. The quantities of material required by this design are: Concrete 233 cu. ft., steel 36- $\frac{5}{8}$ " round bars 9' 3" long.

The combined spread footing is employed in those cases where the footings under wall columns are not permitted to extend beyond the building line; this necessitates extending the footing under the wall column to the adjacent interior column and making it of such dimensions that its center of area coincides with the center of gravity of the column loads that bear upon it. The footing thus becomes a distributing beam, uniformly loaded by the upward reaction of the soil, and is reinforced accordingly in the upper face longitudinally between columns, and in the lower face transversely under each column.

The designs given in the tables on pages 136 to 139 cover a fairly wide range of conditions and as will be noted it is only required to know the loads and the distance center to center of the columns to obtain a complete solution of the problem. Results are all given in terms of the distance l in feet center to center of columns. Where conditions depart from what might be called the average, the results given in the tables will be slightly in error but not sufficiently so to disturb the safety or economy of the design.

Example—Given a 24-inch square wall column carrying a load P_1 , of 350,000 pounds and a 26-inch diameter interior column carrying a load P_2 , of 450,000 pounds, or $P_2/P_1 = 1.3$. The columns are spaced 18 feet on centers and the allowable soil pressure is 6,000 pounds per square foot.

The sum of the loads is 800,000 pounds and the distance c is one foot. Entering the table on page 138 with $P_1 + P_2 = 800,000$ we find opposite the ratio $P_2/P_1 = 1.3$; the following dimensions and steel areas:

$$L = 1.13l + 2c = (1.13)(18) + (2)(1) = 22.34 \text{ ft.}$$

$$B = \frac{121}{l} = \frac{121}{18} = 6.72 \text{ ft.}$$

$$H = 0.2l + 0.25 = (0.2)(18) + (0.25) = 3.85 \text{ ft.}$$

$$h = 3.6 - \frac{l}{6} = 3.6 - \frac{18}{6} = 0.60 \text{ ft.}$$

$$A_s = 27.3 \text{ sq. in.}$$

$$A'_s = \frac{2,465}{l^2} = \frac{2,465}{(18)^2} = 7.60 \text{ sq. in.}$$

$$A''_s = \frac{1,895}{l^2} = \frac{1,895}{(18)^2} = 5.85 \text{ sq. in.}$$

The disposition of the reinforcing steel is indicated in the cuts at the head of the table.

Where soil conditions are of such a nature that spread footings cannot be used, resort must be had to piles of either wood or concrete. If the piles are cut off below the low water line, wooden piles may be used, but if exposed to alternate wet and dry conditions wood is subject to rot and concrete piles should be employed. The tables of pile caps given on pages 141 and 142 are designed for concrete piles having an assumed carrying capacity of 30 tons per pile. The style and reinforcement of cap and number of concrete piles required are determined from the tables, when the column load is known.

Designs for concrete piles of the pre-cast type are given in the table on page 143. Except under the most adverse conditions as regards surface and sub-soil, a load of 30 tons per pile may be safely used and if the piles are driven to rock a 50% increase in load should be permissible. The amount of reinforcement used is considered a minimum consistent with successful handling of the pile from the casting yard to its place in the work.

COMBINED COLUMN FOOTINGS

A_s = Tension steel in top
 A'_s = Transverse steel under Column P_2
 A''_s = Transverse steel under Column P_1
 l = Distance c. to c. of columns in feet.

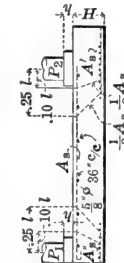
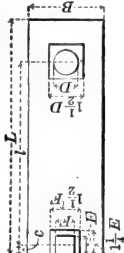

Unit Stresses
 f_s , 16,000
 f_c , 650

Plan

Elevation

Section

$P_1 + P_2$ lb.	P_2/P_1	Soil value = 4,000 pounds per square foot					Soil value = 5,000 pounds per square foot							
		L ft.	B ft.	H ft.	h ft.	A_s sq. in.	A'_s sq. in.	A''_s sq. in.	B ft.	H ft.	h ft.	A_s sq. in.	A'_s sq. in.	A''_s sq. in.
300,000	1.2	1.09l+2c	74/l	0.17l+0.25	2.3-6	12.9	638/l ²	532/l ²	58/l	0.19l+0.25	2.1-6	11.6	456/l ²	350/l ²
	1.3	1.13l+2c	71/l	0.17l+0.25	2.3-6	12.4	630/l ²	485/l ²	56/l	0.19l+0.25	2.1-6	11.1	455/l ²	380/l ²
	1.4	1.17l+2c	69/l	0.16l+0.25	2.3-6	12.4	680/l ²	480/l ²	54/l	0.18l+0.25	2.1-6	11.0	476/l ²	340/l ²
	1.5	1.20l+2c	67/l	0.16l+0.25	2.3-6	11.7	670/l ²	450/l ²	53/l	0.18l+0.25	2.1-6	10.4	482/l ²	322/l ²
	1.2	1.09l+2c	98/l	0.17l+0.25	2.8-6	17.4	1121/l ²	935/l ²	77/l	0.19l+0.25	2.6-6	15.6	805/l ²	671/l ²
400,000	1.3	1.13l+2c	96/l	0.17l+0.25	2.8-6	16.2	1142/l ²	895/l ²	75/l	0.19l+0.25	2.6-6	14.5	817/l ²	628/l ²
	1.4	1.17l+2c	93/l	0.16l+0.25	2.8-6	16.2	1225/l ²	875/l ²	73/l	0.18l+0.25	2.6-6	14.5	871/l ²	622/l ²
	1.5	1.20l+2c	90/l	0.16l+0.25	2.8-6	15.5	1200/l ²	810/l ²	71/l	0.18l+0.25	2.6-6	13.8	867/l ²	578/l ²
	1.2	1.09l+2c	122/l	0.17l+0.25	3.2-6	21.4	1734/l ²	1446/l ²	96/l	0.19l+0.25	3.0-6	19.2	1249/l ²	1041/l ²
	1.3	1.13l+2c	119/l	0.17l+0.25	3.2-6	20.0	1710/l ²	1420/l ²	94/l	0.19l+0.25	3.0-6	17.9	1283/l ²	987/l ²
500,000	1.4	1.17l+2c	115/l	0.16l+0.25	3.2-6	20.0	1870/l ²	1340/l ²	91/l	0.18l+0.25	3.0-6	17.9	1351/l ²	966/l ²
	1.5	1.20l+2c	111/l	0.16l+0.25	3.2-6	19.3	1840/l ²	1220/l ²	88/l	0.18l+0.25	3.0-6	17.2	1330/l ²	887/l ²
	1.2	1.09l+2c	146/l	0.17l+0.25	3.6-6	25.8	2480/l ²	2070/l ²	115/l	0.19l+0.25	3.3-6	23.1	1794/l ²	1494/l ²
	1.3	1.13l+2c	141/l	0.17l+0.25	3.6-6	24.4	2397/l ²	2000/l ²	111/l	0.19l+0.25	3.3-6	21.9	1788/l ²	1375/l ²
	1.4	1.17l+2c	136/l	0.16l+0.25	3.6-6	24.4	2620/l ²	1870/l ²	107/l	0.18l+0.25	3.3-6	21.9	1867/l ²	1333/l ²
600,000	1.5	1.20l+2c	133/l	0.16l+0.25	3.6-6	23.1	2630/l ²	1760/l ²	105/l	0.18l+0.25	3.3-6	20.6	1894/l ²	1263/l ²
	1.2	1.09l+2c	169/l	0.17l+0.25	3.9-6	29.9	3330/l ²	2770/l ²	133/l	0.19l+0.25	3.6-6	26.8	2390/l ²	1996/l ²
	1.3	1.13l+2c	164/l	0.17l+0.25	3.9-6	27.9	3240/l ²	2705/l ²	129/l	0.19l+0.25	3.6-6	25.0	2420/l ²	1860/l ²
	1.4	1.17l+2c	159/l	0.16l+0.25	3.9-6	28.0	3580/l ²	2550/l ²	125/l	0.18l+0.25	3.6-6	24.9	2550/l ²	1820/l ²
	1.5	1.20l+2c	155/l	0.16l+0.25	3.9-6	26.4	3590/l ²	2380/l ²	122/l	0.18l+0.25	3.6-6	23.5	2555/l ²	1703/l ²
700,000	1.2	1.09l+2c	193/l	0.17l+0.25	4.2-6	34.1	4340/l ²	3620/l ²	152/l	0.19l+0.25	3.9-6	30.5	3140/l ²	2610/l ²
	1.3	1.13l+2c	187/l	0.17l+0.25	4.2-6	32.1	4210/l ²	3520/l ²	147/l	0.19l+0.25	3.9-6	28.7	3130/l ²	2410/l ²
	1.4	1.17l+2c	182/l	0.16l+0.25	4.2-6	31.9	4690/l ²	3350/l ²	143/l	0.18l+0.25	3.9-6	28.4	3340/l ²	2385/l ²
	1.5	1.20l+2c	177/l	0.16l+0.25	4.2-6	30.2	4670/l ²	3110/l ²	139/l	0.18l+0.25	3.9-6	26.9	3320/l ²	2210/l ²
	1.2	1.09l+2c	219/l	0.17l+0.25	4.5-6	40.1	5340/l ²	4340/l ²	174/l	0.19l+0.25	4.2-6	34.1	3740/l ²	2910/l ²

COMBINED COLUMN FOOTINGS

A_s = Tension steel in top
 A'_s = Transverse steel under
 Column P_2
 A''_s = Transverse steel under
 Column P_1
 l = Distance c. to c. of
 columns in feet

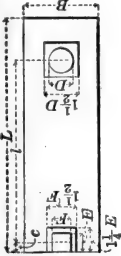

Unit Stresses
 f_b , 16,000
 f_c , 650

Soil Value = 4,000 pounds per square foot Soil Value = 5,000 pounds per square foot

$P_1 + P_2$ lb.	P_2/P_1	Soil Value = 4,000 pounds per square foot						Soil Value = 5,000 pounds per square foot					
		L ft.	B ft.	H ft.	h ft.	A_s sq. in.	A'_s sq. in.	A''_s sq. in.	B ft.	H ft.	h ft.	A_s sq. in.	A'_s sq. in.
900,000	1.2	1.09+2c	217/1	0.17+0.25	38.3	5490/2	4570/2	171/1	0.19+0.25	34.3	3970/2	3310/2	
	1.3	1.13+2c	210/1	0.17+0.25	36.2	5310/2	4440/2	165/1	0.19+0.25	32.4	3950/2	3040/2	
	1.4	1.17+2c	204/1	0.16+0.25	34.2	5890/2	4210/2	160/1	0.18+0.25	32.2	4180/2	2985/2	
	1.5	1.20+2c	199/1	0.16+0.25	34.1	5900/2	3930/2	156/1	0.18+0.25	30.3	4180/2	2790/2	
	1.2	1.09+2c	242/1	0.17+0.25	42.5	6820/2	5690/2	190/1	0.19+0.25	38.1	4890/2	4080/2	
1,000,000	1.3	1.13+2c	235/1	0.17+0.25	39.9	6650/2	5550/2	185/1	0.19+0.25	35.7	4970/2	3820/2	
	1.4	1.17+2c	228/1	0.16+0.25	40.1	7360/2	5260/2	179/1	0.18+0.25	35.7	5230/2	3735/2	
	1.5	1.20+2c	221/1	0.16+0.25	37.9	7280/2	4850/2	174/1	0.18+0.25	33.7	5200/2	3465/2	
	1.2	1.09+2c	264/1	0.17+0.25	46.4	8120/2	6770/2	207/1	0.19+0.25	41.5	5810/2	4840/2	
	1.3	1.13+2c	257/1	0.17+0.25	43.6	7930/2	6680/2	202/1	0.19+0.25	39.0	5930/2	4560/2	
1,100,000	1.4	1.17+2c	250/1	0.16+0.25	43.5	8860/2	6320/2	197/1	0.18+0.25	38.6	6330/2	4520/2	
	1.5	1.20+2c	242/1	0.16+0.25	40.9	8720/2	5820/2	190/1	0.18+0.25	36.3	6210/2	4140/2	
	1.2	1.09+2c	288/1	0.17+0.25	50.6	9660/2	8060/2	227/1	0.19+0.25	45.3	6990/2	5830/2	
	1.3	1.13+2c	280/1	0.17+0.25	47.6	9450/2	7890/2	220/1	0.19+0.25	42.6	7020/2	5400/2	
	1.4	1.17+2c	272/1	0.16+0.25	47.4	10480/2	7480/2	214/1	0.18+0.25	42.1	7480/2	5340/2	
1,200,000	1.5	1.20+2c	264/1	0.16+0.25	44.6	10380/2	6920/2	208/1	0.18+0.25	39.6	7430/2	4960/2	
	1.2	1.09+2c	310/1	0.17+0.25	54.3	11210/2	9320/2	244/1	0.19+0.25	48.6	8080/2	6740/2	
	1.3	1.13+2c	301/1	0.17+0.25	50.9	10940/2	9100/2	237/1	0.19+0.25	45.6	8160/2	6275/2	
	1.4	1.17+2c	293/1	0.16+0.25	50.9	12150/2	8690/2	230/1	0.18+0.25	45.3	8650/2	6170/2	
	1.5	1.20+2c	284/1	0.16+0.25	47.9	12000/2	8000/2	223/1	0.18+0.25	42.6	8550/2	5700/2	
1,300,000	1.2	1.09+2c	334/1	0.17+0.25	58.5	13000/2	10830/2	263/1	0.19+0.25	52.3	9370/2	7820/2	
	1.3	1.13+2c	324/1	0.17+0.25	55.0	13100/2	10100/2	255/1	0.19+0.25	49.2	9440/2	7260/2	
	1.4	1.17+2c	315/1	0.16+0.25	54.9	14000/2	10000/2	248/1	0.18+0.25	48.7	10040/2	7175/2	
	1.5	1.20+2c	306/1	0.16+0.25	51.5	13900/2	9300/2	240/1	0.18+0.25	45.8	9900/2	6600/2	

COMBINED COLUMN FOOTINGS

A_s = Tension steel in top
 A'_s = Transverse steel under Column P_2
 A''_s = Transverse steel under Column P_1
 l = Distance c. to c. of columns in feet

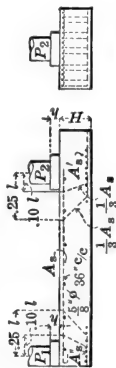
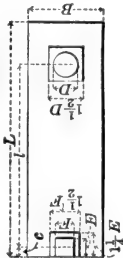

Unit Stresses
 f_s , 16,000
 f_c , 650

Plan

Elevation

Section

$P_1 + P_2$ lb.	P_2 / P_1	Soil Value = 6,000 pounds per square foot					Soil Value = 8,000 pounds per square foot						
		L ft.	B ft.	H ft.	h ft.	A_s sq. in.	A'_s sq. in.	A''_s sq. in.	B ft.	H ft.	h ft.	A_s sq. in.	A'_s sq. in.
300,000	1.2	1.09l+2c	48/l	0.2l+0.25	11.0	361/l ²	301/l ²	36/l	0.23l+0.25	1.9-6	9.5	239/l ²	198/l ²
	1.3	1.13l+2c	46/l	2.1-6	10.5	356/l ²	274/l ²	34/l	l	9.1	9.1	228/l ²	176/l ²
	1.4	1.17l+2c	45/l	0.2l+0.25	9.9	363/l ²	289/l ²	33/l	0.23l+0.25	1.9-6	8.6	229/l ²	164/l ²
	1.5	1.20l+2c	43/l	0.2l+0.25	9.4	349/l ²	233/l ²	32/l	0.23l+0.25	1.9-6	8.2	227/l ²	151/l ²
	1.2	1.09l+2c	63/l	0.2l+0.25	14.8	623/l ²	519/l ²	47/l	0.23l+0.25	2.0-6	12.8	407/l ²	339/l ²
400,000	1.3	1.13l+2c	62/l	0.2l+0.25	13.8	647/l ²	498/l ²	46/l	0.23l+0.25	2.0-6	12.0	418/l ²	322/l ²
	1.4	1.17l+2c	60/l	0.2l+0.25	13.1	645/l ²	461/l ²	44/l	0.23l+0.25	2.0-6	11.3	408/l ²	291/l ²
	1.5	1.20l+2c	58/l	0.2l+0.25	12.4	636/l ²	424/l ²	43/l	0.23l+0.25	2.0-6	10.8	410/l ²	273/l ²
	1.2	1.09l+2c	79/l	0.2l+0.25	18.2	980/l ²	816/l ²	58/l	0.23l+0.25	2.3-6	15.8	620/l ²	517/l ²
	1.3	1.13l+2c	77/l	0.2l+0.25	17.0	998/l ²	768/l ²	57/l	0.23l+0.25	2.3-6	14.8	641/l ²	493/l ²
500,000	1.4	1.17l+2c	74/l	0.2l+0.25	16.1	982/l ²	702/l ²	55/l	0.23l+0.25	2.3-6	14.0	637/l ²	455/l ²
	1.5	1.20l+2c	72/l	0.2l+0.25	15.5	980/l ²	653/l ²	53/l	0.23l+0.25	2.3-6	13.4	623/l ²	416/l ²
	1.2	1.09l+2c	94/l	0.2l+0.25	21.9	1388/l ²	1156/l ²	70/l	0.23l+0.25	2.7-6	19.1	903/l ²	752/l ²
	1.3	1.13l+2c	91/l	0.2l+0.25	20.8	1393/l ²	1071/l ²	67/l	0.23l+0.25	2.7-6	18.0	888/l ²	684/l ²
	1.4	1.17l+2c	88/l	0.2l+0.25	19.7	1389/l ²	993/l ²	65/l	0.23l+0.25	2.7-6	17.1	890/l ²	636/l ²
600,000	1.5	1.20l+2c	86/l	0.2l+0.25	18.5	1397/l ²	932/l ²	64/l	0.23l+0.25	2.7-6	16.1	908/l ²	606/l ²
	1.2	1.09l+2c	109/l	0.2l+0.25	25.5	1865/l ²	1554/l ²	80/l	0.23l+0.25	3.1-6	22.1	1180/l ²	985/l ²
	1.3	1.13l+2c	106/l	0.2l+0.25	23.7	1890/l ²	1454/l ²	78/l	0.23l+0.25	3.1-6	20.6	1200/l ²	923/l ²
	1.4	1.17l+2c	103/l	0.2l+0.25	22.5	1902/l ²	1358/l ²	75/l	0.23l+0.25	3.1-6	19.5	1215/l ²	869/l ²
	1.5	1.20l+2c	100/l	0.2l+0.25	21.2	1890/l ²	1260/l ²	74/l	0.23l+0.25	3.1-6	18.4	1213/l ²	809/l ²
700,000	1.2	1.09l+2c	125/l	0.2l+0.25	29.0	2455/l ²	2045/l ²	92/l	0.23l+0.25	3.1-6	25.2	1560/l ²	1300/l ²
	1.3	1.13l+2c	121/l	0.2l+0.25	27.3	2465/l ²	1895/l ²	89/l	0.23l+0.25	3.1-6	23.7	1566/l ²	1204/l ²
	1.4	1.17l+2c	117/l	0.2l+0.25	25.6	2450/l ²	1750/l ²	87/l	0.23l+0.25	3.1-6	22.2	1592/l ²	1138/l ²
	1.5	1.20l+2c	114/l	0.2l+0.25	24.2	2457/l ²	1636/l ²	84/l	0.23l+0.25	3.1-6	21.0	1563/l ²	1042/l ²
	1.2	1.09l+2c	109/l	0.2l+0.25	25.5	1865/l ²	1554/l ²	80/l	0.23l+0.25	3.1-6	22.1	1180/l ²	985/l ²

COMBINED COLUMN FOOTINGS

A_s = Tension steel in top
 A'_s = Transverse steel under Column P_2
 A_s = Transverse steel under Column P_1
 l = Distance c. to c. of columns in feet

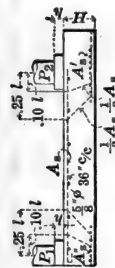
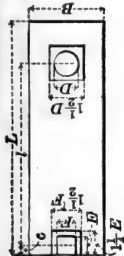

Unit Stresses
 f_s 16,000
 f_c 650

Plan Soil Value = 6,000 pounds per square foot Elevation Soil Value = 8,000 pounds per square foot

$P_1 + P_2$ lb.	P_2 / P_1	L ft.	Soil Value = 6,000 pounds per square foot					Soil Value = 8,000 pounds per square foot						
			B ft.	H ft.	h ft.	A_s sq. in.	A'_s sq. in.	A''_s sq. in.	B ft.	H ft.	h ft.	A_s sq. in.	A'_s sq. in.	A''_s sq. in.
900,000	1.2	1.09l+2c	140/l	0.2l+0.25	3.8-	32.6	3075/l ²	2460/l ²	104/l	0.23l+0.25	3.3-	28.3	1995/l ²	1660/l ²
	1.3	1.13l+2c	136/l	0.2l+0.25	3.8-	30.8	3110/l ²	2393/l ²	100/l	0.23l+0.25	3.3-	26.8	1975/l ²	1520/l ²
	1.4	1.17l+2c	132/l	0.2l+0.25	3.8-	29.0	3110/l ²	2220/l ²	98/l	0.23l+0.25	3.3-	25.2	2022/l ²	1440/l ²
	1.5	1.20l+2c	129/l	0.2l+0.25	3.8-	27.3	3270/l ²	2180/l ²	95/l	0.23l+0.25	3.3-	23.7	1999/l ²	1330/l ²
	1.2	1.09l+2c	156/l	0.2l+0.25	4.0-	36.2	3820/l ²	3180/l ²	115/l	0.23l+0.25	3.5-	31.4	2440/l ²	2030/l ²
1,000,000	1.3	1.13l+2c	152/l	0.2l+0.25	4.0-	33.9	3890/l ²	2990/l ²	112/l	0.23l+0.25	3.5-	29.4	2480/l ²	1908/l ²
	1.4	1.17l+2c	147/l	0.2l+0.25	4.0-	32.2	3870/l ²	2760/l ²	109/l	0.23l+0.25	3.5-	27.9	2504/l ²	1788/l ²
	1.5	1.20l+2c	143/l	0.2l+0.25	4.0-	30.4	3865/l ²	2575/l ²	106/l	0.23l+0.25	3.5-	26.4	2487/l ²	1638/l ²
	1.2	1.09l+2c	170/l	0.2l+0.25	4.3-	39.4	4530/l ²	3780/l ²	126/l	0.23l+0.25	3.7-	34.2	2930/l ²	2440/l ²
	1.3	1.13l+2c	166/l	0.2l+0.25	4.3-	37.1	4640/l ²	3570/l ²	122/l	0.23l+0.25	3.7-	32.2	2940/l ²	2260/l ²
1,100,000	1.4	1.17l+2c	161/l	0.2l+0.25	4.3-	34.8	4640/l ²	3320/l ²	119/l	0.23l+0.25	3.7-	30.2	2980/l ²	2128/l ²
	1.5	1.20l+2c	156/l	0.2l+0.25	4.3-	32.7	4600/l ²	3065/l ²	115/l	0.23l+0.25	3.7-	28.4	2933/l ²	1953/l ²
	1.2	1.09l+2c	186/l	0.2l+0.25	4.6-	43.0	5430/l ²	4520/l ²	137/l	0.23l+0.25	4.0-	37.3	3460/l ²	2880/l ²
	1.3	1.13l+3c	181/l	0.2l+0.25	4.6-	40.4	5510/l ²	4240/l ²	133/l	0.23l+0.25	4.0-	35.1	3490/l ²	2685/l ²
	1.4	1.17l+2c	176/l	0.2l+0.25	4.6-	37.9	5550/l ²	3960/l ²	130/l	0.23l+0.25	4.0-	33.0	3560/l ²	2540/l ²
1,200,000	1.5	1.20l+2c	170/l	0.2l+0.25	4.6-	35.7	5460/l ²	3640/l ²	126/l	0.23l+0.25	4.0-	31.0	3517/l ²	2343/l ²
	1.2	1.09l+2c	200/l	0.2l+0.25	4.9-	46.1	6280/l ²	5230/l ²	148/l	0.23l+0.25	4.2-	40.1	4040/l ²	3360/l ²
	1.3	1.13l+2c	194/l	0.2l+0.25	4.9-	43.3	6340/l ²	4875/l ²	144/l	0.23l+0.25	4.2-	37.6	4090/l ²	3150/l ²
	1.4	1.17l+2c	189/l	0.2l+0.25	4.9-	40.8	6400/l ²	4570/l ²	140/l	0.23l+0.25	4.2-	35.4	4130/l ²	2950/l ²
	1.5	1.20l+2c	183/l	0.2l+0.25	4.9-	38.4	6340/l ²	4225/l ²	135/l	0.23l+0.25	4.2-	33.3	4030/l ²	2690/l ²
1,300,000	1.2	1.09l+2c	216/l	0.2l+0.25	5.1-	49.7	7320/l ²	6100/l ²	159/l	0.23l+0.25	4.5-	43.2	4680/l ²	3880/l ²
	1.3	1.13l+2c	209/l	0.2l+0.25	5.1-	46.7	7350/l ²	5660/l ²	154/l	0.23l+0.25	4.5-	40.6	4680/l ²	3610/l ²
	1.4	1.17l+2c	203/l	0.2l+0.25	5.1-	43.9	7380/l ²	5280/l ²	150/l	0.23l+0.25	4.5-	38.1	4730/l ²	3380/l ²
	1.5	1.20l+2c	198/l	0.2l+0.25	5.1-	41.2	7410/l ²	4940/l ²	146/l	0.23l+0.25	4.5-	35.8	4720/l ²	3147/l ²

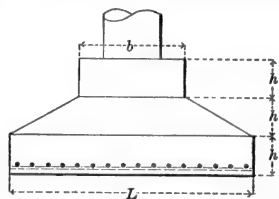

SQUARE COLUMN FOOTINGS

Unit Stresses

f_s 16,000

f_c 650

L		Soil Value	Column Load	Minimum Column Diameter	h		b		Reinforcement Round Bars Each Way		Weight of Steel	Volume of Concrete
ft.	in.	lb. per sq. ft.	in 1000lb.	in.	ft.	in.	ft.	in.	No.	Size	lb.	cu. ft.
5	0	4000	96	13	0	7	1	10	14	1/2	88.8	23.7
5	0	6000	145	16	0	8	2	3	16	1/2	100.3	29.3
5	0	8000	194	18	0	10	2	7	15	1/2	94.1	38.8
5	6	4000	116	14	0	8	2	1	14	1/2	97.0	33.3
5	6	6000	175	17	0	10	2	6	15	1/2	104.0	44.4
5	6	8000	234	19	0	11	2	10	16	1/2	110.9	51.6
6	0	4000	137	15	0	9	2	3	14	1/2	106.3	44.5
6	0	6000	207	18	0	11	2	9	16	1/2	121.4	58.2
6	0	8000	278	20	1	0	2	11	18	1/2	136.6	65.2
6	6	4000	161	16	0	9	2	4	17	1/2	140.3	51.6
6	6	6000	242	19	1	0	2	10	17	1/2	140.3	73.2
6	6	8000	324	21	1	2	3	4	17	1/2	140.3	91.5
7	0	4000	186	17	0	10	2	6	17	1/2	151.5	66.2
7	0	6000	280	20	1	1	3	1	18	1/2	160.4	92.3
7	0	8000	375	23	1	3	3	7	19	1/2	169.3	113.6
7	6	4000	212	18	0	11	2	9	18	1/2	172.3	84.3
7	6	6000	322	22	1	1	3	3	20	1/2	191.4	105.2
7	6	8000	429	24	1	4	3	9	20	1/2	191.4	137.4
8	0	4000	240	19	1	0	2	10	18	1/2	184.1	103.6
8	0	6000	363	22	1	3	3	6	20	1/2	204.6	138.7
8	0	8000	487	25	1	5	4	0	21	1/2	214.8	166.3
8	6	4000	272	20	1	0	2	11	21	1/2	228.7	116.0
8	6	6000	410	24	1	3	3	8	23	1/2	250.5	155.8
8	6	8000	546	26	1	7	4	3	21	1/2	228.7	209.7
9	0	4000	303	21	1	1	3	2	21	1/2	242.6	141.8
9	0	6000	456	24	1	5	3	11	22	1/2	254.1	198.5
9	0	8000	611	27	1	8	4	6	22	1/2	254.1	247.4
9	6	4000	333	21	1	3	3	5	16	5/8	310.8	183.4
9	6	6000	506	25	1	6	4	1	18	5/8	349.7	233.2
9	6	8000	678	29	1	9	4	9	19	5/8	369.1	289.5
10	0	4000	370	22	1	3	3	6	17	5/8	348.1	201.7
10	0	6000	559	26	1	7	4	3	19	5/8	389.0	271.6
10	0	8000	750	30	1	10	4	11	20	5/8	409.5	333.5
10	6	4000	405	23	1	4	3	8	18	5/8	387.5	237.0
10	6	6000	614	28	1	8	4	7	19	5/8	409.0	318.5
10	6	8000	822	30	2	0	5	2	20	5/8	430.5	401.3
11	0	4000	442	24	1	5	3	11	18	5/8	406.4	277.8
11	0	6000	671	28	1	9	4	8	20	5/8	451.5	363.0
11	0	8000	902	33	2	0	5	5	22	5/8	496.7	440.7
11	6	4000	484	25	1	5	4	0	20	5/8	472.5	301.8
11	6	6000	731	30	1	10	4	11	21	5/8	496.1	416.8
11	6	8000	983	34	2	1	5	7	22	5/8	519.8	498.5
12	0	4000	524	26	1	6	4	2	22	5/8	542.9	347.8
12	0	6000	792	31	1	11	5	2	22	5/8	542.9	475.9
12	0	8000	1067	35	2	2	5	10	24	5/8	592.2	564.8
12	6	4000	566	26	1	7	4	3	23	5/8	591.7	396.0
12	6	6000	857	32	2	0	5	4	22	5/8	566.0	537.0
12	6	8000	1158	38	2	2	6	1	26	5/8	668.9	611.4

REINFORCED CONCRETE PILE CAPS
CARRYING CAPACITY OF EACH PILE=30 TONS

$f_c = 16,000$ lb. per sq. in.
 $f_s =$ less than 650 lb. per sq. in.

Punching shear = 120 lb. per sq. in.
 Bond stress = 100 lb. per sq. in.

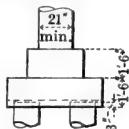
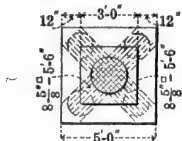

4 PILES

Column load = 232,000 lb.
 Concrete = 1.89 cu. yd.
 Reinforcement = 118 lb.

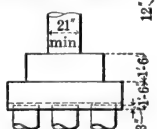
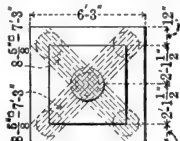

5 PILES

Column load = 237,000 lb.
 Concrete = 3.17 cu. yd.
 Reinforcement = 156 lb.

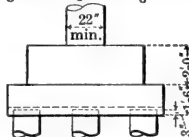
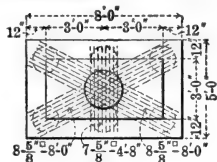

6 PILES

Column load = 346,000 lb.
 Concrete = 3.55 cu. yd.
 Reinforcement = 217 lb.

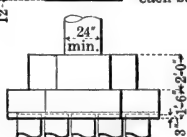
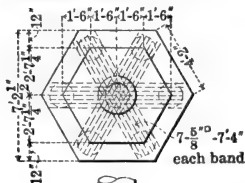

7 PILES

Column load = 403,000 lb.
 Concrete = 42.4 cu. yd. *4-24 Cu. Yd.*
 Reinforcement = 208 lb.

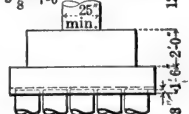
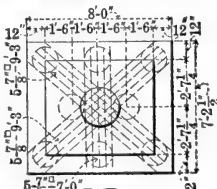

8 PILES

Column load = 457,000 lb.
 Concrete = 5.56 cu. yd.
 Reinforcement = 337 lb.

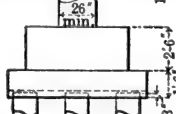
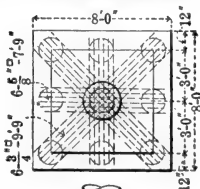

9 PILES

Column load = 512,000 lb.
 Concrete = 6.89 cu. yd.
 Reinforcement = 352 lb.

REINFORCED CONCRETE PILE CAPS

CARRYING CAPACITY OF EACH PILE = 30 TONS

$f_c = 16,000$ lb. per sq. in.

Punching shear = 120 lb. per sq. in.

$f_s =$ less than 650 lb. per sq. in.

Bond stress = 100 lb. per sq. in.

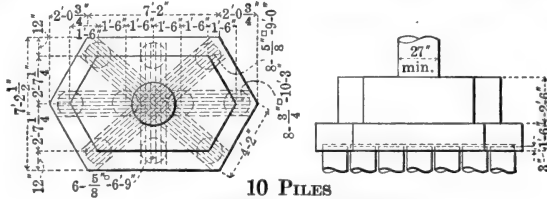

10 PILES

Column load = 570,000 lbs.
Concrete = 7.32 cu. yds.
Reinforcement = 408 lbs.

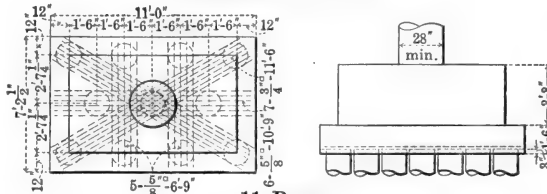

11 PILES

Column load = 619,000 lb.
Concrete = 10.04 cu. yds.
Reinforcement = 491 lbs.

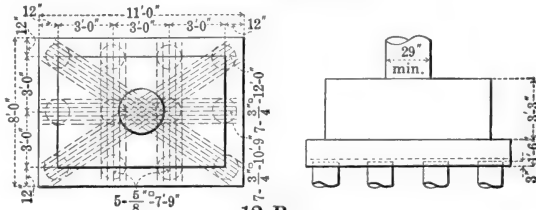

12 PILES

Column load = 674,000 lbs.
Concrete = 11.39 cu. yds.
Reinforcement = 577 lbs.

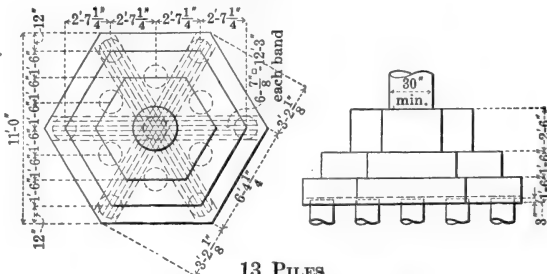

13 PILES

Column load = 729,000 lbs.
Concrete = 12.63 cu. yds.
Reinforcement = 583 lbs.

REINFORCED CONCRETE PILES

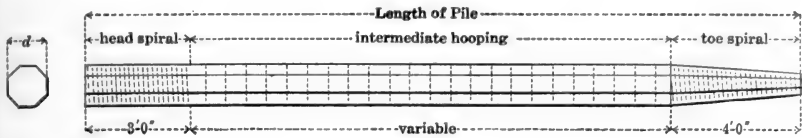

Concrete Mixture: 1: 2: 4

Length of Pile	Diameter of Pile	Round Bar Verticals		HEAD SPIRAL		HOOPING		TOE SPIRAL		Volume of Concrete per Pile
				Rounds	Pitch	Rounds	Spacing	Rounds	Pitch	
ft.	in.	No.	Size	Size	in.	Size	in.	Size	in.	cu. ft.
14	14	6	5/8	1/4	2	1/4	12	1/4	1 1/2	14.2
16	14	6	5/8	1/4	2	1/4	12	1/4	1 1/2	16.4
18	14	6	5/8	1/4	2	1/4	12	1/4	1 1/2	18.7
20	14	6	5/8	1/4	2	1/4	12	1/4	1 1/2	20.9
22	16	6	5/8	5/16	2	1/4	12	1/4	1 1/2	29.9
24	16	6	3/4	5/16	2	1/4	12	1/4	1 1/2	32.8
26	16	6	3/4	5/16	2	1/4	12	1/4	1 1/2	35.8
28	16	6	7/8	5/16	2	1/4	12	1/4	1 1/2	38.7
30	16	6	7/8	5/16	2	1/4	12	1/4	1 1/2	41.6
32	18	8	3/4	3/8	2	3/8	12	3/8	1 1/2	56.2
34	18	8	7/8	3/8	2	3/8	12	3/8	1 1/2	59.9
36	18	8	7/8	3/8	2	3/8	12	3/8	1 1/2	63.6
38	18	8	1	3/8	2	3/8	12	3/8	1 1/2	67.4
40	18	8	1	3/8	2	3/8	12	3/8	1 1/2	71.1
42	20	8	1 1/8	3/8	1 1/2	3/8	12	3/8	1 1/2	92.3
44	20	8	1 1/8	3/8	1 1/2	3/8	12	3/8	1 1/2	96.9
46	20	8	1 1/4	3/8	1 1/2	3/8	12	3/8	1 1/2	101.5
48	20	8	1 1/4	3/8	1 1/2	3/8	12	3/8	1 1/2	106.1
50	20	8	1 1/4	3/8	1 1/2	3/8	12	3/8	1 1/2	110.7
52	22	8	1 1/4	3/8	1 1/2	3/8	12	3/8	1 1/2	138.8

EARTH AND WATER PRESSURES

P = intensity of pressure at any depth h .
 H = total pressure above A-B.
 M = moment at section A-B.

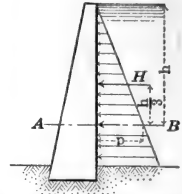
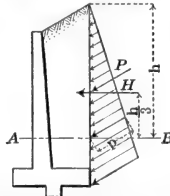
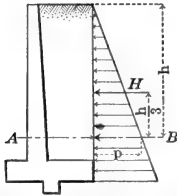

h	EARTH HORIZONTAL w = 100 lb.			EARTH SURCHARGED w = 100 lb.			WATER w = 62.5 lb.		
	$p = 0.2948wh$ lb.	$H = 0.1474wh^2$ lb.	$M = 0.5896wh^3$ in. lb.	$p = 0.7034wh$ lb.	$H = 0.3517wh^2$ lb.	$M = 1.4068wh^3$ in. lb.	$p = wh$ lb.	$H = 0.5ph$ lb.	$M = 4Hh$ in. lb.
1	29	15	59	70	35	141	63	31	125
2	59	59	472	141	141	1,125	125	125	1,000
3	88	132	1,592	211	317	3,798	188	281	3,375
4	118	236	3,773	281	563	9,003	250	500	8,000
5	147	368	7,370	352	879	17,584	313	781	15,625
6	177	531	12,735	422	1,266	30,385	375	1,125	27,000
7	206	721	20,223	492	1,723	48,251	438	1,531	42,875
8	236	944	30,187	563	2,251	72,025	500	2,000	64,000
9	265	1,193	42,982	633	2,849	102,551	563	2,531	91,125
10	295	1,475	58,960	703	3,517	140,673	625	3,125	125,000
11	324	1,782	78,476	774	4,255	187,236	688	3,781	166,375
12	354	2,124	101,883	844	5,064	243,084	750	4,500	216,000
13	383	2,490	129,535	914	5,943	309,060	813	5,281	274,625
14	413	2,891	161,786	985	6,893	386,008	875	6,125	343,000
15	442	3,315	198,990	1,055	7,913	474,773	938	7,031	421,875
16	472	3,776	241,500	1,125	9,003	576,199	1,000	8,000	512,000
17	501	4,259	289,670	1,196	10,164	691,129	1,063	9,031	614,125
18	531	4,779	343,855	1,266	11,395	820,408	1,125	10,125	729,000
19	560	5,320	404,407	1,336	12,696	964,879	1,188	11,281	857,375
20	590	5,900	471,680	1,407	14,067	1,125,388	1,250	12,500	1,000,000
21	619	6,500	546,029	1,477	15,509	1,302,777	1,313	13,781	1,157,625
22	649	7,139	627,806	1,547	17,021	1,497,891	1,375	15,125	1,331,000
23	678	7,797	717,366	1,618	18,604	1,711,574	1,438	16,531	1,520,875
24	708	8,496	815,063	1,688	20,257	1,944,670	1,500	18,000	1,728,000
25	737	9,213	921,250	1,758	21,980	2,198,023	1,563	19,531	1,953,125
26	766	9,958	1,036,280	1,829	23,774	2,472,479	1,625	21,125	2,197,000
27	796	10,746	1,160,509	1,899	25,638	2,768,876	1,688	22,781	2,460,375
28	825	11,550	1,294,290	1,969	27,572	3,088,064	1,750	24,500	2,744,000
29	855	12,398	1,437,975	2,040	29,577	3,430,885	1,813	26,281	3,048,625
30	884	13,260	1,591,920	2,110	31,652	3,798,184	1,875	28,125	3,375,000
31	914	14,167	1,756,477	2,180	33,797	4,190,803	1,938	30,031	3,723,875
32	943	15,088	1,932,001	2,251	36,012	4,609,588	2,000	32,000	4,096,000
33	973	16,045	2,118,846	2,321	38,298	5,055,382	2,063	34,031	4,492,125
34	1,002	17,034	2,317,364	2,391	40,655	5,529,030	2,125	36,125	4,913,000
35	1,032	18,060	2,527,910	2,462	43,081	6,031,375	2,188	38,281	5,359,375

Angle of repose = 33°

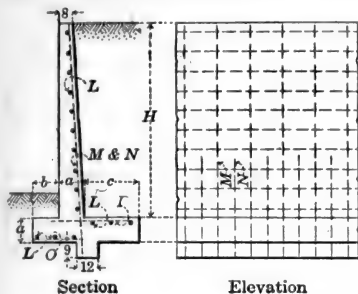

CANTILEVER RETAINING WALLS

SURFACE OF EARTH HORIZONTAL

Angle of repose, 33°.

Weight of earth 100 lb. per cu. ft.

$f_s = 16,000$ lb. per sq. in.

$f_c = 650$ lb. per sq. in.

$n = 15$

CONCRETE

Height of Wall H	a		b		c		Soil Pressure at Toe	Soil Pressure at Heel	Concrete per ft. Length of Wall
	ft.	in.	ft.	in.	ft.	in.			
7	1	0	1	0	1	10	1460	90	10.41
8	1	1	1	1	2	1	1470	270	12.35
9	1	1	1	2	2	9	1770	130	14.04
10	1	2	1	4	2	10	2000	60	16.14
11	1	2	1	6	3	2	2100	90	17.65
12	1	3	1	8	3	7	2210	160	20.37
13	1	4	1	8	4	0	2480	120	23.10
14	1	4	2	1	4	3	2400	240	24.95
15	1	5	2	1	4	7	2680	200	27.79
16	1	5	2	2	4	11	2870	170	29.45
17	1	6	2	3	5	3	3060	160	32.65
18	1	7	2	4	5	7	3280	140	36.00
19	1	7	2	6	6	1	3350	230	38.25
20	1	8	2	8	6	6	3430	310	42.13

REINFORCEMENT

Bars in all Cases of Round Section

Height of wall H in feet	M BARS			N BARS			O BARS			P BARS			L BARS			Pounds per ft. Length of Wall
	Size	Spacing in in.	Length	Size	Spacing in in.	Length	Size	Spacing in in.	Length	Size	Spacing in in.	Length	No.	Size	Spacing in in.	
7	½	24	8' 6"	½	24	3' 9"	¾	12	2' 3"	¾	12	3' 0"	12	½	12	14.4
8	½	24	9' 6"	½	24	4' 3"	¾	12	2' 3"	¾	12	3' 3"	13	½	12	15.7
9	½	17	10' 6"	½	17	4' 9"	¾	12	2' 3"	¾	11½	4' 3"	15	½	12	21.3
10	½	21	11' 9"	½	21	5' 0"	¾	10	2' 6"	½	9½	4' 6"	16	½	12	26.2
11	½	16	12' 9"	½	16	5' 3"	¾	7½	2' 9"	½	8	4' 9"	17	½	12	32.3
12	¾	20	14' 3"	¾	20	6' 3"	½	11	3' 3"	¾	10	5' 6"	20	½	12	41.8
13	¾	16	15' 3"	¾	16	6' 6"	½	10½	3' 3"	¾	12	6' 6"	22	¾	12	63.4
14	¾	13	16' 3"	¾	13	6' 6"	¾	11	4' 0"	¾	10	6' 9"	24	¾	12	75.4
15	¾	16	17' 6"	¾	16	7' 3"	¾	10	4' 0"	¾	11	7' 6"	26	¾	12	88.9
16	¾	13	18' 6"	¾	13	7' 3"	¾	9	4' 3"	¾	9½	7' 9"	27	¾	12	105.2
17	1	15	19' 6"	1	15	8' 0"	¾	8½	4' 3"	¾	8	8' 0"	29	¾	12	122.2
18	1	13	20' 6"	1	13	8' 3"	¾	7½	4' 3"	¾	7½	8' 6"	30	¾	12	139.8
19	1½	14	21' 6"	1½	14	8' 9"	¾	9	5' 0"	1	7½	9' 3"	33	¾	12	174.7
20	1½	13	22' 6"	1½	13	9' 0"	¾	8½	5' 0"	1	7	9' 9"	34	¾	12	192.9

Hooks are required at lower end of M and N bars for walls over 11' 0" in height.

CANTILEVER RETAINING WALLS

SURFACE OF EARTH SURCHARGED
Angle of repose, 33°.

Weight of earth 100 lb. per cu. ft.

$f_s = 16,000$ lb. per sq. in.

$f_c = 650$ lb. per sq. in.

$n = 15$

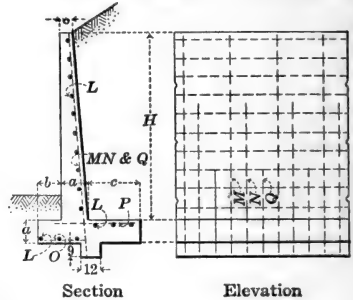

CONCRETE

Height of Wall H ft.	a		b		c		Soil Pressure at Toe lb. per sq. ft.	Soil Pressure at Heel lb. per sq. ft.	Concrete per ft. Length of Wall cu. ft.
	ft.	in.	ft.	in.	ft.	in.			
7	1	0	1	4	2	8	2230	270	11.55
8	1	1½	1	6	3	7½	2370	510	14.79
9	1	3	1	8	4	1	2700	540	18.12
10	1	4½	1	10	4	6½	3020	580	21.61
11	1	6	2	0	4	8	3300	640	24.90
12	1	7½	2	3	5	1½	3730	550	29.12
13	1	9	2	5	5	7	4060	580	33.50
14	1	10½	2	8	5	9½	4340	620	37.90
15	2	0	2	10	6	2	4770	550	42.75
16	2	1½	3	0	6	5½	5170	510	47.70
17	2	3	3	2	6	11	5490	550	53.28
18	2	4½	3	4	7	2½	5930	470	58.85
19	2	6	3	8	7	6	6090	550	65.05
20	2	7½	4	0	7	8½	6330	630	71.30

REINFORCEMENT

Bars in all Cases of Round Section

Height of wall H in feet	M BARS			N BARS			Q BARS			O BARS			P BARS			L BARS			Pounds per Ft. Length of Wall
	Size	Spacing in In.	Length	Size	Spacing in In.	Length	Size	Spacing in In.	Length	Size	Spacing in In.	Length	Size	Spacing in In.	Length	No.	Size	Spacing in In.	
7	½	14	8' 6"	½	14	4' 0"			¾	9½	2' 6"	¾	11	4' 0"	13	½	12	18.9	
8	⅝	17	9' 9"	⅝	17	4' 6"			¾	8	2' 9"	¾	8	4' 9"	14	½	12	24.5	
9	⅝	13	10' 9"	⅝	13	5' 0"			½	12	3' 3"	½	10	5' 9"	17	½	12	33.8	
10	¾	16	12' 6"	¾	16	6' 0"			½	8½	3' 6"	½	8½	6' 3"	19	½	12	43.8	
11	¾	19½	13' 6"	¾	19½	7' 6"	¾	19½	5' 6"	⅝	12	4' 0"	¾	8½	6' 3"	21	½	12	49.5
12	¾	16½	14' 9"	¾	16½	7' 9"	¾	16½	5' 9"	⅝	9	4' 3"	⅝	11	7' 3"	23	½	12	61.9
13	¾	19½	15' 9"	¾	19½	8' 6"	¾	19½	6' 3"	⅝	8	4' 6"	⅝	8	7' 9"	24	⅝	12	85.0
14	¾	16½	17' 0"	¾	16½	9' 0"	¾	16½	6' 6"	⅝	5½	4' 9"	⅝	7½	7' 9"	25	⅝	12	100.3
15	1	18	18' 0"	1	18	9' 6"	1	18	6' 9"	¾	8	5' 3"	¾	9	8' 9"	28	⅝	12	122.4
16	1	16½	19' 3"	1	16½	10' 0"	1	16½	7' 0"	¾	7	5' 6"	¾	8	9' 0"	30	⅝	12	139.2
17	1½	18	20' 3"	1½	18	10' 6"	1½	18	7' 6"	¾	6	5' 9"	¾	7	9' 6"	31	⅝	12	164.0
18	1½	16½	21' 6"	1½	16½	11' 0"	1½	16½	7' 9"	¾	8	6' 3"	¾	8½	10' 0"	34	⅝	12	185.8
19	1½	18	22' 6"	1½	18	11' 9"	1½	18	8' 3"	¾	6½	6' 6"	¾	8	10' 6"	35	⅝	12	215.7
20	1½	16½	23' 9"	1½	16½	12' 3"	1½	16½	8' 6"	¾	6	7' 0"	¾	7½	10' 6"	37	⅝	12	241.0

Hooks are required at lower end of M, N and Q bars for walls over 9' 0" in height.

FOUNDATIONS
BEARING CAPACITY OF SOILS

Soil	SAFE BEARING POWER IN TONS PER SQUARE FOOT	
	Minimum	Maximum
Rock, the hardest, in thick layers in native bed	200	
Rock equal to best ashlar masonry	25	30
Rock equal to best brick masonry	15	20
Rock equal to poor brick masonry	5	10
Clay in thick beds, always dry	6	8
Clay in thick beds, moderately dry	4	6
Clay, soft	1	2
Gravel and coarse sand, well cemented	8	10
Sand, dry, compact and well cemented	4	6
Sand, clean, dry	2	4
Quicksand, alluvial soils, etc.	0.5	1

COEFFICIENTS AND ANGLES OF FRICTION

Materials in Contact	Coefficient	Angle of Friction
Masonry upon masonry	0.65	33° 00'
Masonry upon wood, with grain	0.60	31° 00'
Masonry upon wood, across grain	0.50	26° 40'
Masonry on dry clay	0.50	26° 40'
Masonry on wet clay	0.33	18° 20'
Masonry on sand	0.40	21° 50'
Masonry on gravel	0.60	31° 00'

From "A Treatise on Masonry Construction," by Prof. Ira O. Baker.

AREA OF STEEL REINFORCEMENT PER FOOT WIDTH OF SLAB

Size of Bar	SPACING OF BARS IN INCHES																			
	3	3½	4	4½	5	5½	6	6½	7	7½	8	8½	9	9½	10	10½	11	11½	12	
	Area of Steel in Square Inches																			
¼	round	0.20	0.17	0.15	0.13	0.12	0.11	0.10	0.09	0.08	0.07	0.07	0.07	0.07	0.06	0.06	0.06	0.05	0.05	0.05
	square	0.25	0.21	0.19	0.17	0.15	0.14	0.13	0.12	0.11	0.10	0.09	0.09	0.08	0.08	0.08	0.07	0.07	0.07	0.06
⅜	round	0.44	0.38	0.33	0.29	0.26	0.24	0.22	0.20	0.19	0.18	0.17	0.16	0.15	0.14	0.13	0.13	0.12	0.11	0.11
	square	0.56	0.48	0.42	0.37	0.34	0.31	0.28	0.26	0.24	0.23	0.21	0.20	0.19	0.18	0.17	0.16	0.15	0.15	0.14
½	round	0.78	0.67	0.59	0.52	0.47	0.43	0.39	0.36	0.34	0.31	0.29	0.28	0.26	0.25	0.23	0.22	0.21	0.20	0.20
	square	1.00	0.86	0.75	0.67	0.60	0.55	0.50	0.46	0.43	0.40	0.38	0.35	0.33	0.32	0.30	0.29	0.27	0.26	0.25
⅝	round	1.23	1.05	0.92	0.82	0.74	0.67	0.61	0.57	0.53	0.49	0.46	0.43	0.41	0.39	0.37	0.35	0.33	0.32	0.31
	square	1.56	1.34	1.17	1.04	0.94	0.85	0.78	0.72	0.67	0.63	0.59	0.55	0.52	0.49	0.47	0.45	0.43	0.41	0.39
¾	round	1.77	1.51	1.33	1.18	1.06	0.96	0.88	0.82	0.76	0.71	0.66	0.62	0.59	0.56	0.53	0.51	0.48	0.46	0.44
	square	2.25	1.93	1.69	1.50	1.35	1.23	1.13	1.04	0.97	0.90	0.84	0.80	0.75	0.71	0.68	0.64	0.61	0.59	0.56
7/8	round	2.40	2.06	1.80	1.60	1.44	1.31	1.20	1.11	1.03	0.96	0.90	0.85	0.80	0.76	0.72	0.69	0.66	0.63	0.60
	square	3.06	2.62	2.30	2.04	1.84	1.67	1.53	1.42	1.31	1.23	1.15	1.08	1.02	0.97	0.92	0.88	0.83	0.80	0.77
1	round	3.14	2.69	2.36	2.09	1.88	1.71	1.57	1.45	1.35	1.26	1.18	1.11	1.05	0.99	0.94	0.90	0.86	0.82	0.79
	square	4.00	3.43	3.00	2.67	2.40	2.18	2.00	1.85	1.72	1.60	1.50	1.41	1.33	1.26	1.20	1.14	1.09	1.08	1.00
1 1/8	round	3.98	3.41	2.98	2.65	2.38	2.17	1.99	1.83	1.70	1.59	1.49	1.40	1.33	1.26	1.20	1.14	1.09	1.08	0.99
	square	5.06	4.34	3.80	3.37	3.04	2.76	2.53	2.34	2.17	2.02	1.90	1.79	1.69	1.60	1.52	1.45	1.38	1.32	1.27
1 1/4	round	4.91	4.20	3.68	3.27	2.95	2.68	2.45	2.27	2.10	1.96	1.84	1.73	1.64	1.55	1.47	1.40	1.34	1.28	1.23
	square	6.25	5.36	4.69	4.17	3.75	3.41	3.13	2.89	2.68	2.50	2.34	2.21	2.08	1.97	1.88	1.79	1.70	1.63	1.56

**VERTICAL STEEL REQUIRED FOR GIVEN PERCENTAGES
OF ROUND COLUMN CORE AREAS**

Core Dia.	Core Area	PERCENT OF CORE AREA												
		0.5	0.55	1.0	1.5	2.0	2.5	3.0	3.5	4.0	5.0	6.0	7.0	8.0
in.	sq. in.	Area of Vertical Steel in Square Inches												
12	113	0.57	0.85	1.13	1.70	2.26	2.83	3.39	3.96	4.52	5.65	6.79	7.92	9.05
13	133	0.66	1.00	1.33	1.99	2.65	3.32	3.98	4.65	5.31	6.64	7.96	9.29	10.62
14	154	0.77	1.15	1.54	2.31	3.08	3.85	4.62	5.39	6.16	7.70	9.24	10.78	12.32
15	177	0.88	1.33	1.77	2.65	3.53	4.42	5.30	6.19	7.07	8.84	10.60	12.37	14.14
16	201	1.01	1.51	2.01	3.02	4.02	5.03	6.03	7.04	8.04	10.05	12.06	14.07	16.08
17	227	1.13	1.70	2.27	3.40	4.54	5.67	6.81	7.94	9.08	11.35	13.62	15.89	18.16
18	254	1.27	1.91	2.54	3.82	5.09	6.36	7.63	8.91	10.18	12.72	15.27	17.81	20.36
19	284	1.42	2.13	2.84	4.25	5.67	7.09	8.51	9.92	11.34	14.18	17.01	19.85	22.68
20	314	1.57	2.36	3.14	4.71	6.28	7.85	9.42	11.00	12.57	15.71	18.85	21.99	25.13
21	346	1.73	2.60	3.46	5.20	6.93	8.66	10.39	12.12	13.85	17.32	20.78	24.25	27.71
22	380	1.90	2.85	3.80	5.70	7.60	9.50	11.40	13.30	15.21	19.01	22.81	26.61	30.41
23	415	2.08	3.12	4.15	6.23	8.31	10.39	12.46	14.54	16.62	20.77	24.93	29.08	33.24
24	452	2.26	3.39	4.52	6.79	9.05	11.31	13.57	15.83	18.10	22.62	27.14	31.67	36.19
25	491	2.45	3.68	4.91	7.36	9.82	12.27	14.73	17.18	19.63	24.54	29.45	34.36	39.27
26	531	2.65	3.98	5.31	7.96	10.62	13.27	15.93	18.58	21.24	26.55	31.86	37.17	42.47
27	573	2.86	4.29	5.73	8.59	11.45	14.31	17.18	20.04	22.90	28.63	34.35	40.08	45.80
28	616	3.08	4.62	6.16	9.24	12.32	15.39	18.47	21.55	24.63	30.79	36.95	43.10	49.26
29	661	3.30	4.95	6.61	9.91	13.21	16.51	19.82	23.12	26.42	33.03	39.63	46.24	52.84
30	707	3.53	5.30	7.07	10.60	14.14	17.67	21.21	24.74	28.27	35.34	42.41	49.48	56.55
31	755	3.77	5.66	7.55	11.32	15.10	18.87	22.64	26.42	30.19	37.74	45.29	52.83	60.38
32	804	4.02	6.03	8.04	12.06	16.08	20.11	24.13	28.15	32.17	40.21	48.25	56.30	64.34
33	855	4.28	6.41	8.55	12.83	17.11	21.38	25.66	29.94	34.21	42.76	51.32	59.87	68.42
34	908	4.54	6.81	9.08	13.62	18.16	22.70	27.24	31.78	36.32	45.40	54.48	63.55	72.63
35	962	4.81	7.22	9.62	14.43	19.24	24.05	28.86	33.67	38.48	48.11	57.73	67.35	76.97
36	1018	5.09	7.63	10.18	15.27	20.36	25.45	30.54	35.63	40.72	50.89	61.07	71.25	81.43

COLUMN SPIRALS
PITCH OF SPIRAL FOR GIVEN PERCENTAGE AND VARIOUS WIRE GAUGES
BASED ON AMERICAN STEEL AND WIRE CO., STANDARD GAUGES

GAUGE OF WIRE AND PRACTICAL EQUIVALENT ROD SIZE

Diameter Core	No. 6		No. 3		No. 0		5"		3"		No. 5		7"		1"	
	3"	16"	No. 3	4"	No. 0	5"	16"	8"	8"	No. 5	5"	No. 0	16"	No. 7	0	2"
	1/4%	3/4%	1/2%	1%	1 1/2%	1 3/4%	1 1/2%	1 3/4%	1 1/2%	1 3/4%	1 1/2%	1 3/4%	1 1/2%	1 3/4%	1 1/2%	1 3/4%
12	1 1/2"	1 1/4"	3"	2 1/4"	1 1/2"	1 1/4"	1 1/4"	2"	2 1/4"	1 1/2"	1 1/4"	1 1/4"	2 3/8"	2 1/4"	1 1/2"	2 7/8"
13	1 3/4"	1 1/2"	2 7/8"	2 1/4"	1 3/4"	1 1/4"	1 3/4"	1 5/8"	2 1/8"	2 1/4"	1 1/2"	1 1/4"	2 1/4"	2 1/4"	1 3/4"	2 9/8"
14	1 5/8"	1 3/4"	2 5/8"	2 1/4"	1 5/8"	1 1/2"	1 5/8"	1 5/8"	2 1/4"	2 1/4"	1 3/4"	1 1/4"	2 1/4"	2 1/4"	1 5/8"	2 1 1/8"
15	1 7/8"	1 5/8"	2 3/8"	2 1/4"	1 7/8"	1 1/2"	1 7/8"	1 7/8"	2 1/4"	2 1/4"	1 5/8"	1 1/2"	2 1/4"	2 1/4"	1 7/8"	2 1 1/4"
16	1 9/8"	1 7/8"	2 1/2"	2 1/4"	1 7/8"	1 1/2"	1 7/8"	1 7/8"	2 1/4"	2 1/4"	1 5/8"	1 1/2"	2 1/4"	2 1/4"	1 7/8"	2 1 1/2"
17	1 5/4"	1 5/4"	2 1/8"	2 1/4"	1 5/4"	1 1/2"	1 5/4"	1 5/4"	2 1/4"	2 1/4"	1 5/4"	1 1/2"	2 1/4"	2 1/4"	1 5/4"	2 1 3/4"
18	1 3/2"	1 3/2"	2"	2 1/4"	1 3/2"	1 1/2"	1 3/2"	1 3/2"	2 1/4"	2 1/4"	1 3/2"	1 1/2"	2 1/4"	2 1/4"	1 3/2"	2 2"
19	1 1/4"	1 1/4"	1 7/8"	2 1/4"	1 1/2"	1 1/2"	1 1/2"	1 1/2"	2 1/4"	2 1/4"	1 1/2"	1 1/2"	2 1/4"	2 1/4"	1 1/2"	2 2 1/8"
20	1 1/2"	1 1/2"	1 7/8"	2 1/4"	1 1/2"	1 1/2"	1 1/2"	1 1/2"	2 1/4"	2 1/4"	1 1/2"	1 1/2"	2 1/4"	2 1/4"	1 1/2"	2 2 1/4"
21	1 3/4"	1 3/4"	1 3/4"	2 1/4"	1 3/4"	1 1/2"	1 3/4"	1 3/4"	2 1/4"	2 1/4"	1 3/4"	1 1/2"	2 1/4"	2 1/4"	1 3/4"	2 2 1/2"
22	1 5/8"	1 5/8"	1 5/8"	2 1/4"	1 5/8"	1 1/2"	1 5/8"	1 5/8"	2 1/4"	2 1/4"	1 5/8"	1 1/2"	2 1/4"	2 1/4"	1 5/8"	2 2 3/8"
23	1 7/8"	1 7/8"	1 7/8"	2 1/4"	1 7/8"	1 1/2"	1 7/8"	1 7/8"	2 1/4"	2 1/4"	1 7/8"	1 1/2"	2 1/4"	2 1/4"	1 7/8"	2 2 1/2"
24	1 9/8"	1 9/8"	1 9/8"	2 1/4"	1 9/8"	1 1/2"	1 9/8"	1 9/8"	2 1/4"	2 1/4"	1 9/8"	1 1/2"	2 1/4"	2 1/4"	1 9/8"	2 2 3/4"
25	1 5/4"	1 5/4"	1 5/4"	2 1/4"	1 5/4"	1 1/2"	1 5/4"	1 5/4"	2 1/4"	2 1/4"	1 5/4"	1 1/2"	2 1/4"	2 1/4"	1 5/4"	2 3"
26	1 3/2"	1 3/2"	1 3/2"	2 1/4"	1 3/2"	1 1/2"	1 3/2"	1 3/2"	2 1/4"	2 1/4"	1 3/2"	1 1/2"	2 1/4"	2 1/4"	1 3/2"	2 3 1/8"
27	1 1/4"	1 1/4"	1 1/4"	2 1/4"	1 1/4"	1 1/2"	1 1/4"	1 1/4"	2 1/4"	2 1/4"	1 1/4"	1 1/2"	2 1/4"	2 1/4"	1 1/4"	2 3 1/4"
28	1 1/2"	1 1/2"	1 1/2"	2 1/4"	1 1/2"	1 1/2"	1 1/2"	1 1/2"	2 1/4"	2 1/4"	1 1/2"	1 1/2"	2 1/4"	2 1/4"	1 1/2"	2 3 1/2"
29	1 3/4"	1 3/4"	1 3/4"	2 1/4"	1 3/4"	1 1/2"	1 3/4"	1 3/4"	2 1/4"	2 1/4"	1 3/4"	1 1/2"	2 1/4"	2 1/4"	1 3/4"	2 3 3/8"
30	1 5/8"	1 5/8"	1 5/8"	2 1/4"	1 5/8"	1 1/2"	1 5/8"	1 5/8"	2 1/4"	2 1/4"	1 5/8"	1 1/2"	2 1/4"	2 1/4"	1 5/8"	2 3 1/2"
31	1 7/8"	1 7/8"	1 7/8"	2 1/4"	1 7/8"	1 1/2"	1 7/8"	1 7/8"	2 1/4"	2 1/4"	1 7/8"	1 1/2"	2 1/4"	2 1/4"	1 7/8"	2 3 3/4"
32	1 9/8"	1 9/8"	1 9/8"	2 1/4"	1 9/8"	1 1/2"	1 9/8"	1 9/8"	2 1/4"	2 1/4"	1 9/8"	1 1/2"	2 1/4"	2 1/4"	1 9/8"	2 4"
33	1 5/4"	1 5/4"	1 5/4"	2 1/4"	1 5/4"	1 1/2"	1 5/4"	1 5/4"	2 1/4"	2 1/4"	1 5/4"	1 1/2"	2 1/4"	2 1/4"	1 5/4"	2 4 1/8"
34	1 3/2"	1 3/2"	1 3/2"	2 1/4"	1 3/2"	1 1/2"	1 3/2"	1 3/2"	2 1/4"	2 1/4"	1 3/2"	1 1/2"	2 1/4"	2 1/4"	1 3/2"	2 4 1/4"
35	1 1/4"	1 1/4"	1 1/4"	2 1/4"	1 1/4"	1 1/2"	1 1/4"	1 1/4"	2 1/4"	2 1/4"	1 1/4"	1 1/2"	2 1/4"	2 1/4"	1 1/4"	2 4 1/2"
36	1 1/2"	1 1/2"	1 1/2"	2 1/4"	1 1/2"	1 1/2"	1 1/2"	1 1/2"	2 1/4"	2 1/4"	1 1/2"	1 1/2"	2 1/4"	2 1/4"	1 1/2"	2 4 3/8"
37	1 3/4"	1 3/4"	1 3/4"	2 1/4"	1 3/4"	1 1/2"	1 3/4"	1 3/4"	2 1/4"	2 1/4"	1 3/4"	1 1/2"	2 1/4"	2 1/4"	1 3/4"	2 4 1/2"
38	1 5/8"	1 5/8"	1 5/8"	2 1/4"	1 5/8"	1 1/2"	1 5/8"	1 5/8"	2 1/4"	2 1/4"	1 5/8"	1 1/2"	2 1/4"	2 1/4"	1 5/8"	2 4 3/4"
39	1 7/8"	1 7/8"	1 7/8"	2 1/4"	1 7/8"	1 1/2"	1 7/8"	1 7/8"	2 1/4"	2 1/4"	1 7/8"	1 1/2"	2 1/4"	2 1/4"	1 7/8"	2 5"

Percentage of Spiral Reinforcement

COLUMN SPIRALS

WEIGHT IN POUNDS PER FOOT OF HEIGHT
(Weights do not include Spacers)

No. 3 WIRE—EQUIVALENT $\frac{1}{4}$ " ROUND BAR

Based on American Steel and Wire Co.'s Standard Gauge

Diameter of Spiral	PITCH OF SPIRAL IN INCHES									*Factor to Add for Finishing Spiral
	in.	1½	1¾	2	2¼	2½	2¾	3	3½	
12	4.10	3.51	3.08	2.74	2.47	2.24	2.06	1.77	1.55	1.30
13	4.43	3.80	3.32	2.96	2.66	2.42	2.22	1.91	1.68	1.40
14	4.76	4.08	3.57	3.18	2.86	2.60	2.39	2.05	1.80	1.50
15	5.09	4.36	3.82	3.39	3.06	2.78	2.55	2.19	1.92	1.55
16	5.42	4.65	4.07	3.61	3.26	2.96	2.72	2.33	2.05	1.60
17	5.75	4.93	4.31	3.83	3.46	3.14	2.88	2.47	2.17	1.70
18	6.08	5.21	4.56	4.05	3.65	3.32	3.05	2.61	2.29	1.80
19	6.41	5.49	4.81	4.27	3.85	3.50	3.21	2.75	2.41	1.90
20	6.74	5.78	5.06	4.49	4.05	3.68	3.38	2.90	2.54	2.00
21	7.07	6.06	5.31	4.71	4.25	3.86	3.54	3.04	2.66	2.05
22	7.40	6.34	5.55	4.92	4.45	4.04	3.71	3.18	2.78	2.10
23	7.73	6.63	5.80	5.16	4.64	4.22	3.87	3.32	2.91	2.20
24	8.06	6.91	6.05	5.38	4.84	4.40	4.04	3.46	3.03	2.30
25	8.39	7.19	6.30	5.60	5.04	4.58	4.20	3.60	3.15	2.40
26	8.72	7.47	6.54	5.82	5.24	4.76	4.37	3.74	3.28	2.50
27	9.05	7.76	6.79	6.04	5.43	4.94	4.53	3.88	3.40	2.55
28	9.38	8.04	7.04	6.26	5.63	5.12	4.70	4.02	3.52	2.60
29	9.71	8.33	7.29	6.48	5.83	5.30	4.86	4.17	3.65	2.70
30	10.04	8.61	7.53	6.70	6.03	5.48	5.03	4.31	3.77	2.80
31	10.37	8.89	7.78	6.92	6.23	5.66	5.19	4.45	3.89	2.90
32	10.70	9.17	8.03	7.14	6.42	5.84	5.36	4.59	4.02	3.00
33	11.03	9.46	8.28	7.36	6.62	6.02	5.52	4.73	4.14	3.05
34	11.36	9.74	8.52	7.58	6.82	6.20	5.68	4.87	4.26	3.10
35	11.69	10.02	8.77	7.80	7.02	6.38	5.85	5.01	4.39	3.20
36	12.02	10.31	9.02	8.02	7.22	6.56	6.01	5.15	4.51	3.30
37	12.35	10.59	9.27	8.24	7.42	6.74	6.18	5.30	4.64	3.40
38	12.68	10.87	9.52	8.46	7.61	6.92	6.35	5.44	4.76	3.50

* Weight of one extra turn at top and bottom of spiral.

COLUMN SPIRALS

WEIGHT IN POUNDS PER FOOT OF HEIGHT
(Weights do not include Spacers)

No. 0 WIRE—EQUIVALENT $\frac{5''}{16}$ ROUND BAR

Based on American Steel and Wire Co.'s Standard Gauge

Diameter of Spiral	PITCH OF SPIRAL IN INCHES									*Factor to Add for Finishing Spiral
	in.	1½	1¾	2	2¼	2½	2¾	3	3½	
12	6.48	5.56	4.87	4.33	3.90	3.55	3.26	2.80	2.46	2.05
13	7.00	6.01	5.26	4.68	4.22	3.83	3.52	3.02	2.65	2.20
14	7.53	6.46	5.65	5.03	4.53	4.12	3.78	3.25	2.85	2.40
15	8.05	6.90	6.04	5.36	4.84	4.40	4.04	3.47	3.04	2.45
16	8.57	7.35	6.44	5.72	5.15	4.69	4.30	3.69	3.24	2.50
17	9.10	7.80	6.83	6.07	5.47	4.97	4.56	3.92	3.43	2.70
18	9.62	8.25	7.22	6.44	5.78	5.26	4.82	4.14	3.63	2.85
19	10.14	8.70	7.61	6.77	6.09	5.54	5.08	4.36	3.82	3.00
20	10.66	9.14	8.00	7.10	6.41	5.83	5.34	4.59	4.02	3.15
21	11.19	9.59	8.39	7.46	6.72	6.11	5.60	4.81	4.21	3.25
22	11.71	10.04	8.78	7.78	7.03	6.40	5.86	5.03	4.41	3.30
23	12.23	10.49	9.18	8.16	7.35	6.68	6.13	5.26	4.60	3.50
24	12.75	10.93	9.57	8.51	7.66	6.97	6.39	5.48	4.80	3.65
25	13.28	11.38	9.96	8.88	7.97	7.25	6.65	5.70	4.99	3.80
26	13.80	11.83	10.35	9.20	8.29	7.53	6.91	5.93	5.19	3.95
27	14.32	12.28	10.74	9.55	8.60	7.82	7.17	6.15	5.39	4.05
28	14.84	12.73	11.13	9.90	8.91	8.10	7.43	6.37	5.58	4.10
29	15.37	13.17	11.53	10.25	9.22	8.39	7.69	6.60	5.78	4.30
30	15.89	13.62	11.92	10.60	9.54	8.67	7.95	6.82	5.97	4.40
31	16.41	14.07	12.31	10.95	9.85	8.96	8.21	7.04	6.15	4.60
32	16.94	14.52	12.70	11.29	10.16	9.24	8.47	7.27	6.36	4.75
33	17.46	14.97	13.09	11.64	10.48	9.53	8.73	7.49	6.56	4.80
34	17.98	15.41	13.48	11.99	10.79	9.81	8.99	7.71	6.75	4.90
35	18.50	15.86	13.88	12.34	11.10	10.10	9.26	7.94	6.95	5.05
36	19.02	16.31	14.27	12.69	11.42	10.38	9.52	8.16	7.14	5.20
37	19.54	16.75	14.67	13.04	11.74	10.66	9.78	8.38	7.34	5.40
38	20.06	17.20	15.06	13.38	12.04	10.95	10.04	8.61	7.53	5.55

* Weight of one extra turn at top and bottom of spiral.

COLUMN SPIRALS

WEIGHT IN POUNDS PER FOOT OF HEIGHT
(Weights do not Include Spacers)

No. $\frac{3}{0}$ WIRE—EQUIVALENT $\frac{3}{8}$ " ROUND BAR

Based on American Steel and Wire Co.'s Standard Gauge

Diameter of Spiral	PITCH OF SPIRAL IN INCHES									*Factor to Add for Finishing Spiral
	in.	1½	1¾	2	2¼	2½	2¾	3	3½	
12	9.02	7.73	6.77	6.02	5.43	4.94	4.53	3.89	3.42	2.85
13	9.74	8.36	7.32	6.51	5.85	5.33	4.89	4.21	3.69	3.05
14	10.47	8.98	7.86	6.97	6.30	5.73	5.26	4.52	3.96	3.30
15	11.20	9.60	8.41	7.46	6.73	6.13	5.62	4.83	4.23	3.40
16	11.92	10.22	8.95	7.94	7.17	6.52	5.98	5.14	4.50	3.50
17	12.65	10.85	9.49	8.43	7.60	6.92	6.35	5.45	4.77	3.75
18	13.38	11.47	10.04	8.91	8.04	7.31	6.71	5.74	5.05	3.95
19	14.11	12.09	10.59	9.40	8.48	7.71	7.07	6.05	5.32	4.20
20	14.83	12.72	11.13	9.88	8.91	8.10	7.43	6.38	5.59	4.40
21	15.56	13.34	11.68	10.37	9.35	8.50	7.80	6.69	5.86	4.50
22	16.29	13.96	12.22	10.83	9.78	8.90	8.16	6.99	6.13	4.60
23	17.01	14.59	12.77	11.36	10.22	9.29	8.52	7.31	6.40	4.85
24	17.74	15.21	13.31	11.83	10.65	9.69	8.88	7.62	6.67	5.10
25	18.47	15.83	13.86	12.32	11.09	10.09	9.25	7.93	6.93	5.30
26	19.19	16.45	14.40	12.80	11.53	10.48	9.61	8.24	7.22	5.50
27	19.92	17.08	14.95	13.29	11.96	10.88	9.95	8.55	7.49	5.60
28	20.65	17.70	15.49	13.77	12.40	11.27	10.34	8.86	7.76	5.70
29	21.37	18.32	16.04	14.26	12.83	11.67	10.70	9.17	8.03	6.00
30	22.10	18.95	16.58	14.74	13.27	12.06	11.08	9.48	8.30	6.10
31	22.83	19.57	17.12	15.22	13.70	12.46	11.42	9.79	8.57	6.40
32	23.55	20.19	17.67	15.71	14.14	12.86	11.79	10.11	8.85	6.60
33	24.28	20.82	18.21	16.19	14.57	13.25	12.15	10.42	9.12	6.70
34	25.01	21.44	18.76	16.68	15.01	13.65	12.51	10.73	9.37	6.80
35	25.74	22.06	19.30	17.17	15.45	14.04	12.89	11.04	9.66	7.00
36	26.45	22.68	19.85	17.65	15.88	14.44	13.24	11.35	9.93	7.20
37	27.18	23.31	20.40	18.13	16.33	14.83	13.59	11.66	10.21	7.50
38	27.91	23.92	20.95	18.62	16.75	15.23	13.99	11.96	10.47	7.70

* Weight of one extra turn at top and bottom of spiral.

COLUMN SPIRALS

WEIGHT IN POUNDS PER FOOT OF HEIGHT
(Weights do not Include Spacers)

NO. $\frac{5}{0}$ WIRE—EQUIVALENT $\frac{7}{16}$ ROUND BAR

Based on American Steel and Wire Co.'s Standard Gauge

Diameter of Spiral	PITCH OF SPIRAL IN INCHES									*Factor to Add for Finishing Spiral
	in.	1½	1¾	2	2¼	2½	2¾	3	3½	
12	12.72	10.91	9.56	8.50	7.66	6.97	6.40	5.49	4.82	4.00
13	13.75	11.79	10.33	9.18	8.27	7.53	6.91	5.93	5.21	4.30
14	14.78	12.67	11.09	9.87	8.89	8.09	7.42	6.37	5.59	4.70
15	15.80	13.55	11.86	10.55	9.50	8.65	7.93	6.81	5.97	4.80
16	16.83	14.43	12.63	11.23	10.12	9.20	8.44	7.24	6.36	4.90
17	17.85	15.31	13.40	11.92	10.73	9.76	8.95	7.67	6.74	5.30
18	18.88	16.19	14.17	12.60	11.35	10.32	9.46	8.11	7.12	5.60
19	19.91	17.07	14.94	13.28	11.96	10.88	9.98	8.54	7.50	5.90
20	20.93	17.95	15.71	13.97	12.58	11.44	10.49	9.00	7.89	6.20
21	21.96	18.82	16.48	14.65	13.19	12.00	11.00	9.44	8.27	6.40
22	22.98	19.70	17.25	15.33	13.81	12.56	11.51	9.88	8.63	6.50
23	24.01	20.58	18.01	16.02	14.42	13.11	12.02	10.32	9.04	6.90
24	25.03	21.46	18.78	16.70	15.04	13.67	12.54	10.75	9.42	7.20
25	26.06	22.34	19.55	17.38	15.65	14.23	13.05	11.18	9.78	7.50
26	27.09	23.22	20.32	18.07	16.26	14.79	13.56	11.62	10.19	7.75
27	28.11	24.10	21.09	18.75	16.88	15.35	14.07	12.05	10.57	7.95
28	29.14	24.98	21.86	19.43	17.49	15.91	14.60	12.49	10.93	8.05
29	30.16	25.86	22.63	20.12	18.11	16.47	15.09	12.95	11.34	8.45
30	31.19	26.74	23.40	20.80	18.72	17.02	15.61	13.39	11.70	8.65
31	32.21	27.61	24.17	21.48	19.34	17.58	16.12	13.82	12.08	9.05
32	33.24	28.49	24.93	22.17	19.95	18.13	16.65	14.26	12.48	9.30
33	34.22	29.37	25.70	22.85	20.57	18.70	17.14	14.70	12.87	9.40
34	35.26	30.25	26.47	23.53	21.18	19.26	17.65	15.14	13.23	9.60
35	36.30	31.13	27.24	24.22	21.80	19.82	18.17	15.56	13.63	9.90
36	37.30	32.01	28.01	24.90	22.41	20.38	18.68	16.00	14.00	10.20
37	38.32	32.90	28.80	25.60	23.05	20.93	19.20	16.46	14.41	10.60
38	39.35	33.77	29.58	26.29	23.62	21.49	19.72	16.90	14.78	10.90

* Weight of one extra turn at top and bottom of spiral.

COLUMN SPIRALS

WEIGHT IN POUNDS PER FOOT OF HEIGHT
(Weights do not Include Spacers)

No. $\frac{7}{0}$ WIRE—EQUIVALENT $\frac{1}{2}$ " ROUND BAR

Based on American Steel and Wire Co.'s Standard Gauge

Diameter of Spiral	PITCH OF SPIRAL IN INCHES									*Factor to Add for Finishing Spiral
	in.	1½	1¾	2	2¼	2½	2¾	3	3½	
12	16.52	14.15	12.41	11.04	9.96	9.03	8.30	7.14	6.26	5.20
13	17.85	15.31	13.39	11.92	10.74	9.77	8.96	7.70	6.76	5.60
14	19.18	16.45	14.40	12.81	11.54	10.48	9.63	8.27	7.26	6.10
15	20.52	17.59	15.40	13.67	12.34	11.22	10.28	8.84	7.75	6.25
16	21.85	18.75	16.40	14.56	13.14	11.93	10.96	9.39	8.27	6.40
17	23.18	19.88	17.38	15.44	13.95	12.67	11.61	9.96	8.75	6.90
18	24.52	21.01	18.40	16.33	14.73	13.40	12.29	10.52	9.23	7.25
19	25.84	22.14	19.40	17.22	15.53	14.11	12.94	11.09	9.72	7.65
20	27.17	23.30	20.40	18.10	16.33	14.85	13.62	11.69	10.24	8.00
21	28.51	24.44	21.41	18.99	17.13	15.56	14.28	12.26	10.74	8.30
22	29.84	25.56	22.38	19.84	17.94	16.30	14.95	12.83	11.21	8.40
23	31.17	26.73	23.39	20.79	18.72	17.03	15.61	13.39	11.73	8.90
24	32.50	27.86	24.39	21.68	19.52	17.75	16.28	13.96	12.23	9.30
25	33.83	29.00	25.40	22.57	20.32	18.48	16.94	14.53	12.70	9.70
26	35.16	30.12	26.37	23.46	21.12	19.20	17.61	15.08	13.22	10.00
27	36.50	31.29	27.38	24.34	21.89	19.93	18.27	15.64	13.72	10.30
28	37.83	32.43	28.38	25.23	22.71	20.65	18.94	16.21	14.19	10.40
29	39.16	33.59	29.38	26.12	23.51	21.38	19.60	16.81	14.72	11.00
30	40.49	34.71	30.36	27.00	24.31	22.10	20.28	17.38	15.21	11.20
31	41.82	35.85	31.37	27.89	25.11	22.83	20.93	17.95	15.68	11.70
32	43.14	36.97	32.38	28.78	25.90	23.55	21.61	18.52	16.21	12.10
33	44.47	38.14	33.38	29.67	26.70	24.28	22.26	19.08	16.70	12.20
34	45.80	39.28	34.35	30.55	27.50	25.00	22.90	19.65	17.18	12.50
35	47.13	40.40	35.36	31.44	28.30	25.73	23.59	20.20	17.70	12.90
36	48.46	41.57	36.37	32.33	29.10	26.46	24.23	20.76	18.18	13.30
37	49.80	42.70	37.38	33.22	29.92	27.18	24.92	21.37	18.71	13.80
38	51.13	43.83	38.38	34.11	30.68	27.90	25.60	21.93	19.19	14.20

* Weight of one extra turn at top and bottom of spiral.

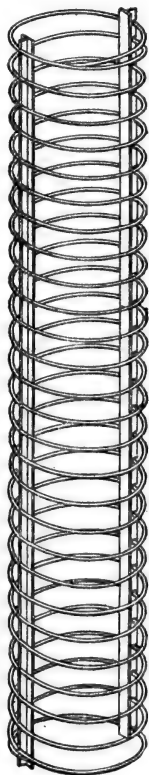

COLUMN SPIRALS

STANDARD WIRE AND SPACERS

STANDARD WIRE

Gauge	Practical Equiv.	Diameter	Area	Wt. per lin. ft.
No.	Rod	in.	sq. in.	lb.
3	$\frac{1}{4}$ " ϕ	0.2437	0.0467	0.1578
0	$\frac{5}{16}$ " ϕ	0.3065	0.0740	0.2497
$\frac{3}{8}$	$\frac{3}{8}$ " ϕ	0.3625	0.1029	0.3473
$\frac{5}{8}$	$\frac{7}{16}$ " ϕ	0.4305	0.1453	0.4901
$\frac{7}{8}$	$\frac{1}{2}$ " ϕ	0.4900	0.1886	0.6363

American Steel & Wire Co. Gauges.

STANDARD SPACERS

SPIRAL		WIRE		T-SECTION SPACERS	
Diam. in.	Height ft.	Gauge	Practical Equiv.	Size	Wt. per ft. for two Spacers
9 to 15	1 to 15	3	$\frac{1}{4}$ " ϕ	1 x 1 x $\frac{1}{8}$	1.60
16 to 30	1 to 20	3	$\frac{1}{4}$ " ϕ	$1\frac{1}{4}$ x $1\frac{1}{4}$ x $\frac{1}{8}$	2.00
9 to 15	1 to 15	0	$\frac{5}{16}$ " ϕ	$1\frac{1}{4}$ x $1\frac{1}{4}$ x $\frac{1}{8}$	2.00
16 to 30	1 to 20	0	$\frac{5}{16}$ " ϕ	$1\frac{1}{4}$ x $1\frac{1}{4}$ x $\frac{3}{16}$	2.96
9 to 15	1 to 15	$\frac{3}{8}$	$\frac{3}{8}$ " ϕ	$1\frac{1}{4}$ x $1\frac{1}{4}$ x $\frac{1}{8}$	2.00
16 to 30	1 to 20	$\frac{3}{8}$	$\frac{3}{8}$ " ϕ	$1\frac{1}{4}$ x $1\frac{1}{4}$ x $\frac{3}{16}$	2.96
9 to 30	1 to 20	$\frac{5}{8}$	$\frac{7}{16}$ " ϕ	$1\frac{1}{2}$ x $1\frac{1}{2}$ x $\frac{3}{16}$	3.60
9 to 30	1 to 20	$\frac{7}{8}$	$\frac{1}{2}$ " ϕ	$1\frac{1}{2}$ x $1\frac{1}{2}$ x $\frac{3}{16}$	3.60

NOTE.—For spirals over 30 inches in diameter use twice the number of spacers specified for spirals under 30 inches in diameter.

COLUMNS

AREAS, PERIMETERS, WEIGHTS, VOLUMES AND MOMENTS OF INERTIA

NOTE—Moments of Inertia calculated about Axis A-A

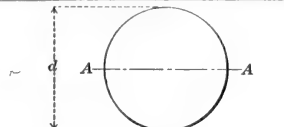
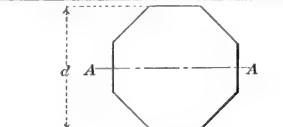
d										
	Area	Perimeter	Weight per ft.	Volume per ft.	Moment of Inertia	Area	Perimeter	Weight per ft.	Volume per ft.	Moment of Inertia
in.	sq. in.	in.	lb.	cu. ft.	in. ⁴	sq. in.	in.	lb.	cu. ft.	in. ⁴
12	113.1	37.70	117.8	0.78	1018	119.3	39.76	124.3	0.83	1136
13	132.7	40.84	138.2	0.92	1402	140.0	43.08	145.8	0.97	1565
14	153.9	43.98	160.3	1.07	1886	162.4	46.39	169.2	1.12	2105
15	176.7	47.12	184.1	1.22	2485	186.4	49.70	194.2	1.29	2775
16	201.1	50.27	209.5	1.40	3217	212.1	53.02	220.9	1.47	3591
17	227.0	53.41	236.5	1.57	4100	239.4	56.33	249.4	1.66	4577
18	254.5	56.55	265.1	1.77	5153	268.4	59.65	279.6	1.86	5753
19	283.5	59.69	295.3	1.97	6397	299.1	62.99	311.6	2.08	7142
20	314.2	62.83	327.3	2.18	7854	331.4	66.27	345.2	2.30	8768
21	346.4	65.97	360.8	2.40	9547	365.3	69.59	380.5	2.53	10658
22	380.1	69.12	395.9	2.64	11499	401.0	72.90	417.7	2.78	12837
23	415.5	72.26	432.8	2.88	13737	438.2	76.21	456.5	3.04	15335
24	452.4	75.40	471.2	3.14	16286	477.2	79.53	497.1	3.31	18181
25	490.9	78.54	511.4	3.41	19175	517.8	82.84	539.4	3.59	21406
26	530.9	81.68	553.0	3.69	22432	560.0	86.16	583.3	3.89	25042
27	572.6	84.82	596.5	3.97	26087	603.9	89.47	629.1	4.19	29123
28	615.8	87.96	641.5	4.27	30172	649.5	92.78	676.6	4.51	33683
29	660.5	91.11	688.0	4.59	34719	696.7	96.10	725.7	4.84	38759
30	706.9	94.25	736.3	4.91	39761	745.6	99.41	776.7	5.17	44388
31	754.8	97.39	786.2	5.24	45333	796.1	102.72	829.3	5.52	50609
32	804.2	100.53	837.7	5.58	51472	848.3	106.04	883.6	5.89	57462
33	855.3	103.67	890.9	5.94	58214	902.2	109.35	939.8	6.26	64988
34	907.9	106.81	945.7	6.30	65597	957.7	112.66	997.6	6.64	73231
35	962.1	109.96	1002.2	6.68	73662	1014.8	115.98	1057.1	7.04	82234
36	1017.9	113.10	1060.3	7.06	82448	1073.6	119.29	1118.3	7.45	92043
37	1075.2	116.24	1120.0	7.47	91998	1134.1	122.61	1181.3	7.87	102704
38	1134.1	119.38	1181.3	7.87	102354	1196.3	125.92	1246.1	8.30	114265
39	1194.6	122.52	1244.4	8.29	113561	1260.0	129.23	1312.5	8.74	126777
40	1256.6	125.66	1308.9	8.72	125664	1325.5	132.55	1380.7	9.20	140288

COLUMNS

AREAS, PERIMETERS, WEIGHTS, VOLUMES AND MOMENTS OF INERTIA.

NOTE.—Moments of Inertia calculated about Axis A-A

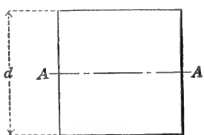
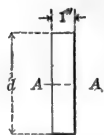
d									
	Area	Perimeter	Weight per ft.	Volume per ft.	Moment of Inertia	Area	Weight per ft.	Volume per ft.	Moment of Inertia
in.	sq. in.	in.	lb.	cu. ft.	in. ⁴	sq. in.	lb.	cu. ft.	in. ⁴
12	144	48	150.0	1.00	1728	12.0	12.5	0.083	144
13	169	52	176.0	1.17	2380	13.0	13.5	0.090	183
14	196	56	204.2	1.36	3201	14.0	14.6	0.097	229
15	225	60	234.4	1.56	4219	15.0	15.6	0.104	281
16	256	64	266.7	1.78	5461	16.0	16.7	0.111	341
17	289	68	301.0	2.01	6960	17.0	17.7	0.118	409
18	324	72	337.5	2.25	8748	18.0	18.8	0.125	486
19	361	76	376.0	2.51	10860	19.0	19.8	0.132	572
20	400	80	416.7	2.78	13333	20.0	20.8	0.139	667
21	441	84	459.4	3.06	16207	21.0	21.9	0.146	772
22	484	88	504.2	3.36	19521	22.0	22.9	0.153	887
23	529	92	551.0	3.67	23320	23.0	24.0	0.160	1014
24	576	96	600.0	4.00	27648	24.0	25.0	0.167	1152
25	625	100	651.0	4.34	32552	25.0	26.1	0.173	1302
26	676	104	704.2	4.69	38081	26.0	27.1	0.181	1465
27	729	108	759.4	5.06	44287	27.0	28.1	0.187	1640
28	784	112	816.7	5.44	51221	28.0	29.2	0.194	1829
29	841	116	876.0	5.84	58940	29.0	30.2	0.201	2032
30	900	120	937.5	6.25	67500	30.0	31.2	0.208	2250
31	961	124	1001.0	6.67	76960	31.0	32.3	0.215	2483
32	1024	128	1066.7	7.12	87381	32.0	33.3	0.222	2731
33	1089	132	1134.4	7.56	96827	33.0	34.4	0.229	2995
34	1156	136	1204.2	8.03	111361	34.0	35.4	0.236	3275
35	1225	140	1276.0	8.50	125052	35.0	36.5	0.243	3573
36	1296	144	1350.0	9.00	139968	36.0	37.5	0.250	3880
37	1369	148	1426.0	9.50	156180	37.0	38.5	0.257	4221
38	1444	152	1504.2	10.02	173761	38.0	39.6	0.264	4573
39	1521	156	1584.4	10.57	192787	39.0	40.6	0.271	4943
40	1600	160	1666.7	11.11	213333	40.0	41.7	0.278	5333

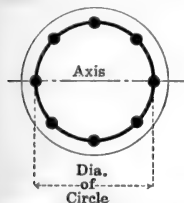

MOMENT OF INERTIA
OF COLUMN VERTICALS ARRANGED IN A CIRCLE
EXPRESSED IN TERMS OF CONCRETE

INCHES⁴

$$I = nI_s$$

Diameter of Circle	<i>n</i> = 12				<i>n</i> = 15			
	Percentage of Column Verticals				Percentage of Column Verticals			
in.	1%	2%	3%	4%	1%	2%	3%	4%
12	244	488	732	976	305	610	915	1220
13	336	672	1008	1344	420	840	1261	1681
14	452	904	1356	1808	565	1130	1696	2261
15	596	1192	1787	2383	745	1491	2234	2979
16	771	1543	2314	3085	964	1928	2893	3857
17	983	1966	2949	3932	1229	2458	3686	4915
18	1235	2471	3706	4942	1544	3089	4633	6178
19	1534	3067	4601	6135	1917	3835	5752	7669
20	1883	3766	5649	7532	2354	4708	7062	9416
21	2289	4578	6866	9155	2861	5723	8584	11445
22	2757	5514	8271	11028	3446	6893	10339	13786
23	3293	6587	9880	13173	4117	8234	12351	16469
24	3905	7809	11714	15618	4881	9763	14644	19525
25	4597	9194	13791	18389	5747	11494	17241	22988
26	5378	10756	16134	21512	6723	13447	20170	26893
27	6254	12509	18763	25018	7819	15638	23456	31275
28	7234	14467	21701	28935	9043	18086	27129	36173
29	8324	16648	24971	33295	10406	20812	31218	41623
30	9533	19065	28598	38131	11917	23834	35751	47669
31	10869	21737	32606	43475	13587	27175	40762	54349
32	12340	24681	37021	49362	15427	30854	48282	61709
33	13957	27914	41870	55827	17448	34896	52344	69747
34	15727	31454	47181	62908	19661	39322	58983	78643
35	17660	35321	52981	70642	22078	44156	66234	88312
36	19767	39534	59301	79068	24711	49423	74134	98845
37	22057	44113	66170	88226	27574	55147	82721	110294
38	24539	49079	73618	98158	30678	61355	92033	122710
39	27226	54453	81679	108905	34036	68073	102109	136146
40	30128	60256	90384	120512	37664	75328	112992	150656

NOTE.—For calculation of the moment of inertia the bars are assumed transformed into a continuous cylinder having a sectional area equivalent to the sum of the area of the bars.

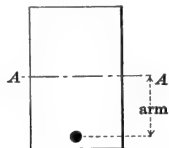

MOMENTS OF INERTIA OF BARS
INCHES⁴
FOR VARIOUS DISTANCES FROM AN AXIS A-A

Values Expressed in Nearest Whole Numbers

Arm in.	SQUARE BARS							ROUND BARS						
	1/2"	5/8"	3/4"	7/8"	1"	1 1/8"	1 1/4"	1/2"	5/8"	3/4"	7/8"	1"	1 1/8"	1 1/4"
2	1	2	2	3	4	5	6	1	1	2	2	3	4	5
2 1/2	2	2	4	5	6	8	10	1	2	3	4	5	6	8
3	2	4	5	7	9	12	14	2	3	4	5	7	9	11
3 1/2	3	5	7	9	12	16	19	2	4	5	7	10	12	15
4	4	6	9	12	16	20	25	3	5	7	10	13	16	20
4 1/2	5	8	11	16	20	26	32	4	6	9	12	16	20	25
5	6	10	14	19	25	32	39	5	8	11	15	20	25	31
5 1/2	8	12	17	23	30	38	47	6	9	13	18	24	30	37
6	9	14	20	28	36	46	56	7	11	16	22	28	36	44
6 1/2	11	17	24	32	42	54	66	8	13	19	25	33	42	52
7	12	19	28	38	49	62	77	10	15	22	29	39	49	60
7 1/2	14	22	32	43	56	71	88	11	17	25	34	44	56	69
8	16	25	36	49	64	81	100	13	20	28	39	50	64	79
8 1/2	18	28	41	55	72	92	113	14	22	32	43	57	72	89
9	20	32	46	62	81	103	127	16	25	36	49	64	81	100
9 1/2	23	35	51	69	90	114	141	18	28	40	54	71	90	111
10	25	39	56	77	100	127	156	20	31	44	60	79	99	123
10 1/2	28	43	62	84	110	149	172	22	34	49	66	87	110	135
11	30	47	68	93	121	153	189	24	37	53	73	95	120	149
11 1/2	33	52	74	101	132	168	207	26	41	58	80	104	132	162
12	36	56	81	110	144	182	225	28	44	64	87	113	143	177
13	42	66	95	129	169	214	264	33	52	75	102	133	168	208
14	49	77	110	150	196	248	306	38	60	87	118	154	195	241
15	56	88	127	172	225	285	352	44	69	99	135	177	224	276
16	64	100	144	196	256	324	400	50	79	113	154	201	255	314
17	72	113	163	221	289	366	452	57	89	128	174	227	287	355
18	81	127	182	248	324	410	506	64	99	143	195	255	322	398
19	90	141	203	276	361	457	564	71	111	160	217	284	359	443
20	100	156	225	306	400	506	625	79	123	177	241	314	398	491
21	110	172	248	338	441	558	689	87	135	195	265	346	438	541
22	121	189	272	371	484	613	756	95	148	214	291	380	481	594
23	132	206	298	405	529	670	827	104	162	234	318	416	526	649
24	144	225	324	441	576	729	900	113	177	254	346	452	573	707
25	156	244	352	479	625	791	977	123	192	276	376	491	621	767
26	169	264	380	518	676	856	1056	133	207	299	407	531	672	830
27	182	285	410	558	729	923	1139	143	224	322	438	573	725	895
28	196	306	441	600	784	992	1225	154	241	346	471	616	779	962
29	210	329	473	644	841	1065	1314	165	258	372	506	661	836	1032
30	225	352	506	689	900	1139	1406	177	276	398	541	707	895	1105
32	256	400	576	784	1024	1296	1600	201	314	452	616	804	1018	1257
34	289	452	650	885	1156	1463	1806	227	355	511	695	908	1149	1419
36	324	506	729	992	1296	1640	2025	254	398	573	779	1018	1288	1591
38	361	564	812	1106	1444	1828	2256	283	443	638	868	1134	1435	1772
40	400	625	900	1225	1600	2025	2500	314	491	707	962	1257	1590	1964
42	441	689	992	1351	1764	2233	2756	346	541	779	1061	1385	1753	2165
44	484	756	1089	1482	1936	2450	3025	380	594	855	1164	1521	1924	2376
46	529	827	1190	1620	2116	2678	3306	415	649	935	1272	1662	2103	2597
48	576	900	1296	1764	2304	2916	3600	452	707	1018	1385	1810	2290	2828

BEAM QUANTITIES

CUBIC FEET OF CONCRETE PER LINEAR FOOT OF BEAM

Depth	WIDTH IN INCHES														
	4	5	6	7	8	9	10	11	12	13	14	15	16	17	18
6	0.17	0.21	0.25	0.29	0.33	0.38	0.42	0.46	0.50	0.54	0.58	0.63	0.67	0.71	0.75
7	0.19	0.24	0.29	0.34	0.39	0.44	0.49	0.53	0.58	0.63	0.68	0.73	0.78	0.83	0.88
8	0.22	0.28	0.33	0.39	0.44	0.50	0.56	0.61	0.67	0.72	0.78	0.83	0.89	0.94	1.00
9	0.25	0.31	0.38	0.44	0.50	0.56	0.63	0.69	0.75	0.81	0.88	0.94	1.00	1.06	1.13
10	0.28	0.35	0.42	0.49	0.56	0.63	0.69	0.76	0.83	0.90	0.97	1.04	1.11	1.18	1.25
11	0.31	0.38	0.46	0.53	0.61	0.69	0.76	0.84	0.92	0.99	1.07	1.15	1.22	1.30	1.38
12	0.33	0.42	0.50	0.58	0.67	0.75	0.83	0.92	1.00	1.08	1.17	1.25	1.33	1.42	1.50
13	0.36	0.45	0.54	0.63	0.72	0.81	0.90	0.99	1.08	1.17	1.26	1.35	1.44	1.53	1.63
14	0.39	0.49	0.58	0.68	0.78	0.88	0.97	1.07	1.17	1.26	1.36	1.46	1.56	1.65	1.75
15	0.42	0.52	0.63	0.73	0.83	0.94	1.04	1.15	1.25	1.35	1.46	1.56	1.67	1.77	1.88
16	0.44	0.56	0.67	0.78	0.89	1.00	1.11	1.22	1.33	1.44	1.56	1.67	1.78	1.89	2.00
17	0.47	0.59	0.71	0.83	0.94	1.06	1.18	1.30	1.42	1.54	1.65	1.77	1.89	2.01	2.13
18	0.50	0.63	0.75	0.88	1.00	1.13	1.25	1.38	1.50	1.63	1.75	1.88	2.00	2.13	2.25
19	0.53	0.66	0.79	0.92	1.06	1.19	1.32	1.45	1.58	1.72	1.85	1.98	2.11	2.24	2.38
20	0.56	0.69	0.83	0.97	1.11	1.25	1.39	1.53	1.67	1.81	1.94	2.08	2.22	2.36	2.50
21	0.58	0.73	0.88	1.02	1.17	1.31	1.46	1.60	1.75	1.90	2.04	2.19	2.33	2.48	2.63
22	0.61	0.76	0.92	1.07	1.22	1.38	1.53	1.68	1.83	1.99	2.14	2.29	2.44	2.60	2.75
23	0.64	0.80	0.96	1.12	1.28	1.44	1.60	1.76	1.92	2.08	2.24	2.40	2.56	2.72	2.88
24	0.67	0.83	1.00	1.17	1.33	1.50	1.67	1.83	2.00	2.17	2.33	2.50	2.67	2.83	3.00
25	0.69	0.87	1.04	1.22	1.39	1.56	1.74	1.91	2.08	2.26	2.43	2.60	2.78	2.95	3.13
26	0.72	0.90	1.08	1.26	1.44	1.63	1.81	1.99	2.17	2.35	2.53	2.71	2.89	3.07	3.25
27	0.75	0.94	1.13	1.31	1.50	1.69	1.88	2.06	2.25	2.44	2.63	2.81	3.00	3.19	3.38
28	0.78	0.97	1.17	1.36	1.56	1.75	1.94	2.14	2.33	2.53	2.72	2.92	3.11	3.31	3.50
29	0.81	1.01	1.21	1.41	1.61	1.81	2.01	2.22	2.42	2.62	2.82	3.02	3.22	3.42	3.62
30	0.83	1.04	1.25	1.46	1.67	1.88	2.08	2.29	2.50	2.71	2.92	3.13	3.33	3.54	3.75
31	0.86	1.08	1.29	1.51	1.72	1.94	2.15	2.37	2.58	2.80	3.01	3.23	3.44	3.66	3.88
32	0.89	1.11	1.33	1.56	1.78	2.00	2.22	2.44	2.67	2.89	3.11	3.33	3.56	3.78	4.00
33	0.92	1.15	1.38	1.60	1.83	2.06	2.29	2.52	2.75	2.98	3.21	3.44	3.67	3.90	4.13
34	0.94	1.18	1.42	1.65	1.89	2.13	2.36	2.60	2.83	3.07	3.31	3.54	3.78	4.01	4.25
35	0.97	1.22	1.46	1.70	1.94	2.19	2.43	2.67	2.92	3.16	3.40	3.65	3.89	4.13	4.38
36	1.00	1.25	1.50	1.75	2.00	2.25	2.50	2.75	3.00	3.25	3.50	3.75	4.00	4.25	4.50
37	1.03	1.28	1.54	1.80	2.06	2.31	2.57	2.83	3.08	3.34	3.60	3.85	4.11	4.37	4.63
38	1.06	1.32	1.58	1.85	2.11	2.38	2.64	2.90	3.17	3.43	3.69	3.96	4.22	4.49	4.75
39	1.08	1.35	1.63	1.90	2.17	2.44	2.71	2.98	3.25	3.52	3.79	4.06	4.33	4.60	4.88
40	1.11	1.39	1.67	1.94	2.22	2.50	2.78	3.06	3.34	3.61	3.89	4.17	4.45	4.72	5.00
41	1.14	1.42	1.71	1.99	2.28	2.56	2.85	3.13	3.42	3.70	3.99	4.27	4.55	4.84	5.12
42	1.17	1.46	1.75	2.04	2.33	2.63	2.92	3.21	3.50	3.79	4.08	4.38	4.67	4.96	5.25
43	1.19	1.49	1.79	2.09	2.39	2.69	2.99	3.28	3.58	3.88	4.18	4.48	4.78	5.08	5.38
44	1.22	1.53	1.83	2.14	2.44	2.75	3.06	3.36	3.67	3.97	4.27	4.58	4.89	5.19	5.50
45	1.25	1.56	1.88	2.19	2.50	2.81	3.13	3.44	3.75	4.06	4.38	4.69	5.00	5.31	5.63
46	1.28	1.60	1.92	2.24	2.56	2.88	3.19	3.51	3.83	4.15	4.47	4.79	5.11	5.43	5.75
47	1.31	1.63	1.96	2.28	2.61	2.94	3.26	3.59	3.92	4.24	4.57	4.90	5.22	5.55	5.88
48	1.33	1.67	2.00	2.33	2.67	3.00	3.33	3.67	4.00	4.33	4.67	5.00	5.33	5.67	6.00

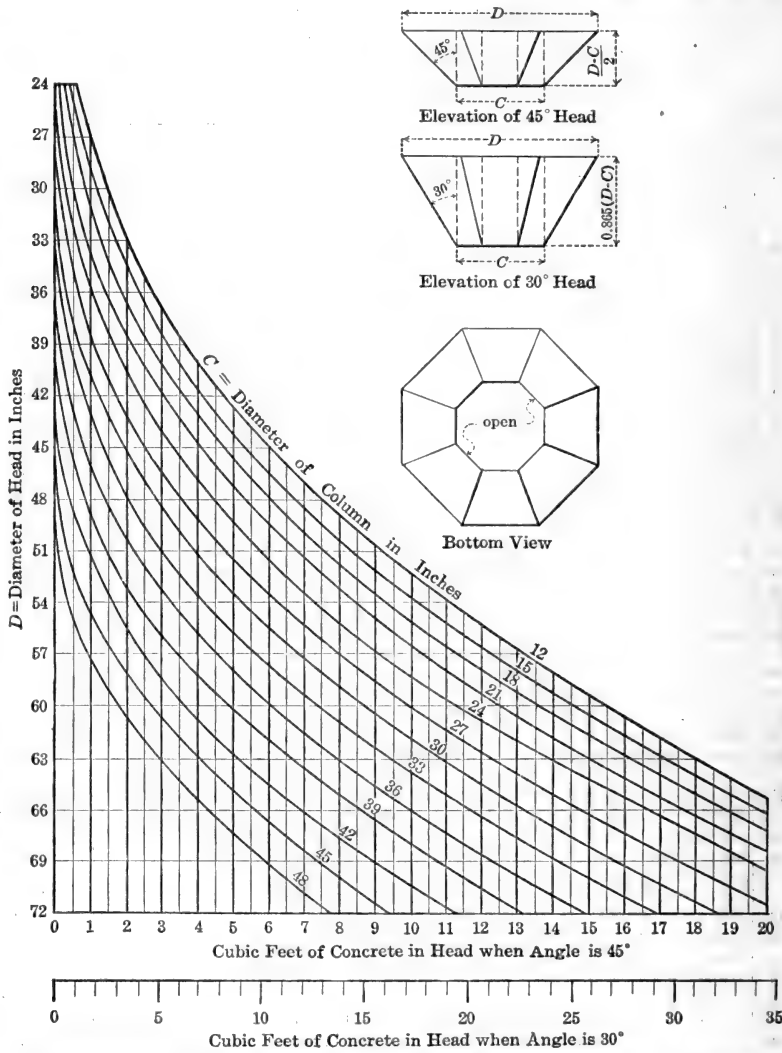

The above diagram gives the volume of the ring of concrete forming the head. Volumes given are for octagonal heads and columns. For square heads and columns multiply the volume by 1.21 For round heads and columns multiply the volume by 0.95.

DIAGRAM 17

For obtaining volume of concrete in column heads of columns supporting flat slab floors.

QUANTITIES OF MATERIALS FOR ONE CUBIC YARD OF RAMMED CONCRETE BASED ON A BARREL OF 3.8 CUBIC FEET

The following table gives the quantities of materials required for one yard of concrete. The results given have been taken from a similar table in Concrete Plain and Reinforced by Taylor and Thompson, with the author's permission, to use this copyrighted matter.

Proportions by Parts			Proportions by Volumes		PERCENTAGES OF VOIDS IN BROKEN STONE OR GRAVEL												
					50% Broken Stone Screened to Uniform size			45% Average Condition			40% Gravel or Mixed			30% Graded Mixtures			
					Cement	Sand	Stone	Cement	Sand	Stone	Cement	Sand	Stone	Cement	Sand	Stone	
Cement	Sand	Stone	Packed Cement	Loose Sand	Loose Stone	50% Broken Stone Screened to Uniform size			45% Average Condition			40% Gravel or Mixed			30% Graded Mixtures		
						Bbl.	Cu. Ft.	Cu.Ft.	Bbl.	Cu. Yd.	Cu.Yd.	Bbl.	Cu. Yd.	Cu.Yd.	Bbl.	Cu. Yd.	Cu.Yd.
1	1	1.5	1	3.8	5.7	3.19	0.45	0.67	3.08	0.43	0.65	2.97	0.42	0.63	2.78	0.39	0.59
1	1	2	1	3.8	7.6	2.85	0.40	0.80	2.73	0.38	0.77	2.62	0.37	0.74	2.43	0.34	0.68
1	1	2.5	1	3.8	9.5	2.57	0.36	0.90	2.45	0.34	0.86	2.34	0.33	0.82	2.15	0.30	0.76
1	1	3	1	3.8	11.4	2.34	0.33	0.99	2.22	0.31	0.94	2.12	0.30	0.90	1.93	0.27	0.82
1	1.5	2	1	5.7	7.6	2.49	0.43	0.70	2.40	0.51	0.63	2.31	0.49	0.65	2.16	0.46	0.61
1	1.5	2.5	1	5.7	9.5	2.27	0.58	0.80	2.18	0.46	0.77	2.09	0.44	0.74	1.94	0.41	0.68
1	1.5	3	1	5.7	11.4	2.09	0.44	0.88	2.00	0.42	0.84	1.91	0.40	0.81	1.76	0.37	0.74
1	1.5	3.5	1	5.7	13.3	1.94	0.41	0.96	1.84	0.39	0.91	1.76	0.37	0.87	1.61	0.34	0.79
1	1.5	4	1	5.7	15.2	1.80	0.38	1.01	1.71	0.36	0.96	1.63	0.34	0.92	1.48	0.31	0.83
1	1.5	4.5	1	5.7	17.1	1.69	0.36	1.07	1.60	0.34	1.01	1.51	0.22	0.96	1.37	0.29	0.87
1	1.5	5	1	5.7	19.0	1.59	0.34	1.12	1.50	0.32	1.06	1.42	0.30	1.00	1.28	0.27	0.90
1	2	3	1	7.6	11.4	1.89	0.53	0.80	1.81	0.51	0.76	1.74	0.49	0.74	1.61	0.45	0.68
1	2	3.5	1	7.6	13.3	1.76	0.49	0.87	1.68	0.47	0.83	1.61	0.45	0.79	1.48	0.42	0.73
1	2	4	1	7.6	15.2	1.65	0.46	0.93	1.57	0.44	0.88	1.50	0.42	0.84	1.38	0.39	0.78
1	2	4.5	1	7.6	17.1	1.55	0.44	0.98	1.48	0.42	0.94	1.41	0.40	0.89	1.28	0.36	0.81
1	2	5	1	7.6	19.0	1.47	0.41	1.03	1.39	0.39	0.98	1.32	0.37	0.93	1.20	0.34	0.84
1	2	5.5	1	7.6	20.9	1.39	0.39	1.08	1.31	0.37	1.01	1.25	0.35	0.97	1.13	0.32	0.87
1	2	6	1	7.6	22.8	1.32	0.37	1.11	1.25	0.35	1.06	1.18	0.33	1.00	1.06	0.30	0.89
1	2.5	3	1	9.5	11.4	1.72	0.61	0.73	1.66	0.58	0.70	1.60	0.56	0.68	1.49	0.52	0.63
1	2.5	3.5	1	9.5	13.3	1.62	0.57	0.80	1.55	0.55	0.76	1.49	0.52	0.73	1.38	0.49	0.68
1	2.5	4	1	9.5	15.2	1.52	0.54	0.86	1.46	0.51	0.82	1.40	0.49	0.79	1.29	0.45	0.73
1	2.5	4.5	1	9.5	17.1	1.44	0.51	0.91	1.37	0.48	0.87	1.31	0.46	0.83	1.20	0.42	0.76
1	2.5	5	1	9.5	19.0	1.37	0.48	0.96	1.30	0.46	0.92	1.24	0.44	0.87	1.13	0.40	0.80
1	2.5	5.5	1	9.5	20.9	1.30	0.46	1.01	1.23	0.43	0.95	1.17	0.41	0.91	1.07	0.38	0.83
1	2.5	6	1	9.5	22.8	1.24	0.44	1.05	1.17	0.41	0.99	1.11	0.39	0.94	1.01	0.36	0.85
1	2.5	6.5	1	9.5	24.7	1.18	0.42	1.08	1.12	0.39	1.02	1.06	0.37	0.97	0.96	0.34	0.88
1	2.5	7	1	9.5	26.6	1.13	0.40	1.11	1.07	0.38	1.05	1.01	0.36	0.99	0.91	0.32	0.90
1	3	4	1	11.4	15.2	1.42	0.60	0.80	1.36	0.57	0.77	1.30	0.55	0.73	1.21	0.51	0.68
1	3	4.5	1	11.4	17.1	1.34	0.57	0.85	1.28	0.54	0.81	1.23	0.52	0.78	1.13	0.48	0.72
1	3	5	1	11.4	19.0	1.28	0.54	0.90	1.22	0.52	0.86	1.17	0.49	0.82	1.07	0.45	0.75
1	3	5.5	1	11.4	20.9	1.22	0.52	0.94	1.16	0.49	0.90	1.11	0.47	0.86	1.01	0.43	0.78
1	3	6	1	11.4	22.8	1.16	0.49	0.98	1.11	0.47	0.94	1.05	0.44	0.89	0.96	0.41	0.81
1	3	6.5	1	11.4	24.7	1.12	0.47	1.02	1.06	0.45	0.97	1.01	0.43	0.92	0.92	0.39	0.84
1	3	7	1	11.4	26.6	1.07	0.45	1.05	1.01	0.43	0.99	0.96	0.40	0.95	0.87	0.37	0.86
1	3	7.5	1	11.4	28.5	1.03	0.44	1.09	0.97	0.41	1.02	0.92	0.39	0.97	0.83	0.35	0.88
1	3	8	1	11.4	30.4	0.99	0.42	1.11	0.93	0.39	1.05	0.88	0.37	0.99	0.80	0.34	0.90
1	4	5	1	15.2	19.0	1.13	0.64	0.80	1.08	0.61	0.76	1.04	0.59	0.73	0.96	0.54	0.68
1	4	6	1	15.2	22.8	1.04	0.59	0.88	0.99	0.56	0.84	0.95	0.54	0.80	0.87	0.49	0.73
1	4	7	1	15.2	26.6	0.96	0.54	0.95	0.92	0.52	0.91	0.88	0.50	0.87	0.80	0.45	0.79
1	4	8	1	15.2	30.4	0.90	0.51	1.01	0.85	0.48	0.96	0.81	0.46	0.91	0.74	0.42	0.83
1	4	9	1	15.2	34.2	0.84	0.47	1.06	0.80	0.45	1.01	0.76	0.43	0.96	0.68	0.38	0.86
1	4	10	1	15.2	38.0	0.79	0.44	1.11	0.75	0.42	1.06	0.71	0.40	1.00	0.64	0.36	0.90
1	5	10	1	19.0	38.0	0.73	0.52	1.03	0.69	0.49	0.97	0.66	0.46	0.93	0.60	0.42	0.84
1	6	12	1	22.8	45.5	0.62	0.52	1.04	0.58	0.49	0.98	0.56	0.47	0.94	0.50	0.42	0.84

NOTE.—Variations in the fineness of the sand and the compacting of the concrete may affect the quantities by 10% in either direction.

Use 45% column for average conditions and for broken stone with dust screened out.

Use 50% column for broken stone screened to uniform size

Use 40% column for gravel or mixed stone and gravel.

Use 30% column for scientifically graded mixtures.

BARS

One of the assumptions always made in connection with the design of reinforced concrete structures is that the steel and concrete are so intimately united by means of the bond that the two materials act together as a single new material. For many years it was insisted upon that the adhesion between concrete and plain bars was sufficient, but as the art of reinforced concrete construction developed the sufficiency of this adhesion began to be questioned and various methods were devised, such as hooking or splitting the ends of the bars, to prevent their slipping in the concrete. Such methods are but makeshifts at best, as bond to be effective must be continuous, and in practically all reinforced concrete designs of to-day the demand is for a deformed bar of proper design—a bar that grips the concrete in a positive manner by means of projecting ribs normal to the direction of stress.

The design tables appearing in this book are based on the employment of a properly designed deformed bar, and their use in connection with other types of bars is not recommended.

CORRUGATED ROUNDS



STANDARD SIZES

SIZE IN INCHES	$\frac{3}{8}$	$\frac{1}{2}$	$\frac{5}{8}$	$\frac{3}{4}$	$\frac{7}{8}$	1	$1\frac{1}{8}$	$1\frac{1}{4}$
Net Area in Square Inches .	0.11	0.19	0.30	0.44	0.60	0.78	0.99	1.22
Weight per Foot in Pounds.	0.38	0.66	1.05	1.52	2.06	2.69	3.41	4.21
Perimeter in Inches	1.23	1.66	2.10	2.53	2.95	3.36	3.80	4.23

CORRUGATED SQUARES



STANDARD SIZES

SIZE IN INCHES	$\frac{1}{4}$	$\frac{3}{8}$	$\frac{1}{2}$	$\frac{5}{8}$	$\frac{3}{4}$	$\frac{7}{8}$	1	$1\frac{1}{8}$	$1\frac{1}{4}$
Net Area in Square Inches .	0.06	0.14	0.25	0.39	0.56	0.76	1.00	1.26	1.55
Weight per Foot in Pounds.	0.22	0.49	0.86	1.35	1.94	2.64	3.43	4.34	5.35
Perimeter in Inches	1.00	1.50	2.00	2.50	3.00	3.50	4.00	4.50	5.00

Specifications. Purchasers can greatly influence the prompt shipment of orders for ordinary "mill shipment" by considering, in the preparation of their specifications and material bills, the factors connected with the methods and internal organization of a steel mill.

Adherence to the Manufacturers' Standard Specifications for Deformed Concrete Reinforcing Bars (see page 188), will always facilitate prompt shipment. It is, of course, possible to furnish any class of material that is within the power of the mill to roll, but where specifications are in any way special the entire order must be made from special heats. The process is one out of the ordinary routine of the mill, billets already prepared cannot be used, and delay in the filling of the order is certain.

Sizes. It is necessary in the rolling of steel bars, for a mill to finish rolling all of the bars on its schedule of one particular size before changing the rolls for other sizes of bars. In mill parlance, what is known as a "rolling" extends over a period of several days and an order containing a large number of sizes might be compelled to remain in the mill until the completion of the entire rolling, so that where quick shipment is desired, the number of sizes on an order should be kept as low as possible.

In addition to confining the order to as few sizes as may be consistent with the requirements, every endeavor should be made to avoid specifying bars in $\frac{1}{16}$ th sizes. This is an error frequently made by inexperienced designers in an effort to meet a theoretical steel area required by their calculations, and can only result in delay at the mill and increased labor and confusion in the field through the necessity of handling a multiplicity of bars of slightly varying size.

Lengths. In ordinary mill practice the bars are rolled to lengths varying from 100 to 300 feet and sheared into lengths called for by the material bills as they come from the rolls. When, however, the number of lengths are very large and where there are only a small number of bars of one length, the shearing cannot be done as fast as the bars are rolled, consequently the bars must be laid to one side and sheared after the conclusion of the rolling in order that the operation of the mill may not be delayed. It is, therefore, always desirable to keep the number of lengths as low as possible where quick shipment is a necessary requirement.

The lengths should always be given to the nearest inch as bars are not ordinarily sheared to a greater degree of accuracy. Where it is important that the length called for be exact, a note to this effect should be placed opposite the item on the order.

Fabrication. For all reinforced concrete structures there is usually a considerable amount of fabricated reinforcement to be furnished. Sometimes this fabrication is done in the field but through the use of special machinery and methods of operation all classes of bending and other fabrication of bar reinforcement can be accomplished with greater accuracy and advantage in the shop than in the field, and in the majority of instances it is advisable for the purchaser to specify "shop fabrication."

Accompanying all orders for fabricated material there should be furnished in addition to the list of number of pieces, size and length of bar, a sketch of each differently fabricated piece with the dimensions plainly marked thereon. A few of the details

most frequently encountered in practice are given below, showing in each case the detail dimensions required by the shop.

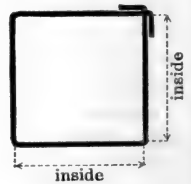
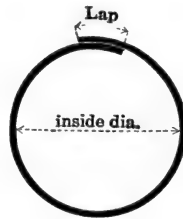
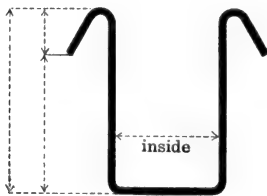
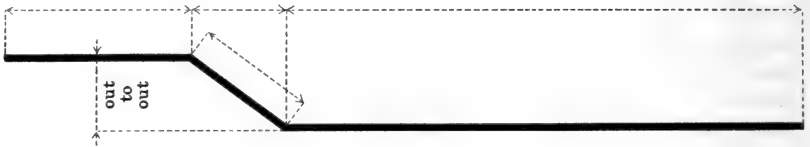
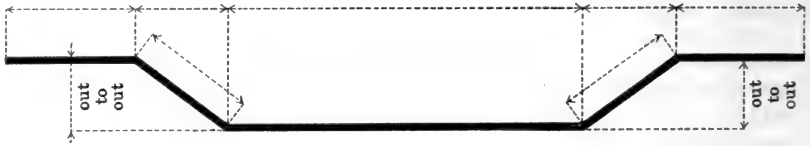

**AMERICAN STEEL AND WIRE CO.'S STEEL AND IRON WIRE GAUGE
AND DIFFERENT SIZES OF WIRE**

Diameter Inches	Steel Wire Gauge	Diameter Inches	Area, Square Inches	Pounds per Foot	Feet per Pound	Feet per 2,000 Lbs.
$\frac{1}{2}$		0.500	0.19635	0.6625	1.50	3018
	$\frac{7}{0}$	0.490	0.18857	0.6363	1.51	3023
$\frac{11}{32}$		0.468	0.17202	0.5804	1.72	3445
	$\frac{6}{0}$	0.460	0.16619	0.5608	1.78	3566
$\frac{7}{16}$		0.437	0.14998	0.5061	1.97	3952
	$\frac{5}{0}$	0.430	0.14532	0.4901	2.04	4081
$\frac{13}{32}$		0.406	0.12946	0.4368	2.28	4578
	$\frac{4}{0}$	0.393	0.12130	0.4094	2.44	4885
$\frac{3}{8}$		0.375	0.11044	0.3726	2.68	5367
	$\frac{3}{0}$	0.362	0.10292	0.3473	2.87	5758
$\frac{11}{16}$		0.343	0.09240	0.3117	3.20	6412
	$\frac{2}{0}$	0.331	0.08604	0.2904	3.44	6887
$\frac{5}{16}$		0.312	0.07645	0.2579	3.87	7755
	0	0.307	0.07402	0.2497	4.00	8011
	1	0.283	0.06290	0.2123	4.71	9420
$\frac{3}{16}$		0.281	0.06210	0.2092	4.78	9560
	2	0.263	0.05432	0.1834	5.45	10905
$\frac{1}{4}$		0.250	0.04908	0.1656	6.03	12077
	3	0.244	0.04675	0.1578	6.33	12674
	4	0.225	0.03976	0.1342	7.45	14903
$\frac{7}{32}$		0.218	0.03732	0.1259	7.94	15885
	5	0.207	0.03365	0.1135	8.81	17621
	6	0.192	0.02895	0.0977	10.23	20471
$\frac{3}{16}$		0.187	0.02746	0.0926	10.79	21598
	7	0.177	0.02460	0.0830	12.04	24096
	8	0.162	0.02061	0.0696	14.36	28735
$\frac{5}{32}$		0.156	0.01911	0.0644	15.52	31056
	9	0.148	0.01720	0.0580	17.24	34482
	10	0.135	0.01431	0.0483	20.70	41408
$\frac{1}{8}$		0.125	0.01227	0.0414	24.15	48309
	11	0.120	0.01130	0.0382	26.17	52356
	12	0.105	0.00865	0.0292	34.24	68493
$\frac{3}{32}$		0.093	0.00679	0.0229	43.66	87336
	13	0.092	0.00664	0.0224	44.64	89286
	14	0.080	0.00502	0.0169	59.17	118343
	15	0.072	0.00407	0.0137	72.99	145985
	16	0.063	0.00311	0.0105	95.23	190476

PROPERTIES OF SECTIONS

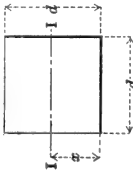
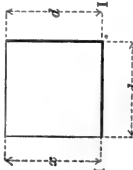
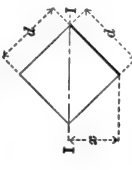
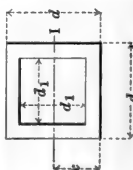
SECTION	AREA	DISTANCE FROM MOMENT AXIS TO EXTREME FIBRE	MOMENT OF INERTIA	RADIUS OF GYRATION	SECTION MODULUS
	sq. in.	x in.	I in. ⁴	$r = \sqrt{I \div A}$ in.	$S = I \div x$ in. ³
	d^2	$\frac{d}{2}$	$\frac{d^4}{12}$	$\frac{d}{\sqrt{12}} = 0.2887d$	$\frac{d^3}{6}$
	d^2	d	$\frac{d^4}{3}$	$\frac{d}{\sqrt{3}} = 0.5773d$	$\frac{d^3}{3}$
	d^2	$\frac{d}{\sqrt{2}} = 0.7071d$	$\frac{d^4}{12}$	$\frac{d}{\sqrt{12}} = 0.2887d$	$\frac{d^3}{6\sqrt{2}} = 0.1179d^3$
	$d^2 - d_1^2$	$\frac{d}{2}$	$\frac{d^4 - d_1^4}{12}$	$\sqrt{\frac{d^2 + d_1^2}{12}}$	$\frac{d^4 - d_1^4}{6d}$

PROPERTIES OF SECTIONS

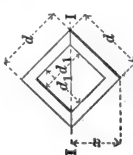
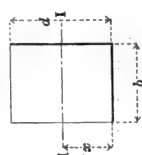
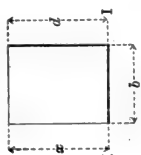
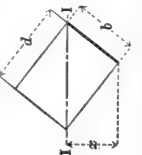
SECTION	AREA	DISTANCE FROM MOMENT AXIS TO EXTREME FIBRE	MOMENT OF INERTIA	RADIUS OF GYRATION	SECTION MODULUS
	A sq. in.	x in.	I in. ⁴	$r = \sqrt{I \div A}$ in.	$S = I \div x$ in. ³
	$d^2 - d_1^2$	$\frac{d}{\sqrt{2}} = 0.7071d$	$\frac{d^4 - d_1^4}{12}$	$\sqrt{\frac{d^2 + d_1^2}{12}} = 0.2887 \sqrt{d^2 + d_1^2}$	$\frac{d^4 - d_1^4}{6d \sqrt{2}} = 0.1179 \frac{d^4 - d_1^4}{d}$
	bd	$\frac{d}{2}$	$\frac{bd^3}{12}$	$\frac{d}{\sqrt{12}} = 0.2887d$	$\frac{bd^2}{6}$
	bd	d	$\frac{bd^3}{3}$	$\frac{d}{\sqrt{3}} = 0.5773d$	$\frac{bd^2}{3}$
	bd	$\frac{bd}{\sqrt{b^2 + d^2}}$	$\frac{b^3 d^3}{6(b^2 + d^2)}$	$\frac{bd}{\sqrt{6(b^2 + d^2)}}$	$\frac{b^2 d^2}{6 \sqrt{b^2 + d^2}}$

PROPERTIES OF SECTIONS

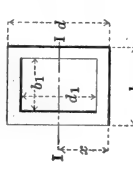
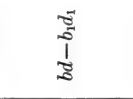
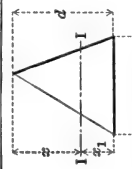
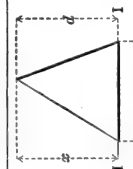
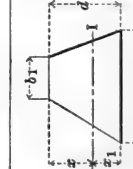
SECTION	AREA	DISTANCE FROM MOMENT AXIS TO EXTREME FIBRE	MOMENT OF INERTIA	RADIUS OF GYRATION	SECTION MODULUS
	A sq. in.	x and x_1 in.	I in. ⁴	$r = \sqrt{I \div A}$ in.	$S = I \div x$ in. ³
	$bd - b_1d_1$	$\frac{d}{2}$	$\frac{bd^3 - b_1d_1^3}{12}$	$\sqrt{\frac{bd^3 - b_1d_1^3}{12(bd - b_1d_1)}}$	$\frac{bd^3 - b_1d_1^3}{6d}$
	$\frac{bd}{2}$	$x = \frac{2d}{3}$ $x_1 = \frac{d}{3}$	$\frac{bd^3}{36}$	$\frac{d}{\sqrt{18}} = 0.2357d$	$\frac{bd^3}{24}$
	$\frac{bd}{2}$	d	$\frac{bd^3}{12}$	$\frac{d}{\sqrt{6}} = 0.4082d$	$\frac{bd^2}{12}$
	$\frac{d(b+b_1)}{2}$	$x = \frac{d(b_1 + 2b)}{3(b+b_1)}$ $x_1 = \frac{d(b+2b_1)}{3(b+b_1)}$	$\frac{d^3(b^2 + 4bb_1 + b_1^2)}{36(b+b_1)}$	$\frac{d}{6(b+b_1)} \sqrt{2(b^2 + 4bb_1 + b_1^2)}$	$\frac{d^3(b^2 + 4bb_1 + b_1^2)}{12(b_1 + 2b)}$

PROPERTIES OF SECTIONS

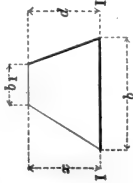
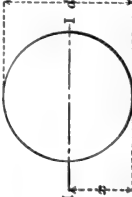
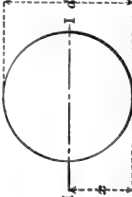
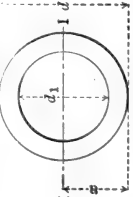
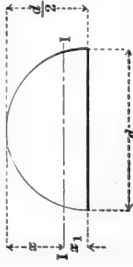
SECTION	AREA	DISTANCE FROM MOMENT AXIS TO EXTREME FIBRE	MOMENT OF INERTIA	RADIUS OF GYRATION	SECTION MODULUS
	A sq. in.	x and x_1 in.	I in. ⁴	$r = \sqrt{I \div A}$ in.	$S = I \div x$ in. ³
	$\frac{d(b+b_1)}{2}$	d	$\frac{d^3(b+3b_1)}{12}$	$\frac{d}{\sqrt{6}} \sqrt{\frac{b+3b_1}{b+b_1}}$	$\frac{d^2(b+3b_1)}{12}$
	$\frac{\pi d^2}{4} = 0.7854d^2$	$\frac{d}{2}$	$\frac{\pi d^4}{64} = 0.0491d^4$	$\frac{d}{4}$	$\frac{\pi d^3}{32} = 0.0982d^3$
	$\frac{\pi(d^2-d_1^2)}{4} = 0.7854(d^2-d_1^2)$	$\frac{d}{2}$	$\frac{\pi(d^4-d_1^4)}{64} = 0.0491(d^4-d_1^4)$	$\frac{\sqrt{d^2+d_1^2}}{4}$	$\frac{\pi(d^4-d_1^4)}{32d} = 0.0982 \frac{(d^4-d_1^4)}{d}$
	$\frac{\pi d^2}{8} = 0.3927d^2$	$x = \frac{d(3\pi-4)}{6\pi} = 0.2878d$ $x_1 = \frac{2d}{3\pi} = 0.2122d$	$\frac{d^4(9\pi^2-64)}{1152\pi} = 0.0069d^4$	$\frac{d\sqrt{(9\pi^2-64)}}{12\pi} = 0.1322d$	$\frac{d^3(9\pi^2-64)}{192(3\pi-4)} = 0.0238d^3$

TIMBER

UNIT STRESSES IN POUNDS PER SQUARE INCH AND WEIGHTS PER CUBIC FOOT

		White Oak	Western Hemlock	Spruce	Norway Pine	Shortleaf Pine	Longleaf Pine	Douglas Fir
BENDING	EXTREME FIBRE STRESS							
	Ultimate	5,700	5,800	4,800	4,200	5,600	6,500	6,100
	Working Stress	1,100	1,100	1,000	800	1,100	1,300	1,200
	MODULUS OF ELASTICITY							
Average	1,150,000	1,480,000	1,310,000	1,190,000	1,480,000	1,610,000	1,510,000	
SHEARING	PARALLEL TO GRAIN							
	Ultimate	840	630	600	590	710	720	690
	Working Stress	210	160	150	130	170	180	170
	LONGITUDINAL TO GRAIN							
	Ultimate	270	270	170	250	330	300	270
	Working Stress	110	100	70	100	130	120	110
COMPRESSION	PERPENDICULAR TO GRAIN							
	Elastic Limit	920	440	370	300	340	520	630
	Working Stress	460	220	180	150	170	260	310
	PARALLEL TO GRAIN							
	Ultimate	3,500	3,500	3,200	2,600	3,400	3,800	3,600
	Working Stress	1,300	1,200	1,100	800	1,100	1,300	1,200
	WORKING STRESSES FOR COLUMNS							
<i>l/d</i> less than 15	975	900	825	600	825	975	900	
<i>l/d</i> more than 15	1,300(1- <i>l/60d</i>)	1,200(1- <i>l/60d</i>)	1,100(1- <i>l/60d</i>)	800(1- <i>l/60d</i>)	1,100(1- <i>l/60d</i>)	1,300(1- <i>l/60d</i>)	1,200(1- <i>l/60d</i>)	
Weight per cu. ft. (green) pounds	48	41	33	42	50	50	38	
Weight per cu. ft. (dry) pounds	43	27	27	32	36	40	32	

The stresses given are for green timber. For temporary structures an increase of 50% in the working stresses is permissible.

WOODEN BEAMS—UNIFORMLY LOADED

Loads given are total loads for a beam one inch thick and for a maximum bending stress of 1,000 pounds per square inch.

Span in Feet	DEPTH OF BEAM IN INCHES									
	2	4	6	8	10	12	14	16	18	20
2	187									
3	148									
4	111									
5	89	356								
6	74	296								
7	63	254								
8	56	222	500							
9		198	444							
10		178	400	711						
11		162	364	646						
12		148	333	593	926					
13			308	547	855					
14			286	508	794					
15			267	474	741	1067				
16			250	444	694	1000				
17				418	654	941	1281			
18				395	617	889	1210			
19				374	585	842	1146			
20				356	556	800	1089	1422		
21					529	762	1037	1354		
22					505	727	990	1293	1636	
23					483	696	947	1237	1565	
24					463	667	907	1185	1500	1852
25						640	871	1138	1440	1778

SQUARE WOODEN COLUMNS

Loads given are in thousands of pounds for a working stress parallel to the grain of 1,000 pounds per square inch.

$$P = 1,000 \left(1 - \frac{l}{60d} \right)$$

Height of Column	SIDE OF SQUARE IN INCHES									
	4	6	8	10	12	14	16	18	20	24
5	12.0	27.0	48.0	75.0	108.0	147.0	192.0	243.0	300.0	432.0
6	11.2	27.0	48.0	75.0	108.0	147.0	192.0	243.0	300.0	432.0
7	10.4	27.0	48.0	75.0	108.0	147.0	192.0	243.0	300.0	432.0
8	9.6	26.4	48.0	75.0	108.0	147.0	192.0	243.0	300.0	432.0
9	8.8	25.2	48.0	75.0	108.0	147.0	192.0	243.0	300.0	432.0
10	8.0	24.0	48.0	75.0	108.0	147.0	192.0	243.0	300.0	432.0
11		22.8	46.4	75.0	108.0	147.0	192.0	243.0	300.0	432.0
12		21.6	44.8	75.0	108.0	147.0	192.0	243.0	300.0	432.0
14		19.2	41.6	72.0	108.0	147.0	192.0	243.0	300.0	432.0
16			38.4	68.0	105.6	147.0	192.0	243.0	300.0	432.0
18			35.2	64.0	100.8	145.6	192.0	243.0	300.0	432.0
20			32.0	60.0	96.0	140.0	192.0	243.0	300.0	432.0

To obtain the carrying capacity of beams or columns where the unit stress is other than 1,000 pounds per square inch, increase or decrease the table loads proportionately.

AREAS OF CIRCULAR SEGMENTS
FOR RATIOS OF RISE AND CHORD

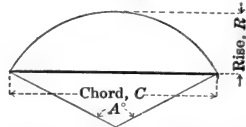

Area = $C \times R \times$ Coefficient

A°	Coefficient	$\frac{R}{C}$	A°	Coefficient	$\frac{R}{C}$	A°	Coefficient	$\frac{R}{C}$	A°	Coefficient	$\frac{R}{C}$
1	0.6667	0.0022	46	0.6722	0.1017	91	0.6895	0.2097	136	0.7239	0.3373
2	0.6667	0.0044	47	0.6724	0.1040	92	0.6901	0.2122	137	0.7249	0.3404
3	0.6667	0.0066	48	0.6727	0.1063	93	0.6906	0.2148	138	0.7260	0.3436
4	0.6667	0.0087	49	0.6729	0.1086	94	0.6912	0.2174	139	0.7270	0.3469
5	0.6667	0.0109	50	0.6732	0.1109	95	0.6918	0.2200	140	0.7281	0.3501
6	0.6667	0.0131	51	0.6734	0.1131	96	0.6924	0.2226	141	0.7292	0.3534
7	0.6668	0.0153	52	0.6737	0.1154	97	0.6930	0.2252	142	0.7303	0.3567
8	0.6668	0.0175	53	0.6740	0.1177	98	0.6936	0.2279	143	0.7314	0.3600
9	0.6669	0.0197	54	0.6743	0.1200	99	0.6942	0.2305	144	0.7325	0.3633
10	0.6670	0.0218	55	0.6746	0.1224	100	0.6948	0.2332	145	0.7336	0.3666
11	0.6670	0.0240	56	0.6749	0.1247	101	0.6954	0.2358	146	0.7348	0.3700
12	0.6671	0.0262	57	0.6752	0.1270	102	0.6961	0.2385	147	0.7360	0.3734
13	0.6672	0.0284	58	0.6755	0.1293	103	0.6967	0.2412	148	0.7372	0.3768
14	0.6672	0.0306	59	0.6758	0.1316	104	0.6974	0.2439	149	0.7384	0.3802
15	0.6673	0.0328	60	0.6761	0.1340	105	0.6980	0.2466	150	0.7396	0.3837
16	0.6674	0.0350	61	0.6764	0.1363	106	0.6987	0.2493	151	0.7408	0.3872
17	0.6674	0.0372	62	0.6768	0.1387	107	0.6994	0.2520	152	0.7421	0.3901
18	0.6675	0.0394	63	0.6771	0.1410	108	0.7001	0.2548	153	0.7434	0.3946
19	0.6676	0.0416	64	0.6775	0.1434	109	0.7008	0.2575	154	0.7447	0.3977
20	0.6677	0.0437	65	0.6779	0.1457	110	0.7015	0.2603	155	0.7460	0.4013
21	0.6678	0.0459	66	0.6782	0.1481	111	0.7022	0.2631	156	0.7473	0.4049
22	0.6679	0.0481	67	0.6786	0.1505	112	0.7030	0.2659	157	0.7486	0.4085
23	0.6680	0.0504	68	0.6790	0.1529	113	0.7037	0.2687	158	0.7500	0.4122
24	0.6681	0.0526	69	0.6794	0.1553	114	0.7045	0.2715	159	0.7514	0.4159
25	0.6682	0.0548	70	0.6797	0.1577	115	0.7052	0.2743	160	0.7528	0.4196
26	0.6684	0.0570	71	0.6801	0.1601	116	0.7060	0.2772	161	0.7542	0.4233
27	0.6685	0.0592	72	0.6805	0.1625	117	0.7068	0.2800	162	0.7557	0.4270
28	0.6687	0.0614	73	0.6809	0.1649	118	0.7076	0.2829	163	0.7571	0.4308
29	0.6688	0.0636	74	0.6814	0.1673	119	0.7084	0.2858	164	0.7586	0.4346
30	0.6690	0.0658	75	0.6818	0.1697	120	0.7092	0.2887	165	0.7601	0.4385
31	0.6691	0.0681	76	0.6822	0.1722	121	0.7100	0.2916	166	0.7616	0.4424
32	0.6693	0.0703	77	0.6826	0.1746	122	0.7109	0.2945	167	0.7632	0.4463
33	0.6694	0.0725	78	0.6831	0.1771	123	0.7117	0.2975	168	0.7648	0.4502
34	0.6696	0.0747	79	0.6835	0.1795	124	0.7126	0.3004	169	0.7664	0.4542
35	0.6698	0.0770	80	0.6840	0.1820	125	0.7134	0.3034	170	0.7680	0.4582
36	0.6700	0.0792	81	0.6844	0.1845	126	0.7143	0.3064	171	0.7696	0.4622
37	0.6702	0.0814	82	0.6849	0.1869	127	0.7152	0.3094	172	0.7712	0.4663
38	0.6704	0.0837	83	0.6854	0.1894	128	0.7161	0.3124	173	0.7729	0.4704
39	0.6706	0.0859	84	0.6859	0.1919	129	0.7170	0.3155	174	0.7746	0.4745
40	0.6708	0.0882	85	0.6864	0.1944	130	0.7180	0.3185	175	0.7763	0.4787
41	0.6710	0.0904	86	0.6869	0.1970	131	0.7189	0.3216	176	0.7781	0.4828
42	0.6712	0.0927	87	0.6874	0.1995	132	0.7199	0.3247	177	0.7799	0.4871
43	0.6714	0.0949	88	0.6879	0.2020	133	0.7209	0.3278	178	0.7817	0.4914
44	0.6717	0.0972	89	0.6884	0.2046	134	0.7219	0.3309	179	0.7835	0.4957
45	0.6719	0.0995	90	0.6890	0.2071	135	0.7229	0.3341	180	0.7854	0.5000

TRIGONOMETRIC SOLUTION OF TRIANGLES

$$a^2 = b^2 + c^2 - 2bc \cos A \quad b^2 = a^2 + c^2 - 2ac \cos B \quad c^2 = a^2 + b^2 - 2ab \cos C \quad s = \frac{a+b+c}{2}$$

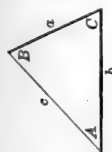

RIGHT TRIANGLE

Given	To Find			AREA
	A	B	C	
a, b	$\tan A = \frac{a}{b}$	$\tan B = \frac{b}{a}$	90°	$\frac{ab}{2}$
a, c	$\sin A = \frac{a}{c}$	$\cos B = \frac{a}{c}$	90°	$\frac{a^2 \cot A}{2}$
A, a	90° - A	90° - A	90°	$\frac{a^2 \cot A}{2}$
A, b	90° - A	90° - A	90°	$\frac{b^2 \tan A}{2}$
A, c	90° - A	90° - A	90°	$\frac{c^2 \sin 2A}{4}$

OBLIQUE TRIANGLE

Given	To Find			AREA
	A	B	C	
a, b, c	$\cos \frac{1}{2} A = \sqrt{\frac{s(s-a)}{bc}}$	$\cos \frac{1}{2} B = \sqrt{\frac{s(s-b)}{ac}}$	$\cos \frac{1}{2} C = \sqrt{\frac{s(s-c)}{ab}}$	$\frac{ab \sin C}{2}$
a, A, B		$\sin B = \frac{b \sin A}{a}$	180° - (A + B)	$\frac{a \sin C}{\sin A} \cdot \frac{b \sin C}{\sin B}$
a, b, A				$\frac{a \sin C}{\sin A} \cdot \frac{b \sin C}{\sin B}$
a, b, C	$\tan A = \frac{a \sin C}{b - a \cos C}$			$\frac{\sqrt{a^2 + b^2 - 2ab \cos C}}{2}$

NATURAL TRIGONOMETRIC FUNCTIONS

	SINES							
	0'	10'	20'	30'	40'	50'	60'	
0	0.00000	0.00291	0.00582	0.00873	0.01164	0.01454	0.01745	89
1	0.01745	0.02036	0.02327	0.02618	0.02908	0.03199	0.03490	88
2	0.03490	0.03781	0.04071	0.04362	0.04653	0.04943	0.05234	87
3	0.05234	0.05524	0.05814	0.06105	0.06395	0.06685	0.06976	86
4	0.06976	0.07266	0.07556	0.07846	0.08136	0.08426	0.08716	85
5	0.08716	0.09005	0.09295	0.09585	0.09874	0.10164	0.10453	84
6	0.10453	0.10742	0.11031	0.11320	0.11609	0.11898	0.12187	83
7	0.12187	0.12476	0.12764	0.13053	0.13341	0.13629	0.13917	82
8	0.13917	0.14205	0.14493	0.14781	0.15069	0.15356	0.15643	81
9	0.15643	0.15931	0.16218	0.16505	0.16792	0.17078	0.17365	80
10	0.17365	0.17651	0.17937	0.18224	0.18509	0.18795	0.19081	79
11	0.19081	0.19366	0.19652	0.19937	0.20222	0.20507	0.20791	78
12	0.20791	0.21076	0.21360	0.21644	0.21928	0.22212	0.22495	77
13	0.22495	0.22778	0.23062	0.23345	0.23627	0.23910	0.24192	76
14	0.24192	0.24474	0.24756	0.25038	0.25320	0.25601	0.25882	75
15	0.25882	0.26163	0.26443	0.26724	0.27004	0.27284	0.27564	74
16	0.27564	0.27843	0.28123	0.28402	0.28680	0.28959	0.29237	73
17	0.29237	0.29515	0.29793	0.30071	0.30348	0.30625	0.30902	72
18	0.30902	0.31178	0.31454	0.31730	0.32006	0.32282	0.32557	71
19	0.32557	0.32832	0.33106	0.33381	0.33655	0.33929	0.34202	70
20	0.34202	0.34475	0.34748	0.35021	0.35293	0.35565	0.35837	69
21	0.35837	0.36108	0.36379	0.36650	0.36921	0.37191	0.37461	68
22	0.37461	0.37730	0.37999	0.38268	0.38537	0.38805	0.39073	67
23	0.39073	0.39341	0.39608	0.39875	0.40142	0.40408	0.40674	66
24	0.40674	0.40939	0.41204	0.41469	0.41734	0.41998	0.42262	65
25	0.42262	0.42525	0.42788	0.43051	0.43313	0.43575	0.43837	64
26	0.43837	0.44098	0.44359	0.44620	0.44880	0.45140	0.45399	63
27	0.45399	0.45658	0.45917	0.46175	0.46433	0.46690	0.46947	62
28	0.46947	0.47204	0.47460	0.47716	0.47971	0.48226	0.48481	61
29	0.48481	0.48735	0.48989	0.49242	0.49495	0.49748	0.50000	60
30	0.50000	0.50252	0.50503	0.50754	0.51004	0.51254	0.51504	59
31	0.51504	0.51753	0.52002	0.52250	0.52498	0.52745	0.52992	58
32	0.52992	0.53238	0.53484	0.53730	0.53975	0.54220	0.54464	57
33	0.54464	0.54708	0.54951	0.55194	0.55436	0.55678	0.55919	56
34	0.55919	0.56160	0.56401	0.56641	0.56880	0.57119	0.57358	55
35	0.57358	0.57596	0.57833	0.58070	0.58307	0.58543	0.58779	54
36	0.58779	0.59014	0.59248	0.59482	0.59716	0.59949	0.60182	53
37	0.60182	0.60414	0.60645	0.60876	0.61107	0.61337	0.61566	52
38	0.61566	0.61795	0.62024	0.62251	0.62479	0.62706	0.62932	51
39	0.62932	0.63158	0.63383	0.63608	0.63832	0.64056	0.64279	50
40	0.64279	0.64501	0.64723	0.64945	0.65166	0.65386	0.65606	49
41	0.65606	0.65825	0.66044	0.66262	0.66480	0.66697	0.66913	48
42	0.66913	0.67129	0.67344	0.67559	0.67773	0.67987	0.68200	47
43	0.68200	0.68412	0.68624	0.68835	0.69046	0.69256	0.69466	46
44	0.69466	0.69675	0.69883	0.70091	0.70298	0.70505	0.70711	45
	60'	50'	40'	30'	20'	10'	0'	

COSINES

NATURAL TRIGONOMETRIC FUNCTIONS

	COSINES							
	0'	10'	20'	30'	40'	50'	60'	
0	1.00000	1.00000	0.99998	0.99996	0.99993	0.99989	0.99985	89
1	0.99985	0.99979	0.99973	0.99966	0.99958	0.99949	0.99939	88
2	0.99939	0.99929	0.99917	0.99905	0.99892	0.99878	0.99863	87
3	0.99863	0.99847	0.99831	0.99813	0.99795	0.99776	0.99756	86
4	0.99756	0.99736	0.99714	0.99692	0.99668	0.99644	0.99619	85
5	0.99619	0.99594	0.99567	0.99540	0.99511	0.99482	0.99452	84
6	0.99452	0.99421	0.99390	0.99357	0.99324	0.99290	0.99255	83
7	0.99255	0.99219	0.99182	0.99144	0.99106	0.99067	0.99027	82
8	0.99027	0.98986	0.98944	0.98902	0.98858	0.98814	0.98769	81
9	0.98769	0.98723	0.98676	0.98629	0.98580	0.98531	0.98481	80
10	0.98481	0.98430	0.98378	0.98325	0.98272	0.98218	0.98163	79
11	0.98163	0.98107	0.98050	0.97992	0.97934	0.97875	0.97815	78
12	0.97815	0.97754	0.97692	0.97630	0.97566	0.97502	0.97437	77
13	0.97437	0.97371	0.97304	0.97237	0.97169	0.97100	0.97030	76
14	0.97030	0.96959	0.96887	0.96815	0.96742	0.96667	0.96593	75
15	0.96593	0.96517	0.96440	0.96363	0.96285	0.96206	0.96126	74
16	0.96126	0.96046	0.95964	0.95882	0.95799	0.95715	0.95630	73
17	0.95630	0.95545	0.95459	0.95372	0.95284	0.95195	0.95106	72
18	0.95106	0.95015	0.94924	0.94832	0.94740	0.94646	0.94552	71
19	0.94552	0.94457	0.94361	0.94264	0.94167	0.94068	0.93969	70
20	0.93969	0.93869	0.93769	0.93667	0.93565	0.93462	0.93358	69
21	0.93358	0.93253	0.93148	0.93042	0.92935	0.92827	0.92718	68
22	0.92718	0.92609	0.92499	0.92388	0.92276	0.92164	0.92050	67
23	0.92050	0.91936	0.91822	0.91706	0.91590	0.91472	0.91355	66
24	0.91355	0.91236	0.91116	0.90996	0.90875	0.90753	0.90631	65
25	0.90631	0.90507	0.90383	0.90259	0.90133	0.90007	0.89879	64
26	0.89879	0.89752	0.89623	0.89493	0.89363	0.89232	0.89101	63
27	0.89101	0.88968	0.88835	0.88701	0.88566	0.88431	0.88295	62
28	0.88295	0.88158	0.88020	0.87882	0.87743	0.87603	0.87462	61
29	0.87462	0.87321	0.87178	0.87036	0.86892	0.86748	0.86603	60
30	0.86603	0.86457	0.86310	0.86163	0.86015	0.85866	0.85717	59
31	0.85717	0.85567	0.85416	0.85264	0.85112	0.84959	0.84805	58
32	0.84805	0.84650	0.84495	0.84339	0.84182	0.84025	0.83867	57
33	0.83867	0.83708	0.83549	0.83389	0.83228	0.83066	0.82904	56
34	0.82904	0.82741	0.82577	0.82413	0.82248	0.82082	0.81915	55
35	0.81915	0.81748	0.81580	0.81412	0.81242	0.81072	0.80902	54
36	0.80902	0.80730	0.80558	0.80386	0.80212	0.80038	0.79864	53
37	0.79864	0.79688	0.79512	0.79335	0.79158	0.78980	0.78801	52
38	0.78801	0.78622	0.78442	0.78261	0.78079	0.77897	0.77715	51
39	0.77715	0.77531	0.77347	0.77162	0.76977	0.76791	0.76604	50
40	0.76604	0.76417	0.76229	0.76041	0.75851	0.75661	0.75471	49
41	0.75471	0.75280	0.75088	0.74896	0.74703	0.74509	0.74314	48
42	0.74314	0.74120	0.73924	0.73728	0.73531	0.73333	0.73135	47
43	0.73135	0.72937	0.72737	0.72537	0.72337	0.72136	0.71934	46
44	0.71934	0.71732	0.71529	0.71325	0.71121	0.70916	0.70711	45
	60'	50'	40'	30'	20'	10'	0'	

SINES

NATURAL TRIGONOMETRIC FUNCTIONS

	TANGENTS							
	0'	10'	20'	30'	40'	50'	60'	
0	0.00000	0.00291	0.00582	0.00873	0.01164	0.01455	0.01746	89
1	0.01746	0.02036	0.02328	0.02619	0.02910	0.03201	0.03492	88
2	0.03492	0.03783	0.04075	0.04366	0.04658	0.04949	0.05241	87
3	0.05241	0.05533	0.05824	0.06116	0.06408	0.06700	0.06993	86
4	0.06993	0.07285	0.07578	0.07870	0.08163	0.08456	0.08749	85
5	0.08749	0.09042	0.09335	0.09629	0.09923	0.10216	0.10510	84
6	0.10510	0.10805	0.11099	0.11394	0.11688	0.11983	0.12278	83
7	0.12278	0.12574	0.12869	0.13165	0.13461	0.13758	0.14054	82
8	0.14054	0.14351	0.14648	0.14945	0.15243	0.15540	0.15838	81
9	0.15838	0.16137	0.16435	0.16734	0.17033	0.17333	0.17633	80
10	0.17633	0.17933	0.18233	0.18534	0.18835	0.19136	0.19438	79
11	0.19438	0.19740	0.20042	0.20345	0.20648	0.20952	0.21256	78
12	0.21256	0.21560	0.21864	0.22169	0.22475	0.22781	0.23087	77
13	0.23087	0.23393	0.23700	0.24008	0.24316	0.24624	0.24933	76
14	0.24933	0.25242	0.25552	0.25862	0.26172	0.26483	0.26795	75
15	0.26795	0.27107	0.27419	0.27732	0.28046	0.28360	0.28675	74
16	0.28675	0.28990	0.29315	0.29621	0.29938	0.30255	0.30573	73
17	0.30573	0.30891	0.31210	0.31530	0.31850	0.32171	0.32492	72
18	0.32492	0.32814	0.33136	0.33460	0.33783	0.34108	0.34433	71
19	0.34433	0.34758	0.35085	0.35412	0.35740	0.36068	0.36397	70
20	0.36397	0.36727	0.37057	0.37388	0.37720	0.38053	0.38386	69
21	0.38386	0.38721	0.39055	0.39391	0.39727	0.40065	0.40403	68
22	0.40403	0.40741	0.41081	0.41421	0.41763	0.42105	0.42447	67
23	0.42447	0.42791	0.43136	0.43481	0.43828	0.44175	0.44523	66
24	0.44523	0.44872	0.45222	0.45573	0.45924	0.46277	0.46631	65
25	0.46631	0.46985	0.47341	0.47698	0.48055	0.48414	0.48773	64
26	0.48773	0.49134	0.49495	0.49858	0.50222	0.50587	0.50953	63
27	0.50953	0.51320	0.51688	0.52057	0.52427	0.52798	0.53171	62
28	0.53171	0.53545	0.53920	0.54296	0.54674	0.55051	0.55431	61
29	0.55431	0.55812	0.56194	0.56577	0.56962	0.57348	0.57735	60
30	0.57735	0.58124	0.58513	0.58905	0.59297	0.59691	0.60086	59
31	0.60086	0.60483	0.60881	0.61280	0.61681	0.62083	0.62487	58
32	0.62487	0.62892	0.63299	0.63707	0.64117	0.64528	0.64941	57
33	0.64941	0.65355	0.65771	0.66189	0.66608	0.67028	0.67451	56
34	0.67451	0.67875	0.68301	0.68728	0.69157	0.69588	0.70021	55
35	0.70021	0.70455	0.70891	0.71329	0.71769	0.72211	0.72654	54
36	0.72654	0.73100	0.73547	0.73996	0.74447	0.74900	0.75355	53
37	0.75355	0.75812	0.76272	0.76733	0.77196	0.77661	0.78129	52
38	0.78129	0.78598	0.79070	0.79544	0.80020	0.80498	0.80978	51
39	0.80978	0.81461	0.81946	0.82434	0.82923	0.83415	0.83910	50
40	0.83910	0.84407	0.84906	0.85408	0.85912	0.86419	0.86929	49
41	0.86929	0.87441	0.87955	0.88473	0.88992	0.89515	0.90040	48
42	0.90040	0.90569	0.91099	0.91633	0.92170	0.92709	0.93252	47
43	0.93252	0.93797	0.94345	0.94896	0.95451	0.96008	0.96569	46
44	0.96569	0.97133	0.97700	0.98270	0.98843	0.99420	1.00000	45
	60'	50'	40'	30'	20'	10'	0'	

COTANGENTS

NATURAL TRIGONOMETRIC FUNCTIONS

COTANGENTS								
	0'	10'	20'	30'	40'	50'	60'	
0	∞	343.77371	171.88540	114.58865	85.93979	68.75009	57.28996	89
1	57.28996	49.10388	42.96408	38.18846	34.36777	31.24158	28.63625	88
2	28.63625	26.43160	24.54176	22.90377	21.47040	20.20555	19.08114	87
3	19.08114	18.07498	17.16934	16.34986	15.60478	14.92442	14.30067	86
4	14.30067	14.72674	13.19688	12.70621	12.25051	11.82617	11.43005	85
5	11.43005	11.05943	10.71191	10.38540	10.07803	9.78817	9.51436	84
6	9.51436	9.25530	9.00983	8.77689	8.55555	8.34496	8.14435	83
7	8.14435	7.95302	7.77035	7.59575	7.42871	7.26873	7.11537	82
8	7.11537	6.96823	6.82694	6.69116	6.56055	6.43484	6.31375	81
9	6.31375	6.19703	6.08444	5.97576	5.87080	5.76937	5.67128	80
10	5.67128	5.57638	5.48451	5.39552	5.30928	5.22566	5.14455	79
11	5.14455	5.06584	4.98940	4.91516	4.84300	4.77286	4.70463	78
12	4.70463	4.63825	4.57363	4.51071	4.44942	4.38969	4.33148	77
13	4.33148	4.27471	4.21933	4.16530	4.11256	4.06107	4.01078	76
14	4.01078	3.96165	3.91364	3.86671	3.82083	3.77595	3.73205	75
15	3.73205	3.68900	3.64705	3.60588	3.56557	3.52609	3.48741	74
16	3.48741	3.44951	3.41236	3.37594	3.34023	3.30521	3.27085	73
17	3.27085	3.23714	3.20406	3.17159	3.13972	3.10842	3.07778	72
18	3.07768	3.04749	3.01783	2.98869	2.96004	2.93189	2.90421	71
19	2.90421	2.87700	2.85023	2.82391	2.79802	2.77254	2.74748	70
20	2.74748	2.72281	2.69853	2.67462	2.65109	2.62791	2.60509	69
21	2.60509	2.58261	2.56046	2.53865	2.51715	2.49597	2.47509	68
22	2.47509	2.45451	2.43422	2.41421	2.39449	2.37504	2.35585	67
23	2.35585	2.33693	2.31826	2.29984	2.28167	2.26374	2.24604	66
24	2.24604	2.22857	2.21132	2.19430	2.17749	2.16090	2.14451	65
25	2.14451	2.12832	2.11233	2.09654	2.08094	2.06553	2.05030	64
26	2.05030	2.03526	2.02039	2.00569	1.99116	1.97680	1.96261	63
27	1.96261	1.94858	1.93470	1.92098	1.90741	1.89400	1.88073	62
28	1.88073	1.86760	1.85462	1.84177	1.82907	1.81649	1.80405	61
29	1.80405	1.79174	1.77955	1.76749	1.75556	1.74375	1.73205	60
30	1.73205	1.72047	1.70901	1.69766	1.68643	1.67530	1.66428	59
31	1.66428	1.65337	1.64256	1.63185	1.62125	1.61074	1.60033	58
32	1.60033	1.59002	1.57981	1.56969	1.55966	1.54972	1.53987	57
33	1.53987	1.53010	1.52043	1.51084	1.50133	1.49190	1.48256	56
34	1.48256	1.47330	1.46411	1.45501	1.44598	1.43703	1.42815	55
35	1.42815	1.41934	1.41061	1.40195	1.39336	1.38484	1.37638	54
36	1.37638	1.36800	1.35968	1.35142	1.34323	1.33511	1.32704	53
37	1.32704	1.31904	1.31110	1.30323	1.29541	1.28764	1.27994	52
38	1.27994	1.27230	1.26471	1.25717	1.24969	1.24227	1.23490	51
39	1.23490	1.22758	1.22031	1.21310	1.20593	1.19882	1.19175	50
40	1.19175	1.18474	1.17777	1.17085	1.16398	1.15715	1.15037	49
41	1.15037	1.14363	1.13694	1.13029	1.12369	1.11713	1.11061	48
42	1.11061	1.10414	1.09770	1.09131	1.08496	1.07864	1.07237	47
43	1.07237	1.06613	1.05994	1.05378	1.04766	1.04158	1.03553	46
44	1.03553	1.02952	1.02355	1.01761	1.01170	1.00583	1.00000	45
	60'	50'	40'	30'	20'	10'	0'	

TANGENTS

NATURAL TRIGONOMETRIC FUNCTIONS

	SECANTS							
	0'	10'	20'	30'	40'	50'	60'	
0	1.00000	1.00000	1.00002	1.00004	1.00007	1.00011	1.00015	89
1	1.00015	1.00021	1.00027	1.00034	1.00042	1.00051	1.00061	88
2	1.00061	1.00072	1.00083	1.00095	1.00108	1.00122	1.00137	87
3	1.00137	1.00153	1.00169	1.00187	1.00205	1.00224	1.00244	86
4	1.00244	1.00265	1.00287	1.00309	1.00333	1.00357	1.00382	85
5	1.00382	1.00408	1.00435	1.00463	1.00491	1.00521	1.00551	84
6	1.00551	1.00582	1.00614	1.00647	1.00681	1.00715	1.00751	83
7	1.00751	1.00787	1.00825	1.00863	1.00902	1.00942	1.00983	82
8	1.00983	1.01024	1.01067	1.01111	1.01155	1.01200	1.01247	81
9	1.01247	1.01294	1.01342	1.01391	1.01440	1.01491	1.01543	80
10	1.01543	1.01595	1.01649	1.01703	1.01758	1.01815	1.01872	79
11	1.01872	1.01930	1.01989	1.02049	1.02110	1.02171	1.02234	78
12	1.02234	1.02298	1.02362	1.02428	1.02494	1.02562	1.02630	77
13	1.02630	1.02700	1.02770	1.02842	1.02914	1.02987	1.03061	76
14	1.03061	1.03137	1.03213	1.03290	1.03368	1.03447	1.03528	75
15	1.03528	1.03609	1.03691	1.03774	1.03858	1.03944	1.04030	74
16	1.04030	1.04117	1.04206	1.04295	1.04385	1.04477	1.04569	73
17	1.04569	1.04663	1.04757	1.04853	1.04950	1.05047	1.05146	72
18	1.05146	1.05246	1.05347	1.05449	1.05552	1.05657	1.05762	71
19	1.05762	1.05869	1.05976	1.06085	1.06195	1.06306	1.06418	70
20	1.06418	1.06531	1.06645	1.06761	1.06878	1.06995	1.07115	69
21	1.07115	1.07235	1.07356	1.07479	1.07602	1.07727	1.07853	68
22	1.07853	1.07981	1.08109	1.08239	1.08370	1.08503	1.08636	67
23	1.08636	1.08771	1.08907	1.09044	1.09183	1.09323	1.09464	66
24	1.09464	1.09605	1.09750	1.09895	1.10041	1.10189	1.10338	65
25	1.10338	1.10488	1.10640	1.10793	1.10947	1.11103	1.11260	64
26	1.11260	1.11419	1.11579	1.11740	1.11903	1.12067	1.12233	63
27	1.12233	1.12400	1.12568	1.12738	1.12910	1.13083	1.13257	62
28	1.13257	1.13433	1.13610	1.13789	1.13970	1.14152	1.14335	61
29	1.14335	1.14521	1.14707	1.14896	1.15085	1.15277	1.15470	60
30	1.15470	1.15665	1.15861	1.16059	1.16259	1.16460	1.16663	59
31	1.16663	1.16868	1.17075	1.17283	1.17493	1.17704	1.17918	58
32	1.17918	1.18133	1.18350	1.18569	1.18790	1.19012	1.19236	57
33	1.19236	1.19463	1.19691	1.19920	1.20152	1.20386	1.20622	56
34	1.20622	1.20859	1.21099	1.21341	1.21584	1.21830	1.22077	55
35	1.22077	1.22327	1.22579	1.22833	1.23089	1.23347	1.23607	54
36	1.23607	1.23869	1.24134	1.24400	1.24669	1.24940	1.25214	53
37	1.25214	1.25489	1.25767	1.26047	1.26330	1.26615	1.26902	52
38	1.26902	1.27191	1.27483	1.27778	1.28075	1.28374	1.28676	51
39	1.28676	1.28980	1.29287	1.29597	1.29909	1.30223	1.30541	50
40	1.30541	1.30861	1.31183	1.31509	1.31837	1.32168	1.32501	49
41	1.32501	1.32838	1.33177	1.33519	1.33864	1.34212	1.34563	48
42	1.34563	1.34917	1.35274	1.35634	1.35997	1.36363	1.36733	47
43	1.36733	1.37105	1.37481	1.37860	1.38242	1.38628	1.39016	46
44	1.39016	1.39409	1.39804	1.40203	1.40606	1.41012	1.41421	45
	60'	50'	40'	30'	20'	10'	0'	

COSECANTS

NATURAL TRIGONOMETRIC FUNCTIONS

COSECANTS								
	0'	10	20'	30'	40'	50'	60'	
0	∞	343.77516	171.88831	114.59301	85.94561	68.75736	57.29869	89
1	57.29869	49.11406	42.97571	38.20155	34.38232	31.25758	28.65371	88
2	28.65371	26.45051	24.56212	22.92559	21.49368	20.23028	19.10732	87
3	19.10732	18.10262	17.19843	16.38041	15.63679	14.95788	14.33559	86
4	14.33559	13.76312	13.23472	12.74550	12.29125	11.86837	11.47371	85
5	11.47371	11.10455	10.75849	10.43343	10.12752	9.83912	9.56677	84
6	9.56677	9.30917	9.06515	8.83367	8.61379	8.40466	8.20551	83
7	8.20551	8.01565	7.83443	7.66130	7.49571	7.33719	7.18530	82
8	7.18530	7.03962	6.89979	6.76547	6.63633	6.51208	6.39245	81
9	6.39245	6.27719	6.16607	6.05586	5.95536	5.85539	5.75877	80
10	5.75877	5.66533	5.57493	5.48740	5.40263	5.32049	5.24084	79
11	5.24084	5.16359	5.08863	5.01585	4.94517	4.87649	4.80973	78
12	4.80973	4.74482	4.68167	4.62023	4.56041	4.50216	4.44541	77
13	4.44541	4.39012	4.33622	4.28366	4.23239	4.18238	4.13357	76
14	4.13357	4.08591	4.03938	3.99393	3.94952	3.90613	3.86370	75
15	3.86370	3.82223	3.78166	3.74198	3.70315	3.66515	3.62796	74
16	3.62796	3.59154	3.55587	3.52094	3.48671	3.45317	3.42030	73
17	3.42030	3.38808	3.35649	3.32551	3.29512	3.26531	3.23607	72
18	3.23607	3.20737	3.17920	3.15155	3.12440	3.09774	3.07155	71
19	3.07155	3.04584	3.02057	2.99574	2.97135	2.94737	2.92380	70
20	2.92380	2.90063	2.87785	2.85545	2.83342	2.81175	2.79043	69
21	2.79043	2.76945	2.74881	2.72850	2.70851	2.68884	2.66947	68
22	2.66947	2.65040	2.63162	2.61313	2.59491	2.57698	2.55930	67
23	2.55930	2.54190	2.52474	2.50784	2.49119	2.47477	2.45959	66
24	2.45859	2.44264	2.42692	2.41142	2.39614	2.38107	2.36620	65
25	2.36620	2.35154	2.33708	2.32282	2.30875	2.29487	2.28117	64
26	2.28117	2.26766	2.25432	2.24116	2.22817	2.21535	2.20269	63
27	2.20269	2.19019	2.17786	2.16568	2.15366	2.14178	2.13005	62
28	2.13005	2.11847	2.10704	2.09574	2.08458	2.07356	2.06267	61
29	2.06267	2.05191	2.04128	2.03077	2.02039	2.01014	2.00000	60
30	2.00000	1.98998	1.98008	1.97029	1.96062	1.95106	1.94160	59
31	1.94160	1.93226	1.92302	1.91388	1.90485	1.89591	1.88709	58
32	1.88708	1.87834	1.86970	1.86116	1.85271	1.84435	1.83608	57
33	1.83608	1.82790	1.81981	1.81180	1.80388	1.79604	1.78829	56
34	1.78829	1.78062	1.77303	1.76552	1.75808	1.75073	1.74345	55
35	1.74345	1.73624	1.72911	1.72205	1.71506	1.70815	1.70130	54
36	1.70130	1.69454	1.68782	1.68117	1.67460	1.66809	1.66164	53
37	1.66164	1.65526	1.64894	1.64268	1.63648	1.63035	1.62427	52
38	1.62427	1.61825	1.61229	1.60639	1.60054	1.59475	1.58902	51
39	1.58902	1.58333	1.57771	1.57213	1.56661	1.56114	1.55572	50
40	1.55572	1.55036	1.54504	1.53977	1.53455	1.52938	1.52425	49
41	1.52425	1.51918	1.51415	1.50916	1.50422	1.49933	1.49448	48
42	1.49448	1.48967	1.48491	1.48019	1.47551	1.47087	1.46628	47
43	1.46628	1.46173	1.45721	1.45274	1.44831	1.44391	1.43856	46
44	1.43956	1.43524	1.43096	1.42672	1.42251	1.41835	1.41421	45
	60'	50'	40'	30'	20'	10'	0'	

SECANTS

FUNCTIONS OF NUMBERS 1 TO 49

No.	Square	Cube	Square Root	Cube Root	Logarithm	1,000	No. = DIAMETER	
						x Reciprocal	Circum.	Area
1	1	1	1.0000	1.0000	0.00000	1000.000	3.142	0.7854
2	4	8	1.4142	1.2599	0.30103	500.000	6.283	3.1416
3	9	27	1.7321	1.4422	0.47712	333.333	9.425	7.0686
4	16	64	2.0000	1.5874	0.60206	250.000	12.566	12.5664
5	25	125	2.2361	1.7100	0.69897	200.000	15.708	19.6350
6	36	216	2.4495	1.8171	0.77815	166.667	18.850	28.2743
7	49	343	2.6458	1.9129	0.84510	142.857	21.991	38.4845
8	64	512	2.8284	2.0000	0.90309	125.000	25.133	50.2655
9	81	729	3.0000	2.0801	0.95424	111.111	28.274	63.6173
10	100	1000	3.1623	2.1544	1.00000	100.000	31.416	78.5398
11	121	1331	3.3166	2.2240	1.04139	90.9091	34.558	95.0332
12	144	1728	3.4641	2.2894	1.07918	83.3333	37.699	113.097
13	169	2197	3.6056	2.3513	1.11394	76.9231	40.841	132.732
14	196	2744	3.7417	2.4101	1.14613	71.4286	43.982	153.938
15	225	3375	3.8730	2.4662	1.17609	66.6667	47.124	176.715
16	256	4096	4.0000	2.5198	1.20412	62.5000	50.265	201.062
17	289	4913	4.1231	2.5713	1.23045	58.8235	53.407	226.980
18	324	5832	4.2426	2.6207	1.25527	55.5556	56.549	254.469
19	361	6859	4.3589	2.6684	1.27875	52.6316	59.690	283.529
20	400	8000	4.4721	2.7144	1.30103	50.0000	62.832	314.159
21	441	9261	4.5826	2.7589	1.32222	47.6190	65.973	346.361
22	484	10648	4.6904	2.8020	1.34242	45.4545	69.115	380.133
23	529	12167	4.7958	2.8439	1.36173	43.4783	72.257	415.476
24	576	13824	4.8990	2.8845	1.38021	41.6667	75.398	452.389
25	625	15625	5.0000	2.9240	1.39794	40.0000	78.540	490.874
26	676	17576	5.0990	2.9625	1.41497	38.4615	81.681	530.929
27	729	19683	5.1962	3.0000	1.43136	37.0370	84.823	572.555
28	784	21952	5.2915	3.0366	1.44716	35.7143	87.965	615.752
29	841	24389	5.3852	3.0723	1.46240	34.4828	91.106	660.520
30	900	27000	5.4772	3.1072	1.47712	33.3333	94.248	706.858
31	961	29791	5.5678	3.1414	1.49136	32.2581	97.389	754.768
32	1024	32768	5.6569	3.1748	1.50515	31.2500	100.531	804.248
33	1089	35937	5.7446	3.2075	1.51851	30.3030	103.673	855.299
34	1156	39304	5.8310	3.2396	1.53148	29.4118	106.814	907.920
35	1225	42875	5.9161	3.2711	1.54407	28.5714	109.956	962.113
36	1296	46656	6.0000	3.3019	1.55630	27.7778	113.097	1017.88
37	1369	50653	6.0828	3.3322	1.56820	27.0270	116.239	1075.21
38	1444	54872	6.1644	3.3620	1.57978	26.3158	119.381	1134.11
39	1521	59319	6.2450	3.3912	1.59106	25.6410	122.522	1194.59
40	1600	64000	6.3246	3.4200	1.60206	25.0000	125.66	1256.64
41	1681	68921	6.4031	3.4482	1.61278	24.3902	128.81	1320.25
42	1764	74088	6.4807	3.4760	1.62325	23.8095	131.95	1385.44
43	1849	79507	6.5574	3.5034	1.63347	23.2558	135.09	1452.20
44	1936	85184	6.6332	3.5303	1.64345	22.7273	138.23	1520.53
45	2025	91125	6.7082	3.5569	1.65321	22.2222	141.37	1590.43
46	2116	97336	6.7823	3.5830	1.66276	21.7391	144.51	1661.90
47	2209	103823	6.8557	3.6088	1.67210	21.2766	147.65	1734.04
48	2304	110592	6.9282	3.6342	1.68124	20.8333	150.80	1809.56
49	2401	117649	7.0000	3.6593	1.69020	20.4082	153.94	1885.74

FUNCTIONS OF NUMBERS 50 TO 99

No.	Square	Cube	Square Root	Cube Root	Logarithm	1,000	No. = DIAMETER	
						x Reciprocal	Circum.	Area
50	2500	125000	7.0711	3.6840	1.69897	20.0000	157.08	1963.50
51	2601	132651	7.1414	3.7084	1.70757	19.6078	160.22	2042.82
52	2704	140608	7.2111	3.7325	1.71600	19.2308	163.36	2123.72
53	2809	148877	7.2801	3.7563	1.72428	18.8679	166.50	2206.18
54	2916	157464	7.3485	3.7798	1.73239	18.5185	169.65	2290.22
55	3025	166375	7.4162	3.8030	1.74036	18.1818	172.79	2375.83
56	3136	175616	7.4833	3.8259	1.74819	17.8571	175.93	2463.01
57	3249	185193	7.5498	3.8485	1.75587	17.5439	179.07	2551.76
58	3364	195112	7.6158	3.8708	1.76343	17.2414	182.21	2642.08
59	3481	205379	7.6811	3.8930	1.77085	16.9492	185.35	2733.97
60	3600	216000	7.7460	3.9149	1.77815	16.6667	188.50	2827.43
61	3721	226981	7.8102	3.9365	1.78533	16.3934	191.64	2922.47
62	3844	238328	7.8740	3.9579	1.79239	16.1290	194.78	3019.07
63	3969	250047	7.9373	3.9791	1.79934	15.8730	197.92	3117.25
64	4096	262144	8.0000	4.0000	1.80618	15.6250	201.06	3216.99
65	4225	274625	8.0623	4.0207	1.81291	15.3846	204.20	3318.31
66	4356	287496	8.1240	4.0412	1.81954	15.1515	207.35	3421.19
67	4489	300763	8.1854	4.0615	1.82607	14.9254	210.49	3525.65
68	4624	314432	8.2462	4.0817	1.83251	14.7059	213.63	3631.68
69	4761	328509	8.3066	4.1016	1.83885	14.4928	216.77	3739.28
70	4900	343000	8.3666	4.1213	1.84510	14.2857	219.91	3848.45
71	5041	357911	8.4261	4.1408	1.85126	14.0845	223.05	3959.19
72	5184	373248	8.4853	4.1602	1.85733	13.8889	226.19	4071.50
73	5329	389017	8.5440	4.1793	1.86332	13.6986	229.34	4185.39
74	5476	405224	8.6023	4.1983	1.86923	13.5135	232.48	4300.84
75	5625	421875	8.6603	4.2172	1.87506	13.3333	235.62	4417.86
76	5776	438976	8.7178	4.2358	1.88081	13.1579	238.76	4536.46
77	5929	456533	8.7750	4.2543	1.88649	12.9870	241.90	4656.63
78	6084	474552	8.8318	4.2727	1.89209	12.8205	245.04	4778.36
79	6241	493039	8.8882	4.2908	1.89763	12.6582	248.19	4901.67
80	6400	512000	8.9443	4.3089	1.90309	12.5000	251.33	5026.55
81	6561	531441	9.0000	4.3267	1.90849	12.3457	254.47	5153.00
82	6724	551368	9.0554	4.3445	1.91381	12.1951	257.61	5281.02
83	6889	571787	9.1104	4.3621	1.91908	12.0482	260.75	5410.61
84	7056	592704	9.1652	4.3795	1.92428	11.9048	263.89	5541.77
85	7225	614125	9.2195	4.3968	1.92942	11.7647	267.04	5674.50
86	7396	636056	9.2736	4.4140	1.93450	11.6279	270.18	5808.80
87	7569	658503	9.3274	4.4310	1.93952	11.4943	273.32	5944.68
88	7744	681472	9.3808	4.4480	1.94448	11.3636	276.46	6082.12
89	7921	704969	9.4340	4.4647	1.94939	11.2360	279.60	6221.14
90	8100	729000	9.4868	4.4814	1.95424	11.1111	282.74	6361.73
91	8281	753571	9.5394	4.4979	1.95904	10.9890	285.88	6503.88
92	8464	778688	9.5917	4.5144	1.96379	10.8696	289.03	6647.61
93	8649	804357	9.6437	4.5307	1.96848	10.7527	292.17	6792.91
94	8836	830584	9.6954	4.5468	1.97313	10.6383	295.31	6939.78
95	9025	857375	9.7468	4.5629	1.97772	10.5263	298.45	7088.22
96	9216	884736	9.7980	4.5789	1.98227	10.4167	301.59	7238.23
97	9409	912673	9.8489	4.5947	1.98677	10.3093	304.73	7389.81
98	9604	941192	9.8995	4.6104	1.99123	10.2041	307.88	7542.96
99	9801	970299	9.9499	4.6261	1.99564	10.1010	311.02	7697.69

DECIMALS OF AN INCH FOR EACH $\frac{1}{64}$ th

Fractions				Decimals	Fractions				Decimals
64ths	32nds	16ths	8ths		64ths	32nds	16ths	8ths	
$\frac{1}{64}$				0.015625	$\frac{33}{64}$				0.515625
	$\frac{1}{32}$			0.03125		$\frac{17}{32}$			0.53125
$\frac{3}{64}$				0.046875	$\frac{35}{64}$				0.546875
		$\frac{1}{16}$		0.0625			$\frac{9}{16}$		0.5625
$\frac{5}{64}$				0.078125	$\frac{37}{64}$				0.578125
	$\frac{3}{32}$			0.09375		$\frac{19}{32}$			0.59375
$\frac{7}{64}$				0.109375	$\frac{39}{64}$				0.609375
			$\frac{1}{8}$	0.125				$\frac{5}{8}$	0.625
$\frac{9}{64}$				0.140625	$\frac{41}{64}$				0.640625
	$\frac{5}{32}$			0.15625		$\frac{21}{32}$			0.65625
$\frac{11}{64}$				0.171875	$\frac{43}{64}$				0.671875
		$\frac{3}{16}$		0.1875			$\frac{11}{16}$		0.6875
$\frac{13}{64}$				0.203125	$\frac{45}{64}$				0.703125
	$\frac{7}{32}$			0.21875		$\frac{23}{32}$			0.71875
$\frac{15}{64}$				0.234375	$\frac{47}{64}$				0.734375
			$\frac{1}{4}$	0.25				$\frac{3}{4}$	0.75
$\frac{17}{64}$				0.265625	$\frac{49}{64}$				0.765625
	$\frac{9}{32}$			0.28125		$\frac{25}{32}$			0.78125
$\frac{19}{64}$				0.296875	$\frac{51}{64}$				0.796875
		$\frac{5}{16}$		0.3125			$\frac{13}{16}$		0.8125
$\frac{21}{64}$				0.328125	$\frac{53}{64}$				0.828125
	$\frac{11}{32}$			0.34375		$\frac{27}{32}$			0.84375
$\frac{23}{64}$				0.359375	$\frac{55}{64}$				0.859375
			$\frac{3}{8}$	0.375				$\frac{7}{8}$	0.875
$\frac{25}{64}$				0.390625	$\frac{57}{64}$				0.890625
	$\frac{13}{32}$			0.40625		$\frac{29}{32}$			0.90625
$\frac{27}{64}$				0.421875	$\frac{59}{64}$				0.921875
		$\frac{7}{16}$		0.4375			$\frac{15}{16}$		0.9375
$\frac{29}{64}$				0.453125	$\frac{61}{64}$				0.953125
	$\frac{15}{32}$			0.46875		$\frac{31}{32}$			0.96875
$\frac{31}{64}$				0.484375	$\frac{63}{64}$				0.984375
			$\frac{1}{2}$	0.5				1	1.00

DECIMALS OF A FOOT FOR EACH $\frac{1}{32}$ OF AN INCH

In.	0"	1"	2"	3"	4"	5"	6"	7"	8"	9"	10"	11"
0	0.0000	0.0833	0.1667	0.2500	0.3333	0.4167	0.5000	0.5833	0.6667	0.7500	0.8333	0.9167
$\frac{1}{32}$	0.0026	0.0859	0.1693	0.2526	0.3359	0.4193	0.5026	0.5859	0.6693	0.7526	0.8359	0.9193
$\frac{2}{32}$	0.0052	0.0885	0.1719	0.2552	0.3385	0.4219	0.5052	0.5885	0.6719	0.7552	0.8385	0.9219
$\frac{3}{32}$	0.0078	0.0911	0.1745	0.2578	0.3411	0.4245	0.5078	0.5911	0.6745	0.7578	0.8411	0.9245
$\frac{4}{32}$	0.0104	0.0937	0.1771	0.2604	0.3437	0.4271	0.5104	0.5937	0.6771	0.7604	0.8437	0.9271
$\frac{5}{32}$	0.0130	0.0964	0.1797	0.2630	0.3464	0.4297	0.5130	0.5964	0.6797	0.7630	0.8464	0.9297
$\frac{6}{32}$	0.0156	0.0990	0.1823	0.2656	0.3490	0.4323	0.5156	0.5990	0.6823	0.7656	0.8490	0.9323
$\frac{7}{32}$	0.0182	0.1016	0.1849	0.2682	0.3516	0.4349	0.5182	0.6016	0.6849	0.7682	0.8516	0.9349
$\frac{8}{32}$	0.0208	0.1042	0.1875	0.2708	0.3542	0.4375	0.5208	0.6042	0.6875	0.7708	0.8542	0.9375
$\frac{9}{32}$	0.0234	0.1068	0.1901	0.2734	0.3568	0.4401	0.5234	0.6068	0.6901	0.7734	0.8568	0.9401
$\frac{10}{32}$	0.0260	0.1094	0.1927	0.2760	0.3594	0.4427	0.5260	0.6094	0.6927	0.7760	0.8594	0.9427
$\frac{11}{32}$	0.0286	0.1120	0.1953	0.2786	0.3620	0.4453	0.5286	0.6120	0.6953	0.7786	0.8620	0.9453
$\frac{12}{32}$	0.0312	0.1146	0.1979	0.2812	0.3646	0.4479	0.5312	0.6146	0.6979	0.7812	0.8646	0.9479
$\frac{13}{32}$	0.0339	0.1172	0.2005	0.2839	0.3672	0.4505	0.5339	0.6172	0.7005	0.7839	0.8672	0.9505
$\frac{14}{32}$	0.0365	0.1198	0.2031	0.2865	0.3698	0.4531	0.5365	0.6198	0.7031	0.7865	0.8698	0.9531
$\frac{15}{32}$	0.0391	0.1224	0.2057	0.2891	0.3724	0.4557	0.5391	0.6224	0.7057	0.7891	0.8724	0.9557
$\frac{16}{32}$	0.0417	0.1250	0.2083	0.2917	0.3750	0.4583	0.5417	0.6250	0.7083	0.7917	0.8750	0.9583
$\frac{17}{32}$	0.0443	0.1276	0.2109	0.2943	0.3776	0.4609	0.5443	0.6276	0.7109	0.7943	0.8776	0.9609
$\frac{18}{32}$	0.0469	0.1302	0.2135	0.2969	0.3802	0.4635	0.5469	0.6302	0.7135	0.7969	0.8802	0.9635
$\frac{19}{32}$	0.0495	0.1328	0.2161	0.2995	0.3828	0.4661	0.5495	0.6328	0.7161	0.7995	0.8828	0.9661
$\frac{20}{32}$	0.0521	0.1354	0.2188	0.3021	0.3854	0.4688	0.5521	0.6354	0.7188	0.8021	0.8854	0.9688
$\frac{21}{32}$	0.0547	0.1380	0.2214	0.3047	0.3880	0.4714	0.5547	0.6380	0.7214	0.8047	0.8880	0.9714
$\frac{22}{32}$	0.0573	0.1406	0.2240	0.3073	0.3906	0.4740	0.5573	0.6406	0.7240	0.8073	0.8906	0.9740
$\frac{23}{32}$	0.0599	0.1432	0.2266	0.3099	0.3932	0.4766	0.5599	0.6432	0.7266	0.8099	0.8932	0.9766
$\frac{24}{32}$	0.0625	0.1458	0.2292	0.3125	0.3958	0.4792	0.5625	0.6458	0.7292	0.8125	0.8958	0.9792
$\frac{25}{32}$	0.0651	0.1484	0.2318	0.3151	0.3984	0.4818	0.5651	0.6484	0.7318	0.8151	0.8984	0.9818
$\frac{26}{32}$	0.0677	0.1510	0.2344	0.3177	0.4010	0.4844	0.5677	0.6510	0.7344	0.8177	0.9010	0.9844
$\frac{27}{32}$	0.0703	0.1536	0.2370	0.3203	0.4036	0.4870	0.5703	0.6536	0.7370	0.8203	0.9036	0.9870
$\frac{28}{32}$	0.0729	0.1562	0.2396	0.3229	0.4062	0.4896	0.5729	0.6562	0.7396	0.8229	0.9062	0.9896
$\frac{29}{32}$	0.0755	0.1589	0.2422	0.3255	0.4089	0.4922	0.5755	0.6589	0.7422	0.8255	0.9089	0.9922
$\frac{30}{32}$	0.0781	0.1615	0.2448	0.3281	0.4115	0.4948	0.5781	0.6615	0.7448	0.8281	0.9115	0.9948
$\frac{31}{32}$	0.0807	0.1641	0.2474	0.3307	0.4141	0.4974	0.5807	0.6641	0.7474	0.8307	0.9141	0.9974
1												1.0000

AMERICAN SOCIETY FOR TESTING MATERIALS

PHILADELPHIA, PA., U. S. A.

AFFILIATED WITH THE
INTERNATIONAL ASSOCIATION FOR TESTING MATERIALS

STANDARD SPECIFICATIONS FOR PORTLAND CEMENT

ADOPTED, 1904; REVISED, 1908, 1909, 1916, 1917.

Portland cement is the product obtained by finely pulverizing clinker produced by calcining to incipient fusion, an intimate and properly proportioned mixture of argillaceous and calcareous materials, with no additions subsequent to calcination excepting water and calcined or uncalcined gypsum.

I. CHEMICAL PROPERTIES

Chemical Limits. The following limits shall not be exceeded:

Loss on ignition, per cent	4.00
Insoluble residue, per cent	0.85
Sulfuric anhydride (SO ₃), per cent	2.00
Magnesia (MgO), per cent	5.00

II. PHYSICAL PROPERTIES

Specific Gravity. The specific gravity of cement shall be not less than 3.10 (3.07 for white Portland cement). Should the test of cement as received fall below this requirement a second test may be made upon an ignited sample. The specific gravity test will not be made unless specifically ordered.

Fineness. The residue on a standard No. 200 sieve shall not exceed 22 per cent by weight.

Soundness. A pat of neat cement shall remain firm and hard, and show no signs of distortion, cracking, checking, or disintegration in the steam test for soundness.

Time of Setting. The cement shall not develop initial set in less than 45 minutes when the Vicat needle is used, or 60 minutes when the Gillmore needle is used. Final set shall be attained within 10 hours.

Tensile Strength. The average tensile strength in pounds per square inch of not less than three standard mortar briquettes composed of one part cement and three parts standard sand, by weight, shall be equal to or higher than the following:

Age at Test Days	Storage of Briquettes	Tensile Strength lb. per sq. in.
7	1 day in moist air, 6 days in water	200
28	1 day in moist air, 27 days in water	300

The average tensile strength of standard mortar at 28 days shall be higher than the strength at 7 days.

III. PACKAGES, MARKING AND STORAGE

Packages and Marking. The cement shall be delivered in suitable bags or barrels with the brand and name of the manufacturer plainly marked thereon, unless shipped in bulk. A bag shall contain 94 lb. net. A barrel shall contain 376 lb. net.

Storage. The cement shall be stored in such a manner as to permit easy access for proper inspection and identification of each shipment, and in a suitable weather-tight building which will protect the cement from dampness.

IV. INSPECTION

Inspection. Every facility shall be provided the purchaser for careful sampling and inspection at either the mill or at the site of the work, as may be specified by the purchaser. At least 10 days from the time of sampling shall be allowed for the completion of the 7-day test, and at least 31 days shall be allowed for the completion of the 28-day test. The cement shall be tested in accordance with the methods hereinafter prescribed. The 28-day test shall be waived only when specifically so ordered.

V. REJECTION

Rejection. The cement may be rejected if it fails to meet any of the requirements of these specifications.

Cement shall not be rejected on account of failure to meet the fineness requirement if upon retest after drying at 100 degrees C. for one hour it meets this requirement.

Cement failing to meet the test for soundness in steam may be accepted if it passes a retest using a new sample at any time within 28 days thereafter.

Packages varying more than 5 per cent from the specified weight may be rejected; and if the average weight of packages in any shipment, as shown by weighing 50 packages taken at random, is less than that specified, the entire shipment may be rejected.

MANUFACTURERS' STANDARD SPECIFICATIONS FOR DEFORMED CONCRETE REINFORCEMENT BARS ROLLED FROM BILLETS

REVISED APRIL 21, 1914

Manufacture. Steel may be made by either the open-hearth or Bessemer process. Bars shall be rolled from standard new billets.

Chemical and Physical Properties. The chemical and physical properties shall conform to the following limits:

Properties Considered	Structural Grade	Intermediate Grade	Hard Grade
PHOSPHORUS, maximum, Bessemer	0.10	0.10	0.10
Open-hearth	0.06	0.06	0.06
Ultimate tensile strength, lb. per sq. in. . .	55-70,000	70-85,000	80,000 min.
Yield point, minimum, lb. per sq. in. . . .	33,000	40,000	50,000
Elongation, per cent in 8-in., minimum . .	<u>1,250,000</u> Tens. Str.	<u>1,125,000</u> Tens. Str.	<u>1,000,000</u> Tens. Str.
COLD BEND WITHOUT FRACTURE: Bars under $\frac{3}{4}$ -in. in diameter or thickness	$180^\circ d = 1t$	$180^\circ d = 3t$	$180^\circ d = 4t$
Bars $\frac{3}{4}$ -in. in diameter or thickness and over	$180^\circ d = 2t$	$90^\circ d = 3t$	$90^\circ d = 4t$

The intermediate and hard grades will be used only when specified.

Chemical Determinations. In order to determine if the material conforms to the chemical limitations prescribed in the preceding tables, analysis shall be made by the manufacturer from a test ingot taken at the time of the pouring of each melt or blow of steel, and a correct copy of such analysis shall be furnished to the engineer or his inspector.

Yield Point. For the purposes of these specifications, the yield point shall be determined by careful observation of the drop of the beam of the testing machine, or by other equally accurate method.

Form of Specimens. Tensile and bending test specimens may be cut from the bars as rolled, but tensile and bending test specimens of deformed bars may be planed or turned for a length of at least nine inches if deemed necessary by the manufacturer in order to obtain uniform cross-section.

Number of Tests. (a)—At least one tensile and one bending test shall be made from each melt of open-hearth steel rolled, and from each blow or lot of ten tons of Bessemer steel rolled. In case bars differing $\frac{3}{8}$ -inch and more in diameter or thickness are rolled from one melt or blow, a test shall be made from the thickest and thinnest material rolled. Should either of these test specimens develop flaws, or should the tensile test specimen break outside of the middle third of its gauged length, it may be discarded and another test specimen substituted therefor. In case a tensile test specimen does not meet the specifications, an additional test may be made.

(b)—The bending test may be made by pressure or by light blows.

Modifications in Elongation for Thin and Thick Material. For bars less than $\frac{7}{16}$ -inch and more than $\frac{3}{4}$ -inch nominal diameter or thickness, the following modifications shall be made in the requirements for elongation:

(a)—For each increase of $\frac{1}{8}$ -inch in diameter or thickness above $\frac{3}{4}$ -inch, a deduction of 1 shall be made from the specified percentage of elongation.

(b)—For each decrease of $\frac{1}{16}$ -inch in diameter or thickness below $\frac{7}{16}$ -inch, a deduction of 1 shall be made from the specified percentage of elongation.

Finish. Material must be free from injurious seams, flaws or cracks, and have a workmanlike finish.

Variation in Weight. Bars for reinforcement are subject to rejection if the actual weight of any lot varies more than 5 per cent over or under the theoretical weight of that lot.

NOTE:—The chemical and physical properties are given for three different grades of steel. In using the specification care should be taken to indicate clearly the grade desired.

GENERAL SPECIFICATONS FOR MATERIALS AND LABOR USED IN REINFORCED CONCRETE CONSTRUCTION

MATERIALS

Cement. The cement used for reinforced concrete construction shall be Portland cement which shall meet the requirements of the specifications and methods of tests last adopted by the American Society for Testing Materials.

Aggregates. (a) *Fine.*—Fine aggregates shall consist of uniformly graded sand or screenings by particles not exceeding $\frac{1}{4}$ -inch in diameter; not more than 30 per cent by weight shall pass a sieve having 50 meshes per linear inch.

Particles shall be hard and clean; shall be free from coatings and soluble substances; shall contain no vegetable loam or other organic matter; and shall yield a 1:3 mortar of a strength at the age of seven days of not less than 70 per cent of that of 1:3 mortar of the same consistency and made with the same cement and standard Ottawa sand.

(b) *Coarse.*—Coarse aggregates shall consist of gravel or crushed stone which is retained on a screen having $\frac{1}{4}$ -inch diameter holes and shall be graded from the smallest to the largest particles. The maximum size of particles shall be determined from the following table:

Nature of work	Maximum Sizes in Inches
Light slabs or partitions using mesh or expanded metal . .	$\frac{1}{2}$
Flat Slab Floors, Beams and Slabs, Girders, Columns, Re- taining Walls, Footings and other moderately heavy work	$\frac{3}{4}$
Heavy work	$1\frac{1}{2}$

Size and quality of stone for rubble concrete shall meet the approval of the Engineer.

All coarse aggregates shall be clean, hard, durable, free from coatings and all deleterious matter.

Water. The water used in mixing concrete shall be free from oil, acid, alkali or organic matter. Concrete shall not be mixed with sea water.

Metal Reinforcement. Bars used as reinforcement in reinforced concrete work shall be manufactured from new billet-steel and shall satisfy the specifications known as the Manufacturers' Standard Specifications for Billet-Steel Concrete Reinforcement Bars. All bars other than spiral wire shall be an approved deformed bar having a positive mechanical bond with the concrete equal to that of the Corrugated Bar, manufactured by the Corrugated Bar Company, Inc., Buffalo, N. Y.

FORMS

Character. Forms for reinforced concrete construction shall be substantial and unyielding, and shall conform to the design of the structure. They shall have a smooth surface in contact with the concrete, which shall be free from adhering material or from other defects which shall mar the finished surface. They shall be sufficiently tight to prevent the leakage of mortar.

The forms shall be so made that all interior angles caused by the junction of slabs and beams or other members shall be chamfered one inch. All exterior angles shall be made square.

Oiling and Inspection. Before placing the concrete in the forms, all debris in the space to be occupied by the concrete shall be removed. Handholes shall be provided at the base of the forms of all columns to render this space accessible for cleaning.

The forms shall be thoroughly oiled (thin mineral oil) before the concrete is placed; or the surface shall be thoroughly wetted (excepting in freezing weather).

PLACING OF REINFORCEMENT

All reinforcement shall be placed in accordance with the plans furnished by the Engineer.

All loose rust or scale, all adhering material, and all oil or other substance which will tend to destroy bonding between the concrete and the reinforcement shall be removed before pouring begins.

MIXING OF CONCRETE

Mixing shall be done in a batch machine mixer of a type which will insure uniform distribution of the materials throughout the mass, and shall continue for the minimum time of one and one-half minutes after all ingredients are assembled in the mixer. For mixers of two or more cubic yards capacity the minimum time of mixing shall be two minutes. The drum of the machine shall be operated at a uniform speed of 200 feet per minute.

Unit of Measure. Measurements of fine and coarse aggregates and of cement, shall be by loose volume. The unit of measure shall be a bag of cement containing 94 pounds net, which should be considered the equivalent of one cubic foot.

Proportioning. The fine and coarse aggregates shall be so proportioned with the cement as to secure the ultimate compressive strength, in twenty-eight days, upon which the design of the structure was based.

The following table is recommended as the maximum ultimate compressive strength of different mixtures of concrete at twenty-eight days:

TABLE OF COMPRESSIVE STRENGTHS OF DIFFERENT MIXTURES OF CONCRETE (In Pounds per Square Inch)

Aggregate	1:3*	1:4½*	1:6*	1:7½*	1:9*
Granite, trap rock	3300	2800	2200	1800	1400
Gravel, hard limestone and hard sandstone . . .	3000	2500	2000	1600	1300
Soft limestone and sandstone	2200	1800	1500	1200	1000
Cinders	800	700	600	500	400

Consistency. The materials shall be mixed wet enough to produce a concrete of such consistency as will flow sluggishly into the forms and about the metal reinforcement, and which at the same time can be conveyed from the mixer to the forms without separation of the coarse aggregate from the mortar. A properly mixed concrete is one which thoroughly sustains or supports the coarser aggregate throughout the mass and which when dumped from a barrel or buggy neither breaks nor flows readily over the edge.

Retempering. The remixing of mortar or concrete that has partly set shall not be permitted.

*The proportions here given are on the basis of separately measured aggregates. For instance; a 1:6 mixture refers to a mixture based on one part of cement and six parts of aggregates which were measured before being combined. A standard 1:2:4 mix, therefore, falls in the above class of 1:6 mix.

Conveying and Placing. After the mixing of the concrete has been completed, it shall be conveyed as rapidly as possible to the place of deposit. No concrete shall be placed which has partly set. Where concrete is conveyed by spouting, the plant shall be of such size and design as to insure a practically continuous flow in the spout. The angle of the spout shall be such as to allow the concrete to flow without a separation of the ingredients. The spout shall be thoroughly cleaned by flushing before and after each run. Where it is impossible to deliver the concrete at the place of deposit without separation of the ingredients, the concrete shall be discharged upon a mixing board where it shall be mixed by turning until of uniform consistency before placing in the forms.

The concrete shall be deposited in the forms in such a manner as will permit the most thorough compacting obtained by working with a straight shovel or slicing tool kept moving up and down until all the ingredients are in their proper place.

Light horizontal reinforcement shall be raised from the bottom forms to allow the flow of the concrete under it. Where chairs are used, or where heavy reinforcement is definitely wired in place, the mass shall be thoroughly worked to insure contact of the mortar with the lower face of the reinforcing material.

Before concrete is placed upon previously poured concrete, care shall be taken to remove all debris from the concrete surface. All laitance shall be removed and the surface shall be thoroughly wetted and slushed with mortar consisting of one part Portland cement and two parts fine aggregate.

When it is necessary to stop pouring at a place where pouring will be resumed at a later date, all necessary grooves for joining future work shall be made before the concrete has set.

Construction Joints. Construction joints in columns shall be located at the base of the bell or flare occurring immediately below the floor slab in flat slab construction. In beam and girder construction the joint in the columns shall be located at the base of the lowest intersecting member at each floor.

Vertical joints formed by bulkheads which it may be necessary to construct in slab or beams shall be made at the center of the span of such slab or beam. In girders into which intersecting members are framed at the center of the span, the bulkhead shall be located within the middle third of the length of the span of such girder. On large beams or girders these bulkheads shall be placed inclined upward toward the nearest column.

Horizontal joints in large girders or other massive units shall be properly keyed by notching.

Lintel beams, whether above or below the slab, shall be poured monolithically with the slab.

No construction joints shall be allowed in footings, the pouring to be continued until the whole footing is completed to the base of the column.

All other joints in pouring shall be made only upon the approval of the Engineer.

Placing Concrete in Freezing Weather. No concrete shall be mixed or placed at a freezing temperature unless special precautions are taken to prevent the use of materials covered with ice crystals or containing frost, and to prevent the concrete from freezing before it has set and sufficiently hardened.

The material used shall be warmed well above the freezing point and the space of

the structure in which pouring is taking place shall be maintained at a temperature well above the freezing point. Aggregates and water used shall not be heated to more than 70 degrees. The use of salt to lower the freezing point shall not be permitted.

Placing Concrete Under Water. Concrete may be placed only in still water, with the use of a tremie properly designed and operated. Concrete shall be mixed with more water than is ordinarily permissible so that it will flow readily through the tremie. Coarse aggregate used in concrete thus placed shall not be more than one inch in diameter.

In case the flow of concrete is interrupted, or in case it is necessary to provide a construction joint, care shall be taken to remove all laitance before proceeding with the work.

Protection of Exposed Surfaces. The surfaces of concrete exposed to premature drying shall be covered and kept wet for a period of at least seven days after pouring.

REMOVAL OF FORMS

Forms shall not be removed from the concrete until it is sufficiently hard to permit of this being done with safety.

In weather of a temperature above 60 degrees, the minimum time after pouring for the removal of forms shall be as follows:

Wall forms and forms for the sides of beams	2 days
Column forms and forms under slabs of span less than 4 feet	4 days
Slabs of span between supported girders or shoring between 4 and 10 feet	6 days

Supports or shoring shall be maintained under horizontal members a minimum time after pouring in accordance with the following table:

Beams, Girders and Flat Slabs in ordinary building construction	3 weeks
Spans over 30 feet	At least 1 month

Under all floors upon which building materials are being placed during construction, the supports or posts shall be left at least two weeks longer than specified in the above schedules.

In weather of a temperature below 60 degrees, the forms and supports shall be left in place a longer period, depending upon the weather encountered.

Especial care shall be taken in the removal of forms from any concrete that may have become frozen. Where it is likely that the concrete might have frozen, it may be tested by placing a piece of the concrete in warm water or upon a stove, after which, if the concrete is properly set, it shall not show any deterioration due to such treatment. A similar test may be made directly upon the structure by submitting it to the flame of a blow torch, which treatment will not produce any melting, if the concrete is properly set. If the concrete has frozen, the forms shall not be removed from it until it has had sufficient time to thoroughly thaw and set in warm weather.

RECOMMENDATIONS ON DESIGN AND WORKING STRESSES IN REINFORCED CONCRETE CONSTRUCTION.

(From the Final Report of the Joint Committee on Concrete and Reinforced Concrete, July 1, 1916)

Massive Concrete. In the design of massive or plain concrete, no account should be taken of the tensile strength of the material, and sections should usually be proportioned so as to avoid tensile stresses except in slight amounts to resist indirect stresses. This will generally be accomplished in the case of rectangular shapes if the line of pressure is kept within the middle third of the section, but in very large structures, such as high masonry dams, a more exact analysis may be required. Structures of massive concrete are able to resist unbalanced lateral forces by reason of their weight; hence the element of weight rather than strength often determines the design. A leaner and relatively cheap concrete, therefore, will often be suitable for massive concrete structures.

It is desirable generally to provide joints at intervals to localize the effect of contraction.

Massive concrete is suitable for dams, retaining walls, and piers in which the ratio of length to least width is relatively small. Under ordinary conditions this ratio should not exceed four. It is also suitable for arches of moderate span.

Reinforced Concrete. The use of metal reinforcement is particularly advantageous in members such as beams in which both tension and compression exist, and in columns where the principal stresses are compressive and where there also may be cross-bending. Therefore, the theory of design here presented relates mainly to the analysis of beams and columns.

General Assumptions. (a) *Loads.*—The forces to be resisted are those due to:

1. *The dead load*, which includes the weight of the structure and fixed loads and forces.
2. *The live load*, or the loads and forces which are variable. The dynamic effect of the live load will often require consideration. Allowance for the latter is preferably made by a proportionate increase in either the live load or the live load stresses. The working stresses hereinafter recommended are intended to apply to the equivalent static stresses thus determined.

In the case of high buildings the live load on columns may be reduced in accordance with the usual practice.

(b) *Lengths of Beams and Columns.*—The span length for beams and slabs simply supported should be taken as the distance from center to center of supports, but need not be taken to exceed the clear span plus the depth of beam or slab. For continuous or restrained beams built monolithically into supports the span length may be taken as the clear distance between faces of supports. Brackets should not be considered as reducing the clear span in the sense here intended, except that when brackets which make an angle of 45 degrees or more with the axis of a restrained beam are built monolithically with the beam, the span may be measured from the section where the combined depth of beam and bracket is at least one-third more than the depth of the beam. Maximum negative moments are to be considered as existing at the end of the span as here defined.

When the depth of a restrained beam is greater at its ends than at midspan and the slope of the bottom of the beam at its ends makes an angle of not more than 15 degrees with the direction of the axis of the beam at midspan, the span length may be measured from face to face of supports.

The length of columns should be taken as the maximum unstayed length.

(c) *Stresses*.—The following assumptions are recommended as a basis for calculations:

1.—Calculations will be made with reference to working stresses and safe loads rather than with reference to ultimate strength and ultimate loads.

2.—A plane section before bending remains plane after bending.

3.—The modulus of elasticity of concrete in compression is constant within the usual limits of working stresses. The distribution of compressive stress in beams is, therefore, rectilinear.

4.—In calculating the moment of resistance of beams the tensile stresses in the concrete are neglected.

5.—The adhesion between the concrete and the reinforcement is perfect. Under compressive stress the two materials are, therefore, stressed in proportion to their moduli of elasticity.

6.—The ratio of the modulus of elasticity of steel to the modulus of elasticity of concrete is taken at 15, except as modified in section on "Working Stresses."

7.—Initial stress in the reinforcement due to contraction or expansion of the concrete is neglected.

It is recognized that some of the assumptions given herein are not entirely borne out by experimental data. They are given in the interest of simplicity and uniformity, and variations from exact conditions are taken into account in the selection of formulas and working stresses.

The deflection of a beam depends upon the strength and stiffness developed throughout its length. For calculating deflection a value of 8 for the ratio of the moduli will give results corresponding approximately with the actual conditions.

T-Beams. In beam and slab construction an effective bond should be provided at the junction of the beam and slab. When the principal slab reinforcement is parallel to the beam, transverse reinforcement should be used extending over the beam and well into the slab.

The slab may be considered an integral part of the beam, when adequate bond and shearing resistance between slab and web of beam is provided, but its effective width shall be determined by the following rules:

(a)—It shall not exceed one-fourth of the span length of the beam;

(b)—Its overhanging width on either side of the web shall not exceed six times the thickness of the slab.

In the design of continuous T-beams, due consideration should be given to the compressive stress at the support.

Beams in which the T-form is used only for the purpose of providing additional compression area of concrete should preferably have a width of flange not more than three times the width of the stem and a thickness of flange not less than one-third of the depth of the beam. Both in this form and in the beam and slab form the web stresses and the limitations in placing and spacing the longitudinal reinforcement will probably be controlling factors in design.

Floor Slabs Supported Along Four Sides. Floor slabs having the supports extending along the four sides should be designed and reinforced as continuous over the supports. If the length of the slab exceeds 1.5 times its width the entire load should be carried by transverse reinforcement.

For uniformly distributed loads on square slabs, one-half the live and dead load may be used in the calculations of moment to be resisted in each direction. For oblong slabs, the length of which is not greater than one and one-half times their width, the moment to be resisted by the transverse reinforcement may be found by using a proportion of the live and dead load equal to that given by the formula $r = \frac{l}{b} - 0.5$, where l = length and b = breadth of slab. The longitudinal reinforcement should then be proportioned to carry the remainder of the load.

In placing reinforcement in such slabs account may well be taken of the fact that the bending moment is greater near the center of the slab than near the edges. For this purpose two-thirds of the previously calculated moments may be assumed as carried by the center half of the slab and one-third by the outside quarters.

Loads carried to beams by slabs which are reinforced in two directions will not be uniformly distributed to the supporting beams and the distribution will depend on the relative stiffness of the slab and the supporting beams. The distribution which may be expected ordinarily is a variation of the load in the beam in accordance with the ordinates of a parabola, having its vertex at the middle of the span. For any given design, the probable distribution should be ascertained and the moments in the beam calculated accordingly.

Continuous Beams and Slabs. When the beam or slab is continuous over its supports, reinforcement should be fully provided at points of negative moment, and the stresses in concrete recommended in the section on "Working Stresses," should not be exceeded. In computing the positive and negative moments in beams and slabs continuous over several supports, due to uniformly distributed loads, the following rules are recommended:

(a) For floor slabs the bending moments at center and at support should be taken at $\frac{wl^2}{12}$ for both dead and live loads, where w represents the load per linear unit and l the span length.

(b) For beams the bending moment at center and at support for interior spans should be taken at $\frac{wl^2}{12}$ and for end spans it should be taken at $\frac{wl^2}{10}$ for center and interior support, for both dead and live loads.

(c) In the case of beams and slabs continuous for two spans only, with their ends restrained, the bending moment both at the central support and near the middle of the span should be taken at $\frac{wl^2}{10}$.

(d) At the ends of continuous beams the amount of negative moment which will be developed in the beam will depend on the condition of restraint or fixedness, and this will depend on the form of construction used. In the ordinary cases a moment of

$\frac{wl^2}{16}$ may be taken; for small beams running into heavy columns this should be increased, but not to exceed $\frac{wl^2}{12}$.

For spans of unusual length, or for spans of materially unequal length, more exact calculations should be made. Special consideration is also required in the case of concentrated loads.

Even if the center of the span is designed for a greater bending moment than is called for by (a) or (b), the negative moment at the support should not be taken as less than the values there given.

Where beams are reinforced on the compression side, the steel may be assumed to carry its proportion of stress in accordance with the ratio of moduli of elasticity, as given in the section on "Working Stresses." Reinforcing bars for compression in beams should be straight and should be two diameters in the clear from the surface of the concrete. For the positive bending moment, such reinforcement should not exceed one per cent of the area of the concrete. In the case of cantilever and continuous beams, tensile and compressive reinforcement over supports should extend sufficiently beyond the support and beyond the point of inflection to develop the requisite bond strength.

In construction made continuous over supports it is important that ample foundations should be provided; for unequal settlements are liable to produce unsightly, if not dangerous cracks. This effect is more likely to occur in low structures.

Girders, such as wall girders, which have beams framed into one side only, should be designed to resist torsional moment arising from the negative moment at the end of the beam.

Bond Strength and Spacing of Reinforcement. Adequate bond strength should be provided. The formula hereinafter given for bond stresses in beams is for straight longitudinal bars. In beams in which a portion of the reinforcement is bent up near the end, the bond stress at places, in both the straight bars and the bent bars, will be considerably greater than for all the bars straight, and the stress at some point may be several times as much as that found by considering the stress to be uniformly distributed along the bar. In restrained and cantilever beams full tensile stress exists in the reinforcing bars at the point of support and the bars should be anchored in the support sufficiently to develop this stress.

In case of anchorage of bars, an additional length of bar should be provided beyond that found on the assumption of uniform bond stress, for the reason that before the bond resistance at the end of the bar can be developed the bar may have begun to slip at another point and "running" resistance is less than the resistance before slip begins.

Where high bond resistance is required, the deformed bar is a suitable means of supplying the necessary strength. But it should be recognized that even with a deformed bar initial slip occurs at early loads, and that the ultimate loads obtained in the usual tests for bond resistance may be misleading. Adequate bond strength throughout the length of a bar is preferable to end anchorage, but, as an additional safeguard, such anchorage may properly be used in special cases. Anchorage furnished by short bends at a right angle is less effective than by hooks consisting of turns through 180 degrees.

The lateral spacing of parallel bars should be not less than three diameters from center to center, nor should the distance from the side of the beam to the center of the nearest bar be less than two diameters. The clear spacing between two layers of bars should be not less than one inch. The use of more than two layers is not recommended, unless the layers are tied together by adequate metal connections, particularly at and near points where bars are bent up or bent down. Where more than one layer is used at least all bars above the lower layer should be bent up and anchored beyond the edge of the support.

Diagonal Tension and Shear. When a reinforced concrete beam is subjected to flexural action, diagonal tensile stresses are set up. A beam without web reinforcement will fail if these stresses exceed the tensile strength of the concrete. When web reinforcement, made up of stirrups or of diagonal bars secured to the longitudinal reinforcement, or of longitudinal reinforcing bars bent up at several points, is used, new conditions prevail, but even in this case at the beginning of loading the diagonal tension developed is taken principally by the concrete, the deformations which are developed in the concrete permitting but little stress to be taken by the web reinforcement. When the resistance of the concrete to the diagonal tension is overcome at any point in the depth of the beam, greater stress is at once set up in the web reinforcement.

For homogeneous beams the analytical treatment of diagonal tension is not very complex, the diagonal tensile stress is a function of the horizontal and vertical shearing stresses and of the horizontal tensile stress at the point considered, and as the intensity of these three stresses varies from the neutral axis to the remotest fibre, the intensity of the diagonal tension will be different at different points in the section, and will change with different proportionate dimensions of length to depth of beam. For the composite structure of reinforced concrete beams, an analysis of the web stresses, and particularly of the diagonal tensile stresses, is very complex; and when the variations due to a change from no horizontal tensile stress in the concrete at remotest fibre to the presence of horizontal tensile stress at some point below the neutral axis are considered, the problem becomes more complex and indefinite. Under these circumstances, in designing recourse is had to the use of the calculated vertical shearing stress as a means of comparing or measuring the diagonal tensile stresses developed, it being understood that the vertical shearing stress is not the numerical equivalent of the diagonal tensile stress, and that there is not even a constant ratio between them. It is here recommended that the maximum vertical shearing stress in a section be used as the means of comparison of the resistance to diagonal tensile stress developed in the concrete in beams not having web reinforcement.

Even after the concrete has reached its limit of resistance to diagonal tension, if the beam has web reinforcement, conditions of beam action will continue to prevail, at least through the compression area, and the web reinforcement will be called on to resist only a part of the web stresses. From experiments with beams it is concluded that it is safe practice to use only two-thirds of the external vertical shear in making calculations of the stresses that come on stirrups, diagonal web pieces, and bent-up bars, and it is here recommended for calculations in designing that two-thirds of the external vertical shear be taken as producing stresses in web reinforcement.

It is well established that vertical members attached to or looped about horizontal members, inclined members secured to horizontal members in such a way as to insure against slip, and the bending of a part of the longitudinal reinforcement at an angle, will increase the strength of a beam against failure by diagonal tension, and that a well-designed and well-distributed web reinforcement may under the best conditions increase the total vertical shear carried to a value as much as three times that obtained when the bars are all horizontal and no web reinforcement is used.

When web reinforcement comes into action as the principal tension web resistance, the bond stresses between the longitudinal bars and the concrete are not distributed as uniformly along the bars as they otherwise would be, but tend to be concentrated at and near stirrups, and at and near the points where bars are bent up. When stirrups are not rigidly attached to the longitudinal bars, and the proportioning of bars and stirrups spacing is such that local slip of bars occurs at stirrups, the effectiveness of the stirrups is impaired, though the presence of stirrups still gives an element of toughness against diagonal tension failure.

Sufficient bond resistance between the concrete and the stirrups or diagonals must be provided in the compression area of the beam.

The longitudinal spacing of vertical stirrups should not exceed one-half the depth of beam, and that of inclined members should not exceed three-fourths of the depth of beam.

Bending of longitudinal reinforcing bars at an angle across the web of the beam may be considered as adding to diagonal tension resistance for a horizontal distance from the point of bending equal to three-fourths of the depth of beam. Where the bending is made at two or more points, the distance between points of bending should not exceed three-fourths of the depth of the beam. In the case of a restrained beam the effect of bending up a bar at the bottom of the beam in resisting diagonal tension may not be taken as extending beyond a section at the point of inflection, and the effect of bending down a bar in the region of negative moment may be taken as extending from the point of bending down of bar nearest the support to a section not more than three-fourths of the depth of beam beyond the point of bending down of bar farthest from the support but not beyond the point of inflection. In case stirrups are used in the beam away from the region in which the bent bars are considered effective, a stirrup should be placed not farther than a distance equal to one-fourth the depth of beam from the limiting sections defined above. In case the web resistance required through the region of bent bars is greater than that furnished by the bent bars, sufficient additional web reinforcement in the form of stirrups or attached diagonals should be provided. The higher resistance to diagonal tension stresses given by unit frames having the stirrups and bent-up bars securely connected together both longitudinally and laterally is worthy of recognition. It is necessary that a limit be placed on the amount of shear which may be allowed in a beam; for when web reinforcement sufficiently efficient to give very high web resistance is used, at the higher stresses the concrete in the beam becomes checked and cracked in such a way as to endanger its durability as well as its strength.

The section to be taken as the critical section in the calculation of shearing stresses will generally be the one having the maximum vertical shear, though experiments show that the section at which diagonal tension failures occur is not just at a support even though the shear at the latter point be much greater.

In the case of restrained beams, the first stirrup or the point of bending down of bar should be placed not farther than one-half of the depth of beam away from the face of the support.

It is important that adequate bond strength or anchorage be provided to develop fully the assumed strength of all web reinforcement.

Low bond stresses in the longitudinal bars are helpful in giving resistance against diagonal tension failures and anchorage of longitudinal bars at the ends of the beams or in the supports is advantageous.

It should be noted that it is on the tension side of a beam that diagonal tension develops in a critical way, and that proper connection should always be made between stirrups or other web reinforcement and the longitudinal tension reinforcement, whether the latter is on the lower side of the beam or on its upper side. Where negative moment exists, as is the case near the supports in a continuous beam, web reinforcement to be effective must be looped over or wrapped around or be connected with the longitudinal tension reinforcing bars at the top of the beam in the same way as is necessary at the bottom of the beam at sections where the bending moment is positive.

Inasmuch as the smaller the longitudinal deformations in the horizontal reinforcement are, the less the tendency for the formation of diagonal cracks, a beam will be strengthened against diagonal tension failure by so arranging and proportioning the horizontal reinforcement that the unit stresses at points of large shear shall be relatively low.

It does not seem feasible to make a complete analysis of the action of web reinforcement, and more or less empirical methods of calculation are therefore employed. Limiting values of working stresses for different types of web reinforcement are given in the section on "Working Stresses." The conditions apply to cases commonly met in design. It is assumed that adequate bond resistance or anchorage of all web reinforcement will be provided.

When a flat slab rests on a column, or a column bears on a footing, the vertical shearing stresses in the slab or footing immediately adjacent to the column are termed punching shearing stresses. The element of diagonal tension, being a function of the bending moment as well as of shear, may be small in such cases, or may be otherwise provided for. For this reason the permissible limit of stress for punching shear may be higher than the allowable limit when the shearing stress is used as a means of comparing diagonal tensile stress. The working values recommended are given in the section on "Working Stresses."

Columns. By columns are meant compression members of which the ratio of unsupported length to least width exceeds about four, and which are provided with reinforcement of one of the forms hereafter described.

It is recommended that the ratio of unsupported length of column to its least width be limited to fifteen.

The effective area of hooped columns or columns reinforced with structural shapes shall be taken as the area within the circle enclosing the spiral or the polygon enclosing the structural shapes.

Columns may be reinforced by longitudinal bars; by bands, hoops, or spirals, together with longitudinal bars; or by structural forms which are sufficiently rigid to

have value in themselves as columns. The general effect of closely spaced hooping is to greatly increase the toughness of the column and to add to its ultimate strength, but hooping has little effect on its behavior within the limit of elasticity. It thus renders the concrete a safer and more reliable material, and should permit the use of a somewhat higher working stress. The beneficial effects of toughening are adequately provided by a moderate amount of hooping, a larger amount serving mainly to increase the ultimate strength and the deformation possible before ultimate failure.

Composite columns of structural steel and concrete in which the steel forms a column by itself should be designed with caution. To classify this type as a concrete column reinforced with structural steel is hardly permissible, as the steel, generally, will take the greater part of the load. When this type of column is used, the concrete should be adequately tied together by tie plates or lattice bars, which, together with other details, such as splices, etc., should be designed in conformity with standard practice for structural steel. The concrete may exert a beneficial effect in restraining the steel from lateral deflection and also in increasing the carrying capacity of the column. The proportion of load to be carried by the concrete will depend on the form of the column and the method of construction. Generally, for high percentages of steel, the concrete will develop relatively low unit stresses, and caution should be used in placing dependence on the concrete.

The following recommendations are made for the relative working stresses in the concrete for the several types of columns:

(a) Columns with longitudinal reinforcement to the extent of not less than 1 per cent and not more than 4 per cent, and with lateral ties of not less than $\frac{1}{4}$ inch in diameter 12 inches apart, nor more than 16 diameters of the longitudinal bar: the unit stress recommended for axial compression, on concrete piers having a length not more than four diameters, in section on "Working Stresses."

(b) Columns reinforced with not less than 1 per cent and not more than 4 per cent of longitudinal bars and with circular hoops or spirals not less than 1 per cent of the volume of the concrete and as hereinafter specified: a unit stress 55 per cent higher than given for (a), provided the ratio of unsupported length of column to diameter of the hooped core is not more than 10.

The foregoing recommendations are based on the following conditions:

It is recommended that the minimum size of columns to which the working stresses may be applied be 12 inches out to out.

In all cases longitudinal reinforcement is assumed to carry its proportion of stress in accordance with Section (c) 6, page 195. The hoops or bands are not to be counted on directly as adding to the strength of the column.

Longitudinal reinforcement bars should be maintained straight, and should have sufficient lateral support to be securely held in place until the concrete has set.

Where hooping is used, the total amount of such reinforcement shall be not less than one per cent of the volume of the column, enclosed. The clear spacing of such hooping shall not be greater than one-sixth the diameter of the enclosed column and preferably not greater than one-tenth, and in no case more than $2\frac{1}{2}$ -in. Hooping is to be circular and the ends of bands must be united in such a way as to develop their full strength. Adequate means must be provided to hold bands or hoops in place so as to form a

column, the core of which shall be straight and well centered. The strength of hooped columns depends very much upon the ratio of length to diameter of hooped core, and the strength due to hooping decreases rapidly as this ratio increases beyond five. The working stresses recommended are for hooped columns with a length of not more than ten diameters of the hooped core.

The Committee has no recommendation to make for a formula for working stresses for columns longer than ten diameters.

Bending stresses due to eccentric loads, such as unequal spans of beams, and to lateral forces, must be provided for by increasing the section until the maximum stress does not exceed the values above specified. Where tension is possible in the longitudinal bars of the columns, adequate connection between the ends of the bars must be provided to take this tension.

Reinforcing for Shrinkage and Temperature Stresses. When areas of concrete too large to expand and contract freely as a whole are exposed to atmospheric conditions, the changes of form due to shrinkage and to action of temperature are such that cracks may occur in the mass unless precautions are taken to distribute the stresses so as to prevent the cracks altogether or to render them very small. The distance apart of the cracks, and consequently their size, will be directly proportional to the diameter of the reinforcement and to the tensile strength of the concrete, and inversely proportional to the percentage of reinforcement and also to its bond resistance per unit of surface area. To be most effective, therefore, reinforcement (in amount generally not less than one-third of one per cent of the gross area) of a form which will develop a high bond resistance should be placed near the exposed surface and be well distributed. Where openings occur the area of cross-section of the reinforcement should not be reduced. The allowable size and spacing of cracks depends on various considerations, such as the necessity for water-tightness, the importance of appearance of the surface, and the atmospheric changes.

The tendency of concrete to shrink makes it necessary, except where expansion is provided for, to thoroughly connect the component parts of the frame of articulated structures, such as floor and wall members in buildings, by the use of suitable reinforcing material. The amount of reinforcement for such connection should bear some relation to the size of the members connected, larger and heavier members requiring stronger connections. The reinforcing bars should be extended beyond the critical section far enough, or should be sufficiently anchored to develop their full tensile strength.

Flat Slab. The continuous flat slab reinforced in two or more directions and built monolithically with the supporting columns (without beams or girders) is a type of construction which is now extensively used and which has recognized advantages for certain types of structures as, for example, warehouses in which large, open floor space is desired. In its construction, there is excellent opportunity for inspecting the position of the reinforcement. The conditions attending deposition and placing of concrete are favorable to securing uniformity and soundness in the concrete. The recommendations in the following paragraphs relate to flat slabs extending over several rows of panels in each direction. Necessarily the treatment is more or less empirical.

The co-efficients and moments given relate to uniformly distributed loads.

(a) *Column Capital*.—It is usual in flat slab construction to enlarge the supporting columns at their top, thus forming column capitals. The size and shape of the column capital affect the strength of the structure in several ways. The moment of the external forces which the slab is called upon to resist is dependent upon the size of the capital; the section of the slab immediately above the upper periphery of the capital carries the highest amount of punching shear; and the bending moment developed in the column by an eccentric or unbalanced loading of the slab is greatest at the under surface of the slab. Generally the horizontal section of the column capital should be round or square with rounded corners. In oblong panels the section may be oval or oblong, with dimensions proportional to the panel dimensions. For computation purposes, the diameter of the column capital will be considered to be measured where its vertical thickness is at least $1\frac{1}{2}$ inches, provided the slope of the capital below this point nowhere makes an angle with the vertical of more than 45 degrees. In case a cap is placed above the column capital, the part of this cap within a cone made by extending the lines of the column capital upward at the slope of 45 degrees to the bottom of the slab or dropped panel may be considered as part of the column capital in determining the diameter for design purposes. Without attempting to limit the size of the column capital for special cases, it is recommended that the diameter of the column capital (or its dimension parallel to the edge of the panel) generally be made not less than one-fifth of the dimension of the panel from center to center of adjacent columns. A diameter equal to 0.225 of the panel length has been used quite widely and acceptably. For heavy loads or large panels especial attention should be given to designing and reinforcing the column capital with respect to compressive stresses and bending moments. In the case of heavy loads or large panels, and where the conditions of the panel loading or variations in panel length or other conditions cause high bending stresses in the column, and also for column capitals smaller than the size herein recommended, especial attention should be given to designing and reinforcing the column capital with respect to compression and to rigidity of connection to floor slab.

(b) *Dropped Panel*.—In one type of construction the slab is thickened throughout an area surrounding the column capital. The square or oblong of thickened slab thus formed is called a dropped panel or a drop. The thickness and the width of the dropped panel may be governed by the amount of resisting moment to be provided (the compressive stress in the concrete being dependent upon both thickness and width), or its thickness may be governed by the resistance to shear required at the edge of the column capital and its width by the allowable compressive stresses and shearing stresses in the thinner portion of the slab adjacent to the dropped panel. Generally however, it is recommended that the width of the dropped panel be at least four-tenths of the corresponding side of the panel as measured from center to center of columns, and that the offset in thickness be not more than five-tenths of the thickness of the slab outside the dropped panel.

(c) *Slab Thickness*.—In the design of a slab, the resistance to bending and to shearing forces will largely govern the thickness, and, in the case of large panels with light loads, resistance to deflection may be a controlling factor. The following formulas for minimum thicknesses are recommended as general rules of design when the diameter of the column capital is not less than one-fifth of the dimension of the panel from

center to center of adjacent columns, the large dimension being used in the case of oblong panels. For notation, let

t = Total thickness of slab in inches.

L = Panel length in feet.

w = Sum of live load and dead load in pounds per square foot.

Then, for a slab without dropped panels, minimum $t = 0.024L\sqrt{w+1\frac{1}{2}}$; for a slab with dropped panels, minimum $t = 0.02L\sqrt{w+1}$; for a dropped panel whose width is four-tenths of the panel length, minimum $t = 0.03L\sqrt{w+1\frac{1}{2}}$.

In no case should the slab thickness be made less than six inches, nor should the thickness of a floor slab be made less than one-thirty-second of the panel length, nor the thickness of a roof slab less than one-fortieth of the panel length.

(d) *Bending and Resisting Moments in Slabs.*—If a vertical section of a slab be taken across a panel along a line midway between columns, and if another section be taken

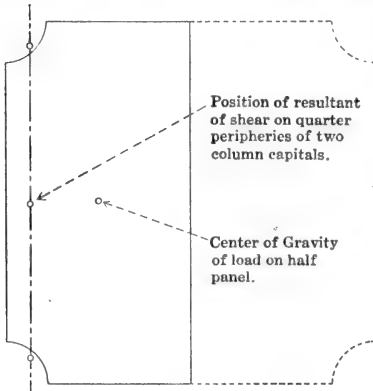

FIG. 10

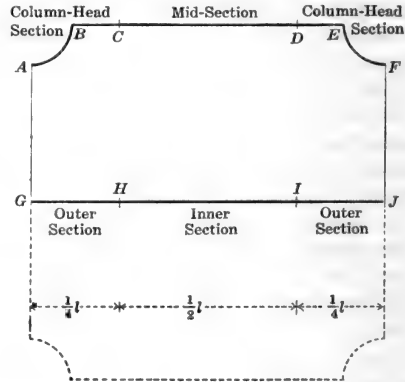

FIG. 11

along an edge of the panel parallel to the first section, but skirting the part of the periphery of the column capitals at the two corners of the panels, the moment of the couple formed by the external load on the half panel, exclusive of that over the column capital (sum of dead and live load) and the resultant of the external shear or reaction at the support at the two column capitals (see Fig. 10), may be found by ordinary static analysis. It will be noted that the edges of the area here considered are along lines of zero shear except around the column capitals. This moment of the external forces acting on the half panel will be resisted by the numerical sum of (a) the moment of the internal stresses at the section of the panel midway between columns (positive resisting moment) and (b) the moment of the internal stresses at the section referred to at the end of the panel (negative resisting moment). In the curved portion of the end section (that skirting the column), the stresses considered are the components which act parallel to the normal stresses on the straight portion of the section. Analysis shows that, for a uniformly distributed load, and round columns, and square

panels, the numerical sum of the positive moment and the negative moment at the two sections named is given quite closely by the equation

$$M_x = \frac{1}{8} w l \left(l - \frac{2c}{3} \right)^2$$

In this formula and in those which follow relating to oblong panels:

w = sum of the live and dead load per unit of area;

l = side of a square panel measured from center to center of columns;

l_1 = one side of the oblong panel measured from center to center of columns;

l_2 = other side of oblong panel measured in the same way;

c = diameter of the column capital;

M_x = numerical sum of positive moment and negative moment in one direction.

M_y = numerical sum of positive moment and negative moment in the other direction.

(See paper and closure, *Statcal Limitations upon the Steel Requirement in Reinforced Concrete Flat Slab Floors*, by John R. Nichols, Jun. Am. Soc. C. E., Transactions Am. Soc. C. E. Vol. LXXVII.)

For oblong panels, the equations for the numerical sums of the positive moment and the negative moment at the two sections named become,

$$M_x = \frac{1}{8} w l_2 \left(l_1 - \frac{2c}{3} \right)^2$$

$$M_y = \frac{1}{8} w l_1 \left(l_2 - \frac{2c}{3} \right)^2$$

Where M_x = is the numerical sum of the positive moment and the negative moment for the sections parallel to the dimensions l_2 , and M_y is the numerical sum of the positive moment and the negative moment for the sections parallel to the dimensions l_1 .

What proportion of the total resistance exists as positive moment and what as negative moment is not readily determined. The amount of the positive moment and that of the negative moment may be expected to vary somewhat with the design of the slab. It seems proper, however, to make the division of total resisting moment in the ratio of three-eighths for the positive moment to five-eighths for the negative moment.

With reference to variations in stress along the sections, it is evident from conditions of flexure that the resisting moment is not distributed uniformly along either the section of positive moment or that of negative moment. As the law of the distribution is not known definitely, it will be necessary to make an empirical apportionment along the sections; and it will be considered sufficiently accurate generally to divide the sections into two parts and to use an average value over each part of the panel section.

The relatively large breadth of structure in a flat slab makes the effect of local variations in the concrete less than would be the case for narrow members like beams. The tensile resistance of the concrete is less affected by cracks. Measurements of deformations in buildings under heavy load indicate the presence of considerable tensile resistance in the concrete, and the presence of this tensile resistance acts to decrease the intensity of the compressive stresses. It is believed that the use of moment co-efficients somewhat less than those given in a preceding paragraph as derived by analysis is warranted, the calculations of resisting moment and stresses in concrete

and reinforcement being made according to the assumptions specified in this report and no change being made in the values of the working stresses ordinarily used. Accordingly, the values of the moments which are recommended for use are somewhat less than those derived by analysis. The values given may be used when the column capitals are round, oval, square or oblong.

(e) *Names for Moment Sections.*—For convenience, that portion of the section across a panel along a line midway between columns which lies within the middle two quarters of the width of the panel (*HI*, Fig. 11), will be called the inner section, and that portion in the two outer quarters of the width of the panel (*GH* and *IJ*, Fig. 11) will be called the outer sections. Of the section which follows a panel edge from column capital to column capital and which includes the quarter peripheries of the edges of two column capitals, that portion within the middle two quarters of the panel width (*CD*, Fig. 11) will be called the mid-section, and the two remaining portions (*ABC* and *DEF*, Fig. 11), each having a projected width equal to one-fourth of the panel width, will be called the column-head sections.

(f) *Positive Moment.*—For a square interior panel, it is recommended that the positive moment for a section in the middle of a panel extending across its width be taken as $\frac{1}{25}wl\left(l-\frac{2c}{3}\right)^2$. Of this moment, at least 25 per cent should be provided for in the inner section; in the two outer sections of the panel at least 55 per cent of the specified moment should be provided for in slabs not having dropped panels, and at least 60 per cent in slabs having dropped panels, except that in calculations to determine necessary thickness of slab away from the dropped panel at least 70 per cent of the positive moment should be considered as acting in the two outer sections.

(g) *Negative Moment.*—For a square interior panel, it is recommended that the negative moment for a section which follows a panel edge from column capital to column capital and which includes the quarter peripheries of the edges of the two column capitals (the section altogether forming the projected width of the panel) be taken as $\frac{1}{15}wl\left(l-\frac{2c}{3}\right)^2$. Of this negative moment, at least 20 per cent should be provided for in the mid-section and at least 65 per cent in the two column-head sections of the panel, except that in slabs having dropped panels at least 80 per cent of the specified negative moment should be provided for in the two column-head sections of the panel.

(h) *Moments for Oblong Panels.*—When the length of a panel does not exceed the breadth by more than 5 per cent, computation may be made on the basis of a square panel with sides equal to the mean of the length and the breadth.

When the long side of an interior oblong panel exceeds the short side by more than one-twentieth and by not more than one-third of the short side, it is recommended that the positive moment be taken as $\frac{1}{25}wl_2\left(l_1-\frac{2c}{3}\right)^2$ on a section parallel to the dimension l_2 , and $\frac{1}{25}wl_1\left(l_2-\frac{2c}{3}\right)^2$ on a section parallel to dimension l_1 ; and that the negative moment be taken as $\frac{1}{15}wl_2\left(l_1-\frac{2c}{3}\right)^2$ on a section at the edge of the panel correspond-

ing to the dimension l_2 , and $\frac{1}{15}wl_1\left(l_2-\frac{2c}{3}\right)^2$ at a section in the other direction. The

limitations of the apportionment of moment between inner section and outer section and between mid-section and column-head sections may be the same as for square panels.

(i) *Wall Panels.*—The co-efficient of negative moment at the first row of columns away from the wall should be increased 20 per cent over that required for interior panels, and likewise the co-efficient of positive moment at the section half way to the wall should be increased by 20 per cent. If girders are not provided along the wall or the slab does not project as a cantilever beyond the column line, the reinforcement parallel to the wall for the negative moment in the column-head section and for the positive moment in the outer section should be increased by 20 per cent. If the wall is carried by the slab this concentrated load should be provided for in the design of the slab. The co-efficient of negative moments at the wall to take bending in the direction perpendicular to the wall line may be determined by the conditions of restraint and fixedness as found from the relative stiffness of columns and slab, but in no case should it be taken as less than one-half of that for interior panels.

(j) *Reinforcement.*—In the calculation of moments all the reinforcing bars which cross the section under consideration and which fulfill the requirements given under paragraph (l) of this chapter may be used. For a column-head section reinforcing bars parallel to the straight portion of the section do not contribute to the negative resisting moment for the column-head section in question. In the case of four-way reinforcement the sectional area of the diagonal bars multiplied by the sine of the angle between the diagonal of the panel and straight portion of the section under consideration may be taken to act as reinforcement in a rectangular direction.

(k) *Point of Inflection.*—For the purpose of making calculations of moments at sections away from the sections of negative moment and positive moment already specified, the point of inflection on any line parallel to a panel edge may be taken as one-fifth of the clear distance on that line between the two sections of negative moment at the opposite ends of the panel indicated in paragraph (e), of this chapter. For slabs having dropped panels the co-efficient of one-fourth should be used instead of one-fifth.

(l) *Arrangement of Reinforcement.*—The design should include adequate provision for securing the reinforcement in place so as to take not only the maximum moments, but the moments at intermediate sections. All bars in rectangular bands or diagonal bands should extend on each side of a section of maximum moment, either positive or negative, to points at least twenty diameters beyond the point of inflection as defined herein or be hooked or anchored at the point of inflection. In addition to this provision bars in diagonal bands used as reinforcement for negative moment should extend on each side of a line drawn through the column center at right angles to the direction of the band at least a distance equal to thirty-five one-hundredths of the panel length, and bars in diagonal bands used as reinforcement for positive moment should extend on each side of a diagonal through the center of the panel at least a distance equal to thirty-five one-hundredths of the panel length; and no splice by lapping should be permitted at or near regions of maximum stress except as just described. Continuity of reinforcing bars is considered to have advantages, and it is recommended that not more than one-third of the reinforcing bars in any direction be made of a length less

than the distance center to center of columns in that direction. Continuous bars should not all be bent up at the same point of their length, but the zone in which this bending occurs should extend on each side of the assumed point of inflection, and should cover a width of at least one-fifteenth of the panel length. Mere draping of the bars should not be permitted. In four-way reinforcement the position of the bars in both diagonal and rectangular directions may be considered in determining whether the width of zone of bending is sufficient.

(m) *Reinforcement at Construction Joints.*—It is recommended that at construction joints extra reinforcing bars equal in section to 20 per cent of the amount necessary to meet the requirements for moments at the section where the joint is made be added to the reinforcement, these bars to extend not less than 50 diameters beyond the joint on each side.

(n) *Tensile and Compressive Stresses.*—The usual method of calculating the tensile and compressive stresses in the concrete and in the reinforcement, based on the assumptions for internal stresses given in this chapter, should be followed. In the case of the dropped panel the section of the slab and dropped panel may be considered to act integrally for a width equal to the width of the column-head section.

(o) *Provision for Diagonal Tension and Shear.*—In calculations for the shearing stress which is to be used as the means of measuring the resistance to diagonal tension stress, it is recommended that the total vertical shear on two column-head sections constituting a width equal to one-half the lateral dimensions of the panel, for use in the formula for determining critical shearing stresses, be considered to be one-fourth of the total dead and live load on a panel for a slab of uniform thickness, and to be three-tenths of the sum of the dead and live loads on a panel for a slab with dropped panels. The formula for shearing unit stress may then be written $v = \frac{0.25W}{bjd}$ for slabs of uniform thickness, and $v = \frac{0.30W}{bjd}$ for slabs with dropped panels, where W is the sum of the dead and live load on a panel, b is half the lateral dimension of the panel measured from center to center of columns, and jd is the lever arm of the resisting couple at the section.

The calculation of what is commonly called punching shear may be made on the assumption of a uniform distribution over the section of the slab around the periphery of the column capital and also of a uniform distribution over the section of the slab around the periphery of the dropped panel, using in each case an amount of vertical shear greater by 25 per cent than the total vertical shear on the section under consideration.

The values of working stresses should be those recommended for diagonal tension and shear in the section on "Working Stresses."

(p) *Walls and Openings.*—Girders or beams should be constructed to carry walls and other concentrated loads which are in excess of the working capacity of the slab. Beams should also be provided in case openings in the floor reduce the working strength of the slab below the required carrying capacity.

(q) *Unusual Panels.*—The co-efficients, apportionments, and thicknesses recommended are for slabs which have several rows of panels in each direction, and in which the size of the panels is approximately the same. For structures having a width of one,

two, or three panels, and also for slabs having panels of markedly different sizes, an analysis should be made of the moments developed in both slab and columns, and the values given herein modified accordingly. Slabs with paneled ceiling or with depressed paneling in the floor are to be considered as coming under the recommendations herein given.

(r) *Bending Moments in Columns.*—Provision should be made in both wall columns and interior columns for the bending moment which will be developed by unequally loaded panels, eccentric loading, or uneven spacing of columns. The amount of moment to be taken by a column will depend upon the relative stiffness of columns and slab, and computations may be made by rational methods, such as the principal of least work, or of slope and deflection. Generally, the larger part of the unequalized negative moment will be transmitted to the columns, and the column should be designed to resist this bending moment. Especial attention should be given to wall columns and corner columns.

WORKING STRESSES

General Assumptions. The following working stresses are recommended for static loads. Proper allowances for vibration and impact are to be added to live loads where necessary to produce an equivalent static load before applying the unit stresses in proportioning parts.

In selecting the permissible working stress on concrete, the designer should be guided by the working stresses usually allowed for other materials of construction, so that all structures of the same class composed of different materials may have approximately the same degree of safety.

The following recommendations as to allowable stresses are given in the form of percentages of the ultimate strength of the particular concrete which is to be used; this ultimate strength is that developed at an age of twenty-eight days, in cylinders 8 inches in diameter and 16 inches long, of proper consistency† made and stored under laboratory conditions. In the absence of definite knowledge in advance of construction as to just what strength may be expected, the committee submits the following values as those which should be obtained with materials and workmanship in accordance with the recommendations of this report.

Although occasional tests may show higher results than those here given, the Committee recommends that these values should be the maximum used in design.

TABLE OF COMPRESSIVE STRENGTHS OF DIFFERENT MIXTURES OF CONCRETE
(In Pounds per Square Inch)

Aggregate	1:3*	1:4½*	1:6*	1:7½*	1:9*
Granite, trap rock	3300	2800	2200	1800	1400
Gravel, hard limestone and hard sandstone . . .	3000	2500	2000	1600	1300
Soft limestone and sandstone	2200	1800	1500	1200	1000
Cinders	800	700	600	500	400

NOTE.—For variations in the moduli of elasticity see section on “Working Stresses.”

Bearing. When compression is applied to a surface of concrete of at least twice the loaded area, a stress of 35 per cent of the compressive strength may be allowed in the area actually under load.

† See Consistency, page 191.

Axial Compression. For concentric compression on a plain concrete pier, the length of which does not exceed four diameters, or on a column reinforced with longitudinal bars only, the length of which does not exceed 12 diameters, 22.5 per cent of the compressive strength may be allowed.

For other forms of columns the stresses obtained from the ratios given in the preceding section on "Design" may govern.

Compression in Extreme Fiber. The extreme fiber stress of a beam, calculated on the assumption of a constant modulus of elasticity for concrete under working stresses may be allowed to reach 32.5 per cent of the compressive strength. Adjacent to the support of continuous beams stresses 15 per cent higher may be used.

Shear and Diagonal Tension. In calculations on beams in which the maximum shearing stress in a section is used as the means of measuring the resistance to diagonal tension stress, the following allowable values for the maximum vertical shearing stress in concrete, calculated by the method given in Formula 22 (see page 8) are recommended:

(a)—For beams with horizontal bars only and without web reinforcement, 2 per cent of the compressive strength.

(b)—For beams with web reinforcement consisting of vertical stirrups looped about the longitudinal reinforcing bars in the tension side of the beam and spaced horizontally not more than one-half the depth of the beam; or for beams in which longitudinal bars are bent up at an angle of not more than 45 degrees or less than 20 degrees with the axis of the beam, and the points of bending are spaced horizontally not more than three-quarters of the depth of the beam apart, not to exceed $4\frac{1}{2}$ per cent of the compressive strength.

(c)—For a combination of bent bars and vertical stirrups looped about the reinforcing bars in the tension side of the beam and spaced horizontally not more than one-half of the depth of the beam, 5 per cent of the compressive strength.

(d)—For beams with web reinforcement (either vertical or inclined) securely attached to the longitudinal bars in the tension side of the beam in such a way as to prevent slipping of bar past the stirrup, and spaced horizontally not more than one-half of the depth of the beam in case of vertical stirrups and not more than three-fourths of the depth of the beam in the case of inclined members, either with longitudinal bars bent up or not, 6 per cent of the compressive strength.

The web reinforcement in case any is used should be proportioned by using two-thirds of the external vertical shear in Formula 24 or 25 (see page 9). The effect of longitudinal bars bent up at an angle of from 20 to 45 degrees with the axis of the beam may be taken at sections of the beam in which the bent up bars contribute to diagonal tension resistance (see "Diagonal Tension and Shear," page 198) as reducing the shearing stresses to be otherwise provided for. The amount of reduction of the shearing stress by means of bent up bars will depend upon their capacity, but in no case should be taken as greater than $4\frac{1}{2}$ per cent of the compressive strength of the concrete over the effective cross-section of the beam (Formula 22). The limit of tensile stress in the bent up portion of the bar calculated by Formula 25, using in this formula an amount of total shear corresponding to the reduction in shearing stress assumed for the bent up bars, may be taken as specified for the working stress of steel, but in the calculations the stress in the bar due to its part as longitudinal

reinforcement of the beam should be considered. The stresses in stirrups and inclined members when combined with bent up bars are to be determined by finding the amount of the total shear which may be allowed by reason of the bent up bars, and subtracting this shear from the total external vertical shear. Two-thirds of the remainder will be the shear to be carried by the stirrups, using Formulas 24 or 25 (see page 9).

Where punching shear occurs, provided the diagonal tension requirements are met, a shearing stress of 6 per cent of the compressive strength may be allowed.

Bond. The bond stress between concrete and plain reinforcing bars may be assumed at 4 per cent of the compressive strength, or 2 per cent in the case of drawn wire. In the best types of deformed bar the bond stress may be increased, but not to exceed 5 per cent of the compressive strength of the concrete.

Reinforcement. The tensile or compressive stress in steel should not exceed 16,000 pounds per square inch.

In structural steel members the working stresses adopted by the American Railway Engineering Association are recommended.

Modulus of Elasticity. The value of the modulus of elasticity of concrete has a wide range, depending on the materials used, the age, the range of stresses between which it is considered, as well as other conditions. It is recommended that in computations for the position of the neutral axis, and for the resisting moment of beams and for compression of concrete in columns, it be assumed as:

(a)—One-fortieth that of steel, when the strength of the concrete is taken as not more than 800 pounds per square inch.

(b)—One-fifteenth that of steel, when the strength of the concrete is taken as greater than 800 pounds per square inch.

(c)—One-twelfth that of steel, when the strength of the concrete is taken as greater than 2,200 pounds per square inch, and less than 2,900 pounds per square inch, and

(d)—One-tenth that of steel, when the strength of the concrete is taken as greater than 2,900 pounds per square inch.

Although not rigorously accurate, these assumptions will give safe results. For the deflection of beams which are free to move longitudinally at the supports, in using formulas for deflection which do not take into account the tensile strength developed in the concrete, a modulus of one-eighth of that of steel is recommended.

SUBJECT INDEX

	PAGES
AMERICAN Society for Testing Materials, cement specifications	186-187
AREAS—Circles	182-183
Circular segments	174
Column sections	157-158
Corrugated Bars	164
Reinforcement for slabs	148
Triangles	175
Various sections	168-171
Wire	167
BARS—Moments of inertia	160
Reinforcing	164-166
Specifications	188-189
BEAMS—Continuous, moments and shears	38-48
Continuous, moment factors	196-197
Quantities of concrete	161
Rectangular, designing diagrams, explanation	10
Rectangular, diagrams for values of j , k and K	16
Rectangular, formulas	6
Rectangular, standard notation	5
Rectangular, tables of safe loads	79-90
Rectangular, table of values of p , k , j and K	15
Reinforced for compression, designing diagrams, explanation	12-13
Reinforced for compression, diagram	20
Reinforced for compression, formulas	8
Reinforced for compression, standard notation	5
Span of	194-195
Stirrup reinforcement, table	107
Tee, continuous, explanation of tables	59-60
Tee, designing diagrams, explanation	11-12
Tee, diagrams for values of K and j	17-18
Tee, diagrams for values of k and j	19
Tee, dimensions	195
Tee, formulas	7
Tee, standard notation	5
Tee, tables of safe loads	91-106
Wooden	173
BENDING and direct stress, combined	13-14
and direct stress, combined, diagrams	21-24
BOND—Formulas	8
Standard notation	6
Strength	197-198
BRACKETS	194-195
BUILDING code requirements for live loads	51-52
BUILDING materials—weights of	56
CAPS for reinforced concrete piles	141-142
CEMENT specifications	186-187
CIRCLES—Areas and circumferences	182-183
CIRCULAR segments—Areas	174
CIRCUMFERENCES of circles	182-183
COLUMN—Heads, diagram for volume of concrete in	162
Sections, areas, perimeters, etc.	157-158
Spirals, pitch and percentage	150
Spirals, standard wire and spacers	156
Spirals, weight per foot	151-155
Verticals, moments of inertia	159-160

	PAGES
COLUMNS —Bending moments	209
Designing diagrams, explanation	13-14
Formulas	9
Joint Committee recommendations	200-202
Length	195
Spiral, tables of safe loads	122-132
Square tied, tables of safe loads	115-121
Standard notation	6
Tables, explanation	114
Vertical steel for various percentages of core area	149
Wooden	173
COMPRESSIVE reinforcement of beams, diagram	20
CONCRETE —General specifications	190-193
Massive	194
Quantities of materials	163
CONSTRUCTION —General specifications	190-193
Recommendations on design and working stresses, Joint Committee	194-211
CORR —Plate floors—Explanation	108-109
Tables	110-113
CORRUGATED Bars	164
CUBES and cube roots of numbers	182-183
DECIMALS of a foot	185
of an inch	184
DEFLECTION —General formulas	26-37
DESIGN —Final report of Joint Committee	194-211
DESIGNING diagrams—Explanation	10-14
DIAGRAM —Compressive reinforcement of beams	20
Distribution of load for rectangular slabs	25
Values of K , j and k for rectangular beams and slabs	16
Values of k and j for tee beams	19
Values of K' for combined bending and direct stress	21
Values of k for combined bending and direct stress	22
Volume of concrete in column heads	162
DIAGRAMS —Designing, explanation	10-14
Moment and shear coefficients for continuous beams, equal spans	45-48
Values of F for combined bending and direct stress	23-24
Values of K and j for tee beams	17-18
DIAGONAL tension and shear	198-200
DISTRIBUTION of load for rectangular slabs, diagram	25
EARTH pressures	144
F —Diagram for values of, for combined bending and direct stress	23-24
FIREPROOFING —Explanation of slab and beam tables	58
FLAT SLAB —Explanation of	108-109
Column heads, diagram for volume of concrete in	162
Joint Committee recommendations	202-209
Floors, tables	110-113
FLOORS and roofs—Explanation of tables	57-60
FOOTINGS —Combined column, tables	136-139
Explanation of tables	133-135
For reinforced concrete piles	141-142
Square column, table	140
FORMULAS —For columns	114
For properties of sections	168-171
For reactions, bending moments, shears and deflections	26-37
For reinforced concrete design	5-9
For trigonometric solution of triangles	175

	PAGES
FOUNDATIONS—Bearing capacity of soils	147
FRACTIONS and equivalent decimals	184
FRICITION—Coefficients and angles	147
FUNCTIONS—Natural trigonometric	176-181
of numbers	182-183
GYRATION—Radius of, various sections	168-171
INERTIA—Moments of, bars	166
Moments of, column sections	157-158
Moments of, column verticals	159
Moments of, various sections	168-171
<i>j</i> —Diagram for values in rectangular beams and slabs	16
<i>j</i> —Diagram for values in tee beams	17-19
<i>j</i> —Table of values for rectangular beams and slabs	15
JOINT Committee—Final report on design and working stresses	194-211
K—Diagram for values of, rectangular beams and slabs	16
Diagram for values of, tee beams	17-18
Table of values, rectangular beams and slabs	15
<i>k</i> —Diagram for values of, combined bending and direct stress	22
Diagram for values of, rectangular beams	16
Diagram for values of, tee beams	19
Table of values of, rectangular beams and slabs	15
<i>K'</i> —Diagram for values of, combined bending and direct stress	21
LOAD—Building code requirements	51-52
Distribution of, for rectangular slabs	25
LOADS—Dead and live	194
Safe, for flat slab floors	110-113
Safe, for rectangular beams	79-90
Safe, for spiral columns	122-132
Safe, for square tied columns	115-121
Safe, superimposed for clay tile ribbed slabs	67-72
Safe, superimposed for ribbed slabs	73-78
Safe, superimposed for solid concrete slabs	61-66
Safe, for tee beams	91-106
In warehouses	49-50
For wooden beams and columns	173
LOGARITHMS of numbers	182-183
MANUFACTURERS' standard specifications for deformed bars	188-189
MATERIALS—Building, weight of	56
Quantities for concrete	163
Weights of	53-55
MODULUS—Section, various sections	168-171
MOMENTS—Bending, continuous beams	38-48
Bending, general formulas for	28-37
Of inertia, bars	160
Of inertia, column sections	157-158
Of inertia, column verticals	159
Of inertia, various sections	168-171
Theorem of three	38-44
<i>p</i> —Table of values of, rectangular beams and slabs	15
PERIMETERS—Column sections	157-158
PILE caps	141-142
PILES—Reinforced concrete	143
PRESSURES—Earth and water	144
PROPERTIES of sections	168-171
RADIUS of gyration of various sections	168-171
REACTIONS—General formulas for	28-37
RECIPROCALs of numbers	182-183

	PAGES
REINFORCEMENT—Corrugated Bars	164-166
RETAINING walls—Cantilever	145-146
RIBBED slabs—Clay tile, safe load tables	67-72
Explanation of tables for	59
Steel or wood forms, safe load tables	73-78
ROOFS—Floors and, explanation of tables	57-60
SECTION modulus—Various sections	168-171
SECTIONS—Properties of	168-171
SEGMENTS—Area of circular	174
SHEAR for continuous beams	38-48
SHEAR—Diagonal tension and	198-200
Explanation of slab and beam tables	58
Formulas for	8
General formula for	28-37
Standard notation for	6
SHRINKAGE—Reinforcing for202
SLAB—Area of reinforcement per foot width	148
Flat, Joint Committee recommendation	202-209
SLABS—Clay tile ribbed, explanation of tables	59
Clay tile ribbed, tables of safe loads	67-72
Continuous, moment factors	196-197
Distribution of load for rectangular	25
Flat, explanation of	108-109
Flat, tables	110-113
Ribbed, explanation of tables	59
Ribbed, table of safe loads	73-78
Solid concrete, explanation of tables	58-59
Solid concrete, tables of safe loads	61-66
Supported on four sides	196
SOIL values—Combined column footings	136-139
Square column footings	140
SOILS—Bearing capacity of	147
SPACERS—Column spiral, tee section	156
SPACING of slab bars for steel areas per foot width	148
SPAN of beams	194-195
SPECIFICATIONS for deformed bars	188-189
for Portland cement	186-187
general, for reinforced concrete	190-193
SPIRALS—Column, pitch and percentage	150
Column, standard wire and spacers	156
Column, weight per foot height	151-155
SQUARES and square roots of numbers	182-183
STIRRUP reinforcement for uniformly loaded beams	107
STRESS—Combined bending and direct	13-14
Combined bending and direct, diagrams	21-24
STRESSES—Joint Committee recommendations	194-211
Temperature and shrinkage	202
Timber	172
Working, Joint Committee	209-211
TABLES—American Steel and Wire Company's gauges	167
Area of reinforcement per foot width of slab	148
Areas of circular segments	174
Bearing capacity of soils	147
Caps for reinforced concrete piles	141-142
Cantilever retaining walls	145-146
Column spiral weights	151-155
Column vertical steel	149

	PAGES
TABLES —Combined column footings	136-139
Corrugated Bars	164
Decimals of a foot	185
Decimals of an inch	184
Earth and water pressures	144
Flat slab floors	110-113
Functions of numbers	182-183
Moments of inertia of bars	160
Moments of inertia of column verticals	159
Natural trigonometric functions	176-181
Properties of column sections	157-158
Properties of sections	168-171
Quantities of materials for concrete	163
Reinforced concrete piles	143
Safe loads, clay tile ribbed slabs	67-72
Safe loads, rectangular beams	79-90
Safe loads, ribbed slabs, steel or wood forms	73-78
Safe loads, solid concrete slabs	61-66
Safe loads, tee beams	91-106
Spiral columns, safe loads	122-132
Spiral wire and spacers	156
Spirals, pitch and percentage	150
Square column footings	140
Square tied columns, safe loads	115-121
Stirrup reinforcement for uniformly loaded beams	107
Timber	172-173
Trigonometric solution of triangles	175
Values of p , k , j and K	15
Volume of concrete in beams	161
TEMPERATURE —Reinforcing for	202
THEOREM of three moments	38-44
TIMBER —Tables	172-173
TRIANGLES —Trigonometric solution of	175
TRIGONOMETRIC —Natural, functions	176-181
Solution of triangles	175
VOLUMES —Column sections	157-158
Of concrete in beams	161
Of concrete in column heads	162
WALLS —Cantilever retaining	145-146
WAREHOUSES —Table of weight of contents	49-50
WATER pressure	144
WEB reinforcement—Formulas for	8-9
Standard notation for	6
For uniformly loaded beams	107
WEIGHTS of building materials	56
Column sections	157-158
Column spirals	151-155
Corrugated Bars	164
Of materials	53-55
Of timber	172
WIRE —American Steel and Wire Company's gauges	167
Column spiral	156
WOODEN beams and columns	173

RICE LEADERS OF THE WORLD ASSOCIATION

ANNOUNCES THE ELECTION TO
MEMBERSHIP OF THE

CORRUGATED BAR COMPANY, INC.



THIS Association is a coöperative organization composed solely of concerns which adhere to the highest standards in the conduct of their business. These are the

QUALIFICATIONS FOR MEMBERSHIP

- HONOR:** A recognized reputation for fair and honorable business dealings.
- QUALITY:** An honest product, of quality truthfully represented.
- STRENGTH:** A responsible and substantial financial standing.
- SERVICE:** A recognized reputation for conducting business in prompt and efficient manner.

Membership in the Association is an evidence of the distinctive position which the Corrugated Bar Company, Inc. holds as a Specialist in Concrete Reinforcement and Design.

It testifies as to the quality of this company's products and service, and the character of the directing officials.

It is a further assurance that these products are made by a concern worthy of utmost confidence, as only manufacturers of the highest standing in name, product and policy are privileged to display the Association Emblem.

CORRUGATED BARS

THE question of using plain or deformed bars for reinforced concrete construction has been answered in the United States where the volume of such construction is probably greater than in all the rest of the world. Fifteen years ago about 80% of the reinforcement used was plain bars, to-day 80% is deformed bars.

Nearly all building codes, architects' and engineers' specifications and committee recommendations of technical societies allow larger working values for the bond stress of deformed than for plain bars.

A review of available test data on bond shows clearly that American practice is on a very sound basis. Diagram 1 is the average resulting from the tabulation and analysis of the thousands of bond tests made by recognized authorities in the United States and Europe on both plain and Corrugated Bars. The variation in the case of plain bars, from a very low

value for a minimum to a maximum value which approximates only the average of Corrugated Bars, is due entirely to the fact that the bond of a plain bar is a function of accidental surface condition. A smooth bar has a very low bond value; a rusty, pitted, rough bar may have a high value.

An important difference in behavior between plain and Corrugated Bars is shown in Diagram 2. This diagram is a composite of load slip curves taken from University of Illinois tests where conditions were practically identical, and illustrates clearly that plain bars reach a maximum bond value at about 0.01 inch slip and then decrease while Corrugated Bars have much higher bond at the same slip and increase in resistance until a final value several times that of plain bars is reached.

It is not good engineering practice to leave the bond—the most important function of the reinforcement—to chance, while all the other physical properties of the material are required to conform to rigid specifications within narrow limits.

To realize the highest efficiency of bond value, a deformed bar of proper design is required; merely roughening the surface of a bar by haphazard projections may actually decrease its bond value. The twisted bar, for example, for years considered a standard deformed bar, has been found on careful examination to have lower bond resistance than a plain bar.

The conditions governing the design of a satisfactory deformed bar are clearly stated in Bulletin No. 71, University of Illinois, Engineering Experiment Station, as follows: "In a deformed bar of good design the projections should present bearing faces as nearly as possible at right angles to the axis of the bar. The areas of the projections should be such as to preserve the proper ratio between the bearing stress against the concrete ahead of the projections and the shearing stress over the surrounding envelope."

Of all the deformed bars on the market the Corrugated Bar is the only one that substantially fulfills these requirements.



CORRUGATED ROUNDS



CORRUGATED SQUARES

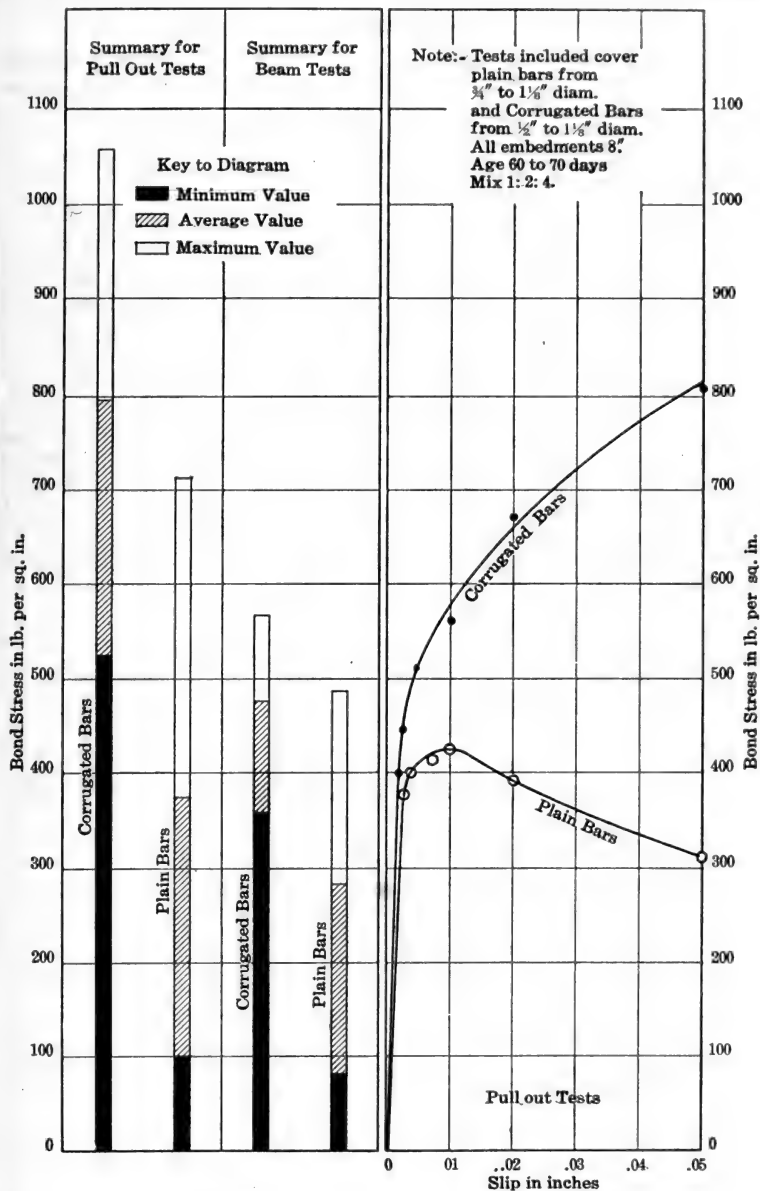
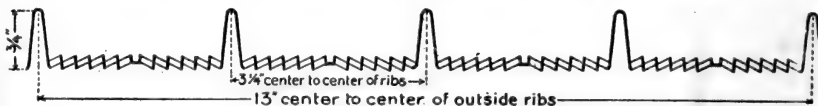
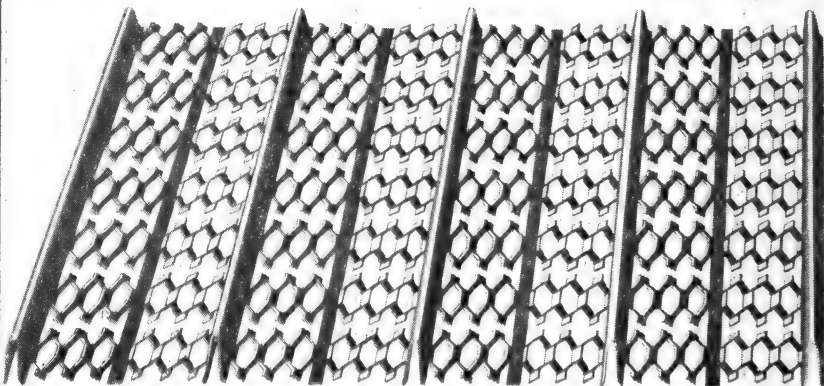

DIAGRAM 1

DIAGRAM 2

CORR-MESH

CORR-MESH is a ribbed expanded metal—a one-piece product, made from a high-grade of rolled sheet steel. The ribs provide strength and stiffness to the sheets which give firm support to concrete and plaster both during construction and after. The metal between the ribs is expanded into a diamond mesh.



3/4" RIB CORR-MESH

For walls and partitions, *3/4" Rib Corr-Mesh* is plastered both sides with cement mortar, forming a monolithic wall of great strength. The ribs do away with extra studding—a saving in material and labor cost.

For walls and floors, *3/4" Rib Corr-Mesh* acts as form work. It supports the wet concrete; no deck centering is required.

APPLICATION OF 3/4" RIB CORR-MESH

FOUNDRIES AND LIGHT MANUFACTURING PLANTS: Replaces corrugated iron and wood siding. *Corr-Mesh* is the ideal method of construction for roofs, floors, partitions and exterior walls.

RAILROADS: Handsome, permanent, fireproof stations, sheds and wayside buildings in stucco at low cost.

AMUSEMENT PARK BUILDINGS: *Corr-Mesh* makes possible the only low cost construction on which insurance can be obtained.

CORR-MESH

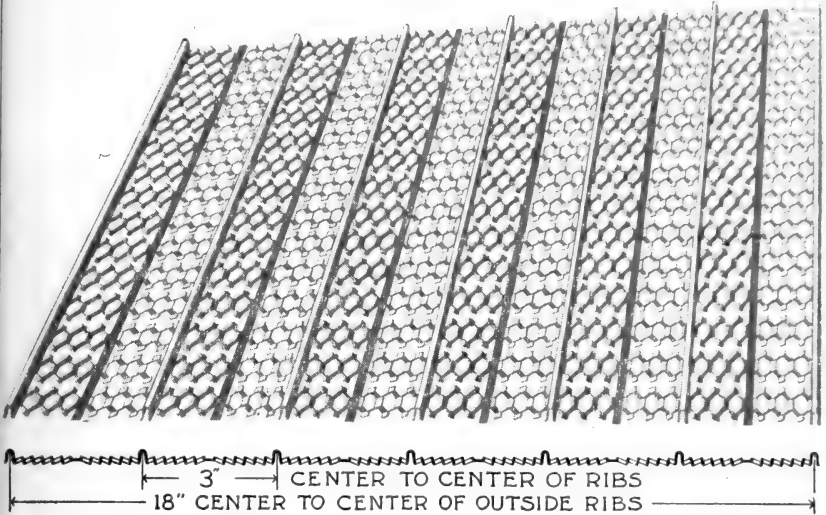

$\frac{5}{16}$ " RIB CORR-MESH

For ceilings, $\frac{5}{16}$ " *Rib Corr-Mesh* is used extensively, where it greatly reduces the material required in the supporting framework, and cuts down the cost of erection.

For stucco construction it eliminates furring strips and makes a strong and permanent reinforcement for the plaster covering.

APPLICATION OF $\frac{5}{16}$ " RIB CORR-MESH

RESIDENCES: Stucco walls are handsome, permanent and fire-resisting. Old wooden houses may be transformed at small cost into attractive residences of greatly increased value.

GARAGES, STABLES AND OUTBUILDINGS of stucco construction with $\frac{5}{16}$ " *Rib Corr-Mesh* are low in cost, permanent, and free from repair expense.

FENCES which present an artistic and substantial appearance are constructed with *Corr-Mesh*.

CORRUGATED BAR COMPANY, INC.

BUFFALO, N. Y.

FABRICATED REINFORCEMENT READY TO PLACE IN THE FORMS



READY TO PLACE
CORR-BAR UNITS

SHOP fabricated reinforcement marks a turning point in reinforced concrete construction. It is only a question of time when the practice of organizing a fabrication crew, for each job, with local inexperienced common labor, must give way to well-established shop practice, in which hand labor is replaced by machine production.

Shop fabrication secures accuracy, thereby eliminating one important factor of uncertainty in construction. It secures economy and facilitates supervision and inspection. It saves storage and working space at the building site, often a matter of great importance, and by decreasing the amount of labor in the field removes some of the uncertainty and annoyance connected with the handling of labor.

Reinforcement should not only be fabricated in the shop, but assembled into units, as far as practicable, properly marked and made ready to place directly in the forms.

For beam reinforcement the Corr-Bar Unit is an ideal example of shop fabricated reinforcement. Instead of depending upon the skill of the individual workman to fabricate and assemble twenty to thirty pieces and place them properly in the forms, one unit is made in the shop by machine operators under the direction of an organization especially trained to do this work. The unit is inspected and marked and so equipped with supporting devices as to insure its proper place in the structure.

ENGINEERING SERVICE DEPARTMENT



THE Corrugated Bar Company, Inc., since its inception, more than twenty-five years ago, has been primarily an engineering organization. It has been a pioneer in the field of reinforced concrete not only in the development of scientifically correct reinforcing materials and systems of construction, but through investigation and presentation of rational methods of design.

Under the direction of its engineers elaborate and painstaking research and test programs have been carried out, earning for the company an enviable reputation and standing in professional circles.

The engineering department has developed under highly competitive conditions, making it of necessity efficient and economical in the execution of its designs and it is safe to say that for variety and wealth of experience it is unsurpassed by any organization of its kind. As a result of its experience it has been called upon frequently to act in a consulting capacity on numerous reinforced concrete structures in the United States and many foreign countries. The constantly increasing demand for this class of service resulted in the organization of an Engineering Service Department.

The service rendered by this department—divorced entirely from the company's products—is available to architects and engineers on a fee basis and consists of:

1. A study of conditions and selection of a type of construction best suited to the purpose of the building.
2. Preliminary and comparative sketches, estimates and cost data as a basis of negotiation between the architect or engineer and his client.
3. Preparation of detail plans and specifications including placing diagrams, fabrication details and bar lists.

By the use of this Service the owner obtains a low bid on the construction best suited to his building and it guarantees full patent protection on any materials or construction involved in the plans supplied.

CORRUGATED BAR COMPANY, INC.

**MUTUAL LIFE BUILDING
BUFFALO, N. Y.**

DISTRICT OFFICES

NEW YORK, N. Y.

Whitehall Building, 17 Battery Place

CHICAGO, ILL.

Great Northern Building, 20 W. Jackson Street

PHILADELPHIA, PA.

Transportation Building, 26 S. Fifteenth Street

BOSTON, MASS.

27 School Street

ST. LOUIS, MO.

Boatmen's Bank Building

DETROIT, MICH.

Penobscot Building

MILWAUKEE, WIS.

Wells Building

KANSAS CITY, MO.

Waldheim Building

ST. PAUL, MINN.

Pioneer Building

ATLANTA, GA.

Grant Building

SYRACUSE, N. Y.

Union Building

HOUSTON, TEXAS

700 N. San Jacinto Street

ERRATA—"USEFUL DATA," FIRST EDITION

- Page 13, line 1, change 747 in denominator of fraction to 805. ✓
- Page 13, line 1, change 7.76% to 7.2%. ✓
- Page 13, line 2, change 7.76 to 7.2. ✓
- Page 14, line 4, change 496 to 505. ✓
- Page 14, line 4, change 292 to 283. ✓
- Page 15, in formula at top of page change P to p . ✓
- Page 22, shift decimal point, in all figures at top of diagram, one place to the left, to read 0.17, 0.18, 0.20, etc. ✓
- Page 26, line 3 from bottom, change W to w . ✓
- Page 26, bottom line, change W_m to w_m . ✓
- Page 27, line 4, change "foot" to "unit." ✓
- Page 27, line 14, change W_m to w_m . ✓
- Page 27, line 14, change "foot" to "unit." ✓
- Page 29, in formula 4 second equation, change $(l-x)$ to $(2l-x)$. ✓
- Page 29, in formula 5 third equation, change $\frac{R_1x}{l}$ to R_1x . ✓
- Page 29, in formula 5 sixth equation, change " $d < b$ and on same side of load" to read " $a < b$ and y on same side of load as b ." ✓
- Page 30, in formula 9, second equation from bottom, change $\frac{3fS}{l}$ to $\frac{fS}{4l}$. ✓
- Page 30, in formula 9, last equation, change l^3 to L^3 . ✓
- Page 32, in formula 13, sixth equation, change $2w$ to w . ✓
- Page 32, in formula 15, fourth equation, change $\frac{wl^2}{3}$ to $\frac{wl^2}{12}$. ✓
- Page 32, in formula 15, fifth equation, change $\frac{fS}{4l^2}$ to $\frac{fS}{l^2}$. ✓
- Page 33, in formula 18, last equation, change $\frac{9wl^2}{32}$ to $\frac{wl^2}{32}$. ✓
- Page 34, in formula 19, second equation, change $2l$ to $4l$. ✓
- Page 34, in formula 19, third equation, change $2l$ to $4l$. ✓
- Page 34, in formula 20, fourth equation, change to read $\frac{w_2x}{2}(l-x) + \frac{w_1x}{6l}(l^2-x^2)$. ✓
- Page 35, in formula 24, fourth equation, change to read $M_x = \frac{3wlx}{20} - \frac{wl^2}{30} - \frac{wx^2}{6l}$. ✓
- Page 36, in formula 26, last equation, change l^3 to L^3 . ✓
- Page 37, change $Mm = \frac{Px}{2l}(2l-a)$, to $Mm = \frac{P}{8l}(2l-a)^2$. ✓
- Page 37, change $Vm = R_1 = \frac{(l-a)}{l} \Sigma P$, to $Vm = R_1 = P + p \frac{(l-a)}{l}$. ✓
- Page 37, change $Vm = \frac{4P}{l}(l-a)$, to $Vm = R_1 = \frac{4P}{l} \left(l - \frac{3a}{2} \right)$. ✓
- Page 37, change $x = \frac{1}{2\Sigma P}(pb - Pa)$, to $x = \frac{l}{2} + \frac{1}{2\Sigma P}(pb - Pa)$. ✓
- Page 141, in 7 pile cap, change 42.4 cu. yd. to 4.24 cu. yd. ✓
- Page 144, in nomenclature, change P to p . ✓
- Page 149, in fourth column, change 0.57 to 0.75 under "PERCENT OF CORE AREA." ✓
- Page 175, Reverse the order of the first two formulas for "AREA." ✓
- Page 175 in fourth line from the bottom, change 5 under the radical to s . ✓

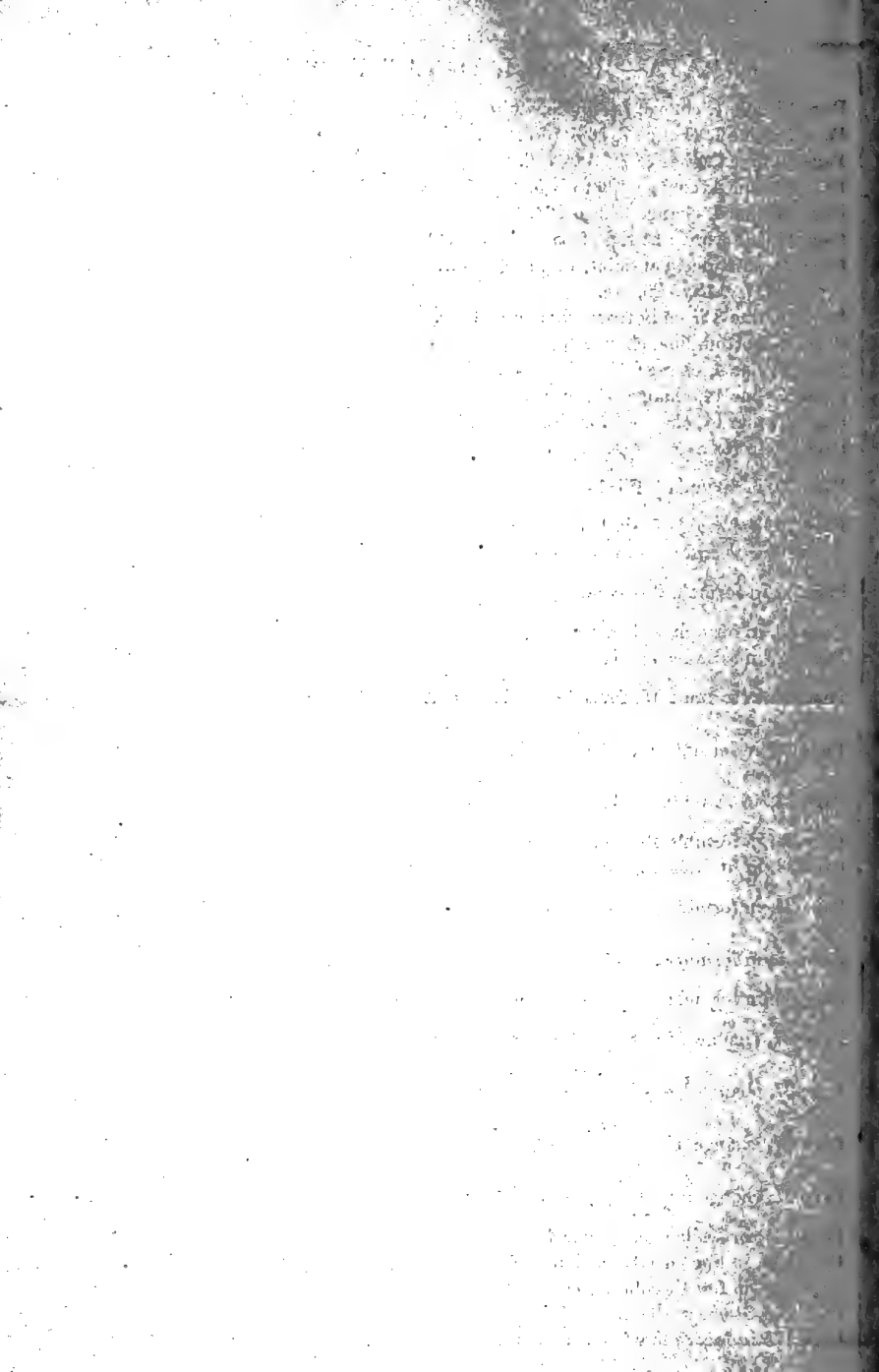

THE
MATHEWS-NORTHRUP
WORKS
BUFFALO CLEVELAND AND NEW YORK



45

11-45

PLEASE DO NOT REMOVE
CARDS OR SLIPS FROM THIS POCKET

UNIVERSITY OF TORONTO LIBRARY

S&M
A
45

