

Historic, archived document

Do not assume content reflects current scientific knowledge, policies, or practices.

76th Anniversary

Vaughan's

Whole-
sale . . .
Price . . .
List . . .
to the . . .
Trade

Chicago . . .
601 W. . . .
Jackson Blvd.
New York . . .
47-49
Barclay St.

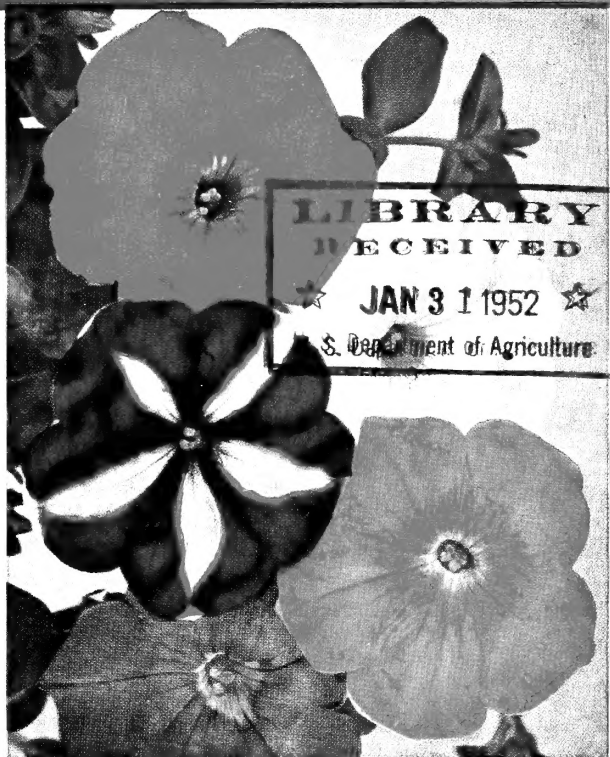

PETUNIA VAUGHAN'S SPECIAL DWARF SMALL FLOWERING MIXED

GREEN LIST

1952

WE PREPAY combination orders amounting to \$25.00 or more, within 30 miles of Chicago. Fertilizers may be included with other items in combination orders.

TERMS: Sixty days to Seed Houses of approved credit, except on cash items named below, or on special quotations. Canadian and foreign accounts payable in United States funds.

Grass, Farm, Bird and Clover Seeds, Onion Sets, Potatoes, Fertilizers, Raffia, Reeds, Mushrooms Spawn and Flower Pots are always net cash.

Garden Tools, Supplies and Insecticides, 1 per cent, 10 days, net 30 days.

CASH DISCOUNTS: We allow a discount of 1½ per cent for cash with order, and on sixty-day goods paid for within 10 days (excepting items sold for net cash, or so quoted).

DISCOUNTS ON STANDARD RETAIL PACKETS FOR RESALE

In no case will a discount be allowed on open account where the retail value of the order sent in at one time is less than \$1.00.

 We will, however, allow a discount of 40 per cent from the retail prices of packets (only) if a check for the full amount accompanies the order. The cost of entering such orders on the records and ledgers is too expensive.

On orders for packet seeds not on consignment that are for resale, discounts on prices in our **SPRING RETAIL CATALOG** will be given as follows:

40 per cent on orders amounting to \$1.00 or more (for packets only exclusive of special offers and collections) when less than 5 of a kind are ordered at one time.

50 per cent on orders (for packets) amounting to \$1.00 and over when at least 5 of a kind are ordered.

25 per cent on single ounces or larger quantities, if order for such amounts to \$1.00 or over and when the variety ordered is not priced in this catalog (the green list) by the ounce or the same quantity as ordered.

None of these seeds are returnable. They are sold outright.

25 per cent on "trade packets" from our "Book for Florists."

Postage will be charged on all of the above orders.

NO ORDER WILL BE CHARGED TO OPEN ACCOUNT FOR AN AMOUNT LESS THAN 75 CENTS.

SEEDS MAILED PREPAID.—We prepay postage, insurance, express or freight when so ordered and charge to customer's account.

C. O. D. BULB ORDERS.—No bulbs will be shipped C. O. D.

INSURANCE.—If package exceeds \$2.00 in value it will be sent by insured mail (insurance fee added on invoice) or express, and if prepaid such prepayment charged to customer. If purchaser wishes seeds by parcel post not insured, at own risk—he must so state when ordering.

Routing Shipments.—Railroad or Express routes given by buyers, which should be on each order, will be strictly followed by us where possible. In all cases where the route is left to our judgment we will select the best we know, but entirely at the risk of the buyer, we assuming no responsibility for delays in transportation.

Please use on every order the following words as routing instructions: "FREIGHT," "TRUCK," "EXPRESS," or "MAIL."

FOR INDEX—See Inside Back Cover.

John C. Vaughan, Pres.

Carl V. Cropp, Vice-Pres.

76th Anniversary

Established 1876

Incorporated 1901

Vaughan's Seed Company

NEW YORK 7
17-49 Barclay Street
Phone BARclay 7-4020

CHICAGO 6
601 W. Jackson Blvd.
Phone FRanklin 2-7560

CHICAGO LOOP STORE:
10 W. RANDOLPH STREET
Nursery and Trial Grounds: Western Springs, Ill.

All telegrams and letters should be addressed to our warehouse and general office at 601 W. Jackson Blvd., Chicago, or 47 Barclay Street, New York.

All prices in this list cancel previous quotations and are subject to advance without notice.

VAUGHAN'S SEED CO. gives no warranty, express or implied, as to the productiveness of any seeds, bulbs, or plants it sells; nor does it warrant fertilizers other than in respect to data required of the seller by statutes. It is expressly agreed that the limit of liability for all claims for loss or damages due to any cause shall be in a sum no greater than the invoice price of the goods and in no case shall it be responsible for loss or damage of the crop.

World Tension and H. C. L. Increase Home Gardens

The increase in home vegetable gardening which developed in 1951 may be expected to continue at higher speed in 1952. The threat of war combined with a rapidly rising cost of living constitute a powerful incentive for the home owner who has garden space.

Come war or peace, he cannot lose by growing as much of his own vegetables as space permits; and two wars have proved that the people do not have to be drafted to take this defense measure.

For leadership in Liberty Gardening the public will depend largely upon the seed trade, and dealers who prepare themselves to supply information as well as seeds and supplies will be well repaid. Your stocks should be replenished early so that if a rush develops you will be ready for it.

Vaughan's Seed Co. helps you do this by listing in this catalogue all the garden goods which we have found desirable for a progressive seed store to carry.

Besides our seeds and bulbs, all the gadgets, tools, insecticides, weed killers, hormones, and other chemical aids and fertilizers which you should offer can be found listed here at lowest prices, and can be ordered from our nearest branch, to reach you in a matter of hours.

New Varieties Assured a Good Market

International tension and the increasing cost of living will stimulate demand for vegetable seeds in 1952. An active campaign to increase home vegetable gardening will be made with government support.

These factors, plus the increasing cost of seed production, all suggest that seedsmen should not wait to cover their needs, since shortages and higher prices may develop. New varieties offer an attractive opportunity, as home gardeners will be looking for the best. We recommend the new All America green pod bush bean Wade; Vaughan's Early Hybrid Tomato, and The Vaughan Hybrid Cucumber as having exceptional merit.

ARTICHOKE

Native of Barbary and South Europe. Perennial or Annual if sown in hot bed in February and transplanted soon as danger of frost is over. Grows 3 to 4 ft. high.

Large Green Globe	Oz.	¼ Lb.	Lb.
Black loam or sand soil best.....	\$0.75	\$2.25	\$6.50

ASPARAGUS

Grown from seed or roots

Mary Washington	Lb.	5 Lbs. Per Lb.	25 Lbs. Per Lb.
Developed by Dr. J. B. Norton, U. S. Department of Agriculture, for resistance to asparagus rust, and considered the most desirable of the Asparagus family. One year is gained in the crop if roots are planted instead of seed, if properly handled. Black loam is most desirable soil for growing. Write for culture.....	\$1.00	\$0.95	\$0.90
	Doz.	100	1000
Roots—1 year old	\$0.40	\$2.00	\$18.00
Roots—2 years old select45	2.50	23.50
Paradise Asparagus	Per Lb.	5 Lbs. Per Lb.	25 Lbs. Per Lb.
A new variety considered desirable for freezing as flavor is particularly good	\$2.00	\$1.90	\$1.85

BEANS

Annual. Any rich garden is suitable for planting. Distance between rows should be 24 to 28 in., while in the row they may be as close as 4 to 6 in. Planting should not be made till the ground has warmed and all danger of frost is over. Average time of maturity given because of the variation in season under different soil conditions and different planting dates.

WAX PODS

	5 Lbs. and over Per Lb.	5 Lbs. Per Lb.	25 Lbs. Per Lb.
Cherokee Wax. 53 days. A new introduction that is comparable with the wax beans to Black Valentine in the green. It has a narrower pod than Sure Crop and is of higher quality. Very prolific.....	\$0.26	\$0.25	\$0.24

BEANS. Wax Pod—Continued

	5 Lbs. and over Per Lb.	Bags Per Lb.	5 Bags Per Lb.
Golden Bountiful Wax (Sure Crop). 53 days. Plant large, sturdy, very productive. Pods 6 to 6½ inches long, ¾ inch wide. Flat, thick, stringless, small amount of fiber, good texture, quality and color. Seeds purplish black, kidney shaped and trifle flattened. Does best in sand loam.	\$0.26	\$0.25	\$0.24
Davis Stringless (Gold Standard Wax). 52 days. Plant medium large and fairly productive. Pods 6 inches long, ½ inch broad; stringless, fleshy, free of fiber. Well drained soil of any kind is suitable. Good color, and plant is quite hardy.25	.24	.23
Pencil Pod Wax . 55 days. Plant large, strong and bears an abundance of pods over a long period making it excellent for home garden use. Pods 6 inches long, ⅞ inch broad. Nearly round, stringless, nearly straight, fleshy, free from fiber and excellent quality. Seed oblong, slightly flattened. Does best in black loam soil.28	.27	.26
Round Pod Kidney Wax (Brittle Wax). 55 days. Very desirable for both home garden and canning trade. Plant medium large, erect, vigorous and productive. Pods waxy light yellow, 5½ inches long, ¾ inch thick. Round, fleshy, brittle, stringless and without fiber. Seed white; blackish eye, kidney shape. Does best in medium heavy soil.28	.27	.26
Top Notch Golden Wax . 52 days. A superior type to the old Improved Golden Wax. Very productive and compact plant. Creamy yellow pods that are straight, oval, stringless and brittle. 5 inches long, ½ inch wide. Seed solid white with brown eye. Decidedly the most prolific of the Golden Wax types. Does best in sand loam.28	.27	.26
Unrivalled Wax . 52 days. Medium size bush of upright growth bearing profusely of rich waxy, yellow pods, 5 inches long, ¾ inch wide; flat and fleshy, brittle, stringless in early stage. Seed small; long, round, yellowish brown. Does best in medium light soil.26	.25	.24

GREEN POD BEANS

While not as attractive looking as the Wax, yet, as a rule, they yield heavier, are just as tender and of as good quality, not as susceptible to disease, especially to blights.

	5 Lbs. and over Per Lb.	Bags Per Lb.	5 Bags Per Lb.
Black Valentine Stringless . 52 days. Medium size bush bearing quantity of long fleshy pods. 6 inches long, ¾ inch wide and from oval to flat, with good green color. Stringless and of good quality, excellent shipper. Seed black, oval. Does best in heavy soil.	\$0.23	\$0.22	\$0.21
Bountiful . 49 days. One of the foremost Market Garden types. A sturdy bush, bearing long flat pods; 6½ inches long, ½ inch wide; stringless, straight, medium light green, some fiber but an excellent shipper. One of the fastest picking beans, good flavor. Seed: solid straw color or brownish yellow. Does well in any soil.25	.24	.23

BEANS. Green Pod—Continued	5 Lbs. and over Per Lb.	Bags Per Lb.	5 Bags Per Lb.
Contender. 47 days. An outstanding release for 1950 and the work of Dr. B. L. Wade. This variety has Tendergreen quality, is exceptionally heavy yielding and is the earliest maturing variety yet bred. Resistant to greasy pod mosaic and common bean mosaic.....	\$0.25	\$0.24	\$0.23
Giant Stringless Green Pod. 53 days. Very similar to Landreth's Stringless, but pods a little more curved and more fleshy with more indentation between the beans. Pods 6 inches long, $\frac{1}{8}$ inch in diameter. Stringless, tender, good flavor, a good canner and home garden sort. Seed: oval and yellowish brown. Does best in heavy soil.....	.23	.22	.21
Logan. 52 days. A cross between a strain of U. S. 5 Refugee and Stringless Black Valentine originated by U.S.D.A. Yields well under adverse conditions such as hot weather at blooming time. It is resistant to powdery mildew and common bean mosaic.27	.26	.25
Longreen. 52 days. A tendergreen type of plant that has broader leaves and pods averaging one inch longer. The pods are round and stringless and of fine quality.....	.26	.25	.24
Rival. 52 days. A 1949 introduction of Dr. W. J. Zaumeyer, U.S.D.A. at Beltsville, a Tendergreen type resistant to mosaic which under most conditions will outyield Tendergreen.28	.29	.30
Streamliner. 55 days. A large bush bearing a heavy crop of long, straight semi-flat pods, 7 inches long, $\frac{1}{2}$ to $\frac{3}{8}$ inches wide and fleshy. Seed a clear white, kidney shaped, excellent as dry bean. Does well in medium heavy soil.28	.27	.26
Stringless Green Pod (Landreth's Stringless). 50 days. The Landreth's Stringless is the best type as it is longer, smoother, straighter than the old type Burpee's Stringless and is used almost exclusively for it. Medium size bush, productive, bearing long, round pods of good color. Pods $5\frac{1}{2}$ inches long, $\frac{1}{8}$ inch in diameter. Stringless, fleshy, nearly straight. Good quality. Seed, coffee brown. Does best in heavy clay soil.....	.22	.21	.20
Tendergreen. 52 days. Good sized bush bearing long round pods of excellent color. 6 inches long, $\frac{3}{8}$ inch through. Good green color, straight, stringless. Seed, mottled buff and purple. Does best in black loam soil.....	.27	.26	.25
Topcrop. 50 days. Gold Medal winner 1950 All America. Dr. W. J. Zaumeyer's most recent introduction and a variety that may top the Tendergreen class. It is mosaic resistant and heavier yielding than Tendergreen. The round pods of Topcrop are $5\frac{1}{2}$ to 6 inches long, $7/16$ inch wide. Seed development is slow, making for a very meaty pod, even in relatively advanced stages of maturity....	.29	.28	.27
Wade. 55 days. Gold medal winner 1952 All America. This variety received the highest number of points ever given a vegetable entry in the All America. Wade is a dark, podded tendergreen type with resistance to mosaic. The Wade is ideal for market, canning or freezing. Wade is named for its originator, the late Dr. B. L. Wade.....	.35	.34	.33

BEANS—Continued

SHELL BEANS

Shell Beans used in the mature stage and considered by many superior to green beans. All of these may be grown throughout the Northern districts. Any medium heavy soil is good for shell beans.

	5 Lbs. and over Per Lb.	Bags Per Lb.	5 Bags Per Lb.
Dwarf Horticultural (Speckled Cranberry) (Dwarf Cherry). Plant medium size, fairly productive 60 days for green shell and 90 days for ripe shell. Pods dark green becoming greenish yellow splashed with carmine. Pods 5 inches long, $\frac{5}{8}$ inch wide. Nearly round at green stage, stringless but having fiber. Seeds full oval, pinkish buff splashed and streaked with purplish red.....	\$0.29	\$0.28	\$0.27
English Broad Windsor. Long Pod. <i>Vicia faba</i> ; (Fava or Horse Bean) 80 to 90 days. Stalk tall slender, erect, pods green hairy, 5 to 6 inches long containing 4 to 6 beans. Green shell beans large flat, light green. Dry seed large circular, flat, reddish brown with black eye. Should be planted early in the north.....	.25	.24	.23
Red Kidney. 95 days. Plant is large, vigorous. Pods 5 inches long, $\frac{1}{2}$ inch broad. Dark green, oval, flat, stringy, tough. Seed reddish brown, kidney shape.24	.23	.22
White Kidney. 100 days. For dry shell use only. Plant is large, hardy, productive. Pods 5 $\frac{1}{2}$ inches long, $\frac{1}{2}$ inch wide. Seed long, white kidney shape. Kidney types as well as field types do well on any medium heavy soil.25	.24	.23
White Marrow. 100 days. Plant large with semi-runners, hardy. Pods 5 inches long, $\frac{1}{2}$ inch in diameter. Seed white, oval, short.....	.25	.24	.23
Field Beans, Great Northern. 90 days. Hardier and heavier vine than the navy, having a longer pod and larger beans. Seed a little longer than round, and clear white in color.18	.17	.16
Michelite. 85 days. A medium small Navy type. A better producer than the standard Navy or than Robust. Bred for resistance to blight. It contains less fat, less gas, and is more resistant and productive.....	.18	.17	.16

SOY BEANS

Bansei. 90 days. Plant 18 to 24 inches, erect, prolific, best for short seasons. Pods 2 to 2 $\frac{1}{2}$ inches by $\frac{1}{2}$ inch by $\frac{3}{8}$ inch, hairy, pale green, indented between fruits, pale yellow as it turns ripe, fruit pale green turning to glossy yellow, oval, flattened. Nodules on roots of plant plentiful and large. $\frac{3}{8}$ inch across.....	.18	.17	.16
-------------------------------------------------------------------------------------------------------------------------------------------------------------------------------------------------------------------------------------------------------------------------------------------------------------------------------------------------------------------------------------------	-----	-----	-----

POLE BEANS

Horticultural Cranberry (Speckled Cranberry, Wren's Egg). 70 days. As a snap bean; 80 days for green shell, excellent home or Market Garden type. Pods 6 inches long, $\frac{5}{8}$ inch wide, thick, straight, stringless, dark green becoming yellowish green splashed with violet red as age progresses.25	.24	.23
-------------------------------------------------------------------------------------------------------------------------------------------------------------------------------------------------------------------------------------------------------------------------------------------------------------------------	-----	-----	-----

BEANS. Pole—Continued

	5 Lbs. and over Per Lb.	Bags Per Lb.	5 Bags Per Lb.
Kentucky Wonder (Old Homestead or Texas Prolific). 65 days. The most widely used of the pole bean types being especially desirable in the south. The type we offer is well selected and rust resistant. An excellent pole, thrifty and very productive, bearing fruit till frost if kept picked. Pods up to 9 inches long and ½ inch in diameter. Nearly round, indented between beans, curved, meaty brittle, fiberless, with a distinct flavor. Seed: buff brown or dun color. All pole beans do best in medium heavy soil.\$0.24		\$0.23	\$0.22
Kentucky Wonder Wax . 65 days. Very similar to Kentucky Wonder green pod. A good climber and productive. Pods 7 inches long, ½ inch in diameter and oval. Fleshy, brittle. Seed chocolate brown, oval flattened.....	.31	.30	.29
Lazy Wife . 74 days. Excellent for snap, green shell or dry beans for the home and Market Garden. A good climber and productive. Pods 6 inches long, ¾ inch wide. Thick, straight, fleshy, brittle and tender. Seed white and plump.	.25	.24	.23
Missouri Wonder . 66 days. Plant is large, good climber. Pods 6 inches by ½ inch. Nearly round, medium green, splashed with red, tough and stringy, seed oblong, grey mottled with tan26	.25	.24
Scarlet Runner . A large tall growing plant bearing brilliant scarlet flowers. Pods 6 inches long, ¾ inch wide, fleshy. Seed long, oval; dark purple mottled with bluish violet...	.27	.26	.25
Yard Long (French Asparagus Bean) (<i>Vigna Sesquipedalis</i>). 70 days. Belongs to the Cow Peas group used mostly as a curiosity. Pod 18 inches long with seed widely spaced, nearly round having slight string and of fair quality. Seed of reddish brown with black circle around eye.35	.34	.33

LIMA BEANS

Bush types are very desirable having a different flavor from garden beans They should be planted after the ground warms and in rich soil, always planting with the eye down and not too deep.

	5 Lbs. and over Per Lb.	Bags Per Lb.	5 Bags Per Lb.
Baby Fordhook . 70 days. Developed by Dr. Roy Magruder, Beltsville, Maryland, USDA. Bush very similar in appearance to Baby Potato. Pods 2½ inches long, ¾ inch wide, filled with small plump beans having a very remarkable flavor. Seed deep green early and fading with age; 3 to 4 in a pod.....\$0.24		\$0.23	\$0.22
Burpee's Improved Bush . 75 days. Bush large and productive. Pods 4¾ inches long, 1¼ inches wide, ¾ inch thick. Seed large flat, greenish white.....	.26	.25	.24
Cangreen Bush . 65 days. Similar to Henderson's Bush. In season of growth and the same size, but remains green when ripening, whereas Henderson turns white. This green color makes it better for commercial canners.....	.22	.21	.20

BEANS. Lima.—Continued

	5 Lbs. and over Per Lb.	Bags Per Lb.	5 Bags Per Lb.
Fordhook 242. 73 days. This is a Fordhook type, large, thick-seeded, 3 to 4 beans to the pod, of fine flavor, easy to shell. Pods are uniform, holding size on late sets. Early and total yield seems heavier and a distinct advantage is its ability to bear pods in hot dry weather. . . .	\$0.25	\$0.24	\$0.23
Fordhook Bush. 75 days. Plant is large, erect, very productive. Pods 4 inches long, 1¼ inches wide, ½ inch thick, containing 3 to 4 large green shell beans of excellent quality. Seed white with greenish tinge; large, plump. Care must be used in planting to have eye down and not too deep.25	.24	.23
Henderson USDA No. 2. 65 days. Very similar to Henderson but a few days earlier and heavier producer, bush similar in all respects. Pods 2¾ inches long, ¾ inch wide, containing 3 to 4 seeds, small oval, flattened, white when ripe. The Lima most used in the northern districts because of earliness and uniformity of maturing.21	.20	.19

POLE LIMA

King of the Garden. 88 days. Plant is tall, hardy, vigorous climber and one of the most grown. Pods 6½ inches long, 1¼ inches wide, ⅜ inch thick, with 4 to 5 large oval beans, greenish white. Seed white, large flat.26	.25	.24
----------------------------------------------------------------------------------------------------------------------------------------------------------------------------------------------------------------------------------------	-----	-----	-----

BEETS

In general, beets may be planted about April 20 to May 1st in the vicinity of Chicago, and they will attain bunching size or cooking size in about 50 to 60 days. The bottoms and tops may be used for greens at an earlier stage. The dates given are for the bunching period when the beet is usually at its prime eating stage; size about 1¾ inches.

	Lb.	5 Lbs. Per Lb.	25 Lbs. Per Lb.	100 Lbs. Per Lb.
Crosby's Egyptian. 50 days. Root flattened globe with small tap root, dark red; interior dark purplish red with slight zoning, excellent for bunching due to large tops.	\$0.75	\$0.70	\$0.65	\$0.60
Detroit Dark Red. 55 days. A very heavy crop of large fine roots if allowed to grow. Roots dark red, globe shaped, smooth, uniform, with small tap root; skin has a crackled appearance around neck. Interior a very dark blood red with very little appearance of zoning; tops medium dark green with red tinge. One of the most universally used types.75	.70	.65	.60
Detroit Perfected. 55 days. As above but more solid dark red interior.80	.75	.70	.65
Early Flat Egyptian. 45 days. An early forcing type having a flat turnip shaped root, red with small tap root; interior dark purplish red with very slight zoning. Tops medium and upright.75	.70	.65	.60
Early Wonder. 50 days. This may be had in light or dark colored interior. Root, from globe to flattened globe, dark red with small tap root; interior deep purplish red with lighter zoning, tops medium small and green, quite similar to Crosby's Egyptian.75	.70	.65	.60

BEETS—Continued

	Lb.	5 Lbs. Per Lb.	25 Lbs. Per Lb.	100 Lbs. Per Lb.
Green Top Bunching. 55 days. Early, tops medium and erect. Foliage greyish green, but does not turn red or brown in the fall. Roots round, smooth and glossy, slightly flattened when mature. Flesh bright blood red. Beet 2½ to 3 inches in diameter.	\$0.80	\$0.75	\$0.70	\$0.65
Long Dark Blood. 75 days. Roots long, smooth, dark red, tapering to a point, 6 to 8 inches long, remaining tender to maturity. Interior dark red as outside with no zoning, tops medium.....	.75	.70	.65	.60

SWISS CHARD

All Chards are used as greens, the tops, if kept cut, will continue to produce greens the season through.

	Lb.	5 Lbs. Per Lb.	25 Lbs. Per Lb.
Broad White Ribbed. 55 days. About 20 inches tall; broad, slightly crumpled, medium green leaves with broad nearly white ribs, very fleshy.....	\$0.55	\$0.50	\$0.45
Summer Spinach (Smooth Leaved). 45 days. The leaves are used for greens the same as spinach or beet top. Sow early in the spring and thin to six inches in the row. Cut the leaves off and new ones grow quickly. Small beet like root.55	.50	.45
Fordhook Giant. 57 days. About 20 inches tall with broad, crumpled, dark green leaves having broad, white, fleshy ribs.55	.50	.45
Lucullus. 52 days. The most popular type; about 20 inches tall, leaves yellowish green, heavily crumpled, wide with broad white ribs.55	.50	.45
Ruby Chard. A recent introduction, having all the chard characteristics excepting color. It has dark green, heavily crumpled leaves and crimson stem and mid rib.....	.85	.80	.75

MANGEL WURZEL

(Stock Beets). 110 days. Heavy yielding with high feeding value.

	Lb.	5 Lbs. Per Lb.	25 Lbs. Per Lb.
Golden Tankard. 100 days. 8 to 10 inches long, 4 to 5 inches in diameter, nearly cylindrical; deep yellow below ground, gray above, flesh yellow with white zones....	\$0.45	\$0.40	\$0.35
Mammoth Long Red. 110 days. Most popular and widest used for stock, poultry, etc. Long tapered roots 12 to 14 inches long, 3 to 5 inches in diameter, tapering to point ¼ to ½ out of ground; light red, flesh white tinged with red or rose45	.40	.35

SUGAR BEET

Used largely for sugar by refineries. Excellent stock feed but not as heavy producer as Mangels. Grows entirely underground.

	Lb.	5 Lbs. Per Lb.	25 Lbs. Per Lb.
Klein's Wanzleben. 100 days. 9 to 11 inches long, 3 to 5 inches in diameter, tapered grey white, interior white....	\$0.45	\$0.40	\$0.35

BROCCOLI

	¼ Lb.	Lb.	5 Lbs. Per Lb.
Green Sprouting Calabrese. 70 days. A good strain for Market, Home Garden or freezing, suitable in north or south. 18 inches tall; branching, forming compact head of bluish green flower buds. After the main head is removed smaller heads are produced from the branches which continue to the end of the season.....	\$0.45	\$1.35	\$1.25
De Cicco. 60 days. An extremely early strain that produces heads for market 10 days to 2 weeks ahead of Early Green Sprouting. Plants medium tall, light green in color, and very productive.....	.50	1.50	1.45

BRUSSELS SPROUTS

	Oz.	¼ Lb.	Per Lb.
Long Island Improved. 90 days. Plant 20 to 24 inches tall with a thick set of small cabbage-like heads the entire length of the stem. Heads 1½ inches in diameter; dark green, excellent quality. Maturing from lower branches upward.	\$0.30	\$0.80	\$2.35

CABBAGE—Yellows Resistant

	¼ Lb.	Lb.	5 Lbs. Per Lb.
All Head Select or Resistant. 80 days. Firm heads, flat to slightly rounded at top, will stand for a long time without bursting. Nearly 100% resistant. Excellent for shipping and early Sauerkraut	\$0.75	\$2.25	\$2.10
All Seasons Improved. 90 days. Nearly 100% resistant in the strongest yellow soil. It is used more for kraut than any other purpose, heads large, 7 inches deep.....	.75	2.25	2.10
Bugner. 100 days. This is the most popular of all the green types of cabbage for market, home garden, kraut and storage. It is one of the heaviest for size of head, being firm, tender and excellent quality. 8 inches in diameter, round, flattened slightly, deep through, 7 inches, weighing 10 pounds or more, outer leaves deep purplish green with a tight folded leaf covering the head.....	.75	2.25	2.10
Detroit Resistant. 63 days. A resistant Golden Acre type of fine uniformity and larger than Golden Acre; a few days earlier than Racine Market. Weight of head 3½ pounds.	1.00	3.00	2.85
Globe. 75 days. Resistant Glory of Enkhousen and very similar in all respects.....	1.00	3.00	2.85
Jersey Queen. 66 days. Very similar to Early Jersey but bred for resistance to yellows.....	.75	2.25	2.10
Marion Market. 75 days. A resistant type of Copenhagen and very similar except a little later and coarser. A very popular mid season market garden variety. Heavy producer and desired for kraut.....	.70	2.00	1.85
Racine Market, Wisconsin Pride. 64 days. Large, round headed, uniform cabbage with characteristic blue green color. Will remain in field longer than other Early cabbages without splitting.....	1.00	3.00	2.85

CABBAGE YELLOWS RESISTANT—Continued	¼ Lb.	Lb.	5 Lbs. Per Lb.
Wisconsin Ballhead Improved. 100 days. Head 7 inches in diameter, nearly round. Solid, smooth, uniform, weighing 7 pounds, smaller and more uniform than No. 8.	\$0.75	\$2.25	\$2.10
Wisconsin Copenhagen. 67 days. A very fine strain of Copenhagen that is resistant.75	2.25	2.10
Wisconsin Hollander No. 8. 110 days. Heads round to flattened, dark green. 8 inches wide, 6½ inches deep and of good quality, weighing 8 pounds. A load will not weigh within 400 pounds as much as the same bulk of Bugner.75	2.25	2.10

CABBAGE—Standard Varieties

Charleston Wakefield. 73 days. Heads pointed or bluntly so, heart shaped, 7½ inches long, 7 inches wide, 4½ pounds in weight. A good southern cabbage for early shipping.45	1.25	1.15
Copenhagen Market. 67 days. Desirable for early Market Home Garden or Kraut. Head round, 7 inches in diameter, weighing 4 pounds, having outer leaves cupping near head but lower so head shows above foliage. Suitable for any soil and sure heading.45	1.25	1.15
Copenhagen Market Extra Early. 65 days. Similar to regular but Danish grown.65	1.85	1.75
Danish Ballhead, Short Stem or Dwarf Amagar. 105 days. Used for shipping, storage and Kraut. Heads round, 7 to 8 inches in diameter, very firm, smooth, solid, weighing 8 pounds. Interior very closely packed, exceptional quality.50	1.50	1.40
Early Flat Dutch. 75 days. Flat head 11 inches wide, 6 inches deep, weighing 10 pounds; medium green color, good keeper.45	1.25	1.15
Early Jersey Wakefield. 62 days. Very pointed, hard head, 7 inches long, 5 inches wide. Desirable for the southern trade; stands close planting, weight 3 pounds.45	1.25	1.15
Golden Acre. 60 days. An early round head 6 inches in diameter and weighing 3 pounds; very firm and one of the earliest for market or Home Garden. Similar to Copenhagen but earlier and smaller.45	1.25	1.15
Golden Acre Early (AH 45). 57 days. Danish grown and similar in all respects to regular Golden Acre but a little earlier and smaller.75	2.25	2.10
Penn State. 105 days. Ballhead type selected from Danish Ballhead. Very uniform and an excellent storage or shipping type. Head a flattened globe 8 inches wide, 7 inches deep, weighing 5 to 6 pounds.50	1.50	1.40
Premium Flat Dutch. 110 days. 12 inches wide, 7 inches deep, weight 12 pounds. One of the largest flat heads and an excellent grower anywhere.45	1.25	1.15

CABBAGE—Continued**CABBAGE—Red**

	¼ Lb.	Lb.	5 Lbs. Per Lb.
Early Red Acre. (Early Red). 90 days. The earliest red cabbage. Earlier than Haco Red, has larger head and is more uniform in color, size and maturity.....	\$0.65	\$1.85	\$1.70
Rock Red Long Island Strain. 100 days. The darkest red strain throughout of any. 7 inches across, 6 inches deep, very dark, weighing 6½ pounds65	1.85	1.70
Red Wisconsin Resistant. 100 days. Same as mammoth Rock Red except it has been bred for yellows resistance.	1.00	3.00	2.85

CABBAGE—Chinese

Chinese Cabbage, Chihli. 70 days. Heads 18 to 20 inches long, 5 to 6 inches wide with heavy rib. All very tender and of the highest quality, tapering at top with nearly flat base. Very firm and well blanched but must be planted in July so as to head in fall cool weather. May be stored by wrapping in paper and keeping in cool dry basement.....	.35	.95	.90
Chinese Cabbage, Michihli. 75 days. A fine new strain of Chinese cabbage that is remarkable for its uniformity and sure headedness.50	1.50	1.40
Paoing or Wong Bok. 80 days. Heads short, flattened ends, 9 to 10 inches long, 6 to 7 inches in diameter; blanches not quite equal to Pe T'sai and not so firm or as good storage.35	.95	.90

CABBAGE—Savoy

Improved Long Island Savoy. 90 days. The best strain we have had. 7 inches across, 6 inches deep, weighing 5 pounds. Extremely savoyed leaves and a hard head of dark green leaves.75	2.25	2.10
-------------------------------------------------------------------------------------------------------------------------------------------------------------------------------------------------	-----	------	------

CARDOON

	Oz.	¼ Lb.	Per Lb.
Large Smooth. A large smooth spineless variety of excellent quality. The swollen leaf stalk is the part eaten. It should be hilled when it starts to bulge at the base and will bleach to a very tender cream color.....	\$0.50	\$1.50	\$4.50

CARROT

	Lb.	5 Lbs. Per Lb.	25 Lbs. Per Lb.
Chantenay, Greater. 75 days. Roots 7 inches long, 2 inches through, sloping shoulder, tapering to a blunt point, deep orange skin and interior deep orange with red core nearly as deep color as Chantenay Red Core. Excellent bunching type having good top.....	\$0.95	\$0.90	\$0.85
Chantenay Red Core. 70 days. Roots 4½ to 5 inches long, 2¼ inches thick, tapering to a blunt point. Skin deep orange and interior same with distinct red core. Better for canning than bunching though used for both.....	.95	.90	.85

CARROTS—Continued

	Lb.	5 Lbs. Per Lb.	25 Lbs. Per Lb.
Early Short Scarlet (Dutch Horn). 63 days. 3 inches long, tapered with blunt point, 1½ inches in diameter; looks like a short Chantenay. Skin and flesh reddish orange, good quality.	\$0.95	\$0.90	\$0.85
Danvers Half Long Red Core. 75 days. This is the red core type and superior to the old type of pale core. 7 inches long, 2 inches in diameter, tapering to a slightly blunt point. Skin and flesh deep orange with a nearly indistinct core.95	.90	.85
Hutchinson. (Waltham Strain)	1.10	1.05	1.00
Imperator, Long. 77 days. 8 inches long, 1½ inches through, sloping shoulder and tapering to point. Skin and flesh deep orange, fine grained, tender; used for bunching in West and South.95	.90	.85
Improved Long Orange. 88 days. Roots 11 inches long, 2¼ inches in diameter, large strong tops, roots tapered to a point, skin and flesh orange with light colored core. Mostly for stock use.95	.90	.85
Nantes Half Long. 70 days. 6 to 7 inches long, 1¼ inches thick; deep orange flesh and skin, practically coreless, and the most tender and has best quality of any. Small tops and rather hard to bunch in heavy soil.	1.10	1.05	1.00
Oxheart (Guerande). 70 days. Roots bright orange, 4½ by 2½ inches, blunt, heart shape, flesh coarse, orange color, medium tops. For stock feed mostly.95	.90	.85
Sweetheart. 70 days. While there are a variety of Carrots having red cores this one excels all others, even the Touchon types. It is cylindrical, with an orange golden interior throughout. Tender, sweet and brittle, averaging 1½ inches by 6 inches, carrying its size to nearly the tip.	1.10	1.05	1.00
Touchon. 70 days. 7 inches long, 1½ inches in diameter, nearly cylindrical, carrying its size nearly to the blunt end. Rich orange, coreless and very similar to Nantes Half Long.	1.10	1.05	1.00

CAULIFLOWER

	Oz.	¼ Lb.	Lb.
Autumn Giant. 75 days. 2 feet tall, late large head 8 inches across, deep, nearly clear white. "Recommended only for Southern or for Western growing."	\$0.75	\$2.00	\$6.00
Ideal. 60 days. An all American Bronze Medal Winner of 1949. Tends to head very well even under adverse conditions	4.00	13.50	40.00
New Snowball. 60 days. Weight 2 pounds, firm, compact, pure white, a most sure header.	1.00	3.00	9.00
Special Select Snowball. 55 days. Very uniform, all heading within few days. 6 inches across, a fine white head weighing 2 pounds.	1.50	4.25	12.50

CELERY

	Oz.	¼ Lb.	Lb.
Easy Blanching. Full Heart. 110 days. Early green variety of erect, compact growth, blanching easily; 18 to 22 inches tall, stalks thick, solid, excellent flavor.	\$0.75	\$2.00	\$6.00
Giant Pascal. 140 days. 24 to 26 inches tall, late, green celery, stalk round, thick and solid. For winter use blanches white.40	1.35	4.00
Golden Self-Blanching Short. 90 days. 20 to 24 inches tall, stocky, solid, thick, stalks blanching easily. Standard shipper.50	1.65	5.00
Golden Self-Blanching Tall. 85 days. 24 to 26 inches tall, stems thick, not as firm as dwarf types, blanches easily..	.75	2.00	6.00
Michigan Resistant. 100 days. Resistant to Fusarium Yellows, strain of Golden Self-Blanching, 24 inches tall, solid, medium thick stalks blanching readily.	1.35	5.00	18.00
Prague, Large Smooth, Celeriac. 110 days. (Turnip Rooted Celery.) Roots 3 to 4 inches in diameter; round, fairly smooth and hollow dark green stalks, used for soups and salads45	1.35	4.00
Summer Pascal. A vigorous, compact, summer type, resistant to blight. Has fewer stalks than Utah, but more than Giant Pascal; Long solid, Crisp, stringless and of excellent quality.60	2.00	6.00
Utah Golden (Salt Lake, Golden Crisp). 125 days. Sturdy compact, solid, broad, thick, round stems; of finest quality. Green type for fall or winter. 20 to 22 inches tall....	.50	1.65	5.00
White Plume. 125 days. Foliage green, tinted white, 18 to 20 inches, stalk blanching easily to nearly white.....	.50	1.65	5.00

CHERVIL

Double Curled. 70 days. Similar to Parsley, leaves bright green, finely divided and curled; aromatic, used for garnishing and flavoring.	\$0.30	\$0.85	\$2.50
------------------------------------------------------------------------------------------------------------------------------------------------------	--------	--------	--------

CHICORY

	¼ Lb.	Lb.	5 Lbs. Per Lb.
Large Rooted Magdeburg. 65 days. Roots used for Coffee. 12 to 14 inches long, 2½ inches thick at top, tapering to medium point. Nearly white.	\$0.65	\$1.75	\$1.65
Asparagus or Radichetta. 55 days. Dandelion looking foliage, with tender flower shoots both of which are used; the shoots have a faint Asparagus flavor.....	1.00	3.00	2.85
Witloof or French Endive. 150 days. Very similar to Magdeburg but the roots are harvested, then set out in sand 4 inches deep or more. They will produce a cluster of tightly folded leaves about 4 inches long that are used for salad.55	1.60	1.55

CHIVES

Allium Schoenoprasum. 90 days. Small perennial type of onion, used for flavoring. Flower very delicate shade of white, pink, purple and lavender. Used in Rockeries, Wild Gardens or Herb Gardens.....	1.50	4.50	4.35
---------------------------------------------------------------------------------------------------------------------------------------------------------------------------------------------------------------	------	------	------

COLLARDS

	¼ Lb.	Lb.	5 Lbs. Per Lb.
Georgia. 75 days. Non-heading form of cabbage growing 2 to 3 feet tall; erect, having a cluster at the top. Used for greens mostly in the south.....	\$0.30	\$1.00	\$0.95
Cabbage or Heading. 75 days. This type produces a compact plant with a loose cluster of leaves resembling a head, 1½ to 2 feet tall.30	1.00	.95

SWEET CORN

Dates and data refer to corn at edible stage and will vary according to soil and season. Date taken when 50% or more in edible condition.

OPEN POLLINATED

	5 Lbs. and over Per Lb.	Bags Per Lb.	5 Bags Per Lb.
Adams Early (Burlington). Roasting corn. 75 days. Hardy, used in south. 6½ feet tall. Ear 7 to 8 by 2 inches, 12 to 14 rows of white kernels, fairly tender.....	\$0.18	\$0.17	\$0.16
Bantam Evergreen. 90 days. Stalks 7 feet tall, thrifty, good foliage. Ears 8 inches long, 2 inches in diameter, 14 to 16 rows of kernels, golden cream color, good flavor, excellent quality; remains in picking condition for some time..	.19	.18	.17
Black Mexican. 85 days. Stalk 6 feet tall, ears 8½ inches long, 8 rowed, excellent flavor and very sweet; kernels white at early eating stage, turning black with age.....	.19	.18	.17
Country Gentleman. 95 days. Stalk 7 feet tall, ear 8 inches long, 2 inches thick, kernels zig-zag, deep, slender white.	.21	.20	.19
Early Evergreen. 94 days. Stalk 7 feet tall, ears 7½ inches long, 2½ inches thick; 14 to 20 rows of kernels, white...	.19	.18	.17
Golden Bantam. 83 days. Stalk 5½ feet, bearing one and sometimes two ears 6½ inches long, 1¾ inches through; 8 rows of kernels. One of the sweetest and best.....	.19	.18	.17
Golden Bantam, Early. The same as regular Golden Bantam but 5 days earlier.....	.19	.18	.17
Golden Bantam Improved. 85 days. 5½ feet tall, 10 to 14 rows of kernels; ear 8 inches long, 2 inches through. Flavor nearly as good as regular.....	.19	.18	.17
Golden Midget. 70 days. The sweetest of all sweet corns. Borne on stalks 2½ to 3 feet tall. Ideal for the home garden.26	.25	.24
Golden Sixty Day. 68 days. Stalk 5 feet tall, ear 6½ inches long, 2¼ inches through. An excellent market garden type.19	.18	.17
Golden Sweet. 68 days. Stalk 4½ feet tall, ear 6 inches long, slender, 8 rowed.....	.19	.18	.17
Howling Mob. 83 days. Stalk 7 feet tall, ear 7½ inches long with 12 to 16 rows of kernels; white with medium heavy cob.19	.18	.17
Stowell's Evergreen. 95 days. Stalk 8½ feet tall, heavy; ears 8 inches long, medium heavy cob, 16 to 20 rows of kernels, white with excellent quality.....	.19	.18	.17

SWEET CORN—Continued

HYBRID AND TOP CROSSES

Heavier yielding than open-pollinated types, also giving more even ripening, an economy of picking.

	5 Lbs. and over Per Lb.	Bags Per Lb.	5 Bags Per Lb.
Bancross. 76 days. Stalk 69 inches tall, ear 6½ by 1¾ inches, 10 to 12 rows of kernels; deep yellow, excellent quality.	\$0.29	\$0.28	\$0.27
Improved Carmelcross. 75 days. An improvement over Mar-cross 39. Ears are a little larger and time to maturity no longer. Ideally suited as an early shipping variety adapted to the entire country.32	.31	.30
Early Southern Cross. 75 days. A new introduction that ranks with Improved Carmelcross. The ears are not quite as tapering as the Carmelcross.30	.29	.28
Golden Cross. 79 days. Stalk 72 inches tall, ear 6½ by 1¾ inches. Excellent for canner or market garden for midseason.32	.31	.30
Illinois #10. 80 days. An excellent later maturing tall stalked corn that is ideally adapted to the southern sections. The ears are over 8 inches long and are very cylindrical.34	.33	.32
Illinois Golden No. 21. 83 days. A fine 1950 introduction from Walter Huelsen, University of Illinois. Highly productive, ears 8" in length with 16 rows of kernels, stalks are 7½ feet tall and relatively free from tillers. Quite resistant to drouth.29	.28	.27
Ioana (I.45xP39). 81 days. Bright yellow Sweet Corn produced by the Iowa Station at Ames, Iowa. It has a larger amount of foliage than most Corn and has an excellent flavor. Very productive, 87 stalks bearing 123 ears, free from smut. Ear 8 by 1¾ inches, carrying 12 to 14 rows of kernels of medium size. Stalk 86 inches in height, ear base 26 to 30 inches.34	.33	.32
Iochief. 83 days. All America Gold Medal Winner 1950. Released for 1950 by Dr. Haber of Iowa State, this has been judged all over the country as the best late yellow hybrid sweet corn yet introduced. The ears are over 8 inches with 16 rows of kernels. Stalks are around 6 feet tall and free from tillers.36	.35	.34
Improved Golden Label. 82 days. Stalk 84 inches tall, Ears 7½ by 1¾ inches, 14-16 rows of kernels. An excellent new corn with exceptional yielding capabilities and top quality.29	.28	.27
Lee. 73 days. A midseason yellow hybrid, completely resistant to disease. Ears 7-7½ inches, 12-14 rows and slightly tapering. A top variety with the canners.32	.31	.30
Our Choice. 68 days. Our most popular Early yellow hybrid. Stalk short but sturdy, highly resistant to bacterial wilt. Ears 7¼ by 1¾ inches, tapering abruptly at tips; 10-14 rowed, with light cream-yellow, medium-broad kernels of fine quality.32	.31	.30

SWEET CORN—Continued	5 Lbs. and over Per Lb.	Bags Per Lb.	5 Bags Per Lb.
Stowell's Hybrid. 93 days. Stalk 7½ feet tall, ear 8 by 2¼ inches, 16 to 18 rows of medium deep kernels; white, tender.	\$0.45	\$0.42	\$0.40
Surprise. (Improved Span Cross.) 64 days. Stalk 54 inches tall, ear 6¾ by 1¾ inches. Very good yellow type and very early32	.31	.30
Wilson. 83 days. Produced at the Connecticut Experimental Station, under the direction of Dr. Singleton. Stalks 74 inches tall, ears 7½ inches by 2 inches with 16 to 20 rows of Golden Yellow kernels, having excellent flavor..	.29	.28	.27
Country Gentleman Hybrid. 99 days. 8x6. Stalk 7 feet, ear 8 by 2 inches, one of the best canners but hard to produce parents.45	.42	.40
Narrow Grain Hybrid. 98 days. Stalk 8½ feet, ear 7 by 2 inches with 18 to 22 rows of kernels.....	.45	.42	.40

POP CORN

	Lb.	5 Lbs. Per Lb.	25 Lbs. Per Lb.
Jap Hulless. 105 days. Stalk 5 to 5½ feet tall, bearing ears 4 inches long by 1½ inches. Kernels pop to large size and are free of hard centers.	\$0.18	\$0.17	\$0.16
Illinois Hulless. 100 days. A new introduction from the University of Illinois, the work of Dr. B. L. Weaver. A tall stalked open pollinated top quality white pop corn. This corn will outpop even the hybrids and is definitely more tender.28	.27	.26
Minnhybrid 250. 110 days. Very similar to Victory White Hulless, but a much heavier producer. Has a very large expansion when popping.55	.50	.45
Purdue Hybrid 31. 110 days. One of Glen Smith's productions, and one of the heaviest producing corns, and one of the best popping, so far as volume of popped corn... .	.50	.45	.40
South American. 110 days. Stalk 6 to 7 feet, ear 7 inches, having 12 to 14 rows of kernel, which are large yellow and pop to enormous size. Usually 2 ears to a stalk and well filled. When popped it is free from hard centers. .	.18	.17	.16
White Rice. 90 days. Stalk 6½ feet tall, ear 6 inches long, rather sharp kernels, which disappear when popped. . .	.18	.17	.16

CORN SALAD

	Oz.	¼ Lb.	Lb.
Feticus (Lamb's-Lettuce). Mache-Stick, Salat, 45 days. Large, thick leaved type; used as winter salad.....	\$0.25	\$0.75	\$2.25

CRESS

	Oz.	¼ Lb.	Lb.
Curled Garden (Peppergrass). 50 days. Hardy, quick growing, finely curled deep green foliage; pungent flavor, used for gardening.	\$0.15	\$0.30	\$0.85
Upland Cress. 50 days. Dwarf plant with slender stalks; used for salads.25	.75	2.25
Water Cress (Water Kresse, Creeson). 75 days. Perennial water plant; long stems, small thick leaves, pungent flavor. Used for salads and garnishing.75	2.50	7.50

CUCUMBERS

Days are given from time of planting to slicing stage.

b.s.—Black Spine. w.s.—White Spine.

Lb.	5 Lbs. Per Lb.	25 Lbs. Per Lb.
-----	-------------------	--------------------

Hybrids

Early Surecrop Hybrid. 63 days. All America winner 1951. An excellent early long dark green slicing hybrid cucumber. Oz. (only)—\$2.85.			
The Vaughan Hybrid 65 days. A new introduction for this year. We recommend this variety as the best slicer available. The fruit are long, thin and dark green. The vines are as any true hybrid resistant to mosaic.	\$2.25	\$8.50	\$25.00
A & C. w.s. 68 days. 10 inches long, 2¼ inches through. Fruit uniform, cylindrical, tapering at ends; dark green, nearly free from any light striping on blossom end.	1.00	.95	.90
Arlington Improved White Spine. w.s. 62 days. Fruit 7 by 2½ inches, medium dark green, slightly tapered to blunt ends; an excellent slicer.95	.90	.85
Boston Pickle. b.s. 58 days. Fruit 6 by 2¼ inches, early prolific pickling variety; fruit symmetrical, slightly tapered.90	.85	.80
Chicago Westerfield. b.s. 58 days. 6½ by 2¼ inches, fruit medium green, nearly square ends; best pickling.90	.85	.80
Cubit. 63 days. An All American 1943 Bronze Medal Winner. A prolific white spine variety, distinguished by uniform dark green skin and long, blunt ended, cylindrical shape.95	.90	.85
Davis Perfect. w.s. 65 days. Fruit 10 by 2½ inches, tapered both ends. Good slicer but superseded by A & C.90	.85	.80
Early Fortune. w.s. 58 days. Fruit 8½ by 2½ inches; dark green, slightly tapered.90	.85	.80
Improved Long Green. b.s. 68 days. Fruit 11 by 2½ inches, medium dark green turning to rusty yellow; used for chunk pickles.95	.90	.85
Japanese Climbing. b.s. 68 days. Fruit 7 to 8 inches long by 2¼ inches, medium green; vine quite hardy and productive.	1.15	1.10	1.05
Lemon. b.s. 65 days. Nearly round, lemon color, 2½ inches, used for pickles and salads.	1.10	1.00	.95
Mandarin. w.s. 45 days. 10 to 12 by 1½ inches; long, straight and early. Medium green, crisp.		SOLD OUT	
Marketer. w.s. 60-65 days. A very fine dark green, prolific market cucumber, slightly tapered to each end, holding a rich dark green color exceptionally well.	1.25	1.15	1.10
Mincu. w.s. 45 days. The most prolific early pickle we have had; 5 by 2½ inches, pale green, very desirable for northern climates such as Canada.90	.85	.80

CUCUMBERS—Continued

	Lb.	5 Lbs. Per Lb.	25 Lbs. Per Lb.
National. b.s. 54 days. 5 by 2¼ inches, fruit straight, blunt, best for small pickles.....	\$0.90	\$0.85	\$0.80
Quick Grow. b.s. 50 days. A little smaller than Chicago and selected for territory where blight is bad. The crop matures early before the blight gets the vines.....	.90	.85	.80
Straight Eight. w.s. 62 days. 10 by 2 inches, good dark green, well rounded at the ends; good quality.....	1.00	.95	.90
The Vaughan. w.s. 74 days. 15 by 2¼ inches, very dark green, one of the best in normal seasons; few seed and very firm flesh.	1.00	.95	.90
West Indian Gherkin. b.s. 60 days. Very prolific, small fruits and heavy spine; all over 1½ to 2 inches, long, oval, good for pickles.	1.15	1.10	1.05
Yorkstate. b.s. 54 days. A new mosaic resistant pickle that shows high quality with good yield. Bred by Dr. H. Munger of Cornell University.....	1.50	1.40	1.35

DANDELION

	¼ Lb.	Lb.	5 Lbs. Per Lb.
Improved Thick Leaf. 95 days. More erect and heavier foliage than the common. 18 to 24 inches across; blanches readily if tied or covered.....	\$2.50	\$7.50	\$7.25

DILL

Long Island Mammoth. 2½ feet high, bushy; seeds flat, of strong bitter flavor; used for pickles.....	.20	.60	.55
-------------------------------------------------------------------------------------------------------------	-----	-----	-----

EGG PLANT

Black Beauty. 80 days. Bush 26 inches tall, bearing 4 to 6 large dark purple fruits; smooth, firm, excellent market type.	1.60	4.75	4.50
Fort Meyer. (Florida High Bush) 83 days. Tall plant, carrying the fruit well up off the ground, vigorous, resistant to blight and wilt. Fruits long, oval, carrying size full length of fruit, which is jet black.	1.60	4.75	4.50
New York Purple. 83 days. Plant spineless, bearing 4 to 5 fruits; fruit broad, oval, black to purple, a little larger than Black Beauty.	1.60	4.75	4.50

ENDIVE

	Lb.	5 Lbs. Per Lb.	25 Lbs. Per Lb.
Broad Leaved Batavian Escarole. 92 days. 14 to 16 inches across, blanches to cream color and should be planted reasonably close so as to help blanching. Leaves serrated and twisted.	\$0.80	\$0.75	\$0.70
Green Curled. Green ribbed, deep cut leaf margins; blanches well, not as curly as Moss Curled.....	.80	.75	.70
Moss Curled. 95 days. 14 to 16 inches across, medium green, very finely cut and curled foliage; midribs narrow and white.80	.75	.70

ENDIVE—Continued

	¼ Lb.	Lb.	5 Lbs. Per Lb.
Rose Ribbed. 95 days. 16 to 18 inches across, not so finely curled as Moss Curled. Favorite for fall as it is fairly hardy and blanches well; midribs pink or rose colored...	\$0.80	\$0.75	\$0.70
White Curled. 100 days. 12 to 13 inches across; distinct type; finely curled, broad ribs with shade of pink, creamy white heart.80	.75	.70

GARLIC

	Lb.	5 Lbs. Per Lb.	25 Lbs. Per Lb.
Bulbs consisting of cloves that are broken apart for planting. They have one common root attachment as do Shallots. Used as seasoning. Price varies with market.	\$0.45	\$0.42	\$0.40

GARDEN HUCKLEBERRY

	Oz.	¼ Lb.	Lb.
Garden Huckleberry. 100 days. 3 to 4 feet tall, bushy, bearing large number of berries the size of large Huckleberries and turning black when ripe. Used for pies same as Elderberries.65	2.25	6.50

HORSE RADISH

	Per 1000	Per 100
Grown from rootlets or head cuttings. Planted in rows by laying in shallow trench, pressing tip down and covering with 3 inches of soil. Lift main root twice during season and rub off all roots except at tip end, and all leaves except the main set. Requires entire season for growth. Appetizer for meats. 6 to 8 inch size.....		
8 to 12 inch size.....		"ASK FOR PRICES"

HERBS

	Oz.	¼ Lb.	Lb.
Anise. 90 to 100 days. 14 to 16 inches high, leaves similar to Celery, with finely divided stem leaves. Seed oblong, grey, small, used for delicate flavor in food, drink, or for scenting linen.	\$0.20	\$0.60	\$1.75
Basil, Sweet. Large leaved. 90 days. 12 to 14 inches tall; leaves green, aromatic, used for seasoning, green or dry. Pot and grow in kitchen in winter.30	1.00	3.00
Borage. 90 to 100 days. 16 to 16 inches tall; flowers blue, leaves green and hairy. Used mostly in making cordials.40	1.25	3.75
Caraway. 80 days. 18 to 24 inches, finely cut or lacinated foliage; seeds the second year, roots may be used as carrot but usually seed is preferred and used as seasoning in pastry.15	.35	1.00
Catnip. Perennial. 3 feet tall, erect branches, greyish-green foliage; leaves and young shoots used for drink and seasoning.65	2.25	6.50
Coriander. 90 days. 24 to 30 inches tall, branching. Seed used in drinks and culinary.15	.35	1.00

HERBS—Continued

	Oz.	¼ Lb.	Lb.
Fennel. Florence (Finocchio). 85 days. .30 to 36 inches tall, with thickened leaves at base that are used for sweet flavor.	\$0.20	\$0.50	\$1.50
Fennel, Sweet. 80 days. 24 inches tall, used as vegetable, raw or cooked when plant is young and tender, used in liquors.25	.65	2.00
Lavender, Vera (True). 2½ feet tall, flowers violet blue, leaves and flowers both used for perfumes.90	3.50	10.00
Rosemary. Perennial 18 to 22 inches tall, foliage grey-blue; plant in any good well drained soil. Leaves used for seasoning.75	2.50	7.50
Rue. Perennial. 18 to 22 inches tall, very strong odor and very bitter but used for seasoning.65	2.50	6.50
Saffron. (False) 3 feet tall. True Saffron is a bulb and has no seed. False Saffron is an annual and grows on any soil. The flower is used for coloring, being a very deep yellow.55	1.75	4.25
Sage. Perennial. 14 to 16 inches tall, foliage pale green or grey-green. Any soil if well drained is suitable; leaves and tender stems used for seasoning.30	1.00	3.00
Savory, Summer. 8 to 12 inches tall; bushy. Any good warm soil is suitable. Young branches and leaves are used for seasoning.35	1.00	3.25
Sweet Marjoram. 15 to 18 inches tall, branching; leaves and young stems used for seasoning. Any soil suitable. .	.55	1.75	4.25
Thyme. Perennial. 8 to 10 inches tall; branching. green to grey-green foliage, leaves are aromatic with some bitterness; used for seasoning.65	2.25	6.50

In the above items of Herbs, where we cannot supply seed, we offer plants as per our retail catalogues, less 25%.

KALE or BORECOLE

	¼ Lb.	Lb.	5 Lbs. Per Lb.
Dwarf Blue Curled Scotch. 55 days. 15 inches tall, wide spreading blue green leaves. Should frost to get best flavor.	\$0.30	\$0.90	\$0.85
Dwarf Green Curled. 55 days. 15 inches tall, very much the same as Blue Curled except in color.30	.90	.85
Tall Green Scotch. 75 days. 30 inches tall, numerous large deep yellowish green leaves.30	.90	.85

KOHLRABI

Early White Vienna. 55 days. Produces bulbs above the ground of a pale greenish white color and are eaten when about 2 inches or more in size. Flavor of turnip.40	1.25	1.20
Early Purple Vienna. 60 days. Same as White except purple color.40	1.25	1.20

LEEK

Broad Scotch or London Flag. Early, 10 inches tall, 1½ inches thick, white, leaves medium green. Drooping.....	\$0.75	\$2.25	\$2.10
Elephant. For winter use, very large and a long clear white stalk.75	2.25	2.10
Large Musselburg. Stem 8 inches long, white with medium green leaves. Not as hardy as Carentan.....	.75	2.25	2.10

LETTUCE—CURLED VARIETIES

	Lb.	5 Lbs. Per Lb.	25 Lbs. Per Lb.
Black Seeded Simpson. 46 days. Early curled with broad frilled light green leaves. Plant large, compact, one of best for outdoors.	\$0.95	\$0.90	\$0.85
Early Curled Simpson. 45 days. w.s. Quite similar to Black Seeded but less crumpled or frilled and leaves are yellowish green.95	.90	.85
Grand Rapids Forcing. b.s. 43 days. Best for greenhouse forcing, light green, broad curly and heavily fringed....	.95	.90	.85
Salad Bowl. 45 days. Gold Medal AA 1952. A great new leaf lettuce originated by Dr. Ross C. Thompson at Beltsville, Md. A very fine lettuce for the home garden use. A head fills a salad bowl with a perfect rosette of rich green and very decorative leaves. Seems to stand sun better than Oak Leaf, is a faster and larger grower, ¼ Lb. much slower to bolt, and of extremely high quality.....	\$2.25	\$6.75	\$6.50

LETTUCE—HEADING VARIETIES

Heads best in cool weather and cool soil.

	Lb.	5 Lbs. Per Lb.	25 Lbs. Per Lb.
Bibb. 57 days. One of the best winter forcing varieties. Small dark green, loose heads. Preferred by high class hotels on account of its excellent flavor. It does best in the cool months and is excellent for greenhouse growing. May be grown out of doors if planted early or so late that it can mature in cool weather.	\$1.50	\$1.45	\$1.40
Big Boston. 75 days. A cabbage butter head type having brown tinge on the margins of the leaves, firm, well folded head, buttery yellow at heart.	1.00	.95	.90
California Cream Butter. b.s. 75 days. Heads large solid with golden yellow interior leaves thick dark green tinged with brown.	1.50	1.40	1.35
Chicken. w.s. A cutting lettuce affording the largest amount of foliage of dark green butter type. Cuts until frozen....	.95	.90	.85
Crisp as Ice. 74 days. b.s. Medium small, dark green, overlaid with dark brown, firm well blanched head crumpled leaves. More desirable than Mignonette.....	1.75	1.65	1.55

LETTUCE—Heading Varieties—Continued

	Lb.	5 Lbs. Per Lb.	25 Lbs. Per Lb.
Great Lakes. 75 days. Top place winner in the All American selections for 1943. This is a tight-heading summer lettuce of the Iceberg type which does equally well in cool weather. Bred by Keith C. Barrons in cooperation with the United States Government and introduced from the Michigan State Experiment station. It stands the longest of any without going to seed, and remains sweet the whole season. It is so slow going to seed the frost gets it before it can mature a seed crop.....	\$2.95	\$2.85	\$2.75
Iceberg. w.s. 84 days. Plant large, wavy fringed light green leaves tinged at margin with brown. A large compact crumpled head.	1.35	1.30	1.25
Imperial 456. 80 days. Developed by Cornell Experiment Station as a variety suitable for those who wish to grow head lettuce in July and August. Of the Imperial type and said to withstand high temperatures and tip burn better than any other Imperial.	2.75	2.65	2.60
Imperial 44. b.s. 82 days. Long well folded leaves, hard, well formed heads similar to Imperial 152 but heads better in warm weather.....	1.85	1.75	1.70
Improved Hanson. w.s. 80 days. Plant large with broad, thick frilled light yellowish green leaves forming large globular head.	1.35	1.30	1.25
May King. w.s. 63 days. Early butter head, medium small heads, round firm leaves light green tinged with brown..	1.25	1.15	1.10
New York No. 12 or Wonderful (Los Angeles). w.s. 80 days. Large dark green crisp heading with large outer leaves which are notched and curled on the edges, tight folded head.	1.85	1.75	1.70
Oak Leaf. w.s. 40 days. A rather indefinite head, medium size, medium green. Leaves deeply lobed with middle lobe having a long finger-like point.	1.50	1.45	1.40
Prizehead. w.s. 47 days. Plant large loose leaved, broad crumpled and frilled, outer leaves tinged red, inner ones green.95	.90	.85
Univalled, White Seeded Big Boston. w.s. 76 days. Same as Big Boston without tinge on leaves.	1.05	1.00	.95

LETTUCE—COS TYPES

Express. w.s. 70 days. Small dark green early and best of Small Cos.	1.05	1.00	.95
Paris (or Trianon). w.s. 75 days. Medium large, self folding, medium dark green leaves, smooth compact head, solid..	1.05	1.00	.95

MUSHROOM SPAWN.

Improved Vita Pure White

Pr. brick, 25c. 10 bricks for \$2.25

Bottle spawn, 85c per carton.

10 cartons for \$8.00

MUSKMELON

Should be planted in warm sandy loam early in June.

	5 Lbs. Per Lb.	25 Lbs. Per Lb.
Banana. 98 days. 18 inches long, 4 inches through, fruits smooth grey-green to lemon color, flesh salmon.....	\$1.10	\$1.05
Bender's Surprise. 90 days. A superior Milwaukee Market for growing in heavy soil. Fruits oval, 8 inches long, 7 inches through, coarse netting, decided ribbing, flesh-bright salmon, fine flavor.	1.10	1.05
Extra Early Hackensack. 80 days. Fruits large, globular flattened, 5½ inches long, 6½ inches across, heavily ribbed with coarse netting, flesh green.	1.10	1.05
Extra Early Osage. 84 days. Fruits 7 inches long, round, shallow furrows and netting, flesh thick, salmon orange..	1.10	1.05
Hale's Best 936. 85 days. Medium small, uniform for boxing, no ribbing, heavy netting, small cavity, thick flesh, deep salmon.	1.10	1.05
Hales Best Jumbo. 85 days. An excellent melon, popular on some of the best growing sections, which is similar to Hales Best 936, but with fruits considerably larger.....	1.10	1.05
Early Bender (Schoons Hardshells). 95 days. Very similar to Golden Osage but harder shell and not as thick flesh, same color.	1.10	1.05
Hearts of Gold. 80 days. Nearly round, 4 to 5 inches through, deep orange flesh of distinct flavor, closely netted.	1.10	1.05
Honey Dew. 112 days. Fruits large round, smooth, pale green or creamy white, fine grain, deep orange, excellent flavor.	1.20	1.15
Honey Rock. 85 days. Skin grey-green covered with sparse, coarse netting, flesh thick, orange salmon, green rind beneath the skin, ¼ inch thick.....	1.10	1.05
Iroquois 90 days. A fusarium wilt resistant medium sized very high quality melon bred by Cornell University. Salmon colored flesh that is very sweet. Fine for either market or home growing.	1.20	1.15
Michigan Pride. 85 days. Nearly round 6 inch through, heavy netting, small seed cavity, orange yellow flesh, thick. A Vaughan specialty. Try this one.	1.10	1.05
Milwaukee Market. 80 days. Fruits 8 inches long, 7 inches through. Does best in sandy soil. The heaviest flesh of any of the melons, sparse but coarse netting, slight ribbing.	1.10	1.05
Rocky Ford. 95 days. 5½ inches long, 5 inches through, heavily netted, green flesh of a different flavor.	1.10	1.05
Tip Top. 95 days. Size 7 inches long, 6½ inches through, deeply ribbed, flesh thick, skin nearly smooth, slate green turning to yellowish.	1.10	1.05
Wisconsin Pride. 85 days. Nearly round 6½ inches through, skin hard, heavily netted exceptionally thick flesh, orange color. Best of the Honey Rock types.	1.10	1.05

WATERMELON

	Lb.	5 Lbs. Per Lb.	25 Lbs. Per Lb.
Blacklee. Bred by M. N. Walker of University of Florida, a Tom Watson type, Fusarium Wilt resistant. Fruits are long, solid, dark green, with thin but firm rind. Quality very good. Reportedly heavier producer than Klechly types.	\$0.95	\$0.90	\$0.85
Citron, Red-Seeded. 92 days. Round, 7½ inches through, flesh white, hard, seed imbedded in flesh and red, shell smooth, green with dark striping.95	.90	.85
Citron, Green-Seeded (Colorado). 92 days. 8½ inches through, otherwise same as Red-Seeded.95	.90	.85
Cole's Early or Harris Earliest. 80 days. 10½ inches long, 8½ inches through, skin red firm, seeds black, fine appearance and flavor. "A top rate early home garden melon."95	.90	.85
Congo. 88 days. A new anthracnose resistant melon that is an All America winner for 1951. This melon has a tough rind with bright red flesh and may replace Florida Giant in the South as the leading shipping watermelon.	1.90	1.85	1.80
Dixie Queen. 85 days. 15 inches long, 12½ inches through. Skin light green alternately striped with dark green rind thin, tough flesh dark pink with few small white seeds. Good shipper.	1.25	1.20	1.15
Hybrid Dixie Queen. 85 days. A true F, hybrid that has the characteristics of Dixie Queen only the melons are larger and sweeter. Lb. (only)—\$22.00.			
Early Kansas (Russian Red, Kansas Queen). 85 days. 15 inches long, 13 inches through, dark green with alternate stripes of lighter shade, flesh red with brown seed.95	.90	.85
Florida Giant. 95 days. Vigorous vines, bear heavy crops of exceptional large round fruit. The skin is solid, dark green, flesh red and firm, seed black. Presents a very attractive appearance when cut. Melons weight from 40 pounds up.	1.00	.95	.90
Georgia Rattlesnake. 92 days. 21 inches long, 9 inches through, light green with dark stripes, flesh pink, seed white.95	.90	.85
Golden Honey, Hungarian. 90 days. Nearly round, 12 inches through, skin dark green irregular faint markings of darker color seed brown and flesh orange.95	.90	.85
Halbert Honey. 87 days. 20 inches long, 12 inches through, rind deep green, flesh dark pink with white seed.95	.90	.85
Hawkesbury. 90 days. A recent introduction that is a grey rind shipping wilt resistant melon. Melons average 30 pounds. Flesh red and seeds black.95	.90	.85
Ice Box. 78 days. Nearly round, 6 inches through, with light green mottled skin, very thin shell and ripe before you realize it, sugary red flesh, black seed.95	.90	.85

WATERMELON—Continued

	Lb.	5 Lbs. Per Lb.	25 Lbs. Per Lb.
Japanese Seedless. 85 days. An exciting new novelty that has attracted more publicity than any vegetable variety ever introduced. An icebox type of melon with bright red flesh and no true seeds. A delight to eat. Retail packet of 20 seeds (.50 retail value) in lots of five \$1.85.			
Kleckley's No. 6. 95 days. (Blight Resistant). Large oblong, 22 inches, dark skin, thick flesh blood red, seed small white.	\$0.95	\$0.90	\$0.85
Klondyke No. 7. Black Seeded Resistant.95	.90	.85
New Hampshire Midget. 78 days. All America 1951. A small very early melon that is sweet and red fleshed. The rind is thin so the melon is only adapted to home gardens.	2.50	2.25	2.15
Ovid. 80 days, nearly round, 9 inches through, dark skin with stripings of dark green, red flesh with black seed..	.95	.90	.85
Stone Mountain, No. 5 (Wilt Resistant). 85 days. 14 inches long, 12 inches through, dark green skin, flesh bright crimson. Fruits are ideal for home and market garden.....	1.10	1.05	1.00
Sweetheart. 88 days. 13 inches long, 11 inches through, light grey with fine green veining flesh bright red, seed black.95	.90	.85
Tom Watson. 92 days. 22 inches long, 12 inches through, rind is thin dark green, tough, seed brown with some mottling.95	.90	.85
Winter New. 85 days. Nearly round, 9 inches. Excellent for storing and quite early to mature. Very prolific and of fine quality.....	1.25	1.20	1.15

MUSTARD

Chinese Smooth Leaf. Plant medium large, vigorous, leaves, broad slightly crumpled, scalloped edges, seed reddish brown.55	.50	.45
Florida Broad Leaf. Large, upright, leaves very large and thick bright green, smooth with toothed edges and pale green mid-rib.55	.50	.45
Fordhook Fancy. Upright, deep green, leaves large thick, broad whitish mid-rib, frilled and curled on edge, plume like, slow to seed.....	.55	.50	.45
Giant Southern Curled. Very hardy, leaves long, wide light green, tinged with yellow, heavily crumpled and curled.55	.50	.45
Tendergreen. Quick growing spinach greens, leaves oblong, thick, smooth, dark green with lighter ribs, slow to seed, resistant to drouth.....	.55	.50	.45

OKRA

Clemson Spineless. 55 days. Uniform, spineless strain of Perkins, but with less foliage, pods green straight ridged. Plant 4½ feet, pods 7 inches.....	.55	.50	.45
Dwarf Long Pod. 55 days. 3 feet tall, pods 7 inches long, dark green, ridged pointed prolific.....	.55	.50	.45
Perkins' Mammoth. 62 days. 4½ feet tall, dark green, fleshy tender pods, tapered and ribbed.....	.55	.50	.45
White Velvet. 60 days. Plant 3 feet tall, pods 6 to 7 inches long, fleshy tender and slender.....	.55	.50	.45

ONION

	Lb.	5 Lbs. Per Lb.	25 Lbs. Per Lb.
Crystal White Wax. 90 days. Similar to yellow Bermuda except clear, glistening white. Used in south for early onion. Only good for sets in north.....	\$2.50	\$2.40	\$2.30
Early Yellow Globe. Excellent globe shaped onion which will stand storage better than most early varieties. Under normal conditions bulbs are ready 10 days to two weeks ahead of Southport Yellow Globe.	1.75	1.65	1.60
Golden Globe. 115 days. The true Golden Globe grown from our own bulbs. An oblong globe called Bottleneck; deep golden yellow, firm and hard, excellent keeper. Does best when sown for sets and wintered over then planted out for large onions the following year when they will make an early market onion maturing before the thrips injure.	1.30	1.25	1.20
Bunching, He-Shi-Ko. Large coarse leaves, large pencil type of onion suitable for bunching only, never forms bulb. Hardy as White Welsh and more tender.....	2.00	1.90	1.85
Ebenezer Yellow. 100 days. Bulbs deep flattened, medium size, dark yellow, firm, thick skin. The best yellow for sets.	1.30	1.25	1.20
Ebenezer White. 110 days. Like yellow Ebenezer from which it was selected, and can be used as Portugal though not as clear a white. Better keeper than Portugal, and may be used for pickles.	1.75	1.65	1.60
Iowa Yellow Globe #44. 110 days. A splendid new keeping onion that is a synthetic selection of Brigham. Extremely uniform as to size and type.....	2.25	2.15	2.10
Large Red Wethersfield. 100 days. Bulbs, large, flat on bottom, rounding on top, purplish red, flesh fine, firm....	1.75	1.65	1.60
Michigan State Sweet Spanish. 115 days. An improved keeping strain of sweet Spanish.	2.75	2.65	2.60
Prizetaker. 115 days. Bulbs, large globe shape, skin glossy, straw shade, flesh mild.	2.75	2.65	2.60
Riverside Yellow (Utah Strain), Sweet Spanish. 115 days. Globe with golden yellow skin, quite mild, sweet flesh. Keeps till last of February.	2.75	2.65	2.60
Riverside White Sweet Spanish. 115 days. Shape and characteristics as Riverside Yellow. Color white.	2.75	2.65	2.60
Southport White Globe. 110 days. Bulbs medium large, globular, firm, clear white, skin thin but reasonably good keeper.	3.00	2.90	2.85
Southport Red Globe. 110 days. Bulbs globe shaped with small neck, deep red skin, flesh white, good keeper.	2.00	1.90	1.85
Southport Yellow Globe. 110 days. Bulbs (Ball type or Globe type), state which wanted, medium size, solid. Deep Yellow skin and the best long keeper	1.75	1.65	1.60
Special Yellow Globe (Mountain Danver). 100 days. Globe shape, some flattened, deep yellow skin, white flesh, good keeper and early.	1.75	1.65	1.60
Valencia. 115 days. A strain of Spanish larger than regular, and more globe shape.	2.75	2.65	2.60

ONION—Continued

	Lb.	5 Lbs. Per Lb.	25 Lbs. Per Lb.
White Portugal. 100 days. Bulb medium size, thick flat white, fine grained. Sets used for pickling.....	\$1.75	\$1.65	\$1.60
White Lisbon. An all year bunch onion, does not bulb unless on poor ground or unfavorable weather. The best bunch onion where pencil type wanted.	2.25	2.15	2.10
Yellow Globe Brigham. 110 days. A flatter type of Yellow Globe than the ball. A very heavy cropper.	1.75	1.65	1.60

ONION SETS—WRITE FOR PRICES

PARSLEY

	Lb.	5 Lbs. Per Lb.	25 Lbs. Per Lb.
Champion Moss Curled. 70 days. Plant compact, dark green, exceedingly fine cut, dense.	\$0.70	\$0.65	\$0.60
Double Curled. 70 days. Very similar to Moss though not as curled.70	.65	.60
Plain. 72 days. Leaves bright green, deeply cut, flat, not curled, stem small, solid.70	.65	.60
Hamburg Rooted. 90 days. Root 8 to 10 inches long, parsnip like, used for flavoring. Leaves plain, deeply cut, stem hollow, tinged with purple.70	.65	.60
Vaughan's XXX. Very Moss Curled. 75 days. Similar to Moss Curled but much finer curled and dark green.70	.65	.60

PARSNIP

Hollow Crown. All America. 95 days. Roots 10 to 12 inches long, 2½ to 3 inches through, hollow crowned, tapered..	.55	.50	.45
Guernsey. 95 days. Root a little shorter, sloping shoulder, tapering to point.55	.50	.45

PEAS

They require cool weather to do their best.

	5 Lbs. and over Per Lb.	Bags Per Lb.	5 Bags Per Lb.
Alaska (Resistant). 57 days. Plant 32 inches tall, slender light green, uniform in maturing. Pods 2¾ inches long, blunt light green, round and straight, full of peas. Seed small round, smooth bluish green.	\$0.14	\$0.13	\$0.12
Alderman (Improved Telephone). 74 days. Vines 4½ inches, dark green, coarse, pods 4½ inches long, single large, plump straight, dark green pointed, contain 8 to 12 peas. Seed large, light green.19	.18	.17
American Wonder. 61 days. Plant 16 inches, dark green, fairly coarse, pods single and double, light green, blunt straight, filled with 6 peas. Seed green, somewhat square.19	.18	.17
Dwarf Grey Sugar. 65 days. Plant 28 inches, slender with purple blossoms, pods double light green, heavily curved, semi-pointed, strongly indented. Seed small mottled grey.21	.20	.19
Dwarf Telephone (Daisy). 76 days. Plant 24 inches, light green, stocky, pods 4½ inches long, medium light green, slightly curved broad pointed and attractive, contain 8 to 10 peas. Seed large, bluish cast.23	.22	.21
Giant Stride. 74 days. 27 inches, sturdy dark green, pods 5½ inches, slightly curved pointed, thick walled, dark green. Seed wrinkled, light green.....	.19	.18	.17

PEAS—Continued

	5 Lbs. and over Per Lb.	Bags Per Lb.	5 Bags Per Lb.
Gradus Early. 57 days. Vine 34 inches, medium green and stocky, pods 4 inches long, broad plump pointed, contain 8 to 10 peas. Seed large, cream.....	\$0.19	\$0.18	\$0.17
Green Bayou. 65 days. A cross of Creole and Thomas Laxton made by Dr. Julian Miller of Louisiana State. Vines are resistant to heat and peas have quality comparable to Alaska19	.18	.17
Laxton's Progress (Laxtonian, Hundredfold). All same group differing mostly in color. 62 days. Plant 16 inches, medium dark green, pods 4½ inches, dark green, curved.19	.18	.17
Little Marvel. 64 days. Vine 18 inches, dark green, stocky, pods 3 inches, dark green, blunt plump, well filled, 7 to 8 peas. Seed light green.....	.20	.19	.18
Nott's Excelsior. 60 days. Vine 16 inches, dark green, slender, pods 2¾ inches, blunt, round, plump, light green, contains 6 to 7 peas. Seed square, light green....	.19	.18	.17
Premium or Little Gem. 60 days. Vine 22 inches, dark green, pods 2¾ inches, light green, round straight blunt contain 6 to 7 peas. Seed green, medium size.....	.19	.18	.17
Thomas Laxton. 62 days. Vine 36 inches, deep green, pods 3½ inches, deep green, plump broad, blunt, contain 7 to 8 peas. Seed medium size, cream and green.....	.19	.18	.17
Improved Telephone. Same as Alderman.....	.19	.18	.17
World's Record. 57 days. Vine 30 inches, light green, pods 3 inches, light green, straight, pointed, broad, plump, contain 7 to 8 peas. Seed large, cream and green.....	.19	.18	.17

PEPPERS

Do best in warm loam soil.

	Oz.	¼ Lb.	Lb.
Bell, Large. 60 days. Mild small erect plant, prolific, fruit 3 by 2½ inches, pendant, blunt, largely 4-lobed, deep green, changing to scarlet.	\$0.55	\$1.65	\$5.00
Bullnose Hot. 60 days. Small plant, prolific, fruit hot, 3 by 2¾ inches, dark green with dark purple splashing, turning to crimson.45	1.50	4.50
California Wonder Golden. 80 days. The same as California Wonder except peppers are a bright gold in place of scarlet. A very fine new introduction.....	.60	2.00	6.00
California Wonder. 75 days. Sweet, plant vigorous fruit 4½ by 3½ inches, 4-lobed, upright, deep green, changing to scarlet, flesh thick.....	.45	1.50	4.50
California Wonder Early. 65 days. Very similar to California Wonder but more prolific.....	.45	1.50	4.50
Cayenne, Long Red. 70 days. Hot plant productive, large fruit, 5 by ¾ inch, pendant, tapering, deep green, changing to red.45	1.50	4.50
Chili Red. 82 days. Plant low, spreading, productive. Fruits erect, conical, very hot; color light green, changing to bright red. Used in making pepper sauce.45	1.50	4.50

PEPPERS—Continued

	Oz.	¼ Lb.	Lb.
Dixie Wonder. 80 days. A California Wonder type that is resistant to heat. Louisiana State was the originator of this variety.	\$0.45	\$1.50	\$4.50
Hungarian Hot. 65 days. Plant medium tall and very prolific, having as many as 16 full size fruits, 7 by 1½ inches at shoulder, tapering to a straight point. Pale yellow green, changing to deep crimson.55	1.65	5.00
Hungarian Sweet. Same as Hot, but sweet.60	2.00	6.00
King of the North (Early Giant). 64 days. Sweet, short, prolific, fruit 4½ by 3 inches, 4-lobed, smooth dark green, changing to red.60	2.00	6.00
Magnum Dulce. 67 days. Sweet, 5½ by 3½ inches, four-lobed, slightly tapering, smooth medium heavy walls, excellent shipper, dark green turning to bright crimson..	.45	1.50	4.50
Patrick Henry. 58 days. The first early green Pepper. Sweet 3 to 4 lobed with thick flesh. A new introduction of Vaughan's.55	1.65	5.00
Pimento Perfection. 73 days. Sweet, plant erect, large prolific, fruit 3½ by 2½ inches, top shape, heavy walls, smooth, pendant, dark green turning to bright crimson.45	1.50	4.50
Pimento, Sunnybrook. 73 days. Sweet, rather tall plant, prolific, fruit 2½ by 2¾ inches, called a squash pepper or tomato pepper due to shape, deep green turning to deep red.45	1.50	4.50
Ruby King. 68 days. Sweet, erect, prolific plants, fruit 5 by 3 inches, 3-lobed, tapered, smooth, deep green turning to deep red.60	2.00	6.00
Windsor A. 57 days. Sturdy fairly prolific, fruit 4½ by 2½ inches, mostly 3-lobed, some pointed, pendant, rich green turning to deep red.45	1.50	4.50
World Beater. 75 days. Sweet, vigorous, upright, prolific fruit 5 by 3½ inches, mostly 4-lobed, smooth.45	1.50	4.50

PUMPKINS

Grow in most any soil.

	Lb.	5 Lbs. Per Lb.	25 Lbs. Per Lb.
Cushaw, Golden. 110 days. Vine type, fruit 20 inches long, 10 inches through large part, crooked neck tapering to an enlarged ball end. Skin golden yellow, flesh thick, dry and sweet.	\$0.95	\$0.90	\$0.85
Cushaw, Striped. 110 days. Shape and size very similar to Golden Cushaw, a little larger with light green and white striping intermingled.95	.90	.85
Cushaw White. 110 days. Smaller and straighter neck than other Cushaw types. Nearly white.95	.90	.85

P
PUMPKINS—Continued

	Lb.	5 Lbs. Per Lb.	25 Lbs. Per Lb.
Kentucky Field. 120 days. Prolific variety grown mostly in the south, fruit from nearly round to flattened, pale green to cream turning to orange yellow, flesh deep yellow.	\$0.90	\$0.85	\$0.80
Large Cheese. 120 days. Fruits 6 by 12 inches, flat, ribbed, cream color, flesh thick, orange yellow.95	.90	.85
Large Connecticut Field. 110 days. Fruits 12 by 14 inches, hard smooth, ribbed, deep orange, flesh thick, yellow. ..	.95	.90	.85
Small Sugar. 110 days. Fruit 8 by 10 inches, skin hard smooth ribbed, thick flesh, deep yellow.80	.75	.70
Vaughan's Mammoth Prize. 120 days. Fruit 22 by 18 inches skin reddish yellow, flesh thick, bright yellow.95	.90	.85
Winter Queen or Luxury. Fruits 7 by 9 inches, skin thin netted, orange yellow, flesh thick, yellow, sweet.95	.90	.85

SWEET POTATO PLANTS

Prices 25% less than retail catalogue.

RADISH

Most any soil but prefer light loam.

Brightest Long Scarlet (Cardinal). 26 days. Roots 5½ inches long, tapering, crisp, scarlet with white tip.	\$0.55	\$0.50	\$0.45
Cavalier. 23 days. Roots are olive shaped and bright scarlet. Tops are slightly larger than Short Topped Scarlet Globe. .	.55	.50	.45
Cherry Belle. 23 days. All America winner 1949. A very short topped Strain with round bright red roots. A fine variety for the commercial grower.75	.70	.65
Cincinnati Market. 28 days. Roots 7 inches long, tapering end, deep red, flesh white, tender.55	.50	.45
Crimson Giant. 28 days. Roots large globular, 1½ inches through, firm white flesh remaining so for long period. .	.55	.50	.45
Early Deep Scarlet Turnip. 26 days. Early short top variety, roots flattened ball, 1 inch through, dark scarlet, flesh pinkish white.55	.50	.45
Earliest White Turnip. White Box. 20 days. Roots turnip shaped, 1 inch, white in and out, small top.55	.50	.45
French Breakfast. 25 days. Root oblong, thicker at bottom, 1½ inches by ¾ inch, blunt, scarlet with white tip, flesh white. Will not stand after maturity.55	.50	.45
Giant Butter. 28 days. Roots 1¾ inches, round, keeps firm after others go to seed, deep red.55	.50	.45
Scarlet Globe Short Top. 23 days. Roots round to olive, bright scarlet, very short top, not suitable for out of doors early in spring. Crisp, tender.55	.50	.45
Scarlet Globe Medium Top. 23 days. Very much the same as Short Top but with top 4 inches longer. Best for out of doors.55	.50	.45

RADISH—Continued

	Lb.	5 Lbs. Per Lb.	25 Lbs. Per Lb.
Scarlet Turnip White Tip (Sparkler). 26 days. About 1/3 of root white, ball shaped, smooth scarlet, flesh white....	\$0.55	\$0.50	\$0.45
White Icicle. 27 days. Root 5 1/2 inches long, tapering to point. Flesh clear white, brittle, longer standing than Early Scarlet Globe55	.50	.45
White Strassburg. Summer radish. 40 days. Roots 5 inches long, tapering and smooth.....	.55	.50	.45

RADISH—WINTER VARIETIES

California Mammoth. 60 days. Roots 8 inches long, cylindrical, thickest at lower end, leaves coarse, large, flesh white.60	.55	.50
Chinese Mammoth or Celestial. 60 days. 8 inches long, 2 1/2 inches in diameter, cylindrical, white flesh.60	.55	.50
Long Black Spanish. 58 days. Roots 7 inches long, 2 inches through, skin black, flesh white.60	.55	.50
Rose or Scarlet China. 52 days. Roots 5 inches long, cylindrical, larger at lower end, blunt, bright rose red, flesh white.60	.55	.50
Round Black Spanish. 56 days. Roots top shaped, with cracked lines, longitudinal flesh white.60	.55	.50

RHUBARB

Victoria. Large stalks, thick, some red and sometimes called strawberry.	1.60	1.55	1.50
Vaughan's Mammoth. One of the largest and excellent for winter forcing.	1.60	1.55	1.50

ROCKET

(Ruccoli). Rapid growing greens used by the Italians.....	3.50	3.35	3.25
------------------------------------------------------------------	------	------	------

SALSIFY

(Vegetable Oyster) Mammoth Sandwich Island. Hardy, slow growing, best when left in ground all winter and used in spring before new growth starts.....	2.00	1.90	1.85
--------------------------------------------------------------------------------------------------------------------------------------------------------------	------	------	------

SORREL

French Broad Leaved. 60 days. Leaves large, oblong, medium green, rather bitter flavor, used in spring.....	3.00	2.90	2.80
Narrow Leaved. 60 days. Same as French except leaves are more narrow.	3.00	2.90	2.80

SPINACH

Sow early or late as it does not do well in hot weather.

	Lb.	5 Lbs. Per Lb.	25 Lbs. Per Lb.	100 Lbs. Per Lb.
Bloomsdale Savoy Reselect. 39 days. Leaves large, oval shaped, curved, heavily savoyed, dark glossy green.....	\$0.35	\$0.32	\$0.31	\$0.30
Bloomsdale Dark Green. 42 days. A selection out of Bloomsdale for its dark color and longer standing before going to seed.....	.35	.32	.31	.30

SPINACH—Continued

	Lb.	5 Lbs. Per Lb.	25 Lbs. Per Lb.	100 Lbs. Per Lb.
Bloodsdale Long Standing. 45 days. Plant large, erect, sturdy, leaves very crumpled and blistered, dark green.	\$0.38	\$0.35	\$0.34	\$0.32
King of Denmark (Antvorskov). 48 days. Exceptionally long standing, medium smooth, broad, rounded, dark green, slightly crumpled.38	.35	.34	.32
New Zealand. Does best in hot, dry weather, large plant with small, thick pointed, dark green leaves which should be picked throughout the season.40	.37	.36	.34
Nobel. 45 days. Plant large and spreading, slow to form seed heads, leaves large, thick, smooth, pointed with rounded tip, medium green.35	.32	.31	.30
Old Dominion. 40 days. A longer standing, blight resistant type of Virginia. Similar to Savoy but leaves more pointed. For fall planting.35	.32	.31	.30
Viking. 45 days. Selection from Nobel for darker leaves, very large, thick.35	.32	.31	.30
Virginia Blight Resistant. 39 days. Upright, seeding early, desirable for planting in infested soil. Leaves smoother than other Savoy types.35	.32	.31	.30

SQUASH

Plant when weather and soil are warm.

Banana. 105 days. Vine, fruit 20 by 5 inches, slate-grey color, flesh thick, fine grained yellowish, excellent quality.	\$0.95	\$0.90	\$0.85
Boston Marrow. 97 days. w.v. Fruit 12 by 9 inches, resembles Hubbard in size and shape, deep orange skin, hard, rough, flesh thick yellow.95	.90	.85
Buttercup. 100 days. Fruit 4½ by 6½ inches, shape similar to Turban, skin thin, dark green with narrow grey stripes or mottlings, flesh orange. The smoothest, best flavored squash yet produced.	1.25	1.20	1.15
Butternut Squash. 100 days. Unlike other squash, when baked and served without the shell it spreads like butter without any sign of stringiness. When growing it looks more like an old fashioned potato masher than a squash. The skin is dull yellow; a long, thick neck ends in a bulge in which lie all the seed.	1.25	1.20	1.15
Caserta. All America vegetable gold medal winner for 1949. This fine squash of the Italian Cocozelle type was developed by Dr. Lawrence C. Curtis of the University of Connecticut Experiment Station. It bears a week earlier, is much more prolific and more valuable than Cocozelle for garden, market or shipping.	1.00	.95	.90
Cocozelle. 65 days, s.b. Fruits 20 by 4½ inches, cylindrical straight, dark green with lighter green stripes changing to deep yellow, flesh firm, greenish white.95	.90	.85
Crookneck Giant. 55 days. s.b. Fruit 20 by 4½ inches, neck curved, skin lemon yellow, warted, flesh thick yellow.95	.90	.85

SQUASH—Continued

	Lb.	5 Lbs. Per Lb.	25 Lbs. Per Lb.
Crookneck Yellow Summer. 52 days. s.b. Fruits 10 by 4 inches, similar to Giant Crookneck but smaller.....	\$0.95	\$0.90	\$0.85
Delicious Green. 102 days. w.v. Fruit 11 by 8 inches, top shaped, skin dark green with lighter striping toward blossom end, flesh orange color.95	.90	.85
Delicious Golden. Same general characteristics as Green, but golden orange skin, flesh thick orange.95	.90	.85
Des Moines Jumbo. 80 days. An improved Acorn similar in shape but with a more rounded blossom end. From one-half to again as large as the regular Acorn, with thicker flesh.95	.90	.85
Mammoth White Bush. Very similar to Early White Bush, slightly warted and larger.95	.90	.85
Hubbard, Blue. 110 days. w.v. Fruits large, round pointed both ends, ridged rough, hard shell blue-grey.95	.90	.85
Hubbard, Chicago Warted. 110 days. w.v. Fruits 13 by 9 inches, pointed each end, dark green, flesh orange, good keeper.95	.90	.85
Hubbard, Golden. 100 days. Smaller, more prolific than Warted, fruits 11 by 8 inches, pointed both ends, rough orange red with faint cream stripes toward blossom end.95	.90	.85
Hubbard, Kitchenette. A small home type of Warted Hubbard.95	.90	.85
Hubbard, Improved. Shape of Warted Hubbard but not as rough or large, same season.95	.90	.85
Italian Marrow Black (Zucchini). 64 days. s.b. 20 by 4 inch fruit, black skin, smooth attractive, prolific.95	.90	.85
Italian Marrow Grey (Zucchini). 63 days. s.b. Fruit 12 by 5 inches dark green with lighter green stripes, changing to golden.95	.90	.85
Mammoth Chili. 100 days. Fruit 22 by 18 inches, nearly globular, skin light yellow mottled with orange, flesh solid, orange.95	.90	.85
Prolific Straightneck. 55 days. Fruit 14 by 3 inches, straight, lemon yellow slightly rough, should supplant the crook-necks as more desirable.95	.90	.85
Sweet Potato, Improved or Delicata. 110 days. Vigorous vine, resistant to mosaic. Fruit average 8 to 9 inches with a diameter of 4 inches. The fruit have a green striped cream skin and the thick flesh is orange.....	.95	.90	.85
Uconn. 75 days. All America Gold Medal winner, 1950. A bush type of Acorn that is heavier yielding than the regular Acorn.	1.15	1.10	1.05
Vegetable Marrow, English. 100 days. w.b. Fruit 10 by 5 inches, cream yellow skin turning nearly white, thick flesh creamy, used for Diabetics.95	.90	.85

TOBACCO

	Oz.	¼ Lb.	Lb.
Connecticut Seed Leaf. Suitable for northern states, hardy cigar type.	\$0.40	\$1.25	\$3.75
White Burley. Resistant to root rot, used for plug fillers.40	1.25	3.75

TOMATOES

Dates are from setting of plants to first ripe fruits.

TRUE F1 HYBRIDS		¼ Lb.	Lb.	5 Lbs. Per Lb.	
Vaughan's Early Hybrid Tomato. 72 days. A 1951 introduction of a very fine early true F1 hybrid tomato that is adapted to either market or home growing. The fruits are large, a bright red and borne in great numbers. Trials indicated this variety out-yielded all other sorts by a wide margin until August 10th.....oz.		\$6.00	\$20.00	\$60.00	\$55.00
Vaughan's Hybrid Tomato. 85 days. A midseason red tomato that bears a great quantity of 5 to 6 ounce tomatoes. A fine variety for the home where the smaller size is desired.oz.		6.00	20.00	60.00	55.00
STANDARD TYPES					
Beauty, Livingstons. 82 days. Medium large plant vigorous, prolific, fruit pink medium large, medium flat smooth purplish pink.....		1.65	4.85	4.75	
Bonny Best, Certified. 74 days. Plant medium size, fruits red or called by gardeners yellow as they take a yellowish green near stem end as they ripen, semi-globe smooth, bright scarlet.		1.45	4.35	4.25	
Bounty. Certified 65 days. Plants small size, very prolific, producing more fruit for its size than any other plant we have grown. Fruits medium large, round to globe shape, pale green in the early stage turning to a very rich red throughout, coloring well on the inside. An excellent home garden type.		1.65	4.85	4.75	
Break O'Day Certified. 70 days. Partly resistant to wilt and nail head rust, open, spreading growth, prolific, fruit red, medium size, globe shaped, smooth, a yellowish cracked appearance about stem end.		1.65	4.85	4.75	
Crimson Cushion (Beefsteak) (Red Ponderosa). 96 days. A large wilt resistant variety, fruit red, large flat, scarlet fairly smooth.		2.50	7.50	7.25	
Dwarf Stone. 92 days. Tree form, short compact, fruit red, medium large flat, bright color, solid.		1.95	5.85	5.75	
Earliana. 66 days. Plant open spreading, finely cut leaves, fruit red flattened, medium size, fairly smooth, the first early general purpose tomato.		1.95	5.85	5.75	
Early Chatham. 60 days. A small vine variety bred especially for northern districts where there are cool nights and little hot sunshine. The vine is small and open, permitting the sun to enter. Of medium size, red, smooth and prolific. Bred and supplied by the Michigan U. P. Experiment station and seed supplied us by Dr. Bowser who has spent several years selecting and crossing this strain.		1.95	5.85	5.75	
Firesteel. 68 days. Medium small vine, adapted to drouth conditions and sure cropper, fruit red, medium size medium green turning to deep red, smooth and free from cracks.		1.95	5.85	5.75	

TOMATOES—Continued

	¼ Lb.	Lb.	5 Lbs. Per Lb.
Garden State or Scarlet Canner. 83 days. Similar to Greater Baltimore. Very prolific, bearing deep scarlet red fruit that are extra smooth and solid. Plants vigorous, holding charge well, which gives protection against sun scald. We highly recommend this tomato.	\$1.65	\$4.85	\$4.75
Giant Tree or Italian Potato Leaved. 88 days. The finest large tomato. Some fruits weigh over two pounds and the quality for table use is outstanding. This is a Vaughan Specialty.	8.75	25.00	24.50
Globe, Livingston. 82 days. Plant strong, fairly prolific, primarily a greenhouse type, fruit pink, large full globe, smooth, ripens evenly.	1.65	4.85	4.75
Greater Baltimore, Certified, Indiana Strain. 82 days. Plant large robust, somewhat open, fruit red, large solid.	1.40	4.10	4.00
Grothens Globe. 68 days. A selection from Break O'Day, having much heavier vines than its parent, and showing excellent market possibilities. Fruits red, globe shape, walls thick and firm, free from yellow color at stem end. Fruits average 7 to 8 ounces.	1.70	5.10	5.00
John Baer, Certified. 70 days. Plant medium size, open, fruit red, medium size, smooth semi-globe to flat.	1.45	4.35	4.25
Jubilee. 80 days. The deep orange flesh is thick and heavy with small seed cavities and a mild non-acid flavor. The yellow skinned fruits are large smooth globes, borne on vigorous vines which can be staked and pruned. Yellow tomatoes are rich in Vitamin C, and this is the best one so far.	1.95	5.85	5.75
Marglobe. 76 days. Plant vigorous, heavy foliage, resistant to blight, fruit red, medium large semi-globe, smooth, solid.	1.35	3.95	3.85
Marglobe Certified. Same as uncertified. Certified by Michigan State.	1.40	4.10	4.00
Oxheart. 90 days. Heavy coarse plant, fruit heart shape, pink, solid with few seeds.	2.80	8.50	8.00
Pan America. About 80 days. One of the latest Government developments for which they claim superiority of quality, firmness and productivity.	1.70	5.10	5.00
Ponderosa Yellow. Same as regular, only color yellow.	2.30	6.85	6.75
large flat, roughened, small seed cells.	2.25	6.75	6.50
Ponderosa Yellow. Same as regular, only color yellow.	\$2.30	\$6.85	\$6.75
Pritchard (Scarlet Topper) Certified. 76 days. Self topping, resistant to fusarium and nail head, fruit red with thick walls semi-globe.	1.30	3.85	3.75
Queens. 79 days—A new introduction that is the result of a cross between Valiant and Rutgers made by L. G. Schermehora of the New Jersey Exp. Sta. The plant is intermediate in type between Valiant and Rutgers. Fruits are smooth and of deep globe shape. The peak of the crop is harvested about a week earlier than Rutgers.	5.00	15.00	14.00

TOMATOES—Continued

	¼ Lb.	Lb.	5 Lbs. Per Lb.
Rutgers. 86 days. Plant large with thick stems, fruit red, globular, thick walls, good canner.	\$1.20	\$3.60	\$3.50
Rutgers Certified. Same as regular but State Certified.	1.35	3.95	3.85
Stokesdale Certified. 73 days. Medium size vine but prolific, fruit red, globe shape, good walls, good canner type.	1.65	4.85	4.75
Stone Improved. 85 days. Plants are large and the fruit a deep scarlet red. Medium late in season.	1.55	4.60	4.50
Valiant. Certified. 70 days. A deep Marglobe type of tomato, having large, smooth red fruits, with few seed and firm solid flesh. Excellent for home or market garden.	1.95	5.85	5.75
Victor. 65 days. Maturing uniformly during first weeks of picking.	1.55	4.60	4.50
Wisconsin No. 55 Certified. 83 days. A new release of the University of Wisconsin that is earlier than Stokesdale or Rutgers to mature and has a quality as good. It is larger with no shoulder cracks and practically no blossom end rot. Ripens evenly and stands shipping very well.	1.95	5.85	5.75

TOMATOES—SMALL FRUITED SORTS

All about 73 days, all coarse sprawling vines except where noted, very prolific.

	Oz.	¼ Lb.	Lb.
Cherry, Red or Yellow. Cherry-like clusters of small fruit.	\$0.65	\$2.00	\$6.00
Italian Canner. A red fruited plum-shaped type, about 2 to 2½ inches long by ¾ inch, firm, solid with no air space. A remarkable keeping tomato that is extremely popular for use in making paste.65	2.00	6.00
Peach, Red or Yellow. About 1¼ inches through; round, fuzz like peach.65	2.00	6.00
Plum, Red or Yellow. About 1½ inches through and some longer.65	2.00	6.00
Yellow Pear. 70 days. Plant very dwarf with enormous amount of fruit of same shape as red pear. Much superior as it can be grown in small garden area.65	2.00	6.00
Ground Cherry (Husk or Strawberry).65	2.00	6.00

TOMATO, FORCING SORTS

	Pkt.	Oz.	¼ Lb.
Livingston's Globe, Pink. (Extra Select).	\$0.25	\$2.25	\$7.50
Michigan State, Red.20	.75	2.00
Waltham Forcing, Red.20	.75	2.00

TURNIPS

Most any soil suitable. Days are those normally required to make bunching size from planting time. w indicates white flesh; y indicates yellow; g indicates tops used for greens.

	Lb.	5 Lbs. Per Lb.	25 Lbs. Per Lb.
Amber Globe. 76 days. y. Tops large, cut leaved, roots round, 6 inches through, light yellow with green top, flesh yellowish, white	\$0.55	\$0.50	\$0.45

TURNIPS—Continued

	Lb.	5 Lbs. Per Lb.	25 Lbs. Per Lb.
Early White Milan. 42 days. w. Early forcing type, tops small, strap leaved, roots small flat white throughout.	\$0.55	\$0.50	\$0.45
Early Purple Milan. 42 days. w. Tops small, strap leaved, roots flat white with purple tops, flesh white.55	.50	.45
Early Snowball. 40 days. w. Tops small erect, roots medium size, round, white throughout, tender55	.50	.45
Purple Top Strap Leaf. 46 days. w. Tops medium small, upright, roots flat, purple at top, white below, flesh white.50	.45	.40
Purple Top White Globe. 57 days. w. Tops dark green, cut leaved roots globe shaped, smooth, upper part purple, lower white, flesh white and tender.50	.45	.40
Seven Top. g. Hardy, grown principally for greens especially in the south. Roots not usable.50	.45	.40
Shogoin. 30 days. g. Tops 18 inches, erect bright green, strap leaves, roots globular white.50	.45	.40

RUTABAGA

American Purple Top. 90 days. Roots 5 inches through, rather top shape with small neck, yellow with purple top, flesh light yellow.45	.42	.40
Laurentian. 90 days. 4 inches in diameter and 5 to 6 inches in depth, being one of deepest top shape roots of any of the Rutabaga. Rich yellow flesh and very tender, nearly free of side roots. One of the best for table use.45	.42	.40
Neckless. 85 days. Similar to American Purple Top but with smaller neck, roots flattened globe, with purple top, flesh yellow.55	.50	.45

RAPE SEED**Bags Included**

Per 100 lbs.
5 Bags
or More Bag
Lois

Dwarf Essex	\$14.00	\$14.50
-----------------------	---------	---------

BIRD SEEDS

Sunflower—Large Grey	19.00	19.50
Sunflower—Hybrid Black	12.00	12.50
Bird Rape—Large Black	14.00	14.50
Canary	12.00	12.50
Hemp	20.00
Wild Bird Seed.	8.00
Packed in 5 lb. Colored Bags.	11.00

"Parks" Lawn Seed

formerly Chicago Parks

VAUGHAN'S HIGH-GRADE LAWN GRASS SEED

Vaughan's Parks, Columbian and Dense Shade Mixtures are of the highest grades. There are no brands so well or favorably known, and our many years of extensive advertising of these mixtures make them sure and ready sellers.

VAUGHAN'S "PARKS" for sun.

VAUGHAN'S "COLUMBIAN" for medium shade.

VAUGHAN'S "DENSE SHADE" for heavy shade.

Package Quantity Prices for these mixtures.



	100 lbs.
One-Pound Cartons (Retail \$1.15) ea. 80c.....	\$76.00
Two- and Three-Pound Cartons.....	75.00
Five-Pound Cartons or Bags, Each \$3.90.....	74.00
10- and 25-Pound Bags.....	73.50
50- and 25-Pound Bags.....	73.00
100-Lb. Lots	72.00
500-Lb. Lots	71.00
Lots of 10 to 25 lbs.....	74c per lb.

On larger lots, ask for prices.

VAUGHAN'S FAMOUS "MERION BLUE GRASS FORMULA" 100% PERENNIAL GRASSES

Contains: Merion Blue Grass, Illahee Creeping Fescue or Penn State Chewings Fescue Highland Bent. 1 lb., \$2.25; 5 lbs., \$2.20 per lb.; 10 lbs., \$2.18 per lb.; 50 lbs., \$2.17 per lb.; 100 lbs., \$2.15 per lb. Retails for \$3.25. Limit 100 lbs.

Produces thicker turf, stays greener all summer and stands closest mowing. 1 lb. covers 750 sq. ft., 3 times as much as standard blue grass mixtures, thus being no more expensive to sow an equal area.

Merion Blue Grass, propagated from a single plant selection, which has demonstrated in trials throughout the country ability to stay green all summer, stand close mowing, and resist leaf spot and other diseases. Because its growth is more stocky and spreading than standard blue grass, it covers more ground, and less seed is required for a given area. We regard it the most important lawn grass introduction in the last century.

Illahee Fescue or Penn State Chewings are improved strains of fescue, stronger growing and more resistant to disease. They thicken the turf, do well on sandy soils and in shade. Both in short supply, we will use whichever available on receipt of order.

Highland Bent, dry land or upland bent, more drought and disease resistant than most bents and not requiring the care of creeping bent, it spreads underground and makes a thick turf, helping keep down weeds and spreading quickly to cover bare spots.

VAUGHAN'S EXCEL LAWN MIXTURE An Economy Mixture Containing NO TIMOTHY

An ideal mixture for those wanting quick results.	100 lbs.
Price	\$55.00
5 lb. bags, each \$2.90.....	57.00
1 lb. cartons (sell for 85c each), Each 60c.....	59.00

All Grass Seed Net Cash, F. O. B. Chicago or New York

Fancy Grasses

Prices Subject to Change

Orders Booked at the Lowest Price on Day Received

We carry a full line of native and imported grass seeds and would be pleased to have your inquiries. We can quote to advantage. We buy direct from growers and are recleaners.

	5 to 10 Bags	1 to 5 Bags
Kentucky Blue Grass —Standard 80%	\$55.00	\$56.00
Fancy—85%	57.00	58.00
Extra Fancy—90%	62.00	63.00
Refined—98%	69.00	70.00
Red Top —Fancy—Purity 92%	40.00	41.00
Extra Fancy—Purity 95%	42.00	43.00
Refined—Purity 97% to 98%	46.00	47.00
Clover —White Dutch, Fancy	74.00	75.00
Choice	72.00	73.00
Rye Grass —Domestic	13.50	14.00
Perennial Rye Grass	19.00	19.50
Chewings Fescue	94.00	95.00
Domestic Creeping Red Fescue	94.00	95.00
Imported Creeping Red Fescue	84.00	85.00
Astoria Bent —Blue Tag	110.00
Seaside Bent —Blue Tag	105.00
Highland Bent	100.00
Alta Fescue or Ky 31	74.00	75.00
Poa Trivialis	61.00	62.00

Ask for our monthly price list on Grass and Field Seeds

GRASS SEED DEALS

A Vivid Window Streamer Printed in Five Colors Which Will Bring You
Business—Furnished Free to All Dealers

Vaughan's Lawn Mixtures Contain No Timothy

Vaughan's Parks—Deal No. 1

Retails for
\$62.20

Cartons	Ret. Price
10—1 lb.	\$1.15
5—2 lbs.	2.30
7—5 lbs.	5.60

\$40

Net Cash

Recommend Parks Lawn Mixture for beauty and durability. It produces a fine turf that will endure. The splendid reputation of this mixture for over half a century makes it an easy seller and keeps satisfied customers. For seeding and care of lawn, call customers' attention to lawn booklet enclosed in every carton and bag of Vaughan's lawn seed.

EXCEL MIXTURE

Deal No. 2

Retails for \$53.75

Cartons	Ret. Price	Bags	Ret. Price
17—1 lbs.	\$0.90	9—5 lbs.	\$4.35

\$35

Net Cash

All Grass Seed sold on net cash terms, transportation extra, and bags included except where noted.

Sell the Home Garden Market Carry Vaughan's Packet Seeds

If you carry bulk seeds, no doubt you have many calls for varieties which you do not stock. This is especially likely in the case of flower seeds, for which demand is now breaking all previous records.

The profitable and efficient way to fill such orders is from a Vaughan's Seed assortment, which may be obtained on a sale or return basis, under which you pay only for the packets sold, and we buy back the unsold packets.

Vaughan's Seeds will attract to your store discriminating buyers, who know our reputation, and who cannot find our seeds at every corner store.

We offer several sizes of assortments, from \$65.00 retail value up, each with an attractive, compact display case of the self-serve type, from which your customers may make selection.

For a standard assortment, fill out and mail the contract order below, and it will come to you by express prepaid.

VAUGHAN'S SEED CO., 601 W. Jackson Blvd., Chicago, Ill.

Please forward in due course an assortment of VAUGHAN'S SEEDS for season of 1952. The undersigned will pay upon request for all seeds at retail prices less 40% on all packets sold, and retail price less 25% on all large packages. He agrees to sell at such time, and Vaughan's Seed Co. agrees to purchase all seeds then in good condition at retail prices less 40% on all packets, and retail price less 25% on all large packages. Unsold seed and display boxes to be returned in good order when called for and amount due for all seeds and boxes not so returned to be paid at the same time net cash. This purchase will be credited against the amount due from the undersigned.

If after deducting the above regular commission, the amount due us exceeds \$20.00, an extra 15% discount will be allowed on all net sales over this amount. The undersigned agrees to pay to Vaughan's Seed Co. a return of not less than \$20.00.

19

Your Firm Name _____

Your Address _____

Sign here _____

SUMMER-FLOWERING BULBS

Special Prices on Large Quantities



Tuberous-Rooted Begonias

All Prices Subject to Change
Without Notice

AMARYLLIS Vaughan's Hybrids

	Doz.	100
2¼-2½ inch	\$2.40	\$16.00
2½-2¾ inch	2.50	18.00
2¾-3 inch	3.50	25.00

ACHIMENES

This is closely related to the gloxinia. Plant 6 to 7 bulbs in a 5-inch pot, or 9 to 10 in a 6-inch pot. The soil used for potting should be rich in humus and of an open, porous nature, allowing perfect drainage. A good mixture to use is equal parts of loam, leaf mold and sand. About one-third of the depth of the pots or pans should be occupied with drainage. After the young growth appears, great care should be taken to keep the soil moist, for a single severe drying will ruin the plant. Blooming time 8 to 10 weeks after planting. Mixed colors. 100, \$8.00; 1000, \$75.00.

BEGONIAS

TUBEROUS-ROOTED

Double Camellia flowered, separate colors.

	Belgium Grown			California Grown		
	Doz.	100	1000	Doz.	100	1000
Small size	\$1.10	\$7.00	\$60.00	\$1.50	\$10.00	\$ 90.00
Medium size	1.75	11.00	100.00	2.10	14.50	135.00
Large size	1.95	13.50	125.00	2.85	19.50	185.00
Lloydii for hanging baskets.....	2.85	19.50	185.00

	Doz.	100	1000
Callas, Yellow, 2-2½ inches	\$2.70	\$17.50	\$165.00
2½-3 inches	4.75	32.00	300.00
Callas, Pink, 1½-2 inches	2.25	14.50	135.00
Gloxinias, 1¼-1½ inches	1.40	9.00	80.00
1½-2 inches	2.50	16.00	150.00
Hyacinthus Candicans, 1½-1¾ inches60	4.00	35.00
1¾ inches and up.....	.75	5.00	45.00
Montbretias, mixed55	3.50	30.00
Montbretias Earlham Hybrids, mixed75	5.00	45.00
Tigridias, separate colors	6.50	60.00
Tigridias, mixed	6.00	55.00
Tuberoses, Dwarf Pearl, 3-4 inches	4.00	35.00
4-6 inches	7.00	60.00
Tuberoses, Mexican Single	4.50	40.00
Zephyranthus Candida45	3.00	25.00
Zephyranthus Rosea	6.00	55.00

VAUGHAN'S GLADIOLI

All Prices Subject to Change Without Notice

FIRST Sizes Are 1½ Inch and Up. SECOND Size 1¼ to 1½ Inch

The crop of Gladiolus Bulbs this year is only medium as to large bulbs. There are plenty of second size. The various diseases are still cutting in heavily in some growers stocks. The demand for the larger size bulbs is already heavy, therefore we suggest that when you get this catalogue you will get your orders placed at once so we can set aside your order for delivery whenever you want from January to May 15th.

Please allow us to send good substitutes in case we are out of the variety you order.

ABU HASSEN. Deep Blue. First Size	100	1000
Second Size	\$4.50	\$40.00
BEACON. Salmon-scarlet. First Size	3.50	30.00
Second Size	2.50	20.00
BLUE BEAUTY. Fine medium blue. First Size	2.10	16.00
Second Size	3.75	32.50
BURMA. Deep Rose. First Size	3.00	25.00
Second Size	4.00	35.00
CHAMOONY. Tall dark rose bordered silver. First Size	3.50	30.00
Second Size	3.00	25.00
CORONA. New light pink with creamy-white throat. First Size	4.50	40.00
Second Size	4.00	35.00
DEBONAIR. La France pink. First Size	2.50	20.00
Second Size	2.10	16.00
EARLY ROSE. Rich rose, lighter in throat. First Size	2.75	22.50
Second Size	2.10	16.00
ELIZABETH THE QUEEN. Fine ruffled lavender. First Size	3.00	26.00
Second Size	2.75	22.50
ETHEL CAVE-COLE. New large light pink. First Size	2.75	22.50
Second Size	2.20	17.00
GENERAL EISENHOWER. Salmon Pink. First Size	4.25	37.50
Second Size	3.50	30.00
FLAMING SWORD. Scarlet, early. First Size	2.50	20.00
Second Size	2.10	16.00
GOLD DUST. Golden yellow. First Size	2.75	22.50
Second Size	2.10	16.00
JEANIE. Clear pink with white mid ribs, yellow throat. First Size	3.00	25.00
Second Size	2.50	20.00
JUNE BELLS. Pure white. First Size	3.25	27.50
Second Size	2.75	22.50
KING LEAR. Deep reddish purple. First Size	3.25	27.50
Second Size	2.75	22.50
LADY JANE. Cream or light yellow. First Size	3.00	25.00
Second Size	2.50	20.00
LEEUWENHORST. Light Pink. First Size	3.50	30.00
Second Size	3.00	25.00
LEADING LADY. Large cream white. First Size	4.50	40.00
Second Size	4.00	35.00
MAID OF ORLEANS. Milky white, cream throat. First Size	2.75	22.50
Second Size	2.30	18.00
MARGARET BEATON. White with orange-red blotch in throat.		
First Size	2.50	20.00
Second Size	2.10	16.00
MARGARET FULTON. Rose-salmon. First Size	2.50	20.00
Second Size	2.10	16.00

MINUET. Best Lavender. First Size	100	1000
Second Size	\$3.50	\$30.00
MISS BLOOMINGTON. Deep lemon-yellow. First Size	3.00	25.00
Second Size	2.50	20.00
MODERN TIMES. Crimson Carmine. First Size	2.10	16.00
Second Size	3.50	30.00
NEW EUROPE. Brick red. First Size	3.00	25.00
Second Size	2.75	22.50
PICARDY. Delicate apricot pink. First Size	3.50	30.00
Second Size	3.00	25.00
Third Size	2.30	18.00
PINK RADIANCE. Clear light pink with recurve petals. First Size ..	3.50	30.00
Second Size	3.00	25.00
PURPLE SUPREME. Tall Purple. First Size	3.50	30.00
Second Size	3.00	25.00
RED CHARM. Fine medium red. First Size	3.50	30.00
Second Size	3.00	25.00
ROSA VAN LIMA. Bright pink with light throat. First Size	2.75	22.50
Second Size	2.30	18.00
SILENTIUM. Improved Margaret Beaton — white with red throat.		
First Size	2.50	20.00
Second Size	2.10	16.00
SNOW PRINCESS. A very fine white. First Size	2.30	18.00
Second Size	2.00	15.00
SPIC & SPAN. Bright Pink. First Size	6.50	60.00
Second Size	5.50	50.00
STOP LIGHT. Dazzling red. Very good spike. First Size	3.25	27.50
Second Size	2.75	22.50
SPOTLIGHT. Deep yellow, red throat. First Size	4.25	37.50
Second Size	3.50	30.00
VALERIA. Best red. First Size	2.90	24.00
Second Size	2.00	20.00
VAN TIENHOVEN. Poppy red. First Size	3.00	25.00
Second Size	2.50	20.00
WANDA. Cream sport of Puards. First Size	3.00	25.00
Second Size	2.50	20.00
WHITE GOLD. Large cream. First Size	2.75	22.50
Second Size	2.20	17.00
YELLOW EMPEROR. Deep clear yellow. First Size	2.50	20.00
Second Size	2.20	17.00
YELLOW HERALD. Yellow. First Size	3.25	27.50
Second Size	2.75	22.50
STANDARD MIXED. Not a field grown mixture, but blended thor- oughly after harvest. All good, standard sorts. First Size	2.50	20.00
Second Size	2.00	15.00

EXTRA FINE MIXTURE

A mixture of fine, popular, higher priced varieties, contain-
ing a fine range of colors. **First Size**.....

First Size	\$3.00	\$25.00
Second Size	2.30	18.00

DE LUXE MIXTURE

Put up 100 to the bag, to assure a splendid mixture. All high
class, superfine varieties. **First Size**.....

First Size	4.00	35.00
Second Size	3.50	30.00

500 1st Size Glads, 10 Named Varieties, and Display Box

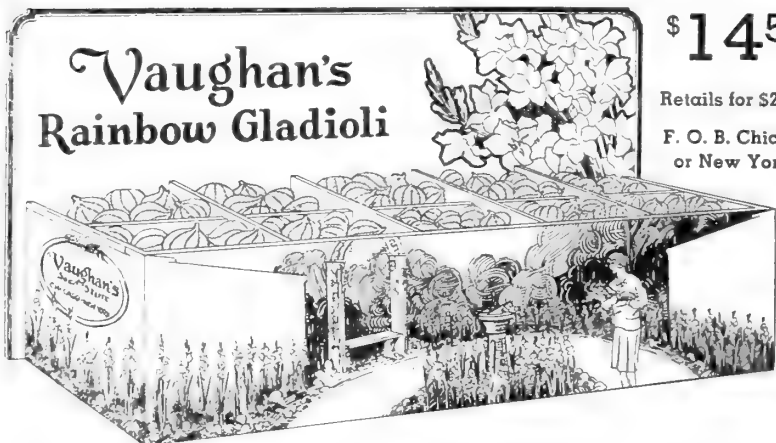

\$14⁵⁰

Retails for \$29.00

F. O. B. Chicago
or New York

Gladiolus Display Box Holding 500 1st Size Bulbs 50 each of 10 Named Varieties

Vaughan's gladioli are famous. For years they have been nationally advertised. You have only to put this box on your counter to sell out quickly.

We use **FIRST SIZE BULBS**, the size which sells best over the counter. The 10 named varieties (50 each) of good named varieties. The price to you is \$14.50 for the box and 500 bulbs of 10 named varieties. You retail them for 75c a dozen, or more, because the selection is worth more, doubling your money. Each variety is packed 50 in a bag labeled with its name. You empty one bag into a compartment, and refill in the same manner when it is empty. This prevents mixtures and loss of bulbs. After the display box and first collection have been bought, refill orders will be accepted for \$14.00 for 500 bulbs, 50 each of 10 varieties, in bags of 50; or \$27.00 for 1,000 bulbs, 100 each of ten varieties. Colored pictures are provided to paste on the compartments. This box keeps the bulbs in the open air, thus preventing bacterial rot which comes when they are sealed in cartons. The named varieties are kept apart without mixing, which adds greatly to their value. **Varieties Subject to Change Without Notice.**

Sell Vaughan's Famous Rainbow Garden of Gladioli (56 No. 3 bulbs)

VARIETIES SUBJECT TO CHANGE AFTER APRIL 15th.

Each: \$1.50; 10 for \$14.00; 20 for \$27.00; Prepaid 600 Miles.

Retailing at \$2.00, this is an unexcelled leader. It includes 56 bulbs, 8 each of the following varieties, each separately bagged and labeled: **Margaret Beaton**, huge white orange-scarlet blotch; **Picardy**, pink; **Spotlight**, deep rich yellow red throat; **Red Charm**, medium red; **Elizabeth The Queen**, giant ruffled lavender; **Ethel Cave Cole**, delicate pink; **Miss Wisconsin**, rose pink, darker towards the edge.

Ornamental and Flowering Shrubs

Our shrubs are nursery-grown and are transplanted every two or three years. They are nice, shapely bushes with plenty of good fibrous roots, and are such plants as are in demand by the first class retail trade. They should not be compared to stock that is never moved from the cutting or seeding beds until sold.

Our Nursery is located at Western Springs, 15 miles west of Chicago, on the C. B. & Q. R. R., two blocks south of 47th Street, on Wolf Road.

Visitors are invited to inspect our stock at any time. We have a choice lot of specimens such as are not usually seen. Our customers will be pleased with the class of stock we send them.

Shipping Directions: All stock is sold F. O. B. Western Springs. Packing charges to be added on all orders for shrubs, dormant roses, fruits, trees, evergreens, and vines, at cost. Always give full explicit shipping directions, as our responsibility ends on delivery to the express or freight office in good condition. **All trees, shrubs and plants shipped subject to customer assuming risk regarding his own State Nursery Inspection Regulations. Certificate furnished with each shipment.**

Where personal selection of stock is made at our Nursery we charge according to its value.

Warning—Prices on all nursery stock subject to change without notice. 5 plants of one kind supplied at 10 rate. 30 plants of one kind supplied at 100 rate.

ACANTHOPANAX Pentaphyllum. (Aralia Pentaphylla). Five lobed glossy leaves and prickly branches; for partial shade.	Each	10	100
4 to 5 ft.....	\$1.00	\$8.50
5 to 6 ft.....	1.10	10.00
AMELANCHIER Canadensis (Shadblow Serviceberry). Large shrub with white flowers on arching branches. Purple fruit.			
3 to 4 ft.....	1.00	9.00
4 to 5 ft.....	1.15	10.00
AZALEA Mollis (Chinese A.) 15 to 18 in. B&B.....	4.00	37.50
BERBERIS Koreana (Korean Barberry). Colorful autumn foliage; clusters of brilliant red berries.			
18 to 24 in.....	.60	5.00	\$45.00
2 to 3 ft.....	.75	6.50
Mentorensis. (Patent No. 99) (New Evergreen Barberry). 18 to 24 in.....	.85	7.50	62.50
Thunbergi (Green-leaved Barberry). 18 to 24 in.....	.60	4.50	40.00
Thunbergi Atropurpurea (Red-leaved Barberry).			
18 to 24 in.....	.65	5.50	50.00
24 to 30 in.....	.75	6.50
30 to 36 in.....	.90	8.50
Thunbergi Erecta (Truehedge Columnberry). Plant Patent No. 110. Pyramidal habit; dense glossy foliage.			
2 to 3 ft.....	.85	7.50	70.00
3 to 4 ft.....	1.15	11.00

	Each	10	100
BUDDLEIA (Butterflybush or Summer Lilac).			
Fascinating. (Pink). Field grown.....	\$0.60	\$4.50	\$40.00
Dubonnet. (Red). Field grown.....	.60	4.50	40.00
Orchid Beauty. Field grown.....	.60	4.50	40.00
Royal Purple. Field grown.....	.60	4.50	40.00
BUXUS Microphylla Koreana (Korean Box). Excellent for dwarf hedge. Hardier than the English Box.			
From 2½ in. pots.....	.50	4.50	40.00
CALYCANTHUS Floridus (Sweet Shrub). Large chocolate red flowers with a pineapple fragrance. 18 to 24 in.....	.70	6.00
24 to 30 in.....	.85	7.50
CARAGANA Arborescens (Siberian Peatree). Golden pea-shaped blossoms in May. 3 to 4 ft.....	.60	5.00
CORNUS Alba Sibirica (Siberian Redtwig Dogwood). Brilliant coral red branches in winter and spring.			
18 to 24 in.....	.60	5.00	45.00
3 to 4 ft.....	.70	6.00	50.00
4 to 5 ft.....	.85	7.00	65.00
Amomum (Silky Dogwood). Spreading habit. Creamy white flowers followed by bright blue fruits. Stems have attractive winter color.			
2 to 3 ft.....	.50	4.00	35.00
3 to 4 ft.....	.60	5.00	40.00
4 to 5 ft.....	.70	6.00	55.00
Stolonifera Flaviramea (Goldentwig Dogwood). The bark is a bright golden yellow.			
2 to 3 ft.....	.60	5.00	45.00
3 to 4 ft.....	.70	6.00	55.00
COTONEASTER Acutifolia (Peking Cotoneaster). A dense growing shrub with dark green oval leaves; jet black berries in the fall.			
2 to 3 ft.....	.75	6.50
3 to 4 ft.....	.90	8.00
CYDONIA Japonica (Japanese Quince). Crimson flowers in April and May. A good border shrub.			
18 to 24 in.....	.60	5.00	45.00
2 to 3 ft.....	.75	6.50	60.00
DEUTZIA Gracilis (Slender Deutzia). A low-growing shrub with graceful branches.			
9 to 12 in.....	.60	5.00
ELSCHOLTZIA Stauntoni (Heathermint). Produces reddish purple spikes in autumn.			
18 to 24 in.....	.75	6.50
2 to 3 ft.....	.85	7.50
EUONYMUS Alatus Compacta (Dwarf Burningbush). Intense crimson fall foliage on compact ball shaped bush.			
18 to 24 in.....	1.90	17.50
2 to 2½ ft.....	2.75
2½ to 3 ft.....	3.25
3 to 3½ ft.....	4.50
3 to 3½ ft. B&B.....	5.00
3½ to 4 ft. B&B.....	5.75
4 to 4½ ft. B&B.....	6.75
4½ to 5 ft. B&B.....	8.50
5 to 5½ ft. B&B.....	10.00

EUONYMUS—Cont.

Europæus (European Spindletree). Tall erect shrub often loaded with orange berries which hang from rose colored capsules.	Each	10	100
3 to 4 ft.....	\$0.75	\$7.00
4 to 5 ft.....	1.10	10.00
6 to 8 ft.....	2.75	25.00
Radicans (Wintercreeper). Produces berries similar to those of the Bittersweet.			
From 2½ in. pots.....	.60	5.50	\$50.00
Radicans Colorata (Purple leaf Winter Creeper)			
From 2½ in. pots.....	.45	3.50	25.00
From 3 in. pots.....	.55	4.50	35.00
Radicans Vegetus (Bigleaf Wintercreeper).			
From 2½ in. pots.....	.60	5.50	50.00
From 3 in. pots.....	.85	7.50	65.00
FORSYTHIA Intermedia Spectabilis (Goldenbell). This old familiar shrub is covered with golden yellow blossoms in the early spring.			
2 to 3 ft.....	.60	5.50	50.00
3 to 4 ft.....	.75	6.50	60.00
4 to 5 ft.....	.85	7.50
Spring Glory. Prolific producer of large pale yellow flowers.			
2 to 3 ft.....	.85	7.50
HALESIA Tetraptra (Great Silverbell). Clusters of white bell shaped flowers hang from branches in early May.			
2 to 3 ft.....	.85	7.50
4 to 5 ft.....	1.75	15.00
5 to 6 ft.....	2.15	20.00
HAMAMELIS Vernalis (Winterblooming Witchhazel).			
2 to 3 ft.....	1.10	10.00
3 to 4 ft.....	2.15	20.00
5 to 6 ft. B&B.....	5.25
HIBISCUS Syriacus (Rose of Sharon). (Althea). Flowers are like the double Hollyhock.			
Double Purple, Pink, Red or White. 3 to 4 ft.....	.85	7.50	65.00
HYDRANGEA Arborescens Grandiflora (Snowhill H.)			
18 to 24 in.....	.65	5.50	50.00
2 to 3 ft.....	.85	7.50
Blue Hydrangea. 2 yr.....	1.10	10.00
Paniculata Grandiflora. 18 to 24 in.....	.65	5.50	50.00
2 to 3 ft.....	.85	7.50
Quercifolia (Oakleaf Hydrangea). The dark green leaves resemble the Oak leaf.			
18 to 24 in.....	1.30	12.00
3 to 4 ft. B&B.....	4.00
KERRIA Japonica pleniflora. Showy yellow flowers.			
2 to 3 ft.....	1.00	9.00
KOLKWITZIA Amabilis (Beautybush). Graceful shrub bearing pink flowers in June.			
18 to 24 in.....	.75	6.50
2 to 3 ft.....	.85	7.50
3 to 4 ft.....	1.00	9.00
LIGUSTRUM Amurense (Amur Privet, North).			
18 to 24 in., 3 canes up.....	...	2.50	20.00
2 to 3 ft.....	...	3.50	30.00
3 to 4 ft. heavy.....	...	4.50	40.00
Ibota Regelianum (Regel's Privet). 18 to 24 in.....	.60	5.50

	Each	10	100
LONGICERA Demissa. A small Honeysuckle for partial shade.			
2 to 3 ft.....	\$0.75	\$6.50
Fragrantissima (Winter Honeysuckle). Fragrant white flowers in March.			
18 to 24 in.....	.55	4.50
Korolkowi Floribunda (Broad Blueleaf H.)			
3 to 4 ft.....	.85	7.50
Korolkowi Zabeli (Zabel Honeysuckle). The best of the red Honeysuckles.			
3 to 4 ft.....	.75	6.50	\$60.00
4 to 5 ft.....	.90	8.50	75.00
Ruprechtiana (Manchurian Honeysuckle).			
2 to 3 ft.....	.60	5.00
Tatarica Alba or Rosea (White or Pink Bush H.)			
2 to 3 ft.....	.60	5.00
3 to 4 ft.....	.70	6.00	55.00
Tatarica Rubra (Red Bush Honeysuckle).			
2 to 3 ft.....	.60	5.00
3 to 4 ft.....	.70	6.00	55.00
PHILADELPHUS (Mockorange).			
Common Mockorange. Profuse large white flowers.			
3 to 4 ft.....	.70	6.00	55.00
4 to 5 ft.....	.75	6.50
5 to 6 ft.....	.85	7.50
Lemoinei (Lemoine Mockorange). One of the smaller varieties. Produces fragrant white flowers.			
2 to 3 ft.....	.75	6.50
Minnesota Snowflake Patent No. 538. More double than P. Virginialis.			
2 to 3 ft.....	1.00	9.00
Virginialis (Virginal Mockorange). Abundant semi-double white blooms in June.			
2 to 3 ft.....	.75	7.00	65.00
5 to 6 ft.....	1.50	12.50
PHYSOCARPUS Opulifolius (Common Ninebark). 5 to 6 ft...	.75	6.50	60.00
Opulifolius Aureus (Goldenleaf Ninebark). 5 to 6 ft.....	.75	6.50	60.00
Opulifolius Nana (Dwarf Ninebark). 2 to 3 ft.....	.70	6.00	50.00
PRUNUS Besseyi (Hansen's Improved Bush Cherry). The dark red fruits are quite tasty.			
2 to 3 ft.....	.60	5.00	45.00
Glandulosa Sinensis (Double Pink Flowering Almond). Popular shrub bears heavily in early spring.			
2 to 3 ft.....	.85	7.50
RHAMNUS Frangula (Glossy Buckthorn). 3 to 4 ft.....	.75	6.50
RHODOTYPOS Kerrioides (Jetbead). Large, single white flowers in May followed by jet-black berries.			
2 to 3 ft.....	.80	7.50
ROSA Hugonis (Father Hugo's Rose). Single yellow flowers in May. 2 yr.....	.75	6.50	60.00
Rugosa Belle Poitevine. Large semi-double pink. 2 yr.....	.75	6.50
Rugosa F. J. Grootendorst. Double red clusters. 2 yr.....	.90	7.50
Rugosa Hansa. Purplish-red semi-double. 2 yr.....	.75	6.50
Rugosa Pink Grootendorst. Double pink clusters. 2 yr.....	.90	7.50
Multiflora (Fence Rose). Seedlings ¼ in. caliper at crown.			
15 to 18 in. 500, \$30.00; 1000, \$55.00; 5000, \$250.00....		8.00

SALIX Discolor (Pussy Willow). 3 to 4 ft.....	\$0.70	\$6.50
SPIRAEA Arguta (Garland Spirea). Showy white blooms in the early spring.			
2 to 3 ft.....	.70	6.50	\$60.00
Anthony Waterer. Rose-red flowers in May.			
18 to 24 in.....	.70	6.00	55.00
Bumalda Froebeli (Froebel Spirea). Rose pink bloom through summer.			
18 to 24 in.....	.50	4.50	40.00
24 to 30 in.....	.70	5.50	50.00
Macrothyrsa. The improved Billiard.			
2 to 3 ft.....	.75	6.50
Trichocarpa (Korean Spirea). Clusters of white flowers in late spring.			
3 to 4 ft.....	.60	5.00
4 to 5 ft.....	.85	7.50
Vanhouttei (Bridalwreath). The familiar hardy, graceful shrub of many uses.			
2 to 3 ft.....	.55	4.50	40.00
3 to 4 ft.....	.65	5.50	50.00
SYMPHORICARPOS Racemosus (Snowberry) 3 to 4 feet....	.50	4.50	40.00
SYRINGA Japonica (Tree Lilac). Creamy white clusters in June.			
3 to 4 ft.....	1.00	9.00
4 to 5 ft.....	1.50	12.50
5 to 6 ft.....	2.00
Microphylla (Littleleaf Lilac).			
3 to 4 ft.....	1.75
Persica (Persian Lilac). Light lilac blooms, appearing later than the Common Lilac			
2 to 3 ft.....	.75	6.50	60.00
3 to 4 ft.....	.85	7.50	70.00
Villosa (Late Lilac). Clusters of flesh colored flowers in late Spring.			
3 to 4 ft.....	.85	7.50
4 to 5 ft.....	1.00	9.00
Vulgaris Alba (Common White Lilac). A white variety of the Common Lilac.			
2 to 3 ft.....	.75	6.50
Vulgaris Purpurea (Common Purple Lilac). A favorite of long-standing.			
2 to 3 ft.....	.65	5.50	50.00
3 to 4 ft.....	.75	7.00
FRENCH HYBRID LILACS			
Charles Joly (Double Wine Red). 18 to 24 in.....	1.15	10.50
Marechal Lannes (Bluish Violet).			
12 to 15 in.....	1.15	10.50
Mme. Lemoine (Double White).			
18 to 24 in.....	1.00	9.00
2 to 3 ft.....	1.60	15.00
President Grevy (Double Blue). 18 to 24 in.....	1.00	9.00
2 to 3 ft.....	1.60	15.00
TAMARIX Hispida. Spikes of rose pink flowers; feathery foliage.			
3 to 4 ft.....	.85	7.50

	Each	10	100
VIBURNUM Burkwoodi (Gardenia-Scented Snowball).			
18 to 24 in.....	\$2.50
Dentatum (Arrowwood.)			
4 to 5 ft.....	.90	\$8.50
5 to 6 ft.....	1.00	9.50
Fragrans. 3 to 4 ft. B & B.....	5.00
4 to 5 ft. B & B.....	6.00
Lantana (Wayfaring Tree). 3 to 4 ft.....	.90	8.00	\$75.00
4 to 5 ft.....	1.00	9.00	85.00
Lentago. (Nannyberry).	1.00	9.00
4 to 5 ft.....	1.15	10.00
Opulus. (Cranberrybush). 3 to 4 ft.....	.90	8.50
4 to 5 ft.....	1.00	9.00
Opulus Sterile (Snowball). 3 to 4 ft.....	1.00	9.00
4 to 5 ft.....	1.25	10.00
VITEX Macrophylla (Hardy Lilac Chastetree). Bright lavender spikes in summer.			
18 to 24 in.....	.60	5.00
WEIGELA. Bristol Ruby (Patent Number 492). Profuse ruby red blooms in June.			
3 to 4 ft.....	1.50	13.50
Rosea (Pink Weigela). An old favorite; rosy pink flowers.			
3 to 4 ft.....	.75	6.50

Polyantha Forcing Roses

Dick Koster. Flowers like Marqo Koster, but rose-red in color. XXX grade, per 10, \$7.50; per 100, \$68.00.

Gloria Mundi. Double, lasting, glowing orange-scarlet in large clusters. Sold out for this spring; available again in late fall.

Margo Koster. Dwarf bushy plants with clusters of unusual globe-shaped flowers of vivid orange, flushed coral-pink. Sold out for this spring; available again in late fall.

Orange Triumph. Produces huge clusters of magnificent salmon blooms. XXX grade per 10, \$7.50; per 100, \$68.00.

Triomphe Orleansis. Brilliant cherry-red, lasting in color, blooms profusely in trusses, vigorous and erect with bright glossy green foliage. Considered the finest of red Polyanthas. XX grade, per 10, \$6.50; per 100, \$58.00; per 250, \$140.00.

Ask for list of Patented and Standard varieties of Hybrid Tea, Floribunda and Climbing Roses which will be available in February, after our grade counts are completed.

Ornamental and Shade Trees

All our trees are nursery grown and are one or more times transplanted.

ACER Dasycarpum (Silver Maple).	Each	10
8 to 10 ft. 1¼ to 1½ in. caliper.....	\$3.50	\$32.50
10 to 12 ft. 1½ to 1¾ in. caliper.....	4.35	40.50
Ginnala (Amur Maple).		
4 to 5 ft.....	1.35	12.50
5 to 6 ft.....	1.90	17.50
Platanoides (Norway Maple).		
8 to 10 ft., 1¼ to 1½ in. caliper.....	5.50	52.50
Platanoides Columnare (Columnar Norway Maple).		
10 to 12 ft., 1½ to 1¾ in. caliper.....	8.50	80.00
10 to 12 ft., 1¾ to 2 in. caliper.....	9.50	90.00
BETULA. Alba (European White Birch).		
8 to 10 ft.....	3.25	30.00
8 to 10 ft., 1 to 1¼ in. caliper.....	4.25	40.00
6 to 8 ft. clumps.....	5.25	50.00
Pendula Gracilis (Cut-Leaved Weeping Birch). 8 to 9 ft.....	5.00	47.50
CELTIS Occidentalis (Hackberry).		
8 to 10 ft. 1 to 1¼ in. caliper.....	4.00	37.50
8 to 10 ft. 1¼ to 1½ in. caliper.....	4.90	47.50
CERCIS Canadensis (Redbud).		
3 to 4 ft.....	1.50	14.00
CORNUS Florida (Flowering Dogwood).		
2 to 3 ft. B&B.....	4.00	37.50
Florida Rubra (Pink Flowering Dogwood).		
2 to 3 ft., B&B.....	4.75	45.00
CRATAEGUS Carrieri (Carrier Thorn).		
5 to 6 ft.....	3.00	27.50
6 to 7 ft.....	4.00	37.50
7 to 8 ft., 1¼ to 1½ in. caliper B&B.....	8.75
Coccinea (Thicket Hawthorn)		
8 to 10 ft. Bush B&B.....	8.75
Crusgali. (Cockspur Thorn)		
6 to 7 ft.....	5.25	50.00
7 to 8 ft., 1 to 1¼ in. caliper B&B.....	10.00
Mollis (Downey Hawthorn)		
6 to 7 ft.....	4.00	37.50
7 to 8 ft., 1¼ to 1½ in. caliper B&B.....	8.75
8 to 10 ft., 1½ to 1¾ in. caliper B&B.....	10.00
Oxyantha Splendens (Paul's Double Scarlet Hawthorn).		
4 to 5 ft.....	3.50	32.50
5 to 6 ft.....	4.50	42.50
FRAXINUS Americana (American White Ash).		
8 to 10 ft., 1¼ to 1½ in. caliper.....	3.25	30.00
10 to 12 ft., 1½ to 1¾ in. caliper.....	4.00	37.50
10 to 12 ft., 1¾ to 2 in. caliper.....	5.25	50.00
GINKGO Biloba. 6 to 8 ft., ¾ to 1 in. caliper.....	4.25	40.00
7 to 8 ft., 1 to 1¼ in. caliper.....	5.25	50.00
8 to 9 ft., 1¼ to 1½ in. caliper.....	6.00	57.50
GLEDITSIA Triacanthos (Honey Locust)		
1 to 1¼ in. caliper.....	3.50	32.50
1¼ to 1½ in. caliper.....	4.25	40.00
1½ to 1¾ in. caliper.....	4.75	45.00
1¾ to 2 in. caliper.....	6.25	60.00

GLEDETSIA—Continued		Each	10
Triacanthos Inermis (Thornless Honeylocust)			
8 to 10 ft., 1 to 1¼ in. caliper.....		\$3.75	\$35.00
8 to 10 ft., 1¼ to 1½ in. caliper.....		4.50	42.50
10 to 12 ft., 1½ to 1¾ in. caliper.....		5.00	47.50
1¾ to 2 in. caliper.....		7.00
MAGNOLIA Soulangeana. (Saucer Magnolia)			
2 to 3 ft. B&B.....		7.50
3 to 4 ft., B&B.....		8.75
4 to 5 ft., B&B.....		11.50
5 to 6 ft., B&B.....		13.75
Soulangeana Lennei (Lenne Magnolia).			
4 to 5 ft., B&B.....		11.50
Stellata (Star Magnolia).			
18 to 24 in., B&B.....		7.50
2 to 2½ ft., B&B.....		8.50
MALUS Almey (Almey Crab). 4 to 5 ft.....			
		3.00	27.50
Hopa (Hopa Crab), 4 to 5 ft.....			
		2.15	20.00
Purpurea Eleyi (Eley Fl. Crab). 4 to 5 ft.....			
		2.15	20.00
Ioensis Plena (Bechtels Crab).			
3 to 4 ft.....		2.15	20.00
4 to 5 ft.....		3.00
PRUNUS Blirieana (Blirieana Plum).			
4 to 5 ft.....		2.50
5 to 6 ft.....		2.75
Thundercloud (Purpleleaf Plum).			
4 to 5 ft.....		2.50
Triloba (Flowering Plum).			
3 to 4 ft.....		1.10	10.00
SALIX Niobe (Niobe Weeping Willow). 8 to 10 ft.....			
		2.50	22.50
SORBUS Aucuparia (European Mountain Ash).			
8 to 10 ft.....		4.25	40.00
TILIA Cordata (Littleleaf European Linden).			
8 to 10 ft., 1 to 1¼ in. caliper.....		3.00	27.50
8 to 10 ft., 1¼ to 1½ in. caliper.....		4.50	42.50
8 to 10 ft., 1½ to 1¾ in. caliper.....		5.75	55.00
8 to 10 ft., 1¾ to 2 in. caliper.....		7.00
10 to 12 ft., 2 to 2¼ in. caliper.....		8.50
Platyphyllos Pyramidalis (Pyramidalis European Linden).			
8 to 10 ft., 1¾ to 2 in. caliper.....		7.50	70.00
10 to 12 ft., 2 to 2¼ in. caliper.....		8.50	80.00
12 to 14 ft., 2½ to 2¾ in. caliper.....		12.50
12 to 14 ft., 2¾ to 3 in. caliper.....		15.50
ULMUS Americana (American Elm).			
Pumila (Chinese Elm).			
8 to 10 ft., 1 to 1¼ in. caliper.....		3.25	30.00
10 to 12 ft., 1¼ to 1½ in. caliper.....		4.50	42.50
12 to 14 ft., 1½ to 1¾ in. caliper.....		5.25	50.00
14 to 16 ft., 1¾ to 2 in. caliper.....		6.25	60.00
Molinei (Moline Elm).			
8 to 10 ft., 1 to 1¼ in. caliper.....		4.00	37.50
10 to 12 ft., 1¼ to 1½ in. caliper.....		4.75	45.00
12 to 14 ft., 1½ to 1¾ in. caliper.....		5.25	50.00
Elm Hedging. Available in Chinese Elm only. 2 to 3 ft. seedlings.			
not transplanted.....		per 100 \$7.50	1.00

All prices f.o.b. our nursery, Western Springs, Ill., packing charges additional at cost. Subject to change without notice.

All trees personally selected in our nursery will be charged for according to their value.

Vaughan's Evergreens

Prices listed, unless otherwise noted, include balling and burlapping. All our evergreens are two or more times transplanted.

JUNIPERUS Chinensis (Chinese Juniper).	Each	10
Vigorous broad columnar tree; green to blue green foliage.		
3 to 3½ ft.	\$5.25	\$50.00
3½ to 4 ft.	6.40	60.00
4 to 4½ ft.	7.50	70.00
4½ to 5 ft.	8.50	80.00
5 to 5½ ft.	9.50	90.00
Chinensis Keteleeri. Of broad pyramidal form; green foliage.		
3 to 3½ ft.	6.00	56.00
3½ to 4 ft.	7.50	70.00
4 to 4½ ft.	8.50	80.00
4½ to 5 ft.	10.00	95.00
5 to 5½ ft.	11.00	105.00
7½ to 8 ft.	20.00
8 to 9 ft.	22.50
Chinensis Pfitzeriana (Pfitzer Juniper).		
One of the best of all Junipers. Broad bushy habit. Thick, rich green foliage, giving feathery appearance.		
18 to 24 in. spread.	4.25	40.00
2 to 2½ ft. spread.	5.50	52.50
2½ to 3 ft. spread.	7.00	67.50
3 to 3½ ft. spread.	8.50	80.00
3½ to 4 ft. spread.	10.00
6 to 6½ ft. spread.	25.00
6½ to 7 ft. spread.	27.50
Chinensis Pfitzeriana-upright (Upright Pfitzer). These have been staked into an upright growing habit.		
3½ to 4 ft.	11.75	110.00
4 to 4½ ft.	13.75	130.00
4½ to 5 ft.	17.50
5 to 5½ ft.	18.50
Glauca Hetzi (Hetz Blue Juniper). Habit is similar to the Pfitzer; foliage is a pleasing blue.		
18 to 24 in.	4.25	40.00
Horizontalis Plumosa (Andorra Juniper). Of low-spreading, irregular form with bright green foliage, reddish purple in fall.		
15 to 18 in.	3.50	32.50
18 to 24 in.	4.25	40.00
2 to 2½ ft.	5.00	47.50
4 to 4½ ft.	8.50	80.00
Sabina Von Ehron. Semi-spreading, picturesque drooping branches, and very dark green foliage.		
3 to 3½ ft.	5.75	55.00
3½ to 4 ft.	6.50	60.00
4 to 4½ ft.	7.50	70.00
4½ to 5 ft.	9.50	90.00
Sabina Von Ehron-Upright. Staked form of above.		
4½ to 5 ft.	10.00	95.00
5 to 5½ ft.	11.50	110.00

JUNIPERUS Continued

	Each	10
Virginiana (Eastern Redcedar). Tall growing, of dense conical habit. Foliage is dark green; bronze in winter.		
6 to 6½ ft.....	\$8.00	\$75.00
Virginiana Burk. Of compact pyramidal growth, dark steel blue foilage.		
3½ to 4 ft.....	7.75	72.50
5½ to 6 ft.....	13.50	127.50
6 to 6½ ft.....	15.00
6½ to 7 ft.....	17.50
7 to 7½ ft.....	20.00
Virginiana Canaerti (Canaert Redcedar). Rich deep green foliage, heavily tufted.		
3 to 3½ ft.....	7.00	65.00
3½ to 4 ft.....	7.75	72.50
4½ to 5 ft.....	10.00	95.00
5 to 5½ ft.....	11.75	110.00
5½ to 6 ft.....	13.50	127.50
6 to 6½ ft.....	15.00
6½ to 7 ft.....	17.50
7 to 7½ ft.....	20.00
Virginiana Glauca (Silver Redcedar). A form of the Redcedar with silvery tinged foliage.		
4½ to 5 ft.....	10.00	95.00
5 to 5½ ft.....	11.75	110.00
5½ to 6 ft.....	13.50	127.50
6 to 6½ ft.....	15.00
6½ to 7 ft.....	17.50
7 to 7½ ft.....	20.00
Virginiana Hilli (Dundee Juniper). Of dense, conical form; foliage bluish gray green, fine plum color in fall and winter.		
3 to 3½ ft.....	7.00	65.00
3½ to 4 ft.....	7.75	72.50
5½ to 6 ft.....	13.50	127.50
6 to 6½ ft.....	15.00
6½ to 7 ft.....	17.50
PICEA. Excelsa (Norway Spruce). Tall tree with dark green needle foliage often used for windbreaks.		
3 to 3½ ft.....	4.25	40.00
3½ to 4 ft.....	5.00	47.50
4 to 4½ ft.....	6.00	55.00
4½ to 5 ft.....	7.50	70.00
5 to 5½ ft.....	8.50
5½ to 6 ft.....	10.00
Pungens Glauca (Colorado Blue Spruce). Popular for its abundance of heavy rich foliage. Selected blue.		
2½ ft.....	8.00
3 ft.....	9.50
4 ft.....	14.00
PSEUDOTSUGA Douglasi (Douglas Fir). A graceful pyramidal specimen tree.		
2 to 2½ ft.....	5.25	50.00

All evergreens personally selected and tagged in the Nursery, will be charged for according to their value, usually 25% above catalog price.

TAXUS Cuspidata (Japanese Yew). Rich dark green foliage spreading bushy habit. Does best in shade.		
18 in.	Each \$5.00	10 \$47.50
2 ft.	7.00	65.00
2½ ft.	9.50	90.00
3 ft.	12.50	120.00
3½ ft.	15.00
5 ft.	30.00
5½ ft.	35.00
Cuspidata Capitata (Upright Japanese Yew). Erect, symmetrical form of cuspidata.		
18 in.	5.75	55.00
2 ft.	6.50	60.00
2½ ft.	7.50	72.50
3 ft.	10.00	95.00
3½ ft.	13.50
3½ ft. Specimen.	17.50
4 ft.	17.50
4 ft. Specimen.	20.00
4½ ft.	25.00
4½ ft. Specimen.	27.50
5 ft. Specimen.	35.00
5½ ft. Specimen.	40.00
Cuspidata Nana (Dwarf Yew). A slow-growing, dwarf form of the Spreading Yew.		
18 in.	5.75	55.00
3 ft.	20.00
3½ ft.	25.00
4 ft.	30.00
Hicksi (Hick's Yew). Very compact, narrow upright.		
2 ft.	5.50	52.50
4 ft.	14.00
4½ ft.	16.50	160.00
5 ft.	18.00
5½ ft.	22.50
Media Kelseyi (Kelsey Yew). Bushy upright habit; abundant red berries.		
2 ft.	7.50	72.50
2½ ft.	9.00	85.00
THUJA Occ. Douglasi Pyramidalis (Douglas Pyramidal Arborvitae).		
Of compact, tall slender form; foliage dark green with lighter tips.		
6 to 6½ ft.	10.50	100.00
6½ to 7 ft.	12.00	110.00
Occ. Globosa (American Globe Arborvitae). A round compact form, dark green foliage.		
24 in.	4.00	37.00
30 in.	4.50	42.50
3 ft.	6.00	57.00
Occ. Pyramidalis (American Pyramidal Arborvitae). A compact, narrowly pyramidal tree with bright green foliage.		
5 to 5½ ft.	7.00	65.00
5½ to 6 ft.	8.00	75.00
6 to 6½ ft.	9.00	85.00

Thyjo—Continued

Occ. Rosenthalii (Rosenthal Arborvitae). Dark green dense foliage; compact grower.

2½ to 3 ft.....	\$6.00	\$57.50
3 to 3½ ft.....	6.75	65.00
3½ to 4 ft.....	7.75	72.50
4 to 4½ ft.....	9.00	85.00
4½ to 5 ft.....	9.50	90.00
5 to 5½ ft.....	10.00

Occ. Wareana (Ware Arborvitae). Broad pyramidal habit.

2½ to 3 ft.....	6.00	57.50
3 to 3½ ft.....	6.75	65.00
5 to 5½ ft.....	10.00
5½ to 6 ft.....	11.50

Hardy Vines

	Each	10	100
AMPELOPSIS Engelmani. A hardy and quick-growing, self-clinging vine. 2 year	\$0.50	\$4.00	\$35.00
Veitchi (Boston Ivy). The grandest hardy climbing vine that clings tightly to stone or brick. Good glossy green leaves, three-lobed. 2-year No. 1.....	.60	4.50	40.00
Aristolochia Siphon (Dutchman's Pipe). A vigorous climber with large heart shaped leaves. Thrives in sun or shade. 2-year grafted	1.35	12.50
BIGNONIA Radicans. (Trumpet Creeper). Showy trumpet-shaped flowers of brilliant orange-scarlet. 2 year.....	.50	3.75	30.00
Mme. Gallen. More dwarf than above, but has immense flower clusters. 2-year, grafted.....	1.00	9.50
CELASTRUS Scandens (American Bittersweet). Hardy climber, with orange-capsuled fruit in autumn. 2-year..	.50	4.00	35.00
3-year70	6.50
CLEMATIS—Small-flowering.			
Paniculata. The finest small-flowering Clematis. Pure white, deliciously fragrant flowers. September. 2-year..	.50	4.50
CLEMATIS—Large-Flowering.			
Henryi, single white; Jackmani, rich deep purple; Mme. Ed. Andre, wine red; Ramona, blue. 2-year No. 1.....	1.00	8.50
Henryi, Jackmani or Mme. Ed. Andre. 2½-inch pots. Not available after April 1st.....	.75	6.50	60.00
HEDERA Helix Baltica (Hardy English Ivy). Excellent ground cover. 2¼ in. pots.....	.60	4.00	35.00
HYDRANGEA Petiolaris (Climbing Hydrangea). From 3 in. pots.....	1.50	14.00
LONICERA Heckrottii (Everblooming Honeysuckle). Flowers dark red and creamy yellow. 2 year60	5.50
Japonica Halliana (Hall's Honeysuckle). Very fragrant pure white flowers changing to yellow. 2-year.....	.50	4.00	30.00
POLYGONUM Auberti. Fast growing vine, producing foamy masses of white flowers in late summer. 2-year.....	.65	5.50
PUERARIA Thunbergiana (Kudzu Vine). 1-yr. No. 1.....	.45	3.50	30.00
WISTARIA Rosea. (Pink Wistaria). Grafted plants.....	.90	7.50
Sinensis Alba. Pure white flowers. Grafted plants.....	.90	7.50
Sinensis Purpurea. Purple flowers. Grafted plants.....	.90	7.50

All Prices F. O. B. Our Nurseries, Western Springs, Ill. Subject to Change Without Notice. Packing Charges Additional at Cost.

Vaughan's Peonies

5 of a Kind at the 10 Rate—25 of a Kind at the 100 Rate

We have put the following varieties in storage and can only supply them in divisions from 3 to 5 eyes while the stock lasts.

Peonies may be planted in early spring with good results.

	Each	10	100
8.7 Avalanche. A magnificent flower that opens like a rose. Pure snow-white with a few pencillings of carmine on the edge of the center petals. Delightfully fragrant; late mid-season. A very good cut flower and cold storage variety.	\$0.60	\$5.00	\$40.00
8.1 Duchess de Nemours. Superb cup-shaped sulphur-white flowers with a greenish reflex that lights up the entire flower. Early, free-bloomer; fragrant. A good commercial variety.50	4.00	35.00
7.6 Edulis Superba. Usually blooms for Decoration Day. The flowers are a beautiful deep, vivid pink, with a silvery reflex, and are borne profusely on tall, strong stems. Excellent cut-flower; fragrant.....	.50	4.00	35.00
8.2 Gold Mine (Oriental Peony). Cup-shaped flowers of dark rose-pink with deep golden center. A strong grower and profuse bloomer. Midseason.....	.60	5.00	40.00
8.2 Grover Cleveland. Large compact flowers of rich bright crimson on stiff stems. It has excellent foliage and is one of our most desirable reds. Late midseason.....	.65	5.00	45.00
8.1 L'Etincelante (Single). Very broad petals of bright carmine with silvery border. A crown of golden stamens at the center.....	.65	5.00
8.6 Mikado (Oriental Peony). Guards velvety crimson, forming a cup enclosing a filigree cushion of crimson petals edged and tipped gold.....	.60	5.00
8.8 Richard Carvel. Large globular flowers of uniform bright crimson. Tall, profuse bloomer; delicate fragrance. Excellent for cut-flowers; usually blooms for Decoration Day.90	7.50
9.0 Sarah Bernhardt. Tall, vigorous grower and prolific bloomer. The color is a dark rose-pink, edged lighter pink, center flecked crimson; late midseason.....	.65	5.00	45.00
9.4 Tourangelle. Pearly-white overlaid with delicate shades of salmon. Late60	5.00
Unnamed Double Pink40	3.00	25.00
Unnamed Double Red50	3.50	30.00
Unnamed Double White50	3.50	27.50

Vaughan's Irises

"S" refers to the three standard or upright curling petals.

"F" refers to the three falls or drooping petals.

	Each	10	25
Berkley Gold. 38 in. A large deep clear yellow self of fine form, heavy substance, and smooth texture.....	\$0.50	\$4.00	\$7.50
California Gold. 36 in. Magnificent, large flowers of dazzling, deep golden yellow.....	.30	2.25	4.50
Christabel. 38 in. Very showy; large flowers of gleaming copper-red30	2.50	5.00
City of Lincoln. 40 in. A magnificent bicolor. "S" bright yellow; "F" rich, velvety red, edged gold.....	.30	2.50	5.00
Copper Lustre. 36 in. Huge flowers of a blend of glowing copper and gold with iridescent sheen.....	.30	2.50
Elmohr. 36 in. A hardy colossal seedling of Wm. Mohr. Reddish mulberry with pinkish glow.....	.60	4.50
Garden Flame. 38 in. A large, richly colored Iris of deep rose-mahogany. Late60	4.50
Garden Magic. 44 in. A late very dark velvety red.....	.50	4.00
Golden Majesty. 42 in. A truly superb deep yellow Iris. Large blooms of thick substance do not fade.....	.30	2.50	5.00
Grand Canyon. 40 in. Very large, ruffled flowers of an odd blend of plum, copper, and gold.....	.50	3.50	7.50
Great Lakes. 48 in. An exquisite blue. Ideally formed blooms with flaring "F" and crisp petal texture.....	.50	4.00
Gudrun. 36 in. Enormous flowers of lovely pure white, dusted with soft gold at the throat.....	.30	2.25	4.50
Indian Hills. 37 in. A stunning Iris of rich wine purple.....	.30	2.25	4.50
Master Charles. 38 in. A gorgeous flaring flower of rich, glowing mulberry purple90	7.50
Morocco Rose. 38 in. "S" lustrous pale pink; "F" deep rose-lene pink, long and flaring. A beautiful creation.....	.40	3.00	6.25
Nightfall. 36 in. Rich blackish pansy-purple color. "S" several shades lighter than "F".....	.50	3.50	7.50
Ola-Kala. 36 in. Brilliant ruffled deep orange-yellow. Dykes Medal winner in 1948.....	.60	5.00
Ormohr. 40 in. Extra large blooms of soft gray lavender; veined violet with rosy glow.....	.30	2.50	5.00
Prairie Sunset. 37 in. A gorgeous blend of peach, apricot, rose, copper and gold, like a prairie sunset.....	.60	4.50	8.75
Sable. 40 in. Almost perfect black with a silky sheen. Excellent form, hardiness, and intense color make it "tops" in its color class.....	.50	4.00

Specialty Food Counts Today—And Dealer Sales Always Multiply

ADVERTISED
NATIONALLY

ROSE-FOOD

FINEST
ROSE FOOD



Special Balanced Rose Food (7-8-5). An organic no filler, 100% plant food of dried blood, fish scrap, bone meal, potash, cottonseed meal, tobacco powder, meat tankage and neutro-phosphate. This is a special mixture for growing roses and is a balanced, all-purpose fertilizer which can also be used on all flowers, shrubbery, etc. This type mixture has been used by commercial growers and florists for many years and has given excellent results. 1 lb. retails for 35c; carton of 24, \$5.60. 5-lb. bag retails for 85c; price per carton of 12 packages, \$6.00; 10-lb. bag retails for \$1.35; price per carton of six, \$5.40; 25-lb. bag, \$2.25 each, six for \$12.00; 100-lb. bag, \$6.75 each, five for \$32.50.

Rhodo-Azalea



As in the case of Roses, there are hundreds of thousands of neighborhood customers who KNOW that their acid-loving plants like Rhododendrons, Azaleas, Camellias, Mountain Laurel and Kalmias etc., need what has heretofore been unpro-

curable. EXCESSIVE ACID is required to produce blooms on such plants that sometimes have never bloomed. This is a balanced ration of 3% Nitrogen, 20% of Acid and 3% of Potash. ALL these specialty foods beautifully packaged in 3-4 colors. 2 lbs. retails at 50c; doz., \$4.00; 5 lbs. retails at 85c; carton of 12 packages, \$6.00; 10 lbs. retails at \$1.35; carton of 6 packages, \$5.40; 25 lbs., \$2.25; six for \$12.00; 100 lbs., \$6.75.

FOR ACID-LOVING PLANTS

Dahlia-Lily-Bulb



Dahlia, "Glads," Tulips, Lilies, Peonies and all bulb plants need an ABUNDANCE OF POTASH. This prize-winning food (American Dahlia Society) is 5% Nitrogen, 6% Phosphorus and 15% of POTASH (the highest available) will

convince professionals and amateurs alike. Instructions on every package. 5 lbs. retails at 75c; carton of 12 packages, \$5.40; 10 lbs. retails at \$1.25; carton of 6, \$5.40; 25 lbs., \$2.25; six for \$12.00; 100 lbs., \$6.75.

Organic Turf, Tree and Ornamental Food 10-6-4. A high percentage of this plant food is organic. 25 lb. bag retails at \$3.50 each, 4 bags for \$9.35; 100 lb. bag retails at \$9.00; 3 bags for \$18.00.

FOR ALL BULBOUS PLANTS

Package Fertilizers Prices Subject to Market Changes. Terms Net Cash.

Fertilizers f. o. b. Chicago unless otherwise noted.

- Activo.** Make your own fertilizer easy, quick. Odorless! Organic! Just sprinkle Activo on kitchen waste, leaves, garden rubbish, sewage sludge, etc. Sprinkle in outdoor toilets, reduces odors, makes easily handled ash of waste. No. 2 size \$1.00; treats 450 lbs. compost. Carton of 6, \$4.00; dozen, \$7.20; No. 7 size, \$2.00; treats up to 1800 lbs. Carton of 6, \$9.75; doz., \$18.60; No. 25 size, \$4.25; three for \$12.60; treats up to 3 tons compost. 50 lb. size, each \$7.20; 100 lb. size, \$12.10.
- Adco.** 5 lb. bags, per sack of 10, \$11.40; 20 lb. bag, \$2.75; 5 for \$13.25; 150 lb. bag, \$15.00.
- Aluminum Sulphate.** 5 lb. pkg., doz., \$5.40; 10 lb. pkgs., doz., \$9.60, 100 lbs., \$3.50.
- Ammonium Nitrate, 34% Nitrogen.** Used for its nitrogen. A very desirable fertilizer for all plants in which a large leaf development or rapid growth is desired. Use one pound to 50 square feet of ground or bench, or a tablespoonful to a bushel of soil or 3 gallons of water. 25 lbs., \$2.25; 50 lbs., \$3.35; 100 lbs., \$6.25.
- Armour Vertagreen Plant Food.** Vertagreen is a high quality blended and balanced plant food for lawns, flowers, shrubs, trees and garden vegetables, 1 lb. package retails 15c, per case of 32, \$2.88; 5 lb. package retails for 50c, per carton of 12, \$3.84; 10 lb. bag retails for 90c; per case of 6, \$3.54; 25 lb. bag retails for \$1.60; each \$1.05; 50 lb. retails at \$2.65, price each, \$1.85; 100 lb. bags retail for \$4.25; per ton \$58.00. 500 lbs. or more delivered free to your railroad station within 500 miles of Chicago.
- Dried Blood.** Price 100 lbs., \$12.00.
- Bone Meal Regular.** 5 lb. pkgs., doz., \$6.00; 10 lb. pkgs., doz., \$10.20; 25 lb. bags, 4 for \$7.00; 100 lb. bags, ea., \$5.25; ton, \$100.00.
- Es-Min-El.** This contains all essential mineral elements which are necessary for good crops such as manganese, calcium, magnesium sulphur, iron, copper, zinc, barium, strontium, nickel, cobalt, vanadium titanium, tin, lead, chromium and boron. Many fertilizers or plant food mixtures do not contain these minerals but they can now be added to the soil. 5-lb. package is enough for 5000 square feet of space. 5-lb. package retails for \$1.50; price, per case of 10 packages, \$10.00.
- Fertil-Flo.** A new soluble plant food 79% available. Contains 10% nitrogen, 52% phosphoric acid, 17% water soluble potash. When dissolved, no residue remains. A good starter solution. 1 lb. dissolved as instructed is sufficient for approximately 400 sq. ft. on lawn or garden. 3 oz. tins retail at 35c ea.; \$2.80 per dozen. 1 lb. retails at \$1.00 ea.; \$8.00 per dozen. 10 lbs., \$4.00. 25 lbs., \$6.00.
- Feedz an' Weedz.** With this dry mixture you can kill lawn weeds and feed lawn grasses in one operation. It blends a balanced plant food, 6-10-4, with the selective weed killer, 2,4D, so that both retain full effectiveness. Use a fertilizer spreader to apply at the rate of 1½ pounds for 100 square feet. 10 lbs., covers 600 square feet, retails at \$1.85, carton of 6 packages, \$6.60; 25 lbs., covers 1,500 square feet, retails at \$3.00, 4 for \$8.00; 100 lbs., \$6.75.
- Horn Shavings, Synthetic.** 100 lbs., \$6.75; 500 lbs., \$32.50.
- Horn Shavings.** The regular old type shavings. 25 lbs., \$3.75; 50 lbs., \$6.65; 100 lbs., \$12.75.
- Hy-Gro Plant Food.** Famous 13-26-13 soluble formula and starter solution. Produces healthier growth and heavier yields—speeds earlier growth of seeds—checks wilting of transplants. Contains growths, hormones, minerals and other plant nutrients—provides all the food necessary for healthy plant growth. This formula was not obtainable during the war. 3 oz. glass jar retails at 40c, packed 24 to carton, price per carton, \$6.00; 1 lb. jar retails at \$1.00, packed 12 to carton, price per carton, \$8.00; 10 lb. container, retails at \$6.50 each, 3 for \$12.84; 100 lb. drum each, \$27.00.



FERTILIZERS—F. O. B. Chicago—Continued



Groganic. 6-11-6. A long lasting plant food rich in organics. Contains no filler whatever. Bulk is provided by dried blood, fish scraps, castor pomace, and vegetable meal. Boron is added to correct acidity and manganese sulphate to prevent chlorosis (yellowing) in leaves. 5 lb. retails at 75c ea.; \$5.70 per dozen. 10 lb. retails at \$1.25 ea.; \$9.60 per dozen; 25 lb. retails at \$2.75; 6 for \$11.00; 80 lb. bags retail at \$6.25; 5 bags for \$20.60.



Hyponex. Contains all of the known major and minor elements of plant food with vitamin VI added. Analysis 7% Nit., 6% Phos., 19% Pot. 1 oz. packet makes 6 gals. Retails at 10c, price per carton of 72 pkts., \$4.80; 3 oz. retails for 25c. Doz. \$2.00; 1 lb. retails for \$1.00. Doz., \$8.00; 10 lbs., \$5.34; 25 lbs., \$10.00; 50 lbs., \$16.67; 100 lbs., \$26.67.

Hydrated Lime. For sweetening sour soil. Price per 10 lb. bag, 40c; 12 bags for \$4.20; 50 lb. bag price 95c; 6 bags for \$5.10.

Kem Liquid Plant Food. A complete balanced ration for plants, lawns and ornamentals; a nutrient solution containing all essential elements including Calcium Boron, Sulphur, etc. Quart size, per doz., \$4.20; retails at 60c each.



Loma Analysis 5-10-5. A scientifically prepared plant food for flowers, vegetables, lawns and potted plants. 5-lb. carton, 12 in case, per case, \$3.60; 10-lb. bags, 10 in a sack, per sack, \$5.60; 25-lb. bags, 4 in a sack, per sack, \$4.68; 50-lb. bags, 2 in a sack, per sack, \$3.84; 100-lb. bag, \$3.15. 500 lbs. or more \$10.00 per ton freight allowance on direct shipments from fertilizer plant at Lockland, Ohio.



Mineralized Loma High Analysis 8-8-8. This plant food supplies quantities to enable the plants to derive full benefit from the 15 essential minerals, not merely as traces, but in sufficient abundant Nitrogen, Phosphoric Acid and Potash in the mixture. 25 lbs. retails for \$2.50, price per bale of 4, \$6.60; 100 lb. bag retails at \$8.00, 5 bags for \$26.50. 500 lbs. or more delivered free to your railroad station within 500 miles of Chicago.

Muriate of Potash. Should be used liberally, especially for all root crops. 25 lbs., \$1.50; 50 lbs., \$2.50; 100 lbs., \$4.50. **Write for prices on larger quantities.**

Organi-Green. Organic Lawn Food. Total Nitrogen organic 5%, available phosphoric acid, 2.25%. All organic, will not burn, long lasting, kiln dried. Recommended especially for lawns. Put up in 50 lb. bags. 5 bags for \$7.50, 10 bags for \$14.00, ton for \$54.00.

J. M. T. C.

ORG · A · NUR
ALL-ORGANIC-MANURE

A good fertilizer with a peat moss base impregnated with a high grade manure. 50-lb. bag, \$1.75; 5 bags for \$8.25; 10 bags for \$16.00.

Organic Turf, Tree and Ornamental Food 10-6-4. A high percentage of the food elements in this mixture are organic. 25 lbs. retails at \$3.50; four bags for \$9.35; 100 lb. bag retails for \$9.00; three bags for \$18.00.

FERTILIZERS—F. O. B. Chicago—Continued

Ra-Pid-Gro the Foliage Plant Food. Analysis, 23-21-17 with Minor Elements, Vitamins and Growth Hormones. Good for all crops. 8 oz. retails at 69c, packed 24 to a carton, 1 lb. retails at \$1.25, packed 12 to a carton, 5 lb. retails at \$4.50, packed 6 to a carton, 10 lb. retails at \$8.75, packed 4 to a carton, 25 lb. retails at \$21.00 and 50 lb. drum at \$42.00. In case lots dealer's discount is 40%.

Pulverized Limestone. 100 lbs., \$1.60; 500 lbs., \$7.00; 1000 lbs. \$12.00; 2000 lbs., \$18.50.

Sheep Manure, Pulverized (Vaughan Brand). Bale of six 5-lb. pkgs., \$1.70; bale of six 10-lb. pkgs., \$2.90; in 25-lb. bags, \$3.20 per 100 lbs.; per 1000 lbs., \$29.00; in 50-lb. bags, \$2.90 per 100 lbs.; 500 lbs., \$14.00; 1000 lbs., \$27.50.

Superphosphate 20%. 80-lb. bag, \$1.75; 480 lbs., \$9.90; 960 lbs., \$19.20.

Floralife. Makes cut flowers live longer. Ceiling prices, 25—10c packets, \$1.25; carton of 100 packages, \$5.00. Handy home size retails at \$1.00 each, six cans for \$3.60; 100 qt. size retails for \$3.00; six for \$10.50.

Plant Life—New—A well-known liquid fertilizer for house plants. Ceiling prices, retails at 25c; per display carton of 24, \$4.00. 50c size, doz., \$4.00.

Special Tree & Turf Food. 10-8-6. 100 lbs., \$3.75; 500 lbs. or over, \$3.60 per 100 lbs.

Shredded Cattle Manure. 25 lb. bags, per 100 lbs., \$3.20; per 1000 lbs., \$29.00; in 50 lb. bags, \$2.90 per 100 lbs., 500 lbs., \$14.00; 1000 lbs., \$27.50.

Plant Prod. (15-30-15). A soluble fertilizer for all types plants. Price 10 lbs. retails at \$5.00 each, 3 for \$10.00; 25 lbs. for \$7.75; 100 lbs., \$18.00.

Plant Marvel. Feed as you water. Economical! Use it indoors or outdoors. Convenient attractive lithographed container. ½ lb. can makes 125 gallons of liquid plant food. ½ lb. can retails at 75c each, carton of 24, \$12.00, 1 lb. can retails at \$1.25 each, carton of 12, \$10.00; 10 lb. drum \$5.50 each; 25 lbs. \$12.50; 50 lbs. \$22.50 each; 100 lbs. \$40.00 each. Handy Aluminum measure and directions included in each package. Trial size packet makes 50 qts. of Plant Food, retails at 35c each, carton of 24, \$5.04. Display carton of 48 pkgs. \$10.08.

The New Era Big 3. To make plants grow and bloom. Put up in colorful transparent plastic bags.

Potting Soil. 1½ lb. size put up 24 to a carton, price per carton \$3.60, retail 25c, 4 lb. size put up 12 to a carton, price per carton \$4.00, retail 55c.

Peat Humus. Highly organic soil conditioner. 1 lb. size put up 24 to a carton, price per carton \$3.60, retail 25c, 3 lb. packed 12 to a carton, price per carton \$4.00, retail 55c.

African Violet Soil. A special soil for African Violets. 1½ lb. put up 24 to a carton, price per carton \$3.60, retail 25c, 4 lb. packed 12 to a carton, price per carton \$4.00, retail 55c.



measure and directions included in each package. Trial size packet makes 50 qts. of Plant Food, retails at 35c each, carton of 24, \$5.04. Display carton of 48 pkgs. \$10.08.



FERTILIZERS—F. O. B. Chicago—Continued

Special Balanced Rose Food. 7-8-5. An organic no filler, 100% plant food of dried blood, fish scrap, bone meal, potash, cottonseed meal and phosphate. This is a special mixture for growing roses and is a balanced, all-purpose fertilizer which can also be used on all flowers, shrubbery, etc. This type mixture has been used by commercial growers and florists for many years and has given excellent results. 5-lb. bag retails for 85c; price per carton of 12 packages, \$6.00; 10-lb. bag retails for \$1.35; price per carton of six, \$5.40; 25-lb. bag, \$2.25 each, six for \$12.00; 100-lb. bag, \$6.75 each, five for \$32.50.



Take-Hold Plus Rooting Hormone. High analysis plant food 10-52-17 plant starter. Supplies needed ingredients immediately. Leaves no sludge to clog sprayer. Plants mature earlier. For flowers, vegetables, shrubs and pot plants. 2-oz. pkt. retails at 25c, carton of 24 pkts., \$3.60; 12-oz. retails at 85c, per carton of 12, \$6.12.

Terra-Lite (Mikamagic). Finest quality Vermiculite for agricultural and horticultural growing. A sterilized seed starting medium composed of particles of natural mica. Holds water like a sponge without caking or packing down. It has been sterilized at over 2000° F. Since it is disease free, danger of damping off is eliminated from soil borne causes. Put up in 1/2 peck packages for resale. Retails at 40c each. Per carton of 12, \$2.94; 1/2 bushel bag,

each, 85c; carton of 6 bags for \$3.18; 2 bushel bag each, \$1.25; 10 bags, \$11.50. 4 bushel bag ea., \$1.75; 10 bags for \$16.00.

Vigoro. A specially prepared plant food. It contains all elements plants need for healthy growth. Because it is a complete plant diet it is really more economical than incomplete waste or by-product materials. A good seller. Price: 100-lb. bags, \$2.90 ea., ton (2000 lbs.), \$58.00; 50-lb. ea., \$1.85; 25-lb. bags, \$1.05 ea.; 10-lb. pkgs., 90c ea., \$3.54 per case of 6;

5-lb. pkgs., 50c ea., \$3.84 per case of 12; 1-lb. pkgs., 15c ea., \$2.88 per case of 32. 500 lbs. or more delivered free to your railroad station within 500 miles of Chicago.



Vigoro Tablets. Per case of 48 pkgs. of 12 tablets, \$3.96.

Plantabb's, Fulton's. Odorless plant food in tablet form; supply a complete balanced plant food including Vitamin B₁. Put up in boxes, 10c size, per dozen, 75c; 25c size, per dozen, \$2.00; 50c size, per dozen, \$4.00; \$1.00 size, per dozen, \$8.00; \$3.50 size, \$2.35 each. Special discount of 5% on orders totaling \$6.00. 10% on orders for \$12.00.



Imported
Canadian
Horticultural

Granulated Peat Moss—A moisture-retaining humus, garden size, bag of about 25 lbs., \$1.95; 10 bags for \$18.75; half bales of about 50 lbs. ea., \$3.20; 5 bales for \$15.00; large size bale, about 100 lbs., \$4.25; 10 bales for \$39.50.

Imported German Peat Moss. Large bales about 100 lbs. each, \$4.20; 10 bales for \$39.50.

Insecticides and Fungicides

- Acme All Round Spray.** 1 lb. package retails at \$1.10, per case of 24, \$17.76; per dozen packages, \$9.25; 4 lb. package retails at \$3.50; 12 for \$28.32.
- Acme 6% Chlordane Dust.** For dusting in gardens and on lawns to control ants, cut worms, chiggers, wire worms, etc. 1 lb. sifter top carton retails each 60c, per dozen, \$5.10; per carton of 24, \$9.60; 4 lb. bag retails at \$1.50; 6 for \$6.60; carton of 12, \$12.00.
- Acme Tomato Dust.** Contains basic copper arsenate. The latest improvement in the insecticide field, containing a safe arsenical for controlling the tomato worm and the tomato fruit worm as well as the early and late blight and other fungus diseases which infest the tomato plant. Will not cause worm wilt. A full pound in a sifter package. Retails 60c each. Per dozen, \$5.20; carton of 24 packages, \$9.84; 4-lb. pkgs., doz., \$12.96.
- Acme Garden Guard Spray.** A combination spray for controlling sucking and chewing insects. Can be used as a dust or spray. 1 lb. handy shaker top carton—retails ea. 50c; doz. cartons, \$4.20; per case of 24 cartons, \$8.00; 4-lb. pkgs., per case of 12, \$8.64.
- Acme Garden Guard Pump Gun.** Retails, each, 65c; doz., \$5.60; carton of 24, \$10.40.
- Acme 5% Lindane Spray.** 4 oz. retails at 80c each; price per carton of 12, \$6.40. Pints retail at \$2.70 each; price per carton of 12, \$21.60.
- Acme Red River Potato Mix with D.D.T.** A special formula for potatoes. 1-lb. bags, doz., \$7.00; carton of 24 bags, \$13.44; 4-lb. bags, \$2.10; six for \$11.50, carton of 12 bags, \$22.56.
- Ant Killer Jones.** ½-oz. bottles, dozen, 75c; 2-oz., dozen, \$2.00.
- Antrol Ant Traps** (12 to a display carton). Prices, per case, \$1.60; carton of 48 traps, \$6.00.
- Arsenate of Lead, Dry.** Prices, 1-lb. 60c; 12 for \$6.00; carton of 24, \$11.52; 4-lb. bag, \$1.45; carton of 12 bags, \$14.88.
- Azofume 10** (Dusting Form). We consider this dust as an ideal addition to the Azobenzene family. Ideal for dusting evergreens for control of Red Spider and Mites. Where small pockets of spider occur in greenhouses on carnation and roses, dusting with Azofume 10 fills in. Also recommended for outside use on phlox, roses and evergreens. Price 1 lb. retails for 80c; doz., \$6.40; 4 lb. pkg. retails for \$2.40; carton of 6 pkgs., \$9.60; 50 lbs., \$17.50.
- Black Leaf 40.** Prices, 1 oz. bottle, 30c; dozen, \$2.95; carton of 24, \$5.58; 2-lb. tins, dozen, \$36.85; 1-lb., dozen, \$20.70; 5-lb. tin, \$6.25; case of 6, \$36.60; 5-oz., dozen, \$8.55; 10-lb. tin, each, \$11.50; six for \$65.10; 5-lb. tins, six for \$36.60.
- Bordeaux Mixture.** Prices 1-lb. bags, each, 50c; dozen, \$4.35; carton of 24, \$8.40; 4-lb. package, \$1.35; carton of 12, \$11.52.
- Bug-A-Boo.** Containing Rotenone. The ideal spray for vegetable crops. 4-oz. bottles retails 50c, dealer ceiling price, case of 24, \$7.20; 8-oz. bottle retails 75c, dealer price, carton of 12, \$5.40.



INSECTICIDES—Continued

Bug-Geta Pellets. Compressed Metaldehyde-Arsenical bait to kill slugs, snails, cut-worms and grasshoppers. 12 oz. box retails at 50c, carton of 24 for \$8.00, 2 lb. retails at \$1.00, carton of 12 for \$8.00.

Dimite. Recommended for control of mites and red spiders. 2 oz. retails at 69c, carton of 24 for \$11.04.

Du Pont Floral Dust. Provides in most cases complete control of insects and diseases affecting flowers and fruit trees. Excellent for roses. Non-injurious. Use as dust or spray. 8-oz. guns, retail at 79c; per carton of 24, \$12.80. 1-lb. canisters retail at \$1.15; per carton of 12, \$8.65. 4-lb. canisters, retail at \$3.50; per carton of 6, \$14.00.

Du Pont Fruit Tree Spray. 1 lb. retails at \$1.15, carton of 12 for \$8.65, 3 lb. retails at \$2.75, carton of 8 for \$13.75.

Du Pont Tomato Dust. 2 lb. retails at 85c, carton of 12 for \$6.80.

Du Pont Methoxychlor. 50% Technical. 8 oz. retails at 75c, carton of 24 for \$12.00.

Du Pont Vegetable Garden Dust. Specially formulated to control most insects and diseases in vegetable gardens. Superior for blight control. Contains methoxychlor, rotenone and "Parzate" fungicide. Use as dust or spray. 8-oz. guns, retail at 79c; per carton of 24, \$12.80. 1-lb. canisters, retail at \$1.15; per carton of 12, \$8.65.

Du Pont Rose Dust. This new quick-acting fungicide stops black spot, rust, powdery mildew and other blights. Also protects carnations, snapdragons and tulips. 8-oz. guns, retail at 69c; per carton of 24, \$11.00. 1-lb. canisters, retail at \$1.00 per carton of 12, \$7.50.

Garden Bug Blaster: New revolutionary garden dust gun containing multi-purpose insect and fungus dust for flowers and vegetables. Analysis: 7% copper, ¾% Rotenone, 10% sulphur, and 2% D.D.T. This insecticide is safe to use on vine crops. Eliminates stooping; you can now do your dusting in upright position, blows dust underneath foliage. Retails at \$1.98 each, complete with duster and 2 lbs. of above formula. Price per carton of 24, \$29.76.

Bug Blaster Refill. 2 lb. package retails at \$1.29 each. Price per carton of 12, \$9.72.

Carbon Disulphide. Prices, 1-lb., 65c; dozen for \$7.20.

Cyanogas. Calcium Cyanide "A" grade for Ants, Moles, Rats, etc. Ceiling prices, 4-oz. tins, 12 in a display carton, \$2.90; 1-lb., dozen, \$7.25; 5-lb., dozen, \$30.00; 25 lbs., \$9.35; 100-lb. drum, \$24.00.

Cyanogas Calcium Cyanide "G" Greenhouse Fumigant. 5-lb. tins, \$7.25; 5-lb., dozen, \$30.00; 25 lbs., \$9.35; 100-lb. drum, \$24.00.

Evergreen. A pyrethrum spray. Price, 1 oz., doz., \$2.80; 6 oz., doz., \$9.25.

Flowers of Sulphur. (Subject to fluctuation.) 50-lb. bag, \$2.40; 10 bags for \$21.00.

Fungine. 1 quart, 95c; dozen, \$10.20; 1 gallon, \$2.75.

Grape and Rose Dust, Hammond's. 1-lb. canisters, dozen, \$3.00; carton of 24, \$5.76; 5-lb. packages, \$1.00; dozen, \$10.80; 25-lb. bag, \$4.25; per 100 lbs., in bulk, \$15.00.

Kalite ¾% Rotenone Bug Duster. This practical, efficient duster bag contains a pound of impregnated Rotenone Dust. A practical package for dusting home gardens. Price per carton of 24 1-lb. packages, \$5.60; 4-lb. bags, 12 to a carton, \$6.96.



INSECTICIDES—Continued

Isotox Garden Dust. Contains Lindane for control of Aphids, Japanese Beetles, Thrips, Caterpillars, Ants and Black Widow Spiders. 1 lb. retails at 85c, carton of 24 for \$13.60, 5 lb. retails for \$3.25, carton of 6 for \$13.00.

Lemon Oil. ½-pt. cans, 6 for \$2.10; 1-pt. cans, 6 for \$3.40; 1-qt. cans, 6 for \$6.00; gallon, \$2.95; three for \$8.40.

Lime Sulphur Dry. 1-lb. packages, dozen, \$5.35; carton of 24, \$10.32; 5-lb. packages. Carton of six, \$10.80.

McCormick's Red Arrow Dust (Rotenone) 2-lb. bags retail at 60c each. Dealer price per carton of 12 bags, \$4.80.

Nicotine Pyrox. 20-oz. (24 to a case), case, \$9.66; 5-lb. (8 to a case), per case, \$12.60; 25-lb. drum, each, \$5.60.

No-Nib-l. Rabbit Repellent 6 oz. retails at \$1.25 each. Carton of 12, \$9.00.

Paris Green. ¼-lb. packages, per dozen, \$2.00; 1-lb. packages, dozen for \$6.00; 5 lbs., \$2.50.

Para Scalecide. Qt. cans, case of 12, \$11.32; gals., case of 6, \$12.68.

Pratt's Fruit Tree Spray or Dust. 1-lb. sifter canister, 24 to a case, \$12.48; 3-lb. bag, 16 to a case, \$14.56.

Pomo-Green with Nicotine. 5-lb. pkg., six for \$15.35.

Red Arrow Insect Spray. Non-poisonous, kills by contact both chewing and sucking insects. 4-oz. bottle, dozen, \$8.00; 1 pint, dozen, \$22.70; quart retails at \$5.00 each. Dealer price, 6 quarts for \$21.60.

Red Arrow No. 720. Assortment consists of 24 1-oz. and 2 only 4-oz. bottles. Retails for \$10.40; dealers' price, \$5.60.

Rotenone Garden Guard Pump Gun. The old proven Rotenone insecticide which controls both sucking and eating insects. A full pound in a pump gun duster ready to use. Retails 65c each. Per dozen, \$5.45. Carton of 24 packages, \$10.40.



Rotecide. 1 oz. bottles, dozen, \$2.60; carton of 24, \$5.00; gallon, \$6.00.

D. D. T. Rototec. Contains full amount of Rotenone plus 5% D. D. T. 4-oz. bottle retails at \$1.25; price per dozen, \$9.00; pint bottle retails at \$2.75; price per dozen, \$19.80.

Scalecide. Quart, per dozen, \$8.98; gallon case of 6, \$10.72; 5 gallons, \$6.98.

Slug Shot. 1-lb. cartons, dozen, \$4.80; case, 24 packages, \$8.64; 5-lb. tins (12 to a case), dozen, \$14.04; 25-lb. bags, each, \$3.75; 50-lb. bags, each, \$7.50.

Snarol with Metaldehyde. 1-lb. package, retails 35c. Dealer price, \$2.80 per carton of 12; 2½-lb. package retails 75c; dealer price per carton of 12, \$6.00.

Stop. A tree banding compound. Perfect safeguard for trees. 1 lb. jar retails at \$1.05 each, carton of 24, \$16.80; 7½ lb. jar retails at \$6.25 each; 4 for \$16.65.

Sulphate of Iron. 5 lbs., 50c; per dozen, \$5.40; 100 lbs., \$3.95.

Trio-gen. E kits, dozen, \$10.80. A kits, each \$1.65; 12 for \$18.00; B kits, each \$4.20; 12 for \$48.00. C kits, each \$6.25; six for \$36.00. D estate kits, each \$20.00.

Tobacco Dust, Regular Grade. Fine for dusting. 1-lb. package, retails 30c; carton of 12, \$2.40; 5-lb. packages, retails 80c, per dozen, \$6.40; 10 lbs., retails, \$1.35; per carton of 6, \$5.40; 25-lb. bag for \$2.10.

Tree Tanglefoot. 6 oz., per dozen, \$7.20; 1 lb. cans, per dozen, \$12.00; 5 lb. cans, per case of 6, \$28.00; 25 lb. pails, each, \$21.00; 3 for \$59.64.

INSECTICIDES—Continued

- Tobacco Stems.** Bales of about 100 lbs., per 100 lbs., \$2.95; per 1000 lbs., \$26.00 (3 bales 1000-lb. rate).
- Volck Nursery and Garden Spray.** 4 oz., per dozen, \$3.00; per carton of 24, \$5.60; pints, per dozen, \$5.60; 1 gallon, per case of 4, \$7.60; 5-gallon cans, each, \$7.50.
- Wettable Dusting Sulphur.** Put up in attractive 2-lb. cans, which retail at 55c each. Per dozen, \$4.68.
- Vermine.** ½ pints, dozen, \$4.80; pints, dozen, \$6.60; quarts, 95c; gallon, \$2.95.
- D. D. T. Yamtox.** A new insecticide which promises to replace Rotenone in control of many insects. Put up in 1-gallon cans, per case of 6, \$54.00. Freight allowed in 12-gallon lots.

PROTEXALL COMBATS ALL PLANT PESTS

- Protexall,** introduced by us last year as a one-shot spray or dust using new post-war insecticides and fungicides to combat almost all insects and plant diseases with one treatment, has been remarkably successful. It contains D.D.T., Rotenone, Fermate, and Sulphur. Protexall spray is a powder which mixes easily with water. Protexall Dust comes mixed with a spreader and is ready for instant use. It is necessary to order the form you prefer and have the equipment to use, since the spray material does not make an efficient dust, and the dust cannot be used as a spray.
- Protexall Spray.** 4 oz. package retails at \$1.25, per carton of 12, \$9.00; 1 lb. retails at \$3.75, per carton of 12, \$27.00; 5 lb. package, retails for \$16.00. Per carton of 6, \$57.60. 1 oz. will make approximately 4 gallons of spraying solution.
- Protexall Dust.** 1 lb. package retails 95c, price per carton of 24 packages, \$13.68, 4 lb. package retails at \$3.50, per carton of 12, \$25.20.

All Forms of D. D. T.

- D.D.T. 50% Wettable Dust.** For diluting in water for spraying, or mixing with talc to prepare dust of desired strength. One pound in 100 gallons of water makes effective garden spray leaving a heavy residual deposit on plants. Three pounds to 100 gallons of water makes effective and safe spray for cattle, horses, hogs and other farm animals, or residual spray for walls of barns, stables, hog or poultry houses and milk sheds. 1 lb. retails for \$1.25, per dozen, \$9.00; 3 lbs., \$1.80; carton 48 lbs., \$24.00.
- D.D.T. 25% Liquid Spray.** D.D.T. in emulsion form has given results on some insects superior to those from wettable powders. This is safe to use on garden and greenhouse plants, also for spraying barns and other buildings to control flies. Eight ounces will make 25 gallons of garden spray. 8 oz. retails each \$1.50, doz. \$12.00. Gallons, each, \$4.25; case of six, \$22.50.
- D.D.T. 5% Household Spray.** An oil spray for lasting control of pests. For spraying or brushing on screens and porch walls, and general household use according to directions. Kills bedbugs, flies, mosquitoes, moths, ants, silverfish and many others. Do not use on plants or animals. Pints per dozen, \$4.50; quarts per dozen, \$6.00; gallons per carton of 6-1 gallons, \$8.10.
- D.D.T. 5% Dust.** A ready-mixed garden dust of D.D.T. combined with a fine, light, weight filler, safe to use on all plants in gardens and greenhouses, also on livestock, dogs, pet animals (except cats) and poultry. Its extra strength assures maximum pest control. 1 lb. retails for 45c; per dozen, \$3.60; per carton of 24, \$6.80. 25 lbs., \$2.95; 50 lbs., \$5.50; 4 lb. pkgs., each, 80c, dozen, \$8.80.

INSECTICIDES—Continued

Sprayway Mothproofer. Bomb as illustrated is trouble free and inexpensive to use. Leaves no stain or crystallization on fabric. Contains paradichloro-benzene plus other active moth repellents. Retail each, \$1.39; carton of 12, \$11.15.

Sprayway Aluminum Enamel Bomb like above. Fun to apply **SPRAYWAY ALUMINUM PAINT**. One coat covers radiators, fixtures and other equipment. Any surface—brick, metal or wood—will take a coat of **SPRAYWAY ALUMINUM PAINT**. Retail each, \$1.39; carton of 12, \$11.15.

Bug-go Insect Spray-Bomb Kills All Household Insects. The most effective aerosol insecticide. Deadly to flies, roaches, bedbugs, silverfish, ants, mosquitoes, wasps, and any crawling or flying pests. Contains DDT, Pyrethrum and Piperonyl Butoxide, three killing ingredients. (If one doesn't get them, the others will.) Approved by U. S. Department of Agriculture. Leaves no unpleasant odor. Used as directed, is completely harmless to humans. Retail each, \$1.30; carton of 12, \$10.40.



Parathion 15% Wettable Powder. Good control of Cyclamen Mite, Red Spider, Thrips, Aphids, and various nematodes. Price per 1 lb. can retails each, \$1.75, dozen, \$14.00; 4 lb. bag, retails each, \$6.00, six for \$24.00; 50 lb. drum, \$48.00.

Marlate 50 Insecticide. Active Ingredient: Methoxychlor Technical 50% (Equivalent to 44% 2, 2-bis) (paramethoxyphenol) 1, 1, 1-Trichlorethane and 6% other isomers and reaction products. 4 lb. bags, retail each, \$4.50; per carton of 12, \$33.20. 8 oz. canister retails each 75c, case of 24 \$12.00.

San-A-Lizer Repellent. A repellent in cake form (non-breakable) that fastens to the inside lid of any garbage can. No tools necessary to install it. Takes less than 10 seconds. This product will absolutely keep animals and insect pests away from garbage can. Even more important, it will deodorize garbage so that a woman can keep her garbage can in the kitchen, if she wishes. San-A-Lizer contains no poison, is absolutely harmless to human beings, yet it ends all garbage can nuisance. Packed 48 to the case, complete with two display cartons. Retail price, 25c cake, price per carton of 48 packages, \$7.20.

CHLORDANE, RIVALS D. D. T.

Chlordane. (Water Base—2½% Chlordane). Especially for household uses. It is a non-staining, non-oily liquid with a delicate cedar aroma. Killing power lasts for weeks. Ants, cockroaches, flies, water beetles, earwigs, carpet beetles, silverfish, moths destroyed with Octa-Kill. For plants and flowers dilute Octa-Kill with five parts water. Pint retails 79c; case of 24, \$11.38; quart retails \$1.39, case of 12, \$10.00.

Chlordane Emulsion Concentrate (Water Soluble—45% Chlordane) Spray. For crop and animal spraying 1 part is mixed with 200 parts water. By allowing a heavier run-off this can be used to spray farm buildings, animal areas, and for household use. Recommended maximum dosage 1 qt. per acre. 1 oz. retails 39c, display ctn. of 24, \$5.60; 4 oz. retails 75c, ctn. of 12, \$5.40. ½ pints retail \$1.25, case of 12, \$9.00; pints retail \$1.95, case of 12, \$15.20; quarts retail \$3.25, case of 6, \$13.65; gallon jugs retail \$8.15, case of 4, \$26.00.

6% Chlordane Dust. For dusting in gardens and on lawns to control ants, cut worms, chiggers, wire worms, etc. 1 lb. sifter top carton retails each, 60c. per dozen, \$5.10; per carton of 24, \$9.60; 4 lb. bag retails at \$1.50; 6 for \$6.60; carton of 12, \$12.00.

DU PONT SEED DISINFECTANT

Seed disinfectants control seed borne diseases of farm crops.
Regular or 2% Ceresan for seed treatment of small grains.

Regular Ceresan.

	Ret. Price per pkg.	Dealer Price	Packages per Case
1 1/2-lb.	\$ 1.75	\$ 15.25 per Doz.	1 Doz.
75-lb.	60.10	48.55 per Drum	1 only

New Improved Ceresan for Wheat.

	Ret. Price per pkg.	Dealer Price	Packages per Case
4-oz.	\$.50	\$ 10.80 per Case	3 Doz.
1-lb.	1.30	10.50 per Doz.	1 Doz.
4-lb.	4.35	20.00 per Case	1/2 Doz.
100-lb.	85.00	69.60 per Drum	1 only

Ceresan M

	Ret. Price per pkg.	Dealer Price	Packages per Case
14-oz.	\$ 1.25	\$ 10.10 per Case	1 Doz.
3-lb.	3.55	16.20 per Case	1/2 Doz.
40-lb.	35.85	29.40 each	1 only
100-lb.	85.00	69.60 each	1 only

New Improved Semesan Bel for seed, white and sweet potatoes.

	Ret. Price per pkg.	Dealer Price	Packages per Case
2-oz.	\$.50	\$ 38.85 per Case	12 Doz.
1-lb.	2.30	19.40 per Case	1 Doz.
4-lb.	7.50	35.25 per Case	1/2 Doz.
40-lb.	70.35	58.40 per Drum	1 only
100-lb.	166.00	141.50 per Drum	1 only

Semesan for Flower and Vegetable Seeds.

	Ret. Price per pkg.	Dealer Price	Packages per Case
1/3-oz.	\$.20	\$ 17.40 per Case	12 Doz.
2-oz.	.60	13.40 per Case	3 Doz.
12-oz.	2.85	24.80 per Case	1 Doz.
25-lb.	72.65	60.95 per Drum	1 only

Arasan

	Ret. Price per pkg.	Dealer Price	Packages per Case
3/4-oz. Pkg.	\$.25	\$ 10.80 per Case	72
8-oz. Can	1.00	15.50 per Case	2 Doz.
2-lb. Can	3.20	26.50 per Case	2 Doz.
4-lb. Can	6.00	25.00 per Case	1/2 Doz.
25-lb. Drum	30.00	24.00 each	1 only
100-lb. Drum	115.00	93.00 each	1 only

Arasan SF

	Ret. Price per pkg.	Dealer Price	Packages per Case
3-lb. Bag	5.20	50.20	1 Doz.

Special Semesan. Control for brown patch, dollar spot, etc., in bent lawns.

	Ret. Price per pkg.	Dealer Price	Packages per Case
1 1/2-lb. Can	\$ 3.75	\$ 32.85 per Case	1 Doz.
25-lb. Drum	52.05	44.00 per Drum	1 only
100-lb. Drum	197.60	171.50 per Drum	1 only

Tersan 75 (75% Thiuram)—More concentrated, less inerts.

	Ret. Price per pkg.	Dealer Price	Packages per Case
5 1/3 oz.	\$1.00	\$ 15.50	2 Doz.
3-lb. Bag	6.75	50.00	1 Doz.

INSECTICIDES—Continued

Du Pont F-531. A cadmium fungicide for the control of dollar spot on golf courses, lawns and other fine turfs. 1-lb. can retails at \$2.10, \$8.40 per case of 6; 25-lb. drum, \$37.50, \$30.00 a drum; 100-lb., \$140.00, \$112.00 a drum.

AGRICULTURAL CHEMICALS**PHYGON-XL (Replaces Phygion Wettable)**

	Ret. price per pkg.	Dealer Price	Packages per case
2 oz. can	\$.50	\$ 7.20 per case	24
4½ oz. container	1.00	7.20 per case	12
1 lb. container	2.70	21.60 per case	12
4 lb. bag	6.16	66.24 per Case	12
100 lb. drum	150.00	135.00 each	1

PHYGON-XL-DDT

	Ret. price per pkg.	Dealer Price	Packages per case
Seed Protectant for use in the dust or slurry method of application.			
1 lb. can	\$ 2.70	\$ 21.60 per case	12
50 lb. drum	87.50	72.50	1
100 lb. drum	170.00	140.00	1

(Fungicides and Insecticides)

Spergon Seed Protectant—recommended for Peas, Beans, Lima Beans, Corn, and other seeds; non-toxic.

	Ret. price per pkg.	Dealer Price	Packages per case
1 oz. envelope	\$.25	\$ 3.60 per case	24
5 oz. can	1.00	7.20 per case	12
1 lb. can	2.25	18.00 per case	12
10 lb. drum	20.00	14.00 per drum	1 only

Spergon (wettable) Fungicide—A dip for Croft Lily Bulbs and cuttings; controls Downy Mildew on Cabbage, Cantaloupes and Cucumbers.

	Ret. price per pkg.	Dealer Price	Packages per case
4 oz. can	\$.50	\$ 3.60 per case	12
1 lb. can	1.25	10.00 per case	12
10 lb. can	10.00	7.00	1 only

Spergon Gladiolus Dust—Controls Thrips and corm decay. A dust containing Spergon and DDT, to be applied to corms before planting or storage in the Fall. Also Tulips, Narcissus and Iris.

	Ret. price per pkg.	Dealer Price	Packages per case
2 oz. envelope	\$.25	\$ 3.60 per case	24
1 lb. can	1.50	10.80 per case	12
10 lb. can	10.75	7.50	1 only

Phygion Rose Dust-Insecticide Fungicide—A dust containing Phygion, an outstanding fungicide for Black Spot and Mildew Control; DDT for insect control.

	Ret. price per pkg.	Dealer Price	Packages per case
1 lb. container	\$.75	\$ 5.40 per case	12
5 lb. drum	3.00	24.00 per case	12

Synklor-50-W Chlordane Insecticide—A dry wettable powder containing 50% technical chlordane; controls ants, Chinch Bugs, Grubs, Roaches and Wire Worms.

INSECTICIDES—Continued

	Ret. price per pkg.	Dealer Price	Packages per case
8 oz. can	\$ 1.50	\$ 10.80 per case	12
1 lb. can	2.50	18.00 per case	12
5 lb. drum	5.65	25.50 per case	6
10 lb. drum	10.80	8.20 per drum	1 only
100 lb. drum	81.00	65.00 per drum	1 only

POST-WAR FUNGICIDE

Fermate. This new fungicide which has been thoroughly tested gives remarkable control of plant diseases, with safety to all plants. Reliable specific for black spot on roses, leaf spot on chrysanthemums, snapdragon rust, anthracnose of tomatoes, and brown rot of cherries. Recommended for use against all fungi and mildews. 8 oz. pkg., per doz., \$6.30; per carton of 24, \$12.00; 3 lbs., \$2.40, six for \$13.50; case of 12, \$23.40.

Manna. Starter, tonic and plant food combination in pellet form. Use direct in soil or in liquid solution. 25c packet will make about 14 gallons of solution. Price per display card of 24 packets, \$3.60; \$1.00 size, per dozen, \$7.20; 2,000 pellet size, retails at \$12.00; price each, \$7.50; per case of 6, \$21.60.

SODIUM SELENATE

Sodium selenate, when applied to the soil, is absorbed by the plants, and makes them poisonous to insects.

It works best with soft plants. It kills red spider and aphid on chrysanthemums and carnations, cyclamen mites on chrysanthemums and saintpaulias, foliar nematodes and midge on chrysanthemums.

Complete instructions for use are sent with the material and must be followed closely.

Pure Sodium Selenate is a granular powder, very concentrated: One pound treats 1,800 square feet of bench area. This material is completely water-soluble. Per lb., \$5.75.

P-40 is Two Per Cent Sodium Selenate and ninety-eight per cent carrier (superphosphate in the present material). It is a dilute material. Three pounds treat only 100 square feet of bench area. 3 lbs., \$2.25; per carton 12 packages, \$22.80; 25 lbs., \$5.75; 50 lbs., \$11.25; 100 lbs., \$21.50.

Growth Regulating Hormones

Fruit-Hold. Prevents premature drop of fruit. Invisible fingers hold the fruit to the tree when sprayed with this newly developed plant hormone. Contains alpha naphthyl acetic acid. Will not spot fruit, mixes easily and leaves no objectionable residue. $\frac{3}{4}$ oz., 50c; doz., \$3.60; 2 oz., \$1.00; doz., \$7.20; 8 oz., \$3.50; 1 lb., \$7.50.

Rosetone. A proven combination of Hormones and Vitamins. Insures the success of your roses. Soak roots of bushes in Rosetone before planting. Water your established rose bushes for better growth. $\frac{1}{2}$ -oz. package retails at 25c, per Display Carton of 72 packages, \$12.00; 3 oz. retails for \$1.00, per Display Carton of 36, \$24.00.

ROOTONE

PATENTS PENDING

Rootone. A hormone root-forming powder, ¼-oz. packet retails for 25c; dozen, \$2.00; 2-oz. jar, dozen, \$8.00; 1-lb. jar, each, \$3.50; six for \$20.00.

Rootone No. 10. 2-oz. pkg. retails at \$2.00; 12 for \$16.00. 1-lb. can, \$7.00. Write for leaflet.

Transplantone. For treatment of transplants of all kinds. Contains the root forming hormones, vitamin B₁. Price, ½-oz. packet retails at 25c; dozen, \$2.00; 3 oz., dozen, \$8.00; retails at \$1.00; 1-lb., three for \$8.00; retails at \$4.00 each.

Plant Magic Vitamin B-1 Tablets. Vitamin B-1 Tablets, the famous Plant Magic brand, containing extra growth-substances. The proved transplanting aid. Also for flower-plant feeding and for fortifying vitamin-deficient soils. Garden magazine articles report amazing results. Each tablet makes 2 to 7 gal. Packet retails, 25c; doz. pkt., \$1.80. 100 tablet bottle, 50c; doz. bottles, \$3.60.



California Liquid Vitamin B-1. Four oz. bottle makes 30 gallons of solution. 1 teaspoon to one gallon of water. 4 oz. size retails at 35c, per dozen, \$2.80; case of 2 dozen, \$5.00; 8 oz. retails at 50c; per dozen, \$4.00; case of 2 dozen, \$7.50.

Seed-Protect. Protects corn, many varieties of seeds from fungi. Another Protex item that should have volume sales. Can be sold with every purchase of seeds. Just let your customer know that you have it! They won't buy what they don't know exists. 2 oz., 35c; doz., \$2.52; 16 oz., \$1.50; doz., \$14.40; 5 lbs. \$6.00.

STIM ROOT

Stim Root. An improved rooting compound containing several different hormone-like chemicals in sufficient quantities to produce root stimulation in the hard type of cuttings, and still is safe to use on the softer, more easily injured plants. Also contains

a fungicide that checks fungi that rot cuttings. A small amount of dust will coat each cutting evenly, making a pound go further. ¾-oz. size retails for 50c, dealer price, \$7.20 per case of 24; 2-oz. size retails for \$1.00, dealer price, \$7.20 per case of 12; 1-lb. size retails for \$5.00, dealer price, \$36.00 per case of 12.

Hormodin Powder. Combination package No. 1-2-3 in one carton. Retails for 75c; price, each, 55c; dozen, \$6.00.

No. 1 Powder, 1¼ oz. tin. Retails for 50c; price, each, 40c; dozen, \$4.00; 1 lb. retails \$3.00; each, \$2.25; 3 for \$6.00.

No. 2 Powder, 1¼ oz. tin. Retails for 75c; price, each, 60c; dozen, \$6.00; 1 lb. retails \$4.50; each, \$3.25; 3 for \$9.00.

No. 3 Powder, 1 oz. tin. Retails for \$1.00; price, each, 75c; dozen, \$8.00; ½ lb. retails \$4.50; each, \$3.25; 3 for \$9.00.

HORMONES—Continued

Fruitone. The hormone spray for stopping pre-harvest drop, 2½-oz. packet, dozen, \$2.00, retails at 25c per packet; 2-oz. retails for \$1.00, dozen, \$8.00; 12 oz. retails for \$5.00 each; dealers' price per carton of 6, \$20.00.

SEED-LESS-SET (New Concentrate) HORMONE SPRAY

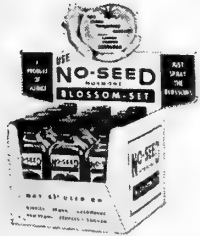

A new scientific development insures "set" of first tomato flowers which usually fall off during early spring; eliminates seeds; causes weeks earlier ripening; increases yield and size of fruit; pollinates self-sterile plants. ½ oz. makes 1 gal., each, \$1.00; per doz., \$7.20. 2 oz. makes 4 gal., each \$2.50; per doz., \$18.00. 8 oz. makes 16 gals., each, \$7.50; six for \$30.00, 20 oz. makes 40 gals., each, \$12.50.

No Seed. Hormone Blossom-set. 4 oz. retails at 75c; per case of 12, \$5.40; Pint retails at \$1.75; per case of 12, \$12.60.

G & O Rabbit Repellent. With safety to all, including the rabbits. This 200 mesh fine snuff-like product is impregnated with rain resistant repelling "naturals" so that an application should last several weeks. 5-lb. package will treat 100 to 150 individual plants or 200 to 250 running feet of plant row. Per carton of 24 1-lb. packages, \$8.00. Retails for 50c; 5-lb. bag retails for \$1.75. Price per carton of 6, \$7.00.



G & O Crow Repellent. ½ pint retails for 40c, packed 24 to a carton, price per carton, \$6.40; pint retails at 60c, price per dozen, \$4.80.

Chemical Weed Killers

Dandy-Kill with Nitrogen. Special formula with 2,4D that adds nitrogen to the soil as the weed is destroyed. (Kills weeds and feeds the grass.) 2 oz. jar retails each, 40c; carton of 24 jars, \$5.76. 6 oz. jar retails 75c each; carton of 12, \$5.40.

Season's Biggest Bargain!

BARWEED 2, 4-D

Weed Killer. Case of 24 \$1.00 bottles for \$6.00, (25c each) 3 cartons for \$17.40; 6 cartons for \$32.80. Every farmer and gardener is a prospect for 2,4-D. Barweed Brand of this famous Weed Killer was manufactured by American Cyanamid Company and widely advertised. Each \$1.00 bottle contains 8 fluid ounces, full strength (over 16% 2,4-D content) Ester type, most effective form of this chemical.

This will make a hot leader at 49 cents, but there is no restriction on the price at which you can re-sell this bargain. Barweed bottles are brand new merchandise, packed in original cases; and your orders will be filled in any quantity as long as our supply holds out. We advise that you get your share of this bargain without delay.

WEED KILLERS—Continued



TO KILL WOODY PEST-PLANTS

New Improved Weedone. Contains 13% 2,4D plus 2,4,5-T. With this combination of weed killers you can keep your grounds free from almost any unwanted plant growth. This newest improved Weedone will control Willow, Locust, Sumac, Poison Oak, Poison Ivy, and other woody weeds. 8 oz. covers 1500 sq. ft., retails at \$1.00, per case of 36, \$21.60; qt. cans retail at \$2.75, per case of 12, \$19.80; gallon retails at \$6.95, per case of 6, \$29.19; 5 gallons retails for \$25.00, each \$20.00.

Weedone Brush Killer 32. Butoxy Ethanol Ester Formulation 2,4-D acid equivalent, 1 1/3 lbs. per gallon. 2, 4, 5-T acid equivalent, 2/3 lb. per gallon. Price, per gallon, \$9.25; case of 6 gallons, \$53.40; 5 gallons, \$42.50; 54 gallon drum, \$418.50.

Weedone Concentrate 48. Contains approximately 39% ethyl ester, or 3 lbs. (48 oz.) of 2,4-D acid equivalent per gallon. 1 gallon cans each \$5.50, case of 6 1-gals. for \$28.74; 5 gal. cans, each, \$22.90.

Weedar 64. Contains approximately 68% of the alkanolamine salt of 2,4-D or 4 lbs. (64 oz.) 2,4-D acid per gallon. 1 gallon cans, each \$5.60; case of 6 1-gals. \$30.12; 5 gal. cans, each \$24.05.

Notts Sel-Tox, New Selective Crab Grass Killer. It contains phenol mercuric acetate solubilized, which has been proved in exhaustive tests to kill crab grass without injuring desirable lawn grasses. It can be used at any stage of growth, from the seedling stage to maturity, with equal effectiveness. Though a poison, it is mixed with water 100 times its bulk, and is easily handled with safety at all stages. Apply with watering can or sprayer. Complete directions on each bottle.

Quantity	Area Treated		Retail Price
8 oz.	1,000 sq. ft.	\$1.00 Per Doz., \$7.20
16 oz.	2,000 sq. ft.	1.50 Per Doz., 10.80
Quart	4,000 sq. ft.	2.50 Per Doz., 18.00
Gallon	16,000 sq. ft.	9.00 Per 4, 21.60

**Lethal Wand for Spot Weed Killing.**

Weed-wand is a plastic tube 1 inch in diameter, 34 inches long, in which any 2,4D spray is placed. A capillary wick at the business end of the wand is

constantly wet with the spray material, and when pressed against a weed administers a fatal dose. Weighs, filled, 15 oz. No stooping, no fatigue, and kills only the plants you want to die. Each, \$1; per dozen, \$8.00.

WEEDUST

TRADE MARK

Ready to use. 12 oz. can. Just one shake for each weed. Price, 75c; per dozen, \$6.00.

CRAB-NOT IS BEST CRAB GRASS KILLER

**Contains Potassium Cyanate—Recommended in April, 1950 Issue of
Better Homes & Gardens**

Since 2,4D made it easy to kill dandelions with a spray, crab grass has become the No. 1 Weed in lawns throughout this country.

Potassium Cyanate (PC for short) is nonpoisonous, an entirely distinct product from the deadly potassium cyanide. It is safe to use where pets and children play.

Two formulae of Crab-Not are offered, Standard, the processed form of PC alone; Special, a combination of PC and 2,4D. The special formula kills dandelions, chickweed and other lawn weeds together with crab grass in the same operation.

FORM 1—STANDARD FORMULAE

Size	Retail Price	Packing Per Case	Shipping Weight	Approx. Coverage	Dealer Cost Per Case
4 oz.	\$1.00	12	5 lbs.	600 sq. ft.	\$ 7.20
16 oz.	2.95	12	16 lbs.	2,400 sq. ft.	21.24
2-lb.	5.00	6	16 lbs.	5,000 sq. ft.	20.00
6-lb.	10.95	2	14 lbs.	14,400 sq. ft.	15.30
40-lb.	51.50	1	45 lbs.	2½ acres	41.60

FORM 2—SPECIAL FORMULAE, WITH 2,4D

Size	Retail Price	Packing Per Case	Shipping Weight	Approx. Coverage	Dealer Cost Per Case
4 oz.	\$1.25	12	5 lbs.	600 sq. ft.	\$ 9.00
16 oz.	3.50	12	16 lbs.	2,400 sq. ft.	25.20
2-lb.	6.00	6	16 lbs.	5,000 sq. ft.	24.00
6-lb.	12.50	2	14 lbs.	14,400 sq. ft.	17.90
40-lb.	59.00	1	45 lbs.	2½ acres	49.50

A triple acting dust for garden plants which kills insects of all types, and protects against fungus diseases. 4 oz. sifter top retails at 25c each, per case of 24 \$3.34. 10 oz. handy applicator gun retails for 79c; price per case of 24 guns, \$12.72; 10 oz. refills retails at 59c; per case of 24, \$9.48. 2 lb. pkg. retails at \$1.79, per carton of 12, \$15.04.

EndoPest

A preparation of 2-4D in liquid form which kills most lawn weeds. ½ pint retails at 98c, per case of 24, \$14.16; quart retails at \$2.69, per case of 12, \$19.44.

EndoWeed

Du Ponts Ammate (Ammonium Sulfamate). A non-poisonous weed killer which can be applied by hand or power sprayer or can be applied dry. Will kill poison ivy, poison oak, poison sumac, dandelions and plantain. Use ¾ to 1 lb. to a gallon of water. 2 lb. bottle retails at \$1.00 each; dealer price, dozen, \$8.00. 6 lb. carton retails at \$2.70 each; dealer price, 4 for \$7.20; 50 lb. drum, each \$9.65; 350 lb. barrel, \$58.63.

Herbicide. Quart cans, per case of 12, \$6.90; gallon cans, per case of 6, \$8.70; 5 gallon can, \$6.00.

Legume Inoculants



Nitragin. Inoculant. Garden size, for Peas, Sweet Peas, Beans, Lima Beans and Lupines. Retail for 15c; dozen, \$1.20.

Alfalfa. Sweet Clover, Bur Clover and Hubam Clover. 1 bu. size retails for 50c; dozen, \$3.84.

Clovers. Medium and Mammoth Red, Alsike Crimson and White Clovers. 1 bu. size retails for 50c; dozen, \$3.84.

All Vetches. Hairy, Spring, Wild, Hungarian, Common. **Peas.** Winter, Canadian, Garden and Sweet. **Broad Beans.** 100 lb. size, inoculates up to 100 lb. seed, retails for 50c; dozen, \$3.84.

Beans. String, Snap, Wax, Navy, Kidney and Scarlet Runner. 1 bu. size retails for 50c; dozen, \$3.84.

Peanuts and Cowpeas. Lime, Velvet and Mung Beans. Kudzu, Crotalaria, Beggar Weed, Alyce Clover. 2 bu. retails for 35c; each, 23c. 5 bu. size retails for 55c; each, 37c.

Lespedeza. All varieties unhulled or hulled. 100 lb. size retails for 50c; each, 32c.

Soybeans. All varieties. 2 bu. size retails for 35c; each, 23c. 5 bu. size retails for 55c; each 37c. 25 bu. size retails for \$2.50; each \$1.67.

Lupines. All varieties. Garden size up to 8 lbs. Carton of 12, \$1.20; retails each 15c.

Nod 'O Gen. A pure culture of nodule bacteria. Garden size combination for peas, sweet peas, lima beans, Lupines. Dozen, \$1.20; retails at 15c pkg.

For Alfalfa, Sweet Clover, Red Clover, Alsike, etc., 1 bushel size, each, 30c; 2½ bushel size, each, 54c.

For large seeds, such as Soybeans, Cowpeas, Lespedeza, etc., 2 bushel size, each, 20c; 5 bushel size, each, 33c.

Lawn Signs, Metal. These attractive signs have raised letters, baked enamel finish for long attractive service. Have center holes for attaching to stakes. Size 3¾x12 inches. Colors, green on white and black on white. Sign wording—**Keep Off Grass.** Retail complete, sign and stake at 50c; price per dozen, \$4.00.



TERRA COTTA GRASS GROWING HEADS

Heads should be soaked in water for 24 hours; also soak seed in separate dish over night. Fill the head with water and spread the seed very thickly all over head. Keep head filled with water at all times. In warm temperature seed may appear to be dry, if so, spray lightly with water, using care not to wash seed off head. Keep in a saucer to protect the furniture.

We can supply "Sunny Jim," with seed, per dozen, \$3.60, packed 24 to a carton at \$7.00 per carton. Retail at 50c each.

We can also supply the larger heads. "Buddy" with seed at dozen, \$4.80; per carton of 24, \$8.75. Retail at 60c.



Pest Poisons and Repellants



Dog-Check. The ideal repellent as a means of checking doggie habits. Safe and harmless to use. New formula will permit spraying on new growth. Unaffected by rain, one spraying usually lasts from two to three weeks. Packaged in handsome glass containers. 3-oz. size, 60c; display carton of 12, \$4.32; 8-oz. size, \$1.00; display carton of 12, \$7.20.

Dog Check Powder. Keeps dogs off furniture. 2 oz. size, 35c; display carton of 12, \$2.52. 8 oz. size, \$1.00; display carton of 12, \$7.20.

Ant-"X" Jelly Bait. Tubes, garden size, 35c; display carton of 12 tubes, \$2.52.

Ant-"X" Traps. Death box. 300 grain size for grease and sweet eating type ants, each 25c; display carton of 12 traps, \$1.80.

Rat-Nots. The safe way to exterminate rats. Prepared bait containing squill can be used without fear of harming humans, dogs, livestock, etc. Trial size, 9 Nots, 25c; display carton of 12 packages, \$1.80; estate size, 50 Nots, \$1.00; display carton of 12 packages, \$7.20.

Mouse-Nots. Impregnated seed bait kills mice. Fall is a good time to destroy mice in the house or orchard. Trial size, 9 Nots, 25c; display carton of 12 packages, \$1.80; estate size, 50 Nots, \$1.00; display carton of 12 packages, \$7.20.

Mole Nots. Life saver for lawns and seed beds. Trial size, 8 Nots, 35c; display carton of 12 packages, \$2.52; estate size, contents 50 Nots, \$1.00; dozen, \$7.80; jumbo size, contents 125 Nots, \$2.00; dozen, \$14.40; gardener size, contents 400 Nots, \$5.00; dozen, \$36.00.

5% discount on orders of six display cartons of an assortment of the above

FLYING DISK



Flying Disk. Scare birds and animals away from newly planted seeds, berries, tender seedlings, fruit trees, etc. Made of shining aluminum. FLYING DISKS spin and whirl giving blinding reflections and weird jingling, crackling sounds. Easily strung across area to be protected—or from branches of fruit trees and vines. 10 Flying Disks with complete instructions, only 25c. Display carton of 24 pkgs., \$4.00.

PEST POISONS AND REPELLANTS—Continued



D-Con (Warfarin) The sensational new pest destroyer guaranteed to clear your place of rats and mice. Safe, clean, easy to handle. D-Con 8 oz. Concentrate with Lurex (makes 6 lbs. bait) Each \$2.98, 12 for \$24.00. D-Con 1 lb. Ready-Mix with Lurex. Each \$1.69, 12 for \$13.68. D-Con's Mouse Prufe—4 oz. ready for use in handy household package. Each 89c, 12 for \$7.20.

D-Con's Mouse Prufe—4 oz. ready for use in handy household package. Each 89c, 12 for \$7.20.

Sla-Rat. Contains the new superior rat and mouse poison, death dealing "Warfarin". A prepared bait ready to use. Complete description on container. 8 oz. retails at 65c, dozen \$5.20, 1 lb. retails at \$1.00, 6 for \$3.60. 5 lb. retails for \$4.00, each, carton of 2 for \$5.34. Concentrated form, 4 oz. retails for \$1.25, dozen \$9.00, 12 oz. retails for \$2.75, dozen for \$22.00.

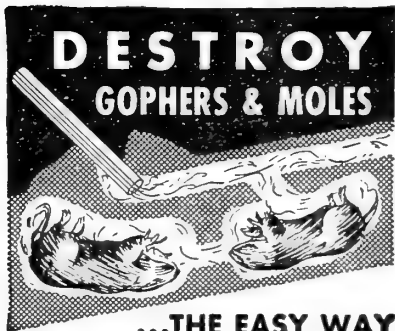

Mole Traps, improved Reddick, with patented setting attachment, retails at \$2.25 each; dozen, \$18.00.

Chaperone Powder Dog Repellent. A new household dog repellent for keeping dogs off rugs and furniture. Odorless to humans and does not stain, but is very repulsive to dogs. 1-oz. tin, dozen, \$4.00; large size, dozen, \$8.00.

Chaperone Liquid Dog Repellent. For outdoor and garden use. Keeps dogs away longer from trees, shrubs and plants than most liquid repellents. 4-oz. bottle, retails at 60c, dozen, \$4.80. 8 oz. can, retails at \$1.00, dozen, \$8.00.

Dog-Shoo. Quarts, dozen, \$6.80; gallons, each, \$1.50; case of six, \$8.10.

Dogzoff. Per dozen, \$6.00; per gross, \$64.80; retail, each 75c.

Rodent Rockets. Novel, effective destroyers; strike like a match and blitz out whole families of gophers, moles, rats, field mice, ants, etc., at one "shot." Safe, sure efficient aids to hunters in "un-treeing" holed-up woodchucks, raccoons, etc. Price per dozen, \$1.20; 3 dozen for \$3.30. Packed 6 dozen to carton. Per carton of 72, \$6.30; 144 for \$12.00.

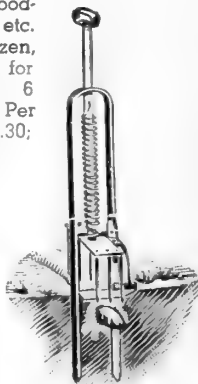

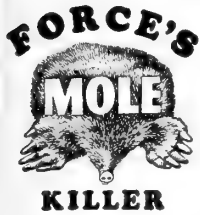

The Accepted Mole Control for nurseries, greenhouses, gardens, cemeteries, parks, and residential lawns. Small size, 35 pellets, retail ea. 30c; display carton of 12 for \$2.16. Regular size, 75 pellets, retail ea. 60c; display carton of 12 for \$4.32. Large size, 185 pellets, retail ea. \$1.00; display carton of 12 for \$7.20. Commercial size, 875 pellets, retail ea. \$3.25; 3 for \$5.85.

Sprayers and Dusters

Arnold Hose Sprayer. with transparent chamber. Brass. Each, \$3.75; six for \$20.00. Chrome, with stationary nozzle. Each, \$3.95; six for \$22.00; with adjustable nozzle, each, \$4.75; six for \$26.00.



Arnold Weed-O-Spray combination set consisting of one plastic sprayer and two Weed-O cartridges. Retail at \$1.75; doz., \$14.00.

Cartridges. For hose gun. Arsenate of lead, Bordo, Rotenone, Pyrethrum and Sulphur, Nicotine, Cryolite, D.D.T. Dozen, \$3.20; three dozen, \$9.50.



Smith's Special No. 24GO. 4-gallon, each, \$8.50.
Dobbins' Galvanized No. 21G. 3 1/2 gal. capacity. Each, \$7.75; six for \$44.70. The above Dobbins' Sprayers are equipped with oil and chemical resisting hose and gaskets and discs for cone or flat spray discharge.

Dobbins' Big-Head Sprayer. 4-gal. capacity, galvanized, each, \$10.60; 6 for \$60.60. Stainless steel tank, each \$17.40.



BLIZZARD COPPER CONTINUOUS SPRAYER

Very durable, seamless brass pump, solid copper quart tank with adjustable nozzle for straight and underleaf spraying. Retails each, \$5.65; six for \$23.60; 12 for \$45.20. Pint size retails at \$5.00; six for \$21.00; 12 for \$40.00.

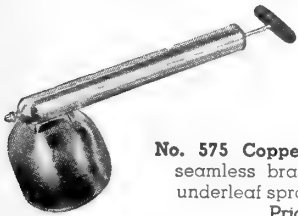

No. 594 Chapin Duster. One of the finest hand dusters for handling all types of dusts. Retails at \$1.25 each; price per dozen, \$8.88; 3 dozen for \$26.40.

No. 575 Copper Continuous. Full quart size sprayer, durable, seamless brass pump with adjustable nozzle for straight and underleaf spraying. Retails at \$5.65 each; price per dozen, \$45.00. Prices subject to change.

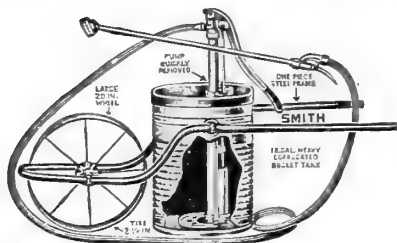

Wheelbarrow Sprayer. Tank holds 18 gallons. Fully equipped with hose, nozzle, etc. Price each, \$34.20.

Dobbin's Deluxe Garden Sprayer. No. 8. A new high quality 2 gal. sprayer especially suitable for suburban and city



home use. Streamline oval tank with ultra modern comfortable carrying handle. Appeals particularly to women. Can be used for all insecticides, fungicides and weed control chemicals. Complete with high pressure hose, extension and automatic shut off. Retail at \$11.85; price each, \$8.95; three for \$26.25.



Insect-O-Gun. This is a 3 gallon Lawn and Garden Insecticide Sprayer. The most compact, simple and easy to use sprayer available. Just put insecticide in the pint jar, attach to the garden hose, and the water pressure does all of the work. Eliminates pumping and carrying a heavy tank. Recommended for applying 2,4-D for exterminating weeds. Retail at \$5.95. Price each, \$4.15; three for \$11.90; 12 for \$42.84.



Gro-Gun. For all liquid fertilizers, soluble plant foods and weed killers. Any pint or quart Mason jar will fit this gun; no moving parts, no valves, nothing to go wrong. Retail at \$2.95. Price per doz., \$23.60.

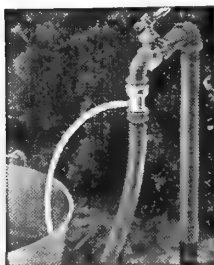

Fertilizer Applicator

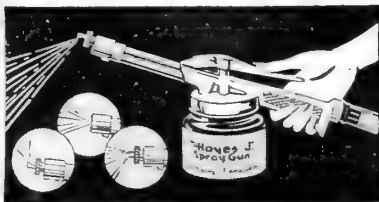

Hayes Jr. Garden Spray



Hayes-Ette Spray Gun

Fertilizer Applicator. The easy way to fertilize lawn and garden. Retail at \$2.25 each. Three, \$4.95; six, \$9.00.

Hayes Jr. Spray Gun. An all purpose sprayer. To be attached to your hose. Operates on 30 to 75 lb. pressure. Each \$6.45; three for \$16.90.

Hayes-Ette Garden Spray. Each, \$2.65; three for \$7.25; dozen, \$27.60.

Hudson Sprayers and Dusters

Hudson Special 2AD Sprayer.

3½ gallon copper tank, on a two wheel cart which rides on 6 inch disc wheels rubber tired. Fitted with brass boom with three nozzles with discs for flat-fan spray spaced 9 inches apart. Retails at \$23.60, price each, \$17.70.



New Hudson Perfection Presto-Seal Sprayer. 4 gallon galvanized tank, price each, \$9.90; with stainless steel tank, price each, \$17.70.

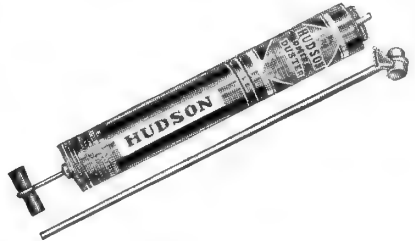
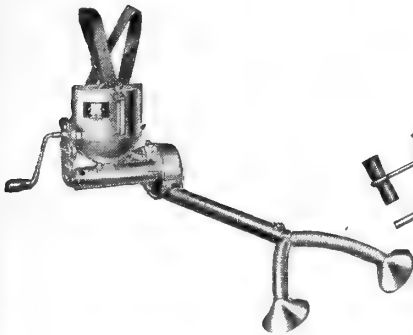

Hudson Roto Power Duster No. 806B.

Will hold 12 to 15 lbs. of powder, depending upon the gravity of the dust being used. Weight 12 lbs., complete with

all necessary equipment. Price each, \$29.70.

Hudson Admiral Duster. Ruggedly built of finest materials throughout. Attractively lithographed in two colors. Counter or window display card lithographed in three attractive colors packed in each carton, price per carton of 12, \$18.00. Weight 21½ lbs. per carton.



PNEUMATIC HAND SPRAYER

Pneumatic Hand Sprayer. Galvanized continuous one quart size with two nozzles for straight and underleaf spraying. Each, \$1.60; dozen, \$14.40.

Pneumatic Tin Hand Sprayer. Same as above, each, \$1.45; dozen, \$12.00.

Tin Hand Sprayers. Full qt. size, retails at 70c; per doz., \$5.40.

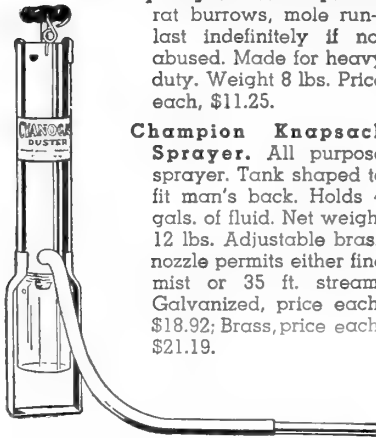

Cyanogas Foot Pump. For pumping Cyanogas A-Dust into insect nests, rat burrows, mole run-ways, and for other burrowing pests. Will last indefinitely if not abused. Made for heavy duty. Weight 8 lbs. Price each, \$11.25.

Champion Knapsack Sprayer. All purpose sprayer. Tank shaped to fit man's back. Holds 4 gals. of fluid. Net weight 12 lbs. Adjustable brass nozzle permits either fine mist or 35 ft. stream. Galvanized, price each, \$18.92; Brass, price each, \$21.19.



G. S. Master Sprayer. This sprayer can be used for spraying all types of insecticides, flower and vegetable gardens, fruit and ornamental trees. Sprays from a fine mist to a 35 ft. spray stream. Made of 100% brass throughout. Jr. Model each, \$4.75; 6 for \$27.00; Master Model with adjustable nozzle and 45 degree brass extension, each, \$6.45; 6 for \$34.80.

Utility Portable Power Sprayer. 25 gal. steel tank, 1½ H. P. engine, 12½ ft. high pressure hose and adjustable spray gun. Price each, \$165.00. Write for leaflet.



DUSTERS



FEENEY

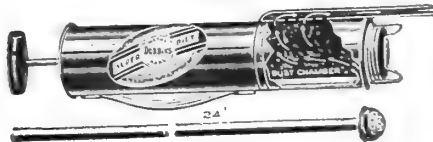

DOBBIN'S

American Beauty Duster. The most powerful hand duster made. Each, \$25.50.

Feeney Duster. Model C. retails each at \$1.50; dozen, \$11.40.

Dobbin's Improved Hand Duster. No. 132 retails each at \$2.25; dozen, \$18.90.

Labels and Markers

Rainbow Garden Label. is a weather-proof label of masonite, 1/8 inch thick, 1 1/2 x 3 inches, 1/8-in. thick, coated with aluminum based waterproof paint. It is held at the right tilt to be legible from standing position, on 9 inch metal stake with swan-neck locking curve. Kit of 10 markers with ink and marking pen, \$1.00, 12 kits for \$8.00. 14 inch stake kit of 12, complete \$1.25, 12 kits for \$10.00. 18 inch kit of 24, complete \$2.50, 12 kits for \$20.00.

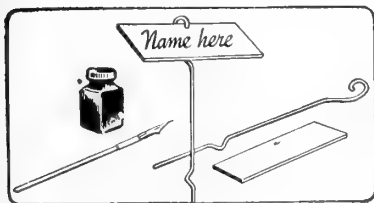

Large Kit. For commercial growers and nurserymen. Stake 18 in. high with larger slabs 4x2 1/2 in. including weather-proof marking fluid and pen, per kit of 100, \$6.50. Three kits for \$18.00.

Vaughan's Transparent Permanent Plastic Label. Made of the plastic "styrene," which is as transparent as glass, but unbreakable, and weather proof, this label is provided with a tilted plaque, easily read from above, on which the name is written in a scriptor red marking pencil. Small size, overall height 6 inches, plaque 2x4-in., doz., \$1.20; 100, \$9.00. Large size, overall length 12 1/2 inches, plaque 2 1/2 x 5-in., doz., \$1.80; 100, \$13.67. Scriptor red pencil, 25c ea.



Speedy Brush Pen. This is the new amazing brush pen. Will write or mark on porous surfaces. It can be used on wood, leather, textiles, cardboard, paper, glass, tin and cellophane. The ink dries instantly and does not smear. When ordering specify type of nib; chisel, square or round. Price each with bottle of instant drying ink \$1.95. Per dozen, \$16.00. Extra nobs at 35c each; dozen, \$2.80. Speedy Ink price, per 4-oz. bottle, 80c; 16-oz. bottle, \$2.60; 32-oz. bottle, \$4.50.

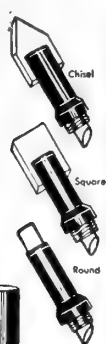

POT AND TREE LABELS

We carry the best quality of Wooden Labels made in the country. They are smooth, strong and neat. Samples free.

Pot Labels, Wooden

In lots of 10,000 we allow 5 per cent discount.

	Per 1000	
	Plain	Painted
4 x 5/8 inch.....	\$2.65	\$3.20
5 x 5/8 inch.....	2.90	3.50
6 x 5/8 inch.....	3.10	3.85
8 x 5/8 inch.....	4.65	6.00
10 x 5/8 inch.....	5.60	6.85
12 x 5/8 inch.....	6.50	8.10

Garden Stakes or Labels

	Plain	Painted
8 x 7/8 inch.....per 1000	\$7.10	\$8.25
10 x 7/8 inch.....per 1000	8.00	9.35
12 x 1 1/8 inch.....per 1000	13.30	15.25

Tree Labels, Wooden

3 1/2 inch, wired.....per 1000	3.25	3.95
--------------------------------	------	------

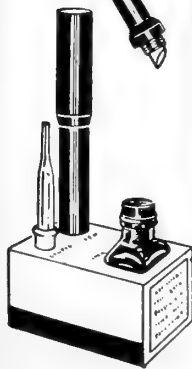

No. 1 Copper tree labels, copper-wired. Per 100, \$2.25; per 1000, \$20.00.



Everlasting Perma Label. New improved. Made of zinc. Price per 100, 85c; per 1000, \$7.35.
Pencils, indelible, weatherproof, for writing on labels, per doz., 85c; 3 doz., \$2.40; gross, \$7.80.

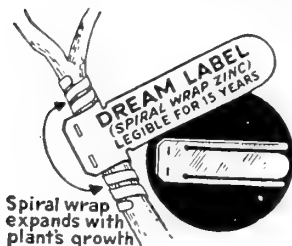

Dream Label. Expand as plant grows. Dream Labels are made of rustless zinc, 1x4 inches, with prongs that can be spiraled around stem and will expand with growth. Data etched with acid remain legible for 15 years. Inconspicuous, enduring, noncorrosive. "Kit" size, 24—4 inch Labels, one oz. of etching ink (enough for 200 Labels) and a writing applicator retails for \$1.00; per doz. kits, \$7.80. 50 Zinc Labels, one oz. of etching ink and writing applicator retails for \$1.75; doz., \$13.80. 1,000 Zinc Labels, 5 oz. bottle of etching ink and applicator for \$15.65.

Celex Garden Labels. New fast selling popular priced permanent garden markers. 3½ inches. Copper wires attached. Weatherproof mark with ordinary black pencil writing. May be erased and label reused. Packed in cellophane bag containing one dozen; twelve bags on attractive easel back. Display card buff and green. Retails at 25c per bag of 12 labels. Per card of 12 bags, \$2.00.

Simplex Weatherproof Plant Labels.

White celluloid with transparent cover of genuine mica including copper wires for attaching. Per 100, \$3.00.

Red Clay Flower Pots and Bulb Pans.

Discontinued temporarily.



SEED FLATS

Made from clean Pecky Cypress, knocked down, put up in bundles of ten flats each.

	Inside Dimensions	Per Bundle of 10
No. 3	21½ x 14 x 2¾ inches.....	\$4.75
No. 3-A	21½ x 14 x 3¾ inches.....	5.25
No. 4	24 x 15 x 2¾ inches.....	5.55
No. 4-A	24 x 15 x 3¾ inches.....	5.95



CUT WORM PROTECTIVE COLLARS. Provides three-way aid: protects against deadly cut worms, provides plant nourishment, conserves plant moisture. Package of 24, 30c. Per doz. pkgs., \$2.40. Per gross, \$27.00.

PANSY BASKETS

Price, 2 quart size, 500 for \$17.00; 1,000 for \$32.00; 3 quart size, 500 for \$18.00; 1,000 for \$34.00.

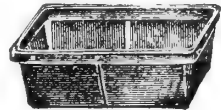

WOOD VENEER PLANT BANDS

Used by the largest growers for vegetable plants, perennial plants, carnations, snaps and stocks. For transplanting in greenhouse or outdoors. Packed 1000 to carton.

	Weight Per 1000	Price Per 1000
2 x2 x2½	14 lbs.	\$4.65
2½x2½x2½	17 lbs.	4.95
2 x2 x3	16 lbs.	4.95
2½x2½x3	20 lbs.	5.40
3 x3 x3	21 lbs.	5.80
3 x3 x4	32 lbs.	5.90
4 x4 x4	40 lbs.	7.05



BIRD GROWTH-STIMULATING PLANT BANDS

A band for every purpose. Units of 1,000 only.

Vita-Band D contains root growth until grower chooses to let root through Band. Only quick, slight pressure is needed to crack Band. Do not remove Vita-Band "D" when transplanting. Band disintegrates in the soil permitting free growth of roots from time of transplant. Nutrient-treated with quickly available plant food.

Vita-Band "D" and No. 10 is packed 2,000 to the case—except sizes 3" by 3", 4" by 3", and 4" by 4", which are packed 1,000 to the case.

Price per 1000—sizes in inches

Plant bands 1½x1½	1¾x1¾	2x2	2x2	2½x2½	3x3	4x4	4x4
	x2½	x2½	x3	x3	x3	x3	x4
Vita-Band D	\$3.50	\$3.80	\$4.25	\$4.85	\$5.60	\$6.45	\$8.60 \$10.90



Vita-Band 10 for short growing periods. Will usually contain root growth up to approximately 8 to 10 weeks. Nutrient-treated with quickly available plant food . . . your judgment determines need for additional feeding. Vita-Band 10 is identical to Vita-Band "D" except Vita-Band 10 is removed at time of transplant. Vita-Band "D" is not.

Per 1½x1½x2½	1¾x1¾x2½	2x2x2½	2x2x3	2½x2½x3	3x3x3	4x4x3	4x4x4
1,000	\$3.30	\$3.60	\$4.05	\$4.50	\$5.40	\$6.20	\$8.15 \$10.25

PAPER POTS. Neponset Red Flower. F.O.B. Chicago or New York.

2 inch, packed 1000 to case, per 100, \$1.00; per 1000, \$8.20.	3½ inch, packed 1000 to case, per 100, \$1.55; per 1000, \$11.60.
2¼ inch, packed 1000 to case, per 100, \$1.00; per 1000, \$8.20.	4 inch, packed 500 to case, per 100, \$1.75; per 1000, \$14.00.
2½ inch, packed 1000 to case, per 100, \$1.10; per 1000, \$8.25.	5 inch, packed 500 to case, per 100, \$2.50; per 1000, \$17.25.
3 inch, packed 1000 to case, per 100, \$1.35; per 1000, \$8.70.	6 inch, packed 500 to case, per 100, \$2.95 per 1000, \$21.80.

Discount on paper pots, 5%, in quantities of 10,000 or over.

New Bird Vita-Pots. For growing and shipping, containing nutrients that are readily available as plant develops. Eliminate labor of knocking plants out of pots and repacking rootball. Eliminate handling and storage of heavy pots. Lightweight, reduces shipping charges. Will also reduce damage claims.

F.O.B. Chicago or New York.

2 inch, packed 1000 to case, per case, \$13.30.	4 inch, packed 500 to case, per case, \$11.60.
2¼ inch, packed 1000 to case, per case, \$13.65.	5 inch, packed 500 to case, per case, \$15.20.
2½ inch, packed 1000 to case, per case, \$14.20.	6 inch, packed 500 to case, per case, \$19.80.
3 inch, packed 1000 to case, per case, \$15.75.	

Subirrigating Window Box. Attractive metal indoor window box, designed to apply water at plant roots. Finished in pale green to blend handsomely with plant colors. Length 27 in., width 5¼ in., height 6 in. Sturdy steel construction. Each, \$2.65; six for \$13.80.

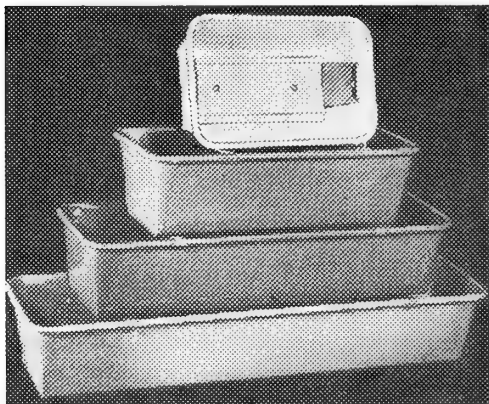

New Streamlined All Steel Window Flower Box.

Leak proof, rigid, green baked enamel finish. Water-tight seams, fully interlocked. Water wells at each end of box to keep plants moist and healthy. Also has a drain. Nested to save storage, shipping and extra handling. 15 inch, packed 12 to carton, weight 26 lbs., per dozen, \$12.60.

24 inch, packed 12 to carton, weight 38 lbs., per dozen, \$15.60.

30 inch, packed 12 to carton, weight 44 lbs., per dozen, \$17.40.

36 inch, packed 12 to a carton, weight 60 lbs., per dozen, \$21.60. 5% discount on orders for three dozen.

TWINE AND FLORIST THREAD

"The Queen" White Cotton. For tying parcels, flowers, etc. Put up in 5-lb. sacks. 100 lbs. for \$92.00; sack, \$4.95.

Polished Cotton. No. 128. For parcels, per lb., 95c; 10 lbs. for \$9.00.

Florists Thread. Similar to Silkaline. Samples on application. Thread, 2 oz. spools, 8 in box, \$1.85; (10 boxes at \$17.50 per box).

PLANT STAKES AND SUPPORTS

Bamboo Cane Stakes. Plain and green painted. Sizes usually run in plain 6 feet, in painted 18 to 48 inches, graded in sizes running 6 inches apart.

	100	1000	Bale of 2000		100	1000	Bale of 2000
1½ foot	\$0.90	\$3.75	\$ 6.25	3 foot	\$1.35	\$7.75	\$13.50
2 foot	1.00	4.95	8.00	3½ foot	1.75	9.75	16.95
2½ foot	1.15	5.95	10.50	4 foot	1.90	10.75	18.50
6 Foot Natural—100, \$2.50; 1000, \$16.50.							

Prices subject to change without notice.

Plant Stakes, Wooden. Light turned, painted green, per 100, 18-inch, \$3.25; 2 foot, \$4.95; 2½ foot, \$6.25; 3 foot, \$7.75; 3½ foot, \$9.35; 4 foot, \$10.95; 5 foot, \$13.95.

Heavy, for Dahlias, per 100, 3 foot, \$12.95; 4 foot, \$16.50; 5 foot, \$21.00; 6 foot, \$24.95.

Heavy Tonkin, natural color. Heavyweight bamboo, entire stake same weight, do not taper. Ideal for roses, dahlias and young trees.

	Diameter	Doz.	100		Diameter	Doz.	100
4 foot	½ to ⅝ inch	\$1.40	\$8.00	6 foot	⅝ to ¾ inch	\$2.00	\$10.50
5 foot	½ to ⅝ inch	1.85	9.25	7 foot	⅝ to ¾ inch	2.20	11.50

Prices subject to change without notice.

No. 9 Wire	Per 100	Per 500	No. 8 Wire	Per 100	Per 500
1½ foot	\$1.75	\$8.25	4 foot	\$3.90	\$16.25
2 foot	2.00	9.25	5 foot	4.95	20.00
2½ foot	2.45	11.50	6 foot	5.50	23.50
3 foot	2.85	11.75	Prices subject to change.		

Adjusto Plant Support. 36-inch, dozen, \$3.10; 3 doz. for \$9.00; 48-inch, dozen, \$3.80; 3 doz. for \$10.80; 60-inch, dozen, \$4.20; 3 doz. for \$12.00.

Extra wire hoops, dozen\$1.75

Wayward Vine Guide and Support. For Training and Supporting Ivy,

Small Fruiting Trees and all other Vines, etc., on Brick, Stucco, Stone and Cement Walls without defacing. No nails—no holes. Price, box of 25, including cement, 70c; per dozen, \$8.00.

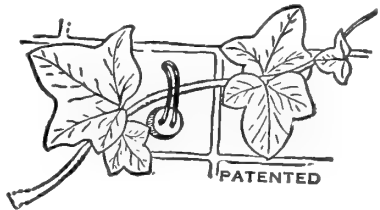

Train-Eits. New weatherized trellis netting. Ideal support for Sweet Peas, Morning Glories or any of the other light climbing vines. Made in three sizes. No. 1—60"x72", retails at 65c each, per carton of 2 dozen, \$10.40; No. 2—60"x96", retails at 85c each, price per carton of 2 dozen, \$13.60; No. 3 — 60"x180", retails at \$1.25 each, price per carton of 1 dozen \$10.00.

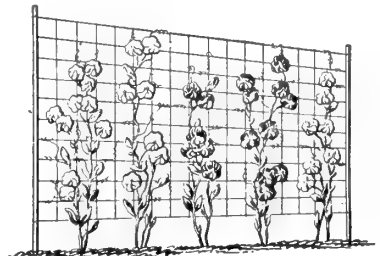



Metal Wicket Shields. Green enameled wicket shields protect shrubs, flower beds, new lawns, etc. Color matches green foliage, making the protective fence inconspicuous. No sharp prongs to tear and scratch fingers or clothing. Approximately 21" high x 13" wide (opening). In bundles of 12, retails \$2.25 per dozen; carton of six dozen, \$9.00.

G & O new 44 inch Tomato Rods green enameled 1/4 inch diameter will last several years. Doz. \$1.80. Six doz. for \$10.20.

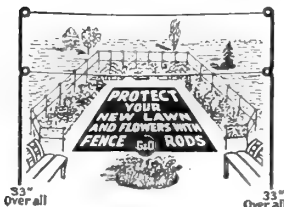

Protection Fence Rods. Stiff strong green enameled rod, supports one or two rows of wire, heavy twine or clothes line. Very handy for circling trees and ornamentals, to keep dogs at safe distance. 33 inches overall, doz. \$1.50; six dozen \$8.30. 48 inches overall, doz. \$1.75; six dozen \$9.90.



KEEP "EM" OFF
THE GROUND

RAFFIA FOR BASKETRY—Also Used for Tying Plants

RAFFIA, NATURAL, Best Grade, per lb. 50c

10 lb. lots	\$0.45	50 lb. lots	Per lb.	\$0.35
25 lb. lots38	100 lb. lots33
Bale lots, about 225 lbs., per lb., 31c				

RAFFIA, COLORED.

	Per lb.		Per lb.
1 lb. lots	\$0.95	50 lb. lots	\$0.80
5 lb. lots87	100 lb. lots78
25 lb. lots82		

Prices subject to change as market fluctuates.

Adams Peony and Tomato Supports. Made of strong galvanized wire. Will not rust. The best support for Peony and Tomato Plants. After Peonies have bloomed, supports can be removed and used for bushy late bloomers such as hardy asters, heliniums and mallows. Can also be used for supporting delphiniums and larkspur.

Wire Gauge	Dia. Top Ring	Height	Weight per 100	Price per 100
No. 6	14"	30"	142 lbs.	\$41.00
No. 6	18"	30"	164 lbs.	52.00
No. 6 Flower Supports				
	10"	30"	120 lbs.	28.00



Help YOUR FLOWERS HOLD UP THEIR HEADS
with
G&D PATENTED METAL
PLANT PROPS

All heights shown are overall. Deduct 4" from 16 size and 6" from all other sizes for net height.

66" 42" 30" 16"

BAKED GREEN ENAMEL FINISH

Wire Plant Props. These require no tying, as the loop at the top can be slipped around the plant stem. To determine the net height of each prop, deduct the following from the overall length: 4 inches from the 16-inch size, 6 inches from all other sizes. This represents the depth to which the stake should be pushed into the ground. It looks better if the shortest practical height is used.

Prices: 16 inches overall, dozen, 50c; six dozen, \$2.70; 30 inches overall, dozen, \$1.10; six dozen, \$6.00; 42 inches overall, dozen, \$1.25; six dozen, \$6.90; 66 inches overall, dozen, \$2.00; six dozen, \$10.80; 78 inches overall, dozen, \$2.85; six dozen, \$16.00.

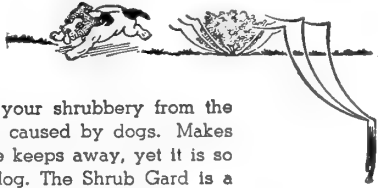

Shrub-Gard. An invention that protects your shrubbery from the menace of destructive corrosive action caused by dogs. Makes the dog's visit so uncomfortable that he keeps away, yet it is so constructed that it will not harm the dog. The Shrub Gard is a unit of steel spring wires that are flexible and will not tear clothing of passersby. Each Shrub Gard has three prongs and covers approximately two and one half lineal feet. Harmless to dogs or humans. Packed one dozen to a carton. Weight 2½ lbs. Price per carton of dozen, \$2.85; six dozen for \$15.60.



Twist-Ems. New handy utility plant ties, deep green color, same shade as foliage of plants. Do not break or come loose. The wire running through the center of tape makes them unbreakable and they cannot come unfastened. Tape protects stem against injury. For all types of plants and other vegetable crops. Price 4 inch per 1,000, 90c; 25,000 lots at 80c per 1,000; 8

inch per 1,000, \$1.75; 25,000 lots at \$1.55 per 1,000; 12 inch per 1,000, \$2.60; 25,000 lots at \$2.25 per 1,000; 16 inch per 1,000, \$3.50; 10,000 lots at \$3.20 per 1,000. Write for prices of larger quantities.

Twist-Ems Assortments. Assortment B contains 24 pkgs. of 100 8-inch. Retail at 25c per pkg. Price per asst., \$4.00. C asst. contains 24 pkgs. of 200 4-inch. Retail at 25c per pkg.; per asst., \$4.00. D asst. contains 24 pkgs. of 100 16-inch. Retail at 50c per pkg. Per asst., \$8.00. G asst. 250 ft. continuous roll packed 12 to a display ctn. \$8.00, retails at \$1.00 per roll.

Prices subject to change.



Tin Case

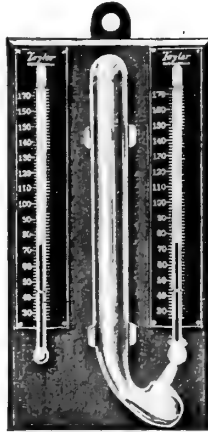

No. 5532-S Humidiguide



Taylor Utility



Hotbed



Self Registering

THERMOMETERS

Tin Case. Standard grade (tested). 12 inches. Guaranteed accurate tin case thermometers, black oxidized metal scale, heavy magnified easy reading tube, each, \$3.25; 3 for \$9.50; doz., \$34.80.

Self Registering Tycos. No. 5448, with magnet. 10 in. Maximum and minimum registering thermometers mounted on substantial plastic frame, guaranteed accurate, complete with magnet, each, \$8.50. Three for \$22.50.

Soil Thermometer, Tel-Tru No. FC. 220. New type dial stem, highly recommended for measuring soil temperatures. Very accurate. Dial diameter $2\frac{1}{8}$ in., stem length 6 in. Registers from 0 to 220°. Price each, \$2.75; 3 for \$7.50.

Taylor Utility Thermometer. White vitreous enamel scale, black figures and graduations; easy reading red permacolor tube which will not fade; prongs on top and bottom for easy mounting, about 8 inches. Each, \$1.50; three for \$4.40; doz., \$16.30.

Hotbed (Mushrooms). All glass heavy plain, each, \$1.60; 3 for \$4.50.

No. 5532S Humidiguide. Permacolor tubes with magnifying lens, indoor temperature range. Scales have burnished metal figures and graduations on a polished lacquer background. Frame is mahogany bakelite with revolving humidity table and easy filling reservoir. Each in attractive box complete with spare wicks and instructions. Each \$8.00. Wicks for Humidiguide, per doz. \$1.50.

Standard Recording Thermometer No. 200. Furnished with daily chart No. 3 or weekly chart No. 2. Range of temperature 20° to 120° F. Price, \$60.00.

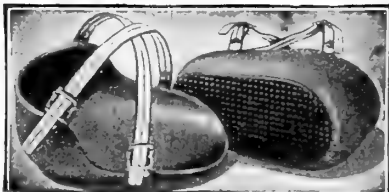

Knee Pads. Pair, \$1.60; six for \$9.00
Dozen pair, \$17.40.

Prices subject to change without notice

VAUGHAN'S WICK-FED METAL SEED STARTER



View of Wick-fed Starter with Plant Bands.
Size, 12x18 inches, 4 inches high.

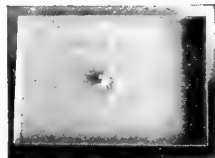

How wick is placed in
bottom of starter.



End view showing water
pan below.

Complete, with Fibre Glass Wick, 60 Plant Bands, and Sphagnum Moss.
(Weight 4½ lbs.) Retails each for \$2.95. Price, 3 for \$6.00. Doz. \$23.40.

This seed starter must not be confused with the fragile, impractical pasteboard devices which have disappointed so many customers. This is a full size "flat," made of 28 gauge steel enameled green to last for years, which you will be glad to have in your sun parlor or living room window.

It makes use of two of the most recent scientific developments in seed starting: 1. Wick-feeding of water, which keeps the soil at just the right moisture, never drying out, never too wet, and never dripping dirty water from an overflow. 2. The use of sphagnum moss to prevent damping off of seedlings, highly recommended by the U. S. D. A.

As shown in the illustrations, water is supplied to the soil from a pan placed underneath the starter, by the agency of capillary attraction, through a fibre glass wick, the top of which is frayed and embedded in the soil, the lower end being immersed in water in the pan below. Any suitable pan, saucer, or dish can be used.

Fill this container with water daily, and the wick will do the rest. This method of watering leaves nothing to chance or judgment, and solves in the easiest imaginable way one of the most serious problems of seed-box management. It has been thoroughly tested by Cornell University. The wick will last indefinitely.



Seeds may be sown in the starter in rows, broadcast or, as shown in the illustration, in plant bands. If started in plant bands, and grown one plant to a band, sturdy, full size pot plants will be produced without transplanting. Seedlings may be easily transferred.

Corning Mulching Wool. Put up in bats 24 inches by 96 inches. 1½ inches thick at 1½ lbs. per cubic ft. density. Price per bat, \$1.35; three for \$3.90; per carton of 9 bats, \$10.80.

SPHAGNUM MOSS

Pulled and pressed for us in North Woods on annual contracts with reliable concerns. Prices variable with season's changes.

BURLAPPED BALES. Standard size.

F.O.B. Chicago, 10 bales, \$23.50. F.O.B. Wisconsin points, 10 bales, \$21.00.
(One to five bale lots, 10 cents higher)

The above are prevailing prices on orders shipped before April first.

Write us for prices on later shipments.

Prices Subject to Change without Notice

Gro-Quick Electric Seed Bed Heater. Soil heating cable and thermostat. Jr. package contains thermostat and 40-foot 200-watt cable for 3x6 foot hot bed or 20 square feet of cold frame. Retail at \$6.75, dealer price, 3 for \$13.50; 6 for \$24.30. Sr. package contains thermostat and 80-foot 400-watt cable for 6x6 foot hot bed or 40 square feet of cold frame. Retail at \$9.00, dealer price, 3 for \$18.00; 6 for \$32.40. Jr. cable only retails \$2.25; dealer price, 3 for \$4.50. Sr. cable only retails \$4.50; dealer price, 3 for \$9.00.

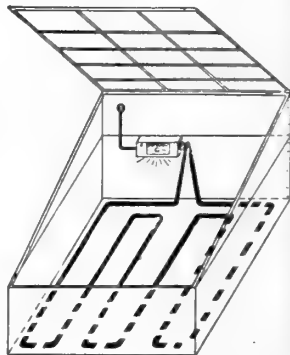

Vitapane Glass Substitute. Used everywhere glass is used.
Price per 50-foot rolls, \$8.00.

Cel-O-Glass, 28 and 36 inches wide and 25- and 100-ft. rolls. For poultry houses only. Specify on order. Price 10 $\frac{3}{4}$ c per square foot.

KNIVES—Schrade Finest American Cutlery

Asparagus—American fishtail. Dozen, \$6.00.

Potato—Humphrey's Concave, per gross, \$15.00; dozen, \$1.80.

Grafting Wax. $\frac{1}{4}$ -lb. bars, per lb., 90c;
 $\frac{1}{2}$ -lb. bars, per lb., 75c; 1-lb. bars, 60c;
10 lbs. (1-lb. bars), per lb., 58c.



Vaughan's Budding and Prop., No. 86281, with brass caps, each, \$3.00; doz., \$33.00.

White Handle, No. 83023W. Silver nickel shackle for chain attach. Each, \$2.25; 3, \$6.25.

JARDIERS, VASES, BOXES

Jardier Pot Covers. Popularize the potted plant—because they safeguard the appointments of the finest homes—table tops, linens, window sills—from soilage and overflowing saucers. These are inexpensive, yet take the place in beauty and service of expensive jardinieres. Save time and labor over other methods of trim.

PAPER MACHE CONTAINERS

No. 600 Wedgewood. Top opening 10½ inch x 4½ x 7½ inch deep. Wide base assures stability. Wide curved ends prevent kinking and breaking stems. Very strong. 30 in carton. White. Price per carton, \$8.40.

No. 800 Fantasy. Top 10½ inches x 4½ x 10 in. tall. Attractive fan-type vase with exclusive features. Embossed panels form rectangular corners inside which prevent stems from shifting. Wide flat bottom and weighted base. 12 to carton. White. Price per carton, \$5.20.



JARDIERS FOR STANDARD SIZE POTS

In Imitation of Pottery—Stucco Effect

Sizes	Diam. Top Inside	No. Per Carton	Price Per Carton
No. 3J straight side....	4¼ in.	200 White	\$14.80
No. 4J-1	5½ in.	100 White	8.50
No. 5J-1	6¾ in.	90 White	11.00
No. 6J-1	7¾ in.	60 White	9.25
No. 7J-1	8¾ in.	40 White	9.40

(EXAMPLE: Use No. 6 Jardier for a 6-in. Pot.)



VASES

No. 400 Rose Vase, Height 10 in., Top Diam. 5¼ in. per carton of 40. White. \$8.40.

No. 500 Spray Vase, Height 10 in., Top Diam. 7½ in., per carton of 18. White. \$5.80.

No. 700 Mum Vase, Height 13 in., Top Diam. 9½ in. White. Per carton of 12, \$5.80.

NOTE—No. 3, No. 4 and No. 5 Standard Jardiers are extensively used as "vases" for shortstemmed flowers.

Moist-Shur Plantray. Green rubber, unbreakable saucers. For all types of pot plants.

No. 1, takes up to 6" pot, retails at 40c, per dozen, \$2.50.

No. 2, takes up to 8" pot, retails at 70c, per dozen, \$4.80.

No. 3, takes up to 12" pot, retails at \$1.35, per dozen, \$9.60.



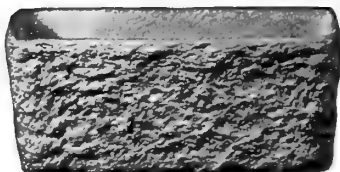

No. 4 Jardier Bulb Box

most practical method of carrying out the beautiful box idea. Jardier Boxes are self-aerating—same as Jardier Vases—stimulating plant growth.

No. 4—White. 12 in. long—4½ in. wide—4 in. deep. \$24.00 per 100—50 per carton.

Hyacinth Glasses (Vases). In crystal shade only. Per carton of 24 vases, \$4.00; 3 carton lots at \$3.70 per carton; 6 carton lots at \$3.60 per carton.



Galv. Vase

A GOOD VARIETY OF SIZES IN THESE FLOWER VASES

And they are built right. Galvanized, hand soldered, with wire reinforcement at the top—the sides tapering so that they nest. Attractively striped in red.



Hyacinth Glass

Style	Diameter		Ht.	Price per Doz.
	Top	Bot.		
253	4¾ in.	3½ in.	10 in.	\$11.40
255	6½ in.	5¼ in.	12 in.	13.00
257	6½ in.	5¼ in.	15 in.	16.00
65	7½ in.	6½ in.	8 in.	12.00
66	9 in.	7½ in.	10 in.	16.20
68	9 in.	7½ in.	12½ in.	18.00
68B	9 in.	7½ in.	15½ in.	19.20
69	9 in.	7½ in.	18 in.	21.00

Price Subject to Change.

BOWLS FOR GROWING BULBS

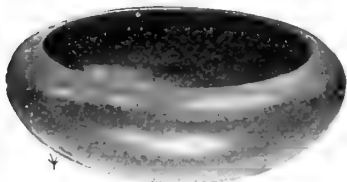

No. A. Pottery Bulb and Flower Bowl Assortment. This assortment consists of the following: 15 — 6-in. bowls; 15 — 7-in. bowls and 6—8-in. bowls. The assortment retails for about \$32.10 and comes in assorted colors of yellow, blue, old rose and white. Price per complete assortment, \$22.50.

F. L. Style Pottery Bowls, in Blue, Yellow, Old Rose and Green. 6-inch diam., dozen, \$6.60; 7-inch diam., dozen, \$7.80; 8½-inch diam., dozen, \$10.20.

Neva Clog Stapling Pliers. Can be used for stapling packages. Handy time saver, very economical. Price each, \$3.95; three for \$11.50. Staples A1000, ¼ inch and L1000, 9/32 inch, 35c per M, in 10,000 lots, 30c per M; in 25,000 lots, 27c per M.

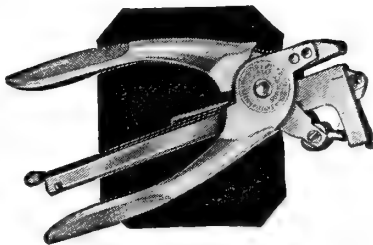

Flexible Rubber Coated Gloves. Made with new high tensile fabric construction and processed to provide the maximum in comfort, flexibility and wear. Coating is fully water and liquid proof. Oil and grease resistant. Provides complete hand protection against dirty, rough or harmful materials. Ideal for gardening and general work around the greenhouse, home or farm. Price per pair, \$1.00; per dozen pair, \$9.00.



Made of imported leather processed to make it pliable as kid and washable. An ideal glove for men and women gardeners. Will outwear six cotton gloves. Sizes for women: "Small," "Medium," "Large" — for

men: "Medium" and "Large." Per dozen pair, ladies' small, medium and large, \$13.20; men's medium and large, per doz. pair, \$14.40.



Green Thumb Gloves



New Bluettes Home and Garden Gloves

Green Thumb Gloves. New improved. Soft, washable for garden and house use, small, medium and large. Specify size when ordering. Price per pair, retail, 89c; per dozen, \$7.08.

New Bluettes Home and Garden Gloves. Neoprene coated elastic knit. Short fingers to fit every hand snug to the tips. Knit lining unlike old style rubber coated canvas gloves. In Small, Medium and Large sizes. Price pair, \$1.39, doz., \$11.00. Specify sizes when ordering.

Prices subject to change.

Bird Houses and Feeders



Bird Feeder

No. FS21. Garden Craft Feeding Station. This is one of the most successful bird feeders. It is equipped with a spindle for mounting, and the double weather vane keeps the sheltered end headed into the wind, thus keeping the food dry in rainy or snow weather. Size 24 x 12 x 12. Shipping weight, 16 pounds. Price, stained brown.....\$6.25
Price, stained, with glass back..... 8.20
Erection post bored for mounting rod..... 2.25



Feeding Station



Automatic Bird Feeders

Automatic Bird Feeders. (Patented). An economical feeder for all kinds of seeds, cracked corn or other small food. If filled with sunflower seeds it unfailingly attracts Cardinals, rose-breasted Grosbeaks, Finches and many other large as well as small pretty birds all year around. Birds enjoy swinging with the feeder. Ea. \$ 3.25
Six for 18.00

No. FS10. Garden Craft Bird Feeder. This cleverly constructed feeder will provide endless pleasure and satisfaction for bird lovers. Size 8x3x10 inches. Shipping weight, 3 pounds. Retail at \$2.70; 6 for \$10.80. Erection pole with arm. Retail at \$1.75; price, 3 for \$4.95.



Wren House No. 16

Wren House No. 16. The steps help nestlings to reach the exit, bottom removable for cleaning. Brown, each, \$1.75; six for \$9.60.

Blue Bird House No. 5. Like above, Brown, \$1.35; six for \$7.20.

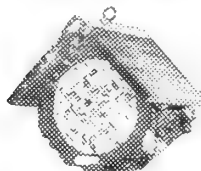

Suet Feeder

Community Diner. Aerial Picnic
Grounds for clinging and perching birds. No. CDD filled, each \$1.35; dozen \$13.00. No. CDE filled with 24 extra tid bits each, \$2.10; dozen \$21.00. Extra pkg. of 24 tidbits retail at \$1.35 per carton, 12 ctns. for \$10.80.

Hollow Log Suet Bird Feeder. Hollowed out of a natural tree log. Contains a large 12 oz. suet cake. Price complete, retails \$2.75 ea. Doz., \$19.80. Extra 12 oz. suet cake for feeder, retails ea. \$1.00. Doz., \$5.40.

Hollow Log Wren House. A natural haunt. Actually a hole in the tree. A small log smoothly hollowed out. Easily opened for cleaning. Bracket type, retails for \$2.00 each; per case of 18, \$21.60. Hanging type, slightly larger, retails for \$3.00 each. Per doz., \$21.60.



Wren House

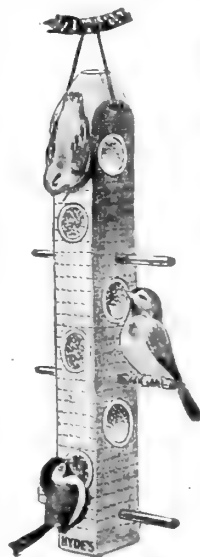

Community Diner

Except where specified otherwise items listed on this page will be shipped by exp., charges collect.



Robin Roost No. 4

Martin House No. X215. 20-compartment house, two stories high, unpainted, \$14.60. Painted two coats in white and green, \$18.00. **X315**—Twenty-eight compartment house, three stories high, unpainted, \$18.00. Painted two coats, white and green, \$21.00. Crating charge, \$1.50 extra. Erection Pole for Martin House, each, \$12.00.

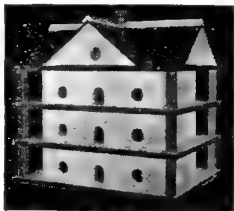

Martin House No. X215

Robin Roost No. 4. Robins will not occupy a nesting box, but insist on a covered sheltered shelf which allows them to see on at least three sides. Stained brown, each, \$1.95, six for \$10.80.

Hollow Log Blue Bird Houses. Bracket type, retails each \$2.75; doz., \$19.80. Hanging type. Retails each, \$4.00; doz., \$28.80.

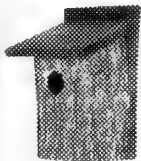

Blue Bird House

Ornamental Bird Bath. The ornamental frame is in wrought iron finish, the bowl has an aluminum finish. The bath stands about 30 inches above the ground and the bowl is 16 inches in diameter. A child or animal can hardly be hurt by the tipping of this light bird bath. It takes less than a minute to assemble. This bird bath weighs only 9 lbs. Retail \$4.95.

Price each\$ 3.75

Six for 20.40

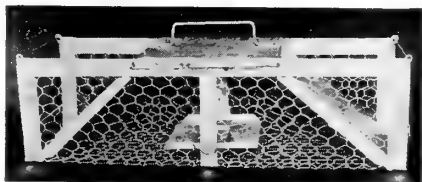
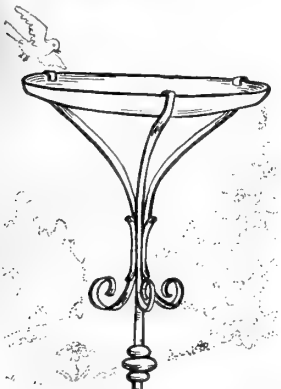

Havahart Animal Traps. No. 1—5x5x18 inches. For weasels, rats and chipmunks, each, \$2.50; 3 for \$7.00. No. 2—7x7x24 inches. For muskrats, minks, squirrels and rabbits. Each, \$3.35; 3 for \$9.00.



Gardex. Cultivator No. 713. Practical for small flower beds, between narrow rows, etc. 11 in. long. Packing wt. 1 doz. 5 lbs. Retail 50c ea.; doz., \$4.00.



Gardex. Culti-Weeder No. 714. A double purpose tool for cultivating and with weeding blade. 16 in. long. Packing wt., 1 doz. 6 lbs. Retail 60c ea.; doz., \$4.80.

Prices subject to change.

Garden Equipment and Supplies



Ross Root Feeder. Complete with 12 Ross nutrient cartridges. Retail complete for \$4.98. Price per dozen, \$35.90, six for \$18.60. Extra cartridges retail at \$1.00 per carton of 12. Price per dozen cartons, \$7.20.

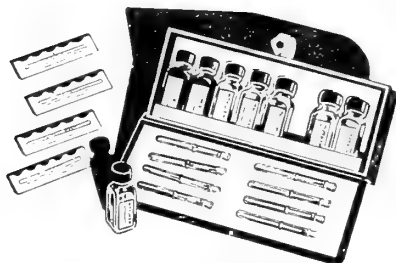

Sudbury Home Garden. Soil Test Kit. Tests for Nitrogen, Phosphorus, Potash and acidity in the soil. Each, \$2.15; six for \$12.12.

New Club Model Kit. An inexpensive kit for garden clubs, 4-H clubs, etc. A very good value for amateurs. Cased in attractive imitation leather, makes a wonderful gift. Each, \$4.10; 3 for \$11.76

Horticultural Size Kit. Contains enough material to make 60 individual tests. Retail at \$14.95, three for \$29.90.

De Luxe Professional Model will make 200 tests. Retail at \$29.95, three for \$59.90.

When ordering testing fluid for refills, it requires No. 2 and No. 3 to make Nitrogen Tests, No. 4 and No. 5 for Phosphorus Tests and No. 6 and No. 7 to make Potash Tests, therefore when ordering, please order two numbers as tests cannot be made unless they are used in combination as specified above. 2 oz. bottle retails for \$1.35; six for \$5.40. 6 oz. bottle retails for \$2.50; six for \$10.00.

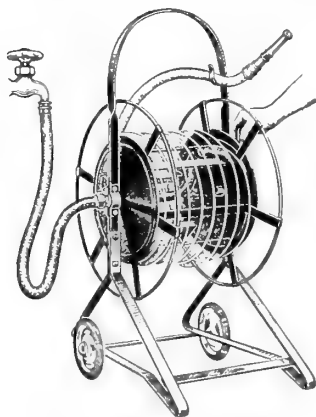

REAL REEL

The only portable reel permitting water to run through the reeled-up hose. Equipped with 5 ft. of accessory hose and connection to attach to hydrant as illustrated. Saves time and work. The hose does not need to be removed from the reel to connect it to the water current. Made of the best steel with rubber tire wheels, very durable. Price, retail each, \$14.95; \$10.00 ea.; 4 for \$38.00.

The New Crescent Hosnap Coupling.

Screwing of couplings and twisting of hose eliminated. This coupling operates by merely pushing in. It locks quickly. Can be removed simply by pushing down collar. Made of brass. Retail each at \$1.25; doz., \$10.50; 3 doz. lots, doz., \$10.00.



Lincoln Park or Butterfly. Cheapest and best sprinkler made. Retail \$1.25; dozen, \$10.00; three doz. for \$29.00. Mounted on stand. 2-foot retails at \$2.75; six for \$11.00; 4-foot retails for \$3.25; six for \$13.00; 6-foot retails for \$4.25; six for \$17.00.

Watering Pot. 2 quart home size. Pastel green with rose design, for watering house plants. Each, \$1.50; dozen, \$16.20.

Justrite Brass Hose Nozzle. For lawn and garden. Can be changed from fine spray to stream, $\frac{3}{4}$ in. retails for \$1.35; dozen, \$10.80.

Scollay's Famous Florists' Sprinkler. We are general western agents. None better for floral work. Beware of cheap imitations. Made of best quality of rubber and will out-wear any other sprinkler on the market. Large size, plain top, No. 1, 6 inches high, \$1.60; 3 for \$4.50; dozen, \$16.80.

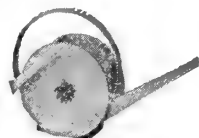

Ross No. 10 Hand Sprinkler. Preferred by nurserymen and home owners. Cap. 13 gals. per min. Do not compare with cheaper imitations. Retail, each, \$1.45. Per dozen, \$11.40.



Ross Square Spray Heads for Scientific Sprinkling. It sprinkles a square, making it easy for you to install your own underground system, at a very low cost. Threaded for $\frac{1}{2}$ in. pipe, capacity $3\frac{1}{4}$ gals. per minute. Has a slotted adjusting screw to control the area of the spray. 54A. Price, per dozen, \$6.60. 64A. $\frac{1}{2}$ or $\frac{1}{4}$ circle heads. Dozen, \$6.60.



ing screw to control the area of the spray. 54A. Price, per dozen, \$6.60. 64A. $\frac{1}{2}$ or $\frac{1}{4}$ circle heads. Dozen, \$6.60.

Rain King Sprinkler Model H. Chrome plated. Adjustable for coarse or medium shower. Can be used for revolving or stationary sprinkling by simply turning lock wheel. 11 $\frac{1}{4}$ in. tall; 9 $\frac{1}{4}$ in. from nozzle to nozzle. Retail \$7.65 ea. Price each, \$5.10; 12 for \$57.36. Shipping weight, 5 lbs. each.

Rain King Sprinkler Model K. Automatic, that you can set instantly to sprinkle any size circle 5 to 50 ft. by simply turning the button on top of the sprinkler. Retail \$8.50 ea. Price each, \$5.67; 12 for \$63.72. Shipping weight, 5 lbs. each.

Rain King Sprinkler Model D. Can be adjusted to operate slow or fast. Will operate on any water pressure. Retail \$5.95. Price each, \$3.97; 12 for \$44.64. Shipping weight, 4 lbs. each.

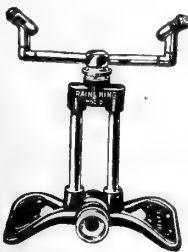



IRRIGATOR

NATURAIN PERFORATED PIPE

Made of durable aluminum and stainless steel. Each section 5 ft. long, weight less than a pound. Ordinary pressure will throw water 20 feet. Extra 5 ft. lengths can be connected with a twist of the wrist. Primary unit with hose connection, retails at \$2.95; per dozen, \$23.60; Secondary unit, retails at \$2.75; per dozen, \$22.00. With ordinary pressure five units can be used.

Ever Tight Hose Couplings. 3/4-inch, complete, dozen, \$7.80; 3 dozen, \$22.50.

Brass Clinching Hose Couplings. 3/4-inch, dozen, \$3.90; 3 dozen, \$10.80.

Brass Clinching Hose Menders. 3/4-inch, dozen, \$1.50; gross, \$16.00.

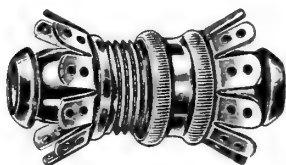

Brass Clinching Mender



Brass Clinching Coupling

Water Wand. Watering shrubs, flowers and trees is a simple job with Waterwand; no danger of washing away the rich top soil. Retails each, \$4.00; per dozen, \$28.80.



Use Erosionet for New Lawns, Weak Lawns and Stubborn Terraces. Made of strong, open mesh fabric. Will hold your seed and sod firmly in place. Prevents washouts, does not present an unsightly appearance, grass and clover soon rendering it almost invisible. Can be removed when grass becomes 2 1/2 inches high. Width, 45 inches. Price per yard, 23c; 25 yard lots, 21c per yard; 100 yard lots, 19 1/2c per yard; rolls of 250 yards, 18 1/2c per yard.



Soil Soaker. Irrigation hose for deep soaking. No. 0, 12 foot, each, \$1.20; 6 for \$6.48. No. 1, 18 feet, each, \$1.55; 6 for \$8.64. No. 2, 30 feet, each, \$2.35; 6 for \$13.32. No. 3, 50 feet, each, \$3.75; 6 for \$21.60.

Hothouse Sprinkler. All brass, distributes water evenly; 3/4 inch connection; 3-inch face retails at \$1.00; 12 for \$8.00; 4-inch face retails at \$1.30; 12 for \$10.40



Telespray. Sprinkler that works like a telescope. Attach hose, turn on water, and it extends to a sprinkling system 24 feet long. By varying water pressure you control coverage from a 6-inch strip to a 40-foot width. Made of aluminum alloy, it won't rust, needs no maintenance, has no moving parts, weighs only 2¼ lbs. Retail price \$14.95. Three for \$29.90.

Junior model in 3-foot unit—extends to 12 feet. Material and operation exactly the same as regular model. Retail price \$9.95. Three for \$19.90.

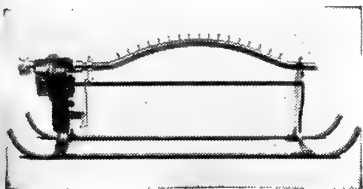

Avon Lawn and Garden Sprinkler Model

No. 950. This type sprinkler is highly recommended by expert landscapers and nursery men. Its unique principle of oscillating back and forth enables one side of area covered to absorb while the other side is being irrigated. This principle prevents wash out or uneven distribution. Size 21"x6½"x7", mounted on sled-like frame that moves with ease by pulling hose to change

its position. Covers about 1500 sq. ft. or more depending on water pressure, in a rectangular area 30 ft. on either side and 30 ft. in width. Price each, \$10.35; 6 for \$59.80.

Metco Wave Sprinklers. Wave type.

Model J retails at \$10.95 each, 3 for \$22.90, 6 for \$35.82. Model M retails at \$12.95 each, 3 for \$25.90, 6 for \$46.62.

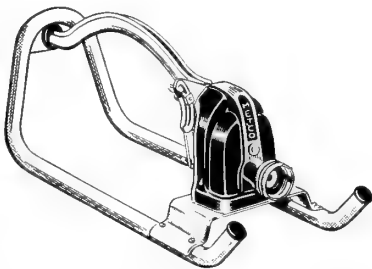

Swan Double Braid Green Garden Hose

No. 127. Full ½ inch. This hose is guaranteed for 15 years. Has smooth, tough inner tube and 2 braids of heavy rayon cords. A beautiful green cover of wear resisting Neoprene, equipped with nickel plated maxivolume coupling. Will not burst under 800 lb. water pressure. 50 ft. only weighs 16 lbs. Easy to handle. Price per 25 ft. length, each \$4.60; pkg. lot of 5 lengths for \$20.90. Per 50 ft. length coupled, \$8.58; pkg. lot of 5 lengths \$39.00.

Swan Black Single Braid Hose No. 705. Full ½ inch. Same construction as above.

Guaranteed for 5 years. 50 ft. length weighs 14 lbs. Price per 25 ft. length each \$3.46; pkg. lot of 5 lengths \$15.75. Price per 50 ft. length coupled, \$6.38; pkg. lot of 5 lengths \$29.00.

Swanite Reinforced Plastic Garden Hose. Single Braid No. 867. $\frac{5}{8}$ inch green, light-weight. Does not kink, fade, crack or rot or sun-check; with full nickel-plated, maxivolume coupling. Will withstand highest pressure. Guaranteed for five years. Price per 25 ft. length each \$4.40; pkg. lot of 5 lengths \$20.00. Price per 50 ft. length, \$8.03; pkg. lot of 5 lengths, \$36.50.

Rubber Garden Hose. $\frac{5}{8}$ inch, single braid, coupled, 50 ft. length, price \$6.95; $\frac{3}{4}$ inch, double braid, coupled, 50 ft. length, price \$13.50.



Hose, Garden. Non-Kinkable, $\frac{3}{4}$ in., 50 foot lengths, coupled, \$9.75; six for \$55.25.

Special Garden Hose. $\frac{5}{8}$ inch, 50 foot lengths, \$5.75; six for \$33.00.



Clemson Lawn Mower



Grass Catcher

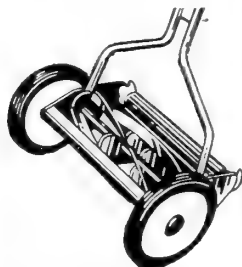

Heineke Hand Mower

Heineke Hand Mower. Smooth operating; trouble free. 16" cutting width; 10" wheels; rubber tires and rubber roller; approximate shipping weight 37 lbs. Trimmed in colorful red and cream. A superior product backed by over 45 years experience. Retail at \$21.00; each, \$15.50; three for \$45.00.

American Bent Grass Mower. 16 in., 7 blade, ball bearing, 10 in. wheels, semi-pneumatic tires, price each, \$19.75; three for \$57.00.

Clemson Lawn Mower No. E17. Finger-tip adjustment. Cutting height changed in a second. Large semi-pneumatic wheels insuring easier operation. Full 17" cut. Ruggedly built yet only weighs 35 pounds complete. Tubular handles. Retail at \$33.95; each, \$23.95; in lots of three, each \$23.50; in lots of six, each \$23.00.

Grass Catcher. No. HS-231. Durable canvas kid grass catcher with solid aluminum bottoms. Has a sturdy bottom brace to practically eliminate wear and tear of bottoms. Also adds to catcher's overall strength. Adjustable to fit all hand mowers from 12 to 18 inch widths. Retail at \$2.85; each, \$2.25; six for \$11.40.

Power Mower Grass Catchers. Model No. 1, 22 inches wide, 15 inches deep. Sturdy wire frame, aluminum bottom with carrying handle. Has effective built-in instant attaching spring hooks. Holds firmly in place on mower. Fits all power mowers where maximum outside dimension is from 17 inches to 21 inches wide. Retail at \$3.75, price each, \$2.85; three for \$8.25. Model No. 2 fits all mowers 18 inches to 24 inches wide. Same construction as above, retail at \$4.25, price each, \$3.10; three for \$8.50.

Prices subject to change.



PAT. PENDING

picking up things strewn around a lawn. Can also be used for picking up apples, pears and vegetables on the ground. Price each, \$2.00, postpaid, dozen, \$16.00.

Excello 24-in. Lawn Sweeper. Save time and energy, eliminate tedious raking. Let the quiet Excello lawn Sweep gently sweep leaves, grass clippings, small twigs, and paper from your lawn and driveway into a canvas basket with easy action. Width 24 in. All castings of special aluminum alloy. Strong, durable and rust-proof. Semi-pneumatic tires. Brush unit mounted on self-adjusting chrome steel bearings. Aluminum alloy caster wheels provide ease of operation. Shipping weight 55 lbs. Price each, \$34.00.

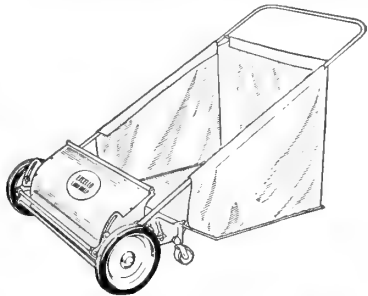

Water-Weight Lawn Roller Dunham With Oilite Bearings. Water ballast lawn rollers, steel handles, plain bearings, acetylene welded drums with anti-turf-tearing tires, non-rust shut water entrance. The most efficient and easiest running roller made. Weighs 50% more when filled with sand. Water is more convenient.

No.	Dia.	Length	Sections	Filled Water	Price
1	12½ in.	18 in.		100 lbs.	\$ 7.50
2	14 in.	24 in.	1	160 lbs.	11.60
4	18 in.	24 in.	1	220 lbs.	13.50
7	24 in.	24 in.	1	400 lbs.	18.00

Prices subject to change without notice.

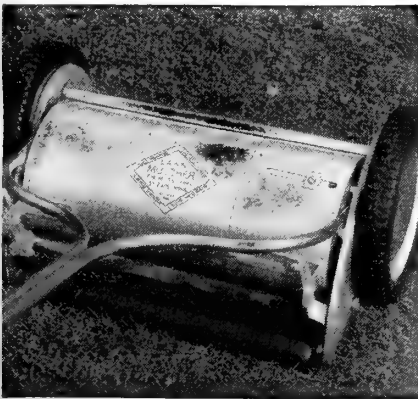

The Lawne-Mulcher. Is easily attached to standard hand mower. Returns the cuttings to the soil as a mulch. Grass is ground to a fine pulp, practically disappears. No grass catcher is required, no raking necessary. Lightweight, weighs less than 4 lbs. Made of aluminum, rust-proof. Price each, \$4.85; 3 for \$13.90.

Carborundum Brand home and garden sharpening stone for knives, shears, scythes, etc. Dozen, \$7.80.

Prices subject to change.

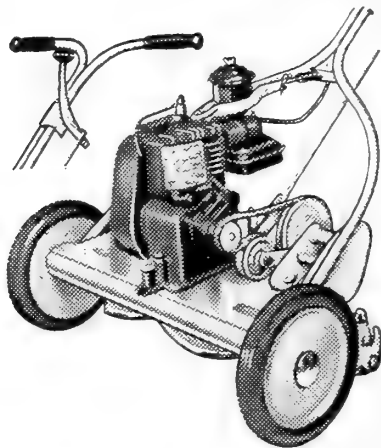

Heineke Excello Power Lawn Mowers. Long-lasting, sturdy construction for maximum performance . . . for the average size lawns. Stepped up power with Briggs and Stratton 1.1 H.P. air cooled 4 cycle engine. Light weight, easy to operate, positive clutch action, semi-pneumatic tires, all steel construction. Shipping weight 130 lbs. 18", each \$81.85; 21", with 1.6 H.P. engine, shipping weight 140 lbs., price each, \$92.80. 24" with 2 H.P. engine, with double traction rubber tire wheels, shipping weight 180 lbs., price each \$142.30. Write us for pamphlets on these high grade power mowers.

Kaufman Electric Grass Trimmer. Trims around walks, driveways, borders, trees, shrubs, stones, posts, fences, buildings, steep terraces, etc. Trims in minutes, not hours. Balanced weight; easy to handle. Retail at \$46.70. Three for \$93.40.



Huffy Rotary Mowers. With latest improved features. Extension on handle helps to keep cord away from mower. Easier to manage. Quiet. Better way to mow lawns. Push the button and you are on your way effortlessly. Four razor-sharp blades are free-swinging; retract if obstacle is hit, preventing damage. Flip-over handle helps you mow in either direction without turning mower. Write for descriptive leaflet.

Model 52-16 in. $\frac{1}{8}$ H.P. electric, \$43.69 each.

Model 52-18 in. $\frac{1}{8}$ H.P. electric, \$48.48 each.

Model 52-16PP, gasoline engine, \$64.31 each.

Model 52-18PP, gasoline engine, \$72.56 each.





Aluminum Garden Trowel. Made of all aluminum. One piece, heavy duty trowel. Retails each, 65c; per dozen, \$4.80.

Standard Garden Trowel. Full polished with hardwood handle and riveted blade. Retails each 50c; doz., \$3.80.

Melco Polished Featherlight Garden Set. Retails per set of 3 for \$3.95; 6 sets for \$15.80.



Velvet Grip. No Blister trowel. Made of cast aluminum. First trowel improvement in generations. Retails at \$1.25 each, Per dozen \$10.00.



Clyde Draw Cut Pruner No. 5402. 24-inch long handle, each, \$5.25; three for \$15.45.

Buckeye Pruner. 20 inch handle, \$3.00; dozen, \$33.00; 24 inch handle, \$3.25; dozen, \$36.00.

DOO-KLIP GRASS SHEARS

Long handle grass shear; does perfect trimming. Has only one handle. No extra levers to operate. The blades are made of case hardened, rust resisting steel. Easily opened for sharpening by removing one nut. Retails at \$3.85; six for \$14.00; doz., \$27.00.

DOO-KLIP GRASS SHEAR STANDARD

With offset handle with electroplated serrated blades. Retails at \$2.15. Per dozen, \$15.12.

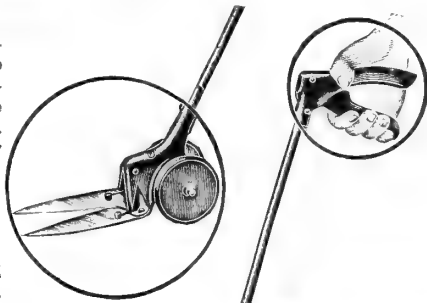

PORTER TWINCUT PROFESSIONAL ONE-HAND PRUNER

This pruner is drop forged from selected tool steel. The patented pivot bolt cannot tighten or loosen in use, yet can be easily adjusted. Equipped with new concealed locking device. Instantly locks or unlocks the closed tool with the touch of the thumb. 9 inches, full polish, price, each, \$4.95; dozen, \$56.40.





Hedge Shears. 8-inch, each \$2.50; 6 for \$10.50.

Village Blacksmith Aristocrat Hedge Shear. The hardwood handles are lacquered to a bright finish. They are riveted to a full width tang with three over-size double strength rivets. The handles cannot loosen. The lower blade is serrated to hold branches in place. Tempered tool steel blade, 8". Retails at \$3.50 each; 6 for \$15.00.

Imported Pruning Shear. Finest quality, 8½ in. Full polished with ratchet and lock nut. Retails at \$2.50 each; price per dozen, \$18.00.

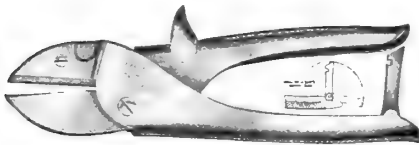
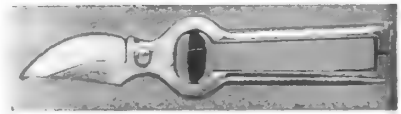
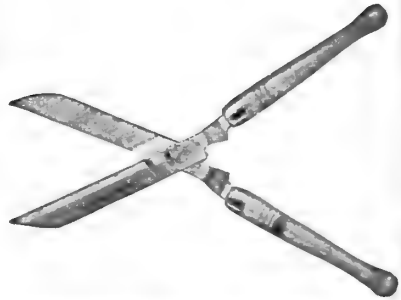

Snap Cut Pruner. Heavy duty, full polished. Retails each, \$2.75; per dozen, \$22.00.

Henckel Imported Pruning Shears. Highest quality. 8½ inch full polished with replaceable coil spring. Each, \$3.75; doz., \$39.00; 9½ inch, each, \$4.95; doz., \$49.20.



Henry No. 4773 American Rieser Pattern (Professional Pattern) Pruning Shear.

Full polished. Best quality. Oval bevel, steel plated, hardened and tempered. Double flat brass spring



with ratchet lock and Henry spring catch. Retails at \$3.95 each, \$2.75; 6 for \$15.80.

Henry No. 4750 Pruning Shear. An efficient California type pruning shear with ratchet, lock, nut, volute spring. Maroon enameled infra red baked malleable handles, 9-inch. Has spring



catch. Retails at \$2.00; per dozen, \$16.00.



Trimmer, California Pole. Curved, draw-cut saw with crook for removing branches. Retails at \$3.25 each; six for \$13.00.

Saws Double-Edged Pruning. 18 in. Retails at \$1.95 each; doz., \$16.00.





Henry Pruning Shear Assortment No. 48-60. 2½ dozen fast selling numbers, made up of six different styles, including attractive counter display to hold one of each style. This set retails for \$60.93. Price per set, \$40.62. Kit consists of 2½ dozen top quality shears, assorted over six styles, including colorful box to display one of each style.

Henry Flower Picker No. 711. Cuts flower and holds it. Saves hands from scratches and thorns. Red enameled handle, nickel plated blades. Length overall 6¾ inches. Retail at \$1.50 each, price per dozen, \$12.00.

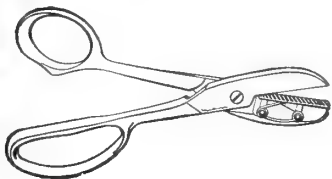

Tree Protector, Pruning Paint and Tree Wound Dressing. Acts as a balm and repellent against gnawing animals. Price, pints per dozen \$6.00, quarts per dozen \$10.80, gallons per carton of 3, \$6.00.

Fine Tar. Dixie quality. For painting shrubs and trees after pruning. Price, pints \$3.80 per dozen, quarts \$6.60 per dozen.

Tree Pruner. Standard, 6-foot each, \$2.65, doz., \$30.00; 8-foot pole, \$2.95, doz., \$33.20; 10-foot pole, \$3.35, doz., \$37.80; 12-foot pole, \$3.75, doz., \$42.60. Extra blades, dozen, \$2.60; each, 25c.



Grass Whip. Made of highest quality steel. Retail ea., \$2.15; doz., \$17.20.



Forester Steel Long Handled Brush Pruners. No. 2—27 inch. Retail at \$9.40. Each, \$7.00, three for \$18.80; No. 3—34 inch. Retail at \$11.20. Each, \$8.40; three for \$22.40.

Porter Point Cut Pruners, 20 inch. Retail at \$8.40. Each, \$6.30; three for \$16.80; six for \$30.00.

English Unity Garden Tools

A complete line of hand garden tools, made in Sheffield, England, of Sheffield steel, by one of the oldest garden tool manufacturers in England, whose long experience both in manufacturing and gardening makes these tools outstanding.



No. F-20. Handy for weeding in Garden or Lawn. Has 4 twisted Sheffield steel prongs and short polished hardwood handle. Slides right into the earth and brings the weeds out Roots and all.

DOZEN \$5.75. RETAILS for \$.75 each.

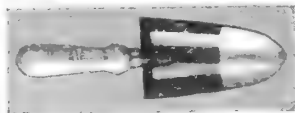

No. T-15 Trowel. One of the finest trowels made, with blade 5½" long and 3" across of Sheffield steel with hardwood polished handle. Blade is fully curved to hold soil. The handle is so set that you never scrape your knuckles.

DOZEN \$4.00. RETAILS for \$.50 each.



No. F-11. Weeds with a 14" polished hardwood handle for getting under Bushes, Hedges, Trellises and other hard places.

DOZEN \$6.90. RETAILS for \$.90 each.



No. T-16 Trowel. With long handle to reach the hard to get at places without getting on your knees.

DOZEN \$5.20. RETAILS for \$.65 each.



No. F-27. Cultivating fork with 3 flat, heavy Sheffield steel prongs. Solid shank which fits 2 inches over the handle.

DOZEN \$5.75 RETAILS for \$.75 ea.



No. T-13 Trowel. Flat stamped from one piece of heavy gauge Sheffield steel, long shank with short hardwood polished handle.

DOZEN \$4.40. RETAILS for \$.55 each.

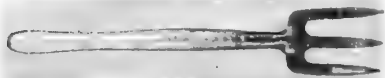

No. F-28. Cultivating fork, with 14" polished hardwood handle for places hard to reach.

DOZEN \$6.90. RETAILS for \$.90 ea.

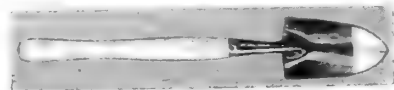

No. T-6 Trowel. With 14" hardwood polished handle for easy reaching.

DOZEN \$5.20. RETAILS for \$.65 each.



No. H-6 Solid Sheffield steel Dutch Hoe Heads—an old time favorite that holds its popularity with professional gardeners.

4" Doz. \$10.00. RETAILS for \$1.25 each.

5" Doz. 10.40. RETAILS for 1.30 each.

6" Doz. 10.80. RETAILS for 1.35 each.

8" Doz. 14.00. RETAILS for 1.75 each.



No. 581-Spading Fork. A man's tool, with tines $\frac{5}{8}$ " wide 12" long, $10\frac{1}{2}$ " double strap front and back with 2 Rivets completely through the handle. A professional fork for professional gardeners. Tines of Sheffield Steel with real ash handle.

DOZEN \$29.00. RETAILS for \$3.65 each.

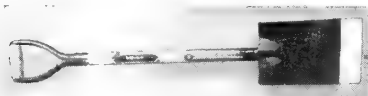

No. 535-Spade. For all kind of spading, light or heavy. Spade is 7" across and $11\frac{1}{2}$ " long of Sheffield steel with heavy ash handle. Long one piece straps front and back riveted through the handle.

DOZEN \$26.45. RETAILS for \$3.35 ea.



No. 577-Lady's Spading Fork. Weight less than 3 lbs. Tines $\frac{1}{4}$ -inch square, for easy sliding through all types of soil. Fork is $5\frac{1}{2}$ " x 9" of fine Sheffield steel with genuine ash handle, with 2 long straps riveted through the handle.

DOZEN \$26.45. RETAILS for \$3.35 each.



No. 529-Lady's Spade. A companion to the #577 fork, as a lightweight tool strong enough to withstand plenty of abuse. Spade is $5\frac{1}{2}$ x 9" Double straps $8\frac{1}{2}$ " long riveted in 2 places for extra strength.

DOZEN \$26.45. RETAILS for \$3.35 ea.

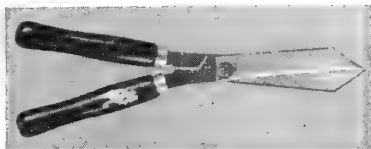

No. S-6 Lady's Hedge Shear. It has 6" blades with black polished hardwood handle. Blade is hardened Sheffield steel with keen and durable cutting edges. Can be used for trimming arborvitae, spruce, yew, and many other evergreens.

DOZEN \$14.00. RETAILS for \$1.75 each.



No. S-10 Hedge Shear. This has 8" notched blades of medium weight with hardwood polished handles. Hardened Sheffield steel blades with keen and durable cutting edges hold their sharpness for a long time.

DOZEN \$20.80. RETAILS for \$2.60 each.



No. S-30 Hedge Shear. This has 10" notched blades with ferrules pinned right through. Polished hardwood handles, hardened Sheffield steel blades. A tough shear for all type of cutting.

DOZEN \$36.00. RETAILS for \$4.50 each.



Village Blacksmith Grass Hook No. 6.
Made of high quality steel. Retail at
\$1.00 each; per dozen, \$8.00.

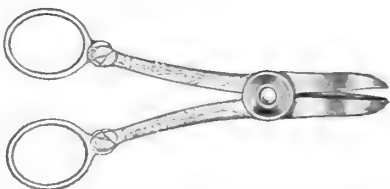

**Clauss Garden Club Rose and Flower
Holder Shear.** Cuts and holds flower
stems in one quick motion. Retail at
\$3.00 each; per dozen, \$24.00.

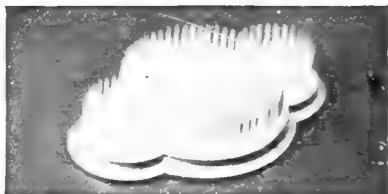
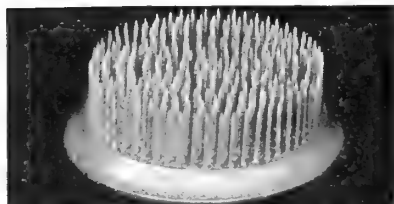

Pin Flower Holders. Solid Brass Needle pointed nails. Closely cast in heavy lead
alloy base. Guaranteed not to rust. Sprayed with aluminum metallic paint.

No.	Size of Base Round Style	Price Per Doz.	Three-in-one Oval Style	Price per doz.
25-R	1 $\frac{3}{4}$ "	\$2.25	60-O	\$ 5.40
40-R	2 $\frac{3}{8}$ "	4.00	75-O	7.00
50-R	2 $\frac{5}{8}$ "	4.80	150-O	12.60
80-R	3"	7.20		
100-R	3 $\frac{1}{2}$ "	8.40		

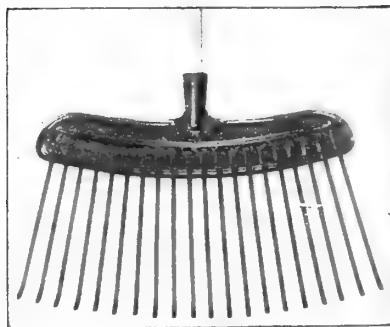

LAWN RAKE

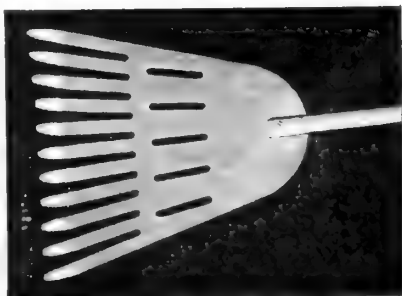

ALUMINUM BROOM RAKE

Lawn Rake. Durably made of 20 genuine spring steel tines. Handle measures 47
in., over all length 58 in. Packed 12 to a bundle. Price per doz., \$10.20.

Aluminum Broom Rake. New and different, thoroughly tested. Width of blade at
tines 12 $\frac{7}{8}$ ". Shipping weight 15 lbs. per dozen. Price per dozen, \$6.00; 3 dozen
for \$17 40.

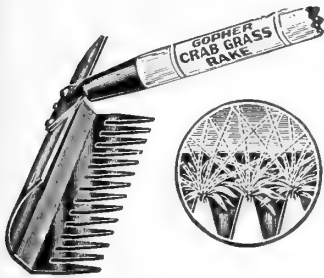

Crab Grass Rake

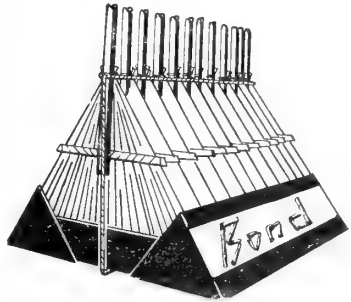

Improved Bamboo Rake

Gopher Crabb Grass Rake. Retail at \$1.75 each; six for \$7.00.

New Improved Bamboo Rake. Sturdy construction. Model 81 standard, 18 in. spread with 33 tines, galvanized wire bound and 48 in. Douglas fir

handle. Weight per dozen, 13 lbs. packed. Price per dozen \$6.60.

Model 79. Giant 24 in. spread with 26 tines, copper wire bound and 48 in. Douglas fir handle. Price per dozen, \$9.60.



Gardex. Midget Rake No. 715. 5 curved teeth. Overall length 12½ in. Packing wt., 1 doz. 5 lb. Retail 60c ea.; doz., \$4.80.

Lon-Groom Lawn Edger, No. 44. This edger cuts a clean line along the edge of the sidewalk and not a groove. Retail at \$1.65; dealer price, \$13.20 per dozen; 4 dozen lots at \$12.60.

Flexible Striking Lawn Mower Blade. No grinding, no sharpening necessary. Flexible striking blade is made of the finest steel and heat treated for that purpose. Being flexible it will always be in contact with the revolving blades of the "lawn-mower," thus assuring cutting at all times, "when properly installed." Does a nice clean cutting job without any effort. Will cut wet grass just as nice as dry grass. Made in 14", 16", 18" and 20". Specify size when ordering. Price per doz., \$15.00.

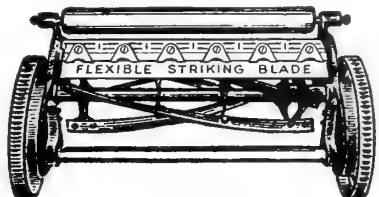

GEORGE TRACTOR MODEL L.G.

Large 16 inch wheel with 6 inch wide tread pulls through everything. Ample power for all attachments. A ruggedly built, quality tractor. 50-lb. wheel.

2 H.P. Briggs & Stratton engine. Belt type, rope starter, weight 125 lbs. Retail at \$107.50, each \$86.00.

Cultivator, \$11.50.

Hitch for attaching any 16 inch or 18 inch hand mower, each, \$3.60.

24 inch Sickle Bar mower, each, \$31.75.

Snow Plow Blade, 25-inch, each \$8.50.

2 inch Power take off pulley 50c.

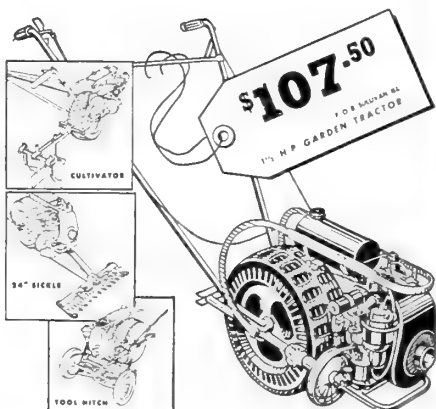

Flower Tubs "Richmond Style." These are made of finest fir lumber, securely bound with welded wire hoops. They are nicely painted green, paint of best oils. Florists will find them ready sellers where a substantial yet attractive tub of moderate price is required. Prices F.O.B. Chicago. Prices subject to change without notice.



Inside Top Diameter	Depth Inside	Price Each	Per Dozen
7 in.....	6 in.	\$1.10	\$12.00
8 in.....	8 in.	1.20	13.20
10 in.....	9 in.	1.55	17.40
12 in.....	11 in.	2.10	23.40
14 in.....	13 in.	2.85	33.00
16 in.....	15 in.	3.50	39.50

Beautiful California Plantubs made of Redwood. For utility and beauty in any garden, impregnated with linseed oil to preserve natural beauty of wood. Rounded top and bottom edges to prevent splintering. Made of well seasoned California redwood. Bound with brass bands. Ventilation under tub. Grooved handles.

Size	Price
No. 1—12 in.....	\$3.35 ea. 6 for \$16.20
No. 2—14 in.....	4.50 ea. 6 for 24.00
No. 3—16 in.....	6.00 ea. 6 for 29.20
No. 4—18 in.....	6.45 ea. 6 for 31.80
No. 5—20 in.....	6.75 ea. 6 for 34.80

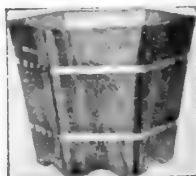



Exotic New Flower Beauty Bowl. Bowls are blown glass. The refractive qualities of the water with which these Beauty Bowls are filled, gives them a sparkle duplicated only in solid crystal globes. This makes the vivid colors of the flowers come to life, and since they are artificial, they never fade, nor does the water need changing. Bowls are 3 in. in diameter and stand 4½ in. high. These retail at \$1.00 ea. Price per carton of 12 assorted flowers is \$7.20. Shipping weight per carton of 12, 3 lbs.



Plant Fountain Sprinkler. For sprinkling seedlings, plants and clothes. 8 oz. capacity. Retail for \$1.50 each; doz., \$10.80.

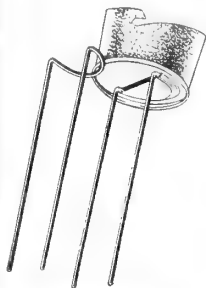

Flat Bottom Cemetery Vase No. 2A. Detachable stem. Packed 3 doz. to carton. Price per carton, \$4.80, gross, \$18.00. Weight per carton, 11 lbs.

Cone Shaped Cemetery Vase No. 4. 9½ in. deep, 5 in. in diameter at top. Stem or spike is 3 in. long, made of No. 9 gauge steel. Packed 3 doz. to carton. Price per carton, \$4.80; per gross, \$18.00. Weight per carton, 12 lbs.

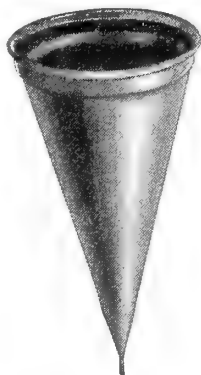

Wick-Fed Plastic Pots. 4 inch diameter in following shades—ivory, yellow, red and pink with black base. Retail each at \$1.00; per dozen, \$7.20. 5 inch retail at \$1.50; per dozen \$10.80.



WEEDERS—Best of All the Leaders Johnson Weeder. A sturdy hand weeder, blade is detachable. Price per dozen, \$4.80, gross, \$45.00; extra blades, dozen, \$1.60.



Weed Digger

Retails each, 75c; per dozen, \$6.00.



Lang's Weeder

Per dozen, \$2.80; per gross, \$32.40.
Retails each, 35c.

Fertilizer Spreaders



Salem Improved Fertilizer Spreaders. Will spread any kind of commercial fertilizer, grass seed or top dressing. Has new disc wheels, foot rest and selective feed control. 16 inch, hopper capacity about 20 lbs. Retail at \$7.50. Price each, \$5.35. Three for \$15.75. 20 inch, hopper capacity about 40 lbs. Retail at \$11.50. Price each, \$8.25. Three for \$24.15. 30 inch, hopper capacity about 80 lbs. Retail at \$17.50. Price each, \$12.45. Three for \$36.75. Super Heavy 36 inch, hopper capacity over 100 lbs. Retail at \$35.50. Price each, \$24.85.

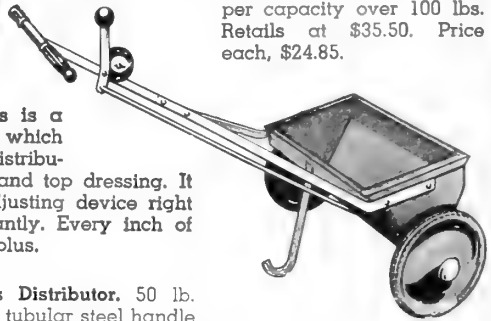

Masters Perfect Distributors. This is a sturdy and efficient machine which solves the problem of even distribution of fertilizers, grass seed and top dressing. It has a shut-off control and adjusting device right on the handle. Shuts off instantly. Every inch of ground is covered, but no surplus.

Heavy Duty Model 30 Masters Distributor. 50 lb. capacity, all steel construction, tubular steel handle with two bicycle type rubber grips. Rubber tires. Finest home lawn spreader. Retail at \$12.95, price each, \$8.75, 3 for \$25.80.

No. 25D. New Deluxe Model. 20 lb. capacity with tubular handle rubber grips and rubber tires. Retail at \$10.25; each, \$7.25; three for \$20.00.

Model M241, with steel wheels, 24", retail at \$33.95, price each, \$23.50; 3 for \$67.90.

Model 241D, with rubber tires, retail at \$41.50; each, \$28.00.

Model M361S, 36", retail at \$47.25; price each, \$31.75.

Model M361D, 36", with rubber tires, retail at \$53.25; price each, \$36.00.

Model M361SD, stainless steel agitator and bottom—semi-pneumatic tires. Retail each \$63.95; price each, \$43.50.

Masters Handi-Cart. Replaces the old-fashioned wheelbarrow for every purpose. Garden work really becomes a pleasure. **Just dip it down and rake** grass cuttings, leaves, earth or gravel in the cart. Can also mix cement right in the cart. No. 18-S, size of wheels 10 in. diameter. Extreme overall width of cart 20 in. Size of hopper body 26½x16x12½ in. Retail at \$10.50. Price each, \$7.50. Three for \$21.00.



No. 20-D, new deluxe model with heavy tubular handle and rubber grips. Extreme overall width of cart 25 in. Size of hopper body 27½x21x13½ in. Retail for \$15.25. Price each, \$10.50; three for \$30.50.

Sunbeam Model A1 Electric Hedge Trimmer. A superior hedge trimmer, built and powered to do long tedious trimming jobs required of a professional gardener. Light in weight, sturdy construction, equipped with 10 ft. of cord and plug. Price each, \$31.43. Three for \$88.86. Extra cord, 50 ft., \$3.15; 75 ft., \$4.38; 100 ft., \$5.78.

**Bonham
Garden
Cultivator**

Makes gardening a pleasure. Complete with cultivator teeth, plow and furrower. All metal parts are dipped in weather-proof and rust resistant paint. Price each, \$3.25; six for \$16.80.

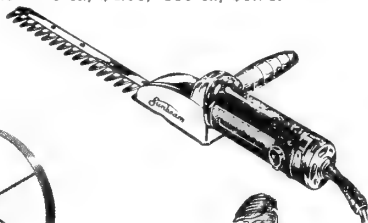

Flame Sprayer Weed Burner. Dobbin's 4-gallon heavy all-welded (not riveted or soldered) corrugated fuel and air tank tested to 100 lbs.; burns kerosene, range oil, stove or light furnace oil. Price complete, \$17.60; three for \$51.75 (weight 17 lbs.).

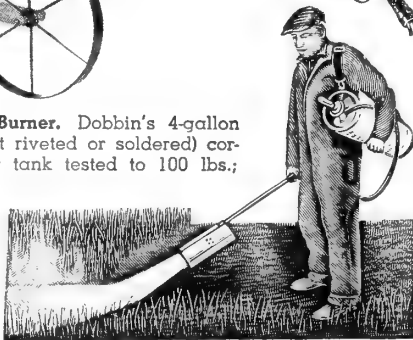

New Hoseless, Completely Portable Flame Thrower. Weighs only 10 lbs. Performs in any position, up or down. Burns kerosene or fuel oil. Retails each, \$18.00, 3 for \$36.00.

**Saxolin Duplex Crinkled
Waterproof Tree
Wrap.** 4 inch width,
per roll, 65c; master
roll of 10, \$6.00; three
rolls for \$17.40.

Wire Fruit Picker. A
mechanical apple and
fruit picker, so simple
children can pick fruit
with no danger. With-
out pole, price, retails
at 85c; doz., \$6.60.



Garden and Farm Tools

SEEDERS

Cyclone, Retail ea.....	\$ 3.25
New Handy Seeder, each.....	.60
Dozen	6.00
Three Dozen	17.70

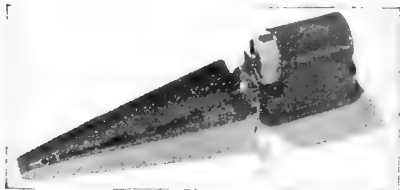

New Handy

Vibra-Seeder. A battery operated flower and vegetable seeder for commercial and home gardeners—fits palm of hand—will sow row or flat in fraction of time normally required. Operating cost one flashlight battery per season. A real time, labor and seed saver. Retail at \$2.25; six for \$9.00; doz., \$16.80.



Hotkaps

New Method of Plant Protection

trial pkg. of 250 with fibreboard setter, \$4.95; 1000 for \$16.50; in lots of 5,000, \$16.35 per M.; in lots of 10,000, \$16.25 per M. Write for price on larger quantities. Fibreboard setters, doz., \$1.85.

Hotkaps. New method of plant protection. 25 garden pkg. complete with fibreboard setter, each 75c; 12 pkgs. for \$8.20. 100 home pkg. with fibreboard setter, \$2.60; 6 pkgs. for \$15.00; \$4.95; 1000 for \$16.50; in lots of 5,000, \$16.35 per M.; in lots of 10,000, \$16.25 per M. Write for price on larger quantities.

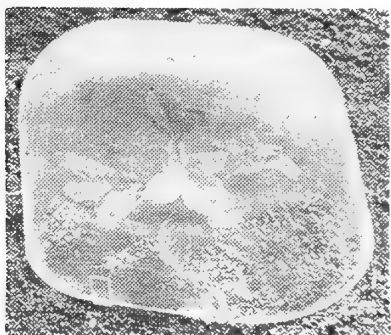

Plastex Hothouse. Life-long plastic plant protectors. Far superior to paper plant protectors. Moulded of polystyrene, fully transparent and unbreakable. Resists wind, maintains moist atmosphere, prevents burning from high temperatures. Carton of 12, \$2.52; carton of 50, \$9.95.

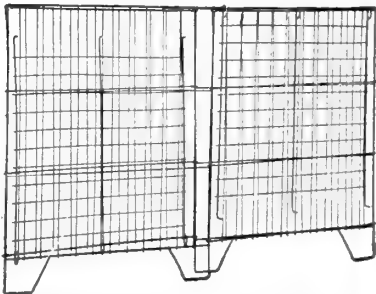

Foldaway Incinerator. All welded construction, painted green enamel. Ideal for burning leaves, paper, etc. Folds away flat. Height 24½ inches, depth 18½ inches, width 18½ inches. There are four sides, plus top and bottom, to insure that material burned in this incinerator cannot be carried away by the wind, to constitute a fire hazard. When folded flat, the entire incinerator measures 37x24x1¼ inches and can be stored in small space until needed again. Retail price each, \$2.65; per carton of 12, \$21.60.

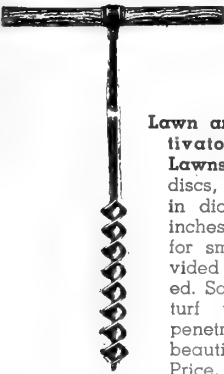

Greenlee Earth Auger. Especially adaptable for drilling holes for feeding fertilizer to trees and Evergreens. 2 inch diameter, length 40 in. Each, \$4.25. Three for \$11.50.

Lawn and Green Cultivator For Home Lawns. No. 8T, 8 discs, each 10 inches in diameter, rolling width 16 inches. Net weight 32 lbs. Ideal for small lawns. Tray is provided so weight may be added. Soil aeration is essential to turf upkeep. Permits water penetration. Lawns can be kept beautiful during dry hot spells. Price, each, \$10.75.



No. 30, 19 discs, each 10 inches in diameter, rolling width 18 inches. Net weight 100 lbs. Price each, \$33.00.



Bulb and Plant Setter. Small hand tool for cultivated soil. Each, 75c, per dozen, \$7.60. Long Handle Tool, \$4.75 ea.

Rowe'l-Ezy. Instead of shears to clip the grass near walks, beds, borders and other edges which lawn mowers cannot reach, Rowe'l-Ezy (roll easy) will do it faster and better. One turn of the rubber tired driving wheel is equal to 16 snips with the shears in your weary hand. It works forward and backward, on your left or right, and where lawn is above or below a walk. It will save you hours of the most tedious lawn task. Retail each, \$4.95. Six for \$19.80.



Reflecto Figures. Low priced reflecting house numbers. This silent salesman with 120-3 inch numerals complete in display stand at \$28.80, retails for \$48.00. It contains 12 each, numerals from 1 to 0 with screws. 6 to 17 inch panels at \$4.80 per dozen, 20 inch panels at \$5.04 per dozen.

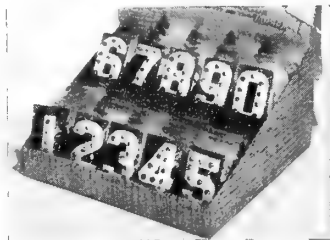

Terms: 1st of Month Following Date of Invoice

ALL PRICES SUBJECT TO CHANGE WITHOUT NOTICE

We Do Not Open New Accounts on This Stock Under \$25.00

Please Accompany Order Under that Amount with Cash

CANNAS

Dormant Roots ready for February 1st, 1952.

City of Portland. 3½ ft. Compact, luxuriant, dwarf growth. Leaves green. Flowers rosy pink.....	100 \$6.00	1,000 \$55.00
Dorothy S. A new dwarf, continuous flowering, clear salmon red canna. A sport of President. Produces large flowers and grows 4 ft. tall. Very vigorous and drought-resistant.....	8.00	70.00
King Humbert. 4 ft. scarlet flowers, bronze leaves, greatest favorite today.	6.00	55.00
Yellow King Humbert. 4 ft. An orchid flowering sport of the well known variety King Humbert.....	6.00	55.00
The President. 4 ft. In color a rich glowing scarlet with immense rounded flowers 7" across when fully open, produced on strong, erect stems well above the large green foliage.....	6.00	55.00
Hungaria. 3½ ft. Very compact, almost dwarf, and of luxuriant growth. Leaves bluish green, never burn. Flowers LaFrance pink.	6.00	55.00

CALADIUMS

Vaughan's Special Fancy-Leaved

Caladiums are easily grown but should not be put in a Carnation temperature. Start the bulbs in flats, turning them upside down, since this is a crown-rooting bulb and the roots come out around the top (center) eye. This direct contact with the growing medium produces roots more quickly than the opposite method. Use a mixture of one part leaf-mold, one part good garden loam, and one part peat moss or other coarse neutral material, throwing in a small amount of coarse charcoal or other rubble for drainage. Press the bulb halfway into the soil and place the flats under a bench. The flats can also be placed on top of the flows, but if this is done, they should be shaded. The temperature should be 80 to 85 degrees or higher, as the higher the temperature, the better starting results you will have. Be careful that the flats do not dry out if placed either on the flows or returns. Water sparingly until the bulbs begin to sprout and have roots 4 to 6 inches long. When the sprouts begin to show, place the bulbs in 5 or 6-inch pots, using a good rich leaf-mold. Water copiously when in full growth and use weak liquid manure once weekly if possible.

NAMED VARIETIES OR ASSORTED

	Doz.	100	1,000
No. 2 Size 1 inch—1½ inch.....	\$2.50	\$14.00	\$135.00
Nc. 1 Size 1½ inch—2½ inch.....	3.00	24.00	225.00
Jumbo 2½ inch—3½ inch.....	4.00	32.00	300.00
Man.moth 3½ inch and Up.	6.00	47.50	450.00

FLOWER SEEDS

The following items are selected from our list of over 3,000 varieties, the world's largest list of flower seeds. Our mixtures are not left-overs of old seed, but are hand blended from fresh seed of separate colors and named sorts. You are assured of high germination and quality seed by our rigid standards.

	Oz.	Lb.
Alyssum Vaughan's Little Gem.....	\$.60	\$6.00
Asters Wilt Resistant Giant Branching Mixed.....	.60	6.00
Princess Mixed	1.25	16.00
Bachelor Button Blue Boy.....	.30	3.00
Bachelor Button Mixed.....	.30	3.00
Calendula Vaughan's Special Mixed.....	.40	4.80
Cosmos Early Mammoth Mixed.....	.30	3.20
Dianthus Laciniatus Double Gaiety (new).....	.80	8.00
Larkspur Vaughan's Special Mixture.....	.50	5.40
Supreme (base branching type) Mixed.....	.80	8.00
Marigold Monarch Dwarf Mixed.....	.50	5.00
Marigolds African Double Tall Mixed.....	.50	5.00
Morning Glory Clarke's Early Heavenly Blue.....	.30	3.00
Nasturtium Gleam Hybrid Double Mixed10 lbs., \$10.00	.15	1.20
Nasturtium Tall Single Vaughan's Special Mixture.....	.15	1.50
Nasturtium Dwarf Single Vaughan's Special Mixture.....	.15	1.50
Petunia Rosy Morn Select.....	1.60	22.00
Petunia Vaughan's Small Flowered Bedding Mixed.....	1.80	24.00
Snapdragon Rust Resistant Vaughan's Special Mixture, all varieties	1.60	22.00
Zinnias All Giant Mixture.....	.60	6.00
Zinnias Lilliput Mixture50	5.40
Zinnias Dahlia Flowered Gold Medal Mixture.....	.60	6.00
Sweet Peas Vaughan's Special Mixture of Early Flowering Spencers 1 lb. \$3.00; 5 lbs., \$14.00.		
Pansies. Long a specialty with us. We introduced Swiss Giants to America. Our strain of Super Swiss Giant finest available. ½ oz., \$1.25; ¼ oz., \$2.25; oz., \$8.00.		
Surprise Garden. A formula blend of over 80 varieties of easy-to- grow annuals. Immensely popular with home gardeners, coun- try clubs, operators of roadside stands, etc., for masses of cut flowers and for bedding. Sow early and late for continuous bloom. Lb., \$2.80.		

If your copy of this catalogue does not include our complete list of flower seeds, it will be sent on request.

We wish to call your especial attention to the exceptionally advantageous prices to be found in this issue of our DEALERS' CATALOG.

WE ARE OFFERING THE FOLLOWING

Novelties and Meritorious Varieties of Flower Seeds

- Ageratum** Blue Bedder
Blue Cap
- Alyssum** Vaughan's Little Gem
Violet Queen
- Annuals** for Cutflowers
- Antirrhinum** Rust Resistant Maximum
Mixed
- Aster** Princess, colors and mixture
- Bush Balsam**
- Calendula** Pacific Beauty Mixed
- Candytuft** Giant Hyacinth fld. Select
- Carnation** Vaughan's Special Mixture
- Cleome** Pink Queen
Helen Campbell (white)
- Coleus** Glory
Vaughan's Rainbow Mixture
- Cosmos** Sensation
Radiance
- Cuthbertson** Sweet Peas
- Cynoglossum** Firmament
- Dahlia** Unwin's XXX Dwarf Hybrids
- Delphinium** Pacific Hybrids
- Dianthus** Heddensis Finest Mixed
Laciniatus Double Gaiety
- Gourds** Vaughan's Special Mixture
- Gypsophila** Elegans Grandiflora Alba
- Helianthus** Sun Gold
- Ipomoea** Blue Star
Darling
Pearly Gates
Scarlett O'Hara
- Larkspur** Supreme Varieties
- Marigold** Frills
Glitters
Happiness
Real Gold
Cupid
Cupid Mixed
Color Magic
Flash
Naughty Marietta
Red Head
Sunny
- Myosotis** Varieties
- Nicotiana** Daylight
- Nierembergia** Purple Robe
- Pansy** Vaughan's Super Swiss Giant
Mixture
Vaughan's Super Maple Leaf Mixture
- Petunia** Dwarf California Giants
Improved Vaughan Blend
Supreme Florist Strain
Ruffled Little Giants Mixed
Fringed Snowstorm
Dwarf Elk's Pride
Snowstorm Improved
Celestial Rose Improved, finest
bedding strain
- Phlox** Annual Vaughan's Special Mixture
Drummond's Gigantea
Nana Compacta
Beauty, colors and mixture
- Portulaca** Single Jewel
Double Scarlet Glow
- Pyrethrum** Roseum Giant Robinson
Mixed
- Salvia** Splendens Vaughan's Master-
piece
- Scabiosa** Super Crown Imperial Hybrids
- Stocks** Non-Branching Column
- Verbena** Vaughan's Best Mixture
- Vinca Rosea** (Periwinkle)
- Viola** Cornuta
King Henry
Johnny Jump Up
- Zinnia** Dahlia Flowered Gold Medal
Hybrids
Lilliput Tom Thumb Mixture
Floradale Scarlet
Giant Cactus Flowered Hybrids
Vaughan's Special Mixture Giant Sorts
Vaughan's Mixture of Midget Zinnias
- All of Our Vaughan's Special Mixtures,**
which are Formula-blended

Vaughan's ^{The} World's _{Best} Flower Seeds

We Can Deliver the Goods

Of every item offered in our flower seed list we hold large stocks or definite promise of early delivery from reliable producers. Our prices are competitive, based for seeds of the highest quality, from the ablest growers in the world.

Dealer orders have the right of way and we urge that you cover on all requirements for the season by ordering at once.

Key to Symbols

- ☐ **Annuals.** These attain full growth from seed, flower and die first year.
 # **Biennials.** These grow from seed the first year, bloom and die the next, though some varieties bloom the first year.
 ① **Perennials.**
 ÷ **Greenhouse Plants.** Start inside and cultivate in pots, or else transplant outside when danger of frost is over.
 + **Stove Plants.** To be grown inside all the year round for pots only.
 = **Climbing Plants.**
 * Denotes varieties which we specially recommend.

Quantities of ¼ lb. and over are charged at the pound rate (½ lb. at the oz. rate), ½ oz. at the oz. rate. 10c is the lowest price we charge on any orders on any items ordered by weight, regardless of the price per unit.

We do not sell half ounces where the price per ounce is 15c or under.

All prices are subject to change without notice.

	Oz.	Lb.
Abronia ☐ Umbellata (Sand Verbena), rose, 10 inches.....	\$0.80	\$8.00
Abrus + = Precatorius (Weather Plant), light purple, 7 feet....	.40	4.00
Abutilon + (Flowering Maple), 40 in. Hybridum Maximum, huge flowers in fine shades, seedlings bloom within 6 months. ¼ oz., \$1.50	5.50
Achillea ① Ptarmica fl. pl., The Pearl, small white flowers, 30 in. ¼ oz., 60c	2.00
Filipendula Parker's Variety, yellow, 4 to 5 ft.... ¼ oz., 60c	2.00
Aconitum ① (Monk's Hood, Cupid's Car)		
Napellus, dark blue, 36 in..... ¼ oz., 50c	1.60
Napellus, Barker's Variety, amethyst blue..... ¼ oz., 60c	2.00
Wilsoni, rich blue, 6 to 7 ft. ¼ oz., 60c	2.00
Acroclinium ☐ * Roseum fl. pl., large flowered double hybrids (Sensation mixed)40	4.00
Roseum Album Pl., white, double flowering (50 per cent true)	.30	3.00
Roseum fl. pl., double-flowering rose 20 in.....	.30	3.00
Roseum Double mixed.....	.30	3.00

	Oz.	Lb.
Adlumia ① = <i>Cirrhus</i> (Allegheny Vine), hardy climber.....	\$0.60
Adonis Aestivalis □ (Flos Adonis), red, 12 inch.....	.10	\$1.00
African Orange Daisy , see <i>Dimorphotheca</i> .		
Agapanthus + <i>Umbellatus</i> (Lily of the Nile), blue, 16 inches....
Agertha ÷ <i>Coelestis</i> (<i>Amelloides</i>) (Blue Daisy, Blue Marguerite) blue, floriferous, 20 in. ¼ oz., 40c	1.40
Ageratum □ + ÷ <i>Mexicanum Album</i> White, 2 ft.....	.40	4.00
<i>Coeruleum</i> Blue, 2 ft.....	.40	4.00
★ Blue Ball, 6 inches.....	.90	12.00
Blue Ball Improved..... ¼ oz., 60c	2.20	30.00
★ Blue Bedder, deep lavender blue, 4 inches.....	1.50	20.00
Blue Cap, a choice strain, 4 inches.....	1.50	20.00
Blue Perfection, true blue, fine, 8 inches.....	.90	12.00
Fairy Pink, soft salmon rose pink, 5 in..... ¼ oz., \$1.00	3.50
Imperial Dwarf Blue, 6 inches.....	.80	8.00
Dwarf White, 6 inches.....	.80	8.00
★ King of the Blues. Dwarf small foliage clusters deepest blue flowers90	12.00
Little Blue Star, compact, many small blue flowers, charming, 4 inches	1.20	16.00
★ Midget Blue, very dwarf, delicate foliage, covered with true <i>ageratum</i> blue flowers, 2 to 3 inches.....	1.50	20.00
★ Purple Perfection (Improved Blue Perfection), deeper and richer blue, 6 inches.....	.90	12.00
Tall Mixed40	4.40
Golden (<i>Lonas Inodora</i>), fluffy golden flowers, 12 inches ¼ oz., \$1.20	4.00
<i>Lasseauxi</i> , clear pink, excellent cut flower, 1 foot. ¼ oz., 60c	2.00
Dwarf <i>Ageratum</i> s will not always come true, varying in height.		
Agrostemma <i>Coeli Rosa</i> □ (Rose of Heaven, Mullein Pink), rose, 12 in.15	1.50
<i>Coronaria</i> ① <i>Atrosanguinea</i> (Rose Champion), deep blood red, 28 inches15	1.50
Alpine Wallflower , see <i>Cheiranthus Linifolius</i> .		
Allwoodii , see <i>Dianthus</i> .		
Aloe <i>Variegata</i> or "Partridge Breast Aloe," the finest and most favored quick growing succulent with beautifully variegated leaves. 100 seeds \$1.00; 500 seeds \$3.75; 1000 seeds \$7.00.		
Aionsoa □ <i>Warszewiczii</i> , brilliant tomato-red, 20 in.....	.50	5.00

	Oz.	Lb.
Alyssum , Benthami □ (maritimum), Sweet Alyssum (Madwort), 10 inches	\$0.20	\$2.00
Compactum, Lilac Queen, 9 inches.....	.60	6.00
Erectum, 3 inches.....	.40	4.00
Lutescens, straw yellow, 5 inches.....	.60	6.00
Snow Cloth. A special selection, each plant absolutely flat and a compact mass of white without green center, 2 inches70	7.00
★ Vaughan's Little Gem (Carpet of Snow), extra fine strain, re-selected, 3 inches.60	6.00
Little Dorrit, white, 4 inches.....	.40	4.00
★ Violet Queen, pretty bright violet, deeper than Lilac Queen, 6 inches60	6.00
Argenteum ①, yellow flowered, 24 in..... ¼ oz., 60c	2.20
Rock Garden Varieties, mixed ①..... ¼ oz., 70c	2.40
Saxatile ① Compactum (Gold Dust), 12 inches.....	.50	5.00
Sulphureum Citrinum, sulphur yellow, 16 in. ¼ oz., 60c	2.00
Amaranthus □ Caudatus (Love-Lies-Bleeding), red, 2½ ft.....	.10	1.00
Caudatus Viridis, with yellow-green foliage.....	.25
Melancholicus Ruber, dark red leaves, 3 feet.....	.20
Molten Fire, brilliant Poinsettia-like tips, 4 feet.....	.90	10.00
Salicifolius (Fountain Plant), green with bronze tips, blood red, showy, 30 inches60	6.00
★ Tricolor Splendens, very beautiful foliage, 36 inches.....	.60	6.00
Many sorts mixed50	5.00
Vaughan's Special Mixture60
Ammobium □ Alatum Grandiflorum, white, well known ever- lasting, 18 in.....	.30	3.00
Ampelopsis ① = Veitchi (Boston Ivy), clean seed.....	.60	6.00
Amsonia Tabernaemontana ① long stems with willow-like foliage and heads of light blue flowers in panicles. Especially good for cutting, 2 to 3 feet..... ¼ oz., 60c	2.00
Anagallis □ Grandiflora Coerulea (Poor Man's Weather Glass), dark blue, center deep purple, 10 inches.....	.80	8.00
Terra Cotta, red80	8.00
Mixed40	4.00
Anchusa ① Italica, Dropmore Variety, large, pure, gentian-blue, excellent perennial for cutting, 6 feet.....	.60	6.00
★ Feltham Pride, dwarf, large, bright blue..... ¼ oz., 50c	1.60
Lissadell, gentian blue, 6 feet.....	.50
★ Capensis □ Blue Bird, vivid indigo-blue, 2 feet.....	.50	5.00
Myosotidiflora, pretty, pale-blue Forget-me-not flowers, 15 in. ¼ oz., \$1.20	4.00

	Oz.	Lb.
Anemone ① □ ★ Coronaria, St. Brigid, True Irish strain, large flowers, semi-double, superb, 18 inches... ¼ oz., 65c	\$2.00	\$28.00
French Single Mixed.80	8.00
Pulsatilla ① (Pasque Flower) violet-lilac, 12 in... ¼ oz., \$1.60	5.50
Angel's Breath , see Gypsophila Elegans.		
Angel's Trumpet , see Datura.		
Annuals for Rock Gardens, mixed50	5.00
Anthemis ① Kelwayi, lemon-yellow, 36 inches.....	.30	3.00
Tinctoria (Ox-Eye Chamomile), light yellow, 30 inches.....	1.00
Perry's Variety, large, pale golden-yellow flowers, 2 ft.....	.50
Sancta Johannis, golden yellow.	1.50
Antigonon + = Leptopus (Mountain Rose Coral Vine) rose.....	.80	8.00

ANTIRRHINUM (Snapdragon) ① □**Majus Grandiflorum (30 Inches High)**

Crimson King	¼ oz., 45c	1.40
Golden King, yellow, very large flower.....	¼ oz., 45c	1.40
Queen Victoria, very large, pure white.....	¼ oz., 45c	1.40
Rose King, deep rose self.....	¼ oz., 45c	1.40
Choice mixed	¼ oz., 40c	1.20

Majus Nanum (20 Inches High)

Majus Nanum, many sorts mixed.....	.90	10.00
------------------------------------	-----	-------

"SNAPS" for Greenhouse Forcing

NOTICE: Original packets of Greenhouse Snapdragons as listed in "Book for Florists" special discount of 25% on single packet price only

		Oz.	
Afterglow, golden bronze	⅛ oz., \$2.30	\$16.00
Cheviot Maid Reselected	⅛ oz., 2.30	16.00
Cheviot Maid Supreme, dark rose pink	⅛ oz., 2.30	16.00
Coates Yellow Perfection	⅛ oz., 2.30	16.00
Ethel, yellow	⅛ oz., 2.30	16.00
Early Glorious, reddish copper.....	⅛ oz., 2.30	16.00
Lucky Strike Improved.....	⅛ oz., 2.30	16.00
Rose Queen, dark pink.....	⅛ oz., 2.30	16.00
Sunlite, Improved Suntan	⅛ oz., 2.30
Suntan, orange tan	⅛ oz., 2.30
Westover Early White	⅛ oz., 2.30	16.00
Greenhouse Varieties Mixed	¼ oz., 4.00	14.00

Majus Nanum Grandiflorum (20 Inches High)

Black Prince, nearly black, small dark leaves.....	¼ oz., \$0.45	\$1.40
Crimson King, deep crimson.....	¼ oz., .45	1.40

ANTIRRHINUM Majus Nanum Grandiflorum—Continued

			Oz.	Lb.
Dazzler, bright scarlet	1/4 oz.,	\$0.45	\$1.40
Eclipse, fiery crimson	1/4 oz.,	.45	1.40
Exquisite, soft silvery pink, cream lip	1/4 oz.,	.45	1.40
Flame, orange scarlet	1/4 oz.,	.45	1.40
Golden Monarch, best yellow, massive spike	1/4 oz.,	.45	1.40
Golden Queen, bright yellow	1/4 oz.,	.45	1.40
His Excellency, fiery scarlet, no trace of orange	1/4 oz.,	.45	1.40
Nelrose, old rose, shaded blush, large flower	1/4 oz.,	.45	1.40
Prima Donna, terra cotta, white tube	1/4 oz.,	.45	1.40
Purity, pure white	1/4 oz.,	.45	1.40
Red Emperor, rich deep scarlet	1/4 oz.,	.45	1.40
Rose Eclipse, intense rose pink	1/4 oz.,	.45	1.40
Royal Rose, rich deep rose	1/4 oz.,	.45	1.40
Royal Cerise, cerise-carmine	1/4 oz.,	.45	1.40
St. George, orange cerise	1/4 oz.,	.45	1.40
Victory, terra cotta orange shading to yellow in center	1/4 oz.,	.45	1.40
Vaughan's Special Mixture of Dwarf Sorts, including Majus Nanum, Majus Nanum Grand and Majestic	1/4 oz.,	.35	1.20

"Majestic" Half Dwarf Sorts

A type of Snaps with flowers of the Maximum sort and the height of the semi-tall sorts.

Avalanche, pure white	1/4 oz.,	\$0.65	\$2.20
Dawn of Day, pure apricot suffused gold	1/4 oz.,	.65	2.20
Delight, apricot	1/4 oz.,	.65	2.20
Eldorado, golden yellow	1/4 oz.,	.65	2.20
Evensong, chamois	1/4 oz.,	.65	2.20
Golden Dawn, buff, overlaid salmon	1/4 oz.,	.65	2.20
Orange King, exquisite blend of rich terra cotta, merging to pure deep orange	1/4 oz.,	.65	2.20
Red Chief, deep scarlet	1/4 oz.,	.65	2.20
Rose Beauty, rose pink self	1/4 oz.,	.65	2.20
Rose Marie, salmon rose, gold center	1/4 oz.,	.65	2.20
Rose Princess, rose pink	1/4 oz.,	1.50	5.50
Startler, glowing cerise	1/4 oz.,	.65	2.20
Twilight, delicate apricot with yellow and salmon	1/4 oz.,	.65	2.20
Majestic Mixed	1/4 oz.,	.50	1.80

Maximum, New Giant Flowered (32 Inches High)

Appleblossom, delicate pink, white throat	1/4 oz.,	\$0.45	1.40
Canary Bird, canary-yellow	1/4 oz.,	.45	1.40
Copper King, burnished copper	1/4 oz.,	.45	1.40
Purple King, velvety dark garnet	1/4 oz.,	.45	1.40
Scarlet	1/4 oz.,	.45	1.40
Snowflake, lovely pure white	1/4 oz.,	.45	1.40
The Rose	1/4 oz.,	.45	1.40
Maximum, Mixed, many kinds	1/4 oz.,	.45	1.20
* Antirrhinum. Vaughan's Special Mixture. Contains the Maximum, Majus, Majus Nanum and Majus Nanum Grandiflorum sorts (no Tom Thumb)			1.40	\$18.00

ANTIRRHINUM—Continued

		Oz.	Lb.
Tom Thumb (6 to 10 Inches High)			
Baby Rose	1/4 oz., \$0.90	\$3.00
Magic Carpet Mixed, creeping habit, covered with a variety of soft and pleasing colors.....	1/4 oz., .50	1.80
Sutton's Little Gem (Rock Hybrids Mixed).....	1/4 oz., .50	1.80
Tom Thumb Yellow	1/4 oz., .50	1.80
Red	1/4 oz., .50	1.80
Roseum	1/4 oz., .50	1.80
White	1/4 oz., .50	1.80
Mixed, all colors	1/4 oz., .45	1.50
Colossal Mixed. Large florets on strong stems, coming into flower very early. 3 ft.....	1/4 oz., .80	3.00
Goldenrod, bright golden yellow flowers on thick erect spikes. 2 1/2 ft.	1/4 oz., 1.25	4.00
Naramek Strain Mixed, a vivid blend including two-toned combinations of yellow-bronze, pink-rose, yellow-ruby and orchid-rose. Many oddly marked and streaked	1/4 oz., 1.00	3.60
Velvet Giant, deep crimson with an undertone of orange-bronze	1/4 oz., .55	2.00

GIANT RUFFLED TETRA

There are many strains of "Tetra" snapdragons but in our opinion this is the finest, based on observations made of various plantings and the results shown in our own trials.

Vaughan's Supreme Mixed \$1.80 \$25.00

RUST RESISTANT ANTIRRHINUM

The University of California, co-operating with leading growers of that State, has produced a race of Antirrhinum which is 75 per cent or better rust resistant. With the rust possibility reduced it will make the Snapdragon as popular as the wilt resistant strains have made Asters.

Maximum, Alaska, white, 2 1/2 to 3 feet.....	1/4 oz., \$0.60	\$2.00
Appleblossom, rose pink, white tube	1/4 oz., .60	2.00
Campfire, pure luminous scarlet.....	1/4 oz., .60	2.00
Canary Yellow	1/4 oz., .60	2.00
Copper Queen, burnished copper.....	1/4 oz., .60	2.00
Crimson, fiery scarlet	1/4 oz., .60	2.00
Indian Summer, coppery orange scarlet.....	1/4 oz., .60	2.00
Golden Glory (Yellow Giant), deep yellow.....	1/4 oz., .60	2.00
Loveliness, pure soft rose-pink	1/4 oz., .60	2.00
Pink Sensation, pure pink	1/4 oz., .60	2.00
Red Cross, crimson white tube.....	1/4 oz., .60	2.00
Salmon Rose Shades	1/4 oz., .60	2.00
Swing Time, fresh rose, white throat, yellow nose.	1/4 oz., .60	2.00
Maximum, all colors, mixed.....	1/4 oz., .35	1.25	\$16.00
Majus Grandiflorum, Brilliant Rose.....	1/4 oz., .45	1.50
Cherry Rose, a most brilliant shade of deep cherry rose	1/4 oz., .45	1.50
Daintiness, rose pink, white tube.....	1/4 oz., .45	1.50
Orange Shades, deep to light orange.....	1/4 oz., .45	1.50
Padre, rich crimson	1/4 oz., .45	1.50
Reveille, deep luminous yellow, upper lip of each floret toning to a lighter lemon yellow, 22 inches	1/4 oz., .45	1.50

RUST RESISTANT ANTIRRHINUM Maximum —Continued		Oz.	Lb.
★ Rosalie, rich deep rose with underlying tone of topaz or amber	¼ oz., \$0.45	\$1.50
Shasta, pure white	¼ oz., .45	1.50
Stoplight, copper scarlet.....	¼ oz., .45	1.50
Yellow Jacket, deep yellow.....	¼ oz., .45	1.50
Grandiflorum Mixed90	\$10.00
Nanum Grandiflorum, Amber and Gold.....	¼ oz., .60	2.00
Bumble Bee, crimson white tube, yellow nose... ¼ oz., .60		2.00
Carmine Rose	¼ oz., .60	2.00
Dandy, glowing orange, white tube.....	¼ oz., .60	2.00
DuBarry, flaming salmon rose	¼ oz., .60	2.00
Garnet (Ruby)	¼ oz., .60	2.00
Indian Girl, old gold	¼ oz., .60	2.00
Wild Fire, bright orange	¼ oz., .60	2.00
Mixed.		1.50	20.00
Super-Majestic Type —Semi-tall giant flowered. Best for home gardens.			
Harmony, terra cotta shaded rose	¼ oz., .70	2.40
Orange Shades	¼ oz., .70	2.40
Orchid Shades	¼ oz., .70	2.40
Pink and Rose Shades	¼ oz., .70	2.40
Red Rocket, bright red	¼ oz., .70	2.40
Rose Sensation, rose pink	¼ oz., .70	2.40
Royal Crimson, garnet crimson	¼ oz., .70	2.40
Super Majestic Mixed.....		1.50	20.00
★ Vaughan's Special Mixture, all rust resistant varieties.....		1.60	22.00
Apple of Peru or Sodom, see Nicandra.			

AQUILEGIA (Columbine) ①

Alpina, blue, 24 inches.....	¼ oz., .70	2.40
Canadensis, old rose with yellow, 30 in.....	¼ oz., .90	3.20
Chrysantha, light chrome-yellow, fine, 36 inches.....		1.50	20.00
Grandiflora Silver Queen, silvery white, fragrant, 24 inches	¼ oz., .45	1.50	20.00
Clematiflora Mixed, spurless, with beautiful open flowers like Clematis.	⅛ oz., \$1.00; ¼ oz., 1.75
Coerulea Blue. Sky-blue with white corolla. Rocky Mt.			
Columbine	¼ oz., .80	3.00
★ Mrs. Nicholls, improvement on Coerulea, flowers bolder and richer blue.....	¼ oz., .80	3.00
Rose Queen, light to dark rose, white center... ¼ oz., .60		2.00
Long Spurred Blue Shades.....	¼ oz., .90	3.20	48.00
Crimson Star, rich crimson, center white tinged carmine.	¼ oz., 1.25	4.00
Copper Queen, copper red, straw corolla, 18 in. ¼ oz., .90		3.20
Dobbie's Imperial Hybrids. Strain with large, long-spurred flowers in strong, brilliant tones of all colors.		2.00	28.00
Longissima, delicate pale yellow.....	⅓ oz., 2.00	15.00
Longissima Hybrids, 30 in., very long spurred variety in many attractive shades.	⅓ oz., 1.50
Orange and Scarlet Shades.....	¼ oz., .90	3.20
Vaughan's Super Mixture, flowers of enormous size in brilliant color range.....	¼ oz., .90	3.20

	Oz.	Lb.
AQUILEGIA (Columbine) Long Spurred —Continued		
*Mrs. Scott Elliott's Improved Varieties.....	\$2.00	\$28.00
Double mixed40	4.00
Single Mixed30	3.00
★Vaughan's Special Mixture	1/4 oz., \$0.90	3.20
Arabis ① (Alpine Rock Cross), Alpina Nana Compacta		
8 inches	1/4 oz., \$0.45	1.50
Alpina white, 1 foot.....	.60	6.00
Rosea pink, 1 foot.....	1/4 oz., .70	2.50
Snow Cap, shining snow white, compact cushions, 8 inches.....	1/4 oz., .60	2.00
Aralia + ÷ Sieboldii, 100 seeds, \$0.30; 1000 seeds, \$2.40.		
Arctotis □ Breviscapa Aurantiaca, dark orange, purple disc, 6 inches	1/4 oz., .90	3.20
Grandis (Blue-Eyed African-Daisy), 3 feet.....	.60	6.00
Large-Flowering Hybrids, numerous beautiful colors, 1 foot	1/4 oz., .85	3.00
Armeria ① (Thrift) Formosa, red, 2 ft.	1.00	14.00
Formosa, Large Flowering Hybrids, 2 feet.....	1.50	20.00
*Giant Pink, deep pink flowers, 2 feet.....	1/4 oz., 2.25	8.00
Asclepias Curassavica ÷, orange, 2 feet.....	1.00
Tuberosa. One of the showiest of our native perennials, producing from July until frost, brilliant orange flowers with purplish stems and hairy leaves. 1 foot.....	1.50	20.00

ASPARAGUS + ÷

Plumosus Nanus (Lath House grown) 1000 seeds, \$1.75; 5000 seeds, \$8.00; 10,000 seeds, \$14.00.		
Sprengerii (Emerald Feather) 1000 seeds, \$1.75; 5000 seeds, \$8.00; 10,000 seeds, \$14.00.		

Asperula Azurea Setosa □ (Blue Woodruff), sky-blue, 12 inches..	.20	2.00
------------------------------------------------------------------------	-----	------

ASTERS □**TALL SORTS****GIANTS OF CALIFORNIA (2½ to 3 Feet)**

Flowers of same type as the Crego, but more substantial and larger, measuring 5 to 6 inches in diameter; they stand up well in shipping; a true non-lateral type. They are an American Beauty Aster with Comet or Crego type flowers.

Appleblossom	Dark Purple	Light Purple	Peachblossom	
Crimson	Deep Rose	Light Blue	White	
Loveliness, rich pink touched with salmon				
Each of the above.....	1/4 oz., \$0.40	\$1.50	\$20.00	
Giants of California, mixed, many colors.....		1.25	16.00	

VARIOUS SORTS**KIRKWELL (12 in.)**

Low growing, base branching plants, bearing as many as 40 flowers which average over 2 inches across and fully double.

Dark Blue		Rose Pink	
	Salmon Pink		
Each of the above.....	1/4 oz., \$0.90	\$3.20
Mixed, the above and others.....	1/4 oz., .80	3.00
Giant California Sunshine. Mixed.....		1.25	16.00

ASTERS—Continued

	Oz.	Lb.
Imbricated Pompon. Mixed. Flowers very freely produced, often as many as 20 on a dwarf, bushy plant. Blooms very early. The small round pompon blossoms have an outside row of short guard petals.....	\$1.25	\$16.00
King Mixed80	8.00
Super Giant El Monte, Improved Giants of California, deep glowing crimson, 2½ feet.....	1.40	18.00
Super Giant Los Angeles. The flowers are large, are most artistic, due to the unusual curling and interlacing of the petals, giving a light feathery effect. The color is a pure shell pink.....	1.40	18.00

★ ★ ASTER WILT RESISTANT STRAINS

Protect Asters with Insecticides Containing D.D.T.

To kill leaf hoppers, which transmit the yellow disease, for which there has hitherto been no reliable treatment. Occasional spraying or dusting with this lasting insecticide should protect your asters from infection, which is the chief enemy of these beautiful flowers in sections where the wilt disease is not established in the soil. We recommend Protexall (Page 53) D.D.T. 5% dust, and D.D.T. 50% wettable dust. Wilt resistant varieties are resistant only to wilt, but in general are more vigorous, and less susceptible to other infections.

	Oz.	Lb.
Ball Deep Rose, 2½ to 3 ft.....	\$1.00	\$10.00
Ball Purple, 2½ to 3 ft.....	1.00	10.00
Ball Early White, 2½ to 3 ft.....	1.00	14.00
Ball Late White, 2½ to 3 ft.....	1.00	12.00

BOUQUET TYPE (2 ft.)

Plants are upright, bearing quilled flowers on long stems; habit allows entire plant to be cut as one bunch. Very early.

Crimson Bouquet, bright crimson. White Bouquet, pure white.

Each of the above..... ¼ oz., \$0.65 2.20

CREGO (OSTRICH FEATHER) 2½ FT.

	Deep Rose	Pink	Violet
Azure Blue			
Blue Flame	Cattleya	Crimson	Lavendar
		Mid-blue	Purple
Each of the above.....			
			White
Crego Mixed, all colors.....			

Each of the above.....	\$0.70	\$7.00
Crego Mixed, all colors.....	.60	6.00

EARLY BEAUTY, 2½ to 3 Ft.

	Carmine Rose (deep rose)	September Beauty (delicate shell pink)	White
Azure Blue			
Crimson			
Purple			
Each of the above.....	1.00	12.00	
Early Beauty Mixed, all colors.....	.90	10.00	

EARLY GIANT, 1½ Ft.

Light Blue, a big lacy flower with curled and interlaced petals. Blooms early	1.60
Peachblossom, white flushed lavender pink.....	1.60
Rose Marie, rich lively shade of rose.....	1.60
Early Giant Mixed, all colors.....	1.50	20.00

GIANT BRANCHING (Vick's or American Branching) 2 to 2½ Ft.

	Mary Semple, Pink	Sensation, Red
Azure Blue (Lavender)		
Crimson		
Deep Rose	Purple	White
Each of the above.....	.70	7.00
Giant Branching Mixed, all colors.....	.60	6.00

ASTERS Wilt Resistant Strain—Continued

	Oz.	Lb.
Giant Mammoth Peony Flowered, Silvery Rose, 2½ to 3 ft.....	\$1.25	\$16.00
Heart of France, rich dark red medium sized flowers, 1½ to 2 ft..	1.00	14.00

PRINCESS (2 to 2½ Feet)

An attractive cutting type on long stems. Flowers have a full deep crested center surrounded by several rows of dainty plume-like guard petals.

Anne, peachblossom	Golden Sheaf, deepest yellow		
Barbara, orchid	Linda, clear rose		
Bonnie, soft salmon rose	Margaret, true rose		
Elizabeth, pure white	Marsha, cinnabar scarlet		
	Susan, clear deep blue		
Each of above.....	¼ oz., \$0.45	\$1.50
Pat, new, bright crimson.....	¼ oz., .50	1.80
Mixed, all colors		1.25	\$16.00

QUEEN OF THE MARKET (20 Inches)

Azure Blue	Light Blue (Dark Lavender)		
Ballet Queen (Deep salmon rose)			
Crimson	Scarlet		
Dark Blue	Rose		
Flesh Pink	White	Oz.	Lb.
Each of the above.....		\$0.80	\$8.00
Queen of Market Mixed, all colors.....		.70	7.00
Ballet Type Mixed.....		1.00	12.00

REMO (14 Inches)

Plants of compact growth, large semi-double flowers, the bright colors being further accented by a rich yellow center. Early.

Dark Blue	Light Blue		
Dark Red	Light Rose		
Dark Rose			
Each of the above.....		\$1.50	\$20.00
Mixed, the above		1.50	20.00

ROYAL (2 to 2½ Feet)

Azure (Dark Lavender)	Rose Pink	Shell Pink	
Peachblossom	Scarlet	White	
Purple			
Each of the above.....			.80 8.00
Royal Mixed, all colors.....			.70 7.00

SUPER GIANT (3 ft.)

The largest flowered of the Wilt Resistant group. Long wiry non-branching stem and huge Ostrich-Feather flower. Blooms from late Summer to frost.

Beverly Hills, azure blue	Hollywood, pure paper white		
El Monte, crimson	Pasadena, peachblossom		
Each of the above	¼ oz., \$0.65	\$2.20
Mixed, the above.....	¼ oz., .65	2.20

VAUGHAN'S EXCELSIOR MIXTURE OF TALL ASTERS WILT RESISTANT

This is a mixture of the most beautiful, striking and distinct colors of the tall growing Asters, selected from the cream of the **Early Beauty, Giants of California, Ostrich Feather, Giant Branching** and other desirable sorts.....

	Oz.	Lb.
Wilt Resistant Vaughan's Florist Mixture.....	1.20	16.00
Vaughan's Special Mixture of Wilt Resistant Varieties.....	1.20	16.00
<hr/>		
Single Chinese Rainbow Mixed.....	.50	5.00
<hr/>		
Aster Perennial , Large Flowering Varieties, mixed. ¼ oz.,	\$0.90	\$3.20
Alpinus, blue, 12 in. ¼ oz.,	1.20	4.00
Goliath, soft blue, 15 in. ¼ oz.,	1.00	3.60
Mixed, 15 in. ¼ oz.,	.70	2.40
Amellus Hybridus, 30 in. ¼ oz.,	.90	3.20
Aubrietia ①, Large Flowering Hybrids, 6 inches. ¼ oz.,	.50	1.80
Bougainvillei ① dark blue, dwarf 6 in. ¼ oz.,	.50	1.80
Deltoides, lilac, 6 in. ¼ oz.,	.45	1.50
Eyrii, large blue, very free flowering. ¼ oz.,	.50	1.80
Graeca, grayish lilac, 6 inches. ¼ oz.,	.35	1.20
Hendersoni, large purple flowers, 6 in. ¼ oz.,	.50	1.80
Leichtlini, reddish crimson, 6 in. ¼ oz.,	.50	1.80
Purpurea, true deep purple. ¼ oz.,	.60	2.20
Whitewell Gem, glowing rosy-purple with slight tinge of blue, 6 in. ¼ oz.,	.45	1.50
New Giant Hybrids ¼ oz.,	.60	2.20
Semi-Double Hybrids, produces 75% semi-double flowers in all known colors of this family and many art shades ¼ oz.,	2.00	7.00

Auricula, see Primula.

Australian Pea Vine, see Dolichos Lignosus.

Baby Primrose, see Primula Malacoides.

Baby's Breath, see Gypsophila Paniculata.

Bachelor's Button, see Centaurea.

Balloon Vine □ = (Cardiospermum) (Love-in-a-Puff)..... .30 \$3.20

BALSAMS—DOUBLE

Improved Double Camellia-Flowered, choice mixed, 2 ft.....	.60	6.40
Double Rose-Flowered, best quality, mixed 2 ft.....	.60	6.40
Double Rose and Camellia-Flowered, mixed.....	.60	6.40
Tall Mixed50	5.00
Bush flowering. Flowers form pretty rich bouquets above the foliage		
Cinnabar, brilliant red.....	1.00	14.00
Rose	1.00	14.00
Scarlet	1.00	14.00
Torch dwarf vermilion red.....	1.00	14.00
White	1.00	14.00
White reflected rose	1.00	14.00
Mixed90	10.00
<hr/>		

Balsam □ = Pear (Momordica Charantia)..... .80 8.00
 Apple (Momordica Balsamina)..... .80 8.00
 Apple and Pear Mixed..... .80 8.00

	Oz.	Lib.
Baptisia Australis ① (False Indigo), blue, pea-shaped flower, 36 inches	\$0.60	\$6.00
Bartonia □ Aurea, golden yellow, 24 inches.....	.30	3.20
Basket Flower , see <i>Centaurea Americana</i> .		
Bean Scarlet Runner30
Beard Tongue , see <i>Pentstemon</i> .		
Bear's Ears , see <i>Primula auricula</i> .		
BEGONIA □ ÷		
Gracilis Adeline, carmine rose, 8 inches	$\frac{1}{4}$ oz., \$1.00; $\frac{1}{2}$ oz., \$1.75
Carmen, bright rose, bronze foliage, 10 inches	$\frac{1}{4}$ oz., .90; $\frac{1}{2}$ oz., 1.50
Dwarf Luminosa, dark scarlet, foliage reddish brown 6 in.	$\frac{1}{4}$ oz., \$1.00; $\frac{1}{2}$ oz., \$1.75; $\frac{1}{8}$ oz., 3.00
Indian Maid, bright deep scarlet buds and flowers with deep lustrous bronze foliage. 10 inches	$\frac{1}{4}$ oz., 1.00; $\frac{1}{2}$ oz., 1.75; $\frac{1}{8}$ oz., 3.00
★ Luminosa, dark scarlet, foliage, reddish brown, 10 inches	$\frac{1}{4}$ oz., 1.00; $\frac{1}{2}$ oz., 1.75; $\frac{1}{8}$ oz., 3.00
★ Prima Donna, limpid rose, shading to carmine, 10 inches	$\frac{1}{4}$ oz., .60; $\frac{1}{2}$ oz., 1.10; $\frac{1}{8}$ oz., 2.00
White Pearl, clear white, 10 inches	$\frac{1}{4}$ oz., 1.00; $\frac{1}{2}$ oz., 1.75
Semperflorens		
Bois de Vaux Rose, floriferous pyramidal compact growth, green metallic foliage, decorated with narrow red border, 8 in., $\frac{1}{4}$ oz., \$1.00; $\frac{1}{2}$ oz., \$1.75
★ Enchantress, fresh rose color, 8 inches	$\frac{1}{4}$ oz., 1.00; $\frac{1}{2}$ oz., 1.75
Erfordia, rosy carmine, 10 inches.....	$\frac{1}{2}$ oz., 1.00; $\frac{1}{8}$ oz., 1.75
Fire Sea, red flowers, green foliage, 6 inches	$\frac{1}{4}$ oz., 1.00; $\frac{1}{2}$ oz., 1.75
G. Knacke, salmony-pink, 7 in.	$\frac{1}{4}$ oz., 1.00; $\frac{1}{2}$ oz., 1.75
Ile de France, pure white with yellow stamens, foliage light green, 12 inches. $\frac{1}{4}$ oz., 1.00; $\frac{1}{2}$ oz., 1.75
King of the Reds, dwarf glowing scarlet, bronze foliage	$\frac{1}{4}$ oz., 1.00; $\frac{1}{2}$ oz., 1.75; $\frac{1}{8}$ oz., 3.00
Masterpiece, large clear rose pink	$\frac{1}{4}$ oz., 1.00; $\frac{1}{2}$ oz., 1.75; $\frac{1}{8}$ oz., 3.00
Scandinavia Pink, large flowers, green foliage.	$\frac{1}{4}$ oz., 1.00; $\frac{1}{2}$ oz., 1.75
Scandinavia Red	$\frac{1}{4}$ oz., 1.00; $\frac{1}{2}$ oz., 1.75
Vernon, blood red, dark leaves, 14 inches	$\frac{1}{8}$ oz., 1.50; $\frac{1}{4}$ oz., 2.50	8.00
Winter Romance, carmine rose, green foliage.	$\frac{1}{4}$ oz., 1.00; $\frac{1}{2}$ oz., 1.75
Semperflorens mixed	$\frac{1}{8}$ oz., 1.75; $\frac{1}{4}$ oz., 1.00
Vaughan's Special dwarf mixture for florists.....	$\frac{1}{4}$ oz., 2.00
Vaughan's Special mixture, all varieties.....	$\frac{1}{4}$ oz., 1.25; $\frac{1}{2}$ oz., 2.00

BEGONIA—Continued

	Oz.	Lb.
Ball Deep Rose, deep rich rosy red which gradually fades to a bright luminous pink.....
$\frac{1}{8}$ oz., \$7.00; $\frac{1}{4}$ oz., \$12.50; $\frac{1}{2}$ oz., \$20.00	\$60.00
Ball Red, medium large flowers of brightest scarlet red, fairly dwarf in growth and uniform in habit.		
$\frac{1}{8}$ oz., \$7.00; $\frac{1}{4}$ oz., \$12.50; $\frac{1}{2}$ oz., 20.00	60.00
Ball White, rather small flowers, but very freely produced.....	$\frac{1}{8}$ oz., \$7.00; $\frac{1}{4}$ oz., \$12.50; $\frac{1}{2}$ oz., 20.00	60.00
Christmas Cheer, crimson scarlet.....	$\frac{1}{8}$ oz., \$1.20; $\frac{1}{4}$ oz., 2.20
Illusion, rose with white blotch on each petal, foliage of bright green.	$\frac{1}{4}$ oz., \$1.50; $\frac{1}{2}$ oz., 2.75

Bellis ① □ (Double English Daisy), 6 inch Monstroza, double rose	$\frac{1}{4}$ oz., \$0.60	2.00
Double white	$\frac{1}{4}$ oz., .60	2.00
Double crimson	$\frac{1}{4}$ oz., .60	2.00
Double red	$\frac{1}{4}$ oz., .60	2.00
Double mixed	$\frac{1}{4}$ oz., .60	2.00
Monstroza Tubulosa Aetna dark red.....	$\frac{1}{4}$ oz., .60	2.00
Longfellow white with red.....	$\frac{1}{4}$ oz., .45	1.50
Snowball, excellent white variety.....	$\frac{1}{4}$ oz., .45	1.50
Extra Choice double mixed.....	$\frac{1}{4}$ oz., .45	1.50

Bell of Ireland , graceful branching stems, so surrounded by 2 in. flowers there is little room for leaves; the bell shaped calyx is green and delicately veined, containing the white corolla. 2 ft.	4.00	\$50.00
Bird of Paradise (Poinciana Gillesii), yellow and red, 10 feet....	1.00	12.00

Black Eyed Susan, see Rudbeckia and Thunbergia.

Blanket Flower, see Gaillardia.

Blazing Star, see Liatris.

Bleeding Heart, see Dielytra.

Blue Daisy, Blue Marguerite, see Agathea.

Blue Lace Flower (Didiscus Coeruleus).....	.60	6.00
---------------------------------------------------	-----	------

Bocconia ① Japonica (Plume Poppy) decorative, 8 ft.....	.50	5.00
----------------------------------------------------------------	-----	------

Boltonia ① (False Chamomile), Latisquama, delicate pink, 4-5 feet	$\frac{1}{4}$ oz., 40c	1.20
--------------------------------------------------------------------------------	------------------------	------	-------

Bonavist Bean, see Dolichos.

Boston Ivy ① = see Ampelopsis Veitchi.

Brachycome □ Iberidifolia (Swan River Daisy). Mixed, 12 in....	.60	6.00
-----------------------------------------------------------------------	-----	------

Brazilian Morning Glory (Ipomoea setosa)35	3.80
-------------------------------------------------------	-----	------

Briza □ Maxima (Quaking Grass), 18 in.....	.20	2.20
---------------------------------------------------	-----	------

Gracillima Minor, slender, graceful, 6 in.....	.20	2.20
------------------------------------------------	-----	------

Browallia □ Elata (Blue Amethyst), blue, 18 inches.....	.90	10.00
----------------------------------------------------------------	-----	-------

Viscosa Compacta Sapphire. Compact pot plant, dark blue with white eye, 9 inches.....	$\frac{1}{4}$ oz., \$1.75; $\frac{1}{2}$ oz., \$1.00
---------------------------------------------------------------------------------------	------------------------------------------------------	-------	-------

Speciosa Major, large deep blue flowers, 12 in....	$\frac{1}{4}$ oz., \$3.50	12.00
----------------------------------------------------	---------------------------	-------	-------

Burning Bush, see Kochia and Dictamnus.

Buttercup, see Ranunculus.

Butterfly Flower, see Schizanthus and Asclepias Tuberosa.

Bush Escholtzia, see Hunnemannia.

	Oz.	Lb.
Cacalia □ (Tassel Flower), Mixed, 16 inches.....	\$1.00	\$12.00
Aurea, yellow	1.00	12.00
Scarlet	1.00	12.00
Cactus. All kinds and forms mixed.....	1.25	16.00
Calandrinia □ Umbellata, crimson violet, very fine, 6 in.....	1.25	16.00
Calceolaria + ÷ # Hybrida (Old Lady's Wallet, Pouchflower), Grandiflora Triumph Strain. A truly outstanding strain. Bright shades of yellow, orange, red and rose; the flowers are large and mostly tigered or spotted. This strain produces lushy, shapely plants with clean foliage $\frac{1}{4}$ oz., \$2.25; $\frac{3}{8}$ oz., \$4.00
★ Multiflora Nana Mixed, the average size of the blooms is only 1½ inches, but the amount of flowers pro- duced is unsurpassed. The color scheme is extra- ordinarily gay and full of contrast..... $\frac{1}{4}$ oz., \$3.001/128 oz., 1.75
All Colors and Types Mixed... $\frac{1}{8}$ oz., 6.00; $\frac{1}{4}$ oz., 11.50
California Blue Bells , see Phacelia Campanularia.		
California Poppy , see Escholtzia.		
California Native Wild Flowers50	5.00

CALENDULA □ (Pot Marigold)

Pacific Beauty. This new family of Calendulas produces uniformly larger flowers of better formation, longer and straighter stems and is more resistant to summer heat.		
Apricot Beauty. A lovely apricot.....	\$0.40	\$4.80
Cream Beauty. Creamy white, shading to soft light yellow..	.40	4.80
Lemon Beauty, pure lemon yellow.....	.40	4.80
Persimmon Beauty. A true golden-orange of unusual brilliance.	.40	4.80
Mixed40	4.80
Apricot Queen40	4.80
Gold, light center, 20 inches.....	.40	4.80
Lemon Queen Improved, lemon yellow, dark eye.....	.40	4.80
Long Orange Improved, bright golden yellow with light eye....	.40	4.80
Masterpiece, dark center, clear orange, 24 inches.....	.40	4.80
Orange Improved, light center, 20 inches.....	.40	4.80
White (Moonlight), soft creamy yellow.....	.40	4.80
Forcing Varieties, mixed40	4.80
Chysantha or Sunshine, buttercup-yellow, 2 feet.....	.30	3.20
Lemon Queen, light center30	3.20
Orange Beauty, bright deep orange, slightly suffused with yellow, inner petals curl gracefully inward40	4.80
Orange King, select dark eye, 18 inches.....	.30	3.20
Orange, Shaggy, petals long, deeply fringed, 16 inches.....	.40	4.80
Pastel Bedding Mixture, Art shades, 20 inches.....	.30	3.20
Radio, quilled orange colored petals, 20 inches.....	.30	3.20
Sensation (Campfire), brilliant orange flowers, 20 inches.....	.30	3.20
Sensation Improved, dark orange, greatly improved, 20 inches..	.40	4.80
Yellow Colossal, very large, double flowers, clear, bright golden yellow40	4.80
Vaughan's Special Mixture40	4.80
Trial Ground Mixture, a fine blend of all standard varieties plus varieties on which they are working and not yet introduced..	.40	4.80
Mixed20	2.20

CALLIOPSIS □**Tall Sorts**

	Oz.	Lb.
Bicolor, all double mixed, 40 inches.....	\$0.30	\$3.00
Nigra Speciosa, very dark, 40 inches.....	.25	2.50
Marmorata, Tiger mixed, yellow and red-brown, 40 inches..	.25	2.50
Drummond Golden Crest, rich golden yellow with a reddish brown zone50
*Golden Crown Improved, with yellow maroon center, 2 feet	.25	2.50
Golden Wave, golden yellow with brown red ring.....	.25	2.50
Semi-double, mixed, 40 inches.....	.25	2.50
Tall Sorts, mixed, 40 inches.....	.25	2.50
Vaughan's Special Mixture40	4.00

DWARF SORTS

Tom Thumb Dazzler, maroon with yellow border, 12 inches.....	.40	4.00
Dwarf Sorts, mixed, 8 inches.....	.25	2.50

CAMPANULA

Carpatica ① (Hare Bell, Carpathian Bellflower), Alba white, 9 inches	¼ oz., \$0.45	1.50
Blue, 10 inches	¼ oz., .45	1.50
Cullinmore, a lovely hybrid form of Carpatia and other dwarf growing species. Much more prolific than Carpatia. Its flowers of various shades of blue are produced all summer. Very nice edging or rock garden plant.....	
Garganica, dwarf trailer, blue flowers. ⅓ oz., \$1.50; ¼ oz., \$2.80	
Grandiflora, see Platycodon.			
Latifolia Macrantha Blue, large-fl'd., 40 inches.....	¼ oz., .85
Medium # Calycanthea Cup and Saucer, Blue, 36 inches.....		.90	10.00
Calycanthea, Lilac (Light Blue).....		.90	10.00
Pink90	10.00
White90	10.00
Mixed80	8.00
Single (Canterbury Bells), Blue, Lilac, Rose and White, 36 inches, each40	4.00
Mixed40	4.00
Double, Blue, 32 inches.....		.50	5.00
Rose50	5.00
White50	5.00
Mixed50	5.00
Double and single mixed80
Annual Canterbury Bells, Mixed. □ Blooms in six months from seed, 2½ feet90	10.00
Persicifolia (Peach Bell), ① Alba, white, fine, 30 inches	¼ oz., \$0.60	2.00
Coerulea, blue, 30 in.....	¼ oz., .60	2.00
Wedgewood, large flowers of deep violet blue. ¼ oz., 1.25		4.00
Double Blue.	¼ oz., .70	2.40
Single Mixed	¼ oz., .60	2.00
Pyramidalis (Chimney Bells) ① Alba, white, 5 feet. ¼ oz., .35		1.20
Blue, lavender blue, 5 feet.....	¼ oz., .35	1.20
Mixed	¼ oz., .35	1.20
Rapunculoides, spires of loosely swung bell-shaped blossoms, soft blue to deep violet.....	¼ oz., .60	2.00
Rotundifolia ① (Blue Bells of Scotland) blue, 12 in. ¼ oz., 1.40		5.00
Perennial Varieties, mixed ①	¼ oz., .60	2.00
Rock Garden Varieties, mixed	¼ oz., .60	2.00

	Oz.	Lb.
Canary Bird Flower □ = (Canary Creeper), yellow, fine climber for shade	\$0.30	\$3.00
Campion. see <i>Lychnis</i> .		
Candytuft □ (<i>Iberis</i>), <i>Coronaria</i> , <i>Empress</i> , large trusses of pure white flowers, 12 inches.....	.25	2.50
Giant Hyacinth Flowered White, Florist Type, extra select, this is a superior strain; it grows about 1½ feet high, with enormous trusses of blooms.....	.50	5.00
Little Prince, dwarf, large spikes, 6 inches.....	.30	3.00
Umbellata , <i>Alba</i> , white, 12 inches.....	.30	3.00
<i>Carminæa</i> , 12 inches.....	.30	3.00
Flesh, pink, 12 inches.....	.30	3.00
<i>Lilacina</i> , lilac, 12 inches.....	.30	3.00
<i>Purpurea</i> , crimson, 12 inches.....	.30	3.00
Rose Cardinal, rose pink, 1 foot.....	.30	3.00
Mixed, all colors, 1 foot.....	.20	2.20
Vaughan's Special Mixture30	3.00
<i>Hybrida Nana Mixed</i> , 10 inches.....	.45	4.40
Miniature Gem , early flowering white rock or border plant 4 in.60	6.00
Gibraltarica ① lilac shading off to white, 12 inches.....	.80	8.00
Queen of Italy ② rosy lilac, 10 inches.....	.80	8.00
Sempervirens ① white, 12 inches	1.50	22.00
Canna + ÷ □ mixed.....	.80	8.00
Canterbury Bells , see <i>Campanula Medium</i> .		
Cape Marigold , see <i>Dimorphotheca</i> .		
Cardinal Climber (<i>Ipomoea Sloteri</i>) □ = 25 feet, fiery cardinal-red	.90	10.00
Cardinal Flower (<i>Lobelia Cardinalis</i> .) 18 inches..... ¼ oz., 70c	2.40	32.90

CARNATIONS

CHABAUD'S GIANT □

(Early and Perpetual Flowering, Clove Scented, 16 to 20 inches)

	Oz.	Lb.
Jeanne Dionis (Chabaud White)..... ¼ oz., \$0.60	\$2.20
Cardinal ¼ oz., .60	2.20
Copper red, salmon rose ¼ oz., .60	2.20
Deep rose ¼ oz., .60	2.20
Flesh ¼ oz., .60	2.20
Marie Chabaud, yellow ¼ oz., .60	2.20
Maroon (Nero) ¼ oz., .60	2.20
Rose pink ¼ oz., .60	2.20
Best mixed	1.25	\$18.00
Enfant de Nice , extra large flowers, long stiff stems.		
White ¼ oz., 2.20	8.00
Salmon ¼ oz., 2.20	8.00
Rose ¼ oz., 2.20	8.00
Red ¼ oz., 2.20	8.00
Mixed 4 ozs., \$14.00; ¼ oz., 1.25	4.00

CARNATIONS—Continued

		Oz.	Lb.
Grenadin ① Dark Velvety Brown (King of the Blacks), 20 inches	¼ oz., \$0.60	\$2.00	\$25.00
Red, half high type.....	¼ oz., .60	2.00	25.00
Golden Sun, yellow, excellent cutflower, 2 feet..	¼ oz., .60	2.00	25.00
Triumph Rose	¼ oz., .60	2.00	25.00
White Gold, soft yellow.....	¼ oz., .60	2.00	25.00
White	¼ oz., .60	2.00	25.00
Mixed	¼ oz., .45	1.50	20.00
Dwarf Bright Scarlet, 14 inches.....	¼ oz., .60	2.00	25.00
Margaret Double Mixed □ 16 to 20 inches.....		1.00	14.00
Giant Malmaison Margaret Mixed, 16 to 20 inches.....		1.50	22.00
Malmaison J. M. Bridgeford. From seed sown indoors (or out- doors), bears in 90 days on long stems, lovely fully double Carnations, 3 to 4 inches across, of all Carna- tion colors, including yellow. Flowers throughout the summer. 1¼ feet	¼ oz., \$0.60	2.00
Super Giant Mixed strain similar in habit and earliness to Chau- baud Giant Improved but with extra large flowers. The flowers are at least one-third larger than Chabaud Giants. Very double and strongly clove scented... ¼ oz., \$0.80		3.00
★ Vaughan's Special Mixture □	¼ oz., 1.65	6.00
Vienna Dwarf, Double ①, extra choice mixed.....	¼ oz., .50	1.60	22.00
Professor Malmgreen, gay brick red flowers, fine for cutting	¼ oz., 1.20	4.00
Cassia = ÷ Marylandica (Indian Senna), racemes of showy yellow flowers, 30 inches.....	¼ oz., .55	2.00
Castor Oil Bean, see Ricinus. Cat Mint, see Nepeta.			
Catananche ① Coerulea, blue, with dark eye, everlasting, 30 in.		1.00	14.00

CELOSIA □

Childsii (Chinese Wool Flowers), Crimson, 2 feet.....		.80	8.00
Deep Rose80	8.00
Yellow.80	8.00
Mixed80	8.00
Cristata (Coxcomb) Tall Crimson, 24 inches.....		.60	6.00
★ Tall Royal Velvet, richest carmine or crimson, foliage bronze- green with reddish margins.....		.80	8.00
Tall sorts, mixed, 24 inches.....		.50	5.00
Tall Crimson Glory, brilliant cherry-red overlaid with silver. Leaves bright green		1.25	16.00
Nana Aurea, dwarf golden, 12 inches.....		1.40
Empress, bright crimson combs, dark foliage, 12 inches.		.90	12.00
President Thiers (Glasgow Prize), dark crimson 12 inches90	12.00
Rosea, 12 inches.....		.90	12.00
Dwarf sorts, extra choice mixed, 12 inches.....		.80	8.00

CELOSIA—Continued

	Oz.	Lb.
Plumosa, Ostrich Plume, Crimson, 24 inches.....	\$0.90	\$9.00
Ostrich Plume, Orange, 24 inches.....	.90	9.00
Ostrich Plume, Scarlet, 24 inches.....	.90	9.00
Pride of Castle Gould. Compact pyramidal plants produce immense flower heads, resembling willow plumes in many shades. 24 inches..... ¹ / ₄ oz., \$0.35	1.20
* Lilliput Fire Feather, fine for pots, 1 foot.....	.90	12.00
Golden Feather, 1 foot.....	.90	12.00
*Mixed, 1 foot.....	.90	12.00
Thompsoni Magnifica, mixed, 24 inches.....	.80	8.00

CENTAUREA

	Oz.	Lb.
Americana □ (Basket Flower) lilac, handsome, 4 feet.....	\$0.40	\$4.00
Alba, white, 4 feet.....	.40	4.00

SUPER GIANT CENTAUREA CYANUS (Bachelors Buttons) □ 3 Feet

The flowers of these strains are large, fully double and colors intensified. Long stems for cutting.

	Oz.	Lb.
Black Boy, blackish maroon.....	\$0.30	\$3.00
Blue Boy, rich deep blue, very large flowers.....	.30	3.00
Pinkie, deep pink.....	.30	3.00
Red Boy, deep red.....	.30	3.00
Snowman, best white.....	.30	3.00
* Super Giant, Vaughan's Mixture of New Varieties.....	.30	3.00
Cyanus (Corn Flower).		
Double Jubilee Gem, vivid blue flowers, 12 inches.....	.50	5.00
Polar Gem, a new white, same habit as Jubilee Gem, 1 foot.....	.90	10.00
Mixed, all colors.....	.25	2.50
Jubilee Type Mixed, similar in habit to Jubilee Gem and Polar Bear, in a fine range of color.....	1.50	20.00
Candidissima, silvery foliage, 1½ feet.....	2.20	30.00
Dealbata Rose Delight, ① Rose flower, silvery leaf, 18 inches.....	.70	7.00
Gymnocarpa + ÷ silvery foliage, 24 inches.....	.50	5.00
Imperialis □ (Giant Sweet Sultan) Amaranth, 3 feet.....	.70	7.00
Brilliant Rose.....	.70	7.00
Deep Lavender.....	.70	7.00
Splendens, purple.....	.70	7.00
White, pure.....	.70	7.00
Mixed.....	.70	7.00
Macrocephala ① golden yellow, 36 inches.....	.60	6.00
Montana ① corn-flower-blue, large flowers, 24 inches.....	.50	5.00
Moschata □ mixed (Sweet Sultan), 32 inches.....	.50	5.00
Suaveolens □ (Sweet Sultan), canary-yellow, 2 feet.....	.80	8.00
* Vaughan's Special Mixture, including all the annual sorts.....	.50	5.00
Perennial Sorts, mixed ①..... ¹ / ₄ oz., \$0.50	1.80
Centranthus □ Macrocephala, mixed 1-2/3 ft.....	.20	2.00
Cerastium ① Tomentosum (Snow in Summer), silvery white foliage, white flowers, 16 inches.....	.60	6.00
Chamomile. see Anthemis.		
Chalk Plant. see Gypsophila.		

Cheddar Pink, see *Dianthus Caesius*.

Cheiranthus Allioni ① # (<i>Siberian Wallflower</i>), orange, 18 inches	Oz.	Lb.
	\$0.35	\$3.50
Allioni, Golden Bedder, large deep golden yellow, 1½ feet.	.35	3.50
Kewensis ① □ (<i>Winter-blooming Wallflower</i>), fragrant flowers, sulphur passing to golden and violet, 30 inches	¼ oz., \$0.50	1.80
Linifolius □ (<i>Alpine Wallflower</i>), lilac, 1 foot.....	.80

Maritimus, see *Virginia Stocks*.

Chilean Bellflower, see *Nolana*.

Chinese Lantern Plant, see *Physalis*
Franchetti.

Chimney Bells, see *Campanula*

Chinese Money Plant, see *Lunaria*.

Pyramidalis.

Chinese Wool Flower, see *Celosia*

Chinese Bellflower, see *Platycodon*.

Chinese Forget-me-nots, see *Cynoglossum Amabile*.

Childsii.

CHRYSANTHEMUM

	Oz.	Lb.
Carinatum □ Single mixed	\$0.25	\$3.00
Double Mixed40	4.00
Vaughan's Rainbow Mixture, a surprising blend of entirely new shades and color combinations in Annual Chrysanthemums30	3.00
Coronarium □ Double Mixed, 4 feet.....	.30	3.00
Inodorum □ Bridal Robe, pure white, extra double, 20 inches	¼ oz., \$0.30	1.00
Snowball. Extra double, dwarf white, 20 inches..	¼ oz., .40	1.40
*Korean Hybrids, Early Flowering Hybrids	¼ oz., \$2.75; ½ oz., 1.50	10.00
Leucanthemum ① □ King Edward, white with yellow disk40	4.00
Conqueror (Victor) giant flowered; giant white, 2 to 3 feet.. See also Daisy Shasta.	.70	7.00
Segetum Eastern Star20	2.20
Mixed40	4.00
Vaughan's Special Double and Single Mixed, annual sorts.....	.50	5.00
Vaughan's Special Mixed Single, annual sorts.....	.50	5.00

CINERARIA HYBRIDA + ÷ #

Hybrida Grandiflora , Extra Choice Mixed.....	40.00
.....	½ oz., \$1.75; ⅞ oz., \$3.00	
Hybrida , All Varieties Mixed.....
.....	½ oz., 4.20; ¼ oz., 8.00	
*Cremer's Prize Mixture, re-selected 22 inches.....	32.00
.....	⅞ oz., \$2.50; ½ oz., \$4.50	
Vaughan's Columbian Mixture, contains the best large flowering types and colors as well as Cremer's, Potsdam, Siter's and Gold Center strains.....
.....	½ oz., \$2.40; ⅞ oz., \$4.25; ½ oz., \$8.00	
Berlin Market (Potsdam or Weissensee) mixed, full bouquets of medium-sized flowers in rich colors, perfect market plants	32.00
.....	⅞ oz., \$2.50; ½ oz., \$4.50	
Multiflora Nana , mixed, 10 inches... ..	32.00
.....	⅞ oz., \$2.50; ½ oz., \$4.50	
Gold Center
.....	⅞ oz., \$2.50; ½ oz., \$4.50	

CINERARIA—Continued

	Oz.	Lb.
Siter's Rainbow Mixture, immense flower heads of medium sized blooms, bright edged types, small leaves..... $\frac{1}{8}$ oz., \$2.50; $\frac{1}{2}$ oz., \$4.50	\$32.00
Stellata Feltham Beauty. Beautiful mixture of many colors. $\frac{1}{4}$ oz., \$1.75; $\frac{3}{8}$ oz., \$3.00
Cineraria + \div Maritima Diamond, leaves pure white, 16 inches. Maritima Candidissima, 16 inches.....	.40 .40	\$4.00 4.00
Cinquefoil , see <i>Potentilla</i> .		
Clarkia <input type="checkbox"/> Elegans Double, Albatross, pure white, 2 feet.....	.50
Brilliant, double bright carmine.....	.50
Firebrand, brightest scarlet.....	.50
Illumination, orange and rose.....	.50
La France, salmon pink.....	.50
Mayblossom, glowing rose.....	.50
Orange King, bright salmon orange.....	.50
Purple Prince, rosy purple.....	.50
Queen Mary, carmine.....	.50
Salmonea Perfecta, the best salmon.....	.50
Scarlet Queen, glowing scarlet.....	.50
White Prince50
Elegans double mixed40	4.00
* Vaughan's Special Mixture.....	.50	5.00
Cleome Pink Queen <input type="checkbox"/> 3 feet, tall and attractive border plant with huge heads of a refreshing pink without trace of blue or magenta.....	1.00	10.00
Helen Campbell, large glistening pure white flowers, slightly earlier to bloom than Pink Queen and with larger flower-head.90	12.00
Lutea, rich golden yellow flowers, 8 feet.....		
Clove Pink , see <i>Dianthus Plumarius</i> .		
Cluster Pink , see <i>Dianthus Hyb. Atrococcineus</i> .		
Cobaea <input type="checkbox"/> = Scandens (Cathedral Bells), violet, climber.	1.25	16.00
Cockscomb , see <i>Celosia Cristata</i> .		
Coix Lachrymae <input type="checkbox"/> (Job's Tears).....	.15	1.80
Coleus + Vaughan's Rainbow Mixture.....		
..... $\frac{1}{8}$ oz., \$1.00; $\frac{1}{4}$ oz., \$1.75	6.00
Glory. A mixture of bronze, pink, apricot shades, cream, etc. A remarkably fine strain; it is unequalled for the beautiful form and its large leaves..... $\frac{1}{8}$ oz., \$1.25; $\frac{1}{4}$ oz., \$2.00	7.00
Large Leaved Mixed $\frac{1}{8}$ oz., \$1.00; $\frac{1}{4}$ oz., \$1.50	5.00
Collinsia mixed <input type="checkbox"/> for cutting or edging, 1 foot.....	.20	2.00
Columbine , see <i>Aquilegia</i> .		
Coneflower , see <i>Rudbeckia</i> .		

	Oz.	Lb.
Convolvulus Major □ = (Morning Glory). ★ Crimson Rambler , true Convolvulus that really climbs. The flower is a good crimson, very free flowering.....	\$0.20	\$2.00
Major mixed, all colors.....	.15	1.50
Minor, Dwarf, mixed, 12 inches.....	.15	1.50
Pink, free flowering, for edges and borders.....	.80	8.00
Royal Ensign , a deep bright ultramarine blue, with a white halo and a yellow throat, excellent for edgings	80	8.00
Coral Bells , see Heuchera. Coral Vine , see Antigonon.		
Cordyline , see Dracaena.		
Coreopsis ① □ (Tickseed) Lanceolata Grandiflora , yellow, 3 feet.	.30	3.20
Double New Gold, very choice, 3 feet.....	.40	4.00
Mayfield Giant , taller than type, flowers larger, 40 inches..	.40	4.40
Corn Flower , see Centaurea. Corn Flower Aster , see Stokesia.		
Corn , Ornamental Squaw, multi-colored kernels..... 10 lbs., \$5.0060
Strawberry. While this is really a "Pop Corn" and a very good one at that, its charm is in its attractive effect of the tiny ears which are only 2 inches long and 1½ inches wide and are a rich and shiny mahogany color, not unlike a gigantic strawberry. They are enclosed in straw-colored husks which may be bent back showing the ear.....	.30	3.00
Cosmos □ Giant Flowered , 4 to 5 feet, mixed.....	.25	2.50
Double Extra Early White (Whirlwind), 32 inches. ¼ oz., 50c	1.60
Pink (Peachblossom) ¼ oz., 50c	1.60
Red (Carnelia) ¼ oz., 50c	1.60
Mixed	1.20	16.00
Fiesta, new, gold striped scarlet.....	2.20	28.00
Orange Flare, orange blooms in four months, 16 inches...	.40	4.40
Orange Ruffles, semi-double.....	.40	4.40
Yellow Flare, a rich butter yellow, an excellent companion to Orange Flare, 3 to 4 feet.....	.40	4.40
Mammoth Early Flowering Crimson, 32 inches.....	.40	4.40
Pink40	4.40
White40	4.40
Mixed30	3.20
Sensation, mixed, mammoth fluted flowers, blooms ten weeks after sowing, 54 inches.....	.40	4.00
Dazzler, very rich deep amaranth crimson.....	.50	5.50
★ Pink, special selection50	5.50
Radiance, soft rose with deep crimson zone.....	.50	5.50
★ White, special selection50	5.50

Cowslip, see Primula Veris.

Creeping Baby's Breath, see Gypsophila Repens

	Oz.	Lb.
Cuphea □ Avalon Hybrids..... ¼ oz., 60c	\$2.00
Firefly, deep rosy scarlet, deepening to almost purple, early flowering, 16 inches	1.25	\$16.00
Cupid's Car. see Aconitum.		
Cut Flower Mixture of Annuals35	3.40

CYCLAMEN PERSICUM GIGANTEUM + ÷ 1 Foot

Our Cyclamen seed is American and European grown by most careful and experienced growers.

We supply 25C seeds of one variety at the 1000 rate.



	Seeds Per 1000	Seeds Per 100
Baardse's Wonder, salmon with white border.....	\$14.00	\$1.00
Bonfire, brilliant salmon.....	12.00	1.25
Bright Red	12.00	1.25
Dark Blood Red.....	12.00	1.25
Dark Salmon (Glory of Wandsbek or Pearl of Zehlendorf).....	12.00	1.25
Fringed White	12.00	1.25
Lavender	12.00	1.25
Light Salmon (Rose of Zehlendorf).....	12.00	1.25
Mozart, deep pink.....	12.00	1.25
Orange Beauty	12.00	1.25
Pink Pearl, salmon pink.....	12.00	1.25
Pure Rose	12.00	1.25
Pure White	12.00	1.25
Saffron Red Silver Edge.....	12.00	1.25
Salmoneum Oculatum	12.00	1.25
Salmon Rose Improved.....	12.00	1.25
Salmon Scarlet (America Improved).....	12.00	1.25
Soft Rose with Carmine Eye (Rose of Marienthal Improved)....	12.00	1.25
Victoria Improved, fringed light salmon, with brighter salmon eye..	12.00	1.25
White with Carmine Eye.....	12.00	1.25
New Ruffled, mixed	12.00	1.25
Vaughan's Florist, mixed	12.00	1.25
Persicum Giganteum, mixed.....		
..... ¼ oz. \$14.00. ⅛ oz. \$7.50; oz. \$50.00		

CYCLAMEN—Continued

	Oz.	Lb.
Cyclamen Europaeum ① Flowers fragrant, mostly deep rose....		
..... ½ oz., \$2.00; ¼ oz., \$1.25
Cynoglossum Amabile □ (Chinese Forget-me-not), sweet scented, ultramarine-blue, 2 feet.....	\$0.20	\$ 2.20
Amabile Blue Bird , fine bright blue, 18 to 24 inches.....	.60	6.00
Firmament , rich blue flowers, dwarf, 15 to 18 inches....	.30	3.00
Pink , 2½ feet.....	.50	5.00
Cyperus Alternifolius (Umbrella Plant), ornamental grass	¼ oz., 50c	1.60
Cypress Vine = □ (Ipomoea Quamoclit).		
Scarlet90	10.00
White50	5.00
Mixed50	5.00
* Hybrida (Cardinal Climber, Ipomoea Sloteri).....	.90	10.00

DAHLIA ① □

Double Large Flowering Mixed , 36 inches.....	1.25	16.00
Cactus Flowered Best Mixed ½ oz., \$2.75; ¼ oz., \$1.50	5.00
Double Mixed , good quality.....	1.00	14.00
Selecta , an extra choice strain..... ¼ oz., \$1.50	5.00
Lilliput (Pompon) Small flowered, special mixed ¼ oz., 1.25	4.00
Zulu Mixed , black leaved dwarf double hybrids, flowers vari- ous shades of crimson and scarlet; also some orange- golden and lilac.	1.00	14.00
Single Giant Perfection , mixed, 4 feet.....	.60	6.00
Coltness Scarlet , 18 inches.....	.90	10.00
Yellow90	10.00
Hybrids mixed70	7.00
Unwin's Dwarf Hybrids , semi-double dwarf, many attractive shades, 2 feet.....	1.00	10.00
Unwin's Dwarf Hybrids , Extra Select Strain, 18 to 24 inches....	1.25	16.00
Ideal Bedding , mixed double and semi-double flowers with twisted petals, many charming shades, 18 to 24 inches ¼ oz., 50c	1.50
Daisy , ① Shasta, Alaska , best white, 40 inches.....	.60	6.00
Shasta Giant Double ½ oz., \$1.00; ¼ oz., \$1.75	6.50
Marconi Reselected, the largest Shasta Daisy today, the flowers are around seven inches in diameter and stems 2½ to 3 feet long..... ½ oz., \$1.00; ¼ oz., \$1.75	6.50
Hybridum Shasta Daisy , pure white early flowering spring Marguerite40	4.00
Datura □ (Angel's Trumpet—Trumpet Flower), Double Mixed....	.60	6.00
Double white , 40 inches.....	1.50	20.00

Delphinium

	Oz.	Lb.
Belladonna, light blue, 4 to 5 feet.....	\$0.80	\$8.00
Light Blue Improved, 4 to 5 feet.....	1.80	24.00
Bellamosum, dark blue, 4 to 5 feet.....	1.00	14.00
Improved, large deep blue flowers, 5 feet.....	1.80	24.00
Cardinale, scarlet, 30 inches..... ^{1/4 oz., 50c}	1.80
Chinese Album Grandiflorum, white, 3 feet.....	.80	8.00
Coeruleum, gentian-blue, 36 inches.....	.80	8.00
Azure Fairy, soft azure-blue, 20 inches.....	.80	8.00
Blue Mirror, bright navy-blue flowers with no spurs 1½ to 2 feet..... ^{1/4 oz., 50c}	1.60	22.00
Cambridge Blue, azure or sky blue, 36 inches.....	1.20	16.00
Mixed (the tall vars.).....	.80	8.00
Elatum Hybridum Lamartine, rich deep blue with pure white eye..... ^{1/4 oz., \$0.60}	2.00	28.00
Blackmore and Langdon Hybrids, a special fine strain.....	1.60	22.00
Gold Medal Hybrids, an extra choice strain.....	1.00	12.00
Wrexham Strain, mixed (Hollyhock Delphinium), 6 feet.....	2.00	28.00

PACIFIC GIANT (Vetterle and Reinelt) 5 to 6 Feet

This strain produces plants that are 60 to 65 per cent mildew resistant. The flowers are of immense size, tightly set on straight stems that are strong and whippy. The flowers **do not shatter** and represent a truly outstanding addition to the cut flower market.

	Oz.	Lb.
Black Knight Series. Deep mid-night violet, the darkest of all..... ^{1/8 oz., \$1.00; 1/4 oz., \$1.75}	\$6.00
Blue Bird. Clear medium blue with white bee, huge tall spikes ^{1/8 oz., 1.00; 1/4 oz., 1.75}	6.00
Blue Jay. Brilliant true medium blue with dark bee. ^{1/8 oz., 1.00; 1/4 oz., 1.75}	6.00
Cameliard Series. This is a pure lavender self, with white bee. ^{1/8 oz., 1.00; 1/4 oz., 1.75}	6.00
Galahad Series. Clear white of enormous size, averaging three inches in diameter of individual flowers with glistening texture ^{1/8 oz., 1.00; 1/4 oz., 1.75}	6.00
Guinevere. Light pink lavender self with white bee. ^{1/8 oz., 1.00; 1/4 oz., 1.75}	6.00
King Arthur. Brilliant royal violet with large white bee. ^{1/8 oz., 1.00; 1/4 oz., 1.75}	6.00
Percival, white with contrasting black bee. ^{1/8 oz., 1.00; 1/4 oz., 1.75}	6.00
Summer Skies. Clearest light blue with white bee. ^{1/8 oz., 1.00; 1/4 oz., 1.75}	6.00
Round Table Series. As the name implies, this represents all of the color combinations of the above Knights and their Ladies. ^{1/8 oz., 1.00; 1/4 oz., 1.75}	6.00
Pacific Giant Clear White. Individual florets 2 to 2½ inches in diameter. Well placed on large well balanced spikes. Clear glistening white with heavy texture. Not Mildew resistant. ^{1/4 oz., 1.50}	5.00

DELPHINIUM PACIFIC GIANT—Continued

	Oz.	Lb.
Pacific Giant Dark Blue Shades.....	¼ oz., \$1.50	\$5.00
Pacific Giant Lavender Pastel Shades. Color range from light lavender to deep smoky lavender, generally of two tone combinations with brown or black bees.....	¼ oz., 1.50	5.00
Pacific Giant Light Blue Shades.....	¼ oz., 1.50	5.00
Pacific Giant Mixed.....	¼ oz., 1.25	4.00

DIANTHUS—Pinks

	Oz.	Lb.
Allwoodii ① Mixed. Hybrid between Carnation and Pink. Blooms first year from seed.....	¼ oz., \$0.90	\$3.00
Alpinus ①, mixed colors, 9 in., rock plant.....	¼ oz., .90	3.00
Arenarius (Sand Pink) ①, white, fringed, 1 foot.....	
Barbatus, see Sweet William.		
Caesius ① (Cheddar Pink), flesh, 6 in.....	¼ oz., .40	1.40
Chinensis fl. pl. □ Double Chinese, mixed, 16 inches.....	.40	4.00
Single, extra choice mixed, 16 inches.....	.40	4.00
Chinensis X Barbatus □ ① single annual Sweet William....	.80	8.00
Deltoides (Maiden Pink) ①, rosy magenta, 8 inches.....	
Brilliant, rose-tinted magenta, 8 inches.....	¼ oz., .90	3.20
Erecta, Red
Heddensis Westwood Beauty, Red Shades. This is the result of a cross between Dianthus Heddewigii and Dianthus Chinensis, combining the large open flowers of Heddewigii and the long stems of Chinensis. Flowers single, 1½-2¼ inches, deeply lacinated. The color is somewhat variable in red shades of crimson and scarlet, some having attractive white edgings..	.80	8.00
Heddensis, Finest Mixed. An entirely new tetraploid variety combining the large open flowers of Dianthus Heddewigii with the rugged growth and long stemmed habit of Dianthus Chinensis. Well-formed 2 in. flowers in large numbers on 16 in. stems, suitable for cutting. All the traditional Dianthus colors in this new variety.....	.70	7.00
Heddewigii □ fl. pl. double, choice mixed, 12 inches.....	.50	5.00
Brilliant, large florets in rich colors of crimson, cerise, pink and white, many with dark eyes. Free flowering with good stems for cutting.....	1.00	10.00
Fireball, double, brilliant dark scarlet.....	.90	10.00
Single varieties, choice mixed.....	.40	4.00
Hybridus Latifolius Atro-coccineus pl. ① double scarlet.....	.90	12.00
Loveliness ① the flowers have large lacinated petals of a most exquisite mauve-pink, fragrant.....
Laciniatus □ Gaiety, large, showy fringed flowers in a wide color range80	8.00
Double Gaiety. A fully double form of the popular D. Gaiety, with large showy fringed flowers in a wide range of color.	.80	8.00
Salmoneus (Salmon Queen), single salmony-scarlet, 8 inches..	.80
Snowball, double white90
Single Fringed, choice mixed, 1 foot.....	.40	4.40
Double Fringed, mixed, 1 foot.....	.50	5.00

DIANTHUS—Continued

	Oz.	Lb.
Segueri □ big bushy plants long-laden with large notch-petalled blossoms that may be anything from soft pink to deep carmine, usually marked with maroon circles and white dots. Blooms from mid-July until well into autumn..... ¼ oz., 50c	\$1.80
Vaughan's Special Mixed, Double and Single Pinks.....	.70	\$7.00
Vaughan's Special Mixture, Single Pinks.....	.60	6.00
Vaughan's Special Mixture, Double Pinks.....	.70	7.00
Plumarius ① (Clove Pink) Cyclops, Red Hybrids, red and rose..	.90	10.00
Fl. Pl., double mixed, 20 in.....	1.25	16.00
★ Highland Rose Hybrids, clear rose with deeper zone of various red shades, 9 inches..... ¼ oz., .60	2.00
Single, mixed, 20 inches.....	.60	6.00
Double and Single, mixed.....	1.25	16.00
Nanus, Fl. Pl., early flowering, mixed, 10 in... ¼ oz., 60c	2.00
★ Spring Beauty, a mixture of extra double giant flowered pinks in a splendid color-variation.....	1.50	20.00
Scoticus, Double Scotch, mixed self colors of various tints of pink, rose, salmon and white, the same colors in combination with a bright crimson zone. 16 inches	¼ oz., .60	2.00
Semperflorens, double mixed, 20 inches.....	1.00	14.00
★ Plumarius Vaughan's Special Mixture..... ¼ oz., .70	2.40	...
Best Rock Varieties, ①, mixed..... ¼ oz., 1.25	4.00
Sweet Wivelsfield □, Single Mixed.....	.60	6.00
Sweet Wivelsfield, Double mixed.....	1.25	16.00
★ Winteri ① the flowers are of bold form, pure colors, habit compact and flowers first year from seed, deliciously scented, ideal rock plant, 12 inches.....
Dicentra , see Dielytra.		
Dictamnus ① Fraxinella (Gas Plant—Burning Bush), pink, 30 inches	¼ oz., 35c	1.25
Fraxinella Albus, white, 30 inches..... ¼ oz., 35c	1.25
Mixed	¼ oz., 35c	1.25
Dictamnus seeds germinate very slowly and unevenly.		
Didiscus □ Coeruleus (Lavender Lace Flower), blue, 2 feet60	6.00
Dielytra ① Eximia, dwarf type, effective rock plant... ¼ oz., .80	2.80
Digitalis (Foxglove Fairy Thimble)		
Gloxiniaeflora, # spotted flowers, mixed, 4 feet.....	.50	5.00
The Shirley, large-flowered mixed, 4 feet.....	.70	7.00
Pastel Shades. Distinctly new pastel tints of pink, apricot, buff, rose and heliotrope.....	1.00	14.00
Grandiflora (Ambigua), chrome-yellow marked with brown, 36 in.80
Purpurea, Monstrosa mixed80
★ Vaughan's Special Mixture..... ¼ oz., 40c	1.40
Dimorphotheca □ Aurantiaca (Orange or African Daisy—Cape Marigold), glossy orange-golden flowers, 12 inches.....		
Aurantiaca New Hybrids.....	.80	8.00
Salmon Beauty, soft salmon pink..... ¼ oz., 40c	1.40
White Beauty	¼ oz., 40c	1.40
Ecklonis (Peacock's Eye), white with blue disc, 2 ft.	¼ oz., 65c	2.20
Glistening White, the petals of the daisy-like flower glisten like white enamel, 6 to 8 inches.....	1.50	20.00
Golden West, bright yellow, orange center... ¼ oz., 40c	1.40

	Oz.	Lb.
Dolichos □ = (Hyacinth or Bonavist Beans), mixed.....	\$0.10	\$1.00
Princess Helen (Daylight), pure white.....	.20	2.40
Soudanensis (Darkness), rose-purple.....	.20	2.40
Lignosus +, Australian Pea Vine, purple.....	.90	10.00
Doronicum ① <i>Caucasicum Magnificum</i> , Gerbera-like flower of clear yellow. ¼ oz., \$2.50	8.00
Dracaena ÷ <i>Indivisa</i> . Ornamental leaved plants.....	.30	3.00
Dracocephalum □ <i>Moldavicum</i> , 2 ft., lavender bee plant.....	.20	2.20
Echinops ① <i>Ritro</i> (Globe Thistle), violet, 5 feet..... ¼ oz., .60	2.00
Edelweiss ① (Lions' Foot <i>Leontopodium Alpinum</i>), flowers white and star shaped, both flowers and leaves are wooly, 6 inches ¼ oz., \$1.20	4.00
Emerald Feather , see <i>Asparagus Sprengeri</i> .		
Emilia Flammea , see <i>Cacalia</i> .		
English Daisy , see <i>Bellis</i> .		
Erinus ① <i>Alpinus</i> (Roman Wallflower), dark blue 6 inches ⅛ oz., 1.50
Eryngium ① <i>Planum</i> , dark blue, 4 ft.....	1.20
<i>Amethystinum</i> , amethyst blue, 3 ft.....	.80
Erysimum □ <i>Perofskianum</i> (Fairy Wallflower), orange, 2 feet....	.20	2.20
<i>Golden Gem</i> (<i>Dwarf Compact</i>), golden-yellow, early blooming	.90
ESCHOLTZIA (California Poppy) □		
Californica. Dwarf Erecta Varieties, 1 foot.		
<i>Ramona Hybrids</i> , a good bright mixture.....	.60	6.00
Californica, Spreading Varieties, 1 foot.		
<i>Aurantiaea</i> , orange.20	2.20
<i>Carmine King</i> , crimson-carmine.....	.30	3.00
<i>Chrome Queen</i>30	3.00
<i>Golden West</i> , yellow orange center....	.20	2.20
<i>Mandarin</i> , inside of petals orange, outside scarlet.....	.20	2.20
<i>Mikado</i> , orange-crimson30	3.00
<i>Purple Glow</i> , reddish purple.....	.30	3.00
<i>Vesuvius</i> , fiery orange-red.....	.30	3.00
Double and Semi-Double Varieties.		
<i>Mixed</i>60	6.00
<i>Monarch Art Shades</i> , double, 1 foot.....	.90	10.00
<i>Mixed</i> , many colors20	2.20
<i>Vaughan's Special Mixture</i>60	6.00
Hunneemannia (<i>Bush Escholtzia</i>), yellow, 18 inches.....	.60	6.00
Eulalia ① <i>Japonica</i> (<i>Zebra Grass</i>).....	.90	10.00
Euphorbia <i>Heterophylla</i> □ <i>Mexican Fire Plant</i> , <i>Fire on the Mountain</i> or <i>Annual Poinsettia</i> , carmine, 36 inches.....	1.00	14.00
<i>Variegata</i> □ (<i>Snow-on-the-Mountain</i>), 24 inches.....	.40	4.40
Corollata ① (<i>Wild Baby's Breath</i>), large white flowers, leaves turn a rich wine color in fall..... ¼ oz., \$1.50	5.00
Evening Glory , see <i>Ipomoea Bona Nox</i> .		
Evening Primrose , see <i>Oenothera</i> .		
Evening Scented Stocks , see <i>Matthiola</i>		
Everlasting Flowers □ mixed, many kinds.....	.60	6.00
Everlasting Flowers , see <i>Acroclinium</i> , <i>Echinops</i> , <i>Gomphrena</i> , <i>Gypsophila Paniculata</i> , <i>Helichrysum</i> , <i>Lunaria</i> , <i>Physalis</i> , <i>Rhodanthe</i> , <i>Statice</i> and <i>Xeranthemum</i> .		
Exacum ÷ □ <i>Affine</i> , light blue flowers, 6 inches.... ¼ oz., \$3.00

Everlasting Pea , see <i>Lathyrus Latifolius</i> .	Fire Cracker Plant , see <i>Cuphea</i> and <i>Salvia</i> .		
Fairy Thimble , see <i>Digitalis</i> .	Flax , see <i>Linum</i> .		
Fairy Wallflower , see <i>Erysimum Perofskianum</i> .	Flora's Paint Brush , see <i>Cacalia</i> .		
False Indigo , see <i>Baptisia Australis</i> .	Floss Flower , see <i>Ageratum</i> .		
False Lupin , see <i>Thermopsis</i> .	Flowering Sage , see <i>Salvia</i> .		
False Sunflower , see <i>Heliopsis</i> .	Forget-Me-Not , see <i>Myosotis</i> and <i>Cynoglossum Amabile</i> .		
Farewell to Spring , see <i>Godetia</i> .	Fountain Plant , see <i>Amaranthus</i> .		
Fennel Flower , see <i>Nigella</i> .	Four o'Clock , see <i>Marvel of Peru</i> .		
Feverfew , see <i>Matricaria</i> and <i>Pyrethrum Parthenifolium Aureum</i> .	Foxglove , see <i>Digitalis</i> .		
		Oz.	Lb.
Fire-on-the-Mountain (<i>Euphorbia Heterophylla</i>) 3 feet.....		\$1.00	\$14.00
Flowering Kale , decorative and colorful for garden or pots.....		.80	8.00
Freesia ① ÷ <i>Refracta Alba</i> , white, 12 inches.....		2.25	30.00
Rainbow Hybrids, colored varieties..... ¼ oz., 80c		2.80	44.00
Fuchsia □ ÷ <i>Lady's Ear Drops</i> , double and single mixed. ⅛ oz., \$10.00; ¼ oz., \$18.00; ½ oz., \$35.00	
Gaillardia (Blanket Flower).			
<i>Grandiflora</i> ① □, perennial varieties, choice mix, 3 feet....		.50	5.00
<i>Aurea Pura</i> , large pure yellow flower, long strong stem.		1.00	12.00
<i>Bremen</i> , coppery scarlet, yellow tip.....		.90	10.00
<i>Burgundy</i> , wine-red flowers, 2½ inches in diameter....		1.00	14.00
<i>Dazzler</i> , yellow with maroon center.....		1.00	12.00
<i>Goblin</i> , large yellow bordered red flowers, 12 to 15 inches		1.25	16.00
<i>Monarch Strain</i> , a robust strain very varied in coloring and with flowers of giant size and perfect form.....		.90	10.00
<i>Portola Hybrids</i> , shades of bronzy red, golden tipped, about 50 per cent true, 3 feet.....		.90	10.00
<i>Lorenziana</i> □ double mixed, 20 inches.....		.40	4.00
Double Sunshine, harmonious blending of giant annual gaillardias, ranging from almost red with slight though sharply contrasting yellow tipping to less and less red until some flowers are a pure self yellow, 2½ to 3 inches across, 2½-foot stems.....		.80	8.00
<i>Picta</i> □ single, mixed, yellow and copper-red, 20 inches... ..		.60	6.00
<i>Indian Chief</i> , deep coppery scarlet with a dark brown center, 12 inches80	8.00
Garden Heliotrope , see <i>Valeriana</i> .			
Gauze-Flower , see <i>Gypsophila Elegans</i> .			
Geranium (<i>Pelargonium</i>) ① <i>Zonale</i> , single, extra large flowering mixed, 1½ feet..... ¼ oz., \$1.00		3.50	48.00
<i>Flowerland Improved Hybrids</i> , single large flowered saved from named varieties and will provide a wide range of colors		¼ oz., \$1.70	6.00
<i>Newest Large Flowering Mixed</i> ¼ oz., .80		3.00	40.00
Gerbera , (<i>Transvaal Daisy</i>) + ÷ <i>Jamesoni</i> "Flowerland" strain, beautiful colors, 24 inches... ¼ oz., \$2.00; ½ oz., 3.50		12.00

	Oz.	Lb.
Geum ① Coccineum Fl. Pl. Mrs. Bradshaw, glowing red, 2 feet	\$1.50	\$20.00
Lady Stratheden (Golden Ball), yellow, double, 2 feet	1.50
Giant Spider Plant , see Cleome Pungens.		
Gilia □ Achillæefolia, light blue.....	.20	2.20
Capitata Reselected (Thimble Flower), corn flower blue, 30 inches.30	3.00
White20	2.20
Mixed20	2.20
Rubra (Ipomopsis Coronopifolia) 40 inches.....	2.00
Gilly Flower , see Stocks.		
Globe Amaranth □ (Gomphrena), 18 inches, mixed.....	.30	3.00
Globosa Rubra, 18 inches.....	.50	5.00
Buddy, dwarf and compact, bright reddish purple.....	.90	10.00
Globe Flower , see Trollius.		
Globe Thistle (Echinops Ritro) 5 feet	1/4 oz., \$0.60	2.00
Gloxinia ÷ □ Vaughan's Columbian Mixture.....	1/8 oz., 8.00
Spotted and Stained, mixed.....	1/4 oz., \$2.25; 3/2 oz., 4.00
Robusta Grandiflora	1/4 oz., 1.75; 3/2 oz., 3.00
Fine mixed	1/8 oz., 5.00

GODETIA □

Tall Double Grandiflora, 2 feet		
Gladiola-like flowers in long trusses; excellent for cutting,		
Mixed	\$0.50	\$5.00
Carmine60
Rose60
Rosy Morn, deep rose.....	.60
Upright Single, 16 inches		
Duke of York, rich scarlet on white.....	.60	6.00
Kelvedon Glory, glowing salmon-orange.....	.90	10.00
Sybil Sherwood, bright salmon-pink softened by indefinite edging of white90	10.00
Dwarf Compact Single		
Rosamond, vivid rose with white, 9 inches.....	.60
Dwarf Double Azalea Flowered		
Sybil Sherwood, double, 14 inches.....	.90
Dwarf Single Sorts, Mixed, 1 foot.....	.60	6.00
Dwarf Double, Mixed	1.00	14.00

Gold Dust , see Alyssum Saxatile Compactum.	Golden Flower of the Incas , see Tithonia.
Golden Feather , see Pyrethrum Parthenifolium.	Golden Marguerite , see Anthemis Kelseyii.
Gomphrena , see Globe Amaranth.	

GOURDS—Ornamental □ =

SMALL FRUITED		Oz.	Lb.
Apple-shaped		\$0.40	\$4.00
Bottle, Miniature40	4.00
Flat Striped, flat, round green and white stripes.....		.40	4.00
Nest Egg, practical nest eggs.....		.40	4.00
Orange, the well-known Mock Orange.....		.40	4.00
Pear-Shaped, green and white.....		.40	4.00
Pear-Shaped, striped yellow and green.....		.40	4.00
Pear-Shaped, white40	4.00
Spoon, small ball-shaped fruit with slender necks, deep orange. By slicing off a side a satisfactory spoon is made.....		.40	4.00
Warted, all shapes40	4.00
Small Fruited Varieties, mixed.....		.40	4.00
LARGE FRUITED			
Bottle. Large, the original Thermos bottle. Makes fine bird houses.		.40	4.00
Calabash or Pipe Gourd, fruit is used in making pipes.....		.40	4.00
Cave Man Club, Maranka or Dolphin, knobby, club-shaped, green.		.40	4.00
Dipper, fruit makes an excellent dipper and may be used for birds' nests40	4.00
Dishcloth or Towel, fruit is made up of a spongy-like porous pulp, which may be dried and used as a sponge.....		.40	4.00
Hercules' Club, fruit grows 3 to 4 feet long.....		.40	4.00
Turk's Turban, brightly colored.....		.40	4.00
Large-Fruited Sorts, mixed30	3.00
Vaughan's Special Mixture, all shapes and sizes of these interest- ing fruits are included in this mixture.....		.40	4.00
All Kinds Mixed40	4.00
—————			
Gray Catmint , see Nepeta.			
Greek Mallow , see Sidalcea.			
Grevillea ÷ Robusta (Silk Oak).....		1.25	16.00
Gymnothrix ÷ Latifolia, effective for bouquets.....		1.25	16.00
Gypsophila Elegans □ Alba Grandiflora, London Market flow- ers much larger than those of G. elegans, 8 to 9 over- lapping petals, 18 inches.....		.5 lbs., \$4.50	.10 1.00
Alba Grandiflora, Special Florist Strain.....		.5 lbs., 7.50	.15 1.60
Carminea, vivid rose, 18 inches.....		.20	2.20
Crimson, 18 inches20	2.20
Mixed, 18 inches20	2.00
* Oldhamiana ① the buds are first almost white but open a lively shade of pink that darkens as the flowers mature. Each individual flower measures slightly more than one- quarter of an inch in diameter, 42 inches.....		1.40	18.00
Pacifica ① tiny pink flowers, 4 feet.....		¼ oz., 70c	2.40 30.00
Paniculata ① (Chalk Plant), fine perennial white, 42 inches..		.30	3.20
Compacta, small white flowers borne in great profusion. 2 to 3 ft.....		¼ oz., \$0.60	2.00
* Snow White, double white, 36 inches.....		¼ oz., .70	2.50 36.00
Repens ① (Creeping Baby's Breath), white, 6 inches.....		.90	12.00
Rosea, light rose, 6 inches.....		.90	12.00
Helenium ① Riverton Gem, crimson and old gold... ¼ oz., \$0.80		3.00

	Oz.	Lb.
Helianthemum ① (Sun Rose), Mutabile, mixed, rock plant, 12 inches	\$1.00	\$12.00
Helianthus , see Sunflower.		
Helichrysum		
Monstrosum fl. pl. □ double mixed, 34 inches.....	.60	6.00
Vaughan's Special Mixture, from named sorts.....	.80	8.00
Canary Yellow		Rose Queen
Crimson		Salmon Queen
Fire Ball		Silver Ball
Golden Ball		Violet Queen
Each of above90	10.00
Tom Thumb Mixed, dwarf.....	.90	10.00
Heliotrope ÷ + □ Giant Flowered, mixed..... ¹ / ₄ oz., \$0.35	1.25	16.00
Regale Mixed (Dwarf)..... ¹ / ₄ oz., .60	2.00	28.00
Helipterum □ Sanfordii, yellow, everlasting, 12 in.....	.90	10.00
Helleborus ① Niger, Christmas Rose, 15 in.....	.90	10.00
Hesperis ① # Matronalis Alba (Sweet Rocket) white, 40 inches..	.30	3.00
Matronalis (Sweet Rocket) Red.....	.30	3.00
Mixed30	3.00
Heuchera ① Sanguinea Hybrida, mixed, 30 inches.....		
..... ¹ / ₈ oz., \$1.75; ¹ / ₄ oz., \$3.00	10.00
Sanguinea, crimson, 30 in..... ¹ / ₈ oz., 2.25; ¹ / ₄ oz., 4.00
Splendens, bright scarlet-crimson, true..... ¹ / ₄ oz., \$5.00; ¹ / ₈ oz., \$2.75
Hibiscus ① □ ÷ (Marsh Mallow), Giant Yellow or Sunset (Golden Bowl), 18 inches.....	1.00	12.00
Crimson Eye, white with red eye. 4 ft.....	1.00	12.00
Mallow Marvels, mixed, 4 feet.....	.90	10.00
Pink or Rose. 4 feet.....	.90	10.00
Red, 4 ft.90	10.00
Trionum, ivory dark violet center, 2½ feet..... ¹ / ₄ oz., 40c	1.40
Hollyhock ① Allegheny, Mammoth, best mixed, 8 feet.....	.50	5.00
Annual ★ Indian Spring, if sown in February will bloom freely in early August. It produces flowers of vary- ing attractive bright rose and rosy-carmine shades..	.60	6.00
Indian Summer, double flowers in a wide range of color. Blooms from seed first year, if sown early....	1.20	16.00
Chaters Double Triumph, waved and fringed flowers in art shades, 6 to 7 feet.....	1.20	16.00
Black, Special Stock.....	1.20	16.00
Cerise Beauty, a brilliant cerise selection out of Newport Pink.	1.20	16.00
Colorado Sunset (Queen of Sheba) buff yellow.....	1.20	16.00
Deep Rose	1.20	16.00
Deep Salmon Red	1.20	16.00
Imperator Improved Mixture (Begonia Flowered Crested), with frilled collar.....	1.20	16.00
Lilac Beauty	1.20	16.00
Maroon	1.20	16.00
Newport Pink	1.20	16.00
Palling Belle, silvery pink flowers.....	1.20	16.00
Salmon Rose	1.20	16.00
Scarlet, blood red	1.20	16.00
White	1.20	16.00
Yellow	1.20	16.00
Mixed. extra choice	1.00	12.00

	Oz.	Lb.
HOLLYHOCK —Continued		
Vaughan's Special Mixture, includes all the Doubles, and Emperor, etc.	\$1.00	\$14.00
Single Mixed50	5.00
Everblooming Annual, single mixed.....	.50	5.00
Everblooming Annual, double mixed.....	.40	4.00
Honesty , see Lunaria.		
Horned Violet , see Viola Cornuta.		
Humulus □ = Japonicus (Japanese Hop).....	.50	5.00
Hunnemannia □ Fumariaetolia (Bush Escholtzia), yellow, 18 inches		
Sunlite, semi-double60	6.00
Sunlite, semi-double80	8.00
Hyacinth Bean , see Dolichos.		
Iberis , see Candytuft.		
Impatiens □ ÷ Sultanii brilliant carmine.....		
..... 1/8 oz., 85c; 1/4 oz., \$1.50	5.00
Sultanii Hybrids	5.00
Beauty of Klettgau (new), flowers of fire-scarlet red, larger than other sorts. 1/8 oz., \$4.50; 1/4 oz., \$2.50; 3/8 oz., \$1.20
Nana Carmine, dwarf, free flowering.....
..... 1/8 oz., \$4.50; 1/4 oz., \$2.50; 3/8 oz., \$1.20
Hybrida Nana Mixed.....	1/8 oz., \$4.50; 1/4 oz., 8.00	30.00
Holstii □ ÷ ①, very fine, brilliant cinnabar, 18 inches.		
..... 1/8 oz., 85c; 1/4 oz., 1.50	5.00
New Hybrids	1/8 oz., 85c; 1/4 oz., 1.50	5.00
Incarvillea ① (Hardy Gloxinia) Delavayi, rosy carmine, 24 in.		
..... 1/4 oz., .90	3.00
Ipomoea □ = Blue Star, light sky blue accentuated by five deeper blue mid-ribs to form an attractive star.....		
Bona Nox (Evening Glory), large blue.....	.60	6.00
Bona Nox (Evening Glory), large blue.....	.30	3.30
* Clarke's Early Flowering Heavenly-Blue, pure sky-blue, white throat		
.....	.30	3.00
Columbia, the vines grow about 10 feet high and are covered with attractive foliage and produce many 3-inch trumpets of blue, edged bluish white with a reddish star.....		
.....	.60	6.00
Cornell, red with white border.....	.50	5.00
Crimson Rambler, flower a good crimson, willing climber..	.20	2.00
Darling, giant flowers in a brilliant shade of rose-cerise, with a sharply contrasting snowy white throat.....	.60	6.00
Giant Pink, Northern Light30	3.00
Noctiflora (Moonflower), white seeded.....	.25	2.40
Moonflower, black seeded.....	.25	2.40
Pearly Gates, satiny white with a creamy shading in the throat30	3.00
Quamoclit, see Cypress Vine.		
Rose Marie, rose pink, semi-double.....	.40	4.40
Imperialis, Best Fringed, mixed.....	.50	5.00
* Heavenly-Blue Improved, Early Flowering slightly later flowering, deeper blue than Clarke's.....		
.....	.30	3.00
* Scarlet O'Hara, flowers carnelian red, 3 1/2 inches across....	.50	5.00
Setosa (Brazilian Morning Glory), red, large flowered.....	.35	3.80
Mixed50	5.00
Iris ① Siberian, mixed, 3 feet.....		
.....	.50	5.00
Giant Bearded, large flowered "German" irises. Our seed is saved from a fine collection and seedlings show a remarkable range of color richness..... 1/4 oz., \$0.70		
.....	2.50
Isatis ① Glauca, yellow, tree blooming, 2 feet..... 1/4 oz., 40c		
.....	1.40

Jacaranda Mimosaeifolia □, a tree in subtropical regions with foliage as finely cut as a fern, symmetrical and elegant. Showy blue or violet flowers valuable in the north for conservatory decorations or subtropical bedding, 40 in.100 seeds, 30c; 1000 seeds, \$2.60		
Jack in the Bush , see <i>Nigella</i> .	Jerusalem Cross , see <i>Lychnis</i> .	
Jacob's Ladder , see <i>Polemonium</i> .	Joseph's Coat , see <i>Amaranthus</i> .	
Jerusalem Cherry , see <i>Solanum</i> .		Oz.
Job's Tears , (<i>Coix Lachrymae</i>).....		Lb.
Kalanchoe <i>Globulifera</i> <i>Coccinea</i> ÷ bright scarlet,		\$0.15
12 inches	1/8 oz., \$3.00	\$1.80
Kale Flowering , decorative and colorful plants for garden or pots.	
Kansas Gayfeather , see <i>Liatris Pycnostachya</i>
Kaulfussia Amelloides □, blue showy daisy flower, 15 in.....	1/4 oz., .80	8.00
.....	1/4 oz., .60
Kenilworth Ivy (<i>Linaria Cymbalaria</i>).....	
Kniphofia , see <i>Tritoma</i> .		
Kochia Childsii □ (Summer Cypress, Burning Bush), 40 inches....		.15
Lady in the Green , see <i>Nigella</i> .		1.50
Lagenaria , see <i>Gourds</i> .		
Lantana ÷ □ <i>Hybrida</i> , mixed, 30 inches.....		.70
Dwarf Hybrids70

LARKSPUR ① □

Supreme, an entirely new strain of Giant Imperial or base branching habit, with spikes of large fully double flowers, the colors of which are distinct and different from those of existing strains.		
Dark Blue Supreme, rich violet purple.....	.80	8.00
Lilac Supreme, a clear lilac.80	8.00
Pink Supreme, a clear rose pink.....	.80	8.00
Rose Supreme, rich deep rose.....	.80	8.00
Salmon Supreme, true salmon.80	8.00
White Supreme, a true white without a trace of pink.....	.80	8.00
Supreme Mixed, the above and others not yet offered.....	.80	8.00
Regal Rose, long spike of well-spaced florets in a rich rose. Of the popular base-branching habit, early.....	.80	8.00
The Giant Imperial branch from the base of the plant. They are ideal for cut flowers as the flower stems are 3 to 4 feet long.		
Giant Imperial, □ Blue Bell, medium blue, deeper than sky blue, lighter than lilac50	5.00
Blue Spire, intense Oxford-blue50	5.00
Brilliant Rose50	5.00
Carmine King, deep carmine rose.....	.50	5.00
Daintiness, delicate lavender50	5.00
Dazzler, a rich scarlet50	5.00
Deep Carmine King Improved, new very distinct improvement over Carmine King50	5.00
Exquisite Pink Improved, soft pink shaded salmon.....	.50	5.00
Gloria Improved, rich deep salmon rose pointed petals.....	.50	5.00
Lilac Spire, lilac.....	.50	5.00
Lilac King, rich lilac, fully double.....	.50	5.00
Los Angeles Improved, rosy salmon.....	.50	5.00
Miss California, deep pink on salmon ground.....	.50	5.00
Pink Perfection Improved, lively light pink, large double florets, excellent upright habit.....	.50	5.00

	Oz.	Lb.
LARKSPUR Giant Imperial—Continued		
Rosalind, rose suffused salmon.....	\$0.50	\$5.00
Sweet Lavender, lavender.....	.50	5.00
White King, glistening white with rounded broad petals....	.50	5.00
Mixed, all colors.....	.40	4.40
*Vaughan's Special Mixture Giant Imperial.....	.50	5.00
Stock Flowered Double Dark Blue, 3 to 4 feet.....	.50	5.40
Empress Rose, pink.....	.50	5.40
La France, salmon pink.....	.50	5.40
Lilac Supreme, deep lilac.....	.60	6.60
Lustrous Carmine (Newport Pink).....	.50	5.40
Rosamond, pure rose, early flowering.....	.50	5.40
Rose Queen, deep rose-pink.....	.50	5.40
Salmon Rose.....	.50	5.40
Sky-blue (Ageratum-blue).....	.50	5.40
White.....	.50	5.40
Mixed.....	.40	4.40
*Vaughan's Special Mixture.....	.50	5.40
Improved Giant Hyacinth-Flowered □. 3¾ feet.		
Dark Blue.....	1.00	14.00
Lilac.....	1.00	14.00
Pink.....	1.00	14.00
Purple.....
White.....	1.00	14.00
Giant Hyacinth Flowered Mixed, all colors.....	1.00	14.00
Super Majestic, huge double blossoms on long clean stems, 5 feet.		
Lavender.....	.50	5.00
Rose Pink.....	.50	5.00
White.....	.50	5.00
Deep Salmon Pink, new.....	.50	5.00
Super Majestic, mixed.....	.50	5.00
Vaughan's Special Mixture, tall, annual sorts.....	.50	5.40
<hr/>		
Lathyrus Latifolius ⊕ = (Everlasting Pea), mixed.....	.90	10.00
Latifolius, Pink Beauty, very fine, 6 feet.....	.90	12.00
Red, magenta, 7 feet.....	.90	12.00
White Pearl, 5 feet.....	.90	12.00
Lavatera + □ Albus Splendens, white, 30 inches.....	.80	8.00
Splendens Loveliness, glowing pink flowers, bronzy foliage.....	.80	8.00
Splendens, mixed.....	.50	5.00
Lavender Lace Flower □ (Didiscus Coeruleus), 2 feet.....	.60	6.00
Lavandula ⊕ Vera, true lavender..... ¼ lb., \$3.50	.90	10.00
Munstead Variety, early, 1 foot.....	1.80	24.00
Leptosiphon □ French Hybrids, 5 inches.....	.40	4.00
Leptosyne □ Golden Rosette, golden yellow, double, 16 inches....	1.00	12.00
Stillmani, golden yellow, 18 inches.....	.60	6.00
Leucanthemum. see Shasta Daisy and Chrysanthemum Maximum.		
Liatris ⊕ Spicata, purple rose, 20 inches..... ¼ oz., 60c	2.00
Pycnostachya (Kansas Gayfeather), purple, 5 feet.....	1.80	24.00
September Glory, 6 feet, purple flowers..... ¼ oz., 80c	3.00

	Oz.	Lb.
Lilium ① Formosanum Giant White.....	\$2.50	\$32.00
Regale (Regal Lily), pink outside, interior primrose-yellow, 4 ft.	1.00	12.00
Tenuifolium (Siberian Lily), coral-red, 20 inches. ¼ oz., \$0.60	2.00
Mixed ¼ oz., .90	3.20
Linaria Cymbalaria ① □ (Kenilworth Ivy) for hanging baskets and rockwork, 3 inches..... ¼ oz., \$0.60	2.00
Maroccana Excelsior □ mixed, 12 inches.....	.40	4.00
Fairy Bouquet, dwarf, large flowers in many new colors.	.50	5.00
Northern Lights, brilliant new colors which include clear white, bright yellows, blues and carmines combined with reds and bronzes with yellow lip.....	.60	6.00
Linum Collinum. ① Flower a lighter blue and dwarfier in habit than Narbonense. Free flowering..... ¼ oz., .50	1.80
Grandiflorum Rubrum □ (Scarlet Flax), 16 inches.....	.20	2.20
Narbonense ①, steel-blue, veined, 2½ feet.....
Heavenly Blue, flowers twice as large as the common Perenne and of a luminous ultramarine blue ¼ oz., .80	2.80
Perenne ①, blue, 30 inches30	.30	3.20
Flavum ①, yellow, fine, 12 inches..... ¼ oz., .40	1.50
Nanum Compactum, yellow, 6 inches..... ¼ oz., .40	1.50
Lisianthus ÷ Russellianus (Eustoma), rare gentianaceae, large deep purple flowers, 20 inches..... ⅞ oz., \$1.00	6.00
Lobelia Cardinalis ① (Cardinal Flower), scarlet, 3 feet. ¼ oz., .70	2.40	32.00
Erinus □ Gracilis Blue, light blue, light green foliage, 10 inches.....	.60	6.60
Alba white, 10 inches.....	.60	6.60
Speciosa, dark blue flowers and dark foliage, 10 inches.	.80
Mixed, the above.....	.80
Compacta, Blue Gown, clear deep blue without eye, 6 inches.....	1.50	20.00
Blue Stone, mid-blue, 4 inches..... ¼ oz., .60	2.00
Cambridge Blue, clear blue..... ¼ oz., .70	2.40
Crystal Palace, true, 4 inches..... ¼ oz., .50	1.80	24.00
Emperor William, dwarf gentian blue, 4 inches 1.50	1.50	20.00
Mrs. Clibran, purple, large, white eye, 6 inches 1.50	1.50	20.00
Pumila Splendens Bedding Queen..... 1.50	1.50	20.00
Snowball (Albus), dwarf pure white, 4 in..... 1.50	1.50	20.00
Mixed Dwarf Sorts 1.50	1.50	20.00
Pendula Sapphire, large deep navy blue flowers with white eye..... ¼ oz., .50	1.80
Hamburgica, sky-blue, white eye..... ¼ oz., .50	1.80
Tenuior □ (Ramosa nana compacta), fine gentian blue, 10 to 12 inches..... ¼ oz., .80	2.80
Love Grove , see Nemophila. Love-in-a-Mist , see Nigella.		
Luffa = □ Acutangula, Dish Cloth Gourd.....	.40	4.00
Lunaria # Biennis (Honesty—St. Peter's Penny—Money Plant), lilac purple, 4 feet.....	.60	6.00
Alba white, 3½ feet.....	.60	6.00
Mixed60	.60	6.00

	Oz.	Lb.	
Lupinus , Hartwegi □ Giant King, Dark Blue, 3 feet.....	\$0.40	\$4.00	
King, Heliotrope40	4.00	
King, Sky-blue40	4.00	
King, White40	4.00	
King, Mixed30	3.00	
Tall Annual, mixed.....	.30	3.30	
Pixie Delight (Dwarf Annual). Early free blooming in shades of pink, rose, blue, lavender and white; many bicolor combinations90	10.00	
Polyphyllus ① Albus , 3 feet, white.....	.60	6.00	
Carmineus, carmine60	6.00	
Coeruleus, blue60	6.00	
Roseus, pink60	6.00	
Downer's Hybrids, perpetual flowering Hybrids.....	.60	6.00	
★ Russell, most unusual color combinations. The seed we offer is grown from originator's stock seed.....	.80	8.00	
Mixed80	8.00	
★ Vaughan's Special Mixture. A mixture of all the better named sorts90	10.00	
Subcarnosus □ blue, dwarf (Texas Blue Bonnet), 12 inches..	
Lychnis , Arkwrightii, large flowers in brilliant colors, varying from orange-scarlet to soft salmon-pink, 2 to 3 ft. ¼ oz., .60	2.00	
Chalcedonica. Scarlet (Maltese or Jerusalem Cross), 36 inches	.60	6.00	
Viscaria Splendens, early, deep rose, 16 inches.....	.40	4.40	
Haageana Hybrida, mixed, extra choice, 18 inches. ¼ oz., 60c	2.00	
Lythrum ① Superbum Beacon, spikes of clear rosy red which last a month or more. For moist or wet locations in border 3 feet	¼ oz., 50c	1.80
② Roseum Superbum, rose pink, 3 feet.....	.60	6.00	
Madwort , see Alyssum.			
Maiden-in-the-Green , see Nigella.			
Maiden Pink , see Dianthus Deltoides.			
Malcolmia , see Virginia Stocks.			
Mallow , see Lavatera.			
Mallow Marvels , see Hibiscus.			

MARIGOLD (Tagetes—Velvet Flower) □

Gigantea Sunset Giants , rich mixture of yellow and orange, 2½ to 3 feet	\$0.70	\$7.00
Orange Sunset, fine deep orange, 2½ to 3 feet.....	.80	8.00
Dwarf Pot O'Gold, dwarf compact plants, 12-15 inches in height, well branched, bearing a dozen or more bright deep orange blossoms at one time.....	.60	6.00
Wildfire , a cross between the French and African strains in a full range of colors found in the French types, 14 to 20 inches.....	.90	10.00

AFRICAN—TALL DOUBLE FISTULOSA

All Double Lemon, 2½ to 3 feet.....	1.00	12.00
All Double Orange	1.00	12.00
All Double Mixed	1.00	12.00
★ Lemon Queen, Los Angeles Florist Strain, All Double.....	1.00	12.00
★ Prince of Orange, Los Angeles Florist Strain, All Double.....	1.00	12.00
Vaughan's Special Mixture Double Tall African Sorts.....	.90	10.00
Double Tall African Mixed.....	.50	5.00

MARIGOLD—Continued**CARNATION FLOWERED**

	Oz.	Lb.
The well-known, extremely popular loosely ruffled broad petaled flower form, on 2 to 2½ foot branching plants, nearly 100% double.		
Burpee's Gold, early flowering, deep orange, odorless foliage, 2 ft..	\$0.60	\$6.00
Frills, flowers vivid golden orange, 3½ inches across, odorless foliage, 2 feet.....	.60	6.00
Golden Supreme, golden yellow, odorless foliage.....	.80	8.00
Guinea Gold, orange loosely ruffled flowers, 2 to 2½ feet.....	.50	5.00
Orange Supreme, deep orange 2½ ft.....	.90	10.00
Real Gold, giant exhibition blooms, 4½ inches and more across, very deep, very double golden orange illuminated with yellow.	.70	7.00
Yellow Supreme, creamy lemon yellow fragrant, 2½ feet.....	.60	6.00

CHRYSANTHEMUM FLOWERED

Early Dixie Sunshine, very early, large lemon yellow flowers, 4 ft.	.80	8.00
Glitters (All America Bronze Medal 1951), large clear lemon-yellow blooms on bushy erect plants, 2½ feet tall. Foliage dark green.	1.20	16.00
Golden Bedder, very early strain of uniform habit, flowers of a golden orange90	10.00
Goldsmith, giant incurved chrysanthemum-like golden orange flowers up to 4 inches across, and perfect ball shape, 18 inches.	1.00	12.00
Happiness, golden-yellow flowers, 3¼ inches across. Plants of uniform habit; early to flower.....	1.20	16.00
Limelight, pale primrose yellow flowers, early and free flowering, measuring 1½ to 2½ inches in diameter, 20 inches.....	.90	10.00
Mammoth "Mum", flowers fluffy, ball-like, light sulphur yellow. Blooms early, 30 inches.....	1.25	16.00
Yellowstone, the clear golden yellow companion to Goldsmith. The double chrysanthemum-like flowers are borne on 3 to 5 foot stems, late flowering. 18 inches.....	1.00	12.00
Hybrids, many distinct flower types, orange and yellow shades..	.90	10.00

AFRICAN—TALL VARIETIES

Vaughan's Special Mixture of "Odorless Foliaged" Varieties.....	.60	6.00
Vaughan's Treasure Chest, wide variety of shade and color, extremely high percentage of double.....	1.20	14.00
Crown of Gold (Collarete or Crown Type), orange 2½ inch flowers, crested broad guard petals, odorless foliage, 2 feet.....	.50	5.00

AFRICAN—DWARF DOUBLE

Cupid, large chrysanthemum-like flowers of primrose-yellow completely cover the compact dwarf plant. Flowers are 2-2½ inches across and borne in great profusion. Odorless foliage.....	¼ oz., \$0.70	2.50	32.00
Cupid Mixed, of the same compact habit as "Cupid" with large chrysanthemum-like flowers in rich shades of orange, yellow and golden yellow	¼ oz., \$0.70	2.50	32.00
Tom Thumb Golden Crown, dwarf form of Guinea Gold, golden orange90	9.00

FRENCH—TALL DOUBLE

Winter Harmony, it is of quilled scabious type, a single row of reddish brown guard petals and encircling a golden orange quilled center, with mahogany brown dots on tip of each quilled petal. Produces 100% double flowers 2½ inches in diameter80
-----------------------------------------------------------------------------------------------------------------------------------------------------------------------------------------------------------------------------------------------------------	--	-----	------

MARIGOLD—French—Tall Double, Continued		Oz.	Lb.
Lieb's Winter Flowering, variegated maroon and golden yellow flowers, late blooming, excellent for winter cut flowers when greenhouse grown		\$0.80	\$8.00
Double Tall French Mixed40	4.40

FRENCH—HARMONY TYPE—DWARF DOUBLE

Harmony, scabiosa-like flower of deep orange with maroon collar of broad petals, 1 foot30	3.60
All Double Early Harmony40	4.40
Butterball, a bright canary-yellow, early flowering, 6 to 8 inches ..	.60	6.00
Dwarf Coronet Improved, golden yellow center, deep mahogany red collar. Plant compact, free and early blooming60	6.00
Extra Dwarf Harmony80	8.00
Golden Harmony, the flowers are solid luminous golden yellow color with a single row of broad guard petals of the same bright yellow60	6.00
Melody, golden yellow, 12 to 15 inches30	3.60
Spotlight, rich yellow bordered mahogany red, early flowering 100% all double, 1 foot40	4.40
Spry, the flowers are a very light orange crested center and maroon outer petals, 6 to 8 inches60	6.00
Sunkist, dwarf compact early and continuous blooming orange color flowers, 6 to 8 inches60	6.00
Harmony Hybrids, wide and varied range, striking color combinations, 1¾ inch flowers with crested center and flanking guard petals, 1 foot30	3.60

FRENCH—DWARF DOUBLE

All Double Striped (Royal Scot), 1 foot60	6.00
Color Magic, brilliant colors of non-fading red to pure gold, many varied striped and mottled combinations in red and gold. Full double flowers, 2½ inches in diameter. Dwarf compact plant. Blooms from early Summer to killing frost. The largest flowered of the French sorts	1.20	14.00
Golden Ball, golden yellow40	4.40
Primrose, low growing type about the same height and possibly a little lower than Melody. The flowers are proportionately large, and of a sulphur yellow shade. They are excellent for double-ness and very profuse flowering60	6.00
Robert Beist, large dark brownish maroon, 1 foot60	6.00
Scarlet Glow, brightest red of all the Double Dwarf French Marigolds, opening brilliant scarlet, turning to rich tangerine. Fully double, 1¾ to 2 inches across, 1 foot50	5.00
Yellow Pygmy, free flowering, dwarf and compact tiny flowers; lilliput type of bloom, 1 inch in diameter, light lemon yellow, 8 inches50	5.00
Double Dwarf French Finest Mixed40	4.00
Vaughan's Florist Mixture of Newer Varieties, including Spry, Butterball, Sunkist, etc.	1.00
Monarch Strain Finest Mixed, wide range of colors, 1 foot50	5.00

FRENCH—DWARF SINGLE

Flash, bright combination of color ranging from vivid red through bronze with a few yellow flowers to give harmonious contrast, 15 inches40	4.40
-------------------------------------------------------------------------------------------------------------------------------------------------	-----	------

MARIGOLD—French—Dwarf Single , Continued	Oz.	Lb.
Legion of Honor, yellow blotched brown.....	\$0.40	\$4.40
Naughty Marietta, golden yellow flowers with a mahogany base..	.60	6.00
Red Head, rich mahogany changing to bronzy gold, with crested center of golden petals edged maroon, 1 foot.....	.60	6.00
Sunny, single bright yellow flowers, about 2 inches across, with attractive wavy edges. Well rounded plants covered with bloom. 15 in.60	6.00
Vaughan's Special Mixture of Double and Single French Sorts....	.45	4.80
Tagetes Signata Pumila, golden orange, 10 inches.....	.50	5.00
Gnome, large flowered golden yellow, 9 inches.....	.70	7.00
Marsh Marigold or Marsh Mallow , see Hibiscus.		
Marvel of Peru ① □ Four o'clock, mixed, 24 inches.....	.20	2.20
Matricaria ① □ Capensis fl. pl., double white Feverfew, 24 inches.	.80	8.00
★ Double White, extra select, 2 to 3 feet under glass, 18 inches, outdoors	¼ oz., 65c	2.20
Eximia fl. pl., Golden Ball, for pots and edging,		
8 inches	¼ oz., 50c	1.80
Matthiola Bicornis □ (Evening Scented Stock), rosy lavender, 18 inches25	2.80
Mesembryanthemum □ Criniflorum (Livingstone Daisy), plants slightly spreading in habit, covered with daisy-like flowers. 3 inches	¼ oz., 35c	1.25
Crystallinum (Ice Plant), flowers small pinkish white, 8 in....	.80	8.00
Mexican Blue Sage , see Salvia Azurea.		
Mexican Fire Bush , see Kochia.		
Mexican Fire Plant , see Euphorbia Heterophylla.		
Mexican Sunflower , see Tithonia.		
Microsperma Golden Tassel , flowers of a bright chrome yellow with handsome light green foliage like that of the Chinese Primrose, 8 to 9 inches.....	¼ oz., 60c	2.00

MIGNONETTE □

Goliath, or Red Giant, 12 inches.....	.50
Golden Goliath, giant golden yellow, 12 inches.....	.50
Grandiflora, large flowering, 16 inches.....	.20	2.00
Machet, regular stock, reddish, 16 inches.....	.30	3.00
Vaughan's Selected Stock80	8.00
Mixed25	2.80
Mimosa □ Pudica (Sensitive Plant), 2 feet.....		
	1.00	12.00
Mimulus ① □ Tigrinus, Large Flowering, single (Queen's Prize), mixed, 1 foot.....	¼ oz., 50c	1.60
Mina □ = (Flag of Spain) Lobata, beautiful climber, scarlet with yellow	¼ oz., 70c	2.40
Mirabilis □ Uniflora, bright rose flower of the most unusual "trumpet in trumpet" form, 30 in.	1.00	12.00
Mirabilis , see Marvel of Peru.		
Momordica , see Balsam Apple and Pear.		
Money Plant , see Lunaria.		
Monk's Hood , see Aconitum.		
Moon Flower or Moon Vine , see Ipomoea.		
Mountain Rose , see Antigonon.		
Mourning Bride , see Scabiosa.		
Mullein , see Verbascum.		
Musk Plant , see Mimulus Moschatus.		
Morning Glory , see Convolvulus and Ipomoea.		

	Oz.	Lb.
Myosotis # (Forget-Me-Not), Alpestris, Indigo Blue, (Sutton's Royal Blue), 12 inches	¼ oz., \$0.45	\$1.50 \$20.00
Indigo Blue Compacta, deep blue, 6 inches	¼ oz., .60	2.20
Blue, 12 in.	¼ oz., .25	.80 8.00
Blue Eyes, bright blue, white eye, early, 1 foot	¼ oz., 1.00	3.60
Blue Spire (Erecta), vivid blue flower deeper than Indigo, borne in clusters on 12 in. stems of column-like habit	¼ oz., \$1.00	3.60
Robusta Grandiflora , an improved alpestris blue	¼ oz., .60	2.20
Rosea, 12 in.	¼ oz., .25	.80
White		1.00 14.00
Victoria, dwarf, sky-blue, 8 in.	¼ oz., .60	2.20
Indigo Blue, dwarf	¼ oz., .60	2.20
Rosea,	¼ oz., .60	2.20
White, dwarf	¼ oz., .60	2.20
*Oblongata "Early" Blue Bird, 1 foot	¼ oz., .30	1.00 12.00
Palustris Semperflorens ① □, true Marsh Forget-Me-Not, 12 in.		1.00 14.00

SINGLE DWARF NASTURTIUMS □ 12 in.

Empress of India, deep crimson, dark leaved15	1.50
Dwarf Sorts, all colors, mixed15	1.20
Vaughan's Special Dwarf Mixed15	1.50

SINGLE TALL NASTURTIUMS

Tall Sorts Finest Mixed 10 lbs., \$10.00	.15	1.20
Vaughan's Special Tall mixed15	1.50

DOUBLE TALL NASTURTIUMS

Fire Gleam, vivid orange scarlet15	1.20
Golden Gleam, large, golden yellow, semi-double flowers 10 lbs., \$10.00	.15	1.20
Indian Chief, foliage dark green, vivid scarlet flowers15	1.20
Mahogany, dark mahogany red15	1.20
Orange Gleam, deep glowing golden orange15	1.20
Scarlet Gleam, scarlet 10 lbs., \$10.00	.15	1.20
Glorious Gleam Hybrids 10 lbs., \$10.00	.15	1.20

DOUBLE DWARF NASTURTIUM

Garnet Gem, rich garnet red15	1.50
Globe of Fire, scarlet15	1.50
Golden Globe, golden yellow15	1.50
Mahogany Gem, deep velvety mahogany red15	1.50
Ruby Gem, bright ruby red15	1.50
Gem Mixed 10 lbs., \$10.00	.15	1.20

Native Wild Flowers ① Mixture, for sun and shade 2.40

Nemesia □ Grandiflora Compacta Triumph, mixed 9 inches		1.50 20.00
Compacta Edelweiss (White Gem), pure white, 8 inches ¼ oz., 90c	3.20
Blue Gem, 9 inches ¼ oz., 60c	2.00
Fire King, 9 inches, scarlet ¼ oz., 60c	2.00
Orange King, 9 inches, rich orange ¼ oz., 60c	2.00
Strumosa Suttoni, mixed, 12 inches	1.50	20.00
Suttoni Scarlet ¼ oz., 60c	2.00

	Oz.	Lb.	
Nemophila □ Insignis (Baby Blue Eyes), sky-blue, 6 inches.....	\$0.20	\$2.00	
Mixed, 6 in.20	2.00	
Nepeta ① (Gray Catmint), Mussini, violet, 12 inches.. ¼ oz., 35c	1.20	
Nicandra □ Physaloides (Shoo-fly Plant), pale blue, bell-like flowers, free blooming, 3 feet.....	.40	4.40	
Nicotiana □ Affinis white, sweet scented (Tobacco Plant), 32 in....	.40	4.00	
Affinis Hybrids, mixed colors, 32 inches.....	.30	3.00	
Crimson Bedder, dwarf, pyramidal, deep crimson, 32 inches	¼ oz., 25c	.90	12.00
Nana Crimson Flame.....	¼ oz., 35c	1.20
Daylight, pure white, sweet-scented flowers. Plants of bushy habit, 1½ to 2 ft., very free flowering.....	.90	10.00	
Sanderae , Crimson King, dark velvety crimson, red, 30 inches	.60	
Hybrids, mixed, 30 inches.....	.40	4.40	
*Suaveolens (Orange Blossom), white fragrant... ¼ oz., 80c	3.00	
Nierembergia Hippomanica □ ① delicate lavender flowers, 1 to 1½ inches across with yellow eye, 6 inches.....	¼ oz., \$2.25; ½ oz., \$1.25	8.00
Purple Robe, 6 inches, several shades deeper blue than Hippomanica from which it is selected. Blooms over a long period	½ oz., \$1.50; ¼ oz., \$2.50	9.00
Nigella □ (Love-in-a-Mist) Damascena, Miss Jekyll, dark blue, 1½ feet20	2.00	
Miss Jekyll, sky blue, 1½ feet.....	.20	2.00	
Double mixed, 1½ feet.....	.20	2.00	
Nolana □ (Chilean Bellflower) Lanceolata Blue Ensign, ultramarine blue, white center, 6 inches.....	2.40	
None So Pretty , see Silene or Pansy.			
Oenothera (Evening Primrose), Macrocarpa ① (Missouriensis), soft-yellow, 12 inches	¼ oz., 60c	2.00
Fruticosa, Youngi chrome yellow, 1½ feet.....	¼ oz., 45c	1.40
Lamarckiana # □, yellow, 12 inches.....	.20	2.20	
Old Lady's Wallet , see Calceolaria.			
Old Maid , see Vinca Rosea.			
Oxypetalum Coeruleum, star shaped blue flowers, silver veiled, borne in sprays, 15 inches.....	
Painted Daisy Annual, see Chrysanthemum Carinatum.			
Painted Daisy Perennial, see Pyrethrum Roseum.			
Painted Tongue , see Salpiglossis.			

PANSY MIXTURES

We have always prided ourselves upon the highest quality of flower seeds and one of our specialties has been our Pansy Strains. While we realize that Pansy mixtures and varieties are being offered today at much lower prices than at which we list them, it is our confident feeling that the difference in quality far more than offsets the difference in cost. Rather than to compromise quality by offering less carefully selected strains, we feel that our customers will, in turn, get greater satisfaction by continuing to offer the 76 Year Old Vaughan Quality.

	Oz.	Lb.	
America, Vaughan's Improved Early Flowering, compact and full color range. Ideal for basket and bedding use.....	¼ oz., 65c	\$2.20	\$30.00
Engelmann's Giant Mixture . Dark and light shades, immense flowers, compact and early flowering.	¼ oz., \$1.25; ½ oz., \$2.25	8.00
Jumbo Mixed. Extra large and early; long stemmed flowers....	½ oz., \$1.20; ¼ oz., \$2.00	7.00

PANSY MIXTURES—Continued

	Oz.	Lb.
Vaughan's Winter Flowering. Reselected Strain. Extra long stemmed, upright growing, particularly adapted for growing under glass for cut flower purposes.....	1/8 oz., \$3.50	\$12.00
Masterpiece, fine strain with fluted petals, mixed colors	1/4 oz., 80c	3.00
Oregon Giants (Originator's Stock). A fine strain of giant ruffled pansies. The large flowers of heavy texture have a delicate fragrance and come in all shades and coloring. Long stems and luxuriant foliage..	1/8 oz., \$1.35; 1/4 oz., \$2.50	9.00
Trimardeau, mixed, showy		1.50 \$20.00

VAUGHAN'S GIANT MIXED

Large flowers of good substance in a complete color range in light and dark shades. Probably the best general complete high grade mixture obtainable.....	1/4 oz., \$1.70	6.00
-----------------------------------------------------------------------------------------------------------------------------------------------------------	-----------------	------	------

VAUGHAN'S SUPER MAPLE LEAF GIANT MIXED

A distinct variety we introduced and named several years ago. The colors include a wide range of bright colored varieties on plants of compact habit with large, attractive foliage. The majority of the flowers will average 4 inches across.	1/8 oz., \$1.35; 1/4 oz., \$2.50	9.00
Vaughan's Maple Leaf Giant Mixture..	1/8 oz., \$1.20; 1/4 oz., \$2.00	7.00	90.00

VAUGHAN'S SWISS GIANT

The flowers are very large, borne on long stems, of perfect form and substance. They are most freely produced and about as early as the Hiemalis or "Ice" pansy type. The plants bloom all summer. Their most important charm, however, is in their great variety of colors such as were not known in pansy mixture before the advent of these Swiss Giants. We are the introducers in this country.

	Oz.	Lb.	
Vaughan's "Improved" Swiss Giants, a blend of four growers' stocks and contains a large variety of colors....	1/4 oz., \$2.00	\$7.00	
*"Super" Swiss Mixture, special selection of this famous variety	1/8 oz., \$1.25; 1/4 oz., 2.25	8.00
Dwarf Super Swiss Giant Mixture....	1/8 oz., \$1.20; 1/4 oz., 2.00	7.00
* Geneva Giants, grown from originator's stock.	1/8 oz., \$1.25; 1/4 oz., \$2.25	8.00
Swiss Alpenglow, rich, velvety, garnet red and cardinal shades.	1/8 oz., \$1.20; 1/4 oz., \$2.00	7.00
Swiss Berna, dark violet blue.....	1/8 oz., \$1.20; 1/4 oz., \$2.00	7.00
Swiss Blue (Ullswater) (Thuner See), a solid blue pansy with dark blotches.	1/8 oz., \$1.20; 1/4 oz., \$2.00	7.00
* Swiss Coronation Gold, canary yellow, lower petals flushed golden orange, slightly ruffled..	1/8 oz., \$1.20; 1/4 oz., \$2.00	7.00
Swiss Firebeacon, wallflower red with touch of orange.....	1/8 oz., \$1.20; 1/4 oz., 2.00	7.00
Swiss Raspberry Rose, an entirely new color in the Swiss giant strain. A lovely tint of pink best described as Raspberry Rose. It has a suggestion of a lighter tone on the edges of the petals and is marked with a velvety blotch in a deeper tone	1/8 oz., \$1.20; 1/4 oz., \$2.00	7.00
* Swiss Pure White.....	1/8 oz., \$1.20; 1/4 oz., 2.00	7.00
Swiss Yellow with 3 blotches (Rheingold, Firnen Gold).	1/8 oz., \$1.20; 1/4 oz., \$2.00	7.00
Swiss Mixture, a very choice strain.....	1/4 oz., 80c	3.00	\$40.00
Giant King of the Blacks.....	1/4 oz., 60c	2.00
Adonis, light blue	1/4 oz., 60c	2.00
Bright Blue	1/4 oz., 60c	2.00

PANSY GIANT—Continued

	Oz.	Lb.	
Dark Purple	¼ oz., 60c	\$2.00
Delft Blue	¼ oz., 80c	3.00
Orange.....	⅛ oz., \$1.20; ¼ oz., 2.00	7.00
Prince Henry, darkest blue.....	
St. Knud, golden orange.....	¼ oz., 80c	3.00
White with Purple eye.....	¼ oz., 80c	3.00
Lord Beaconsfield, violet blue, top petals white... ¼ oz., 60c		2.00
Pure yellow	¼ oz., 60c	2.00
Hiemalis or Ice Pansy, Early Blooming, Blue Boy lavender.	¼ oz., 60c	2.00
Helios, pure yellow	¼ oz., 60c	2.00
Winter Sun, golden yellow with black eye.....	¼ oz., 60c	2.00

Papaver, see Poppy. **Paris Daisy**, see Chrysanthemum Frutescens.

Pasque Flower, see Anemone Pulsatilla.

Passiflora ÷ = (Mammoth Passion-flower) Coerulea, blue..... 2.00
Edulis, white

2.00

....

Peach Bell, see Campanula Persicifolia.

Pennisetum Ruppelianum □, ornamental grass for edging canna beds..... ¼ oz., 60c 2.00
Longistylum

¼ oz., 60c

2.00

....

Pentstemon ①, Barbatus, showy scarlet flowers, tall erect branching plants

¼ oz., 80c

3.00

....

(Beard Tongue) Grandiflorus, rosy mauve, 16 in... ¼ oz., 80c

2.80

....

Hardy Perennial Mixed..... ¼ oz., 70c

2.40

....

Sensation ① □, a wonderful mixture..... ¼ oz., 60c

2.00

\$28.00

Perilla Nankinensis, dark purple foliage..... .40 4.00

Periwinkle, see Vinca.

Persian Daisy, see Pyrethrum Roseum.

PETUNIA Hybrida □ 1½ Feet

Blotched and Striped (Inimitable).....	¼ oz., 35c	1.20	16.00
Blue King (Blue Bee), a fine mid-blue, color of Viola Jersey Gem..		1.25	16.00
Flaming Velvet, rich velvety blood red.....		1.80	26.00
General Dodds, blood-red.....	¼ oz., 35c	1.25	16.00
Howard's Star, dark velvety purple, blotched with white.....		1.50	20.00
Howard's Star Improved.....	¼ oz., 80c	3.00	40.00
Norma, violet blue, white star.....		1.20	16.00
Radlance, cerise rose underlaid with salmon.....	¼ oz., 75c	2.40
Topaz Rose, fiery velvety rose, slightly suffused with gold	¼ oz., 55c	2.00
Violet Blue (Violacea), same shade as Blue Bird.....	¼ oz., 35c	1.25	16.00
White King	¼ oz., 35c	1.25	16.00
De Luxe Bedding Mixture, the best balanced mixture.....		1.50	20.00
Good mixed		1.00	12.00

HYBRIDA NANA COMPACTA, 12 Inches

Admiral, rich violet blue.....	⅛ oz., \$2.75; ¼ oz., \$5.00	18.00
Alderman, deep blue, 10 in.....	¼ oz. .45	1.50
Blue Ball, violet blue.....	
Bright Eyes, dwarf, upright growing, small flowering, soft pink white throat.....	¼ oz., .70	2.50
Celestial Rose Improved.....	¼ oz., .50	1.60	24.00
Celestial Rose, regular stock.....	¼ oz., .40	1.50	20.00
Cheerful, clear salmon pink with deeper rose veining towards the throat	¼ oz., 2.50	9.00

PETUNIA, <i>Hybrida Nana Compacta</i>—Continued		Oz.	Lb.
Cream Star, soft creamy white flowers.....			
Dwarf Flaming Velvet (King Henry), very choice	1/8 oz., 3.20; 1/4 oz., 6.00	22.00
English Violet, rosy mauve lavender or purple violet.....			
.....	1/4 oz., .80	3.00
Fire Chief, brilliant scarlet red.			
.....	1/8 oz., \$1.25; 1/4 oz., 2.25	8.00
Glow, of dwarf bushy growth, flowers dazzling carmine-red	1/4 oz., 1.75	6.00
Glowing Rose, uniformly compact plants, flowers rich glowing rose	1/4 oz., .80	3.00
Heavenly Blue, reselected	1/4 oz., .70	2.40
Igloo, compact, free blooming, white 12 to 15 inches.....	1/4 oz., .75	2.50
Martha Washington, blush pink veined rich wine-red, deepening at throat.....	1/8 oz., 2.50; 1/4 oz., 4.50
Miniature Rose Gem, 6 in. ball shaped form.....	1/4 oz., .75	2.50
Miniature Violet Gem, 6 in.....	1/4 oz., .70	2.50
Peach Red. Uniform pink, with no tendency to fade—a vivid, in- tense peach red. Shapely plants, 12 inches tall, have a spread of 18 to 24 inches with no ungainly runners....	1/4 oz., .80	3.00
Rose of Heaven Select, a brilliant rose pink.....	1/4 oz., .50	1.80	\$24.00
Rose of Heaven regular.....	1/4 oz., .35	1.25	16.00
Rose Queen Improved, brilliant rose.....	1/4 oz., 1.40	5.00
*Rosy-Morn Select, rose, white throat.....	1/4 oz., .50	1.60	22.00
Rosy-Morn, ordinary stock	1/4 oz., .35	1.20	16.00
Ruby Red, good sized flowers of ruby red of heavy substance and velvety texture.....	1/8 oz., \$1.25; 1/4 oz., 4.00
Salmon Supreme, light salmon, white throat.			
.....	1/4 oz., \$5.50; 1/2 oz., \$10.00
Snowball, pure white flowers, very compact.....			
Snow Queen, white compact.....	1/4 oz., .45	1.50
Snow White, pure white flowers.....	1/4 oz., .60	2.00
Sutton's Blue Bedder, mid-blue	1/4 oz., .45	1.50
Topaz Queen, extra dwarf, scarlet rose.....	1/4 oz., .45	1.50
Twinkles, masses of small bright rose flowers with white star	1/4 oz., .70	2.40
Velvet Ball, velvety blood red.....	1/8 oz., \$3.20; 1/4 oz., 6.00	22.00
Violacea (Blue Bird), very deep violet, 12 inches....	1/4 oz., .60	2.00	28.00
White Perfection, one of the best white, compact growth flowers over 2 in. across, free flowering.....	1/4 oz., .60	2.00	28.00
Vaughan's Special Dwarf small flowering choice mixed.....		1.80	24.00
Dwarf choice mixed.....		1.25	16.00

LARGE FLOWERING—BALCONY PETUNIAS

Size of flowers, 3 to 4 inches across

Balcony Black Prince, deep velvety red.....	1/4 oz., \$1.00	3.00
Blue, deep violet purple.....	1/4 oz., .70	2.50
Red, dark	1/4 oz., .70	2.50
Rose, fiery rose	1/4 oz., .70	2.50
Rosy Morn, pink with white throat.....	1/4 oz., .70	2.50
Royal Rose, clear warm rose.....	1/4 oz., 1.00	3.00
Star of California, violet shaded crimson, white blotches	1/4 oz., .70	2.50
White, one of the finest whites in petunias....	1/4 oz., .70	2.50
Balcony, mixed, the above.....	1/4 oz., .45	1.50	22.00

PETUNIA—Continued**LARGE FLOWERING—Plain Edged Flowers**

	Oz.	Lb.
Burgundy, shades of purple or carmine with white throat and tube with violet veins.....	$\frac{1}{8}$ oz., \$2.25; $\frac{1}{4}$ oz., \$7.50
Dwarf Pink Glory, deep rose, white throat.....	$\frac{1}{8}$ oz., \$2.25; $\frac{1}{4}$ oz., \$7.50	\$28.00
* Elk's Pride Reselected Dwarf, velvety violet.....	$\frac{1}{8}$ oz., 2.25; $\frac{1}{4}$ oz., 7.50	28.00
Snowstorm, glistening white with a touch of yellow in throat.....	$\frac{1}{8}$ oz., 2.25; $\frac{1}{4}$ oz. 7.50	28.00
* Giant Flaming Velvet, very large deep dark red.....	$\frac{1}{8}$ oz., 2.25; $\frac{1}{4}$ oz., 7.50	28.00
White Cloud, 12 inches, one of the best large-flowered whites.....	$\frac{1}{8}$ oz., \$2.25; $\frac{1}{4}$ oz., \$7.50	28.00

LARGE FLOWERING DWARF—Fringed

Lace Veil, large pure white flowers..	$\frac{1}{8}$ oz., \$2.00; $\frac{1}{4}$ oz., \$7.00
Setting Sun, fringed, brilliant rose pink, the very best of its color, 12 inches.....	$\frac{1}{8}$ oz., \$2.25; $\frac{1}{4}$ oz., \$7.50

LARGE FLOWERING—Fringed Single

Blushing Maid. The flowers are of largest size, deeply fringed and ruffled, of a rosy pink and white with yellow veins and throat. One of the loveliest giant single Petunias.	$\frac{3}{8}$ oz., \$1.20
Dainty Lady, delicately fringed dark cream flower of medium size.....	$\frac{1}{8}$ oz., \$2.00; $\frac{1}{4}$ oz., 7.00
* Fluffy Ruffles. Large flowering, Extra Choice Mixed, the strain we offer is the best in California; it is truly superb.....	$\frac{1}{8}$ oz., \$2.25; $\frac{1}{4}$ oz., \$4.00; $\frac{1}{4}$ oz., \$7.50
Royalty, ruffled and waved blossoms varying from pure white touched with purple through varying combinations of purple and white to rich self-colored blooms.....	$\frac{1}{8}$ oz., \$2.25; $\frac{1}{4}$ oz., \$7.50
Scarlet Beauty, fringed bright scarlet..	$\frac{3}{8}$ oz., \$1.75; $\frac{1}{4}$ oz., \$7.50
Fringed Snowstorm, pure white fringed flowers, yellow throat.....	$\frac{1}{8}$ oz., \$2.25; $\frac{1}{4}$ oz., \$7.50
The Art, large fringed flowers boldly striped and blotched brilliant carmine-rose and pure white.	$\frac{1}{8}$ oz., \$5.00; $\frac{1}{4}$ oz., \$9.00	32.00
Theodosia, Re-selected, pink with yellow throat.....	$\frac{1}{8}$ oz., \$2.25; $\frac{1}{4}$ oz., \$7.50
White Beauty.....	$\frac{1}{8}$ oz., 2.25; $\frac{1}{4}$ oz., 7.50
White Mound. Flowers identical in size and color of Lace Veil, but growth habit a perfect mound.	$\frac{1}{8}$ oz., \$2.25; $\frac{1}{4}$ oz., \$7.50
Large Flowering Fringed, Extra Choice Mixed.....	$\frac{1}{8}$ oz., 3.25	24.00
Ruffled Nana Compacta Little Giants Mixed.....	$\frac{1}{8}$ oz., 3.00; $\frac{1}{4}$ oz., 5.50	20.00

GIANT FLOWERED, SINGLE with Large Veined Throats**Size of Flowers, 4 to 6 Inches Across**

Copper-Red, dark throat.....	$\frac{1}{8}$ oz., \$3.50
Glamour, luscious salmon rose delicately veined brown in a creamy open shallow throat, huge ruffled blooms.....	$\frac{1}{8}$ oz., \$4.00; $\frac{1}{4}$ oz., \$14.00
Irene, dark carmine red with white center, slightly veined, flowers 4 to 6 in. in diameter.....	$\frac{1}{8}$ oz., \$4.00; $\frac{1}{4}$ oz., \$14.00
Pink Shades.....	$\frac{3}{8}$ oz., \$2.00
Prince of Wuerttemberg, dark crimson, black throat.....	$\frac{3}{8}$ oz., 1.80; $\frac{1}{8}$ oz., 3.20
Princess of Wuerttemberg, ruffled pink	$\frac{3}{8}$ oz., 1.80; $\frac{1}{8}$ oz., 3.20

PETUNIA, Giant Flowered, Single—Continued		Oz.	Lb.
Ruffled Monsters, in splendid mixture.	$\frac{1}{8}$ oz., \$2.70; $\frac{1}{4}$ oz., \$5.00	\$36.00
Salmon Beauty (Marylyn), rich salmon.	$\frac{1}{8}$ oz., \$4.00; $\frac{1}{4}$ oz., \$14.00
Dwarf Giants of California, Ramona strain, dark and light shades.	$\frac{1}{8}$ oz., \$3.00; $\frac{1}{4}$ oz., \$5.50	40.00
★ Dwarf Giants of California, mixed, "Vaughan Blend," extra choice; there is none better than our strain of this.	$\frac{1}{8}$ oz., \$3.80; $\frac{1}{4}$ oz., \$13.20	50.00
Dwarf Giants of California, dark selection.	$\frac{1}{8}$ oz., \$3.00; $\frac{1}{4}$ oz., \$5.50	40.00
Extra Dwarf Giants of California Mixed.	$\frac{1}{4}$ oz., \$1.50; $\frac{3}{8}$ oz., \$2.75; $\frac{1}{2}$ oz., \$5.00
★ Giants of California, mixed; the very best strain in California.	$\frac{1}{8}$ oz., \$3.00; $\frac{1}{4}$ oz., \$10.00	36.00
Giants of California Supreme Florist strain, ruffled open throats, all in lighter rose and pink shades.	$\frac{1}{8}$ oz., \$3.00; $\frac{1}{4}$ oz., \$10.50	40.00
Vaughan's Best Mixture of large flowering single sorts, includes all the best varieties.	$\frac{1}{8}$ oz., \$3.00; $\frac{1}{4}$ oz., \$10.50	40.00
DOUBLE FLOWERING			
All Double America, rose pink, small flowered.	1000 seeds, \$1.50 net; $\frac{1}{4}$ oz., \$5.00; $\frac{3}{8}$ oz., \$9.00
Colossal Shades of Rose.	Trade pkt., \$2.00 net; $\frac{1}{8}$ oz., \$22.50; $\frac{1}{4}$ oz., \$80.00	300.00
All Double Dwarf (Victorious) Giant Fringed			
Attraction, brightest carmine-rose combination.	$\frac{3}{8}$ oz., \$18.00; $\frac{1}{2}$ oz., \$10.00
Blue Brocade Improved, true violet blue.	$\frac{3}{8}$ oz., \$18.00; $\frac{1}{2}$ oz., \$10.00
Fantasy, conspicuously striped with rich, velvety violet blue and white.	$\frac{3}{8}$ oz., \$17.00; $\frac{1}{2}$ oz., \$9.00
Gaiety, a bicolor in rose or light rose-red with white ground.	$\frac{3}{8}$ oz., \$18.00; $\frac{1}{2}$ oz., \$10.00
Illumination Improved, bright red overlaid with a scarlet sheen.	$\frac{3}{8}$ oz., \$18.00; $\frac{1}{2}$ oz., \$10.00
Loveliness, salmon pink.	$\frac{3}{8}$ oz., \$18.00; $\frac{1}{2}$ oz., \$10.00
Mayflower, bright carmine-red veining on white.	$\frac{3}{8}$ oz., \$17.00; $\frac{1}{2}$ oz., \$9.00
Prima Donna (Salmon), the nearest to orange in petunias.	$\frac{3}{8}$ oz., \$18.00; $\frac{1}{2}$ oz., \$10.00
Pure White Improved, large well-fringed flowers of purest white.	$\frac{3}{8}$ oz., \$17.00; $\frac{1}{2}$ oz., \$9.00
Purple Glow, deep glowing purple with velvety blue sheen.	$\frac{3}{8}$ oz., \$17.00; $\frac{1}{2}$ oz., \$9.00
Rosy Carmine Improved (World Beauty or Pink Perfection), bright rose, very uniform in growth and habit.	$\frac{3}{8}$ oz., \$18.00; $\frac{1}{2}$ oz., \$10.00
Silver Blue, clear blue.	$\frac{3}{8}$ oz., \$17.00; $\frac{1}{2}$ oz., \$9.00
Mixed, a well-balanced range of colors.	$\frac{3}{8}$ oz., \$17.50; $\frac{1}{2}$ oz., \$32.00; $\frac{3}{4}$ oz., \$60.00
Paecelia □ <i>Companularia</i> (Wild Heliotrope, California Blue Bells), gentian blue with white anthers, 6 inches.40	\$4.00
Tanacetifolia, blue, for bees, 2 feet.15	1.60

PHLOX DRUMMONDI Grandiflora ☐ 1 Foot

	Oz.	Lb.
Alba, pure white	\$1.20	\$16.00
Alba Oculata, white with dark eye.....	1.20	16.00
Brilliant, deep rose, dark eye.....	1.20	16.00
Chamois Rose, carmine eye.....	1.20	16.00
Cinnabar scarlet	1.20	16.00
Crimson Starred White	1.20	16.00
Dark Blue, violet	1.20	16.00
Flaming Velvet (Atropurpurea), rich deep reddish purple.....	1.20	16.00
Flesh, delicate flesh color with rose eye.....	1.20	16.00
Isabellina, buff yellow	1.20	16.00
Rosea, pink	1.20	16.00
Rosea Albo oculata, rose with eye.....	1.20	16.00
Scarlet, dark eye.....	1.20	16.00
Scarlet, white eye	1.20	16.00
Stellata Atropurpurea crimson starred white.....	1.20	16.00
Violet with white eye.....	1.20	16.00
Drummondii Grandiflora mixed	1.00	12.00
Cuspidata or Star, mixed.....	1.20	16.00
Gigantea Art Shades, enormous flowers in soft art shades with white eye	1.60	22.00
Mellow Moon, soft pastel yellow.....	2.00	28.00
Red Glory, brilliant red with large creamy white eye.....	2.00	28.00
Rosy Morn, very bright pink with white eye.....	2.00	28.00
Simon Glory, pure salmon pink, white eye.....	2.00	28.00
Tetra Red, large trusses of delicately scented, deep red flowers..	1.50	20.00
★ Vaughan's Special Mixture, includes all the grandi- flora varieties listed	1.20	16.00
Nana Compacta, mixed, 6 inches.....	1.00	14.00
Atropurpurea, velvety red purple.....	1.25	16.00
Apricot Yellow	1.25	16.00
Coerulea Oculata, blue with white eye.....	1.25	16.00
Fireball, scarlet	1.25	16.00
Isabellina, buff yellow	1.25	16.00
Mirabilis (Surprise), salmon-pink, white eye.....	1.25	16.00
Salmon Rose (chamois).....	1.25	16.00
Snowball	1.25	16.00
Violet	1.25	16.00
Violet with eye.....	1.25	16.00
Vaughan's Beauty. A large flowered strain of Dwarf Phlox with florets twice the size of regular strains and borne in great profusion. 8 in.....		
Blue Beauty	2.00	28.00
Crimson Beauty	2.00	28.00
Mauve Beauty	2.00	28.00
Pink Beauty	2.00	28.00
Salmon Beauty	2.00	28.00
Scarlet Beauty	2.00	28.00
Violet Beauty	2.00	28.00
White Beauty	2.00	28.00
Mixed, a well balanced blend.....	2.00	28.00
Cecily Mixed, flowers immense, coloring bright, nearly all blos- soms have a white eye.....	1.20	16.00
Decussata ① perennial varieties, mixed, 3 feet.....	1.50	22.00
Physalis ① Franchetti (Chinese Lantern Plant), 28 inches.....	1.80	24.00
Gigantea, much larger seed pods.....	2.00

	Oz.	Lb.
Physostegia ① (False Dragon Head) <i>Virginica</i> , rosy lilac, 4 ft. ¼ oz., 60c	\$2.00
Pimpernel , see <i>Anagallis</i> . Pin Cushion Flower , see <i>Scabiosa</i> .		
Pinks , Chinese and others, see <i>Dianthus</i> .		
Platycodon ① □ <i>Grandiflorum Album</i> ¼ oz., 70c	2.40
Blue	2.40
Double White	8.00
Double Blue	8.00
Plumbago Capensis ÷ = spikes of rich pale blue flowers	100 seeds, 50c net; 1,000 seeds, \$4.00 net
Poinciana Gillesii, see <i>Bird of Paradise</i>	1.00	\$12.00
Polemonium ① <i>Coeruleum</i> blue, 30 inches.....	1.20
<i>Richardsoni</i>	1.20
Polyanthus ①, see <i>Primula Veris</i> .		
Poppy Mallow , see <i>Callirhoe</i> .		
Poor Man's Weather Glass , see <i>Anagallis</i> .		
Plume Poppy , see <i>Bocconia</i> .		

ANNUAL POPPY—*Papaver* □

Poppy Double Carnation Flowered, Double Peony Flowered and Cardinal Type cannot be supplied, due to regulations of the United States Narcotic Division.

American Legion (Improved Flander's Field) brilliant orange-scarlet, 30 inches.....	.15	2.00
Glaucum (Tulip Poppy), deep scarlet, 20 inches.....	.50	5.00
Pierrot (Annual Single), brilliant scarlet-red flowers with black blotches at the base. Foliage light grayish-green.....	.80	8.00
Scarlet King double, glowing scarlet.....	.20	2.20
Double and Single mixed20	2.20
Shirley , choice mixed, 20 inches.....	.20	2.20
Sweet Briar, double, deep rose pink, 30 inches.....	.40	4.40
Double <i>Begonia</i> Flowered, mixed, 30 inches.....	.40	4.40
Dazzler, orange scarlet, 28 inches.....	.40	4.40
Shirley Ryburgh Hybrids, double Shirley.....	.30	3.30
Vaughan's Special Mixture.....	.50	5.00

PERENNIAL POPPY, 20 Inches

Nudicaule ① □ (Iceland) <i>Coonara</i> Pink, shades of pink longest stems and best color range.....
Emperor , deep tangerine-orange, with extremely large overlapping petals	¼ oz., .45	1.50
Empress , double salmon rose and pink tones.....	¼ oz., .45	1.50
Gartford Giant Art Shades , large flowers, beautifully fluted in lovely pastel shades.....	¼ oz., .50	1.80
Kelmescott Mixture , best strain, strong wiry stems when well grown 3 feet long. Large flowers in a great variety of beautiful colors.....	¼ oz., .50	1.80
Red Cardinal , 12 in., brilliant.....	¼ oz., .90	3.20
Sanford's Giants , Best Mixture, largest flowers, longest stems and best color range.....	¼ oz., .45	1.50
Sunbeams (New Hybrids), mixed, 1½ feet.....	¼ oz., .30	1.00
Yellow Emperor , clear lemon yellow, flowers 3½ to 4 inches, on low bushy plants.....	¼ oz., .60	2.00
Yellow Wonder (<i>Amurensis</i>), buttercup yellow flowers on stems 25 inches long, heat and drought resisting	¼ oz., .70	2.40
White		1.00
Single, mixed80
★Vaughan's Special Mixture. <i>Nudicaule</i> Vars.....	¼ oz., .60	2.00

POPPY—Continued	Oz.	Lb.
Orientele ① dark scarlet, 40 inches.....	\$0.90	\$10.00
Beauty of Livermere, oxblood-red with dark blotch..		
..... ¼ oz., .90	3.50
Brilliant, scarlet	¼ oz., .60	2.00
Mrs. Perry, shrimp pink	¼ oz., 1.20
Mahony, maroon crimson	¼ oz., .60	2.00
Princess Victoria Louise, salmon.....	¼ oz., .60	2.00
Rembrandt, finest orange-scarlet.....	¼ oz., .60	2.00
Salmon Shades, ranging from light to dark, extra large flowers	¼ oz., .60	2.00
Hybrids, mixed		1.50
New Hybrids, seed saved from named sorts... ¼ oz., .80		2.80
Vaughan's Special Mixture of Oriental Poppies.. ¼ oz., .85		3.00

The named vars. of Oriental Poppies do not come 100% true from seed.

PORTULACA (Rose Moss—Sun Plant)

Single Large-Flowering—6 Inches

Single, mixed, all colors.....	.60	6.00
Jewel. A dazzling crimson flower four times the size of the ordinary single sorts. Very free flowering.....	.90	10.00

Double Large-Flowering

Best Quality, mixed		1.25	16.00
Pink	¼ oz., 80c	2.80
Salmon	¼ oz., 80c	2.80
Scarlet	¼ oz., 80c	2.80
Scarlet Glow	¼ oz., 80c	2.80	40.00
White	¼ oz., 80c	2.80
Yellow, golden	¼ oz., 80c	2.80
Yellow Sulphur	¼ oz., 80c	2.80

Potentilla ① (Cinquefoil), Double Mixed..... ¼ oz., 50c 1.80

Pot Marigold, see Calendula. **Pretty Betsy**, see Valeriana Rubra.

Pouchflower, see Calceolaria.

PRIMULA Chinensis Fimbriata—Chinese Primrose, 9 Inches

★ Vaughan's Special Mixture	150 seeds, \$0.60
Single Chinese Primrose mixed colors. ⅞ oz., \$3.75; ½ oz., 7.00		\$50.00
Giant Chinese Star Mixed.....	⅞ oz., 1.50

PRIMULA Obconica ① □ 12 Inches

Grandiflora Avalanche, white			
..... ½ oz., \$1.75; ⅞ oz., \$3.00; ½ oz., \$5.50		
Appleblossom pink. ½ oz., \$1.75; ⅞ oz., \$3.00; ½ oz., \$5.50		
Coerulea, blue ... ½ oz., 1.75; ⅞ oz., 3.00; ½ oz., 5.50		
Better Days, deep carmine red.....			
..... ½ oz., 1.75; ⅞ oz., 3.00; ½ oz., 5.50		
Dark Blood Red... ½ oz., 1.75; ⅞ oz., 3.00; ½ oz., 5.50		
Fasbender Red ... ½ oz., 1.75; ⅞ oz., 3.00; ½ oz., 5.50		
Lachrosa (Friesdorf), salmon-rose			
..... ½ oz., 1.75; ⅞ oz., 3.00; ½ oz., 5.50		
Mueller's (Berlin) Rose			
..... ½ oz., 1.75; ⅞ oz., 3.00; ½ oz., 5.50		
Mohnstein's Dark Red.....			
..... ½ oz., 1.75; ⅞ oz., 3.00; ½ oz., 5.50		
Perle von Niederrhein, large flowered, free blooming.....			
scarlet red ... ½ oz., 1.75; ⅞ oz., 3.00; ½ oz., 5.50		

PRIMULA Obconica. Grandiflora —Continued		Oz.	Lb.
Rose Queen, bright carmine rose.....
..... 3/2 oz., \$1.75; 1/8 oz., \$3.00; 1/8 oz., \$5.50
Mixed	1/8 oz., 4.50; 1/4 oz., 8.00
Wyaston Wonder Gigantea. The trusses are enormous size composed of individual blossom that will average 2 1/2 in. in diameter.
Crimson 1/4 oz., \$1.50; 3/2 oz., \$2.75; 1/8 oz., \$5.00
Orchid Lavender	3/2 oz., 3.50; 1/8 oz., 6.50
PRIMULA—Various Sorts			
Many of the hardy primroses germinate slowly and unevenly.			
Acaulis Blue, flowers, rich blue, very select stock.....
..... 3/2 oz., \$3.00; 1/8 oz., \$5.50
Auricula, Extra Large Flowering, Mixed, 8 inches.....
..... 1/4 oz., .90	\$3.00
Monarch strain choice mixed.....	1/8 oz., \$1.00; 1/4 oz., 1.75	6.00
Denticulata Grandiflora Hybrida, ①, lilac.....
Florindae ①, yellow, sweet scented, 40 inches.....	1/8 oz., 1.00
Japonica ①, mixed, very fine, 20 inches.....	1/4 oz., 1.25	4.00
Malacoides + (Imp. Baby Primrose) Light Lilac, 16 inches.....
..... 1/4 oz., 8.00	30.00
Princess Mary, deep rose pink.....	1/8 oz., \$2.50; 1/4 oz., 4.50
Salmon Rose	3/2 oz., 2.50
Mixed	1/8 oz., 3.50; 1/4 oz., 6.50	24.00
Veris ① Polyanthus Giant Munstead, light shades.....
1 foot	1/4 oz., 2.20	8.00
Colossea, large flowers borne on long stems in a wide range of colors. Excellent for cutting. This is the best strain of this type	1/8 oz., \$1.60; 1/4 oz., \$3.00	10.00
Giant Bouquet, the flowers are often 2 inches across. They are produced in great numbers and display an immense variety of coloring from white to cream, yellow, scarlet, purple and crimson. Borne on strong stems they are excellent for cutting, as well as making a splendid show in the garden.....	1/8 oz., \$2.00; 1/4 oz., \$3.50	12.00
Giant Crimson	1/4 oz., \$4.50	16.00
Grandiflora Mixed	1/4 oz., 2.20	8.00
Lutea, yellow, 12 in.....	1/4 oz., .80	3.00
Monarch Strain, giant flowers on strong stiff stems, many shades	1/4 oz., 2.20	8.00
Red shades	1/4 oz., .80	3.00
Mixed	1/4 oz., .85	3.00
Vulgaris ① (The true Yellow Primrose), 6 inches.....	1/4 oz., 1.40	5.00
Pueraria ÷ = Thunbergiana (Kudzu Vine), fragrant purplish violet			
.....
Purple Cone Flower (Rudbeckia Purpurea), 40 inches. 1/4 oz., \$0.30	.90
Pyrethrum ① □ Parthenifolium Aureum (Golden Feather), 1 foot.....70
Cinerariaefolium ①, Persian Insect Powder Plant. 1/4 oz., .40	1.50
Roseum (Painted or Persian Daisy) ① Hybridum,
Single Mixed, 32 inches.....	1.25	\$16.00
Atrosanguineum, blood red.....	1.50
James Kelway, velvety red, varies.....	1/4 oz., .80	3.00
Roseum Rose	1/4 oz., .80	3.00
★ Grandiflorum Robinson's Giant Hybrids.....	2.50	32.00
Grandiflorum Mixed	1.50	20.00

PYRETHRUM—Continued		Oz.	Lt.
Roseum Robinson's Dark Crimson		\$2.50	\$32.00
Double Pink	¼ oz., \$3.00	10.00
Double Red	¼ oz., 3.00	10.00
Double Sulphur	¼ oz., 3.00	10.00
Double White	¼ oz., 3.00	10.00
Double Mixed		2.50	32.00
Double Pyrethrum do not produce 100% double flowers; the percentage is better the second year.			
Ranunculus ① □ (Buttercup) Asiaticus Superbissimus, mixed, Giant French Hybrids, 12 inches.....	
Red Chamomile , see Adonis Autumnalis.			
Red-Hot Poker , see Tritoma.			
Rhodanthe □ mixed, 12 in.....		.30	3.20
Ricinus □, Borboniensis Arboreus, 10 to 15 ft.....		.30	3.20
Crimson Spire, 6 feet.....		.30	3.20
Cambodgensis, very dark, 4 ft.....		.30	3.20
Gibsoni, dark red leaves, stalk almost black, 5 ft.....		.30	3.20
Sanguineus, red leaves, 7 ft.....		.30	3.20
Mixed, many kinds15	1.40
Zanzibariensis Mixed15	1.60
Enormis, carmine seeds, 7 ft.....		.30	3.20
Rock Plants , Annual, mixed50	5.00
Rock Plants , Perennial, mixed.....		1.40	18.00
Rock Cress , see Arabis.		Rock Rose , see Helianthemum.	
Rock Soapwort , see Saponaria Ocymoides		Rose Champion , see Agrostemma Coronaria	
Rose of Heaven , see Agrostemma Coeli Rosa.			
Rose Moss , see Portulaca.			
Rudbeckia , *Kelvedon Star □, deep golden yellow, deep mahogany zone, dark brownish central disc, semi- double and single flowers, 3 feet..... ¼ oz., \$0.30		.90
Hirta, Herbstwald (Autumn Tints).....		1.00	12.00
My Joy (Giant Black Eyed Susan).....		.90	12.00
Newmanii (Speciosa) ①, orange rays, black..... disc		1.50
Purpurea ① (Echinacea), red, 4 feet..... ¼ oz., .30		.90
Starlight □, semi-double large flowers ranging in color from primrose-yellow to mahogany, some bicolors with mahog- any centers, 3 feet	¼ oz., 70c	2.40
Sage , see Salvia			
Salpiglossis □ (Painted Tongue—Trumpet Flower)			
Emperor (Superbissima), mixed, very fine.....		.60	6.00
Brown and Gold90	9.00
Purple and Gold.....		.90	9.00
Rose, Crimson and Gold.....		.90	9.00
Rose and Gold.....		.90	9.00
Scarlet and Gold90	9.00
Velvety Red90	9.00
Velvety Violet90	9.00
Violet and Gold90	9.00
White and Gold90	9.00
Gloxiniaeflora, mixed, very choice.....		.60	6.00
Giant Flowered Dwarf, mixed, compact branching habit fine for bedding, 20 inches.....		.80	8.00
Vaughan's Special Mixture of named sorts.....		.90	9.00

	Oz.	Lb.
Salvia Splendens □ (Scarlet Sage—Fire Cracker Plant) 24 inches.	\$2.00	\$28.00
Splendens, America (Globe of Fire), 16 inches	3.00	40.00
Brightness, more compact habit and earlier to bloom than the Splendens Type over which it is a definite improvement. Comes into flower with Bonfire. 24 in....	2.50	36.00
Clara Bedman or Bonfire, erect habit, 18 in.	2.50	36.00
Blaze of Fire, earliest of all, bright scarlet, dwarf, 10 in..	4.00	54.00
Harbinger, very early, scarlet, 16 inches.....	3.00	40.00
St. John's Fire, earliest to bloom, bright scarlet, spikes stand densely and rigidly upright on uniform and compact plants, 10 in.	4.50	64.00
Vaughan's Masterpiece, extra early, red, 10 inches....	3.00	40.00
Zurich , early flowering red	2.50	36.00
Farinacea ⊙ □, bright light blue, 40 in..... ¹ / ₄ oz., 70c	2.50
Blue Bedder, compact, deeper blue, 3 ft.....	3.00	42.00
Patens ÷ □, navy blue, 30 in..... ¹ / ₄ oz., 70c	2.50
Pratensis ⊙ (Meadow Sage), dark blue, 30 in.....	1.50	20.00
Sand Pink (Dianthus Arenarius)
Sanvitalia □ Procumbens fl. pl., yellow, black center, 6 inches. (This is also called "Creeping Zinnia").....	.80	8.00
Saponaria (Soapwort) Ocymoides Splendens ⊙, rose, 12 in.....	.60	6.00
Vaccaria □ Alba, 24 inches.....
Rose, excellent for cutting.....	.15	1.80
Satin Flower , see Godetia.		
Scabiosa (Pin Cushion Plant), large flowering, □, double tall, mixed, 36 inches30	3.30
Double Large Flowering Black Prince50	5.00
Amethyst (Ageratum blue)50	5.00
Azure Fairy, azure blue50	5.00
Blue Cockade, deep azure blue50	5.00
Blue Moon, Imperial Giant80	8.00
Cherry Red50	5.00
Fire King, rich, rosy crimson50	5.00
Loveliness, soft, delicate salmon-rose.....	.50	5.00
Oxford Blue, deepest blue.....	.50	5.00
Peachblossom, deep flesh50	5.00
Rose, bright rose50	5.00
★ Rosette, deep rose, heavily suffused salmon.....	.50	5.00
★ Salmon Beauty, pure salmon, giant-flowered.....	.50	5.00
Shasta, white50	5.00
Yellow, sulphur50	5.00
Vaughan's Super Crown Imperial Hybrids.....	.50	5.00
Improved Giant Hybrids40	4.00
Dwarf Mixed, 18 inches.....	.80	8.00
Heavenly Blue, clear lavender blue.....	.80	8.00
Peace, pure white80	8.00
Caucasica ⊙ Alba, white, very fine.....	1.50	20.00
Blue	1.50	20.00
Goldingensis, deep lavender.....	2.00
House's New Hybrids.....	2.50	32.00
Perfecta, large, fringed, lilac.....	2.00	28.00
Schizanthus □ (Butterfly Flower), Wisetonensis. mixed, 16 inches	1.00	12.00
Bridal Veil, pure white, excellent, 1-1/3 feet.....
..... ¹ / ₈ oz., 85c; ¹ / ₂ oz., \$1.50
★ Pansy Flowered (Danbury Park Strain), 16 inches. ¹ / ₄ oz., .85	3.00

SCHIZANTHUS—Continued		Oz.	Lb.	
Dr. Badger's Giant Hybrids, large flowers, brilliant range of colors from light pink to deep purple through rose, but without any whites each flower with a large golden blotch		¼ oz., 50c	\$1.80
★ Masterpiece, Vaughan's Dwarf Excelsior Hybrids, large blotched flowers in splendid color range....		¼ oz., \$1.20	4.00
Wisetoniensis Monarch Strain.....		¼ oz., .60	2.00
★ Vaughan's Excelsior Hybrids		¼ oz., .70	2.40
Scutellaria ① (Skull Cap) Coelestina, pretty, blue				
Siberian rock plant, 6 inches.....		½ oz., .65	4.40
Sea Lavender (Statice Latifolia), 30 inches.....			1.00	\$12.00
Shamrock60	6.00
Shasta Daisy Alaska , best white, 40 inches.....			.60	6.00
Silk Oak , see Grevillea.				
Shoo Fly Plant , see Nicandra.				
Siberian Wallflower , see Cheiranthus Allionii.				
Sidalcea # (Greek Mallow) Rose Queen, rose flowers, 4 feet....		
Rosy Gem, mallow-rose, 18 inches.....			1.60
New Hybrids, 3 feet.....		¼ oz., 50c	1.60
Silene Armeria □ (Sweet William Catchfly), red, 12 inches.....			.30	3.00
Pendula □ Rosea, rose.....			.30	3.00
Mixed30	3.00
Skull Cap , see Scutellaria.				
Snapdragon , see Antirrhinum.				
Sneeze Wort , see Helenium.				
Soapwort , see Saponaria Ocymoides.				
Snow in Summer , see Cerastium				
Similax + Asparagoides			1.80	24.00
Solanum Celestial (Capsicum Pepper).....		¼ oz., 80c	2.80
Christmas Cherry Improved.....		¼ oz., 70c	2.50
Hlavacek's Masterpiece, cherries freely produced, compact plant		¼ oz., 80c	3.00
Patterson Variety, large orange red cherry-like fruits, compact habit, 12 in.			1.00	12.00
Gold Ball, a yellow form of the above.			1.00	12.00
Speedwell , see Veronica Spicata.				
Spider Flower , see Cleome.				
Star of Texas (Xanthisma Texanum).....		¼ oz., 60c	2.00
★ Statice □ Bonduelli, deep yellow, 3 feet.....			.30	3.20
Caspia ① large, lilac, 30 inches.....		¼ oz., 50c	1.80
Dumosa, dense cushions of pure silvery grey flowers, 18 in..			1.00	12.00
Latifolia ① blue, 30 inches.....			1.00	12.00
Perezii ① lilac, 24 inches.....		¼ oz., 40c	1.40
Sinuata □ Atro-coerulea, "True Blue," 36 inches.....			.30	3.60
Kaempf's Atro-coerulea, 30 inches.....			.30	3.60
Lavender Queen, clear bright lavender.....			.30	3.60
★ Market Grower's Blue, deep blue, 3 feet.....			.30	3.60
Pastel shades, mixed30	3.60
Rosea Superba, the best pink, 36 inches.....			.30	3.60
★ Pure White, 36 inches.....			.30	3.60
Mixed30	3.00
New Shades, Mixed40	4.40
Suworowii □ bright rose, 30 in.....			.90	12.00
Stevia Serrata , ÷ pure white, 28 in.....		¼ oz., 60c	2.00

STOCKS

Our Stocks are produced by the most careful growers and are **equal to the best in the market.**

Large Flowering, Double Dwarf, Ten Weeks, 14 Inches

This is the only type that blooms satisfactorily outdoors in the middle west.

Blood Red	Canary Yellow	Lavender		
Brilliant Pink (Rosy Morn)	Dark Blue	Rose (Carmine Pink)		
	Light Blue	White	Oz.	Lb.
Each of the above	1/4 oz., 40c	\$1.20
Extra Choice Mixed, all colors		1.00	\$12.00
Good Mixed70	7.00

Beauty of Nice, 24 to 30 inches.

Mixed, all colors	1.00	12.00
-------------------	------	-------

"Non-Branching" Column Stocks

American Beauty, rich deep carmine rose	1/4 oz.,	\$1.50	5.00
Apricot No. 20	1/4 oz.,	1.50	5.00
Blue, a rich shade of mauve or lilac blue	1/4 oz.,	1.50	5.00
Chamois Pink	1/4 oz.,	1.50	5.00
Deep Apricot	1/4 oz.,	1.50	5.00
Gardenia, glistening snow-white flowers of gigantic size	1/4 oz.,	1.50	5.00
Illusion, scarlet red	1/4 oz.,	1.50	5.00
Lilac Lavender	1/4 oz.,	1.50	5.00
Pink Giant, rich rose pink with slightly lighter center of flower. Large florets closely set on long stems	1/4 oz.,	\$1.65	6.00
Purple Heart, bright violet purple	1/4 oz.,	1.50	5.00
Rose Pink No. 11	1/4 oz.,	1.50	5.00
Rose Pink No. 14, deep rose	1/4 oz.,	1.50	5.00
Ruby	1/4 oz.,	1.50	5.00
* Silvery Lilac	1/4 oz.,	1.50	5.00
No. 22 Supreme, supremely fine in its rich silvery rose shading, with extra long stems and fine heavy spike	1/4 oz.,	1.50	5.00
Vaughan White No. 1, pure white companion to Silvery Lilac in height and bloom date	1/4 oz.,	1.50	5.00
White Giant, long stemmed pure white. Florets of good size closely set on long stems	1/4 oz.,	1.65	6.00
Yellow Wonder, best yellow	1/4 oz.,	1.50	5.00
White No. 16 early pure white, large floret, compact spike	1/4 oz.,	1.50	5.00
Non-Branching Column, Vaughan's Special Mixture	1/4 oz.,	1.50	5.00

Bismarck (Early Giant Imperial), 28 to 32 Inches

Antique Copper	Elk's Pride, royal purple	Lavender		
Appleblossom	Fiery Blood-Red	Lilac		
Buttercup, rich yellow	Flesh	Rose		
Chamois	Golden Rose	Shasta, glistening white		
Dark Blue			Oz.	Lb.
Each of above	1/4 oz., 50c	\$1.80
Bismarck Mixed, all colors	1/4 oz., 40c	1.20	\$16.00

Early Colonial

Since it does not produce a center spike, no pinching is required to make the plants branch. The 2-inch florets are borne in clusters or spikes 15 inches long, averaging 70% double flowers.

Mayflower, red rose	Puritan, pure white		
Priscilla, silvery lavender	Rose Standish, bright rose		
Each of the above.....	1/4 oz., 70c	\$2.50
Early Colonial Mixed.....	1/4 oz., 70c	2.50

Giants of California

This magnificent group comes very early, having the branching habit of the **Bismarck**, with mammoth flowers on longer stems.

Blood Red (Red Wood)	Rose (Yosemite)		
Blue (Pacific)	Rose Carmine (Sequoia)		
Chamois (Santa Barbara)	Velvety Violet (Mojave)		
Lavender (Tahoe)	White (Santa Maria)		
Pink (Monterey)	Yellow (Golden Gate)		
Each of the above	1/4 oz., 60c	\$2.00
Giants of California Mixed, all colors.....	1/4 oz., 50c	1.80	\$24.00

Brompton or Winter Mixed.....1/4 oz., 80c 2.80 40.00

Stokesia ① *Cyanea* (Stokes' Aster, Cornflower Aster), large flowering, blue, 16 in. 2.20 30.00

St. Peter's Penny, see *Lunaria*.

Sun Plant, see *Portulaca*.

Strawflower, see *Helichrysum*.

Sun Rose, see *Helianthemum*.

Summer Cypress, see *Kochia*.

Strawberry Baron Solemacher,

Red Fruited	2.00
Yellow Fruited	2.00

SUNFLOWER □

Annus Purpureus (Red Sunflower), 7 feet.....	.20	2.20
Cucumerifolius (Miniature Type) <i>Stella</i> , large flowered, 5 feet....	.50	5.00
Vaughan's Special Mixed35	3.80
Mammoth Russian single large of gigantic dimensions. The Kansas yellow sunflower, 8 feet. Ask for prices on larger lots.....30
Sun Gold , brilliant golden yellow, 100% double, globe shaped...	.30	3.00

Surprise Garden Mixture. A carefully prepared "Formula Blend" comprising over eighty different flower varieties. This is one of our leaders and gives 100% customer satisfaction. Blended to give bloom throughout the entire summer and until frost in fall. No vines or dwarf varieties.....10 lbs., \$26.00 2.80

Swan River Daisy, see *Brachycome*.

Sweet Alyssum, see *Alyssum Benthami*.

Sweet Rocket, see *Hesperis*.

Vaughan's Sweet Peas

Summer Spencer Varieties

We supply ¼ lb. of any one variety of Summer Spencers for 50c. We can offer substitutes for older varieties which we have dropped from our list when the improved and newer sorts were introduced.

	Oz.	Lb.
Ambition, rich deep lavender	\$0.20	\$1.80
Ascot, bright pink20	1.80
Avalanche, glistening white20	1.80
Bonnie Briar, mammoth rose pink.....	.20	1.80
Bridal Veil, white20	1.80
Chieftain, pure satiny rose20	1.80
Chinese Blue, rich deep blue20	1.80
Chloe, deep shell pink on cream.....	.20	1.80
Crimson King, rich deep, clear crimson.....	.20	1.80
Ecstasy, blush pink20	1.80
Flagship, true clear deep blue.....	.20	1.80
Flamingo, cerise scarlet20	1.80
Gigantic, black seeded, white.....	.20	1.80
Gleneagle, large lavender20	1.80
Grand National, cream20	1.80
Highlander, pure lavender20	1.80
Jubilee, scarlet cerise20	1.80
King White, pure white20	1.80
Leader, salmon pink on cream ground.....	.20	1.80
Miss California, orange-salmon with cream-pink.....	.20	1.80
Mrs. Tom Jones, bright delphinium blue.....	.20	1.80
Olympia, deep rich purple.....	.20	1.80
Peggy Ann, salmon pink.....	.20	1.80
Pinkie, large, rose pink.....	.20	1.80
Pinnacle, deep rose pink on white.....	.20	1.80
Powerscourt, lavender20	1.80
Prince of Orange, deep orange.....	.20	1.80
Red Supreme, bright luminous red.....	.20	1.80
Ruffled Burpee Blue, mid-blue.....	.20	1.80
Crimson, rich crimson.....	.20	1.80
Exquisite, salmon-cerise20	1.80
Fluffy Ruffles, cream-pink.....	.20	1.80
Rose20	1.80
White, white seeded20	1.80
Mixed	10 lbs., \$15.00	.20
Smiles, shrimp pink.....	.20	1.80
Tangerine Improved, deep salmon-orange.....	.20	1.80
Warrior, rich chocolate maroon.....	.20	1.80
Welcome, dazzling scarlet20	1.80
Youth, exquisite pink, picotee edge on white.....	.20	1.80

Vaughan's Special Mixture of Summer Spencer Varieties

Mostly from separate varieties..10 lbs., \$14.00; 100 lbs., \$135.00	1.50
Spencer Hybrids , mixed.....10 lbs., 12.00; 100 lbs., 115.00	1.30
Vaughan's Florists' Mixture of Spencer Varieties , this is a mixture made by ourselves chiefly of light colored varieties.....	.20
	2.00

SWEET PEAS—Continued**Sweet Peas in Mixture**

Vaughan's Prize Mixture , this mixture contains the cream of the new and standard sorts, including many of the early Spencer varieties. Per lb., \$1.00; 5 lbs., \$4.50		
Eckford (Grandiflora) Mixture , this mixture contains over thirty varieties, lb., 80c; 5 lbs., \$3.80.	Oz.	Lb.
Cupid Grandiflora , choice mixed, 6 inches.....	\$0.15	\$1.60
Cupid Spencer , mixed, 6 inches.....	.80	8.00

Spring-Flowering (Cuthbertson)

The following list of Spring Flowering varieties represents the latest improvements in this increasingly popular class. They retain identical characteristics of the already popular Spring Flowering Peas in every respect, but represent further refinements and the addition of several new colors.

Seed should be sown from the middle or end of October to February in the greenhouse for flowering in spring and summer or outside just before ground freezes up.

Billy, light carmine.	Jessie, mauve.		
Carol, clear pink, white ground.	Jimmie, deep scarlet.		
Coline, scarlet.	Katie, rose cream-pink.		
Danny, navy blue.	Kenneth, rich oxblood-crimson.		
David, bright rose-crimson.	Lois, rose pink white ground.		
Evelyn, salmon cream pink.	Marion, cream, black-seeded.		
Frances, salmon on white ground.	Tommy, clear medium blue.		
Frank G, rosy lavender.	William, picotee rose pink on white background.		
Hazel, light blue.			
Janet, black seeded white.			
Each of the above.....		.20	2.20
Mixed. All of the above and others.....		.20	2.20

SWEET PEAS—Early or Winter-Flowering Spencers

Duplexed varieties often have 3 to 4 standards and the same number of wings, giving the appearance of a semi-double flower.

	Oz.	¼ Lb.	Lb.
A. C. Zvolanek, rose pink, long stems.....	\$0.30	\$0.85	\$3.00
American Beauty, crimson rose on white ground.....	.30	.85	3.00
Amethyst, an early flowering "Royal Purple".....	.30	.85	3.00
Apollo, soft salmon pink30	.85	3.00
Bacchus, deep maroon.....	.30	.85	3.00
Ball Blue Supreme, same rich blue but much larger flower than Mrs. Hoover.....	.30	.85	3.00
Ball Rose Improved.....	.30	.85	3.00
Ball Orange Improved, brilliant orange.....	.30	.85	3.00
Ball Rose Supreme, large wavy flowers of a bright silvery rose pink.....	.30	.85	3.00
Ball White, pure white.....	.30	.85	3.00
Ball's Rose Queen, extra deep red rose30	.85	3.00
Blue Bird, fragrant violet blue.....	.30	.85	3.00
Boon, deep coral pink.....	.30	.85	3.00
Bridesmaid, soft silvery pink.....	.30	.85	3.00
Burpee's White, pure white.....	.30	.85	3.00
Daphne, soft salmon pink on cream ground30	.85	3.00
Fiesta, orange cerise.....	.30	.85	3.00
Fragrance, mammoth lavender.....	.30	.85	3.00
Gardenia, fragrant white flowers, ruffled and duplexed....	.30	.85	3.00
Giant Rose, largest rose pink.....	.30	.85	3.00
Grenadier, glowing poppy-scarlet.....	.30	.85	3.00
Harmony, clear lavender.....	.30	.85	3.00
Hope, black seeded white.....	.30	.85	3.00

SWEET PEAS, Early Spencer —Continued	Oz.	¼ Lb.	Lb.	
Jeanne Mamitsch, striking pink, shading off to deepest pink.	\$0.30	\$0.85	\$3.00	
Josie, pink, large and free bloomer.	.30	.85	3.00	
Laddie Improved, rose pink on white ground.	.30	.85	3.00	
Mariner, clear marine-blue	.30	.85	3.00	
Mrs. Herbert Hoover, clear blue	.30	.85	3.00	
New Ball Rose, free flowering rich deep rose.	.30	.85	3.00	
Oriental, deep cream, black seeded.	.30	.85	3.00	
Pride, pure deep even cerise.	.30	.85	3.00	
Princess Blue, rich light blue.	.30	.85	3.00	
Ramona, coral rose, yellow shading.	.30	.85	3.00	
Red Bird, crimson-red	.30	.85	3.00	
Redwood, deep bright rich crimson.	.30	.85	3.00	
Sequoia, golden rose salmon cerise.	.30	.85	3.00	
Shirley Temple, large, frilled soft pink.	.30	.85	3.00	
Snow Queen, pure white, black seeded.	.30	.85	3.00	
Sparks, brilliant poppy scarlet.	.30	.85	3.00	
Tahoe, delightful shade of mid-blue.	.30	.85	3.00	
Tophat, deep purple blue.	.30	.85	3.00	
Treasure Island, sparkling golden orange.	.30	.85	3.00	
Triumph, deep lilac mauve.	.30	.85	3.00	
Twilight, medium clear lavender	.30	.85	3.00	
Valencia, orange	.30	.85	3.00	
White Champion, long stemmed, pure white, white seeded.	.30	.85	3.00	
White Harmony, standard white	.30	.85	3.00	
Zvolanek's Cascade, large flowered white, white seeded.	.30	.85	3.00	
Mixed, Early Flowering Spencers, many kinds. 10 lbs., \$18.00	2.00	
★ Vaughan's Special Mixture, Early Flowering Spencers	5 lbs., 14.00	.30	3.00

Sweet Rocket, see Hesperis.

Sweet Sultan (Centaurea Moschata), mixed, 30 inches. **Oz.** **Lb.**
\$0.50 \$5.00

SWEET WILLIAM ① (Dianthus Barbatus)

Seedlings of all double Sweet William produce about 40% of single blooming plants. Dwarf Sweet Williams will produce some tall plants.

	Oz.	Lb.
Single Mixed	\$0.40	\$4.00
★ Single Dwarf (Midget), mixed, 6 inches, many showy, rich colors	\$3.20
Giant Auricula Eyed, extra large flowers.	.60	6.00
Mammoth Flowered, single mixed.	.50	5.00
Single Blood-red (Atrosanguineus).	.50	5.00
Copper Red	.80	8.00
Giant White Special, very large flowers.	.80	8.00
Homeland, dark red flowers with sharply defined clear white center	.90	10.00
Newport Pink (Pink Beauty), salmon rose.	.60	6.00
Nigrescens, almost black.	.50	5.00
Purple Beauty, bright deep purple.	.90	10.00
Scarlet Beauty, scarlet	.60	6.00
Double Mixed	.60	6.00
Giant Flowered Mixed	.60	6.00
★ Dwarf Midget Mixed	1.20	16.00
Vaughan's Special Mixture, double and single.	1.00	12.00
Barbatus X Chinensis Single annual Sweet William.	.80	8.00

	Oz.	Lb.
Tagetes , see Marigold.		
Tahoka Daisy □, 20 inches, beautiful lavender blue daisy	¼ oz., 50c	\$1.80
Tassel Flower , see <i>Cacalia</i> .		
Texas Pride , see <i>Phlox Drummondii</i> . Texas Blue Bonnet , see <i>Lupinus Subcarnosus</i> .		
Texas Queen Ann's Lace Flower , white, 3 feet.....	.50	\$5.40
Thalictrum ① (<i>Meadow Rue</i>) <i>Dipterocarpum</i> , lilac-rose, 40 inches..	4.00
<i>Adiantifolium</i> , 18 in.50	5.40
<i>Aquilegifolium</i> Mixed, 40 in.....	.80	8.00
Thimble Flower , see <i>Gilia Capitata</i> .		
Thermopsis ① <i>Caroliniana</i> , long yellow panicles, 18 inches	¼ oz., 50c	1.80
Thorn Apple , see <i>Datura</i> .		
Throat Wort , see <i>Trachelium Coeruleum</i> .		
Thunbergia □ ① (<i>Black Eyed Susan</i>), mixed, fine climber.....	.80	8.00
<i>Gibsoni</i> , brilliant glowing orange.....	¼ oz., \$1.75	6.00
Tickseed , see <i>Coreopsis</i> .		
Tigridia □ Fine Mixed	¼ oz., 85c	3.00
Tithonia □ <i>Avalon Earliest</i> , flowers from orange topaz, through tangerine	1.00	12.00
<i>Torch</i> . (All America Silver Medal 1951), brilliant orange-scarlet flowers on long stout stems, compact, 3 to 4 ft.....	1.80	24.00
Torenia ÷ □ (<i>Wishbone Flower</i>) <i>Fournieri</i> , blue, 12 inches	¼ oz., \$1.50	5.00
<i>Fournieri White</i>	¼ oz., 1.50	5.00
<i>Fournieri Compacta White</i>	¼ oz., 1.50	5.00
<i>Fournieri Compacta Blue</i>		
Trachelium ① (<i>Throatwort</i>) <i>Coeruleum</i> , blue, 24 inches	¼ oz., .60	2.00
Trachymene , see <i>Didiscus</i> .		
Tradescantia Mixed, saved from named varieties.....	2.00
Transvaal Daisy , see <i>Gerbera</i> .		
Tritoma ① (<i>Kniphofia</i> — <i>Red Hot Poker</i> , <i>Torch Lily</i>), <i>Hybrida Mirabilis</i> , blooms first year.....	¼ oz., .50	1.80
<i>Miracle Mixed</i>	¼ oz., .40	1.40
<i>Perpetual Flowering Hybrids</i>	¼ oz., .40	1.40
<i>Pfizer's Hybrids</i> , scarlet, red and yellow.....	¼ oz., .50	1.50
Trumpet Flower , see <i>Datura</i> or <i>Salpiglossis</i> .		
Trollius ① (<i>Globe Flower</i>) <i>Europæus</i> , yellow, 20 in. ¼ oz., .80	3.00
<i>Ledebouri</i> , orange, 24 inches.....	¼ oz., 1.70	6.00
Mixed	¼ oz., 1.20	4.00
Tunica ① □ <i>Saxifraga</i> (<i>Coat Flower</i>), lilac-rose, dwarf, 10 inches90	10.00
Valeriana (<i>Garden Heliotrope</i> , <i>Pretty Betsy</i>), <i>Rubra fl.</i> <i>Alba</i> , white, 3 feet.....	.60	6.00
<i>Rubra fl. Coccinea</i> , purple rose, 3 feet.....	.60	6.00
<i>Rubra Mixed</i>60	6.00
Velvet Flower , see <i>Marigold</i> .		
Venidium □ <i>Fastuosum</i> , orange flowers, black zone, 2 to 3 feet	¼ oz., .70	2.40
<i>Fastuosum Hybrids</i> , 2 to 3 feet.....	¼ oz., .80	2.80
Verbascum ① (<i>Mullein</i>) <i>Miss Willmott</i> , milk white, 5 feet	¼ oz., .70	2.40
<i>Olympicum</i> , yellow, wooly leaves, 6 feet.....		
<i>Harkness Hybrids</i> , immense spikes of pure yellow, 7 ft.	¼ oz., 70c	2.40

VERBENA HYBRIDA □ ①

	Oz.	Lb.
Blue Shades	\$0.90	\$10.00
Dark Blue90	10.00
Defiance, brilliant scarlet90	10.00
Mayflower, beautiful pink90	10.00
Purple Mantle90	10.00
Mammoth, Mixed90	10.00
Nana Compacta. Blue Sentinel, rich navy-blue self... ¼ oz., 80c	3.00
Danebrog, intense scarlet, large white eye.....	1.00	12.00
White	1.50
Mixed	1.25	16.00
Dwarf Upright Mixed, well-branched plants of dwarf upright habit, large flower heads, in a range of bright colors.....	2.50	36.00
Gigantea, giant flowered in splendid mixture.....	1.00	12.00
Alba, white, 1½ feet.....	1.25	16.00
Annapolis Blue, spreading habit, shades of light to dark blue in same flower	1.25	16.00
Appleblossom, delicate cameo pink.....	1.25	16.00
Beauty of Oxford Hybrids, rose pink to rose red.....	1.25	16.00
Brightness, bright rosy cerise scarlet, large white eye.....	1.25	16.00
Brilliant, rich, deep, flame rose with medium sized white eye.....	1.25	16.00
Cerise Queen, salmon cerise.....	1.25	16.00
Crimson Glow, glowing crimson without eye.....	1.25	16.00
Etna, geranium red with creamy yellow eye.....	1.25	16.00
Floradale Beauty, salmon rose.....	1.25	16.00
Giant Salmon Pink	1.25	16.00
Lavender Glory, true lavender, cream white eye.....	1.25	16.00
Luminosa, flame-pink	1.25	16.00
Lucifer, vivid scarlet, self	1.25	16.00
Rosea Stellata, rose pink, white eye.....	1.25	16.00
Royale, deep blue, creamy yellow eye.....	1.25	16.00
Salmon King, clear deep salmon.....	1.25	16.00
Spectrum Red, intense bright red	1.25	16.00
Violacea Stellata, violet with white eye.....	1.25	16.00
Vivid, brilliant sunproof scarlet.....	1.25	16.00
* Vaughan's Best mixture, contains all best colors.....	1.25	16.00
Bush Type, plants of uniform bushy habit, 8 to 10 inches high, and 12 to 15 inches across, flowers practically touching each other.		
Firelight, vivid red	¼ oz., \$0.80	3.00
Roselight, bright rose-pink	¼ oz., .80	3.00
Salmon Queen, bright salmon pink with small white eye.....	1.50	20.00
Starlight, mid-blue with creamy-white eye.....	1.50	20.00
Snow White, pure white, large flowered.....	¼ oz., .80	3.00
Mixed, includes the above and others.....	2.00	28.00
Violet Bouquet, finest mixed upright growth, auricula eyed brilliant mixed	¼ oz., 40c	1.50
Royal Bouquet Mixed. This variety has an upright growth on straight stems, making it a good cut flower sort and a symmetrical bedding plant. The flowers are very large in many charming colors; 15 to 18 inches.....	¼ oz., 70c	2.40
Bipinnatifida (Fern leaved). The plants reach 18 inches in height by 2 feet wide with great piles of ferny, feathery gray-green foliage covered with clusters of lavender blue flowers. The flowers resemble sprays of lilac candytuft... ¼ oz., \$0.60	2.00

VERBENA—Continued

		Oz.	Lb.
Bonariensis Improved ①, upright growing, slender branched stems, numerous umbels of rosy lavender flowers. Germination takes full six weeks unless sown in a temperature of 75 degrees.....	¼ oz., .60	2.00
Erinoides (Moss Verbena), deep purple, 12 inches... ¼ oz., .40		1.50
Lemon ÷ (Citriodora), foliage fragrant..... ¼ oz., 1.20		4.00
Venosa □ deep lilac, 12 inches..... ¼ oz., .40		1.50
Lilacina, delicate lavender blue..... ¼ oz., .40		1.40
<hr/>			
Veronica ① Spicata (Speedwell), various blue shades, 18 inches	¼ oz., .70	2.40
Dwarf Sorts Mixed	¼ oz., .50	1.60
Vinca Rosea (Old Maid Periwinkle) □ Mixed, 12 inches.....		1.40	\$18.00
Fl. Albo, white with pink eye.....		1.40	18.00
Alba Pura, pure white.....		1.40	18.00
Delicata, soft pink.....		1.40	18.00
Rosea		1.40	18.00
Viola Cornuta , □ ① (Horned Violet), Avalanche , giant pure white	½ oz., \$1.50; ¼ oz., \$2.75	10.00
Admiration , dark blue	¼ oz., .70	2.50
Apricot , apricot orange..... ¼ oz., .80		3.00
Arkwright Ruby , bright, ruby crimson; fragrant... ¼ oz., 1.50		5.00
Blue Beauty , early, bright blue... ½ oz., \$1.00; ¼ oz., 1.75		6.00
Blue Butterfly , vivid midblue shading to white in upper petals	¼ oz., 1.10	4.00
Blue Elf , 9 inches, the upper petals are deep violet blue, lower petals light violet blue with gold eye and black lines radiating from center. Flowers ¾ inches in diameter, small dark green foliage..... ½ oz., 80c; ¼ oz., \$1.40		5.00
Blue Perfection , 8 inches.....		2.50	36.00
* Chantreyland , bright apricot-orange..... ¼ oz., .80		3.00
Chinese Blue , pure sky blue..... ¼ oz., 2.00		7.00
* King Henry (Purple King), rich violet blue with small yellow eye	¼ oz., .90	3.00
* Large Flowering Scotch , a splendid mixture... ¼ oz., 1.60		6.00
Lutea Splendens , chrome-yellow, 8 inches..... ¼ oz., .90		3.20
Miss Helen Mount , two upper petals rich violet; two smaller lower petals are lavender and lower petal is canary yellow with black lines radiating from eye... ¼ oz., \$0.80		3.00
Papilio , blue and white, 8 inches..... ¼ oz., .90		3.00
Puck , velvety purple-violet and yellow..... ¼ oz., .90		3.00
White Perfection , 8 inches..... ¼ oz., .90		3.00
Mixed, large flowering..... ¼ oz., .90		3.00
* Vaughan's Special Mixture , a blend of bright gay colors	¼ oz., 1.50	5.00
Odorata Semperflorens , Blue Sweet Violet..... ¼ oz., .90		3.00
Nigra (Black Imp), pretty small black flowers... ¼ oz., 1.20		4.00
Johnny Jump Up , little pansy faces of various colors	¼ oz., 1.10	4.00
Virginia Stocks □ (Malcolmia), mixed, 12 inches.....		.30	3.00
Compacta mixed30	3.00

	Oz.	lb.
Viscaria <input type="checkbox"/> Blue Pearl, pure lavender blue without eye.....		
..... ¼ oz., 50c	\$1.80
Cardinalis, bright carmine, 13 in.....	.35	\$3.00
Oculata Nana Compacta, mixed, 8 inches..... ¼ oz., 45c	1.50
Blue Bouquet	¼ oz., 50c	1.80
Fiery Red, brilliant red, compact, 12 inches.. ¼ oz., 30c	1.00
Mixed, many sorts, 12 in.....	.70	7.00
Wahlenbergia , see Platycodon.		
Wallflower <input type="checkbox"/> Double Early Wonder, mixed..... ¼ oz., 40c	1.40
Double Tall Branching, mixed	¼ oz., 80c	2.80
Parisian Forcing Mixed, single; will bloom first year.....	.40	4.00
Annual Blood-red, single, 12 inches.....	.40	4.00
Yellow, single, 12 inches.....	.40	4.00
Single mixed30	3.00
Wild Flowers for Deep Shade ¼ oz., 80c	3.00
Winecup , see Callirhoe.		
Wisteria ① Sinensis, blue.....
Xanthisma <input type="checkbox"/> Texanum (Star of Texas), bright yellow, 18 inches	¼ oz., 60c	2.00
Xeranthemum <input type="checkbox"/> Superbissimum, mixed, (Pompon) Everlasting flower70	7.00

ZINNIA

We supply ¼ lb. of one variety at the pound rate.

California Giants Double 3 to 4 feet (Mammoth)

Brightness, deep-rose60	6.00
Cherry Queen, a brilliant rose cerise.....	.60	6.00
Crimson Queen, rich crimson.....	.60	6.00
Daffodil, canary yellow.....	.60	6.00
Enchantress, light rose, dark rose center.....	.60	6.00
Golden Queen, golden yellow60	6.00
Grenadier, bright dark red60	6.00
Isabellina, soft creamy-yellow60	6.00
Lavender Gem, deep rosy lavender.....	.60	6.00
Miss Wilmott, soft pink60	6.00
Orange King, orange scarlet60	6.00
Purity, largest and best white.....	.60	6.00
Rose Queen, striking deep rose.....	.60	6.00
Salmon Queen, deep salmon apricot.....	.60	6.00
Scarlet Queen, glowing deep scarlet.....	.60	6.00
Violet Queen, deep purple60	6.00
Mixed50	5.00
* Vaughan's Special Mixture.....	.60	6.00

Giant Dahlia Flowered Double 2½ to 3 feet.

Canary Bird, a rich canary yellow.....	.60	6.00
Crimson Monarch, the largest and best red.....	.60	6.00
Dream, deep rosy lavender.....	.60	6.00
Eldorado, salmon apricot.....	.60	6.00
Exquisite, light rose, center deep rose.....	.60	6.00
Golden Dawn, golden-yellow60	6.00
Golden State, rich carmine.....	.60	6.00
Illumination, a striking deep rose self.....	.60	6.00
Luminous, bright pink60	6.00
Orion, orange and gold.....	.60	6.00

ZINNIA. Dahlia Flowered—Continued

	Oz.	Lb.
Polar Bear, the best white in Zinnias.....	\$0.60	\$6.00
Royal Purple, deep rich purple without a trace of blue.....	.60	6.00
Scarlet Flame, bright scarlet.....	.60	6.00
Will Rogers, brilliant scarlet red.....	.60	6.00
Super Crown of Gold, Pastel Tints, mixed.....	.60	6.00
Dahlia Flowered, mixed.....	.50	5.00
* Gold Medal Mixture, an extra fine strain.....	.60	6.00
Giant Varieties, mixed.....	.60	6.00
Indian Summer Mixture, bright and warm colors only of Dahlia Flowered and California Giants.....	.60	6.00
Burpee's Super Giant. Flowers are 5½ to 6½ inches across. Rare and unusual shades and many two and three-tone effects, 3 foot.....	.60	6.00
David Burpee, giant shaggy flowers in many pastel shades.....	.70	7.00
Floradale Scarlet, intense scarlet-red flower, twisted curled petals. Large flower, often 5 in. across.....	.90	10.00
Luther Burbank, of delicate pastel or art shades, including many unusual two and three-color combinations, 3 to 4 ft.60	6.00
Peppermint Stick Mixed, medium sized flowers with petals striped in various color combinations such as red and white, red and yellow, purple and white, carmine and white and orange and yellow.80	8.00
Riverside Beauty, warm rich azalea-pink flower on long stems, petals are twisted and curled presenting an informal appear- ance with no trace of stiffness. Large flowers measuring 5 to 5½ inches across.90	10.00
Giant Cactus Flowered Hybrids (Giant Burpee Hybrids), large flowers, 6 in. and up in diameter, in all the softer zinnia colors as well as pastels found in no other mixture. Some of the flower petals are fluted, others flat and twisted.....	1.75	18.00
..... ¼ oz., 35c; ¼ oz., 60c		
Lilliput (Pompon) Double Black Ruby, deep blackish maroon, 1½ to 2 feet.....	.60	6.00
Canary yellow.....	.60	6.00
Crimson.....	.60	6.00
Dainty Gem, bicolor rose.....	.60	6.00
Deep Flesh, this is a bright pink.....	.60	6.00
Golden Gem.....	.60	6.00
Purple.....	.60	6.00
Rose Bud, rose pink.....	.60	6.00
Scarlet Gem.....	.60	6.00
Salmon Rose.....	.60	6.00
Valencia, burnt orange.....	.60	6.00
White Gem.....	.60	6.00
Pastel shades, mixed.....	.60	6.00
Lilliput, double mixed.....	.50	5.40
* Vaughan's Special Mixture of Lilliput varieties.....	.60	6.00
Pumila fl. pl. (Cut and Come Again), Double Dwarf, 2 to 2½ feet, Mixed.....	.50	5.00
Aurea (Golden Ball).....	.60	6.00
Pinkie, rose pink.....	.60	6.00
Salmon Rose, watermelon pink.....	.60	6.00
Scarlet (Fire Ball).....	.60	6.00
Spun Gold, delicately tinted butter yellow.....	.60	6.00

ZINNIA. <i>Pumila fl. pl.</i> —Continued	Oz.	Lb.
Sunshine Tints, rich pastel shades.....	\$0.60	\$6.00
White (Snow Ball)60	6.00
Vaughan's Special Mixture60	6.00
Fantasy Mixed , shaggy ray-like petals, like Cactus Dahlias, medium sized flowers, 2½ to 3 feet.....	.60	6.00
Melody, orchid lavender60	6.00
Orange Lady, rich orange.....	.60	6.00
Rosalie, bright intense rose.....	.60	6.00
Star Dust, deep golden yellow.....	.60	6.00
White Light, pure white.....	.60	6.00
Wild Fire, rich dazzling scarlet60	6.00
Navajo Mixed, flowers medium size, petals strongly tipped white or yellow in bicolor effect, 2 feet.....	.80	8.00
★ Vaughan's Special Mixture, all Elegans vars.....	.60	6.00
NEW CUPID ZINNIAS, the Smallest of All, 1 foot		
Goblin, golden orange.....	.80	8.00
Pixie, very attractive bright yellow.....	.80	8.00
Cupid, mixed60	6.00
Gracillima pl. (Red Riding Hood), fiery red.....	.60	6.00
Linearis , single, orange, dwarf, early, 10 inches.....	1.20
Mexicana (Haageana), Hybrida, single Mexican hybrids, 16 inches90	10.00
Hybrida, fl. pl., double hybrids, 16 inches.....	.70	7.00
Double Golden Yellow.....	.90	10.00
Persian Carpet, fully double ball-shaped flowers of the miniature type in a sparkling range of variegated colors, resembling tiny dahlias, each pointed petal tipped with contrasting color.	1.50	20.00
★ Vaughan's Midget Mixture90	10.00
Scabiosa Flowered or Harmony type, mixed, on a single corona of outside petals stands a semi-globular crown with a large number of small florets, 2½ to 3 feet.....	.70	7.00
Tom Thumb, Miniature Mixed, 6 to 8 inches.....	.90	10.00
Surprise Garden Mixture. A carefully prepared "Formula Blend" comprising over eighty different flower varieties. This is one of our leaders and gives 100% customer satisfaction. Blended to give bloom throughout the entire summer and until frost in fall. No vines or dwarf varieties.....10 lbs. \$26.00	2.80
Cut Flower Mixture of Annuals , well balanced mixture from named varieties35	3.40
Annuals for Rock Gardens50	5.00
Perennial Seeds, Tall, mixed	1.00	14.00
Perennial Seeds, Medium Height, mixed	1.40	18.00
Perennial Seeds, Dwarf, mixed	1.40	18.00

Insert Packets

Glassine Transparent "Insert" Bags. Ideal for small or expensive seeds. "Absolutely seed tight" even Begonia. Shows up smallest packets to advantage. 1½ inches x 2½ inches; 1,000, \$2.00. Prices on these bags subject to advance.

Flower Seed Gauges, (12 different sizes).....per set \$4.00 net

TABLE OF CONTENTS

	Page		Page		Page
Activo	60	Grafting Wax	92	Protection Fence Rods....	89
Adco	60	Grass Catcher	102	Protexall	67
Aerosol Bomb	68	Grasses, Lawn	38-39	Pruning Paint	107
Aluminum Sulphate	60	Grass Growing Heads....	76	Pruning Tools	105-107
Amaryllis	41	Grass Hook	107	Pump Sprays	79-82
Ammate	75	Grass Shears	105		
Ammonium Nitrate	60	Grass Whip	104	Rabbit Repellent	73
Ant Killer	64	Gro-quick Hot Bed Heater.	92	Raffia	88
Arcasyn	69			Rakes	110-111
Arsenate of Lead.....	64	Hedge Trimmer	115	Repellents	73, 77-79
Azofume	64	Herbicide	75	Rodent Rockets	78
		Hole-in-One	117	Root Feeder	98
Bacto—See Activo	60	Hormodin	73	Rootone	72
Baskets	85	Hormones	71-73	Rose Food	63
Begonias	41	Horn Shavings	60	Roses	50
Bird Feeders	96-97	Hose Supplies	98-102		
Bird Houses	96-97	Hot Kaps	116	Saws	106
Bird Seed	37	Hyacinth Glasses	94	Seeder	116
Black Leaf 40.....	64	Hy-Gro Plant Food.....	60	Seed Flats	84
Bone Meal	60	Hyponex	61	Seed Starter	91
Bordeaux Mixture	64	Incinerator	116	Seed Protect	72
Bulb Bowls	94	Inoculants	76	Sel Tox	74
Bulb Box Offer.....	44	Insect Destroyers	64-71	Semesan	69
Bulb Planter	117	Irises	58	Sheep Manure	62
Bulbs	41-44	Jardiers	93-94	Shears, Grass	105
Brush Pen	83			Shrub Guard	89
		Kem Liquid Plant Food..	61	Shrubs	45-50
Caladiums	118	Knee Pads	90	Sodium Selenate	71
Cannas	118	Knives	92	Soil Soaker	100
Carts	114			Soil Test Kit.....	98
Cattle Manure	62	Labels	83, 84	Spergon	70
Cel-O-Glass	92	Lawn Edger	104, 117	Sprayers	79-82
Cemetery Vases	113	Lawn Mowers	102, 104	Sprinklers	99-101
Ceresan	69	Lawn Mower Blades.....	111	Stakes, Plant	87
Chlordane	68	Lawn Roller	103	Staplers	95
Cultivator	115	Lawn Seed	38	Stim Root	72
Cut Worm Protector.....	85	Lawn Signs	76	Sulphate of Iron.....	66
Cyanogas	65	Lawn Sweeper	103	Super Phosphate	62
Cyanogas Pump	82	Lethal Wand	74		
		Lime	61	Terra-Lite	63
Dandy Kill	73	Loma	61	Tersan	69
D.D.T.	67			Thermometers	90
Dogzoff	78	Mika Magic—Terra-Lite..	63	Thread	86
Doo Klip	105	Mole Trap	78	Tractor	112
Dusters	81-82	Moss, Sphagnum	92	Trainettes	87
		Mulching Wool	91	Transplantone	72
Earth Auger	117	Muriate of Potash	61	Traps Havahart	97
Endo Pest	75	Mushroom, Spawn	22	Tree Pruners	107
Endo Weed	75			Tree Wrap	115
Erosionet	100	Nitragin	76	Trees	51-52
Es-Min-El	60	Org-a-Nur	61	Triogen	66
Evergreens	53-56			Trowels	105
		Packet Seeds	40	Tubs	112
Fermate	71	Peat Moss	63	Twine	86
Fertilizer Applicator	80	Pen. Brush	83	Twist-Ems	89
Fertilizer Spreader	114	Pencils	84		
Fertilizers	59-63	Peonies	57	Vases	93-94
Flame Gun	115	Phygon	70	Vegetable Seed	2-37
Flora Life	62	Plant Bands	85	Vertagreen	60
Flower Holders	110	Plant Life	62	Vigoro	63
Flower Pots	85-86	Plant Props	89	Vine Guides	87
Flower Seeds	119-184	Plant Stakes	87	Vines, Hardy	56
Flowers of Sulphur	65	Plant Supports	87-88	Vitamin B1	72
Flower Shears	110	Plant Tabs	63	Vitapane	92
Fruit Picker	115	Plant Trays	93		
Fruit Spray—Pratts	66	Pliers	95	Water Wand	100
Fungicides	64-71	Peony Supports	88	Weeders	97, 113
		Pots, Paper	85-86	Weed Killers	73-75
Garden Supplies	98-109	Pots, Wick Fed	113	Weedone	74
Garden Tools	108-109	Potting Soil	62	Wicket Shields	86
Gladiolus	42-44	Power Mower	104	Wick Fed Pots	113
Gloves	95			Window Box	86



Vaughan's Surprise Garden Mixture

A carefully prepared "Formula Blend" comprising over eighty different flower varieties. This is one of our leaders and gives 100% customer satisfaction. Blended to give bloom throughout the entire summer and until frost in fall. No vines or dwarf varieties.

Lb., \$2.80; 10 lbs., \$26.00.



VAUGHAN'S SEED CO.

CHICAGO 6—601 W. Jackson Blvd.

NEW YORK 7—47 Barclay Street