

VETERINARY STUDIES FOR
AGRICULTURAL STUDENTS

M. H. REYNOLDS

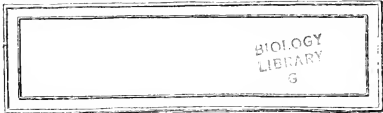
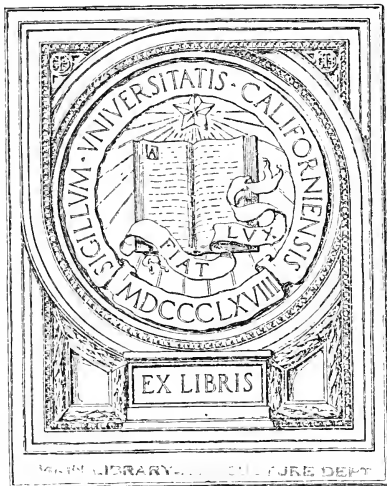

Digitized by the Internet Archive
in 2008 with funding from
Microsoft Corporation

VETERINARY STUDIES



THE MACMILLAN COMPANY
NEW YORK · BOSTON · CHICAGO · DALLAS
ATLANTA · SAN FRANCISCO

MACMILLAN & CO., LIMITED
LONDON · BOMBAY · CALCUTTA
MELBOURNE

THE MACMILLAN CO. OF CANADA, Ltd.
TORONTO

VETERINARY STUDIES

FOR

AGRICULTURAL STUDENTS

BY

M. H. REYNOLDS, B.S., D.V.M., M.D.

PROFESSOR OF VETERINARY MEDICINE, UNIVERSITY OF MINNESOTA;
MEMBER INTERNATIONAL COMMISSION ON CONTROL OF BOVINE TUBERCULOSIS;
MEMBER AMERICAN VETERINARY MEDICAL ASSOCIATION

EIGHTH EDITION

New York

THE MACMILLAN COMPANY

1922

All Rights Reserved

PRINTED IN THE UNITED STATES OF AMERICA

BIOLOGY
LIBRARY
G

COPYRIGHT, 1910, AND 1922,
BY THE MACMILLAN COMPANY.

Set up and electrotyped. Published December, 1910. Reprinted August, 1911.
Eighth edition.—Set up and electrotyped. Published November, 1922.

LIBRARY OF THE GEOLOGICAL SURVEY

PREFACE TO EIGHTH EDITION

I WISH to thank my many fellow teachers who have shown appreciation by continuing to use this textbook in spite of inaccuracies and evident need of revision. I wish to emphasize again the fact that Veterinary Studies is intended to some extent as a teacher's outline. Each teacher must add material as he may think wise, or leave out entire subjects according to local needs. I find that very many pupils taking veterinary class work in agricultural schools need review work on physiology. The necessity for a practical working knowledge of physiology is evident. Some knowledge of anatomy is plainly necessary in order that disease processes may be located, and that students may understand animal conformation. Some elementary pathology is absolutely necessary in order that pupils may have some understanding of what disease processes really are.

Causes and prevention of diseases should be considered as of paramount importance, and only carefully selected diseases should be presented. These should be diseases which are uniform in symptoms and history and therefore easily recognized, and of such diseases, those that are rather easily and simply treated or are preventable.

There may be perhaps exception to this, in case of stock owners who do not have access to trained veterinarians. In such case it is a matter of plain common sense that they must do the best they can for themselves.

However, we veterinary teachers of agricultural students should have constantly in mind the fact that we are educating expert stockmen—not poorly trained quack veterinarians. The student who has had a proper course should better appreciate the competent veterinarian and call him more promptly and intelligently.

Appreciation is due Dr. E. A. Hewitt, of the College of Agriculture, University of Minnesota, for reviewing and criticizing the lectures on anatomy and physiology.

M. H. REYNOLDS.

UNIVERSITY OF MINNESOTA,
September, 1922.

PREFACE TO FIRST EDITION

DURING ten years' experience in teaching veterinary subjects to agricultural students, certain difficulties have been constantly encountered. Others doing this work have probably had similar experience. There has been the difficulty of imperfect training, or entire lack of previous training, in physiology and other subjects which medical men recognize as fundamental. There is always present the difficulty of presenting a technical subject in untechnical language; difficulty in securing satisfactory illustrations; and difficulty in giving the kind and character of veterinary work which is generally demanded and conceded as necessary, without giving our students a sort of training which will turn some of them into unqualified practitioners. There has been serious difficulty in covering, without a textbook, a satisfactory amount of ground. Many students do not take notes well.

During this time I have been more and more impressed with the belief that a textbook, wisely illustrated and carefully edited for its legitimate use, would enable me to cover very much more ground within the available time.

The style of editing that has been adopted was selected with a view to presenting the subject matter to students in a conspicuous and easily grasped way. This must be our excuse and answer to criticism which the expert printer may legitimately make.

This work has been written more particularly as a text for veterinary classes in agricultural schools and colleges; but it is hoped that it may prove helpful also to stockmen who are not able to attend our agricultural colleges, but who care to know more of the animal machines with which they are working. I take this occasion to deprecate the blind dosing of stock to which farmers and stockmen are very much inclined. The student should realize the impossibility of writing a prescription that will

fit all cases of a certain disease, and he will hesitate to risk the use of medicines of which he knows very little in diseases of which he knows less.

Lecture notes which have been collected during a period of ten years have formed the basis for this work, and I am now unable, in many cases, to give credit to authorities that have been consulted, where credit is fairly due.

Illustrations have not been used in any case merely as pictures. Every one is intended to illustrate something and make that illustration as impressive as possible.

Suggestions to the teacher. It is not intended that this textbook should entirely supplant lecture work. On the contrary, nearly every lesson may be supplemented to advantage and so give opportunity for originality and the greatest effectiveness. It will be readily understood that certain subjects are of great importance in some states, and unimportant in others. Each teacher should add what he thinks best for his grade of pupils and his local needs.

When time permits much time can be profitably spent on more extended anatomy work, especially for students who wish advanced live stock work. It can be readily illustrated and easily impressed: for instance, that smooth or rough hips depend upon a fraction of an inch, more or less, on the external angle of the ilium; and that high or low withers, in the main, depend upon variations in the length of the superior spinous processes of the dorsal vertebræ; and that conformation depends upon the bony skeleton and muscular developments.

Much time with considerable actual practice should be given to the study of unsoundness; to common forms of lameness, and the types of conformation which tend toward these unfortunate conditions. Common irregularities of the teeth are easily illustrated in classroom. These are given as suggestions and to impress the fact that this text is not expected to cover the entire field of veterinary teaching for all agricultural colleges.

I respectfully suggest that teachers should insist upon study of illustrations. In my own class work I find the constant difficulty that students glance at the illustrations carelessly and hurriedly, and thus fail to get the benefit which they might easily have. Students may be selected at random and asked to

draw upon the board, from memory, illustrations from the lesson for that day. After a few practice lessons of this kind, students easily learn how to study textbook illustrations.

M. H. REYNOLDS.

UNIVERSITY OF MINNESOTA,
October, 1903.

CONTENTS

ANATOMY

LECTURE		PAGE
I.	ANATOMY	
	<i>Bones.</i> —Kinds, peculiarities, development, structure and composition.	
	<i>Head.</i> —Face, cranial, and hyoid bones; dentition of horses, table; dentition of cattle, table; estimating age by teeth; original application, common disorders	1
II.	OSTEOLOGY	
	<i>Spinal column.</i> —General characteristics of vertebrae. Cervical, dorsal, lumbar, sacral, and coccygeal vertebrae.	
	Sternum. Ribs. Practical application, common disorders	7
III.	FRONT LIMB	
	Shoulder, arm, forearm, and foot—bones of, common disorders	10
IV.	POSTERIOR LIMB	
	Pelvis, thigh, leg, and foot—bones of, practical application, disorders	14
V.	FOOT	
	Bones, horny hoof, matrix, plantar cushion, back tendons, good foot described, practical application, disorders of the foot	19
VI.	ARTICULATIONS (JOINTS)	
	General groups, examples; varieties of freely movable, immovable, slightly movable.	
	Structures at joints; articulations described, practical application, disorders	24
VII.	MUSCULAR SYSTEM	
	Peculiar property of muscle, kinds, classification, parts, microscopic structure, source of heat and power, practical application, disorders	29

LECTURE		PAGE
VIII.	NERVOUS SYSTEM	
	General function, nerve centers.	
	<i>Cerebrospinal system</i> .—Brain, cranial nerves, spinal cord, spinal nerves.	
	<i>Sympathetic system</i> .—Composition, ganglia, sympathetic nerves, practical application.	
	Disorders	33
IX.	CIRCULATION	
	<i>Blood</i> .—Circulatory apparatus, course of the blood, blood supply of the body, principal arteries and veins.	
	<i>Lymphatic system</i> .—Parts, function.	
	Practical application, disorders	42
X.	RESPIRATION	
	Definition, stages, parts, purpose, respiratory apparatus, practical application, disorders	51
XI.	DIGESTIVE APPARATUS	
	Definition, organs of digestion, anatomy of each, practical application	57
XII.	PHYSIOLOGY OF DIGESTION	
	Definition of digestion, food groups, course and history of each group, practical application and suggestions	64
XIII.	URINARY ORGANS	
	Structure, function, and physiological operation of each, practical application, disorders	68
XIV.	MAMMARY GLANDS	
	Anatomy, function, products, blood supply, nerve supply, and nerve control, practical application, disorders .	72
	PATHOLOGY	
XV.	PATHOLOGY	
	Hyperaemia (congestion), inflammation, fever, heat production and expenditure, symptoms of fever, results of fever, practical application	77
XVI.	PATHOLOGY (Continued)	
	Hemorrhage, dropsy, hypertrophy, atrophy, degenerations and infiltrations, collapse, syncope, death, necrosis, practical application	83

LECTURE		PAGE
XVII.	WOUNDS	
	Healing, and development of new blood vessels.	
	Healing of osseous, cartilage, and nerve tissues. New tissue, how skin recovers a surface	88
XVIII.	WOUNDS (<i>Continued</i>)	
	Bad treatment, bleeding, sewing, bandaging, washing, dry treatment, maggots, practical suggestions . . .	91
	CAUSE AND PREVENTION	
XIX.	CONTAGIUM	
	The individual bacterium, plagues in history, dissemination, development of outbreaks, body entrance, method of injury, resistance, how destroyed in nature, classification, practical suggestions	96
XX.	DISINFECTION	
	Purpose, sources of infection, thoroughness, attendants, how to burn a carcass, common disinfectants, methods of disinfection	102
XXI.	HEREDITY—AIR	
	Theory of heredity in relation to disease, in-and-in breeding.	
	Air impurities, relations to disease, standards of purity, ventilation, practical application	106
XXII.	VENTILATION	
	Stable air, necessity, unventilated air, natural forces, air currents, outlets	109
XXIII.	VENTILATION (<i>Continued</i>)	
	<i>Stable construction.</i> —Space, location, stable construction for ventilation, ventilation, amount of air needed	114
XXIV	FOOD AND WATER	
	<i>Food.</i> —Excess, deficiency, bulk, quality, balance, intervals, poisonous foods.	
	<i>Water.</i> —Excess, deficiency, parasites, sewage, intervals.	
	Practical application	119

LECTURE	PARASITIC DISEASES	PAGE
XXV.	PARASITISM	
	<i>Parasitism.</i> —Sources, how nourished, effect on host, general prevention, general treatment, practical application.	
	<i>External Parasites.</i> —Lice, flies, ringworm, sheep ticks, ticks, treatment and suggestions for each	124
XXVI.	SHEEP SCAB	
	Body scab, foot scab, head scab, general prevention, general symptoms, treatment, dips, dipping, disinfection	130
XXVII.	MANGE	
	<i>Horse mange</i> and <i>cattle mange</i> , cause, symptoms, treatment of each	137
XXVIII.	INTERNAL PARASITES	
	Bots, roundworms, tapeworms, treatment	141
XXIX.	NODULE DISEASE OF SHEEP	
	General history, cause, injury, diagnosis, treatment, prevention	145
XXX.	STOMACH WORM (SHEEP)	
	Parasite, life history, symptoms, treatment, drenching sheep, management of infected flock, prevention	149
XXXI.	VERMINOUS BRONCHITIS, NASAL GRUB, AND CATARRH	
	<i>Verminous bronchitis.</i> —Cause, life history of parasites, symptoms, treatment, prevention.	
	<i>Nasal grub.</i> —Cause, life history, symptoms, treatment.	
	<i>Catarrh.</i> —Simple catarrh defined, causes, prevention, treatment	153
INFECTIOUS DISEASES		
XXXII.	ACTINOMYCOSIS (LUMPY JAW)	
	Description, relation to public health, parts involved, treatment	158

LECTURE		PAGE
XXXIII.	ANTHRAX	
	History, distribution, susceptible animals, cause, transmission, introduction and spread, incubation, symptoms, post mortem, diagnosis, vaccination	163
XXXIV.	SYMPTOMATIC ANTHRAX	
	Cause, symptoms, post mortem, prevention, vaccination	167
XXXV.	BACILLUS NECROPHORUS INFECTIONS	
	Explanation, cause, infection, foot rot, lip-and-leg ulceration, canker sore mouth, necrotic stomatitis, symptoms, treatment, management, etc., for each	170
XXXVI.	FOOT-AND-MOUTH DISEASE	
	Definition, symptoms, similar diseases, dissemination, prevention, treatment	177
XXXVII.	HEMORRHAGIC SEPTICEMIA	
	Etiology, history and development, symptoms, post mortem, summary, differential diagnosis	180
XXXVIII.	TEXAS OR TICK FEVER	
	Economic importance, causes, transmission, susceptibility, incubation, symptoms, post mortem, prognosis, treatment, prevention, tick extermination, vaccination	185
XXXIX.	TUBERCULOSIS	
	Prevalence, cause, modes of infection, structures affected, symptoms, diagnosis, treatment, prevention, summary, disposition of tuberculous cattle, accredited herd plan	192
XL.	TUBERCULIN TEST FOR TUBERCULOSIS	
	Tuberculin effect on health, accuracy, thermal, intradermal, and ophthalmic tests, importance to breeders	198
XLI.	GLANDERS	
	Susceptible animals, causes, incubation, symptoms, acute cases, chronic cases, farey, diagnosis, mallein tests, prevention, suggestions	203

LECTURE		PAGE
XLII.	HOG CHOLERA	
	Definition, symptoms, autopsy, cause, how scattered, vaccination, common mistakes, suggestions	208
XLIII.	COMMON MINOR DISEASES OF SWINE	
	Posterior paralysis, congestion of the lungs, constipation, cause, symptoms, treatment of each, drenching swine, suggestions	215
DIETETIC DISEASES		
XLIV.	AZOTURIA	
	Prevalence, history, parts affected, duration, causes, symptoms, prevention, treatment, prognosis	218
XLV.	LYMPHANGITIS (ELEPHANT LEG)	
	Cause, symptoms, prevention, treatment, prognosis	222
XLVI.	LAMINITIS (FOUNDER)	
	Definition, symptoms, cause, pathology, termination, prevention, treatment	224
XLVII.	HEAVES	
	Definition, cause, symptoms, prevention, post mortem, treatment	227
XLVIII.	HOVEN, OR BLOAT (ACUTE TYMPANITES)	
	Definition, causes, symptoms, treatment, prevention	230
XLIX.	PARTURIENT PARALYSIS (MILK FEVER)	
	Causes, symptoms, prevention, treatment, prognosis	233
L.	CHOKER	
	Explanation, symptoms, prevention, treatment, general suggestions	238
MISCELLANEOUS DISEASES		
LI.	UN SOUNDNESS	
	Unsoundness, normal condition, ringbone, sidebone, spavin, splints, curb, bog spavin, open joint, hygromas, miscellaneous unsoundness	241

LECTURE		PAGE
LII.	UN SOUNDNESS (<i>Continued</i>)	
	<i>Examination</i> at rest, in motion, examination in detail.	
	<i>Lameness</i> .—Locating lameness, tests	249
OBSTETRICS		
LIII.	OBSTETRICS	
	Organs described, normal periods of gestation.	
	<i>Accidents of pregnancy</i> .—Sporadic abortions, infectious abortions, symptoms, results	254
LIV.	OBSTETRICS (<i>Continued</i>)	
	<i>Infectious abortion</i> .—Causes, virus, dissemination, infection, results, importance, various classes of stock, diagnosis, prevention, management of aborting herd, disinfection, medical treatment, vaccines, calves	259
LV.	OBSTETRICS (<i>Concluded</i>)	
	<i>Accidents of pregnancy</i> .—Retention of fetus, volvulus, or twist.	
	<i>Accidents of parturition</i> .—Infection, inflammation of the uterus, inversion of the uterus, retention of the afterbirth, hemorrhage	264
LVI.	DISORDERS OF THE UDDER	
	<i>Garget</i> .—Definition, causes, symptoms, results, prevention, treatment.	
	<i>Udder diseases and accidents</i> .—Injuries, obstruction, warts, cowpox, etc.	269
LVII.	DIFFICULT PARTURITION	
	<i>Difficult parturition</i> .—Nature's plan, normal presentations, causes of difficulty, common faulty presentations, aid, suggestions, operations	274
MEDICINES		
LVIII.	COMMON MEDICINES	
	Common measurements and weights, giving medicines, various common medicines as to physiological effects, doses and uses	280

LECTURES		PAGE
LIX.	COMMON MEDICINES (<i>Continued</i>)	
	Various common medicines, as to physiological effects, doses and uses	284
LX.	COMMON MEDICINES (<i>Concluded</i>)	
	Various common medicines, physiological effects, doses and uses	287
	MINOR SURGICAL OPERATIONS	
LXI.	MINOR SURGICAL OPERATIONS	
	Castration, various kinds of stock. <i>Dehorning</i> , by caustic, shears, saw. <i>Docking</i> . <i>Draiding abscess</i> . <i>Removing warts</i> . <i>Tapping for bloat</i>	291

ILLUSTRATIONS

FIG.		PAGE
1.	Skeleton. <i>B. A. I.</i> Facing	1
2.	Horse Skull. <i>Chauveau</i>	2
3.	Teeth of Horse 6 Years Old (Lower Jaw)	4
4.	Teeth of Horse 8 Years Old (Upper Jaw). <i>Clarke</i>	4
5.	Teeth of Horse 20 Years Old (Lower Jaw). <i>Clarke</i>	5
6.	Grinding Surface of Molars. <i>Huidekoper</i>	5
7.	Typical Cervical Vertebra. <i>Chauveau</i>	7
8.	Typical Dorsal Vertebra (Front View). <i>Chauveau</i>	8
9.	Typical Lumbar Vertebra (Front View). <i>Chauveau</i>	8
10.	Lateral View of the Sacrum. <i>Chauveau</i>	8
11.	Anterior Limb of the Horse. <i>Chauveau</i>	11
12.	Posterior Limb of the Horse. <i>Chauveau</i>	15
13.	Bones of the Horse's Foot. <i>Chauveau</i>	19
14.	The Hoof. <i>Chauveau</i>	20
15.	The Hoof Matrix. <i>Chauveau</i>	21
16.	Voluntary Muscle. <i>Reynolds</i>	30
17.	Muscle Fibers. <i>Hewes</i>	31
18.	The Cerebrospinal Nervous System. <i>Magnin</i>	33
19.	Neuron	34
20.	Medullated Nerve Fibers	35
21.	Spinal Cord and Brain in Diagram. <i>Reynolds</i>	36
22.	Relation of the Sympathetic and Cerebrospinal Systems, Partly Diagrammatic. <i>Chauveau</i>	38
23.	Circulation, General View. <i>Magnin</i>	43
24.	Circulation, Diagrammatic. <i>No. 1, Reynolds; No. 2, after Overton</i>	44
25.	Capillary Circulation. <i>Eddy</i>	45
26.	The Lymphatic System (Human). <i>Eddy</i>	48
27.	A Lymph Node. <i>Eddy</i>	49
28.	Respiration in Diagram. <i>Reynolds</i>	52
29.	Stomach of the Horse (External and Internal Views). <i>Chauveau</i>	58
30.	Stomach of the Cow. <i>After Chauveau</i>	59
31.	Section of Horse Kidney. <i>Chauveau</i>	68
32.	Urinary Apparatus in Diagram. <i>Reynolds</i>	69
33.	One Quarter and Teat of the Cow's Udder. <i>Thanhoffer</i>	72

FIG.		PAGE
34.	Milk Vesicles and Outlet Ducts. <i>Chauveau</i>	73
35.	Badly Treated Wire Wound. <i>Reynolds</i>	91
36.	General Groups of Bacteria. <i>Reynolds</i>	99
37.	Ventilation. <i>Paige</i>	109
38.	Ventilation. <i>Paige</i>	112
39.	Ventilation. <i>Paige</i>	115
40.	Cupola Ventilation. <i>Paige</i>	116
41.	Ventilation. <i>Paige</i>	116
42.	Cattle Louse (Female). <i>Neuman</i>	126
43.	Sheep Tick and Enlarged Proboscis. <i>Neuman</i>	128
44.	Plain Case of Sheep Scab	131
45.	Sheep Scab Mites. <i>Curtice, Luggier, Pettit</i>	132
46.	Mange Mite. <i>Neuman</i>	137
47.	Horse Botfly and Larva. <i>Neuman</i>	141
48.	Horse Bots and Botfly. <i>B. A. I.</i>	142
49.	Common Tapeworm of Sheep. <i>Curtice</i>	144
50.	Nodule Disease. <i>Reynolds</i>	146
51.	Stomach Worm on Tip of Grass Blade. <i>Ransom</i>	149
52.	Sheep Gadfly. <i>Brauer</i>	155
53.	Actinomycosis (Lumpy Jaw). <i>Reynolds</i>	159
54.	Actinomycosis. <i>Reynolds</i>	160
55.	Actinomycosis. <i>Reynolds</i>	160
56.	Bacterium Anthracis. <i>Reynolds</i>	163
57.	Bacillus Neerophorus. <i>B. A. I.</i>	170
58.	Foot Rot (Sheep). <i>Williams</i>	171
59.	Lip and Leg Ulceration. <i>B. A. I.</i>	175
60.	Hemorrhagic Septicaemia. <i>Reynolds</i>	181
61.	Hemorrhagic Septicaemia. <i>Reynolds</i>	182
62.	Hemorrhagic Septicaemia. <i>Reynolds</i>	183
63.	Hemorrhagic Septicaemia. <i>Reynolds</i>	184
64.	Texas Fever Tick. <i>Pettit</i>	185
65.	Bovine Tuberculosis. <i>Reynolds</i>	192
66.	Bovine Tuberculosis. <i>Reynolds</i>	193
67.	Bovine Tuberculosis. <i>Reynolds</i>	194
68.	Bovine Tuberculosis. <i>Reynolds</i>	195
69.	Glanders (Farcy). <i>Reynolds</i>	204
70.	Glanders (Farcy). <i>Reynolds</i>	205
71.	Glanders (Farcy). <i>Reynolds</i>	206
72.	Hog Cholera. <i>Reynolds</i>	209
73.	Hog Cholera. <i>Reynolds</i>	210

FIG.		PAGE
74.	Hog Cholera. <i>Reynolds</i>	211
75.	Hog Cholera. <i>Reynolds</i>	212
76.	Foundered Hoof. <i>B. A. I.</i>	225
77.	Showing Where to Tap for Bloat. <i>Reynolds</i>	230
78.	Trocar and Cannula	231
79.	Parturient Paralysis. <i>Reynolds</i>	233
80.	Parturient Paralysis. <i>Reynolds</i>	234
81.	Parturient Paralysis. <i>Reynolds</i>	235
82.	Wire for Relieving Choke. <i>Reynolds</i>	239
83.	Ringbones. <i>Reynolds</i>	243
84.	Sidebones. <i>Reynolds</i>	243
85.	Spavins (Two Types). <i>Reynolds</i>	244
86.	Navicular Disease. <i>Reynolds</i>	247
87.	Generative Organs of the Mare. <i>Fleming</i>	254
88.	Fetus and Fetal Membranes of the Cow at Mid-pregnancy. <i>Fleming</i>	255
89.	Bovine Cotyledons. <i>Fleming</i>	256
90.	Presentations. <i>B. A. I.</i>	275
91.	Holding Horse's Head for Drenching. <i>Reynolds</i>	281
92.	Throwing Cattle. <i>Reynolds</i>	291
93.	Restraint for Castration. <i>White</i>	292
94.	General View of Scrotum and Sheath. <i>White</i>	292
95.	A Good Type of Emaseculator. <i>White</i>	293

VETERINARY STUDIES

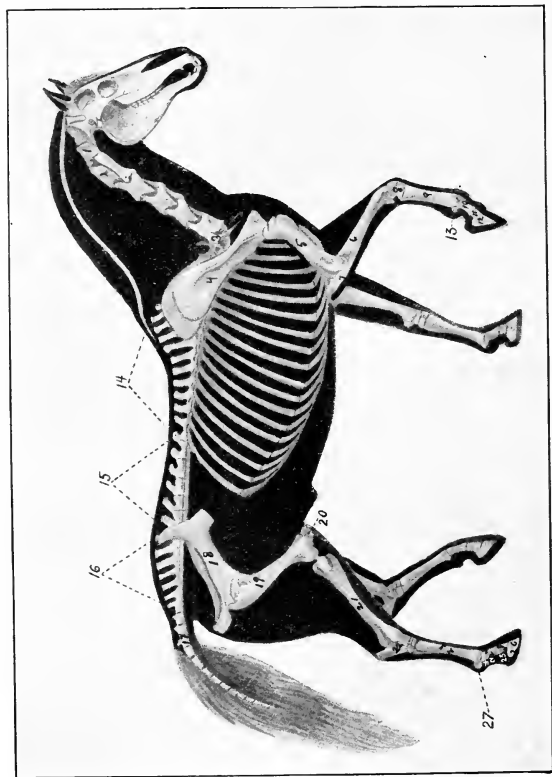

FIG. 1.—SKELETON. (B. A. I.)

1, Atlas; 2, axis; 3, seventh cervical vertebra; 4, scapula; 5, humerus; 6, radius; 7, ulna; 8, carpals; 9, metacarpals; 10, first phalanx; 11, second phalanx; 12, third phalanx; 13, sesamoids; 14, dorsal vertebrae; 15, lumbar vertebrae; 16, sacral vertebra; 17, coccygeal vertebrae; 18, pelvis; 19, femur; 20, patella; 21, tibia; 22, tarsals; 23, metatarsals; 24, first phalanx; 25, second phalanx; 26, third phalanx; 27, sesamoids.

VETERINARY STUDIES

LECTURE I

ANATOMY

Anatomy is the science which treats of forms, structures, and relations to body organs. These organs are divided for study into groups as follows: bones, muscles, joints, nervous system, circulatory apparatus, respiratory apparatus, urinary apparatus, digestive apparatus, and reproductive apparatus.

OSTEOLOGY, BONES

Kinds.—Bones are classified as long, short, flat, and irregular.

Long bones are more or less elongated in form and have a marrow-filled canal in the shaft, example—humerus, femur, radius, and tibia. They are used in the legs as columns of support and for levers pulled by muscles to produce motion.

Short bones are usually short in form, and have no medullary canal. Examples of this class are carpals and tarsals. They are used, for example, in the knee and hock where complicated articulation is needed with ability to stand pressure.

Flat bones, like those of the skull and the ribs, consist of two plates of hard bone tissue connected by porous bone. They are used to enclose and protect vital organs and to provide muscle anchorage.

Irregular bones are usually found in the median line of the body; example, vertebrae. These are adapted for weight support and muscle anchorage.

Peculiarities.—Terms used in describing and recognizing bones are: elevations, depressions, borders, surfaces, angles, and extremities.

Development.—Bones develop around centers of ossification (bone formation) either in cartilage or membrane. Long bones develop from cartilage; the flat bones develop from membrane.

Bones grow in diameter by the production of new bone cells at the inner surface of the periosteum. They grow in length by the development of bone cells in a cartilage matrix between centers of bone formation in the shaft and extremities of the bone. A long bone, for instance, may have three centers of ossification, one in the shaft and one in each end, with a layer of this cartilage matrix in the end between the centers of ossification. Bone cells in the lacunæ (spaces) throughout the substances of the bone, prepare and deposit lime salts and other material.

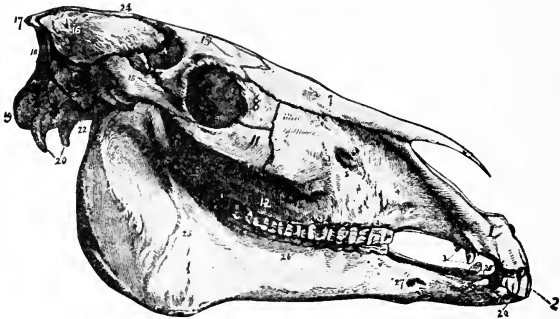

FIG. 2.—HORSE'S SKULL. (Chauveau.)

1, Premaxillary bone; 2, upper incisors; 3, upper canine teeth; 4, superior maxillary bone; 5, nasal bones; 6, lacrimal bone; 7, malar bone; 8, upper molar teeth; 9, frontal bone; 10, temporal bone; 11, parietal bone; 12, occipital; 13, styloid processes; 14, parietal crest; 15, inferior maxilla; 16, inferior molars; 17, inferior canine teeth; 18, inferior incisor teeth.

Structure and composition.—In a general way, bones consist of surface plates of fine texture, hard bone with porous bone inside of this. In the short, flat and irregular bones, this porous bone makes up the whole interior. A long bone consists of two enlarged extremities, composed of porous bone, and a shaft having a surface of hard bone, covered on the inside with bone of the porous texture. This porous bone then surrounds the medullary canal which is characteristic of long bones. A thin layer of cartilage covers all articular surfaces. The porous bone is filled with red marrow and the medullary canal is filled with yellowish marrow.

Except at the articular surfaces, bones are covered by a thin tough membrane, called periosteum. This is a matrix or mother

membrane and plays a most important part in the growth and nourishment, and repair in case of injury.

The head contains 26¹ bones, divided into two groups as follows: *cranium* 9, *face* 17. *Cranium* 9: occipital 1, frontal 2, parietal 2, temporal 2, ethmoid 1, sphenoid 1. *Face* 17: superior maxillary, 2; inferior maxillary, 1; premaxillary, 2; palate, 2; malar, 2; lachrymal, 2; nasal, 2; vomer, 1; inferior turbinated, 2; hyoid 1.

Teeth.—Mares have on each jaw: 6 incisors and 12 molars, or in all 18. Geldings and stallions have, in addition, 2 canines or tushes, making 20 teeth on each jaw. All the incisors and the first three molars are temporary and are replaced. The last three come in as permanent teeth, according to the following table.

DENTITION OF HORSES—(*Chauveau*)

Kind	Number	When Appear	When Replaced
Incisors	Center	Birth	2½ years.
	Middle	4 to 6 weeks	3½ years.
	Corner	6 to 9 months	4½ years.
Canines	4 to 5 years	
Molars	1st	Birth	2½ years.
	2d	Birth	2½ years.
	3d	Birth	3½ years.
	4th	10 to 12 months ..	
	5th	2 years	
	6th	4 to 5 years	

Age of horses by the teeth.—Tell by shedding and appearance of the teeth up to 4 years, according to table. Cups wear out of center pair of incisors of *lower jaw* at about 6 years; cups wear out of middle pair of incisors at about 7 years; and cups wear out of corner incisors at about 8. Quality of the teeth, kind of food, and the way the teeth fit together to be considered. They may wear very unevenly and be very deceptive. The upper incisors are much less reliable as to disappearance of cups than are the lower.

Cattle have 8 incisors on the lower jaw and none on the upper. Their molars are like those of horses in number, and the first three are also temporary. The calf has the two center

¹ Sisson recognizes: pterygoids, 2; turbinated 4 (2 dorsal and 2 ventral), and an interparietal, making 10 for the cranium and 21 for the face.

pairs of incisors at about birth; the next pair at about 14 days, and the corner pair by about 3 weeks. Thus the calf has a full mouth of temporary incisors at about one month.

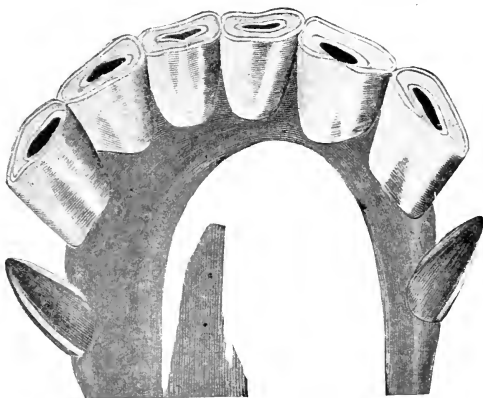

FIG. 3.—SIX YEARS, LOWER JAW.

The incisors are replaced in pairs beginning with the center at $1\frac{1}{2}$, $2\frac{1}{2}$, $3\frac{1}{2}$ and the corner pair at $4\frac{1}{2}$ years.

In young horses, the grinding surfaces of the incisors are wide from side to side. At about 13 to 15 years these surfaces are as

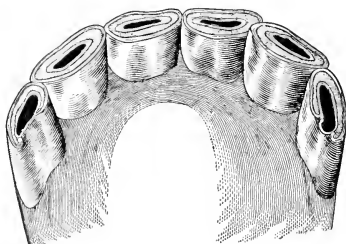

FIG. 4.—EIGHT YEARS, UPPER JAW.

Note.—Figures 4 and 5 are drawn on different scales.

wide from before back as from side to side. In very old horses, this surface is narrow from side to side.

The incisors of young horses extend at nearly right angles from

the end of the maxillary bones; those of very old horses meet at an acute angle, and the teeth appear to project forward from the ends of the jaws.

Original observations.—The student should make original observations, recording freely by notes and drawings. He should

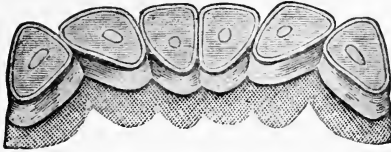

FIG. 5.—TWENTY YEARS, LOWER JAW.

study the part played by individual bones or groups of bones in determining the size and shape of the head.

Study, *e.g.*, the nasal, frontal, superior maxillary, and inferior maxillary bones. Note what relation they bear to shape of nose, width between the eyes, “coarseness” of the head, and width between bones of the lower jaw.

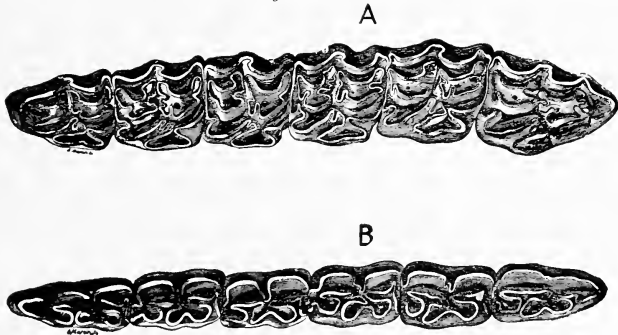

FIG. 6.—GRINDING SURFACES OF MOLARS.

Horse six to seven years old. *A*, right-hand superior molars; *B*, left-hand inferior molars.

Spend as much time as possible in practice at estimating horses' ages by their teeth. Note especially temporary and permanent teeth present, “cups,” and shape of wearing surface.

Common disorders.—Among the more common diseases and abnormal conditions of the bones of the head and the teeth are:

actinomycosis, caused by a fungus and characterized by enlargement and destruction of the bones of the upper or lower jaw especially. *Big head* (osteoporosis), which affects the bones of the horse, usually including the head bones. The bones become very light in weight and very fragile.

Common disorders of the *teeth* are: variations from normal number more or less; improper fit, parrot mouth where the upper incisors overhang the lower; undue relative width of the upper jaw, leading to uneven wear, ragged edges, and injury to cheeks or tongue; caries (decay); and toothache with abscess at the root.

LECTURE II

OSTEOLOGY

Spinal column.—This consists of about 55 pieces, called vertebrae. There are 7 cervical, 18 dorsal, 6 lumbar, 5 sacral, 15 to 21 coccygeal.

There are certain general characteristics possessed by all vertebrae, regardless of location in the spinal column; for instance, each vertebra has a body, arch, and spinal canal.

The *body*, convex in front and concave behind, is below the spinal canal. The head of the body of each vertebra is rounded and fits perfectly into the cavity of the rear end of the preceding vertebra. Between each pair is considerable cartilage, which serves the purpose of an elastic pad.

The *arch* incloses the sides and top of the spinal canal. (1) The *transverse processes* are the portions which project horizontally on each side from the arch. (2) The *superior process* projects upward from the top of the arch. (3) The *articular processes* are four in number: two in front, and two behind. The former articulate with the rear articular processes of the preceding vertebra, and the latter with the front processes of the succeeding.

Cervical vertebrae.—The framework consists of 7 cervical vertebrae, all agreeing in certain general characters.

The body is long, thick, and has an inferior spine projecting downward from its under surface. The superior processes are long from before to behind, and together form a long rough line. The transverse processes are also long from before to behind. In these characteristics the cervical vertebrae differ radically from the others.

Special cervical vertebrae.—There are certain cervical verte-

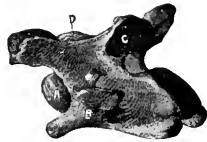

FIG. 7.—TYPICAL CERVICAL VERTEBRA.

A, Head of the body; B, transverse process; C, articular process; D, superior spinous process.

bræ which have marked individual peculiarities. The *atlas*, immediately supporting the head, has a small thin body with no

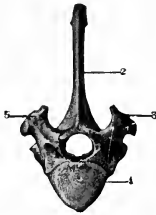

FIG. 8.—TYPICAL DORSAL VERTEBRA, FRONT VIEW.

1, Head of the body; 2, superior spinous process; 3, transverse process.

head, but instead, two surfaces for articulating with the occipital bone. The *axis* is long, and has, in place of the head, a peculiar projection known as "odontoid process." This process is shaped somewhat like a tooth. Hence the name. The superior process is long from front to rear. The *seventh* cervical vertebra has a long superior process, somewhat resembling those of dorsal vertebræ. It also presents a small articular surface for articulation with the head of the first rib.

Dorsal vertebræ.—These are located in the back, and are 18 in number. They also have certain general characteristics. The body is short. There are four articular cavities, two in front and two behind for the heads of the ribs. Superior processes are long and flat from side to side, transverse processes short and small. None of the dorsal vertebræ differ very markedly from this general type.

Lumbar vertebræ.—These make up the framework of the loin. In general the body is longer and wider than the dorsal. The superior processes are also shorter. The transverse processes are long, flat, and thin.



FIG. 9.—TYPICAL LUMBAR VERTEBRA, FRONT VIEW.

1, Body; 2, head; 3, superior spinous process; 4, transverse process.



FIG. 10.—LATERAL VIEW OF THE SACRUM.

1, Spinal canal, anterior portion; 3, superior spinous processes.

Sacrum.—This constitutes the croup. It consists of five pieces, united in the adult. It articulates with the last lumbar vertebra in front, with the first coccygeal vertebra behind, and with the pelvis on each side. This portion of the spinal column is triangular, with the base forward.

Coccygeal vertebræ.—These are 15 to 21 in number, and located in the tail. The spinal canal is developed in the first three or four. The first one is occasionally united to the sacrum.

The sternum.—This is located in the front and lower portion of the chest, and extends from before to behind. It consists of six or seven pieces of cartilaginous bone and has distinct prolongations of cartilage from both the front and rear ends. On each side are articular surfaces for the first eight ribs. The sternum is commonly called the breast bone.

Ribs.—These usually number 18 pairs, and are described as the first, second, third, etc., beginning with the front pair. They all articulate above with the dorsal vertebræ; the lower ends of the first eight articulate with the sternum by means of cartilages. The remaining ten connect with the sternum by means of long cartilages, each of which rests against the preceding one. The ninth, or first asternal, rib is united rather closely to the eighth, which articulates with the sternum.

The *shaft* shows external convex and internal concave surfaces and two borders: anterior or front, and posterior or rear. The *superior* or upper *extremity* shows a head and a small projection, the tuberosity. These articulate with the dorsal vertebræ as already explained. Function of the ribs is to form a supporting and movable wall for the chest, protecting the soft organs and performing a very important function in opening the chest for respiration.

Practical application.—The student should now study, for himself, the part played by each group of vertebræ in determining the conformation of its region. Take, *e.g.* the cervical, dorsal, lumbar, and sacral groups, and note what relation they bear to length of neck, height and shape of withers and length of back, width and length of loin, length and slope of the croup. The student should also study the influence of shape of rib upon width of back and shape of sides. Record fully by notes and drawings.

Common disorders.—Domestic animals are subject to many disorders of this region but few of these affect the vertebræ especially. There are occasional fractures and dislocations. Tuberculosis, osteoporosis, etc., may affect these bones as well as others. Sometimes adjacent vertebræ unite by a bone-forming process following inflammation (ostitis) most frequently resulting from injury.

LECTURE III

FRONT LIMB

This limb is composed of 20 bones, and includes the shoulder, arm, forearm, and foot.

Shoulder.—The shoulder contains but one bone, the *scapula*, or shoulder blade. This is triangular and situated at the front portion of the chest wall. Its direction is downward and forward, and it articulates below with the head of the humerus, or arm bone. The inner surface is somewhat concave. The external surface is divided into two portions by a long ridge which extends lengthwise of the bone. The upper portion is flat and thin.

Arm.—The arm contains a single long bone, the *humerus*. Its upper end articulates with the scapula, and the lower end with the ulna and radius. It offers for description a shaft and upper and lower extremities. A peculiar feature of the *shaft* is a sort of furrow, which twists partially around the bone and is known in anatomy as the furrow of torsion. The *superior extremity* shows a rounded head, which is fitted for articulation with a corresponding cavity of the scapula, and the bicapital groove in front, which holds the tendon of the biceps muscle.

The *inferior extremity* is flattened. Its articular surface has two condyles, separated by a shallow groove, fitting it for articulation with the radius. This extremity shows, on its posterior surface, a deep fossa which fits the peculiar articular surface of the ulna and gives a perfect hinge joint that is not easily dislocated.

Forearm.—The forearm contains two bones, the *radius* and *ulna*. In the horse and cow these are firmly united. The radius belongs to the group classified as long bones, and articulates with the humerus above and the carpal bones below. Its anterior surface is convex and smooth; its posterior surface, concave. The ulna is also a long bone, located just back of the radius. The shaft is triangular. The upper extremity shows a marked enlargement which is useful for attachment of muscles

and gives leverage. It contains a deep notch with a large beak at the top for articulation with the humerus. The inferior portion of this bone is slender and more or less pointed, containing at its extremity a small knob.

Foot.—The foot includes 7 carpals, 3 metacarpals, 2 sesamoids, 3 phalanges, and 1 navicular.

The *carpals* consist of seven small, short bones, and with the articulation of the carpals to the radius above, and the metacarpals below, make up what is commonly known as the knee joint.

The *metacarpals* are located in what is known as the region of the cannon. They are three in number: a large one in the middle, which is long and more or less cylindrical; and one rudimentary metacarpal on each side. These together articulate above with the carpals, and the large one below with the first phalanx and the sesamoids. The small metacarpals are commonly known as splint bones.

The *first phalanx* is commonly known as the pastern bone. It is the shortest bone in the body that is classified as a long bone. The shaft shows an anterior convex surface and a posterior surface which is flattened and rough. The upper extremity is marked by two shallow cavities, separated by a median groove and fitted for articulation with the two convex surfaces and the median ridge which mark the inferior extremity of the large metacarpal. The lower extremity has two convex articular surfaces separated by a median groove.

The *sesamoids* are two small, somewhat triangular, and ir-

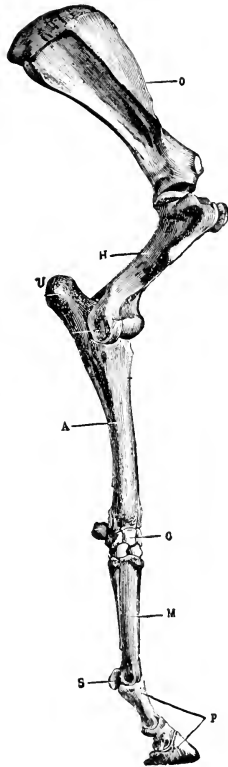

FIG. 11.—ANTERIOR LIMB OF THE HORSE.

O, Scapula; H, humerus; A, radius; U, ulna; C, carpals; M, metacarpals; S, sesamoids; P, phalanges.

regular bones, placed side by side just back of the upper part of the pastern bone. These articulate with the large metacarpal. They are side by side and together form a groove for the flexor tendons.

The *second phalanx*, or coronet bone, is short and somewhat square in form. It articulates with the first phalanx above, and the third phalanx and navicular below. The upper and lower extremities of this bone resemble the upper and lower extremities of the first phalanx. About half of this bone is below the crown of the hoof.

The *third phalanx*, or pedal bone, is pyramidal in shape and irregular. Its superior face shows two shallow cavities separated by a median ridge fitted for articulation with the second phalanx. The anterior face is convex and quite rough. The inferior surface is the one on which the foot rests. It is called the sole. The superior border of the anterior face has quite a projection which is especially fitted for the insertion of a tendon. This is technically known as the pyramidal process. The lower portion of this bone is continued outward and backward on each side into what is known as the wing.

The *navicular bone* is located just back of the upper part of the third phalanx. It is long and narrow, and placed transversely. Its anterior surface articulates with the third phalanx. Its posterior surface is covered with cartilage and forms a gliding surface for the tendon of the deep flexor muscle which passes over this bone to its attachment on the sole or inferior surface of the third phalanx.

Practical application.—Note how the length and slope of the scapula affects the type of shoulder, gait and speed; how the length and slope of the humerus affects the type of arm and the gait. The cow and hog, for instance, have a comparatively horizontal humerus. Note the effect of length of radius and principal metacarpal on conformation of the limb and the relative length of these two segments. Note effect of the first and second phalanges on the relative length and slope of the pastern, giving a springy pastern or a short, upright, stilty one. Which horse interferes, the one with the long pastern toeing out or the pigeon toed horse?

Disorders of the bones on the front limb are numerous. The scapula, radius and ulna are all liable to fracture, usually as the result of a kick. The carpal bones are subject to a disease

called knee spavin, a bony enlargement especially on the inner side of the knee. The metacarpal is subject to fracture and splint, the latter a bony enlargement resulting from injury and inflammation and producing temporary lameness and an unsoundness. The principal metacarpal is a common seat of fracture and is a rather favorable place so far as treatment and recovery are concerned. The first and second phalanges are subject to fracture and ringbone, the latter a bony enlargement due to inflammation produced by injury, and to heredity. This causes serious unsoundness and often permanent lameness. Fracture of the first phalanx is not uncommon. Both the first and second phalanges are often injured in barb wire accidents. The third is subject to sidebone, *i.e.*, a bony enlargement having about the same causes and results as ringbone. The sole of the third phalanx is subject to common and serious injury by puncture through the sole. The navicular bone is subject to injury from puncture resulting in inflammation of this bone and to one form of a rather common disease of roadsters known as navicular disease.

LECTURE IV

POSTERIOR LIMB

The posterior limb contains 20 bones, and is divided for study into pelvis, thigh, leg, and foot.

Pelvis.—The pelvis is divided into two halves, each half being composed of three bones closely united. These are: (*a*) the *ilium*, the external angle of which forms the prominence of the hip. Its internal angle articulates with the sacral vertebræ at the highest point of the croup. Its shaft articulates at the cotyloid cavity with the ischium and pubis. The three bones of the pelvis form at this point the cotyloid cavity into which fits the head of the humerus at the hip joint. (*b*) The *ischium* forms the posterior portion of the floor of the pelvic cavity through which the young must pass at birth. It articulates at the cotyloid cavity with the two other bones of the pelvis. Its posterior angle forms the prominence commonly known as the pin bone. (*c*) The *pubis* forms the front part of the floor of the pelvic cavity and articulates with the ilium and ischium at the cotyloid cavity. To the breeder, the pelvis is for obvious reasons, a most important part. These bones are distinct in early life, but become united as the animal grows older. The two halves of the pelvis bound the pelvic cavity, which contains the rectum, bladder, and sexual organs. Each half of the pelvis articulates with the sacrum at the croup.

Thigh.—One bone only, the *femur*, is contained in the thigh. This bone articulates above with the pelvis and below with the larger of the two leg bones, the tibia, and with the patella. The femur belongs to the group which we have classified as long bones, and is the heaviest and strongest bone in the body. This bone offers for study a shaft and upper and lower extremities. The *shaft* shows four faces,—external, internal, and anterior, which are smooth and convex, and a posterior face which is rough and irregular on the surface. On the *upper extremity* we find a smooth rounded head which articulates with a deep cavity in the pelvic bone above. On the external side and projecting

above the head is a large elevation or bony prominence known as the external, or great, trochanter, which gives attachment and leverage to powerful muscles of the hip. Below this are two smaller trochanters which give attachment to other muscles of this region. The inferior extremity is somewhat flat from side to side and is formed by two rounded surfaces which are called condyles. These are separated by a deep groove known as the trochlea and resemble the lips and groove of a pulley, thus fitting the inferior extremity for its peculiar articulations with the patella and tibia.

Leg.—This part contains three bones,—the tibia, the fibula, and the patella. The *tibia* is a long bone with a somewhat triangular shaft larger at the upper than at the lower end. It articulates above with the femur and fibula, and below with the bones of the hock, *i.e.* the tarsal bones. Like the femur, this bone offers for study a distinct shaft, upper and lower extremities.

The *shaft* of the tibia presents three surfaces,—the external, internal, and posterior; and three borders,—the anterior, external, and internal. The *superior extremity* shows in front a depression for one of the ligaments which attaches the patella to the tibia, also a small articular surface for the fibula on the outer side, and two oval depressions with a marked projection between them for articulating with the condyles of the femur. These are smooth and covered with a thick pad of fibrocartilage. The *inferior extremity* presents an external and an

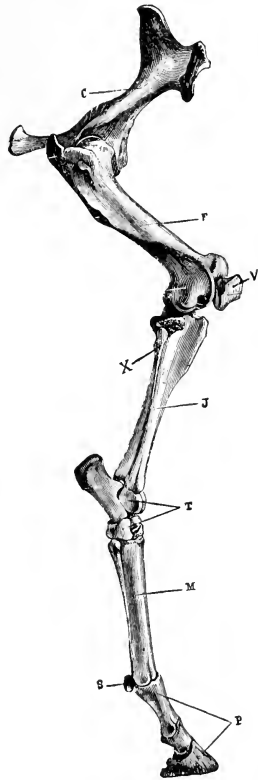

FIG. 12.—POSTERIOR LIMB OF THE HORSE.

C, Pelvic bone; F, femur; V, patella; J, tibia; X, fibula; T, tarsals; M, metatarsals; S, sesamoids; P, phalanges.

internal tuberosity. Its articular surface consists of two shallow cavities and a median ridge, all three of which extend diagonally forward and backward.

This bone articulates with four others; viz. femur, fibula, and one of the tarsal bones, the astragalus.

The *fibula* is a small rudimentary bone which articulates with the external portion of the head of the tibia, and is situated on the external side of that bone.

The *patella* is small, short, and located in front of the lower extremity of the femur, and attached to the tibia below by three strong ligaments. It is often displaced outward when the limb is in the condition popularly known as "stifled." This bone offers for study three faces: superior, to which muscles are attached; the anterior, which is convex and somewhat irregular; and the posterior, which is so shaped as to fit nicely into the femoral groove already mentioned.

Foot.—In its anatomy, the foot bears a very close resemblance to the corresponding portion of the anterior limb, and is divided for study into the tarsus, metatarsus, and digit.

The *tarsus* is composed of six or seven small bones, arranged in two rows, forming a very complicated articulation at the hock. The upper row contains the astragalus and os calcis. The lower row usually consists of four small bones. Two of these are especially interesting because they are the common seat of bone spavin, a serious cause of lameness and unsoundness.

The *astragalus* is interesting because it furnishes the articular surfaces for the lower end of the tibia. Note the peculiar, diagonal, pulley-like groove with which the astragalus articulates with the tibia and its important bearing in the action of the hock and cannon.

The *os calcis* is somewhat elongated and lies behind the astragalus. It corresponds to the prominent portion of the human heel and is the seat of the "capped hock." The bones of this region correspond to the human tarsal bones making up the ankle.

The *metatarsals* closely resemble the metacarpals of the front leg and consist of three bones, a large one in the center and one small rudimentary bone on each side, *i.e.* on the inside and outside of the middle bone. The large metatarsal furnishes the supporting axis for this region as in the anterior limb. The shaft is fairly smooth and has a small articular surface on each

side for the rudimentary metatarsal. It is supposed that the small metacarpal and metatarsal bones are merely survivals in the process of evolution, and that in the primitive animals from which the modern horse is descended these bones were larger than they are now, having the same length and the same functional importance as the principal metacarpal and metatarsal bones. The original ancestor of the horse is supposed to have had five metacarpals and five metatarsals with corresponding digits or toes, and to have walked on five toes instead of one.

The horse has three *phalanges* and the cow six. These bones are closely similar to the phalanges of the front pastern. They are commonly known as the first, second and third phalanges, or *os suffraginis*, *os corona*, and *os pedis*.

The sesamoids and navicular bones are very similar to the corresponding bones of the front limb already described. Animal-husbandry students should find the application of preceding lessons helpful by giving a clear view of the anatomical basis of conformation, type and action.

Practical application.—Note how the external angle of the *ilium* fixes the “roughness” or “smoothness” of the hips; how the length and slope of the *femur* fixes the length and slope of the thigh, and controls the action of the limb, for example the cow and hog have comparatively horizontal femurs and are awkward travelers. Note the *tibia* in its relation to length and slope of the leg or gaskin, or lower thigh, as this region is variously named, and how this affects the stride of the roadster.

The *tarsal* bones make the framework and determine largely the conformation and strength of the hock.

Whether the point of the hock is prominent or otherwise depends on the *os calcis*, one of the tarsal bones. Good hock action depends to an important extent upon the peculiar oblique articular surfaces of the astragalus and tibia. The principal metatarsal determines the length of the cannon, and this in turn affects the stride of the roadster and the power of the draft horse.

Length and slope of the pastern depends on length and slope and articulations of the first and second phalanges and these give elastic spring or jar and cause the horse to go clear or interfere at the ankle.

Disorders of the posterior limb are even more numerous than those of the fore limb. The three pelvic bones are all subject

to fracture and in the female this may interfere with the birth of her young.

The external angle of the *ilium* is often fractured, causing the deformity known as "hipped" or "hip shot." The shaft of the femur is occasionally fractured as in throwing for surgical operation—usually a hopeless fracture, except in very young animals. The patella of the horse is quite subject to dislocation over the external condyle of the femur causing the condition known as "stifled," the horse being unable to bring the hind leg forward. The shaft of the tibia is a common seat of fracture, usually from kick while weight is on the injured limb. The tarsal bones at the lower, inner, front part of the hock are often affected with bone spavin, due to injury and heredity and usually characterized by local inflammation, an abnormal growth of bone (exostosis) and a typical, chronic lameness. The metatarsals, phalanges, and navicular bones are subject to about the same disorders as the corresponding parts of the front limb.

LECTURE V

THE FOOT

The foot, technically, includes all structures at and below the knee in front and the hock behind. This lecture only deals with that portion of the foot below the ankle.

Bones.—First phalanx; two sesamoid bones; second phalanx; navicular bone; and third phalanx. For first and second phalanges, sesamoids, and navicular, see Lecture III.

The *third phalanx* is an irregular bone of loose spongy texture. The body is shaped somewhat like the hoof and shows at the top in front a prominence called the pyramidal process, and on each side a projection called the wing, under which may be seen a groove, through which groove an artery passes on its way to form part of an arch within the substance of the bone. From this arch are given off the branches which distribute nourishment to the vascular parts. Above the wings, inside the hoof, are cavities into which the lateral cartilages fit. They are of firm cartilage and may be felt above the crown of the hoof on each side. They are attached below to the wings of the third phalanx and plantar cushion. To the front and sides of the third phalanx are attached the sensitive laminae. The inferior surface is concaved to receive the sensitive sole, or velvety tissue.



FIG. 13.—BONES OF THE HORSE'S FOOT.

1, Metacarpal; 2, sesamoids; 3, first phalanx; 4, second phalanx; 5, navicular bone; 6, third phalanx (os pedis); 7, basilar process; 8, 8, wings; 9, pyramidal process.

The *navicular bone* is also a sesamoid bone; *i.e.*, it is formed in tendon. It is a short bone in structure, but rather long and slender in shape, and placed crosswise just back of the articulation between the second and third phalanges. Its inferior surface is smooth except for a slight ridge in the center. The tendon of the deep flexor muscle passes over this surface on its way to its insertion on the bottom of the third phalanx. The ends of the navicular bone unite on each side with the wings of the third phalanx by tough fibrous tissue.

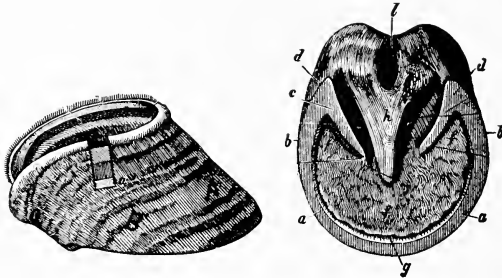

FIG. 14.—THE HOOF.

The Wall. *A*, Toe; *B*, quarter; *C*, heel.

Ground Surface. *a-a*, toe; *a-b*, quarter; *b-d*, heel; *c*, bar; *f, f, f*, sole; *g*, white line; *h*, frog; *l*, cleft of the frog.

Horny hoof.—This is to be regarded as an appendage of the skin. It covers all of the third phalanx and part of the second. It is divided for study into wall, sole, and frog.

The *wall* is that part which may be seen when looking at the hoof in front and at the sides when the foot is on the ground. It is composed of horny, tubular fibers, which grow from the coronary band. Between these tubular fibers is a material which holds them together. The wall is divided into toe, quarters, and heels. At the top is a groove into which the coronary band fits, the crown of the hoof. The wall unites below with the sole. The smooth shining layer which should cover the surface of the wall is periople. The duty of this layer is to prevent undue evaporation from the hoof. Beneath the periople is the horny wall which gives shape to the foot and protects the soft parts within. Inside this hard layer come the laminae; these are thin leaves of horny material which dovetail in with the sensitive laminae.

The *sole* is composed of horny material resembling that of the wall. It is concave below, convex above. Its outer border unites with the wall at the "white line." Its upper surface is covered by the vascular velvety tissue.

The *frog* is a V-shaped elastic pad with a depression, called by horsemen "the cleft," in its ground surface. It is located between the bars on each side, and below the plantar cushion. Its function is to act as a pad and to lessen jar when traveling.

Matrix.—The matrix (horn-generating membrane) fits inside of the horny part of the hoof and covers like a stocking the other parts within the hoof. It is from this that all the horny parts grow. It is composed of three parts: (1) coronary band; (2) sensitive laminae; (3) velvety tissue.

The *coronary band* is the elastic ring that may be felt at the crown of the hoof. It is studded with little papillae. From these grow downward the tubular fibers which make up the hard layer of the wall.

The *sensitive laminae* are 500 to 600 layers of vascular tissue into which fit and from which grow the horny laminae of the wall. An inflammation here is called laminitis or founder.

The *velvety tissue* covers the upper surface of the hard sole. Like the coronary band and sensitive laminae, it is sensitive and richly supplied with blood. The under surface is thickly studded with papillae, similar to those of the coronary band, and from these in a similar way grow the shorter tubular fibers which make up the hard sole and frog. The student can easily understand why injury to the coronary band, *e.g.* a wire cut which results in a healing by scar tissue, leaves a split which lengthens downward in the hoof; why founder is so painful; and why deep injuries to the sole are so apt to be serious.

Plantar cushion.—This is a wedge-shaped mass of elastic tissue located between the lateral cartilages on each side, below the sole of the third phalanx and above the horny sole of the



FIG. 15.—THE HOOF MATRIX.

1, Periople ring; 2, coronary band; 3, sensitive laminae; 4, heel. Velvety tissue on the sole not shown.

hoof. It assists the horny frog in lessening jar in travel and protects the insertion of the deep flexor tendon.

“**Back tendons.**”—This is a term used by horsemen to include the tendons of the superficial and deep flexor muscles of the foot and the suspensory ligament.

The *superficial flexor muscle*, of the front foot, has its origin on the lower end of the humerus and its insertion by tendon on the sides of the second phalanx. Its function is to flex the foot at the first interphalangeal articulation.

The *deep flexor muscle*, of the front foot, has its origin in common with the superficial flexor on the lower end of the humerus, and its insertion by a tendon which spreads out on the sole of the third phalanx. Its duty is to flex the second and to assist in flexing the first interphalangeal articulation.

The *suspensory ligament* is broad and very strong. It attaches by its upper end to the carpal bones and to the large metacarpal. Its lower end divides into two branches which pass forward on each side and attach to the front tendon. Its duty is to support the metacarpo-phalangeal articulation (fetlock).

Practical application.—The shape and peculiar characteristics of each hoof correspond by correlation with the remainder of the limb, except as the hoof has been varied by artificial means. So in judging the hoof it is also necessary to consider the characteristics of the entire limb.

The front limb may be said to be normal in position and direction when it appears on front view that a vertical line from the front of the scapulo-humeral articulation passes down the center of the limb and to the ground at the center of the toe.

On viewing such a limb from the side it should be evident that a vertical line downward from the bony prominence at the middle of the scapula would divide the external surface of the limb into two equal portions and reach the ground immediately back of the heels.

Viewing the hoof and pastern alone it should be seen that the hoof is in direct line with the pastern and metacarpal or metatarsal bones, and that a line extending from the center of the cannon through the center of the pastern would pass through the center of the toe.

The hind limb when viewed from behind should show that a vertical line downward from the prominence at the posterior portion of the pelvis on each side (tuberosity of the ischium)

would divide the entire limb into two equal portions and reach the ground back of the center of the horny frog.

For the front hoof the wall at the toe and the anterior surface of the pastern should make an *angle* of not less than 45 nor more than 50 degrees with the level ground surface, the wall at the toe and the anterior surface of the pastern having the same slant.

For a normal hind hoof the *angle* should be from 50 to 55 degrees, and the anterior faces of the hoof and pastern should still have the same slant.

A normal hoof has a good quality of horn, and moderately wide *heels*. The hind hoof is narrower and more pointed at the toe than the front hoof. The *wall* from coronary band to ground surface should be straight and smooth. The *heels* should be rounded, well developed, and of the same height at the top of the coronary band. The *sole* should be distinctly concave and show no marked separation from the wall. The *frog* should be large and elastic, the two portions of the same size, with a shallow groove along the center. The *bars* should be straight, extending forward and inward. The *lateral cartilages*, felt above the coronary band on each side, should be elastic. The sole in the angles between the bar and the wall at the heel should not show red stain. There should be no separation of the horny fibers as in toe or quarter cracks. The wall should be reasonably thick. This can be usually determined by tapping the wall with a hammer, noticing its rigidity.

Disorders of the foot are mentioned in connection with the anatomy of the anterior and posterior limbs.

LECTURE VI

ARTICULATIONS OR JOINTS

Articulations are divided into several groups for the purpose of study. These groups are: immovable, slightly movable, and freely movable.

Examples: Immovable, between the skull bones; slightly movable, between vertebræ; freely movable, between scapula and humerus.

Freely movable articulations.—The freely movable articulations are subdivided according to shapes of the articular surfaces and varieties of movement that can be produced. These subdivisions are: ball-and-socket, hinge, pivot, imperfect hinge, and gliding.

The *ball-and-socket* articulation, of which we find examples at the shoulder and hip, is made by a rounded head of one bone fitted into a rounded cavity of some other bone; for instance, at the shoulder we have a rounded head of the humerus fitted into the glenoid cavity of the scapula. At the hip a rounded head on the superior extremity of the femur fits perfectly into the cotyloid cavity of the pelvic bone. It will be readily seen that the ball-and-socket joint permits the greatest variety of movements.

The *hinge joint* is made by two articular surfaces of such shape and so fitted together that no lateral or rotary motion is possible. Only two movements are allowed at joints of this kind: flexion and extension. The articulation between the humerus above and the ulna and radius below offers a good example of this kind.

Pivot joint is one where portions of two bones are in contact in such a way as to permit of rotary motion; for example, between the atlas and axis, the rotation being around the odontoid or toothlike processes of the axis. Articulations of this kind permit of rotation only.

The *imperfect hinge joint* is one which permits of two principal motions—flexion and extension, and to a limited extent some other motion, as for instance rotary or lateral movement.

We may find a type of this articulation between the temporal and inferior maxillary bones, or between the femur and tibia. Articulations of this kind are formed by oval heads fitting in oval sockets.

Gliding joints permit only simple gliding movement between the articular surfaces. The articular surfaces in joints of this kind are more or less nearly flat.

Immovable articulations.—At *immovable articulations* the bones are united by cartilage and practically continuous. The only movement permitted is by cartilage elasticity, as between the cranial and the pelvic bones.

Slightly movable articulations.—At *slightly movable articulations*, bones are united by a cartilage which is elastic enough to permit of slight movement, *e.g.* the common intervertebral articulations.

At *freely movable articulations* the articulating bony surfaces are each covered by a thin layer of smooth, glistening, and elastic articular cartilage. This cartilage gives a smooth gliding surface. It also lessens jar by its elasticity and protects the bony surface beneath.

Structures at joints.—These structures are bones, cartilage, ligaments, tendons, muscles, synovial membrane, and synovial fluid. Any or all of these may be involved in injury and disease.

Ligaments are either bands or sheets of white or yellow connective tissue. The white ligaments are very strong and inelastic. Their sole function is to hold bones together at articulations. The yellow ligaments are composed of yellow elastic connective tissue, and are especially useful as assistants to muscles, particularly in supporting parts of the body, like the head of the horse, which constantly tend to fall.

Synovial membranes are sometimes called capsules. These are serous membranes, quite thin, but composed of two layers, deep and superficial. This membrane affords at each joint a closed sack and is for the purpose of secreting synovia. The synovial membrane does not cover the surface of the articular cartilage, as is frequently supposed, but incloses the articulation like a sack, being attached at one side near the edge of the articular surface of one bone, and at the other side near the articular edge of the other bone. The synovial membrane is usually attached also to the inner surface of the capsular or other ligaments of the joint. Disease and injury of a synovial

membrane are always serious, as for example, "open joint," and this is true of all serous membranes in general.

Synovia is a *viscid* fluid, slightly yellow or nearly colorless. It has an oily feeling, but is not an oil chemically. This fluid is quite rich in albumen, which gives it the viscid property, and adapts it so well for lubricating articular surfaces. Muscles and tendons are discussed in Lecture VII.

Kinds of motion.—These are: *flexion*, or bending, in which the two articulating bones are brought nearer each other; *extension*, the reverse of flexion, by which bones are straightened on each other; *adduction*, bringing the lower extremity of the moving bone toward the median line; *abduction*, in which the lower end of the moving bone is carried from the median line; *circumduction*, in which the articulation forms the apex of a cone circumscribed by the moving bone; *rotation*, in which one bone rotates as a pivot on another.

Joints are named according to the bones involved. In the limbs the upper bone is named first. In the vertebræ, the anterior bone is named first.

DESCRIBING ARTICULATIONS, EXAMPLES¹

Scapulo-humeral articulation.—This is a ball-and-socket joint, the rounded head of the humerus fitting the glenoid cavity of the scapula.

Ligaments at this joint are: (*a*) glenoid, a cartilaginous rim around the cavity which deepens the cavity; (*b*) capsular, a sort of capsule fitting around the joint like a bag; (*c*) two bundles of ligament fibers in front of the joint connecting the extremities of the scapula and humerus.

Movements.—All the motions, except true gliding, are possible at this articulation. The synovial membrane is quite loose and affords a lining for the capsular ligament.

First interphalangeal articulation.—This is an imperfect hinge joint. The articular surface of the inferior extremity of the first phalanx is characterized by two condyles and a median groove which fit with two shallow cavities and a median ridge on the superior extremity of the second phalanx.

Ligaments.—The articular extremities which make up this articulation are supported by the following ligaments and ten-

¹All freely movable articulations are described in this general way in anatomy.

dons: in front by the tendon of the anterior extensor muscle; on the sides by two lateral ligaments, one on each side; behind by the posterior ligament and the tendons of the shallow and deep flexor muscles which pass over the posterior of the joint. The posterior ligament is really a thick strong pad of fibrocartilage.

Movements.—Flexion and extension, together with a limited lateral movement.

Practical application and disorders.—Among the more common disorders of articulations are sprains, dislocations, synovitis, arthritis, open joint, and ankylosis.

A *sprain* is an injury due to a strain of articular structures, especially ligaments, overstretching or actually rupturing the fibers. Sprains are characterized by the usual symptoms of inflammation, pain, heat, swelling, etc.; disinclination to flex the joint or bear weight upon it, most common at ankle, hock and stifle. Treat by complete rest, fixation if necessary, cold water or ice several days, then massage and light use soon as appears advisable.

Dislocation may be partial or complete and implies that a bone is out of its proper place at an articulation. This is usually the result of severe injury, and it is frequently associated with sprain of ligaments or other structures. It is indicated by change in length or shape of the limb, by either more or less mobility, and frequently by pain, heat, and swelling. Reduce the dislocation by pulling and pushing the bone back into place and treat as for sprain.

Synovitis is an inflammation of the synovial membrane, usually the result of injury or infection. Very mild form is seen in bog spavins, wind puffs, etc. Severe and acute cases occur, for example, in connection with open joint where we have extreme pain and lameness. The most conspicuous symptom is bulging of the synovial capsule with or without lameness.

Arthritis implies a general inflammation of local articular structures, including synovial membrane (synovitis), articular cartilage, bone, ligaments, etc. Arthritis is characterized especially by lameness, local tenderness, pain and swelling. Articular rheumatism is a good example. Bone spavins and articular ring bones illustrate the results of an arthritis in which articular cartilages and adjacent bones are seriously involved. Treatment of severe arthritis must be left to the veterinarian.

Open Joint implies that the capsular ligament and synovial membrane have been punctured, as by a nail in the foot, or by barb-wire cut at the hock. This is usually followed by infection and is characterized by extreme pain, swelling, tenderness, lameness and especially by the great pain and escape of synovia. This is always a serious disorder and must be left to a competent veterinarian.

Anchylosis implies union of two or more bones at a normally movable articulation. It is the result of inflammation of periosteum, articular cartilage and bone. The cartilage is destroyed and the bones become united, resulting in a "stiff-joint" often seen in ringbone and bone spavin.

LECTURE VII

MUSCULAR SYSTEM

The peculiar property of muscle tissue is the power of self-contraction and self-movement. The muscles of the animal body are of three kinds, voluntary, involuntary, and heart muscle.

Involuntary muscles act independently of the will, and are under the control of the sympathetic and cerebrospinal nervous systems.

Voluntary muscles are under the control of the will through the cerebrospinal nervous system.

Heart muscle is not under control of the will but is similar to voluntary muscle in structure.

Voluntary muscles.—What is popularly termed “lean meat” is composed of voluntary muscles. These are classified into simple, digastric, biceps, triceps, penniform, bipenniform. The *belly* is the active working part (lean meat). The *tendon* is a strong cord or band of white connective tissue. This merely serves to give connection with a distant object, usually a bone. Tendons are strong, but have no power of contraction. The strength of a muscle depends upon the thickness of the belly. The extent of its movement depends upon the length of the belly.

The two ends of a muscle are defined as origin and insertion. The *origin* is the less movable end; *insertion* the more movable end. It may happen at one time that one end is the insertion, at another time the origin.

A *simple* muscle is characterized by a single belly with not more than one tendon at either end; a *digastric* muscle has two bellies connected by a tendon; a *biceps* muscle has two tendons at one end; a *triceps* muscle has three tendons at one end.

They are also classified according to function into flexors, extensors, abductors, adductors, and rotators.

Muscles are paired in a double sense. The rule is that for any given muscle there is a corresponding muscle on the other

side of the body, and also one or more opposing muscles on its own side.

The belly of a muscle has a rich blood supply; the tendon has very little.

A muscle produces motion by pulling upon some bone which acts as a lever with the fulcrum at a joint.

The muscle fibers may attach directly to the bone, or indirectly through tendon fibers. The connection between the muscle fiber and the tendon fiber is by insertion of the conical point of

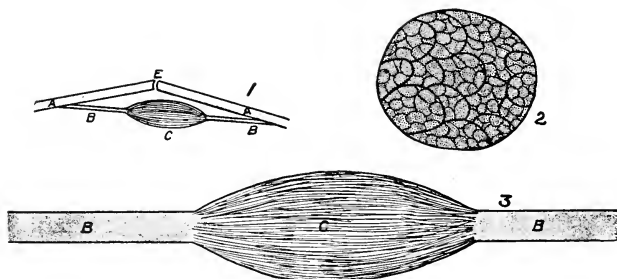

FIG. 16.—VOLUNTARY MUSCLE. (M. H. R.)

1. Action of Muscle in Producing Motion. Muscle does its work by shortening its belly. *A, A*, bones; *B, B*, tendons; *C*, belly of muscle; *E*, articulation (joint).

2. Muscle in Cross Section. Showing "bundle of bundles" arrangement of the fibers. Dots represent single fibers.

3. Diagram of Simple Muscle. *B, B*, tendons; *C*, belly (lean meat).

the muscle fiber into a conical cavity at the end of the tendon fiber.

Structure.—The voluntary muscle consists of bundles of bundled fibers; each individual fiber has its own delicate sheath. A number of fibers are inclosed within a common connective tissue sheath and constitute a minute bundle. A number of these bundles are in turn wrapped within a connective tissue sheath, forming a larger bundle. These larger bundles may in turn be wrapped by means of another connective tissue sheath into a still larger bundle.

The voluntary muscle fiber is long, threadlike, marked by cross stripes which are very close together, and may end in tendon fiber. These muscle fibers are about $1/1500$ of an inch wide, but may be very long—one inch or less.

Involuntary muscles.—Involuntary muscle fibers have the peculiar property of being able to act independently of the will in contraction and relaxation. They are controlled in this action by two kinds of motor nerve fibers from the sympathetic and cerebrospinal nervous systems. One kind stimulates, causing contraction; the other kind inhibits, causes relaxation of the involuntary muscle fibers. These are merely long, spindle-shaped cells, which do not end in tendon fibers. They may be arranged in the form of small bundles, and are usually in the form of thin sheets. Involuntary muscle tissue is lighter in color than voluntary, and usually incloses hollow organs forming one of the coats or layers. The middle coat of the stomach and intestines is composed of involuntary muscle fibers.

Function.—It is their function to carry on work which could not be intrusted to conscious control and with which the brain could not well be burdened.

Peristaltic action of the stomach and intestines is produced by the rhythmic action of these muscle fibers.

The heart muscle fibers differ from both the typical voluntary and the typical involuntary fibers. They are striped, but operate independently of the will.

Source of heat and power.—Muscular power comes from oxidation of food material in the various tissues of the body, particularly in the muscles and larger glands. During the process of oxidation, carbonic gas and other materials are developed. Power is increased by proper nourishment, and is decreased by lack of nourishment. Muscles lose in strength by overwork because they are consumed more rapidly than rebuilt.

Description of voluntary muscle.—The masseter muscle is located on the outer part of the cheek. *Form*, flat, broad, thick, four-sided. *Origin*, on the temporal and superior maxillary

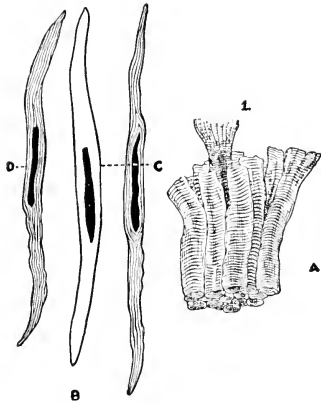

FIG. 17.—MUSCLE FIBERS.

A, Bundle of voluntary fibers, side view. *B*, *C*, *D*, Three involuntary fibers, spindle-shaped cells with nuclei.

bones. *Insertion*, on the outer surface of the inferior maxillary. *Action*, elevates the lower jaw. *Nerve supply*, from a branch of the fifth cranial nerve (trifacial).

Practical application.—The student should now make practical observations for himself, recording as in previous lectures. He may select at the teacher's discretion several short thick muscles and several long slender ones, and should note locations, attachments, and probable functions, and should make a statement concerning the probable working efficiency of muscles of these different types. This refers to the amount of load to be moved and long or short distance of movement.

Study a skeleton, and also a horse in motion, and note how the horse pulls, or lifts a load. What occurs at the articulations and how is this brought about?

Study the location and size of muscles and the relations of these considerations to body conformation.

Note how the voluntary muscles supplement the bony framework in giving conformation and type in shape of neck, smoothness of shoulder, width of back and loin, type of quarter, forearm, gaskin, lower thigh or "twist."

Short, heavy muscles (bellies) produce powerful but short action; long, slender muscles reverse this and give weak power and long movement.

Disorders are numerous. *Wounds* are common and repair is only fairly good—partly by connective tissue in place of the normal muscle. *Sprains* are similar in nature, symptoms, and treatment to those described for ligaments in the preceding chapter.

Atrophy (sweeny), e.g., of the shoulder and hip muscle, is a common disorder of muscle tissue. Treatment must remove the cause, often a severe lameness elsewhere, and improve nutrition of the wasted muscle by rich blood supply to it, by liniment, blister, or irritating injections, for example. Muscle tissue is subject to various disorders such as fatty infiltration of the heart muscle in old and excessively fat horses and dogs.

LECTURE VIII

NERVOUS SYSTEM

Function.—The peculiar function of the nervous system is to control the various organs and systems of the body, and compel them to work in harmony. The peculiar property of

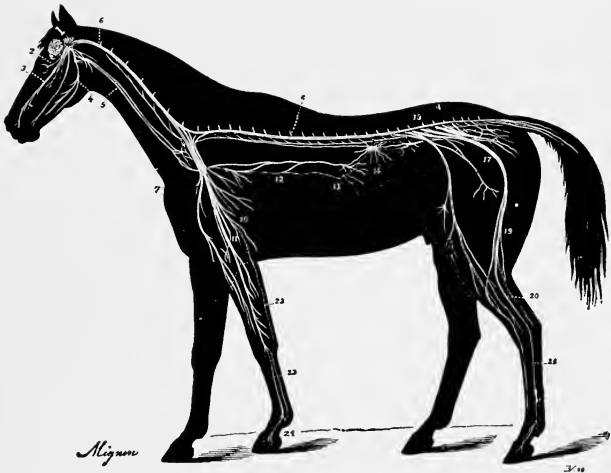

FIG. 18.—CEREBROSPINAL NERVOUS SYSTEM.

1, Brain; 2, optic nerve; 3, superior maxillary nerve; 4, inferior maxillary nerve; 5, pneumogastric nerve; 6, spinal cord; 10, radial nerve; 11, median nerve; 12, pneumogastric nerve; 13, portion of solar plexus; 14, solar plexus; 17, sciatic trunk; 19, great sciatic nerve; 20, posterior tibial nerve; 21, posterior plantar nerve; 22, internal radial nerve; 23, anterior plantar nerve; 24, digital nerves.

nerve tissue is irritability. The nervous system is composed of nerve centers, nerves, and nerve cells or neurons.

A *nerve center* is composed of nerve cells or neurons with their branches: (a) (axons)—commonly called nerve fibers—over which impulses pass from the cells, and (b) shorter

branches (dendrites), over which impulses come to the cell body from the axon of some other cell or from a terminal sense organ, as a taste bud on the tongue or a tactile (sense of touch) corpuscle in the skin, connective tissue, and blood vessels. The function of a nerve center is to receive and dispose of impressions which may be brought to it, to provide connection for nerve

fibers, and in the case of the forebrain to originate conscious impulses.

Some *nerve fibers* or axons are composed of a central filament, the axis cylinder, or axon, surrounded by one or two protecting sheaths; others are composed of the central filament only. Nerve fibers conduct impulses between the various tissues and organs, and nerve centers. A nerve fiber or axon then is a long, very slender, white or grayish thread, the extension of a nerve cell.

A nerve is composed of an indefinite number of nerve fibers supported within a common sheath.

A *nerve cell* or neuron is an irregularly shaped microscopic cell, having a varying number of branches, one of which may

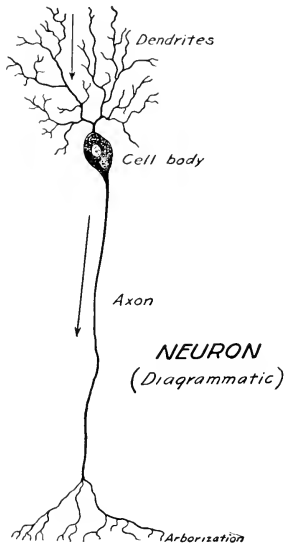

FIG. 19.

continue to indefinite length as the axis cylinder or central filament previously mentioned.

Nerve Fibers.—Classified according to function, nerve fibers are either: motor, sensory, or special sense. Each of these conveys but one certain impulse and in one direction only.

Motor fibers are those which convey impulses to the muscles and control muscular action; for example an electric shock, or a pin prick of a motor nerve, causes the muscles which it supplies to contract.

Sensory fibers are those which convey impulses toward brain centers and give only sensation to the structures to which they

are distributed; for example, irritation of a sensory nerve gives an impression of pain, but no motion or special sensation.

Fibers of *special sense* as in olfactory, optic, and auditory nerves, transmit only sensations that pertain to the functions of the special senses like hearing and sight. A jar on the head irritating the optic nerve gives a sensation of flashes of light. Irritation of the auditory nerve gives an impression of sound, etc.

Many of the cranial and all the spinal nerves contain both motor and sensory fibers and are therefore mixed.

Nerves are therefore classified as motor, sensory, and mixed nerves, and nerves of special sense according to the kind or kinds of fibers composing them.

The nervous system is subdivided for study into the cerebrospinal and sympathetic nervous systems. But these are very intimately related to each other. Working together they constitute one united system.

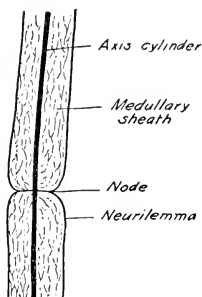

MEDULLATED NERVE FIBRE

FIG. 20.

CEREBROSPINAL SYSTEM

The cerebrospinal nervous system consists of the brain and spinal cord, together with their nerves and ganglia. The brain and spinal cord should be considered as one complex organ located within a continuous canal, the brain to be considered as merely an enlargement at the anterior extremity. The cranial cavity should be considered as an enlargement at the anterior extremity of the spinal canal. The cranial bones may be considered as peculiarly developed vertebrae.

Brain.—This organ is located in an ovoid cavity, the walls of which are formed by the cranial bones. It is covered by three membranes: (1) The *dura mater* is tough, thick, and strong, and fitted to the inner surface of the cranial bones. (2) The *arachnoid* consists of two layers forming a closed sack, the outer layer fitted closely to the *dura mater*, and the inner layer fitted closely to the *pia mater*. (3) The *pia mater* is thin,

delicate, and fits closely to the brain substance—over the convolutions and into the depressions.

Gray matter, folded into convolutions, covers the surface. The interior is composed of white matter.

Function.—The physiological function of the brain is to receive messages, consider information, and send out appropriate impulses or orders to the proper organs.

Divisions.—The brain is divided for study into: (a) cerebrum; (b) cerebellum; (c) medulla; (d) isthmus.

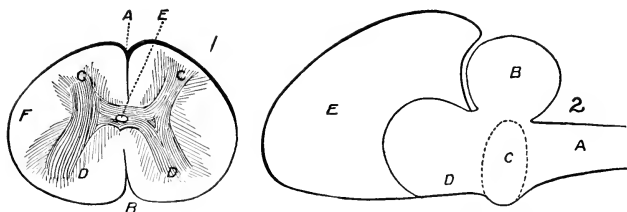

FIG. 21.—SPINAL CORD AND BRAIN IN DIAGRAM. (M. H. R.)

1. Cross Section of the Spinal Cord. *A*, superior median fissure; *B*, inferior median fissure; *C*, *C*, superior gray horns; *D*, *D*, inferior gray horns; *E*, central canal; *F*, white substance.

2. Vertical Mid-Section of Brain. *A*, medulla; *B*, cerebellum; *C*, pons or bridge; *D*, isthmus; *E*, cerebrum.

The *cerebrum*, is largest, and located in the anterior part of the brain cavity, and is divided into two lobes or hemispheres by the median fissure.

The *cerebellum*, smaller than the cerebrum, is located in the posterior and inferior part of the brain cavity, and consists of three small lobes. Section shows the arbor-vitæ (tree of life) arrangement of nerve tissue. It is the function of the cerebellum to control the voluntary muscles that they may work in harmony.

The *medulla* is a continuation of the spinal cord and extends from the occipital opening in the brain cavity to the pons or bridge, and is located posterior and inferior to the cerebellum.

Within the medulla are located a number of important centers, among them the ones controlling respiration; the caliber of blood vessels and distribution of the blood according to the needs of the body; the center controlling the processes of swallowing; the vomiting center; and the center controlling the secretion of saliva.

The *isthmus* is that part of the inferior portion of the brain which connects the pons with the cerebrum.

Cranial nerves.—There are twelve pairs of which the first is *olfactory*—smell; second, *optic*—sight; third, *oculo-motor*, to several muscles which move the eyeball and iris, controlling in part the size of the pupil of the eye; fifth, *trigeminal*, or *trifacial*, to eye, skin of the face, teeth, etc.; seventh, *facial*, principally motor to muscles of face, mouth, tongue, ear, and neck; eighth, *auditory*, to internal ear—hearing; ninth, *glossopharyngeal* to tongue and pharynx, sense of taste and general sensation; tenth, *vagus*, sometimes called the wandering pair, distributed to heart, lungs, stomach, liver, intestines and other abdominal organs.¹

Spinal cord.—That portion of the cerebrospinal system which extends within the spinal canal from the occipital opening to the sacrum is known as the spinal cord. It weighs about 10.5 ounces and consists of white matter on the outside and gray matter in the interior, and is covered by the same three membranes as the brain. The spinal cord is marked throughout its entire length by two fissures, one extending along the superior surface, and another along the inferior surface.

It is the function of the spinal cord to act as a means of communication between the brain and spinal nerves, and as a reflex nerve center.

Spinal nerves.—There are about 42 pairs. Each nerve has *origin* in two roots. One root (superior) comes from the upper portion of the cord and is composed of sensory fibers. The other root (inferior) comes from the lower portion of the cord and is composed of motor fibers. The nerve is therefore mixed.

These nerves *emerge* from the spinal canal in pairs, one on each side and at each articulation of the vertebræ. They are *named* cervical, dorsal, etc., according to location in the spinal column.

The spinal nerves *supply*, by their superior branches, the skin and muscles of the neck and back with both sensation and motion. By their inferior branches they supply the lower

¹The fourth, *pathetic*, nerves, and sixth, *abducens*, are motor nerves to other muscles of the eyeball, coöperating with the third in moving it. The eleventh, *spinal accessory*, is also a motor nerve to muscles of the head, neck, withers, arm, etc. The twelfth, *hypoglossal*, controls the muscles of which the tongue is largely composed.

portion of the body and limbs with both sensation and motion and furnish other branches which in part make up the two great sympathetic nerve trunks.

THE SYMPATHETIC SYSTEM

This consists of two cords, one on each side of the spinal column, and extending from the head to root of tail, together with all the nerves which branch from these two trunks. These cords are not smooth, but have enlargements called ganglia at

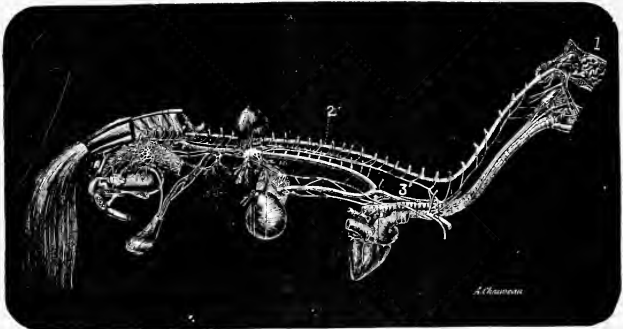

FIG. 22.—RELATION OF THE SYMPATHETIC AND CEREBROSPINAL SYSTEMS. PARTLY DIAGRAMMATIC. (*Chauveau.*)

1, Brain; 2, spinal cord; 3, sympathetics.

intervals along their course. Each cord resembles somewhat a small, rather flat, and knotted rope.

Composition.—These two trunks are composed of nerves from the medulla and from the inferior branches of all the spinal nerves except the coccygeal. By this arrangement and composition, and the frequent connections of sympathetic with cerebrospinal nerves, there is constituted a very perfect union of these two into one great nervous system.

Ganglia.—The knots along the two main trunks are ganglia of nerve cells and fibers. One of these, the solar plexus, is really composed of two large ganglia, united by a large cord and many filaments. It supplies the stomach, intestines, liver, pancreas, spleen, and kidneys. An injury to the solar (cæliac) plexus is always serious.

Sympathetic nerves.—These control, in part, involuntary muscle fibers and through these the organs of circulation, respiration, and digestion, the size of the pupil of the eye, and the work of the various glands including the liver, spleen, pancreas, and kidneys.

Practical application.—Summarizing, we may say that the *cerebrospinal* nervous system controls the muscles of the skeleton (lean meat), gives sensation to skin and skeletal muscles, and the special sensations of sight, hearing, taste, smell, etc.

The *sympathetic* nervous system controls the involuntary muscle fibers of the blood vessels, increasing or decreasing their capacity as needed; it controls the involuntary muscle fibers of the digestive organs, such as the stomach and intestines, producing the necessary motion automatically; it controls the movements and work of the bladder, the movements of the hair, and the involuntary muscle fibers of the iris (colored portion of the eye), making the pupil large or small, according to the intensity of light. Directly or indirectly the sympathetic nerves also control in part the work of secretion and excretion in the salivary glands, liver, kidneys and other organs.

The student should now make practical observations. He may, for example, record past experience or present observations concerning horses and cattle, taking those of sluggish, well balanced, and highly nervous organizations. Compare these different types as to working efficiency, feeding, and keeping. Quiet steers do better. What is the physiological explanation? Note the effect of excitement on high type dairy cows as to production—quantity and quality of milk considered. What is the explanation? What connection between excitement in the brain and milk in the udder?

In making these studies, bear in mind that the quantity and quality of digestive fluids, food absorption, distribution and utilization of food material, the amount of blood flowing through a cow's udder, and the degree of gland cell activity in the udder are all under the direct influence of the nervous system.

Disorders of the nervous system are often complicated and difficult to handle. Veterinary services are usually necessary. The following are typical disorders which the stockman should understand in a general way. It is important to understand that nerve tissue is subject to the same actual disease changes as other tissues—atrophy, congestion, inflammation, and degenera-

tion, for example—and that these changes interfere with normal function.

Posterior paralysis of swine is of many types, due to several different causes and characterized by partial or complete motor paralysis of the hind quarters.

Milk fever (poorly named) is a common disorder of cows at calving time, characterized by both motor and sensory paralysis, loss of consciousness, etc. (See Lecture XLIX.) Treated by pumping the udder full of air and giving hypodermic stimulants when necessary.

Stringhalt, or spring halt, is a peculiar affection usually of one or both hind legs, characterized by a sudden jerking of the limb upward. Treatment by a veterinary surgical operation cures in some cases.

Rabies (hydrophobia) is a serious disorder of the nervous system, usually produced by inoculation from the bite of an affected animal—usually a dog—the virus being in the saliva. This is characterized in the dog by unnatural affection at first, then by a tendency to run away from home, biting animals or people en route, then paralysis of the lower jaw and tongue, hoarse, unnatural bark, and death. Some cases are mild, quiet, and deceptive. Treatment of bitten person by prompt vaccination is a reasonably certain preventive. Animals that have been bitten should be killed or securely confined for a month or more.

Facial paralysis is usually due to paralysis of the 7th cranial nerve, and is indicated by a drawing of the lips toward the sound side.

Tetanus (lock jaw) affects various domestic animals and people. It is caused by inoculation with a bacillus common in garden earth, and is characterized by tense, persistent contraction of the voluntary muscles, including those of the jaws; by a spasmodic movement over the eyeball of a membrane often called the haw or third eyelid (properly the nectitating membrane). It is frequently fatal, but can usually be prevented by prompt injection of large doses of anti-tetanic serum soon after an injury, for example a nail puncture in the foot.

Over heat, often called sunstroke, is either an exhaustion of the temperature regulating nerve machinery or an overwhelming of the nervous system by an excessive accumulation of heat within the body. It is most apt to affect the animal that is out of condition for heat and exercise, or the horse that has been

overheated before or one that is already slightly ailing when going to work. Over heat is characterized by lagging in harness, undue panting, and sudden check of perspiration, very high fever, livid mucous membranes, rapid, weak pulse, and difficult respiration.

Stop work at the first warning; get the horse to shade, sprinkle cold water over the body, especially back and head, or apply ice pack to head and cold water over the body until his temperature reaches about 104 degrees; then stop. Give stimulants, *e.g.*, aromatic ammonia if the horse can swallow easily; or a hypodermic injection of 40-60 grains camphor dissolved in olive oil 1-4. Call veterinarian promptly.

Forage poisoning has apparently been identified with "food poisoning" (botulism) in people. The symptoms differ with the severity of attack and in different classes of animals; it is most common in horses and is very often associated with mouldy feed, this being, perhaps, a secondary factor. The specific cause appears to be *Bacillus botulinus*. This disorder is characterized by plain disturbances of the nervous system, which involve especially sensory nerves and motor nerves to the muscles of head, neck, and limbs. There is often a peculiar, sweetish odor in the breath, and an inability to swallow normally. The animal is dull or excited, and stands in a peculiar attitude or moves imperfectly. Coma (stupor) or sometimes violent struggling is common in later stages. Mortality is high.

Change feed, and physic. At present there is an encouraging prospect for an antiserum.

LECTURE IX

CIRCULATION

Blood.—This is a complex fluid consisting of serum, fibrin factors, and two kinds of corpuscles—the red and the white.

Serum is the watery, straw-colored, fluid portion of the blood less the fibrin (clot) factors. It contains various nutrient and waste materials, including oxygen and carbon dioxide gases, mineral matters and many inorganic compounds.

The fibrin factors are fibrinogen and an enzyme. When blood is exposed to the air or comes in contact with a foreign surface, the fibrinogen is changed by an enzyme (thrombin) and forms tiny threads of fibrin of which the clot is composed. Red corpuscles are entangled in the meshes, giving the red color.

Red corpuscles are tiny discs, resembling in shape silver dollars with the sides slightly concaved. Human corpuscles are about $1/3200$ of an inch in diameter. About six in a row could be placed across the end of a fine hair. They are born in the red marrow of the bones, and die principally in the blood stream and spleen. Apparently their chief function is to carry oxygen from the lungs to the tissue cells.

White corpuscles (leucocytes) are much fewer in number, and are of several kinds, most of them larger than the red corpuscles. They have the power of independent movement and may change their own shape. The ratio in the blood of the horse is about 1 white to 500 red. White cells have their birth in various tissues, like lymph gland, or adenoid tissue and bone marrow, and some probably in the blood stream. Leucocytes have several very important duties, such as destroying disease-producing bacteria and aiding in the formation of blood clot and the absorption and distribution of fat as a nutrient. The temperature of the blood in the various domestic animals ranges from 101 to 104° F. In the horse it varies from 100° to 101.5°; in the cow it is about 1 degree higher; in sheep it is from 100° to 104°. Its specific gravity is about 1060, and it constitutes about $1/15$ the body weight.

Summing up the functions of blood, we may say that it distributes nutrient materials and oxygen. It drains the tissues of their waste, poisonous and useless materials. It serves as a means of intimate connection between organs, *e.g.*, as by conveyance of internal secretions produced by one organ and needed as a necessary stimulant for the work of another organ.

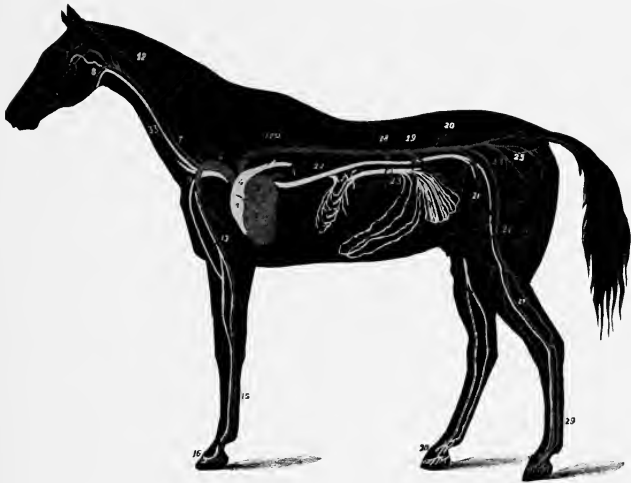

FIG. 23.—CIRCULATION. ARTERIES GRAY, VEINS WHITE.

1, Heart, right ventricle; 2, left ventricle; 3, left auricle; 4, pulmonary artery; 5, pulmonary veins; 6, anterior aorta; 7, carotid artery; 9, left maxillary artery; 13, humeral artery; 14, radial artery; 15, metacarpal artery; 16, digital artery; 17, posterior aorta; 18, coeliac trunk; 19, mesenteric trunk; 20, renal (kidney) artery; 22, posterior vena cava (vein); 23, portal vein; 24, external iliac artery; 25, internal iliac artery; 27, femoral artery; 28, posterior tibial artery; 29, metatarsal artery; 30, venous supply to the foot; 33, jugular vein.

It serves as a hot water heat circulating plant, carrying surplus heat from actively working organs like voluntary muscles and heart, where much heat is produced, and from internal organs where heat loss is low, to skin and extremities, where the heat loss is rapid.

Circulatory apparatus.—Heart, arteries, veins, capillaries, lymph spaces, lymphatic vessels, and lymph glands constitute the circulatory apparatus.

Heart.—The heart is enclosed by a serous sac, the pericardium, which supports it in place beneath the third, fourth and fifth dorsal vertebræ by attaching to the large blood vessels at its base, to the diaphragm behind, and to the sternum below. The horse's heart measures about 10.5 inches in length by 7.5 wide at the base, and is cone-shaped; the weight is variable but aver-

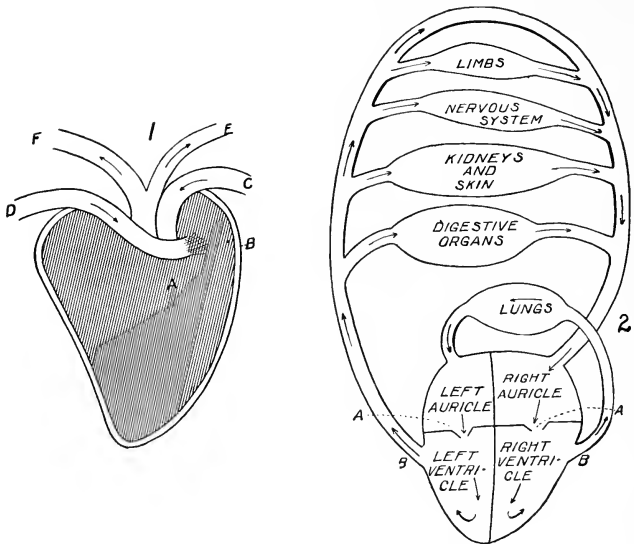

FIG. 24.—CIRCULATION. DIAGRAMMATIC.

1. Heart and Blood Vessels. *A*, Heart; *B*, pericardium; *C*, anterior vena cava; *D*, posterior vena cava; *E*, anterior aorta; *F*, posterior aorta.
2. The Circulation in Diagram. *A, A*, auricle-ventricle valves; *B, B*, semilunar valves.

ages about nine pounds. The heart contains four cavities which are easily seen when it is cut open. The two located at the base are called auricles; and the two at the apex, ventricles.

The auricles are much alike; as are also the ventricles, except that the left ventricle is larger and has a wall which is more than twice as thick as the right. The heart is covered by the pericardium and lined with the endocardium. Its muscle fibers are involuntary so far as control is concerned, but are striped.

The opening between the right auricle and the right ventricle is guarded by the right auriculo-ventricular (tricuspid) valve; the opening between the right ventricle and the pulmonary artery is guarded by the right semilunar valve.

The opening between the left ventricle and the left auricle is guarded by the left auriculo-ventricular (bicuspid) valve, and the opening to the aorta from the left ventricle is guarded by

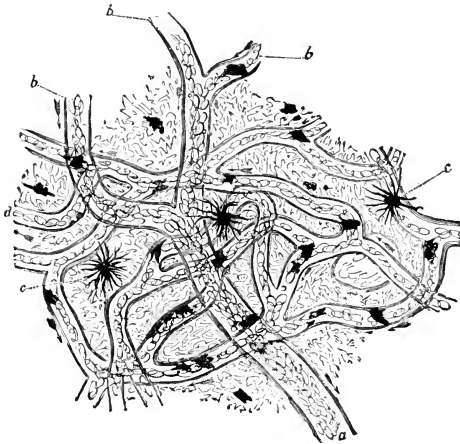

FIG. 25.—CAPILLARY CIRCULATION. (*Eddy.*)

In the web of a frog's foot ($\times 100$); *a*, *b*, small veins; *d*, capillaries in which the corpuscles are seen to follow one another in single series; *c*, pigment cells in the skin.

the left semilunar valve. Valves at these places are necessary to prevent the blood from moving backward instead of forward.

Course of the blood.—Entering the right auricle of the heart through two large veins, the anterior and posterior vena cava, and the coronary vein, the blood passes through this auricle into the right ventricle, thence to the lungs, through the pulmonary artery back to the left auricle, through four to eight pulmonary veins, past the valves on the left side, and finally to the left ventricle which sends it through the systemic circuit. The systemic blood leaves the left ventricle through a large artery, the aorta, which distributes blood through its branches to all parts of the body.

The *pulmonary circulation* is the flow of blood which occurs between the heart and the lungs.

The *systemic circulation* is that which occurs between the heart and all the rest of the body, except the lungs.

Arteries, veins and capillaries.—These are elastic tubes which distribute blood to the tissues and then collect and convey it back to the heart. *Arteries* have thicker and more elastic walls than veins; they remain open after death although empty; the stream flows in jets; the blood is lighter in color than that in the veins and flows from the heart and they have no valves. In all these points, the arterial system differs from the venous. Both arteries and veins consist of three coats: outer, fibrous; middle, muscular; inner, serous.

Capillaries are the small vessels which connect minute arteries with minute veins. They are generally about one twenty-fifth of an inch in length, and one twenty-five-hundredth of an inch in diameter.

BLOOD SUPPLY OF THE BODY

Arteries.—The *aorta* is the trunk artery which receives blood from the left ventricle for distribution through the systemic circuit to practically the entire body except the lungs; *i.e.* excepting the pulmonary circuit. It is about two inches long and branches into two large trunks, the anterior aorta and the posterior aorta. The *anterior aorta* supplies the head, neck, and front limbs; and the posterior supplies nearly all the rest of the body.

The anterior aorta is smaller and shorter (one inch long) than the posterior. Its course is upward and forward. It branches into the right and left *axillary* arteries. These lie near the trachea, one on each side, for a short distance, and then bend around the anterior borders of the first ribs and terminate at the inner part of each shoulder in the *humeral* arteries (right and left), which are the continuing branches of the axillary. Each humeral furnishes blood for the corresponding front limb.

The *common carotid* arteries, right and left, have their origin in a single vessel, the *cephalic* artery, which branches from the right axillary near the division of the anterior aorta into right and left axillary arteries. They supply structures in the neck and head.

A corpuscle, on its way from the heart to the brain, would

pass through the aorta, anterior aorta, right axillary, cephalic, and common carotid, and then through a branch of the carotid to the brain, each of these arteries being a branch of the preceding.

The *posterior aorta* curves upward and backward, through the diaphragm, then under the bodies of the dorsal and lumbar vertebræ to the lumbo-sacral articulation. This large artery supplies blood to the thoracic and abdominal organs and trunk, and then terminates in four branches named *iliaes*,—two external and two internal.

The two *external iliaes* correspond somewhat to the two axillaries in front and the two femoral arteries to the two humeral, for it is the femoral arteries which continue the external iliaes and distribute blood to the posterior limbs and feet.

The two *internal iliaes* are smaller and distribute blood to the pelvic organs.

Veins.—Veins collect and return the blood distributed by the arteries and usually accompany the arteries. One large vein commonly accompanies each large artery, and two small veins accompany each of the smaller arteries; but this course is not invariable.

The *anterior vena cava* corresponds to the anterior aorta and the *posterior vena cava* to the posterior aorta. Each returns the blood to the heart which its corresponding aorta has distributed.

All the veins except those of the bones, small veins in the feet, and the veins of the brain and spinal cord, have valves.

Valves are most common and numerous in the veins of the extremities and in those veins which pass through and between voluntary muscles.

Pulmonary veins, four to eight in number, have their origin in many small branches within the lungs. They return blood from lungs to heart in the pulmonary circuit, and carry pure blood.

The *anterior vena cava* has its origin between the two first ribs at the juncture of the two jugular and two axillary veins. Jugular vein corresponds to carotid artery, and axillary vein to axillary artery.

The *posterior vena cava* has its origin near the last lumbar vertebra at the union of the common iliac veins. It passes beneath and at one side of the bodies of the vertebræ, through liver and diaphragm, and discharges its blood into the right auricle of the heart.

LYMPHATIC SYSTEM

Parts.—The *lymphatic system* consists of vessels and glands.

Lymphatic vessels.—These have thin transparent walls and are found in most of the body tissues. They have valves like the veins and carry lymph, or, in the lacteals, chyle. The current in the lymph vessels is like that in the veins in that it flows toward the heart and is very sluggish. The lacteals are lymphatic vessels which drain the digestive canal, chiefly the small intestines.

There are two main vessels: the thoracic and right lymphatic.

The *thoracic* is situated near the vertebral column within the abdomen and thorax, on the right side, near the heads of the ribs and discharges its lymph into the anterior vena cava. Its opening in the vein is protected by a valve in order that blood may not get into the duct. This duct drains all the body except the right side of the face, head, and neck, the right shoulder, and the right front limb.

The *right lymphatic duct* is not always present in typical form. When present it is a very short vessel into which empty all the vessels that drain these latter regions. It discharges into the anterior vena cava with or near the thoracic duct.

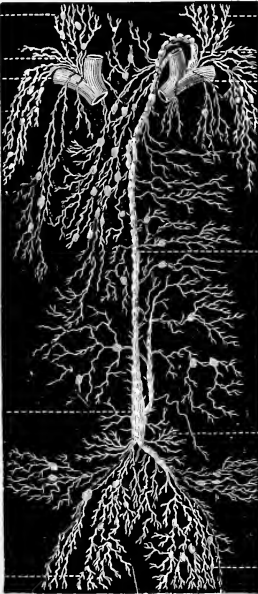

FIG. 26.—THE LYMPHATIC SYSTEM. HUMAN. (Eddy.)

a, Union of left jugular and subclavian veins, and point of union with the thoracic duct; *b*, thoracic duct; *c*, right jugular and subclavian veins, and point of union of right lymphatic system; *d*, receptacle for food absorbed from the intestine; the oval bodies are glands.

Lymph glands.—The lymph glands serve in part to remove from the lymph fluid disease germs and other harmful bodies. Their structure and function is something like that of a sponge filter.

Function.—The lymph fluid is essentially the blood minus the red blood corpuscles. The general fluid movement is from blood capillaries into lymph spaces, then lymph vessels, and, finally, back to the blood of the anterior vena cava. The lymph fluid distributes nourishment by osmosis directly to the body tissues, and removes waste materials by the same process. For example, in the lymph fluid held by the lymph spaces of the cows' udder and very close to the milk-gland cells, are the food materials from which the gland cells may manufacture the casein, fat, sugar, and other ingredients of milk. The nutritious materials are as a rule taken into the lymph from the blood, and waste materials which the lymph receives from the tissues are poured into the blood through the thoracic duct and the right lymphatic duct.

Practical application.—The student should see in the circulation something more than a collection of technical terms and abstract theories concerning the physics of circulation.

The blood serves, in a general way, as a wholesale distributor of needed materials to the tissues, and as a wholesale collector of waste and poisonous substance from the tissues. The lymph fluid is, in a general way, the retail distributor and collector; and the two, after all, constitute one circulation system, the lymph being the watery portion of the blood, plus white corpuscles. It comes into the tiny lymph spaces from the capillaries and returns to the large vein (anterior vena cava) through two large lymph vessels, the right lymphatic and the thoracic. The entire circulatory system has an intimate and important part in all disease processes, such as congestion, inflammation, tissue degeneration, and restoration after inflammation. An abundant circulation through the dairy cow's udder makes possible the production of a large quantity of milk. A disturbance in the circulation of a human brain causes a person to faint and fall.

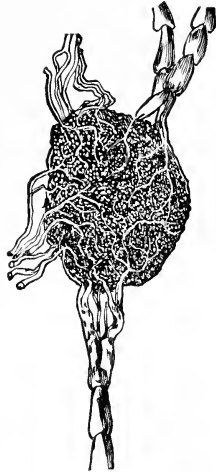

FIG. 27.—A LYMPH NODE.
(Eddy.)

Disorders of circulation and diseases of the organs of circulation are numerous and of great importance, but too complicated and difficult, as a rule, for the stockman to handle. The heart, blood vessels, lymph vessels, and lymph glands are often involved in disease. The heart may undergo a fatty degeneration, or it may dilate, or the valves become diseased and fail to close their openings. Arteries may become thin and weak, and dilate greatly (aneurism), or become inflamed, degenerate and become brittle, and then rupture (calcareous degeneration). Capillaries may be injured by toxic substances in the blood, then leak or rupture (tissue hemorrhage). Veins become inflamed or the venous wall may weaken and stretch, resulting in varicose veins.

Lymph vessels and glands may become infected by bacteria, then inflamed and swollen. The glands often suppurate, and are destroyed after infection by the bacteria of tuberculosis, glanders, etc. Ordinary "weed" or "elephant leg" (lymphangitis) is a good example of disease of lymph vessels and glands. This disease of horses is characterized by chill, then fever, and sudden swelling of one hind leg on the inside and high up. This swelling extends around the leg and down to the foot. After the inflammation subsides, the limb is left larger than normal. Both lymph vessels and lymph glands are involved and the disease is apt to recur, each time leaving the leg larger than before.

LECTURE X

RESPIRATION

Respiration is the process by which the tissues gain oxygen and give off impurities. This process is controlled by the respiratory center, a group of nerve cells located in the medulla, a portion of the brain. Fibers from these cells form part of the tenth cranial (vagus) nerve to the lungs and respiratory muscles. This respiratory nerve mechanism is stimulated by the presence of CO_2 in the blood, or by lack of oxygen; whereas, it is inhibited (restrained) by oxygen and thus the needed rate of respiration is maintained. Apparently, the plain simple purpose of respiration is twofold: (1) to get oxygen into the blood and various body tissues, and (2) to get carbonic gas (CO_2) and various other organic impurities out of the blood and body tissues. It is a common mistake to suppose that respiration is confined to the lungs. A very important portion of the true respiration occurs between the blood and individual tissue cells apart from the lungs.

Respiration includes oxidation and also elimination of waste products. This involves a double series of exchanges, one series occurring in the lungs and a reversed series occurring mainly in the tissue cells. All tissues and even the blood, when functioning, consume oxygen and form carbon dioxide.

Continuous oxidation processes in the body result in continuous production of carbonic acid gas, urea, water, and other waste products.

Stages.—There are four stages in the complete act of respiration: (*a*) air comes into the lungs; (*b*) blood takes out part of the oxygen; (*c*) tissues take part of the oxygen away from the blood and give back to the blood carbonic gas and other materials in exchange; and (*d*) the blood trades off its carbonic gas and other materials to the air for oxygen.

Oxygen is carried to the tissues by the blood, and waste products are washed away from the tissues by the same fluid.

The blood cannot unite with sufficient oxygen or eliminate its

waste materials unless it is brought in contact with air. It is in the lungs that the red blood cells and serum load up with oxygen, and it is here that carbon dioxide gas (CO_2) and other volatile impurities are eliminated from the blood. The water, CO_2 , and other volatile compounds in the blood capillaries, and oxygen in the inspired air, are separated in the lungs by a thin animal membrane. Nature is constantly endeavoring there to equalize pressures and satisfy chemical affinities between free gases on one side of this membrane and gases held by a liquid on the other side of this same membrane.

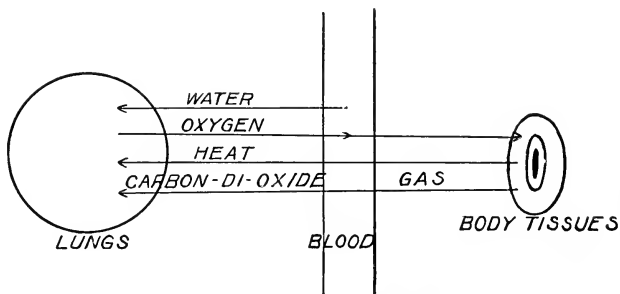

FIG. 28.—RESPIRATION IN DIAGRAM. (M. H. R.)

Aside from chemical combination, each gas moves either way according to the partial pressure of the gas on one side and the tension of the same gas in the liquid on the other side of this membrane. The tension of the oxygen in venous blood is much lower than oxygen pressure in lung air. The tension of CO_2 in the venous blood is much higher than its pressure in the lung air. These variations in pressures and tensions do not appear to account for all exchange. The living tissue cells appear to have a part and probably interfere with the perfect working of these forces and a portion of the CO_2 is carried as carbonate and bicarbonate of soda.

The factors that vary the proportion of oxygen consumed and CO_2 excreted are: body weight, amount of body surface, also rate and depth of respiration. We have the lowest rate of respiratory change in the body during fasting and highest rate on a nitrogenous diet.

The amount of oxygen absorbed and CO_2 developed increase

rapidly with increase of body temperature, as in fever, and also with physiological activity. Muscular activity greatly increases oxygen consumption. Physiologists tell us that even shivering multiplies the respiratory changes by two, and that external cold has a similar effect.

Parts.—The respiratory system consists of nasal chambers, pharynx, larynx, trachea, bronchi, and lungs. These organs are all lined with mucous membrane. This whole system is merely a device to bring a thin sheet of blood into close relation with a sheet of air which has the needed oxygen. In other words its function is to bring blood and air so near each other that the exchange may be rapid and the blood take away oxygen and leave waste matters.

Nostrils.—Two in number. These are openings at the front of the nasal cavities. The skin covering the nostrils is comparatively thin, quite sensitive, and supported by cartilages.

The inferior turbinated bones, two in number, and scroll shaped, are located on the outer wall of each nasal cavity. Apparently they are there for the purpose of warming cold air by their very rich blood supply and also provide a favorably shaped, moist surface to catch dust and bacteria, on their way to the lungs.

Nasal cavities.—Two in number, one on each side of a median partition. This partition is composed of the vomer, a portion of the ethmoid, and the median cartilage. Each cavity connects in front with the outside air through the nostril and behind with the pharynx through an opening which may be called the posterior nostril or, technically, the posterior nares. Each chamber also connects laterally with the sinuses of the head (shown in class). The floor, roof, and sides are formed by the various face bones, together with portions of the frontal, ethmoid, and sphenoid, and the median cartilage already mentioned. The mucous membrane lining the nasal chambers is divided for study into two portions: the upper, the olfactory, in which are distributed the terminations of the olfactory nerves, and the lower, the Schneiderian.

Pharynx.—This is a muscular sac situated beneath the cranium, and back of the soft palate which constitutes a partition between the pharynx and mouth cavities. This organ belongs to both the respiratory and digestive systems. Its walls are composed of two coats: the inner mucous and outer mus-

cular. It connects by openings with the nasal chambers above, with the mouth in front, and with the esophagus behind, with the lungs below, and on each side with the Eustachian tube to the middle ear.

Larynx.—A cartilaginous box located at the upper end of the trachea and composed of five pieces—one epiglottis, one thyroid, two arytenoids, one cricoid. Twelve muscles attach to these cartilages for the purpose of controlling them.

The *epiglottis* is a tongue-shaped piece of flexible cartilage which aids in preventing food from entering the larynx during the act of swallowing and then opens during respiration.

The *thyroid* cartilage (shield-like) is located at the upper and front portion of the larynx, extending well around on the sides.

The *arytenoids* are two in number, one on each side. The two taken together are shaped somewhat like the front part of a pitcher, situated at the sides of the upper part of the larynx, coming together at the median line. These cartilages give attachments to the vocal cords. One of these cartilages, usually the left, is paralyzed in the disease of horses which is known as roaring.

The *cricoid* is shaped like a ring with a process on the upper and front part which causes this cartilage to resemble a seal ring. It is located at the lower portion of the larynx and connected with the trachea.

The *vocal cords* are a pair of narrow fibrous bands so situated as to include a narrow triangular space between them. They are attached in front to the thyroid and behind to the arytenoids.

Trachea, or windpipe.—This is located beneath and in front of the esophagus. It is a long tube composed of about 50 cartilage rings and lined with mucous membranes. It begins at the cricoid cartilage above and terminates in the bronchi below. It therefore connects the larynx and bronchi. It is lined by a mucous membrane which is covered by ciliated cells.

Bronchi.—The bronchi are two in number, are branches of the trachea, and very similar to it in structure and function. One bronchus attaches to the root of each lung.

Each bronchus divides into smaller and smaller branches like the branches of a tree. At the end of each terminal branchiole there is a minute cavity, the air sac or alveolus, and making up the wall of this alveolus are a large number of microscopic air

cells. Microscopic blood vessels are placed everywhere between alveoli and in their walls. Thus, we have in effect a thin sheet of blood separated from a thin sheet of air by the thinnest possible layer of animal membrane.

Lungs.—There are two, right and left. These are the essential organs of respiration, and are located in the thoracic cavity. The pleura is a thin serous membrane one layer of which lines the chest cavity. Another layer encloses the lungs, each in a separate sack. Each lung is cone-shaped. In the lungs of a horse the lobes are not distinctly marked. Some authors make no definite divisions; others describe the right lung as having three lobes, and the left two.

In the cow's lungs the lobes are distinctly marked. The left lung has three distinct lobes. The right lung has four lobes by reason of the anterior lobe being divided into two parts: first and second.

The bronchi are subdivided until they are very small and are then called bronchioles. Each bronchiole terminates in a very small cavity made by a number of air cells opening together. These cells have very thin walls, and are separated by loose connective tissue in which minute blood vessels are located. Blood is then separated from the air by only a very thin membrane.

Practical application.—The agricultural student who takes "Dressing and Curing Meats" should make observations concerning the probable relations between external appearance of the chest and actual chest capacity. This question has frequently arisen in connection with discussions on bovine tuberculosis. Is the external appearance probably a reliable guide as to actual chest capacity? Why or why not?

Study a skeleton or chart and note the curvature of the ribs. Bear in mind that the ribs move forward and outward during inspiration. What relation, if any, between length of rib, degree of rib curvature and possible chest expansion? What type of nostril, nasal chamber, and larynx do you usually find with great lung capacity?

The working efficiency of every cell in the body, nerve, muscle, secretory gland cell (*e.g.*, milk gland), depends greatly upon its supply of oxygen and the removal of its waste.

Disorders of the respiratory organs are many and usually require professional treatment. The following are practical examples of respiratory disorders: *Catarrh* of respiratory mucous

membrane may affect any portion of it. This is expressed by irritation, inflammation, and discharge.

Bronchitis is an inflammation of the mucous membrane lining the bronchial tubes. This may be acute and severe or chronic and mild. Its characteristics are local irritation, chill, fever, cough and discharge, with increased pulse and hurried respiration, especially the cough.

Pneumonia is an inflammation of the lung substance, *i.e.*, air sacs or alveoli, air cells and other tissues of the lungs. Here we have chill, fever, great depression, respiration hurried and out of the usual ratio of about 1:4 with the pulse, increased pulse, dark mucous membranes and marked fever, especially the depression, greatly hurried respiration, and dark mucous membranes, *e.g.*, that of the eye.

Congestion of the lungs is merely an over filling of the blood vessels of the lungs to an extent that interferes with capacity and movement of air in the alveoli and air cells. The symptoms are those of suffocation, extremely short, hurried respiration and dark mucous membranes.

Pleurisy is an inflammation of the pleura and is local or general. Its chief expression is extreme pain on movement of the affected portion of the pleura as in breathing, coughing or any movement of the body that affects the inflamed pleura. Other symptoms noted by the veterinarian are *e.g.*, fever, fluid in the pleural (chest) cavity, friction sound, peculiar way of breathing, etc.

Tuberculosis often affects the lungs especially in cattle. This is characterized by enlarged, cheesy and gritty abscess pockets in the lung substance and glands of the thoracic cavity.

Roaring is a disease of the larynx. In this one of the arytenoid cartilages is paralyzed, falls in the way of the air current during inspiration and causes a noisy inspiration called roaring when the horse is exerted.

Heaves is another respiratory disorder, characterized by a harsh cough and difficult expiration. (See Lect. XLVII.)

LECTURE XI

DIGESTIVE APPARATUS

Definition.—The digestive apparatus consists of various organs which carry on the processes of food reception, digestion, and absorption. The digestive apparatus also expels various undigested and waste materials. The organs of digestion are the mouth, pharynx, esophagus, stomach, and intestines, together with certain other organs; viz., the salivary glands at the mouth, and the liver and pancreas in the abdominal cavity.

Mouth.—At the mouth we find the lips, teeth, tongue, and palate.

The horse has a freely movable and sensitive upper lip, which is used in selecting food. The cow has hard cartilaginous lips and selects her food mainly by the tongue.

The tongue is used by the cow to select and gather her food, and by all animals to control the food while in the mouth and assist in swallowing. This organ is composed largely of muscular tissue with some connective tissue, and is covered by the common mucous membrane. Its surface is studded with several kinds of papillæ, similar to those on the human tongue. These aid in controlling the food while in the mouth and have to do with the sense of taste. They are especially prominent and strong on the cow's tongue.

The hard palate forms the roof of the mouth, and consists of portions of the superior maxillary and palate bones covered by tough connective tissue, and overlaid with mucous membrane. This connective tissue and its covering of mucous membrane is thrown up into a series of transverse ridges, easily seen on the roof of a horse's mouth, sometimes called "bars."

The soft palate is a membranous structure containing some muscular tissue. Its function is to separate the posterior opening of the nose chamber and pharynx from the mouth.

The principal salivary glands on each side are: one parotid, one submaxillary, and one sublingual. They secrete saliva which helps to change insoluble and useless starch into a soluble and

useful sugar. It also assists in swallowing by so moistening the food that it passes easily along. This is especially important for animals, especially the ruminants, like the horse, cow, and sheep, that live upon a dry and more or less bulky food and require very large quantities of saliva.

The *parotid* is located behind the lower jaw and below the base of the ear. It is connected with the mouth by Steno's duct, through which its saliva flows to the mouth.

The *submaxillary* lies in the space between the flat portions of the inferior maxilla, external to the larynx. Its saliva reaches

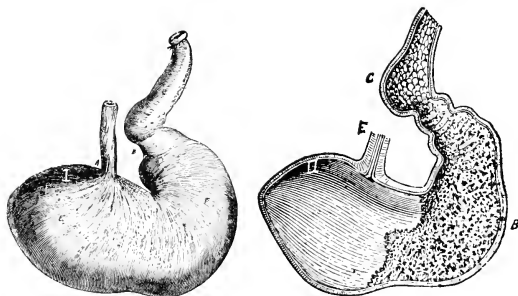

FIG. 29.—STOMACH OF THE HORSE.

1. External View. *A*, esophagus; *B*, pyloric portion; *C*, duodenum; *E*, *E*, left sac; *F*, right sac.
2. Internal View. *B*, right sac; *C*, duodenum; *E*, esophagus.

the mouth through Wharton's duct, which opens at the side of that portion of the tongue where it attaches underneath.

The *sublingual* lies beneath the tongue, and its saliva escapes into the mouth through fifteen or twenty small ducts, the ducts of Rivini. The work of each organ and each step in digestion depends to a great extent upon the normal condition and work of the preceding.

Pharynx.—The pharynx belongs to both the digestive and respiratory systems and was described in the lecture on respiration.

Esophagus.—The esophagus is a slender, elastic tube four to five feet long and one inch in diameter, connecting the pharynx and stomach. It is composed of two coats or layers. The inner is mucous membrane; the outer is muscular, and is composed of

two sets of muscle fibers, one set encircling the esophagus, the other placed lengthwise.

In cattle and sheep, the esophagus terminates at the opening between the first and second stomachs in the trough-like "esophageal groove." This groove is about six inches long and connects with the first, second and third stomachs. It controls the movement of food and water to the several stomachs. When food is first swallowed, it passes mainly into the cow's first stomach although some of it usually goes to the second. Liquids, includ-

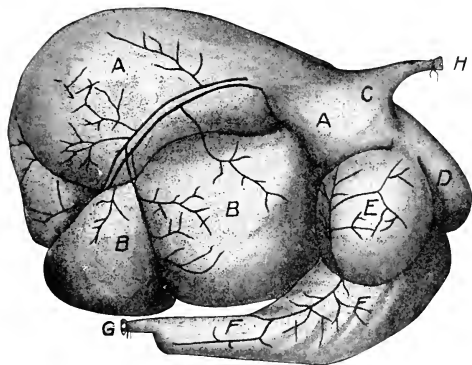

FIG. 30.—STOMACH OF THE COW.

A, A, and *B, B,* different portions of the paunch or rumen; *C,* termination of the esophagus; *D,* second stomach (reticulum); *E,* third stomach (omasum); *F, F,* fourth stomach (abomasum); *G,* small intestine, just beyond the pylorus; *H,* esophagus.

ing soluble foods, pass on to the second and third, the overflow even passing into the fourth.

Stomach.—The stomach is located in the anterior portion of the abdominal cavity. Its function is to receive food and furnish the gastric juice to aid in digestion.

The horse's stomach shows two distinct portions. The mucous membrane which lines the interior on the left side is light colored, firm, and tough, like the mucous membrane of the esophagus, of which it is a continuation. On the right side of the stomach the mucous membrane is soft and red. Thus the horse has a partially double or two-cavity stomach as compared with the four-cavity stomach of the cow and the sheep. The

horse's stomach holds about $3\frac{1}{2}$ gallons, and the cow's stomachs about 45 gallons. The cow's stomach is compound with four cavities.

The first cavity, the paunch or rumen, is much the largest, and acts as a sort of storage vat where a certain amount of fermentation occurs, probably as a process of digestion. It holds about 36 gallons and is partly divided into two sacs, right and left. Its lining mucous membrane is more or less covered with a coarse moss-like mass of papillæ.

The second cavity, the *reticulum* (tripe), is smaller than the first and connects freely with the rumen and with the third cavity. Its mucous lining is built into a coarse, heavy, honey-comb-like structure commonly called tripe. Its function is apparently storage, particularly of water, thereby aiding the rumen in its work of rumination by holding a needed reserve supply of water. Its capacity is about 2.5 gallons.

The third cavity, the *omasum* (manyplies), holds about 3 gallons and its interior is almost filled with a mass of flat, leaf-like folds of the mucous membrane. The surface of these folds is covered with small, hard papillæ, which are believed to complete the work of the teeth by further reducing the food particles. The thin cakes of food between the folds are normally rather dry.

The fourth stomach, *abomasum*, is the true stomach. Its lining is a soft, pink mucous membrane containing the gastric glands, which produce the gastric juice for the work of digestion. Anatomically, the first three cavities or stomachs are really bulges in the esophagus. The abomasum receives food and water from the omasum and discharges them into the first section of the small intestine. Its digestive fluid (gastric juice) is largely water, and contains pepsin, hydrochloric acid, and rennin ferment, and aids in digestion of proteid food materials.

Gastric juice is furnished by glands in the right side of the horse's stomach, and by the cow's fourth stomach. The effect of gastric juice is to make proteid matters soluble. It does this by the action of its pepsin ferment, which is very active.

Small intestine.—This begins at the stomach, the common opening being guarded by the pylorus, a strong sphincter muscle like a purse string. The small intestine is divided into three parts: duodenum, jejunum, and ileum. The small intestine is about 72 feet long in the horse and 140 feet long in the cow, and

extends from the stomach to the cecum, at which point the large intestine begins.

The stomach, and the small and large intestine have the same three coats: inner mucous, middle muscular, and outer serous.

The *mucous coat* in the small intestines is thickly studded with villi. Various intestinal glands furnish fluids which assist in digestion.

The *muscular coat* is composed of two sets of fibers; those of one set encircle the bowel, and those of the other set run lengthwise. This arrangement is for the purpose of producing peristaltic action of the intestines, *i.e.*, the writhing movements seen in dissection work or in butchering when the warm intestine is quickly removed and exposed to the air.

The *outer coat* is the peritoneum, a serous membrane which lines the abdominal cavity and also covers the various abdominal organs.

The liver is the largest gland in the body, weighing about 11 pounds, and is situated in the abdominal cavity on the right side and well forward against the diaphragm. It manufactures about 12 pounds of bile in 24 hours. The liver of the horse shows three fairly distinct lobes, namely, the left, right and middle. The liver is inclosed in a strong capsule called Glisson's capsule. The cow has a gall bladder but the horse has none, and from the horse's liver, bile flows more or less constantly into the intestine. Bile aids somewhat in digestion of fats; it has a slight cathartic effect; it aids absorption and tends to prevent putrefaction. The liver cells convert sugar received from the blood into animal starch (glycogen), and store it up as such, and finally they reconvert this glycogen into a soluble sugar and give it out to the blood in proportion as the blood loses its sugar. One of the most important functions of the liver is to remove or else make harmless, various poisons which originate in the body and are taken to the liver by the blood. Also the bile aids the pancreatic enzymes.

Pancreas.—The pancreas is much smaller than the liver, weighing only about 17 ounces, but is said to furnish about 11 pounds of pancreatic fluid daily. It is located in the abdominal cavity below the posterior aorta and behind the stomach and liver. The ends are called head and tail; it is long, triangular and much like a big salivary gland. Pancreatic fluid empties into the intestine at or near the bile duct. This fluid contains four

different ferments; one which acts on starch, a second on protein, another on fats, and one which curdles milk. Pancreatic juice is probably the most important of the digestive fluids.

Large intestine.—In the horse this is about 25 feet long, with a capacity of 33 gallons; in the cow, 42 feet long with a capacity of 18 gallons. Its parts include the cecum, large colon, small colon.

The *cecum* (blind pouch) of the horse is three and a half feet long with a capacity of $7\frac{1}{2}$ gallons. The cecum of the cow is much smaller, being about 30 inches long and 5 inches in diameter. Its inlet from the small intestine and the outlet to the large colon are at one end of the cecum; the other end forms a blind pouch.

The equine cecum appears to serve about the same function as the bovine rumen, *i.e.*, holding for maceration and fermentation, which facilitates the digestion of crude fiber.

The *large colon* of the horse is 12 feet long with a capacity of 20 gallons. Here is where most of the gas collects when a horse bloats in a case of flatulent colic.

The *small colon* in the horse is 10 feet long, capacity 6 gallons. In a cow the large and small colons are studied together, and are 35 feet long, with a capacity of 14 gallons.

The large intestine of both animals is long, large, and sacculated to hold contents a long time and offer a large amount of absorbing surface. It takes contents about five days to pass through the alimentary tract of the cow, and about three days to pass through that of the horse.

Practical application.—At this point the student may have a practical and interesting exercise by dissecting out the gullet, stomach and intestine, liver and pancreas of one or more domestic animals. Sheep and hogs are convenient to handle and very satisfactory if one or two animals can be used. This work may be taken up in connection with classes in "dressing and curing meats" or in the dissection room. The student should actually see and handle these organs if possible. He should endeavor to see the *mouth*, not in a vague way, but as a place where a horse may have diseased teeth and toothache, or have a very sore mouth, caused by the beards of wild barley, or squirrel tail grass; and as a place where young pigs may have canker sore mouths.

He should see the *esophagus* as a tube much like a piece of

rubber tubing, except that the esophagus is composed of muscular tissue lined with mucous membrane. He should also see it as a tube that is liable to choke on dry oats or a piece of potato. The *stomach* should be seen as a hollow organ that may become inflamed or filled with a mass of rapidly fermenting food in a case of bloat. The *intestine* should be seen as a long, soft tube, built up of the same three layers as the stomach, but very long, much folded, and delicate of structure and as an organ in which may occur an inflammation (enteritis) or an impaction of dry contents and stoppage. The whole intestine should be regarded as a very long tube lined with a sheet of mucous membrane for the production of digestive fluids and for the absorption of nutrients.

Diseases of the digestive organs are numerous. Many are preventable. Some of these diseases are easily recognized and, in the absence of veterinary help, may be fairly well treated by the stockman, *e.g.*, bloat in cattle and sheep and canker sore mouth in young pigs. See later chapters.

LECTURE XII

PHYSIOLOGY OF DIGESTION

Definition.—Digestion is a chemical and physical process by which food matters are made soluble and capable of absorption.

The digestive fluids are saliva, gastric juice, pancreatic juice, bile and intestinal juice. These are the active agents which bring about the changes necessary to render food matters soluble and absorbable.

Food groups.—These are of two general classes: organic and inorganic.

The organic group is divided into three subgroups: carbohydrates (sugars and starches); proteids (egg albumin, casein, gluten, etc.); and fats.

The inorganic group includes water, sodium, potassium, lime, sulphur, phosphorus, iron, etc. These form a very important part of the ration. Normal growth of young animals is impossible without the necessary mineral matters, especially phosphate of lime, which forms about four fifths of the total. In case of older animals a mineral-deficient diet results in a mineral drain from the tissues, for example in case of a cow giving milk or carrying a calf.

COURSE AND HISTORY OF FOOD GROUPS

Carbohydrates.—Starch cells are broken up by the teeth, and the starch is changed by the saliva¹ and pancreatic juice into soluble sugars. Physiologists differ somewhat as to details, but during the process of digestion at least two sugars,—dextrose (grape sugar), maltose and dextrine, an intermediate body between sugar and starch, are formed. After these chemical changes come absorption, storage in the liver, then distribution, and use. A large part of the products are taken into the portal

¹ Authorities differ. Some deny the power of herbivorous saliva to do this.

circulation and carried to the liver. Most of the portion carried to the liver is there changed back from sugar to a starch called glycogen and stored in the liver as such. As the blood loses its sugar, it is resupplied from the liver. Thus the liver becomes a storehouse for surplus sugar and at the same time serves to maintain a uniform percentage of sugar in the blood. Some of the sugar may be changed into fat. The fat and sugar are ultimately oxidized, liberating mechanical energy, heat, CO_2 , and water. The two latter are excreted by the skin, lungs and kidneys.

Proteids.—These are not affected by the saliva. But they are changed to soluble amino acids, intermediate products, and blood proteids by the gastric and pancreatic juices, and by the epithelial cells which line the intestine and through which absorption takes place. The digested proteids are then absorbed into the blood which goes to the liver, and are ultimately distributed to tissue cells to replace worn out parts or to build up new parts as in growing animals.

It has been held that proteid nutrients are especially necessary to repair tissues that have been worn out by mechanical work; but there is good reason to suppose that this has been overestimated in the past, and that carbohydrates have much to do with the ultimate source of physical power.

The proteid products are finally oxidized, and give heat and mechanical energy. They are excreted from the body as CO_2 , urea and water. The urea is excreted mainly by the kidneys, and the water by all the excretory organs.

Fats.—These are digested mainly by the pancreatic fluid. They are not acted on by either the saliva, or the gastric juice, and they are but slightly affected by the bile, although the latter is indirectly important in the digestion and absorption of fats. The pancreatic fluid emulsifies a portion which reaches the lacteals in this emulsified condition. The remainder is digested by separating the glycerin from the fatty acid (fat consists of a fatty acid plus glycerin). Glycerin is readily soluble and easily absorbed. The fatty acid unites with alkaline material from the bile and pancreas to form soluble soap, and thus the remainder of the fat is absorbed. Distribution is made by the blood current and finally, assimilation takes place, *i.e.*, building tissue cells, and then oxidation. Fat may either be deposited into and become a part of the cell bodies

or it may be deposited between the cells, where it becomes a stored reserve. Under some conditions such storing up of fatty matter may constitute a diseased condition, as when the heart muscle undergoes fatty degeneration. The final changes which fats undergo are oxidation, whereby heat and mechanical energy are given out, and then excretion as CO_2 and water.

Practical application and suggestions.—Mature animals need a constant supply of food to provide heat and energy for physical work and, in the case of fattening animals, to furnish storage fat. Young and growing animals must have food to supply heat and energy for physical work, and also for the building of new cells.

The more thorough the digestion and absorption, the better will be returns for food consumed, although large gains in weight or large milk production do not seem to depend so much on actual difference in ability to digest quantity as upon ability to assimilate and use for the special purpose.

Thorough digestion with imperfect absorption means wasted food, and useless work for the digestive organs.

Generous feeding is therefore not enough; there must be intelligent feeding.

Best results are secured when feeding is regular and when the rations are well balanced and the bowels are in a condition midway between diarrhea and constipation.

Both digestion and absorption depend to a considerable extent upon the condition of the mucous membrane lining the digestive tube, through which absorption must take place. To get the best results from food, with the least risk to health, horses should receive most of their water before feeding.

Usually there is no profit in grinding grain for horses, unless they have poor teeth or eat too rapidly; and yet this may be economical when done on a large scale. This method is to cut and wet the hay or straw, then mix in the ground grain. This is a safe method and secures thorough digestion and absorption, and horses so fed are not stuffed with hay.

Only as much hay should be fed at one time as the horse will clean up at each feed with the grain. Feeders are usually surprised to find how well their horses do with greatly reduced hay ration and the same amount of grain. There is less danger from stomach and bowel troubles, and almost no danger from heaves.

Dry bran for horses that eat hurriedly is to be avoided as such horses are liable to choke on it.

The cow's stomach is quite different from that of the horse in its plan and size, and her intestinal canal is nearly twice as long. Her large paunch and other stomachs, as well as the long intestine, indicate that she can utilize a coarser diet than the horse, and that she can digest and absorb such foods more thoroughly. They also indicate that nature intends her to eat larger quantities at a time and at longer intervals than the horse, and that the same is true as to the amount of water she drinks.

Idle horses are frequently overfed. This is not only a waste of food but an actual injury to the horse, and creates a tendency to such diseases as azoturia, lymphangitis (elephant leg), and heaves.

Horses doing ordinary work need from 30 to 50 per cent more grain with the same roughage as compared with idle horses. Horses on winter pasture, cornfields, etc., need from one third to one fourth as much grain as when at moderate work. The horse that is off work should have exercise every day if possible. Exercise lessens very much the danger from many diseases.

LECTURE XIII

URINARY ORGANS

The urinary organs are the kidneys, ureters, bladder, and urethra.

Kidneys.—These two important organs are situated in the sublumbar regions and are supported in place by large blood vessels and connective tissue. They differ in shape, size, and location, the right kidney being larger, farther forward, and more nearly round than the left. Each is covered by a fibrous capsule from which

bundles of connective tissue branch to penetrate the organ and form a framework.

Internal structure. The kidneys have a rich blood supply from the renal arteries, which branch directly from the posterior aorta. One set of capillaries supplies the Malpighian

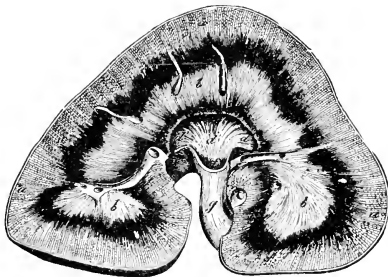

FIG. 31.—LENGTHWISE SECTION OF THE HORSE'S KIDNEY.

a, cortical portion; *b*, medullary portion; *d, d*, pelvis; *g*, ureter.

body, the other supplies the tubules. A kidney is essentially a mass of minute tubes held together by connective tissue, and supplied with a large quantity of blood. On cutting open a kidney we may see two distinct portions separated by a wavy line, and a cavity at the root. The two portions are the cortical (outside) and the medullary (center).

The cavity at the root, called the pelvis, is merely the funnel-shaped origin of the ureter.

Urine tubules make up a large part of the bulk of the kidney. Each tubule begins in the cortical portion, in a little sac like

cavity, the Malphigian body within which is a tangled network of finest arterioles, the glomerulus. The little sac narrows at the open end, and from this narrowed neck continue the tubule. Each tubule makes certain convolutions, descends to the medullary portion, and thence returns to the cortical, where it makes other convolutions; finally terminating in a larger duct through which the urine escapes to the pelvis of the kidney and then into the ureter. Each tubule is thus very long in proportion to its size, and there are a large number of them.

Function of the kidneys.—The kidneys have four functions: (*a*) to remove useless or waste and poisonous materials from the blood; (*b*) to remove excess of normal substances from the blood; (*c*) to keep the blood faintly alkaline by removing or adding alkaline materials as needed; (*d*) to maintain normal volume and concentration of the blood.

How accomplished.—The water and salts in solution are removed from the blood within the little sacs at the beginnings of the tubules. This probably is done by a process of filtration under pressure. The urea, albumin, etc., are discharged farther on into the water of the urine tubules. These are taken from the blood in a process of secretion by the epithelial cells which line the tubules.

Urine.—Urine is composed of water, salts of sodium, potas-

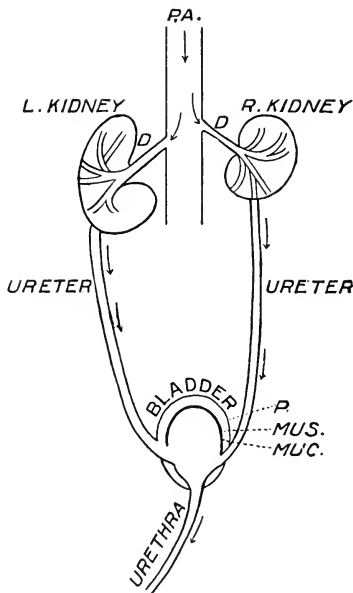

FIG. 32.—URINARY APPARATUS IN DIAGRAM.
(M. H. R.)

P, A, posterior aorta; *D, D,* renal arteries;
P, peritoneal coat of bladder; *Mus.,* muscular coat; *Muc.,* mucous coat.

sium, calcium, etc., together with various organic matters, as urea and uric acid, and various aromatic substances which give the odor. Its reaction in herbivorous animals is alkaline. The specific gravity for horse's urine is about 1036, and for cow 1025. Either may vary within the normal range. Horses excrete about 10 pints in 24 hours, and cattle about 25 pints. The urine is continuously excreted by the kidneys and runs, drop by drop into the bladder.

Ureters.—These are two slender tubes which conduct urine from the kidneys to the bladder. They are about the size of a goose quill, about one foot long, and they terminate at the bladder, where they extend for an inch, between its muscular and mucous coats, before reaching the interior, preventing backward flow of urine into the ureters.

Bladder.—The bladder is a muscular sac, a urine reservoir, ovoid in shape, located in the inferior and anterior part of the pelvic cavity. This organ is supported in place by several ligaments, which attach to neighboring organs. It is in relation above, in the male, to the rectum; in the female, to the uterus and vagina and below to the floor of the pelvis. It is covered in front by peritoneum and is in relation to the coiled small intestine.

Openings.—There are three openings, all on the posterior portion of the organ: viz., one leading to the urethra, and two for the ureters. The neck of the bladder contains circular muscle fibers which act as a sphincter and control the outlet to the urethra.

Coats.—The bladder has three coats, mucous, muscular (of several layers), and serous (peritoneal). The latter covers only a portion of the bladder.

Urethra.—This canal conducts urine from bladder to exterior of body.

Practical application.—The kidneys should be seen by the student as a device for bringing a constantly renewed and thin sheet of blood as close as possible to a thin sheet of epithelial cells, lining a suitable device (urine tubules) for carrying off the product.

The ureters, bladder, and urethra should be seen as mechanical devices for disposing of the urine.

Disorders of the urinary organs are numerous, but not of common occurrence. *Diabetes* is indicated by excessive and fre-

quent urination, great thirst, loss of weight, lack of endurance and unthrift. Treatment depends largely on removal of the cause, often bad food or irritant medicine. *Suppression* of urine is usually the result of obstruction in bladder or urethra, disease of kidneys, paralysis of bladder and other such causes. It is a symptom rather than a disease. *Uremia* or poisoning by unexcreted products, is the disease which results from suppression of the urine, and is apt to be serious.

Azoturia (see Lecture XLIV) is not a disease of the urinary organs, although very abnormal urine is a conspicuous symptom.

Nephritis is an inflammation of one or both kidneys due to irritant food or medicine, to injury from calculus (stone) infection, etc. It is indicated by condition of the urine—usually less than normal and rich in sediment—by peculiar attitude and movement—especially of the hind parts—and local dropsy of the belly, scrotum, legs, and other parts.

Cystitis is an inflammation of the bladder due to infection, injury, calculus or irritant medicines. It is indicated by persistent, mild, colicky pains, uneasy movements of hind feet, and frequent urination with persistent pain after each attempt. Urine is often discharged in jets instead of in a continuous stream. Remove the cause as soon as possible and call a veterinarian.

Calculus (stone) in the bladder occasionally forms as a deposit from the urine and causes trouble. Male cattle and sheep that have been overfed on roots are apt to form small calculi in the bladder or urethra. Small stones may escape from the bladder and obstruct the urethra. Horses are liable to have larger calculi in the bladder. The symptoms then are those of retention of urine and cystitis. Examination by rectum confirms the diagnosis. Removal may be made by veterinary operation.

LECTURE XIV

MAMMARY GLANDS

The cow's udder is taken as a type of mammary gland. It is located under the inguinal region and supported by skin, loose connective tissue, and bands of white fibrous tissue which attach to the fibrous tunic of the abdomen and act as ligaments to help support the organ. The udder is covered by thin soft skin and fine hair.

Anatomy.—The udder is divided into two lateral halves, each of which has two glands, the front and the back. Each half is incased in a fibrous sac of yellow elastic tissue, thus the two lateral halves are well separated by the double, connective tissue membrane. The two quarters in each half are not so separated.



FIG. 33.—ONE QUARTER AND
TEAT OF COW'S UDDER.
(O. K. C.)

C, milk cistern. Note constriction at end of teat. Holes, shown in the gland above, are milk ducts cut across.

The substance of each gland is made up of yellow glandular tissue, connective tissue, nerves, blood vessels, etc. Each gland is divided into lobes, which are subdivided into lobules. Each quarter of a cow's udder is merely a compound gland, with its connective tissue framework,

nerves, blood and lymph vessels, etc. The gland tissue proper consists of a mass of branching tubes. The terminal branches end in little sac-like cavities called alveoli. These and the milk ducts (tubes) are lined with epithelial cells like all other similar structures. These lining cells are the factories in which the casein, sugar, fat, etc., are produced, from materials brought to them by the blood and lymph.

There is one milk duct for each lobule. These small ducts unite to form larger and larger ducts, and thus the milk is conveyed into the milk cistern which is located at the base of each

teat. Milk escapes from the cistern through a single large canal.

The milk duct is closed and controlled at the end of the teat by a circular involuntary muscle and is therefore not under voluntary control. The milk ducts draining each lobe are surrounded by circular voluntary muscle fibers and are therefore under voluntary control. By these she is able to "hold up" her milk.

The gland structure is undeveloped and rudimentary until maturity is reached, and does not become active until the close of the first pregnancy.

The growth of the mammary gland is apparently stimulated by and dependent upon some substance given to the blood by the body of the fetus or the "yellow body" of the ovary. This same substance appears to check milk secretion. Removal of the body of the fetus by birth, or absorption of the yellow body after birth, permits the glands to produce milk.

Blood supply.—The mammary glands receive their supply through the mammary artery, which distributes branches through the two glands in each half of the udder, one mammary artery on each side. This artery divides and branches until the finest arterioles terminate in capillaries distributing blood to every portion of the udder. The nutrition for one half of the udder thus comes through the external iliac artery, then through the prepubic, a branch of the external iliac, then through a branch of the prepubic, the external pudic. The *mammary artery* is one of the terminal branches of the external pudic. From this the distribution is through arterioles, capillaries, and lymph spaces to the cells.

The large vein which may be felt in front of the udder on each side, and called by dairymen the "milk vein," is properly the subcutaneous abdominal vein. Three veins, the external pudic, the perineal vein, and the abdominal subcutaneous vein, drain each lateral half of the udder.

Nerve supply.—The mammary glands have their nerve supply through the first lumbar pair of spinal nerves.

Products.—Colostrum is the fluid which accumulates in the udder during the latter part of pregnancy. It differs from milk

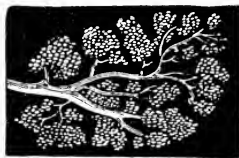

FIG. 34.—ALVEOLI AND OUTLET DUCTS. MAGNIFIED.

in that it contains the colostrum cells, a few oil globules, much albumin, and but little casein, fat or sugar. It has a mild, cathartic effect on the young animals.

Milk is a complex alkaline fluid with a specific gravity of 1018 to 1040. It is composed of oil globules suspended in milk plasma, and is therefore an emulsion. Milk globules consist almost entirely of fat. They are from .0004 to .0012 of an inch in diameter. The plasma consists of water, with casein, sugar, salt, albumin, and whatever else may be in solution in the water.

Milk production.—The production of the casein, sugar, fat, etc., is a manufacturing process, not mere filtration; for there is no casein or milk sugar in the blood, and but very little fat. Secreting cells take certain elements from the blood and lymph and put them together to make the milk ingredients.

The formation of milk consists of two processes; one of these is gland secretion, *e.g.*, of the casein and milk sugar, by the lining epithelial cells. In the other process, the fat or cream is formed as tiny droplets in the ends of these cells. The end of the cell may either cut off or rupture, freeing the fat droplet in the cavity of the alveolus. The cell is then repaired and forms the next droplet, of fat.

Practical application.—It is important to remember that the two lateral halves of the cow's udder are completely separated by a strong partition, but that the front and back quarters in each half are not so separated. This is important in connection with garget and other diseases of the udder.

Pressure of milk within the udder checks secretion; removal of this pressure stimulates or at least permits secretion; hence the importance of complete milking.

The quantity and quality of milk depends, first of all, upon hereditary peculiarities of the individual cow; after this it depends upon food and thoroughness of digestion and absorption. They depend, also, upon the length of time the cow has been milking, the length of time she has been carrying her calf, the condition of her nervous system, and, to a very great extent, upon the quantity and composition of blood passing through the udder.

The composition of blood for milk production depends upon the amount and character of food received, and upon the thoroughness of digestion and absorption from intestines into the blood.

The relative proportion of gland tissue and connective or framework tissue is presumably a matter of heredity, except as the udder is affected by injury or disease.

Ability to digest large amounts of food material, the tendency to dairy assimilation, the capacity for large flow of blood through the udder, the tendency to a large number of gland cells within the udder, and the tendency to relatively large proportion of gland tissue as compared with the connective tissue are all matters of heredity, fixed by a long line of intelligent breeding.

Mare's milk differs from cow's milk in possessing more water and sugar and less fat, casein, albumin, and mineral matter. Her udder differs from that of the cow in having but one gland in each half. There are from two to four cisterns at the base of the teat instead of one, and each cistern has an excretory canal to the point of the teat.

Here again we have the same general device which in effect puts a thin sheet of moving blood as close as possible to a thin sheet of epithelial cells supplying the latter with materials for manufacture and with this, suitable devices for holding and disposing of the product (in this case milk).

A cow's udder may consist largely of gland tissue, with just enough connective tissue to support it and hold shape; it may consist largely of connective tissue with a relatively smaller amount of gland tissue. What is the probable structure of the udder that remains large and hard after milking? What are some of the reasons why small udders may produce well and large udders produce poorly?

Note the large vein running from under the udder forward under the belly. This is the abdominal subcutaneous vein previously mentioned; it varies greatly in size and shape, and drains the inguinal region, including the udder. What possible relation is there between the size of this vein and the milk-producing capacity of the udder? Why is a very large vein and a large opening for it in the belly wall significant?

What effect has unusual nerve excitement on the production of milk? Explain this effect.

Disorders.—Disorders of the udder may be of great importance even though slight and local. *Garget* may refer to an unusual congestion or to a true inflammation (mammitis), involving the mucous membrane of the milk ducts, alveoli, and the connective tissue framework of the udder. *Injuries* to the

udder and teats are rather common, and become serious by reason of infection. *Obstructions* in the teat duct involve the mucous membrane and appear in the form of small tumors or local membranous obstruction or as a general thickening of this membrane.

Many of these cases can be cured by a veterinary operation. *Abscess*, due to infection, may destroy a considerable amount of gland substance and is treated by external drainage and surgical cleanliness. *Cowpox* affects the skin of udder and teats and resembles smallpox. It is usually spread by the milker's hands. Upon the udder where not broken and irritated by the milker's hands, there is first a sort of blister, the contents of which later change to yellowish pus, thin scab, and finally a pitted sear for each blister.

Suppression of milk may result from ill health, lack of nutrition, or general disease of the udder, and there appears to be a suppression of bacterial origin, apparently infectious.

See Udder Diseases and Accidents, Lecture LVI.

LECTURE XV

PATHOLOGY

Physiology is the study of the body organs and their functions in health.

Pathology is the study of diseased organs and their disordered functions. Healthy conditions are taken as a basis for studying the diseased conditions. Pathological processes are but healthy ones modified.

HYPEREMIA (CONGESTION)

Definition.—Hyperemia is an abnormal accumulation of blood in any part, due either to an increased inflow or a decreased outflow. The color of an hyperemic part may be distinctly red in active hyperemia or bluish in passive hyperemia.

A practical example is congestion of the lungs of a fat hog exercised on a hot day, or the first stage of founder in a horse's foot, or the congestion of a cow's udder after calving.

There are two kinds of hyperemia, active and passive. Generally speaking, both types are local conditions.

Active hyperemia is characterized by an excessive quantity of blood in the arteries of some tissue or organ. It is caused by disturbances of the arteriole nerve supply (vasomotors), *i.e.* any agencies that produce dilation of the arteries, as body temperature disturbances, chemical irritants, etc. It may be the result of lack of blood elsewhere in the body; *e.g.* sudden chilling of the skin of a horse frequently produces active hyperemia of the lung or other internal organs. Active hyperemia is usually temporary, and permanent injury may be slight or may not occur. As a rule a part so affected is red, warm and dry. An active hyperemia may lead, if long continued, to enlargement of the part or organ. The vessels themselves may enlarge to several times their former size.

Passive hyperemia, passive congestion (venous or mechanical), is a condition in which the current of venous blood is obstructed, outflow is decreased, and blood accumulates in veins

and capillaries. An organ so affected is apt to be bluish in color, spongy, moist and cool. This condition may be due to weakened heart action, or to obstruction in veins, and less frequently to obstruction in arteries or capillaries. Some of the local changes that may follow passive congestion are exudation of serum (dropsy), abnormal development of connective tissue, clots in the vessels, and local tissue death (necrosis).

ANEMIA

Definition.—Anemia is an abnormal condition characterized by a deficiency of total volume or a deficiency of corpuscles. Anemia due to deficiency may be either general or local. Disturbances of the nerve fibers (vasomotors) which control the involuntary muscle fibers of the blood vessels have the same relation to anemia as to hyperemia. By contracting or relaxing, the muscle fibers decrease or increase the size and therefore, the holding capacity of the blood vessels.

General anemia.—This refers to a state of ill health characterized by general lack in total volume of blood or to a lack in relative number of corpuscles. This may be caused by hemorrhage, poor nutrition, destruction of red cells, as by chemical poisons or by bacterial toxins, or disorder of blood-forming tissues. General anemia is seen in the horse disease known as swamp fever, where the mucous membranes become pale, or in a case of castration when the colt bleeds badly.

Local anemia.—Local anemia may be due to: decreased inflow or increased outflow; for example, pressure upon the part; contraction of arteries supplying this part; excessive blood elsewhere in the body; cold or chemical agents. In such cases the organ is pale, flabby and dry, and it does not bleed normally when cut.

Results.—Either anemia or passive congestion results in tissue starvation, deprivation of oxygen and accumulation of waste, and the seriousness depends upon extent, location and duration. An anemia may be very serious in vital organs or much less important in such organs as the skin and muscles. During anemia, nutritive changes are restricted and the processes of excretion are checked. Waste products therefore accumulate.

Complete and persistent anemia results in death of the tissue (necrosis).

INFLAMMATION

Definition.—Inflammation is the protective and curative response of any tissue to an injury. It is a complex pathological process consisting of disturbances of circulation, and constructive and destructive tissue changes. Pain, heat, redness, swelling and impairment of function are the symptoms of inflammation. These may be slight and not evident in mild and chronic inflammation.

The *changes* which occur in the blood vessels during inflammation as in pneumonia for example are: (1) dilation of small arteries, capillaries, and veins; (2) increased current velocity at first, then decreased; (3) obstruction of the blood current, due to the collecting of corpuscles in the capillaries and small veins, and the adherence of white corpuscles to their walls; (4) when the velocity of the blood begins to decrease, both kinds of corpuscles and the blood plasma may pass through the walls of small veins and capillaries, *i.e.*, exudation. Thus the bronchioles and air cells become filled in a case of pneumonia.

The changes in an inflamed tissue, the udder for instance, are variable. In the beginning of an inflammation, the causing agent produces cell degeneration, and in some instances cell death, whereas in the later stages of inflammation there may be cell multiplication and regeneration of tissue as in the healing of a wound.

Inflammation varies according to (*a*) resisting power of tissue, (*b*) activity of cause, (*c*) length of time the cause is in action.

Causes of inflammation.—Inflammation may be caused by mechanical injury, such as barb-wire cut; by chemical action as in careless burn of the skin by caustic potash, in dehorning young calves; by excessive tissue activity, *e.g.*, a badly over-worked kidney caused by an overdose of turpentine; injury by extremes of heat and cold, or by toxins from bacteria or from dead tissue. Inflammation thus caused has little tendency to spread beyond the part injured, and there is usually little or no pus unless germs invade the inflamed area.

“Microbes,” “microorganisms,” “bacteria,” and “germs” are synonymous terms as commonly used. These can cause inflammation without the aid of other local injury as for example, a suppurative (pus) inflammation of glands in the throat

of a colt that has distemper, or a nonsuppurative inflammation in the shoulder of a calf which has been affected by black leg. Such inflammation is more commonly caused by irritant chemical agents which the germs manufacture.

Terminations.—Inflammation may terminate in (a) resolution and regeneration, (b) degeneration and death of the tissue, or (c) new growths.

In case of *resolution*, the exudate is liquefied and removed by the lymphatics and veins, or it is carried out by leucocytes (white corpuscles). The blood current then starts again in the small vessels; the corpuscles move away in the reëstablished current, or else become degenerated and are removed; and, thus the organ or tissue becomes approximately normal again. There is usually some new tissue formation.

Local death.—If death of the part occurs, tissues may be dissolved and absorbed if small in amount, or the part may slough, *i.e.*, separate from healthy tissue as in case of a frozen ear. Inflammation may extend to and involve surrounding tissues, and thus the life of the animal may be ultimately destroyed, as in extensive gangrene of a cow's udder.

If new growths occur, there develop new tissues, *e.g.*, tumors, granulations in a wound, and scar tissue, as in case of large foot resulting from a wire cut in a horse.

FEVER

Definition.—Fever is an abnormal condition characterized by an excess of heat in the body. It is not a disease, but merely a symptom of disease. Fever is usually a defensive response to an attack, for example, an infection, which produces dangerous toxins, the higher temperature being unfavorable to the causative germs.

Cause.—Fever results from any disturbance that causes an increase of heat production or decrease of heat loss, usually the former. It should be distinguished from overheat, the former being an increased body temperature due to increased heat production within the body or to decreased heat loss. In overheat there is an excessively high body temperature not the result of disturbance of heat production or heat dissipation, but caused by absorption and accumulation of heat from without.

The normal temperature of horse is 100 to 101.5 degrees F.

One hundred and four degrees F. is called high, 106 degrees F. very high. Normal temperature of adult cattle varies from 100 to 102.5 degrees; of sheep from 100 to 104 degrees. The nervous system has control of body temperature through heat production and heat loss, increasing or decreasing production by tissue oxidation, and increasing or decreasing loss through control of the amount of blood sent to the surface of the body, more or less perspiration, etc. The body temperature, like the temperature of a room, is therefore a balance between heat production and heat loss.

Heat production.—The source of animal heat is the oxidation of body tissue and fuel materials in the blood and the consequent breaking up of complex chemical compounds into simpler ones. The principal heat-furnishing organs are the most active organs, *e.g.*, the muscles and secreting glands.

Heat expenditure.—Body heat is normally expended about as follows: warming food and drink, 2 per cent; warming air in lungs, 5 per cent; evaporation from lungs, 8 per cent; evaporation of moisture from the skin surface and radiation from skin, 85 per cent. The expenditure of heat in evaporation of moisture from the skin surface is very much larger than in either of the others. On an average there is sufficient heat developed daily in the body of a medium-sized horse to raise 4550 gallons of water 1.8 degrees F.

Symptoms of fever.—Chill and elevation of temperature; dry, hot skin; quickened pulse and respiration (normal pulse of horse, 36 to 45; normal respiration 8 to 14 per minute); scanty urine, and checked secretions in general, milk, perspiration, etc.; loss of flesh and constipation, are symptoms of fever.

Kinds of fever.—Classified according to course, the kinds of fever are: (*a*) *continuous*, with but slight variation in temperature, (*b*) *remittent*, the temperature varies greatly during the day, but does not descend to normal; (*c*) *intermittent*, the temperature varies at different portions of the day and reaches normal each day; and (*d*) *relapsing*, the fever recurs at intervals, with periods of one or more days of normal temperature between.

Results.—(*a*) Emaciation, or general atrophy, which is more or less severe, according to the duration and height of the fever, and is caused by continued unusual oxidation of body tissues during the fever; (*b*) death may occur; or (*c*) recovery may be

made. The recovery may be partial or complete, slow or rapid, depending on the nature of the disease of which the fever is a symptom or condition; the native vigor or vital constitution of the patient; and the conditions under which the patient is kept and under which the disease runs its course.

Practical application.—The student may now understand that *pain* accompanying inflammation may be a useful protection, and that it is due to a stretching of sensory nerve fibers, to pressure on these fibers, or to irritation by bacterial or tissue products. The *heat* is clearly due to increased tissue activity and, therefore, increased oxidation; the *redness* to hyperemia; the *swelling*, to engorgements and exudation of the blood; and the *impaired function* to interference with normal tissue activity by these several conditions.

It is important that the student understand what the possible terminations of an inflammation may be; and what the factors are which affect regeneration and resolution, as in a recovered garget; or degeneration and necrosis, as in abscess or gangrene of an inflamed udder; or which lead to new growth, as in a big foot following wire cut. Obviously, lack of nutrition, poor circulation, destructive medicines, etc., tend toward tissue degeneration and necrosis; whereas vitality, good food, tonics, and proper local treatment favor regeneration, resolution, and recovery. Irritating medicine on a wound of the foot where there is a natural tendency to over-regeneration can only make the matter worse.

It is important, also, to remember that hyperemia, inflammation, fever, etc., within reasonable limits, are protective and curative, but that beyond such limits they may be destructive. It should now be clear to the student why it is dangerous to work a horse that is suffering from fever, as in a mild distemper, because there is already abnormal oxidation, and work increases it. The excretory organs, too, are already overworked.

LECTURE XVI

PATHOLOGY—*Continued*

Hemorrhage.—Any escape of blood from its natural channels, whether into the tissues, or cavities, or upon the body surface, is termed “hemorrhage.”

Causes.—Hemorrhage is caused by injury to the vessel walls, as when cut or torn; diseases of the vessel walls, such as fatty or calcareous degeneration; bacterial toxins, injuring the capillaries; excessive blood pressure inside the vessel, as in hypertrophy of the heart with excessive strength and activity, resulting in rupture of the vessels; change in the quality of the blood, with weakness in the vessel walls, as in purpura, a common disease of horses.

Dropsy.—Any abnormal collection of serous fluid in any cavity or tissue of the body is designated as “dropsy.” This may occur in the abdominal cavity, in the chest cavity, ventricles or the brain, or the loose tissues under the skin. Of those places outside the large cavities, the most common are the limbs and lower portions of the abdomen, as the swelling under the belly of a mare heavy with foal and lacking exercise, or a swelling of sheath and belly in a case of recent castration with infection and lack of exercise. Dropsical fluid is usually of a pale straw color, nearly neutral in chemical reaction, and slightly heavier than water.

Cause of dropsy.—Any local increase of blood pressure; any interference with flow of blood in the veins; or obstruction in capillaries, which is quite common in diseases of the liver or kidneys will cause dropsy. Note the similarity of these causes to the causes of passive hyperemia. Dropsy may be either general or local.

General dropsy may be due to conditions associated with anemia, passive hyperemia, heart trouble, or kidney disease, and may affect the subcutaneous connective tissue over a large area, and any of the serous body cavities.

Local dropsy is limited to some one organ or cavity, and it

may be due to local, mechanical obstruction in the veins or lymphatic vessels, producing sluggish circulation, as in the "stocking" of the horse's hind leg.

Hypertrophy.—The term "hypertrophy" is applied to any enlargement of any part or organ of the body. It may be due to either an increase in the number of elements, or to an increase in the size of existing elements, or to a combination of these two conditions. Hypertrophy may be either physiological, healthy, or pathological, diseased. The cause may be: continued increase of nutrition in a mild active hypermia, or moderately increased use as in a muscle, or the presence of unknown factors probably internal secretions, such as an enlargement of the mammary gland in pregnancy.

Physiological hypertrophy is illustrated in the blacksmith's arm, where there is enlargement of muscles due to an increased exercise and, therefore, increased nutrition to the muscles. If one kidney be removed, the other enlarges to compensate.

Pathological hypertrophy is illustrated in "elephant leg" (lymphangitis) of horses, a condition in which the connective tissue of the skin and underlying parts increases in quantity, resulting in general enlargement of the leg.

In any hypertrophy the newly formed elements are more nearly like the normal when the circulation is most vigorous.

Atrophy.—This is the opposite of hypertrophy and is characterized by decrease in bulk and weight, as, for instance, sweeny of the shoulder muscles in horses. Atrophy may be general or local, and the decrease in size may be due either to decrease in size or number, or to decrease both in size and number of the elements.

The seriousness of this depends upon its extent and the part involved. Atrophy of a nerve trunk means paralysis of function. Atrophy of a shoulder may not be very serious, and the part may easily recover.

Local atrophy, e.g., contracted hoof, or shoulder sweeny, may be caused by: decrease in amount of blood and nutrition; a nerve disturbance, which sometimes results in very rapid atrophy; inflammation interfering with circulation and nutrition; insufficient activity or excessive activity and exhaustion of the tissue elements which are thus worn out faster than they are rebuilt; continuous pressure resulting in anemia and local starvation.

General atrophy may be caused by lack of nutrition or excessive consumption and wastage of the soft tissues, especially of the fats which are first taken; as in typhoid fever in the human body, or influenza in the horse. In this sense, general atrophy is synonymous with emaciation.

Degenerations and infiltrations.—These are characterized by changes in the quality of a tissue; the bulk may or may not remain the same. In general when tissue degenerates, a cheaper material is deposited in, and replaces tissue already diseased as a rule. When infiltration occurs, the lower grade tissue is deposited between and later into the tissue elements, which at the time are otherwise normal as a rule, *e.g.*, the fat old house dog or pet horse. The proper elements may subsequently shrink. In either case the affected organ loses in usefulness. The causes of these degenerative changes are numerous, but they are closely related, *e.g.*, abnormal use or disuse, *i.e.*, disturbance of function; heredity; disturbance of nutrition, excess or deficiency, usually the latter; or certain poisons. No sharp line can be drawn between infiltration and degeneration. Possibly they should be regarded as stages of the same process.

Fatty degeneration is characterized by the development of fatty matter in tissue cells, already diseased as a rule, and replacing the proper tissue elements. This is especially common in muscular and glandular tissue, *e.g.*, heart and liver.

Fatty infiltration is characterized by a deposit of fatty matter between the tissue elements and later in tissue cells.

Calcareous degeneration and infiltration are marked by deposit of lime salts generally in tissues already diseased, as tuberculous lymph glands, and may be caused by any agency that results in imperfect nutrition and lessened vitality. These conditions occur more frequently in the tissues of older people or animals. The muscular coat of the arteries sometimes becomes calcified and brittle in old people and may even break under unusual strain.

Cells normally cartilage often deposit calcium, forming bone as in the lateral cartilages of the horse's foot, causing lameness and the unsoundness known as side bone. There are various other degenerations and infiltrations besides these two named; but in each case there occurs the deposit of some inferior tissue into or between the proper elements of the organ.

Collapse.—The symptoms of collapse are: temperature below normal; surface of the body cold; respirations are very shallow and slow; and the pulse is feeble and very slow or very fast.

Collapse may be the result of: very high fever, poison, suppression of secretion or excretion, rupture of internal organs, excessive hemorrhage.

Syncope.—This term signifies a suspension of heart action. It is more sudden; the symptoms are more brief than in collapse, and it is usually due to obstruction in the nutrient arteries to the heart.

Death.—This condition may be general or only local. When general, there is a permanent arrest of all functions. Death may begin in the heart, lungs, or brain. Heart failure (syncope) is very sudden. Lung failure results in suffocation or asphyxia. Brain failures develop slow symptoms, stupor being present. When death occurs because the blood is altered, the heart is the first organ to cease action.

Necrosis or local tissue death is seen in ulcers, frozen parts, abscess, etc. It is caused by local disturbance of nutrition, starvation; or by disturbance of circulation, as in anemia, passive hyperemia or inflammation. It may be caused by bacterial toxins, caustic medicine, an injury or a bruise.

Practical application and suggestion.—It is evident that the student can have no intelligent conception of any disease until he knows something of such pathological processes as inflammation, dropsy, degeneration, etc., which, together, constitute the disease. With this in mind, diseases like sidebone, sweeny, and abscess become clear.

Many disorders may be averted when one can foresee and change an unfavorable condition to a favorable one. To illustrate, a heavy horse whose foot is too high on the inside puts excess weight against the outer lateral cartilage, causing irritation, inflammation, and side bone. Leveling the foot will prevent the occurrence of this trouble.

An inflammation may be caused by excess functional activity, for example, overwork as when a horse gets a nail puncture in the right foot, causing him to overwork the left foot, so that founder, which is an inflammation of the sensitive laminae, results. The possibility of this condition should be anticipated, and prevented by inducing the horse to lie down, or by supplying him with soft bedding like sawdust, or by the use of slings.

Hemorrhage may vary from an almost invisible dot to a serious loss of blood. It may occur in practically any tissue, under any membrane, and in any cavity; or it may occur upon the body surface. A tiny pin-point hemorrhage may be very significant on the kidney in case of hog cholera, for example. About one-fifteenth of the animal's weight is blood; and one-half of this may be lost without necessary death.

Dropsy results when there is a disturbance of the normal balance between the movement of serum from the capillaries into the lymph spaces, and from these spaces into the lymph vessels, so that serum accumulates in lymph spaces. An example of this condition is the "stocking" of the horse which stands in the stable. "Stocking" disappears with exercise and normal circulation.

The seriousness of atrophy depends upon its extent and location. Atrophy is frequently due to trouble elsewhere, which, if not understood, leads to treatment at the wrong point. For example, a horse steps on a nail, goes lame, and has aweeney at the shoulder. The first place for treatment is in the foot.

Degenerations usually affect tissues which are already diseased. Serious or even fatal degeneration is prevented by anticipating and preventing the original trouble.

LECTURE XVII

WOUNDS

A wound is a sudden break in the continuity of a tissue, caused by external violence.

Healing.—All wounds heal by the production of new cells and new intercellular substance formed from preëxisting tissue cells. The embryonic cells change later into mature cells like those of the adjacent tissue. Complete union implies a restoration of circulation and nutrition. This again implies new blood vessels for the new tissue.

Union by primary intention.—The essential features of this mode are rapid union and the absence of germs and pus. All wounds which heal without suppuration heal in this way. There is always some new tissue formed, although it may not be visible.

By granulation.—This is observed in the healing of open wounds and consists of the formation of new tissue by the multiplication of preëxisting cells. This new tissue fills the space between the wound margins and replaces the tissue that was destroyed.

Newly formed tissue in open wounds is composed of capillaries, embryonic connective tissue cells, and leucocytes. If the wound is free from harmful bacteria and the surfaces are kept at rest and close together, healing is very rapid and but little new tissue is needed. Where there is loss of much tissue, however, it may be impossible to bring the surfaces together and a great deal of new tissue is needed. Connective tissue cells develop from preëxisting connective tissue cells, and epithelial from epithelial, bone from bone, etc.

When wounds are covered with granulations, each little elevation contains a loop or network of new blood vessels. The white blood corpuscles emigrate through the new blood vessels and form part of the pus, when pus is present. Healthy granulations are small, firm, pink in color, and the surface is slightly moistened with a colorless fluid. In this case the wound heals rapidly and usually leaves a small scar.

Proud flesh is merely a mass of profuse granulations, and indicates either a lack of vitality or else external irritation. The latter is usually caused by germs.

Development of new blood vessels.—New blood vessels develop from vessels that previously existed in the injured tissue. The growth of new blood vessels and new tissue for union start together and continue until enough granulation tissue has been developed to fill the wound gap. The new vessels start by budding from capillaries near the surface, and are always short. These buds project farther and farther and gradually change into threads, which gradually hollow into tubes, beginning at the end near the old capillary. It happens frequently that the ends of two neighboring projections meet and unite to form an arch. As this becomes hollowed out, a capillary loop is formed. When the development is complete, then new blood vessels may start from this one and perhaps develop another arch. The thread-like projections are probably hollowed out by the blood current in the parent vessel.

Granulation tissue in the beginning is more vascular than normal tissue, in fact, largely a tuft of capillaries. Useless vessels are constricted and finally obliterated.

Inflammation in wounds is due to foreign material; for instance, dead tissue or foreign bodies, but more commonly to germs which, by multiplication, give rise to wound infection and inflammation.

Osseous tissue.—Wounds in bone tissue heal in the same way as those in other tissues, the wound surface being covered with granulations. The development of new tissue is from the periosteum and from the marrow at the place of injury. At the end of a few weeks, the ends are united by a spongy mass beneath the periosteum and in the medullary canal. This mass, called a callus, gradually becomes organized, and later, is partly removed.

Cartilage.—On account of low nutrition cartilage has very little power of repair. Loss of cartilage is generally repaired by fibrous connective tissue.

Nerve tissue.—After a nerve is cut, the severed portion degenerates. New axis cylinders come down from the stump and grow through or along old sheaths of the severed portion. It is doubtful whether primary union ever takes place. Quick return of sensibility does not necessarily imply restoration of

the injured fibers. The newly grown axis cylinders receive sheaths which probably grow from nerve cells lying within the old sheaths. Whether the new fibers ever reach the old terminals depends upon the amount of intervening tissue and the density of it. The limit of growth is placed at from one to two inches.

The new tissue.—In certain tissues, extensive injuries may be repaired by tissue which closely resembles the original. This is true of connective tissue, skin, tendons, and bones. Muscular tissue seems to have much less ability to repair extensive injuries and repairs partly by connective tissue in place of the original muscle. Scar tissue contracts for a long time after healing is complete. The scar is large when there has been more granulation tissue than necessary, as in foot wounds, or where an extensive removal of tissue necessitates a great amount of scar tissue. Scar tissue in this case is endowed with low vitality, and is poorly nourished.

How skin recovers a surface.—A wound is not entirely healed until it is recovered. This takes place by development of new epithelial cells from those of the skin. These new epithelial cells gradually form new skin which grows from the margin. It covers the granulations loosely at first, but later unites firmly with them. New epithelial cells have the power of ameboid movement. They may become detached from the margin and set up a new covering center elsewhere on the wound surface; in fact skin and other tissue cells may be kept alive a long time under suitable conditions for transplanting. Restoration of the skin surfaces, and for that matter the entire healing, is favored by rest and surgical cleanliness, and is hindered by infection and injurious bacterial products, poor nutrition, and irritating medicines, and the rubbing of sponges, etc., over the surface.

An exception should be noted; viz., that when healing has ceased in case of an old sore, with the surface not yet covered by skin, healing may sometimes be given a vigorous start by a blister.

Many of the preparations commonly used by stockmen do much more harm than good.

LECTURE XVIII

WOUNDS—Continued

The most common wounds which affect stock are those caused by barbed wires, plows, harrows, etc., and are generally large and badly torn. The farmer rarely has to deal with a clean wound that can unite smoothly and heal rapidly.

Bad treatment.—Nearly every farmer has some special dope which he thinks of great value in the treatment of wounds; however, most of these preparations are seriously injurious and greatly retard healing. Various preparations of turpentine, alcohol, vinegar, carbolic acid, strong coal tar dips, dirty cobwebs, irritating oils, and even the mineral acids are frequently used in the treatment of these wounds; and then, because the patient recovers in spite of barbarous treatment, people erroneously conclude that the medicine cured.

Bleeding.—This can usually be checked quite easily. If the blood comes from a large number of small vessels, the hemorrhage can be checked and finally stopped by means of ice, or very cold or very warm water; or the wound may be packed with clean cotton or oakum and tightly bandaged. In case a large blood vessel is severed, it may be better to draw the end out and tie a strong thread around it. The artery may be secured by



FIG 35.—BADLY TREATED WIRE WOUND. (M. H. R.)

means of small forceps or even with a hook made by bending a pin or piece of wire.

In some cases hemorrhage can be easily controlled by a tight bandage placed above or below the wound. If the blood flows in a steady stream, the bandage should be on the side farthest from the heart. If it flows in jets, the bandage should be tied between the wound and the heart.

Ergot and other medicines given internally constrict blood vessels and aid in checking hemorrhage. If a calf should bleed seriously after castration, the scrotum may be firmly packed with a strip of gauze or clean muslin and temporarily tied. If bleeding has been serious and the heart is weak, a stimulant like camphor dissolved in olive oil may be given by hypodermic syringe under the skin.

Sewing.—Comparatively few wounds are materially benefited by sewing or bandaging, except by professional hands. If the wound is made lengthwise of the muscle, there may be considerable advantage in holding the sides together by sewing. No special form of needle or thread is necessary except that both should be clean, and the latter should be of reasonable size. A darning needle and ordinary white cotton thread or twine will do in an emergency. But if the wound is made across the muscle and gapes widely, it is usually unwise to sew, for the sutures will cut out in a few days and make the sear much worse than if it had been left alone. An ordinary open wound is almost certain to be or become infected even after washing and disinfection; hence, an opening should usually be left at the bottom for drainage.

Bandaging.—Occasionally a wound is such that the edges can be held together by means of bandages. If this can be done, there may be considerable advantage in so doing, but these wounds are rare. Bandages must be changed frequently and the wound kept clean, otherwise much more harm than good results. Provision must be made for absorption or escape of pus.

Washing.—Few of these wounds are much benefited by washing or other "home" treatment. If a wound is such that pus can drain from it freely and as rapidly as formed, there is little to be gained by ordinary washing. If, on the contrary, there are deep recesses or pockets from which the pus cannot drain, then the wound must be so altered that these pockets will drain

or else they must be washed out; otherwise the pus may burrow deeper.

Carbolic acid and similar agents are commonly used so dilute, as to be without any effect except cleanliness. When used strong enough to be distinctly antiseptic, they become injurious to the wound surface. If any washing is necessary, then irrigate freely with warm water and salt, one teaspoon to each quart. This is efficient and not injurious. The wound surface must not be rubbed during the process of cleansing.

Dry treatment.—Sometimes quicker and better results can be obtained by the use of nonirritating and astringent antiseptic powder; for instance, the following: iodoform, boracic acid, and tannic acid, in equal parts. This may be dusted over the surface once daily to produce an artificial scab. If the wound is suppurating freely, it may be advisable to irrigate its surface freely for fifteen minutes with 3 per cent creolin, lysol, or carbolic acid in water before applying the powder. Use the powder freely. In some cases it is advisable to make a second application of the powder fifteen minutes after the first.

If the suppuration is checked and the surface scabs over, then use the powder only. If free suppuration begins again, repeat the antiseptic irrigation, and powder.

Maggots.—This trouble can usually be prevented in small wounds by smearing the following mixture around the border: turpentine 1 part, tar 3 parts, fish oil 2 parts; or, powdered naphthalin 1 oz., lanolin 7 oz. If a wound becomes infested with maggots, use chloroform. This may be applied either by spraying or by throwing it in small drops from a sponge.

Practical suggestions.—Wounds frequently heal more rapidly and perfectly in open air and sunlight than in the stable, because there is more ammonia in the air of the stable, and injurious germs are more abundant. Healing of some wounds is retarded by exercise, and such patients should be kept in the stable.

Rest from motion for the injured parts is generally favorable for wound healing.

In dressing a recent wound, all dirt and foreign material, and usually all clots of blood, should be carefully removed. This may be done with a mild antiseptic solution used warm; *e.g.*, 3 per cent carbolic acid or 3 per cent lysol, or the plain salt solution referred to above. Ordinary surgeon's absorbent cot-

ton will do very well, but there should be no unnecessary rubbing.

Healing wounds vary greatly in appearance. The wound that is called "healthy" or that is doing well has been described under "Healing by granulation." Wounds that are "unhealthy" or not doing well may be either pale, or dark with considerable heat, or show large, soft and dark granulations (proud flesh). When repair has apparently ceased and there is no progress toward healing, we say the wound is indolent.

The so-called proud flesh or bad granulation, if excessive, may be removed from "unhealthy" wounds by the knife or by cauterization. Inflamed wounds should be treated with repeated long-continued applications of the weak salt solution previously mentioned.

Punctured wounds, *e.g.*, nail punctures and caulk wounds of the feet, are especially dangerous on account of liability to tetanus (lock jaw) and to deep formation of pus with absorption of septic poisons. In some cases they should be opened freely and exposed to air, which greatly reduces the danger. The original cleansing and disinfection must be thorough and even radical. The ideal way is to make such a wound as nearly sterile as possible, and as soon as possible, and thereafter keep it surgically clean. (See Suggestions.)

War experience on a very large scale has shown the great value of chlorin preparations, especially hypochlorite of sodium as perfected in Dakin's solution, for lacerated and infected wounds. Various modifications of this for veterinary use are now on the market, and promise to be most useful.

Puncture wounds, like nail punctures in the sole of the foot, require special treatment and should be under veterinary care from the first when this is possible. When professional help cannot be had, then for the nail puncture, enlarge the wound in the sole and treat with full strength Lugol's solution of iodine or with tincture of iodine. Then pack the wound with cotton soaked in this solution. This treatment should be repeated two or three times the first day, and thereafter the wound should be kept clean and provision made for escape or absorption and removal of any discharge that may develop.

For caulk wounds the same principle applies. But in these it is often better to irrigate for half an hour three times the first day, with something not so destructive, *e.g.*, 2 per cent Lugol's

or even the normal solution of common salt, mentioned elsewhere in this chapter. A covering of sterile cotton and bandage should be used. Thereafter avoid infection. If reinfection and supuration should occur, then cleaning and disinfection must be repeated.

An ordinary fountain syringe or some similar device is very satisfactory for continued irrigation. The stockman at a distance from veterinary service may very well have on hand, clean, sharp and ready, a few instruments for emergencies, *e.g.*, two pairs snap artery forceps, cattle trocar and cannula, three and a half inch half curved needles, milking tubes, castrating knife and metal dose syringe for giving liquid medicines.

Failure to heal may be due to: age and condition of general nutrition; kind of tissue involved; impaired blood supply; to infection; poor treatment and especially unwise meddling.

Do not rub, wash, bandage, sew or meddle in any way except for good reason. Given a healthy animal and an ordinary wound that drains well, the stockman's chief duty is to protect from flies and dirt. The healing will then usually astonish the owner. Dirty bandages are harmful; fresh air and sunlight are very helpful.

As a matter of fact, medicines never heal a wound. The tissue cells do all the healing and the best that medicine can do is to give the cells a fair chance. The best medicine that can come into contact with a clean wound surface is probably clean serum from the tissues.

CAUSE AND PREVENTION

LECTURE XIX

CONTAGIUM

Any living virus, either plant or animal, which constitutes the specific and primary cause of disease, and which may be transmitted from one animal to another is called a contagium or an infection. An outbreak of animal disease may be *cnzoötic* (local), or *epizoötic* (widely spread).

Description.—In the lower forms of life, bacteria and protozoa, each individual consists of a single cell. The higher forms such as molds, are larger and more complicated. Bacteria molds, etc., are present in the atmosphere on particles of room dust, in drinking water, in the soil, and, in fact, almost everywhere in great abundance.

Size.—Bacteria (plants) and protozoa (animal) are extremely small, requiring the highest powers of the microscope to make them distinctly visible. It is estimated that millions may live comfortably in a single drop of fluid. Bacilli vary from about 1/25000 to 2/25000 of an inch in length. Approximately six red blood corpuscles in a row would fit across the cut end of a fine hair, and about six ordinary bacilli in a row would reach across one corpuscle.

Motion.—Some of these forms of life have the power of self-movement, while others have no true motility.

Nutrition.—Bacteria use for their food both organic and inorganic food materials of wide variety. Like higher beings, they vary in their likes and dislikes. What is wholesome for one may be very injurious to another. Each species has its certain conditions of moisture, temperature, and chemical reaction which are most favorable.

Reproduction.—These little beings reproduce by fission and by spore formation. If the fission is incomplete, they remain in chains. The spore is the hardy resistant form and corresponds imperfectly to seed formation of higher plants. It is estimated that one individual may increase to 1,176,570 in 10 hours.

Plagues in history.—Throughout all the pages of history, we have records of fearful plagues among men and animals. About fifteen hundred years before Christ a great plague of animals swept through Egypt and made a great slaughter of cattle. We are told concerning the plague at Athens, 430 B.C., that dead men, dead animals, and dead birds lay in piles on the streets, and even the temple floors were covered with bodies.

Plagues recurred at intervals through the history of the city of Rome. About 453 B.C. an outbreak, possibly anthrax, destroyed nearly one half the population of Rome, as well as their cattle, and the outbreak spread extensively through what is now Italy. Cattle plague was carried into England in 1745, with heavy loss. This outbreak lasted for several years in various parts of Europe, and the loss cannot be estimated. Within present memory have come several enormously expensive outbreaks of hog cholera and foot and mouth disease. Tuberculosis has long been prevalent. These are all infectious diseases caused by bacteria.

The above are but isolated examples of an indefinite number of outbreaks of various diseases which have appeared among domestic animals.

How scattered.—Germs of diseases are scattered by a very great many agencies; for instance, the germs of hog cholera are disseminated by means of sick animals, diseased carcasses, hog racks, and stock cars, and they may be easily transferred by the shoes or clothing of persons who walk through an infected yard. Dogs, and possibly birds, serve to scatter this disease over wide areas. Watering troughs, tanks, ponds, and sluggish streams are all common sources for spreading infectious diseases. Infections may be spread in any ordinary way that very fine particles of dust are carried.

Development of outbreaks.—It seems to be true of several diseases that the germs may be present with the animal or his surroundings but are not virulent enough to produce disease. Under favorable conditions, and perhaps after passing through the bodies of several susceptible animals in succession, they may increase sufficiently in virulence to produce disease.

Some of the germs producing diseases of domestic animals are believed to live for very long periods of time and even vegetate outside the animal body, possibly in the soil upon or within the tissues of plants. Some germs, especially in the re-

sisting or spore stage, may live for very long periods of time, even years, and under very unfavorable conditions retain virulence, as do the spores of anthrax and black-leg.

Some outbreaks of infectious diseases appear very suddenly, the most virulent and rapidly fatal cases appearing at the beginning. The outbreak then gradually loses virulence, the last cases being of a decidedly chronic nature. This is frequently illustrated in hog cholera. It is possible, however, that, before the virulent form was noticed, there may have been a series of very mild cases, the animals not being appreciably sick; but the germs, in passing through susceptible bodies, greatly increased in virulence until they were able to produce a rapidly fatal type of the disease.

Body entrance.—Germs gain entrance with the inspired air through the respiratory organs; through the digestive organs; and through cuts or scratches in the skin and mucous membranes; and, rarely, infection occurs before birth.

Method of injury.—Germs cause injury and disease in at least two different ways: *First*, by rapid multiplication and mechanical presence in inconceivable numbers, obstructing the capillaries. As an example of disease caused by germs in this way, at least partly by mechanical presence, we have anthrax and, *second*, more common and serious, germs may produce intensely poisonous substances called toxins, in the blood and body tissue. As an example of this we have tetanus and diphtheria.

One class of bacterial toxins are apparently liberated in the body fluid, as produced in tetanus (lockjaw). Another class of bacterial poisons are held in the bodies of bacteria producing them until the bacterial cell is destroyed, as in glanders. These poisons injure or kill in various ways just as do other chemical poisons, tetanus toxin, for instance, which causes excessive stimulation of muscle fibers. Others cause fatal depression of vital organs as in human diphtheria.

Often several species of bacteria coöperate in producing the original disease, as in hog cholera or the pus pockets of actinomycosis. There may occur a secondary invasion by a different species. The second invader may add to the seriousness and even change the features of the disease although it may be incapable of causing the original disease alone. This condition is common in tuberculosis and hog cholera.

Resistance.—The body resists bacterial invasion and injury in various ways. Fever which follows many infections gives a temperature which is unfavorable to the invading bacteria and which otherwise opposes the invasion. The white blood cells, aided by natural substances in the plasma, destroy bacteria. Gland secretions, such as gastric juice, are destructive. Various antagonistic substances are naturally present in the blood and are hurriedly increased when bacterial invasion occurs. In response to the toxin, the body produces antitoxin, as in tetanus or human diphtheria. Substances (bacteriolysins) are produced which dissolve and destroy the invading bacteria. In various ways, then, the body tries to check or destroy the bacteria and neutralize their poisons. These factors together constitute immunity, which is, of course, of all degrees of extent and duration.

Nature disposes of disease germs in a variety of ways, principally by oxidation, by the devitalizing effect of sunlight, by scattering them over wide areas and by enormously diluting them by wind and water.

Classification.—There are three general family types of bacteria:—

Cocccææ.—These are spherical. A great many of the most common diseases are caused by germs which belong to this general family; for instance, erysipelas and various types of blood poisoning, abscesses and sloughing.

Bacteriææ.—These are rod-shaped germs. Among the common diseases of live stock which are caused by germs belonging to this general family are tuberculosis, glanders, tetanus (lock-jaw), and hemorrhagic septicæmia.

Spirillææ.—The individuals are rod-shaped, curved, or spiral and may be short or long. The specific cause of Asiatic fever (human) belongs in this general group. Either type may show the isolated individual or groups adherent in chains.

Filterable virus.—We have also a little understood group of filterable and invisible viruses, *i.e.* viruses which are so small that they pass through laboratory filters and are invisible under

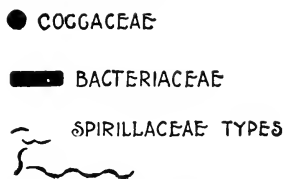

FIG. 36.—GENERAL GROUPS OF BACTERIA. DIAGRAMMATIC. (M. H. R.)

present day microscopes. Several important diseases like pleuropneumonia and hog cholera are caused by filterable viruses.

Protozoa.—Protozoa, minute one-cell animal microorganisms, are now recognized as the cause of such serious diseases as dourine, a venereal disease of horses, and syphilis and malaria of the human.

Practical suggestions.—The student should bear clearly in mind that bacteria or germs usually require very favorable conditions for existence, and especially, for retaining disease-producing power. Sunshine and ventilation, vigorous health, and high resisting power of an animal, are unfavorable to the presence and activity of any contagium. Any factor which increases animal resistance or decreases the virulence of an infection, is a protection against infectious disease.

Disease germs are actual substances, tiny particles of living matter, which may be carried about in any way that any very fine particles of heavy dust may be scattered.

The beginning of an outbreak may come in two ways: by recent introduction of germs, for example anthrax in northern states; or it may apparently be caused by increased virulence in germs already present, but not previously capable of producing disease. Such an increase of virulence may be due to surrounding conditions, which especially favor germ life, or to preliminary passage through an animal of very low resistance. This probably occurs in pneumonia.

Apparently the number of germs taken into the body makes a difference in the severity of some diseases—hence the necessity of sunshine to reduce virulence and destroy germs and of ventilation to carry as many germs as possible out of the stable.

Bearing in mind now what has been said of germs, it is easy to see how glanders, with infection left in feed boxes or water pails, may be spread from horse to horse; how hog cholera with its infection, especially in the manure or carcass, may be easily and rapidly spread; or how lumpy jaw may be spread by germs in the pus scattered from abscesses.

Infectious diseases do not “just happen” any more than mustard just happens in a wheat field. In both cases alike there must be definite planting of seed and favorable conditions for its growth. Spore formation on the part of certain bacilli, anthrax for example, is much more than a scientific phenomenon. A pasture which remains contaminated with anthrax

spores for many years means life or death to animals and people.

Susceptibility and immunity are only relative terms, and they vary within wide limits. They depend on many factors: the species of animals, age, exposure, fatigue, previous disease, heredity, etc. An animal naturally immune to a certain germ may contract infection when greatly fatigued.

Immunity may be natural or acquired. Natural immunity may be racial or individual; to illustrate, the human resists hog cholera, and the hog resists measles and smallpox. Individuals of the same species may differ widely in power of resistance. In an outbreak of cholera in previously unexposed herds, there are usually individuals that never miss a feed. Acquired immunity is *passive* where one animal receives its immunizing substances from another, as in serum—only treatment for hog cholera. It is *active* when an animal is exposed to living virus, either by natural or artificial process, and survives; thereafter providing its own immunizing substance. Passive immunity is temporary; active immunity is relatively permanent, as in the serum-virus treatment for hog cholera or reduced virulence, virus is used to vaccinate calves against blackleg.

LECTURE XX

DISINFECTION

Purpose.—In veterinary practice, disinfection is intended to check the spread of infectious diseases, and to protect animals already diseased from further infection, by killing the causative microorganisms or by rendering them avirulent.

Sources of infection.—In any process of disinfection it is important to know the nature of the infecting germ and the sources from which it comes. Germs of diseases are spread in many ways; for instance by the manure or body fluids of sick animals, by soiled water or food, or by any other contaminated matter. Air may be contaminated from the skin or lungs of diseased animals, for example by the coughing of a tuberculous cow. The soil may be contaminated by the burial of diseased animals or by the deposit of any infectious material upon the surface. In such case, germs may be washed to ponds, sluggish streams, or shallow wells, contaminating the water. Hides, offal, and even the hair of a diseased animal, may be the means of spreading disease, as in case of animals which have died of anthrax.

Diseases are often spread by “carriers,” for example, glanders of horses or tuberculosis of cattle, *i.e.*, by an animal which does not show the disease.

Thoroughness.—Disinfection is not reliable and should not be depended upon unless done most thoroughly. To illustrate, a stable must first be thoroughly cleaned of manure, litter and cobwebs. Scrubbing is often necessary before the disinfectant can be effectively applied. A small yard may be disinfected by burning straw on it, or by removing the earth to a depth of at least six inches and replacing it with fresh earth. Paved flooring may be disinfected by burning over it any inflammable material. Cracks should be disinfected by the free use of corrosive sublimate solution. Food which may have been contaminated should ordinarily be destroyed, but in some cases it may be given to nonsusceptible animals. Drinking places, currycombs,

brushes and all such articles should be disinfected. Dogs, rats, and any of the smaller animals which are liable to convey the disease should be guarded against.

A pail spray pump is satisfactory for the small job; whereas a barrel spray pump is more practical for a larger job. About fifteen feet of hose is usually needed with a piece of metal pipe several feet long at the nozzle end. It pays well to strain very carefully if lime or any sedimenting material is used.

Attendants.—Attendants on sick animals should be most careful about their clothing, particularly trousers and shoes. It is well to use special overalls and overshoes, and leave them in the infected stall or building.

Burning a carcass.—A cross-shaped trench about twelve inches deep in the center, and shallow toward the edges, about seven feet long each way, is dug in the ground. The earth is thrown in the angles, two bars of iron are placed across for a bridge and the fuel placed upon the bars. The trunk of the carcass is placed upon the fuel, another layer of fuel is added, then the internal organs and limbs, and finally another layer of fuel. The cross-shaped trench provides a draft—regardless of the direction of the wind. Cheap fuel oil may prove a great help, especially for cattle.

DISINFECTANTS

Carbolic acid.—Pure carbolic acid is usually seen in the form of light-colored crystals, sometimes slightly red. As sold in the drug stores, it is usually liquefied by the addition of 5 to 8 per cent of water. It is soluble in water up to about 6 per cent. It is objectionable because it is very poisonous, and is not reliable for some infections, hog cholera for instance. It does not destroy clothing or corrode metals as corrosive sublimate does however. The best antidote for internal poisoning or external burns by carbolic acid is probably alcohol, which may be given in large doses for this purpose. For general disinfection use carbolic acid as a 5 per cent solution.

Lysol.—Lysol has about the same qualifications as creolin and compound cresol and acts in a similar manner.

Compound cresol.—Compound cresol (Liq. Comp. Cresol), is a dark brown liquid, consisting of cresol and linseed oil soap, a standard formula, and can be prepared by any druggist. It

mixes well with soft water, and fairly well with ordinary water. This is used in 2 to 3 per cent solution or about 4 ounces per gallon. It is much cheaper and more efficient than carbolic acid and a thoroughly reliable and useful disinfectant.

Proprietary coal tar products.—There is a long list of coal tar products. They are similar to compound cresol, and are usually reliable when approved by the federal Bureau of Animal Industry and used in the approved strength.

Formalin.—Formalin is a very important disinfectant, either as a liquid or vapor. It is active and reliable, when properly used and does not injure paint or metals. It is in the market as a 40 per cent solution of formaldehyd gas. The odor is irritating and disagreeable, somewhat resembling chlorin. Formalin is apparently more active in the presence of moisture. For use in vapor form, at least 20 ounces per 1000 cubic feet should be introduced rapidly into a tight room.

Formalin may be vaporized very satisfactorily by combination with permanganate of potash in powder or fine crystals, in the proportion of 16 ounces of permanganate and 20 ounces formalin for each 1000 cubic feet of air when the inside temperature is 65 degrees F. or above. Use one fourth to one half more of the disinfectants for lower temperatures. A large flaring tin pail is used for each such mixture. *The permanganate should be put in first.*

The building must be made tight. Strips of wet newspaper do very well for cracks and small holes. Leave the building closed for at least six hours, with no inflammable material in the room close to the outfit. This method is applicable only to small tight buildings. At low temperatures, it is unreliable.

Heat.—Fire is the most reliable disinfectant, and the one that should invariably be used where an article is to be destroyed. Moist heat is more active and reliable than dry heat at the same temperature. Boiling for an hour is probably sufficient to destroy or render harmless any known disease producing germs.

Corrosive sublimate.—This is sold in the form of white crystals or powder. It dissolves in about 16 parts of water, and its solubility can be increased by muratic acid or iodide of potash. It is disinfectant in the proportion of 1 to 2000, about 3½ grains to a pint of water, and in even more dilute solution. A convenient solution can be made by dissolving it in alcohol, 1 to 8. A teaspoonful of this to a quart of water gives about 1 to 2000

solution. Corrosive sublimate is very cheap and reliable; but it is poisonous, it coagulates albumin, and corrodes and destroys metals. However it is a very practical disinfectant.

Sulphur.—Probably sulphur is not as efficient a disinfectant as it is generally supposed to be, although a large quantity of it seems to have decided germ destroying properties when it is used after the surfaces to be disinfected have been moistened by steam or otherwise, and when the doors and windows are kept tightly closed for a long period of time afterward. About 10 pounds per 1000 cubic feet of air is needed. It is easily burned if three or four ounces of alcohol are added. The mixture should be placed in an iron kettle and the kettle placed in a tub of boiling water, partly for safety and partly for moisture.

Sunshine.—Sunshine destroys germs. Long exposure to sunshine, where time permits, will render safe, infected clothing or any other article carrying an infection on its surface.

Lime.—Used in the form of fresh whitewash lime is very useful as a disinfectant for many places. It is improved in reliability by $\frac{1}{4}$ to $\frac{1}{2}$ pound fresh chlorid of lime to the gallon. For use by spray pump, it must be rather thin and well strained. Slake by adding 1 pint water to 2 pounds fresh stone lime.

Milk of lime is prepared by adding water to the slaked lime 4 to 1 by volume. Whitewash is merely thinned milk of lime.

LECTURE XXI

HEREDITY—AIR

Heredity is the great law of inheritance that "like tends to produce like." This tendency may apply to any peculiarity. Heredity may appear as a factor in the cause of disease when actual disease germs are transmitted, which is rare, or when a local weakness—an ill shaped hoof and sidebone, for example—or general susceptibility appears which is favorable to the development of disease—for example, a very low resistance to hog cholera. It should be borne in mind that susceptibility and immunity are but varying degrees of the same thing. Statistics are meager, but essential facts are very plain as to the relation of heredity to many diseases. Young pigs from an immune sow are frequently born with considerable immunity; but most of them gradually lose this inherited immunity as they grow older.

Theory.—The modern idea of heredity in relation to disease is that the thing actually inherited is usually only a tendency or a lessened resistance. This may refer to the white corpuscles and serum of the blood as well as to the muscle and tendon or bone cells. This theory of lessened resistance applies to such conditions as spavins, ringbones, sidebones, roaring, and internal diseases alike. Under favorable conditions the actual development of disease may not occur. A stallion with certain defects of the eyes is apt to sire colts with bad eyes. Mares with curby or spavined hocks are equally apt to raise colts with bad hocks. In rare cases the young is born with the actual disease present.

In-and-in breeding.—This tends in some cases toward decrease of physical vigor, infertility, tendency to abortion, and various other diseases, especially when long continued and with unwise mating.

AIR

Air is a very frequent source of disease. Its composition in a general way is: oxygen 1-5, nitrogen, 4-5; more accurately,

oxygen 20.97 per cent, nitrogen 79 per cent, and carbon dioxide gas (CO_2) .03 per cent.

Impurities in air are taken care of by nature through diffusion, oxidation, sunlight, and plant life activity. Common impurities in air are carbonic gas, ammonia, and bacteria of many different kinds; scales and debris of epithelium, hair, sputum, dried manure, dried pus, etc.

Relation to disease.—Diseases related to impure air are many and serious.

Horses' lungs have about 289 square feet of air-absorbing surface or five times the skin area. They may contain at one time 1.5 cubic feet of air. Horses at rest may give off 6.5 to 7.5 cubic feet of CO_2 every hour.

Air begins to get foul when oxygen is reduced to 20.6 per cent, or when CO_2 goes above .05 per cent; neither is necessarily harmful, however.

Carbon dioxide (CO_2) is not of itself poisonous in small quantities but it is significant because of impurities with which it may be associated. Common statements that CO_2 at 1 per cent is very poisonous or fatal are nonsense.¹ When present in very great excess, it supplants oxygen, causes paralysis of heart, and overwork, then failure of the lungs, and, finally, oxygen starvation.

Hydrogen sulphide may also be present in the air. A very small amount is said to be fatal to horses, causing diarrhea and extreme weakness.

Nitrogen is nearly negative in effect. It merely dilutes oxygen and CO_2 .

Ammonia in air must also be regarded as an impurity, so far as animal life is concerned, mainly because of the organic matters with which it associates, and because of its irritating effect upon the respiratory organs.

Practical application.—A very practical lesson and a very obvious one is breed from sound and vigorous stock. Farmers who patronize unsound and inferior sires simply because the cost of service is low are unwise. The Minnesota stallion law specifies infectious diseases, and also the following diseases, as bars for registration on the ground that they are transmissible either directly or indirectly by heredity; bone spavin, ringbone, sidebone, and curb when accompanied by curby hock.

¹See Minn. Exp. Sta. Bulletin 98.

Farmers should not patronize stallions affected with any of these conditions, nor should they be misled into purchasing such stallions. The present outlook is that such stallions will be barred from public service in a large number of states within a few years. It should be borne in mind that a fat animal is not necessarily sound or healthy. Domestic animals may be, and frequently are, in show condition, and yet badly diseased. A show bull may be rotten with tuberculosis; a handsome stallion may be very unsound. Tuberculous cows have broken milk records.

The spread of tuberculosis in a stable is a good illustration of transmission of disease due to bad air conditions. With an infectious case of tuberculosis already in the herd, tuberculosis spreads much more rapidly in unventilated stables than in well-ventilated stables. Bacteria tend to adhere to whatever they may fall upon and do not float in air, except as carried on dust or other particles. Hence, stable dust becomes an important factor in disseminating disease. But it should be remembered that bacteria differ widely in ability to withstand drying. Most of them do not long remain alive and virulent in contact with dry dust, or dry surfaces in a dry atmosphere.

Ventilation is very important and should be thorough. It accomplishes several purposes: it admits oxygen, dilutes, removes impurities, controls moisture and gives the required air movement. Good ventilation implies rapid change in air without direct draughts upon confined animals. Each mature cow or horse should have about 35 square feet of floor space and at least 500 cubic feet of air space, and the air should be renewed frequently.

Sunshine is even more important, for sunshine is nature's universal disinfectant, killing germs of disease. Windows and stable frontage should permit of a sweep of sunlight over the largest possible surface of floors and fixtures.

LECTURE XXII

VENTILATION

Purposes.—There are several purposes in ventilation; viz., getting fresh air with its oxygen into a stable, getting impurities of various kinds out of the stable, regulating temperature, and controlling moisture.

Impurities.—The common impurities of air are: disease germs and their products, dust, carbon dioxide and other gases. Excess heat and moisture in a stable, while not impurities, are very objectionable.

Stable air.—One good authority (F. Smith) reports analyses of air for European stables. These are, of course, variable, but

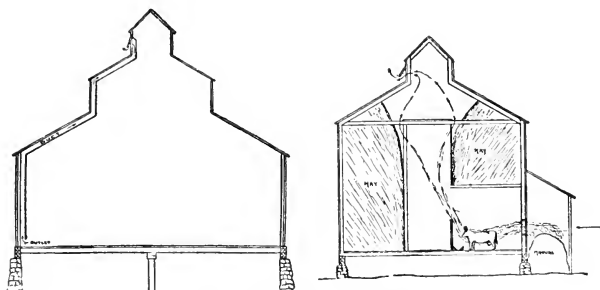

FIG. 37.—VENTILATION. (*Paige.*)

Outlet with too many angles.

Cow receiving inlet air from over a manure pile.

Smith's figures give a good general statement. The average of 28 analyses gave .14 per cent carbonic gas (CO_2). In another series of 28 analyses he found an average of .21 per cent. In recent American work, Clarkson and Smith found .25 per cent CO_2 as an average of 6 tests in a well ventilated stable. In another stable with still better ventilation, they found .14 per cent as the average of 6 tests. For a normal outside air we may take about .03 per cent CO_2 .

In some of our own work (Reynolds and Lipp) with a steer closely confined in specially prepared tight stall, we obtained the following record of CO₂ percentages after varying periods of confinement. After 6 hours, .94 per cent; after 12 hours, .71 per cent; average after two 24-hour periods, 1.03 per cent; after 48 hours, .68 per cent. The animal was a young steer weighing about 500 pounds, and was confined in a stall containing 784 cubic feet of air.

Another steer 200 pounds heavier in the same series of experiments gave for an average of three 24-hour periods, 1.09 per cent; at 42 hours, .98 per cent. It may be interesting for the student to note the decrease of CO₂ rather than an increase, which would usually be expected. This occurred many times in our experimental work and is quite easily explained on chemical grounds.

Necessity of ventilation.—To illustrate the effect of poor sanitary conditions, particularly lack of ventilation, it is only necessary to call attention to the common experience of moving an animal affected with chronic glanders or tuberculosis from a well-lighted and well-ventilated stable to one where the conditions are the opposite. Under the latter conditions there is often rapid development of a disease which had been mild.

Sick animals, especially those affected with respiratory diseases—and this is true of many other diseases—need free ventilation.

A warmly constructed barn in a cold climate is desirable if sanitary conditions, such as abundant air, sunlight, good food, and water, are provided. A good barn, with good ventilation, should maintain a temperature above freezing even in very cold weather. This means warm construction—number and kind of animals taken into consideration. But making a barn warm and tight may very easily establish an ideal place for the propagation of germs, the spread of disease, and lowering of animal vigor.

Carbonic gas (CO₂) can no longer be considered a reliable index of an atmosphere's injurious quality. In fact, our work has shown it to be a very unreliable guide in this respect. But it is a convenient guide as to the amount of ventilation accomplished.

Unventilated stable air.—Writers and teachers on the subject of hygiene are agreed that unventilated air is harmful. The

student may safely take their statements as correct in a general way, but may just as safely doubt the usual explanation.

Work done at the Minnesota Experiment Station seems to demonstrate quite conclusively that the accepted explanations are incorrect; that any probable increase of CO_2 or any probable decrease of oxygen are not especially important. This work seems to show that the injury comes from entirely different factors.

The Minnesota Station has had a number of different animals continue apparently in good health when confined for considerable periods in very high percentages of CO_2 . In one case a steer made good gains, was bright and active, and showed no important physiological disturbances when long confined in air containing CO_2 , ranging as high as 2.67 per cent, or nearly 90 times the average for outside air.

Experimental work shows that decrease of oxygen does not lessen the amount absorbed by the animal until we reach the very low level of about 13 per cent, 20.97 per cent being taken as a normal. But 13 volumes per cent is much lower than would be found in any stable.

Excretion of CO_2 may be checked and difficult respiration occur in case of very great excess of this gas. It has been found by other experimenters that when the air contains from 3 to 4 volumes per cent of CO_2 the excretion of gas might be checked 50 per cent, with no harmful effect detected. The excretion of CO_2 is practically independent of percentage of oxygen in the air. One very good authority tells us that tissue metabolism is not disturbed by variation of oxygen above 10.5. Below 10.5 percentage of oxygen there were marked physiological disturbances; but this is far below any probable stable percentage.

There does not appear to be any good reason for doubting the importance of stable ventilation. It is equally plain, however, that the injurious effects of unventilated air in common stables does not come from high CO_2 or low oxygen percentages, and that we must seek the explanation in other directions.

Accumulation of harmful germs gives a portion of the explanation. Modern research shows that the physical condition of the air, rather than the chemical composition, is the important factor. Aside from bacterial content of the air and irritating substances, the important thing in ventilation is the con-

trol of temperature and moisture. Mere motion, aside from its relation to other factors, has not been shown to be important for stock.

Natural forces.—The factors that operate in natural ventilation are: the force of the wind; the weight of air, as varied by its temperature; the diffusion of gases in obedience to a natural law; and the force of the wind is probably the most important one of these factors, and must always be taken into consideration in planning ventilation or in making mathematical estimates of the amount of air needed. The force of the wind is, of course, irregular; but variations can be made in the ventilat-

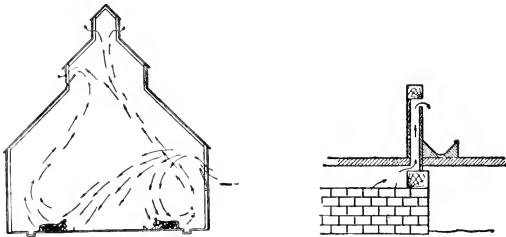

FIG. 38.—VENTILATION. (Paige.)

Air Currents.

Manger front inlet.

ing facilities to compensate for this. The incoming air should not pass over, or through, any contaminating source, such as a manure pile, and it is very important that the general plan of construction should be well considered.

Temperature and weight.—The second factor, difference in weight between the lighter warm and heavier cold air, is not so important in natural (windows and doors) as in artificial ventilation, and yet it is a factor of considerable importance. The heat which warms the air in the lower levels is that which comes from the bodies of the confined animals, as it is radiated from the surface or warmed in passing through the lungs.

Diffusion of gases.—Carbonic gas is considerably heavier than air, but the lower air levels usually do not usually show much more CO_2 than the higher ones on account of diffusion, which takes place in response to the law of diffusion of gases—operating independently of relative weights. This force is so strong

in its action that considerable diffusion takes place through lumber and ordinary brick, and other building materials.

AIR CURRENTS

An entering current of air has the effect of inducing other currents within the stable, the induced currents setting in at right angles to the inlet current.

With windows wide open to windward, and openings on the other side of the stable closed, and with ridge ventilation, it is found¹ that the current of air rushes in, strikes the floor at a variable distance after spreading out somewhat, then rises and most of it passes out at the ridge. A current decreases rapidly in velocity after the first five or six feet from the inlet. The atmosphere immediately under the inlet is but moderately disturbed.

When opposite windows are open, the air comes in from the windward side, strikes the ground, rises again, and a considerable portion passes directly out at the opposite side. But a sudden change in the outside currents may temporarily reverse this series.

The exact movement of air within the stable is varied, of course, by stall partitions and other obstructions.

A strong wind passing over a stable provided with ventilating shaft has an outward suction effect, and this is increased by a properly constructed cap which does not permit the entrance of outside air from below.

¹ Paige.

LECTURE XXIII

VENTILATION—*Continued*

STABLE CONSTRUCTION

Space needed.—A large space—500 cubic feet or more per animal—is important; but this does not lessen the necessity for ventilation. The atmosphere in a large stable housing a given number of animals may become just as foul as that in a smaller stable with the same number of animals, the only difference being the length of time required to reach this condition. The larger space makes possible the admission of a sufficient amount of air, without such drafts as would be the result if the same amount of air per hour were admitted into a smaller stable.

Location.—In order that a stable may be well lighted and well ventilated, it is necessary to exercise care in selecting the location and in planning the proportions of the building. One of the most desirable forms is that of a main part standing east and west and used in a general way for storage purposes, with one or two “ells” at right angles to this on the south. Such an arrangement gives a very satisfactory and well-protected yard on the south, and an even lighting to the various portions of the “ells” in which the animals are kept. When a stable extends east and west, and is wide enough for two rows of stalls, the animals on the north side do not get much sunlight, and the general lighting of their portion of the stable is poor.

Width.—To be capable of the best ventilation, a stable should not be over 25 to 30 feet in width; and the lower the better within reasonable limits, when one is depending on ventilation by doors and windows.

Windows.—In order to secure suitable ventilation in a building of this kind, two sets of windows should be provided, at least one set on each side, or better still, two sets on each side, one above the other. Door should be opposite door, and window opposite window wherever practicable. Sweep of sunlight over floor and fixtures is most desirable.

In general where one is depending upon natural ventilation,

and the air is brought in cold, the inlet should be high; the outlet may be either low or high, and controlled by a damper for cold weather.

Outlets and inlets.—In cases where suitable *outlets* are provided above, and the conditions are favorable, warmed air passes upward and out of the room or building; but if such outlets are not provided, then heated air merely rises to the ceiling, cools, spreads out and descends, and no pure air can come in to take its place. Circular, straight tubes are preferable. It is estimated that a right-angle bend in an outlet diminishes the velocity of the outgoing air about one half. Where it is absolutely necessary that an outlet tube should change its course, it should be done in a curve or slight bend rather than at a right-angle. All parts of ventilator, shafts and tubes should be accessible for cleaning purposes, as it is not uncommon for them to become so obstructed by cobwebs and dust as to be useless. In a general way, the outlet tube, if it must be near an outside wall, should be placed on the south side of the building in order to economize the heat of the sun in rendering it more effective. Central outlet tubes are generally more efficient, because they cool the column of air less, and maintain the current velocity better. One or two outlet tubes are more efficient than a larger number and should be preferred whenever construction permits.

Many small inlets are always better than a few large ones, as they admit the same volume of air, and give it better distribution, without direct currents.

Wing describes a form of cupola ventilation which has been found quite satisfactory in providing air outlet for some barns (see Fig. 40). This cupola outlet seems always in operation. There is no chance for wind to blow in and force strong down drafts. When in working order, it serves always as an outlet. It is easily closed by a rope from the ground floor.

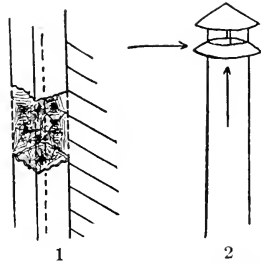

FIG. 39.—VENTILATION. (Paige.)

1. Air duct obstructed by cobwebs and dust.

2. Stationary outlet cowl to utilize the force of the wind for producing upward suction, and to prevent down draft.

This cupola ventilator consists of a common cupola with doors on two opposite sides, hinged above.

Connected with these doors, *S, O*, is a light board *B*, cut in the middle and hinged. When this board is straight, it holds

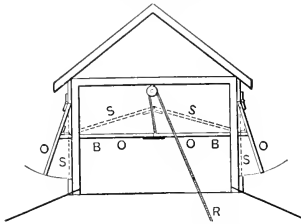

FIG. 40.—CUPOLA VENTILATION.

one or both doors partly open. If the wind blows against one side, that door closes and the lee side door opens. To close both doors pull down on the rope *R*.

Sheringham windows.—

The Sheringham window is simple and efficient for a stable of suitable construction.

The system consists essentially of windows hinged at the bottom and guarded at the sides so as to make troughs as the windows open inward. This gives an upward current, the air passing over the backs of the animals and settling down without direct current.

There should preferably be two sets of windows on each side, the lower windows being generally used for inlets on the windward side, and the higher windows for the outlets on the lee-ward side. This affords a simple, inexpensive, and easily manipulated method of ventilation, and may be

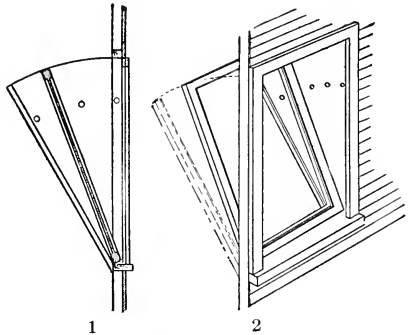

FIG. 41.—VENTILATION. (*Paige*.)

1. Sheringham window in section.
2. Sheringham window, opening inward. Seen from outside.

combined with ventilating shafts. Outlet ventilating shafts should have openings near the ceiling, and also close to the floor, so that their use can be regulated according to season and temperature, the upper openings of the shaft being used in hot weather, and the lower openings in cold weather.

There should be a number of medium-sized or even small windows in this system, rather than a few large ones. The same amount of air can be allowed to enter through the small openings without direct draft and with much better distribution.

For large and expensive stables there are systems of ventilation based upon Prof. King's work. Competent architects should be consulted concerning the plans or the Division of Agricultural Engineering at your state agricultural college.

Amount of ventilation needed.—The horse passes about 45 cubic feet of air through the lungs per hour. This, then, would be the amount which the average horse would use if he were out in the open where the supply is inexhaustible. It is impossible to have the air of any occupied stable as pure as the outside atmosphere. The purpose of ventilation is to come as near to this point as may be feasible.

Air passing at the rate of 3 miles per hour, which is barely perceptible, through total openings equal to 1 foot square, admits 15,840 cubic feet per hour. Inlet openings amounting to 4 square feet admitting a current of air moving at the average rate of 3 miles per hour under average weather conditions are estimated to provide sufficient ventilation for 20 cows.

The following data will serve as a general guide:

RELATIVE AMOUNT OF AIR BREATHED

Horse	100
Cow	82
Hog	32
Sheep	21

AIR NEEDED PER HOUR (*King*)

Horse	4296	cubic feet
Cow	3542	" "
Hog	1392	" "
Sheep	917	" "
Hen	35	" "

Professor Stewart, University of Minnesota, has worked out the following useful data for low outside temperatures:

The amount of air that should be provided per cow per hour is estimated by Stewart as follows: At -10° F, 1800 cubic feet; at 0° F, 2400; at $+10^{\circ}$ F, 3000. This assumes an indoor temperature of 35° to 37° F, and a stable of average construction.

TOTAL OUTLET AREA NEEDED AT VARYING HEIGHTS (*Stewart*)

Outlet 40 feet high	horse 24,	cow 20	square inches.
“ 30 “ “	“ 30,	“ 25	“ “
“ 20 “ “	“ 36,	“ 30, hog 20,	sheep 12 square inches.
“ 15 “ “	“ 42,	“ 36, “ 25,	“ 15 “ “

These figures also assume that the outlet tube is vertical and straight.

If the outlet shaft is not vertical or straight, then the capacity should be increased accordingly.

LECTURE XXIV

FOOD AND WATER

Food.—Food may be a factor in animal disease when it is excessive in amount, insufficient, too concentrated, too coarse, bulky, and innutritious for the animal that receives it; when it is poor in quality, when given in a poorly balanced ration or at irregular or improper intervals, or to a very tired or hot animal; when carrying vegetable or animal parasites, or when suddenly changed, as from poor to rich pasture; and when poisonous.

Excessive amount results in azoturia, heaves, colic, etc., among horses; and in milk fever, etc., among cows. It favors the development of all febrile diseases. Only a certain amount of food can be absorbed or used; the remainder causes trouble.

Deficiency predisposes to all diseases that are favored by a lessened vitality. The deficiency may be total, or there may be one or more special deficiencies, for example, deficiency of vitamins, which are essential to normal growth, and health; or deficiency of certain mineral matters, the lack of which impairs growth and development of framework. Such animals, particularly hogs, tend to "go down." Lack of iodine for the pregnant sow produces pigs that are born without hair, weak and with goiter. Glanders and similar diseases are especially apt to occur, or to increase in severity, among horses that are poorly fed. Deficiency in mineral matters predisposes toward certain diseases of bone. Deficiency of albumin results in loss of energy and strength, and animals so fed are apt to be languid and weak.

Coarse, bulky, and innutritious food may cause colic, indigestion, heaves and impactions, particularly in animals with small stomachs, as the horse.

Poor quality, hay cut too ripe or that has been rained on after cut, light oats, etc., causes the same disorders as deficiency, and also favors colic, impactions, and anemia.

A food may be *poorly balanced* and dangerous though very nutritious. Beans, wheat, oil meal, and cotton seed meal fed alone contain too much protein and not enough ash, fat and carbohydrates and crude fiber. When fed in the unbalanced ration, such excess of protein may cause febrile disturbances, diarrhea, congestion of the liver, azoturia and milk fever. A similar excess of carbohydrates or fats may cause an injurious deposition of fat under the skin into and between the fibers of voluntary muscles, or in the heart or liver. Excess of fats causes diarrhea and checks absorption.

Faulty intervals interfere with digestion and thrift, and may cause such disorders as colic and impaction. Cows may be fed at longer intervals than horses; but both should be fed regularly. A horse that goes a long time without food and then gets an abundance is apt to have colic or founder. The calf that goes past its usual feeding time and then overeats, is very apt to have serious bowel trouble and remain unthrifty for a long time.

Animal parasites infest several foods, *e.g.* stomach worms (of sheep) on grass.

Sudden changes, from poor to rich pastures, favor hoven, impaction, and blackleg.

There are *class differences*—some animals may eat with impunity what others cannot. By first producing digestive disturbances, rich cereals may indirectly cause laminitis in horses,—not in cows however. Pigs can eat acorns freely; but acorns are injurious to other animals.

Poisonous food, such as poisonous plants, may cause heavy losses. Such plants are usually distasteful to stock and are not eaten unless animals are hungry, for example, when on scant pasture or after long shipment by rail. Such losses are nearly all preventable by wise management.

“Wild cherry” and black cherry leaves and occasionally sorghum contain a deadly poison, prussic acid. As a rule cherry leaves are not eaten, but losses of cattle and sheep from such poisonous plants have been reported many times.

The common *sorghum* plant sometimes contains the same poison as cherry leaves. Fortunately it is unusual for sorghum to be poisonous, but serious losses of cattle have occurred because of it. It is safer to test a field of fodder sorghum by turning in only one or two animals the first day.

Laurel leaves are poisonous and cause losses among sheep particularly.

Wild larkspurs have caused heavy losses of cattle and sheep, especially on western ranges.

Whorled milkweed is very poisonous especially to sheep.

Water hemlock (wild parsnip), is poisonous to all classes of stock, and of all plants likely to be eaten, is considered the most dangerous.

Loco plants are poisonous. Their damage is of slow development. Horses, cattle and sheep on the western ranges are often poisoned by it. This plant is peculiar among stock poisons in that it creates a drug habit in stock similar to the opium habit of people.

Roots, like sugar beets and mangels, are not poisonous, but when fed in excess—to sheep at least—are likely to cause serious derangement of the urinary organs, with formation of calculi (stones) in the kidneys, ureters, or bladder.¹

WATER

Water.—Water may be a factor in animal disease when it is *excessive* or *deficient* in amount; when it contains *bacteria*, e.g. the virus of glanders or of hog cholera; or when it contains such low forms of animal life as intestinal *parasites* for example; when it has received *sewage* matter; when it is very *hard*, when it is given at improper *intervals* or in large quantity soon after eating, or when it is given in large *quantities* to a very hot or tired horse.

An *excessive amount* of water is said to lessen the digestibility of foods, increase tissue waste, and favor indigestion.

A *deficient* water supply may cause impactions in cattle and lessen the excretions from skin and kidneys in horses. Horses need about 2 pounds and cows giving milk about 3.5 to 4 pounds of water per pound of dry food, the amount varying according to diet and condition of the atmosphere. Cows need much more than horses in proportion to weight and feed, and can usually be trusted to drink at their own pleasure. Horses will frequently drink too much, especially when tired or hot.

¹ Iowa Exp. Sta. Bul. 112. For detailed information concerning poisonous plants, consult "Poisonous Plants" by Pammel; also Bulletin 20, and Bulletin 575—both relating to poisonous plants and published by U. S. Dept. Agr. Bureau of Animal Industry.

Bacteria frequently contaminate drinking water, which may thus serve as a source of transmission for many germ diseases; like anthrax, foot and mouth disease, hog cholera, and glanders.

Animal parasites also contaminate the water supply, which serves to spread parasitic diseases, intestinal parasites, for example.

Hard water may contain much calcium, magnesium, etc., and is said to cause indigestion, unthrifty conditions, and perhaps calculi.

Intervals may be wrong. Horses should be watered regularly and at as short intervals as convenient. They should not be given large quantities of water sooner than one hour after eating grain. Much cold water interferes with digestion, and when given to a very hot or tired horse may result in founder or indigestion.

Practical application.—With this lesson in mind, the student should hereafter watch for milk fever cases to see if the cow has not been in good condition and rather heavily fed for a cow not milking, and lacking in exercise.

He should be on the watch for azoturia (see Lect. XLIV) and learn whether the horse has not been idle and full fed during the day or so prior to illness. Note also whether there had not been a period of regular work on full feed before this idle period.

He should also watch for cases of heaves among horses to determine whether such horses have been greedy eaters and heavily fed with dusty hay or other bulky food. It will be interesting for the student to be on the lookout for an outbreak of hog cholera in a herd that had access to a small pond or very sluggish stream, to see if there is not an unusually heavy loss in such a case.

The very hot, very tired, or very hungry horse should be fed and watered cautiously, with small quantities, until he is in better condition. Sudden and radical changes from old to new feed of the same kind are to be avoided. The quantity and quality should be watched. Too much hay is the most common error made in the feeding of horses. The working horse in good condition should be fed but little on holidays. For the heavily pregnant mare, excessive feeding is injurious and especial care must be taken to prevent colic in such a mare.

Diseases often associated with overfeeding are: azoturia,

lymphangitis, heaves, founder, garget, calf cholera, colic, etc. Feeding and watering should be so managed as to avoid dissemination of disease, for example tuberculosis in cattle. Given a common feeding and watering trough, so that food or drink can be infected by a diseased animal, and then taken by another, the spread of disease may be rapid.

Such a case is well illustrated by a common cement feed and water trough, where water comes in at one end of the trough and flows past the cattle to the lower end. One diseased animal at the upper end may contaminate the feed and water for many.

PARASITIC DISEASES

LECTURE XXV

PARASITISM

Parasitism may be temporary or permanent, external or internal.

Parasites of domestic animals cause greater losses than is generally realized. Every stockman should be informed concerning the most common and serious parasites, especially those of sheep. Parasitism may be *temporary* when only a portion of the parasite's life history is with one host; *permanent*, when its whole life history is with the same host; *external* or *internal*, when it affects the body surface or the internal organs.

Sources and causes of parasitic diseases.—Parasites may be received into the digestive apparatus with food or drink, they may gain entrance through the respiratory tract, or broken skin; or there may be external infection by contact, as with lice or scab and mange mites.

Nourishment.—Some parasites have mouth and digestive organs, *e.g.*, roundworms of the intestines; others receive their nourishment by surface absorption or osmosis, *e.g.*, tapeworms.

Effect on health of host.—This depends on the organ or organs invaded, the rapidity of multiplication, the amount of nutrition used by parasite, and the amount of irritation caused.

Intestinal parasites cause trouble by obstruction, by irritating and abstracting blood from the mucous membrane, by mechanical irritation, and by using nutrition. Hence, we have symptoms of indigestion, colic, and unthrift.

Liver parasites cause jaundice and general anemia.

Lung and bronchial parasites cause bronchitis or pneumonia.

Parasites in the blood vessels cause disease of the vessel walls, and may indirectly cause obstructions and colic.

Parasites in the brain are more rare, and usually fatal.

Parasites in muscular tissue may cause little disturbance to the animal host, but be very serious to human health; *e.g.*, pig measles and trichina.

General treatment.—Medical treatment must be such as will destroy or remove the parasites. Medicines may aid in removing parasites by suffocating them, by poisoning them, or by caustic or irritating chemical effect on the parasites. Many parasites disappear at a certain stage by means of their own activity and habits; *e.g.*, ticks, bots in horses, grubs in backs of cattle, and grubs in the nasal passages and head cavities of sheep. It is well to remember also that many parasites, bots in the horse's stomach for instance, can resist stronger medicines than the organs or tissues they invade.

Practical suggestions.—Parasitism would be impossible if everything that comes in contact with the animal body were free from parasites. Saddles, harness, blankets, posts, and fences are the usual agents which spread Texas itch or mange among horses; intestinal worms generally gain entrance in the egg or immature form, with the food or drinking water.

Parasitic diseases may often be prevented by forethought and wise management. Intestinal parasites of sheep, like stomach worms, module disease, tapeworms, etc., may be largely prevented by change of grazing ground—pasture, meadow, stubble, millet, sorghum, rape, etc.

Serious trouble from lice in winter should be prevented by proper treatment in the fall, while the weather is still warm enough for vigorous treatment by dipping or washing.

In many cases, the parasite requires two hosts, living its immature stage in one host, and its mature stage in another. Certain immature tape worms which cause losses in sheep, use the dog for their mature form host. Unnecessary association of dogs and sheep on feeding ground is therefore unwise.

Ponds, wells which receive surface drainage, sluggish streams and marshes, should therefore be regarded with suspicion. Sound animals should not be allowed in sheds, yards, or barns where animals diseased by external parasites, like lice or scab mites, have been, until such structures have been disinfected. Intestinal worms which appear in the manure of horses should be destroyed with boiling water,—not merely crushed and thrown away.

EXTERNAL PARASITES

Lice.—These are wingless insects classified into two general groups, biting lice and sucking lice. Each of these general

groups is subdivided into various families and species. As a rule they are specific, *i.e.*, a certain species of louse is parasitic only on a certain species of bird or animal. In size, they vary greatly from mere specks to the giant hog louse which may be $1/5$ of an inch long.

Lice infect especially certain portions of the body surface of each animal, *e.g.*, for cattle, the back; for hogs, back of the ears, for poultry, the fluff and under the wings; for young chickens, the top of the head.

Reproduction.—Lice reproduce by eggs (nits) glued to hairs or feathers. The eggs are very light in color and oval in shape.

Treatment.—(1) Bathe the affected parts with corrosive sublimate in vinegar, 15 grains to the pint; or (2) tobacco water, prepared by steeping for an hour 2 ounces of tobacco to each quart of water; or (3) Professor Riley's kerosene emulsion made by mixing kerosene 2 gallons, soft soap one half pound, water 1 gallon. Dissolve the soap in water and add kerosene slowly while the water is still boiling. Churn 10 minutes and for use, dilute by adding 8 times its bulk of water. This is cheap, harmless, and satisfactory.



FIG. 42.—CATTLE LOUSE. FEMALE.

Haematopinus eurysternus.

For cattle, control lice by dipping or other thorough treatment in the fall before cold weather. Use any good coal tar dip 2 to 3 per cent and repeat in about 10 days. Any treatment for lice should usually be repeated several times at intervals of 10 to 20 days, depending on season, the shorter interval for warmer weather. It is usually advisable to whitewash stalls and sheds. All harboring litter should be removed and burned. Brushes, combs, etc., must also be treated. Clipping is a great aid in the treatment of external parasitism. In fact, it is difficult to treat sheep successfully for either lice, sheep tick, or scab without shearing.

Water solutions and oils are usually inadvisable in cold weather. For treating cattle, horses, and young stock in *cold weather*, dust frequently into the hair along neck, back, and rump, either Persian insect powder or powdered sabadilla seed and sulphur equal parts. A little kerosene oil on a brush and

used frequently, is safe and helpful if done with reasonable caution. Volatile substances, especially wood alcohol, are effective, dry rapidly, are moderate in cost, and are safe in cold weather, when reasonably used. They are more effective, also, than a powder. Powdered sodium fluorid is effective for biting lice but not for sucking lice.

For poultry use whitewash in abundance, and plenty of fine, air-slaked lime dusted into the nests and on the floor. It is a good plan to throw this lime against the wall, so that it will float in the air and then gradually settle down into crevices and over the poultry. Or kerosene may be sprayed over the walls and ceiling and the perches frequently washed with it. Kerosene is cheap, can be rapidly applied, and is very effective. Constant access to dust bath of dust or sifted ashes, air-slaked lime, sulphur, and Persian insect powder, should be given and the poultry house should be kept dry.

Flies.—At times flies prove a serious nuisance for domestic animals, particularly horses and cattle. Various preparations have been tried at different experiment stations with fairly satisfactory results.

No. 1.—Was tested and reported as satisfactory by the Nebraska Experiment Station: Oil of wood tar 1 part; neutral oil (a petroleum product) 4 parts. Mix and shake thoroughly. A very light application of this should be made by brush or spray. It is occasionally necessary to sponge off the hair with a cloth, using a little of the neutral oil on account of a little gum which collects with repeated application.

The following (Jensen) is probably still better: Dissolve 1 pound naphthaline in about 1½ gallons erude oil, applying just sufficient heat to effect solution. Add to this 1 gallon of fish oil. In a separate vessel, dissolve about 2½ pounds of common laundry soap in about 5 gallons of water. When the soap solution is complete, mix it with the oils and naphthaline, put it into an old churn and work it thoroughly together, adding gradually sufficient water to make the product measure 10 gallons. Apply daily or twice a week as needed with brush or spray.

Sheep tick (*Melophagus ovinus*).—This is not a true tick but a wingless fly. The young larvæ are attached at birth to the wool fibers. The pupa stage last from three to six weeks, after which maturity is reached. It is a permanent parasite, *i.e.* the

entire life history is passed on the sheep host. The mature tick pierces the skin in order to suck blood, thus causing serious irritation and unthrift.

The *treatment* commonly used is coal tar dip, 2 or 3 per cent applied after shearing. The wool must be stored where the dipped sheep cannot become reinfected from it.

Dipping should be repeated in from twenty to forty days depending on the weather. Lambs must be protected during shearing time, otherwise the ticks will leave the older sheep and go to the lambs.

Sheds, pens, etc., must be cleaned and disinfected as for lice.

Ticks.—True ticks are temporary parasites, commonly found in brush and tall grass.

Life History.—The young female crawls up on brush or grass or weeds and waits for some animal to come along and brush her

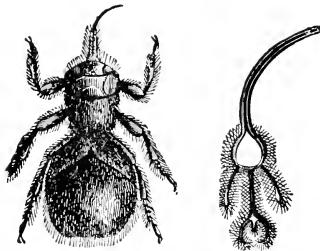

FIG. 43.—SHEEP TICK AND ENLARGED PROBOSCIS.

Melophagus ovinus. Properly a sheep louse.

off. She soon attaches to the skin, gorges with blood, and drops off. After a few days, she begins laying several thousand eggs and dies soon afterward. The eggs hatch in 15 to 20 days if conditions are favorable.

Treatment.—Any safe oily preparation may be used to destroy the common ticks. (See Texas Fever for dipping.)

Ringworm.—This disease appears most commonly on the heads and necks of cattle, especially calves; but man and all domestic animals are also subject to it. It is caused by a vegetable parasite (*Trichophyton*) growing in the skin, somewhat like mildew in a grape leaf. This disease appears in the form of round, raised, and bald patches, especially on the heads and necks of calves during the winter. The patches are scaly or crusty, an inch or two across; the hairs stand erect, then split and break. There are usually several such patches close together. Ringworm spreads readily by inoculation. It is not especially serious; but it is disagreeable.

A good method of treating ringworm is to use scrubbing

brush, soap, and warm water; then apply every other day 10 per cent carbolic acid in glycerin or tincture of iodine and glacial acetic acid in equal parts. Care must be taken not to get this into the eyes.

LECTURE XXVI

SHEEP SCAB

Sheep scab is a result of irritation of the skin, caused by mites, minute animal parasites that puncture the skin from the surface or burrow tunnels in it.

There are three common types of these mites and three types of the disease which they cause. One variety of mites produces body scab, another head scab, and a third foot scab. Body scab is the most common, the others are relatively unimportant.

Mites are permanent parasites, their entire life history being spent on one host; they multiply with enormous rapidity.

BODY SCAB

Body scab is caused by mites (*Psoroptes*) which have power of free movement upon the surface. It is the most common and serious type of scab. This type spreads most rapidly over the individual body, and also rapidly through the flock and from flock to flock.

General history.—This disease is likely to become serious before being noticed by the owner. The parasites which cause this type of the disease do not tunnel into the skin, but cause intense irritation, especially when the sheep are warm. The owner will usually remember, after he has become aware that body scab exists in his flock, that his sheep have seemed uneasy and that they have been rubbing and biting themselves occasionally for some time.

After the disease is under way, the parasites live beneath the crusts, and constantly migrate outward, while the skin slowly heals in the center. The fleece of scabby sheep is usually rough, and the wool matted in places and easily rubbed off. The parasites which cause this form of the disease confine their work almost exclusively to parts of the body where the wool is long and thick.

How spread.—This form of the disease spreads rapidly through the flock; because of the location of parasites upon the body of the sheep, and because of the freely moving habits of the parasites. As a rule, the disease spreads most rapidly in autumn and winter, because the wool is then long and thick, furnishing favorable conditions for the parasites, and because the sheep are kept in closer contact at these seasons. The disease makes more rapid progress then and is much more fatal

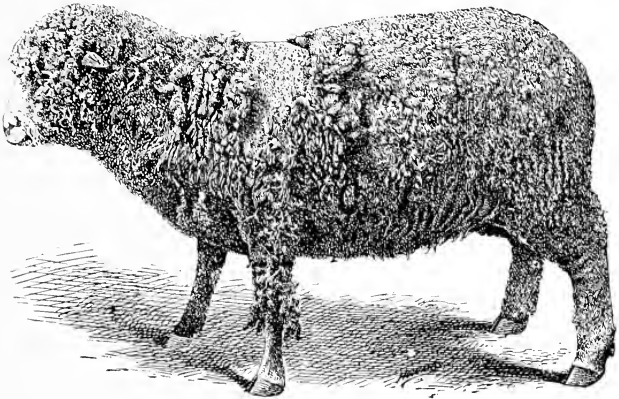

FIG. 44.—A PLAIN CASE OF SHEEP SCAB.

with the weaker sheep. These parasites may be transferred from one sheep to another in a great variety of ways; for instance, tags of wool may be rubbed off and dropped almost anywhere. Diseased sheep infect posts and fences by rubbing against them, also the parasites escape from one sheep to another while the sheep are in close contact in yards and sheds. A loaned buck is liable to bring back scab.

Open pastures and yards usually become safe again after two months. Indoor pens, sheds, etc., once infected, may not be safe in less than a year without radical cleaning and disinfection.

FOOT SCAB

The disease caused by foot scab mites (*Chorioptes*) appears on the feet and limbs. The diseased area extends very slowly,

but may eventually reach the body. This form of scab also spreads very slowly from one animal to another. Sheep which are infected with it are apt to be almost constantly stamping and pawing.

Local treatment.—Any of the sheep dips recommended for body scab may be used to treat this form of the disease. A 10 per cent solution of the creolin is simple, safe, and easily applied on small areas.

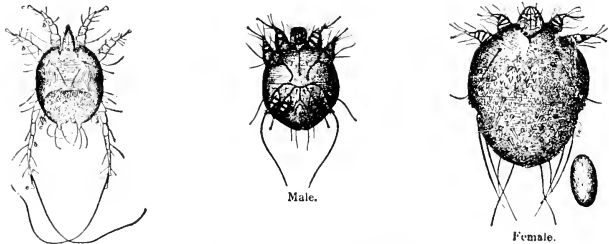

FIG. 45.—SHEEP SCAB MITES.

Psoroptes, male (*Cur-*
tice). Body scab.

Sarcoptes (*Lugger*).
Head scab.

Sarcoptes (*Petit*).
Head scab.

Any dip or ointment that will kill the parasites is sufficient early in the disease, but it may be necessary in old cases to soften the scabs by a little oil or a thorough scrubbing with brush and hot soapsuds.

HEAD SCAB

The mites (*Sarcoptes*) which cause head scab burrow tunnels in the skin. The eggs are deposited in these tunnels and there hatched. This type of scab may appear on almost any portion of the head. It may slowly invade the neck and other portions of the body where the wool is short; but it is less common and less serious than body scab.

GENERAL PREVENTION

Prevention is more important than treatment in any case where it can be secured, because it is surer, it is cheaper, and is usually much easier to administer than treatment.

Spread of scab.—Whether the scab spreads rapidly over the body or not depends to some extent upon the thriftiness or

unthriftiness of the individual animal. When sheep are fat and the wool is well supplied with yolk, this disease spreads more slowly, and is much less serious. The infection is frequently made when one sheep rubs against posts or fences where scabby sheep have previously rubbed. In the latter case, the mites are first transferred from the diseased sheep to the post, and then from the post to the healthy sheep. In other cases, the mites are transferred when a diseased sheep rubs against a healthy one.

Precautions.—Pens, sheds, and yards which have held scabby sheep should be thoroughly cleaned and disinfected; and, unless the disinfection is very thorough, they should not be used for sheep until at least four weeks have elapsed. It is supposed that a hard rain will practically disinfect ground surfaces, but not fences and posts. Fields and pastures in which scabby sheep have been held should not be used again until after an interval of several weeks, and preferably not until after a heavy rain.

GENERAL SYMPTOMS

History and diagnosis.—At the point of infection there occurs the puncture; then a little pimple, soft on top, which ruptures, a little fluid escaping. Dust and other foreign matter collect in this fluid, the initial scab is started, and the diseased area spreads.

Affected sheep are usually uneasy and are seen scratching against posts, rubbing against other sheep, and even biting the itching surface. The irritation is most noticeable when the sheep are heated, as by exercise, or confined in a close room. At first the wool hangs in tags, the sheep begin to pull out portions of the wool with the mouth, and the skin becomes bare in patches which increase as the mites spread, irritating and inflaming the skin. To determine the presence of the mites, scrape off some of the scab and a little of the healthy skin near the border of the scab. Place these scrapings upon some smooth black surface in warm sunshine, and examine with a good hand lens. The mites may then be seen as minute white bodies about $1/50$ of an inch long. They are most certainly recognized when they are seen to move. It is sometimes difficult to distinguish otherwise between the mites and particles of light-colored dust or epithelial scales from the skin surface. One is more apt to

find the mites where the skin is greasy and glistening, and not where the skin is dry and dull. It should be borne in mind when examining a case of head scab that the mites which cause this disease burrow beneath the surface of the skin, so that it is necessary to scrape deeper than for ordinary body scab.

Possible mistakes.—It is well to bear in mind, also, that other conditions may be mistaken for sheep scab, particularly disorders of the skin produced by other external parasites, such as lice and sheep ticks. These are easily seen and they do not cause any marked local lesion. Skin thickening is quite characteristic of scab, but not in the case of ticks or lice. In the so-called “wild fire” of sheep in northwestern states, the skin is red, but not thickened and hardened as in scab. Occasionally we have outbreaks of skin disease among sheep which on superficial examination resemble scab rather closely. These outbreaks, however, are due to the awns of a wild grass (*Stipea sparta*). These spearlike bodies gradually work their way through the wool into the skin, causing inflammation of the skin and considerable irritation.

TREATMENT

Suggestions.—Treatment is comparatively easy where there are but few sheep, but it is more difficult with large flocks. The size of the tank, material to be used, and method of dipping must depend upon the number of sheep, and the accessibility and expense of different materials.

The dipping, as a rule, should not be done immediately after shearing. It is better to wait a week or ten days. Some good may be accomplished without shearing if the wool is parted by hand and care taken to get the medicine down to the skin, but it is the usual experience that dipping unshorn sheep is much less satisfactory.

The entire flock must be dipped, those that are apparently sound as well as those that are diseased. And the owner must bear in mind that after shearing, the wool may be a source of danger, and that it should be so kept and handled as to avoid the possibility of reinfection.

Dipping is effective only when it is thoroughly done and properly repeated. Lime and sulphur, coal tar dips, tobacco and arsenic are the various ingredients that are commonly used in dipping for scab. The quantity of dip required per sheep

varies from two to four gallons, according to the number of sheep dipped and the material used. Less dip is needed for shorn than for unshorn sheep.

It is a good rule to use any dip at about 100 degrees F. Dipping should be repeated in 10 days, and in some cases it may be necessary to give even a third dipping after a second interval of 10 days.

For thorough work the entire flock should be shorn, then 8 or 10 days later dipped and confined for another 8 to 10 days in a place where there have been no scabby sheep for at least two months. At the close of this period of 8 to 10 days, the flock should be redipped and placed again where there is no danger of infection.

Dips.—Several of the patent dips give excellent results, but these are usually more expensive than others and are objectionable, inasmuch as we do not know their composition. The following are perhaps as good as any:

Lime-and-sulphur dip.—This is cheap, safe, and very effective. It has given good satisfaction when made and used according to directions. Make this dip in the following proportions: ordinary sulphur, 24 lbs.; unslaked lime or hydrated lime—but not airslaked—8 lbs.; water, 100 gallons.

The lime and sulphur are placed in a large kettle or other suitable container with enough water to slake the lime and form a paste. After the lime is thoroughly slaked 30 gallons of water is added and the mixture is boiled and stirred for 3 hours. Add water to make up to the original 30 gallons, and allow the solution to settle overnight. The liquid should then be so drawn off as to avoid stirring up the sediment. A spigot placed about 4 inches from the bottom of the barrel or tank works nicely.

For use, add enough water to make a total of 100 gallons. The ooze or sediment is not to be used on the animal body, but makes a good disinfectant for fences, pens and other enclosures.

Lime and sulphur cannot be relied on to kill sheep ticks. Tobacco and sulphur or coal-tar dips should be used when there are both ticks and scab.

Coal-tar dips.—Certain dips of this class are now approved by the Federal Bureau of Animal Industry when used in official strength and directions followed.

Practical suggestions.—Each sheep should be kept in the dip at least two minutes by the watch, and each sheep should go under entirely at least once. Three to five minutes are necessary for bad cases with heavy crusts. Heavily pregnant ewes can be safely dipped if handled with care.

Ewes, lambs, and bucks should be dipped in separate lots. It is not advisable usually to dip sheep that have recent wounds even if the wounds are small unless they are nearly healed. Always water and feed well within three to five hours before dipping. Soft water makes the best dip. The solution should be from 40 to 48 inches deep, with an allowance made for each sheep to carry out in the wool, two quarts to two gallons, depending on the wool.

Drowning and other accidents can be avoided by watchful care. Lambs may be dipped at about one month old.

In using any dip no matter if proprietary or homemade, follow directions exactly. It is not uncommon for stockmen to have unsatisfactory results from the use of well-recognized dips, usually because they try the dip a little weaker than the directions call for, or because they were a little careless and hurried the sheep through the dipping vat too rapidly, or by returning the sheep after dipping to infected pastures or yards.

For a small flock the portable galvanized vats are very convenient. There should be at least one drainage pen with floor to carry the dip from the dripping sheep back to the vat. Two such pens are a great convenience.

Disinfection.—All structures, sheds, pens, posts, etc., that may have been contaminated should be cleaned and well disinfected unless sheep can be kept away from them for a long period, as previously indicated.

Any good dip should make also a good disinfectant for this use. In case a lime-and-sulphur dip is selected, then the "ooze" or sediment which will otherwise be discarded may be used. Plowing or burning over ground makes it safe.

LECTURE XXVII

MANGE

HORSE MANGE

Causes.—Mange of horses, cattle, hogs and many other animals is similar in cause, symptoms, and spread to sheep scab. Horses, like sheep, are subject to three forms of the disease. The most common form in the horse is due to the *Sarcoptes*, which burrows and affects the head, neck, and body. Another form is due to *Psoroptes* which moves freely and affects the surface. A third form is due to the *Chorioptes*, which lives on the surface, moves but little, and affects feet and legs, usually below the knees and hoeks.

Sarcoptes scabiei var. *equi* is a common cause of horse mange. This is one of the smaller mites, practically invisible to the unaided eye. These mites burrow tunnels into and under the skin. The eggs are laid and the young are hatched in these tunnels. On account of this tunneling habit, spread is slow at first and the disease difficult to cure in advanced cases.

Spread of mange mites may be direct from horse to horse or indirect by way of the harness, saddle, blanket, currycomb, or a post, for example.

Symptoms.—The disease usually appears first on the head or side of the neck, and the first symptoms are small pimples and itching. The skin loses hair, becoming thickened, roughened, and wrinkled. Affected horses are much more uneasy at night, particularly in a warm stable.

Treatment.—It is usually necessary to repeat treatment at least once, and in bad cases, several times at intervals of ten

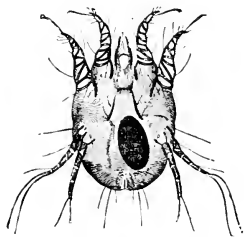

FIG. 46.—MANGE MITE.

The cause of one form of horse mange. *Psoroptes communis equi*.

days. Treat all horses that have been exposed to infection, and watch closely for reappearance of the disease.

If the horses are halter broken and conditions permit, clip the hair and burn it. Soften the scabs and crusts by a thorough application of soft soap well rubbed in over the affected surface. The soap is left on for two or three hours and then washed off. The scab should then be very easy to remove. Allow the skin to dry and apply one of the following treatments.

CATTLE MANGE (BARN ITCH)

This is the same general disease as horse mange and sheep scab. Mange causes serious trouble and losses in range cattle and is occasionally a source of serious trouble among farm herds. Breeding herds seem most apt to become affected on account of the most frequent opportunities for introducing it by the purchase of new breeding stock. This disease is rarely fatal in cattle that are well kept; but is a source of financial losses by reason of unthrift. In farm herds it is a serious nuisance, and should not be neglected or ignored.

Cause.—In cattle there are four types due to *Sarcoptes*, *Psoroptes*, and *Chorioptes* and *Demodex*.

The *Sarcoptes* (burrowing) affect especially the inside of the thigh, root of tail, under surface of the neck and the brisket. The *Chorioptes* affect chiefly the tail and legs. This form is slow, local and much less important than *Psoroptes*. *Demodex* causes small lumps on neck and shoulders from millet to pea size. It is rare and practically incurable. The *Psoroptes* is most common. This form affects the general body surface, and spreads rapidly. It lives upon the surface of the body and can move about rather freely; hence the disease spreads more rapidly than the common mange and is easier to cure. The skin irritation and inflammation is due to punctures which the mites make in order to suck their nourishment.

Symptoms.—Symptoms of cattle mange are similar in a general way to those shown in sheep scab and mange of horses. With cattle, the disease usually appears first on the neck or shoulder or near the tail, and from these places is spread over other portions of the body. The skin becomes bald, thickened and wrinkled and perhaps badly scratched and sore as a result of rubbing.

There may be very little to show for mange while the cattle are out on grass and doing well, although the mites are still present on the body. Fall, winter, and early spring are the seasons of greatest prevalence and annoyance.

TREATMENT

Cattle and horses may be either dipped¹ like sheep or treated with local applications according to the extent of the disease and number of animals affected. Dipping is more thorough and reliable. It may be done either in a long swimming tank, or the animals may be dipped one at a time in a dipping cage.

All exposed animals and every portion of their body surface should be treated either by wash or dip. In case of dipping, all portions of the body should go under the dip at least once and the animal should be kept in the dip from two to four minutes. Treatment should be repeated in seven to ten days. If mange persists, after two good dippings, apply the treatment for Sarcoptic mange. In case of infected herds, dipping should be repeated twice each spring and fall until the disease is entirely removed. The dip should be quite warm, 100 to 105 degrees F.

Stock must not be hungry or thirsty when dipped; they should be fed and watered two to four hours before dipping. It is also important that stock be not heated, as by driving fast before dipping. Let them cool off first.

After treatment, the stock should not be put back into infected yards, pens, or stables. Such enclosures should be either thoroughly disinfected or the stock should be kept out of them for a considerable period.

Almost any oil when freely used on horses is liable to cause temporary loss of the hair.

(a) *Creosote*, diluted with any non-irritating oil, 1 to 16, and used by hand application for small areas,—never for areas covering more than one half of the body at one time.

(b) *Creosote*, 1; oil of tar, 10; soft soap, 10; use like (a).

(c) *Lime and sulphur dip* is an old, thoroughly tried and reliable treatment which is cheap, effective, and safe. Direc-

¹ For detailed information, concerning dipping plants, see Nebraska Station Bulletin 74, North Dakota Station, Bulletin No. 61, or Bureau of Animal Industry, Bulletin 1017.

tions should be followed closely as given under Sheep Scab Lect. XXVI. This dip is prepared as for sheep except that we use twelve pounds of lime instead of eight pounds.

Always treat the apparently healthy skin to a considerable distance beyond the diseased border in case of small areas and local treatment.

Prognosis.—The prospect of recovery is good in recent cases, but if the animal has been long and badly affected and the disease covers a considerable portion of the body, then the prospect is not encouraging. The Sarcoptic horse mange is much harder to cure than common body scab of cattle, and may require three to five dippings at six to ten day periods, depending on the weather.

Disinfection.—All structures which may have become contaminated should be thoroughly *cleaned* and disinfected. The ooze or sediment made in the preparation of lime sulphur dip will serve well for this purpose, or a 6 per cent solution of any of the better coal-tar disinfectants may serve the same purpose.

LECTURE XXVIII

INTERNAL PARASITES

Many kinds of internal parasites seriously affect the various classes of stock. The few selected illustrations used here for the horse and sheep can give only general information on the subject. Space does not permit of detailed information concerning even those parasites selected for discussion. Losses in sheep from parasites, internal and external, are especially important, and, as a rule, they are preventable.

Bots.—The common bot of the horse's stomach is the larva form of the horse gadfly or bot fly, *Gastrophilus intestinalis* (*equi*). This fly is commonly observed buzzing around horses in the summer and early fall. It is about the size of a common honey bee. The bot fly reproduces by oval, light yellow eggs, which are attached by the adult fly to hairs about the neck, breast, and fore-arms.

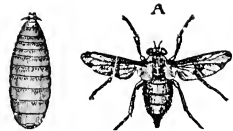

FIG. 47.—HORSE BOT FLY AND LARVA.

Gastrophilus intestinalis equi. Larva in the third stage.

In due time, the eggs hatch and the small larvæ or bots escape. Some are licked off, burrow into the mucous membrane of the lips for a few days, then escape and make their way to the stomach where they firmly attach themselves to the lining by small hooks. They remain thus in the stomach about 10 months, finally passing off with manure. The next, or pupal stage, lasts from four to six weeks, and is passed in manure or in the ground. After this stage the mature fly appears, ready for the next generation.

Another species, *Gastrophilus nasalis*, locates in the horse's nasal chamber. A third species *Gastrophilus hemorrhoidalis* locates in the rectum, and causing intense itching at times. These parasites may be removed by free rectal injections of 0.5 per cent creolin.

Bots rarely do any serious harm, although they are very common. Medical treatment by the use of carbon bisulphide (6

drams in capsules) is quite satisfactory. No food should be allowed during twenty-four hours before treatment. Four to six hours after treatment an oil physic, such as raw linseed oil, should be given. It is usually advisable to have this treatment given by a veterinarian.

Nematodes (round worms).—For pin worms (*Oxyuris equi*) which inhabit the rectums of horses, empty this organ by means

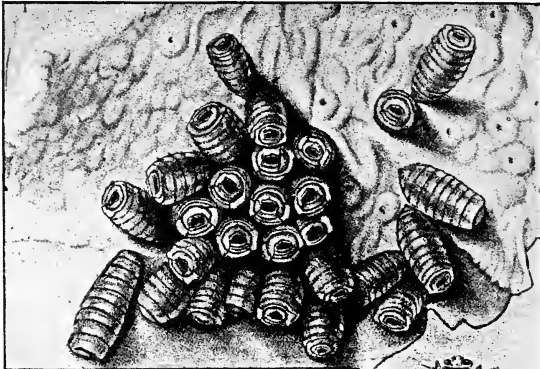

FIG. 48.—HORSE BOTS AND BOT FLY.
(B. A. I.)

The eggs are deposited on the hairs during the fall. They are taken off by the tongue; hatch, and develop mainly in the stomach, into the bots (larvæ).

of warm water injections, and then use $\frac{1}{2}$ gallon of warm rectal injections of astringent and bitter medicine, like a very mild solution of copperas or 0.5 per cent creolin or a strong tea made of quassia chips.¹ Repeat once daily for two or three days and follow with an oily physic, *e.g.*, one quart of raw linseed oil.

Ascaris equi.—For the “long white worms” 6 to 12 inches long, affecting the small intestine of horses, the treatment must be vigorous and continued.

Give a cathartic of 1 quart linseed oil. Feed little or no hay for 4 days. Fast 12 hours, then give 1 to 4 ounces of turpentine in from 1 pint to 1 quart of raw linseed oil on the 5th day, and

¹A large handful of quassia chips in two quarts of water. Steep 15 minutes and let stand overnight.

repeat on the 6th. Beginning on the sixteenth day repeat this whole process, if the first treatment does not seem entirely effective. Always use raw linseed oil.

A second method of treatment is as follows: After giving the preparatory treatment described above, give tartar emetic, 1 to 3 drams depending on the size and the age of the animal, mixing the medicine with a small, damp feed of oats or grain. Repeat in 12 hours. Keep the horse quiet and empty.

Strongyles.—These are also round worms (Nematodes). The horse is affected especially by four species.

In general the mature worm inhabits the cecum and the colon. The eggs are deposited, then pass off with the manure and hatch. The embryo worms are taken in by the future host with water or feed. Some of the immature worms pass through the intestinal mucous membrane and into the blood vessels of the abdominal organs—the intestines for instance, where they are likely to indirectly cause colic and serious disease of the bowel, by obstructing circulation.

The *symptoms* are variable and not diagnostic. There are evidences of intestinal irritation like diarrhea, recurrent colic, unthrift and variable appetite, usually lack of appetite.

Treatment for the strongyle infection in horses is satisfactory if given in time. Best results are secured from oil of chenopodium. The horse is allowed no feed for 36 hours, then is given about 4 drams of this oil in a quart of raw linseed oil.

For the common round worms in hogs, no food is given to the hog for from 8 to 24 hours. Then when the hog is hungry and empty, he is given one to 3 teaspoonfuls of turpentine, according to size and age, diluted about ten times in skimmed milk or thin slop. This dose is repeated daily for several days, and then a physic is given.

Oil of chenopodium, about 45 drops in 1 ounce of castor oil per 100 pounds weight, is also very effective—especially when properly repeated.

Tapeworms or taenia (flatworms).—These are especially serious in sheep, which are infested by several species. Three kinds are common to cattle, sheep and goats. The *life history* of tapeworms is very significant. Taenia are two-host parasites. They pass the larval stage in one host as bladder-like cysts, and their adult form in another species of host as a flat, ribbon-like body of many short segments. For example, the sheep disease known as gid is caused by the bladder worm larva of a tapeworm which

is adult in the dog. A common adult tapeworm of the human, has its larval or cyst stage in the flesh of the hog, causing what is called "measly pork."

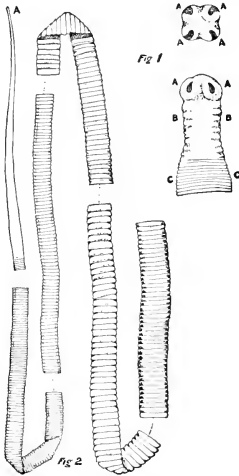

FIG. 49.—A COMMON TAPEWORM OF SHEEP (*Curticc.*)
Taenia expansa.

1. Head and neck; A, A, suckers; B, B, folds in neck; C, C, first segments.

2. Head and body, showing segments. A, head.

The adult tapeworm constantly forms new segments back of the small head. These segments mature while new segments are being added in front of them. The terminal segments, filled with eggs, separate and pass off with the manure, while the head remains attached to the mucous membrane and continues to produce new segments.

The *injury* to the host may be great or slight depending on the location—usually in the intestine—and number of worms. The worms may impair intestinal capacity and function by mere presence in large numbers. They may enter bile ducts and cause serious trouble. Some species have heads armed with hooks which irritate the intestine and thus impair digestion and absorption. They may produce and free to the intestinal contents, toxins or poi-

sons. The cyst stage may seriously disturb the invaded host organ, *e.g.*, the brain as in gid.

*Treatment*¹ can be useful only when given before weakness begins. Preparation for treatment is most important. Allow no dry bulky food for several days. Fast 12 to 24 hours, depending on age and previous feed. Then give 1 to 2 drams freshly ground arca nut in a small feed such as damp bran, or in a small quantity of thin sirup, so that each sheep gets its proper dose. Copper sulphate used as for stomach worms (see Lecture XXX) is also a satisfactory treatment, and may be used for both parasites at the same time. Follow this treatment in 3 or 4 hours by a physic.

¹ For sheep. Dose varies greatly with age and weight.

LECTURE XXIX

NODULE DISEASE OF SHEEP

General history.—The history of outbreaks is often as follows: Sheep have access during the summer and fall to low pastures or pond or well water that receives drainage from a sheep yard or pasture. Perhaps the grass was short and the flock was compelled to graze very close. During the winter the flock becomes unthrifty; some individuals grow thinner and weaker and a number die. A dead sheep is opened and the intestines show on the surface a large number of nodules about the size of garden peas, which are most common on the large intestine. As soon as grass comes and the sheep are turned out they begin to do better, and the disease seems to disappear.

Cause.—The disease is caused by a minute roundworm. Sheep are affected by two species but *Oscophagostomum columbianum* is the common species.¹ The adult worms are about three quarters of an inch in length and inhabit the intestines. The immature forms vary from one hundredth to one sixth of an inch in length, depending on development, and exist inside of the little nodules which constitute the most prominent features of the disease as seen on examination post mortem.

There is some question concerning the life history, but the eggs are apparently laid by the adult female in the intestine and as eggs or embryos pass out with manure, hatch outside, and gain entrance as embryos. The embryo worms find their way through the internal lining of the intestine, and locate in the bowel wall.² Here they give rise as foreign bodies to the little tumors or nodules, about the size of a pea, which nature throws around them, evidently in an attempt to fence them in. They cause irritation as foreign bodies, and this irritation will account for the little tumors which are found on the side of the

¹Cattle and hogs have each one species of nodule worm which does not affect sheep. In these the loss is unimportant.

²Dimock has found evidence which indicates that the eggs may be deposited within the intestinal mucous membrane and there hatch the embryo worms.

intestine; *i.e.*, the nodules. The contents of these nodules is usually cheesy, and greenish or yellowish in color.

Later the young worms leave the nodules and mature in the intestinal canal.

Some of the eggs and adult worms pass out with the manure, and thus infect the pastures and feed yards, ponds, or sluggish streams which receive their drainage.

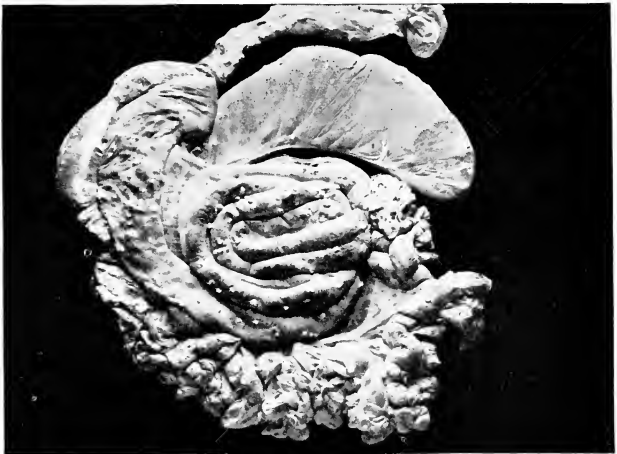

FIG. 50.—NODULE DISEASE. (M. H. R.)
Intestines of sheep.

Injury done.—The extent of injury to the individual sheep depends mainly upon the number of worms present, and the condition of the sheep as to vitality and resisting power. There may be something of an inflammation of the bowels while the young worms are passing through the lining of the intestine, but the main injury is that of starvation. So large a portion of the bowel is affected by the parasites when they are present in great number that there is not enough healthy tissue for absorption of food material. It may be, also, that the worms excrete poisonous substances; or their presence may lead indirectly to the formation of poisonous materials which are absorbed. A badly infested sheep may have plenty of good food

and yet be too weak to eat it, or if able to eat, he may still be starving because the intestinal wall cannot take up the food that may be ready for absorption.

Diagnosis.—This disease is rather common among farm sheep. There is diarrhea, debility, pallor of mucous membranes, and emaciation. Diagnosis can only be made certain by finding the characteristic nodules in an examination of the dead animal, for sheep infested with some other parasitic diseases show similar symptoms and conditions during life.

Treatment.—It is probable that but little can be accomplished by medical treatment, because the worms, during a large part of their life history, are walled up in these nodules and beyond the reach of any medical agent.

It is possible that worm-destroying medicines, like those recommended for stomach worms, if frequently repeated during the summer, might prove both curative and preventive, by killing the adult worms, which live free in the intestine. Pasture infection may be destroyed by plowing and cropping one season. Dr. Dalrymple and others have shown that lambs may suckle the diseased dams under certain conditions and usually remain free from infection. This is accomplished by what is known as the bare-lot method. Under this system lambs are not allowed access to any pasture that can possibly have been contaminated by the older sheep.

The bare-lot method provides that ewes and lambs must be kept in a lot that is bare of any grass or weeds which sheep may eat. This lot must be rather smooth and must drain promptly, without standing pools after rain. No grazing for the older sheep is permitted, the flock being fed on soiling crops and whatever grain may be necessary. Fresh, clean water must be provided. Food and water must be given in such a way that they cannot possibly be contaminated from the ground; food that falls out of the racks must be raked up rather frequently.

Ewe lambs to be kept in the flock should be raised with special care to avoid trouble the next season from chance infection that occurs to such lambs from the bare lot. By this method the lambs may run with the diseased ewes until weaning time with comparatively slight risk of infection. In dealing with a serious outbreak of this disease it should be remembered that infested flocks usually do fairly well during the summer and early fall months. If a flock is badly infested with nodule

disease, it will generally prove good management to nurse the flock through until spring, then depend on getting the sheep into shape for market during the summer, and sell out for butcher stock in the early fall. Such sheep are entirely fit for food purposes when in good flesh.

Prevention.—New sheep should be purchased from a flock that has been thrifty during two previous late winters and early springs, and they should be kept for two seasons on some other pasture than the one previously used on the infected farm. It will be better still if the flock can be kept part of the season on pasture and part of the season on plowed crops; *e.g.*, rape, sorghum, field peas, or meadow land that has not recently been used for sheep pasture. The new flock must not be allowed to drink from any pond or sluggish stream that has received drainage from the infested pasture or barnyard.

With a view to preventing this and other parasitic diseases, the flock should not be kept too long on one pasture, but should be moved from pasture to pasture; and from pasture to stubble fields, cut-over meadow, rape, etc. Sluggish streams and ponds should always be regarded with suspicion.

It is possible to practically rid a flock from the nodule disease by following this course of shifting the flock about for several years, plowing up pastures occasionally, and using plowed crops. The infectiousness of pastures has been shown by careful experiment in which infected sheep were placed on small pastures during a season and then during the next season sheep were kept on this same pasture which were previously free from nodule disease. Rapid infection of the second flock was secured in this way. The disease spreads from ewes to pasture and from pasture to lamb.

LECTURE XXX

STOMACH WORMS (SHEEP)

The stomach worm is an especially common and serious parasite of sheep, and this means much, for parasitic diseases of sheep are the serious ones. This parasite is very widespread especially in permanent grass pastures. It affects sheep of all ages and young cattle, but especially lambs. Older sheep showing no symptoms are the ones usually to blame for spreading the disease.

The parasite (*Haemonchus contortus*) which causes this trouble is a small, threadlike worm, perhaps an inch in length and so slender that it must be looked for carefully or one is liable to miss it. The individual worms are somewhat twisted and are found in the fourth stomach. Frequently they are in motion. If they are present in great numbers, the stomach contents near the mucous membrane may seem to be fairly alive and squirming. The worms vary from reddish to dirty white in color.

Life history.—This parasite is present in the stomach at all times of the year.

The eggs are passed off in the feces, hatch in 14 to 24 hours in warm weather, and reach the ensheathed embryo stage in from ten days to two weeks when conditions of temperature and moisture are suitable. Eggs and newly hatched embryos are very sensitive to freezing or drying, and easily die under these conditions. Ensheathed embryos are very resistant. We cannot depend on



FIG. 51.

Embryo of *Haemonchus contortus* coiled on tip of grass blade. Enlarged 100 times. (Ransom, B. A. 1., Circular 93.)

their natural destruction in much less than a year. They have been shown to be capable of infection after several months.

When the atmosphere is moist, embryos leave the manure or earth and crawl up the moistened blades of grass or similar objects, climbing only while there is moisture. If now they are swallowed by a suitable host, the embryo continues development for about three weeks, at which time the females may begin to produce eggs.

Symptoms.—There are no diagnostic symptoms by which this disease can be distinguished from other internal parasitic diseases of sheep. There is a gradually developing dullness, weakness, and unthrift. Lambs are affected more seriously than older sheep. These are usually unthrifty during the late summer, and some die during the late summer and fall. The most common and evident symptoms are pallor, loss of flesh, and weakness. The appetite is variable; affected sheep are usually dull, listless, and often have unusual thirst and diarrhea. There frequently appear swellings under the jaw.

To make a certain diagnosis it is usually necessary to examine the carcass of sheep recently dead or kill a sick one for this purpose. Examine very carefully the fourth stomach. If this stomach is opened at the top and contents allowed to rest quietly, the stomach worms, if present in sufficient numbers to cause trouble, will be seen in quite active motion, wiggling about like tiny snakes. They may sometimes be found in very large numbers close to the lining membrane as slender reddish worms varying from one half to about one inch in length. If the fourth stomach be emptied and the worms are present in large numbers, some may be seen attached to the mucous membrane.

Management of infected flocks.—An infected pasture may be safe after a year if there has been no use by sheep in the interval. Burning over a pasture is very efficient for the ground actually burned over. A pasture that has been plowed and cropped one season is usually safe. Freezing kills eggs and early stage embryos.

In dealing with an infected flock, we may treat both the lambs and their mothers, beginning with the ewes early in the season before the lambs are old enough to treat. The death loss may thus be prevented and the lambs do much better. It should be clear that there is no way of rapidly eradicating stomach worms

from a diseased flock. The rational hope lies in reduction and gradual eradication.

Low, wet pastures are to be avoided. Hillside pastures are much safer so far as internal parasites are concerned; and if possible permanent pastures for sheep should not be used on account of danger from many kinds of internal parasites. Frequent changes of grazing ground are desirable for any flock, and especially one infested with internal parasites. In case of stomach worms, the flock should move every two or three weeks on pastures, meadows, fields, sowed crops, etc.

Medical treatment.—Sheep intended for medical treatment should have no feed during 12 to 24 hours before the medicine is given. No matter which treatment is to be given, it should be tried on a few sheep before treating a very large number.

The Bureau of Animal Industry has done some careful experimenting in this line, and recommends *coal-tar creosote* as a satisfactory treatment. This medicine is not expensive and is very easily obtained and prepared but variable in quality. It is important to insist upon getting coal-tar creosote.

If reliable coal tar creosote can be secured give as a 1 per cent solution; that is, 1 ounce of the creosote to 99 ounces of water in doses proportioned to the age and size of the sheep. Lambs 4 months old take 2 to 4 ounces; older sheep take 3 to 5 ounces. If there is any reason to suspect the presence of worms in the intestines, then thymol should be added to the creosote treatment. The dose of thymol is from 30 to 100 grains. Each dose of thymol is to be added to the dose of creosote after the latter has been mixed and measured, and should then be given immediately. Only fresh crystallized thymol should be accepted.

Bluestone (copper sulphate) has been accepted as one of the most satisfactory treatments for this trouble, but it needs to be given in carefully regulated doses. Best results are secured from repeated doses every 4 to 6 weeks, from spring till frost. This medicine may be made up as follows: Dissolve 1 pound (avoirdupois) of fresh powdered bluestone in 12 gallons of water. For this treatment the animal must be kept off feed from 20 to 24 hours. The dose for a lamb 6 months old is 40 c.e.; sheep 12 months old, 60 c.e. (about 2 ounces); 18 months, 80 c.e.; 2 years 90 to 100 c.e.; calves 2 to 3 months old take about 100 c.e. When the bluestone treatment is used, sheep

should receive no water on the day that they are treated, either before or after treatment. For the first treatment of a badly infected flock, repeat once or even twice at ten-day intervals. Treatment is easily given with a metal dose syringe.

Drenching sheep.—For giving medicine to sheep, a drenching tube should be used, or a metal dose syringe, or a long-necked bottle. A very satisfactory drenching tube may be easily made with an ordinary tin funnel, which is inserted into one end of a rubber hose about 3 feet long and about one half inch in diameter. A piece of brass or iron tubing 4 to 6 inches long is inserted into the other end of the tube. The metal tube is placed in the animal's mouth between the back teeth; the funnel end is held at a convenient height and medicine poured slowly into it. It is better to give the medicine when the sheep is standing on its feet, because actual experiment has demonstrated that while the animal is in this position more of the medicine goes directly to the fourth stomach, where it is needed. The head must not be raised too high—not higher than level face; otherwise there is danger of passing medicine into the lungs.

Prevention.—Sick animals must be killed, or removed from the flock and confined where there is no drainage to the pasture or yard used by other sheep or cattle. Water should be taken from wells that do not receive surface drainage, from large lakes or from running streams, although stagnant pools are probably not so dangerous in this connection as is commonly supposed. The tank or trough should be high enough so that the water cannot possibly be contaminated from droppings. High and well-drained pasture is always safer than low pastures so far as internal parasites in general are concerned. Infected pastures should be burned over thoroughly and regularly for the purpose of destroying eggs and young worms.

It should be borne in mind that when animals are well fed and well nourished, they are better able to resist the invasion of any parasite.

LECTURE XXXI

VERMINOUS BRONCHITIS, NASAL GRUB, AND CATARRH

VERMINOUS BRONCHITIS

Cause.—This is a disease of the bronchial tubes and lungs, caused by several species of minute roundworms. The worms are similar in different domestic animals, but each animal has its own species. They vary from about one to three inches in length and are white or reddish to brown in color. There is little danger of infection from one kind of domestic animal to another. Sheep, goats, cattle, and pigs are subject to this disease. Older animals may be affected, but frequently carry the parasite without evident injury.

Life history.—The mature worms, eggs, and embryos are found in the bronchial tubes. Either eggs or embryos are deposited in the bronchial tubes. Some may be coughed up, then swallowed and pass with the manure. Future hosts take in the embryos with food or drink, usually grass. The young parasites then go to the lungs. Apparently, but the one host is necessary. Wet pastures appear to be favorable to the spread of this trouble. It is possible that the eggs or dried embryos may be inhaled directly with particles of dust. The parasitism remains long dormant, developing slowly. Embryos are very resistant and tenacious of life. Some species have been shown to survive for months as embryos in water or moist earth. If dried at certain stages of development, the embryos may revive in moisture after a year, according to one good authority.

Symptoms.—At first there is a bronchial catarrh; later a chronic anemia and pallor, with progressive loss of flesh and strength and with shortness of breath. There is a cough which at first is rather harsh, and later very weak. The cough is worse when animals are excited and when they move around. Sometimes small balls composed mainly of worms may be coughed out and actually seen. Respiration is difficult and in

some cases accompanied by wheezing. Calves are able to resist rather longer than sheep.

On examination post mortem there may be found masses of minute threadlike worms in the trachea and bronchial tubes, with a considerable quantity of purulent and viscid liquid in the tubes. Some lobules of the lungs may show very marked pneumonia. There may also be tubercles resembling those of tuberculosis, near the surface of the lungs, and also throughout the lung substance.

Treatment.—Treatment by injection of medicines directly into the trachea has been tried and recommended in some cases, but is very apt to prove unsatisfactory.

Benzine has been tried and reported successful. Inject about one dram (1 teaspoonful) slowly into the trachea. Use an ordinary hypodermic syringe and inject directly through the side of the trachea between two rings. The sheep must be held flat on the side at the time of injection and for five minutes afterward with the head as low as possible. It would be wise to treat but a few sheep at first and note results.

The most promising treatment at present is by chloroform. Inject one-half to three-fourths of a teaspoonful of chloroform into the nostrils with an ordinary medicine dropper. Hold the head up and close the nostrils for a while. It would be well to begin this treatment cautiously.

This treatment should be repeated two or three times at intervals of three to five days. Calves should have the same treatment with proportionately larger doses.

Prevention.—Change pastures often; keep sheep upon forage crops and upon frequently changed pastures. Avoid ponds, and well water which receives drainage from pastures, feed lots or barn yards.

NASAL GRUB—SHEEP (GRUB IN THE HEAD)

This is a very poor name for a disease, but is the only one commonly understood, and is used here for that reason.

Cause.—This disease is caused by the larvæ of a fly (*Oestrus ovis*). This larva inhabits the various cavities of the head which communicate with the nasal chambers. See figure 52.

Life history.—The mature fly resembles the well known bot fly of the horse, is of a dirty yellow or grayish yellow color, and

appears in the middle of the day, from July to September. Sheep become excited when the fly is around, and hold their noses to the ground or against each other, although the fly does not bite or sting. The young larvæ are deposited about the nostrils of the sheep from whence they crawl up into the various cavities of the head, including the horn cores, and may even reach the brain substance. They mature in about nine or ten months and escape from the nose during the spring and early summer. They then pass through another stage before the adult

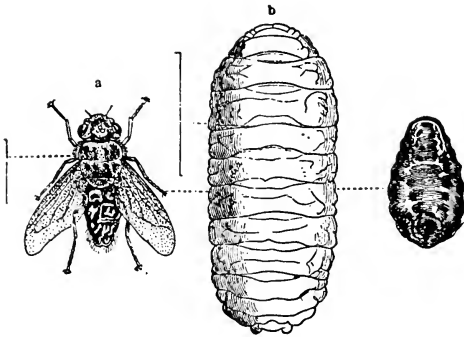

FIG. 52.—SHEEP GADFLY (*Estrus ovis*).

Commonly called "nasal grub." a, adult; b, larva; c, puparium.

fly appears, which occurs in four to seven weeks from the time the grubs escape from the nose.

Symptoms.—A few larvæ may not cause any evident disturbance. When present in larger numbers, the parasites cause great irritation accompanied by a marked catarrhal discharge from the nostrils. The affected animals may refuse to eat well and even cough. The sheep sneeze, shake their heads, and rub their noses and faces against their feet or other objects; sometimes there are attacks of vertigo, and the walk may be unsteady or irregular; severe cases may develop convulsions and die. The nasal mucous membrane becomes thickened and this, with the discharge, interferes with respiration. Such sheep are unthrifty on account of the constant annoyance. On examination post mortem, grubs are found in the various openings and chambers

of the head, and the mucous membrane lining these cavities is inflamed.

Treatment.—Medical treatment under ordinary circumstances is not practical; but much of the trouble may be prevented. Before the sheep are turned out in the morning, their noses may be smeared with tar or with a mixture of tar, turpentine, and fish oil. They may be forced to take their salt through a large hole bored in a log or a plank, tar being smeared around the edges of the hole so that when the sheep take their salt, they get tar around the nose and mouth.

CATARRH IN SHEEP

Sheep catarrh.—A form of catarrh is so frequently associated with nasal grub that it seems best to insert a brief mention of nonparasitic catarrh in this connection.

Simple catarrh in sheep is usually due to bacteria, after cold rains, imperfect ventilation, and damp quarters, or undue exposure after early shearing have made the sheep less resistant. In other words, it is a case of so called "catching cold." Many other cases of catarrh are due to parasitic invasion of the nasal chambers and head sinuses.

Symptoms.—The affected sheep are noticed to be sneezing and coughing with discharge from the nose and eyes. The nasal discharge is thin at first, gradually becoming thicker. Some cases become chronic, especially when the subjects are weak and unthrifty. The inflammation of the nasal mucous membrane may extend into the head sinuses, causing extensive collections of pus, and may also extend down the mucous membrane lining the trachea.

Prevention.—Nonparasitic catarrh is to be prevented, first of all, by abundant ventilation. Sheep are very frequently housed too closely in winter; the interior of the building becomes damp, and the conditions in general are unwholesome. Healthy sheep do not need much protection in the winter-time, so far as warmth is concerned. If they are well sheltered from cold rains, snows, and cold winds, they are most thrifty with abundant ventilation. Sheep that are shorn early in the spring need careful management for a time in order to prevent this catarrh, however.

Treatment.—Sick animals must have shelter which is dry, reasonably warm, and well ventilated. They must be well fed.

Their medicinal treatment should consist mainly of tonics; for instance, a simple, bitter vegetable tonic, like gentian root, which may be given in a powdered form in the feed two or three times daily—about one dram per sheep.

INFECTIOUS DISEASES

LECTURE XXXII

ACTINOMYCOSIS—OR LUMPY JAW

This disease is commonly called lumpy jaw or big head. It is characterized by the development of peculiar enlargements containing pus pockets, usually around the head. The disease may also affect other external parts and internal organs.

Cause.—The tumors and abscesses which characterize lumpy jaw have a common origin; namely the presence and activity of a form of higher bacteria known as actinomyces (*Actinomyces bovis*) aided by various common pus producing bacteria. When the abscesses are opened, there is usually found in the interior, thick glairy pus containing minute grains, usually yellow and sometimes very abundant. These small grains may be bedded in the diseased soft tissues of the tumors. Seen under a microscope, these grains appear to be composed of radiating filaments with club-shaped extremities around the border of the mass. In artificial media it forms long, slender threads, often branching. As the fungus multiplies and spreads the tumor growths increase in size. The tumors are usually very firm on account of the large amount of connective tissue which they contain. The interior is somewhat honeycombed, and the pockets are filled with characteristic pus containing the granules of actinomyces. Animals affected are chiefly cattle, horses, and sheep.

Relation to public health.—Human beings are evidently susceptible to inoculation from this disease, but as the affected parts of diseased carcasses are not commonly used as articles of human food, and animal meats as a rule are cooked before being eaten, there is ordinarily slight danger for human beings. The government meat inspection regulations pass carcasses which are but slightly and locally diseased, and condemn those which are extensively and generally diseased.

Parts involved.—The external parts commonly affected are the bones of the upper and lower jaws, soft tissues between the two branches of the lower jaw, and tongue. This disease some-

times affects the lungs and other internal organs, and may be mistaken for tuberculosis. The lung symptoms, as seen on examination post mortem, vary so much that it is rather difficult to describe them. Sometimes the lungs resemble those seen in ordinary bronchopneumonia. Considerable areas of the lung tissue may be changed to a gray mass, soft to the touch. In still other cases there are developed distinct abscesses with fluid contents.

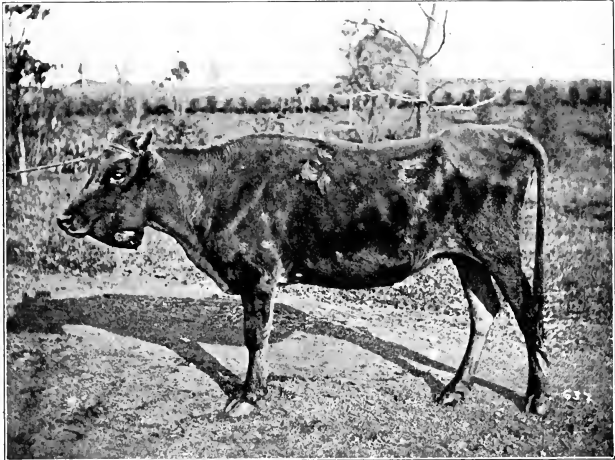

FIG. 53.—ACTINOMYCOSIS—LUMPY JAW. (M. H. R.)

Note the enlarged jaw and the raw, granulating tissue exposed.

This disease is usually of slow development. A small swelling appears somewhere about the head, perhaps under the tongue; or the bones of the face near the teeth begin to bulge slightly outward and the enlargements continue very slowly. The animal may remain thrifty for a long time, or indeed until the disease involves the teeth, tongue, or other organs and interferes directly with nutrition.

Prevention.—There is so little known concerning the life history of the parasite and the methods of infection that a study of prevention can be only partially satisfactory. It is generally agreed that animals develop lumpy jaw only after inoculation.

i.e., when the germs find entrance through some cut or scratch in the skin; through the mucous membrane of the mouth on account of diseased teeth; or through some abrasion of the



FIG. 54.—ACTINOMYCOSIS. (*M. H. R.*)
Inferior maxilla of cow shown in Fig. 53.

mucous membrane of the mouth, gullet, or stomach. It is also generally agreed that the parasite is usually taken in with the food. It is possible that this fungus may live through one stage of its development, and even multiply, upon the surface or in



FIG. 55.—ACTINOMYCOSIS. (*M. H. R.*)
A badly diseased upper jaw.

the tissues of some of the common fodder plants, particularly barley and rye. Direct inoculation from one animal to another usually fails to reproduce the disease.

An animal with a discharging abscess about the head would of course infect food in mangers, feeding troughs, and grass in the pasture, thus offering abundant opportunities for infection. Pastures wherein cases of lumpy jaw seem to develop rather commonly should be placed under cultivation for a time and animals with discharging abscesses confined or sent to market, it being conceded by all authorities that most of these carcasses killed under inspection are fit for food uses and should not be wasted by condemnation.

Treatment.—There are several possible lines of treatment: surgical, caustic, and internal medication.

Surgical treatment.—Removal by knife should be undertaken only by a trained veterinarian, on account of the large blood vessels and other important structures involved.

Caustic.—Destruction of the tumor mass by caustics, arsenic paste, for example is satisfactory in suitable cases, where there is time for a slow cure and the case is not far advanced. This work should also be done by a trained veterinarian. Deep hypodermic injections of tincture of iodine or of Lugol's iodine give good results in some cases. This iodine treatment causes large swelling and violent inflammation, which seems to react unfavorably upon the actinomyces.

Internal medication.—This treatment consists of the internal use of iodide of potash, given by the mouth either as a drench or in the drinking water. Lugol's iodine, by deep hypodermic injection into the tumor, may be combined with the internal treatment. Early cases may be treated in this way with a good prospect of success.

The dose limit is about one fourth dram per one hundred pounds live weight. This dose is given once daily until the animal seems to get off feed and discharges freely from the eyes and nose, indicating a catarrhal disturbance of these mucous membranes. The skin will also become dry, wrinkled and scurfy. Such conditions indicate that the treatment should be discontinued for three or four days. During this period a mild cathartic of epsom salts about one pound to 1000 pounds live weight, should be dissolved in water and given as a drench. The iodide treatment may then be continued for another period of six to ten days, when it may be necessary to discontinue again and give another dose of epsom salts. Treatment should be continued until the tumor is reduced to about one third of its

original size. It may as well be discontinued if there are no favorable results in 4 or 5 weeks.

The time required for successful treatment in suitable cases varies from four to seven weeks. It is not advisable to undertake the treatment of any case where there is evident bony enlargement, or where there is serious disease of the bony structure. Iodid treatment is liable to check milk flow and spoil the flavor of the milk.

LECTURE XXXIII

ANTHRAX¹

One of the oldest diseases known to medical science and one which is almost world wide is anthrax. It affects a wide range of subjects and is usually fatal.

Animals affected.—All of the domestic farm animals are more or less susceptible to anthrax. The disease is transmissible, and very fatal to human beings, chiefly by inoculation, but it may be taken by means of food or water, or by the inhalation of dried spores.

Cause.—Anthrax is caused by a microscopic rod-shaped organism or germ, the *Bacterium anthracis*. The rod stage of the organism is found in living blood, immediately after death, while the spore stage occurs outside of the body. The rod is more easily destroyed than is the spore. The spore may retain its vitality in surface soil, manure, infected foodstuffs, blood, hides, hair and wool of anthrax victims for long periods, and be capable of causing fresh outbreaks. A contaminated pasture for example remains infectious for years.

The period of incubation is probably short. In experimental animals it varies from one to five days.

No true toxin has been demonstrated for this virus; but *B. anthracis* may be present in the blood in such numbers as to block the capillaries. It also produces an enzyme which digests blood serum and destroys the red corpuscles.

Modes of infection.—(1) Dried spores may be inhaled and so reach the general circulation by way of the capillaries of the lungs. Human beings following certain occupations, as wool sorting, mattress making, etc., obtain infection in this way more often than do the lower animals.

¹ This lecture contributed originally by Dr. W. H. Dalrymple, of Louisiana, and later revised by the author.



FIG. 56.—BACTERIUM
(BACILLUS) ANTHRACIS.
(M. H. R.)

The specific cause of anthrax.

(2) When infection is introduced by inoculation through the skin, there results the condition known as external anthrax, carbuncular disease, inoculation anthrax, or malignant pustule. This may be occasioned by insects, especially of the blood-sucking varieties, such as the various horse or gad flies; probably, also, by some varieties of the mosquito. The infection may come through wounds made by infected instruments or utensils; or by wounds coming in contact with virulent material. In the Lower Mississippi Valley the external form occurs very frequently, and some outbreaks extend over considerable territory, among horses and mules, on account of the vast numbers of horseflies during the summer months.

(3) Infection may occur through the digestive tract. This internal, or intestinal, form of anthrax is generally produced by taking the virus in contaminated food or water.

Methods of introduction and spread.—Anthrax virus may be introduced by imported hides, hair, wool, etc., from foreign countries infected with anthrax. Fertilizing materials manufactured from animals affected with the disease may be a source of infection, also running water may become contaminated and spread infection along its course. The refuse water from tanneries has been known to disseminate infection from anthrax hides. Insects, after feeding upon infected blood and tissues, may carry the virus to healthy animals at a distance. Insects may probably, also, infect food materials in troughs and mangers, by conveying virulent matter on their bodies and feet. Carrion birds, through the medium of their excrement or soiled feet, may infect pastures on which they alight. Carnivorous and omnivorous animals, as dogs and hogs, running at large, after feeding upon anthrax carcasses, may carry away virulent blood on their feet; and if these animals themselves die, they become fresh centers of the disease.

Foodstuffs, as grass, cereal grains and their by-products, hay, etc., raised upon lands infected with anthrax spores, may carry those spores and spread the disease. Human beings coming in contact with virulent anthrax material, and having their clothes, shoes, hands, etc., soiled thereby, may spread the disease to animals. Neglect to properly dispose of anthrax carcasses is, perhaps, the factor most responsible for the continuance and spread of anthrax.

Period of incubation.—The time that elapses between infec-

tion and symptoms depends upon the method of infection and the amount of infective material introduced, and may range from a very few hours to several days.

Symptoms.—In *external or cutaneous anthrax*, there is swelling at the point or points of inoculation (carbuncle or malignant pustule), with considerable local edema (localized watery swelling). This is painful and hot at first, but afterwards becomes cold and insensitive. If inoculations have been made by insects, the carbuncles may be numerous over different parts of the body. The swellings extend in the connective tissue along the course of the lymph vessels and glands. This form is seen most frequently in the thinner-skinned herbivora—horse, mule, etc.

In *internal anthrax*, we have various types of the disease, especially a pulmonary or thoracic and an abdominal form. Symptoms vary accordingly and diagnosis even by an experienced veterinarian is not always easy. Some cases, especially the first ones, die very suddenly. The illness may last from a very few hours to several days. In general there are: sudden seizure, great depression, and prostration; rapid rise to high temperature; stupor; muscular weakness and twitchings; vertigo; hurried respirations; increased heart action; visible mucous membranes are hemorrhagic, dark red or a bluish red color or oozing blood; sometimes the coloring matter of the blood appears in the urine. Such cases usually terminate fatally.

External manifestations *in the hog* are usually confined to the throat; and there are generally other symptoms of a specific fever present. As a rule, death takes place from asphyxia. The hog becomes infected from eating anthrax carcasses; and the disease is most frequent in this animal during epizooties.

Course of the disease.—In isolated cases, in limited outbreaks, and in the early stage of an outbreak, the course of the disease is usually very acute and rapid; while, toward the termination of the outbreak, anthrax seems much less fatal, many of the affected animals recovering. Or, in other words, the virulence of the disease seems to become weakened toward the end of the outbreak, or the most susceptible animals die first and with acute cases.

Examination post mortem.—On account of the danger to the operator, and the risk of spreading the disease, through the infectivity of the blood, post-mortem examination of an anthrax

carcass is dangerous. It is therefore recommended only under very unusual conditions, when undertaken by an expert familiar with the danger incurred, and where possible spread of the virus can be controlled.

Diagnosis.—In carcasses of animals dead from anthrax, there is very rapid decomposition and bloating. The blood is dark and does not clot. Exposure of the blood to air does not restore its normal red color. The spleen is greatly enlarged. There may be bloody discharge from rectum, bladder, nostrils, etc. Severe inflammation of various internal organs, with local hemorrhages, is common in acute cases. Local swellings under the skin are not filled with gas, and do not crackle under pressure, as do those of blackleg.

Diagnosis is safest and most reliable by microscopic examination of a small quantity of blood from the extremities (ear of larger animals, or a foot of the smaller), verified by inoculation of laboratory animals with anthrax blood, and followed by microscopic examination of the blood of the inoculated animals.

Treatment.—Ordinary medical treatment appears useless in most cases.

Prevention.—Prevention by vaccination should be practiced annually in anthrax districts, or in sporadic outbreaks, as required, and is very important. There is a small risk of loss from vaccination anthrax; but the loss is less serious than risk from the disease.

There should be cremation of carcasses; very thorough disinfection of premises (stables, sheds, yards, etc.); drainage and cultivation of infected lands; destruction of horseflies, mosquitoes, etc.; drainage of pools and stagnant water where these insects breed or frequent; and effective live-stock sanitary legislation.

There are now three methods of vaccinating; (*a*) by single, reduced virus vaccine; (*b*) by serum with virus; (*c*) by double virus (reduced).

The serum-virus method should be used for horses and sheep, and for cattle, when the disease has already appeared in the herd. The single virus is not usually advisable. The double virus vaccine should be used for cattle when there is serious risk of infection, but the actual disease has not yet appeared.

Serum only should be given in affected herds, to animals of any kind showing fever and not in hopeless condition.

LECTURE XXXIV

SYMPTOMATIC ANTHRAX

Symptomatic anthrax is also known as blackleg, black quarter, etc. It is a fatal, infectious and enzootic disease of thrifty young cattle. It is apt to appear year after year on certain pastures or along certain valleys. Cattle more than two years of age are not usually affected. Sheep and goats are subject to this disease, but cases are rare. Attack and recovery gives immunity.

Cause.—A short spore-forming bacillus (*Bacillus chauvæi*) causes this disease. This bacillus produces spores and the spores are very resistant, being able to remain virulent in the soil for years—under favorable conditions. Infection usually occurs by inoculation, through the skin or mucous membrane; more commonly through the former. So far as it is known, this disease is not contagious by mere association. The period of incubation is short—about 3 to 5 days. Authorities are not fully agreed but *B. chauvæi* is apparently a producer of a virulent toxin.

Symptoms.—The symptoms are local, and general or constitutional.

Local symptoms.—There is usually a pronounced swelling involving the front or hind quarter, and occasionally the loin, breast or throat. It does not extend below the hock or knee. This swelling is characterized by crepitation as one passes the hand over it, due to an accumulation of gas in the loose subcutaneous tissues. An incision into the swelling reveals the presence of dark, frothy blood, with peculiar acetone odor. The swelling is not invariable. Some cases, especially those which appear at the beginning of the outbreak and die very suddenly, may not show the characteristic swelling.

Constitutional symptoms.—The constitutional symptoms are usually acute, and develop rapidly. The animal is dull and without appetite. It shows high fever and marked debility. The constitutional symptoms may last from one to three days, and the case usually terminates fatally. The fever may reach

106° or even 107° F. There is lameness in those cases which show local swellings of the front or hind quarters. Some cases are mild and misleading and diagnosis is not always easy. The duration of typical cases is from a few hours to several days.

Examination post mortem.—Examination of the carcass reveals a tumor filled with gas and dark, frothy blood with fetid odor. The spleen is normal, and blood from the general circulation is also apparently normal, clotting readily on exposure to air. In such features as normal spleen, normally clotting blood, and gas-filled tumor, the disease differs from true anthrax.

Carcasses decompose and bloat rapidly and dark frothy blood may ooze from the natural openings as in true anthrax. The muscles involved in the local lesions are very dark when first exposed to the air, and hemorrhagic conditions are common in the chest and abdominal cavities.

Prevention.—As soon as the disease appears, cattle under two years of age should be promptly changed to another and preferably higher pasture. If the young cattle have been on dry food, their food then should be changed. Such feed may be safely given to horses however. Blackleg carcasses should be handled like those of anthrax, to avoid scattering the virus of a serious disease.

Vaccination is now satisfactory and thoroughly practical. There are a number of commercial preparations on the market that are quite reliable. The federal Bureau of Animal Industry is supplying a blackleg vaccine, which is quite satisfactory. Method of vaccination depends upon the kind of preparation used. Directions usually accompany each shipment from any of the reliable makers.

VACCINATION

The vaccine.—The Bureau or government vaccine consists of a brownish powder furnished in packets of ten and twenty-five doses each. It is made from the muscle of animals affected with blackleg, and is prepared by drying the muscle and grinding and heating it to a temperature which lowers the virulence of the bacilli, but does not destroy them.

Preparation.—The needed outfit consists of a graduated hypodermic syringe of about 5 c.c. capacity; rather short, stout needles of good caliber, and sharp; a small mortar and pestle;

absorbent cotton for filtering, and a measure graduated for cubic centimeters.

All these must be sterilized by boiling, or otherwise, before using. The vaccine is prepared for use by emptying a given number of doses into the mortar, adding a few drops of boiled and cooled water, and thoroughly grinding. Then as many cubic centimeters of water, boiled and cooled, are added as there were doses of vaccine. This is well mixed, filtered in the funnel through loosely packed cotton, and the filtered liquid is used for the vaccination. The injection is made by hypodermic syringe on the side of the neck or back of the shoulder.

Dose.—The dose is 1 c.c. for yearlings and somewhat less for younger animals, down to .5 c.c. for calves.

Suggestions.—It is not usually necessary to vaccinate calves under six months nor over two years. If calves under six months are vaccinated, they may require revaccination next season. Vaccination should be given a few weeks before this trouble usually appears, as the disease tends to appear at approximately the same time each year. Vaccination should not be given to calves that are weak from disease or ill health, nor at the same time with, or soon after, any surgical operation like castration. There should be an interval of at least ten days after the latter operation. Calves that are accustomed to being handled may be vaccinated standing in the stable. Those that are wild must usually be thrown or confined in a chute.

There are several newer immunizing preparations now on the market: (1) *Aggression*, prepared by extracting juices from diseased tissue under pressure, filtering and preserving by phenol (carbolic acid); (2) *filtrate*, a filtrate from a laboratory artificial culture of *B. chauvavi*, and preserved by phenol; (3) *anti-blackleg serum*, from the blood of horses that have had a series of weekly injections of blackleg virus in large doses. This serum seems to have some curative value early in the case.

Treatment.—Medical treatment for this disease is not considered satisfactory or, as a rule, worth while. Prevention by vaccination is easily applied, inexpensive, and usually satisfactory.

LECTURE XXXV

BACILLUS NECROPHORUS INFECTIONS

Here we have a group of similar diseases, each due principally to *B. necrophorus*. Included in this group are: foot-rot of sheep, foul foot in cattle, lip and leg ulceration of sheep, canker sore mouth in young pigs, and necrotic enteritis of older hogs. In each case, the characteristic lesion is a local inflammation with a marked tendency to local necrosis, for example, an ulcer or a diphtheritic membrane.

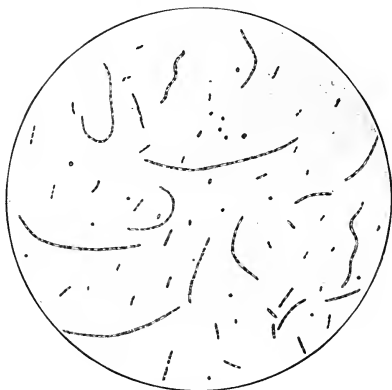

FIG. 57.—BACILLUS NECROPHORUS. (B. A. I.)
Coccoid, bacillary and filamentous forms.

Cause.—The principal cause of necrophorus infections is *Bacillus necrophorus*. A distinctive peculiarity of this bacillus is its tendency to destroy local tissue through its products.

This bacillus is associated with filth. It is apparently a normal inhabitant of the intestines of swine, and perhaps of other animals. Infection is therefore liable to come from manure or from contaminated soil, soil recently fertilized with hog manure, for example.

Infection occurs in all these diseases by inoculation, through wounds of skin or mucous membranes, as when little pigs are teething. The lesions produced depend on the point of inoculation, age and species of the animal, the virulence of the infection and the character of the associated bacteria.

Losses are often serious, especially in lip and leg ulceration, canker sore mouth, and foot-rot.

In dealing with any of these diseases, it is of the utmost importance that one be on guard for the first case. Prompt treatment with early isolation checks or lessens their spread.

FOOT-ROT

Foot-rot is a very old and familiar disease. It is often insidious at first, the appetite appearing good, and the lameness slight; but it must be taken seriously at the beginning, and treated promptly, lest it extend to the deeper structures and involve even the bone. Most outbreaks are infectious.

Cause.—A large percentage of these cases are caused by *Bacillus necrophorus*, which is commonly found in dirt and barn yard filth.

General symptoms.—This disease usually affects the feet and produces lameness, slight and perhaps in one fore foot only at first, between and above the claws. Later the lameness becomes severe. There is a discharge,



FIG. 58.—FOOT-ROT OF SHEEP.

A plain case.

with very offensive odor, and the hoof itself becomes rotten in places. Loose pieces are detached and the sole may be affected in the same way. The sensitive parts may be exposed in very severe cases with a development of profuse granulations. The skin above and between the hoofs is red, tender and swollen, and the toes are widely spread. The animal is lame and, of course, unthrifty.

The discharge is at first fluid and fetid. After one or two weeks it becomes cheesy and foul, and seems to destroy the horn and skin which it touches. In from twenty to thirty days the

claw begins to separate; there appears to be great pain; the sheep travels on its knees. Several months after the beginning of the disease, the claws may drop off in improperly treated or neglected cases.

Differential diagnosis.—It is necessary to distinguish between foot-rot and a very different disease which we know as “foot-and-mouth disease.” Foot-rot begins in the skin between the claws or at the crown of the foot, and slowly involves the wall and sole. It then spreads both as to surface and depth, involving the deeper structures of the foot. Foot-and-mouth disease may also begin with an inflammation of the skin between the claws or just above the hoofs. The skin becomes red, then small vesicles or blisters develop which rupture and later dry. In foot-and-mouth disease the whole hoof may loosen early at the crown, the inflammation involving especially the skin at the crown and sensitive parts under the wall and above the sole. In foot-rot the horn is diseased and separates in pieces. Foot-and-mouth disease affects several feet and perhaps the mouth and udder, also,—simultaneously. Foot rot usually affects one foot at first, and there is little or no fever in common cases, whereas in foot-and-mouth disease the fever is characteristic.

Foot-rot develops slowly, the animals usually eating fairly well for some time. This is not the case with foot-and-mouth disease, which spreads readily from sheep to cattle and swine. Foot-rot does not spread from one species to another.

Treatment.—Clean thoroughly between the toes; pare away all diseased horn and remove the loosened pieces. The hoof, if grown out of shape, must be trimmed to normal proportion. Excessive granulations must be cut away or removed by actual cautery, and be repressed by astringent measures or pressure bandages. Pledgets of tow may be dipped in tar and applied over the granulations, so as to bring pressure at the right point. Patients so treated should be kept upon clean dry footing, and serious cases should be taken up and kept in the yard or in dry stables. For astringent dressing, use tincture of iron, varying it from full strength to 1 to 4 dissolved in water. Four per cent carbolyzed tar makes a good application for cleansing and disinfecting and keeps out dirt. Medical treatment particularly the astringent should be very carefully applied, especially in the crevices and deeper recesses.

It is frequently advisable to treat a whole flock in a general

way. In that case the flock may be driven through a large pan containing a solution which is about four inches deep and the animals should be forced to remain in the pan for several minutes to insure thorough treatment. This solution should be made by dissolving copper sulphate in water in the proportion of one pound to a gallon of water, or use chlorid of lime solution made by dissolving one pound of fresh chlorid of lime to three gallons of water.

Separate the diseased from the apparently healthy. Treat the latter *first* and move these to a clean place, *e.g.*, new pasture. If any of these become lame, examine, and if found diseased, move them to the diseased flock. Repeat trough treatment several times for the sound flock at about two-day intervals. The diseased flock should have the same general treatment, repeated and continued as long as necessary. Trough treatment is satisfactory for both sound and average cases; severe cases must have individual hand treatment.

Prevention and management.—Diseased animals should be isolated from the healthy ones. Vigorous and repeated cleaning and disinfections of the infected premises are necessary to the proper control and must begin early. Any good coal tar dip in 5 per cent strength will do. Either very wet or very dry pastures may be favorable to the development of the disease. Hoofs should be kept pared to reasonable proportions. Cases of foot-rot should not be neglected in the earlier stages, for they are much easier treated then. They may be infectious, and careful treatment and attention may prevent a general outbreak.

FOUL-FOOT

This is a disease of cattle resembling foot-rot of sheep and is apparently infectious, and due in most cases to *Bacillus necrophorus*, which causes foot-rot.

Treatment.—Trim off diseased horn freely. It is sometimes advisable in the early inflammatory stages to poultice with bran or oilmeal, using powdered charcoal quite freely in the poultice. For mild cases, white lotion may be used once daily.

For more serious cases, use ten per cent solution of any good coal tar dip in glycerine once a day for two or three days, then reduce to a 5 per cent solution and use every other day for a week or two as necessary.

After trimming and cleaning, some cases are well treated, by swabbing freely with lysol, or full strength sheep dip, or some other disinfectants, and then drying and applying a powder like searlatone, or compound alum powder or calomel.

It is sometimes advisable to use a roll of tar-soaked oakum, pressed well up between the toes, and held in place by a tar bandage around the foot. Where new tissue seems to grow too rapidly, it may be repressed by means of small pads of oakum or tow, soaked with tar and bandaged firmly over the part that needs checking.

For astringent effect upon the granulations, tincture chlorid of iron, full strength or diluted as indicated to one fourth with water, may be used. Four per cent carbolic acid in tar is very useful, especially as it tends to keep out dirt and foreign matter.

LIP-AND-LEG ULCERATION

In this disease of sheep we again have local necrosis as the chief characteristic. This disorder may occur in connection with foot-rot.

Symptoms.—The chief symptom of this trouble is the ulcers upon the skin most commonly of the legs, or upon the mouth parts, especially lips and muzzle. The ulcers have dry crusts with a granulating surface beneath. They may invade the mucous membrane of the mouth or nostril, or even of the eye. There is often a considerable slough and an offensive odor. Some cases are slight and chronic; others, more severe.

Treatment.—Scrape off the dead and the spongy tissue, then apply to the diseased area either zinc chlorid or silver nitrate, 10 per cent in water, and repeat three times a week, or second, use an ointment of vaseline or lard, one hundred; sulphur, 10; any good dip, five. Under good treatment prognosis is favorable.

CANKER SORE MOUTH (STOMATITIS)

Canker sore mouth is also due to *B. necrophorus*, affects young pigs as a rule and older shoats occasionally. It is a troublesome, difficult disease to manage after there has been a general spread of the virus. Ground surfaces, floors, bellies of brood sows, etc., soon become contaminated with the infection. Many cases occur during the teething of young pigs.

Calves have a similar trouble (calf diphtheria) due to the same virus and characterized by patches of diphtheritic membrane in the mouth, nose, larynx, and even the trachea. The necrotic areas in calves are much larger than in pigs.

Symptoms.—Canker sore mouth is easily recognized by the small ulcers which are most common in the mouth or on the



FIG. 59.—LIP-AND-LEG ULCERATION. (*B. A. I.*)

Produced by artificial infection with *Bacillus necrophorus*.

skin near the mouth. They may invade the nose and adjacent cavities, and the trachea, and even extend to the intestines.

Prevention and management.—Keep brood sows and pigs away from the foot-rot of cattle and sheep and from what may be necrotic enteritis in other hogs. Avoid old pens and yards. In case of outbreak, only the most thorough cleaning and repeated disinfection will suffice.

When the season permits, it may be necessary to move sows and litters repeatedly to fresh grounds, and in some cases, it may pay to clean and disinfect the sow's belly before the pigs are allowed to nurse.

Treatment.—Both the affected and the suspected pigs should be dipped to the ears two or three times a day for several days in some good coal tar dip of 5 per cent strength.

In case of valuable pigs the individual ulcers may be cleaned and treated with 20 per cent silver nitrate, applied by a very small cotton swab.

NECROTIC ENTERITIS

Necrotic enteritis is an infectious inflammation of the bowels of older hogs, due to *B. necrophorus*. It is sometimes mistaken for hog cholera and is often a complication of that disease.

Symptoms.—Diagnosis in the living animals is difficult and uncertain. It may involve any portion of the mucous membrane of the digestive tube.

Autopsy shows the typical local necrosis involving this membrane,—typical ulcers and larger patches of diphtheritic membrane covered with yellowish, cheesy material.

There may be hemorrhages on the mucous membrane of the intestine, kidneys and other organs, resembling the hemorrhages of hog cholera. However necrotic enteritis is usually a slow disease and high fever is not characteristic as in hog cholera.

Treatment.—Present methods of treating necrotic enteritis are very unsatisfactory. There is as yet nothing to be positively recommended. Many cases are undoubtedly complications of hog cholera. In case of doubt, use hog cholera serum.

Prevention and management.—Infection occurs by inoculation; therefore, avoid feed and feeding conditions favorable to this virus and liable to produce the abrasion necessary to infections. The smallest scratch is sufficient for inoculation.

Various intestinal parasites may undoubtedly injure the intestinal mucosa, and permit infections. Treatment for the worms is therefore required as a preventive of this form of enteritis.

LECTURE XXXVI

FOOT-AND-MOUTH DISEASE

Foot-and-mouth disease is a very contagious disease, chiefly of ruminant animals and swine, but horses and other animals are susceptible to it. Some outbreaks are much more virulent than others. Many cases are so mild as to be difficult to recognize; but whether they are virulent or mild they are always a serious matter for the owner of the stock, even though no animals die, and a very serious matter for the public because of extreme ease and rapidity of spread, the great difficulty and expense of eradication and actual money losses incurred. Several outbreaks have occurred in this country due to importations, but they were eradicated and so far as known we have none in America at the present time.

Cause.—The cause is a filterable and apparently invisible virus. Little is known about it except as to its disease producing power.

Infection.—Usually takes place by way of the digestive tube.

Symptoms.—The symptoms are here given for cattle. Sheep and swine show, in general, similar symptoms.

Foot-and-mouth disease develops in from three to five days after exposure. Affected cattle are first noticed to be sluggish. They shiver and later on are stiff and lame, and inclined to lie down by reason of the sore feet. There is a profuse flow of the *saliva*, with frequent swallowing motions and smacking of the lips. The peculiar lesions of the foot-and-mouth disease are *vesicles* or small blisters affecting the mouth and the skin above and between the hoofs, and over the udder and teats. The vesicles soon break, leaving raw surfaces which, as a rule, heal, but sometimes remain as rather chronic ulcers. The skin and superficial tissues around the hoofs become inflamed and swollen; the *stomach* may also be involved; weight is lost, and the milk flow is checked. It should be remembered that the symptoms vary greatly in virulence in different animals and

different outbreaks, and one patient does not usually show all these symptoms.

This disease is not ordinarily fatal, but it causes very serious losses in the checked milk flow, a prolonged unthrifty condition, and seriously diseased feet. There is a marked fever, highest just before the eruption appears. Active symptoms of the disease last from eight to fourteen days. Disease of the skin around the hoofs often follows the mouth symptoms but the two may occur together. When the disease affects sheep and swine it is apt to involve especially the feet. Many cases are obscure and difficult of recognition. Others are severe and easily recognized. Some show no mouth symptoms and others no foot symptoms.

There are several diseases that are easily mistaken for foot-and-mouth disease. (See Foot-rot.)

Vesicular stomatitis affects horses and cattle. The mouth symptoms are similar, but there are no foot or udder lesions and horses are not apt to have foot-and-mouth disease. Hogs and sheep have foot-and-mouth disease, but not vesicular stomatitis.

Cow pox and *sheep pox* are of slow development and slow spread and show pustules after the vesicles. They rarely affect any parts except the udder and adjacent skin.

Dissemination.—The infecting virus may be present in yards, stables, and on the food or feeding utensils on infected farms. Even a road over which diseased animals have passed may be infectious. This disease may be disseminated in an indefinite number of ways, and is recognized as one of the most easily scattered of the infectious diseases. The infectious material is apparently present in the discharge from the vesicles, in the saliva, milk, urine, manure, and perspiration. The infection is probably obtained through the respiratory or digestive organs, usually the latter.

Prevention.—The prevention of this disease is simply the prevention of infection. Infected premises that have not been disinfected may remain infectious for an undetermined period. Until we have more positive information on this point, we may say that it will hardly be safe to risk exposure in less than a year unless the premises can be thoroughly disinfected.

This disease spreads rapidly; it causes heavy losses, and is difficult to control after it has become widely scattered. Any

reasonable suspicion of its existence should be promptly reported to the local health officer and every possible precaution taken to prevent spread.

Treatment is not advised. It is usually advisable to kill and burn every diseased and exposed animal on the farm. The owner is then reimbursed by the state and government.

LECTURE XXXVII

HEMORRHAGIC SEPTICEMIA

This group of diseases is important because of its many forms, and because medical treatment, so far as we know, is useless, and prevention is very uncertain. Those who have had a chance to study outbreaks have often been unable to trace any connection between one outbreak and another, or to trace a previous history for any given outbreak, except that local outbreaks on farms often follow the advent of stock from public stockyards. This disease is worthy of serious consideration, because it is widespread and fatal. It appears suddenly at any season, and under all sorts of conditions; a number of animals die, and the disease may disappear as suddenly as it came.

Etiology.—The specific cause of this disease in cattle is apparently *Bacillus bovisepiticus*. This is one of a group of very similar bacteria, which cause a group of similar diseases in different classes of stock, *e.g.*, chicken cholera, hemorrhagic septicemia of cattle and of sheep, swine plague, septic pneumonia of calves, **etc.** All are characterized by hemorrhages in the tissues or under the skin, mucous membranes or serous membranes. Infection may be caused by inoculation or through the respiratory or alimentary mucous membranes.

History and development.—The onset is usually sudden and unexpected, but in some outbreaks the onset is rather slow, and the cases are chronic. The period of incubation is probably only a matter of a few days. Season and climatic conditions apparently have nothing to do with the prevalence, virulence or disappearance of this disease. The death rate is usually high.

Symptoms.—Symptoms in the living animal are variable and uncertain. There are several fairly distinct types of the disease in sheep and cattle, and symptoms vary accordingly: Some cases are marked by superficial swelling, severe inflammation, and small hemorrhages of the mucous membranes of the eye,

nose, or mouth. Other cases show symptoms of pneumonia with pleurisy—difficult, hurried, and painful respiration and fever. Calves frequently have this type of the disease. Some cases show abdominal pain, high fever, and abnormal movements; and their attitudes indicate abdominal discomfort. In the writer's experience, the temperatures have been either normal or subnormal except where they rose rapidly just before death occurred.

Local changes which correspond to the swellings of anthrax

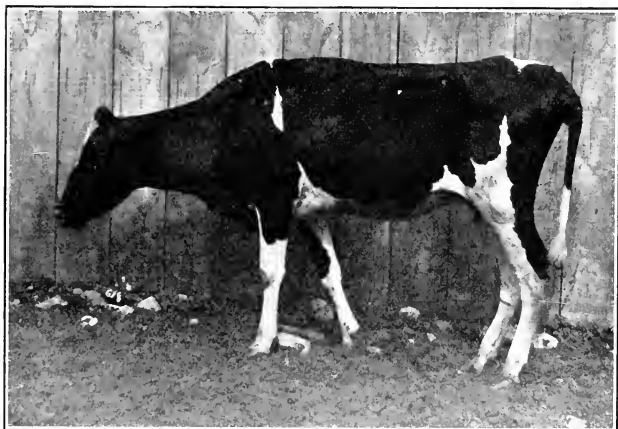

FIG. 60.—HEMORRHAGIC SEPTICEMIA. (M. H. R.)

Meningeal type. Cow stupid. Early stage.

and symptomatic anthrax are occasionally present; usually, however, they are either limited or else wanting.

The urine in some cases is scanty or blood-stained, and this is also true of the bowel discharges.

Many cases of hemorrhagic septicemia, particularly those occurring in cattle, are of the meningeal, or nervous type. In this type of the disease, some cases early show an extreme nervous disturbance, while others develop such symptoms gradually. Cows which have given a normal flow of milk in the morning may give practically none in the evening; they are otherwise apparently normal. There may be no rise of temperature; and

no evidence of pain or discomfort. Later when they attempt to walk, the gait is more or less irregular, resembling very much the gait of milk fever in its early stage. The symptoms¹ during the first 24 to 36 hours are not marked, except that dullness, staggering gait, and cold extremities continue. The skin is harsh and lacking in sensation.

Still later diarrhea often appears and nervous symptoms become more pronounced. The inability to walk naturally is

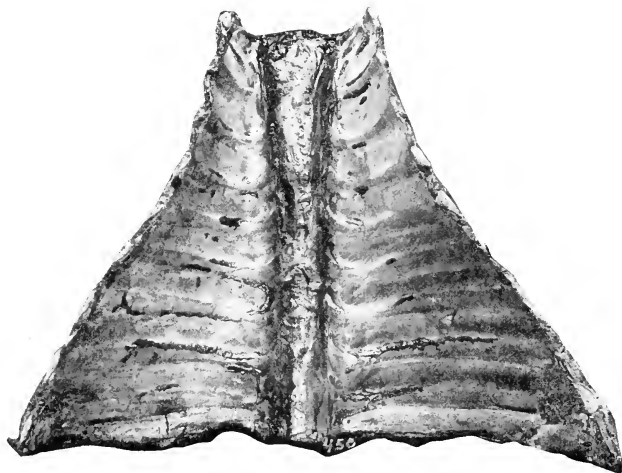

FIG. 61.—HEMORRHAGIC SEPTICEMIA. (M. H. R.)
Hemorrhages on costal pleura.

continued; the neck may be bent to one side, and the muscles, particularly of the face and neck, are spasmodically contracted. The sick animals may remain quiet, moving around very little; but the eyes have a wild expression, and there may be a nervous chewing motion with profuse flow of saliva. The temperatures are often normal or even subnormal.

Later still there often appears intense nervous activity. The eyes become more wild and unnatural; the grinding of the jaws grows more active and more constant; the convulsions of face

¹In case of young calves, these cases may be characterized by profound nervous disturbance very early in their histories.

and neck muscles become more intense; then gradually a period of intense restlessness and activity, and death.

Examination post mortem.

—The blood is apparently normal.

Subcutaneous hemorrhages are common and vary greatly in size and intensity. In some cases they are large and the hemorrhagic condition is marked; in others they are minute, scattered, and few in number. They may appear almost anywhere in the subcutaneous tissues, or involve any of the internal organs; and they usually have sharply defined borders and are easily recognized as hemorrhages.

The *spleen* is not enlarged, but there may be hemorrhages on its surface.

The *serous and mucous membranes* frequently show small hemorrhagic areas, and the *heart*, especially its auricles, is often intensely hemorrhagic.



FIG. 62.—HEMORRHAGIC SEPTICEMIA.
(M. H. R.)

Hemorrhages on endocardium (internal lining of the heart).

DIFFERENTIAL DIAGNOSIS

It is very important to distinguish between blackleg and hemorrhagic septicemia, because we have no demonstrated vaccine or serum either preventive or curative and no medical treatment for hemorrhagic septicemia, whereas blackleg can be easily and cheaply prevented by vaccination.

In both diseases, death is liable to occur suddenly, but blackleg commonly affects only cattle under two years of age, and rarely young calves; whereas hemorrhagic septicemia affects all ages indiscriminately. High temperatures are characteristic of blackleg, but not of hemorrhagic septicemia. Pronounced swelling of the front or hind quarter is characteristic of blackleg, although in some cases which die very suddenly there may be no

noticeable swelling. Swellings of this kind are not characteristic of hemorrhagic septicemia, and when present are small. Blood taken from a blackleg swelling is dark and frothy, and has a peculiar odor. This does not apply to hemorrhagic septicemia.

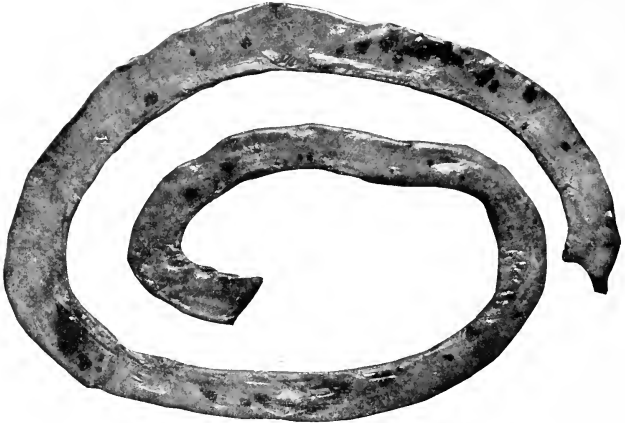

FIG. 63.—HEMORRHAGIC SEPTICÆMIA. (*M. H. R.*)

Hemorrhages (dark spots) on peritoneal surface of intestine.

Blackleg carcasses bloat rapidly; the others do not. The students should compare hemorrhagic symptoms with anthrax also, and note the characteristic differences.

LECTURE XXXVIII

TEXAS OR TICK FEVER¹

This disease passes under a variety of names, such as acclimation fever, red water, bloody murrain, etc.

Economic importance.—The seriousness of tick fever as a disease of cattle, and its bearing upon the southern cattle industry, was not realized until recent years.

Causes.—It has been established that the disease is caused by a microscopic animal parasite, a protozoan (*Piroplasma bigeminum*) which attacks the red corpuscles of the blood. Its multiplication in the blood is rapid and its effects are destructive, involving especially the red blood corpuscles, which it destroys rapidly.

Transmission.—So far as known, the only natural means of transmitting the causative agent of this disease is the southern cattle tick (*Margaropus annulatus*). Other species of ticks attack southern cattle, but this is the most common and is the only one responsible for transmission of the Texas Fever parasite.

The ticks do not carry the protozoan directly from one infected animal to another, but the female ticks develop on infected animals and then transmit the *Piroplasma* in some form to their progeny, which carry it to susceptible animals.

Susceptibility.—Bovines alone seem susceptible to the disease, although the tick, which carries the infection, occasionally infests horses and mules. Calves at birth as a rule have a high

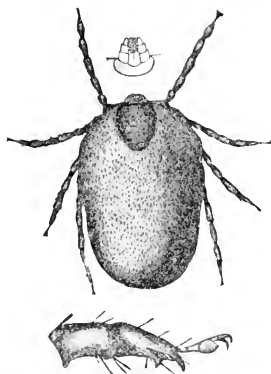

FIG. 64.—TEXAS FEVER TICK.
(Pettit.)

Female engorged. *Margaropus annulatus* (Riley).

¹ This lecture contributed by Dr. Tait Butler.

degree of immunity; but this immunity is gradually lost until at two years of age nearly all are highly susceptible to the disease. Cattle reared in the southern states on tick-free pastures are as susceptible as those raised in the North.

Period of incubation.—Tick fever usually develops in from eight to ten days after direct inoculation of a susceptible animal with the blood of one infected, or that has acquired immunity from a previous attack. When infection occurs in the natural way, a variable time elapses between exposure to tick infestation and the development of the disease. In some cases no evidences of the disease can be detected before from fifteen to thirty—or even ninety—days after exposure. However, a large percentage of cases develop within ten days after inoculation.

Symptoms.—It is frequently stated that tick fever occurs in acute and chronic forms. The chronic form, however, often follows the acute, and appears months after the acute attack. These relapses or secondary attacks are not uncommon in the late fall and early winter. It is then difficult to distinguish them from ordinary debility from other causes except by the history of a previous attack or by an examination of the blood.

Fever.—In the acute type of the disease an elevation of temperature is usually the first noticeable symptom. A temperature of 107 degrees or 108 degrees F. is not unusual, but when it reaches 105 degrees or 106 degrees, other symptoms usually become apparent. While there are considerable fluctuations, temperature generally remains high during five to seven days and may then drop suddenly to normal or below. Many animals die during the extremely high temperature, or, if the temperature falls, it is only as a prelude to death. The period of subnormal temperature is a dangerous one, and collapse should be fortified against; otherwise an animal may succumb that might by proper treatment have been saved.

Other symptoms.—The patient usually stands apart from the herd with head down and back arched, and in severe cases, or when death approaches, it may lie or fall down. The pulse and respiration are hurried. The urine may be highly colored as port wine, or almost black, especially in fatal cases and when near death. The red coloring matter from the red corpuscles, which are rapidly destroyed by the blood parasites (*P. bigeminum*). Other diseases producing bloody urine are rare among

cattle in this country. At first the bowels are constipated, but later diarrhea is not uncommon. The mucous membranes are usually pale and sometimes slightly yellow. As death approaches and the symptoms become aggravated, the animal usually remains down. Occasional periods of excitement, or even convulsions, may occur.

The ticks are usually to be found on the tender parts of the skin, such as between the hind legs, on the escutcheon, on the inside of the elbows, or on the brisket, which is most exposed. Since the disease may develop within ten days after ticks attack the animal, and this time is not sufficient for them to become larger than twice the size of a pinhead, it will be readily appreciated that to find the ticks is not always an easy matter, especially if they are not numerous.

Post-mortem appearances.—Only in animals that die during an acute attack are the changes well marked, and of those just the more pronounced will be given. Other changes may be seen, but they are often slight, or else absent. Small *ticks* on the parts mentioned are very significant. The *blood* is very thin and watery.

The *subcutaneous tissue* may be slightly yellow and infiltrated with yellow-colored serum.

In cases that succumb during the height of or just after the subsidence of the fever, the *spleen* is much enlarged and dark colored. When held up by one end, the contents of the capsule will tend to gravitate to the lower end. When cut it is found to be black, soft, and engorged with blood.

The *liver* is enlarged, yellowish, and usually mottled in color, due to bile-injection. The gall bladder is distended with bile, which is dark colored, thick and ropy.

The *kidneys* are usually engorged and dark, and the bladder contains urine varying in color from slightly red to almost black.

Treatment.—Treatment usually proves unsatisfactory, and the results scarcely justify the expense and trouble which it entails, except in very valuable animals, and in mild cases. The whole herd should be moved to non-infested ground and the ticks removed at least from the sick animals. During the first stages, when constipation is present, a purgative of about one pound of Epsom salts may be given. The salts should be followed by quinin 30 to 90 grains or an equivalent four times a day. If

the temperature drops to normal, or below, stimulants should be used freely for a short time and be followed by iron and strychnin until convalescence is established.

When the first case appears in a herd, all other animals that have been similarly exposed to tick infestation should be removed from further danger of such exposure, and thoroughly greased. Any cheap, nonirritating oil will do, but if it be one fourth kerosene, it will be more effective. When a dipping vat is available, dipping in the arsenical solution, now used in tick eradication, is preferable to local treatment by oil. In this way an outbreak can usually be cut short, and the losses reduced very considerably.

Prevention.—Immunity to tick fever in mature animals, so far as we now know, can only be secured through an attack of the disease. Cattle raised on tick-infested pastures have been rendered immune by mild attacks of the disease while they were young and before they became fully susceptible. If it is true that immunity can only be secured through an attack of the disease, it follows that the only preventive is the exclusion or eradication of the tick.

The ticks on any pasture or farm may be easily and quickly eradicated, and the farm maintained free from them. Hence, it is possible, if not yet practicable, to exterminate these parasites over the entire South and maintain the country tick-free.

METHODS BY WHICH TICKS MAY BE ERADICATED

1. Keep all cattle, mules, and horses out of the tick-infested pasture, lanes, and lots for one season, or, at least, after September 1, and the ticks will be exterminated by May of the next spring. Or,

2. Divide the pasture by a fence, with a rail or board tight on the ground or make a double fence—two fences 10 to 20 feet apart,—and keep all cattle, mules, and horses out of one half, this year after September 1; and out of the other half next year, and the work of eradicating the ticks will have been accomplished. Or,

3. Dip all cattle in the standard arsenical solution once every 14 days from early spring until late fall. If this is done regularly and thoroughly the ticks will certainly be eradicated in one season.

Life history.—The methods just given are based on the following facts concerning the life history of this tick: the full-grown female tick drops off the cattle when she becomes engorged with blood. Her heavy body and small, short legs make crawling difficult, so she gets under the dry grass, or “trash” close at hand. Within a few days she begins laying eggs, and lays from 1,500 to 2,500 during the next two weeks. In warm weather, under favorable conditions, these eggs hatch in two or three weeks. The period may be prolonged for eight weeks, or indeed, the hatching be prevented entirely, if the weather is sufficiently cold.

The young ticks are very small when first hatched, being scarcely visible. They crawl up the grass, weeds, or small twigs, and there wait for the cattle to come along. If no cow, mule, or horse comes along for several months, these small ticks die from starvation, for they have no other known means of obtaining food for development. If the young ticks succeed in lodging upon the skin of a cow, then in three or four weeks (and in cold weather much longer) they reach their full growth. The females, being engorged with blood, drop off and begin laying eggs as did their mothers.

Neither old nor young ticks crawl far, hence a fence with a bottom rail or board on the ground will stop them, but wire fences do not always afford protection.

Ticks do not crawl from one animal to another.

Eggs laid during the cold weather of late fall and early winter do not hatch, but go through the winter as eggs and hatch when warm weather comes in the spring.

All eggs laid before September 1 will probably hatch the same fall, and, therefore, the young ticks will be killed by the cold winter weather or starve to death before spring.

Vaccination.—Not only does tick fever kill hundreds of thousands of dollars' worth of Southern cattle every year and depreciate the value of all those marketed from one fourth to one half cent per pound live weight, but it also offers the greatest existing barrier to the improvement of the quality of cattle in the tick-infested area by rendering the importation of pure-bred animals for breeding purposes extra hazardous and expensive.

For the purpose of conferring immunity on imported pure-bred or other cattle, a method of inoculation has been found practicable which very greatly reduces the otherwise heavy loss.

*Method.*¹—The usual process consists in drawing blood from the jugular vein of an animal (not less than two years old) that was infested with ticks the preceding summer, and injecting it under the skin of the animal to be inoculated. This will produce tick fever, usually in a mild form in from three to ten days. Not more than about three per cent will die from this inoculation if the subjects have been selected with proper care and are judiciously handled. About 5 to 7 per cent are imperfectly immunized.

The dose varies from 1 to 3 c.c., depending on the age of the animal. Young cattle take the larger dose and older cattle the smaller. Cattle that do not show plain reaction, fever, depression, etc., should receive a second or even a third treatment, each dose being 50 per cent larger than the preceding and given at intervals of about 40 days. Young cattle less than one year old may be immunized by the use of young seed ticks but this method is not recommended where the blood-inoculation method is available and is not at all suitable for older cattle.

Important conditions.—The animals should be between six and fifteen months old. Older cattle may be treated, but they are less conveniently handled and results are less satisfactory.

The inoculating should preferably be done during December, January, or February, for tick fever is less severe in cold weather.

All ticks should be kept off the inoculated cattle for about 60 days or until they have fully recovered from the inoculation fever.

The inoculated cattle may then be protected for a time from gross tick infestation by having their legs and under parts of their bodies greased. A few ticks after the cattle have fully recovered from inoculation are useful as they reinforce the immunity.

Inoculated animals on infected premises should be infested with the first crop of ticks appearing in the spring, for these are probably less virulent than those hatched in the fall, and therefore produce a milder type of disease.

In the opinion of the writer the best method of introducing pure-bred animals for improvement of the native stock is to

¹See also Federal Bureau of Animal Industry and State Agricultural Experiment Station bulletins on Texas Fever for additional details of vaccination.

import calves that are under four months of age and allow them to become immunized by tick infestation, as occurs with our native-born stock. But since the eradication of the ticks is now such an easy matter, the only practical method of dealing with tick fever is to prevent it by complete eradication of the ticks.

LECTURE XXXIX

TUBERCULOSIS

The importance of the tuberculosis question is evidenced by its widespread prevalence, human susceptibility to bovine infection, great financial losses, direct and indirect, and its disturbance of breeder's plans.

Prevalence.—Tuberculosis is one of the most widespread and universal diseases affecting either humanity or domestic ani-

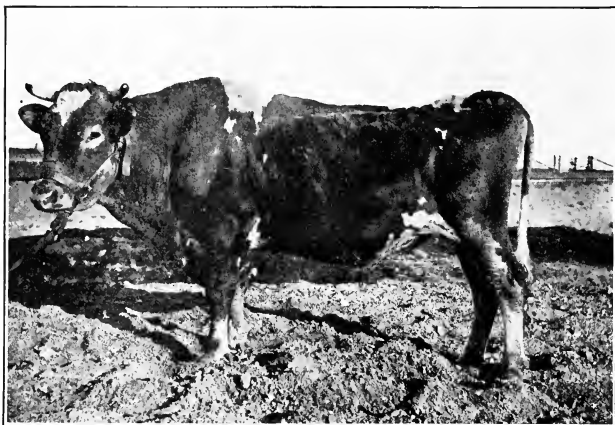

FIG. 65.—BOVINE TUBERCULOSIS. (*M. H. R.*)

A case showing plain symptoms of disease. Rare type.

mals. It affects all of the domestic animals. Prevalence is greatest in the various classes of animals in the order named: cattle, hogs, horses and sheep. Chickens are also quite susceptible to avian tubercle bacilli.

Cause.—No fact in medicine is better established than that tuberculosis is caused by the *Bacterium of tuberculosis*. We cannot have tuberculosis without these germs, and it is prob-

able that few people or domesticated animals can be placed under continued exposure to the germs without ultimately having the disease. Predisposing conditions undoubtedly have much to do with its development—close confinement, lack of exercise, lack of ventilation and sunshine, and injudicious inbreeding, for instance, but these alone cannot cause it.

Modes of entrance.—Germs of tuberculosis enter the body (1) through the lungs, with inhaled air; (2) through the

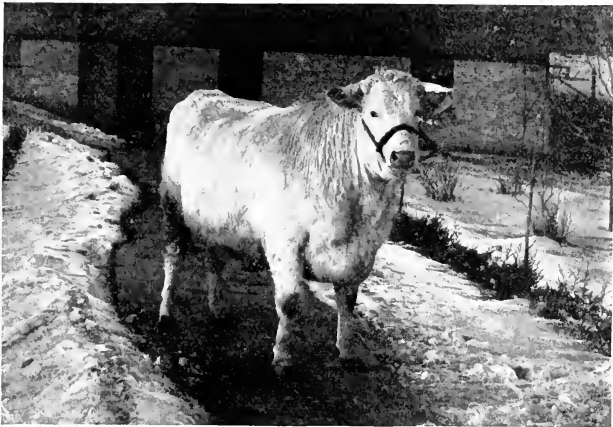

FIG. 66.—BOVINE TUBERCULOSIS. (M. H. R.)

A famous show steer, in prime "condition." Liable to be as badly diseased as the preceding.

stomach and intestines, with food and drink; (3) through broken skin or mucous membrane by inoculation; (4) by infection in *utero*, *i.e.*, before birth. The latter is of very rare occurrence and of small importance.

Structures affected.—Tuberculosis may affect almost any tissue or organ of the body. Milk from tuberculous cows may be tuberculous; but the danger is especially great when the udders are affected. Statistics indicate that about one cow out of every four and six tenths (1:4.6) of all tuberculin reacting cows, give virulent milk.

The extent of tissue diseased may vary from a small lesion

in a small lymph gland to a general invasion of lungs, liver, kidneys, mesenteric glands, peritoneum, and pleura.

Symptoms.—These vary according to extent and location of the disease and are in general unreliable and indefinite. A few cases become thin and rough in appearance, have a chronic cough or chronic diarrhea, and show general debility. The great majority show no symptoms, and may appear to be in the finest possible physical condition. There are a great many

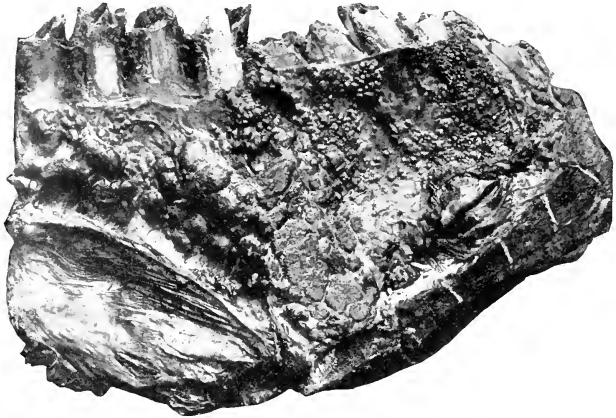

FIG. 67.—BOVINE TUBERCULOSIS. (M. H. R.)

A great variety of tubercles on the chest lining (costal pleura). Sternum below, broken ribs above.

mild or latent cases, having but a small amount of diseased tissue, and the animals may live for many years in apparently good condition. On the other hand, they may succumb to a sudden development of the disease following any condition which produces debility.

When the *lungs* are involved, there may be a persistent cough, shortness of breath, pallor of visible mucous membranes, loss of flesh, and unusual sounds in the lungs.

When *intestines* and mesenteric glands are affected, there may be chronic diarrhea with slow and persistent loss of condition. All these diagnostic symptoms may vary greatly and are often unreliable; *e.g.*, a cow may be in good flesh, her hair

and eyes bright, and yet be extensively diseased, and die in a short time.

Diagnosis.—The only reliable test, practical on a large scale in routine work, is tuberculin, which is very accurate but not infallible.

There are three recognized tuberculin tests (see Lecture XL), all of which are useful.

Medical treatment.—Medical treatment is not practical. It is advisable to destroy or isolate diseased animals at once. Very



FIG. 68.—BOVINE TUBERCULOSIS. (*M. H. R.*)

Tubercles on the great mesentery.

valuable animals may be kept in isolation and used for breeding purposes with good results when considerable added expense and work are justified.

Prevention.—Stockmen should breed and manage with a view to increasing physical vigor. Bear in mind that an animal may have a fine physical appearance and yet be easily susceptible to disease, if not actually diseased and a spreader.

The practice of keeping cattle almost continuously in the stable does not harmonize with plain teachings of physiology, and the results must sooner or later be disastrous. The great law of animal life, that use begets strength and idleness begets

disease, applies to lungs as well as to muscles, and must always hold true. Domestic animals cannot remain generation after generation healthy and vigorous without a reasonable amount of exercise, sunshine, and fresh air. Nature's laws cannot be violated without paying an inevitable penalty.

It is unwise to buy cattle for breeding purposes without knowing that they are free from tuberculosis and this implies first of all dealing with an honest breeder. Tuberculin tests of cattle from an unreliable breeder or jobber are of little value. All sires—this is especially true of cattle—should have abundant exercise in open yards or on treadmills, or be driven or worked. Ventilation must be thorough, and barns should be constructed with a view to allowing the entrance of abundant sunshine. Sunshine kills germs.

The student must not gather from this statement that a herd may not be badly diseased in an ideal stable if tuberculosis spreaders are put into it, nor that good sanitary conditions will clean up a diseased herd. There is abundant proof to the contrary. Such stables are safer and spread of infectious disease must be slower than where conditions are bad.

Summary.—Do not found a herd with tuberculous stock. Do not introduce the disease while trying to improve a herd. Do not allow suspicious animals in stable with healthy ones. Avoid close confinement. Allow plenty of fresh air, exercise, and sunshine to breeding stock.

All breeding cattle should be bought under tuberculin test, from a sound herd and a reliable breeder. Do not buy even on test from a tuberculous herd, or from a herd that has recently been badly affected.

Disposition of tuberculous cattle.—Abundant experiments have demonstrated that healthy calves can be raised from tuberculous cows, and from tuberculous sires. In case of unusual value or breeding, it is sometimes practical to free a herd from tuberculosis by breeding out the disease, instead of by immediately killing all diseased animals. Animals which the owner does not think it advisable to keep in quarantine, at an increased expenditure of time and money, should be slaughtered. It is generally recognized that tuberculous animals should be slaughtered under inspection and many carcasses should be passed as fit for food purposes.

Tuberculous cattle retained for breeding must be kept in a

separate stable—preferably on a different farm. They must not be watered at the same tank as healthy cattle, nor fed from common mangers. The danger in allowing tuberculous and non-tuberculous cattle to associate in the open air, is less than in a stable; but this disease undoubtedly spreads in the open air.

Accredited herd plan.—Every stockman should know about the accredited herd plan.

This is a common movement over the United States by which state and federal authorities are coöperating to free breeding herds from tuberculosis.

Such herds are officially published as tuberculosis-free and the owner receives a certificate to this effect from his state and the federal government.

Requirements of the plan at the present time are, in general, two negative annual tests or three negative semiannual tests of the entire herd.

The owner first signs an application and agreement; his herd is tested (at public expense, in some states), until it becomes accredited. Thereafter it must be regularly tested each year by a private veterinarian at the owner's expense. This veterinarian must have passed a certain official examination.

The advantages to the breeder of being on this list are obvious: advertising and reputation, shipment interstate, advance compliance with laws and regulations concerning sale of pure-bred cattle for breeding purposes, and aiding in eradication of the disease at the fountain source of dissemination.

There is, as a rule, more tuberculosis among pure bred cattle than among grades, and the general movement of the pure bred is from herd to herd whereas the grade moves from farm to killing floor.

Fortunately, the prevalence of tuberculosis among pure-bred cattle is now being reduced and the near future may see the figures reversed as between pure-bred and grade cattle.

The following figures will give the student an appreciation of the volume of this new movement for accredited herds. On February 1, 1922, there were 12,157 accredited herds in the United States; 104,467 herds which had had the first negative test; 18,956 on waiting lists and a total of nearly 143,449 under joint state and federal supervision. Minnesota leads in clean herds at this date (February 1, 1922) with 1310 accredited herds and 2256 other herds with first clean test.

LECTURE XL

THE TUBERCULIN TEST FOR TUBERCULOSIS

Tuberculin is usually seen in tablets or as a straw-colored fluid, slightly more viscid than water.

The active ingredients of tuberculin are chemical products of the bacilli of tuberculosis. A certain broth is infected with the virus of tuberculosis, which is allowed to multiply and grow in this medium until it has become charged with the germ products. The whole fluid is then heated to kill the bacteria and filtered through porcelain. Tuberculin should therefore be not only germ-free, but heated to a high temperature, and cannot be infectious.

Effect on cattle.—Careful experiments have demonstrated that tuberculin has no important effect, favorable or otherwise, upon the health or milk flow of sound cattle; and that the effect on tuberculous cattle is not objectionable. An experiment was conducted by the author at the Minnesota Experiment Station some years ago, which included 23 sound and 5 tuberculous cows, and compared the total milk flow and total butter fat of each animal and of the herd for the week prior to test with the week of test. In this experiment the cattle were given ordinary handling, neither very rough nor unusually gentle.

There was a moderate decrease in the milk flow during the two days of test, not more than could be easily accounted for by unusual handling of the cattle and the presence of strangers. This decrease was almost made up during the succeeding five days. There was a slight increase of butter fat during the week of test. Both variations were easily within the limits of normal variation.

The experiment with the five tuberculous cows produced about the same results, the difference being easily within the limits of normal variations, as neither the total milk flow nor total butter fat for the entire week was materially affected by the test. Similar experiments have been made elsewhere, the results agreeing closely with this general statement. It is undoubtedly pos-

sible for cattle to be so roughly handled during the test that the milk flow may be seriously affected; but this cannot be charged to the tuberculin. In cases where serious results accompany or follow tuberculin tests, the disturbance usually can be traced to some cause other than tuberculin.

There are three methods of making tuberculin tests—the thermal or subcutaneous, the intradermal, and the ophthalmic. These may be used to good advantage in various combinations.

Accuracy.—Averages of very large numbers of animals tested show that tuberculin has a high accuracy, but is not infallible. Advanced cases, recently tested animals, recently infected animals, and certain latent and healed cases may fail to give plain reaction. These are all exceptions; in general, tuberculous cattle react, and the tests are accurate enough to be thoroughly practical.

Thermal or subcutaneous test.—Any number of animals up to 100 or so may be included in one test. These large numbers can be handled to advantage only by one who is thoroughly familiar with the test, who can use a number of thermometers, and has good assistants. The injection is usually made on the neck, on the flat of the rump, or beside the tail head. A veterinary hypodermic syringe, holding 10 to 30 c.c. and provided with several short and well sharpened needles is required. The syringe should be first sterilized and kept clean.

The needle should be short, of fair size, and inserted by sharp push rather than a stab. Some cattle are inclined to kick. This can usually be prevented if an assistant gives the tail a vigorous pull sidewise at the right moment.

Two periods.—The time of each test is divided into two periods: (*A*) before, and (*B*) after injection. During (*A*) the temperatures are taken *e.g.* at about 8 A.M., and then again at 2 and 4 P.M. The tuberculin is given by hypodermic injection at 10 P.M. During (*B*) the temperatures would be taken at 6, 8, 10, and 12 A.M., 2, 4, and sometimes 6 and 8 P.M.

The thermometer.—Self-registering veterinary thermometers are necessary for the thermal test and they should be correct between 100° and 105° F. Any thermometer which varies one half degree or more from the records shown by several others should be discarded.

Temperatures are taken by inserting the thermometer into the rectum or vagina, usually the former. If a number of cattle

are being tested and several thermometers are in use, the latter are secured to the tails for safety. This may be easily done by a wire clamp, rubber hand, and wire hook, or by shoestrings tied so as to give the tail a few inches of play. This permits the operator to use a large number of thermometers, and prevents them from falling to the floor and breaking.

Dose.—The dose is about 1 c.c. or $\frac{1}{4}$ dram Bureau tuberculin per 300 pounds live weight.

Cautions.—Cattle must be kept under the same conditions as nearly as possible on both days; *i.e.*, watered at the same hours,—immediately after a temperature never shortly before—and fed at the same hours on each day, given as nearly as possible the same amounts, and treated alike on the two days.

There are many possibilities of error if the operator is not careful, accurate, and observing. The cattle must not be excited or worried in any way but kept as quiet as possible during the whole test. If the whole stable or any portion of it be much warmer on the second day than on the first, if any cattle are allowed to become thirsty or drink large quantities of cold water, or to go much beyond their feeding time, note should be made of the fact and this considered in making the diagnosis in doubtful cases. Drinking a large quantity of cold water may reduce the temperature one or two degrees at a critical time and spoil a low reaction in a diseased animal.

Cattle that show high temperatures, above 103, during period (A) should ordinarily be released from test. Heavily pregnant cows may be tested if carefully handled and temperatures are normal. It is always possible that an animal may show normal temperature during (A) and then be feverish from causes not connected with the test, during (B). This rarely occurs, but the possibility must be borne in mind.

Importance to breeders.—The value of the test to breeders lies in the fact that it enables them to know whether their cattle are free from tuberculosis, to free their herds and put them on a sound and healthy basis in case they are diseased, and to buy safely.

Diagnosis.—Diagnosis is made mainly upon the fever reaction. If during (B) the temperature rises about 2.5 degrees or more above the highest normal as shown by comparison of the (A) and (B) temperatures, and careless errors have been avoided, it is usually safe to diagnose tuberculosis, providing the (A)

temperatures are not unusually low. To an expert a rise of 1.5 or less may be a plain reaction in some cases and only suspicious or doubtful symptoms in others, so that the animal should be held for retest after 60 days. If the normal temperatures run 100° F. or less, we would not ordinarily condemn on a 2 degree rise. Experience and judgment are essential in this work.

A first plain reaction should never be set aside for a subsequent negative retest, as the first test is the best and each subsequent retest in general decreases in reliability. Obvious reactors should not as a rule be retested.

The reaction.—The most typical reaction is one wherein there is gradual rise and gradual decline of temperature, but many plain reactions are not thus typical. Very abrupt changes in an animal's temperature should be verified with a different thermometer. One high temperature during (B), with the others normal or nearly so, may be only doubtful or suspicious, often it indicates an error in the record. Animals that react sometimes show diarrhea, local swelling at the site of injection, or shivering.

The intradermal test.—This form of tuberculin test is a delicate operation requiring special skill and experience. It is made by injecting into the skin, usually in one of the folds under the root of the tail, a few drops of a special tuberculin with a short and very fine needle.

Tuberculous animals exhibit *reaction* in the form of a persistent, local swelling at the site of injection. This should remain 72 hours or more after the injection has been made. Healthy cattle may have a temporary swelling but are nearly or quite negative as a rule.

The intradermal test in skillful hands is probably as accurate as the thermal test and it has the great advantage of greater speed with regard to the number of cattle that can be tested by an operator in a given time. It is therefore less expensive than the thermal test.

The ophthalmic test.—This test is simpler in operation and interpretation than the thermal and intradermal tests; but it is less reliable for general work. It is made by putting special ophthalmic tuberculin in the eye. This ophthalmic tuberculin may be in either tablet or liquid form. A double treatment, sensitized ophthalmic test, gives most accurate results. By this method, the same eye is treated twice, with an interval of 3 to

5 days between treatments. Following the second treatment, observations begin at about the sixth hour and continue every two hours until about the twentieth hour unless plain reaction occurs in the meantime. Observations may also be made after the first eye treatment, if convenient.

Tuberculous cattle *react* with a temporary inflammation of the eye structures; for example, hyperemia of the conjunctiva, profuse flow of tears, pus in the eye—usually at the inner angle—, and sometimes by swelling of the lid. This reaction may be slight or very temporary, and the evidence, such as pus, may be easily wiped off or lost.

Any two or all of these three tests may be used together in making a combination test. Any wise combination is necessarily somewhat more accurate than either of the single tests, because there are a few tuberculous cattle which at any given time will respond plainly to one test and not to another.

Combination tests should be used, at least in badly affected herds and in herds of great value.

A positive reaction by either test should usually condemn. A suspicious reaction by either test should at least isolate all animals giving such suspicious reactions.

LECTURE XLI

GLANDERS

The words "glanders" and "farcy" refer to the same disease, the latter being commonly used for those forms where the skin and external parts are especially affected. This disease is serious because it may be transmitted to human beings with usually fatal results, and because it results in great loss in horses. It is easily spread among susceptible animals. Obscure cases may be highly infectious.

Susceptible animals.—Glanders is practically confined to donkeys, mules and horses which are susceptible in the order named. Human beings, sheep, and goats are susceptible. Cattle are immune.

Causes.—A minute rod-shaped germ (*Bacillus mallei*) is the direct and specific cause of glanders. Unsanitary conditions and everything which lessens the animal vigor may act as predisposing causes. The disease is more severe and more rapidly fatal among animals which are crowded or overworked.

Incubation.—The period of incubation varies greatly. Different authors have given it variously from three to seven days in experimental work; but in natural cases it is usually about two weeks.

SYMPTOMS

For our purpose, glanders will be divided into but two types: (*a*) *Respiratory glanders*, with or without lung lesions; and (*b*) *Farcy*, affecting principally the skin and superficial connective tissue. Lung lesions may accompany either type. Acute and chronic cases of each form differ mainly in severity of symptoms and rapidity of development.

Respiratory glanders.—This type is characterized in general by the development of nodules, which change to ulcers on the mucous membrane of the respiratory apparatus; by a peculiar sticky discharge from the nose; and sometimes by chronic cough. Certain lymph glands between the branches of the lower jaw

are affected in a peculiar way, becoming swollen, tender, then hardened and adherent.

Acute cases.—In acute cases of respiratory glanders, small tubercles or nodules develop rapidly on the mucous membrane of the respiratory organs and soon change to small *ulcers*, which increase in size and even coalesce. Thus is developed the

peculiar ulcer of glanders, with its dirty gray base and overhanging edges. Very large ulcers and even ragged, gutterlike excavations may develop, particularly on the nasal septum. The ulcers may heal, leaving light-colored, more or less star-shaped scars.

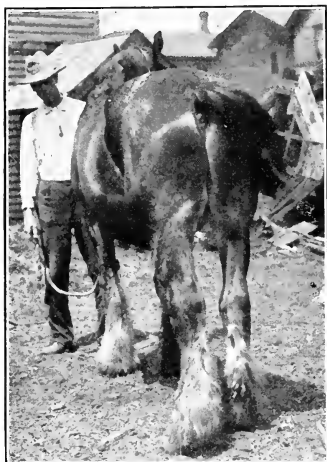

FIG. 69.—GLANDERS (FARCY). (M. H. R.)

A recent case. Note the enlarged leg without farcy buds.

The *fever* may be severe in acute glanders of either type, the temperature rising rapidly to 105 or even 107, and then be quite variable for a few days. There may be also persistent *chills*.

There are also areas of lung inflammation and nodules in some cases. Occasionally there is an apparent recovery from the acute symptoms and then development of a chronic case. This condition applies to both types of glanders.

Chronic cases.—If the disease be chronic, then in general the symptoms develop less rapidly and the disease is slower and milder. The chronic pulmonary form of glanders may be suspected when there is a mild, dry cough, especially if such cough be accompanied by debility and occurs in a stable where an obvious case of glanders has been demonstrated. When the lungs are much affected in chronic cases of pulmonary glanders, the horse is apt to show symptoms of heaves, and on examination post mortem there are found numerous tubercles, usually showing, or easily felt, on the surface of the lungs.

A horse may be affected with a mild, chronic form of the disease and remain in good flesh, be vigorous and apparently in the best of health for years, showing no marked nasal discharge or farcy sores, and yet be very actively infectious to other horses.

Chronic cases may show a chronic nasal discharge, nasal ulcers, and hardened, adherent maxillary glands and unthrift.

Farcy.—In the farcy form of glanders the superficial connective tissues and lymph vessels and glands are especially involved.

In the *acute form*, there is high temperature and local swellings. These swellings often occur on one or both hind legs. As the swellings abate, the characteristic nodules, or farcy buds, appear.

The head may swell badly and farcy sores appear later at irregular intervals and places. Farcy buds tend to heal slowly

and leave scars as shown in Fig. 71. When farcy buds break, there is discharged a clear, viscid pus that is very characteristic.

The *specific symptoms* of farcy may be summed up as the *bud*, the *ulcer*, the *lymphatic cord*, and the characteristic viscid, sticky discharge.

In the chronic form we have similar histories and symptoms, but the latter are less obvious and develop less rapidly.

Diagnosis.—A positive diagnosis on the clinical symptoms may be frequently made. But there are a great many cases which cannot be so diagnosed with certainty. Some show indefinite symptoms and others show none. In such cases, we must rely upon mallein tests of which we now have three.

Mallein tests.—The *temperature test* is conducted as follows:



FIG. 70.—GLANDERS (FARCY). (M. H. R.)

An old case. Note enlarged leg with old farcy buds, healed.

Temperatures are taken at, *e.g.*, 10 A.M., 2 P.M. and 6 P.M. The mallein is then given by a hypodermic injection at about 10 P.M. On the following day temperatures are taken every two hours, beginning at 6 A.M. and continuing until 6 or 8 P.M. or even later if the temperature is rising and the reaction is indefinite. A rise of three degrees or more above the high normal to 104 or higher is diagnostic, and usually means glanders. Such

a rise of temperature is spoken of as a reaction. Reacting animals usually show a prominent and painful swelling at the point of injection—an important consideration in the diagnosis.

This test is being superseded by the newer and simpler tests.

The second mallein test, the *intradermal*, is made by injecting a special mallein with a fine needle into the skin of the lower eyelid. The glandered horse reacts with an inflammation and persistent swelling at the point of injection.

The third mallein test, the *ophthalmic*, is made by placing a special tuberculin in the eye. The glandered horse reacts by inflammation, and pus in the eye, usually at the inner angle.



FIG. 71.—GLANDERS (FARCY). (M. H. R.)

Farcy scars in the face. An old case.

Mallein has revealed the rather serious fact that there are unquestionably many cases of glanders which are never recognized, some of them without doubt infectious.

Prevention.—The common methods of spread must be borne in mind, and the fact be clearly realized that the germ which causes glanders is very easily disseminated.

Some of the more common mediums of spreading it are drinking water, feed boxes and troughs, hitching racks and posts, and public water fountains, which should be abolished and replaced by individual pails. Any means which serves to bring the virus, *B. mallei*, into direct contact with mucous membranes or with the broken skin may be sufficient to cause the disease. Pus from the farcy sores and the nasal discharge are very virulent.

Prevention therefore consists in avoiding conditions which may bring the virus into contact with the mucous membranes

or broken skin. It is never safe to purchase from a stranger, a horse that has nasal discharge or suspicious sores. Stories of having caught cold or a "little distemper" may usually be suspected, under such circumstances.

Treatment.—It is probable that some cases of glanders recover under favorable conditions without treatment, especially in the Northwest; but the disease is dangerous and we have no means of knowing which cases have a reasonable probability of recovery, for medical treatment by the use of drugs is not reliable. For these reasons treatment of glanders is not justified. All cases should be reported to the proper health officers.

Suggestions.—In many states it is wisely made a punishable offense to water a glandered horse at any public watering place, hitch it to a public rack or post, or place it in a public barn.

All plain cases should be killed and all exposed horses and mules should be tested with mallein.

Reactors should usually be killed, whether showing symptoms or not.

In some states, owners receive state reimbursement for glandered horses killed by order of the state.

LECTURE XLII

HOG CHOLERA

To be considered hog cholera, the disease must be infectious by pen exposure, and an attack followed by recovery must give immunity; the blood from a diseased hog should be virulent and capable of reproducing the disease; the living animal should show the symptoms later described; and the carcass of the dead animal should show the symptoms given under autopsy.

Variations in virulence.—Outbreaks of hog cholera vary greatly in virulence and symptoms. In some outbreaks the virulence is marked, and the hogs die quickly; in others a majority of the cases assume the chronic type, the hogs do not die so quickly, and the percentage of loss is not so great.

Various gradations may appear between cases of the utmost virulence and those of the milder type.

General symptoms.—Lack of appetite, fever, and thirst are early symptoms of hog cholera. The hair becomes harsh and dry, the eyes may be watery, and the gait becomes weak and irregular, with imperfect control of the hind legs. The skin around the flanks and fore legs and abdomen may become purple; that of the ears frequently becomes much inflamed, and, if the hog lives for several days, may assume a scabby appearance. Sometimes the tips of the ears slough off. The sick hogs soon separate themselves from the rest of the herd, being disposed to hide in sheltered places, and are little inclined to move about. Chronic cases lose flesh rapidly and sometimes show extreme disturbance of the nervous system, exhibited in partial or complete paralysis of the hind parts, or extreme nervousness. The cough is usually short and hacking. Occasional constipation appears among the earliest symptoms, but is usually not noticed; later, diarrhea appears. In some of the very acute cases which appear at the beginning of an outbreak, the animals die very suddenly—sometimes before the owner realizes that they are sick. Later in the history of the disease, as it appears in a herd, the cases tend to assume the more chronic type.

At times quite large portions of skin and underlying muscular tissue die and slough off, leaving large sores. These sores appear more commonly, perhaps, around the neck, head, and back than elsewhere. This is probably not due to the filterable virus but to secondary invaders.

Farmers must bear in mind that symptoms vary greatly in different outbreaks, and avoid being led into the costly error of mistaking mild cholera for something else. It is not always easy even for an expert to diagnose cholera, and for this reason it is safer to assume that a questionable outbreak is cholera.



FIG. 72.—HOG CHOLERA. (M. H. R.)

Subcutaneous hemorrhages resembling those of hemorrhagic septicæmia. Note the dark spots.

Autopsy.—The skin on parts of the body where the hair is thin, like the flanks and inside of the fore legs and thighs, may be deep red or purple. Hemorrhages may be usually found in the fatty tissue under the skin and on the internal organs. The lungs often show scattered and sharply defined areas which are dark in color, solid and much like liver. Or, there may be a severe general pneumonia with pleurisy. The lymph glands in the mesentery and elsewhere are deeply hyperemic or hemorrhagic.

When the large intestine is opened, dark spots, more or less bloodstained, or even clots of blood, may be seen upon the lining membrane when the disease is of a very acute type. The more chronic cases show peculiar and characteristic ulcers in the lining membrane of the digestive tract, especially the large intestine, and they are usually more numerous near the cecum or blind pouch. These ulcers are irregular in outline, with yellowish or dark centers, and frequently appear as being raised above

the surface. Small ulcers may occur in the back part of the mouth, in the gullet and stomach.

Very small hemorrhages are found on the surface or through the deeper structure of the kidneys.

Cause.—Hog cholera is a very infectious disease which has its origin in a living virus. The virus particles are probably so small as to be invisible with our best microscopes and are capable of passing in some form through a laboratory germ filter.

This is probably a complicated disease in most outbreaks.

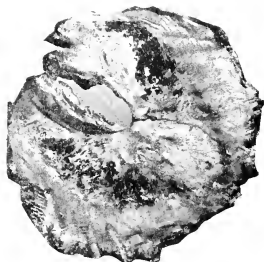

FIG. 73.—HOG CHOLERA.
(M. H. R.)

Hemorrhages (dark spots) on diaphragm. Hemorrhages are characteristic.

The filterable virus is evidently the principal and specific infection. With this virus there is usually one or more secondary invaders. One of the secondary invaders may cause or contribute to the chronic lesions, ulcers of the digestive tract, for instance. Another may cause or contribute to the lung and pleura lesions. This accounts, in part, for the wide variations in symptoms and lesions.

Infection usually occurs by way of the mouth, and the period of incubation is from 8 to 14 days. Simple conditions of keep and feed have much to do with making the animals susceptible, but food and surroundings cannot serve as the first cause of hog cholera. Predisposing factors must be given due consideration, but the most important things to remember are the sick hog and the living virus and that hog cholera never appears without the infection which may be easily carried from one place to another.

If the hog is fed exclusively on corn diet and kept overfat; or if it is kept shut up in dark, damp, and perhaps filthy pens, it will not be able to resist any disease as would the hog kept under more favorable conditions. But these are only contributing factors. The laws of hygiene cannot be neglected without rendering any animals more susceptible to disease; but no degree of ordinary vigor can give assurance of immunity to cholera.

How scattered.—The virus of this disease may be carried from place to place in any way that very fine particles of heavy dust may be carried, *e.g.*, by people, upon shoes, or by wagons or stock cars. Dogs are frequent carriers of the disease. Running streams and shallow lakes are serious factors in its spread. Bowel discharges are very important sources of infection, and, if yards or pens drain into streams or lakes, water then becomes the carrier of infection. Hogs that have died of cholera are

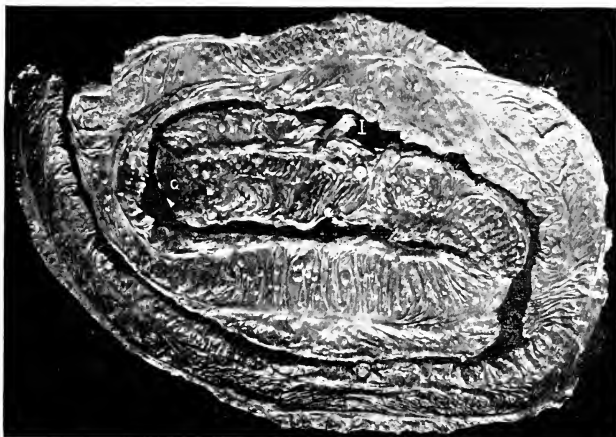

FIG. 74.—HOG CHOLERA. (*M. H. R.*)

Large intestine; mucous membrane showing general distribution of typical ulcers. *I*, Ileum; *C*, caecum or blind pouch.

sometimes thrown into streams or buried in sand near the edge of a stream or lake, thus infecting the water.

Hog cholera virus may live many months; around strawstacks and old sheds under favorable conditions.

When an outbreak appears.—In case there is a suspicious disease among hogs, the matter should be reported promptly to health officers so that this first outbreak may be promptly and rigidly quarantined and the hogs vaccinated. If reliable serum for vaccination is not available then but one person should have the care of a herd of healthy hogs, and should not be allowed to go where there is possibility of carrying the infection on shoes,

for example. No member of the family should go to any farm where swine disease has appeared; nor should any one from the farm where such sickness is present be allowed to walk about the yards of his neighbor. Dogs and other dangerous visitors should be kept away from the pens on uninfected farms by a temporary fence if necessary.

Hogs should not be allowed access to small ponds or mudholes during the prevalence of any suspicious disease. Such ponds and mudholes become deadly centers of infection.

Before a herd becomes infected, it may be desirable to divide it into three or four parts, if serum is not available, and separate these groups widely on different portions of the farm. The

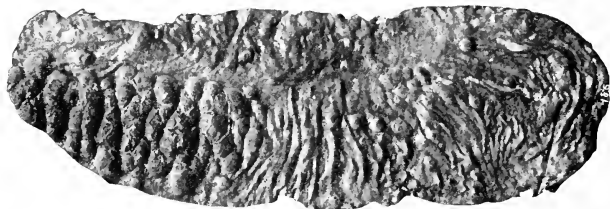

FIG. 75.—HOG CHOLERA. (M. H. R.)

Ulcers in mucous membrane of large colon. Bowel split open. View of the interior.

owner may then lose one group, or even two groups, and still save the others.

If the weather is cool or wet, the herd should be given quarters as warm and dry as possible, because, under conditions of exposure, the mortality is apt to be very high.

So far as we know now it is useless to spend money on medicines in the treatment of hog cholera and before giving credit to patent medicines, one should bear in mind that outbreaks often check suddenly without treatment.

Experience demonstrates that it is desirable to move the healthy animals away from the sick promptly, if serum is not available, and to place them in uninfected sheds, pens, or yards. It is also important to keep the pens, both where the sick and the healthy hogs are confined, thoroughly cleaned and frequently disinfected. For cleansing and disinfecting purposes, unslaked lime used freely is satisfactory, and easily applied. The better grades of coal-tar disinfectants are also satisfactory.

Hog cholera vaccination.—The Dorset-Niles serum is now freely available and is reliable when properly used. The method of producing this serum is, in general, as follows:

A hog that is immune by reason of having passed through the disease or having been vaccinated is given a large quantity of virulent hog-cholera serum. His own blood then develops a property which protects other hogs when it is injected under the skin or into muscular tissue. The serum of this hog's blood produces a prompt but temporary immunity. If the hog which has received such serum be given pen exposure with sick hogs, or an injection with a small quantity of virulent blood (simultaneous vaccination), it then becomes rather permanently immune, for it has had the disease in a mild form and recovered. There are, therefore, two ways of vaccinating by the Dorset-Niles method: serum only, which gives prompt but temporary immunity; and simultaneous vaccination, which gives permanent immunity. The dose of serum varies according to the weight of the hog treated. Serum should be kept unopened and cool until used, and all precautions should be taken to insure clean work in vaccinating.

There are other useful fields for this vaccine: Owners may wish to vaccinate valuable hogs in advance of any possible outbreak, or exposure to disease at stock shows. Another and perhaps the most important field relates to outbreaks of the disease where vaccine can be used early in an outbreak to prevent or lessen losses and thus protect surrounding herds and check the outbreaks.

Common mistakes.—It is a mistake to bury hogs that have died of cholera when the carcasses can be burned, for burning is by far the most efficient means of destroying the germs of such diseases. If it is not convenient to burn the carcasses, they should be buried under at least four feet of earth and covered freely with fresh lime.

It is a mistake, and frequently a serious one, for a farmer to ship in strange hogs from stockyards, and put these with stock hogs already on hand without vaccination or quarantine. The mere fact that the hogs came from an uninfected district is no argument to the contrary, for the car in which they were shipped may have recently carried hog-cholera victims. New breeding stock should usually be isolated for three weeks before putting them with hogs already on the place unless the latter be immune.

This allows time for the disease to appear in case the new hogs have come from infected herds, through infected stockyards, or in infected cars.

It is a mistake to visit your neighbor's hogpens, and walk about among the hogs out of mere curiosity, when your neighbor has told you that some peculiar sickness has appeared in his herd.

It is a mistake to allow the last one or two sick hogs, which usually show a very chronic type of the disease, to linger for months on the farm. It is a better policy to kill such hogs promptly, and have done with the disease. They do not usually become thrifty and profitable feeders for a long time after recovery. On the other hand, they may remain infectious to the last period of their sickness, thus keeping the yards and pens infected and furnishing a supply of infectious material for future outbreaks.

It is a criminal mistake to leave carcasses in gullies, or throw carcasses into any stream, lake, or pond, or to bury them near such body of water.

Suggestion.—An outbreak of hog cholera may be quarantined when it first appears; but it is extremely difficult to quarantine the disease after it has been scattered over several townships. Quarantine to be effective must be prompt and rigid; partial or imperfect quarantine is worse than useless.

Disinfection.—The virus may live for months, under favorable conditions. Sometimes the cheapest way to disinfect is to burn old sheds and pens where the sick hogs have been confined. But if these structures are valuable, other means of disinfection must be considered. Corrosive sublimate, dissolved in water in the proportion of 7.5 grains to each pint, is a good disinfectant; or, whitewash that is made by adding fresh chlorid of lime, one half pound to the gallon, may be used instead of the corrosive sublimate solution. All bedding and loose stuff should be burned or plowed under. The ground may be disinfected by saturating the surface with corrosive sublimate solution, or by burning off straw that has been scattered over the surface, and the danger of infection may be lessened by plowing and planting the infected area.

LECTURE XLIII
COMMON MINOR DISEASES OF SWINE

POSTERIOR PARALYSIS

Posterior paralysis is a rather common and serious condition affecting swine; it involves the hind quarters, and is probably a symptom of several different disorders. In some cases it is probably a disorder of the spinal cord; in others, there is weak bone due to poorly balanced diet. Still others are due to injury inflicted by other stock, etc. Fracture of the femur or other leg bones sometimes occurs in connection with rachitis (rickets), and is mistaken for paralysis. Rachitis may appear, like paralysis in growing swine. Some cases are due to injury of the spinal cord. Paralysis often appears in heavy hogs after shipment by rail. Other cases are due to slow organic disease of the spinal cord, the direct cause of which is not known. A common type of posterior paralysis develops suddenly in old and heavy swine, particularly those in high flesh, and is due to simple constipation.

Symptoms.—Some cases develop suddenly; others gradually. Those which develop slowly show at first, irregular gait behind. The legs cross in walking; there is difficulty in rising and a general lack of control for the hind legs.

If the case develops suddenly, there is inability to use the hind limbs, which are limp and weak—not unlike affected limbs of horses having azoturia. Hogs affected with this trouble often retain good appetite and are, apparently, in good health for weeks, having perfect control of the front limbs. If they move at all, the hind limbs are dragged.

Treatment.—For the heavy hog lacking in exercise, give a decided physic, 10 to 20 grains of calomel or else two compound cathartic pills in a small piece of pork; or 2 oz. castor oil. The rachitic form in young hogs is prevented by feeding skim milk, tankage, etc., and giving more exercise.

CONGESTION OF THE LUNGS

Congestion of the lungs is essentially an engorgement of the pulmonary blood vessels, often caused by active exercise of swine in high flesh.

Symptoms.—These cases are usually acute and are likely to end fatally. The symptoms are those of suffocation. There is marked distress and hurried respiration, the mouth being held open in an effort to get air. The pulse is rapid and weak, and the animal is apt to fall suddenly.

On examination post mortem the pulmonary vessels are found engorged and the lungs dark.

Treatment.—If the condition of the hog permits, use a stimulant: aromatic spirits ammonia 1 to 2 drams, alcohol 4 drams, in water, repeated at short intervals; for example, 15 minutes to one half hour. The animal must be kept warm and the extremities rubbed vigorously. Extreme care is necessary in giving liquid medicines in these cases to avoid killing the animal by suffocation. Hypodermic stimulants are safer.

CONSTIPATION

Constipation is a rather frequent cause of trouble among swine.

Cause.—This trouble is very frequently associated with high feeding and lack of exercise, especially when the food is dry and lacking in laxative material. It rarely affects hogs when on grass, clover, roots, pumpkins, or other fresh vegetables.

Symptoms.—The affected hog is restless, and occasionally strains as though trying to pass manure; its manure is hard and frequently covered with mucus, and the hog becomes dull and loses appetite.

Treatment.—Give 1 to 3 ounces of castor oil, depending on the size of the hog, or as a substitute for the oil give Epsom salts, in 1 to 3 ounce doses dissolved in warm water and administered as a drench. For mild cases of simple constipation, old-fashioned senna tea, with rectal injections of warm water, is usually very satisfactory.

It is necessary to exercise great caution in giving liquid medicine to hogs lest they be suffocated by drawing liquid into the lungs while squealing.

A very simple method of drenching swine is to cut a hole in the toe of an old shoe; insert the toe into the mouth, and allow the hog to chew it while the medicine is poured in slowly and carefully. A short piece of ordinary garden hose with a funnel inserted at one end is also very satisfactory for this purpose. Or, put a piece of rubber hose on the neck of bottle, give medicine slowly and cautiously and, if possible, when the animal is not squealing. The animal may either be thrown down and held, or tied. A loop may be passed around the upper jaw back of the front teeth and held by a turn around a post, but, in this case, medicines must be given with great care.

Black teeth.—Black teeth in young pigs are not of serious importance so far as the teeth are concerned.

DIETETIC DISEASES

LECTURE XLIV

AZOTURIA

Prevalence.—Azoturia is a common and very serious disease which usually affects horses under certain well-defined conditions. It affects the best and most valuable horses and is frequently fatal. Farm horses in the North do comparatively little work during the winter, and are in high flesh when early spring work opens. This condition, together with the fact that the early spring is necessarily a season of irregular work, will explain why so many cases of azoturia occur during the spring months.

History.—Azoturia rarely appears among horses at pasture or among those at regular work. It usually appears during exercise after a period of idleness, on full feed which has succeeded a previous period of work. Any severe exertion after an idle period may cause it, *e.g.*, struggling in the casting harness or when halter-cast in the stall.

This disease is frequently confounded with colic; sometimes farmers call it spinal disease, and sometimes an inflammation of the kidneys; but it is easily distinguished from any of these by its history—which is very uniform—by the symptoms and by the condition of the urine.

Duration.—Ordinary cases begin to either recover or fail within three or four days. The more severe cases may either die in a few days or develop a persistent and more or less complete paralysis of the hind quarters and limbs lasting weeks or even months.

Causes.—The causes of azoturia are classified as predisposing and precipitating.

The *predisposing causes* include high flesh, diet rich in proteid, and full feed during a period of rest following a period of regular work. Most cases appear during the prime of life. Mares are more frequently affected than geldings, but all horses are subject to azoturia.

The *precipitating factor* is active exercise, following idleness on full feed.

Symptoms.—The symptoms appear suddenly, with little or no warning, and are very uniform. The horse comes out of the stable feeling unusually well, then after going a short distance goes suddenly lame, or stiff, or weak, in his hind legs. Both legs may be affected alike, or one only, or one first, then the other. Occasionally one or both front limbs are affected. The horse staggers, is very weak on his affected legs, and may fall before he can be unhitched.

He perspires very freely; the muscles over his loins and hips are rigid to the touch, frequently tender on pressure, and may tremble or twitch.

The urine is highly colored, varying from red to almost black, and increased in specific gravity. This abnormal color is due to the presence of red coloring matter of the blood and voluntary muscles. It may not be conspicuous, however, in mild cases. The pulse may run up to 60 or 80 per minute (normal, 42 to 48); and the temperature increase to 102 or 104 (normal about 101) if the animal is restless, but in many cases they vary but little from normal. The bowels may be normal, and the appetite fairly good in mild cases. Skin sensation may be diminished, as shown by pricking with a pin. The natural peristaltic action of the intestines may be suppressed, but the bowels will usually empty under the influence of an injection or other local irritation. A chronic paralysis affecting one or both hind limbs may be a troublesome factor in the case.

Prevention.—Prevention is simple, easily applied, inexpensive and reasonably certain, and for these reasons, preferable to treatment, which is frequently unsatisfactory even if the patient recovers. Moreover one attack predisposes to another, and the second attack is more easily brought on than the first. Preventing the first attack may prevent several attacks and ultimate death of the horse.

There is but slight danger of azoturia for the horse that is thin and weak, or for the young colt or for the aged horse. This disease often affects the best horse in the barn, one that is in good flesh and in the prime of life. When such a horse has been working on full feed for a time and then stands idle for a few days, or even twenty-four hours, make a large reduction in the grain ration, or if the horse is quite fat, stop all the grain.

A fat horse needs but little grain when standing idle. If he has worked recently, allow him plenty of water and turn him loose in the yard or exercise him every day if possible. If the grain has not been reduced as it should have been while the horse was idle, the next best course is to give him a decided cathartic, a quart of raw linseed oil for example, thirty-six hours before hitching, and then at first, work him very moderately for several hours as quick or violent exercise seems more likely to bring on an attack.

Treatment.—At the first warning of azoturia stop working the horse immediately. Treatment should be done by competent veterinarians whenever such are accessible, for treatment is difficult.

The principal purpose of this lesson is to direct attention to prevention and not toward treatment; but cases will arise, and these cases will occur in sections where competent veterinarians are not located.

If not voided naturally, means should be taken to draw the urine as soon as possible after the disease appears, and three times daily thereafter. This may frequently be accomplished by inserting a hand in the rectum and pressing down moderately on the bladder. The azoturia patient has a much better chance for recovery if he can be kept upon his feet a portion of the time at least, and it is very desirable that this be done for several reasons; but slings should not be used unless the patient can support a portion of his weight upon the limbs. When the patient is unable to do this, put him in a clean, dry stall with plenty of bedding and turn him every four hours, until he can stand with the aid of a sling. Quiet and rest are very important.

Many different lines of treatment have been used by veterinarians during recent years, with differing and even conflicting opinions as to results. Common baking soda has been used in large, half pound, doses. Some veterinarians with wide experience believe they get best results with good nursing and very little medical treatment.

For a cathartic, give one quart of raw linseed oil, or, better, one ounce of aloes with two drams ginger, made into a pill by mixing these with a little molasses. Encourage the horse to drink as much as possible. If he will not drink freely, he may be drenched with weak salt brine to make him thirsty. The

more he drinks within reasonable limits the better. If restless and violent, he should have a sedative; *e.g.* 1 ounce bromid of potassium with 3 drams fluid extract of gelsemium, given in half a pint of sirup. If weather and stable conditions are favorable, the muscles of his hips and loins should be fomented with hot water twice daily, two hours each time during the first few days of illness; after this treatment a stimulating liniment should be used over the muscles twice daily until the patient has recovered.

When chronic paralysis remains after the acute stage has passed, *nux vomica* should be used. Give one to two drams fluid extract *nux vomica* or one to three grains strychnin sulphate twice daily in feed. Begin with small doses and gradually increase until there appear symptoms of nervousness and muscular twitching; then discontinue or rapidly reduce the dose.

Prognosis.—Estimates of results must be made with great caution, for sudden and unexpected changes occur. A large percentage of azoturia cases die in general practice. Prognosis is bad when complete paralysis occurs; when the disease develops violently from the start, the horse going down at the beginning and soon losing control of both limbs; or when the patient grows more and more restless during the progress of the disease, and is unable to support part of his weight in the sling. It is a hopeful sign if the patient can stand alone, or fairly well when assisted by sling.

LECTURE XLV

LYMPHANGITIS (ELEPHANT LEG)

In general, lymphangitis is an inflammation of any lymphatic tissues, but in veterinary practice it usually refers to those of the hind leg of the horse. It appears suddenly and is quite painful, although rarely fatal.

Cause and history.—This disease usually appears among heavy horses of sluggish temperament, such horses seeming much more susceptible than others, and it almost invariably occurs among those that are full fed and have had a period of idleness, perhaps of only one day. In some cases, it results from a local infection, in the foot, for example.

Symptoms.—This disease usually makes its appearance with a chill, followed by fever. The horse is uneasy and in evident discomfort. A sudden extensive swelling appears on the upper inside portion of the hind limb. The swelling increases gradually, extending around the limb and downward. The lymph vessels are swollen and corded. Lymph glands high up in the inguinal region or groin become involved; and these may even develop abscesses, but this is rare. Actual death of the patient from septic infection may even occur.

The horse is quite lame, and the affected limb is very sensitive to the touch. He perspires freely; the pulse is increased; respiration is somewhat hurried and the temperature is raised. The bowels are constipated and the urine is usually dark, colored, and scanty.

Most of the swelling in the limb gradually subsides, and as this general swelling goes down, the inflamed lymph vessels appear as long, cordy swellings. Usually some thickening and enlargement of the leg remains and this disease is apt to recur, each time leaving a somewhat increased enlargement until finally there develops what is commonly known as elephant leg.

Lymphangitis might be confused with simple dropsy or with glanders. It can be distinguished from simple dropsy, however, by its acute pain, its fever, lameness, and cordy swellings; and

it may be distinguished from the farcy form of glanders by its more acute fever and more acute local trouble in the leg; by its early inflammation of lymph glands in the groin, its absence of farcy buds, and failure to react to mallein test.

Prevention.—The grain ration should be very greatly reduced during idle periods. This is true for any horse in fairly good flesh, and particularly true of horses of the type that has been mentioned as especially subject to lymphangitis.

Treatment.—Prompt and vigorous treatment seems to abort the disease in a fair proportion of cases. Hot fomentations over the swollen part, continued for several hours, are one of the most important parts of the treatment. Between the periods of fomentation there should be given a vigorous friction—rubbing upward—and long-continued light exercise. If the horse is able to walk, he should be kept moving about slowly for several hours at a time. During the first 3 or 4 days, and until the active symptoms abate and the horse is again receiving normal exercise, the food should be light and laxative. Later full feed may be resumed.

For acute cases with high fever, four or five quarts of blood may be drawn from the jugular vein. A moderate physic should be given: *c.g.*, 4 to 8 drams of aloes in a physic ball; or, $\frac{1}{4}$ pound Epsom salts dissolved in a pint or more of water, 3 times a day may be substituted for the aloes. One-ounce doses of acetate of potash, dissolved in two pints of water and used as a drench, or given in the drinking water—if the horse will take it so—should be given three times daily for a day or two.

Prognosis.—Lymphangitis usually ends in recovery so far as the general disturbances are concerned. Something may be estimated concerning the probable severity and duration of illness by noting the severity of the chill which comes at the beginning of the attack.

LECTURE XLVI

LAMINITIS (FOUNDER)

Laminitis is a painful and rather frequent disease most common in horses but other classes of stock are subject to it. It is commonly called founder and is essentially an inflammation of the sensitive parts within the hoof, especially the sensitive laminae. Founder is more common in the front feet, but may affect either or both the front and hind feet.

Symptoms.—The horse shows unmistakable evidence of extreme pain and usually persists in lying down. The pain is due to the fact that the horny wall and sole do not permit the inflamed tissues to expand. Respiration, pulse, and temperature may increase as a direct result of the pain; the fever may be marked, the pulse full and strong, and the attitude and expression indicating anxiety. If the front feet are affected, the horse carries as much of the weight as possible upon the hind feet, the two front limbs extending forward. If the hind feet are involved, he extends them forward and stands with the front feet back, under the body, and carrying as much weight as possible to relieve the sensitive hind feet from pressure. He refuses to back, and the artery (planter) just above the ankle throbs. There is often excessive perspiration and a tendency to constipation unless the case be associated with excessive diarrhea.

Causes.—Laminitis frequently results from disturbances of the digestive organs, due to unusual over-feeding, for example, or to a large quantity of cold water, drunk when a horse is very hot or tired. It may be caused by unaccustomed concussion on hard roads, in case of a horse not accustomed to this work, or by exhaustion, and exposure to cold wind or cold water. Laminitis often occurs in one front foot, or one hind foot, as an indirect result of lameness in the opposite limb; the horse overworks the sound limb in order to relieve pain in the lame one, and thus causes laminitis in the foot which had been sound. Laminitis is frequently associated with parturition (delivery) in the

mare or cow, or with pneumonia, or bronchitis. Laminitis especially is apt to occur in a horse that is worked during a period of digestive disturbance.

Pathology.—There is first of all an inflammation of the sensitive parts within the hoof, especially the sensitive laminae, and velvety tissue. In severe cases, this inflammation may become suppurative. This early inflammation is followed by an exudate, which may be either slight or profuse and more or less persistent. In persistent cases with considerable exudate, the toe of the os pedis (third phalanx) is gradually drawn downward against the sole, leaving the sole convex, and the horse permanently unsound.

Termination. — Laminitis may terminate in recovery and practical restoration of the affected parts, or there may remain a convex sole and a chronic

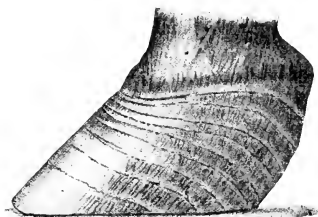

FIG. 76.—FOUNDERED HOOF. (B. A. I.)
An old case.

soreness with a tendency for the hoof to grow to an unnatural shape. See Figure 76. In the latter case, the wall becomes wrinkled transversely, and grows unevenly.

Treatment.—These are usually serious cases, and call for professional attendance and skill if such is obtainable. Any general treatment that could be suggested might be unwise in some cases, and wrongly applied in others.

A treatment that is frequently satisfactory consists in keeping the feet wrapped with burlap and wet with cold water for some time—several days if necessary. Sometimes this may be done by standing the horse in a shallow stream, preferably with a soft bottom, or a pack of crushed ice may be used.

If he is compelled to stand for any great length of time in order to keep the feet in cold water, then he should be supported by a sling. When a horse must be kept in the stable, he should have a large box stall with deep, soft bedding. Severe cathartics must be avoided, but it may be desirable to give very mild doses of aloes, or raw linseed oil. A dose of aloes for this purpose would be one half ounce or less; that of the oil would be about one pint, either one repeated as necessary. Two to

three or even four, ounces of saltpeter also may be given, dissolved in drinking water, or as a drench in a pint of water, three times daily. Large doses of alum often give especially good results, particularly in cases where the foot trouble follows a digestive disturbance. The alum is administered in 2-ounce doses every two hours, each dose dissolved in one quart of water and continued if necessary until a limit of six or eight doses have been given. During this treatment little water is allowed.

Ordinarily the shoes should be removed and the toe, if long, shortened; but the sole should not be thinned or otherwise interfered with. If the horse is compelled to stand he may do so more comfortably with shoes that are rounded, high in the center and thin at toe and heels. If the pain is extreme, and not eased by soft bedding and continuous application of cold water, then something should be given to relieve it. If an acute case can be induced to lie down, great relief and rapid improvement in respiration, pulse, and pain are soon noted.

Prevention.—Intelligent care will prevent many ordinary cases of laminitis. Accustom horses to markedly changed conditions gradually. This applies especially in case of fat and idle horses put to work and to country horses put on city pavement. Keep a heated horse out of cold winds and cold water. Avoid overfeeding and overdriving, and feed a hot horse or tired horse very cautiously.

LECTURE XLVII

HEAVES

This is a disease of horses. It is characterized by a peculiar disturbance of respiration, in which although inspiration is about normal, there is difficult expiration, the air being expelled by two distinct movements instead of the normal one.

True heaves is usually associated with the feeding of considerable quantities of timothy and clover hay—especially dusty hay—and it lessens very materially the value and usefulness of horses affected by it. Light feeders are as a rule free from this disorder, while horses that eat hay greedily are most liable to have it.

In the lungs of horses so affected, the air vesicles are gradually dilated, losing their elasticity; they may even rupture together so as to produce small cavities, from which the air is expelled with great difficulty. During forced expiration, the air may escape into the surrounding tissue. This escape of air from the air cells into the lung tissues (emphysema) usually occurs in connection with heaves, but its relation to the disease is quite problematical. Plainly a horse may have such air leakage without heaves. This condition is probably to be regarded as an effect rather than a cause.

Cause.—Any chronic irritation of the bronchial mucous membrane may cause heaves—chronic bronchitis and severe cough, for example, or repeated violent exercise by a horse not in condition. But we may say that the usual direct cause of heaves is the excessive eating of bulky food, especially hay that is overripe and dusty,—or worse, musty. Tame hay cut very ripe and dusty clover hay are both prone to cause this trouble, which rarely, if ever, develops in horses on pasture or that have only bright, wild hay or a reasonable quantity of early-cut tame hay. This disease is said to be almost unknown in arid regions where timothy and clover hay are grown by irrigation, and where such hay is never exposed to dew or rain and therefore does not develop fungi to a serious extent. Mere bulk and

over-ripeness are probably not the only factors. Many cases of heaves may be due to fungi, especially their spores, rather than to the character of the food with which the fungi are taken.

Symptoms.—A peculiar, explosive cough usually appears before the breathing becomes noticeably disturbed. After a time it is noticed that exercise produces unusual difficulty in breathing, the air being taken in quite easily but expelled with difficulty. When this stage develops, the air is expelled in two efforts instead of one, the latter portion of the tidal air being expelled by a special effort of the belly muscles. Overfeeding, of course, increases the difficulty.

Some cases of heaves may be disguised temporarily by the use of drugs and the feeding of a concentrated diet. This trick may usually be detected, however, by allowing the horse a hearty feed and water, and then giving active exercise or even by actively exercising him without the special feeding and watering. A horse drugged with any belladonna preparation shows greatly enlarged pupils of the eyes. It is usually easy to distinguish between heaves and roaring. The latter is a disease of the larynx due to paralysis of one of the laryngeal cartilages and is shown by the abnormal sounds known as roaring or whistling during inspiration, the movements of the flank and chest being normal.

Prevention.—The prevention of most cases of heaves may be easily described and almost as easily accomplished—by mere avoidance of well-known causes. There is a very general and wasteful feeding of hay. This is not merely a waste; it is an injury to the horse. A case of heaves due to over-feeding is usually discredit to the feeder. Heaves often indicates that the horse is a good feeder and under wiser management would be able to digest a large amount of food and do hard work. There is no satisfactory evidence that heaves is hereditary, and no proof to the contrary.

It is not wise to allow a horse to do very fast or hard work on a distended stomach, which means that the work should be slower and easier during the first hour or so after hearty meals. Little hay should be fed in the morning, and at noon, and a reasonable quantity in the evening.

To prevent heaves, then, feed reasonable quantities of good wild hay, or tame hay cut early and not allowed to become musty. Avoid dusty foods. The amount of hay should be

restricted to much less than is usually fed. Horses that are greedy feeders should be bedded with sawdust or shavings or protected by a muzzle in case other bedding is used.

Autopsy.—On examination post mortem, the lungs may be found to be somewhat bloated and to contain more air than normal. The chambers in the right side of the heart are apt to be enlarged and their walls thickened. In examining the lungs of long-standing cases of heaves, we note that they are pale and float abnormally high in water, due to the emphysema or air in the tissues previously mentioned. The stomach is often larger than normal, due to the overeating of bulky foods and consequent stretching.

Treatment.—In cases of heaves avoid overripe and dusty hay. Allow little bulky food of any kind. Give a small quantity of hay for the morning feed, none at noon, and a very moderate amount in the evening—much less than would be considered careful feeding for a healthy horse. If the hay or grain is dusty, sprinkle it as a regular custom. Use such horses for slow work, and give as much rest as possible after meals.

A month or two of this management will very greatly improve most cases.

Medical treatment is considered unsatisfactory so far as curative effect in bad cases is concerned. Fowler's solution in one-ounce doses three times a day in the feed, long continued and coupled with careful feeding, is often a great help. Proper feeding alone may be said to be almost curative, although subsequent attacks are easily brought on by injudicious management.

LECTURE XLVIII

HOVEN, OR BLOAT (ACUTE TYMPANITES)

Hoven, or bloat, is a form of indigestion in cattle and sheep which is characterized by an abnormal collection of gas in the first stomach or paunch.

Causes.—Bloat is caused by excessive fermentation, which results indirectly from such conditions as sudden changes from dry food to pasture, or from one pasture to a better one, or

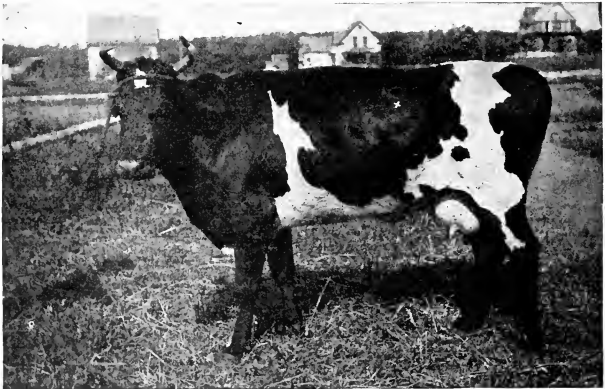

FIG. 77.—SHOWING WHERE TO TAP. (M. H. R.)

See white cross in the flank.

from grass to clover. Easily fermented foods favor hoven. Grasses or clovers, wet by dew or rain, seem especially apt to cause hoven.

Frosted roots and impaction from overfeeding may also result in arrested digestion, and then hoven ensues. Sick cattle frequently bloat after lying for a long time on the side. Choke often leads to hoven.

Symptoms.—There is extreme distention of the stomach, most prominent on the left side with consequent difficulty in breathing. The pulse may be nearly imperceptible. The animal moans, may stagger and fall, then die in convulsions.

Treatment.—If breathing is difficult, do not wait for the effect of medicines; sheep require very prompt treatment to save them. Tap with trocar and cannula, high in the left flank and well forward. (See Fig. 77.) The tube (cannula) may be left in the flank for some time if gas continues to accumulate.

Then give the following as one dose in one pint of sirup:—

(A) Aromatic spirits of ammonia	2 oz.
Turpentine	2 oz.

This is a suitable dose for a thousand pounds live weight. Repeat this in half an hour if necessary or give one double dose; or give (B) 4 oz. hyposulphite of soda in 6 ounces water every half hour until gas ceases to accumulate or until a limit

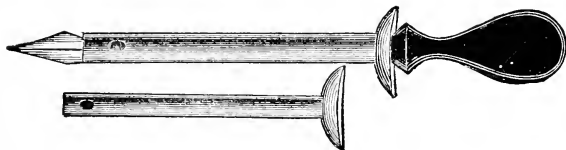

FIG. 78.—TROCAR AND CANNULA.
For tapping bloated sheep and cattle.

of six doses have been given. A third method consists of alternating the two doses (A and B) just described at half hour intervals.

Half an ounce of formalin in a quart of water is a very effective remedy. For mild cases, a large hay rope placed in the mouth and tied around the head is useful. Vigorous massage of the belly by two men with a limber pole is useful in such cases. Both of the latter methods are more effective when sheep are made to stand high in front, or on their hind legs or when cattle are made to stand with the front parts high as possible.

Do not exercise a badly bloated cow or sheep. To do so is dangerous, because the breathing is interfered with by the pressure of the stomach against the diaphragm. When the acute symptoms have subsided give the following for physic:

Epsom salts	1 lb.
Glauber salts	1/4 "
Ginger (ground)	3 oz.
F. e. nux vomica	3 drams

Dissolve these in three pints hot water and use the solution as a drench; repeat in 16 hours if bowels do not move freely.

Prognosis.—A large percentage of cases recover if properly treated soon after disease appears. Death occurs from asphyxia, rupture of the paunch, or rupture of the diaphragm.

Prevention.—Hoven is likely to be quickly fatal to sheep; hence, sheep should be closely watched, when they are first put on dangerous feed like green clover, rape or alfalfa. A large proportion of these cases may be prevented, but some will appear occasionally under conditions which cannot be prevented. There are two reasonably safe methods of turning cattle and sheep on new pasture at any season; from a poor to a richer pasture; or from grass to clover. *First*, feed heavily and then turn them on the new pasture for a few minutes the first day, and increase this time a little each day for a week. Or *second*, give the cattle or sheep a large ration of the dry food to which they have been accustomed, for several days before they are to be turned on the new feed; feed later than usual on the last morning and then turn them out as soon as they are done eating, which should be after the dew is off the grass and not soon after a rain. Under these conditions, cattle and sheep usually may be turned on grass in the spring or put on new or different pasture and left there with little risk.

Pastures where the old grass stands quite heavy, and the young grass has grown up in it, are much less dangerous than those where the stock gets only the new grass. When cattle or sheep are once safely on a rank pasture, or clover, alfalfa, etc., the more continuously they can be left there, the safer they are.

LECTURE XLIX

PARTURIENT PARALYSIS (MILK FEVER)

This serious disease of cows usually appears within a very few days after calving, although it may appear before or some time after calving. Its cause, nature, and pathology are not well understood. However, prevention and treatment are, as a rule, very satisfactory.



FIG. 79.—PARTURIENT PARALYSIS—MILK FEVER. (M. H. R.)
Early stage. Unsteady on hind legs.

Causes.—The causes of parturient paralysis are of two classes, predisposing and precipitating.

Predisposing causes include age (maturity), heavy feeding and milking qualities, pregnancy, easy delivery, lack of exercise, and high temperature in stables. The cow that is a heavy feeder and milker and in the prime of life, with her third or

fourth calf, is the one most subject to this disease. A young heifer, an old cow, or a cow in thin flesh and underfed during pregnancy, is not likely to have this disease.

Precipitating causes include delivery, sudden increase of gland activity in the udder, disturbance of circulation, anxiety and exposure to cold and damp.

Symptoms.—These are known as: early or warning, and diagnostic, or positive.



FIG. 80.—PARTURIENT PARALYSIS. (M. H. R.)

Later stage. Head held unsteadily.

Early symptoms.—Uneasiness, sudden constipation, eyes either stupid or wild, tail switching uneasily, and checked milk flow are early symptoms of milk fever. The gait is peculiar, showing imperfect control of the posterior limbs. Such symptoms, if occurring during the first five days after calving, or within two days before should warn of danger.

Diagnostic symptoms.—The patient goes down, is more or less unconscious and lies in a peculiar position, with her head in the flank; she loses sensation and power of voluntary motion, the sensory and motor nerves become paralyzed; her pupils dilate; she is unable to swallow; her pulse, at first bounding and full, is later depressed; her temperature is usually normal, or even sub-normal; respirations are slow. In typical cases, the symp-

toms are uniform and plain; but some atypical cases are not easily recognized.

Prevention.—Prevention is always more satisfactory than treatment. For a heavy milker, sudden changes in diet are to be avoided, unless toward one lighter and more laxative just before calving. It is sometimes advisable to change especially susceptible cows from pasture to light, dry feed. Food should be light, laxative, easily digested, and small or moderate in quantity. Exercise is desirable. A mild laxative may be given

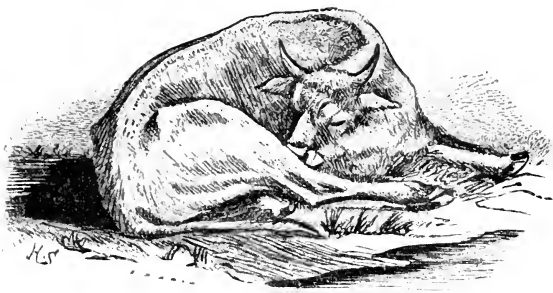

FIG. 81.—PARTURIENT PARALYSIS.

Cow very stupid. Skin has lost sensation. Head in the flank. Still later stage.

2 to 5 days before calving, one quart raw linseed oil, for example.

Allow the cow abundant exercise during the last month of pregnancy, and, if she is nervous, leave the calf near her for a few days.

Usually there should be no milk drawn before calving and but little removed during the first twenty-four hours afterward, not more than the calf would take naturally. This precaution is especially important as a preventive of milk fever in high-type dairy cows, and is reasonably satisfactory if followed with intelligence.

Treatment.—Acute cases are liable to die in 12 to 24 hours if not treated; others may improve greatly and then relapse. Since these cases require skilful treatment, and the affected animals are usually valuable, stockmen should not treat them if competent veterinary services may be had. A line of treatment is

suggested here because cases for the stockman however frequently occur where it is not possible to obtain professional assistance.

The patient must not be allowed to lie flat on the side on account of danger from hoven, but should be propped up by means of bags of sand, bran, or hay, so that she lies on the sternum. If the head is thrown around violently, it should be supported by means of a rope tied to some overhead support. The cow must also be kept quiet and thoroughly warm and dry. Severe cases may require stimulants, like strychnin or camphor oil (1:4) hypodermically injected. Retain heat in cold weather by a covering of four or five blankets. Draw urine twice daily and use large quantities of slightly irritating rectal injections repeated several times, if necessary. Give no medicine or liquid food by the mouth, except as directed by a competent veterinarian, because of difficult swallowing and the danger of producing fatal pneumonia in a case that should have recovered.

Air treatment.—The injection treatment for milk fever has passed gradually through several stages from iodid of potash solution (Schmidt treatment) to various other solutions, then to oxygen gas, and finally to simple, clean air. This air-injection treatment is the one now in most common use. Apparently full distention of the udder is the essential thing, and it matters little what is used for the purpose providing it be clean and not irritating. Great care in cleanliness is necessary to avoid infection of the interior of teat and udder with germs which might cause garget or septicemia (blood poisoning).

The udder and teats should be well brushed, then placed on a clean towel or piece of oilcloth and disinfected with 1 to 1000 corrosive sublimate in water, or 3 per cent lysol or creolin, or 5 per cent carbolic acid. The hands of the operator, the teat tube, the rubber tubing, etc., should all be disinfected, the two latter by boiling. After the teat tube is disinfected, it should not be carelessly handled or be allowed in contact with anything that can contaminate it. Bacterial cleanliness is of the utmost importance. Air is injected by a special syringe in which it is filtered through cotton before entering the udder. The utmost care must be taken as to clean handling and the injection of clean air. The quarters are milked out and pumped full of the filtered air; it is well to give the udder massage treatment in order to disseminate the air through the milk ducts during the

injection process. A broad tape is tied around the teat and left on for about six hours.

The injection may be repeated in three to six hours if necessary. In an emergency, an ordinary bicycle pump connected by rubber tubing to a milk tube may be used, but this, of course, does not filter the air.

Prognosis.—It is difficult to make an accurate estimate. But there is in general a good prospect of recovery in serious looking cases if they are properly and promptly treated.

Sudden and unexpected variations occur. Mortality under the air treatment is not large. The prospect is less favorable if the case develops soon after calving; if it develops rapidly and seems to overwhelm the system; if there is decided loss of animal heat; if tympanites or bloating, or convulsion occurs; if the cornea becomes insensible; if the lower lip hangs loosely.

The prospect is favorable if: the circulation remains good; if feces are passed; or the patient attempts to rise or eat; if rectal irritation causes a discharge of feces, or a subnormal temperature changes to normal.

LECTURE L

CHOKER

Choking, as ordinarily understood, is an obstruction in any portion of the pharynx or esophagus. In horses it is more commonly caused by dry food, rapidly eaten. Cases in which a long section of the esophagus is packed with soft, dry food are especially difficult to handle successfully. Cows more frequently choke on pieces of roots, pumpkins, and even old bones.

Symptoms.—The horse or cow stops eating suddenly and makes ineffectual efforts to swallow, then there are spasmodic actions of the neck and belly muscles. When the animal attempts to drink, some of the water returns through the nose. If the obstruction is of considerable size and is located along the neck portion of the esophagus, it may usually be seen or felt. There is usually a profuse flow of saliva, and particularly in the case of cattle an involuntary chewing action. If the choking occurs in the thoracic portion, then medicines or liquids are swallowed in small quantities without difficulty until the esophagus is full, when they return by the mouth, causing the animal to cough. There is usually marked dejection and distress, with an appearance of anxiety, food and water are refused. Cattle frequently bloat.

Prevention.—Roots should be sliced or pulped unless they are large. Cows often choke when eating hurriedly, especially when attempting to swallow under threatened attack from some other member of the herd. Hence individual feeding lessens this. Horses choking on dry feed are almost invariably rapid eaters, and for such horses it is well to avoid dry bran. Grain, especially oats or similar food, should be fed in such a way that the horse gets it slowly; it may be scattered over the bottom of a large manger, for instance—any device which forces the horse to eat slowly lessens the difficulty. It should also be borne in mind that an animal which has once choked is liable to a recurrence, with consequent recurrence of the same difficulty, during the first week or two after the accident.

Treatment.—In case of choke, food, drink, or medicine may easily cause a fatal pneumonia, by entering the lungs through the pharynx; hence the need of great caution.

If the obstruction is within reach, it should be removed by the hand, the teeth being held apart by some suitable device to protect the arm. A person with long arm and slender hand can frequently relieve choking in the pharynx or upper portion of the gullet, especially if he has an assistant to shove the obstruction upward toward the hand. A thin glove with the ends of the fingers cut off is desirable for protecting the hand.

Dry food that cannot be reached by hand should be softened by the use of oily or mucilaginous drinks, and then gradually worked loose by external manipulation. Frequently the obstructing mass can be loosened at the lower portion, a little at a time, and the loosened portion swallowed.

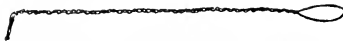

FIG. 82.—FOR RELIEVING CHOKE. (M. H. R.)

Made of No. 10 or 12 wire.

If the choke is along the neck, and caused by dry feed like oats or bran, then water or raw linseed oil injected directly into the dry mass with a good hypodermic syringe may soften and dislodge the obstruction. A case of this kind may often be relieved by washing the feed out through a double-current stomach tube. A single-current tube may be used to siphon out soft feed. Loosen the upper portion of the mass with the fingers, then fill the tube with water, drop the outer end, and siphon out. Repeat as many times as necessary. For this purpose, or for use as a probang, a small sized lawn hose, well oiled, does very well. This method is applicable whether the obstruction is in the neck or within the chest. A probang should not be used in cases where the trouble is due to dry food.

The simple device shown in Figure 82 is very satisfactory for relieving choke due to pieces of vegetables. It consists of a piece of No. 10 to 12 wire, about 12 feet long, the ends bent together and twisted as shown in the cut, leaving a suitable loop at the point which was originally the middle of the wire. This instrument is introduced into the gullet. The farther end passes the obstruction, which is then included by the loop. By pulling

on the wire the obstruction is loosened, moved upward a short distance, or removed entirely. If the obstruction is merely loosened then the process is to be repeated. This has proven fairly satisfactory in the writer's experience. In all such work the nose should be extended, the gullet be kept in as straight a line as possible, and the work be done carefully. The tube or wire loop should be introduced slowly and carefully, high up and well back in the mouth. If the animal coughs, the instrument should be removed and another trial made, as the coughing indicates that the instrument has entered the trachea.

Tense, spasmodic action of the gullet gripping the choke may be controlled by the use of morphin or aconite. Whips and other stiff instruments must be avoided, as they are apt to tear the gullet just below the pharynx. Whatever is used must be smooth and flexible. For at least a week after the removal of the obstruction, the diet should consist of soft food.

There is usually no reason for haste in treating choke. Some cases will recover naturally if water is kept before them and they are left quietly alone. However, in severe cases, and when ordinary measures fail, call your veterinarian before you have bruised and torn the esophagus, making the case hopeless.

MISCELLANEOUS DISEASES

LECTURE LI

UN SOUNDNESS

If at any time a horse has any disease (*e.g.* bone spavin or heaves) which actually makes him less capable of his proper work, or which in its ordinary progress will diminish his natural usefulness, he is unsound. A blemish, *e.g.* a barb-wire scar, impairs appearance and sale value, but not actual service, and is not an unsoundness.

Soundness is usually relative, being rarely if ever absolute or perfect. What we mean in passing a horse as sound, is that he is practically sound.

To be sound, then, a horse must have no disease or other condition that interferes or is likely to interfere with his usefulness. For instance, a horse may have a spavin, which both lessens his ability to work and injures his selling value. The same would be true of heaves. A horse may have a disease from which he will recover; but at the time of examination, he will be technically unsound.

Unsoundness may be temporary or permanent. Temporary unsoundness may be illustrated by an influenza, from which a horse would probably recover, or by a light sprain or an ankle bruised from interfering. In the latter case the question would arise at once as to whether the interfering was due to faulty conformation or to faulty shoeing, for the latter could be easily remedied. In the former case the condition would be incurable and serious; in the latter condition it would be unimportant.

Normal conditions.—It is necessary first of all to become familiar with the usual and unusual normal conditions and appearances for comparison. For instance, the hocks may be perfectly sound, and yet have peculiar bony development. In such case it will be found that both hocks are alike. The knees may have a similar peculiar development, and yet be perfectly sound.

COMMON UNSOUNDNESS AND BLEMISHES

Ringbones, splints, spavins, etc., are abnormal developments of bone tissue, the result of an inflammation of the periosteum. These are all recognized as forms of unsoundness, and usually cause lameness. The inflammation of the periosteum may have its origin in bruises or other injuries, or it may possibly be the

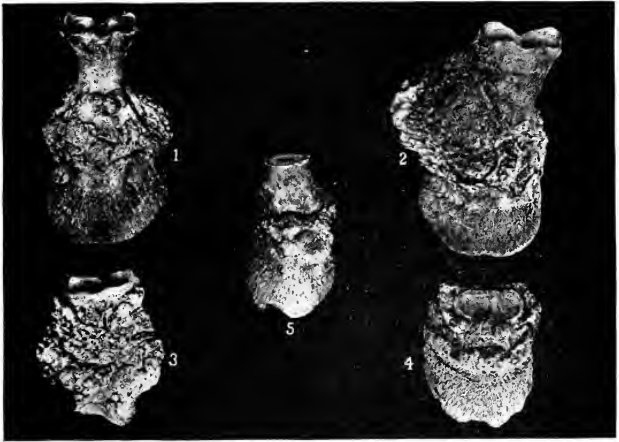

FIG. 83.—RINGBONES. (M. H. R.)

1. Ringbone and sidebone, with general ankylosis.
2. Ringbone and sidebone, with general ankylosis and marked bony enlargement.
3. High ringbone with ankylosis on first and second phalanges.
4. Low ringbone with sidebone, and ankylosis of the second and third phalanges.
5. Ringbone with sidebone, and unilateral ankylosis.

result of an extending inflammation from some adjoining tissue, but in either case the result is usually a projecting development of bony tissue, *i.e.*, an exostosis. Hereditary tendency is another important item among causes.

Ringbone.—This is characterized by an exostosis on some portion of the pastern bones. It may be in front, behind, on either side, or extending entirely around the pastern. It may be located near the crown of the hoof or very much higher. Some ringbones involve the articulation, and are then called articular.

These necessarily cause lameness. Others affect the extremity or the shaft of the bones without involving the articulation. Some are due to injury, others are of rachitic origin (rickets), and due to faulty nutrition resulting in poor quality of bone.

Ringbones are usually much more serious forms of unsoundness than splints, as they are more apt to be permanent in effect, and even if the soreness be relieved, there is likely to be a mechanical lameness because of a stiffened joint. This unsoundness and the lameness resulting from it are very easily detected in plain cases.

Sidebones.—A sidebone is an abnormal condition of the lateral cartilage—most common on the external cartilages of the front feet—characterized by firmness under pressure and some-

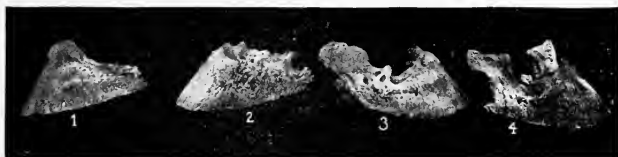

Fig. 84.—SIDEBONES. (M. H. R.)

Due to an inflammation and ossification of the lateral cartilages: 1, normal os pedis; 2, 3, 4, varying types of sidebones.

times enlargement. These cartilages are normally quite elastic. The firmness is due primarily to a deposit of lime, a process of ossification, *i.e.*, bone formation—in the cartilage structure. Sidebones are detected as bonelike structures which appear above the crown of the hoof at the quarter and just beneath the skin on either side. They may or may not cause lameness during the period of inflammation and hardening. In some cases the lameness is persistent. Other cases are very slow and mild and no lameness is noticed.

Spavin.—Bone spavin is one of the most serious forms of unsoundness. This is a disease of the tarsal bones at the lower, inner, front portion of the hock. There is usually something of an exostosis, varying from very small size, commonly called by horse men a “jack,” to very large size which every one recognizes as bone spavin.

There is another form of bone spavin in which there is a slight or no external development. In this form there is disease

of the bones in the deeper parts; and erosions of the articular cartilages. Bone spavins have a tendency to recover without treatment, although in many cases the period required for natural recovery is very long, extending through a period of years. In other cases recovery can never occur. Recovery when brought about by natural or artificial conditions implies that certain of the tarsal bones have united, a process called ankylosis, *i.e.*, union. Inflamed, sensitive surfaces are then no longer rubbing together as the limbs move.

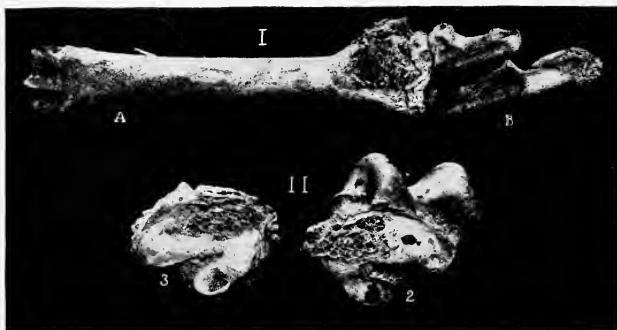

FIG. 85.—SPAVINS. TWO TYPES. (M. H. R.)

I. Spavin with marked bony enlargement. *A*, metatarsals; *B*, tarsals with enlargement and ankylosis.

II. Blind spavin. Extensive ulceration of articular surfaces; no enlargement; no ankylosis. 2, os calcis; 3, scaphoid or large cuneiform.

Many bone spavins doubtless appear as the result of slight injuries in susceptible subjects, particularly those that have a strong hereditary tendency to disease of this kind.

Symptoms.—These cases come out very lame after hard work, step on the toe, and improve with exercise. They often stand with the foot resting in a peculiar way against the other hind foot. In motion they carry the hock joint with as little movement as possible and step on the toe.

What is known as the *hock test* is made by holding up the limb, with the hock sharply bent, for several minutes, then the horse is started suddenly. In case of spavin the first few steps are very lame. Old horses without spavin may respond to this test and so lead to error if one is not careful.

Splints.—Splints appear as small tumors of various shapes and sizes along the metacarpal bones, usually at the junction of the large and small metacarpals. They are generally more serious when located near the knee. Occasionally there appears what is known as a pegged splint, in which the growth extends across the back of the cannon, beneath the suspensory ligament. It is important to avoid mistaking for a splint, the normal enlargement on the inferior extremity of the inner metacarpal.

The lameness which results from splints is recognized by locating the splint and noting sensitiveness on pressure over this point. The horse walks nearly or quite "sound," but trots very "lame," especially on hard ground. He is apt to get worse after long exercise and is worse on rough, hard road.

There is a natural tendency to recover. For this reason lameness from splints is rarely seen in aged horses.

When the splint appears very close to the knee, or in the pegged form, there is less prospect of natural recovery, and, with the latter form, lameness is very apt to be permanent, unless relieved by surgical means.

Curb.—A curb is a result of injury or strain of a short ligament at the back of the hock joint, and is characterized at first by a hot, sensitive swelling just back of the lowest part of the hock joint. After the period of swelling and inflammation subsides, there is apt to remain a hard tumor, particularly on what is known as curby hocks. In cases of young animals with otherwise good legs, proper treatment may reduce the enlargement to slight size or practically remove it.

Capped hock.—This is a soft enlargement, on the point of the hock, and is produced by bruises. Some horses get it by backing up against the stalls and striking so as to injure the point of the hock; bruises may be received during ear shipment. The first swelling may usually be reduced by prompt treatment, but upon slight injury it returns and after several attacks is apt to be permanent. A capped hock does not injure a horse for actual use, but it is unsightly, and materially reduces sale value.

Shoe boil.—Shoe boil appears as an enlargement on the point of the elbow or superior extremity of the ulna. It is very similar to capped hock in cause, character of structures involved, and subsequent history. Shoe boils are unsightly and injure sale, but do not cause lameness.

Synovial sacs.—The ordinary wind puffs, bog spavins, and thoroughpins are typical illustrations of enlarged synovial sacs. They are not usually the cause of lameness and are to be regarded rather as blemishes and indications. They are common in overgrown draft colts that have not had sufficient exercise.

Wind puffs are found just above the ankles and in mature horses usually indicate too much hard work.

Bog spavins are enlargements of the synovial sac of the hock joint, and appear on the inner and front part of the hock. They are often hereditary.

Thoroughpins are similar to bog spavins and wind puffs, except in location. Thoroughpins appear at the upper and back part of the hock. They may or may not connect with the synovial sac of the hock joint.

Open joint is usually the result of puncture of the synovial sac and the entrance of bacteria, which cause an acute inflammation, known as synovitis. This form of lameness can usually be very easily detected, and the cause recognized. It is very serious under all circumstances, and frequently results in death. The veterinarian should be called at once.

Hygromas.—These are enlargements of serous sacs at prominent points and due to injury. They are found at the elbow, knee, external angle of ilium, point of the hock, "pin bone," point of shoulder, etc. They sometimes have thick, hard walls. A common example is found at the knees of stabled cows.

Miscellaneous.—*Corns* usually appear at the inner heel of the front foot—in the angle between the bar and wall. They may be caused by bruise of the sole but more commonly by lateral pressure of the weight from above upon the sensitive laminae and velvety tissue in a contracted heel.

They appear as bruised areas under the sole at the point mentioned. The wall at the affected heel is apt to show ridges which are not parallel with the coronary band. A horse with a corn frequently "points" as in a case of navicular disease.

In case the bruised area becomes infected, pus forms and eventually discharges at the coronary band. The case is then known as a "quittor."

Navicular disease is a slowly developing, chronic affection of the navicular articulation. The navicular bone, with its articular cartilage, the deep flexor tendon, and synovial membrane at that point may be involved in the inflammation and its re-

sults. The disease is more common among light harness horses. It is detected by "pointing" in the stables; after the case is well developed, lameness grows worse if the horse continues to work and generally improves with long rest only to return again with work.

The history of navicular trouble is significant. Slow and vague in its onset, the lameness is variable and irregular at first. Later the horse "goes on his toes" in a stilty manner and

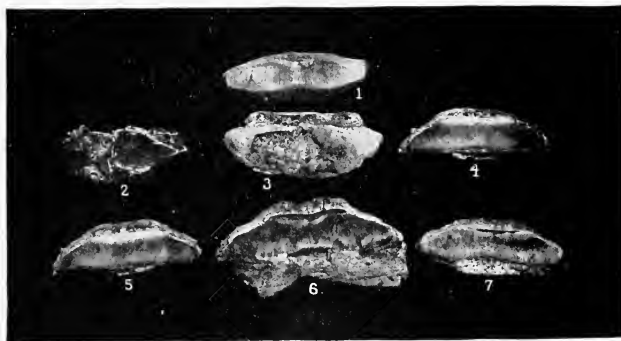

FIG. 86.—NAVICULAR DISEASE. (M. H. R.)

1. Normal navicular bone.
2. Exostosis (bony enlargement) with fracture.
3. Exostosis with extensive ulceration of the articular surface.
- 4, 5, 6, 7. Varying types of exostosis.

stumbles easily if both feet are affected. There may be heat in the hollow of the heels and pressure of the thumb in this hollow together with sharp flexion of the toe causes increased lameness when the horse is made to move.

Dummy.—A dummy is a horse with a brain disease which is indicated by peculiar attitude and stupid actions. The horse is listless, stands with his head down, perhaps resting it on the manger and frequently rests one foot upon the coronet of the other. He drinks with his mouth deep in the water; walks with his head low, although stepping high or dragging the feet; is unable to back; and is subject to sudden brain disturbances such as unreasonable fright and panic. Such a horse will usually leave the front legs crossed if they are put in this un-

natural position by the examiner. A sound horse will not do this unless trained to do so.

Roaring, whistling, heaves.—These disorders of the respiratory organs have been previously described as serious and chronic and should not be overlooked.

Heart disease.—This trouble is indicated by violent or irregular heart action, inability to stand exertion, etc.

Ruptured perineum.—Ruptured perineum is a tear between the rectum and vagina in a mare at the time of foaling and is very objectionable. Some cases are curable by an expert surgical operation.

LECTURE LII

UNSOUNDNESS (*Continued*)

Examination.—An examination for soundness should be systematic and thorough, although it may be rapidly done. Examination should be made with a horse in the stall and as he backs out, stands at rest, and moves about. It is usually necessary to both see and feel and it is not safe to trust the eyes alone. In the stall examine to see whether the horse eribs, weaves or points, or has any stable habit which is objectionable. As he backs out of the stall, he may show peculiar use of the hind legs or imperfect control due to disorders of the nervous system. Very frequently the first intimation of spavin is given as the horse is made to step from side to side, particularly when he steps toward the spavined leg, or an obscure stringhalt may be detected as the horse backs out of the stall or comes out of the stable.

At rest.—Outside the stall the observer should observe the attitude again for a favored limb, dummy, cribber, wind sucker, poor hearing, bad disposition, etc. Beginning in front, examine the *ears* for hearing, for tumors that may develop at the base, for split ears, etc.

In examining the *eyes* it should be borne in mind that periodic ophthalmie (moon blindness) recurs at intervals and leaves the eye more or less nearly normal between times. The eye may show a weakened, or squinting, or hazy appearance that is suggestive.

The *nostrils* should be examined for ulcers, scars, or discharges which would suggest glanders. Dishonest dealers sometimes plug the nostril with sponges to prevent the appearance of suspicious discharge.

The *teeth* should be examined for evidences of cribbing shown by the rounding of the incisors, for age, and for a condition commonly known as parrot mouth, *i.e.*, overhanging upper teeth, which interferes with pasture feeding.

The *lips* should be examined for evidence of paralysis. The

submaxillary lymph glands under the lower jaw should be examined particularly with reference to glanders. (See Glanders. Lecture XII.)

Foul breath may show diseased tooth or diseased maxillary sinus.

The *poll* should be examined for scars or other evidences of present or previous poll-evil, which is a deep discharging sore like fistulous withers.

The *withers* should be examined for scars, for discharging sores, and other evidences of fistulous withers.

The *shoulders* should be examined for sweeny, sore neck, and, particularly, for so called collar boils. The latter are either flat and broad or more prominent tumors, which will usually subject a horse to sore shoulders when he is put to work.

The *elbow* should be examined for shoe boil; the *knee* for scars or what is commonly known as "broken knee," which indicates that the horse is inclined to stumble, and also for knee spavin, a bony enlargement, usually located on the inside.

The *cannon* or shin bones must be examined for splints, and behind them the tendons must be examined for evidences of sprains and other injuries, which are usually indicated by a thickening.

Ankles are to be examined for evidences of interfering, and fractures or other injuries of the sesamoid bones and attached ligaments. The *pastern* is to be examined for ringbones, sidebones, and evidences of the operation known as nerving. In case of doubtful sidebone have the foot lifted and then examine it again. Evidences of nerving are found in scars about midway of the pastern on each side and just at the edge of the back tendon. The sides of the back tendons should also be examined just above the ankle for scars, which would suggest another nerving operation. The mere fact that a horse has been nerved, whether going sound at the time of examination or not, is a very serious objection. This operation is not usually resorted to except as a measure of last resort, and it does not in any sense cure the original disease.

The *feet* should be examined for evidences of contraction at the heels, for flatness or convexity of the sole, corns, founder, navicular disease, thrush, and other foot diseases, such as quarter and toe cracks, and serious injuries to the crown of the hoof by sharp calks.

In examining the feet, the shoe should usually be removed and every portion of the sole and frog examined for nail puncture. A blacksmith's sage knife is best for the purpose.

While passing along the side and flank the *breathing* should be observed to determine whether it is even and regular, or jerky, suggesting heaves. The flank and lower part of the abdomen must be examined for possible ruptures.

Stepping behind the horse compare the two *hips* for evidences of fracture. A horse so affected is commonly described as being hipped or hip-shot. This unsoundness is due to fracture of a small piece off the external angle of the ilium. It does not interfere seriously with working ability, but produces a very awkward appearance and materially lessens value.

The *hocks* must be examined for bog and bone spavins, thoroughpins, curbs, and capped hock. The same examination is made of the cannon, ankle, and pastern as for the front limbs.

In motion.—The horse should be examined while walking and trotting. The movements of the neck and head are studied as he comes toward and passes by the observer, the movements of the limbs being noted as to the height to which they are raised, and the bend of the joints (whether easy and natural or otherwise). The way in which the limb is carried and the foot "lands" upon the ground—whether flat, on the toe, on one side, or on the heel—is to be noted and considered. As the horse passes from the observer, the movements of the hips and hind legs are noted with a view to detecting lameness in those parts. To bring out diseases of the feet examination in motion on hard road or pavement should be made. Then if there is uncertain lameness, motion in deep mud or in snow should be studied. If such conditions are not available, the horse should be made to step over a wagon tongue or a plank, held up about a foot from the ground, in order to detect or make more prominent possible soreness or lameness in the shoulder or hip.

Finally, the horse should be given vigorous exercise on a full stomach; for instance, a run to a heavy wagon, or a short run uphill, to determine whether the respiration is normal, or in other words to test his "wind." While a horse is at rest or at light exercise, it is possible to partially disguise abnormal breathing; but severe exercise on a full stomach will usually bring it out.

The most common and obvious forms of unsoundness are:

Bad eyes; especially cataract; glanders shown at the nose; poll-evil, just back of the ears, at the top of the neck; fistula at the withers; heaves and roaring, shown in breathing; splints, along the cannon; injured tendons; farcy sores on limbs or body; ankles bruised from interfering; sidebones and ringbones at the pastern; navicular disease, corns, founder, cracks in the hoof; fractured hip (hipshot); spavin at the hock in front, and curb at the hock behind.

Lameness.—A lameness is any irregularity of the gait, regardless of cause or degree of severity.

Locating the lameness.—It is usually quite easy for any observer to see that an animal is lame, provided the lameness is at all decided, but there are many cases where lameness is so very slight or complicated that it is difficult even for an expert to locate it.

Examination may be necessary before, during, and sometimes after exercise.

Side.—A very common error is that of locating the lameness on the wrong side. The head and weight of the body in general, come down most noticeably with the sound limb. For instance, a horse which is lame in the left front leg will nod and drop the head, neck and front quarters, as he lands upon the right front leg.

Gait.—Some forms of lameness are detected with great difficulty when the animal is walking, but are easily seen when the horse is trotting. It is usually conceded that the latter is the best gait for diagnostic purposes, although the observer should study the movements at both walk and trot. The pacing gait is rather confusing.

General examination.—The horse should be examined at rest and when he is unblanketed in the stall. He may "point" or he may uneasily raise and repeatedly shift the same foot, indicating the unsound limb and even the location and nature of the trouble.

The horse should then be made to step from side to side, and forward and back, then taken out and observed while walking and trotting, coming toward, passing by, and going from the observer, the latter observing carefully the movements of the entire body and the use of each limb. It is especially important to observe the head and hips in solving the first problem of locating the diseased limb. In case of doubt, circle the animal

both ways; he may show plain lameness when the diseased limb is on the inside. The horse should be tried on both hard and soft ground and on side hill. If the lameness is in the foot, it is most marked when the animal travels on hard ground. When it is in the shoulder, he is likely to travel with great difficulty in deep mud or in snow, or when stepping over a wagon tongue.

When the trouble is in front it should always be borne in mind that the front foot is an especially common seat of lameness, whereas in the hind leg, trouble is most common at the hock.

Sometimes unusual combinations are confusing. A horse lame in both front or both hind limbs is short and stilty in stride, carrying his feet close to the ground, and backing with difficulty. If in trotting two diagonal limbs are lame, the whole body rises as they land and falls as the sound pair land. If two limbs on the same side are lame there is a peculiar see-sawing of the entire body.

Lameness at shoulder, stifle, and hip is indicated by difficulty in bringing the limb forward and there is "swinging leg lameness."

A horse affected with shoulder lameness often rests the lame limb on the toe, with the knee flexed and the limb directly beneath the shoulder. He has a short forward stride, and a swinging leg lameness, which is worse when he travels up hill, or in mud, and often shows plainly when turned short. He has great difficulty in backing, and drags the limb.

OBSTETRICS

LECTURE LIII

OBSTETRICS

Obstetrics is the science which deals with the birth of young animals. The female organs studied in obstetrics are: ovaries, Fallopian tubes, vagina, and uterus.

Ovaries.—These are two small, more or less flattened, spherical organs, suspended in the front part of the broad ligament (see uterus) in the sublumbar region. Their function is to develop, mature, and discharge the ovules or eggs.

Fallopian tubes.—

Two slender tubes consisting of mucous, muscular, and serous coats, the mucous membrane being continuous with that of the uterus. They connect the ovaries, one on each side, with the horns of the uterus. The ovules or eggs pass through these tubes on their way to the uterus.

Uterus (womb).—

The uterus is a muscular sack small in non-

pregnant animals and very large in pregnant animals—located partly in the pelvic cavity and partly in the abdominal cavity.

Structure.—The uterus consists of three layers or coats: (*a*) outer or peritoneal; (*b*) middle, muscular; (*c*) inner, mucous.

The outer (*a*) is the thin, delicate, glistening membrane, the peritoneum, which lines the entire abdominal cavity and covers with another layer every organ within that cavity.

The middle coat (*b*) is composed of two distinct sets of muscle

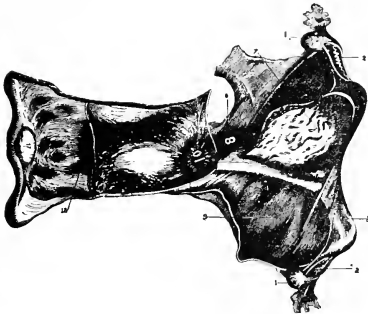

FIG. 87.—GENERATIVE ORGANS OF THE MARE.

1, ovaries; 2, Fallopian tubes; 6, horn of uterus intact; 7, horn of uterus laid open; 8, body of uterus; 9, broad ligament; 10, cervix or neck of the uterus; 13, outlet of the urethra.

fibers. The outer fibers extend lengthwise, and the inner ones around the uterus. The muscular coat gives strength and support to the womb and aids in expulsion of the fetus at birth.

The inner coat (*c*) is a mucous membrane and very similar to that which lines the mouth and whole alimentary canal. This coat has especial importance, since it provides for early nourishment of the ovum and later develops the maternal placenta or afterbirth which gives the bond of union between the mother and fetus during pregnancy.

Shape.—In general the body of the uterus is cylindrical and divides in front into two branches. Each branch connects with a Fallopian tube and through that with the ovary. The body of the uterus narrows behind to a neck which projects into the vagina except in the sow. The cervix (neck), body and

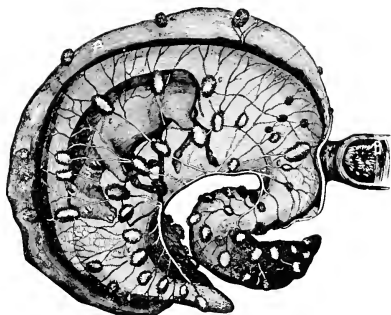

FIG. 88.—FETUS AND FETAL MEMBRANES OF THE COW AT MID-PREGNANCY.

Uterus opened on the right side, exposing fetus and membranes. Note the small, light-colored bodies (cotyledons) which connect uterus and membranes. See also Fig. 89. *A*, uterus; *B*, cervix (neck of uterus).

horns differ greatly in the various domestic animals, *e.g.* the cervix in the cow is from two to three inches long, very firm and with a tortuous canal. The sow has the body of the uterus short, horns long and the cervix not very distinct, the vagina and uterus being more nearly continuous. The rectum is above the uterus, and the bladder below it.

Supports.—The uterus is held in place by four ligaments which are partly folds of the peritoneum. The most important of these are the broad ligaments. These are two wide folds of the peritoneum with some fibrous and muscular tissue, which are attached to the body of the uterus and its horns, one on each side and to the sublumbar region above. A third ligament is attached above to the rectum, and a fourth below to the

floor of the pelvis. These four ligaments all give support to the uterus and hold it in position.

Openings.—There are three openings into the uterus: one behind, opening into the vagina, *i.e.* the cervical canal through the cervix; and two in front, for the Fallopian tubes.

Function.—The function of the uterus is to receive and nourish the ovum and mature it after it has been fertilized.

The ovum attaches to the uterine wall and three covering and supporting membranes are developed around it. These in

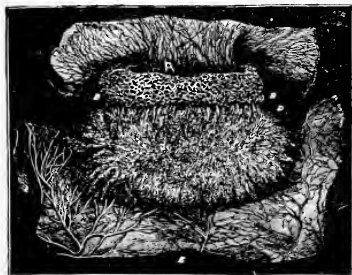

FIG. 89.—BOVINE COTYLEDONS.

A, pedicle of uterine cotyledon; *B, B*, uterine cotyledon; *D*, fetal cotyledon; *E*, fetal membrane.

order from without in are the chorion, allantois and amnion. Here the fetus develops, receiving oxygen and food materials from the maternal uterine walls, through the surrounding placental membranes. There is no direct circulation from mother to fetus.

In the cow, sheep, and goat, contact between the mother's uterus and the chorion

is by about 60 to 100 large, rounded button-like bodies called cotyledons, developed from the mucous membranes of the uterus. Over these fit cap-like bodies from the fetal chorion. The mare has a very different relation between fetus and uterus. Her uterine mucous membrane is provided with a very large number of tiny pockets into which fit minute capillary tufts, making a practically continuous contact between uterus and chorion.

Vagina.—This is a membranous tube which contains much muscular tissue in its walls.

Structure.—There are three coats: (*a*) outer, of loose connective tissue; (*b*) middle, muscular; (*c*) inner, mucous. Close to the cervix, the external surface is covered also by the peritoneum.

Location.—The vagina is located in the pelvis between the rectum above and the floor of the pelvis below. It is capable of great dilation to allow the passage of the young at birth. Be-

tween the uterus and vagina the connection or common opening is through the neck of the uterus, properly the cervix. At this point the uterus narrows greatly and is composed of firmer tissue, especially in the cow. As the time for delivery approaches this narrow canal is dilated until the opening is large enough for the young animal to pass through.

Normal period of gestation.—This varies from two years in the elephant to 30 days in the rabbit. The cow carries young about 283 days; mare, 345 days; sow, 119 days; ewe, 149 days. All these may vary greatly. Old animals usually carry longer than young.

ACCIDENTS OF PREGNANCY

The most serious accidents of pregnancy are: abortion, retention of the fetus, and volvulus (twist in and near the neck of the uterus).

Abortion.—For the purpose of this lesson, abortion may be defined as any premature birth.

Abortions are either sporadic or infectious, usually the latter.

Sporadic abortions may be due to a great variety of conditions; *e.g.*, death of very weak embryos; strong medicines, especially purgatives; mechanical injuries; sudden and unaccustomed exercise; extreme nervous excitement; diseases accompanied by cough or severe pain or high fever; disease of the uterus and lack of constitutional vigor in either sire or dam.

Infectious abortion is an exceedingly serious disease. The actual abortion should be considered as merely one of several serious symptoms of the disease. See "General results." It is due to contagium; *i.e.* to the action of living germs upon the uterus, fetus, and placental membranes.

Infectious abortion, unlike hog cholera, does not spread rapidly through a herd. Cases usually come at irregular intervals throughout the season until a large percentage of the herd may have aborted. See next Lecture.

Symptoms.—Symptoms of approaching abortion depend on the stage of pregnancy, and are frequently obscure or even lacking if the abortion occurs very early. Sometimes there is a discharge from the vagina and its mucous membrane may be deeply congested. Slight labor pains sometimes appear several hours before the fetus is expelled and before the sac is ruptured. Occasionally the animal may be noticed moving around

uneasily. Ligaments at the tail head on each side relax and drop. The udder develops prematurely, especially noticed in heifers.

General results of abortion.—The afterbirth is frequently retained and septicemia (“blood poisoning”) may ensue in the absence of skillful treatment. Garget may appear, which seems to be associated with the condition of the uterus, probably by transfer of infection from the discharge. The appetite may be impaired or lost. The patient may lose flesh or she may come in heat frequently, but remain barren.

Sterility, retention of afterbirth, white scours in young calves, calf pneumonia, calves born weak with tendency to diarrhea may all be features of infectious abortion.

LECTURE LIV

OBSTETRICS—*Continued*

INFECTIOUS ABORTION

In many respects, infectious abortion is the most serious disease confronting the American breeder. Those responsible for its control are confronted with many and serious difficulties. The disease is insidious, the period of incubation being rather long. There is no satisfactory means of individual diagnosis and prevention is uncertain. Management of an infected herd is tedious, expensive, and results often unreliable.

Causes.—Infectious abortion is due to living microorganisms, usually bacteria. It is evident that several different germs are capable of causing this trouble, and if this be true, then we do not have a specific disease due to one specific germ. It is most common in cattle at five to seven months, but may occur at any time after a few weeks of pregnancy. Cattle, horses, sheep, and swine are all subject to an infectious abortion, due to several different microorganisms. The virus generally accepted as being chiefly responsible for abortion in cattle and swine (the *Bacillus of Bang*) appears to be the same, although the disease apparently does not spread from the one class of stock to the other. In mares and ewes, however, the viruses are different.

The student should remember that the act of abortion is only one of several disastrous symptoms, as taught in the preceding Lecture, and not in itself a complete disease.

Abortion in horses, swine, and sheep is less common and less serious than in cattle at present, and this Lecture will treat chiefly of infectious abortion in cattle.

It is evident that infectious abortion may be spread in many ways. It is most easily introduced by the purchase of an infected pregnant cow from a herd in which the disease has prevailed. A cow may abort one or more times, then become more or less immune and subsequently carry calves to full term, but remain infectious for an indefinite period, and thus prove a

very serious, because unsuspected, source of spread. Under natural conditions, infection may occur by way of the respiratory, digestive, or genital tract in breeding. The afterbirth, discharges from the womb and vagina, and manure of abortion calves are all probably infectious.

Results.—A serious percentage of cows which abort subsequently become sterile. Most cows do not abort more than twice and thereafter may become either regular breeders, or shy breeders or sterile, or they may become immune “carriers,” *i.e.* raise calves but remain infectious. Contamination with the virus of abortion may result in abortion, or in a birth at or near full term, with the calf weak and predisposed to diarrhea. Cows which abort are likely to retain placenta and be unthrifty for a long time. Some contract infection of the udder probably from vaginal discharge, terminating in serious case of garget; or there may be a general septicemia or blood poisoning.

Diagnosis.—We have first the history of an unusual number of cows in a herd dropping their calves prematurely. Frequently the vaginal discharge which accompanies abortion is dirty in appearance with shreds of tissue and a foul odor. The mucous membrane of the vagina may become congested and the lips of the vulva swollen several days before abortion occurs. A coming abortion in heifers is often indicated by marked premature development of the udder, and the ligaments at the tail head on each side relax and drop. Older cows are apt to abort without any warning.

There are two serum tests which give useful, but limited information. In a general herd test they furnish information as to the general condition of the herd with reference to the disease. But they do not tell whether a certain cow has aborted or will abort or is a spreader of the disease.

Prevention.—It is necessary to bear in mind the probable cause of this disease and the common methods of dissemination. A farmer owning a healthy herd should not purchase cattle of breeding age from a herd in which this disease has prevailed within three years. He is safer in any case if he buys unbred heifers or mature cows that are heavy springers with good breeding history. He should not do public service with a herd bull where there is possibility of contamination, nor should he use a neighbor's bull if it is possibly contaminated with this infection. It is also safer policy for the breeder to raise his

own females as far as possible and purchase young males that have not been used.

Management of an aborting herd.—Abortion should not be allowed to occur in the herd stable if it can be avoided. The calf and afterbirth should be buried deeply or, better still, burned. Floors and partitions and other contaminated surfaces should be carefully cleaned and disinfected. In case the calf is mature enough to survive, its manure should be treated as though it were certainly infectious.

Some outbreaks of what seems to be infectious abortion are apparently gotten rid of very easily under a treatment which to an experienced veterinarian or bacteriologist would be absurd; but as a rule very painstaking work, long continued, is essential to any assurance of success. An owner should not undertake the treatment of a considerable number of animals unless they are sufficiently valuable to make it worth while, and he realizes that he has a hard task ahead of him.

Sell for slaughter females that have ever been bred and which are not valuable enough to justify the additional work and expense of treatment. Cows that have aborted should be sold for slaughter only; but it is not usually advisable to sell good cows merely because they have aborted.

Medical treatment is now generally discarded as ineffective. There is no reliable cure. Various vaccines and serums are on the market and are well advertised; but they are of doubtful value. There is a living virus vaccine which appears capable of harm by dissemination of the disease. There is also a killed culture vaccine which appears to have little protective value. Neither is advised as yet as a preventive of abortion.

It frequently happens in affected herds that valuable cows abort and then remain sterile. Others are infected and remain sterile without known abortion.

Many of these choice cows can be cured of their sterility by expert veterinary treatment.

When a cow has aborted well along in pregnancy, the afterbirth should be removed as soon as it will come away easily. Cows that have aborted should not be bred until the discharge has ceased for at least a month and the generative organs are normal again.

Males should be used with caution. For cows that have never aborted, use a bull that has had no chance for infection, the

bull's sheath to be disinfected internally before and after each service. If possible, use a different bull for cows that have aborted, he also to be disinfected before and after service, but with a different tubing and nozzle.

In any herd where there is danger of this infection, calves should be born in clean and recently disinfected stalls and from clean and externally disinfected dams.

Treat the stump of the calf's navel cord with tincture of iodine in a cup or wide mouth bottle: This is easier to do with the calf on his feet. Iodine treatment is to be repeated until the cord is dry and hard. Soak it several minutes at each treatment. Equal parts of alum and boracic acid may be dusted freely over the cord after the iodine treatment. It is important to remember that a calf may be infected early in life through milk from dam or nurse cow, the virus coming from the udder in the milk. Or the young calf may be infected from external contamination of the teat and udder by vaginal discharge. It is safer, therefore, in an aborting herd to wean the calf early and raise it on pasteurized, or even boiled, milk. There is then less risk of calf scours and calf pneumonia, which are common in such herds.

Calf-scours serum appears to give good results as a preventive and should be given to all calves in affected herds, as soon as possible after birth, in addition to the sanitary precautions already advised.

Internal disinfection as used here means injection into the vagina, *not uterus*, for females and into the sheath for males. External disinfection for cows means surface in general, but especially around and under the tail and between the thighs; for bulls, the outside of the sheath, especially around the opening.

For *internal disinfection* use one half per cent solution of Lugol's iodine; or, for simple cleansing, common salt, a tablespoonful to the gallon of water. A container, a funnel, and a few feet of 1/2-inch rubber tubing with a short smooth nozzle of some kind is all that is necessary for apparatus. For treating a large number of cows, a simple container for a gravity apparatus is very convenient and cheap. This may be made from a large galvanized iron pail with a stopcock at the bottom. An old-fashioned "shotgun" milk can is an ideal container, since it is already fitted with stopcock at the bottom and has a glass

gauge at the side where the amount given each animal may be easily read off as the fluid lowers in the can. The container may be very conveniently held by an ordinary snap sliding on an overhead wire extending across the stable back of the cows.

Stables.—Frequent cleaning and free use of stable disinfectants is necessary for mangers, partitions, floors, etc., with plenty of lime in the gutter. Manure should be removed and used so that it cannot carry infection to pregnant cows. Feed for breeding females must not be contaminated by discharges from aborting cows, or by manure from calves born of aborting cows.

For disinfection of the cow stable, litter should be cleaned out of the mangers and stalls; walls, partition, floors, etc., should be thoroughly scrubbed using plenty of water and then be disinfected by means of corrosive sublimate, 1 to 1000 in water, or copper sulphate, 5 oz. to a gallon of water, or, by corrosive sublimate in fresh whitewash in the proportion of 1 lb. corrosive sublimate to 1000 lbs. of water (125 gallons).

Many bulletins on abortion have been issued by state experiment stations and the Federal Bureau of Animal Industry. These may be easily secured and should be consulted for details of herd management and individual treatment.

This work should be under the supervision of a competent veterinarian who has given special study to the problems involved.

LECTURE LV

OBSTETRICS (*Continued*)

ACCIDENTS OF PREGNANCY

Accidents of pregnancy are nearly all serious and should be handled by a veterinarian whenever possible. A neighbor's meddling has killed many a fine cow and mare that could have been saved.

Retention of the fetus.—This trouble is most common in cows. The period of retention may vary from normal up to years. A fetus may be dead and mummified, or it may decompose. Aged mares sometimes carry beyond the normal period for delivery and then give normal birth.

Symptoms.—The mother may show labor pains at normal time and all other symptoms of parturition may be present. The symptoms soon disappear and the cow goes on as if non-pregnant, but does not come in heat.

Causes.—Retention of the fetus is due to such causes as partial paralysis of the uterus, excessive adhesions between fetus and uterus, deformed pelvis, and torsion of uterus.

Treatment.—At the normal period of delivery with the cow in labor and not progressing properly, the veterinarian should be called, to dilate the cervix and force delivery if indications justify such radical procedure. This is very difficult in the cow and easier in the mare. If the cow has gone safely past this period, then fatten and sell her for beef.

Volvulus (twist).—A twist sometimes occurs in and near the neck of the uterus and makes delivery exceedingly difficult.

It is much more common in the cow than in the mare, and usually occurs near the termination of pregnancy.

Symptoms.—Labor pains and the normal symptoms of delivery appear at the usual time. If not relieved serious illness may follow. The cow becomes anxious and restless, her respiration is hurried. She shows abdominal discomfort, and if not relieved will probably die. On examination, a spiral twist of

the uterus is easily recognized unless it be far forward and out of reach—which sometimes occurs.

Cause.—Volvulus may be caused by the patient slipping or falling, and especially if the cow or mare rolls over, late in the period of pregnancy. Some authors think it may be due to active and unusual movements of the fetus.

Treatment.—If the twist is slight, the operator may be able to reduce it by introducing the hand into the uterus, grasping some portion of the fetus, and causing the uterus to unwind by a strong, twisting motion. Even when it is possible to introduce the hand, treatment is apt to be a slow and difficult task. It is necessary to proceed slowly as the tissues relax. If the case is at all difficult, call your veterinarian promptly. Sometimes it is necessary to throw the cow or mare, then introduce the hand, grasp firmly one or more limbs of the fetus, and have the cow rolled in the opposite direction from the twist, holding firmly to the fetus meanwhile. If the operator can succeed in getting his hand into the uterus, and especially if he can get one or more fetal limbs through the neck of the uterus, the twist often may be reduced. Many of these cases, however, are exceedingly difficult or incurable.

ACCIDENTS OF PARTURITION

The most common accidents are: (a) Infection; and inflammation of the uterus (metritis); (b) inversion of the uterus; (c) tear in the vagina; followed by infection and vaginitis; (d) retention of fetal membranes; (e) hemorrhage; (f) mammitis (garget).

Metritis.—Inflammation of the uterus is a very serious disorder and apt to result in death from septic metritis or peritonitis. The symptoms usually appear within one to four days, with chill, high fever, thirst, abdominal pain, and cold extremities—ears, horns, etc.—straining, vaginal discharge and swollen, discolored vulva. There is frequently posterior paralysis. Pressure in the right flank is very painful.

Inversion of the uterus.—This disorder is most common in the cow, and may be partial or complete. There may also be partial eversion of the bladder and vagina. It may be due to excessive force used in aiding delivery, or to failure of the uterus to contract after delivery.

Treatment.—Cleanse the protruding uterus thoroughly with hot water and invert it over the hand and arm. Be careful to smooth out each fold and leave the uterus in a natural position. If the organ is greatly swollen and heavy, bathe it in cold astringent solutions, like strong alum water, until the size is sufficiently reduced to permit replacement. A clean, common washtub is very convenient for bathing the soiled and swollen uterus.

Bandaging very firmly with a wide roller of muslin forces out much of the blood, reduces the bulk, and allows handling of the uterus without injury. The bandage should be wide, and be rolled from both ends. To put on the bandage, begin with the middle of the bandage at the end of the uterus and carry the ends around in opposite directions, pulling firmly all the time so as to force the blood back into the general circulation. In very troublesome cases it may be advisable to first throw a cow carefully, then hoist her hind parts by pulleys and ropes until only the shoulders and neck rest upon the floor. The rope should be attached by hobbles or otherwise just above the ankles, and suitable provision made so as to avoid injury to the skin and underlying parts. A good hobble strap will usually do very well. Ordinary rope could be used with several thicknesses of heavy cloth or a flat pad of oakum inside of the rope to protect the skin. In this position the uterus of a very troublesome case may usually be replaced easily, and no harm is done to the cow if she is carefully handled. After replacing, it is sometimes advisable to pack the uterus with cotton and close the outlet by means of sutures through the vulva, or to put on a rope truss.

Finally give the cow 3 oz. tincture of opium and 2 oz. bromid of potassium in $\frac{1}{2}$ pint of sirup. Give a mare two thirds of this dose and the ewe one eighth. Repeat the dose in three hours if the animal is still straining. If necessary, apply rope truss as shown in classroom.

Tear or bruise in vagina.—A vagina may be torn above or below by excessive size of the fetus, by faulty position of the fetus, or by excessive force used in delivery. Infection and inflammation (vaginitis) then follow. This is indicated by unusual swelling of the vulva with dark and discharging mucous membrane. This discharge soon has foul odor. Slight cases usually make prompt recovery under hot water irrigation or

fomentation. Tears and severe bruises must have veterinary service. This calls for immediate operation by a veterinarian, and the injury is much more dangerous for the mare than for the cow.

Retention of the placenta (afterbirth).—This trouble is most common in cows, but is less serious for cows than for mares. It is caused by unusual adhesions between the placenta and the womb, imprisonment of the placental tufts in the corresponding cavities of maternal cotyledons and by a mild inflammation due to infection, often from infectious abortion.

There is normally a short period of exhaustion following delivery. After this period the uterus should recover its normal tone and expel the afterbirth and accompanying fluids. Note the order of development: infection, inflammation with accompanying swelling, and then adhesion.

Treatment.—For the mare the placenta should usually be removed within twelve hours if it fails to come away naturally.

If the cow's afterbirth can be removed easily and without hemorrhage, then the sooner it is removed the better.

Everything in this work must be done carefully and with a view to cleanliness. First, irrigate the vagina with an antiseptic, *e.g.* one half per cent Lugol's iodine, and disinfect the surrounding external parts.

As nearly as possible the entire placenta should be removed by introducing an oiled hand into the uterus, gently separating the placenta from its uterine adhesions, and pulling with the other hand outside.

If a cow's afterbirth does not come away easily and completely and there be no urgent reason for removal, then treatment should be directed against extension of infection.

A good authority recommends iodoform and boracic acid, equal parts, and suggests that this may be put in a capsule and the capsule either left to dissolve in the uterus or opened and the powder scattered in the uterus by hand. The purpose of this treatment is, of course, to check the development of infective organisms.

The patient should be examined from time to time, and it will usually be found after awhile that the afterbirth has been released and will come away easily. In some cases of retained afterbirth there develops a rapid necrosis (death) of the maternal cotyledons, in which case the cotyledons themselves may

come away with the afterbirth and their removal cause no serious harm.

Hemorrhage.—This is rare in the lower animals. It is denoted by rapidly increasing paleness around the eyes and in the mouth and by quick, feeble pulse. Blood may not appear on the outside, and yet the bleeding be extensive. Give 3 oz. f. e. ergot at once, in 4 oz. sirup, and then give 1 oz. ergot in 2 oz. sirup every hour if necessary, up to a limit of six doses; meantime pour ice water over the back and loins.

LECTURE LVI

DISORDERS OF THE UDDER

GARGET (MAMMITIS)

Mammitis is an inflammation of the gland tissue and other structures composing the udder. Some congestion and hardening of the udder is probably normal at about the time of parturition.

Causes.—Garget (mammitis or mastitis) is usually caused directly by germ infection or injury, aided by infection. Germs probably gain entrance in many cases through the milk ducts of the teats. There is great variation in the severity of these cases. Some cases of garget are very mild, and some lead to rapid loss of the udder.

Many cases of garget are the result of infection through the teat from retained afterbirth, or from some purulent discharge from the vagina. The infection from a retained afterbirth or from the vaginal discharge becomes smeared upon the teat; bacteria gain entrance into the milk canal, where they find favorable conditions for multiplication and rapid extension up the milk canal into the udder. Some cases receive their infection from the hands of milkers who have milked other cows which have such infectious material upon the teats or the udder. In other cases the infection may have been carried into the milk duct by milk tubes.

Many preventable causes contribute to garget, *e.g.* excessively high feeding, cold cement floors, high door sills and low udders, washing followed by chilling, etc.

Symptoms.—The symptoms of garget are the usual symptoms of inflammation in any soft organ: *i.e.*, pain, heat, redness, and swelling. This is one of the most easily recognized diseases of live stock.

Results.—Garget usually leaves a damaged udder. In some cases the damage may be extreme and in others slight; but it is probable that few cases are ever completely restored to normal.

The injury to the milk-gland structure includes various degenerations, connective tissue hardening and permanent enlargement, abscesss, or even gangrene. Development of gangrene may be detected by noting that the part which has previously been hot and tender becomes cold, dark in color, and insensitive.

Prevention.—Cows that are wisely fed seem much less liable to udder troubles at the time of calving. Heavy milkers especially should be carefully fed during the last period of pregnancy. The food should be laxative in character, and this same method of feeding should be continued until about the fourth day after calving, when the grain ration may be gradually increased, the cow being put on feed very gradually for several days.

In case of a valuable cow that has just calved, it is well to disinfect the udder and teat with 1 to 1000 bichlorid in water, which may be washed off with water. If possible, this disinfection should be given before any milk is drawn after calving, and should be kept up for a week in the case of a valuable cow. It seems that the cow's udder is most liable to this trouble during the first week or so after calving. Later there does not seem to be so much danger of garget.

Milk tubes do very much more harm than good as a rule, and should never be used except when absolutely necessary, and then only after thorough disinfection of the teat and boiling of the tube. The latter must not be handled in any way to infect the portion which is to enter the teat. Care should be exercised not to milk a cow with hands that have been contaminated from purulent discharges of any kind or with any kind of infectious material. A cow with garget should always be milked last.

Milkers should clean their hands thoroughly for the sake of simple cleanliness and pure milk, if for no other reason, and in addition for the very good reason that they are then not liable to carry infection which may cause garget in the udders of valuable cows.

Floors, door-sills, etc., should be as little likely as possible to injure udders. A cow with very long udder should be so placed in the stable as to avoid injury from tread by another cow.

Treatment.—The diet should be light and laxative. Light feeding during the last few weeks before calving is a good preventive measure in any case.

If internal, or vaccine, treatment of any kind is needed it should be given—or at least directed—by a veterinarian. In most cases the owner can safely give nitrate of potash (saltpeter), 2 ounces at a dose, with $\frac{1}{2}$ pound Epsom salts, three times a day, each dose dissolved in a quart of water.

For external treatment of the udder, apply hot water freely for long periods of time; *e.g.* twice a day 2 or more hours at each treatment. The water should be used as hot as it can be comfortably handled—it is easy to scald an udder—and should be used very freely. This hot-water treatment may be applied to good advantage by putting a sling around the cow's body under the udder and in front of the hips to support the udder. Four holes may be cut for the teats, and woollen cloths packed around the udder to hold the heat and moisture. The hot water can then be poured in from above or be thrown against the packing from below by means of a small dipper. The object is to treat the udder with moist heat for a long period of time.

After each water treatment rub the udder dry and apply a light dressing of olive oil. Long-continued, moderate rubbing and handling of the udder is beneficial. This is best accomplished by first milking dry and then a combined rubbing and gentle kneading action with the hands. This massage, if not unreasonably severe, is helpful, and should be given freely several times a day and for 15 minutes or more at each treatment.

UDDER DISEASES AND ACCIDENTS

Injuries.—Udders and teats are often injured by barbed wire, for example, or by being tread upon in the stable by a cow in the next stall; and these injuries require careful treatment usually by a veterinarian.

Treatment.—In general such wounds should be trimmed, well soaked in a mild, hot antiseptic, like hot saturated boracic acid solution, and then covered with an antiseptic powder. In case but little tissue has been destroyed, it may be well to partly or wholly close the wound and cover a generous portion of the teat with surgeons' adhesive tape. Tears into the milk duct require skillful surgical treatment, and the teat may often be saved in good shape. The owner should not insert a milk tube except as a last resort. It is often safer to trust to long con-

tinued hot mild antiseptic treatment and gentle massage to reduce the swelling and re-open the duct.

Fistula.—This is a small opening in the side of the teat, which opening connects with the milk duct and usually leaks milk at least during milking. It is just an unclosed portion of an old wound.

Treatment.—When the cow is dry, sterilize the teat with tincture of iodine, then with a very slender pointed and sharp knife that has been boiled and carefully handled to avoid infection, rim out the old skin edge, so as to get a fresh raw edge for healing; or sear *very* slightly and superficially in the fistula with a hot wire.

After this treatment, sterilize the wound and teat again with the iodine, and bandage it with adhesive tape, covering plenty of the teat. This must not be tight enough to interfere with the circulation and should usually be left in place several days.

Teat obstruction.—This may be due to a stricture or narrowing of the canal as the result of an injury. Many cases are due to small growths of various forms, which result from a mild infection. They often form while the cow is dry and are found at the next milking. Many of these cases can be cured by a veterinarian's skillful surgical operation.

Warts.—In case warts cause trouble, they may be removed in various ways, as by cutting them off with sharp shears, taking a bit of normal skin all around the wart, or by tying them off by a stout thread close to the teat.

Hard milker.—Otherwise choice cows are often sold or killed, because they are hard milkers. The difficulty in these cases is usually superficial, the end of the milk duct opening being too small. In many cases this can be cured by careful dilation with a slender cone of smooth hard wood or metal.

Sterilize the teat with tincture of iodine. Boil the dilator ten minutes and handle in a way that avoids contamination. Insert the dilator carefully, and leave in place between milkings. Caution is necessary to avoid over-dilation and consequent leakage. The veterinarian uses special dilators or makes a small cross-shaped incision in the outlet by a special instrument.

Cowpox.—Cowpox is a contagious disease and apparently due to a filterable virus which is very closely related to or identical with human smallpox virus. Sheep-pox is probably an entirely different affection. This trouble may be brought into a herd by

recently vaccinated persons. Thereafter, the disease is spread in the herd chiefly by the hands of milkers, but may be transferred from cow to cow by other means.

The period of incubation is from four to seven days. Then there is a little fever and mild general symptoms of slight illness. There soon appear a few nodules on the udder and teats, the size of a pea or smaller. In a day or two these change to vesicles (blisters) which contain a thin, clear fluid. At eight or ten days the centers of the vesicles become depressed and the contents become *purulent* (pus).

A dry scab gradually forms and falls, leaving the typical pitted scar.

The sores heal nicely unless injured in milking. Small, slow healing ulcers may be caused in this way.

Treatment.—Little treatment is necessary beyond very careful milking, unless the vesicles are ruptured and the raw surfaces injured, *e.g.*, in milking. Careful handling and a little vaseline or lanoline are then needed.

LECTURE LVII

DIFFICULT PARTURITION (DYSTOKIA)

Nature's plan.—When the delivery occurs according to nature's evident plan, the ligaments of the pelvis relax; the water bag appears through the neck of the uterus and finally outside the vagina; the neck and vagina gradually dilate to accommodate the fetus, which presents first the apex of a wedge or cone.

Normal presentations.—We recognize two normal presentations, viz., the anterior, in which the two front feet and the nose appear with the fetus resting upon its sternum, and the posterior, in which the two hind legs and tail appear with the fetus resting on the sternum.

Variations from these cause difficulty in delivery.

Cause.—The cause of difficult parturition may lie with either the mother or the fetus, though more commonly with the latter.

If the fault lies with the mother, it is usually because of premature delivery; extreme narrowness and closeness of the pelvic outlet;volvulus; deformities of the pelvis (sometimes fracture); tumors within the pelvis; or induration, hardening, of the uterine neck. Sometimes the trouble is due to excessive accumulations of fat within the pelvis.

If the difficulty lies with the fetus, it is because of faulty presentations, excessive size, monstrosities, or deformities.

Common faulty presentations.—Faulty *anterior* presentations may be: head, or head and neck doubled back; two feet, or feet and legs back; or the neck and one front limb back; or the neck and both front limbs back.

Faulty *posterior* presentation may be: one limb back and doubled at the hock or stifle; or both limbs back with one flexed at each of these points, or both flexed at the same joint, which may be either hock or stifle. Various other false presentations may occur.

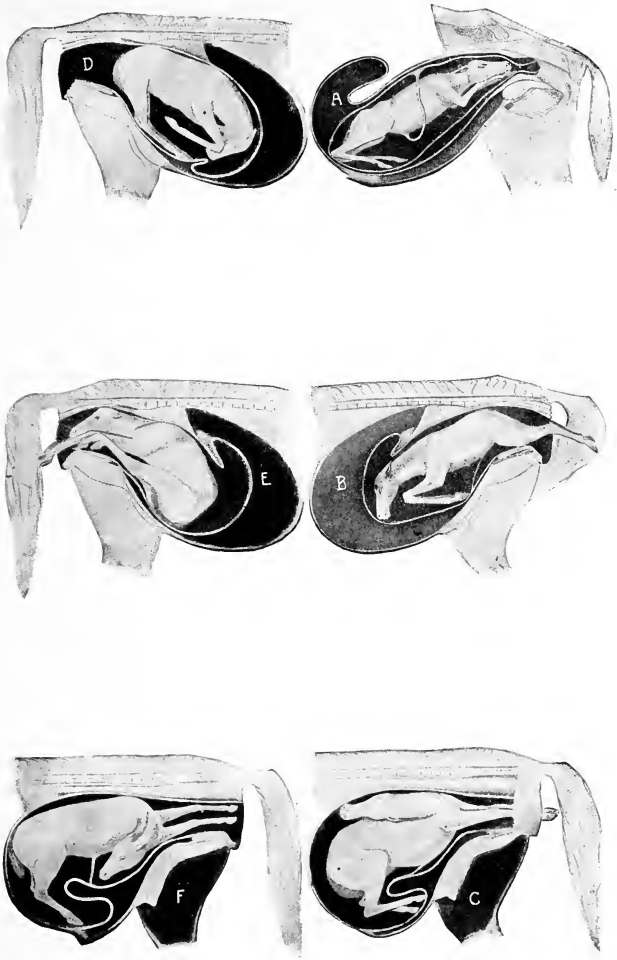

FIG. 90.—PRESENTATIONS. (B. A. I.)

A and B, normal; C, D, E, F, common abnormal presentations.

ASSISTANCE

What may be needed.—There is probably no trouble with farm stock where trained and experienced veterinary assistance is more urgently needed.

Call your veterinarian promptly, if one is available. Do not let all the neighbors try it first and ruin all chances for the veterinarian's success—especially with mares.

If no competent veterinarian is available, then the owner must do the best he can for himself, or with the aid of a careful and experienced neighbor. Plenty of bland oil, *e.g.* linseed, may be required; two small window cords with smooth loops in one end of each loop to loop around limbs; two similar ropes with short, sharp hooks in end to hook in underjaw or eye socket or leg; a pair of small combination pulleys, possibly an embryotomy knife, large trocar and cannula, some antiseptic—*e.g.* creolin—to be used in $\frac{1}{4}$ per cent solution for hands, instruments, and ropes. These should be kept on hand and ready.

Suggestions.—Do not interfere until the water bag has ruptured, unless labor pains have continued for several hours and the water bag does not appear. Then examine by rectum and note location of fetus. Possibly it may not yet be even in position for delivery. In that case if you cannot have veterinary service leave the cow alone and await normal delivery. Examine by rectum every twelve hours or so to note progress. If the cow is strong and the calf alive it may be born naturally a day or two after the first false labor pains.

However, if the first examination by rectum shows the calf well advanced and presenting for delivery and no progress being made then examine by vagina and cervix. There may be a volvulus. See Volvulus in preceding lessons. If the water bag ruptures, in a natural way, and the head, for example, should present without the feet, or the head and one foot, or if one hind foot presents and not the other, or any evidently faulty presentation occurs, then it is time to call your veterinarian, and plan for assistance.

If you cannot have expert help then clean and oil the arm and examine carefully to learn the cause of trouble and position of fetus. Then decide what you will do and how. The rectum should also be examined as the hand goes into the vagina, and if distended should also be emptied.

The patient should stand or lie with head downhill. It is much easier to operate with the patient standing. Occasionally it is of great advantage to have the patient on one side or the other or on her back for a time so as to place the missing part on the upper side. Be patient and not in too great haste. When missing members are secured and all is ready to pull, pour plenty of oil, or, in the absence of oil, warm water, into the uterus and vagina by means of a funnel and rubber tubing. The parts that will offer friction are probably dry by this time, and should be freely oiled or moistened. Clean, non-irritating oil is better.

It is frequently necessary to shove the fetus forward into the uterus in order to secure and straighten some missing parts. Tearing the mother is an accident that must be carefully avoided on account of probable blood poisoning (septic infection).

When one part presents, and others are to be secured, or when one has been secured and it is desirable to return it into the uterus to secure another part, make sure of progress gained by attaching a rope to the part secured. If the patient cannot be made to stand, have her on the side opposite the missing part, which thus comes on top. Work between labor pains, and, when all ready to pull, the assistance should be given moderately and while the mother is straining. Great force is seldom justified either by necessity or by results.

Dropsies.—Sometimes the retarded delivery is due to large accumulations of fluid in the brain cavity (hydrocephalus) of the fetus or within the abdominal cavity (ascites), or to a general accumulation of fluids or gas beneath the skin in the connective tissue and also in the abdominal cavity (general dropsy). In these cases the difficulty may be overcome by tapping the brain and squeezing the soft bones together, or tapping the abdominal cavity and allowing the fluid to escape. A large trocar attached to rubber tubing is convenient for this operation.

Gaseous distention.—Difficulty in delivery may be due to an excessive accumulation of gases within the body of a dead and decaying fetus, and the obvious treatment is to tap with trocar or knife and allow gas to escape.

Embryotomy.—If it becomes necessary to open the fetal body or remove one or more of the fetal limbs, and veterinary help is not available, the operator must know that these are difficult operations and observe certain precautions.

Beware of injuring the maternal parts; be patient and work slowly.

In case of twins, both presenting at the same time, force one back into the uterus and deliver one at a time. Avoid all unnecessary dissections, which are usually very tedious, exhausting to the operator, and mother as well.

Always save the skin, leaving enough to cover the bones and rough parts of the fetus, and to pull on.

Removing a fore limb.—Take the limb that is presenting, attach cord and draw out, as far as possible; slit the skin from as near the top of the scapula as possible to the knee or pastern by means of an embryotomy knife, and dissect the skin loose from the limb, largely by fingers or with the aid of a thin bladed case knife with a square end; then cut last the skin around the knee or pastern. Next cut the muscles between the limb and the sternum. By twisting and pulling at the same time, the limb can then be removed entire, leaving the skin attached to the shoulder. Do the dissecting with one hand, while the other pulls on the skin outside. The skin gives an object to pull by, and protects the parts of the mother from bones. It also keeps the soft parts of the fetus from rolling up as an obstruction when pressed against the parts of the mother.

Removing the head.—If the head can be brought outside the vulva, and there is good reason for removing it (which is not often), cut the skin around the neck, back of the ears, and dissect the skin loose from the muscles by the hand or by a thin bladed case knife with square end, using a knife to cut the connective tissue bands that interfere, as far as the operator can reach. Then cut the cord on top of the neck, the cord that supports the head, and also the muscles around the vertebræ. Strong pulling and twisting on the head will usually bring away head and neck, leaving a quantity of skin to cover remaining vertebræ and to assist in pulling.

Removal of the hind limbs.—This is done on the same general principle as for the fore limb. Supposing the limb is presenting, cut across the pelvic articulation of the limb on the inside so as to sever the ligament which holds the femur strongly to the pelvis. Slit the skin from this point to the hock or pastern according to the case. Dissect the skin loose from the limb, as directed for the fore limb. Then by strong pulling and twisting the limb can be torn loose at this joint.

It is not always necessary to remove both hind legs. With one out of the way the other can sometimes be straightened or the body of the fetus removed with the other straightened forward in the uterus. The soft organs may often be removed from the body of the fetus to advantage, and then delivery be accomplished easily. In some cases it is sufficient, and easier, to disarticulate at the hock instead of at the pelvis.

Cæsarian section.—Removal of the fetus through the flank or median line of the belly is done sometimes, but only as a last resort, more commonly and successfully done with cows and sows than mares. This should only be attempted by an expert, unless the plan is to save only the fetus. In the latter case the work must be done very rapidly. This operation is often performed on sows and is reasonably safe for them.

MEDICINES

LECTURE LVIII

COMMON MEDICINES

Common measurements:

A dime weighs about 40 grains, a nickel 80, a quarter 100, a half dollar 200, a dollar 400 grains. One half dollar and a dime, *e.g.*, would weigh about half an ounce or a dollar and a nickel would weigh approximately an ounce.

Teaspoon holds about 1 fluid dram ($\frac{1}{8}$ oz.).

Tablespoon holds about 4 drams ($\frac{1}{2}$ oz.).

Dessert spoon holds about 3 drams.

Teacup holds about 6 oz.

Giving medicines.—Internal medicines may be given to domestic animals in the form of liquid drench, gelatine capsule ball, or dry powder; or may be mixed with honey or molasses and smeared on the tongue. Some medicines are given under the skin by hypodermic syringe and some by injection into a vein. In giving a drench, remember that a horse's mouth and throat are very sensitive and more easily injured or irritated than the human. Taste the medicine before giving it, if there is doubt about its being too strong. Powders should be finely pulverized, and must not be caustic or irritating. Balls should be in the shape of a cylinder about 2 inches long and $\frac{1}{2}$ to $\frac{3}{4}$ of an inch in diameter. They should be wrapped in thin paper and oiled. They must be reasonably soft and pliable, and the horse should be offered water immediately after swallowing them.

Drenching.—In giving a drench the patient's head must not be held too high, the face should be nearly horizontal, with the nose just a little higher. If the head is too high swallowing is difficult. The operator must not be in a hurry. The medicine should be given in small quantities on top of the tongue, as far back in the mouth as possible, and the horse should be given plenty of time to swallow. If the horse is obstinate about swallowing, pour a tablespoonful of water into the nose after medi-

cine is poured into the mouth. Medicines should not be given through the nose because of danger of choking, and of causing pneumonia. For supporting the head to give a drench, a rope may be tied to the noseband of halter and thrown over the beam—never tied, but held by an assistant. Better still, a cloth loop may be passed around the upper jaw back of the front teeth and through the noseband of the halter in such way that it cannot slip off. This cloth loop is fastened to the overhead rope, which should be held—not tied. Medicines may be given when the patient is lying down, but the operator must be careful not to pour out any medicine when the patient is about to struggle lest choking occur. Plenty of time should be taken.



FIG. 91.—HOLDING HORSE'S HEAD FOR DRENCHING.
(M. H. R.)

Note cloth loop under noseband.

A bottle of rubber or horn, or a dose syringe, is much preferable to a glass bottle, which may break readily, and cut the mouth.

CATHARTICS

Aloes.—Cathartic,¹ laxative,² or bitter tonic, depending upon the dose given, is very reliable and satisfactory for horses, but less so for ruminants. It is very soluble in alcohol and boiling water, but imperfectly so in cold water, and usually requires 15 to 20 hours for operation. It is often desirable to combine it with one fourth its weight of ginger, and give it in conjunction with nux vomica in case the bowels are torpid. Large rectal injections of warm water may be given until the physic acts.

Doses.—Cattle, 1 to 2 oz.; horses, 2 to 8 drams; sheep, 1 to 2 drams; hogs, 1 to 2 drams.

These doses may be administered in a ball with ginger and lard or molasses, or, as a drench, in water or sirup.

Epsom salts (sulphate of magnesia).—This is a saline ca-

¹ Cathartic, moderately vigorous physic.

² Laxative, mild physic.

thartic, which causes a large secretion of fluids from the intestinal walls, thus rendering the bowel contents very fluid. It is very soluble, for it will dissolve in its own weight of warm water. This is a very satisfactory laxative or cathartic for cattle and sheep, but not so good for horses. Epsom salts is useful in small doses for horses in feverish conditions.

Doses.—Cattle take for cathartic one to three pounds; sheep and hogs take one-eighth to one fourth pound. It is frequently desirable to add one sixth the total weight of powdered ginger and give as a drench and it is better to give rather dilute drenches; *e.g.* the cow's dose should be dissolved in two to three pints of water, and the others in proportion.

Raw linseed oil.—Raw linseed oil is used in veterinary practice for diluting stronger medicines, for making liniments and various applications for external use, and it is administered internally as a laxative or cathartic, depending upon the dose used. It is very safe and but slightly irritating for horses, cattle, sheep or swine.

Doses.—Cattle take two to four pints; horses, one to three pints; sheep and hogs take one fourth to one pint.

Rectal injections of warm water may follow the dose of oil, and it is desirable, if there is sufficient time, to prepare horses by several warm bran mashes before giving the oil.

STIMULANTS AND TONICS

Alcohol.¹—Alcohol is a diffusive stimulant, diuretic, antispasmodic, and diaphoretic. Large doses are narcotic. Medicinal doses check spasmodic conditions of involuntary muscle fibers, stimulate the heart and lungs, equalize circulation, and temporarily overcome depression. Alcohol is soluble in all proportions in water, and should be diluted at least four times for internal use.

Doses.—Cattle, two to four ounces; horses, one to two ounces; sheep, one half ounce; hogs, one fourth to one half ounce well diluted as above.

Aromatic spirits of ammonia.—This is a quick, very useful and typical stimulant. It consists of ammonia carbonate, am-

¹A diuretic stimulates the kidneys and increases the flow of urine. A diaphoretic stimulates perspiration. An antispasmodic relieves crampy conditions, especially of involuntary muscle fibres.

monia water, alcohol, water, and various aromatics. It quickly stimulates the heart, lungs, and digestive organs, and increases bronchial secretions, etc. It is antacid and leaves few harmful after effects. It is very useful in cases of exhaustion, sunstroke, colic, hoven, and in certain coughs. The dose for horses and cattle is about one ounce in half a pint of water. Sheep and swine take about one eighth as much.

Camphor.—Camphor is commonly known as camphor gum. Spirits of camphor consists of the gum dissolved in alcohol, in a strength of ten per cent. The gum is readily soluble in alcohol, ether and chloroform, and but slightly soluble in water. Used externally in liniments, it has first a mildly stimulating and then slight local anesthetic effect. The vapor kills fleas, moths, bugs, etc. Internally it is a useful, safe, and dependable stimulant to the vital centers in cases of great depression, shock, or collapse.

In urgent cases for which camphor is most commonly used it should be dissolved in olive oil and given by hypodermic injection. The dose for a horse is about one dram dissolved in four drams of olive oil—about two drams of the solution to be injected at each place.

Gentian.—Powdered gentian root is a stomachic,¹ and tonic. It promotes appetite, increases the secretions and improves digestion. It has some value also as a vermifuge;² but it is especially useful where a simple, bitter tonic is needed, as for highly fed stock “off-feed,” or where debility follows an acute disease like influenza or pneumonia. It is helpful in other cases of debility which are accompanied by poor appetite and digestion.

Horses take one half to one ounce and cattle one or two ounces.

Ginger.—Ginger, as usually seen, is in the powdered root—or, rather, rhizome. This is another stomachic and stimulant. It is very useful for mild digestive disturbances. It is often combined with purgatives as an aid and to prevent griping and depression.

It is especially important with the salines, like epsom salts, given in full doses.

Horses take about one ounce, and cattle two to four ounces.

¹ Stimulates normal activities of the stomach.

² Expels worms.

LECTURE LIX

COMMON MEDICINES (*Continued*)

ANTISEPTICS

Boracic acid.—Boracic acid, a non-irritating, antiseptic powder or crystals. Boracic acid is mainly used externally either in solution (about 3 per cent) or as dry powder dressing for wounds. Sometimes it is used internally for colts and calves which have diarrhea. Boracic acid is soluble in 26 parts cold water, in 3 parts boiling water, or in 6 parts alcohol. For solutions, use the crystals.

Doses.—Colts and calves take 10 to 30 grains in sirup three times a day.

As an outward application for wounds and sores, the acid may be mixed with half its bulk of iodoform.

Carbolic acid.—Carbolic acid deodorizes and kills germs (germicidal). In strong solutions it is irritant, caustic, and locally anesthetic. Internally it is at first a stimulating and afterwards a depressing narcotic, poisonous in sufficient dose and strength. It is used more commonly as an external disinfectant, in 2 to 5 per cent solutions. Dilute solutions kill external parasites. Carbolic acid is useful in the treatment of ringworm used as 10 to 15 per cent solution in glycerine or linseed oil. It is not so commonly used as a dressing in surgical work as formerly—usually dispensed from the drug stores as a 95 per cent solution of the crystallized drug.

Corrosive sublimate (bichlorid of mercury).—This is a caustic, and irritant poison. It is used externally as a caustic and antiseptic. Strong solutions and ointments produce very severe blisters, and frequently destroy the hair follicles.

It is chiefly used as a germicide. For this purpose it is greatly diluted. Corrosive sublimate is cheap and very satisfactory for disinfecting buildings, and other purposes where large quantities must be used. Dilute solution destroys lice and itch mites in the proportion of fifteen grains to a pint of

water. For antiseptic and disinfecting purposes, it may be used four to seven grains to the pint.

Iodin.—Iodin occurs as bluish black, heavy crystals, readily soluble in alcohol and ether, and but slightly soluble in water, although it dissolves in water readily if potassium iodid is added. *Tincture of iodin* is a solution of iodin and iodid of potash in alcohol and contains about 7 per cent iodin. *Lugol's solution* is composed of iodin, 5; iodid of potash, 10; water, 100,—giving 5 per cent iodin.

Iodin is one of our most useful and dependable disinfectants and germicides for surgical work, wound treatment, etc. It is especially valuable in skin disinfection as for castration, or in treatment of the navel cords of the new born. For skin disinfection, navel cords, etc., the tincture is used in full strength.

Lugol's solution is useful and reliable for disinfectant purposes, diluted in water at from 2 to 4 per cent. For some purposes it is used still more dilute as in abortion and sterility work. When iodin is used externally by repeated treatment as a liniment for sprains, bursal enlargements, arthritis, etc., its slow, mild, but persistent, irritating and stimulating action is very useful. It is also very effective as a fungicide as in ring-worm.

Iodin is used internally for actinomycosis (see Lecture XXXII), where it is given internally in the form of iodid of potash or it may be injected as the tincture or as Lugol's solution by hypodermic, directly into the diseased mass.

Iodin in the form of iodid of potash is useful also, when given to pregnant dams to prevent goiter in young pigs, and lambs, and to prevent hairless pigs, etc.

When used internally in excess, the warning symptoms are: catarrhal conditions at eyes and nose, scurvy skin, digestive disturbances, and refusal of food.

Iodoform.—This is used for external and local application. It prevents infection of wounds and acts as a local antiseptic. Iodoform is useful as a dressing for wounds, especially after they have commenced to heal. It may be used alone or mixed with twice its bulk of powdered boracic acid and dusted over the wound surface.

Common lime.—Common lime is an irritant, it neutralizes acids and is astringent. Saturated solution, which is very dilute, is useful in diarrheas and indigestions of young animals,

and may be given with milk quite freely. Carron oil (lime-water and linseed oil in equal parts) is an old and useful application for burns. Whitewashing is a satisfactory method of disinfecting and cleaning up outbuildings, including stables. For this purpose, fresh chlorid of lime, one half pound to the gallon may be added with advantage.

Sodium chlorid (common salt).—Common salt is an essential article of food, restorative, and antiseptic. Very large doses are cathartic and more or less irritating. It is useful as a throat wash, diluted to 5 per cent solution in water. As normal salt solution (about one tablespoonful to one gallon of water), it is an ideal preparation for mechanical cleaning of sensitive surfaces and cavities, *e.g.*, eye, vagina or uterus. For any such purpose it is a good cleanser and less irritating than plain water.

Sodium hyposulphite and sodium sulphite.—These are antiseptic and deodorant; and especially valuable for internal administration, to check fermentation and septic processes in the stomach and intestines, and are therefore valuable in conditions of diarrhea, indigestions, and hoven or bloat. Both the sulphite and the hyposulphite are readily soluble in water and are not likely to do any harm.

Doses.—Horses and cattle take 8 to 10 oz.; of the sulphite sheep and swine take 4 to 8 drams. The doses of hyposulphite are about half as large as for the sulphite. These doses are to be given as drenches, well diluted, and repeated three times daily. Smaller doses may be given every half hour in cases of bloat.

LECTURE LX

COMMON MEDICINES (*Continued*)

DIURETICS

Saltpeter (nitrate of potash).—Saltpeter is very soluble in water, warm or cold. It is mildly antiseptic, and has slight cathartic effect. It is strongly diuretic; it increases secretion from bronchial tubes; it is alterative, a febrifuge¹ and useful in the treatment of all classes of animals. For alteratives and febrifuge effect it is given in about half the doses that are given to stimulate the kidneys.

Doses.—Cattle and horses for diuretic effect take one half to two ounces; sheep and swine, one half to two drams. These doses are given in the drinking water or as a drench.

Sweet spirits of niter.—Stimulant much like alcohol or ether; it is antispasmodic and increases the excretion from skin, lungs, and kidneys. Very large doses are narcotic. It is very useful in cases of spasmodic colic and it is a convenient heart stimulant.

Doses.—As a stimulant and antispasmodic, horses and cattle take two to four ounces; hogs, two to four drams. It is decomposed by water, and should not be mixed with other medicines until just before its use. It is given as a drench with water or in sirup. As an antispasmodic it may be given to advantage with either opium or chloral hydrate.

Oil of turpentine (common turpentine).—Stimulant, antispasmodic, antiseptic, and destroys parasites, both external and internal. It is readily absorbed when swallowed and is excreted by the lungs, skin and kidneys. Medicinal doses stimulate and overdoses irritate the mucous membrane of these organs. For medicinal purposes it is used in indigestion, and in certain conditions of diarrhea and tympanites (bloating); it is a very useful medicine in these conditions and one that is usually at hand.

¹ A febrifuge reduces fever.

It is practically insoluble in water; soluble in ether, alcohol and chloroform and dilutes well in linseed oil.

Doses.—Horses take 1 to 3 ounces and cattle 2 to 6 ounces two or three times a day. The dose for sheep and swine should be about 1/6 of these quantities.

NARCOTICS AND SEDATIVES

Chloroform.—Stimulant, antispasmodic, anodyne,¹ anesthetic. Its stimulating effect resembles that of alcohol, but is less pronounced and more temporary. Applied externally, it evaporates rapidly and is cooling; but is very irritating when applied externally and prevented from evaporating.

Chloroform is very useful in colic, cough, and other spasmodic conditions given internally with eight to ten times its bulk of raw linseed oil or milk and well shaken.

It is very slightly soluble in water, but dissolves freely in alcohol, ether or turpentine, and is useful in spasmodic colic.

Doses.—Horses and cattle take two to four drams repeated every two to three hours, if necessary till the patient staggers. Sheep and hogs take one half to one dram repeated frequently as for horses and cattle.

Sodium bromid.—Small white crystals, readily soluble in water. This medicine is usually considered as the least toxic, least irritating to the stomach and the most hypnotic² of the bromids.

It acts as a nerve depressant especially on the motor centers.

The bromids are often combined with chloral hydrate and are used to control nervous conditions with excessive motor activity, as in convulsive conditions.

Doses.—Horses and cattle take one half to two ounces.

Opium.—Medicinal doses relieve pain and spasmodic conditions, reduce congestion and inflammation; check intestinal secretions and peristaltic movements; and with some animals produce sleep. The various preparations of opium are used especially for the purpose of relieving pain. Opium is a typical anodyne (pain reliever), but there are very painful conditions that arise in practice under which it should never be given, which it is not thought practical to explain in this short lecture

¹ An anodyne relieves pain. An anesthetic removes sensation.

² A hypnotic produces sleep.

further than that the person who is giving opium preparation of any kind to any domestic animal must not forget that it checks intestinal secretion and peristaltic movements of the intestines, and in this way may cause decided constipation at just a time when this would be serious.

DOSE	HORSES	CATTLE	SHEEP	HOGS
Morphine sulphate . . .	3-5 grs.	3-8 grs.	1/2-2 grs.	1/2-2 grs.
Tincture opium (laudanum)	1-2 ozs.	1-3 ozs.	2-6 drs.	2-6 drs.

The tincture should be diluted with water or sirup the same as for alcohol.

Morphin is an active principle of opium, and has the essential physiological properties of opium. Cattle and sheep take very large doses. Morphin and various preparations of opium are sometimes employed in spasmodic colic and may be combined with stimulants or anodynes like ether, sweet spirits of niter or chloral hydrate. It is usually advisable to give a laxative soon after the opium. All opium preparations must be used with great caution, even in relieving pain. They may mask important symptoms and by arresting secretion and excretion, they may do more harm than good.

ASTRINGENTS

Alum (potassium sulphate).—An astringent and styptic.¹ This is not much used internally in veterinary practice. Within recent years very large doses have been used internally and with good results in laminitis. (See Lecture XLVI.)

Alum is soluble in cold water, 1:9, and very soluble in hot water. It is antiseptic, astringent and mildly caustic, locally it coagulates albumin and checks secretion. In the circulation, alum constricts the capillaries.

It is more commonly used externally for its astringent and mild caustic action on profuse granulations, and “weeping” surfaces, and for its antiseptic and astringent effect in stopping leakage of synovia from an open joint with small puncture.

Alum is a common ingredient of astringent and antiseptic dusting powders.

Dose.—The usual dose for internal use for horses and cattle is 1 to 4 drams, well diluted.

¹ A styptic checks hemorrhage, aids coagulation.

Burnt alum is common alum from which the water has been driven off by heating.

It is quite astringent, somewhat caustic, and is sometimes used on excessive granulations in an open wound.

Tannic acid (tannin).—This is a very light, yellowish powder obtained from oak galls. It is soluble in water and glycerin, a powerful astringent and styptic.

It coagulates albumin, checks secretion locally where applied, and is but slightly irritating.

Tannic acid is often used on mucous membranes for its astringent effect in checking the local secretion, as in certain diarrheas when a non-caustic astringent is needed. Externally, tannic acid is used on superficial collar and other harness sores, dusted on as a powder, or dissolved in water or glycerin, about 2 ounces to the pint. Tannic acid dissolved in glycerin is very useful for sore and chapped teats.

Dose.—The internal dose is 1 to 3 drams in solution for horses and cattle. Its chief use for the stockman will be for external application.

MISCELLANEOUS

Collodion.—Collodion is a solution of gun cotton in ether and alcohol. Flexible collodion contains castor oil and Canada balsam, also, and is better for most veterinary uses than plain collodion. It must be kept in a tight bottle and *not exposed to an open flame*.

It is used only as an external application and is very useful in minor surgery.

When painted over a dry surface, it dries promptly and leaves a thin adherent and protective covering that is not sticky. This gives excellent protection against infection and minor injury to superficial wounds. It is useful to cover small, clean wounds, cracked and chapped teats, etc.

Other medicines are often added in order to use the collodion as a carrier.

MINOR SURGICAL OPERATIONS

LECTURE LXI

MINOR SURGICAL OPERATIONS

CASTRATION

This is a very common and useful operation which the stockman should understand. Colts should ordinarily be castrated by qualified veterinarians.

Age.—*Calves* may be castrated at almost any age, but better at between two and four months. *Colts* may be operated on at

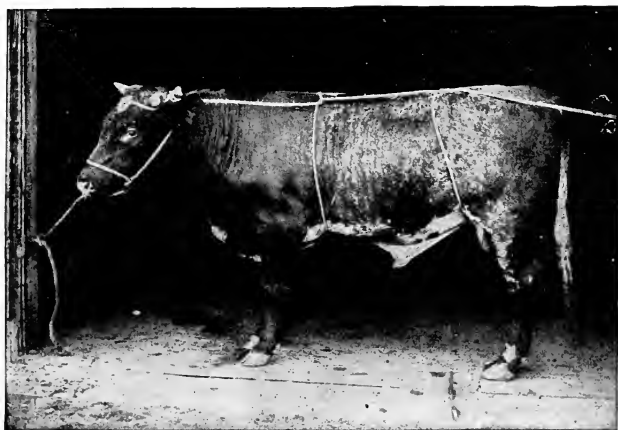

FIG. 92.—TO THROW CATTLE. (M. H. R.)

Pull straight back on the rope.

any age after a few months old, but better at about one year—usually under two years; *lambs* at one to three weeks and pigs any age, but better about two weeks before or two or three weeks after weaning.

Restraint.—*Calves* small enough to be handled easily are

usually held on the ground, clean grass preferred, with the top hind leg held forward; older calves and bulls may be easily

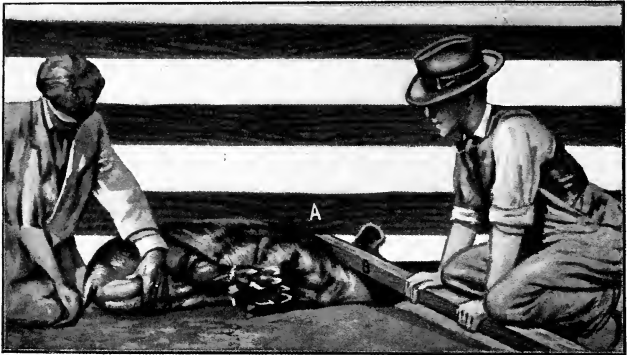

FIG. 93.—RESTRAINT FOR CASTRATION. (White.)

operated standing if well confined. Look out for kicks, especially from older bulls. For the standing operation, it is safer to confine the hind legs by a figure 8 rope tie above the hocks or by ordinary hock kicking hobbles, or to throw and tie securely in some cases.

Young pigs are held by an assistant in either of several convenient ways. Heavier shoats are usually castrated on the ground, clean grass, held with the top hind leg forward by an assistant. Or they may be “hog tied” for the two front and upper hind leg. A heavy boar may be tied short by a loop around the upper jaw and castrated standing. In this case it is advisable to have two assistants hold a pole under the belly, well back, to keep the boar from lying down. The standing

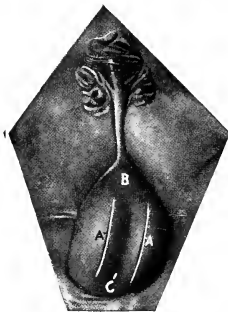

FIG. 94.—GENERAL VIEW OF SCROTUM AND SHEATH. (White.)

A, A, Long incisions parallel to the median line B-C.

operation on boars is inconvenient for some operators. See Figure 93.

Young lambs are held by an assistant and may be docked at the same time.

Large rams may be "hog tied" like the boar on the ground, except that the lower hind leg should be included in the tie. The upper may be either held forward or included in the tie. Older lambs and small rams may be held on the rump, belly up somewhat as for shearing, the assistant holding both hind legs.

Season.—Good weather is desirable especially for lambs—

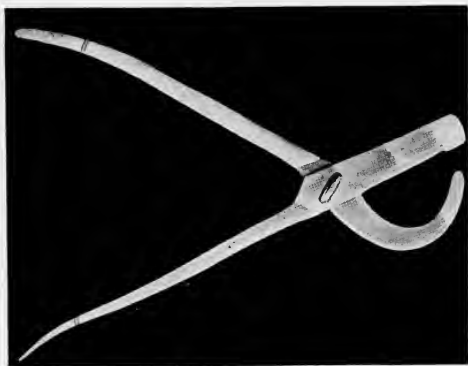

FIG. 95.—A GOOD TYPE OF EMASCULATOR. (White.)

usually spring or fall. Dust should be avoided; therefore a quiet day is preferred.

Operation.—The scrotum incisions should be parallel to and reasonably near the median line or "seam." See Figure 94. This should be done with a free sweeping cut and few movements. Except in case of a ruptured animal, young boar, for instance, the incision should go through the thin transparent sac¹ around the testicle. The incision should be reasonably long and extend to the lowest point where pus could otherwise collect.

The testicle is removed in various ways, the choice depending principally on the danger of hemorrhage. For lambs under about three weeks, the cord is simply pulled in two after freeing the testicle. For pigs, calves and older lambs, the blood vessels may be divided by moderate pulling and slow scraping

¹ Peritoneum.

with the castrating knife, the rest of the cord having been cut first.

For still older animals, an emasculator of the type shown in Figure 95 is desirable both for convenience and safety. It is well to hold the cord in the emasculator for a little while after closing the jaws.

Dangers.—On account of the peculiar anatomy of the parts involved in castration, there are several possibilities of trouble. The student should understand that the peritoneal or belly cavity is continuous with the inguinal canal and sac around the testicle. As the testicle of the young animal descends from the belly to the scrotal cavity, it carries with it the peritoneum, which forms a thin membranous sac closely around the testicle.

Thus an *infection* of the interior of the scrotum or stump of the cord, after removing the testicle, easily leads by extension directly to the abdominal peritoneum and to a fatal peritonitis.

Dangerous *hemorrhage* sometimes occurs after this operation, hence the necessity of keeping recently castrated animals under observation for a few hours. For control of hemorrhage, see Lecture on Wounds. Such hemorrhage is usually due to too rapid scraping or to accidental nicking of the artery above the point of division or to a poor emasculator. Some animals are natural bleeders, *i.e.*, their blood does not clot and they bleed dangerously from wounds that would be trivial for another.

An incomplete or inguinal *hernia* may be overlooked and the intestines come out after castration. Examine for such hernia before removing the testicle.

Premature *closure* of the incision may occur especially if the incision is too small. Such closure prevents proper drainage and favors dangerous disorders, leading to much swelling and even to peritonitis. Make a reasonably long incision at the proper place. If necessary, reopen the wound with clean fingers.

Allow plenty of mild exercise beginning as soon as danger from hemorrhage is past.

DEHORNING

There are several ways of performing this useful operation, all intended to either prevent the horn growth as in case of young calves, or else to so remove the horn as to avoid the growth of an unsightly stub.

Age.—Young calves to be treated by the caustic method, must be treated at about 3 to 5 days, preferably not over 7 days old. After this age it is better in most cases to wait until cattle are about two years old. Young cattle at two years handle and dehorn more easily than when much older. Aged cattle may be dehorned but the horn is hard and more brittle.

Caustic method.—This is applicable only for young calves. Clip the hair around the horn button; apply a broad ring of vaseline around the button, then the caustic. This is a stick of either caustic soda or caustic potash. Wrap paper around one end of the stick to protect the fingers. Dip the other end in a cup of water. *Shake off surplus water* and rub the button with the moist caustic; then turn the calf over and treat the other side in the same way. Treat each button two or three times at intervals long enough to let the horn button dry. Do not allow water from the caustic to fall on or run down over the skin, and do not allow treated calves to be out in a possible rain for a week or more.

If this operation is properly done, there follows a smooth poll.

Older cattle should be well confined that the horn may be removed with saw or clippers. It is well to take about a quarter inch of skin and hair entirely around the horn. When hastily done on a struggling animal, the cut is apt to be too high at some point and an unsightly stub results. For young cattle, the clipper is quick and satisfactory. For older cattle a narrow blade saw (*e.g.*, “meat saw”) usually does better work than the clipper. The blade should be about an inch wide and well stretched in a strong frame. The saw has a further advantage in dehorning old cattle in that it causes less hemorrhage.

Where many cattle are to be dehorned, it usually pays to prepare a good chute intended especially for this purpose. Cuts and directions for constructing such chutes are given in federal Department of Agriculture and various state bulletins.

A few cattle may be dehorned by throwing or by securing the head to a tree or to an overhead stanchion support.

Suggestions.—If dehorning is carefully done at a proper season, dressing or treatment of any kind is not usually needed. Serious hemorrhage is rare and may be controlled by pressure pad and bandage or by lightly burning the bleeding point with the red hot end of a small bolt or end gate rod.

DOCKING

The docking of lambs is a simple and very useful operation, and may be done at the time of castration, *i.e.*, at 7 to 14 days old. The tail is cut off preferably at an articulation between the vertebrae, leaving a stump of about one and a half inches, with enough skin for covering the bone and good healing. This is secured by pushing the skin of the tail toward the body before cutting.

The cutting may be done with chisel and block of wood or hand pruning shears or by an ordinary castration emasculator.

If chisel or pruning shear is used, older lambs may bleed seriously. For such lambs docked by shear or chisel the tail should be tightly tied with string somewhat above the point of incision. It is much more convenient to do this before cutting off the tail. The strings should be removed after a few hours.

A good emasculator removes the tail without causing hemorrhage. Further treatment of the wound after operation is usually unnecessary.

ABSCESS

It is sometimes necessary for a stockman to open an abscess. As a rule the operation is reasonably safe where the abscess is superficial and "pointing," *i.e.*, distinctly soft at some point near the surface. Some judgment is necessary in considering the location and proximity to important structures, like articulations or well known, large blood vessels. The purpose of this operation is merely to get a foreign and harmful substance, pus, out of the way of nature's healing processes.

Procedure.—Make an incision, usually at the point where the abscess is softest under pressure, and then extend it freely to the lowest point where a pocket could otherwise form. For the first incision by an inexperienced operator, something like a cork may be slipped over a slender blade to control the depth and extent of the incision.

The animal should be well confined; otherwise an unexpected movement may cause slashing incision. For any such operation there should be at hand one or two pairs of snap artery forceps for clamping on a possible bleeding vessel.

Treatment.—Free drainage is all that is necessary in many cases. After the pus cavity has been drained it may be desir-

able to wash the cavity with plain water or water which contains a teaspoonful of salt to the quart.

Most of the treatment commonly given such cases by stockmen is harmful rather than useful.

In some cases antiseptic cleansing is necessary; usually, however, little is needed but simple cleanliness and protection from flies.

TAPPING FOR BLOAT

Tapping for bloat is not difficult. It is reasonably safe for cattle and often very urgently necessary for sheep. Tapping a bloated horse is a different matter, however, and must be done by a qualified veterinarian.

The purpose of this operation is to quickly let out gas which has accumulated to a dangerous extent in the first stomach.

Cattle and sheep bloat chiefly in the rumen or paunch. This is so large when an animal is bloated that there is no danger of injuring the paunch except by the small puncture made by the trocar. See Figure 78.

Procedure.—Disinfect the skin, *e.g.*, by tincture of iodine, in the left flank rather high and well forward. See Figure 77. If the skin is too thick and tough for the trocar point, make a small incision in the skin only, and then thrust in the trocar and cannula. Gas will usually escape rapidly and the respiration is relieved. If the tube becomes obstructed by stomach contents, insert the trocar or a clean stick. The tube (cannula) may be left in as long as usually needed.

Subsequent treatment of the small wound is unnecessary, except another local treatment by iodine when the cannula is withdrawn.

Abscesses occasionally follow, but as a rule are easily treated and are not serious.

REMOVING WARTS

The removal of warts in ordinary cases is a simple operation and usually successful when well done. There are various methods.

By incision, the wart may be removed with a narrow ring of normal skin. A sharp pair of curved surgical shears is very convenient for this and many other surgical operations.

After hemorrhage is checked, apply caustic, *e.g.*, nitrate of

silver in stick form or the point of a hot iron, or the point of a large copper sulphate crystal.

Warts that stand well out from the skin, with narrow base, may be successfully *tied off* by a stout linen thread. In this method the thread is tied tightly around the base of the wart as low as possible, and left there. In a short time the wart drops.

INDEX

- ABORTION**, 257
 infectious, 259
Abscess, 296
Actinomyeosis, 159
Air in relation to disease, 106
Alcohol, 282
Aloes, 281
Alum, 289
Ammonia, aromatic spirits of,
 282
Anatomy, 1
Anemia, kinds of, 78
Anthrax, 163
 symptomatic, 167
Arm, 10
Arteries, 46
Articulations, 24
 disorders of, 27
 structures at, 25
 varieties of, 25
Astringents, 289
Atrophy, 84
 kinds of, 84
Azoturia, 218
- BACTERIA**, 96
 bodily resistance toward, 99
 body entrance, 98
 classification of, 99
 how scattered, 97
 method of injury, 98
Bichloride of mercury, 284
Blackleg, 167
Bloat, 230
 tapping for, 297
Bones, 1
 development of, 1
 kinds of, 1
 structure of, 2
Bones and regions, 10
Boracic acid, 284
Bots, 141
Brain, 35
 divisions, 36
 functions, 35
- CAMPHOR**, 283
Canker sore mouth, 174
Capped hock, 245
Carbolic acid, 284
Castration, 291
- Catarrh, sheep**, 156
Cathartics, 281
Chloroform, 288
Choke, 238
Circulation, 42
 apparatus, 43
 disorders of, 50
 heart, 44
Collapse, 86
Collodion, 290
Corns, 246
Constipation, swine, 216
Contagium, 96
Corrosive sublimate, 284
Cowpox, 272
Curb, 245
- DEGENERATIONS AND INFILTRATIONS**,
 85
Dehorning, 294
Dietetic diseases, 218
Digestion, physiology of, 64
 carbohydrates, 64
 fats, 65
 proteins, 65
Digestive apparatus, 57
 liver, 61
 pancreas, 61
 salivary glands, 57
Disinfectants, 103
Disinfection, 102
Docking, 296
Drenching, 280
Dropsy, 83
Dummy, 247
Dystokia, 274
- ELEPHANT LEG**, 222
Embryotomy, 277
Enteritis, necrotic, 176
Epsom salts, 281
- FEVER**, 80
Flies, 127
Food as cause of disease, 119
Foot (horse), 10
Foot, anatomy of, 19
Foot-and-mouth disease, 177
Foot-rot, 171
Forearm, 10
Foul-foot, 173

- Founder, 224
 Front limb, 10
 disorders of, 12
 GARGET, 269
 Gentian, 283
 Gestation, normal periods of, 257
 Ginger, 283
 Glanders, 203

 HEART, DISORDERS OF, 248
 Heaves, 227
 Hemorrhage, 83
 Hemorrhagic septicemia, 180
 Heredity in relation to disease,
 106
 Hog cholera, 208
 Hoof, 20
 Hoven, 230
 Hygromas, 246
 Hyperemia, 77
 Hypertrophy, 84

 INFLAMMATION, 79
 Iodin, 285
 Iodoform, 285

 LAMENESS, 252
 Laminitis, 224
 Leg, 15
 Lice, 125
 Lime, common, 285
 Linseed oil, 282
 Lip-and-leg ulceration, 174
 Lumpy jaw, 159
 Lungs, congestion of, swine, 216
 Lymphangitis, 222
 Lymphatic system, 48

 MAGNESIUM SULPHATE, 281
 Mammary glands, 72
 disorders of, 75
 Mammitis, 269
 Mange, 137
 cattle, 138
 horse, 138
 Matrix (foot), 21
 Medicines, administration of, 280
 common, 280
 Mercury, bichloride of, 284
 Metritis, 265
 Milk fever, 233
 Museles, 31
 disorders of, 32
 structure of, 30
 Muscular system, 29

 NASAL GRUB, 154
 Navicular disease, 246
 Necrophorus, 168
 Nematodes, 142

 Nerves, 37
 cranial, 37
 spinal, 37
 Nervous system, 33
 disorders of, 39
 nerve centers, 33
 nerve fibers, 34
 Nitre, sweet spirits of, 287
 Nodule disease, 145
 injury done, 146
 prevention, 148
 treatment, 147

 OBSTETRICS, 254
 Opium, 288
 Osseous tissue, 89
 Ovaries, 254

 PARASITES, 124
 effect on health of host, 124
 external, 125
 internal, 141
 nourishment of, 124
 parasitic diseases, 124
 Parasitism, 125
 general treatment for, 125
 practical suggestions concerning,
 125
 Parturient paralysis, 233
 Parturition, accidents of, 265
 difficult, 274
 Pathology, 77
 Pelvis, 5, 14
 Perineum ruptured, 248
 Plantar cushion, 21
 Posterior limb, 14
 disorders of, 17
 Posterior paralysis (swine), 215
 Potash, nitrate of, 287
 Pregnancy, accidents of, 257
 Presentations, faulty, 274
 normal, 274

 QUITTOR, 246

 RESPIRATION, 51
 Respiratory system, 53
 parts, 53
 Retention (of fetus), 264
 (placenta or afterbirth), 267
 Ribs, 9
 Ringbone, 242
 Ringworm, 128

 SIDEBONE, 243
 Spavin, 243
 Splints, 245
 Sodium bromid, 288
 Sodium chlorid, 286
 Sodium hyposulphite, 286
 Sodium sulphite, 286

Sternum, 9
 Stomach worms, 149
 medical treatment, 151
 Salt, common, 286
 Saltpeter, 287
 Sheep seab, 130
 how spread, 131
 possible mistakes, 134
 treatment, 134
 Sheep tick, 127
 Shoe boil, 245
 Shoulder, 10
 Stomatitis, 174
 Surgical operations, 291
 Swine diseases, 215
 Symptomatic anthrax, 167
 Syncope, 86
 Synovia, 26
 Synovial sacs, 246

 TANNIC ACID, 290
 Tape worms, 143
 Teats, disorders of, 271
 Teeth and dentition, 3
 age, estimating, 3, 4, 5
 Teeth, disorders of, 6
 Texas fever, 185
 Tick fever, 185

Ticks, 128
 Tuberculin test, 198
 Tuberculosis, 192
 Turpentine, 287
 Tympanites, 230

 UDDER, DISEASES AND ACCIDENTS,
 269
 Urinary organs, 68
 disorders of, 70
 Unsoundness, horse, 241
 Uterus, 254
 inversion of, 264

 VEINS, 47
 Ventilation, 109
 considerations affecting, 114
 natural forces affecting, 112
 necessity, 110
 space needed, 114
 Verminous bronchitis, 153
 Vertebrae, 7
 Volvulus, 264

 WARTS, 272
 Water, cause of disease, 121
 Womb, 254
 Wounds, 88

498382

SF747

R4

1922

BIOLOGY
LIBRARY
G

Regents

UNIVERSITY OF CALIFORNIA LIBRARY

