

NORTH CAROLINA STATE UNIVERSITY LIBRARIES

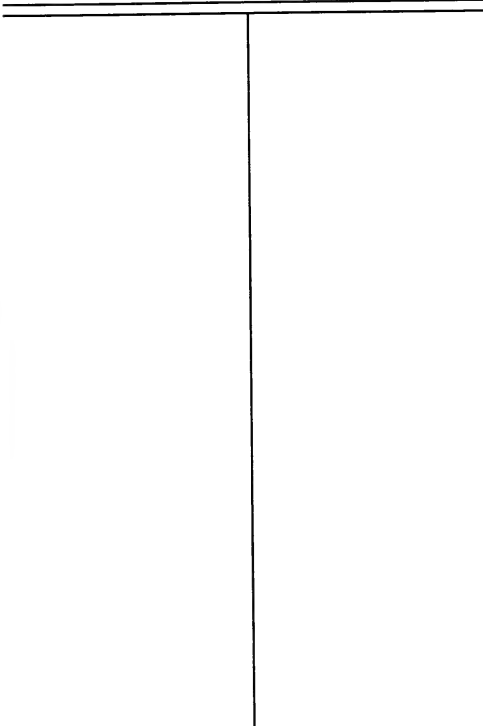

S02321944 P

This book is due on the date indicated unless recalled by the Libraries. Books not returned on time are subject to replacement charges. Borrowers may access their library accounts at: <http://www.lib.ncsu.edu/ads/borrow.html>



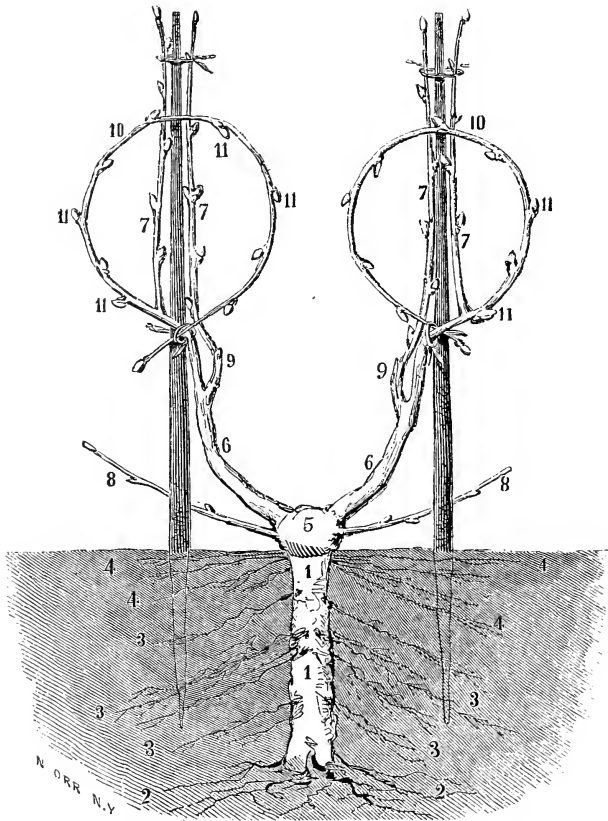

- | | |
|------------------------|------------------------|
| 1. The "Stem," | Der Stamm. |
| 2. The "Foot Roots," | Die Fuss-Würzeln. |
| 3. The "Side Roots," | Seiten-Würzeln. |
| 4. "Surface Roots," | Tag- oder Thau-Würzeln |
| 5. The "Head," | Der Kopf. |
| 6. The "Thighs," | Die Schenkel. |
| 7. The "Bearing Wood," | Tragbares Holz. |
| 8. "Ground Shoots," | Boden-Holz. |
| 9. "Spurs," | Zapfen. |
| 10. "Bows," | Bogen Schoss. |
| 11. "Buds," | Augen. |

THE

VINE-DRESSER'S MANUAL,

AN

Illustrated Treatise

ON

VINEYARDS AND WINE-MAKING.

BY CHARLES REEMELIN,

OF OHIO.

NEW YORK:

G. M. SAXTON & COMPANY,

NO. 140 FULTON STREET.

1856.

Entered according to Act of Congress, in the year 1855,
By CHARLES REEMELIN,
In the Clerk's Office of the District Court of Ohio.

CONTENTS.

	PAGE
Introduction,	7
Names of the various parts of which the Vine is composed,	9
Location and Soil,	14
Preparation of the Ground,	19
How to mark out a Vineyard, and get it ready for the Vines,....	25
The Propagation and Multiplication of Vines, and how to Plant them,.....	29
What species of Grapevine shall we cultivate?	37
Treatment of a young Vineyard the first three years,	41
Vineyard Stakes,.....	48
Trimming young bearing Vines in the fourth year,	55
How to bend the Bows,	61
On Trimming generally,.....	64
How to cultivate the soil of a Vineyard,	71
Vines on Trellises,.....	73
Summer Trimming,.....	77
Gathering the Grapes,	82
Manures,.....	86
Diseases to which Grapevines are subject,	88
Wine-making,.....	89
Mashing the Grapes,	89
Pressing,	94
Treatment of the Wine,	98

INTRODUCTION.

THE object of these pages is to furnish to such as have no opportunity to learn the Vintners' business practically, easily comprehended and reliable instructions, so that even the most inexperienced may, with this book in his hand, start, plant, perfect and cultivate a vineyard, and make good, wholesome wine. The writer is himself a practical vintner, owns vineyards, has worked and does work in them. He gives to the reader the knowledge derived from reading, and also through a somewhat extended intercourse with vintners from various countries, as well as his own actual observation in various parts of the United States and Europe.

His object is not to make money. He has long felt that the United States need, as an important element of its horticultural economy, the domestication of the grape, and that, in the progress of time, the use of wine as *food* must necessarily be a part of the social enjoyments of our people.

He is often asked in private conversation, especially while travelling, various questions about vineyards.

Thus to answer is very tedious. He concluded, therefore, to write this little book, which, being sold cheap, might be in the hands of nearly everybody, and thus, at little cost, give to all who wish it the desired information. The writer trusts that it will be received as an humble contribution to a subject, which certainly is receiving, as it deserves, very general attention.

THE AUTHOR.

The Vine-Dresser's Manual.

NAMES OF THE VARIOUS PARTS OF WHICH THE VINE IS COMPOSED.

I DEEM a knowledge of these various parts, and their names, of much consequence to a correct understanding of the whole subject, and hence will at once describe and name them.

England has no vineyards, and therefore the technical names I shall give are, in general, mere translations of similar words, which in German have an accepted meaning with reference to Grapevines. I give, also, the German in every case, as this may facilitate the intercourse between Americans who plant vineyards and the German vineyard men.

The cut, Fig. 1, represents the various parts of a full grown grape vine, which are severally numbered. The reader should familiarize himself with them by frequent reference.

The Grapevine (Weinstock) is properly divided into two classes:

I. *That below the surface of the ground.*

II. *That above the ground.*

In the ground are :

The "*Stem*," (Stamm,) marked No. 1, is either the result of the planted cutting or of a grapevine root.

No. 2 is the "*Foot*," (Fuss,) or lowest part of the stem, out of which grow, in an obliquely downward direction, those important roots called "*foot-roots*," which, if they spread and grow well, are the chief basis of the whole vine, and without which it cannot be truly healthy. These foot-roots are also marked 2.

From the other buds upon the "*Stem*," arise the "*Side roots*," (Seitenwurzeln;) they grow above the foot, and draw their nourishment like the "*Foot roots*," (Fusswurzeln,) through roots almost as fine as hair, which spring from the main roots. They are marked 3.

The "*Surface Roots*," (Tag Wurzeln,) which grow out of the head of the stem, nearly parallel with the surface, and also out of those buds which are about six inches below the surface of the ground. They are marked 4.

Above the ground are :

Marked 5, the "*Head*," (Kopf,) or the upper part of the "*Stem*," out of which grow the first and second

year those first young twigs, from which are ultimately formed the vines.

Marked No. 6 are the "*Thighs*," (Schenkel,) of the "*Vine Stock*," or if the reader likes it better, simply, the "*Vine*."

Marked No. 7 is the "*Bearing Wood*," (Tragbare Holz,) which grows upon and out of the "thighs," "bows" and spurs, and which is to form the bows and spurs for the next season.

Marked No. 8 are those branches which even after the "thighs" are once formed, are continually growing out of the "head," and often even protrude from the main stem below the surface, called the "Ground Shoots," (Boden Holz.)

Marked No. 9 are those branches which grow from the joints or buds in the "thighs," and which are trimmed down to two or three buds in the fall or spring following their growth, and are called "*Spurs*," (Zapfen.)

Marked No. 10 are those branches immediately above the "thighs," which are early in spring trimmed down to six or eight, or even ten buds, and from which the main product of grapes is expected. During that year they are called "*Bow-branches*," (Bogenschoß,) or simply "*Bows*," (Bogen,) as they are bent artificially into bows, and so tied to the stake or post in the spring.

Marked No. 11 are the "*Buds*," or "*Eyes*" at the joints, which if round and perfect, and hence promising a good harvest, are called "*Fruit Buds*," (*Frucht Augen*,) and if pointed and meagre—" *Wood Buds*," (*Holz Augen*.) Out of the "buds" grow "*Shoots*," (*Ruthen*,) which, when green, are tied up to the stake, and when matured are called "*Wood*."

From the "Wood" grow the "*Leaves*," which afford the requisite shade, and perform an all-important part in the nourishment of the vine and in the growth and ripening of the fruit.

Very near the buds spring forth those smaller branches, which I will call "*twigs*," which in literal translation of the German I might call "*cross-teeth*," (*Aber Zahn*.)

Immediately opposite to the "*Leaves*," grow out of the same buds the "*Grapes*"—and where there are no grapes there will be found those little fibrous twigs called "*Tendrils*," which are a convenient appendage to the grapevine; with them they twine themselves to objects near them, maintaining thereby their fruit and branches above ground, even in a wild state—an indication which practical vine-dressers have not failed to follow. Very often, too, after the grape has partially grown, the fruit gradually disappears, or "*runs out*," into these little "*cord-twigs*," or tendrils, and through this operation very often a crop very promis-

ing in the earlier portions of spring is much diminished. Practical vine-dressers therefore smile at enthusiasts, who count their grapes before this danger is past. These cord-twigs which thus spring from buds, which should bear grapes, are in German called Gabelein, "forks." I name them "*Tendrils*."

The fruit stalk comprising the centre axis with its branches, or the part of the cluster which remains after removing the berries, is called the "*Comb*." Grapes which are "*close berried*" are best.

The berries contain, when ripe, saccharine matter, (never yet brought to crystallization,) water, much coloring matter, and also substances more or less peculiar to taste and smell, according to the kind of grape and the season.

The saccharine matter is the great basis of the fermentation, and therefore of the quality of the wine.

The taste peculiar to each kind of grape arises from the inside coating of the skin of the berry, a matter easily tried by chewing and sucking this skin after the pulp is squeezed out. The peculiar smell also springs from substances immediately connected therewith, and the reason why wine which passes through its first fermentation before the juice is pressed from the crushed grape, possesses the taste and smell peculiar to each grape in a greater degree, must be sought in the fact, that through this process the saccharine slime

is better dissolved, and because then the fermentation absorbs and acts more fully upon those peculiar substances which adhere to the skin.

The "coloring matter" lies in the inside of the skin, and is easily developed, but much modified through the subsequent fermentation in the cellar, and wine treated as it is commonly in the United States, may eventually be colorless, as the coloring matter has no lasting effect, unless the fermentation takes place before pressing out the juice.

Within the berry are the "*Pulp*," and the "*Kernel*."

I have thus named all I deem essential, and the reader and myself will, I trust, hereafter better understand each other.



LOCATION AND SOIL.

THE best location, if it is desired to produce good wine, is the southern exposure of a hill or hillock. There the vines get the proper sunshine, and are also properly protected against storms, especially the north and north-east winds. A location giving an exposure midway between east and south is also favorable, because such an exposure gets the sunshine from morning till pretty late in the evening.

A due eastern exposure is less favorable, since it loses the sun too early ; it is ever exposed to eastern winds, and is sensitive to frosts, even of the lighter sorts, because it receives the rays of the sun so very early and direct, as to subject such locations to injury from freezing nearly every year.

Still worse is a western exposure, because it receives the sun till very late, and hence suffers from the chilly evening dews, which in this country are, comparatively speaking, far colder than in Europe. Such an exposure must necessarily suffer from west winds, and is also more liable to be injured by hail.

Hills and hillocks are far better for wine-culture than plains, which latter may produce greater quantities of wine, but it is invariably of a poorer quality. Plains or hills whose soil, either on the surface or as a substratum, has yellow or blue clay soil, are not favorable for vineyards, because upon such soils neither the atmosphere, nor the sun, rain or dew, can operate as they should, and hence there is danger that the vine will be affected with the wet-rot. The sun's rays hardly ever strike vines upon plains in the proper direction, so as to afford the required warmth, and the wood and the grapes are apt not to get the proper ripening ; such localities are also far more subject to winter and spring frosts, and to mildew. And, in addition, they must necessarily suffer more from destructive insects, snails,

and animals of every description, as it is well known that such prevail more largely upon plains.

There exists, however, a great difference between the foot, the middle, and the crest of hill-sides. The middle gives the best wine; the foot is more or less subject to frost, and does not receive adequately the sun's rays; while the crest is too much exposed to cold winds, in addition to its soil being very seldom good enough.

Nor must neighboring objects be lost sight of in locating vineyards. Favorable is everything which tends to temper and somewhat increase warmth, and which protects against frosts, raw winds, and other casualties; such as woods, buildings, high walls, and adjoining hills, provided they are in the rear or north of vineyards, and such localities will always produce the earliest ripe fruit and the best quality of wine.

Injurious objects, when too near neighbors, such as lakes, ponds, swamps, and cold wet woods, are to be avoided, as from all these cold mists are apt to generate. Hills, houses, trees, &c., should not be so near as to throw a shade over the vineyard. Vineyards should never be planted along deep valleys, hollows or gorges, which run east and west, since such almost invariably produce, in winter especially, constant drafts of wind, and they are more or less injurious. Grass and clover patches should not be too near, as

they draw frosts, and smithies or other large laboratories or manufactories, are also to be avoided on account of the smoke.

Much depends, also, upon the quality of the soil, which changes often within a very small space of ground. A grapevine will grow, to be sure, where other plants grow, but the quality of the wine is always modified by the kind of soil.

A heavy soil—one composed of sticky clay—will not permit sun and rain to penetrate, and may therefore be termed a cold soil. In such, grapevines soon become weak and sickly; in wet seasons their foliage is apt to have a yellowish tint; the roots rot, and even where that should accidentally not take place, the quality of the wine will never be very good. The only way to render such a soil fit for a vineyard, is by a copious application of lime or marl mixed with sand,—yet it may be done, but not efficiently, by mixing with it a sandy loam. Little, however, as vineyards will prosper in such cold soils, they will succeed just as little in too light sandy soils, unless well mixed with clay loam, or clayey marl.

The soil most to be preferred in climates such as the Northern and Middle States of this Union, is that so generally prevailing rich loam, mixed with some gravel and marl. This kind of soil differs largely in various locations, and it will take a more or less lengthened

period of individual experience to find the best locations. We should, however, always examine into the more general admixtures of the soil which we propose to select for our vineyard. There should always be some sand, some clay, some limestone, and some gravel in it. Is there too little sand or gravelly limestone, then, the soil will soon become too clayey and cold, or if there is too much gravel and sand, then vegetation is impeded. Our soils almost invariably lack what European vineyard men prize so highly—gypsum—and this must be supplied by proper manures. The best wines in Europe grow upon the hill-sides of lime or gypsum mountain ridges, whose formation is somewhat mixed with sandstone. The color of the soil is not always a sure indication of the quality of the soil, but it may be assumed as a general rule, that soils for vineyards should neither be a very light yellow, nor a very brown red. To recapitulate, therefore :

The altitude of a vineyard should neither be too high nor too low, as compared with the surrounding country. The exposure should be selected with due reference to giving full chance to the sun's rays during the entire day ; and the soil should neither be too rich nor too poor,—affording to the roots of the vine and to atmospheric influences an easy chance to penetrate.

PREPARATION OF THE GROUND.

THIS matter embraces the foundation of the whole subject of vine culture, and herein nearly every vineyard yet planted in America is defective. Labor is so extremely high here, as to make it seem to us almost impossible to start a vineyard as it should be. Our very best vineyards are spaded up but two feet, while in many parts of Europe they spade up the ground to the depth of three and four, and even five feet. We never prepare the ground itself, during the preceding year, while in Europe it is sowed down in clover, for a few years previous, and well covered with good coatings of gypsum and manure. We trust to the virgin richness of our soil, and in our confidence are apt to forget that spading up the ground for several feet is done for other reasons besides mere fertilizing; and that among these, for us especially, must be a sinking below the subsoil the present surface or upper soil, which being full of decomposed vegetable matter, is the hot-bed of all manner of insects. The spading up and turning of the surface soil beneath its present subsoil, is of the greatest importance, because thereby the "Foot Roots" may penetrate downwardly, and thus give to the whole grapevine not only its vigor, but also its great safeguard against too sudden atmospheric changes, or long-continued droughts. And I may in

connection with this, here remark upon an erroneous suggestion, which I have noticed in some agricultural journals. They suggest a longer "stem." I do not think that the stem should be much longer than twenty inches, but think it of the first importance that the foot roots should penetrate deeply.

The ground intended for a vineyard should be well manured the previous year, either by a coating of lime, where that kind of manuring is proper, or by gypsum, where it can be had; or by ploughing under some green sward, such as clover; or at least by a good and thorough coat of manure, straw, or even leaves.

Of the ground thus prepared, the surface should, for the depth of twelve inches at least, be sunk beneath twelve inches of soil immediately underneath. This is best done, if the ground be loamy, with the spade, or if stony with the mattock. For this purpose a trench is first dug four feet wide, and to the depth to which the vine-dresser is going to spade up and trench his vineyard. Into this first trench, say four feet wide and two to four feet deep, and as long as the vineyard may be, say two hundred feet, is then thrown twelve inches of the surface soil (using the very best steel spades), and by driving the spade into the ground as nearly perpendicular as possible, and not slanting, as lazy laborers are apt to do; for thus alone can this top soil be spaded up to the depth of at least twelve inches. The loose soil

which is left in the trench, having crumbled from the spade, must then be carefully scraped into the first trench, and then the twelve inches of subsoil must again be similarly spaded up and thrown upon the previously spaded up surface soil, and so on, each twelve inches to the depth required. And the loose soil left in the bottom, must also again be carefully shoveled up and thrown upon the other ground. Thus trench after trench will be regularly formed, until the whole allotted piece is finished. Let the reader bear in mind, as the *sine quâ non* of a good vineyard, that it is not a mixture of the surface with the subsoil that's wanted ; but that the subsoil cover, for twelve inches at least, and twenty to thirty if possible, the original surface soil, and the deeper this is done (always in reason) the better. It is far better, view it in whatever light we may, to have a small, good vineyard, than a large, poor one.

The ground thus spaded up should be permitted to settle well, before the vines are planted. One or two good rains will generally accomplish this. The best method is, however, to trench in the fall, and plant in the spring.

There are other methods of preparing the ground. One is to make large holes, throwing the surface soil underneath and planting the vines therein.

Deep ploughing and subsoiling is also frequently

adopted. I have tried all these methods. The first vineyard I set out by merely digging holes; another by ploughing some sixteen inches deep, with a large plough, drawn by four yoke of oxen, and followed with a subsoil plough, drawn by a pair of horses, and another by trenching as above suggested, thirty inches deep. As to results I can only say, that the first planted vineyard is now being dug up, because it was always liable to every disease which happened to prevail in the season, having hardly yielded a fair compensation for the labor expended; the subsoiled vineyard does better, but I have no hopes of its lasting more than twenty years; while a well-trenched vineyard, to the depth of thirty-six inches, with such virgin soil as we have in America, should, and doubtless would last—*if otherwise properly managed*—eighty to one hundred years. I shall hereafter trench any vineyards I may plant, at least thirty-six inches, and recommend the same course to all others.

I am informed that there is now being constructed in Cincinnati, a large plough to be drawn by six yoke of oxen, and warranted to plough the ground twenty-eight inches deep. I have not seen this latest improvement, and can only say that unless this plough does leave a clean furrow, at least twelve inches wide of the promised depth, it will not answer. The large ploughs I *have* seen do not accomplish this. They break the ground

up, mix it somewhat, but do not turn the top soil under. This, for reasons already stated, is not enough.

It is hardly necessary for me to say, that the procedure must be varied with the ground. Some soils are naturally rich to the required depth, though I should fear such soils for vineyards. Others are very rocky and must be worked with the mattock and grubbing hoe. Good sense will in each case dictate the requisite mode, if we will but bear in mind the great point in a vineyard view. This is to get the surface soil beneath the subsoil, so as to afford from the very start of the vine, to the "roots" at the "*foot*" of the vine, an easy, healthy and steady downward growth. They are the life of the vine, and their continued health is most important. If they are but thrifty, then we need not fear but what the "side" and "surface roots" will always grow and prosper in due time and in proper manner.

In vineyards along side hills, it is well to use the stones generally found therein, for the purpose of erecting walls to prevent "washing." These walls should have their foundation deep enough, so as to be out of the reach of heavy winter frosts. They should be so slantingly laid up, as to bear properly "to land." Such walls are not only useful, but they are an ornament to the vineyard and the general landscape. If properly laid up, they last as long as the vineyard.

Where stones are lacking, it may be necessary to

raise banks by sodding them with green sward. They are not as good as stone walls, since the green sward is apt to subject the neighboring vines to frost, but the ground must be protected from washing even at this risk. I take it for granted, however, that there are very few side hills indeed, where by trenching deep enough, there will not be the required quantity of stones.

I have thus indicated the general rules by which we must be guided in the preparation of the ground in each special case, and I must now only add, that it is a great but frequent error to suppose that throwing old logs, brushwood or stones, underneath, promotes the growth of vines. They may not hinder them, if well packed with ground, but great care should be taken not to leave vacuities, as they are sure to impart to the "foot roots" an unhealthy state. Vines should always be planted after the ground is well settled, and not before. The ground should also be well harrowed, so as to render it perfectly even and in complete cultivating order.

Before dismissing this chapter I would add, that according to my experience, there is, in fact, but little actual difference in the *cost* between a well-trenched vineyard and one slovenly laid out. To trench an acre three feet deep, is worth in common soil \$100; two feet deep, \$75. With large ploughs, followed by subsoilers, an acre costs about \$25. To dig holes, merely costs about \$15. But mark it, you save in a well-trenched

vineyard each year, for three years, *one* hoeing, at least, and you get a good crop in the fourth year. Your vines grow up regular, as in such a vineyard but few miss; and lastly, let me say to you, that having started right, you are apt to keep right, and are therefore every way sure to have a good vineyard.

HOW TO MARK OUT A VINEYARD, AND GET IT READY FOR THE VINES.

THE ground being properly prepared and settled, as previously suggested, the next thing to be done is the staking out of the vineyard. To do this, it is well to prepare as many little marking sticks (say twelve inches long and half an inch square, pointed at one end) as there are to be grapehills in the vineyard; for instance, an acre planted four feet apart each way, about 2,200 hills.

The next thing to determine is, how far apart it is intended to have the rows. There is no settled rule upon this subject. I have seen, in Europe, thrifty vineyards one foot apart, and I have seen them ten feet apart. The four by four may, however, be said to be the prevailing and most approved custom. I have myself lately adopted five by five, and I like the appearance of it very well. In Italy, I am told, vines are planted

twenty feet apart, and then they alternate with fruit trees, in the intermediate space,—say a row of fruit trees, and ten feet from it a row of vines, and so on.

I cannot, without occupying too much space, enter into a discussion of the relative merits of wide or narrow planting. I can only say that, in my humble opinion, it is best not to plant narrower than four by four, nor wider than six by six. A vineyard spaded up to the proper depth has cost so much as to be in itself a veto on too wide planting, and I may as well admit that I am no friend to mammoth vineyards. In no business is slovenliness more pernicious than in that of a vintner, and I cannot get clear of the impression that large vineyards cannot receive in all points that close attention which is required to raise good wine, and to guard the vines against premature decay. It is to be expected that various methods will prevail, according to locality, but I doubt not that four by four will prove the most generally applicable. In fact, we may say, that such is actually the case. Let each follow in this matter his own good sense, and adopt, from the best lights around him, the proper width, bearing in mind the humidity or dryness of his soil, and securing the proper *light* and *shade*.

This done, get good strong cords, long enough to reach as often as necessary across the entire vineyard. Mark off one cord by putting in a slip of muslin at each

of the required distances (say four or five feet apart). This is called the marking cord.

These cords and the little sticks being ready, let the vineyard be laid out, as near as possible, into a square piece of ground. Then starting at the northwest corner, fastening the marking cord there, draw it from thence to the northeast corner, putting the little sticks into the ground at the places marked by muslin in the marking cord; then fastening the marking cord at the northeast corner, draw it thence to the southeast corner, again putting in the sticks at the proper places, and thus on from the southeast corner to the southwest, and again from southwest to the place of beginning. This marks the outer rows. This work should be carefully done, so as to get the vineyard into regular squares.

Then draw parallel cords north and south from each of the little sticks on the rows, which stand in the row between the northwest and northeast corner, to the sticks in the row from the southwest to the southeast corner.

Across these parallel cords, which are fastened, the marking cord, east and west, as in the annexed cut, is stretched crosswise, and held there by a person at each end, while two or more hands put in the marking sticks at those places where the marking cord crosses each of the parallel cords. As soon as the sticks are put in at

these cord crossings, and one row is formed, this cross or rather marking cord is removed and again held over another parallel cord, so as again to form another row, and so on to the end. Fig. 2 will illustrate this fully. Almost complete exactness is thus obtained.

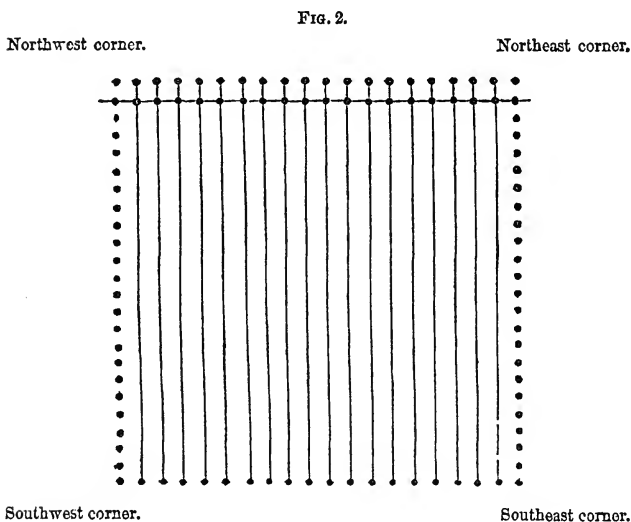

Short rows should, if possible, be avoided, and where this cannot be done, they should be so fixed as not to strike the eye offensively. The direction of the rows should be such as to allow the sun to have the greatest effect—at the same time so as to prevent washing by rains.

THE PROPAGATION AND MULTIPLICATION OF VINES,
AND HOW TO PLANT THEM.

WE have now presented to the reader various matters, such as location and preparation of the ground, and we are now ready to actually start the vineyard. How to do this, whether with cuttings or slips, or with roots, or from the seed, are questions which sometimes perplex speculative minds.

No plant, that I can now think of, is capable of so varied means of propagation as the grapevine. A grapevine can be propagated from the seed, from cuttings, by "layers," and by inoculation and grafting.

It is right and proper that those who have the means, should experiment by raising vines from the seed, as thereby we will get a greater variety of grapevines, and such as will be permanently suitable to each respective locality; but it is not advisable, for any one desirous to set out a vineyard, to attempt to get his vines from the seed, because it will take from five to ten years thus to get bearing vines, and because it is next to impossible to get anything like regular rows by such a method.

A very easy and advantageous multiplication of vines may also be obtained by laying down, or sinking,

from existing and growing vines, branches, or side or ground shoots, as shown in Fig. 3.

FIG. 3.

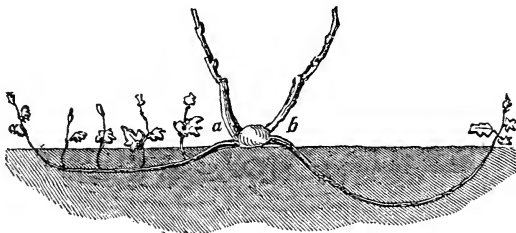

The branch marked *a* is a summer shoot, to raise grape roots, to be put down in June or July. That marked *b* is a permanent layer, to be put down in the fall, winter or spring.

Persons having grape arbors, or vineyards, may thus multiply and spread them, in a very few years, over a very large space of ground. If it is intended to leave these layers in the ground where they are sunk, it is necessary that they should be laid down as deep as cuttings are, say twenty inches; but where these "layers" are made with a view to have them form roots, with a view to be transplanted to other localities, they may be sunk but about eight inches. Permanent "layers" are a convenient, and much to be recommended method, to fill up any vacancies in a

vineyard, which may arise either from the failure of the planted cutting, or from some old grapevine being seriously injured by storms, or other casualties. Such "layers" must, after the first year, be half cut off from the parent vine, and after the second, entirely, or else they would injure the old vine. Those that are intended for transplanting, after they shall have formed roots, must be cut off the same season they are planted in the fall. I refer to the wood cut, Fig. 3, which I trust will convey the proper meaning.

Grafting and inoculating grapevines is done under the same rules as grafting and inoculating fruit trees generally. The graft should, however, always be inserted a few inches under the ground into the stem. I doubt whether either grafting or budding is to be recommended, as a general rule, to raise a vineyard.

The safest and most advantageous propagation and multiplication of vines, in planting a vineyard, is through cuttings. They are easier obtained, and are least expensive. I am free to say, that I prefer cuttings to grape roots, even at the same price, and for the following reasons: They remain in that spot, where they were first planted, and there at once permanently form their roots. These first virgin roots, especially at the foot, can never again be supplied by any second growth. And again, grape roots are always, when planted for sale, set out in the very richest ground,

such as is loamy and well cultivated; and it is easy to imagine, that a vine, taken from such old, rich soil, and then transplanted into the raw, newly-spaded vineyard ground, must necessarily receive a shock to their growth, which must render them more short-lived than vines grown from cuttings. A cutting remains in the

FIG. 4.

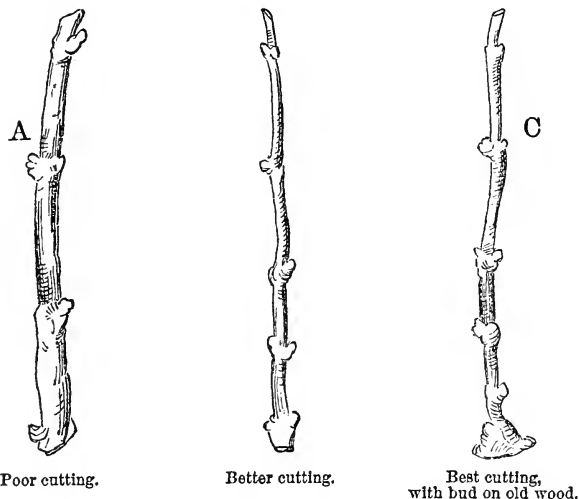

vineyard, and its virgin roots are not torn off or injured. This I regard of great importance. Grape roots *may* bear one year earlier than cuttings; but beyond that much-coveted, and at best doubtful first year, every consideration is in favor of the cutting.

Great care, however, should be taken in the selection of cuttings, and the same must be said of "roots." This cut will assist the reader in guarding against imposition. It represents three different qualities of cuttings.

We may lay down the following general rules :

1st. The vine from which you select your cutting should be healthy, and those not more than ten nor less than three years old.

2d. The wood of the cutting should be soundly ripe of the early spring's growth of the previous year, and not of the second growth, which appears in or after the month of June. The part nearest to the old wood will rarely fail to grow. Cut C represents such a cutting.

3d. The more joints or buds within a given length the better. They should be closer together near the lower end than the upper.

4th. The more compact the stemwood, the finer the sap vessels, and the smaller the *pith*, the better. Coarse reedy cuttings, such as Cut A, are worth but little.

5th. Each cutting should be not less than twenty nor more than twenty-four inches long.

6th. Old wood of more than one year's growth is unsuitable for cuttings.

Cut with a sharp knife smoothly and nicely just below the bud at the foot, being careful not to injure the joint; but above the upper bud, which is to form the "head," leave about two inches of wood, so as to

form a protection to the cutting when in the ground, and that it may be held thereby when planting.

In taking off the first cutting from the old wood, the foot should be the very first bud near, or, if possible, upon the old wood, as in the best cutting, marked letter C.

That proper caution should be used to keep the cuttings right side up into the ground, will, I am sure, be understood by all. The upper part of the cutting may easily be ascertained by the upward pointing of the bud.

The planting is now performed ; if by cuttings, two to each hill, sometimes by making holes with a hoe or spade as near as possible to the *marking stick*, which remains in its place.

The cuttings are then put in and covered carefully with earth.

But there is another, much speedier and equally good method. Have one or two "*stilts*" made, about four feet long and three inches thick, pointed with an iron socket of about twenty-two inches length. See Figs. 5 and 6.

With these stilts the holes are made close to the marking sticks two feet deep, and by moving the stilt from side to side the hole can be made sufficiently large.

There may be one hole to each cutting, or both cut

tings may be inserted at once in the same hole, taking care to keep them separated by placing the fingers between them.

These holes are made as nearly perpendicular as may be, and the cuttings are inserted deep enough to have the upper bud one half an inch below the surface

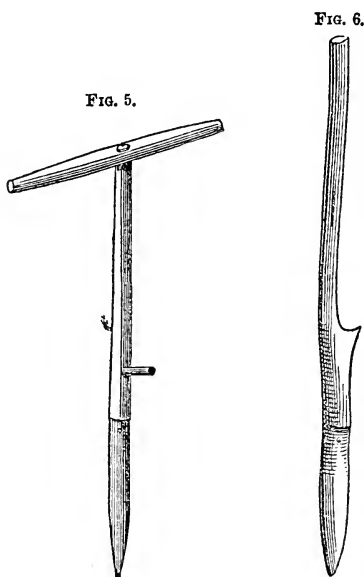

of the ground. The cut, Fig. 7, will illustrate the position.

The cuttings are then held with one hand, while with the other loose earth or sand is poured in, around and

between them. Then pour water into the hole sufficient to "slime" in the sand compactly around the cuttings, at the same time avoid pressing with the feet near to the hole, as this renders the ground hard.

If the holes are dug with the hoe or spade, the cuttings may be put in slanting always *from* the hill, if the surface is not level, and slimed in as above.

FIG. 7.

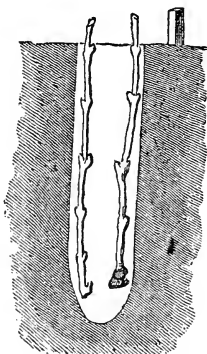

If the planting is made with grape roots, the same care required by fruit trees should be given to have all the bruised roots cut with a sharp knife, and the foot roots carefully surrounded with fine earth, while they are spread in a natural position, and afterwards water is poured around them.

No grape root or cutting should be planted after the 15th of May. They should be in the ground as much

earlier as possible, if the season be favorable and the ground is in proper order. Vineyards should never be set out and planted in wet, slushy weather.

WHAT SPECIES OF GRAPEVINE SHALL WE CULTIVATE ?

IN Europe this question is, and has ever been a much disputed point. The great mass of the vintners follow the traditions of their forefathers, and the various governments as well as the societies for the improvement of wine have found it one of their most insurmountable obstacles to overcome these traditional predilections of the vintners. In Europe the governments have even gone so far as to prohibit by law the planting of certain species of grape vines. These wine "reformers" through government, have, however, not always been right. And yet it would be wrong not to admit that they have done much good. All of us know how easily a theorist, who has made himself the "Sir Oracle" of a neighborhood, may succeed in getting his notions adopted by other theorists, and Europe is not exempt from similar results. In 1832, when I left Germany, the "Riessling" was the fashionable and much approved grape. Four years ago when I returned, it was then the "Traminer," and in 1853, I heard one of the very wine reformers say, "that he actually

believed, that a return to the '*old sorts*' would stop the progress of the grape sickness." If we take the trouble to inquire, we should find that the "old sorts" are grapevines adopted after much experience, and that that experience, although the reasons for it may have been lost, is often worth more than untried experiments.

I am not opposed to all experiments, but I do think that persons who set out "vineyards" had better follow the most approved beaten track of their time. The men to experiment are nursery men. In Europe, there are hundreds of varieties of grapes. Not only has each locality its own favorite, but they frequently again change with each generation. These varieties were all originally imported into, and exchanged between different portions of Europe. Hungary got some of its vines from Greece and Asia Minor; Germany from Italy and Hungary; France and Spain from all parts of the Mediterranean; and then again have all exchanged with each other. A grape approved by one country would be rejected in the other, and *vice versa*. You can find the Hungarian Tookay in Germany, a generally condemned grape, no doubt originally similar to the Malaga grape, and we may, on the other hand, find the white and red Burgundy grape much outside of France. Each imported grape was again changed in each locality by soil, climate and exposure.

In this country, but two wine grapes have yet succeeded in establishing a permanent reputation, to wit:—the Isabella and Catawba. No foreign grape has yet been adopted by us,—or it may perhaps be better said, none of them has yet adopted us. I have three several times imported grapevines from my fatherland,—once also (in 1842) grape seeds; and in 1850, I brought with me, at much personal inconvenience and expense, a bundle of small fruit trees and grapevines, weighing some fifty pounds. I carried them myself from steamboat to steamboat, from car to car; I dipped them into the Neckar, the Rhine, the Weser, the Delaware, the Cumberland, and the Ohio, not omitting even to wet them with the water distilled from the sea by the steamers; but all in vain, so far as the grapevines were concerned. My pears, apricots, plums, cherries, raspberries, have all grown finely—but the grapevines and gooseberries would not be naturalized. A few sprouted, but only for a season. I shall not be discouraged, but will try it again as soon as they shall have a good wine season in Europe, in which their wood and seed ripen fully.

On the whole, then, I would recommend to all who may set out vineyards, to plant good sound Catawba cuttings, taking care to buy only from healthy vineyards. That grape (be it native or imported) is the best yet tried. Let all, however, experiment upon a

separate patch of ground, and on a small scale, through Catawba seeds from especially healthy grapes, and through grafts, and by planting cuttings from Catawba vineyards whose general character has been changed and modified ; and such as are improved by a special good location, a special good soil, a special good climate, or a special good cultivation. Let some of us also keep importing and cultivating grapevines, either from our Western wilds or Western Europe, or any other place. Thus, and thus only, will we get healthy varieties. Experience will, as in Europe, ultimately settle down on a few favorites, which will be called by many local names, each of which will have its admirers. And among these, the varieties of the Catawba which will hereafter arise, will always maintain their ground.

The Isabella grows well in some localities in the United States, especially New York ; but in the Western States, the Catawba is preferable.

A most excellent plan in furtherance of getting varieties, and one at which a good deal of money may be made, is the establishment of a grapevine nursery. Every vineyard owner should devote a small patch to it, where to set out annually, both for sale and a supply for his own vineyards, such cuttings as may exhibit improved bearing qualities. Constant experiments should also be made with the seeds from extra

healthy grapes. Through such means we should soon have decidedly improved varieties of grapes.

If any one is desirous of starting a grape nursery, I would suggest to him the following as a certain and approved method: Have an arbor near your house, lead a few branches of the grapevine, well supplied with good healthy grapes, when nearly ripe, into a room to be warmed, and through this warmth dry the grapes upon the vine, until they are completely shrivelled up. The kernels are taken out and dried in the air, and then planted out, five inches apart, in a bed, and covered with about a half inch of ground. Around and upon the plants which may grow, the ground is gradually raised, until after two or three years the stem begins to form itself. When ready for transplanting, it assumes the color of common yellow or brown leather. Plants thus obtained are as good as cuttings, and will be sure to produce constantly new varieties.

TREATMENT OF A YOUNG VINEYARD THE FIRST
THREE YEARS.

In the First Year.

THE new vineyard must, during the summer, be hoed twice at least, and kept clear of weeds. Should there

be severe drought, it would be well to water the plants. If heavy rains should prevail, by which the plants should be covered with ground too deeply, then they should be eased with great care, so as not to injure, or expose too suddenly to the hot rays of the sun the extremely tender sprouts, usual in such cases. As soon as the sprouts have grown an inch or two, it is well to stir the ground immediately around or near the vine. It is very beneficial to the young vine, always to have the ground well loosened and pulverized around the head. In the fall, the plants which have sprouted, are covered in colder climates. In southern Ohio, this is hardly necessary.

Such vines, or cuttings, as fail to grow, must be supplied in October following with grape roots, or new cuttings, though grape roots are, in such cases, to be preferred, as it gives more uniformity to the vineyard. It is, therefore, well to plant in a separate grape nursery, an extra number of cuttings; and the most thrifty of these may then be used as the supplies for those vacancies.

In the Second Year.

As soon as the weather will admit in the early spring, the branches which may have grown during the preceding year, are trimmed down to one bud, whether

the cuttings have produced more than one sprout or not. That one bud should be upon or near the old wood at the junction of the sprout trimmed off, and ultimately becomes the "*Head*;" the formation and preservation of which is a matter of great moment, and the object of trimming down to one bud is to provide early for a proper "*head*" for each grapevine.

FIG. 8.

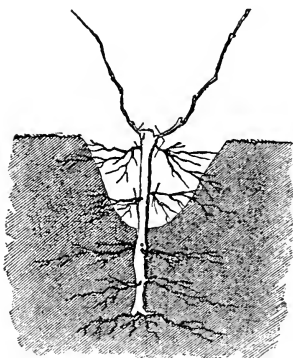

Second Spring before Pruning.

FIG. 9.

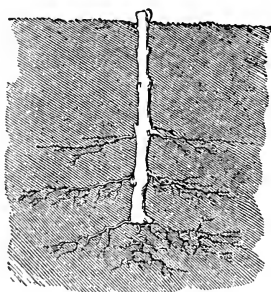

Second Spring after Pruning.

The earth is also removed from around the stem and the surface roots cut off.

Fig. 8 represents the vine as it will appear, if well grown, before the trimming in the second year, and with the earth removed for eight to ten inches around the stem, so as to remove the surface roots which may

have grown. The branches and roots are to be cut where marked.

Fig. 9 represents the vine after trimming.

The sprouts which grow during the second year need not be tied to stakes but left to be moved freely by the winds, as this tends to strengthen the entire vine. Very few of such sprouts are ever blown off.

During this summer the vineyard is hoed twice.

Good vintners recommend pinching off the ends of the sprouts after they have grown to the length of twelve or fifteen inches.

There is no doubt that this promotes the growth and ripening of the small wood, and it is also likely that thereby the more thrifty vines will bear a few grapes the season following; but this practice is a *hurrying process*, which may be adopted where the vines are very forward, but had better, as a general thing, be avoided. From the foot of each leaf stalk grow, during the summer, lateral shoots, which should be pinched off after they form three leaves just beyond the *second* leaf, during this and subsequent years, as directed in the part relating to summer pruning.

Just as bad is the practice to trim the vine during the second summer, with a view to make one or two sprouts grow into long branches for bearing wood for the year following. I would say to all, don't hurry your vines, if you want them to last well.

In the Third Year.

The vines are again trimmed down to the lowest bud, as in Fig. 10. At this time, it is well to apply special manures, and to do everything tending to the healthy development of the vine, as the season following the first crop is expected. Some vintners leave

FIG 10.

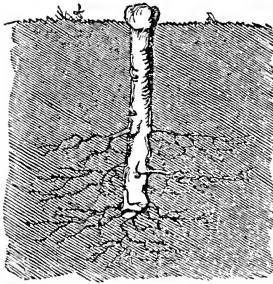

Third Spring after Pruning.

FIG. 11.

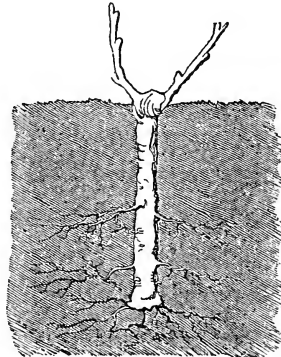
Pruned with a view to *premature* bearing.

this season one or two “spurs,” as in Fig. 11, and by extra manure push their vineyards into a premature crop. Every grape thus obtained, will eventually have to be paid for very dearly indeed; because nothing tends more to the premature decay of vines, than such an early deflowering of it.

In this year, too, one of the vines is removed, if both cuttings have grown in any one hill. The healthiest vine is retained, the other is removed. This should be done with extreme care toward the vine which is intended to remain. The grape roots thus taken out, may be used to supply vacancies, or new vineyards, or be sold to others.

The vineyard may now be supplied with "stakes," and also preparation may be made for whatever system of trimming may be adopted, (for which see the chapter following,) and to the stakes are fastened three or four of the sprouts, which grow during the ensuing summer. Should more than three or four grow, they must be removed by pinching them off. During the third year, I have found it not amiss, to pinch off the ends of vines after August, when they have grown four or more feet high, so as to ripen the wood. This should be done only *after* the shoots have begun to turn brown near the "head."

During this summer, the vineyard is also hoed twice; and especially is it good to give it an extra hoeing in the fall, so as to avoid an *early* spring hoeing, which on account of frosts had better be delayed till after the 10th or 12th of May, with young vines especially.

In the *fourth* year the vineyard, if well treated, will be in good bearing order. The vines should be

trimmed as in Fig. 12. The spurs should not be shorter than six or eight inches, nor longer than twelve inches. Our vintners are apt to trim so as to leave too much bearing wood the first bearing year. Let all remember the rule, which pervades almost every part of vegetable, and even animal life, that the age to which animals or vegetables attain, is governed by the length of time in which they arrive at maturity. The slower the early growth, the longer and healthier is

FIG. 12.

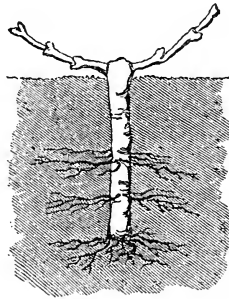

after life. Living too fast in early youth, is sure to produce early old age.

To trim the vine with "bows" this season, I regard as a very pernicious policy no matter how thrifty the vines may be.

Nor can I recommend the common practice of planting cabbage, corn, or other impoverishing crops in

young vineyards. During the first year, such strangers may be admitted; but forever thereafter, nothing but grapevines have any business in a vineyard.

As a general rule, I may add, that the cleaner the vines and ground are at all times kept, the better. Never go into a vineyard in wet weather, nor trim the vines while they are much wet. Keep the ground mellow, and in the most superior tillable order. Keep out of a vineyard, unless you have special business in it. The less one walks about in it, the better. To walk about a vineyard, after a rain, must do it serious injury. Keep visitors and the idly curious also out of your vineyard. No man or woman has any business in a vineyard, except the vine-dresser, and he only when working or tending it.

“VINEYARD STAKES.”

THE manner of putting these in, and *the manner of staking out a vineyard*, is a matter of more moment than is generally supposed. Vineyards are often much disfigured by too heavy and unsightly stakes, resembling fence-rails, which are also injurious from the heavy shade they cast. Stakes should be perfectly straight, well seasoned, and not more than two inches square.

They should be made of hard wood, such as oak or locust. Care should be had that the roots of the vines be not injured when putting them in. In Europe, stakes are made about one inch square, often of pine wood, and taken out in the fall, and reset every spring. This treatment preserves them much.

The stakes must be set in to suit the particular trim of the grapevine, so as to afford fair access to warmth and light.

Where four thighs, or rather four long spurs, are carried to each vine—(a favorite mode of trimming of late in Germany, and one well suited to level, heavy soils)—the thighs should then be only twelve to fourteen inches long, with spurs on them for bearing wood, and no bows, leaving upon each spur four or five buds, or twenty altogether on the vine. The stakes need not be more than three feet high above the ground. They are then set out thus :

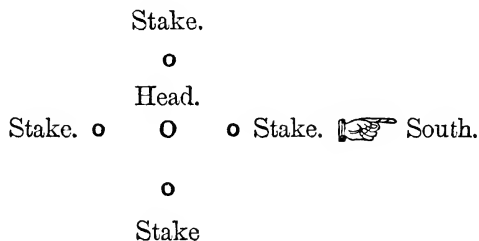

Where three thighs are carried—the favorite Elsa-

tian and Swabian methods—the stakes should be five and a half feet high above ground and set out thus :

o Stake.
 Stake. o **O** Head.  South.
 o Stake.

Where two thighs are carried, the stakes should be six feet high above ground, and set out thus :

Head.
 Stake. o **O** o Stake.  South.

being careful to get them into perfectly straight rows, and one foot each way from the head. This method and the trellis described below, are the two which I would recommend as the best, and are those which I have adopted. The trellis, however, is better adapted to the growing of table grapes than grapes for wine.

A method very much practiced in the vicinity of Cincinnati, is to have a single stake with one “bow” and one “spur;” the spur being trimmed down to two or three buds, the shoots from which furnish the spur and bow for the next year. See Fig. 13.

The general principles laid down for pruning on two stakes may be easily modified and applied to this and other methods.

Where one thigh is carried, with one “bow” and two or three spurs, it is customary to have three stakes

to each vine—one about six feet above ground, just at the head, to which the bow is fastened, and two others about four feet long above ground, and a foot each way north and south from it.

FIG. 13.

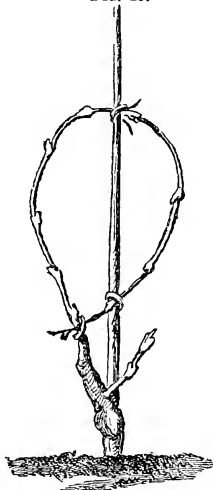

The prevailing mode in the Palatinate along the Rhine, is beginning to be largely adopted in the United States.

FIG. 14.

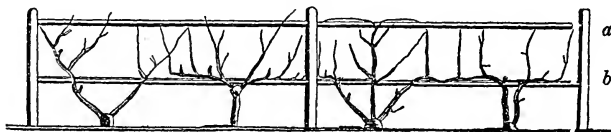

This cut, Fig. 14, represents several modes of training upon trellises. As they are all reducible to the same general principles of trimming, the particular shape is unimportant.

a Represents the top cross piece sixteen feet long and five feet above the ground.

b Represents cross piece of same length and two feet above ground.

A vineyard thus staked out, with the method of trimming adopted in these pages, I regard as decidedly the best. It may be the most expensive at first, but it must eventually be adopted generally in the United States, because it will suit more localities than any other.

The easiest way to put vineyard stakes into the ground is to have a good sound, tough piece of oak wood, as described in a former chapter for putting in cuttings, say four feet long, three inches through at the upper end, tapering toward the lower end, and supplied with a heavy iron socket about eighteen inches long. With this holes are punched into the ground, at the proper places, about eighteen inches deep for the long, heavy stakes, and about ten to twelve inches for the shorter and lighter ones, and into these holes the stakes are inserted, having been previously sharpened. Through this method few or no roots are injured. Charring the ends of the stakes is

an excellent preservative, and I have heard the refuse oil purchased at gas-works also favorably spoken of.

The stakes should be well rammed in, and fastened by punching the earth to them at the surface of the ground. Every spring they should be carefully re-fastened, after being straightened up, and examined to see whether the part in the ground is sound yet. Those of which it may be feared that they will not last through the season, had better be taken out and reset by putting the sound end into the ground, or replaced by new ones. Nothing is more annoying and injurious than to have a whole lot of vines blown down after every heavy shower.

The plan of setting stakes in a vineyard, sprung, doubtless, from the observation made, that a grape-vine, and especially its fruit, is very apt to get injured if left to the mercy of the winds and rain, and dragged about in the mud. The fruit by being elevated from the ground is less subject to the depredations of insects and rabbits, as well as less liable to rot and other diseases. I have already indicated that one great object is also so to set off the vine, with its foliage, &c., as to admit, according to the particular manner of training, the proper effects of sun and atmosphere.

A vineyard badly and slovenly staked out will be an eye-sore to a good vintner, even at a distance; while, on the other hand, one well and artistically

staked out, will gladden the eye of every one that sees it. A slovenly vintner is certain to be detected in this very point, and I want no better evidence of a good vintner than to see him particularly nice in staking out his vineyard.

What system of trimming to adopt for the vines is oftener a matter of fancy than of actual propriety. I have, in this chapter, treated of various methods; in the next I shall particularly describe that which, in my opinion, deserves universal adoption. The reader can, from the cuts given in this and the following chapter, find a safe guide, whether he should choose the method recommended by me, or any other. I do not think it necessary to describe these others more fully, because I am satisfied that any intelligent reader can, if he will but read carefully this and the next chapter, and if he will apply the general rules laid down practically, vary the trim of his vineyard to suit the particular locality, or fancy, as the case may be. I wish to avoid, also, if possible, perplexing the reader, and I therefore indicate to him the method which my own experience points out as the best. At the same time, I have also named other methods, upon which it may be well to "*experiment*," after the reader shall have had some experience in vine-dressing.

TRIMMING YOUNG BEARING VINES IN THE FOURTH YEAR.

THIS branch of a Vine-dresser's labors, whether for young or old vines, being an interference with, and an artificial regulation of, nature, requires more of his skill, judgment, and neatness, than any other. Its object is two-fold:

1st. To secure each summer a proper amount of mature bearing-wood for the next and subsequent years, and by thus concentrating upon particular parts of the vine all its fructifying powers, preserve it in a healthy, vigorous condition.

2d. To improve the quality of the fruit, whether intended for the table or for the making of wine.

The instruction upon this subject would best be given with the grapevine before us. We will endeavor to supply this by cuts, and if the reader will only, with this book in hand, himself learn practically how to trim his grapevine, we have strong assurance that, in a very few seasons, he will be a successful trimmer.

An opinion is prevalent, which I must notice very briefly. It is that grapevines should not be trimmed at all. This opinion springs from that superficial notion, that the experience of European vine-dressers is of little consequence here, and that the treatment of

American vines on American soil should be entirely different. I can only say, that *wild* grapes may be seen in our woods, and in Asia even at this day, and by comparing with them the cultivated grape, this error will readily be discarded. Perseverance through centuries has improved the grape to what it is. The experience of European vine-dressers is that of their predecessors, the Asiatics, as may be learned even out of the Bible, modified, to be sure, but modified with reason and judgment, as we should again modify. The writer of this has seen hundreds of acres of vineyards in this country, and he would unhesitatingly say, that the best vineyards,—not for a season or two, but for ten (and no doubt fifty) years,—are those which are in the hands of such vine-dressers as follow carefully, and systematically, the most approved European modes of trimming. I do not mean, thereby, such as follow blindly and mechanically, but such as, having studied and examined European practice, have adapted it to their own locality and circumstances, being able to understand its principles and apply them.

We will endeavor to make the matter as plain as possible, both in this chapter as in those that follow upon this subject. The reader will remember, that if the grapevine has been properly taken care of and trimmed, it will in the spring of the fourth year present the following appearance :

Each "spur" intended for a "thigh" should be not less than six nor more than ten inches long, leaving at least two and not more than three joints and buds upon it. The head will be well formed and of good size, and care will have been taken to get the thighs to grow out of the sides of the head rather than its centre.

FIG. 15.

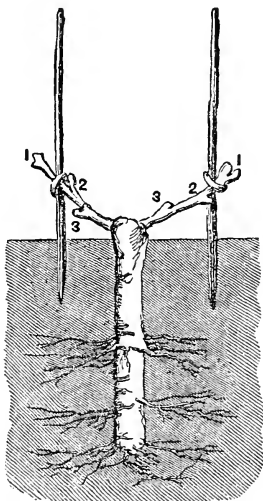

After trimming the fourth year, being ready for bearing.

From the buds marked 1, 2, 3, on each thigh, will, during summer, grow shoots. Those upon 1 and 2 should be carefully tied up to the stake. The shoots

growing out of 3, or which may grow out of the head, should, after two leaves have formed upon them, be pinched off above and beyond the two leaves.

Upon all these shoots at the joints, little twigs or lateral branches, marked *a* in Fig. 16, grow in the early part of summer.

FIG 16.



These must all be removed by hand just above the first small leaf where it is marked in the cut. The leaves at the junction of the laterals with the branch should be carefully preserved, however.

This tends to ripen the branch into good sound bearing wood, for if these laterals were not removed, it would weaken the intended bearing wood the next

season. The vine will in the fall, after the leaves shall have fallen off, if thus trimmed, look thus :

FIG. 17.

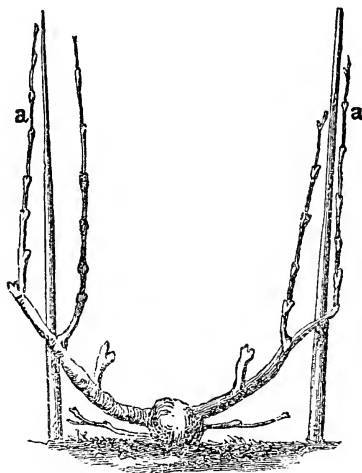

In the fall of the fourth year.

Here, then, are two branches upon each spur or thigh for bearing wood. One such would really be enough, but two are trained, first, to have a spare one in case of accident or loss, and for a spur for the season following, and second, to leave sufficient wood and *leaves* upon the vine, so as not to restrain its growth too much. It is, as already stated, not desirable to have the bearing wood too rank, which would surely be the case if the vine were trimmed too close during summer. There

are, also, both upon the head and the thighs, small shoots with one bud each, which are left there to the length above pointed out, so as to keep the joint alive for future use, and to prevent its closing by becoming gnarled over.

The next point is how to trim such a vine during the winter or spring following. The rule is to cut the

FIG. 18.

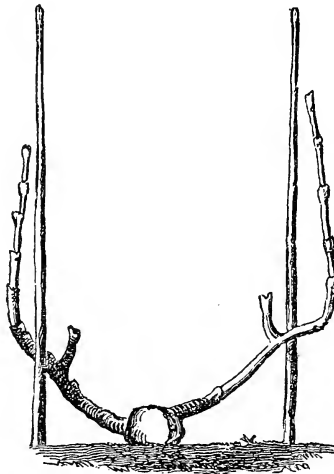

In the Spring of the fifth year after trimming.

thriftiest, and if possible the upper branch *a*, down to from five to eight buds or joints for the bows, and if the lower branch remain, to trim it down, leaving one bud or joint for spurs, and to cut all the remaining branches

away, close to the joint of the thigh, not injuring, however, the bud, which may be upon the thigh itself or upon the head. The trimmed vine will resemble Fig. 18.

The vine may now be said to have reached the dignity of an adult, being ready for the duties of its useful life.

Its pruning and treatment during the following summer and winter, will be described in another chapter.

HOW TO BEND THE BOWS.

BEFORE entering more fully into detail about trimming, it may be well to describe the manner of making bows.

While the hoeing and ploughing may be entrusted to any laborer having a general idea of work, so he be one not apt to shirk work, or slur it over, it is different with bow-making. This requires much practice and skill, or else much damage will be done, by breaking the branches.

The bows should be formed before the buds swell, or else many of them will be stripped off by even a careful workman—the great point being to have them as round as possible, and all breaks and sharp bends should be carefully avoided. Morning is the best time,

because the vines then bend easy. In the afternoon they are dryer, and hence more apt to break. Taking the end of the vine in one hand and the part immediately following the "thigh," in the other, and while passing the vine round with the one hand, pressing it

FIG. 19.

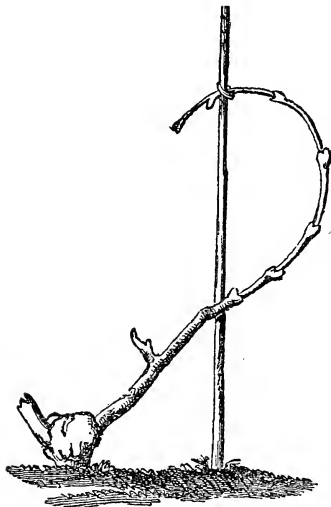

Tying the Vines to the Stakes.

into form by following it out from joint to joint with the thumb of the other hand, and then tying the end with a willow, is the usual mode.

The object of bending the vine into a bow, is to equalize the sap to all the buds, as otherwise the sap

would flow too much to the top. Half bows, in half circles, are also frequently adopted, and answer a good purpose.

In connection herewith, I would recommend to every person owning land, especially where it is intended to have a vineyard, to plant out a willow patch. They need little or no cultivation. Simply pushing twigs about two feet long, fifteen inches into the ground, and with only two or three inches sticking out of the ground, similar to grapevines, about five feet apart, (the wetter the ground the better,) is all that is required for starting them. After they have grown, they should be trimmed back pretty close to the stump, annually; and fifty willow bushes will yield enough for all the purposes of an acre of vineyard, and leave some for basket-making and other purposes about a farm.

The yellow basket willow is the best, though it is well to have a few bushes of the long black willow, as they are the best for sale. Slips may now be had for little or nothing, in the neighborhood of Cincinnati; and let me add, that willow-planting pays well, as basket-makers are getting numerous, and pay a good price.

As soon as the stakes are driven in, the bows must be tied to them; but not helter skelter as some do. The more careful the bows and branches are fastened, the

easier is the subsequent labor of summer trimming, which will be more fully explained in another chapter.

It generally happens, that the vintners are rather late in getting the vine to the stake, and in performing this, the last labor of spring. This done, the vintner feels much lighter, as the buds are by that time more or less forward. The person entrusted with this labor should therefore be more than usually careful, or else he will break off the main buds and do irreparable injury. Good, strong willow twigs should be used for this work. But mark this:—do not tie the vine so *tight* as to stop the flow of the sap and to check the after-growth of the thigh and bearing branch. I have known vines to be sadly girdled by too tight tying. Do not tie the end of the bow too tight to the thigh, as otherwise the sap may be completely stopped and the bow deprived of proper nourishment. I need not add, that too loose tying is also to be avoided.

ON TRIMMING GENERALLY.

THIS important labor, whether for young or old vines, should be done early—if possible before the first of March—at any rate before the sap begins to flow; because through late trimmings much sap is lost, and in

consequence thereof the vine is apt to become sickly, and to decay even. It would be well if our vintners would use all the pleasant days through the winter for this purpose; but trimming *too* early is not to be recommended. We have, in the United States, very warm days during autumn, in which the sap is apt to rise in the vines, enough to swell some of the best buds. Such buds, if the vines were trimmed in the fall, would be sure to be frosted during winter. The outermost buds are also liable to dry out; and hence, I would designate February as the best time for trimming grapevines.

Before trimming, it is proper to remove the earth from around the head, so as to expose for three or four inches the "stem." This is necessary, so that the "*trimmer*" may, by examining the thickness of the "stem," have a safe guide as to the quantity of bearing wood to be left to the vine. This the German vintners call "loading the vine heavy or light," "*viel oder wenig aufladen.*" The "surface roots" growing annually out of the head, are now cut away, so as to leave the head nice and clean of weeds, sprouts and roots. But I must here remark, that I doubt the propriety of going down to the third joint on the "stem," below the "head," and there cutting off the "roots." Many vintners do this, for the purpose of furthering the growth of the "foot-roots." I incline to the opinion

that the practice was adopted, because it accidentally proved successful from some local cause; and I can well imagine peculiar circumstances under which the practice may be right; but, as a general rule, I would warn against it. I have taken up many grapevines, from five to ten years old, and I can say, from practical experience, that those vines were thriftiest upon whose "stem" not only the "foot-roots," but also the "side-roots," were in good condition; and this is almost certain to be the case if the ground has been spaded up and turned over deep enough.

In "*trimming*" grapevines, due regard must be had to the species of the grapevine—the soil—the exposure—the age—the strength—the fertility of the soil—and last, though not least, the possible injuries likely to happen to a vine, from storms or accidental mistakes of the vintner himself. In this labor Franklin's motto should be ever present: "What is fit to be done at all, is fit to be *well* done." Great care and nice judgment are requisite, and no *bungler* has any business in a vineyard.

The object of trimming is to remove all superfluous wood, and thereby strengthen the vine, so as to render it long-lived, and capable of bearing and ripening the proper quantity of grapes.

Vines which have a tendency to generate much wood, as all American vines have, should be "loaded" heavy;

that is, more bearing wood should be left. The better, or rather heavier the soil, the greater the load the vines will bear. In light, warm soils, vines should be loaded very lightly. Young vines, up to the sixth year,

FIG. 20.

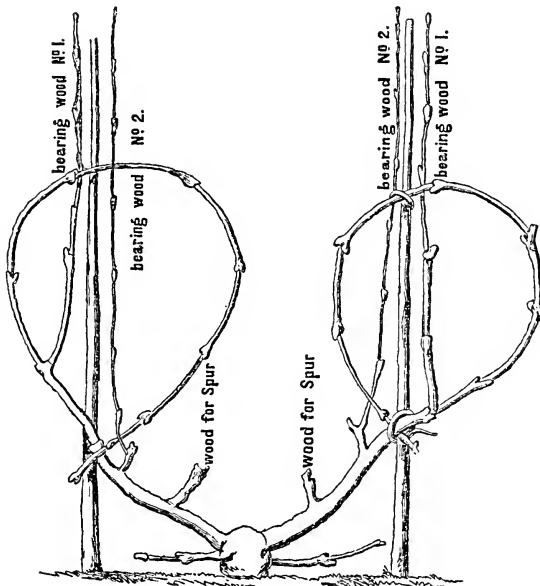

should be trimmed close, it being true of grapevines, as of our youth, "that early curbing is a guaranty of a healthy, mature age." Old vines should be dealt with very gently. Then they may give little, but good,

wholesome wine. Frosted vines, or such as have been injured by hail, or other accidents, must be trimmed back, so as to provide for "new growth" in every injured part.

The preceding cut, Fig. 20, represents a grapevine as it is late in the fall, when a good vintner has attended to it during the preceding summer.

The reader will see, that the vine has two vineyard stakes, say about two feet apart, and that the vine has two "Thighs," which is as much as any vine should be asked to keep up. At the end of the "Thighs" are the "Bows," which were the "chief bearing wood" of the season previous. At the first joint above the "Thigh," Bearing Wood No. 1 is perceived. This was left, by the good vintner, to be trimmed down to six or eight joints, or buds, and to form from it the Bow, or Chief Bearing Wood, for the ensuing summer. The reader will also see Bearing Wood No. 2, which grew out a "Spur," left upon each thigh the spring previous.

This Bearing Wood, No. 2, is trimmed down to two joints, and will form the chief spur for this season. Out of this spur it is intended to train the Bearing Wood No. 1, for the succeeding year, say in 1855 for 1856, of which more hereafter. The reader will also perceive a shoot marked "Wood for Spur," which should be trimmed down to one joint, or bud, so as to

have an extra spur ready if accidentally it should be needed, for renovating the vine with new Bearing Wood. The reader will also perceive two "Ground Shoots." One of these must be cut away, while one

FIG. 21.

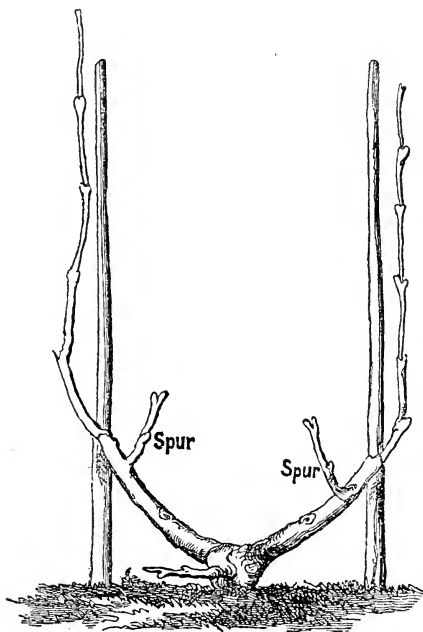

of them had better be trimmed down to three or four joints, so as to have it ready, in case either one of the thighs should be broken off. Such a ground shoot

should also be trained, wherever sound judgment prognosticates the probable future unfitness of existing thighs.

The chief spurs will each bear a few grapes, often the best.

We will now give a cut as the vine should look if trimmed right, believing that this will furnish nearly as correct information as if the instruction were given before the vine itself.

Fig. 21 represents a grapevine, over six years old, having a stem two inches or more thick, and healthy throughout; and bearing this in mind, one may add to, or lighten the "*load*," as good sense will dictate. Few vintners succeed in having *all* their vines in just such perfection. The vines will vary more or less; but the cut will give the general idea.

If the reader will now compare the trimmed vine with the previous cut, he will easily see what must be cut away: namely, the old bow, and all other superfluous wood. I need not add, that every vine bears small shoots, not marked down on the first cut; because, to put them there would have perplexed the reader. All such must be trimmed away.

Should the grapevine to be trimmed be a neglected one, and it is intended to *start* it right anew, then the above cut will, with the explanations, give a general idea how to bring this about.

Never put a "Spur" above the "Bearing Wood," or "Bow," or, as the European vintners have it, "Never put the apprentice above the master," a saying in which lies the whole idea of so trimming as to have the proper number of apprentices ready below, to become subsequent masters. The thighs should never be shorter than eight or ten inches, nor longer than four feet; nor should the bows have more than ten to twelve buds, nor the spurs more than two or three buds. No vine should have more than three thighs—two is enough; nor any one thigh more than one bow, and two spurs, (one will generally be enough.) Should it be intended to get "Layers," it is best to train ground shoots for the purpose.

HOW TO CULTIVATE THE SOIL OF A VINEYARD.

BEFORE any cultivation of the ground, the vineyard should be cleared of all offals from the previous trimming. These offals should be packed down in those spots in the vineyard which have a tendency to wash. They may be used for these purposes in other localities. In Germany, they are gathered up for firewood, as was the old custom in Judea. I have found them most excellent in smoking hams and meat generally, and fancied they gave to meat a better flavor.

The soil of a vineyard should never be cultivated except in dry, warm weather. The drier and warmer, the better. This should especially be the rule in the spring, as ground broken up wet subjects the plants near to injury from even the lightest foot-prints. The rule for breaking ground, in the spring, is simply this: Cultivate as soon as the ground is dry, and warm weather sets in; and don't cultivate, no matter how late you have to wait, until fair weather does set in, and the ground is dry. Don't be in too great a hurry, but improve every fair opportunity. If you delay too long, the buds will swell, and then they are very apt to fall off on even slight shaking.

Whether hoes, ploughs, or cultivators are proper tools, must be determined by circumstances; and they will guide every person having any idea of the cultivation of soil generally. The great point is thoroughness—that is, in turning over every part of the soil, and the most careful attention towards the destruction of all weeds, *particularly around the head of the Vine*. In the spring, the ground should be broken up at least six inches deep, and the rougher the clods are left the better, so that they are fully turned. Rain and warmth will thus penetrate deeper; the ground will wash less, and the clods will be ready to fall entirely to pieces when the second cultivation takes place. The two-pronged hoe, (*karsch*, in German,) is, in my opinion, the

best instrument for this purpose. A good shovel-plough may work for the second, and a cultivator for the third operation. The first should take place before the middle of May, or latest, the first of June; the second, as soon after the vines are through blossoming, and the third early in the fall, (but not in the dog-days says an old vintner at my elbow,) a traditionary rule, for which it may be hard to give a scientific reason, but which I found true to my sorrow, in two instances in which I acted counter to the rule. In each case my vineyard lost more or less of its foliage, and all of its rich, green tint.

There are, as yet, no old vineyards in the United States; but it may be well to mention that old vineyards must be cultivated with greater care than young ones; and their roots, even when near the surface, should not be needlessly torn up and injured.

The same care should also be had in the fall cultivation, so as to disturb as little as possible the tender surface-roots, which grow annually out of the head.

VINES ON TRELLISES.

In the preceding pages, the mode described is applicable particularly for vineyards intended for the manufacture of wine. If the object should be, how-

ever, to raise grapes merely for table use—either for one's family or for market—a different mode, in some respects, may well be pursued, and instead of training the vines upon stakes, trellise work may be adopted.

I may say that the mode of staking out, indicated as the Palatinate method, Fig. 14, may form the general basis for trellises. The vines, instead of being four feet apart, should then be from eight to twelve, and the stakes or posts at least eight feet long above ground.

For trellis planting, I would specially recommend, never to plant close to the walls of houses or fences, since such close planting injures the building, and besides, subjects vines to all kinds of insects which are apt to prey upon them. It impedes, also, the proper cultivation at all seasons of the year. The distance from houses and walls should be at least four feet, and the trellises formed over shaded walks, which may be made in almost endless variety. Such trellises should be on the south side of houses, &c., and every chance afforded for air and sun to operate upon every part of the vine. The early training of the vines is similar to the mode already described, except that they should be planted not less than eight feet apart. Less care need be taken for the formation of the "head," near the ground, and less attention need be paid to the boughs, as well as to the renovation of the thighs. Some form the head three to five feet from the ground, and then

train two horizontal thighs out of it, upon which they trim in winter, four to eight spurs. Others, again, trim for full bows—others for half bows, with more or less spurs in all cases. The general idea is, that being less restrained as to room, particularly along walks and around houses, less strict rules are followed as to trimming, it being varied according to circumstances. Summer trimming is almost invariably entirely dispensed with, unless, indeed, a regular vineyard is planted out upon this principle. Reading the preceding pages will indicate the general rules. Instead of thighs, branches, &c., the vine will then be divided into main and side stems, and branches with half bows and often even without any bows, and relying for bearing wood only upon spurs. Where a vine is intended to be drawn up as high as the roof of a two-storied house, the vine had better be trained upon the two-story principle also, by forming, if I may say so, a two-storied main stem.

To train a vine some twelve to fifteen feet straight up, engenders its rapid growth, and imparts to it a heavy, rich foliage, but such vines are seldom good bearers.

It is in accordance with long experience—one that has never failed—that bending the bearing wood promotes its bearing qualities, and equally useful are all checks to the too rapid upward flow of the sap.

Should such trellised vines be planted in too fat garden or hot-bed ground, they would grow very thriftily in their earlier years; and if this rapid growth tends to loading them early with too much bearing wood, such vines will soon become sickly, and almost invariably their fruit becomes distasteful, and their foliage assumes a disagreeable color. It is far better to have less rich soil.

There is a tendency in the United States towards trellis planting for *all* grapevines. For table grapes this is all right, but we need never expect to make good wine from them. Trellised vines bear a larger crop, and the grapes are more palatable to the taste; but the wine made from them is insipid. I cannot, perhaps, furnish a better illustration of what I mean, than by reminding the reader of cider made out of natural fruit, and compared with that made out of fine table apples—the latter being far inferior.

In Europe, they, therefore, plant upon trellises near large cities certain peculiar varieties of special table grapes, which bear large and early fruit. The "Chasselas," in French, or the German "Gutedel," (good and noble,) are preferred for this purpose. I imported of them both slips and roots twice, but lost them each time in the second or third winter. The Burgundy, Muscatel, and Malvasier grape are also excellent table grapes for trellises. In this country the Isabella ripens

very unequally in vineyards when trained on stakes. It does better on trellises. The Catawba will also answer when trained on trellises for table fruit.

SUMMER TRIMMING.

THIS labor is in German called *Zwicken*, which, being literally translated, means pinching with the forefinger and thumb. It is also sometimes called *Ausbrechen* (breaking off), because the main object of it is, to break off or remove all unnecessary branches, so that the retained useful branches may grow more thriftily, and that the grapes may thereby become more perfect and ripe, by receiving freely the effects of sun and air. Care must be taken that the growing grape be not without its due protection from leaves, as will presently be explained.

This labor requires much practical skill, judgment, and experience. Errors in winter trimming, or accidental losses, may now be remedied by an expert summer trimmer, by promoting, at the proper places, those shoots which the vine stands in need of. Errors in summer trimming are harder to remedy, for obvious reasons. Whoever, therefore, attempts trimming in summer should fully understand winter trimming, for

the two operations are intimately connected. In summer trimming, the vine-dresser must have regard for the trim which is to follow the succeeding winter.

One important point in this matter is to know *where*, that is, at what part of the vine, to leave the shoots

FIG. 22.

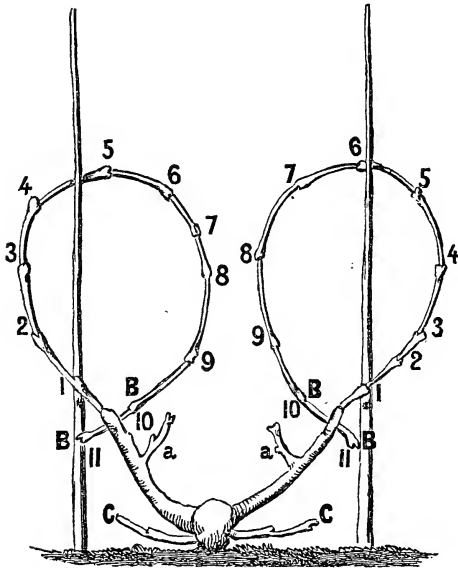

untrimmed, and which shoots to trim away. Some retain simply the thriftiest branches, regardless of the place they grow upon, which is a great error. If the bows are properly fastened to the stakes, the shoots

not to be trimmed will stand immediately upon or near the stake. See Fig. 22.

The shoots, of which one or two are intended to be retained for bearing wood and other purposes, for the seasons following, being marked 1, 2, and 3, a shoot will also generally be retained upon each spur, and is marked *a*. Great care must be had not to retain for these purposes the shoots growing out of the buds marked B; being so near those marked No. 1 and 2, they are apt to be mistaken for them. How many shoots to retain cannot be stated definitely—that depends upon the relative strength, age, and vigor of each vine. For a vigorous vine three shoots may well be left—that is, two upon each of the bows of those marked 1, 2, and 3, and one upon each spur as marked *a*; and also trim one, whenever this can be done, out of the “Head” marked C, the object of the latter being to be prepared for renovating the “thighs.” For an old, decrepit, or sickly vine, two or three new shoots would be enough. A good vine-dresser knows that there must be no attempt to have the foliage disproportionate to the stem and roots below the ground.

Which shoots to trim may be gathered from the preceding remarks. They are marked 5 and upwards. Should there be grapes upon any of them, then they should be so pinched off as to leave one leaf at least, if not two, beyond the outer grape. In fact, no shoot

should be entirely broken off—one or two leaves should always be retained.

To keep the vine in good bearing order, it is absolutely necessary so to trim or dress the vine in summer as to enable the winter trimmer to renovate constantly, and to replace entirely the thighs every four to six years. No "thigh" should be older than five years. Then it should be replaced by an entirely new one. Hence the lowest shoots, marked 1, 2, and 3, are retained upon the bows, and hence, too, one shoot is retained upon each of the spurs, marked *a*—these being intended for gradual renovation, while the ground shoots, marked *C*, are intended for entirely new "thighs," being dressed up and trained for that purpose, as directed for young vines. I need hardly repeat here, what I have said already, that both trimming too high or too low are both extremes to be avoided.

More shoots are dressed up and retained than are needed for the succeeding winter trimming, and that is done both for the purpose of having a surplus in case of accident, and also to give the trimmer a choice, so that in examining the stem and roots, he may, when his vine is unobstructed by foliage, judge more clearly which are the most desirable branches for each respective vine.

When this labor is to be performed cannot be indicated by general rule. As soon as the shoots are

twelve or fourteen inches long, it is time to trim them, and dress and fasten them up. If too long delayed, a heavy storm might break off a good many of them, and thus prove a sad summer trimmer. Most generally, the proper time is in the latter part of May, or early in June.

FIG. 28.

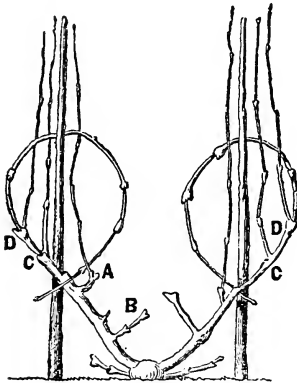

A vine well trimmed.

FIG. 24.

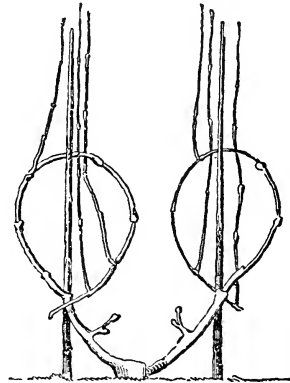

A vine badly trimmed.

Let me repeat here the well-known fact, that the foliage is the great regulator of all vegetation in summer. A good vine-dresser knows, by the very color of the leaf, the amount of foliage required by the vine. Some difference should also be made between dry and rainy seasons. Every grape should have some leaf

over it, to give it shade, and to aid it during the ripening process.

By comparing Figs. 23 and 24, the reader will at once perceive that in the latter, the vine is trimmed so that when the bow is unfastened, the shoot which is to form the next year's bow would be much too high up on the stake.

GATHERING THE GRAPES.

CHEERFULLY the vintner undertakes this, the pleasantest of all his labors. Remuneration for many a toilsome hour now smiles at him from out his favorite vines. So sweet is this feeling, that few vintners can wait for the proper time. Grapes, if intended for wine, should be gathered as late as is possible, and it matters not if they should even get overripe.

Many vintners are of the opinion that the grape, once ripe—which is the case as soon as the stems of the grape bunches turn brown—it is useless to permit the grapes to encumber the vines any longer, as its quality will not be thereafter much improved. But experience demonstrates that while the quantity is slightly diminished, the quality is much improved. In this country, where there are never more than two, and generally but one species of grape, while in Europe from six to

twenty species are often found in the same vineyard, one reason for premature gathering is obviated. The grapes generally ripen all about the same time. Should, however—as will happen—one species of grape ripens before the other, it is best to gather the ripe fruit, and then gather the rest subsequently when ripe.

There is one great objection among our vintners to patient waiting, which must be mentioned. It lies in the *insecurity* of their fruit against poachers. Fruit is for some reason regarded as common property, and the same person who would not take beans, cucumbers, corn, or carrots, will think any one a “*stingy bugger*” who does not look with gratification at any person taking his grapes without leave. The vintners know the prevalence of this freebooting sentiment as to the fruit which has cost them so much labor and money. They will watch it for a fortnight, night and day, but it is too much to expect them to lose their night’s rest much longer, merely to improve the quality of their wine a degree or two. The conclusion is too tempting to be long resisted, to put their grapes “where neither moth entereth, nor rust corrupteth, nor thieves break through and steal.”

This is a serious impediment to an improvement in the quality of our wines, but I fear it will exist for some time, at least until fruit, especially grapes, become more generally cultivated, and then a “fellow feeling”

will overcome the loose morality about fruit poaching. Laws which *follow* up this growing tendency, would certainly be useful. The following general rules are recommended in gathering grapes :

1. Gather only in fair weather, and after the dew is off the grapes.

2. Should rain or heavy fogs occur, stop gathering. It is always bad to go into vineyards while the ground is too wet, and especially in the fall. Aside from the injury to the quality of the wine, it can be proved, that between gathering in fair or foul weather, with and without the dew drops upon the grapes, there is a difference of between five to ten degrees in the quality of the wine.

3. Care should be had not to injure the vines, while searching for the inside grapes.

4. Unripe grapes should, as already stated, be left in the vineyard on the vines, and if there be but few, or if the season will not permit their subsequent ripening, it is a good practice to mix them with some good apples in cider making, but not to put them with the good ripe grapes.

5. Should a few unripe berries be found on a grape-bunch they must be picked out and thrown away,—or should there be a few really ripe berries upon an unripe bunch, then the ripe ones are picked out and gathered, and the unripe bunch itself is left on the vine.

6. Everything, except the *good, sound, ripe* berries, should be carefully picked out, and particularly those dried up kernels—so frequent in this country—the result of the blue rot.

7. Leaves, which casually drop among the gathered grapes should be thrown out.

It is easy to see from the preceding rules, that gathering grapes requires care and attention. I think buckets and tight barrels are better for the purpose of holding the gathered grapes, than baskets. The skins of American Grapes are, to be sure, tougher than the European, though this is fortunately getting less so every year, but very ripe grapes suffer much loss, even here, if handled in baskets.

I would here warn against that voracious eating of grapes, while gathering them, which is characteristic of raw hands. Our grapes have very large kernels and very tough skins, and there is inside also a rather indigestible pulp. All these things are different in Europe. There the kernels are small, the skin very light, and the inside is almost without pulp. Persons in this country read of the Grape Cure in Europe, and from this conclude, that grapes are always healthy. So they no doubt are, if eaten in small quantities, and when perfectly ripe; but I know of five deaths, within my own experience, which from unmistakable signs arose from eating too freely of grapes. One of these

five was a most hearty and very intelligent young German, who laughed at all warnings, and would insist that grapes were surely healthy at all times of the day, and in any amount

MANURES.

WHATEVER experiments may have been made with special manures for vineyards, the best *is*, and will continue to be, the compost manure, if got up right. It may be composed of various kinds of material, easily attainable.

Common stable manure, street sweepings, turnpike dirt, sweepings and slops of houses and chambers, saw-dust, shavings, pomace, leavings from tan yards, tailor, shoe and turning shops, distilleries, ground out of woods, marl, leaves from the vines, and weeds of all kinds, woollen rags, especially; all these, and many other things, which will readily suggest themselves, should be procured, as opportunity offers, in as great a variety as possible, and mixed together in the following manner: A hole is dug, at least four feet deep and six feet wide, as near the vineyard as possible, and into it are these materials thrown promiscuously, and as they are thrown in, covered and mixed half and half

with ground. It is most excellent to pour over it frequently the liquids of horse and cow stables. Let it rot for a year, and then remove it into the vineyard, and the effects of such compost manure are far superior to any other.

Woollen rags are excellent, applied alone. They rot soon, when placed around the stem of the vine and covered with ground.

Horn shavings and filings are also very good, so are hair and all kinds of leather. I prefer, however, to throw every one of these last-named materials into the compost heaps, mixing and rotting them with the rest.

No vineyard should be manured oftener than once in two years; and where the ground is rich, it should be done only every three or four years. During the first three or even four years, no manure need be applied, except preparatory to the first bearing year, and then sparingly immediately around the vines.

The quantity is not so easy to determine, but fifteen to twenty good two-horse loads of compost manure per acre would not be too much.

Woollen rags, horn-shavings, hair, and such special strong manures, had better be applied in the fall. Compost manure, if well rotted, may be applied during fall or spring. I have ever disapproved manuring

during summer, as it disturbs the growth, and is likely to impart a peculiar taste to the wine.

I have always found it best to spread the compost manure all over the vineyard, well covering it, however, with ground. Special manure I have applied more immediately around the vines, and found it a good practice.

During the alternate years in which manure is not applied, ground should be hauled to each vine, taking the ground from the woods. This keeps the vine itself, and especially its head, well supplied with ground, and prevents its being exposed too far above the surface.

DISEASES TO WHICH GRAPEVINES ARE SUBJECT.

I COULD not, consistently, encumber this book with a chapter on "Grape sicknesses," because I am satisfied that I could only give a page or so of speculations, which may prove right, but of which I have not had a fair experience. I have preferred to state only methods known to me to be practical and correct. If they are well followed, I do not think that any serious sickness need be ever apprehended. The grape sicknesses in America may with propriety form a part of such a book as the one now presented, when we shall

have had a further experience of ten or fifteen years, and after we shall have planted really good vineyards. For the same reason I dispense with several other prolific subjects, which usually form a part of such books.

WINE MAKING.

MASHING THE GRAPES.

ALMOST every vine-dresser in this country has his own mode of mashing grapes, as has almost every neighborhood in Europe.

I will endeavor to describe some of the more simple methods, and they may serve the reader as an indication of what he may require, each case being modified by the kind and particularly the quantity of grapes to be mashed.

For a few bushels of grapes I know of no more simple and efficacious method than to prepare a wooden stamper three feet and a half long, of the form represented in Fig. 25, being at the larger end six inches in diameter and having the bottom a little scooped out or concave. Bore holes entirely through the large end with a quarter-inch auger in every direction, and in-

sert round oak or hickory pins, so as to have them project at each end three-eighths of an inch.

Into a clean sweet cask of the capacity of about forty gallons, put about two bushels of grapes, and then pass the stamper up and down among them until they are completely mashed. The small wooden pins projecting as they do, are a great aid in the mashing process.

FIG. 25.

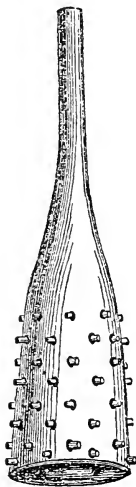
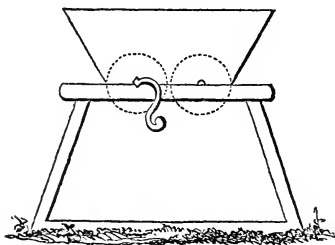

FIG. 26.



As soon as completely mashed, empty the mass into a box upon the press.

Another mode very common in Europe, is treading the grapes with the feet. The grapes are placed in a small tub or cask, the bottom of which is punctured

with small auger holes. This tub is placed upon two sticks put across a larger cask, and the operator treads the grapes with his feet.

A machine of very simple construction having two rollers, between which the grapes are passed, may be constructed for a few dollars, and will answer a good purpose. Fig. 26 will serve for an illustration.

Whenever larger quantities are to be mashed, I would advise the use of the common apple-mashers with horse power. I prefer these as cheapest, very expeditious and effective, and in all localities easily obtained.

After the pomace has been once slightly pressed, I have always subjected it to a second mashing, and again pressing it. The rollers or mashers should not be set too close, as the stems and kernels should not be crushed.

In Europe, about twenty years ago, the practice of separating the "berries" from the "combs" before pressing, was much in vogue.

The comb containing tannin and apple acids, it was deemed desirable to keep these ingredients out of the wine. This was performed by rasps of various construction, one of which is represented in Fig. 27, consisting of two shallow boxes or trays; the bottoms made of crossed slats, laid as represented in cut *a*, Fig. 27, and not laid upon the flat sides of the square. The upper rasp must be small enough to admit of its being

rubbed backward and forward within and upon the lower one, having the grapes between them.

FIG. 27.

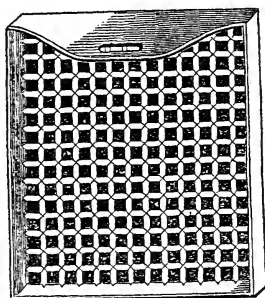

b

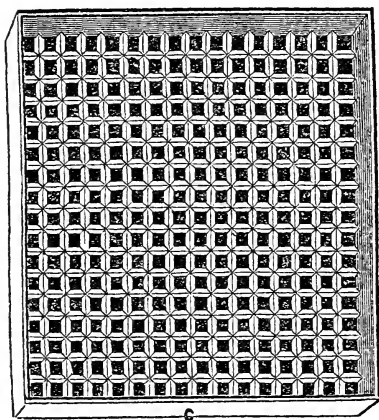

c

The interstices should be of the proper size to suffer the crushed berries to pass through and retain the comb.

The slats may be three-fourths of an inch or an inch in thickness.

These rasps may be of wood of any size from two feet to six feet square ; made somewhat like a window-sash with a rim around the margin six inches high.

They are placed over a tub of the proper size when being used.

This method of mashing grapes will not probably prevail to any great extent in the United States. The harder skin of our grapes and their peculiar pulp render it more laborious, and it is the opinion of many of our best vintners that the "tannin" of the stem, both improves the flavor of the wine and furnishes some preservative qualities.

Many of the wine manufacturers of Europe allow the mashed grapes to ferment in stand casks before pressing, and for grapes thus to be fermented the rasping process is certainly to be recommended.

This fermentation will, I think, not be adopted generally in this country, owing to the warmth of the season at the time of vintage. It is a matter upon which it is well to experiment, however, and the result would be interesting to the public.

The practice most be recommended is to mash the berries upon the stems effectually, and any method which accomplishes this, without too much bruising the comb or crushing the kernel, may be adopted. The

more expeditiously this is done, and the sooner the grapes can be got to the press without unnecessary exposure to the atmosphere, the better.

PRESSING.

AFTER the grapes are mashed, they should be transferred as expeditiously as possible to the *wine press*.

FIG. 23.

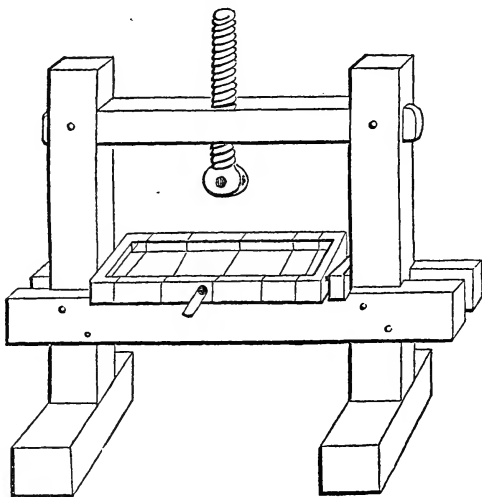

As to the kind of press and other appurtenances of the vineyard, the vintner must be governed by the quantity of grapes, the extent of his present and pro-

spective vineyards, and the dimensions of his *purse*. But this volume being intended especially for beginners and persons having limited vineyards, our description of a wine-press will be of the simplest kind, adapted to the masses of our people, few of whom have large vineyards.

Fig. 28 represents a wine-press of very simple construction, which may be made larger than the dimensions given below when the quantity of grapes demands it.

The upright posts may even be inserted into the ground a distance of four feet instead of into the pieces of timber as represented. They are 10 by 12 inches and 10 feet in height. The top cross piece is 8 by 10 inches and 8 feet long, the ends secured to the upright posts by mortise and tenon. The two lower cross pieces are *notched* into the posts about two feet from the bottom, and are secured by a pin or bolt. Upon these lower cross pieces is placed the floor of the press, which is some four feet square, and is composed either of a solid piece of wood or of several pieces jointed together, so formed as to make a bed of two and a half inches thick with a rim all around of six inches in height. The floor should descend in every direction towards the hole for the spout. The pieces must be driven together by wedges inserted between the floor and the posts.

Upon this "press-floor" is placed the frame, Fig. 29, made of two-inch oak boards—3 feet square and 18 to 24 inches high, fastened together by mortise and tenon, yet so as to be easily taken apart and perforated by holes one-eighth of an inch diameter, about an inch apart, also having notches cut on the lower edge, for the passage of the juice.

FIG. 29.

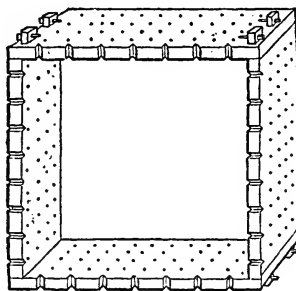

Into this frame are poured the mashed grapes. After levelling them off, a covering of inch boards is placed upon them; this cover is closely fitted to the frame, and can be easily put in and taken out, and upon this a cross piece of oak 6 by 6 inches for the screw to press upon. The screw may be of wood or iron, and is turned by levers inserted in the head.

The sap which first flows from the press makes the best wine, and that which is last expressed is somewhat

inferior. In this country the manufacture of wine is so much in its infancy, that very few persons attempt to preserve the nice distinctions in the quality of wines which prevail in Europe, and the wine is generally thrown promiscuously into the cask.

Cleanliness and despatch in mashing and pressing cannot be too strongly enjoined.

The young wine is easily spoiled because it adopts acids not only from the atmosphere, but also from any implement or utensil which may be sour or unclean.

The press mashers and casks should therefore be scrupulously cleaned before using them, and be kept clean during the entire labor.

Employ none but expert, neat, and cleanly workmen.

Do not let your grapes, either before or after being mashed, stand about for days in tubs or barrels.

Hire hands enough to gather every day enough to fill your press, and, if possible, mash and press them the same evening, and transfer the juice to the cellar, permitting the air to act upon it as little as possible during these operations.

Do not defer procuring your casks to the last moment. Have the transfer casks you fill with, and also your cellar casks, *nicely clean and tight*.

They should be as large as the quantity of wine you expect to make will require. The larger the quantity

fermenting in one body, the steadier is the fermentation and the better the wine.

Large casks are the pride of a good vintner, because they are a guarantee that his wine will have a chance to ferment well.

In Europe, casks of 10,000 gallons are frequent, and less than 500 gallons are seldom used; and such vintners as have smaller quantities either sell their wine from the press, or, clubbing together, get their wine into large casks.

A wine house with a cellar underneath, is desirable in every vineyard of a size sufficient to justify the expense. The construction is simple, and requires no explanation in this volume.

TREATMENT OF THE WINE.

THE young wine fresh from the Press is filled into the casks in the cellar. These casks should be placed upon scantling or scaffolding, and not upon the ground in the cellar.

They should be filled only three-fourths full.

The wine will soon commence fermentation, generally within the next twenty-four hours. The mass bubbles, as cider does, during fermentation, and if the

casks were entirely filled, much of it would run over. It rejects carbonic acid, and also many of the finer aromatic essences escape.

Many devices have been tried to retain these latter. The process adopted in the making of Champagne is for the purpose of securing this great desideratum, and thus the greater part of the carbonic acid and these finer essences are retained.

FIG. 80.

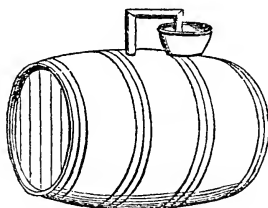

The manufacture of *Champagne*, however, requires an amount of outlay for casks, cellars of extraordinary depth, bottles, &c., which places it beyond the reach of the ordinary vintner of small means; and as this will also place it beyond the scope of this work, we must refer the reader to those works which treat upon the subject, especially if they would pursue their investigations further in this direction.

The securing the finer essences of the wine, may be

attained sufficiently for our purpose by a very simple contrivance, shown in Fig. 30.

A tube of block tin is inserted into the bung of the cask an inch or more, with the shorter arm immersed in a crock of water. As soon as the fermentation shall have fairly commenced, the carbonic acid will escape through the water.

As the fermentation and its consequent pressure subsides, much of the carbonic acid, and many of the aromas, so essential to fine-flavored wine, are retained.

A great advantage is also gained thereby in rendering it less necessary to keep watch over the fermentation, and to close the casks as soon as the fermentation shall have ceased; the external atmosphere being at all times excluded, the oxygen of the air cannot penetrate to the fermenting mass.

When this plan is not adopted, be careful not to fasten the bung during fermentation.

This would cause the cask to burst.

As soon as the fermentation is over, drive in the bung tightly.

After the more violent fermentation is passed, fill the casks brimfull, and for four weeks refill at least once a week, and afterwards, till late in the spring, refill once a month.

In Europe, where wine is a chief element in the food of families, one cask is kept for daily use, and

from this the other casks are replenished. In any cask that cannot be kept full, the vacant space should be *burned out* with brimstone, as hereafter described, at least once a month. The object of this being to keep it perfectly sweet.

Empty wine casks should be thus "burnt out" once each quarter of a year, and especially just before filling or immediately after emptying them. Before burning, the casks should be thoroughly washed out with hot and cold water. The brimstone will not burn unless the casks are nearly clean.

One can also detect by this means whether the casks are perfectly tight, as the smoke will be sure to escape through any crevices, if such exist.

The brimstone is prepared as follows:

Put common brimstone in a pot over a slow fire. Be careful not to melt too rapidly, as this may cause it to ignite. When melted, draw through it strips of stout paper, an inch wide and a foot long, and hold them in the air a few minutes till the brimstone hardens.

To burn out a cask, take out the bung, and after setting fire to one of these strips, quickly insert it into the cask, and drive the bung home upon it, so as to hold it suspended while it burns.

Some wine-makers, after burning with brimstone, again burn the cask out with a small sponge dipped in

the best brandy, fastened to a wire, and inserted into the cask as with the brimstone slip.

The fermented wine is left in the cask upon the lees undisturbed until spring, say March or April. Then it should be drawn off.

About the time that the grapevine is in bloom, the wine undergoes another fermentation in the cellar, again forming small lees.

Wine becomes generally clear a few weeks after it is put into the casks in the fall, and some persons then draw it off. This gives the wine a milder taste, but at the expense of strength. Our wines being naturally strong, this may be done here without *material* injury.

A vintner should take the earliest opportunity to have a good, well-paved, deep cellar, dry and well walled with stone. It should be not less than eight feet deep. In Europe their cellars are seldom less than twelve to twenty feet deep, and are almost invariably arched over.

Thus their wines are preserved from the extreme cold of winter and heat of summer. Cellars should be kept dark, except while working in them. Vegetables, and substances which are apt to create an offensive smell, should not be kept in the same cellar with wine. And the cellar should always be kept scrupulously clean.

As soon as the wine is perfectly clear in the spring, I would recommend the bottling off for family use (a

half gross or so), and laying the bottles in sand. Those who will try this plan will find that after lying thus for some six weeks, their wine will be vastly improved.

In the directions here given for the making of wine, I have confined myself to the simple treatment of such matters as every vintner must know. A much more elaborate work might have been written, but the "*Vine-Dresser's Manual*" is intended for the general cultivator, and not for the extensive wine manufacturer.

A good cultivator will find in this all that is necessary to enable him to make good wine, or better said, to suffer the wine to make itself.

In conclusion, I hope I shall be pardoned for saying that natural, unadulterated wine is entirely healthful, and may with great advantage form a part of the food of our people, and for all classes be made a wholesome addition to the principal meal of the day at least.

All *artificial wines* are injurious, and none more so than those "unfermented wines," as they are called, with which over-scrupulous persons are humbugged. All such are unnatural, and contain foreign substance, more or less unwholesome. Would that good, sound sense were more prevalent on this subject.

May God bless the vintner's skill and toil!

*All the Books on this Catalogue sent by mail, to any part
of the Union, postage paid*

BOOKS FOR THE COUNTRY,

PUBLISHED BY

C. M. SAXTON & CO.,

140 FULTON STREET, NEW YORK,

SUITABLE FOR

SCHOOL, TOWN, AGRICULTURAL, AND PRIVATE LIBRARIES.

Downing's (A. J.) Landscape Gardening.

A Treatise on the Theory and Practice of Landscape Gardening. Adapted to North America, with a view to the Improvement of Country Residences, comprising Historical Notices and General Principles of the Art. Directions for Laying out Grounds and Arranging Plantations, the Description and Cultivation of Hardy Trees, Decoration Accompaniments to the House and Ground, the Formation of Pieces of Artificial Water, Flower Gardens, etc., with Remarks on Rural Architecture. Elegantly illustrated, with a Portrait of the Author. By A. J. Downing. Price \$3 50.

Downing's (A. J.) Rural Essays.

On Horticulture, Landscape Gardening, Rural Architecture, Trees, Agriculture, Fruit, with his Letters from England. Edited, with a Memoir of the Author, by George Wm. Curtis, and a letter to his friends by Frederika Bremer; and an elegant steel Portrait of the Author. Price \$3.

The Practical Fruit, Flower, and Kitchen Gardener's Com-

panion, with a Calendar. By Patrick Neill, LL. D., F. R. S. E., Secretary to the Royal Caledonian Horticultural Society. Adapted to the United States, from the fourth edition, revised and improved by the author. Edited by G. Emerson, M. D., Editor of "Johnson's Farmer's Encyclopedia." With Notes and Additions by R. G. Pardee author of "Manual of the Strawberry Culture." With illustrations. Price \$1.

Munn's (B.) Practical Land Drainer;

Being a Treatise on Draining Land, in which the most approved systems of Drainage are explained, and their differences and comparative merits discussed; with full Directions for the Cutting and Making of Drains, with Remarks upon the various Materials of which they may be composed. With many illustrations. By B. Munn, Landscape Gardener. Price 50 cts.

Elliot's (F. R.) American Fruit-Grower's Guide in Orchard

and Garden: being a Compend of the History, Modes of Propagation, Culture, &c., of Fruit, Trees, and Shrubs, with descriptions of nearly all the varieties of Fruits cultivated in this country; and Notes of their adaptation to localities, soils, and a complete list of Fruits worthy of cultivation. By F. R. Elliot, Pomologist. Price \$1 25

Pardee (R. G.) on Strawberry Culture.

A Complete Manual for the Cultivation of the Strawberry; with a description of the best varieties.

Also, Notices of the Raspberry, Blackberry, Currant, Gooseberry, and Grape; with directions for their cultivation, and the selection of the best varieties. "Every process here recommended has been proved, the plans of others tried, and the result is here given." With a valuable Appendix, containing the observations and experience of some of the most successful cultivators of these fruits in our country. Price 50 cents.

Dana's Muck Manual for the use of Farmers.

A Treatise on the Physical and Chemical Properties of Soils, the Chemistry of Manures; including also the subjects of composts, artificial manures and irrigation. A new edition, with a chapter on Bones and Superphosphates. \$1.

The Stable Book.

A Treatise on the Management of Horses, in relation to Stabling, Grooming, Feeding, Watering, and Working, Construction of Stables, Ventilation, Appendages of Stables, Management of the Feet, and Management of Diseased and Defective Horses. By John Stewart, Veterinary Surgeon. With notes and additions adapting it to American Food and Climate. By A. B. Allen, editor of the American Agriculturist. \$1.

Reemelin's (Chas.) Vine-dresser's Manual.

An illustrated treatise on Vineyards and Wine-making, containing full instructions as to location and soil; preparation of ground; selection and propagation of vines; the treatment of a young Vineyard, trimming and training the vines; manures and the making of wine. Cloth, 50 cts.

Bement's (C. N.) Rabbit Fancier

A Treatise on the Breeding, Rearing, Feeding and General Management of Rabbits, with remarks upon their diseases and remedies, to which are added full directions for the construction of Hutches, Rabbitries, &c., together with recipes for cooking and dressing for the table. Beautifully illustrated. Cloth, 50 cts.

The Horse's Foot, and how to keep it Sound.

With cuts illustrating the anatomy of the Foot, and containing valuable hints on shoeing and stable management in health and in disease. By William Miles. Cloth, 50 cts.

Stephens' (Henry) Book of the Farm;

A Complete Guide to the Farmer, Steward, Plowman, Cattleman, Shepherd, Field Worker, and Dairy Maid. By Henry Stephens. With Four Hundred and Fifty Illustrations; to which are added Explanatory Notes, Remarks, &c., by J. S. Skinner. Really one of the best books for a Farmer to possess. Cloth, \$1.

Johnston's (J. F. W.) Elements of Agricultural Chemistry and Geology. With a Complete Analytical and Alphabetical Index, and an American Preface. By Hon Simon Brown, Editor of the "New England Farmer." Price \$1

Johnston's (James F. W.) Catechism of Agricultural Chemistry and Geology. By James F. W. Johnston, M. A., F. R. S. L. and E., Honorary Member of the Royal Agricultural Society of England, and author of "Lectures on Agricultural Chemistry and Geology." With an Introduction by John Pitkin Norton, M. A., late Professor of Scientific Agriculture in Yale College. With Notes and Additions by the Author, prepared expressly for this edition, and an Appendix compiled by the Superintendent of Education in Nova Scotia. Adapted to the use of schools. Price 25 cts.

Johnston's (James F. W.) Agricultural Chemistry.

Lectures on the Application of Chemistry and Geology to Agriculture. New edition, with an Appendix, containing the Author's Experiments in Practical Agriculture. \$1.25.

Smith's (C. H. J.) Landscape Gardening, Parks and Pleasure Grounds. With Practical Notes on Country Residences, Villas, Public Parks, and Gardens. By Charles H. J. Smith, Landscape Gardener and Garden Architect, &c. With Notes and Additions by Lewis F. Allen, author of "Rural Architecture," &c.

The author, while engaged in his profession for the last eighteen years, has often been requested to recommend a book which might enable persons to acquire some general knowledge of the principles of Landscape Gardening.

The object of the present work is to preserve a plain and direct method of statement, to be intelligible to all who have had an ordinary education, and to give directions which, it is hoped, will be found to be practical by those who have an adequate knowledge of country affairs. Price \$1 25.

Norton's (John P.) Elements of Scientific Agriculture;

Or, the Connexion between Science and the Art of Practical Farming. (Prize Essay of the New York State Agricultural Society.) By John P. Norton, M. A., Professor of Scientific Agriculture in Yale College. Adapted to the use of Schools. Price 60 cents.

Nash's (J. A.) Progressive Farmer.

A Scientific Treatise on Agricultural Chemistry, the Geology of Agriculture, on Plants and Animals, Manures and Soils applied to Practical Agriculture; with a Catechism of Scientific and Practical Agriculture. By J. A. Nash. Price 60 cents.

Chorlton's (Wm.) Cold Grapery.

From direct American Practice: being a concise and detailed Treatise on the Cultivation of the Exotic Grape Vine, under Glass without artificial heat. By Wm. Chorlton, Gardener to J. C. Green, Esq., Staten Island, N. Y. Price 50 cents.

Allen (J. Fisk) on the Culture of the Grape.

A Practical Treatise on the Culture and Treatment of the Grape Vine, embracing its history, with directions for its treatment in the United States of America, in the open air and under glass structures, with and without artificial heat. By J. Fisk Allen. Price \$1.

Hoare (Clement) on the Grape Vine.

A Practical Treatise on the Cultivation of the Grape Vine on Open Walls, with a Descriptive Account of an improved method of Planting and Managing the Roots of Grape Vines. By Clement Hoare. With an Appendix on the Cultivation of the same in the United States. 50 cents.

Mysteries of Bee-keeping Explained;

Being a Complete Analysis of the whole subject, consisting of the Natural History of Bees; Directions for Obtaining the greatest amount of Pure Surplus Honey with the least possible expense; Remedies for Losses given, and the Science of Luck, fully illustrated; the result of more than twenty years' experience in extensive Apiaries. By M. Quinby. Price \$1.

American Bee-keeper's Manual;

Being a Practical Treatise on the History and Domestic Economy of the Honey Bee; embracing a full illustration of the whole subject, with the most approved methods of managing this Insect, through every branch of its Culture; the result of many years' experience. Illustrated with many engravings. By T. D. Miner. Cloth, \$1.

The Cottage and Farm Bee-keeper;

A Practical Work, by a Country Curate, 50 cents.

Weeks (John M.) on Bees.—A Manual;

Or, an Easy Method of Managing Bees in the most profitable manner to their owner; with infallible rules to prevent their destruction by the Moth. With an Appendix by Wooster A. Flanders. Price 50 cts.

The Rose;

Being a Practical Treatise on the Propagation, Cultivation, and Management of the Rose in all Seasons; with a List of Choice and Approved Varieties, adapted to the Climate of the United States; to which is added Full Directions for the Treatment of the Dahlia. Illustrated by engravings. Cloth, 50 cts.

Buist's (Robert) American Flower-Garden Directory;

Containing Practical Directions for the Culture of Plants, in the Flower-Garden, Hot-House, Green-House, Rooms, or Parlor Windows, for every Month in the Year; with a description of the Plants most desirable in each, the Nature of the Soil and Situation best adapted to their Growth, the Proper Season for Transplanting, &c.; with Instructions for erecting a Hot-House, Green-House, and Laying out a Flower-Garden; the whole adapted to either large or small Gardens; with Instructions for Preparing the Soil, Propagating, Planting, Pruning, Training, and Fruiting the Grape Vine. Price \$1 25.

Buist's (Robert) Family Kitchen Gardener;

Containing Plain and Accurate Descriptions of all the different Species and Varieties of Culinary Vegetables, with their Botanical, English, French, and German names, alphabetically arranged, and the best mode of cultivating them in the garden or under glass; also, Descriptions and Character of the most Select Fruits, their Management, Propagation, &c. By Robert Buist, author of the "American Flower-Garden Directory," &c. Cloth, 75 cts.; paper 50 cts.

The American Florist's Guide;

Comprising the American Rose Culturist and Every Lady her own Flower Gardener. Half cloth, 75 cts.

This book is a preservation facsimile.
It is made in compliance with copyright law
and produced on acid-free archival
60# book weight paper
which meets the requirements of
ANSI/NISO Z39.48-1992 (permanence of paper)

Preservation facsimile printing and binding
by
Acme Bookbinding
Charlestown, Massachusetts



2005

