

UMASS/AMHERST



312066005158795

**MASSACHUSETTS
STATE COLLEGE**

SPECIAL COLLECTIONS

* 0 8 1 1 4 1 2 5

GOODELL LIBRARY

5B
355
E468

This book may be kept out

TWO WEEKS

only, and is subject to a fine of TWO CENTS a day thereafter. It will be due on the day indicated below.

CARD





THE
WESTERN FRUIT BOOK ;

OR,

American Fruit-Grower's Guide

FOR THE

ORCHARD AND FRUIT-GARDEN.

BEING A COMPEND OF THE HISTORY, MODES OF PROPAGATION, CULTURE, &c., OF
FRUIT TREES AND SHRUBS, WITH DESCRIPTIONS OF NEARLY ALL THE
VARIETIES OF FRUITS CULTIVATED IN THIS COUNTRY: NOTES
OF THEIR ADAPTATION TO LOCALITIES AND SOILS,
AND ALSO A COMPLETE LIST OF FRUITS
WORTHY OF CULTIVATION.

BY F. R. ELLIOTT.

FOURTH EDITION—REVISED, ENLARGED, AND IMPROVED.

NEW-YORK :
ORANGE JUDD, 41 PARK ROW.
AGRICULTURAL BOOK PUBLISHER.

1865.

634

.2

E. C. Sw

ENTERED, according to Act of Congress, in the year 1857,

BY A. O. MOORE & CO.,

in the Clerk's Office of the District Court of the United States, in and for the Southern District of New York.

TO

PROF. JARED P. KIRTLAND,

This Volume is Dedicated,

BY HIS FRIEND,

THE AUTHOR.

OCT 26 1939 e.t.

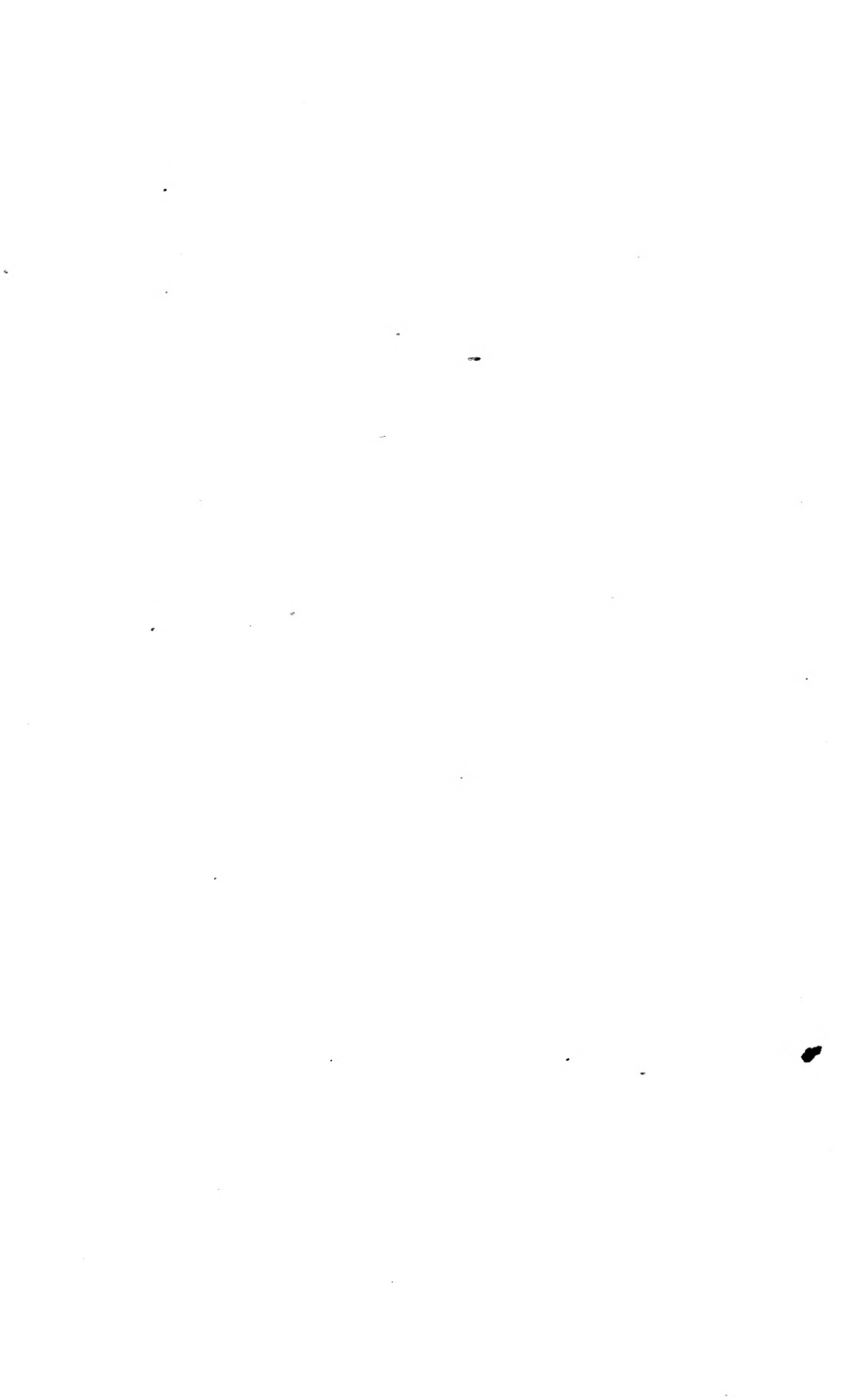

P R E F A C E .

It was my original intention to prepare only a small work, giving descriptions of new Western fruits, or those only that succeeded in the West. As I progressed, my friends urged me to extend it, and make a work for the whole Union; at the same time, it was desired to have the work issued previous to the Spring of 1854, consequently, I was compelled to prepare some of it hastily. The first Edition was, therefore, sent out under circumstances very unfavorable to its successful reception by the public; but, as it has been generally well received, I have thought it due to myself, as well as to the public, to revise and correct it; and, so far as possible, make it the most complete of its kind. In doing this, I have availed myself of liberal and generous notes and comments made for me by a large number of the best pomologists in the United States; of the published transactions of all large pomological conventions, public journals, etc., and of an extensive and careful examination of trees and fruits.

The present Edition has had a careful revision, and the addition of all important knowledge relating to cultivation, diseases, insects, &c.; revision of synonyms; notes of adaptation to localities, embodied in the text descriptive of varieties, and descriptions of over one hundred additional varieties. I have endeavored to add all new sorts worthy of notice. I may have omitted some, but not intentionally.

From what has been previously written upon the subject of fruits and their culture, it may be said to be nearly impossible to embody much of originality with correct teachings. It has not, therefore, been so much my aim to be original, as to present, in a comprehensive and practical form, the entire knowledge of fruits and their culture, from the earliest writers down to the present

day. My designs and illustrations of fruits, with their cores and seeds, concentric lines, etc., have been very generally approved by horticulturists throughout the Union. I have ever considered these features essential to a scientific description, and my only regret is, that the public, as yet, are unwilling to pay a sum warranting the publication of a work wherein every variety of fruit should be fully figured and described.

It will be found, on examination, that I have credited every author with whatever I have extracted from his works: that all descriptions of fruits, made by others, have attached thereto the initials of the author's name, or abbreviations of the title of the work from which they were taken.

I have continued my classification mainly as in previous Editions, simply changing the terms designating their classes. Of the *descriptions* of fruit, some explanation may be necessary. First, is given the *standard* name in capitals. Below this are placed, in smaller type, the various *synonyms*, or local names, by which the same fruit is known in various countries, or parts of the country.

The text, descriptive of nearly every valuable variety, will be found to explain in what section of country, and in what soil, it succeeds best. Having given more attention to Southern fruits, and their seasons, than formerly, and finding many to succeed well South, that have been superseded North and East, I have introduced them throughout the work; hence, I think it will be found as well adapted to that as to other portions of the United States.

It would have given me satisfaction to append to each and every variety its habit of growth, color of wood, form of buds, leaf, &c., &c., but I have been compelled to omit this, except with the most popular sorts, from the fact that such additional matter would swell the volume beyond the intended limits of the work.

F. R. E.

ST. LOUIS, Mo., Jan. 1859.

ACKNOWLEDGMENTS.

IN the difficult task of obtaining correct and adequate specimens of fruit to correspond with the varieties named and described—in preparing my texts of the value of fruits, as modified by localities and soils—in supplying descriptions and specimens of new varieties—I have been greatly assisted by, and my thanks are due to, various pomologists, nurserymen, &c., especially to Charles Downing, Esq., Newburg, N. Y. (from whom I received descriptions of many new kinds of fruit); also Hon. M. P. Wilder, Boston; W. D. Brinckle, Phila.; Robt. Buchanan, Esq., A. H. Ernst, Esq., W. Heaver, Esq., and Prof. J. A. Warder, Cincinnati; C. H. Havens, St. Louis; M. B. Bateham, Esq., Columbus; Chas. Carpenter, Esq., Kelly Island; J. P. Kirtland, and Thos. Brown, Esq., Cleveland; Jno. C. Teas, Raysville, Ind.; Doct. J. A. Kennicott, West Northfield, Cook Co., Ill.



ABBREVIATIONS AND BOOKS QUOTED.

OF these, we enumerate here those only that we have used most freely, either by extract, or as serving for authority to our decisions.

- Allen.* A Practical Treatise on the Culture and Treatment of the Grape Vine. By J. Fisk Allen. 1852.
- Arboretum Britannicum*; or, the Trees and Shrubs of Britain, pictorially and botanically delineated, and scientifically and popularly described. By J. C. Loudon. London. 1845.
- Annales de la Société d'Horticulture de Paris.* Paris. In monthly numbers, 8vo., from 1827 to 1845.
- Adlum.* A Memoir on the Cultivation of the Vine in America, and the best Mode of Making Wine. By John Adlum. Washington, 1828.
- Berckmans' Cat.* Catalogue of L. C. Berckmans & Son.
- Buchanan.* A Treatise on the Grape. By R. Buchanan. Cincinnati, 1854.
- Bon Jard.* Le Bon Jardinier, pour l'Année 1844. Contenant des principes généraux de culture, etc. Par A. Poiteau et M. Vilmorin. Yearly volume. Paris.
- Bridgeman.* The Young Gardener's Assistant. By Thomas Bridgeman. Tenth ed. New York, 1844.
- Baumann's Cat.* Catalogue des Vegetaux en tout genre disponible dans l'Etablissement des Frères, à Bolwiller, 1842.
- Cole.* American Fruit-Book. By S. W. Cole, 1851.
- Coxe.* A View of the Cultivation of Fruit Trees in the United States, and of the Management of Orchards and Cider. By William Coxe. Philadelphia, 1817.
- Chaptal.* Chemistry Applied to Agriculture. By John Anthony Chaptal. American ed. Boston, 1835.
- Cobbett.* The American Gardener. By Wm. Cobbett. London, 1821.
- Coleman.* Reports on the Agriculture of Massachusetts. By Henry Coleman. Boston, 1840-41.
- Cultivator.* The Cultivator, a monthly Journal of Agriculture, &c., edited by Luther Tucker. Albany; continued to the present time.
- Downing.* Downing's Fruit and Fruit Trees of America. 1845.
- Dom. Gard.* The Domestic Gardener's Manual. By John Towers. London, 1839.
- Duhamel.* Traité des Arbres Fruitiers, par M. Duhamel Dumonceau. 2 vols., Paris, 1768.
- Dec.* Physiologie végétale, ou Exposition des Forces et des Fonctions vitales des Végétaux. Par A. P. De Candolle. 3 vols., Paris, 1832.
- Ernst Mans.* Manuscript Notes on Fruits. By A. H. Ernst, Esq. Cincinnati.
- Forsyth.* A Treatise on the Culture and Management of Fruit Trees. By William Forsyth, 7th ed. London, 1824.
- Floy.* Lindley's Guide to the Orchard. American ed., with additions by Michael Floy. New York, 1845.
- Fessenden.* New American Gardener; containing Practical Directions for the Culture of Fruits and Vegetables. By Thos. E. Fessenden. Boston, 1828.
- Gard. Mag.* The Gardener's Magazine, conducted by J. C. Loudon, in monthly numbers. 19 vols., to 1844. London.

- Ga. Pom. S. Rep.* Report of Pomological Society of Georgia.
- Hort.* The Horticulturist, a monthly Journal of Horticulture, Etc. Published by Luther Tucker, and edited by A. J. Downing, from 1846 to 1852, and continued to the present time. J. Jay Smith, editor.
- Hoare.* A Practical Treatise on the Cultivation of the Grape Vine on open walls. By Clement Hoare. London, 1840.
- Hort. Soc. Cat.* See *Thompson*.
- Harris.* A Report on the Insects of Massachusetts injurious to Vegetation. By Dr. T. W. Harris. Cambridge, 1852.
- Hov. Mag. or H. M.* The Magazine of Horticulture, Botany, and Rural Affairs. Conducted by C. M. Hovey. Boston, 8vo., monthly numbers, 1834 to the present time.
- Johnston.* Lectures on Agricultural Chemistry and Geology. By James W. F. Johnston American ed. 2 vols., New York, 1842.
- Jard. Fruit.* Le Jardin Fruitier, par Louis Noisette, 2 ed. 2 vols., Paris, 1839.
- Knight.* Various Articles in the London Horticultural Society's Transactions. By Thomas Andrew Knight, its late President.
- Kenrick or Ken.* The New American Orchardist. By William Kenrick. Boston, 1844.
- Kollar.* A Treatise on Insects Injurious to Gardeners, Foresters, and Farmers. By Vincent Kollar; notes by Westwood. 12mo., London, 1840.
- Loudon.* An Encyclopedia of Gardening. By J. C. Loudon. One thick vol., London, 1835.
- An Encyclopedia of Plants. By the Same. 1 thick vol., London, 1836.
- An Encyclopedia of Agriculture. By the Same. 1 thick vol., London, 1831.
- *Hortus Britannicus.* A Catalogue of all the Plants in Britain. By the same. London.
- The Suburban Horticulturist. By the Same. London, 1842.
- The Suburban Gardener and Villa Companion. By the same. London, 1838 to 1842.
- *Arboretum et Fruticetum Britannicum.* By the same. London, 1838.
- Liebig.* Organic Chemistry, in its Application to Agriculture and Physiology. By Justus Liebig. American ed., Cambridge, 1844.
- Lind.* A Guide to the Orchard and Kitchen Garden; or, an Account of the Fruits and Vegetables Cultivated in Great Britain. By George Lindley. London, 1831.
- Lindley.* An Introduction to Botany. By John Lindley. London, 1832.
- An Introduction to the Natural System of Botany. By John Lindley. London, 1835, 2d ed.
- British Fruits. See *Pomological Magazine*; it is the same work.
- The Theory of Horticulture; or, an Attempt to Explain the Operation of Gardening upon Physiological Principles. By John Lindley. London, 1840.
- The same work, with Notes, by A. Gray, and A. J. Downing. New York, 1841.
- L. or Linnæus.* Species Plantarum, 5th ed. Berlin, 1810, 5 vols.
- Mass. Hort. Society.* Transactions of the Massachusetts Horticultural Society. 1842 to the present time.
- Man.* The New England Fruit Book. By R. Manning, 2d ed., enlarged by John M. Ives. Salem, 1844.
- Man. in H. M.* Manning's articles in Hovey's Magazine.
- Me. P. S. R.* Maine Pomological Society's Report
- Michaux.* The North American Sylva, or Descriptions of the Forest Trees of the United States, Canada, &c. By A. F. Michaux. Paris, new edition. Philadelphia, 1852.
- M-Intosh.* The Orchard and Fruit Garden. By Charles M-Intosh. London, 1819.
- N. Y. Trans.* Transactions of the New York State Agricultural Society, from 1842 to the present time.
- Nois.* See *Jardin Fruitier*.
- New England Farmer.* A weekly periodical devoted to Agriculture, Horticulture, &c. Boston, continued to the present time.
- O. Dub.* See *Duhamel*,

- Pom. Mag. or P. M.* The Pomological Magazine; or, Figures and Descriptions of the most Important Varieties of Fruit cultivated in Great Britain. London, 1828.
- Pom. Man.* The Pomological Manual. By William R. Prince. 2 vols., New York, 1831.
- Prince.* A Treatise on the Vine. By William R. Prince. New York, 1830.
- Prince.* A short Treatise on Horticulture. By William Prince. New York, 1828.
- Poit. or Poiteau.* Pomologie Française. Recueil des plus beaux Fruits, cultivés en France. Par Poiteau. Paris, 1838, and continued in 4to numbers.
- Rivers.* A Descriptive Catalogue of Pears, cultivated by T. Rivers. Sawbridgeworth.
- Ron. or Ronalds.* Pyrus Malus Brentfordiensis; or, a Concise Description of Selected Apples, with a figure of each sort. By Hugh Ronalds. London, 1831.
- Revue Horticole.* Journal des Jardiniers et Amateurs. Audot, Editeur. Paris, 1844, et chaque mois.
- Torrey & Gray.* A Flora of North America: containing abridged descriptions of all the known plants growing North of the Gulf of Mexico. By John Torrey, M.D., and Asa Gray, M. D. New York.
- Thomp.* A Catalogue of the Fruits Cultivated in the Garden of the Horticultural Society of London. 3d ed., London, 1845. [Prepared with great care, by Robert Thompson, the head of the Fruit Department.]
- Thacher.* The American Orchardist. By James Thacher, M. D. Boston, 1822.
- Wilder, MSS.* Manuscript Notes on Fruits. By M. P. Wilder, Esq.
- W. D. B.* Doct. W. D. Brinckle, in ad interim Reports of Pennsylvania Horticultural Society.
- W. R. P.* Articles and Descriptions, by Wm. R. Prince, in various Horticultural Journals.
- Warder's Review.* Western Horticultural Review. J. A. Warder, editor and publisher. A Monthly Journal of Horticulture, &c. Cincinnati, 1850, to the present time.
- Wilder in Hort.* Articles and Descriptions written by Hon. M. P. Wilder, and published in Horticulturist.



CHAPTER I.

INTRODUCTORY REMARKS—HISTORY AND ADVANCEMENT OF FRUITS IN OHIO AND THE WEST—VALUE AS FOOD.

IN almost every country, fruits are regarded as necessaries of life, and have been gradually transferred from the wilds of nature to the cultivated portions of the earth, around the dwellings of man.

Many of the original fruits were unpalatable, but, in the course of cultivation, they have become ameliorated. Superior varieties have been obtained from time to time, to requite the industry and care of the cultivator, until domesticated fruits are not only improved in size and flavor, but increased in number almost innumerable.

In their cultivation, they are affected by soil, situation, and seasons. The Winter of 1855-56 destroyed, by extreme cold, nearly every variety of fruit, the apple only excepted, throughout the entire Western States.

When a fruit tree is to be planted, the object is, to enable it to grow up a healthy and, at the same time, a fruitful tree; and, whether planted in an orchard or in a garden, as a standard or as a dwarf, a certain space is contemplated, that it will, in its maturity, occupy. In order that this may be apportioned properly, the natural habit of the kind must be considered; also, whether it is worked on a free or dwarf-growing stock, whether it is a delicate or hardy sort, and what aspect will be most favorable. All these circumstances must be duly weighed by the fruit-grower, in order to ensure success.

A tree may have too much or too little space. If too much, a part of the intended space is lost; and, if too little, the branches soon interfere, and the trees become crowded, to the manifest injury of each other.

ASPECT is a very material circumstance, and should be modified by the climate and the variety of fruit to be grown. But the nature of the soil, its composition, and depth, requires far the greatest share of the planter's attention. According as this is adapted to the growth of the variety planted, will be his success. Many cultivators imagine that if they can make their trees grow luxuriantly, they will certainly be fruitful. This is a mistake, to prove which, we have only to consider where the most prolific orchards are found, and what are the circumstances which render them so. We find a light, dry, sandy loam, reposing on a subsoil of gravel or rock, invariably

most congenial to the kindly growth and *fruitfulness* of the trees. Perfectly thorough drainage is, in all cases, absolutely essential to productiveness.

Some of the most valuable orchards we have ever seen, stood on a thin, light, loamy soil, on a basis of rock, and constantly pastured. An elevated situation, with a light, loamy soil, will produce the most healthy and fruitful trees, as all fruit trees are more prolific when their growth is moderate; but it will not grow trees as rapidly as the more level, deeper, and richer soils, and would, therefore, be unsuited to the commercial nurseryman.

The increase of the curculio, ægeria, codling moth, and other insects, which are treated of under their appropriate heads, is a subject which has called forth more of ingenuity, practical tact, and scientific experiment, than perhaps any other connected with fruit-growing. The early settlements of the Western States were comparatively exempt for a few years, but the transit of insects is so rapid, that they are soon overrun. This may, perhaps, be termed the "dark side," in fruit culture, and is to be met only by a general diffusion of knowledge.

The Eastern States being possessed of great advantages and facilities for obtaining trees, with various treatises upon fruits, and numerous journals, devoted, in part, to this branch of horticulture, have, until within a few years, been looked to by the South and West for such information and knowledge as was requisite to the successful culture of fruit trees. Experience has proved that such knowledge was often erroneous, when applied in a different climate and soil. It is presumed that this has induced, in the new States, much more attention and discussion than would have occurred under other circumstances.

At this time, horticulturists number in their ranks some of the most intelligent and devoted men from nearly every State in the Union, and their annual and biennial assemblings are diffusing the knowledge acquired by the practice of skillful persons, rendering it accessible to all.

Previous to 1796, there was very little other than the natural fruit of the soil cultivated in Ohio; and not until about 1820 or '22 was there any considerable introduction and planting of "grafted fruits" in the north part of the State. At that time, the nursery of William Coxe, Esq., Burlington, New Jersey, seemed the nearest from which to obtain trees, and, therefore, from thence came most of the first plantations of good fruits. Later, the nurseries of Prince, Kenrick, and Buel, supplied our Northern pioneers; and from these, with the liberal hand which always characterises a fruit-culturist, grafts were distributed freely to whoever would. As early as 1796, or 1797, Israel Putnam introduced and propagated many of the older and best Eastern varieties on the borders of the Ohio river, and

there cultivated both trees and fruits, from whence most of the older orchards of southern Ohio, and probably Indiana, were procured. Governor Worthington, at an early day, 1803, or previous, introduced many fine varieties of fruits into central Ohio. In 1824, Prof. Kirtland imported, from New Jersey to Trumbull County, Ohio, some two hundred sorts of the best fruits then known; and in 1827, or '28, George Hoadley, Esq., sent about one hundred kinds to Cleveland. Alfred Kelly also introduced many fine Eastern varieties; and, as before mentioned, grafts from all these were liberally distributed, followed by additional introductions of new varieties in succeeding years. Add to these, that nearly every pioneer brought with him seeds of the best fruits known in the vicinity of his former residence East, which he planted and grew with care, and we have the heads of the principal introduction of varieties up to about 1832. Since that period, not only have importations of extended varieties been largely made from Eastern nurseries, but the nurseries of trees grown for sale have so multiplied in the whole West, that millions of trees are now annually grown and planted.

For the history that follows, relating to Illinois and Wisconsin, we are indebted to the zeal, enthusiasm, and courtesy of Doctor J. A. Kennicott:

“The first permanent settlements in Illinois were made by the French about 1682, in and about Kaskaskio and Cahokia; and it is said, that ‘the first generation of fruit trees, there planted, had done good service, and gone the way of all the living,’ long before the advent of the present race who people ‘Lower Egypt.’ The Rev. John M. Peck (whom I quote from memory) affirms, that he ate most luscious fruits, some twenty or thirty years ago, the product of the second generation of these old French trees, even then of almost forest size.

“From many sources I gather the fact, that among these old trees were, and still are, perhaps, individuals producing very desirable fruit; all, doubtless, of mature growth, though some may have been brought from Canada, whence the seeds very evidently came, in their route from the old world.

“From this you perceive that Illinois is one of the oldest fruit-growing states; and it is very certain, that our seedling trees generally yield better fruit than the mass of chance varieties in the East; though, good sooth, I have been unable to trace any of our celebrated varieties in cultivation, to these glorious old trees, so graphically described by the Rev. Mr. Peck; and yet, I am by no means certain, that some of our most valuable local varieties did not originate in that classic fruit-land of Southern Illinois.

“It is very probable, also, that, in Central and Northern Illinois there may now be native varieties, surpassing in value, for local cultivation, at least, a large majority of the sorts named in the books.

Analogy would lead to such a conclusion ; for, as a general rule here, of fifty seedling trees, in almost any orchard, at least five will be found worthy of notice, and worth preserving in their natural state, though not desirable for propagation.

“From personal observation, you are already aware that some fruits of high repute East, are nearly worthless here ; and that others are wonderfully improved by the peculiarities of our soil and climate. It is thought, too, that many old fruits have become so changed as to be no longer easily recognized ; and, as their history has been lost, and several local synonyms have been used to designate them, much difficulty and doubt attend our Western nomenclature.

“Perhaps these difficulties will soon be removed, and the doubts cleared up, as in Ohio, by the re-fruiting of our celebrated varieties at the East, from scions obtained here, or by further observation on the fructification here, *under the true names*.

“Many of our varieties, of the first trees transplanted in Western Illinois, and Southern Wisconsin, were disseminated by tree pedlars from the region of the Wabash, in Indiana, and central-eastern Illinois ; and I am only aware that some of their sorts came from Ohio, and others from Kentucky, Virginia, Tennessee, and North Carolina, and a few, doubtless, from the Eastern States ; though what proportion, or what varieties of those brought us by these tree pedlars, I am unable to determine. Very few were sold under EASTERN NAMES, however, and, now and then, a variety is, doubtless, of native origin.

“Among these pedlars’ trees, the RED JUNE is decidedly the most valuable, and the MILAM the most abundant.

“Here-away, I know the origin of four-fifths of the trees planted out in the last ten or twelve years, apart from the pedlars’ trees, which continued to arrive up to three or four years ago. The Buffalo nurseries, and the Cleveland dealers, have furnished the most. The nurseries of Chatauque County sent some early, and the Rochester establishments a great many more recently, and a few ten or twelve years ago. The Flushing nurseries are also represented in our orchards, and, quite lately, those of Michigan and Northern Indiana ; and, in fact, there is scarce an eastern establishment which has not sent trees to the lake region of Illinois and Wisconsin.”

Similar to those named, is that of most Western States, in the historic introduction and origin of fruits. Chance seedlings, of value sufficient to retaining of the original tree, are abundant, while those meriting a first place are rare. The character of “very good” will apply to probably one-tenth of the fruit, while that of “best” will hardly apply to one-thousandth.

Of the value of fruits as food, and the tendency to promote health of system and morality of character, much has been written ; but the following, by Doctor Kennicott, sums up all in few words :

“The free use of ripe fruits not only *prevents disease*, but their regulated enjoyment helps to remove that which already exists. All ripe fruits are, also, more or less nutritious. Professor Salisbury has clearly demonstrated that the APPLE is superior to the POTATO, in the principles that go to increase the muscle and the *brain* of man, and in fattening properties, it is nearly equal, when cooked, for swine, or fed raw to other domestic animals.”

Ripe grapes have cured epidemic dysentery. Physicians have, occasionally, advised the use of “cooling acid fruits;” and the earliest writers have directed the sugary ones, as “figs,” for food in convalescence. Families, where fruits are most plentiful and good, and prized as an article of daily food, are most free from disease of all kinds, and more especially from fevers and “bowel complaints.” Most fruits aid digestion, some directly, some indirectly, and lessen the desire for alcoholic or stimulating drinks. The juicy ones act as “dilutents,” and all as “diuretics;” the free acids neutralizing, or rendering soluble the earthy matters in the blood, and carrying them off rapidly through the natural channels.

CHAPTER II.

ORIGINATING OF VARIETIES — THEIR PROPAGATION, BY BUDDING, GRAFTING, LAYERS, CUTTINGS, RUNNERS, AND SUCKERS.

“OUR garden varieties of fruits are not natural forms. They are the artificial productions of culture. Seedlings from them “have always a *tendency to improve*, but they have also another and a stronger *tendency to return to a natural or wild state*.” Of this, we have a strong evidence, in the production of seedling cherries by Prof. Kirtland, where from several hundred grown from seed gathered from the same tree, only about one-tenth have surpassed, and two-tenths equaled, the parent; the remainder mostly failing back toward the original Mazzard.

Most of our choice varieties cultivated, are from seeds of chance cross-impregnation; few have been the result of artificial skill and care; cross breeding and hybridizing are too often confounded, and while we are constantly in the production of new varieties from *cross breeding*, none are known in fruits from *hybridizing*. Lindley says:

“If the pistils of one species be fertilized by the pollen of another species, which may take place in the same genus, or if two distinct varieties of the same species be in like manner intermixed, the seed which results from the operation will be intermediate between its parents, partaking of the qualities of both. In the first case, the progeny is *hybrid* or male; in the second, it is simply *cross-bred*.” Although of the same genus, no *hybrid* has ever yet been created between the apple and the pear, or the gooseberry and currant. These cross-breeds, when closely resembling the female parent are termed sub-varieties.

This practice of producing new varieties by cross fertilization was advocated by Thomas Andrew Knight, a distinguished horticulturist of England: while that of Dr. Van Mons, of Belgium, was the re-production of seedlings from seedlings in succession; selecting each time those of the seedlings to procure the seed, which proved the best in the fruit. At the eighth generation, in growing from the pear, his seedlings produced fruit at four years old, while at the commencement it required twelve to fifteen years. This he regarded as the correct course to pursue in the amelioration of varieties. The Frederic, of Wurtemberg, originated by him in this way, it is well known, produces its fruit often in the nursery at two years from the bud; while the Dix, a seedling from we know not what variety, requires twelve or fifteen years. This process, however, if taken, as by Van Mons, from the commencement, *i. e.*, a wildling, would require a life-time; but our people have all around them seedlings which at an early age are producing fruit; if, therefore, seed be taken from the best of them, and the choicest again selected, it is not probable that more than ten years would elapse without producing something very superior.

On the other hand, the process of Mr. Knight, of producing by crossing, gives the grower the choice of selecting and growing to whatever form, size, or character he may desire, and this with an almost absolute certainty of success. This process being fully described by Thomas, in his *Fruit Culturist*, we extract therefrom:

“A familiar instance of cross-impregnation in plants occurs in the Indian corn. The pistillate, or seed-bearing flowers, covering the young ear, are remotely situated on the plant from the staminate, or fertilizing flowers, on the summits, or *tassels*. Hence, from this remote position, the pollen, or fertilizing dust, from the summits may not certainly fall on the ear; and, if different sorts grow near, a mixture will probably result. It is well known to farmers, that if different sorts, as white, yellow, and purple, are planted in the same field; or, if common and sweet corn are planted together, each sort no longer remains distinct, but each ear, the second year, is speckled with a promiscuous assemblage of white, yellow, and purple, and of common and sweet corn, of various grades. In fruit trees, the

stamens and pistils are in the same flower, and the chances of accidental mixture from other trees, become very small unless affected by insects, which, becoming thickly dusted with powder from one flower, plunge into the recesses of another, and affect a cross fertilization. Where many varieties grow in one garden, in close proximity, cases of promiscuous intermixture are constantly occurring, which can be developed only by raising fruit from the seedlings.

“In the annexed figure of the pear blossom (Fig. 1), the five central organs *a*, are the *pistils*; the upper extremity of each is the *stigma*. The surrounding thread-like organs, *b*, are the *stamens*, surmounted by the *anthers*. The anthers are little bags or cases, filled with the pollen, or fertilizing dust. When the flowers open, the anthers burst, and discharge the pollen on the stigma, which operates on the embryo fruit at its base.

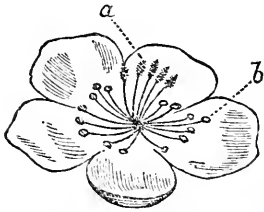

Fig. 1.

“The production of new varieties is greatly facilitated by cross-impregnation, or by fertilizing the pistil of one variety with the pollen of another. This was performed with great success by Knight. Selecting two varieties, while yet early in flower, and before the anthers had burst and discharged the pollen, he cut out with a fine pair of scissors all the stamens, leaving the pistils untouched (fig. 2). When the stigma became sufficiently mature, which was indicated by its glutinous surface, he transferred the pollen of the other sort on the point of a camel’s-hair pencil. The fruit, thus yielded, was unchanged; but its *seeds* partook variously of the nature of both parents, and the trees growing from them bore new and intermediate varieties.

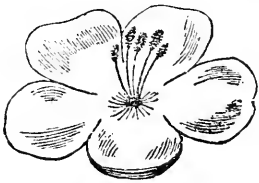

Fig. 2.

“For the success of such experiments, several precautions are requisite. The flower must be deprived of its stamens before it has fully expanded, or before the anthers have already burst and scattered their dust; the pollen must be procured from a bursting, or fully matured anther, when it will be dry and powdery; the stigma must be inoculated as soon as it becomes adhesive or glutinous, otherwise it may be fertilized from another source, and then the intended pollen cannot possibly take effect. For a stigma once inoculated, cannot be inoculated again. It is safest, where practicable, to force the trees by artificial heat into flowering a few days earlier than others, so as to be secure from accidental inoculations of pollen floating in the air; and to prevent its spread by bees, to apply a temporary covering of gauze. A want of attention to these minutiae, has led some experimenters to fancy they had obtained crosses, when they had only natural seedlings.”

Budding.—This process of propagation, as well as that by grafts,

layers, and cuttings, is performed for the purpose of increasing the number of trees or plants of any variety; and is performed on stocks of the same, or closely allied, species. These are designated under each particular head of Apples, Pears, &c., on other pages. The process is also one, which, although well and truly described, in all fruit works, and most of the leading journals, is nevertheless so often attended with failure, that while we here repeat descriptions, we, at same time, advise every new beginner to visit the leading nurseryman, or successful amateur grower, in his immediate neighborhood, and learn more in half a day from practical example, than could be told him were one to write a month. In order to be successful, it is requisite that the stock on which it is intended to operate should be in a thrifty, healthy state, not too early or late in the season, but the best time is just when the terminal bud is forming, in August or September. Various modes of budding are known and described; but that most successful, most rapid, and in common use, is the one termed incorrectly, *American shield budding*, described by Forsyth in 1802—which differs from the common *shield budding*, only in leaving a small piece of wood at base of the bud inserted, instead of taking all out. An incision is made lengthwise through the bark of the stock, and a small cut at right angles at the top, the whole somewhat

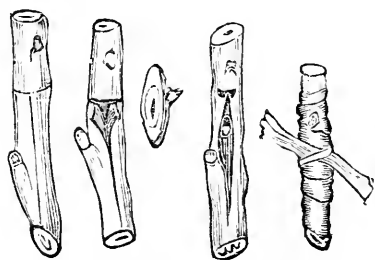

Fig. 3. Fig. 5. Fig. 4. Fig. 6. Fig. 7.

resembling the letter T (fig. 3). A bud is then taken from a shoot of the present year's growth, by shaving off the bark an inch or an inch and a half in length, with a small part of the wood directly beneath the bud (fig. 4). The edges of the bark, at the incision in the stock, are then raised a little (fig. 5), and the bud pushed downward under the bark (fig. 6). A bandage of bass-bark, woollen-yarn, or other substance, is then wrapped around, commencing at the bottom and passing the bud, returning again and tying just below, covering all but the bud (fig. 7). The pressure should be just sufficient to keep the inserted portion closely to the stock, but not such as to bruise or crush the bark. In about ten days, or two weeks, after insertion, the strings will require to be loosened, and at expiration of three weeks removed altogether. The ensuing Spring, as soon as the buds begin to swell strongly, cut off the stock about six inches above the bud; and as the shoot, or bud, grows, tie it to the piece of stock above its insertion until about midsummer, when it will be time to cut away the piece of stock above the bud, leaving a sloping cut downward from the top of insertion of bud. An improper practice with some is, to place the buds in water; this so saturates them with moisture, that they have no attractive force left to imbibe the sap of the stock, and hence often fail to grow. In cutting the shoot

containing buds intended to be inserted, the leaf should immediately be cut off to within half an inch of the bud, otherwise the evaporation will exhaust and injure its vitality. If buds are to be kept a number of days, they should be wrapped in damp moss, or wet cloths; or if to be sent to a distance, the whole wrapped in oiled silk. In this way they will keep without injury ten days or more.

“*Annular budding* is applicable to trees of hard wood, or thick rigid bark, as the walnut and magnolia. A ring of bark is removed from the stock, and another corresponding ring, containing the bud, slit open on one side, is made to fit the denuded space. (Fig. 8.)



Fig. 8.

“*Trees which have been girdled* in winter by mice, may be preserved by a process similar to annular budding, by cutting away evenly the gnawed portions, and applying one or more pieces of bark peeled from the branch of another tree, so as to restore the connection between the two severed portions. This is done as soon as the bark will separate; the same end may, however, be accomplished early in Spring, by cutting away portions of the sap-wood with the bark, and connecting the two parts by several pieces of a branch, care being taken that they coincide accurately, as in grafting. The whole, in either case, is then covered with wax.”

Grafting, like budding, has numerous modes and forms, all resolving into the same thing—that of transferring one variety on to another. Such methods as are in most common practice, we describe.

Whip or tongue grafting. This is most generally practiced when the stock and scion are nearly of equal size. The whole gist of it lies in so forming the graft and stock that the two outer surfaces of albumen, or wood of last year's growth, match one with the other, or if the stock is too large that they match on one side. (See fig. 10.) The tongue is a notch cut in the stock corresponding with one cut in the graft, and, when put together, to serve as support in steadying the graft, until the circulation of the sap has united it with the stock. This is practiced to a large extent by nursery-men on pieces of roots, and is then termed “root-grafting.”

Splice Grafting is similar to tongue grafting, except that no slit is made in either stock or graft. (See fig. 11.)

Crown Grafting is performed in the same manner, only that it is done on small stocks standing in the ground, at a point near the upper rootlet or fibre. (See fig. 12.)

Saddle Grafting. In saddle grafting, the stock is pared obliquely on both sides, till it becomes an inverted wedge, and the scion is slit up the centre, when its sides are pared down till they fit the sides of the stock. (See fig. 13.) This is the best mode to pursue with the cherry and other stone fruits.

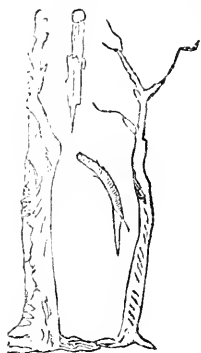

Fig. 9.

Side Grafting, as seen in the cut (fig. 9), is performed by cutting a notch or slit of about one inch long in the side of the stock, paring the outer portion, splitting the graft, and paring the inner portion, then inserting it so as to give a union of the bark and wood—leaving meanwhile the top of the stock to carry on the circulation of sap until the graft becomes united, when it is to be cut away. This is the best for the magnolia and for the hickory, ash, &c.; and also when scions may have been received late in the Spring, or the work of grafting unavoidably delayed.

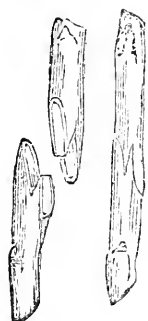

Fig. 10.



Fig. 11.



Fig. 12.

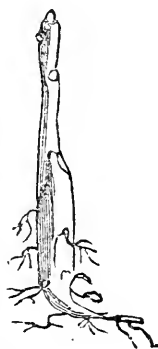

Fig. 13.



Cleft Grafting is an easy, though clumsy mode, rarely practiced, except on limbs, or branches, too large for whip grafting. In this the scion is cut like a wedge, sloping on both sides. The stock is split with a grafting chisel, or large knife, which is drawn to one side, and holds open the split while the scion is pressed in, so that the albumen, or inner barks, match, when the chisel or wedge is drawn away.

Wrapping or Tying. After the operation of grafting is performed, bass-bark, or bass matting, or soft woolen or cotton yarn, is then wrapped around to retain them perfectly in their places. Where small trees or roots are engrafted, and to be planted in nursery-rows, this is all that is necessary; but when grafting is performed on standard trees, it is better to cover the matting with a wax, made in the following manner:

Grafting Wax. 4 parts rosin, 3 parts beeswax, 3 parts iard. This should be well incorporated together while warm, strips of cotton cloth dipped into it, and when cold, cut to the length and width required for the size of limbs you are to engraft, will facilitate the labor ; and when this is done, the first tying of bass mat or woolen string, may be dispensed with.

Grafts which have become dry, may be restored if the moisture is applied so gradually, that its absorption may require several weeks. In one instance, shoots cut early in Autumn, and subjected to thorough drying, were restored to perfect freshness by the next Spring, by wrapping them well in moss, and burying them in the ground ; and, being set, they all grew.

Scions for sending to a distance, are usually packed in damp moss, saw-dust, or fibrous peat. They may be sent by mail, within a very small compass, with great safety, by enwrapping them with oil-silk, or thin oil-cloth, drawing it closely round them, to include the moisture by means of small thread. Partially decayed wood from the forest is also used successfully for keeping scions.

Layering. This is practiced in low shrubs and vines, as the quince and grape. It consists in bending down carefully without breaking a branch, cutting a notch, or slit, on the under side, immediately below a bud, and pegging it securely, so that the centre will be about four inches under ground (see fig. 14). With the grape, trailing the vine on the surface, as shown in fig. 15, and after buds have started a few inches, cover with soil the vine ; each bud will throw out roots, and if the operation

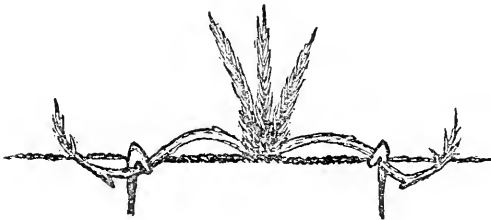

Fig. 14.

be performed in Spring, they may be taken up and separated in the Fall.

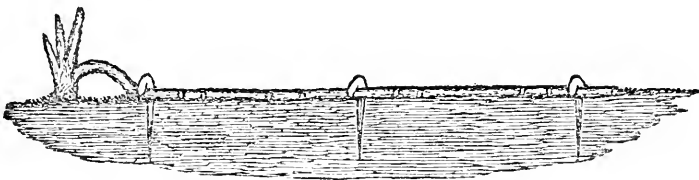

Fig. 15.

Cuttings. Propagation by cuttings is the simplest mode of multiplying a variety. It consists simply in the insertion of a shoot of one year's growth into the soil; the moisture of the soil renews

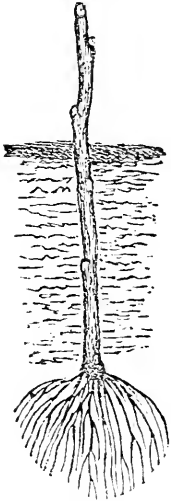

Fig. 16.

the supply of sap, the buds swell, the leaves expand, and the descending juices expend themselves in the production of new roots, which shoot downwards into the soil (fig. 16). Under ordinary circumstances, or in open ground, this mode is only applicable to such species as readily throw out roots, as the currant, gooseberry, quince, and grape. The cutting should be made from eight inches to a foot long, and have all the lower buds cut out, in order to prevent its throwing up suckers. Wood of the last year's growth is used, and the lower end cut square across at the base of a bud. They should be inserted perpendicularly, or when long enough, curved, as see, under the head of Grapes; the earth should be pressed securely at the bottom, and lightly at the top, and, when possible, a mulch of two inches of tan bark, saw-dust, etc., thrown over them to preserve moisture.

Runners, are the mode of self-propagation in the strawberry; as soon as well rooted, they are suited to be removed.

Suckers, are underground runners—often the result of careless cultivation in breaking off roots. They should always be destroyed, but never replanted. The Frost Gage plumb, from having been propagated thus, has become so diseased, as to be nearly discarded, and this in the short space of about fifteen years.

CHAPTER III.

TRANSPLANTING TREES—HOW, WHEN; PACKING, CARE OF WHEN RECEIVED; PRUNING—TIME WHEN, HOW; THE TOPS, THE ROOTS; LABELS FOR; PROTECTION FROM SHEEP, RABBITS, ETC.; TRAINING; FORM OF YOUNG TREES.

THE first care in the removal of trees, should be not to destroy the roots in digging. Small trees are less liable to injury from such cause than large ones, but too often have we seen them wrenched out of the ground, by the strong arm of man, apparently not to injury of roots, but really they were cracked through every portion, and all the tissues through which the circulation of sap is had, broken and injured, often more to injury of tree, than if one-half the roots had been cut off. Again, have we seen trees cut out with spades, leaving only about four to six inches of main root, and a few small fibres. Such trees require a whole year's nursing, with severe shortening-in of limbs, to recover anything like their native vigor, and are not worth, to the planter, over one-half as much as trees well and carefully dug, with roots nearly entire.

Preparing the soil. If an orchard is to be planted, on soil retentive of moisture, or, in other words—level clayey soil—it should first be thoroughly subsoiled, at least twenty-two inches deep; it should then have sufficient number of under-drains, so that no surplus water would ever remain on it over forty-eight hours. Digging deep holes should never be practiced, but the whole soil should be made of fine tilth, and if the ground is well-drained, or naturally dry, dig broad spaces, four feet diameter, and one foot deep. If the ground is not drained, and naturally wet—a location and condition which should never be adopted—let the planting be made by placing the tree on the level ground, and earthing up around it. Upon the level prairies this course has been found most successful, and at times, without even removing the sod beneath the tree.

Many suppose, that a tree grown in the nursery on sandy soil, will not succeed on clay, and so the reverse; this, if they will only use reason, and study the nutritive process in the tree, they will see, at once, has no foundation in fact; but a tree taken from the rich ground of a well-kept nursery, and placed in a barren, half-starved soil, amid grass and weeds, has no more chance of continuing in vigor and

health, than an animal raised upon the rich pastures of our Western country would have, transplanted to some of the bleak, barren hills, of New England. Food for the plant is, therefore, requisite, and this should be prepared in a well, and previously cultivated and enriched soil, and not expected to be supplied in a raw state by application of animal manures immediately to the roots. Prof. Lindley says, "that a small quantity of super-phosphate of lime, as it is called, that is to say, a mixture of oil of vitriol and burnt bones, mixed with dry mould, and thrown in around the roots of a newly-transplanted tree, will generally aid in the formation of root fibres, and consequently assist very much in establishing the plant in its new situation; or, if scattered over the soil next the roots, the rains will distribute it to the places where most required."

How to Plant. Having prepared the place and the soil, we next

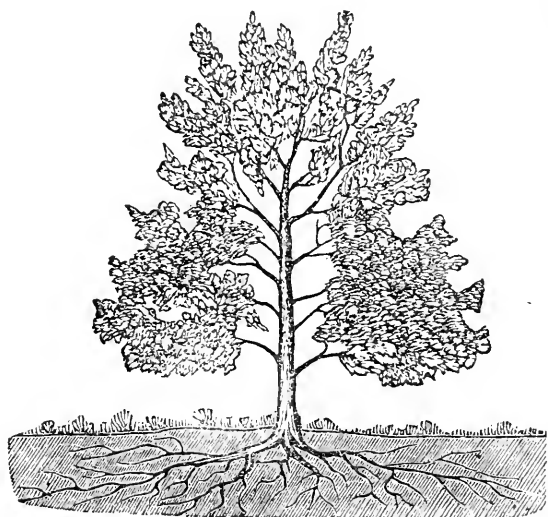

Fig. 17.

proceed to plant the tree. Supposing that the roots, in removing, have been carefully preserved, our tree will present, when placed in the hole prepared for it, the appearance represented in our figure 17, the upper root being about four inches lower than the level of the surrounding soil. If the roots are broken, prune, by a cut from the under side of each end. Now, one man should scatter in carefully the fine earth, while another holds the

body of the tree with one hand, and with the other carefully presses the earth around and beneath every root, taking care to keep the small roots and fibres, each in its place, lifting them as the work progresses to a nearly horizontal position. Leave the earth, if the planting be done in Spring, level around the tree, and with the surrounding surface; if planted in the Fall, earth up a little mound around the stem-end, and over the entire circle of roots, to be drawn away again in the Spring. Avoid treading or other pressure around the tree, other than that made by the hand, in firmly placing the earth around the roots in the process.

Time to Plant. With nearly all trees and all locations, Fall is the best time to transplant; new granulations have to be made, ere the roots broken by removal can again supply themselves, or the plant, with food. This process, if trees are removed in Fall, will

often be found to have taken place during winter, and ere the exhaustion by the leaves from growth in Spring, of their food laid up in bud and bark the year previous, and the roots are again furnishing their support. If, however, trees are removed in Spring, it often happens, especially with cherries, that the supply of food previously laid up is exhausted ere new rootlets are formed. Mulching, and other cares, are often, therefore, more requisite, in order to keep the roots, and prevent too rapid exhaustion in Spring-planted trees.

Packing. Amateurs, as well as nurserymen, often have occasion to forward trees to a distance, and it is desirable that they be so packed, as to ensure success when received. In order to do this, they should be made into a bundle, with damp moss liberally mingled among the roots, the larger trees upon the outside of the bundle, and the small within; tie securely with twisted straw bands, then take long straw, lay it down about two inches thick, with its butts near the centre of the roots of the bundle; lay another layer, with the butts four inches below the tops of the last, and so on, until you have the length of the bundle. Now, lay down the bundle, and carefully lay straw over it, in same manner as underneath, only commencing at the top, so that when the cords are around it, all will be covered; proceed with one end of the cord, first lashed to a strong root, to bind it around, once in about ten inches, all the way to the top. If intended to go any considerable distance, with risk of rough handling, a stout stick should be packed in the centre of each bundle, extending about four inches beyond the tops of the trees. Next, lay down a strong bass matt, or strong cloth, scatter on it straw, then moss, and placing the roots of the bundle upon it, draw it up carefully over, and secure it by strong pack-thread. If moss is not obtainable, let the roots be well puddled, as it is termed, that is, dipped in a thick clayey mud, but avoid packing leaves, grass, etc., among them.

Care of Trees when received. Trees are often lost by not knowing how to care for them when received after long voyages. If dry, withered, or frozen, they should be unpacked and immediately buried, roots and tops, underneath the earth, and there left for some days; or, if late in the Fall, and they are buried where the water drains off readily, let the roots be buried deep, while the tops have only a couple of inches upon them. Trees received dry in Spring, may be immediately immersed in a running stream of water, and after the buds are swollen, planted out in some location for the season, where the mid-day sun will not strike them, and where the earth can be always kept moist by mulching, etc.

Pruning. That certain principles of the nature and habits of a tree, must ever be borne in mind in pruning, to ensure success, is evident; but that the cutting away of small branches, or twigs, if correctly made, will materially affect the health and longevity of a tree, whether made in Spring, just before midsummer, in Fall or Win-

ter, we do not believe. In pruning an old tree, long neglected, where it is requisite to cut away many large branches, attention to the circulation of sap, the new formation of wood, &c., &c., should, by all means, be the guide. Experience, as well as theory, teaches, that the most healthy formation of wood commences in July; that all growth previous is imperfect, and, were it not for that and ensuing months, would rapidly decay; that while wood is not made as rapidly at that time, and afterward, as previous, it is of a firmer, closer, and more healthy character. If, therefore, large limbs are to be removed, let the time from July to September, inclusive, be selected. A subject so liberally treated upon as this has been from the earliest authors down, it would seem should be better understood than appears from the quantity of ill-shapen, malformed trees, to be seen in almost every orchard. Barry says:

“It is not only necessary to know what and why, but also *how* to prune. Theory is only useful as it serves to guide in practice.

“The great point to be observed in making incisions on the stems and branches of trees, is to provide for the speedy and perfect healing of the wounds or cut surfaces. In removing a portion of a branch or stem, if we cut between two joints, so as to leave a portion of

wood above the bud, intended to be cut to, as in fig. 18, this wood dies, and we have the trouble of another pruning to remove it. If we cut too close to the bud, and thus remove a portion of the wood with which it is connected, as in fig. 19, the bud will either die or disappoint us by producing a very feeble growth. The proper way is to take

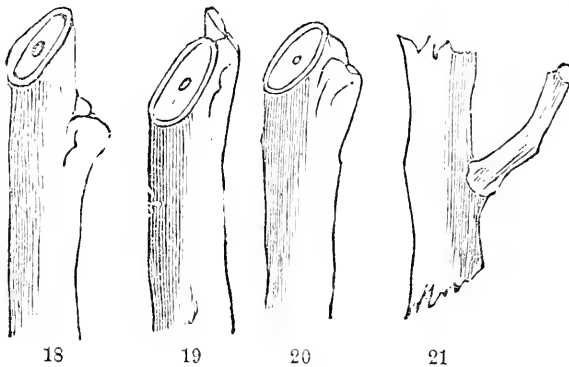

FIGS. TO PRUNING.

Fig. 18, cutting too far above the bud. Fig. 19, cutting too close. Fig. 20, the cut as it should be. Fig. 21, removal of a branch, the cross line indicating the proper place for the cut.

the branch to be operated on in the left hand, place the edge of the knife on it, opposite the lower part of the bud to be cut to, and then make a firm, quick, smooth draw-cut, sloping upwards, so that the knife will come out on a level with the point of the bud, as in fig. 20. In soft-wooded, pithy plants, like the grape vine, for example, half an inch of wood ought to be left above the bud. The cut should also be made, as much as possible, on the lower side of the branch, to prevent rain from lodging in the centre. The position of the bud cut to, is also worthy of consideration in pruning, to produce or modify certain forms. When we wish the new shoot of a lateral

branch to take as much as possible, an *upright* direction, we prune to a bud on the *inside*; and if we wish it to *spread*, we choose one on the *outside*. In the annual suppression, or cutting back of young trees, the bud selected to form the leader is chosen on *opposite sides every successive year*, in order to maintain the growth in a straight line. If cut every year to a bud on the same side, it would, in two or three seasons, show an inclination to that side injurious to the symmetry of the tree.

“*The Removal of Large Branches*, where they are to be entirely separated from the tree, is often very clumsily performed. In orchards it is not at all uncommon to see them chopped off with a common axe; and even in gardens there seem to be few persons who take the proper care in this matter. They are either cut so that a portion of the base of the branch remains, and sends out vigorous shoots, defeating the objects of the pruning, or they are cut so close that a portion of the wood of the main branch or stem is taken with them, and a wound made that years are required to heal up. Both these extremes ought to be avoided.

“The surface of the cut made by the removal of a branch, should in no case be larger than the base of the branch. Where a branch is united to another, or to the main stem, we notice, both above and below the point of union, a small projection or shoulder, as at the cross line in fig 21. The knife must enter just below that shoulder, and, by being drawn upwards in a straight line, the base is so completely removed that no shoots can be produced there; and yet the cut surface on the stem is no larger than the base of the branch. When the saw is used, the surface of the cut should be pared smoothly with the knife, to prevent water lodging on it, and facilitate the healing of the wound.”

Pruning at the time of Transplanting. This is performed, not only to remove bruised and broken roots and branches, but to restore the tree to a proper balance. As trees are ordinarily taken from the ground, the roots are bruised, broken, or mutilated, to a greater or less extent. This obviously destroys the natural balance or proportion that existed between the roots and stem, and in such a condition the tree is unable to grow. The demand upon the roots must, therefore, be lessened, by reducing the stem and branches in length or number, or both; and the more the roots have suffered, the greater must be the reduction of the stem and branches, to bring them to a corresponding condition.

Disbudding. When a tree is unfruitful by reason of its rampant growth, and the cultivator desires to bring it into a bearing state, the best and easiest way is by the simple method of disbudding during the months of April, May, and June. This we consider preferable to “pinching in,” of which, extended directions are to be found on future pages. At the commencement of the Spring growth, the mana-

ger has only to mark the swelling buds, preserving all those which he wishes developed for the formation of spurs, or for extending the leaders, and rubbing off all the rest. This will check the demand upon the roots, consequently stop their extension, and they will send up a diminished supply of sap. Thus, a check upon the vigor of the whole system will be induced.

In the course of a month, more or less, another set of young buds will be produced; and yet another, some four to six weeks ensuing. These must be rubbed closely off, checking the growth, and causing the production of fruitful spurs and buds.

“*Pruning the Roots.* This is practiced as well to promote fruitfulness as to lessen the dimensions of trees. The roots are the organs that absorb from the ground the principal food of the tree, and in proportion to their number, size, and activity, other things being equal, are the vigor and growth of the stem and branches. Hence, when a tree is deprived of a certain portion of its roots, its supply of food from the soil is lessened, growth is checked, the sap moves slowly in its channels, is better elaborated in the leaves, and the young branches and the buds begin to assume a fruitful character.

“Roots are also pruned to prevent them from penetrating too deeply into the earth, and induce the formation of lateral roots near the surface, similar to the cutting back of a stem to produce lateral branches. The principle is the same.

“The work is performed by opening a trench around the tree, the distance from the tree will depend on its size, and the spreading character of the roots. The trench should be the width of a common garden spade, and deep enough to reach all the roots of the tree. If the lateral roots are to be shortened, this is done first. The knife should be placed on the lower side of the root, and the part separated with a clean draw cut, such as would be performed on a branch. If the tree has vertical, or tap roots, they are most easily operated on with a sharp spade, prepared and kept for the purpose. A smart stroke with such a spade, in as nearly a horizontal direction as possible, will separate a pretty strong root. The extent to which root pruning may be performed, depends on the character of the species, the condition of the tree as regards growth, and the object aimed at. Those practicing it for the first time should go to work with great caution. It will be better to operate too lightly than too severely. As regards the season, it may be performed either at the end of the first growth, in July or August, or in the Autumn or Winter, when vegetation is quite suspended. We have operated on cherry trees, with complete success, in August, in a dry time when little growth was going on. At this season, a copious watering should be given after the pruning is performed.”

Pruning, to form particular shapes, to promote the formation of blossom buds, to enlarge the fruit, to cure disease, to increase or les-

sen bulk, are all treated of at length by Loudon and others; but all seems to us summed up in the following, written by M. Dubreuil, in France, and first published in this country in Barry's "Fruit Garden." It is more especially applicable to training of trees in gardens, than of standards in orchards. He says:

"The theory of the pruning of fruit trees rests on the following six general principles:

"I. *The vigor of a tree, subjected to pruning, depends, in a great measure, on the equal distribution of sap in all its branches.*

"In fruit trees abandoned to themselves, the sap is equally distributed in the different parts without any other aid than nature, because the tree assumes the form most in harmony with the natural tendency of the sap.*

"But in those submitted to pruning, it is different; the forms imposed on them, such as espalier, pyramid, vase, &c., change, more or less, the normal direction of the sap, and prevent it from taking the form proper to its species. Thus nearly all the forms given to trees require the development of ramifications, more or less numerous, and of greater or less dimensions at the base of the stem. And, as the sap tends by preference towards the summit of the tree, it happens that, unless great care be taken, the branches at the base become feeble, and finally dry up, and the form intended to be obtained disappears, to be replaced by the natural form—that is, a stem or a trunk with a branching head. It is then indispensable, if we wish to preserve the form we impose upon trees, to employ certain means, by the aid of which the natural direction of the sap can be changed and directed towards the points where we wish to obtain the most vigorous growth. To do this, we must arrest vegetation in the parts to which the sap is carried in too great abundance, and, on the contrary, favor the parts that do not receive enough. To accomplish this, the following means must be successively employed:

"1. *Prune the branches of the most vigorous parts very short, and those of the weak parts long.* We know that the sap is attracted by the leaves. The removal of a large number of wood-buds from the vigorous parts deprives these parts of the leaves which these buds would have produced; consequently, the sap is attracted there in less quantities, and the growth thereby diminished. The feeble parts being pruned long, present a great number of buds, which produce a large surface of leaves, and these attract the sap, and acquire a vigorous growth. This principle holds good in all trees, under whatever form they may be conducted.

* This is not in all cases true. Peach trees, we know, left to themselves, exhibit a very striking example of the unequal distribution of the sap. The ends of the branches attract nearly the whole, leaving the lateral shoots and lower parts to die out. In other species, similar instances might be quoted, and, as a general thing, the proposition is unsound, except in a comparative sense.

“2. *Leave a large quantity of fruit on the strong part, and remove the whole, or greater part, from the feeble.* We know already that the fruit has the property of attracting to it the sap from the roots, and of employing it entirely to its own growth. The necessary result of this is, what we are about to point out—viz., that all the sap which arrives in the strong parts will be absorbed by the fruit, and the wood there, in consequence, will make but little growth, while on the feeble parts, deprived of fruit, the sap will all be appropriated by the growing parts, and they will increase in size and strength.

“3. *Bend the strong parts, and keep the weak erect.* The more erect the branches and stem are, the greater will be the flow of sap to the growing parts; hence, the feeble parts being erect, attract much more sap than the strong parts inclined, and, consequently, make a more vigorous growth, and soon recover their balance. This remedy is more especially applied to espalier trees.

“4. *Remove from the vigorous parts the superfluous shoots as early in the season as possible, and from the feeble parts as late as possible.* The fewer the number of young shoots there are on a branch, the fewer there are of leaves, and, consequently, the less is the sap attracted there. Hence, in leaving the young shoots on the feeble parts, their leaves attract the sap there, and induce a vigorous growth.

“5. *Pinch early the soft extremities of the shoots on the vigorous parts, and as late as possible on the feeble parts, excepting always any shoots which may be too vigorous for their position.* By thus pinching early the strong parts, the flow of sap to such point is checked, and naturally turns to the growing parts that have not been pinched; this remedy is applicable to trees in all forms.

“6. *Lay in the strong shoots on the trellis early, and leave the feeble parts loose as long as possible.* Laying in the strong parts obstructs the circulation of the sap in them, and, consequently, favors the weak parts that are loose. This is only applicable to espaliers.

“7. *In espalier trees, giving the feeble parts the benefit of the light, and confining the strong parts more in the shade, restores a balance,* for light is the agent which enables leaves to perform their functions and their actions on the roots, and the parts receiving the greater proportion of it acquire the most vigorous development.

“II. *The sap acts with greater force, and produces more vigorous growth on a branch or shoot pruned short, than on one pruned long.* This is easily explained. The sap acting on two buds must, evidently, produce a greater development of wood on them than if it were divided between fifteen or twenty buds.

“It follows from this, that if we wish to obtain wood branches, we prune short, for vigorous shoots produce few fruit-buds. On

the contrary, if we wish to obtain fruit branches, we prune long, because the most slender or feeble shoots are the most disposed to fruit.

“ Another application of this principle is, to prune short for a year or two such trees, or parts, as have become enfeebled by over-bearing. (This principle deserves especial attention, as its application is of great importance.)

“ III. *The sap tending always to the extremities of the shoots, causes the terminal bud to push with greater vigor than the laterals.* According to this principle, when we wish a prolongment of a stem or branch, we should prune to a vigorous wood-bud, and leave no production that can interfere with the action of the sap on it.

“ IV. *The more the sap is obstructed in its circulation, the more likely it will be to produce fruit-buds.* This principle is founded on a fact to which we have already had occasion to refer—viz., that the sap circulating slowly, is subjected to a more complete elaboration in the tissues of the tree, and becomes better adapted to the formation of fruit-buds.

“ This principle can be applied to produce the following result: When we wish to produce fruit-buds on a branch, we prevent a free circulation of the sap by bending the branches, or by making annular or circular incisions on it; and, on the contrary, when we wish to change a fruit branch into a wood branch, we give it a vertical position, or prune it to two or three buds, on which we concentrate the action of the sap, and thus induce their vigorous development.

“ V. *The leaves serve to prepare the sap absorbed by the roots for the nourishment of the tree, and aid the formation of buds on the shoots. All trees, therefore, deprived of their leaves are liable to perish.* This principle shows how dangerous it is to remove a large quantity of leaves from trees, under the pretext of aiding the growth, or ripening of fruits, for the leaves are the nourishing organs, and the trees deprived of them cannot continue to grow, neither can the fruit; and the branches so stripped will have feeble, ill-formed buds, which will, the following year, produce a weak and sickly growth.

“ VI. *Where the buds of any shoot or branch do not develop before the age of two years, they can only be forced into activity by a very close pruning, and, in some cases, as the peach, this, even, will often fail.* This last principle shows the importance of pruning the main branches of espaliers particularly, so as to ensure the development of the buds of their successive sections, and to preserve well the side shoots thus produced, for, without this, the interior of the tree will become naked and unproductive, and a remedy will be very difficult.

“ If these principles and practices of pruning be carefully studied

in connection with the habits of growth and bearing of the different fruit trees, pruning will be comparatively an easy matter. The mode of obtaining any particular form or character cannot fail to be perfectly plain and simple: yet no one need hope to accomplish, in all things, the precise results aimed at, for even the most skillful operator is sometimes disappointed; but those who give constant attention to their trees will always discover a failure in time to apply a remedy."

Training. We give the accompanying (fig. 22), taken from "Loudon's Encyclopædia of Gardening," merely as illustrative of the varied modes of training trees in England. Our more favored land requiring no such practice to enable trees to produce abundantly, the forms are only seen in some small gardens, or when the useful and ornamental are attempted to be combined, in training a tree to hide some out-building or unsightly prospect. As the foregoing principles are sufficient, connected with the illustration, to enable almost any one to practice, we add only the terms by which each form is known: *a*, the herring-bone fan; *b*, the irregular fan; *c*, the stellate fan; *d*, the drooping fan; *e*, the wavy fan; *f*, the horizontal; *g*, the horizontal, with screw stem; *h*, the vertical, with screw or wavy shoots; *i*, same, with upright shoots.

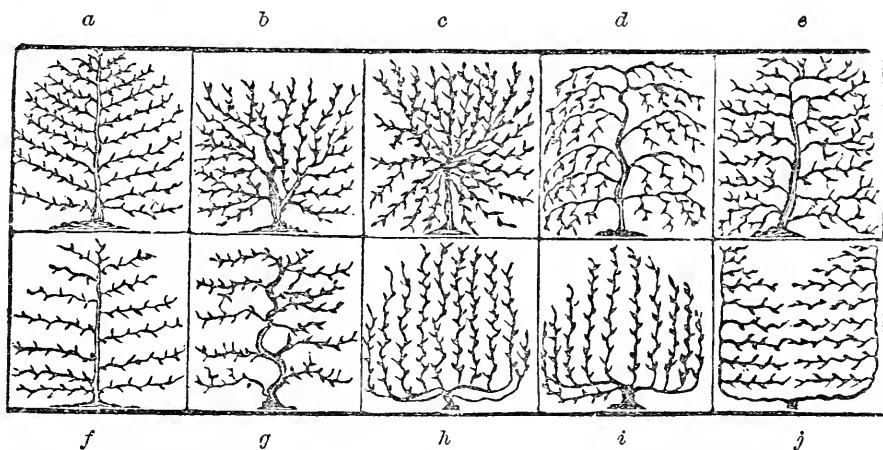

Fig. 22.

Labels. For nursery rows, the best are stakes of red cedar or pine, about eighteen inches long, and four wide, having one side smooth, painted with white paint, or even oiled, and written on with a soft lead pencil, before the oil or paint has dried, and driven down one foot into the ground, at the commencement of each variety.

For standard trees, slips of wood, three inches long, and half an inch wide, and either painted and written on as above—or, having the name burned in with iron type, which is better—then secured to

a side branch by strong copper wire, are those most in use. Labels are also made of sheet zinc, written upon with a mixture of two parts (by weight) of verdigris, two of sal-ammoniac, one of lamp-black, and thirty of water. The ingredients are to be mixed in a mortar, with a small portion of water at first, and the whole added afterwards. Preserve the mixture in a well-corked bottle, shaking it repeatedly at first, and keep the cork downwards, to prevent the escape of ammonia, and it will remain fit for use for years.

If the pieces of zinc are suspended by copper wire, it should be firmly twisted round the zinc, so as not to remain loose, or else the constant motion, from wind, will soon wear off the wire. The wire should be nearly as large as a small knitting-needle, to prevent cracking off by long use. The loop should be large, and passed round a side-shoot, instead of a main branch, to prevent the danger of cutting in by the growth of the tree, and should be attached below a small fork, to prevent its blowing off the end of the branch.

The wire may be wholly dispensed with by the following contrivance: cut the zinc into long triangular strips, half an inch wide and six to ten inches long. Draw the narrow or slender end round the twig, bring it through a hole punched mid-way between the ends, and clinch or twist it with the fingers or a small pair of pincers. These labels may be punched by a tinman at a cheap rate.

Sheet tin may be used instead of zinc, using a sharp awl to write the name, and being particular to cut through the tin coating. Oxidation soon renders the letters distinct. Common pasteboard printed with printers' ink has recently been introduced.

Protection. It often happens that young orchard trees are injured by sheep and rabbits. A simple method for protection is to take three strips of common lath, set them up around the tree, and with strong wire secure them one to another. If closely placed, they will also serve to protect in a great measure from mice; but for protection from the latter, strong "hardware paper," as it is termed, secured around the tree by fine wire, and coated with coal tar, is best.

The form of young trees most desirable for planting, are those so grown as to present a regular tapering form of stem from the root to the terminal bud. This is only obtained by permitting the side branches to grow, and be regularly shortened-in in the nursery, so that not only the stem but the whole tree presents the form of a pyramid. One tree so grown is worth more to the planter than ten grown with long slender stems of uniform size, six or seven feet high. A tree rightly grown (as first described) will have double the quantity of roots, and when removed will need no staking, while the latter will require staking four or five years, and then never make a fine tree.

CHAPTER IV.

DEGENERACY OF VARIETIES—LIMITED AGE. ETC.—INFLUENCE OF SOILS—CLIMATE—STOCKS.

THE theory of degeneracy of varieties at certain periods of existence in the parent tree, once had strong supporters; but we have never been able to reconcile it with any known laws of vegetable life. That all cuttings taken from a seedling plant, no matter how propagated, are but the continuation of a single plant, having existence in a healthy state only so long as the original exists in vigor and health, although advocated, and with considerable reason, is a proposition we cannot accede to. Not only is this adduced as correct, but also that no variety can be procured of a healthy origin except grown on the principle of Van Mons, from seed of a wildling. The failure of varieties to produce fruit on trees of an advanced age, and without care, of size equal to its first appearance when the trees were young, is often cited as evidence of the "running out" of that variety; those so citing seeming not to know that fruit is being produced elsewhere on younger trees, under good treatment, fully equal or surpassing the original. All seedlings are not equally vigorous and healthy, whether grown from a wildling or a cultivated variety; and some varieties are undoubtedly unhealthy when propagated; but that they are more so on account of the term of years they have been continued, admits of doubt. That every tree has its natural limit of life, and this natural limit shortened or lengthened as the tree is over stimulated or evenly treated, we do not question; but that every bud taken from a tree, propagated in various sections of soil and climate, on seedling stocks, or otherwise, must decay at or near the time of the original tree, is a point of belief to which we have not yet arrived. The white Doyenné Pear, the Pennock Apple, the Golden Pippin, have all been cited as evidence to sustain the theory, and yet we have grown all in as perfect state as could be desired by the most critical.

The influence of soils on both tree and fruit is now well known among horticulturists, and the exhaustion of the soil is too often, unwittingly, made to support the theory of degeneracy of varieties. We have repeatedly remarked that it is requisite for the orchardist to fully understand the nature of soil requisite for each distinct variety. We do not believe a fruit originating in soil abundantly supplied with lime will preserve the same character and quality when grown in one deficient in that material. Analysis has shown us somewhat of this,

while practical experience is teaching it yearly, in the evidence of rot, &c., exhibited in varieties grown on trees long unsupplied with aught but the natural ingredients of the soil. As under the head of each variety of fruit we give the analysis belonging thereto, we shall not extend remarks here on a subject too well understood and accepted to require argument in its support. The influence of climate on varieties has the effect to create more or less rapid growth of both tree and fruit, as we go north or south, causing in the tree a coarser, more spongy, soft wood, and more subject to injury from sudden changes of atmosphere, when grown south; and in the fruit, greater size, more open and coarser texture of flesh, and corresponding depreciation in flavor, with earlier maturity in the apple and pear; but the peach, apricot, and nectarine, have additional character and sweetness, as the juices are more elaborated.

The influence of Stocks on varieties seems one not easily explained; for while all know that to propagate a strong growing variety upon a slow growing stock has a tendency at once to reduce its growth of wood and create a fruitful habit, and the reverse, when a slow grower is placed on one of vigorous habit, yet the reason why fruit is better or worse in quality when grown on varied stocks and subject to like soil, has not been explained. Seedling stocks, as most used by nursery-men, are not all alike vigorous or hardy; hence the apparent difference in trees propagated on them and removed to various locations. Under each variety of fruits, we give such information as we have been enabled to gain of the adaptation of certain stocks to the variety, and refer thereto for further remarks.

CHAPTER V.

GATHERING FRUIT—TIME WHEN—FRUIT-ROOM FOR KEEPING AND RIPENING.

THE gathering of hardy fruits, such as apples, pears, quinces, grapes, etc., should be performed in the middle of a dry day, not in the morning before the dew is evaporated, nor in evening when it is depositing; neither should they be gathered immediately after a rain. All fruits should be left until the full size is acquired; but under our clear sun, most varieties of pears are improved if they

are gathered and permitted to mature their juices in the house. If on raising the fruit level with the foot-stalk it separates, it may be accounted ripe; or, if one be cut open, and the seeds found well colored brown or blackish, it is time to pull them. Gathering, with "fruit gatherers," is esteemed most perfect, but if we could induce all our orchard farmers to gather by the hand, we should consider we had accomplished very much. Step-ladders, as seen in fig. 23, are used to facilitate the operation.

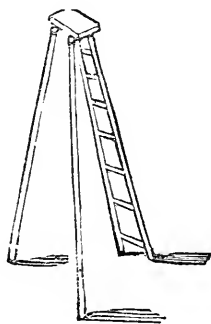

Fig. 23.

The delicate thin-skinned varieties of winter apples should be gathered some ten days earlier than the thick-skinned varieties, if it is intended to have them keep well.

Of the quality of pears being varied by the process of ripening, much has been said, and often with great reason and truth.

The following description of a fruit room is from a foreign journal, and regarded as valuable. Hon. M. P. Wilder, of Boston, has a house built after this manner, except, that in place of the cavity between the inner and the outer walls, the space is filled with charcoal, as a non-conductor, and deemed an improvement, in that it produces a cooler temperature in Summer.

"Experience has shown that fruit will not keep well on the tree, after the latter has ceased to grow; nor will its flavor be so good, because the stoppage of vegetation implies a corresponding fall of the temperature; consequently, the elaboration of the fluid in their tissues cannot be effected. On the contrary, we commonly see fruit become shriveled and dry, if gathered too soon. Hence, the necessity of gathering fruit at two different periods, from one and the same tree. First, from the lower half of the tree, where vegetation ceases first, and eight or ten days later, from the upper half, or extremities of the tree. For this reason, fruits are sooner fit for gathering from espalier trees than from standards; and likewise, sooner from old trees than from young and luxuriant ones. The best guide for ascertaining whether they are fit for gathering, is their easy parting from the tree. The different kinds of nuts, walnuts, chestnuts, etc., are better in flavor, and preserve best, if left on the tree until they drop of themselves. Grapes, destined for either immediate consumption, or to be preserved, must first have attained complete maturity. The longer grapes are allowed to hang, the more their saccharine properties will be enriched. In localities where grapes ripen in the open air, they should be kept from those ripened in houses or on espaliers. In storing fruit, fine dry weather should be chosen, as then it is charged with less humidity, consequently, in the best condition for being laid on the shelves of the fruit room. The best method of gathering fruit is to pluck it off singly with the hand, care

being taken not to cause the least pressure, which would produce a brown speck, and, ultimately, decomposition. Various contrivances have been introduced for the purpose of gathering fruit without the aid of a ladder, but practically, they require too much time, and therefore, a common ladder is, perhaps, the most convenient after all. Long, shallow, and wide cross-handled baskets, having a piece of carpet at the bottom, are in general use about Montreuil. In these baskets the fruit is placed in layers—three layers, separated by leaves, being the usual contents of each basket, which, as they are filled, are carried gently to the fruit room on the head. The fruit, we shall now suppose, having been gathered with due care, and at the proper time, the first condition necessary to preserve it during the winter, is perfect immunity from frost. The process of ripening should also be promoted or retarded, according to circumstances, so as to have only a certain number ready for dessert at one time, thus keeping up a succession from the time they are gathered till the succeeding year's fruit come in. For this purpose, the fruit room should have the temperature uniform and equal; for frequent change of temperature absorbs the fluids, and fermentation soon follows. The temperature should be from 46 to 48 deg. Fahr. A higher temperature would accelerate the process of ripening too much, and a lower would retard it. If fruit is placed in a room or cellar where the temperature is very low—say an ice-house—it will keep a long time, if not destroyed by moisture; but, before it is wanted for dessert, it should be exposed for some time in a higher temperature to attain complete maturity. Light is found unfavorable to the keeping of fruit, and therefore, it should be excluded. The atmos-

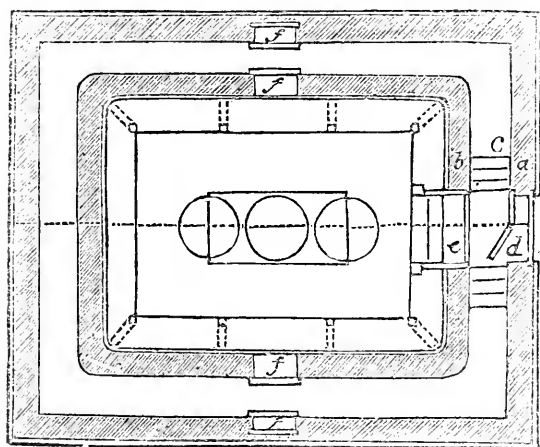

Fig. 24. Ground Plan of a Fruit Room.

phere should be kept rather dry than humid, and the fruit should be placed separately, so as not to touch one another. We would select a northern aspect, and dry place, sheltered, if possible, by high evergreen trees, for the purpose of building the fruit room; the quantity of fruit to be preserved must determine its dimension. The annexed plan is fifteen feet long by twelve feet wide, and nine feet high (inside measure). In a room of this size, 8,000 fruit can be conveniently preserved. It is surrounded by two walls (fig.

24, *a* and *b*). A body of air is interposed between the two walls, and *c*, and which serves to keep the interior from exterior atmospheric influence. The walls are one foot and a half thick, and are built of wood, clay, and straw, which on account of being bad conductors, are preferable to common masonry. The ground (or floor), both in the interior, and at *c*, are made of the same material as the walls. The entrance door is at the north side. In the exterior wall is a double door, *d*, one to open at the outside, and the other in the inside. The door *e*, which is a single one, opens direct into the fruit room, and in severe weather, it is filled up with straw. Four wooden shutters, *f*, two in the interior, and two at the exterior wall, are placed four feet off the ground, and level, for the purpose of cleaning and airing the fruit room, before fruit is put into it. The ceiling is composed of a layer of moss, maintained and covered with laths; the outside is thatched, projecting beyond the exterior wall.

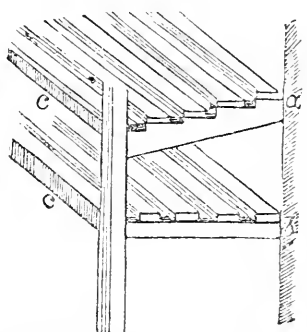

Fig. 25. Section showing the arrangement of the Shelves.

In the interior, benches, or shelves, (fig. 25), from the bottom up to the ceilings, are placed a foot above one another. To facilitate the inspection of the fruit, the shelves above four feet from the ground are placed at an angle of 45 deg., *a*, in the form of a stage; the lower ones are fixed horizontally, *b*. To ensure the circulation of air between the shelves, they are divided in five parts, and a space of an inch left between each of them; those in front, *c*, are provided with a ledgeboard. The centre of the fruit room is reserved for a table (fig. 24), of about six feet long by three feet broad, for the purpose of receiving the fruit previously to being arranged upon the shelves. Such, then, is the mode of constructing a fruit room, by the aid of which we are enabled to furnish the table with an equal quantity of dessert fruit every day throughout the year. When the fruit is brought into the fruit room, they are at first placed upon the central table, which is provided with a quantity of dry moss or cotton; and after having been sorted, all the bruised ones are removed; the sound ones are left for three or four days, to throw off the superabundant moisture; when this has been effected, the shelves are covered with a thin layer of perfectly dry moss or cotton. The fruit are wiped with a piece of flannel, and placed one by one upon the shelves, not touching one another. Grapes can, also, be preserved for a length of time in this place, having been gathered as described above, and taken to the fruit room. Every branch is examined, and the injured berries cut out carefully with a pair of scissors, and fixed the reverse way to a metallic hook, of the

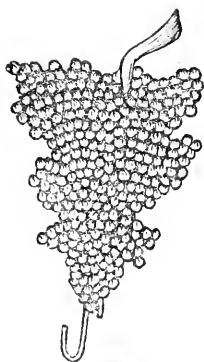

Fig. 26. Method of suspending clusters of Grapes.

form of an S. (Fig. 26.) Attached thus, they are less likely to rot, because the berries are placed in a freer position, and do not touch each other. They are hooked to one or two hoops, as shown at fig. 27, and suspended with a cord to the ceiling, and made movable with two pulleys. Having thus all the fruit

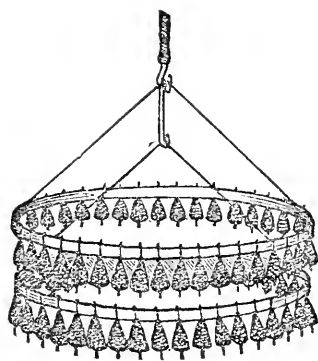

Fig. 27. Movable frame for suspending the Grapes.

disposed in the fruit room, the doors and shutters are opened during eight or ten days, to deprive the fruit of the superabundant moisture; and after this has been done, a fine dry day is chosen to close the fruit room hermetically. The doors are no more opened, except for the work necessary to be done in the interior. Until now, no other mode was known of drying-up superabundant moisture in fruit rooms during winter, except by permitting a greater or less current of air to pass through the apartment. The inconveniences this plan presents are obvious; the interior temperature will change according to the exterior; and, bad as this plan is, if the thermometer stands under freezing point, no use can be made of it at all; hence, the fruit must be abandoned to chance, and disappointment will soon follow. In this case, we recommend the use of chlorine of calcium. This substance has the property of absorbing about double its own weight of moisture, when it becomes liquid after being exposed for a certain length of time to a humid atmosphere, produced by the moisture emitted by the fruit. It is thus suited to maintain the atmosphere in the best condition. To use chlorine of calcium, a wooden box is

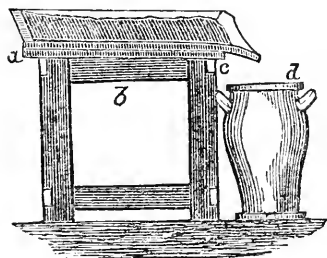

Fig. 28. Box for using the Chlorine of Calcium.

made (fig. 28, *a*.) one foot and a half square by three inches deep, and placed upon a table, *b*, which is at the side, *c*, an inch lower than on the other. The chlorine of calcium, after having absorbed a certain quantity of moisture, becomes liquefied, and runs into the earthenware vase, *d*, placed underneath for the purpose. Should the chlorine become dissolved before the total consumption of the fruits, the dose must be renewed; in

which case, the liquid in the vase, if put in a pan, and placed above the fire, becomes again chlorine of calcium, and as good for use as before.

Fruit in Cellars.—"A great deal of winter fruit suffers early decay, in consequence of a deficiency of ventilation, especially during Autumn, and after the fruit is deposited. Another cause of decay, is the improper location of the shelves or bins, which are placed against or around the walls. By this inconvenient arrangement, the assorting of decayed specimens must be done all from one side, and the shelves must hence be very narrow, or the operator must stretch himself in a most irksome horizontal position. The circulation of the air is, at the same time, greatly impeded by the want of space next the walls. To avoid these evils, the shelves should be in the centre, with a passage all around. This allows circulation of air; and the shelves may be twice the width, with the same conveniences in assorting or picking. If suspended from the joists above, on stiff bars, rats cannot reach them. It is said, that the Germans are very successful in the ventilation of their cellars, by a communication with the principal chimney, the heated air in which necessarily maintains a current, which sweeps out the noxious and stagnant gases from the vegetable and other contents."

THE ALMOND.

Amygdalus communis—Dec. *Rosaceæ* of Botanists.

THE almond tree is a native of the north of Africa, of the mountains of Asia, and of Russia. Linnæus places it in the same genus with the peach and nectarine, and many botanists regard it as the parent of both—the fruit of almond, peach, and nectarine, it is said, have been found growing naturally upon the same branch. How true this may have been, when so recorded, we do not know; but we do know that nature produces no such variations in the present age. The tree bears a general resemblance to the nectarine, but is easily distinguished by its more glossy leaves, and the peculiar color and hardness of the wood. The flowers resemble those of the peach, but are larger than most varieties, and produced in greater profusion. It is a fruit which has been too much neglected, and especially in our South-Western States, where it should be grown in such quantities as to entirely exclude importation from Europe.

Propagation. Easily grown from seed, which should be placed in sand, kept moist during the Winter, cracked in Spring, and sown in drills three feet wide, and one pit every eight inches in the drill, covered two inches deep. Varieties are continued by budding on the wild plum (which is best) the peach and almond. In light soils, the peach answers a very good purpose, but for strong, rich soils, the plum is best.

Soil, Hardihood, and Cultivation. The soil should be well drained, but in our clear, sunny clime, a warm, sandy soil is not essential. The long, hard shell variety is hardy, and productive in the middle and portions of the Northern States; while South, the soft shell, or ladies' almond, is grown without difficulty. The cultivation needed is the same as that of the peach.

Uses. The kernel of the sweet almond is esteemed as an article of food, and used in confectionery, cookery, and perfumery. Bitter almonds are used in medicine, furnishing somewhat of the prussic acid of the shops.

VARIETIES.

CLASS I. *Varieties generally esteemed.*

LONG HARD SHELL.

Long Hard Shell Almond, | Amandier a gros fruit, | Amandier a gros doux.

Flowers, large, pale rose color, opening before the leaves; *stone*, about as large as the soft shell, but the kernel larger and plumper; very hardy; ripens about last September.

LANGUEDOC.

Great-fruited Sweet, | Great Soft Shell, | Large Persian.

The trees are hardy, but its fruiting qualities we do not know. It is said to be very large and sweet.

SOFT SHELL SWEET.

Soft Shell Sweet Almond, Doux a coque tendre, Amandier a coque tendre,		Ladies Thin Shell, Sultan a coque tendre,		Amandier des Dames. Ou Amande Princesse.
--	--	--	--	---

This is the variety common in the shops of the confectioners, with a shell so thin as to be easily crushed between the fingers, and the kernel of which is so generally esteemed at the dessert. The flowers open at the same time with the leaves, and are deeply tinged with red. *Fruit*, oval, compressed; *nut*, oval-pointed, one-sided, tender shell; *kernel*, sweet; ripens in August or in July at the South, where it is only adapted.

CLASS III. *Varieties superseded by better sorts.*

COMMON ALMOND.

Common Sweet, | Amandier a petit Fruit, | Amande Commune.

A variety usually found in nurseries; inferior to the Long Hard Shell.

SULTANA SWEET ALMOND.

Amande Sultane, | Sultan.

A tender-shelled variety; inferior to the Soft Shelled Sweet.

PISTACHIA SWEET.

Amande Pistache.

Small, pointed, inferior fruit.

PEACH ALMOND.

Pecher, | Amandier Pecher.

A cross between the peach and almond. Nearly sweet—often bitter.

BITTER ALMOND.

Differing from the common almond in its bitter kernel.

THE APRICOT.

Armeniaca vulgaris—Dec. *Rosaceæ* of Botanists.

THE common apricot is a fruit tree in occasional, but not general cultivation. It is of olden date, having been mentioned by Columella, and, afterward, by Pliny and Dioscorides. The latter describes it as known in Italy under the name *præcocia*; while the former mentions that it was introduced into that country about the sixteenth year of the Christian era. Thunberg describes it as abounding in Japan, and attaining the size of a large spreading tree. "The Chinese," says Grossier, "have many varieties, which they cultivate both for ornament and use." The barren mountains west of Peking are described by the same author as being covered with these trees; and Professor Pallas states it to be "a native of almost the whole range of the Caucasus." It is also stated to be from Armenia and Arabia, and its name, derived from the Arabic, *berkoche*, whence the Tuscan, *bacoch* or *albicoco*, and the English *apricock*, and, finally, apricot, about the end of the last century. Coxe, in his work, published in 1817, says of the apricot: "This fruit is extremely tender in our severe Winters, in exposed or open situations, unprotected by a wall;" and similar statements have been made by writers, from time to time, until, on account of this erroneous impression, of late years its cultivation has been too much neglected. It is not more tender as a tree than our sweet cherries; and, contrary to general statements, they do not require sheltered southern positions, for, in climates like ours, such situations are the most objectionable, tending suddenly to excite or check the circulation of sap, expanding and breaking the tissue of liber, often destroying the tree in an hour, during the months of February or March, although not, perhaps, apparent until the flow of sap commences returning toward the root, in June or July following. Northern or eastern exposures are best, but, in southern or western positions, shielding the bodies and lower limbs with cotton cloth dipped in whitewash, will often act as a preventive. The trees should be shortened-in "freely," as with the peach; and standards should always be grown more in manner of round-headed dwarfs, than otherwise; for, if so grown, injury to the fruit from late Spring frosts can often be prevented, by covering them with a cloth.

Propagation. The apricot is generally propagated by budding on the plum. The small, yellow wild plum of our Western States makes

one of the best stocks for it. Some use the peach, which answers very well on light, sandy soils, but generally gives too much tendency to wood growth, rather than producing fruit. The seeds grow readily, and pits from isolated trees often produce very good sorts; few, however, ever get into notice, from not surpassing the parent in size, although often proving more hardy and productive. Budding into the limbs of a standard peach, or plum tree, has been thought to add hardihood to the apricot.

Soil and Diseases. Deep, strong, loamy, but not wet soils, are best adapted to successful fruiting the apricot, although they are often grown readily and beautifully on light sand. In the latter case, however, it requires mulching or free watering, otherwise the tree ripens its wood and drops its fruit before fully matured.

The diseases belonging to the apricot as a tree are only the result of exposure, as stated previously; but the fruit is a favorite of the curculio, and frequently destroyed ere half grown. Trees trained against buildings and near walks are often exempt from attacks of this insect.

Uses. "A very handsome and delicious dessert fruit, only inferior to the peach, ripening about Midsummer, after cherries and before plums, at a season when it is peculiarly acceptable. For preserving in sugar or brandy, for jellies or pastries, it is highly esteemed, and, where it is abundant, an admirable liquor is made from the fruit; it is also dried for winter use." It is also used, when partially grown, in the preparation of tarts.

VARIETIES.

CLASS I. *Most generally esteemed.*

BREDA.

Amande Aveline, De Hollande,		Ananas, Persique,		Hasselnussmandel.
---------------------------------	--	----------------------	--	-------------------

This old variety withstands severe frosts in Spring, is hardy as a tree, a good grower, productive although small, and hangs well, even after ripe. *Fruit*, small, roundish, often approaching four-sided; *suture*, well marked; *skin*, orange, becoming rich, brownish orange in the sun; *flesh*, deep orange, parting freely from the stone, juicy, rich, and high-flavored; *stone*, small, roundish, compressed; *kernel*, sweet. *Season*, first of August.

HEMSKIRKE.

A foreign variety, ripening at same time as the peach apricot. Tree very short-jointed wood. *Fruit*, above medium, roundish, compressed; *skin*, orange, with a brownish red cheek; *flesh*, bright, clear orange, tender, juicy, rich flavor; *stone*, small; *kernel*, partially bitter. *Season*, last of July.

LARGE EARLY.

Gros Precoce, De St. Jean,		De St. Jean Rouge, Gros D'Alexandrie,		Gros Freche.
-------------------------------	--	--	--	--------------

This proves to be the finest large early apricot known, and an abundant bearer; foliage large, leaves tapering toward the footstalks, with little ear-like appendages in place of glands.

Fruit, medium size, oblong, compressed; *suture*, deep; *skin*, downy, pale orange in the shade, fine bright orange, with a few ruddy spots, in the sun; *flesh*, pale orange, rich, juicy, separates freely from the stone; *stone*, brown, much flattened, oval, perforated along the back from base to apex; *kernel*, bitter. *Season*, 10th to 15th July.

MOORPARK.

Anson's, Dunmore, Sudlow's Moorpark, Oldaker's Moorpark, De Nancy, Anson's Imperial,		Peche, Peche Gros, Temple's, Dunmore's Breda, Hunt's Moorpark,		Walton's Moorpark, Peach, Royal Peach, Abricot Peche, Wurtemberg.
---	--	--	--	---

This variety has its name from Moorpark, the seat of Sir William Temple, who began gardening in England about 1672, and previous to his decease, in 1698, this variety was cultivated. Moderate bearer. *Fruit*, large, roundish, about two and a quarter inches diameter each way, larger on one side of the suture than the other; *skin*, orange in the shade, but deep orange, or brownish red, in the sun, marked with numerous carmine specks and dots; *flesh*, firm, bright orange, parting free from the stone, quite juicy, with a rich and luscious flavor; *stone*, uneven, peculiarly perforated along the back, where a pin may be pushed through nearly from one end to the other; *kernel*, bitter. *Season*, early in August.

We have been unable to detect any difference between the Moorpark and Peach apricot, and have, therefore, made the Peach a synonym of Moorpark.

MUSCH.

Musch Musch,		D'Alexandrie		Gros Musch.
--------------	--	--------------	--	-------------

This variety takes its name from the city of Musch, on the frontiers of Turkey in Asia. The Moorpark is often sent out for this variety, and so, receiving it from three different sources, we for a long time supposed them identical. The true variety is not of quite as strong growth as Moorpark, wood being very short-jointed. *Fruit*, medium, roundish, about one and a half inch in diameter; *skin*, rich yellow, with orange red spots and marblings on the sunny side; *flesh*, yellow, tender, melting, sweet; *kernel*, sweet. *Season*, last of July.

ROMAN.

Abricot Commun, Germine,		Grosse Germine, Transparent.
-----------------------------	--	---------------------------------

A strong grower, hardy tree, suited to cold, unfavorable situations; good bearer; poor flavor. *Fruit*, medium, oblong, compressed, pale yellow, dotted with a few red spots; *flesh*, dull yellow, soft, dry; *stone*, oblong; *kernel*, bitter. *Season*, 1st of August.

CLASS II. *Embraces varieties, of which many are new and untested, and others suited only to large orchards or certain localities.*

BLACK.

Purple, | Noir, | Du Pape.
Angoumois, | Violet, |

Fruit, small, resembling a plum, round, reddish violet, or purple; *flesh*, tender, juicy, adhering to the stone, astringent; *kernel*, sweet. *Season*, August. George Hoadley, Esq., informs us that this variety has been brought from Germany under name of "Hamburg Apricot," probably from Booth's nursery, near Hamburg.

BROWN'S EARLY.

Origin, Chelsea, Mass. *Fruit*, large, short oval, yellow, bright red cheek; *flesh*, yellow, melting, rich, juicy, luscious flavor. *Season*, middle to last July.

BURLINGTON.

This variety originated at Burlington, N. J., from a seed of the peach apricot, planted by Mrs. Sarah Woolman, in 1838. Native soil, poor gravel. Tree, vigorous; young wood, reddish. *Fruit*, medium size, oblong, somewhat compressed at sides, with distinct suture; *skin*, golden yellow, with red spots, and a ruddy cheek in sun; *flesh*, yellowish, juicy, fine flavor; *stone*, rough, perforated. *Season*, last of July.

EARLY GOLDEN.

Dubois' Early Golden, | Dubois' Early Golden Apricot.

Raised by Charles Dubois, Fishkill Landing, N. Y. Tree, thrifty yet close wood, hardy, productive.

Fruit, small, one and a quarter inch diameter, roundish oval, narrow suture; *skin*, smooth, pale orange; *flesh*, orange, moderately juicy and sweet, but not high flavor; separates from the stone; *kernel*, sweet. *Season*, 10th to 15th July.

KAISHA.

From Syria, new, and but recently introduced into this country. The Journal of the London Horticultural Society, describes it as "roundish, semi-transparent, skin slightly downy, pale citron color in shade, tinged, and marked with red in sun. *Flesh*, tender, juicy, citron color, sugary and delicious, parting freely from the stone, which is small roundish, with a sweet kernel."

LAFAYETTE.

Origin, City of New York. Tree, remarkably vigorous; *fruit*, very large, oval; *skin*, light yellow, marbled with red next the sun; *flesh*, high-flavored and excellent. Ripens in August. (W. R. Prince.)

LARGE RED.

Under this name we received a tree three years since, but it has not yet fruited. Mr. Downing, in the Horticulturist, speaks of it as large, round dark orange red, sweet, and juicy.

NEWHALL'S EARLY.

Origin, Lynn, Mass. *Fruit*, medium, short, oval, bright orange, deep red cheek, tender, juicy, rich delicious flavor; clingstone. *Season*, last July, early in August. (Cole.)

RINGOLD.

Originated, Athens, Ga. *Fruit*, large, roundish, a little oblong; *suture* slight; *skin*, light orange, darker in the sun, where it is beautifully dotted with carmine; *flesh*, deep yellow, juicy and excellent. Ripens just after the orange; hardy and productive. (Wm. N. White.)

ROYAL.

Abricot Royale.

A French variety, with large leaves, and vigorous habit of growth. *Fruit*, above medium, roundish oval, slightly compressed, dull yellow, with a little red; *flesh*, pale orange, firm and juicy. Last of July.

SHAKER PARA.

A variety not yet, to our knowledge, introduced. We have only seen it in the Journal of the London Horticultural Society. Its name, meaning "bit of sugar," is the only description given.

SHIPLEY'S.

Shipley's Large, | Blenheim.

From England; a good grower, and productive. *Fruit*, large, oval' orange yellow, juicy, sweet; *kernel*, bitter. *Season*, last July.

TEXAS.

Originated, Athens, Ga. *Fruit*, small, round, color dark maroon, darker in the sun; *suture*, slight, a mere line; *flesh*, juicy and pleasant, except at the stone, where it is astringent. Adheres to the stone. (W. N. White.)

TURKEY.

Large Turkey, | De Nancy.

Fruit, medium, round, deep yellow in the shade, mottled with brownish orange in the sun; *flesh*, pale yellow, firm, juicy; *kernel*, sweet. *Season*, middle August.

The Blotched Leaved Turkey, or Gold Blotched, is a sub-variety, in all respects resembling the common Turkey, except having most of the leaves more or less blotched with yellow.

CLASS III.—*Varieties superseded by better sorts.*

ALBERGE.

Albergier.

Fruit, small, roundish, yellow; *flesh*, firm, vinous. Middle of August.

BRUSSELS.

Fruit, medium, oval, compressed, pale yellow, with dark brown specks; *flesh*, yellow, firm, brisk flavor; *kernel*, bitter. Middle of August.

ORANGE.

Early Orange,	Royal George,	Royal Persian.
Royal Orange,	Persian,	

Fruit, medium, roundish, orange color, with a ruddy tint in the sun; flesh, dark orange, dry, insipid; kernel, sweet. Season, middle July.

RED MASCULINE.

Early Masculine,	Abricot Precoce,	Abricotier.
Brown Masculine,	Abricotier Hatif,	

Fruit, small, round, yellow, spotted with dark red on the sunny side; flesh, yellow, poor flavor; kernel, bitter. Season, middle July.

WHITE MASCULINE.

White Apricot,	Abricotier Blanc,	White Algiers.
Abricot Blanc,	Early White Masculine,	

Differing from the above only in its color, and ripening a few days later.

THE APPLE.

Pyrus Malus, L.—*Rosaceæ* of Botanists.

OF all fruits natural to temperate climates the apple has ever had preference. The "crafte of graftynge, alterynge, and plantynge of fruits," was written on by a British writer in 1502, but it had then long received the attention of "wise men of the East," and had arrived at all the perfection of the present day; the art of producing and propagating varieties, probably, being then as well understood as now, except however, as compared to the population, by a less number of persons. A native, in its wild state, of this country and of Europe, it is generally understood that, from the variety *pyrus malus* of Lindley, our cultivated sorts have originated. Twenty-two varieties are the number first mentioned and named by Roman writers; these have increased, until now, probably, 2,000 would not include the whole number named and partially or wholly described.

To the labors of Thompson, Downing, Thomas, and others, as well as of local and national Pomological Societies, we owe much for aid in winnowing this immense number, the wheat from the chaff; and yet such is the extent of our country, and the habit of all our pioneer settlers to sow seeds of the best apples, that we are yearly in the production of vast numbers of new seedlings, adapted mainly to their own locality only, but occasionally of such excellence as to warrant their general introduction. It is owing to this, that, notwithstanding pomological writers are daily condemning, our list of esteemed varieties is constantly swelling, to the almost utter con-

founding of the seeker after a knowledge relative to "what varieties to plant."

The pecuniary profits of the orchard, especially of apples, is well understood, and no one, who has land in any way suitable, now hesitates to plant. We have no certain data, but think we do not overstate when we say, that, besides large quantities imported from Eastern States, there are propagated and planted annually over 6,000,000 trees in the States of Ohio, Michigan, Indiana, Illinois, and Wisconsin. The Western country is already producing by millions of bushels, and her "orchards," so to speak, are not yet planted. "Such is the value placed on fruit, such the rapid increase of people in cities, that no one should be at all deterred from continued planting; for, we have not only the wants of increased population of our own land to supply, but that of foreign countries. Already our fruits are sent to England and other distant shores, and eagerly sought for and purchased, at what would here be termed high prices. Although the Newtown pippin, as sent from the Pell orchard, on the Hudson river, has done much toward establishing our reputation abroad, we anticipate an advance in good favor, when the same variety grown on our Southern Ohio, Kentucky, Indiana, and Illinois soils, shall be shown; for certainly they are, like all our Western growths, when compared with those of the East, far superior in size.

The duration of the apple when worked and grown on a healthy seedling stock, was regarded by Mr. Knight, of celebrity in horticulture, at 200 years; yet trees are recorded as being over 1,000 years old, and in annual healthy fruiting condition. So also Mr. Knight regarded "many varieties" as in his time "already on the decline," which Coxe, in his "View of Fruit Trees" published in 1817, says "grow and appear more healthy than any variety in the orchard." Trees of over 200 years are known, in this country, to be healthy and yearly producing their abundance of fine fair fruit.

The puberty or fruit-bearing age of the apple tree varies according to variety, climate, and cultivation. In the rich deep soils, and under the clear sun of our Western States, most varieties come into bearing at about eight years from the bud; or about four or five years from planting out. We speak here only of the cultivated varieties. Wild seedlings would probably require from twelve to fifteen years.

Propagation—By seeds. These should be selected, if intended for stocks, from native seedling trees of strong, vigorous, healthy growth. The common practice is to visit a cider mill in the months of October or November, and take therefrom indiscriminately such as first come to hand; but he who desires to grow fine healthy trees had much better purchase the apples from such trees as we describe, and, if he choose, take them to the press himself. The seed should be entirely separated from the pumice or pulp, although much of it will grow

if spread immediately on the land thinly and plowed in lightly ; but this is a coarse, unworkmanlike method. To free it from the pulp, take a coarse sieve. and after it has lain upon boards for forty-eight hours, proceed to sift it ; the next process is washing in tubs, when most of the pulp which passed through the sieve will rise to the top of the water and may be taken off. If the ground is ready it may now be sown, the ground being made rich in vegetable, or partially mixed with *well rotted* animal manure, trenched or plowed twenty inches deep ; sow the seed in drills of about one foot wide and two feet between each drill ; scatter the seed so that when it grows there will be one plant to every two inches, and cover with about one inch of earth, and one inch of leaf mould, or tan bark, or sawdust. Fresh raw manure induces insects, and consequently diseased roots. If the seed is intended for shipment, or keeping over until the Spring planting, boxes not over six inches deep should be procured, with holes made in the bottom for drainage, and then the seed packed in shallow layers with sand or moss, and placed in the open air on the *north* side of some building or fence.

By Grafting. All of the modes described in previous pages are used in propagating the apple. Seedling stocks of a diameter at the crown of from one-quarter to three-eighths inch are the best ; these are generally obtained from seedlings of one year's growth in our rich western soils ; they should be dug up, have their side roots trimmed to within one inch of the main root, and that cut off to about eight inches ; the graft should then be inserted, in the whip or tongue method, just at the crown or union of top and root. The same course may be adopted with seedlings in the ground, with exception of shortening the roots.

Grafting on small pieces of roots, may answer for the growing of some varieties in the nursery ; but very few, when removed, are found to have made much but small fibrous roots ; and when planted in the orchard, require staking for years, and rarely ever make good trees. The practice has been largely followed, but is now condemned by most nurserymen, and that of grafting only on the whole of a root, as first mentioned, advised. Cleft grafting is generally pursued on trees of large size in the orchard, and may be done in October or November often with as good success as in Spring.

Nurserymen generally practice taking up the seedling trees late in Autumn, and heeling them in, as it is termed, viz., covering them, when laid down at an angle of 45° , with earth. This is done in the cellar or root house, from whence they are taken and grafted in February and March, and repacked in boxes just deep enough to allow one inch of sand on the bottom ; and the stock grafted just coming level with the tops, sand is mixed intimately among them, covering all of root and union of graft. They are then set away in a cool place but free from frost, until the day of planting.

By Budding. This course, from the immense demand for trees and the more ready and extended propagation by means of roots, has almost been discarded during the past six or eight years. Budding is now again, however, coming into favor. Stocks for budding should be thrifty, of about half inch diameter, and the bud, inserted about four to six inches above the ground, and as much on the north side of the stock as possible. The time for this is usually the month of August, varying from early to late in month, as the location is South or North, and the season early or late.

By layers and cuttings. This course is only pursued to increase the quantity of stocks of the Paradise apple on which to dwarf varieties. Some growers West, however, have reputation for increasing largely, and making fine saleable trees more rapidly by means of layers, than otherwise. We have never seen them.

Cutting of Scions. These may be cut at any time from the fall of the leaf in October, to the swelling of the bud in Spring—always, however, taking care that there is no frost in the wood at the time of cutting. We consider the best time late in the Fall, when they may be packed in moss, damped, and wrapped in oil silk, laid in a cool cellar, where they will usually keep well until Spring. The wood of the past season's growth is that required, and best to cut, if possible, from bearing trees. When the cuttings are not made until toward Spring, a black and diseased appearance at the pith will oft be seen in those of vigorous growth. This, while it would, perhaps, be of no moment on the original tree, sometimes is thought to lessen the vitality and success of the scion.

Selection of Trees from a Nursery. Trees of thrifty, not over luxuriant habit, five to seven feet high, three years from bud or graft, with branches from three feet up, well formed into rounded heads, are worth twice as much as trees six years old, ten and twelve feet high, without a branch within eight feet of the ground. It should, however, always be recollected by the purchaser, that all varieties have not the same habit and regular form of growth; that while a nursery-man can supply a tree of the Baldwin, straight, and just to the fancy, he may often find it difficult, nay, impossible, to do so with the Fall Wine, American Pearmain, and many other varieties, at the same age; and in his selection he should be guided more by the stocky pyramidal form of the stem, and the position of branches, rather than height of tree.

Influence of Climate and location. Climate, as we have said on a previous page, has no farther influence than to enhance maturity and vigor as we go South; but location, in its preventing of injury from frosts or severe cold, is quite another thing, and deserving the attention of every planter. Too often do we see orchards planted out in the rich level valley of a farm, when the hills around are neglected. Too often on small farms is this done also, to the loss comparatively

of the best piece of plow land, when, had the planter known that trees planted on his hills would have been more hardy, and have produced fruit five years to every three when grown in the valley, he would have, without doubt, made his orchard on his hills. There are some parts of the West, and very much at the East, where the hills are entirely unsuited to the plow; yet by planting with trees, and digging around until of twelve or more years old, they will make the most profitable of orchards.

On the prairies, a belt of trees around the orchard is considered of great benefit in protecting from the sweeping winds, sometimes destructive to fruit and tree. Here also the selection of the highest knolls and oak groves is found best for success in fruit growing.

Influence of Stock on the hardihood. Recently there has been much speculation respecting the hardihood as well as bearing of budded or grafted trees, all of which has doubtless arisen from the indiscriminate use for stocks, of small pieces of roots. That budding will be found in the main any better than the grafting process, when the latter is performed at the crown of a seedling root, we are disposed to doubt, although many good orchardists now favor it. The only point we can see in its favor, is the hardihood of the stock as compared with that of the variety intended to be grown; this will in some varieties make budding the preferable mode, as it is now well known that some, indeed most, of the strong rapid-growing sorts, of Northern or Eastern origin, are somewhat disposed to "bark-burst" near the ground, and to remedy this, budding will be adopted. But again, all seedlings are not alike hardy—although as a whole, more so than worked varieties; and undoubtedly cultivated sorts may be found, which, if worked as grafts on whole roots, and again reworked at three feet from the ground, would ensure as much hardihood as is in the nature of trees; yet this will never be practiced to any considerable extent, on account of its expense in the growing a tree. That the habit of bearing will be increased or lessened by budding or grafting as we advise, is also another feature at this time in dispute, but we can see nothing to favor it, except the fact that trees budded do produce better than roots grafted on the old common indiscriminate practice of using anything in shape of a piece of root, depending on the richness of soil to create from it a tree for sale. For other remarks on influence of stock, see previous pages.

Transplanting. Trees when taken from the nursery should have their roots immediately covered in the ground, on arriving at their destination. Often trees are left out over night on wagons, subject to severe cold and frost, by which, if not ruined, they are frequently so far injured as to check their entire growth one season. We do not like the practice of shortening back the tops of apple trees where they have been taken up with care; but as usually dug, it is requi-

site to success that the top be shortened back, to correspond with the diminished root. One reason for objecting to the shortening-in, is, that it has a tendency to start the top of the tree too thick, and we prefer with the apple to thin out, rather than increase the number of branches.

The mode of planting has been written on a previous page.

The distance apart, for an apple orchard, depends very much on the soil and the variety—rich deep soils requiring a greater distance than shallow ones of inferior quality. And of varieties, such as the Harvest, American Pearmain, Lady Apple, and other stocky or upright growing sorts, twenty-five feet apart would be sufficient; while the Baldwin, Gravenstein, Sweet Bough, &c., or those of rapid broad growth, would need, on rich soil, forty feet.

Soil and Manures. Of the soil, it is impossible to designate any one that will suit all varieties; we therefore, in our text descriptive designate the principal character of the soil suited to each. "All deciduous trees require a considerable proportion of potash for the elaboration of their juices in the leaves, and are prosperous, or otherwise, in proportion to the supply of that substance in the soil. Liebig has shown that the acids generated in plants are always in union with alkaline or earthy bases, and cannot be produced without their presence. * * * Now, the apple tree during its development, produces a great quantity of acid; and therefore in a corresponding degree, requires alkaline, and probably, earthy bases, as an indispensable condition to the existence of fruit."

"It cannot be denied that ammonia, and also the humus of decaying dung, must have some influence on the growth of the tree in such soils, and also in the development of the fruit; but it is most certain, at the same time, that these alone would be inefficient for the production of the fruit without the co-operation of the alkaline bases. The size, and perhaps the flavor of the fruit may be somewhat affected by the organic part of the manure, but its very existence depends upon the presence in the soil of a sufficient quantity of those inorganic or mineral substances which are indispensable to the formation of acids."

"The analysis of the apple (fruit) shows in 100 lbs. of ashes, deprived of carbonic acid, about 13 lbs. of phosphoric acid, 7 lbs. of sulphuric acid, 38 lbs., of potash, and 25 lbs. of soda; these four bodies forming about 83 per cent. of the whole ash:" while analysis of the ash of the wood exhibits about 16 per cent. of potash, 19 of lime, and 17 of phosphate of lime; and in the ash of the bark, about 5 per cent. of potash, 50 per cent of lime, and 3 of phosphate of lime. Another analysis gives 45 per cent. of lime in the ash of the wood. From these it is apparent that on most of our Western soils, application of lime and potash will be found requisite to the production of healthy wood and fruit. Upon much of the heavily timbered

lands of the West, which have been cut and burned, the ashes from the burned wood has furnished all the lime and potash requisite to success for a certain length of time ; but, already there are orchards in Ohio, where application of lime and potash in the form of wood ashes or otherwise, is required in order to retain health of trees, and perfection in fruit. The Western prairie soils require these only ; of all other ingredients they are naturally abundantly supplied, and application of animal manure is not needed.

Cultivation. Cultivation of the soil of a young orchard is as requisite to success as cultivation of a crop of corn ; but while the trees should be kept free from weeds, suckers, insects, and the like, they should not be so stimulated by application of animal or liquid manures as to induce rank growth. All such over-supply of stimulus induces a degree of tenderness in the constitution, early fruitfulness, and consequent early decay. We recall to mind as we write, two orchards planted about thirty-five years since, one of which has always been highly, even excitingly, cultivated, and is now decaying ; while the other has been more regularly and moderately grown, and is now in a healthy fruiting state. All crops besides wheat, rye, oats, and clover, may be grown in an orchard. Potatoes, peas, and corn are most advisable.

Pruning. The pruning of the apple, as an orchard tree, if annually attended, is but a light task ; it should consist mainly of cutting away all branches that have a tendency to cross or overlap one another—to stop back side limbs that are apparently drawing too rapidly and creating irregular form, and to cut out rank shoots. This is the main of orchard pruning, after the heads are once formed, as they should be at planting, or the first year thereafter, by cutting to a regular rounded form. Some varieties produce their fruit upon short spurs on the limbs ; others on the extreme ends of slender shoots of previous year's growth, and must be pruned with reference thereto ; others, again, naturally grow upright and thick, these require thinning out ; while others, are of straggling, rampant habit, requiring only the checking of branches at the ends to maintain an evenly balanced tree ; these points will be found partially noted in our descriptions of varieties. For the art of pruning, to create particular forms for the garden, and of dwarf trees, we refer our readers to a previous chapter.

Insects and diseases. Of insects injurious to fruit trees, Western cultivators have, until within a few years, been comparatively exempt ; they are now, however, through the great amount of importations of trees from the Eastern States, becoming numerous and troublesome.

The Borer, (Saperda bivittata), is increasing ; destroying yearly many trees, and impairing still more. It is an insect that should be watched and checked on its first appearance. It is destructive, not

only to the apple, but the quince, thorn, mountain ash, suffer equally. The perfect insect is a brown and white striped beetle, about half an inch long, which, flying at night, may be destroyed in the month of June by building bonfires in the orchard. In its larva state, in which it does its work of destruction, it is a fleshy white grub, which enters the tree at the collar, just at the surface of the ground, girdling or perforating the wood to such an extent as often to cause death before its attack is noticed; the small round holes from which dust is ejected indicate its presence. Some cut out the worm with a knife, others use a barbed wire, which is either thrust into the hole and destroys the worm, or on withdrawing brings it out. Downing advises as a preventive, washing the bodies of trees with the following mixture: "one pint of sulphur, one gallon soft soap, and sufficient tobacco water to reduce to the consistence of paint."

The Caterpillar, (Clisiocampa Americana,) or common orchard caterpillar, has been long known as destructive of the foliage of orchards. "This," says Thomas, "is hatched in Spring as soon as the leaf buds begin to open. At this time, it is not the tenth of an inch long, nor so large as a cambric needle, but it continues to increase constantly in size for several weeks, until two inches long, and a quarter of an inch in diameter. It then spins a cocoon, and passes to the pupa state. In the latter part of summer, it comes out a yellowish brown miller, lays its eggs, and dies. The eggs are deposited in cylinders or rings, containing three to five hundred each, encircling the smaller branches, and usually within a few inches of the extremity. They remain through Winter, protected from the weather by a vesicular water-proof varnish, and hatch in Spring, as just stated. Each collection of eggs makes a nest of caterpillars."

A mode for their destruction, is to cut off the small branches which hold the eggs, during Autumn or Winter, and burn them. Those that escape this mode, may be destroyed in May and June, by attaching a sponge or round brush to a pole, and saturating the first with spirits of ammonia, turn it around among their nests. For this work, one hour in the morning early, is worth four at any other time in the day. A little care will correct the evil.

The Canker Worm. (Anisopteryx pometaria.) Of this insect, there are several allied species. They are not confined to the apple, but, if anything, prefer the elm to all others.

"The male is a moth, with pale, ash-colored wings, with a black dot, a little more than an inch across. The female is wingless, oval, dark ash-colored above, and gray beneath.

"The worm usually rises out of the ground very early in the Spring, as soon as the ground is free from frost, though a few find their way up in the Autumn. The females, having no wings, climb slowly up the trunks of the trees, while the winged males hover about to pair with them. Very soon after this, if we examine the trees, we shall

see the eggs, of which every female lays some sixty or a hundred. glued over, closely arranged in rows, and placed in the forks of branches, and among the young twigs. About the twentieth of May, these eggs are hatched, and the canker worms, dusky-brown, or ash-colored, with a yellow stripe, make their appearance, and commence preying upon the foliage."

The remedies preventive of their injuries, are, a belt of canvas saturated with tar and train oil, and encircling the body of the tree. Another is a leaden trough, encircling the body, secured by wooden wedges, between it and the tree, and filled with oil. Another, is spading up the ground underneath all trees on which they appear, in the Fall, and dressing liberally with lime. Another, is bands of straw and cotton-batting tied around the tree, and examined daily to kill all that have become entangled therein.

"*Apate Bicaudatus*.—This is the scientific name given by Mr. Say to a little beetle whose injurious habits have lately been observed. The insects are found burrowing in the pith of the young branches of the apple tree, during the Spring. The branches above the seat of attack soon die. These beetles are from one-quarter to more than three-tenths of an inch long, cylindrical, dark chestnut brown, roughened like a grater, on the fore part of the thorax, with short spines pointing backwards, and armed, in the males, with an incurved spine, near the tip of each wing-cover.

"The *Palmer Worm*, a wanderer, as its name signifies, is a small worm, about half an inch in length, with many legs, and extremely nimble. It appears at different times, in different parts of the country, and on apple, oak, cherry, plum, and other trees. They give the trees the same appearance as the canker worm does; and not only the leaves, but sometimes the fruit is injured or destroyed by them. Their appearance is generally directly after the canker worm; and they differ from them in having sixteen legs, in being much more active in their motions, and in creeping without looping or arching up their backs at every step. They are also smaller and differently colored. The same remedies are applied to prevent their depredations as with the canker worm." For further information respecting this insect, see N. Y. State Agricultural Society's Transactions, 1853.

"The *New York Weevil*, (*Curculio Novboracensis*,) attacks in May and June the buds and young shoots of trees; gnawing them so that they break off and die. They work most in the night, and still, cloudy weather. They may be destroyed or their ravages prevented, by pursuing the same remedies as for the plum weevil." For further description, see as above, N. Y. S. Transactions, 1853.

"The *Oak-pruner*, (*Stenocorus putator*,) occasionally attacks the small branches of the apple tree; and the blight beetle, *Scolytus* or *Tomicus pyri*, whose perforations blast and kill the branches of the

pear tree, has also been found equally injurious to those of the apple tree."

The Apple Moth (*Carpocapsa pomonana*), is the insect which disfigures so many of our apples and pears, causing them to fall prematurely from the tree. The moth has a head and thorax of brown mingled with gray, four wings light gray and brown, and a dark brown oval spot on the hinder margin. In the months of June and July, they deposit their eggs in the eye or blossom end of the fruit; these hatch in a few days, and the worm, a reddish white grub, eats its way to the core, soon after which the apple falls to the ground, when the worm leaves and seeks shelter and protection in the crevices and underneath the rough bark of the tree, where it spins a white web-like cocoon, and remains until the next season.

Remedies.—Keeping the bodies well scraped, and annually washed with lye-water early in Spring, picking up all the fruit as fast as it falls, or letting swine run in the orchard to eat it. Old cloths or tufts of grass, laid in the branches of the trees, attract them, from whence the cocoons may easily be destroyed.

The Bark Louse, a species of *coccus*, or scale insect, is of a brown color, about one-tenth of an inch in length, of oblong oval form, attaching itself to the branches, and injuring the tree by sucking the sap. It is destroyed by strong lye-water, by whale-oil soap, or a mixture of lime, soft soap, and water, of the consistency of common whitewash, and applied to the bark with a hard brush, in Winter or early Spring.

The Woolly Aphis (*Aphis lanigera*), makes its appearance in the form of minute white down, in the crotches and crevices of branches. It is easily destroyed by washing the tree with lye-water, lime wash, or whale oil soap. A good wash for all insects is made of, say five gallons of weak lye, one pound powdered sulphur, and four ounces soot, or "lamp black," thoroughly mixed.

The Blight, or blackening and decay of terminal shoots, we have elsewhere written on, and refer thereto. Boring holes in the trees, and plugging them with sulphur, are about as remedial as whistling to the moon.

Rust on the surface of the leaf is a disease said to affect some of the older plantations in Southern Ohio. We have never seen it, but suspect that it arises, from an unhealthy state of the tree, caused by a deficiency of some elements in the soil, and therefore a result, not a cause of disease.

Of Terms used in Description of Varieties.—Thomas, in his "Fruit Culturist," has the most perfect explanation of terms in general use in the description of fruits, form of trees, etc., as yet published. We therefore adopt most of them, in order to continue uniformity. These terms, as applied to the growth of a tree, in its shoots, have reference mainly to young trees, and comparatively as follows: *Erect* as in

the Early Strawberry. *Diverging*, as in the Domine, or Ribston Pippin. *Spreading*, as in Rhode Island Greening. *Drooping*, when they fall below the horizontal, which many spreading trees do, as they grow into the larger branches of older trees. *Ascending*, when they curve upwards, as in Gravenstein. *Irregular*, as in black Gilliflower. *Straggling*, similar to preceding, but more slender and curved, as in Jonathan. *Straight*, as in Northern Spy, *Stout*, as in Red Astrachan.

“The color of the shoots varies greatly in the same variety at different periods of the year, as well as with different degrees of exposure to the sun, and with a change of soil, climate, and season. When fresh, or very young, all have a greenish color, but gradually assume various shades of yellow, olive, brown, red, purple, and nearly black, as the season advances, and as they become bare, and are exposed to the sun and weather. For this reason, in describing the color, the terms must be relative, and can only be correctly applied by a comparison, at the time, with the color of other sorts. During Winter, and early in the Spring, the shoots of most trees become so much darker than at other times, that it is only practice and by placing the different sorts side by side, that accuracy may be obtained. Skillful culturists will readily distinguish, by a glance at the color of shoots, many of the kinds they cultivate; but the peculiar cast is hard to describe in words, in the same way that it is impossible to describe the hand-writing of an individual, so as to be known from fifty others, although many can, at a glance, know the penmanship of hundreds of different persons. A few of the most strongly marked cases, however, present peculiarities of color which form useful points of distinction. No one, for instance, could easily mistake the yellow shoots of the Bartlett and Dix pears, for the dark brown, or purple, of the Tyson and Forelle; or the light greenish cast of the Bough and Sine Qua Non apples, for the dark color of the Northern Spy, or dark brown of the Baldwin; nor the downy or grayish appearance of the Ladies Sweeting and Esopus Spitzenburg, for the clear, shining brown of the Gravenstein and Red Astrachan.”

The *color* of the leaves may sometimes assist in description, as *light green* in the Yellow Bell-flower and Rambo; *deep green*, as in the Rhode Island Greening; *bluish green*, as in Peck's Pleasant.

Forms of the Apple.—In these we follow the general understanding of terms by most horticulturists, and represented by Barry, from whom we extract:

Round or Roundish (fig. 29), when the outline is round, or nearly so, the length being about equal to the breadth.

Flat (fig. 30), when the ends are compressed, and the width considerably greater than the length.

Conical (fig. 31), in the form of a cone, tapering from the base to the eye.

Ovate, or Egg-shaped (fig. 32).

Oblong (fig. 33), when the length is considerably greater than the width, and the width about equal at both ends, not tapering, as in the conical.

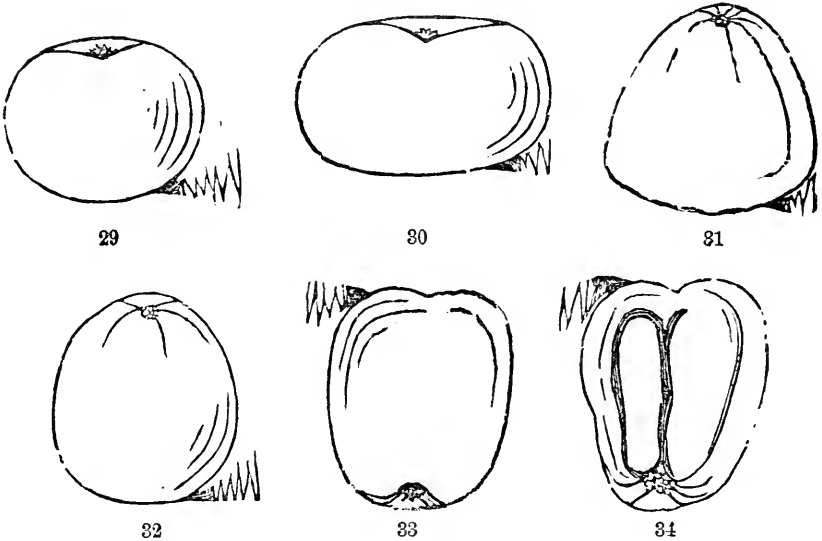

In addition to these forms and their various modifications, some varieties are—

Angular, having projecting angles on the sides.

One-sided, having one side larger than the other.

Ribbed (34), when the surface presents a series of ridges and furrows running from eye to stem.

Of size—Small, as in Gilpin, medium, as in Fameuse, and large, as in Rhode Island Greening.

Of many terms, as Calville, Pippin, Greening, &c., there seems to be no certain definition beyond that of accepted usage. Calville, generally intended to convey the idea of a fruit of light specific weight, and somewhat ribbed or furrowed, especially about the calyx. Pippin generally conveys the idea of a firm brittle texture of flesh, in the apple; while Greening is understood to imply a breaking, tender character. Pearmain, to indicate a particular, roundish conical form, with an aromatic perfume in the flesh.

Uses.—The uses of the apple are so generally known, that it seems superfluous here to mention aught of them. Aside from table use, raw and cooked, making of cider, drying, &c., &c., the apple deserves more attention as food for animals; analysis having shown that it is about equal to the potato in fattening properties.

VARIETIES.

CLASS I. *Most generally esteemed.*

AMERICAN SUMMER PEARMAIN.

Watkin's Early, | Early Summer Pearmain.

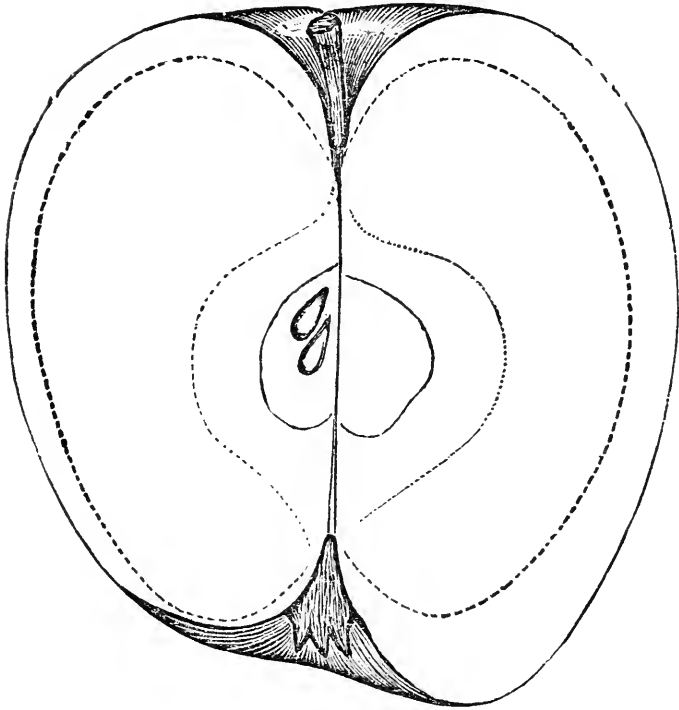

This variety rarely ripens earlier than September, except at the South. In the nursery, the growth of the tree is slow, and, as an orchard fruit, it will not "pay." It cannot, however, be dispensed with for supplying home wants, ripening gradually, as it does, during the whole of September. The tree requires thinning out of small branches, but, as it fruits mostly on the ends of branches, should never be shortened back. It requires a deep, warm soil, well supplied with lime and potash, when it succeeds admirably in all sections.

Size, medium; *form*, roundish oblong, sometimes angular; the form varies, and also size, as grown on top or bottom limbs, and in good or poor soil; *color*, red, streaked and dotted with grayish yellow; *stem*, medium, projecting about even with the surface; *cavity*, narrow; *calyx*, open, erect, slightly recurved; *basin*, deep, round, smooth; *flesh*, tender, sub-acid—best; *core*, small; *seeds*. ovate pyriform.

AUTUMN STRAWBERRY.

Late Strawberry, | Strawberry,

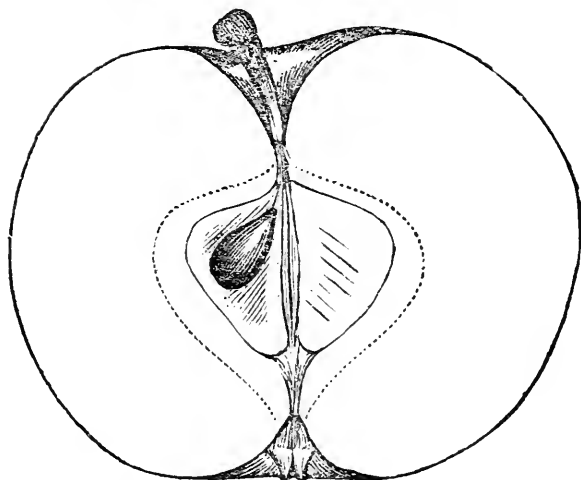

American: originated Western New York. *Size*, medium, or rather below; *form*, roundish; *color*, light and dark red, streaked, and, in the sun, the dark red prevailing, and with a bloom like a plum; *stem*, slender, medium length; *cavity*, open, regular; *calyx*, small, nearly closed; *basin*, shallow, slightly ribbed; *flesh*, yellowish white, tender, juicy, sub-acid; *core*, medium; *seeds*, large, full. October.

AUTUMN BOUGH.

Philadelphia Sweet,
Late Bough,Autumn Sweet Bough,
Summer Bellflower,Autumn Swaar,
Fall Bough.

American. *Tree*, vigorous, productive; *size*, medium, or above; *form*, obtuse conical; *color*, clear light yellow, with occasionally a russet blotch, and a few small russet dots; *stem*, slender, curved to one side; *cavity*, deep, regular; *calyx*, closed with long segments; *basin*, ribbed or furrowed; *flesh*, white, crisp, tender, deliciously sweet; *core*, small; *seed cavity*, hollow; *seed*, plump, full. September.

AUTUMN SEEK-NO-FURTHER.

American. *Fruit*, medium, roundish, pale green, faintly striped with red in sun; *stem*, slender; *cavity*, narrow, deep; *calyx*, open, erect segments; *basin*, round, medium depth; *core*, medium; *flesh*, white, juicy, tender sprightly, sub-acid; "very good." October.

AUTUMNAL SWAAR.

Grown at the West. *Fruit*, large, roundish conic; *skin*, yellow, sprinkled with star-shaped dots; *stalk*, rather short; *cavity*, broad, deep, slightly russeted; *calyx*, small and closed; *basin*, deep, abrupt, and corrugated; *flesh*, yellow, juicy, tender, with a pleasant, rich, mild, sub-acid flavor. September. (Downing.)

AUTUMNAL SWEET SWAAR.

Sweet Swaar, | Sweet Golden Pippin.

Tree, spreading; *shoots*, vigorous, diverging; *fruit*, large, round, flattened, slightly ribbed, rich golden yellow; *stem*, long; *cavity*, open, shallow;

calyx, half closed; *basin*, slightly ribbed, deep; *flesh*, tender, yellowish, spicy, sweet, not juicy; "very good." October.

AUTUMN PEARMAIN.

English Summer Pearmain,		Royal Pearmain,		Sigler's Red.
Summer Pearmain,		Parmain d'Ete,		

Foreign. *Tree*, slender, slow growth, irregular, popular in Kentucky and South; *fruit*, medium, oblong conical, brownish yellow and green, red, blended with yellow, in sun. small brown specks; *stalk*, short; *calyx*, in a broad, shallow basin, slightly plaited; *flesh*, pale yellow, crisp; nearly "best." September.

BALDWIN.

Late Baldwin,		Woodpecker,
Pecker,		Steele's Red Winter.

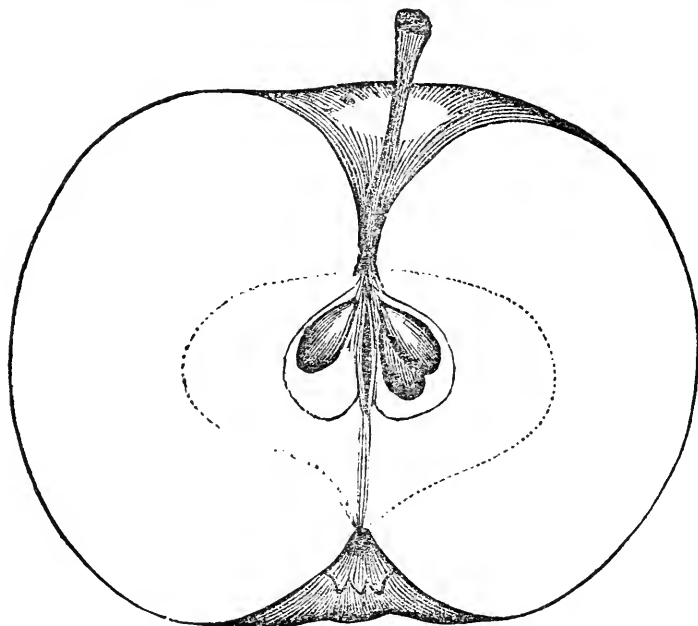

American: originated in Massachusetts. This variety inclines to bitter or dry rot on soils deficient in lime and potash, and, for the Western soils, should be worked where intended to have the head commence. It has proved tender on Western prairie soils, and, in Southern sections, is liable to drop prematurely. Trees fifteen years old do better than while young. Tree, vigorous, upright. dark brown shoots, very productive. Our drawing was taken from an Eastern-grown specimen, and is not more than one-half the size of this variety when grown in Illinois.

Size, large; *form*, roundish, narrowing a little to the calyx; *color*, yellowish, nearly covered and striped with red, dotted with a few russet spots, and with radiating streaks of russet about the stem; *stem*, three-fourths inch long, slender; *cavity*, deep; *calyx*, closed; *basin*, rather narrow, plaited; *flesh*, yellowish white, crisp, tender, sub-acid; *core*, small, compact; *capsules*, ovate hollow; *seeds*, long ovate, pyriform. December to March.

BALTIMORE.

Baltimore Pippin, | Cable's Gilliflower, | Royal Pippin.

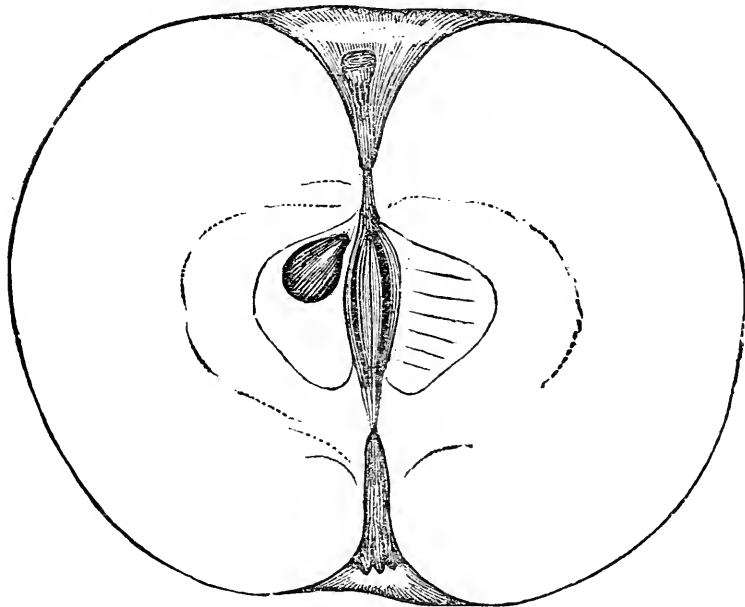

Origin, unknown. *Tree*, thrifty, slender, very productive, on warm, rich soils; *size*, medium to large; *form*, round, or roundish ovate; *color*, light yellow, striped, and splashed with purplish red, a little bronzed russet about the stem, large whitish dots, and often a blue tinge marbled toward the stem, resembling a bloom; *stem*, short; *cavity*, open, deep, regular; *calyx*, small, half open; *basin*, shallow, regular; *flesh*, white, with a slight tinge of yellow, tender, crisp, juicy, sub-acid, sprightly; *core*, medium, or small; *seeds*, obovate pyriform. December to March. This is distinct from the Baltimore of Lindley, which is of pale lemon color, tinged with red, and with large open calyx.

BATCHELOR.

Gross, | King, *erroneously*.

From North Carolina. *Fruit*, very large, roundish, flattened, angular, lemon yellow, washed with lively red on sunny side, gray dots, russet around stem; *stem*, short; *cavity*, deep; *calyx*, small, open; *basin*, deep; *flesh*, white, tender, fine-grained, juicy, mild, sub-acid; *core*, medium. October, November. Very valuable in Southern States.

BENONI.

From Massachusetts. *Growth*, vigorous, erect, good bearer; *fruit*, medium, roundish, narrowing towards the eye, deep yellow, striped with crimson, dotted with white specks; *stem*, short, slender; *cavity*, narrow; *calyx*, large, open; *basin*, furrowed; *flesh*, yellow, crisp, tender, juicy, vinous; "very good;" *core*, close; *seeds*, pale brown. August and September. Succeeds finely on the Western prairies.

BENTLEY'S SWEET.

From Virginia. *Tree*, moderately vigorous, hardy, good bearer, great keeper; valuable South, in rich soils; *fruit*, above medium, oblong irregular, flattened at ends, red and yellow striped, or blotched; *stem*, long, curved; *calyx*, large; *basin*, open, deep, furrowed; *core*, compact; *seeds*, large, ovate pointed; *flesh*, yellowish, firm, tender, juicy; "very good." January to September.

BELMONT.

Gate,
Mamma Beam,

Golden Pippin of some,
White Apple,

Kelly White,
Waxen of some.

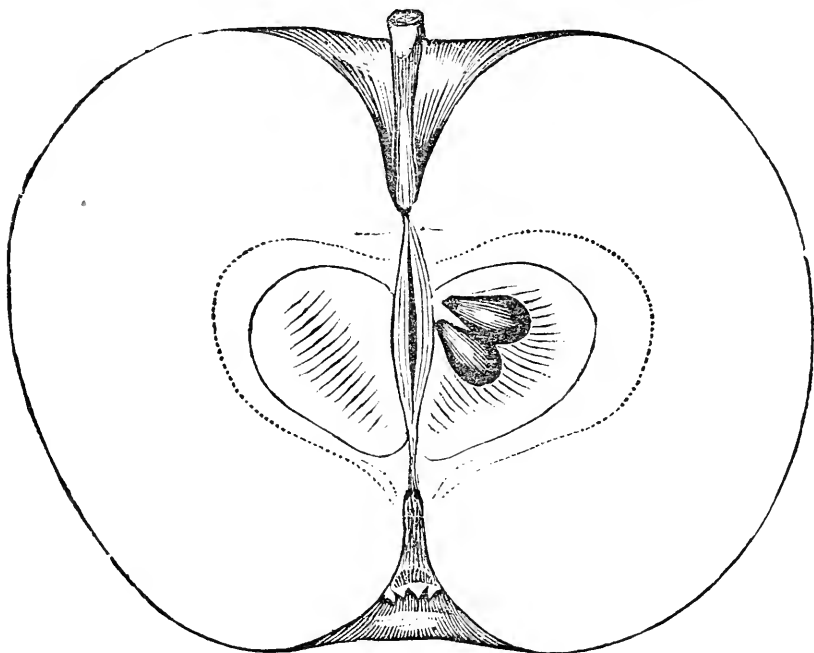

American. By some stated to have originated in Virginia, by others, in Pennsylvania, and, on the authority of Prof. Kirtland, Mr. Downing, in his first edition of "Fruits and Fruit Trees," made it synonymous with the "Waxen" of Cox.

Tree, healthy, vigorous, spreading, wood yellowish, good bearer, does not succeed on the alluvial soils of the West, but on all high, warm, or limestone soils does finely, and makes a large tree.

Size, medium to large; *form*, irregular, usually roundish, sometimes oblong rounded. South it grows very large, and also West, on new rich soils in Wisconsin; but grown South its delicacy, fine grain, and flavor are lost. *Skin*, thin, smooth, glossy, or oily; *color*, rich clear light yellow; at South with a few dark brown specks, and North with a clear vermilion red cheek, with carmine spots; South slight russet marblings, and much of mould or fungus; *stem*, medium length, projecting slightly beyond the surface, always slender; *calyx*, varying from small and close to open and reflexed; *basin*, from shallow to rather deep, always furrowed; *flesh*, yellowish white fine-grained, very tender, juicy, sprightly, sub-acid; *core*

rather large; *seeds*, ovate pointed, abundant, brownish red. November to February, October to January in South-Western States.

BELLFLOWER.

Yellow Bellflower, | Yellow Belle-fleur, | Lady Washington.

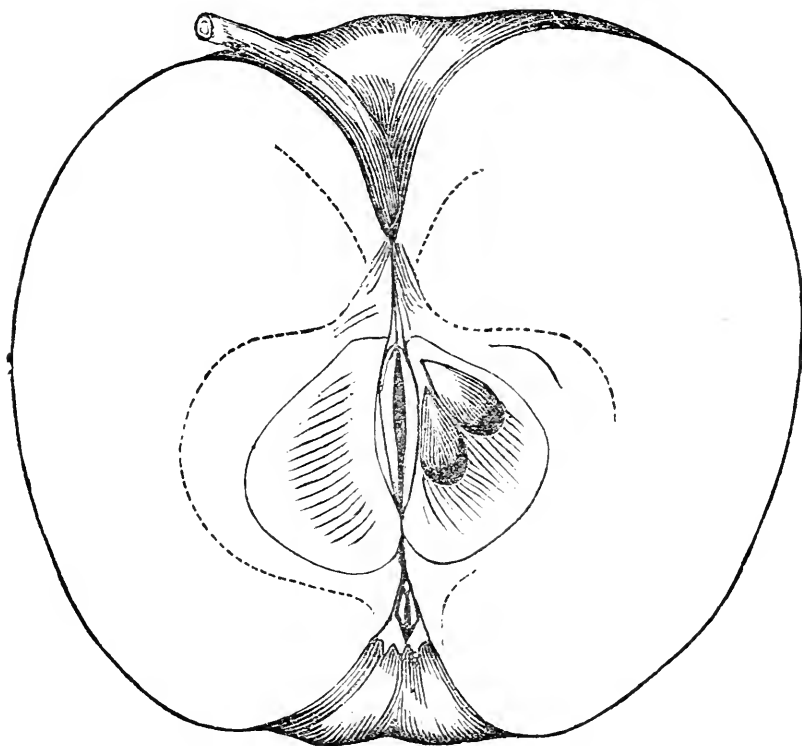

American. *Tree*, of slender, yet healthy growth, with yellowish, rather upright shoots; *fruit*, on ends of limbs, very hardy; grafted on pieces of roots, does not bear well; otherwise, very productive. *Size*, large; *form*, oblong, a little irregular, tapering to the eye; *color*, pale yellow, with a blush next the sun; *stem*, long, slender, curved; *cavity*, deep; *calyx* closed; *basin*, plaited, deep; *flesh*, tender, juicy, crisp, sprightly, sub-acid, *core*, large; *capsules*, long, hollow; *seeds*, large, ovate pyriform, angular at broad end. December to March. October to February, South.

BERRY.

Red Hazel, | Pound.

From Virginia. *Fruit*, above medium, oblate irregular, red, striped, and splashed on greenish yellow, large dots; *stem*, short; *cavity*, broad; *calyx*, open; *basin*, shallow; *flesh*, juicy, vinous; "very good;" *core*, small. December to March. Esteemed South, and will probably prove valuable all South West.

BETHLEHEMITE.

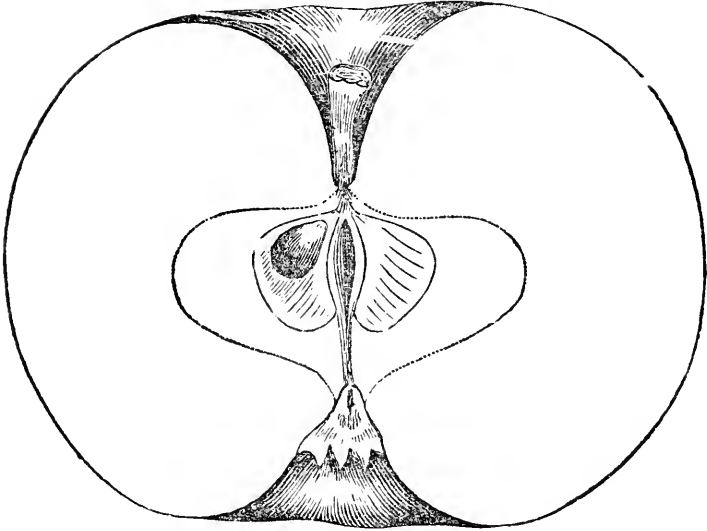

This is a variety somewhat resembling the Newtown Spitzenberg, and we have testimony of one or two who say they know it under that name. Thus far all specimens we have seen were from trees grown in rich, loamy soils, and all we can learn of its history is, that it came from Bethlehem, in Ohio. *Size*, medium; *form*, roundish, flattened, tapering slightly to the apex; *color*, pale yellow ground, striped and stained with two shades of bright red, dotted with irregular-shaped brown dots, some russet about the stem; *calyx*, medium, sometimes large; *basin*, deep, broad, irregular, somewhat furrowed; *stem*, short; *cavity*, narrow, irregular; *flesh*, yellowish white, tender, with a mild, sub-acid juice, and exceedingly pleasant flavor; *core*, small, compact; *seeds*, obovate obtuse pyriform. November to January, but keeps until April. Trees upright, strong growers.

BOHANON.

A variety probably originally of Virginia, and is highly esteemed in Kentucky and South. It much resembles Maiden's Blush. *Fruit*, large, roundish flattened, narrowing to the eye, with inclination to the ribbed surface; light pale yellow, crimson blush on sunny side, russet about stem; *stem*, slender; *cavity*, narrow; *calyx*, partly closed; *basin*, deep, expanded; *core*, open; *seeds*, numerous, light brown; *flesh*, yellowish white, tender, slightly aromatic, sub-acid. September. An excellent regular bearer.

BROADWELL.

Broadwell Sweet.

American. Origin, Southern Ohio. *Tree*, vigorous, spreading, light yellowish shoots, good bearer. *Size*, medium to large; *form*, regular, roundish, flattened at base, and tapering slightly toward the calyx; *skin*, thin, smooth; *color*, light yellow, cloudy flakes, sunny side brownish bronze; *stem*, short

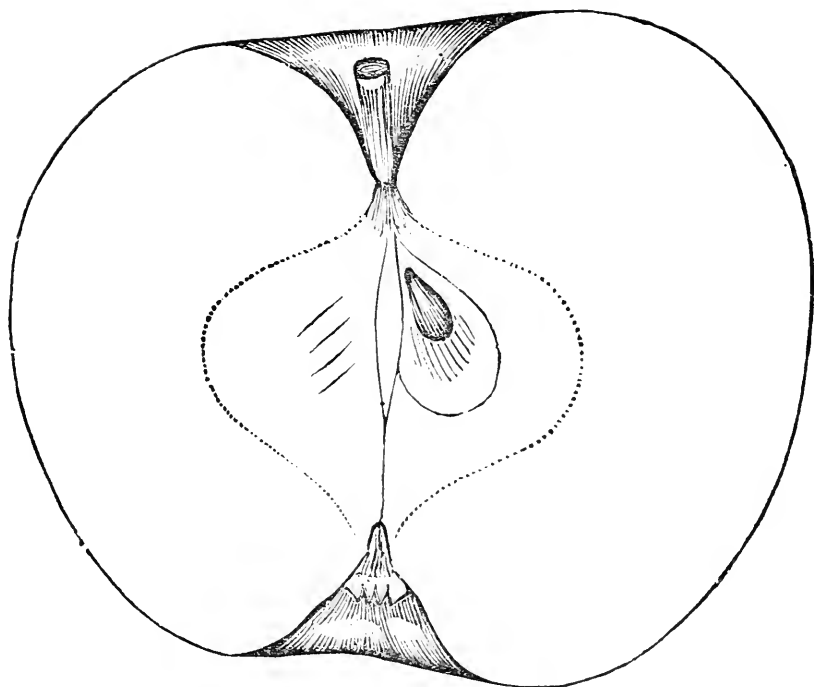

cavity, expanded ; *calyx*, open : *segments*, short ; *basin*, narrow ; *flesh*, white, fine-grained, sweet, juicy ; *core*, close, compact ; *seeds*, small, plump, light-brown. November to March.

BULLOCK'S PIPPIN.

American Golden Russet,
Sheepnose,

Golden Russet, *
Little Pearmain,

Hunt's Russet,
Fall Winesap, *erroneously*.

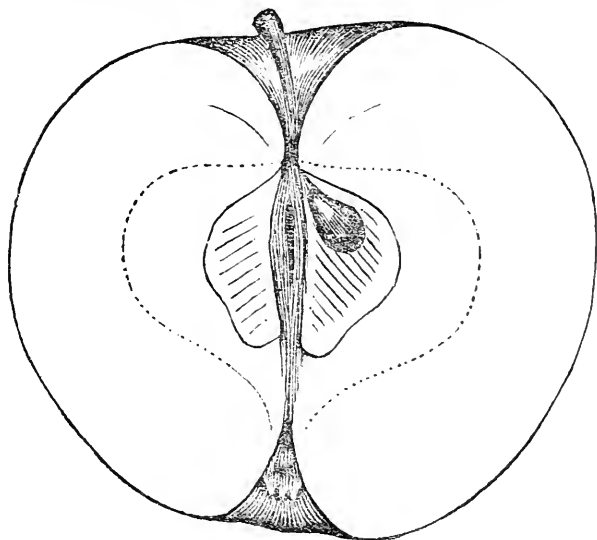

American. *Tree*, ultimately of only medium size, with a round regular head, shoots erect, rather slender, admirably suited to rich soils of Southern Ohio, Indiana, the South-west, etc., etc. Grown South, the fruit is almost entirely covered with russet ; North, on sandy soils, it is a warm, rich yellow, with only marblings of russet.

Size, small to medium ; *form*, roundish ovate, tapering much toward the eye ; *color*, generally rich golden yellow, overspread with soft russet, and in sun, a marbling of red ; *stem*, slender ; *cavity*, narrow, regular ; *calyx*, small, closed ; *basin*, shallow, sometimes furrowed ; *flesh*, yellowish, tender, juicy, almost buttery, delicate, sprightly ; *core*, large for size of fruit ; *seeds*, full, ovate pyramidal. December to March. November to January, South,

CANADA REINETTE.

Canadian Reinette,
Pomme de Caen,
Reinette Grosse du Canada,
De Bretagne,

Januarea,
German Green,
Reinette du Canada,
Grosse Reinette d'Angleterre,
Yellow Newtown Pippin, *erroneously*.

Reinette du Canada Blanche,
Reinette du Canada a' Cortes,
Portugal,
Wahr Reinette,

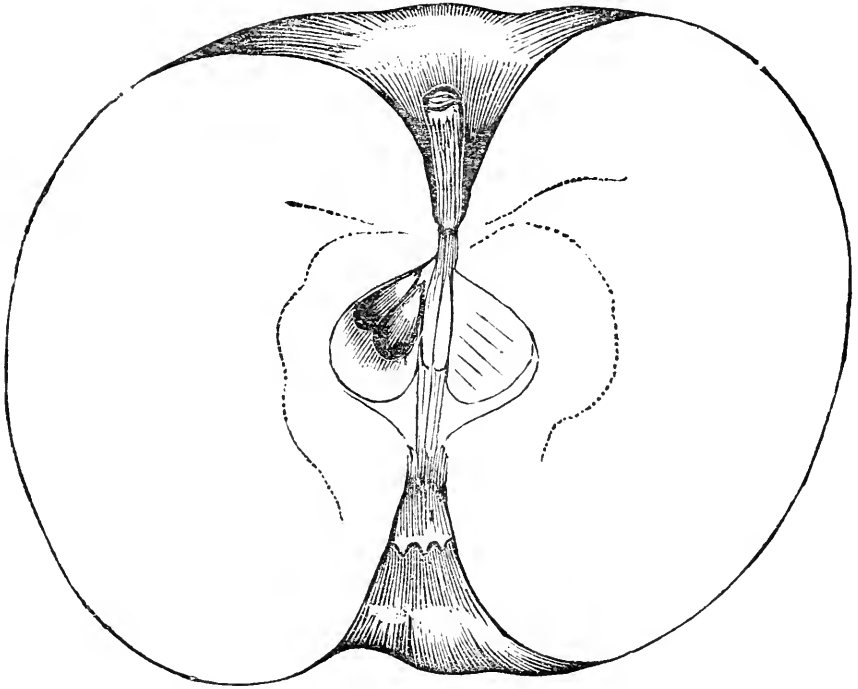

Foreign. Tree, strong, vigorous, upright, spreading, productive, very hardy. *Size*, large ; *form*, roundish, flattened, irregularly angular, much ribbed, sometimes almost oblong and smooth ; *color*, light greenish-yellow, a blush in sun, and small dark green specks, surrounded with light green, suffused beneath the skin ; *stem*, short ; *cavity*, narrow, slightly russeted ; *calyx*, large ; *basin*, deep, angular, with prominent ribs ; *flesh*, yellowish white, crisp, tender, juicy, sub-acid, sprightly ; *core*, small, compact ; *seeds*, dark, almost black. January to May.

CARNATION.

Fruit, medium size ; a delicious sub-acid apple, fully first-rate ; *color*, dark-red, splashed with russet ; *flesh*, white, brittle, and very juicy ; both the *calyx* and *stem* are sunk in deep depressions ; no Autumn apple is superior August, at South.

CAROLINA WINTER QUEEN.

Ladies Sweet, *erroneously*, | Nix's Green.

American. We have seen but little of this apple, but are impressed with the idea that it is destined to be a valuable and popular variety South, far superior to Northern Spy. *Fruit*, above medium, roundish conical; greenish yellow, streaked and stained with red from the stem, a little russet at stem, and few small faint dots; *calyx*, open, segments, reflexed; *basin*, round, medium; *stem*, slender; *cavity*, deep; *core*, medium; *seeds*, abundant; *flesh*, yellowish, sprightly, crisp, juicy; "best." November and January.

CHALLENGE.

American. Origin, near Sandusky, Ohio. Tree, productive, hardy. *Size*, large; *form*, roundish flattened; *color*, rich yellow, with many russet dots, and occasionally a russet patch; when fully exposed to sun, the russet spots become vermilion red; *stem*, projecting even with surrounding surface; *cavity*, deep, regular; *calyx*, with long irregular segments; *basin*, broad, open, medium depth, always furrowed; *flesh*, yellowish white, crisp, juicy, sweet, tender; *core*, medium; *seeds*, large, plump. October and November.

COGSWELL.

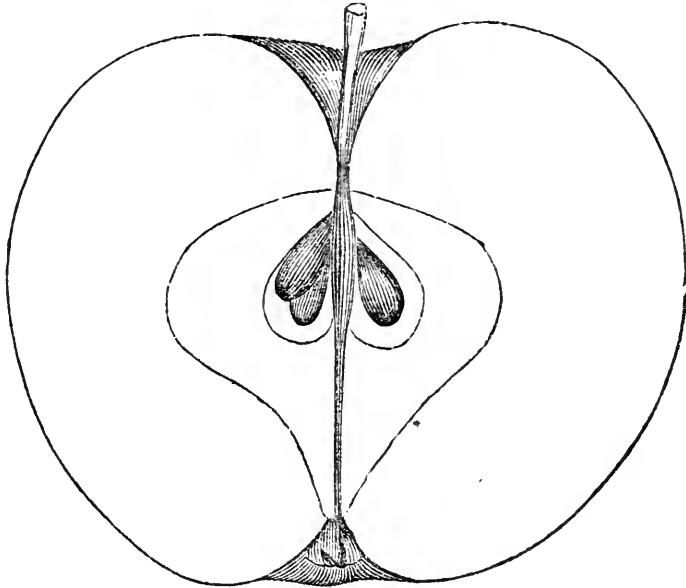
Cogswell's Pearmain, | Ohio Nonpareil, *incorrectly of some*.

American. Native of Connecticut. It has been grown in Mass. and Ohio, and thus far, where the variety has been fruited, it has proved everything that can be required to class it as a first-rate fruit worthy of general cultivation. The tree is a good bearer, producing always fair and even fruit. Tree, moderately vigorous, making rather long annual shoots, of a dark, reddish brown color. The fruit is above medium size, roundish flattened; often angular; and also often, on the same tree, somewhat round-

ish conical; the *color* is rich yellow, covered with stripes, splashes, and dots of red; some russet specks and russet about the stem; *stem*, short; *cavity*, open; *calyx*, medium, nearly closed; *basin*, shallow; *flesh*, yellowish, crisp, juicy, sprightly, aromatic, sub-acid; *core*, small; *seeds*, medium size, dark brown. January to March.

COOPER.

Beauty Red, | Lady Washington, | Seek-no-further, of some erroneously.

An Eastern variety, recovered at West, where it was brought in 1796; its identity with any variety now known East, is not established; hence we must continue under its present name. Growth, upright, stout; branches at right angles; wood, reddish, "subject to canker;" a good bearer, maturing its fruit nearly all at the same time. Succeeds best on rich limestone clay.

Fruit, large, often very large; roundish flattened, greenish yellow, with stripes and blotches of pale red; *calyx*, closed; *basin*, deep; *stem*, slender, short; *cavity*, deep; *flesh*, yellowish, not fine grained, crisp, juicy; "very good." September, but often keeps to November.

COOPER'S EARLY WHITE

Grown in Illinois and Wisconsin, where it is regarded as productive and profitable. *Fruit*, medium; roundish, little flattened; pale yellow, with faint blush, greenish tinge at stem; *stem*, short; *cavity*, narrow, deep; *calyx*, closed; *basin*, deep, abrupt, slightly furrowed; *flesh*, white, crisp, sprightly. September and October. Requires soil supplied with potash.

CORNISH AROMATIC.

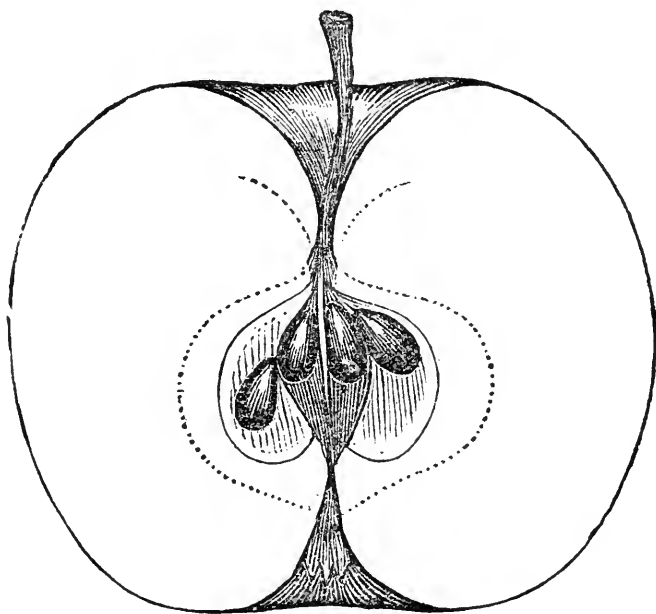

Foreign: requires rich, warm, sandy soil. *Size*, medium; *form*, roundish regular, sometimes a little conical; *color*, yellow ground, mostly over-

spread with rich red, dotted with yellow russet spots; *stem*, long, slender; *cavity*, regular, open, rather deep; *calyx*, small; *basin*, abrupt, furrowed; *flesh*, yellow, crisp, juicy, sub-acid, of flavor closely allied to Esopus Spitzenberg; *core*, open, hollow, regular form; *seeds*, large. November to February.

DANVER'S WINTER SWEET.

Epsé's Sweet.

American. Tree, vigorous, spreading, shoots yellowish, yearly productive; valuable winter fruit for baking or stock.

Size, medium; *form*, roundish oblong; *color*, dull yellow, with orange blush, and small russet specks; *stem*, slender, inclining to one side; *calyx*, small, woolly; *basin*, shallow, rather narrow; *flesh*, yellow, firm, sweet; *core*, large, open; *seeds*, ovate pointed, dark rich brown. December to April.

DRAP D'OR.

Vrai Drap d'Or,		Bay Apple,
Early Summer Pippin, of some,		Bonne du Mai.

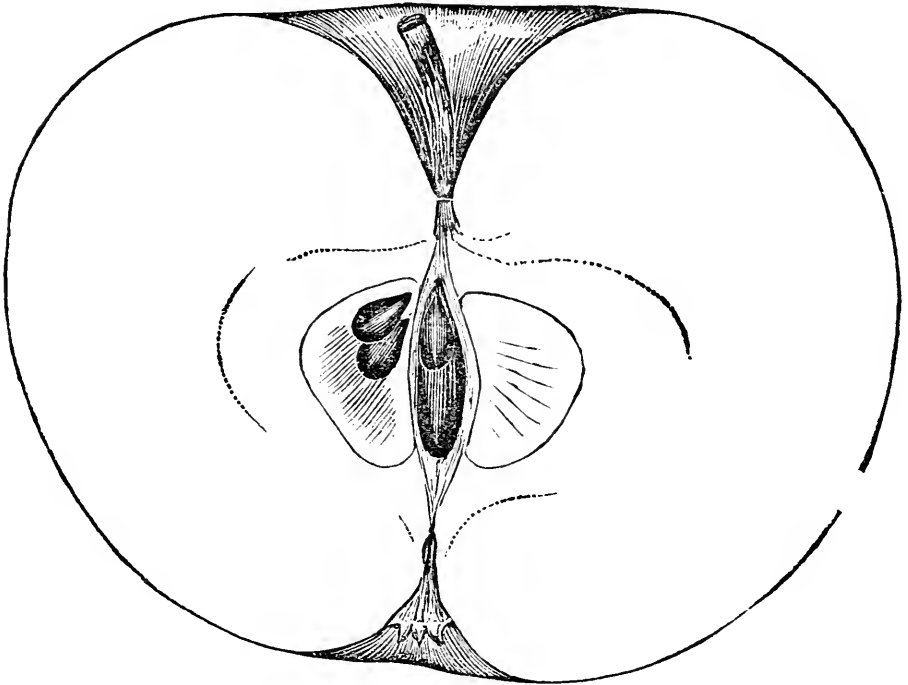

This is, by some, said to be identical with "Cooper." We do not yet so recognize it. Tree, strong grower, wide, broad foliage, moderate bearer. *Size*, large; *form*, roundish, flattened; *color*, dull yellow or gold color, with distinct brown or russet specks; *stem*, short; *cavity*, wide, open; *calyx*, small, half closed; *basin*, shallow, plaited; *flesh*, yellowish white, mild, sub-acid, not fine-grained, tender, juicy, well flavored; *core*, with open, hollow capsules; *seeds*, short, ovate, dark reddish brown. August to October.

DISHAROON.

From Georgia. *Fruit*, large, regular, slightly conical; *calyx*, small, in a narrow basin; *skin*, yellowish green, with many roundish spots made darker by minute specks; *flesh*, fine aromatic, sub-acid. Early Winter, or late Autumn at the South.

DOMINE.

Wells, Hogan,	English Winter, Red Streak, <i>of some</i> ,	Striped R. J. Greening, Well Apple.
------------------	---	--

Origin, uncertain. Tree, strong, vigorous grower; shoots, long, diverging; early, good bearer, profitable orchard sort, West; succeeding finely in most soils. *Fruit*, medium to large, flat, greenish yellow, with stripes and splashes of bright red and large russet specks; *stem*, long, slender, inclining to one side; *cavity*, wide; *calyx*, small; *basin*, broad; *core*, medium; *seeds*, abundant, purplish brown; *flesh*, white, tender, juicy; "very good." November to April.

DUCHESS OF OLDENBURGH.

Foreign. Tree, vigorous, with dark, upright shoots, productive, valued for cooking and market. *Fruit*, medium to large, roundish flattened, light red, striped and splashed on yellow; *stem*, short; *cavity*, acuminate; *basin*, deep; *flesh*, yellowish white, sharp sub-acid. August and September Very fine at the North in Canada.

DUTCH MIGNONNE.

The Dutch *Mignonne*—*Darling*, or *Favorite*—is from Holland, and a fruit which has proved valuable wherever grown. Tree, with strong, upright shoots, and producing abundantly; very fine in South Ohio. *Size*, large; *form*, roundish regular; *color*, dull orange, mostly covered with rich dull red, dotted and mottled with large yellow russet specks, and a dash of russet about the cavity of stem; *stem*, long, slender, curved; *cavity*, narrow, deep; *calyx*, open; *basin*, deep, round, regular; *flesh*, whitish, firm at first, becoming tender when well matured, sub-acid, aromatic flavor; *core*, small, compact; *seeds*, few, defective. November to January.

DYER.

Pomme Royal, Golden Spice, Tompkins, Beard Burden,	Pomme Water, Bullripe, Mygatt's Bergamot,	Bard Apple, White Spice, Smithfield Spice.
---	---	--

American. Tree, a fair grower, not strong, shoots spreading irregular, moderately productive. *Size*, medium; *form*, round, or roundish flattened; *color*, clear yellow, with russet marbled more or less over the surface; *stem*, long, slender; *cavity*, deep, slightly furrowed; *calyx*, with long, recurved segments; *basin*, medium; *flesh*, yellowish white, spicy, sprightly, tender, sub-acid; *core*, medium; *seeds*, small. October and November.

EARLY JOE.

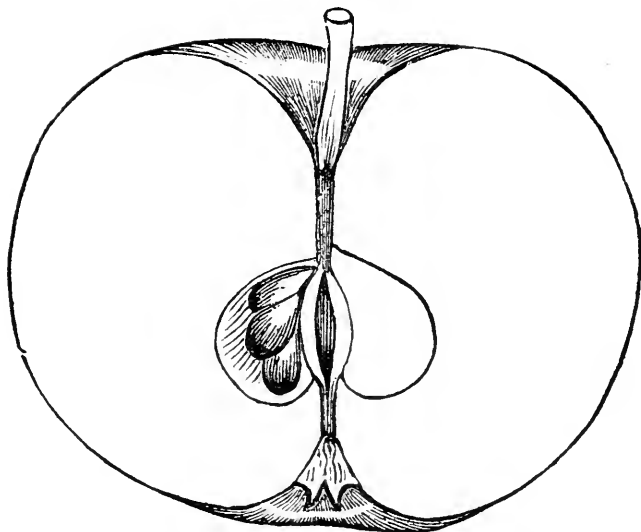

American: origin, claimed Ontario Co., N. Y. It is somewhat questionable if it is not an old Connecticut variety. This apple has the most of delicate-pear flavor of any variety, and, while it is all unsuited to orcharding, one tree should always be planted. While young, it is of slow growth, but, as the trees get older, it improves, and makes a tree of round irregular spreading form, of medium size. It is very hardy, but should have rich, strong soil. Shoots, dark-colored, and so foliage.

Size, medium, or rather below; *form*, roundish flattened; *stem*, rather slender; *cavity*, open, deep, a little russeted; *color*, pale yellowish green, overspread and striped with deep and pale red; *calyx*, small, nearly closed; *basin*, shallow; *flesh*, yellowish white, tender, very delicate; *core*, medium, centre open; *seeds*, short ovate pyriform. Last of August.

EARLY STRAWBERRY.

American Red Juneating, | Red Juneating.

American. Tree, very erect in growth, dark wood, numerous leaves erect, with long footstalks; productive, and successful in all localities, and, although not best in quality, yet generally esteemed.

Size, small; *form*, roundish, varying to angular and conical; *color*, yellowish white, striped and stained over with bright and dark red; *stem*, varying from long straight and slender, to medium, curved; *calyx*, small; *basin*, narrow and shallow; *flesh*, yellowish white, tinged with red, sub-acid, sprightly, tender; *core*, medium; *seeds*, small. July.

EQUINTELEY.

Sol. Carter.

Origin, Yancey Co., N. Carolina. One of the best of the Southern apples.

Fruit, large, oblate, conic, angular, slightly oblique; *skin*, whitish yellow, mostly overspread with beautiful bright crimson, and thinly

sprinkled with whitish dots; *stalk*, short and fleshy, inserted in a broad, deep cavity; *calyx*, closed, set in a deep, rather narrow, irregular basin, *flesh*, yellowish, very tender, almost melting, juicy, with a very mild, sub-acid flavor. November to May. (Downing.)

ESOPUS SPITZENBERG.

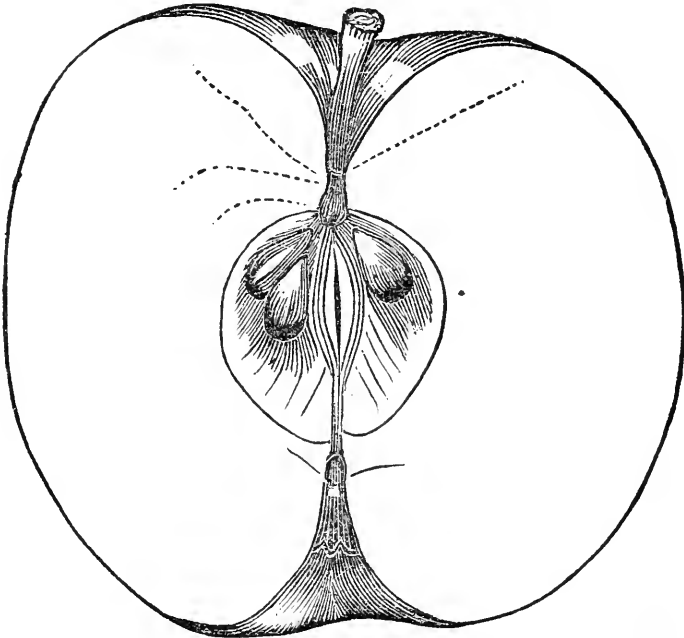

American: origin, on the Hudson River. Tree, healthy, slender shoots; when in bearing, drooping and spreading, making an open head; requires a strong soil and age to produce much or good fruit, and much of lime and potash, when it is a good bearer.

Size, above medium, large when carefully grown; *form*, flattened at base, oblong, tapering roundly toward the eye, considerably ribbed and irregular in its surface, and almost always slightly angular; *color*, rich, lively red on yellow ground, dotted and marbled with yellow russet; *stem*, varying, sometimes short and stout, at others long and slender; *cavity*, deep regular, open; *calyx*, small, closed; *basin*, almost abrupt, furrowed; *flesh*, yellow, crisp, a little tough, exceedingly high flavored and delicious; *core*, regular, ovate, rounded in form; *seeds*, large. January to March.

FALDWALDER.

Fallwater,
Green Mountain Pippin,
Dutch Codlin, *erroneously*,

Waldenner,
Tulpahocken,
Pim's Beauty of the West,

Pound, *erroneously*,
Mountain Pippin,
Burbacker.

American: originated in Berks Co., Penn. Its name is from a Mr Faldwald, with whom it originated. Not worthy a place in small orchards or gardens, but, on rich limestone soils, when grown for distant market, it is highly valuable, being of thick skin, fruit always fair and large, and keeping a long time, even in Southern latitudes. Tree, strong, vigorous grower; shoots, stout, partially spreading.

Fruit, large ; *form*, round, varying to roundish, flattened and roundish ovate ; *color*, pale yellowish green, dull red cheek, dotted with a few small irregular-shaped russet dots, suffused or surrounded with a shade of light

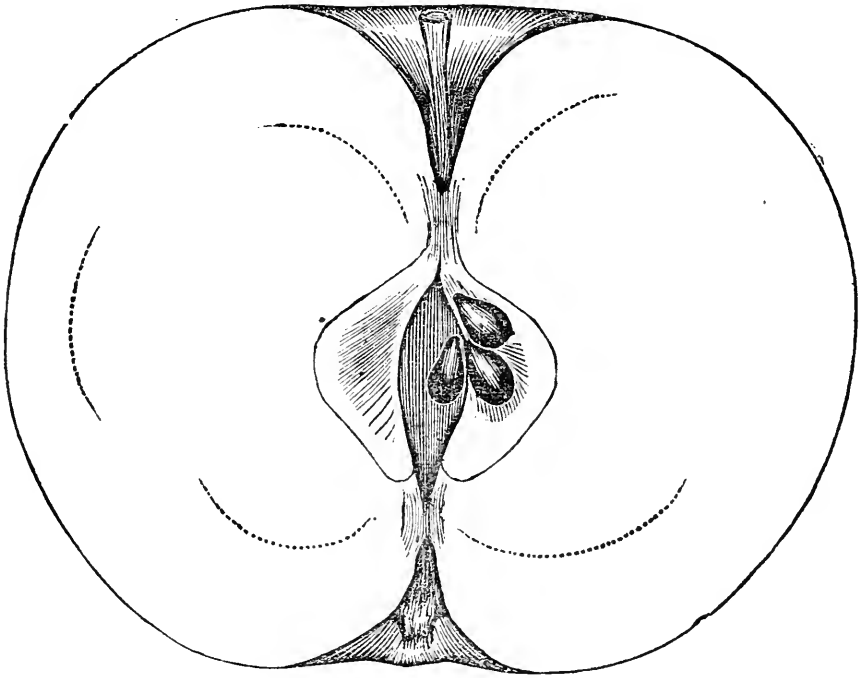

green, presenting, at first glance, appearance as of white specks ; *stem*, short *cavity*, open, generally regular ; *calyx*, small, closed ; *basin*, shallow, open, broad, often slightly furrowed ; *flesh*, yellowish white, rather coarse texture, tender, juicy, mild, sub-acid ; *core*, medium, somewhat open ; *seeds*, ovate pointed. December to May.

FALL PIPPIN.

Philadelphia Pippin.

This is, unquestionably, an American seedling, and probably from the "White Spanish Reinette," which it closely resembles in all but its period of ripening. Great confusion exists among growers respecting it, as the Holland Pippin is often grown under this name, as well as its parent. It is extensively grown at the West and in the Eastern States, and universally succeeds well ; but, where the soil is of a clayey nature, on the alluvial bottoms and deep prairies, it does not answer as well. Tree, of growth vigorous ; shoots, dark ; diverging or spreading ; becomes large ; not always productive ; proves tender on prairie soils.

Size, large ; *form*, roundish, conical, flattened at ends ; *color*, greenish yellow until fully ripe, then rich yellow with a faint blush, when grown in good soil and exposed to sun ; *stem*, long, moderately stout ; *cavity*, deep, round ; *calyx*, above medium, with segments in divisions ; *basin*, deep, wide,

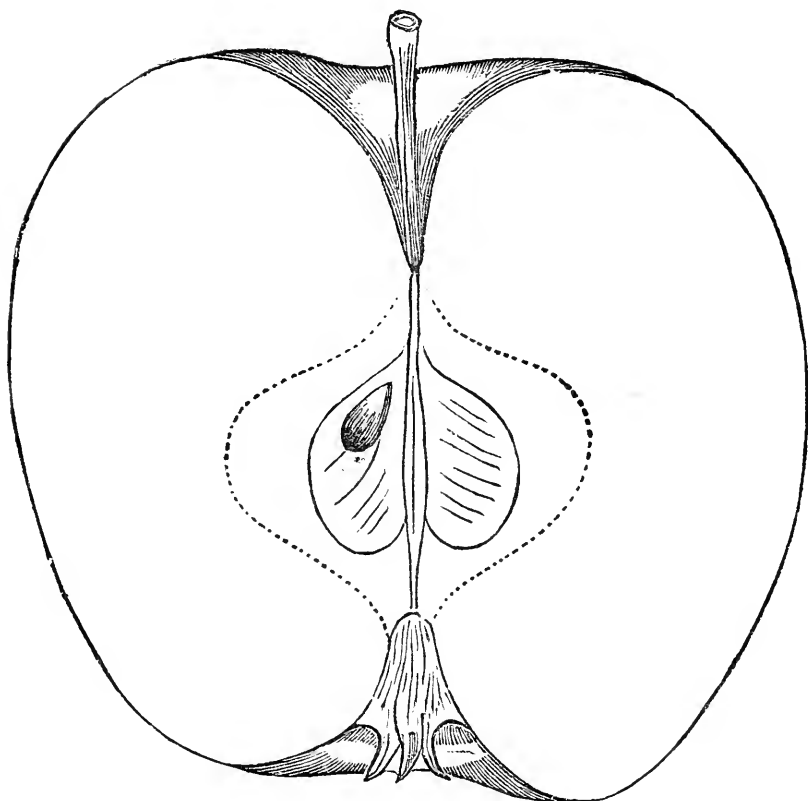

and open; *flesh*, yellowish white, tender, sub-acid, aromatic; *core*, medium, for size of fruit; *seeds*, ovate. October to December

FALL QUEEN.

Summer Horse,		Horse Apple,		Red Gloria Mundi?
Yellow Horse,		Oldfield,		Fall Beauty.

Origin, unknown. Valued highly South and West for cooking. *Fruit*, medium to large, roundish conical, little irregular; greenish yellow to orange, blush in sun, russet lines about stem; *stem*, short; *cavity*, shallow; *basin*, narrow; *core*, large, hollow; *flesh*, yellow, coarse, acid. Last July.

FALL QUEEN OF KY.

Winter Queen, | Ladies' Favorite of Tenn.

Origin, uncertain. Much grown at the South and Southwest, where it is highly esteemed. Tree, very vigorous, upright, an early and abundant bearer. *Fruit*, large, oblate inclining to conic, slightly oblique, angular; *skin*, yellow, striped and marbled with crimson, and thickly sprinkled with brown and whitish dots; *stalk*, short, inserted in a broad, deep-russetted cavity; *calyx*, large, partially closed, set in a large open basin; *flesh*, yellowish, crisp, tender, juicy, with a sprightly mild sub-acid flavor. January to March. (Downing.)

FALL WINE.

Sweet Wine,
Ohio Wine,Wine, of Cole,
Sharpe's Spice,

Uncle Sam's Best.

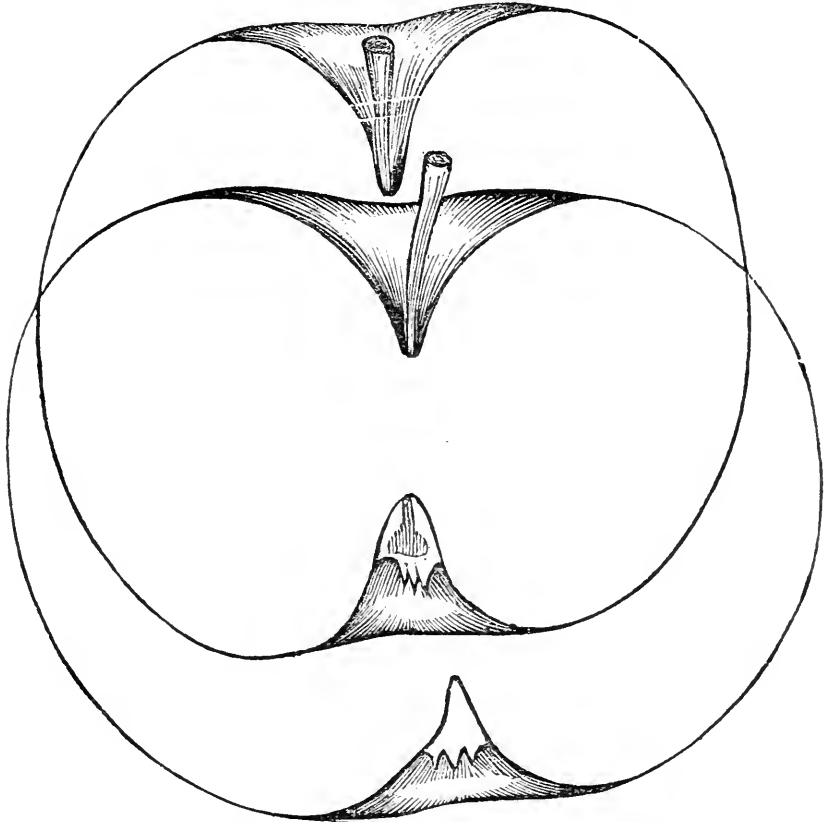

American: its origin unknown; introduced West from the garden of Judge Buel, Albany, about 1832. Tree, of slender, slow growth; drooping when in bearing state; very healthy; producing moderately, but annually, large, beautiful fruit on the rich Western soils, and fruit of medium size on soils of moderate quality. Our figure exhibits from the two soils. It is now much grown in Indiana and Illinois, as "Wine," from which it is quite distinct.

Size, medium to large; *form*, roundish, flattened; *color*, rich red marbled over clear yellow, and with many spots and specks of brownish—sometimes it is faintly striped; *stem*, slender; *cavity*, deep; *calyx*, half closed; *basin*, open, shallow; *flesh*, yellowish, crisp, tender, juicy, delicious, sub-acid, vinous. September to November.

Although evidently an old Eastern fruit, it appears now unknown there, if we except the short description made of it by Cole, and his notice of where grown.

FAMEUSE.

Pomme de Neige, | Sanguineus, | Snow.

Foreign, or rather Canadian origin. It is admirably adapted to all Northern sections, producing yearly, and always fair, smooth fruit. Tree,

of moderate, rather diverging, habit; shoots dark; and, as an orchard tree, only of second size. Without being a fruit of high character, it is just so good that, taken with its production of regular, handsome fruit, it cannot be dispensed with. Tree, hardy and rich; strong or heavy soils suit it best; proves hardy West.

Size, medium; *form*, roundish, somewhat flattened; *color*, greenish yellow, mostly overspread with pale and dark rich red; *stem*, slender; *cavity*, narrow; *calyx*, small; *basin*, shallow, narrow; *flesh*, remarkably white, tender, juicy, with a slight perfume; *core*, close, compact; *seeds*, light brown, long pointed. October to January.

FORT MIAMI.

Scandiana Mala.

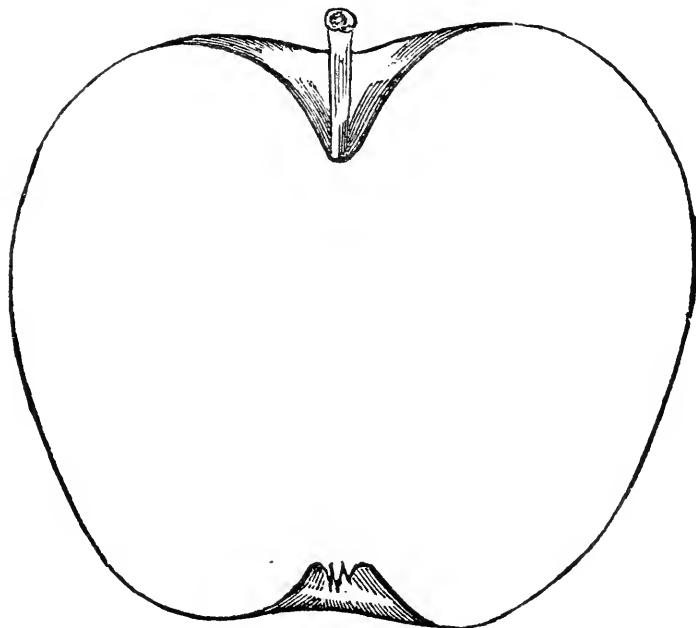

American. Originated near Fort Miami, in Ohio. In April, 1846, we made our outline and descriptions from specimens sent us by A. Spafford, Esq., Perrysburgh, Ohio., since which we have been unable to obtain any of the fruit. Trees, thrifty, healthy growth; shoots, dark color, nearly upright, spreading; not an early bearer, but the original tree said to be very productive.

Fruit, medium to large; *form*, roundish oblong, flattened at both ends, widest at base, uneven, somewhat ribbed; *color*, brownish red, more or less russeted; *stem*, medium size, three-fourth inch long; *cavity*, deep, open, uneven; *calyx*, medium size, closed; *basin*, medium depth, furrowed; *flesh*, yellowish white, crisp, breaking, exceedingly high, spicy, sub-acid flavor. February to May.

FULTON.

Native of Fulton Co., Ill. Original tree, when 19 years old, gave 36½ inches circumference, 3 feet from ground, 25 feet high, and 28 feet across

top, and had produced large crops ten years in succession. *Fruit*, medium, roundish flattened, pale clear yellow, bright red cheek, little russet in stem cavity, small dots; *stem*, short; *cavity*, deep; *calyx*, short segments; *basin*, rather deep; *core*, small; *seeds*, ovate pointed; *flesh*, tender, juicy, mild sub-acid; "very good." November to March.

GARDEN ROYAL.

American. Originated in Mass. Tree, slender, slow grower while young; hardy, and makes a tree of medium size, annually productive; suited to small orchards or gardens where a delicious fruit is desired for table use.

Fruit, rather below medium; *form*, roundish, inclining to flat, very regular; *color*, a yellowish ground, with dull red stripes, becoming brighter in sun; *stem*, short, slender; *cavity*, narrow; *calyx*, large, open; *basin*, shallow; *flesh*, yellowish white, fine-grained, tender, mild, sub-acid. Last of August and September.

GOLDEN SWEET.

Orange Sweet.

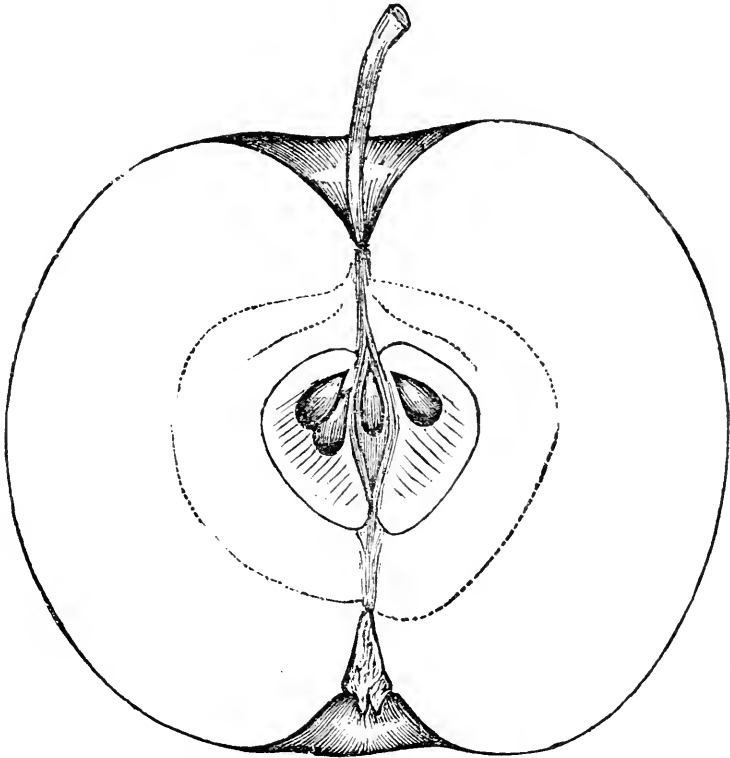

American. Originated in Connecticut. Tree, free grower while young, making, however, an orchard tree of only medium size; spreading, irregular branches; succeeds well in all soils; productive annually of large crops of fair fruit.

Fruit, medium to large; *form*, roundish, rather deeper than wide; *color*,

yellow on green, suffused slightly underneath skin, and with many small greenish dots that become russety in sun; *stem*, medium to long; *cavity*, round, shallow, regular; *calyx*, closed; *basin*, round, moderately deep, slightly furrowed or crimped at base of calyx; *flesh*, yellowish white, very rich, sweet, hardly tender; *core*, medium, round ovate; *seeds*, abundant, ovate pointed. As a baking fruit, or to grow for stock feeding, this is unsurpassed. July and August.

GOLDEN PIPPIN.

American Golden Pippin, New York Greening,	Ribbed Pippin, Newtown Greening.
---	-------------------------------------

An old American sort, of strong growth, not an early, but productive bearer. *Fruit*, large; *form*, variable, sometimes ribbed, roundish flattened; golden yellow, with a few dots, sometimes net russet; *stem*, short, stout; *cavity*, deep; *calyx*, closed; *flesh*, yellowish, tender, juicy, rich, vinous, aromatic; *core*, large. November, February.

GOLDEN BALL.

Belle et Bonne, | Connecticut Apple.

The origin of this variety is somewhat in doubt, but it is probably a native of Connecticut, from whence it has been largely distributed East. The trees do not bear well while young, but improve as they advance in years. Tree, hardy, forming a large round head, with large, glossy, rich green foliage; exceeding valuable for cooking; requires a rich, strong, heavy soil.

Fruit, large; *form*, roundish, narrowing to the eye; *color*, rich yellow, sometimes a faint blush near the stalk, and with rough dots; *stem*, short, stout; *cavity*, broad; *calyx*, half closed; *basin*, shallow; *flesh*, yellowish, tender, sub-acid, nearly acid, perfumed; *core*, medium; *seeds*, large and plump. October to December.

The Belle Bonne of Lindley is quite another fruit, and should not be confounded with this.

GRAVENSTEIN.

King of Pippins, erroneously, | Grave Slije.

Foreign .A variety indispensable to every collection, succeeding finely on all soils, annually productive, fruit always fair, fit for cooking in August, and eating in September and October; shoots, strong, smooth, upright. Tree, large, regular, round head, foliage broad.

Fruit, large; *form*, roundish flattened, a little irregular, somewhat ribbed, on surface undulating; *color*, at first pale greenish, yellow ground, becoming rich yellow, beautifully striped, and splashed with bright red; exposed to sun, red prevails, and becomes of a dark hue, beautiful, few faint light green dots; *stem*, short; *cavity*, open, deep; *calyx*, with open half reflexed segments; *basin*, rather deep, irregular, ribbed; *flesh*, yellowish, crisp, tender, sub-acid, with a peculiar aromatic taste; *core*, large, capsules open, hollow; *seeds*, ovate pyriform, reddish brown.

GRAY VANDERVERE.

Windower,
Green Vandervere,
White Vandervere,

Waldower,
Indian Apple,

Betsey's Fancy,
Vandervere Pippin, *of some.*

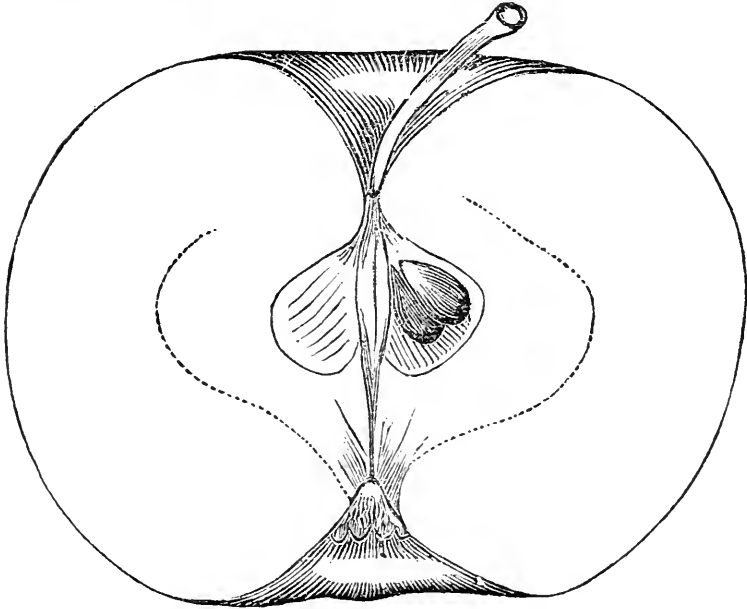

A great bearer, good keeper, by some preferred to the Vandervere. This is the variety common in Philadelphia market, and esteemed highly for cooking. *Fruit*, medium or slightly above, round flattened; *skin*, rough, uneven, mostly a dull red, with gray bloom, small specks of russet, a little bronze at the stem; *stem*, long; *cavity*, open; *calyx*, with short segments; *basin*, broad, open; *core*, medium; *flesh*, yellowish, breaking, moderately juicy. December to March.

HAWLEY.

Douse, | Dow's.

Native of Columbia Co., N. Y. Much resembles Fall Pippin, but larger, and ripens earlier, and is invariably affected with dry rot in all soils. *Fruit*, large, roundish, flattened conical, yellowish green to yellow, with few brown dots; *stem*, slender; *cavity*, wide; *calyx*, small, partly closed; *basin*, medium, slightly plaited; *flesh*, yellowish white, tender, juicy, sub-acid. October, sometimes in September.

GREEN SWEET.

Honey Greening.

Tree, hardy, productive, half spreading; shoots rather slender; fruit valuable for cooking and for stock; wants deep, rich, strong soil; fruit always fair.

Fruit, medium to large; *form*, roundish; *color*, dull greenish white or yellow, with greenish white, or sometimes pale russet dots; *stem*, varying; *cavity*, narrow, russeted; *calyx*, above medium size for the fruit, closed; *basin*, medium, slightly furrowed; *flesh*, greenish white, tender, juicy, and

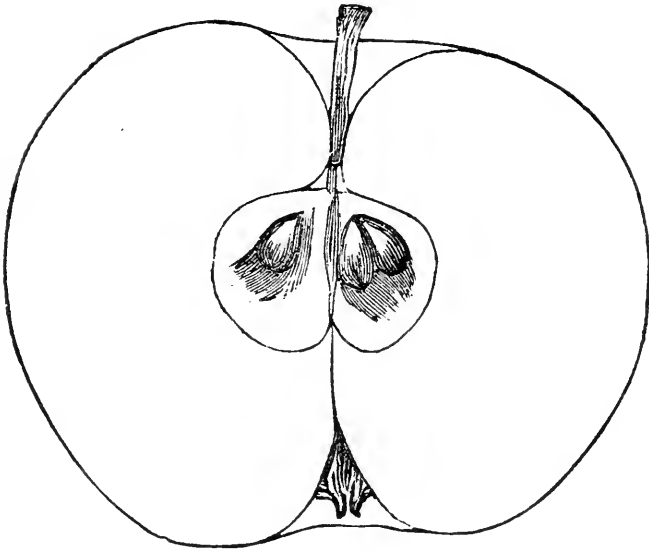

quite sweet ; *core*, medium, round ; *seeds*, ovate. December to March. Grown in Indiana, it is large, has a brownish cheek, and matures in October and November.

EARLY HARVEST.

Yellow Harvest,
Prince's Harvest,
Early French Reinette,

Bracken,
Early June,
July Pippin,

Large White Juneating,
Yellow Juneating.

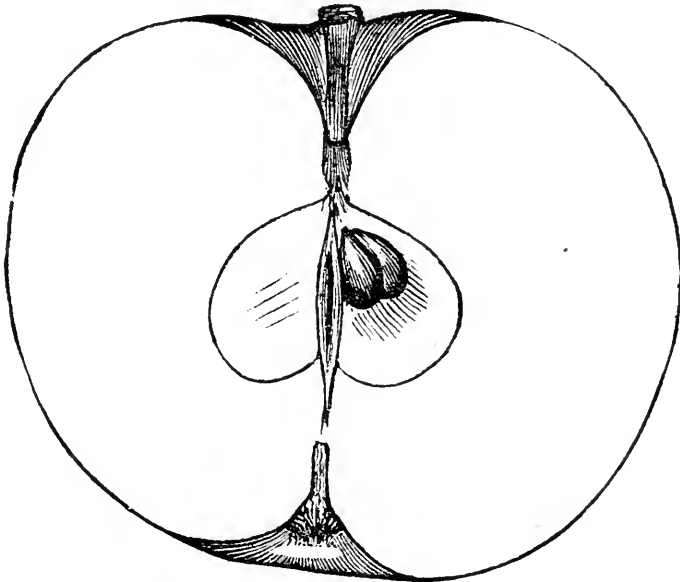

American. Universally esteemed ; requires a soil well supplied with lime and potash, otherwise the fruit is unfair. Shoots, erect, straight ; slow growth, not successful ; root-grafted as an orchard tree.

Fruit, medium; *form*, roundish, rarely a little flattened; *color*, pale light yellow, with a few dots of white; *stem*, medium length, rather slender, often short, and a little stout; *cavity*, open, deep, regular; *calyx*, closed; *basin*, shallow, slightly furrowed; *flesh*, white, tender, juicy, crisp, sprightly, sub-acid; *core*, medium; *seeds*, abundant, light brown, ovate. July.

HEREFORDSHIRE PEARMAIN.

Winter Pearmain, *erroneously*,
Royal Pearmain,

Parmin Royal,
Old Pearmain,

Royale d'Angleterre.

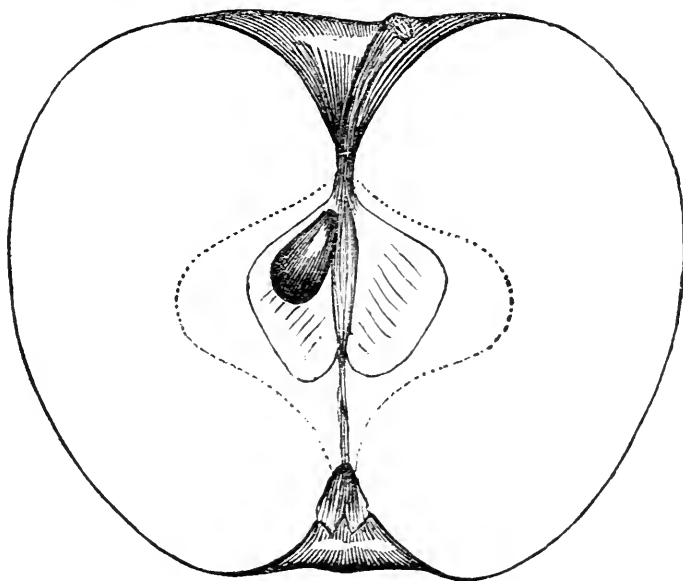

Foreign. Tree, hardy, requiring rich, strong soil, when the fruit is of the highest excellence; some regard this as first-rate, others as only second; cultivation, soil, and location, make the difference. It is best in Northern sections. Shoots, diverging, partially drooping.

Fruit, medium; *form*, roundish conical; *color*, brownish red, mottled, and slightly striped, on a dull, rusty green, or, when fully matured, yellow ground, with stripes and marblings of russet, from the stem, dotted with greyish specks; *stem*, slender; *cavity*, acuminate, russeted; *calyx*, open; *basin*, medium; *flesh*, yellowish, tender, mild sub-acid, aromatic; *core*, medium, laying nearest the stem end; *seeds*, large, ovate, light brown. December to February.

HUBBARDSTON NONSUCH.

Hubbardton Pippin.

American: originated in Mass. A superior fruit, succeeding even better when grown West than in its native locality, but not always hardy. Tree, vigorous grower; shoots, rather slender, very different from the Baldwin, which has often been disseminated as this variety; spreading; very productive.

Fruit, large, West very large; *form*, roundish ovate, very regular; *color*, yellow ground, mostly overspread, and partially striped with rich red; *stem*, short; *cavity*, narrow; *calyx*, with short open segments; *basin*, deep,

round, rarely ribbed; *flesh*, yellowish, mild, sub-acid, juicy. October to February.

HIGH TOP SWEET.

Summer Sweet, of Ohio | Sweet June, of Illinois.

From Plymouth, Mass. Tree, upright, productive. *Fruit*, medium, roundish, greenish yellow, with greenish white dots; *stem*, slender; *calyx*, closed; *flesh*, yellowish white, tender, juicy, sweet; "very good." Last of July. Very popular Southwest and West.

JERSEY SWEETING.

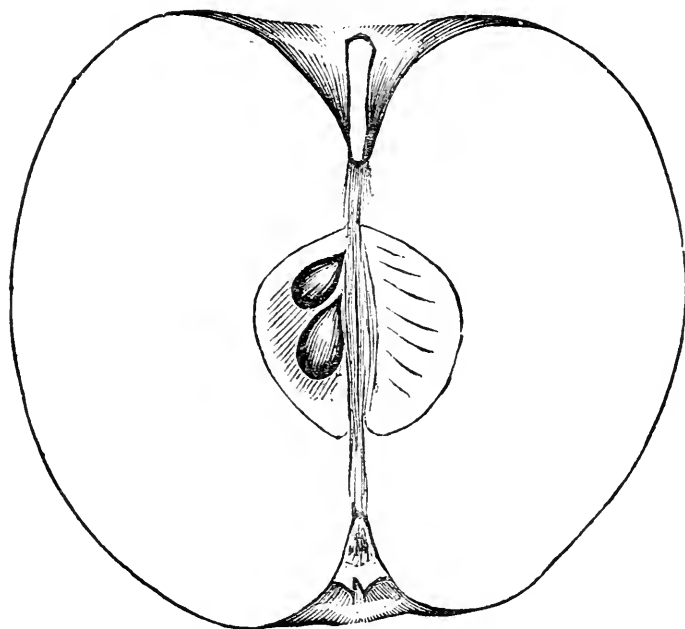

American. Succeeds in all localities, and produces abundantly of fair fruit in all soils—warm, sandy ones giving a closer texture, and more character to the flesh. Shoots, stout, short-jointed, reddish; tree, spreading, round head. For dessert, cooking, or stock, valuable. Is said to decay young; we think incorrect.

Fruit, medium; *form*, roundish ovate, tapering to the eye; *color*, greenish yellow, marked and streaked, often nearly covered with stripes of pale and dull red; *stem*, short; *cavity*, narrow; *calyx*, half closed; *basin*, not deep, sometimes slightly furrowed; *flesh*, white, fine-grained, juicy, tender, sweet; *core*, rather open, medium, round ovate; *seeds*, full, ovate pointed. September and October.

JEFFERSON.

Tree, good habit, spreading; much grown and esteemed in some parts of Kentucky, from whence we once received specimens in April (after lying in a warehouse during Winter), in fine condition. *Fruit*, medium to large, roundish conical, dull red on yellow, splashed; *stem*, slender; *cavity*, moderate; *calyx*, small, partially closed; *basin*, open; *core*, compact; *seeds*, light brown; *flesh*, yellowish white, tender, juicy, sub-acid; almost "best." October to March.

JEFFERIS.

From Chester Co., Pa. Tree, moderate grower, upright habit, constant and abundant bearer. *Fruit*, roundish flattened, pale yellow, striped and stained with red, becoming dark in the sun, dotted with white spots and russet at stem; *stem*, half inch, slender; *cavity*, narrow, deep, *calyx*, nearly closed, woolly; *basin*, deep, regular; *flesh*, white, crisp, tender, juicy; best." September and October.

JEWITT'S BEST.

From Torybridge, Vt. *Fruit*, large, nearly globular, irregular, greenish, shaded with deep red; *stem*, short; *cavity*, deep; *calyx*, closed; *basin*, small; *core*, medium; *flesh*, yellowish, juicy, rich, sub-acid; almost "best." December to February.

JONATHAN.

Philip Rick,		Winesap, <i>erroneously</i> ,
King Philip,		Wine, " "

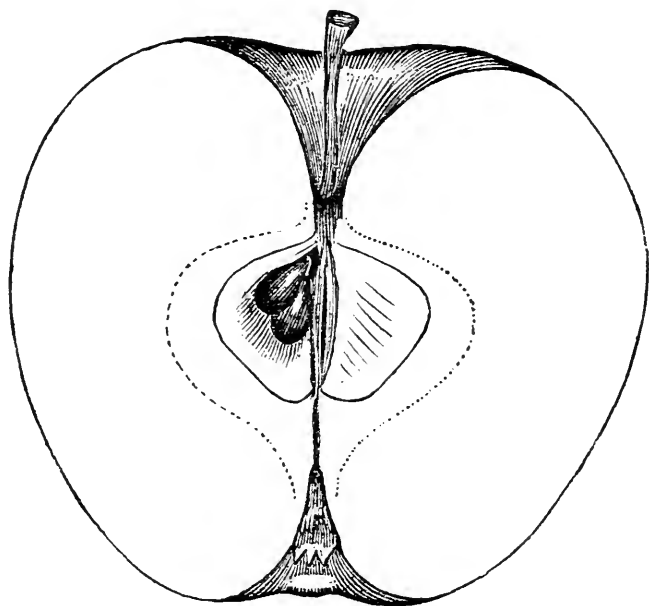

American: originated Kingston, N. Y. Shoots, light brown, slender, diverging; when grown and fruiting, tree has a drooping and pendent habit; very productive; needs rich, strong soil.

Fruit, medium; *form*, roundish, conical, regular; *color*, light yellow ground, mostly overspread, streaked, or stained with rich light red, and with few minute white dots; *stem*, rather long, slender; *cavity*, open, wide; *calyx*, small, nearly closed; *basin*, shallow, slightly furrowed; *flesh*, yellowish white, tender, juicy, slightly acid unless fully matured, when it is sub-acid, sprightly; *core*, medium; *seeds*, full, abundant, dark brown. December to February.

JULIN.

Juling.

Fruit, medium size, roundish, tapering somewhat to the eye, rather one-sided; *calyx*, small, in a narrow basin; *stem*, short, in a moderate cavity; *skin*, thin, yellowish white, striped and marbled with carmine, of a beautiful waxen appearance, sprinkled sparingly with whitish dots; *flesh*, white, tender, juicy, and fine flavored; indeed, the finest summer apple known North and South. Ripens about the middle of July at South; August at North.

KESWICK CODLIN.

Foreign. Very productive. Tree, hardy; valued for cooking, and suited to Western soils; one of best. *Fruit*, medium or above, roundish ovate, conical; greenish yellow, with brownish cheek in sun, and light dots, one or two raised lines from stem to apex; *stem*, slender; *cavity*, shallow; *calyx*, closed; *basin*, furrowed imperceptibly; *core*, medium; *seeds*, ovate; *flesh*, greenish or yellowish white, tender, acid, September and October.

KINGSLEY.

From Monroe Co., N. Y. Tree, erect, moderate grower, hardy, profuse early bearer. *Fruit*, medium, roundish oval; yellowish, striped and splashed with pinkish red, white dots, russet near calyx; *stem*, slender; *calyx*, small, closed; *basin*, shallow; *core*, medium, open; *seeds*, small, dark brown; *flesh*, fine-grained, juicy, sub-acid; "best." November to July. (H. Wendell in Pom. Trans.)

KING OF TOMPKINS COUNTY.

Winter King | King.

This variety we have had more or less acquaintance with for the past ten years. It is really one of the most valuable apples grown at the North. Its origin is uncertain. Supposed to have been brought at an early day from New Jersey to Jacksonville, Tompkins Co., N. Y. It is distinct from "King" of Ky., and Newark King of N. J. Tree, annually productive.

Fruit, large, roundish oblong, somewhat ribbed, pale yellow ground, mostly covered with two shades of red, striped and splashed, brown dots, and russet patches on sunny side; *stem*, stout, thick; *cavity*, open, regular *calyx*, with long pointed segments; *basin*, abrupt, slight furrows, and projecting ribs surrounding; *flesh*, yellowish, crisp, juicy, sub-acid. December to February.

LADY APPLE.

Api, Petit Api, Pomme d'Api,	Pomme Rose, Pomme d'Api Rouge,	Petit Api Rouge, Gros Api Rouge.
------------------------------------	-----------------------------------	-------------------------------------

Foreign. Trees, very upright, forming almost pyramidal heads, like that of a Pear tree, producing the fruit in clusters; require to be ten or more years old, ere bearing much; after which, very productive. Shoots, very dark color, straight, erect, leaves small; appears to succeed in all soils, and the fruit, though small, from its beauty, always commands a high price.

Fruit, small; *form*, flat; *color*, brilliant red, on light, clear yellow; very glossy; *stem*, short; *cavity*, deep; *calyx*, small; *basin*, furrowed; *flesh*, white, crisp, tender, juicy; *core*, small. December to May.

LADIES' SWEETING.

American. We have repeatedly fruited and met with this variety West, where it seems generally to succeed, but varies much in different soils—often not more than second-rate quality; always fair, handsome fruit; profitable for marketing, or stock feeding. “Wood, not very strong; grows thriftily; bears abundantly.”

“*Fruit*, large, roundish ovate, narrowing rapidly to the eye; *skin*, very smooth, nearly covered with red in the sun, pale yellowish green in the shade, with broken stripes of pale red. The red is sprinkled with well-marked yellowish gray dots, and covered, when first gathered, with a thin white bloom. There is also, generally, a faint marbling of cloudy white over the red, on the shady side of the fruit, and rays of the same around the stalk. *Calyx*, quite small, set in a narrow, shallow-plaited basin; *stalk*, half an inch long, in a shallow cavity; *flesh*, greenish white, exceedingly tender, juicy, crisp, delicious, sprightly, agreeably perfumed flavor; keeps without shelving, or losing its flavor, till May.”

LONDON SWEET.

London Winter Sweet, | Winter Sweet, | Heicke's Winter Sweet.

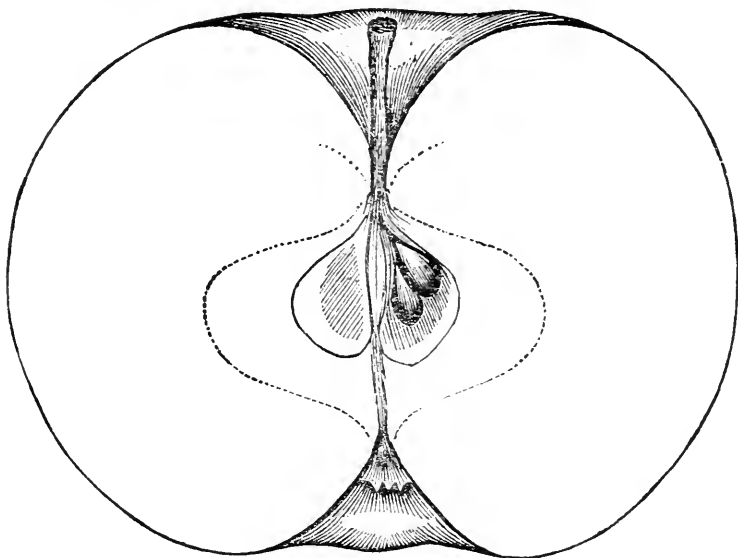

American. Much cultivated in Southern Ohio; often abundant in Cincinnati market. We have been unable to connect it with any other named variety, though it nearest resembles Broadwell. Adapted to the rich deep soils of the West; annually productive.

Fruit, medium, occasionally large; *form*, roundish flattened; *color*, pale yellow, with rarely an irregular patch of bronzed russet; very smooth; grown South, has the fungus or mould, as we think, marring its beauty; *stem*, short, slender; *cavity*, open, medium depth, round, regular; *calyx*, small, closed; *basin*, deep, round, regular; *flesh*, yellowish white, juicy, tender, pleasantly sweet; *core*, rather small; *seeds*, ovate pointed. November to January, but will keep through February.

LOWELL.

Orange, of some, Tallow Apple, Tallow Pippin,	Greasy Pippin, Queen Anne, Pound Royal, <i>erroneously</i> .
---	--

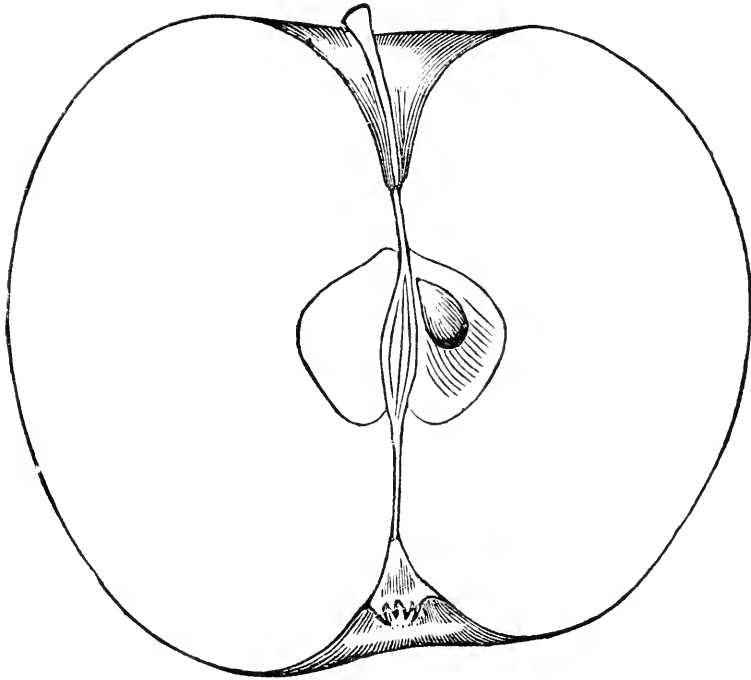

American. The early habit of productiveness, with the large fair fruit, will always command a place in large orchards, where this variety is known. Trees, thrifty, rather strong growers, spreading; most valuable on rich heavy soils.

Fruit, large; *form*, roundish oblong, slightly conical; *color*, green, becoming rich yellow; oily surface; *stem*, long, slender; *cavity*, narrow; *calyx*, small, nearly closed; *basin*, deep, furrowed; *flesh*, yellowish white, rather coarse, sub-acid, fine aroma; *core*, medium or small; *seeds*, ovate, August and early September.

MAIDEN'S BLUSH.

American. Tree a rapid grower, forming a fine spreading head; succeeds, so far as producing annually and abundantly, in all soils; much the best, however, in those termed "limestone clay." Valued for cooking, for drying, and salable in market on account of its handsome appearance.

Fruit, medium to large; *form*, roundish flattened; *color*, clear lemon yellow, with red cheek, varying from faint blush to rich crimson; *stem*, short; *calyx*, closed; *basin*, medium, abrupt; *core*, medium; *flesh*, white, fine-grained, tender, sprightly, rather sharp sub-acid unless fully ripened. September and October.

MANGUM.

Seago, | Maxfield.

From Georgia. *Fruit*, medium, roundish, conical; yellowish, striped and shaded with red; whitish brown dots; *stem*, short, small; *cavity*, broad, often russeted; *calyx*, closed; *basin*, medium; *core*, small; *flesh*, yellow, tender, juicy, mild sub-acid, excellent. October and November Valued South as keeping until March.

MAVERACK'S SWEET.

Southern origin. *Fruit*, very large; roundish, irregular, slightly conical; striped with bright red, and a few greenish dots; *stem*, short; *cavity*, regular; *calyx*, open; *basin*, medium; *skin*, thick; *flesh*, fine-grained, tender, sweet, excellent. November and December at the South; December to March at the North.

MELON.

Norton's Melon, | Watermelon.

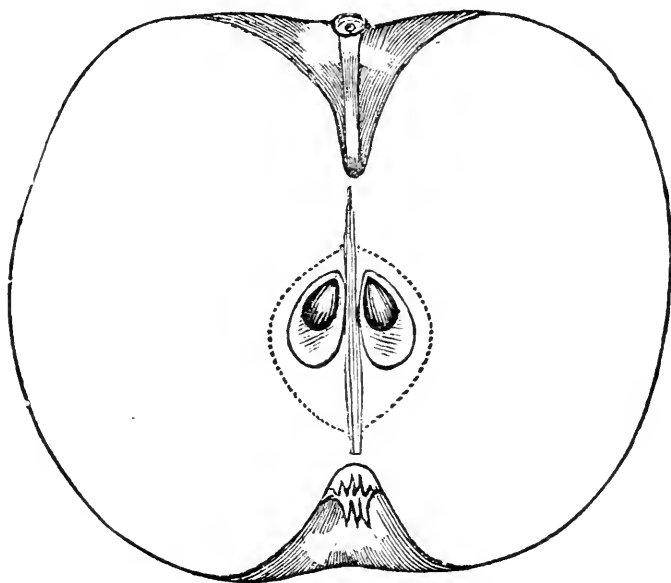

American. Origin questioned—whether New York or Connecticut. It proves fine so far, wherever it has been tested. Tree, vigorous, spreading; shoots, reddish brown; requires deep, strong soil.

Fruit, medium to large; *form*, roundish flattened, regular; surface, glossy, uneven; *color*, pale yellowish white, much overspread with broken streaks and stripes of reddish purple, becoming rich and dark in the sun; *stem*, medium, slender; *cavity*, wide, round, open, marked with greenish russet; *calyx*, closed; *basin*, deep, finely plaited at bottom; *flesh*, white, fine-grained, crisp, tender, juicy, sprightly; *core*, rather small; *seeds* broad, nearly black. October to December.

McLELLAN.

Martin.

From Woodstock, Conn. Trees, moderate growth, annual productive bearers. *Fruit*, medium, round; bright straw color, striped and marbled

with lively red ; *stem*, short, slender ; *cavity*, round ; *calyx*, nearly closed ; *basin*, medium, slightly plaited ; *core*, medium ; *seeds*, small ; *flesh*, white, fine-grained, tender, mild sub-acid ; nearly "best." November to March.

MINISTER.

From Massachusetts. Tree, productive. *Fruit*, large, oblong conical, ribbed ; red striped on greenish yellow ; *stem*, slender ; *calyx*, small, closed ; *basin*, furrowed ; *flesh*, yellowish white, coarse, spongy ; "good ;" showy and salable. October to December.

MICHAEL HENRY PIPPIN.

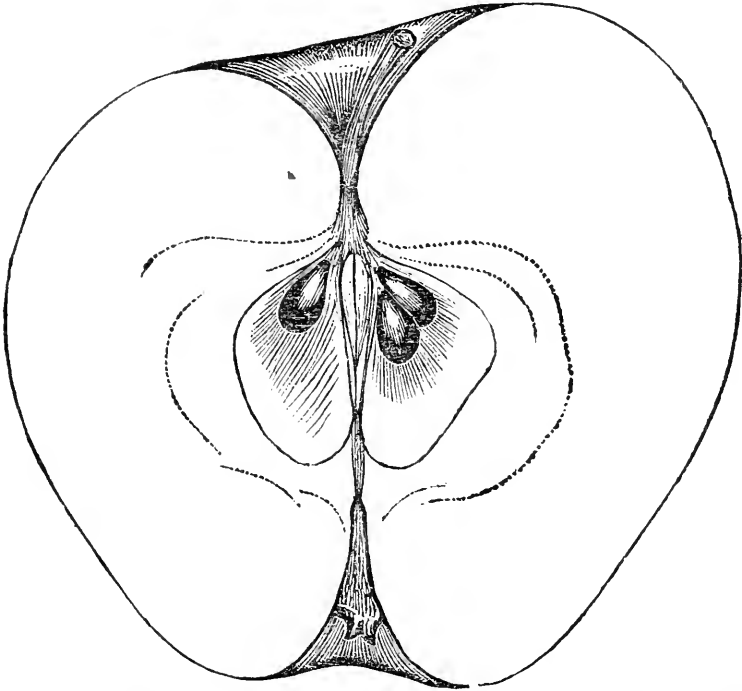

American. Native of New Jersey. It is in extensive cultivation throughout the West, and is very successful. Trees very productive.

Fruit, medium to large ; *form*, angular, roundish conical ; *color*, light yellowish green, with a flush of red, in sun, dotted with irregular formed specks of russet ; often there is a shade of rich yellow, marbled or striped, apparently underneath the skin ; *stem*, usually short ; *cavity*, narrow, regular ; *calyx*, with long segments in divisions ; *basin*, shallow, narrow, somewhat furrowed ; *flesh*, white tender, juicy, sweet ; much valued for cooking and keeping well, being in use from October to March ; *core*, small, compact, surrounded by a broad, coarse vein, giving semblance of a large core ; *seeds*, ovate pointed, light brown.

MOTHER.

Queen Anne, of some, incorrectly.

From Massachusetts. Tree, hardy, moderate growth, annual bearer. *Fruit*, large, roundish ovate ; yellow, mostly overspread, marbled and

striped with shades of dark red, few russet dots; *stem*, slender; *calyx*, small, nearly closed; *basin*, plaited; *flesh*, yellowish, tender, spicy, sub-acid, "best." October to January.

MONMOUTH PIPPIN.

Red Cheek, of some, | Red Cheek Pippin.

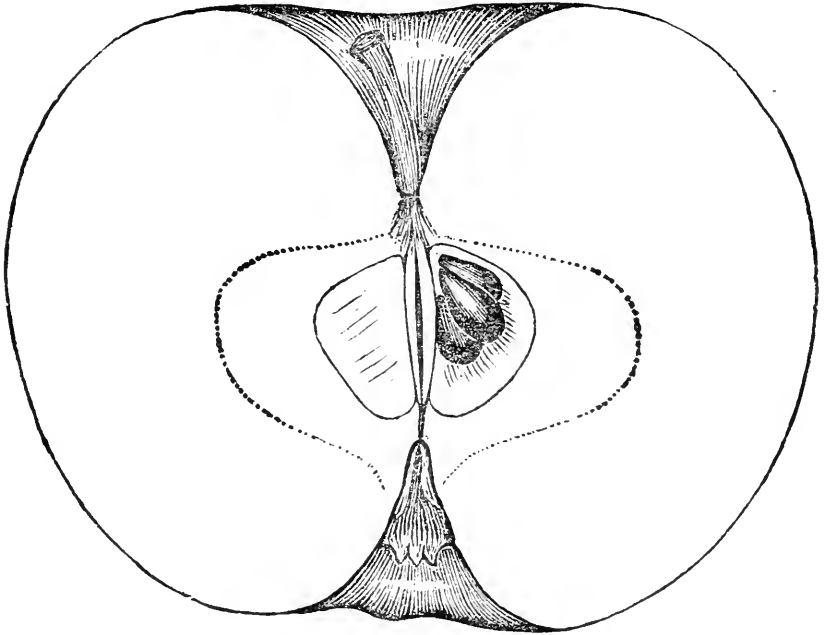

American. Native of Monmouth County, N. J. It is stated as very productive, and of healthy, vigorous growth. We are conversant only with the fruit.

Fruit, large; *form*, roundish flattened; sometimes roundish conical; *color*, pale greenish yellow, with blush-red cheeks, small, raised, rough, brown specks, with a shade of light green suffused around them underneath the skin; *stem*, rather short; *cavity*, deep, regular; *calyx*, medium, segments woolly and often nearly closed; *basin*, wide, abrupt, deep, much plaited; *flesh*, yellowish white, rather coarse-grained; breaking tender, moderately juicy, sub-acid, with considerable aroma, or perfume; *core*, small, compact; *seeds*, oblong ovate, abundant. December to February, and often till April.

MYER'S NONPAREIL.

Ohio Nonpareil, | Cattall Apple.

The original tree, in orchard of Mr. Bowman, Massillon, O., is over fifty years old. It has been claimed as identical with "Cogswell," but it is only a Fall fruit, and the tree a far more upright grower. In our experience, it is one of the most valuable of Fall apples.

Tree, straight, stout growth, forming a compact head; an annual bearer of fruit uniform in size. *Fruit*, large, roundish flattened; red and yellow marbled and splashed; *stem*, medium; *cavity*, regular; *calyx*, partially

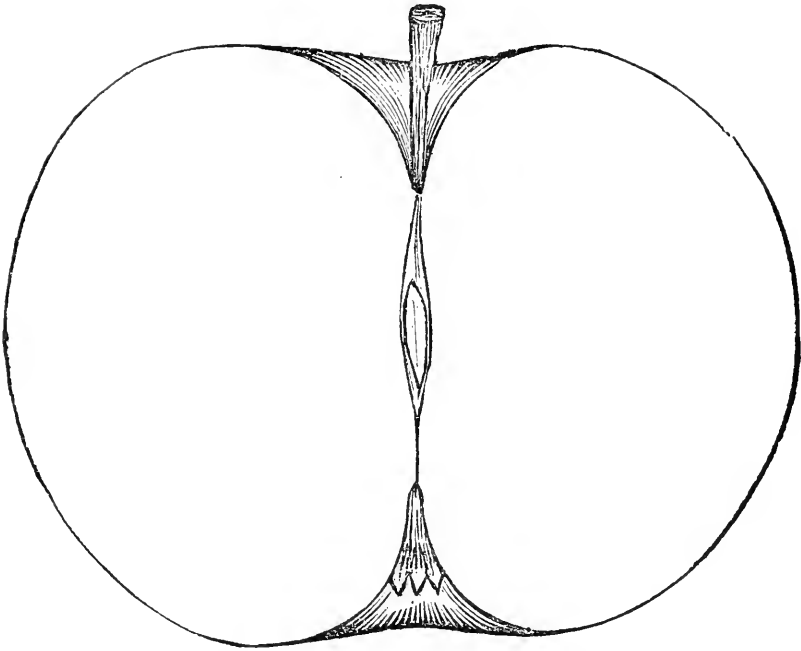

open ; *basin*, not deep ; *flesh*, yellowish white, tender, juicy, sub-acid ;
"best." October to December.

NEWTOWN PIPPIN.

Green Newtown Pippin,
American Newtown Pippin,

| Green Winter Pippin,
Petersburg Pippin.

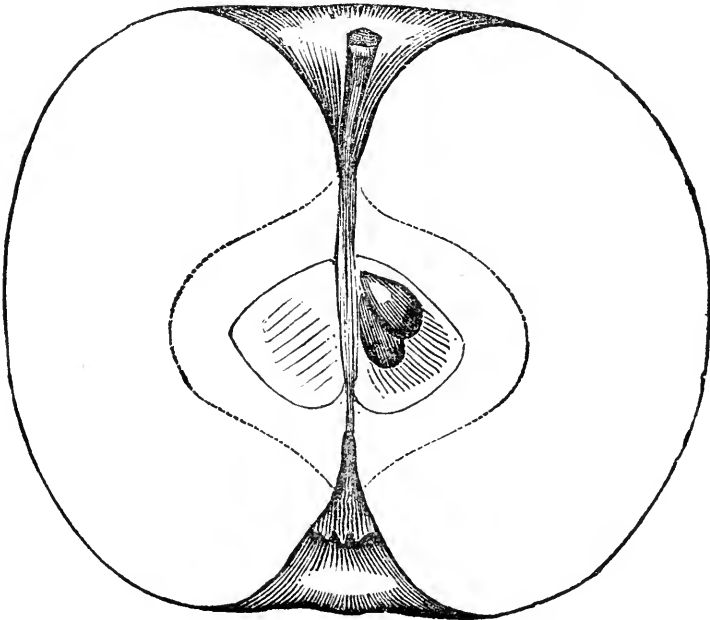

American. Native of Newtown, Long Island. It requires a rich limestone clay soil, or a warm, sandy, rich loam, well dressed with lime and bone dust, in order to secure healthy wood, and fair, smooth fruit. On sandy soils, abounding more or less with iron, we have never seen good fruit grown of this variety. It is distinct in fruit from the Yellow Newtown Pippin, for which see further pages; but it is difficult, if not impossible to detect one from the other by the wood. Growth slender, slow; as an orchard tree, a fine round head, with branches diverging, pendent. On the rich limestone soils of Ohio, and farther west, this and the Yellow Newtown Pippin succeed, and produce fruit even superior to the world-renowned Pell Orchard.

Fruit, medium; *form*, roundish, oblong flattened; *color*, dull green when first gathered, becoming, when ripe, a yellowish green; small minute russet dots, with occasional spots or blotches of russet, and, grown on alluvial soils South, patches of dark green mould; *stem*, slender; *cavity*, acuminate, regular; *calyx*, small; *basin*, deep, abrupt, hollowed, and slightly wrinkled; *flesh*, greenish white, very fine-grained, juicy, crisp, sprightly, perfumed; *core*, compact; *seeds*, dark brown, ovate. February to May.

NEWTOWN SPITZENBERG.

Spiced Ox-eye,
Ox-eye,
Burlington Spitzenberg,

Matchless,
Kountz,

Joe Berry,
Vandervere of New York, and
Eastern States.

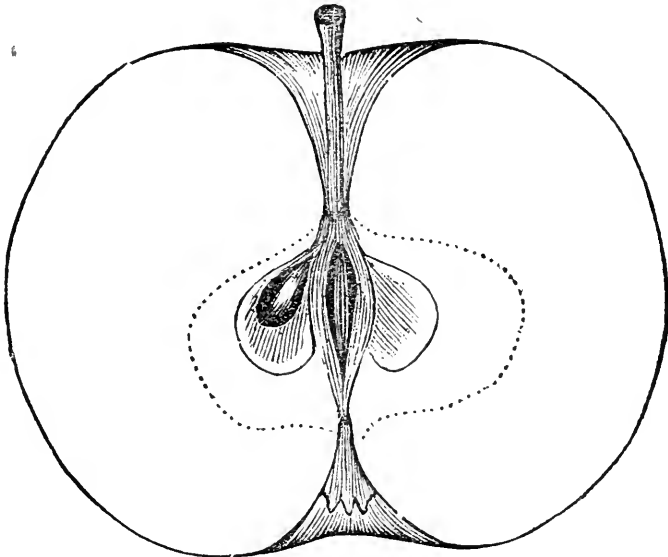

American. From Newtown, Long Island. Originally described by Coxe, in 1817. It is extensively and successfully grown in the West as Ox-Eye, and highly estimated. When Mr. Downing wrote his description of Vandervere, he evidently had this apple before him; and was not acquainted with the true Vandervere.

Fruit, medium; *form*, round, flattened; *color*, yellow ground, mostly striped and splashed with red, which often has appearance as of a bloom; russet dots and lines that near the calyx look like the crests of waves; *stem*, long, slender; *cavity*, narrow, deep, regular; *calyx*, small, segments

erect; *basin*, open, regular, not deep; *flesh*, yellow, tender, slightly sweet, rich, aromatic; *core*, small; *seeds*, few, ovate pointed. December to February.

NORTHERN SPY.

American. Native of East Bloomfield, N. Y. While the quality of this variety secures it a place among first class fruit, it cannot be considered a profitable variety until the trees have acquired at least twenty years of age, as it is tardy in coming into bearing. It is of thrifty, vigorous growth, requiring a rich soil, high state of cultivation, and as an orchard tree, severe thinning out of the tops, as it inclines to make an upright, close head; young shoots, stout, dark, spotted; blooms late, often escaping late frosts in Spring.

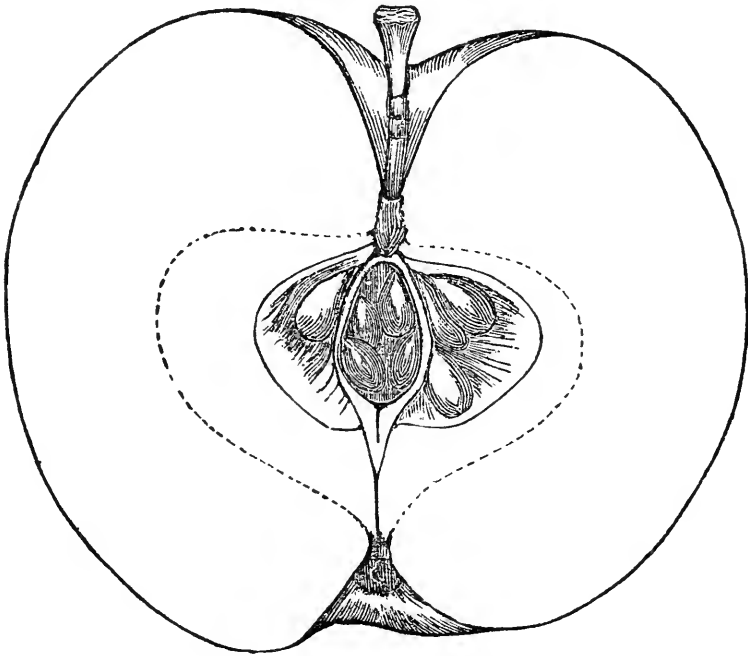

Fruit, medium to large; *form*, roundish conical, sometimes ribbed; *skin*, thin and tender; *color*, light yellow, mostly overspread with light red, striped and slashed with streaks of carmine red, and, when first gathered, covered with a fine bloom; *stem*, slender, projecting about even with the surface; *cavity*, open, wide, deep; *calyx*, small, closed; *basin*, open, regular, other than the furrows produced by ribs of the fruit—not deep, but rather abrupt; *flesh*, yellowish white, very tender, crisp, juicy, sprightly; *core*, large, capsules open; *seeds*, abundant, many of them triangular ovate pointed. January to April. South, it will probably become an early Winter variety.

ORTLEY.

Ortley Pippin
Woolman's Long,
White Bellefleur,
White Bellflower,
Green Bellflower,
Willow Leaf Pippin,
Ohio Favorite,
Detroit,
White Detroit,

Van Dyne,
Jersey Greening,
Davis, *erroneously*,
Hollow Core Pippin,
Greasy Pippin,
Melting Pippin,
Crane's Pippin,
Warren Pippin,

White Pippin, *erroneously*.
Yellow Pippin,
Golden Pippin, *of some*,
Woodward's Pippin,
Tom Woodward Pippin,
Inman,
White 'Seek-no-further, *of some, erroneously*.

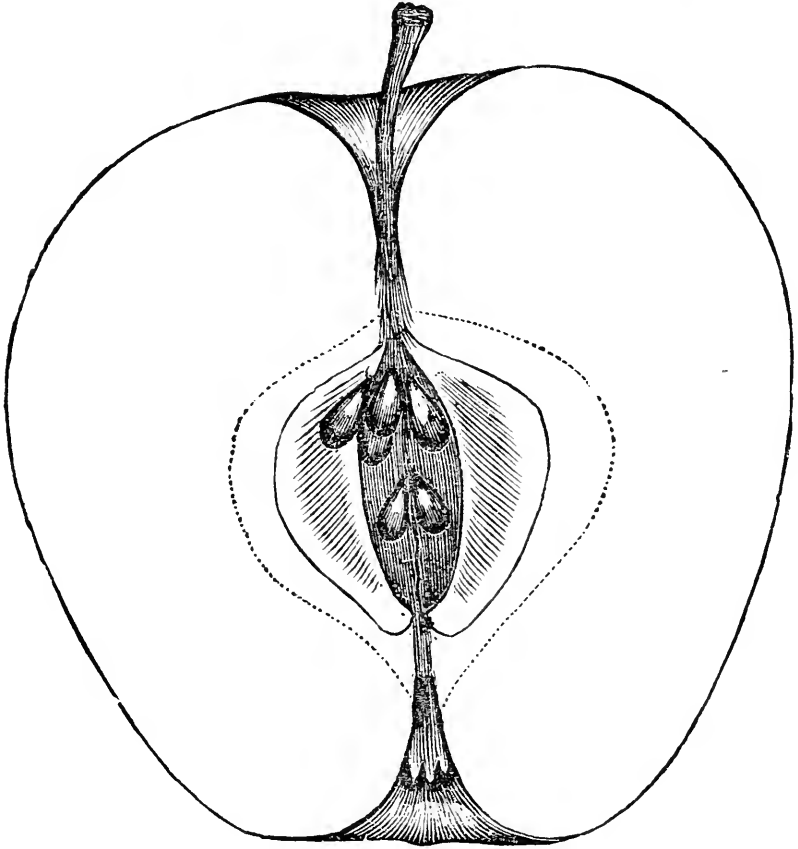

American. Native of New Jersey. First described by Lindley as Ortley, and we therefore follow, as it is as well known by that as any other one of its names. In strong rich soils, throughout the entire Western States, it proves one of the hardiest, most productive, profitable, as well as best varieties known. In size, it is also largely increased over specimens grown North, where the form is more oblong, the texture somewhat closer, and sprightliness a little enhanced. Shoots, slender, brownish, yellow, upright, long jointed.

Fruit, large, when grown on rich soils; *skin*, smooth; *form*, oblong oval, occasionally or often roundish conical; *color*, pale yellowish white, at the North—South it becomes a richer yellow, with specks of dark red, and a vermilion tinge surrounding when exposed to sun; *stem*, varying from short and stout to long and slender; *cavity*, deep, narrow; *calyx*, small,

closed; *basin*, furrowed or plaited, from the surrounding angles or ribs that are often apparent in the fruit; *flesh*, yellowish white, tender, crisp, sprightly, mild acid; *core*, large, open; *seeds*, abundant, loose in the capsules. January to April.

PECK'S PLEASANT.

Waltz Apple.

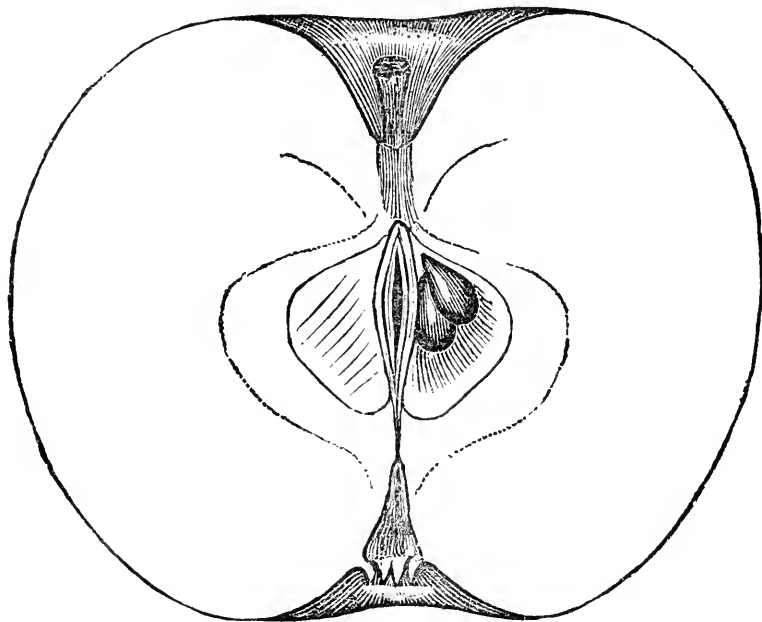

American. Native of Rhode Island. Shoots, rather erect, slightly diverging, vigorous, productive. If on sandy soils, it is of firmer texture than on clays, and keeps better, but is not so large.

Fruit, medium to large; *form*, roundish, slightly (sometimes very much) flattened, with an indistinct furrow on one side; *color*, when first gathered, green, with a little dark red—when ripe, a beautiful clear yellow, with bright blush on sunny side, marked with scattered gray dots, which become small and almost indistinct near the apex; *stem*, varies, mostly short and fleshy; *cavity*, broad, open, and almost always with a slight ridge or wave on one side, connecting with stem; *calyx*, medium size, usually segments half open; *basin*, round, regular; *flesh*, yellowish white, fine grained, firm, yet tender, juicy, mild, aromatic, sub-acid; *core*, medium; *seeds*, abundant, ovate, dark reddish brown. December to February, often keeps to April.

PARADISE WINTER SWEET.

Honey Sweet, of some.

From Columbia Co., Pa. Tree, productive. *Fruit*, large, roundish flattened; dull green, with a pale brownish blush; *stem*, short; *cavity*, rather deep; *calyx*, medium; *basin*, not deep; *core*, medium; *seeds*, ovate pyriform

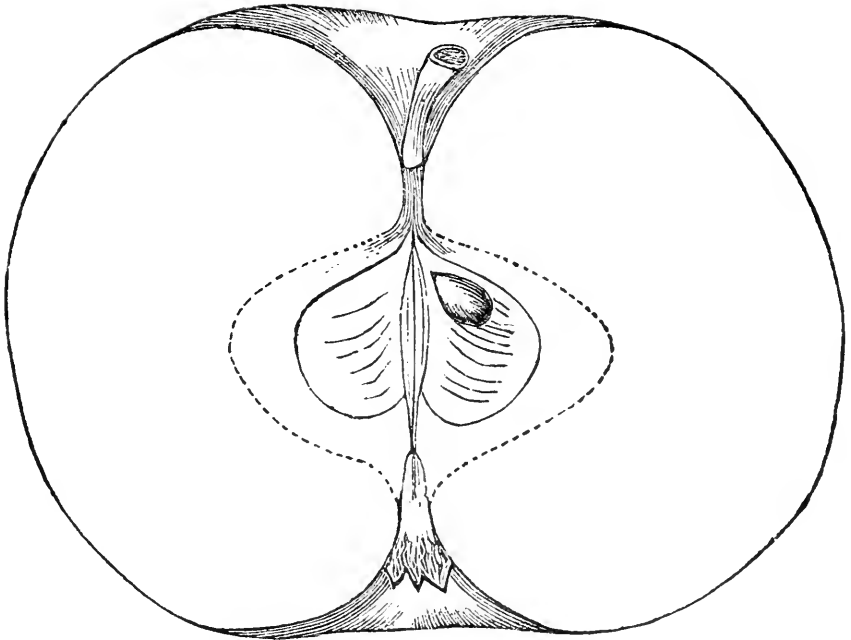

form; *flesh*, white, fine grained, juicy, sweet; "very good." November to March. Quality a little variable.

PEACH POND SWEET.

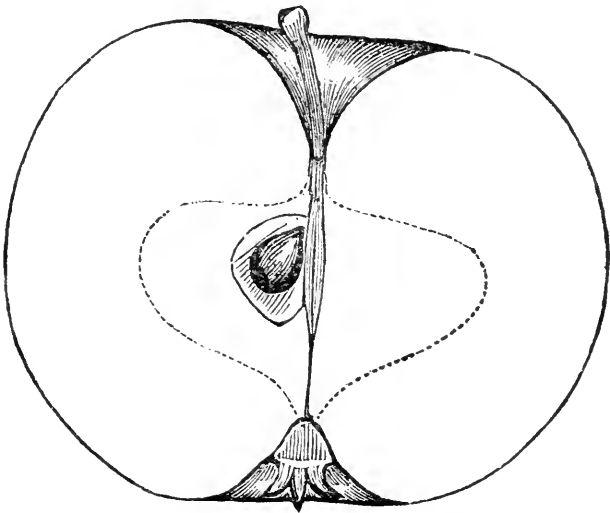

From Dutchess County, N. Y. Tree, moderate growth, spreading; annual moderate bearer. *Fruit*, medium, roundish; pale red, marbled and striped on yellow; *stem*, slender; *cavity*, open, slightly russeted; *calyx*, with segments in divisions; *basin*, deep; *core*, small; *seeds*, ovate pyriform; *flesh*, yellowish, tender, sweet; "very good." October.

PEOPLE'S CHOICE.

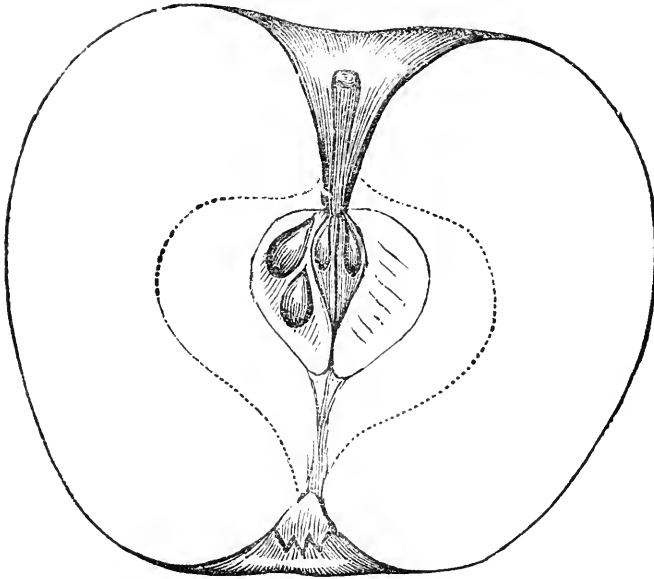

Origin, Pennsylvania. Tree, hardy; shoots, slender, diverging; fruit borne mostly on ends of limbs; requires rich soil, abounding in lime; on young trees, fruit quite small; improves and increases as they advance in years and size, and under good culture.

Fruit, medium; *form*, roundish, slightly flattened; *color*, yellow ground, overspread with warm yellow red, dotted and marbled with yellow russet; *stem*, short; *cavity*, deep, regular; *calyx*, with short, erect segments; *basin*, shallow, broad, open; *flesh*, yellowish crisp, juicy, tender, sub-acid; *core*, small, compact; *seeds*, long; oval-pointed, abundant. January to April.

POMME GRISE.

Grise, | Gray Apple.

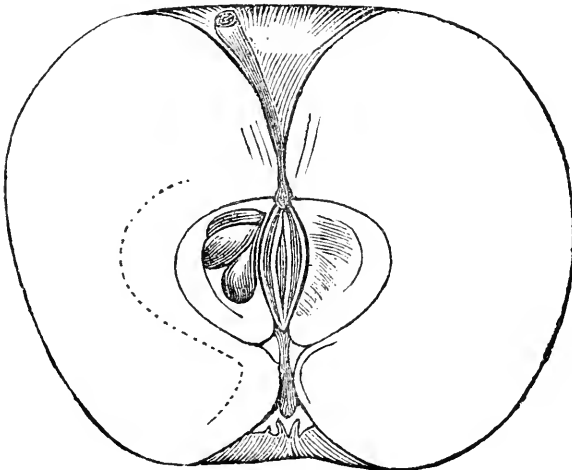

A delicious little apple from Canada, that is especially adapted to Northern and Southwestern sections, and only to gardens. It is a good bearer, of slender growth, forming a tree of small size.

Fruit, below medium; *form*, roundish, somewhat flattened; *color*, yellow, gray, or russet, with a little red towards the eye; *stem*, slender; *cavity*, deep; *calyx*, small; *basin*, round; *flesh*, yellow, tender, sprightly; *ore*, medium; *seeds*, abundant. December to February.

PORTER.

Golden Pippin of Michigan.

American: native of Massachusetts. Tree, slender, slow growth, a regular, even bearer, requires strong soil in which there is good supply of lime and phosphates; succeeds wherever grown—one of the best at South; hardy all West.

Fruit, medium to large; *form*, oblong conical; *color*, bright, clear yellow—when exposed to sun, a fine blush cheek; *stem*, slender; *cavity*, shallow; *calyx*, medium, closed; *basin*, narrow, deep; *flesh*, fine-grained, juicy, firm yet tender, acid. September and October.

POUGHKEEPSIE RUSSET.

English Russet, | Winter Russet?

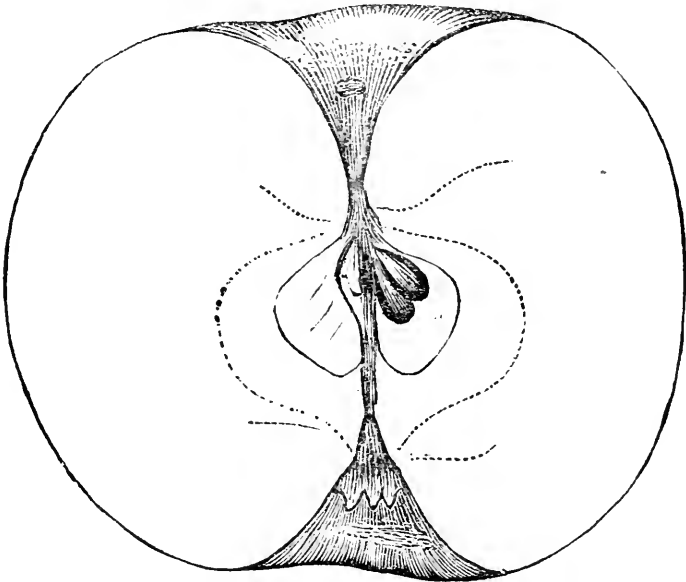

is variety, described by Downing as the "English Russet," is probably an American seedling, and as there are so many sorts known under the general term of English Russet, we prefer to adopt the name of Poughkeepsie Russet, as commemorative of the section whence it was first disseminated. Growth, upright. Shoots, lively brown, profuse bearer, and although only of medium size, its quality of keeping over year renders it very profitable. There is also another called "Crow's Nest," sometimes sold under this name, of which the fruit is larger, does not keep as well, and the tree when grown makes a dense top.

Fruit, medium ; *form*, roundish conical, or roundish ovate, regular ; *color*, light greenish yellow, mostly overspread with brownish russet ; when well matured, becomes yellowish ; *stem*, rather short ; *cavity* round ; *calyx*, small, close ; *basin*, abrupt, regular, round ; *flesh*, yellowish white, fine texture, rather firm, aromatic ; *core*, small ; *seeds*, ovate, reddish brown. All Winter and Spring.

There is cultivated in Central Ohio, a Golden Russet (see our figure) which resembles this, but is larger, and with an open calyx, and often beautifully bronzed with russet yellow. We think they may prove identical, and the soil and location make the apparent difference.

PRIMATE.

Rough and Ready, | Summer Pippin, *erroneously*.

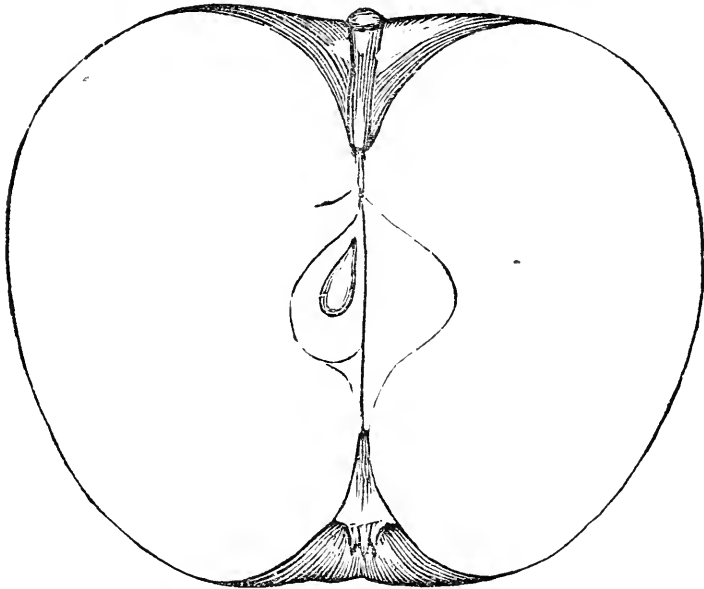

A variety lately come into favorable notice in Central New York, that may yet prove an old sort improved by soil and location. *Fruit*, medium, roundish, tapering to the eye—pale yellow—occasionally, blush red cheek ; *calyx*, closed ; *basin*, deep ; *stem*, varying ; *cavity*, rather narrow ; *core*, with open seed-capsules ; *seeds*, pyriform ; *flesh*, yellowish white, very tender, delicate, juicy, mild sub-acid ; “best.” September and October.

PRYOR'S RED.

Prior's Red, | Pitzer Hill, | Big Hill.

This is evidently a seedling from seed crossed with Westfield Seek-no-further and Roxbury Russet, partaking most largely of the Seek-no-further. Its certain origin we have not learned. It is not regarded as an early bearer, but as very hardy, and the fruit keeping well when grown South, and on rich alluvial soils. Grown at the North, the trees come into bearing at about eight years, and the fruit has very little russet (unless unusually warm seasons), except at stem end ; South, in good culture, it attains

size of four inches diameter, by three inches from stem to eye, and mostly covered with russet. Popular in Kentucky, not so, farther North.

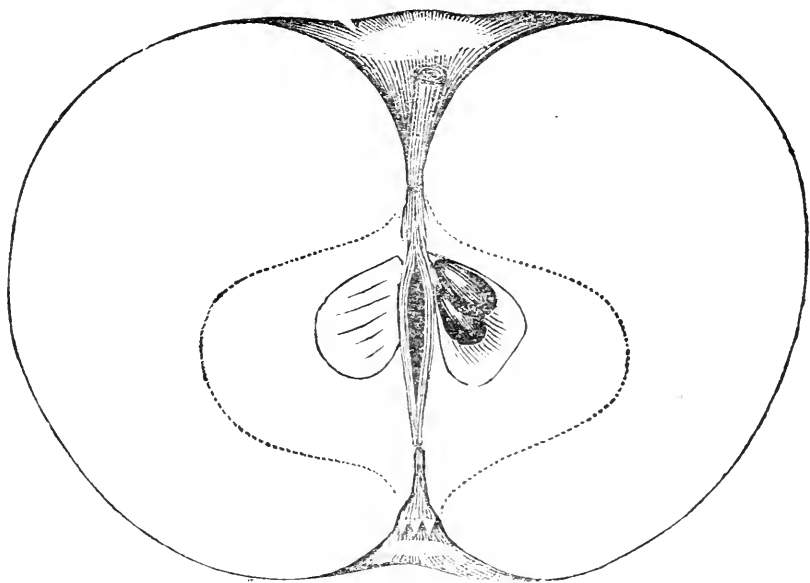

Fruit, medium to very large; *form*, at North, regular roundish, tapering to the eye—South, always angular, sometimes even broad at apex, being roundish angular, flattened; *color*, pale yellow, ground mostly overspread with rich, warm red and russet, marbled and splashed with bronzed yellow near the stem, dark yellow russet spots surrounded with a lighter shade; *stem*, short; *cavity*, narrow; *calyx*, small, segments erect; *basin*, abrupt, pretty deep, round and even, occasionally shallow; *flesh*, yellowish, tender, mild sub-acid, much resembling Westfield Seek-no-further; *core*, medium, marked at distance with a line encircling; *seeds*, varying, generally ovate. January to April.

PUMPKIN SWEET.

Pound Sweet,		French's Sweet,
Lyman's Pumpkin Sweet,		Yankee Apple.

An old Connecticut fruit, valued for baking. In wet soils or heavy clay, liable to be watered-cored. Bears regularly, and evenly distributed. *Fruit*, large, roundish, ribbed at base—yellowish green, whitish dots and streaks; *stem*, short; *cavity*, deep greenish, russeted; *calyx*, small; *basin*, irregular; *flesh*, white tender, sweet; "good." September to November.

RAMBO.

Romante,		Seek-no-further,
Bread and Cheese Apple,		Terry's Red Streak.

American. A native of Delaware, it succeeds in all soils and locations, and has no superior, as a whole, in the general estimation. It succeeds on sandy soils, but the largest and best fruit is grown on strong limestone soils, giving evidence of the food suited best to it, clay or loam.

Fruit, medium; *form*, flat, or roundish flattened, sometimes ribbed or angular; *color*, yellowish white, marbled and streaked with yellow and

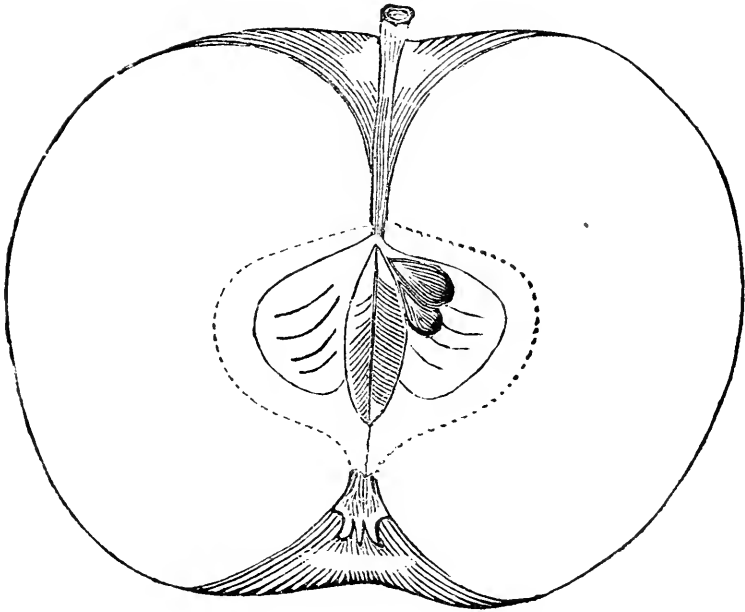

red, and with large rough spots; *stem*, long, slender, often curved; *basin*, acuminate; *calyx*, nearly closed; *basin*, broad, slightly furrowed; *flesh*, greenish white, tender, sprightly, mild sub-acid; *core*, large, rather hollow; *seeds*, abundant, ovate pyriform. October to December, but often keeps to March.

RAULES' JANET.

Raul's Gennetting,
Rawl's Janet,
Winter Gennetting,
Rock Remain,

Jennette,
Jeniton,
Raules' Janette,
Rawle's Jennette,

Rock-Rimmon,
Neverfail,
Yellow Janette,
Indiana Jannetting.

This variety, according to H. P. Byram, Esq., was first brought to the South-western sections, from Amherst Co., Va., near the Blue Ridge, where it was originated by Caleb Raules, who named it Janet, hence the name. According to Geo. Hoadley, Esq., Gov. Worthington had it in his orchard 40 years since, and from thence it was brought to northern Ohio. The Scriptural name of Rock-Rimmon, given it in the Sciota valley, was probably on account of its sure bearing, and long keeping qualities. The tree is tardy in Spring in leaving out, and blossoms some ten days after other varieties; thus escaping late Spring frosts. In quality it is only second rate, and at the North is not desirable, but south of Cincinnati is highly so, as it succeeds when many others often fail. In Missouri it is regarded as essential to every orchard.

Fruit, medium to large; *form*, roundish conical, flattened at stem end; *skin*, thick, tough; *color*, a ground of light pale yellowish green, mostly overspread, striped and stained with dull red, and with a blue or grayish shade lying within as of a bloom; small russet dots, that show most when the fruit is high colored—South, many patches of mould or fungus; *stem*, slender, rather long; *cavity*, deep, regular; *calyx*, nearly closed, short segments; *basin*, open, regular, not deep, sometimes slightly furrowed near

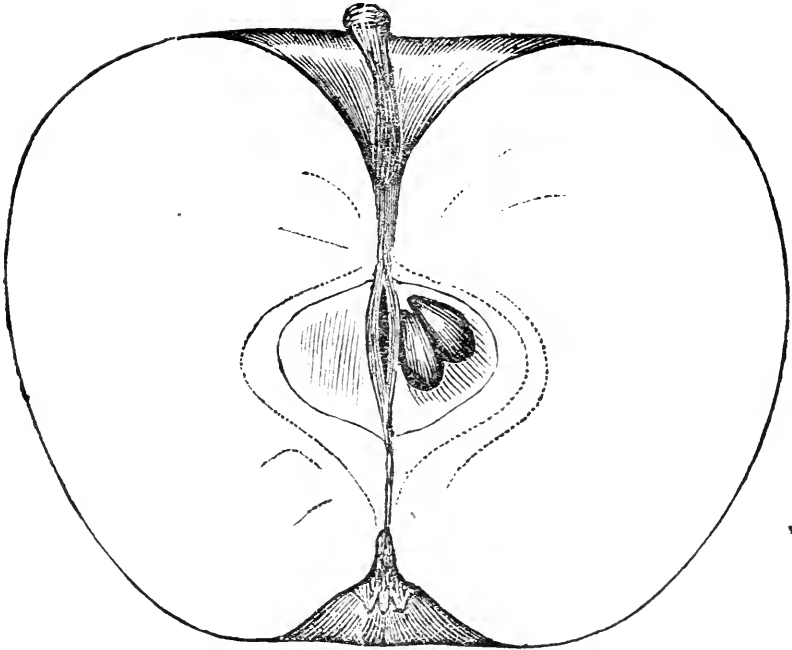

the calyx; *flesh*, yellowish, tender, mild sub-acid; *core*, medium; *seeds*, angular ovate. Late Spring.

RED ASTRACHAN.

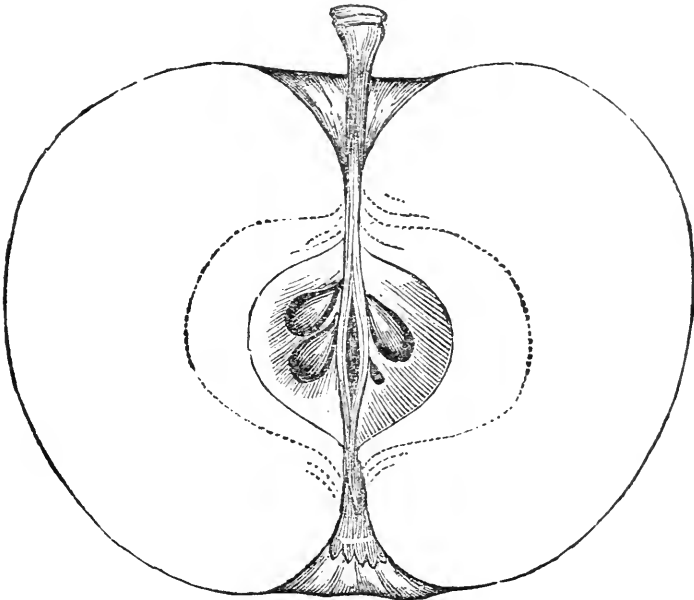

Foreign. Most valuable as a hardy, strong grower, regular, moderate bearer of fruit, always fair. As a dessert fruit, it is rather acid, unless

fully ripe ; but, for marketing or cooking, it has few equals, at its time. Shoots stout, dark brown, broad foliage.

Fruit, medium to large; *form*, roundish, tapering toward the apex; *color*, greenish yellow, mostly overspread with rich purplish crimson, a little russet near the stem and a white bloom; *stem*, varying, generally short; *cavity*, narrow; *calyx*, large; *basin*, shallow, uneven; *flesh*, white, crisp, juicy, acid; *core*, small; *seeds*, ovate, dark brownish black. August.

RED CANADA.

Steele's Red Winter of Mich., | Old Nonsuch, | Richfield Nonsuch.

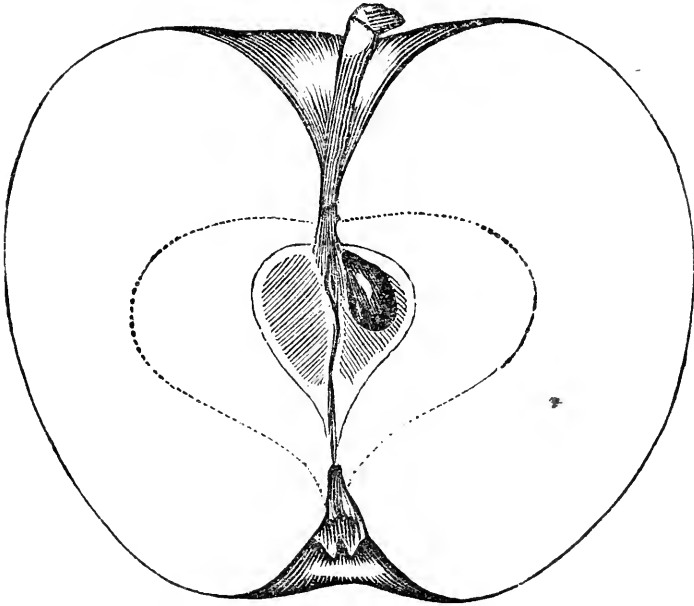

American: probably a native of Massachusetts. Tree, slender growth; shoots diverging; requires rich, strong soil, when it is productive, and always fair and uniform size of fruit. One of the most valuable for orchard, or garden.

Fruit, medium; *form*, roundish conical, flattened at stem end; *color*, rich, clear, yellow ground; when exposed to the sun, overspread with bright, handsome red, two shades, light and dark, intermingling, or striped, many light gray dots, presenting at first sight an appearance of a somewhat rough exterior; *skin*, thin, tender; *stem*, varying from short and stout to slender and long, usually as seen in our figure; *cavity*, deep, regular, a touch of light russet; *calyx*, small, closed; *basin*, open, moderate depth, slightly furrowed, or uneven; *flesh*, yellowish white, crisp, tender, juicy, sprightly, sub-acid, aromatic; *core*, small, compact; *seeds*, ovate pyriform. January to April.

RED JUNE.

Carolina Red June, | Blush June, | Carolina June.

A vigorous grower; early and abundant bearer; popular West and South. *Fruit*, medium, generally oblong conic, but occasionally flat; *skin*, smooth, green in the shade, changing rapidly at maturity to a fine dark

crimson: *stem* and *cavity*, varying in specimens; *calyx*, closed, segments long, reflexed; *basin*, shallow; *flesh*, white, fine-grained, juicy, brisk sub-acid, not rich; *core*, large. Ripens in June at the South and South-west.

RED RUSSET.

Origin, Hampton Falls, N. H. Tree, very vigorous and productive.

Fruit, large, roundish conic; *skin*, yellow, shaded with dull red, and deep carmine in the sun, and thickly covered with gray dots, with a slight appearance of rough russet on most of the surface; *stalk*, rather short and thick, inserted in a medium cavity, surrounded with thin russet; *calyx*, nearly closed, segments long, recurved in a narrow, uneven basin; *flesh*, yellow, solid, crisp, tender, with an excellent rich, sub-acid flavor, somewhat resembling Baldwin. January to April. (Downing.)

RHODE ISLAND GREENING.

Burlington Greening, | Jersey Greening? *Coxe*, | Hampshire Greening.

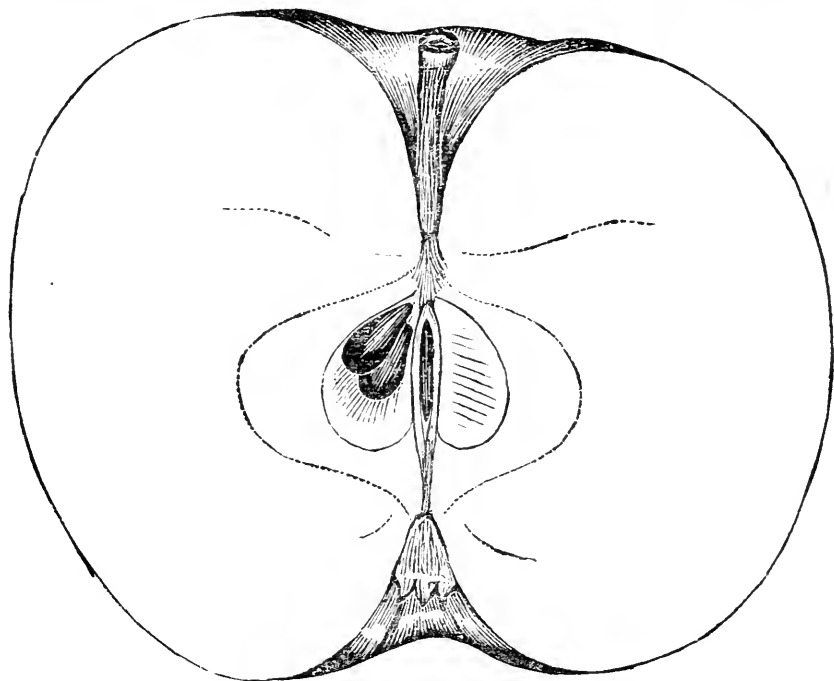

This variety has been condemned in many sections, because of not producing as fine fruit on the same trees without care, as when the trees were young. Testimony has shown that it is a gross feeder, and needs soil well drained, rich in lime and phosphates; on usual soils, where the variety is defective, liberal dressing with wood ashes will answer. On sandy soils, well manured, the texture is closer than on clay. It is unreliable, South; drops too early.

Fruit, large; *form*, roundish flattened, sometimes a little angular at the base end; *color*, green, yellowish green when ripe, with a dull blush, on sun-grown specimens, near the stem; *stem*, medium; *cavity*, open; *calyx*,

rather small, woolly; *basin*, medium depth, slightly furrowed; *flesh*, yellowish, fine-grained, tender, slightly aromatic, lively acid juice; *core*, small; *seeds*, ovate pointed. December to February. The best cooking apple as yet known.

RIBSTON PIPPIN.

Glory of York, | Travers, | Formosa Pippin.

Foreign. Valued in Northern sections; not esteemed South or Central. *Fruit*, medium, roundish, greenish yellow, russet near the stem, dull red in sun; *stem*, slender; *calyx*, small closed; *basin*, open; *core*, small; *seeds*, flattened ovate; *flesh*, yellow, firm, crisp, aromatic, sub-acid. November to February.

RICHMOND.

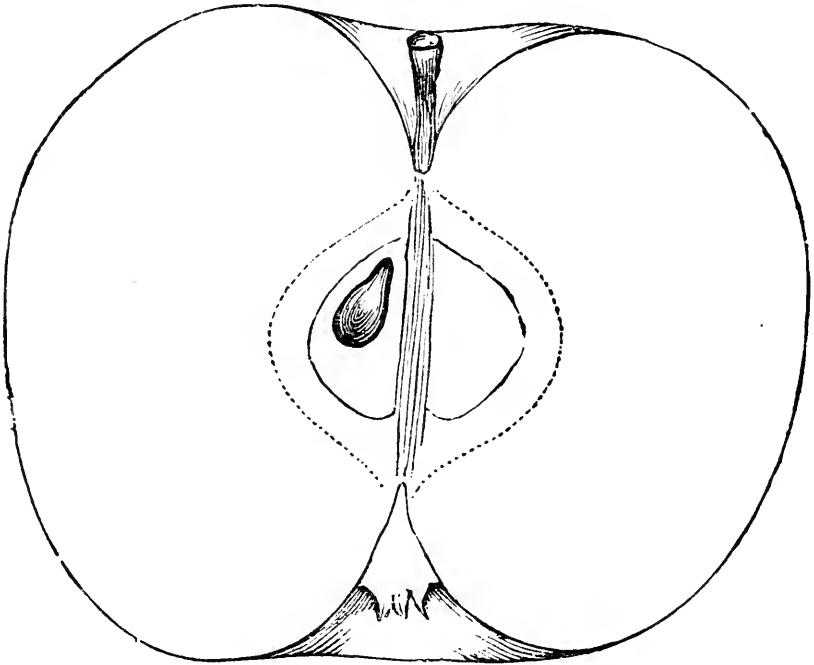

We received this fine variety from D. C. Richmond, Esq., near Sandusky, as a native seedling, and are unable to identify it with any known sort.

Fruit, large; *form* roundish; occasional specimens have one side a little enlarged; *color*, light yellow ground, mostly or quite overspread with light and dark red stripes, many dots or specks of light russet; *stem*, varying, mostly short, slender; *cavity*, deep, open, regular, a little brownish at bottom; *calyx*, large, segments long, *basin*, deep, open, uniformly furrowed; *flesh*, white, tender, juicy, delicate sweet; *core*, medium; *seeds*, large, full. October to December.

ROMAN STEM.

French Pippin, of some.

From New Jersey. Shoots, slender, diverging; succeeds finely on the dry prairies, and on all rich limestone soils; productive. *Fruit*, medium,

roundish oblong, whitish yellow, with brownish or red russet, and patches of blackish russet, unless well grown; *stem*, with a fleshy knob one side; *cavity*, russeted; *calyx*, small, closed; *basin*, narrow; *core*, open, long ovate; *seeds*, ovate pointed; *flesh*, tender, juicy, sub-acid, sprightly; "very good." November to February. One of the best at the Southwest.

ROME BEAUTY.

Roman Beauty, | Gillett's Seedling.

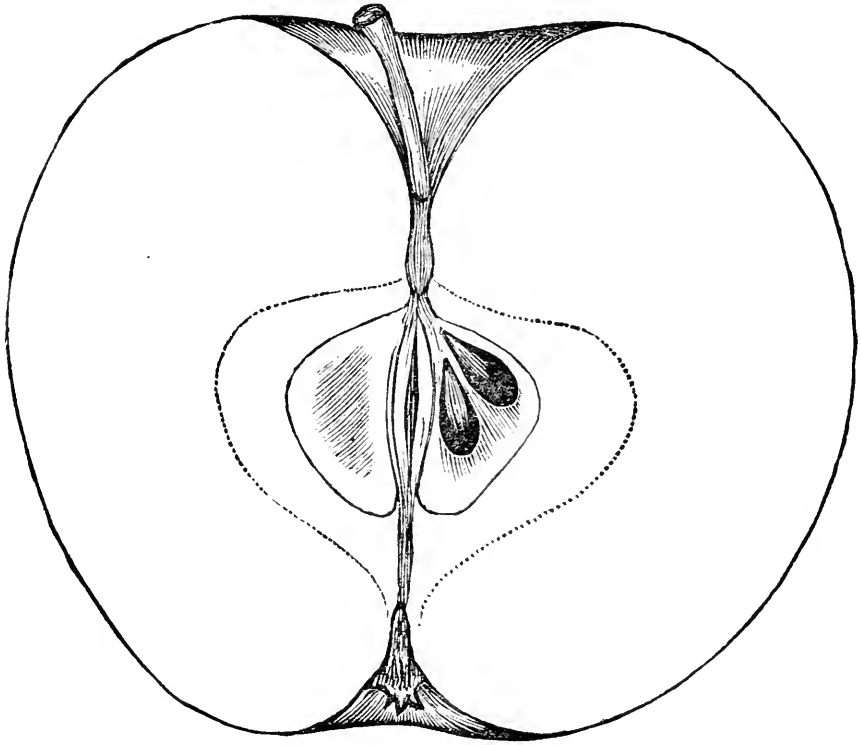

American. Native of Southern Ohio. Requires, to perfect good fruit, a rich, warm, loamy soil. On poor land, it is undersized, deficient in character, and inclined to overbear.

Fruit, large; *form*, roundish; *color*, rich light yellow, mostly overspread and striped with shades of clear, bright red; *stem*, slender; *cavity*, open, regular; *calyx*, nearly closed, segments distinctly separate; *basin*, round, open, moderately deep; *flesh*, yellow, crisp, mild, sub-acid; *core*, medium, somewhat hollow; *seeds*, long ovate, large and full. October to December.

ROSS NONPAREIL.

Foreign. Tree, productive. *Fruit*, below medium, roundish, dull red, blotched and striped, over which is a marbling of thin mellow russet; *stem*, slender; *calyx*, medium; *flesh*, greenish white, juicy, sub-acid, aromatic; "very good," nearly "best." October to November.

ROXBURY RUSSET.

Boston Russet, Marietta Russet,		Putnam Russet, Belpro Russet,		Sylvan Russet.
------------------------------------	--	----------------------------------	--	----------------

American. Origin uncertain, either Connecticut or Massachusetts. It was introduced to the Ohio Valley, in 1796 or '97, by Israel Putnam, and from thence distributed throughout the Southwest. It is a thick-skinned fruit, generally a good keeper, but hardly above second rate in quality; grown on rich prairie soils, it is sometimes liable to "bark burst" near the ground, but elsewhere perfectly hardy, and very productive. Spreading growth, with rather downy shoots; young trees often crooked. Unreliable, West or South.

Fruit, medium to large; *form*, roundish flattened, and often angular; *color*, dull green, overspread with brownish yellow russet, occasionally a faint blush on the sunny side; *stem*, slender; *cavity*, medium; *calyx*, closed; *basin*, round, moderate depth; *flesh*, greenish white, moderately juicy, mild sub-acid; *core*, compact; *seeds*, ovate, defective. January to June.

SMOKEHOUSE.

Gibbon's Smathhouse, Millcreek Vandervere,		Gibbon's Smokehouse, English Vandervere,		Smathhouse, Millcreek.
---	--	---	--	---------------------------

Origin, Lancaster Co., Pa. Has been in cultivation about twenty years. Tree, a free grower, bearing early and abundantly. *Fruit*, above medium; flat; red, striped and mottled on greenish yellow; *stem*, short, slender; *cavity*, narrow; *calyx*, closed; *basin*, shallow; *core*, medium; *seeds*, long, brown; *flesh*, yellowish white, crisp, juicy, delicate, aroma agreeable October, November.

SUMMER ROSE.

Wolman's Harvest,		Woolman's Harvest,		Lippincott.
-------------------	--	--------------------	--	-------------

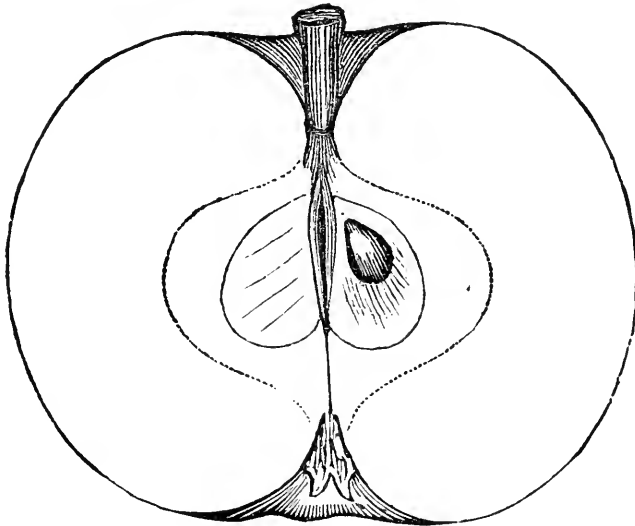

This variety is not valuable for market purposes, but its juicy, sprightly, sub-acid character makes it very desirable for the dessert. Tree, a slow grower, diverging—shoots downy; requires rich, strong soil, lime and

phosphate to perfect the fruit, or keep the tree healthy. Moderate, regular bearer.

Fruit, medium, or rather small; *form*, roundish, sometimes flattened; *color*, rich glossy yellow, blotched and streaked with red; *stem*, varying from stout to slender, short; *cavity*, shallow; *calyx*, partially closed; *basin*, round, slightly furrowed; *flesh*, white, tender, crisp, juicy, sprightly; *core*, medium; *seeds*, ovate. Last of July and August.

SMITH CIDER.

Oregon Spitzenberg, | Smith's Superb.

Origin, Berks Co., Pa. Extensively grown West. *Fruit*, medium, roundish flattened; bright red and yellow, mostly red; *stem*, varying; *cavity*, regular; *calyx*, half closed, long segments; *flesh*, yellowish white, sub-acid; "very good;" varies much in soils. November to December. It is a variety more grown for eating than for cider.

SWAAR.

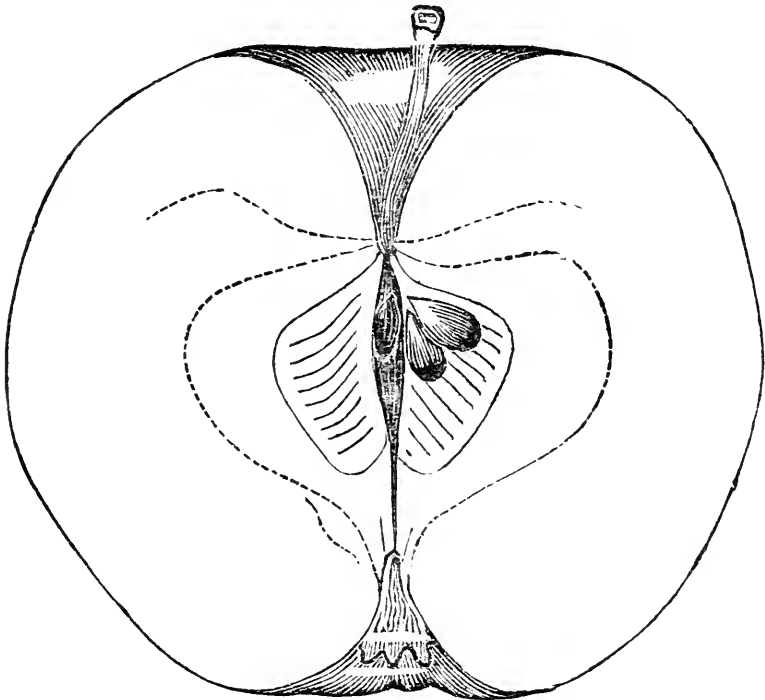

American. "Produced by the Dutch settlers, on the Hudson; its name in low Dutch meaning heavy." It is one of the very best apples, growing well and producing abundantly on all rich, strong soils.

Fruit, medium, to large; *form*, roundish, slightly ribbed or unequal on its surface and often a little angular; *color*, greenish yellow at first, becoming a dull rich yellow, dotted with distinct brown specks, sometimes marbled with gray russet on the side and round the stem, and often tinged with dull red; *stem*, slender; *cavity*, round, deep; *calyx*, small, half closed; *basin*, shallow, somewhat plaited; *flesh*, yellowish, fine-grained, juicy, tender,

spicy aromatic perfume; *core*, small, to medium; *seeds*, broad ovate. January to March.

SWEET BOUGH.

Bough, Early Sweet Bough,		Large Yellow Bough, Sweet Harvest,		Washington, Nyack Pippin.
------------------------------	--	---------------------------------------	--	------------------------------

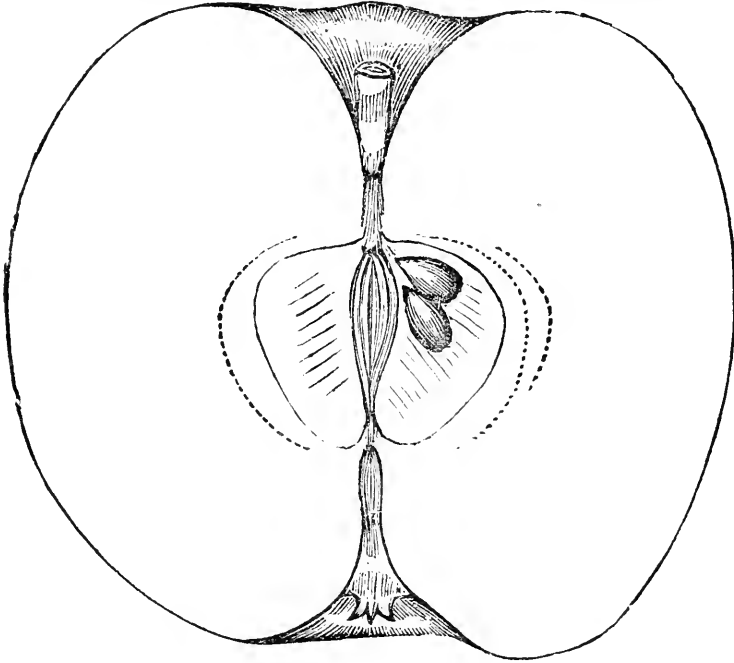

American. First described by Coxe as Bough; we add Sweet, as expressive of its character. Valued as a dessert fruit. Young shoots, yellowish, somewhat irregular, ascending. Tree, a moderate, annual bearer, succeeding in all good soils not wet.

Fruit, large (our figure hardly medium); *form*, roundish, conical ovate, *color*, greenish, becoming pale yellow when fully ripe; *stem*, varying in length; *cavity*, deep; *calyx*, open; *basin*, narrow, deep; *flesh*, white, tender, crisp, sprightly, sweet; *core*, medium, open capsules; *seeds*, ovate, light brown. August.

SWEET PEARMAIN.

Henry Sweet,		Henrick Sweet,		Ladies' Sweet, <i>erroneously</i> .
--------------	--	----------------	--	-------------------------------------

This variety, according to Downing and Thomas, is the "English Sweeting;" but, according to Mr. Manning, the "English Sweeting" is the "Ramsdell's Sweeting," of Downing. (See Hovey's Mag. vol. 12, page 150.) This variety is extensively grown in central Ohio, and farther West, suiting well the rich soils; keeping finely all Winter; highly valued for baking or eating.

Fruit, medium size or often above; *form*, roundish, slightly angular, *color*, dull red, rough russet dots and bluish bloom; *stem*, long, slender; *cavity*, deep, wide, and open; *calyx*, woolly; *basin*, medium; *flesh*, yellow-

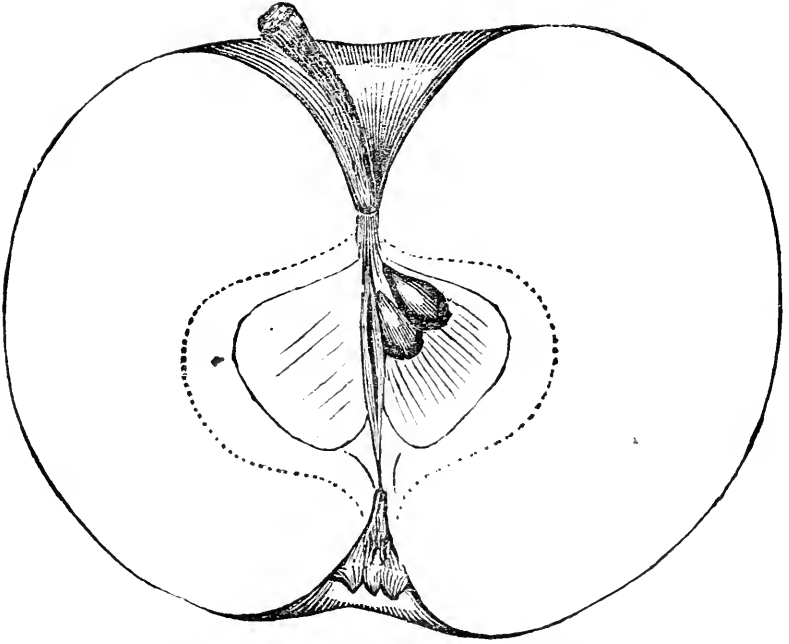

sh, tender, moderately juicy, sweet : *core*, medium, with outer or consecutive lines ; *seeds*, ovate pyriform, dark brown. December to March.

TALMAN'S SWEETING.

Tallman's Sweeting, | Tolman's Sweeting, | Brown's Golden Sweet.

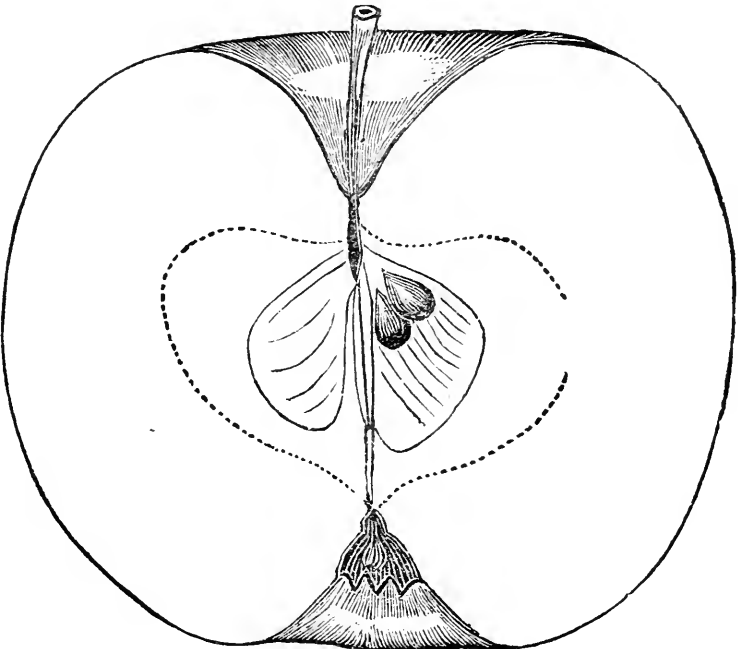

American. Native of Rhode Island; its name from a family by name of Talman. Its value is for baking and stock feeding. Tree, great bearer, fruit keeping well; growth, rapid, upright, strong; wood, dark.

Fruit, medium; *form*, roundish, slightly conical; *color*, light yellow, with a greenish line from stem to apex; *stem*, long, slender; *cavity*, wide, regular; *calyx*, medium; *basin*, moderate depth, furrowed; *flesh*, white, firm, very sweet; *core*, medium; *seeds*, light brown, ovate pointed. November to April.

TIFT'S SWEET.

American. Tree, moderate grower; productive. *Fruit*, medium, roundish flattened, greenish yellow with slight net-work of russet; *stem*, slender; *cavity*, varying; *calyx*, closed; *basin*, deep; segments, long; *core*, small; *flesh*, yellow, firm, sweet, rich, very best for baking. September, November.

VANDERVERE.

Vandervere Pippin, Red Vandervere, Fall Vandervere, Yellow Vandervere,	Baltimore, of some incorrectly, Imperial Vandervere, Pennsylvania Vandervere, Striped Vandervere,	Staalclubs, Watson's Vandervere, White Wine, of some.
---	--	---

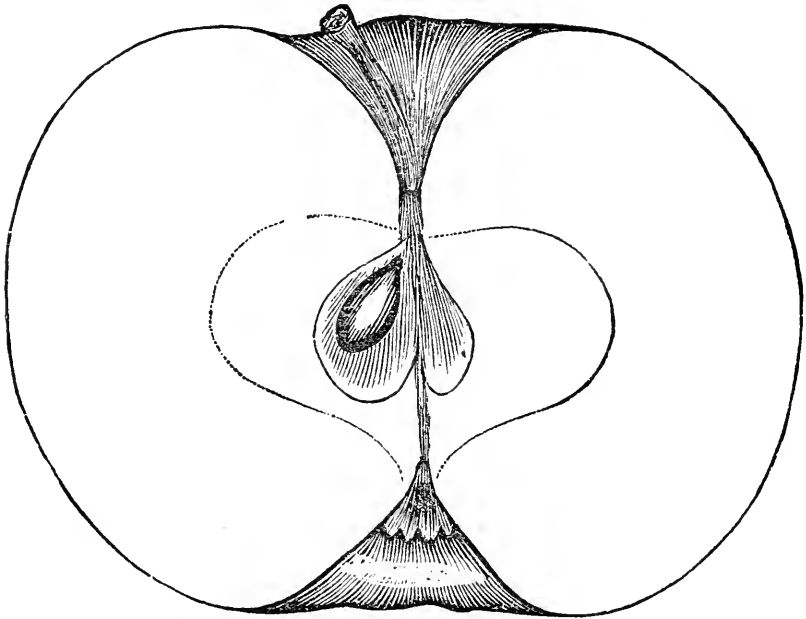

American. Native of Delaware. For other synonyms heretofore used in connection with this variety, see "Newtown Spitzenberg," page 94, Gray Vandervere, page 82, and Smokehouse, page 109. We do not think the true Vandervere has ever been grown to any extent east of Pennsylvania.

The tree is a free grower, productive, and early bearer. Grown on soils deficient in lime, like many of our Western bottoms, and some of prairie, it has always more or less of dry bitter rot, but, when supplied with lime, the rot disappears, the fruit increases in size, and improves in quality; needs good culture. Grown North, it is smaller in size, and much more conical, and less highly-colored than South. Young shoots, spotted.

Fruit, from medium to large; *form*, round flattened, sometimes angular; *color*, orange yellow, striped and stained with yellow red, few streaks of deeper red when grown exposed to the sun, dotted at intervals of a quarter to half-inch with large yellow russet specks; when grown North, these specks are more of gray and much smaller, often russeted about the stem; *stem*, projecting about even with surrounding surface; *cavity*, deep, open, regular; *calyx*, with small segments; *basin*, open, broad, sometimes slight waves or furrows; *flesh*, yellowish white, crisp, aromatic, tender, sprightly, mild sub-acid; *core*, round, compact; *seeds*, large, ovate pyriform. December to February.

WAGENER.

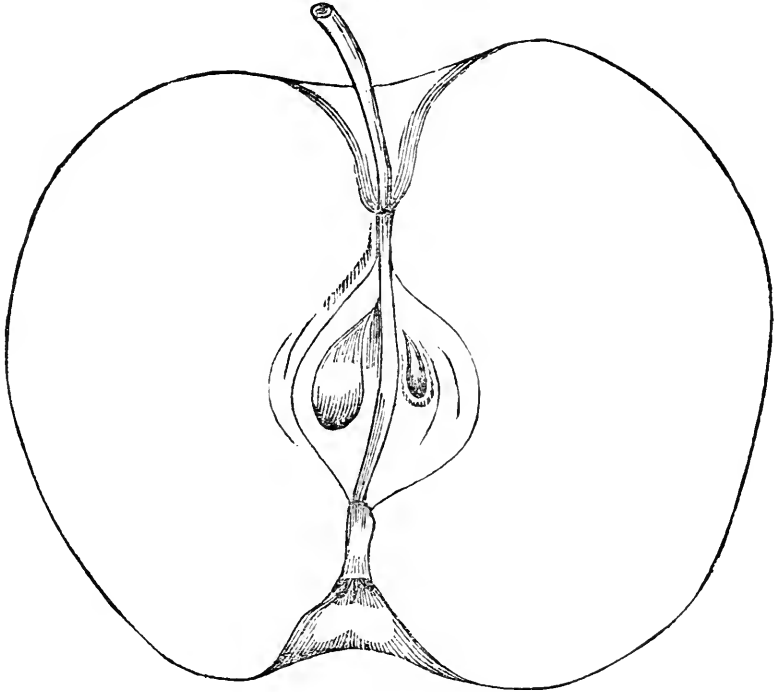

American: "origin, Penn Yan, Yates Co., N. Y.; seed sown in 1791. Tree, thrifty; young shoots, pale green; old wood, dark red; requires free trimming, in order to produce large sized fruit abundantly; annual bearer."⁷⁷

Fruit, medium; *form*, roundish flattened, slightly ribbed at base; *color*, yellow ground, mostly covered with deep, glossy red, with stripes and splashes of light red, and marked with irregular light russet specks; *stem*, slender; *cavity*, wide, deep; *calyx*, small; *basin*, broad, open; *flesh*, yellowish white, fine-grained, crisp, juicy, sprightly, vinous, sub-acid; *core*, small, oblong ovate; *seeds* light brown, ovate pyriform. November to March, but will keep to May.

WESTFIELD SEEK-NO-FURTHER.

Connecticut Seek-no-further, | Seek-no-further, | Red Winter Pearmain, *of some*.

An old variety from Connecticut. For all qualities of tree and fruit has no superior. Very popular in its native State all South and West. Grown

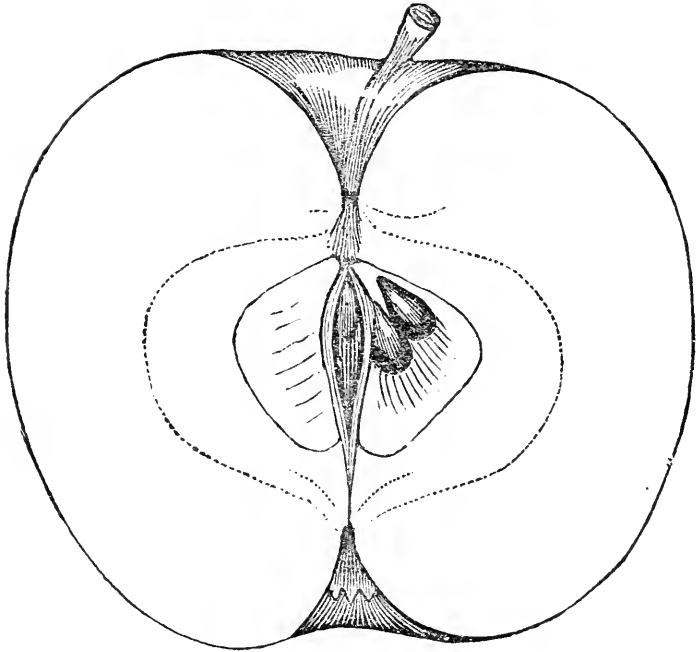

in rich loamy alluvial soils of the South, it is much russeted, and about the stem the russet has appearance of rich bronze ; progressing Northward, it gradually loses its russet, until, on light sandy soils, in Michigan, it becomes a pale yellow ground, with stripes and splashes of clear red and minute dots.

Fruit, medium ; *form*, regular, roundish conical—broad at base ; *color*, light yellow ground, the sunny side striped and splashed with red, small russet dots shaded around with light russet yellow ; often considerable russet about both stem and calyx ; *stem*, long, slender ; *cavity*, open, regular ; *calyx*, usually small, closed, sometimes open, with short segments ; *basin*, regular form, moderate depth ; *flesh*, yellowish, tender, sub-acid, pearmain flavor ; *core*, medium ; *seeds*, ovate. November to February.

WOOD'S GREENING.

Coate's Geening, | Onstine.

American : native of New Jersey. First described by Coxe, from whose nursery it was introduced to the West by Prof. Kirtland, about 1820. This variety has been too little noticed. It should be extensively planted in our Southwestern States and territories. Tree, hardy, slender growth, becoming abundantly fruit of uniform medium size, and always fair and of "best" quality.

Fruit, medium ; *form*, roundish conical, flattened ; *color*, pale green, becoming yellowish, with a few rough spots ; *stem*, short ; *cavity*, acuminate ; *calyx*, rather large ; *basin*, slightly plaited ; *flesh*, greenish white, fine-

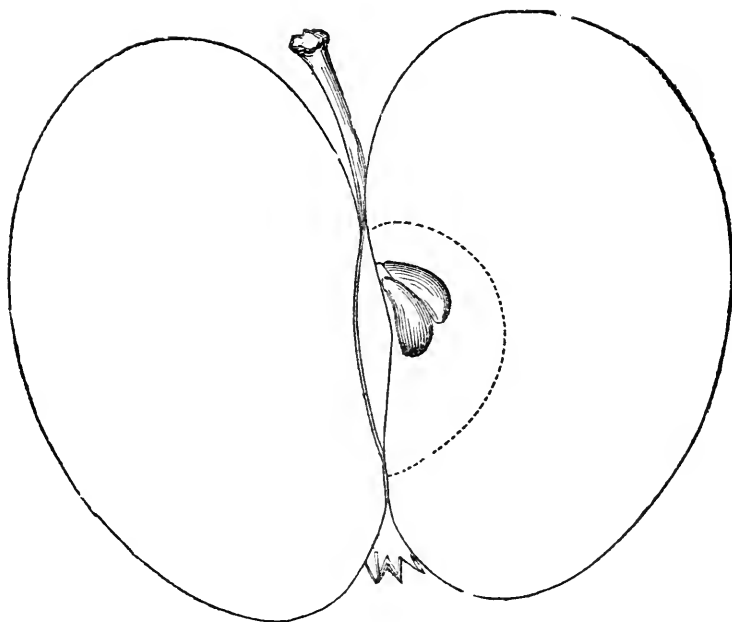

grained, juicy, tender, sprightly, sub-acid; core, small; seeds, ovate. January to March.

WINE.

Wine Apple,		Hay's Winter,		Hollow Crown Pearmain.
Hay's Winter Wine,		Winter Wine,		

American: native of Delaware. Extensively disseminated, and everywhere successful. Strong, heavy clay loams produce the largest fruit, while best quality are grown on sandy loam. Tree, thrifty; shoots, rather slender, spreading; foliage small.

Fruit, medium to large; *form*, round flattened; *color*, light pale yellow ground, mostly overspread and striped with lively red, russet about cavity of stem; *stem*, short; *cavity*, acuminate or narrow, deep; *calyx*, large; *basin*, broad, open, slightly plaited; *flesh*, yellowish, crisp, vinous, sub-acid; *core*, small; *seeds*, large. November to February.

WHITE SEEK-NO-FARTHER.

Green Seek-no-farther,		Pomme Royal, of some,
Flushing Seek-no-farther,		Pound Royal,
Seek-no-farther of Coxe,		Bracy's Seek-no-farther.

From Long Island. Tree healthy, not strong grower; abundant, not regular bearer. *Fruit*, medium to large, roundish oblong, conical, uneven or waived surface; yellowish green, rarely a faint brownish blush, small brownish dots, light shade of green suffused around underneath skin; *stem*, slender; *cavity*, irregular, acuminate; *basin*, broad, abrupt, furrowed; *core*, open; *flesh*, fine-grained, very juicy, tender, sub-acid: "best." November to February.

WINE SAP.

Wine Sap.

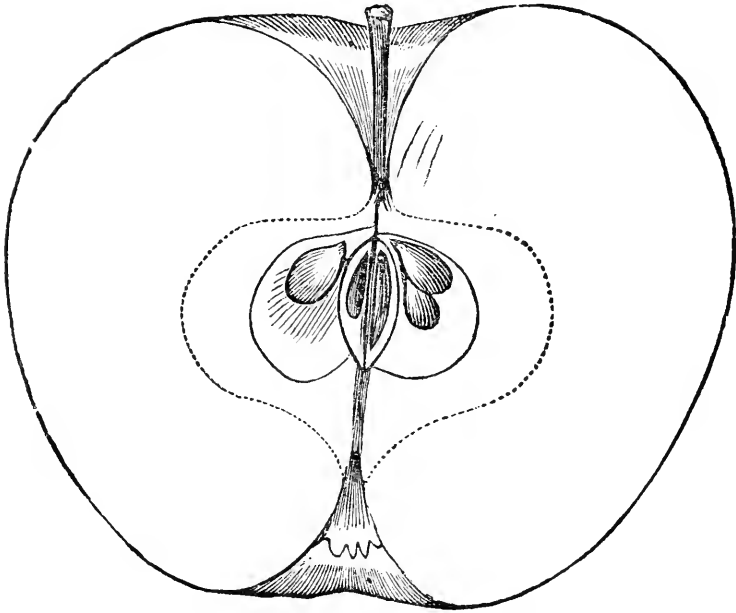

Probably originated in New Jersey. First described by Coxe. It is one of the very best throughout the Southwest, and also in Oregon Territory. The tree is hardy, an early and very productive bearer, irregular in its growth, not forming a handsome head, but producing fair, fine fruit in all soils, from poor sand to limestone clay—largest in the latter, and finest texture in the former—fine on dry prairies.

Fruit, medium; *form*, ovate conical, flattened at base, sometimes roundish conical, occasionally angular and slightly ribbed; *color*, grown North, a bright clear red, stained and striped with darker shades, and with spots of light yellow: grown South, the dark red becomes most prominent, while the patches of light yellow at base are more often seen; it is also more irregular or angular in form, and oft with russet about the stem; *stem*, varying in length, slender; *cavity*, narrow, deep; *calyx*, small, nearly closed; *basin*, abrupt, furrowed; *flesh*, yellowish, juicy, tender, sub-acid, sprightly; *core*, medium; *capsule*, hollow; *seeds*, short, ovate. October to January often keeps till March.

WOOD'S SWEET.

Hyde's Sweet.

From Sudbury, Vt. Growth, similar to Baldwin; productive. *Fruit*, large, irregular, roundish flattened; whitish yellow, oily, shaded and striped with red; *stem*, short; *cavity*, broad, deep, furrowed; *calyx*, small, closed; *basin*, deep; *flesh*, white, tender, juicy, rich, saccharine; "very good" or "best;" *core*, small. September to November.

WHITE PIPPIN.

This variety we have heretofore considered identical with Canada Reineette; probably it is distinct. It is much grown in the Southwestern sections; proves hardy as a tree, productive, and is a good keeper. Tree strong, upright, vigorous grower. *Fruit*, large; *form*, roundish oblong, smooth; *color*, greenish yellow, with dark green specks and light green surrounding and suffused beneath skin, when fully ripe, yellowish green; *stem*, varying; *calyx*, medium; segments, long; *flesh*, yellowish white, crisp, tender, juicy, sprightly, sub-acid; *core*, small, compact; *seeds*, dark. January to May; December to March at South.

WHITE WINTER PEARMAIN.

This variety is extensively grown and much esteemed throughout the Southwest, and in Oregon it is one of the most desirable of apples. In our first edition we made it a synonym of Michael Henry Pippin, from the fact that all the specimens we gathered from various places were identical with that variety. Having since tested it on our own grounds, we are confident of its distinctness. It is undoubtedly an old variety, but what we are unable to determine, therefore retain it under the name by which it is generally known. Tree, thrifty, not rampant grower, young wood, dark speckled, buds, prominent. *Fruit*, above medium, oblong conical, angular or oblique; pale yellow, with slight blush cheek and minute brown dots; *stem*, short; *cavity*, deep; *calyx*, nearly closed; *basin*, uneven, surrounded by five prominences, continued in obscure angles along its sides; *flesh*, yellowish, tender, crisp, juicy, pleasant, very mild sub-acid; "very good." January to April.

WILLOW TWIG.

Willow, | Willow Leaf?

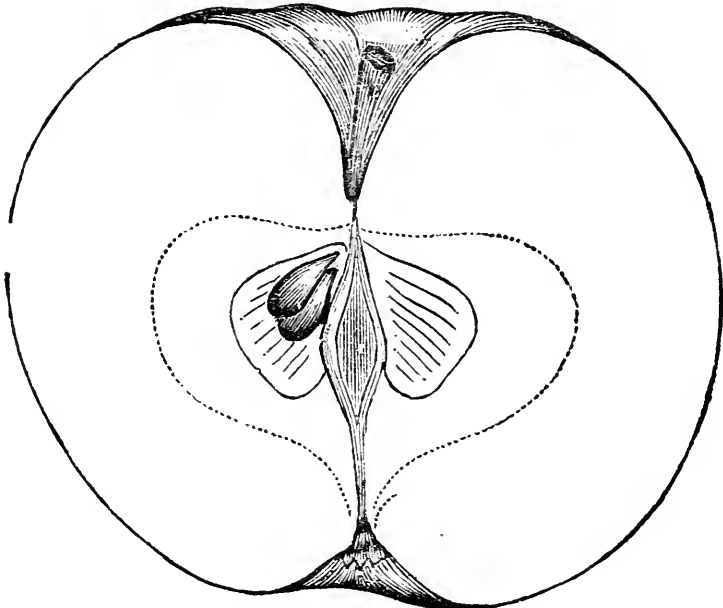

Under these names we have examined specimens, and although there is

a slight difference, we are inclined to think it only from varied location and soil. The variety came from New Jersey. It is esteemed for orcharding on rich bottom lands or prairies, being a good bearer, great keeper, and valuable for Southern exportation. *Fruit*, above medium to large, roundish; dull yellow, striped, splashed, or mottled with light and dark red; *calyx* and *basin*, medium; *stem*, generally short, slender; *cavity*, roundish acuminate; *core*, rather small; *seeds*, oblong pyriform; *flesh*, yellowish, rather dry, breaking, mild sub-acid; not quite "very good." December to May.

WILLIAMS' FAVORITE.

Williams' Favorite Red,		Williams' Red,
Williams' Early,		Williams' Early Red.

From Massachusetts. Tree, medium growth; shoots, reddish brown. *Fruit* medium to large, oblong; fine clear red, very dark in sun; *calyx*, closed; *basin*, narrow; *stem*, slender; *flesh*, yellowish white, tender; "very good." August.

YELLOW NEWTOWN PIPPIN.

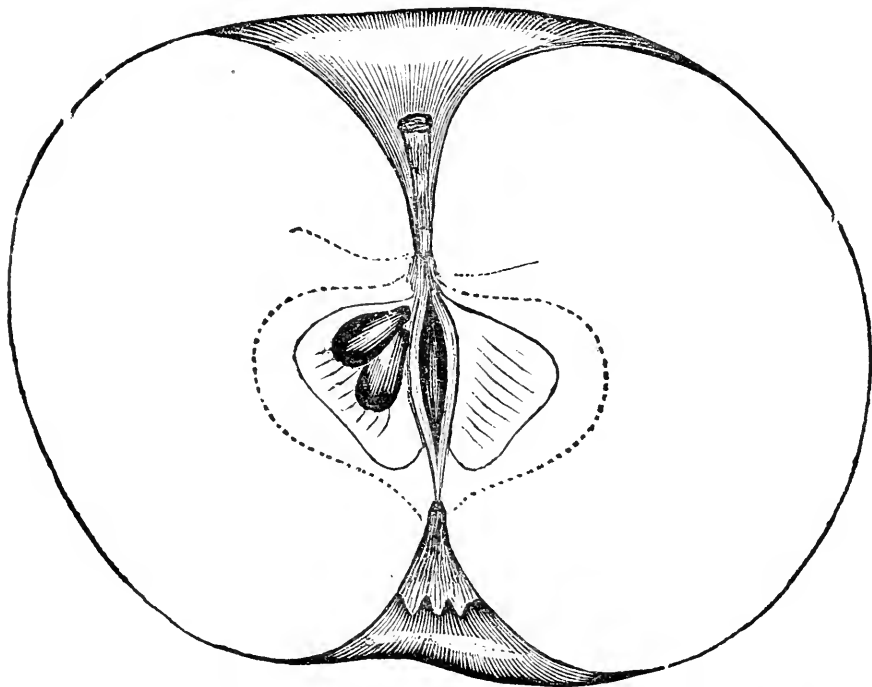

This variety is extensively grown; West it becomes large; keeps well. Trees, though slender growth, good bearers, are apparently perfectly at home in rich limestone soils. That there are two Newtown Pippins, we do not question; see "Newtown Pippin;" but we have supposed there might be *three*, but whether the distinction is without a difference we are yet unprepared to decide. We give here two figures, and descriptions, of which the latter Newtown Pippin of Lewis Sanders, Esq., may possibly prove identical with Y. N. P.

Fruit, medium, to large; *form*, roundish flattened, angular, or broader than long; *color*, clear yellow, with considerable russet from the stem, many small russet dots, and, where exposed to the sun, the yellow becomes very rich and dotted with carmine dots; *stem*, short; *cavity*, deep; *calyx*, large, open; segments, short, stiff, broad; *basin*, broad, irregular only from the slight ribbing of the fruit; *flesh*, yellowish, very firm, crisp, juicy; *core*, medium; *seeds*, purplish black, oblong pyriform. Keeps to June.

NEWTOWN PIPPIN, OF LEWIS SANDERS, KY.

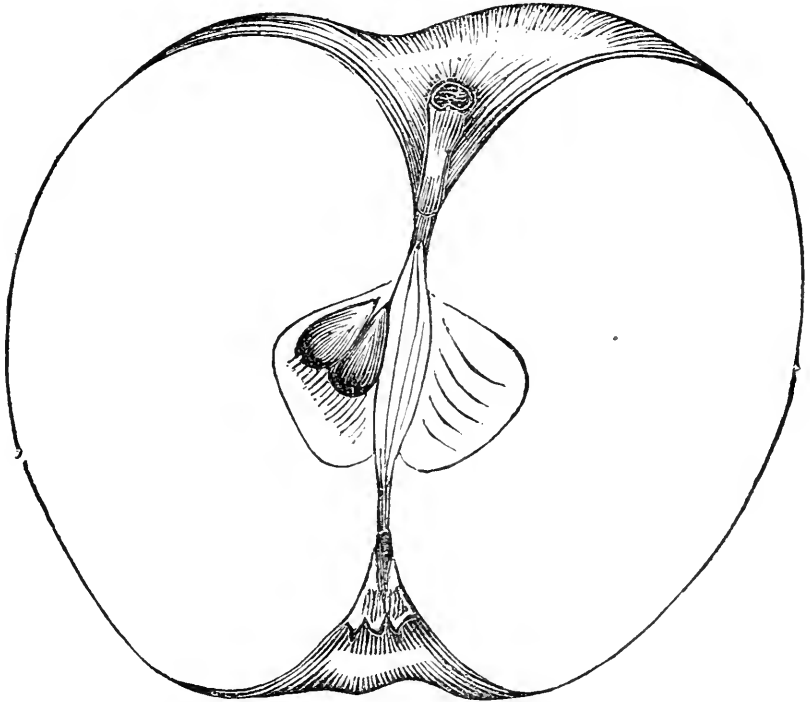

Fruit, large; *form*, angular, roundish conical, prominently ribbed; *color*, dull pale yellow, with whitish yellow marbled and splashed, the latter prevailing mostly at stem end; *stem*, short; *cavity*, acuminate, somewhat russeted; *calyx*, medium, short segments; *basin*, pretty deep, irregular, ribbed; *flesh*, yellowish white, firm, crisp, vinous, juicy, sub-acid, with tinges, and lines, and specks throughout, as if decay had partially taken place; *core*, medium, or rather large; *seeds*, dark, rich reddish brown, ovate pyriform.

CLASS II. *Embraces varieties, of which many are new and untested, and others suited only to large orchards or certain localities.*

ABBOTT.

Abbott's Sweet.

American. Fruit, medium, roundish, slightly conical, dull green, tinged, striped and blotched with red; flesh, tender, juicy, wants flavor. December to March. (Hov. Mag.)

ADAMS.

Noll's No. 1.

A Pennsylvanian seedling of White Deer Township, Union County. Large; roundish oblate; faintly mottled and striped with red on a greenish yellow ground; stem, half an inch long; cavity, broad, acute; calyx, rather large; segments closed; basin, wide, moderately deep, plaited; flesh, greenish white, of fine texture, rather juicy; "very good." (W. D. B.)

ADAM'S PEARMAIN.

Foreign. Fruit, medium, conical, pale greenish yellow, with gray russet; stem, slender; flesh, yellowish, crisp, aromatic. Early Winter. (Lindley.)

AGNES.

American. Fruit, below medium, roundish flattened; stem, short; cavity, deep; calyx, closed; basin, medium; color, yellowish, striped and shaded with red; brown dots; flesh, white, spicy, sub-acid; "good." August to September.

AILES.

From Chester County, Pa. Tree, upright, free grower, profuse bearer. Fruit large, nearly globular; stem, in a narrow cavity; basin, round, medium; yellowish, shaded and striped with red; flesh, yellow, firm, rich vinous; "very good;" core, small. December to May. For baking and stewing.

ALBEMARLE PIPPIN.

Fruit, medium or large, round, yellow, with brown specks; flesh, pale yellow, sub-acid. Grown in Virginia; keeps well. (Thomas.)

ALEXANDER.

Emperor Alexander.

Foreign. Fruit, large, conical, flattened at base, red streaked on greenish yellow; stem, small; cavity, deep; calyx, large; basin deep; flesh, coarse, crisp; showy; poor bearer. October.

ALLEN'S CHOICE.

From Brownsville, Pa. Fruit, medium; roundish flattened; red, shaded and striped, often a dark cheek sprinkled with small white dots; stem, short; cavity, open, deep; calyx, closed; basin, shallow, slightly ribbed; flesh, white, coarse, aromatic; "good." January.

ALLUM.

Hallum, | Rockingham Red.

Much grown in northern N. Carolina, valuable chiefly for its keeping

properties. Fruit, medium, oblate irregular; skin, deep red; flesh, whitish, crisp, tender, juicy, with a brisk acid flavor. January to April. (Downing.)

AMERICAN BEAUTY.

Sterling Beauty.

Origin, Sterling, Mass., received from O. V. Hills. Tree, vigorous and productive. Fruit, above medium, globular, somewhat elongated; color, chiefly deep red, thickly dotted with light gray; stalk, medium, inserted in a rather deep, round cavity; calyx, closed; basin, broad and shallow; flesh, white, crisp, and juicy, with a sweet, rich, vinous flavor. December to April. (Downing.)

ANGLO AMERICAN.

From Canada West. Tree, strong grower, productive. Fruit, medium, roundish conical, slightly angular; yellowish, marbled, striped and splashed with bright red; stem, slender; cavity medium, a little russeted; calyx, large, open; basin, uneven; flesh, white, very tender, juicy, sweet, slightly aromatic, excellent; core, medium. August to September.

ASHMORE.

Red Ashmore, | Fall Wine, *erroneously*.
Striped Ashmore.

American. A desirable variety, deserving attention. Fruit, above medium, regular roundish, slightly conical, few white dots, bright clear red; short, slender stem; deep cavity; calyx, small, closed; deep, regular basin; core, large; capsules hollow; seeds, plump; flesh, white, crisp, tender, juicy, sub-acid, sprightly. September and October. The Black Vandervere, a third rate fruit, is sometimes grown as this variety. The true Ashmore is one of the most showy and desirable market sorts in the South-western States.

ASHLAND.

American. Fruit, medium, roundish flattened, slightly conical, dull greenish yellow, striped and splashed with dull red mingled with bluish gray, and large russet dots; flesh, yellowish white, tender, sweet, dry; hardly "very good;" stem, short; cavity, narrow, deep; calyx, small; basin, shallow; core, small; seeds, ovate flattened. November to January.

AROMATIC CAROLINA.

From South Carolina. "Tree, spreading, pendent, short fruit wood, abrupt terminal buds. Fruit, large, oblate conical, pale red, slightly streaked; heavy bloom; wide basin; open calyx; flesh, tender, melting, aromatic. July. Abundant bearer." (Wm. Sumner, in Hort.)

AUNT'S APPLE.

Fruit, medium to large, ovate flattened, light yellow, streaked with red, radiating from stem, which is short, stout; cavity, open, broad, russeted; calyx, closed; basin, finely folded; flesh, yellow, breaking, sub-acid, musky perfume, juicy; "very good;" core, medium. November to January.

AUNT HANNAH.

From Massachusetts. Fruit, medium, roundish, light yellow; flesh tender, crisp, sub-acid; "very good." Winter.

AUTUMN PIPPIN.

Fruit, above medium; oblong conical; greenish yellow, slight bronzed cheek, sparse green dots; stem, short; cavity deep; calyx, small, closed; basin, deep, narrow; flesh, whitish, juicy, tender, mild sub-acid; core, medium. December. As yet little known out of Vermont.

AVERILL.

Wolf's Den.

Origin, Pomfret, Conn. Tree, vigorous, productive. Fruit rather large, irregularly conic, angular; skin, greenish, yellow striped, and shaded with red; stem, short and stout, inserted in a narrow cavity; calyx, closed, set in a very shallow, slightly furrowed basin; flesh, whitish, tender, juicy, with a pleasant sub-acid flavor. February to June. (Downing.)

BAER.

American. From Berks County, Pa. Fruit, below medium, roundish oblong; skin, mottled with red, and striped with dark crimson on a greenish yellow ground, with numerous gray dots; stem, long, inserted in a wide, deep cavity; calyx, closed, set in a moderately wide, shallow, plaited basin; flesh, tender, pleasant, "very good." April. (Ad. Int. Rep.)

BAILEY SPICE.

American. From Plattsburg, N. Y. Growth, moderate; shoots, reddish brown. Fruit, medium, round ovate, tapering to eye, light yellow, faint blush in sun; stem, long, slender; cavity, deep; calyx, closed; basin, narrow; flesh, yellowish, greenish tint, sprightly, spicy; core, large, open; seeds, light brown. October. "Very good."

BAILEY SWEET.

Patterson Sweet, | Edgerly Sweet,
Howard's Sweet.

From Perry, N. Y. Fruit, medium to large, round, ovate flattened, sometimes ribbed, clear yellowish red, with an occasional russet patch; stem, slender; cavity, narrow, deep; calyx, closed; basin, medium, abrupt, often plaited; flesh, yellow, rather dry, sweet; "very good;" core, medium; seeds, ovate pyriform. November to December.

BAILEY GOLDEN.

From Maine. Fruit, medium, round flattened, yellowish russeted; flesh, white, sub-acid; "good." January.

BAKER'S SWEET.

Long Stem Sweet, | Late Golden Sweet,
White Golden Sweet.

An old fruit of Tolland County, Conn. Tree, crooked grower, productive. Fruit, above medium, roundish elongated; golden yellow, some patches of russet; stem, long; cavity, shallow; calyx, closed; flesh, yellow, coarse, sweet; baking; core, large. November and December.

BARBOUR.

Originated with J. Barbour, Lancaster Co., Pa. Size, medium, roundish oblate, inclining to conical; skin, mottled, and striped with red of different hues on a grayish ground, with numerous gray specks; stem, rather short, in a moderately deep, rather narrow cavity; calyx, small, closed, set in a

shallow plaited basin; flesh, yellowish, white, tender, juicy, flavor pleasant, quality very good. (Ad. Int. Rep.)

BEAN SWEET.

"This fruit I procured of the late Judge Buel. Medium size, ovate oblong. Color, nearly white, producing a splendid appearance when ripe on the tree; crisp and juicy; ripe in October; will keep till February or March; a good baking apple." (B. V. French, Esq., Ms.)

BEEF STEAK.

Garden Apple.

Origin, Massachusetts: Habit, like Baldwin. Fruit, medium, roundish oval; greenish yellow, marbled and striped with red; stem, medium; cavity, deep; calyx, closed; basin, open, shallow; flesh, yellowish, tender, mild sub-acid; "very good;" core, medium. October and November.

BELDEN SWEET.

American. Fruit small, globular, light yellow; stem, medium; cavity, deep; flesh, white, tender, good; core, large, open. February and March.

BEN DAVIS.

From Kentucky. Tree, vigorous grower, constant and abundant bearer. Fruit, large, roundish, striped and splashed with red and yellow; stem, short; cavity, narrow, deep, uneven; calyx, closed; basin, angular; flesh, white, sometimes tinged with red, mild sub-acid, pleasant flavor; core, medium; seeds, large, dark brown. Winter and Spring.

BELZER.

American: Ohio. Fruit, medium, red striped on greenish yellow; flesh, white, fine grained, juicy, sub-acid. August. (T. S. Humrickhouse, in *Hov. Mag.*)

BETTER THAN GOOD.

Juicy Bite.

From Pennsylvania. May prove identical with some already described. Tree, slender, irregular. Fruit, medium, roundish, tapering to the eye; yellowish white; flesh, tender, juicy, sub-acid; "very good." Early Winter.

BETSY'S FANCY.

Origin, unknown, a free grower, rather spreading, good bearer.

Fruit, scarcely medium, oblate; skin, yellowish, shaded with dull red; stem, short, inserted in a moderate cavity; calyx, closed; basin, shallow, and uneven; flesh, compact, tender, pleasant, mild sub-acid flavor. December to March.

BEVAN.

Bevan Favorite, | Striped June.

From New Jersey. Valuable as a market fruit, to transport long distances. Fruit, below medium, roundish flattened, slightly conical, distinct, broad red stripes on yellow; stem, varying from short to long; cavity, shallow; calyx, large; basin, plaited; flesh, firm, tough, sub-acid; seeds, plump, ovate pyriform. August.

BLACK COAL.

Welcome.

This is also another of the Black apples grown West. Fruit, above medium, round, regular smooth, glossy, rich dark red striped, and mostly over-spreading a lighter red, numerous specks; stem, short; cavity, deep, slightly russeted; calyx, closed, woolly or downy; basin, open; core, large, hollow; seeds, loose; flesh, white, slightly tinged with red, crisp, juicy, tender, rather acid. November to February.

BLAKELY.

Origin, Pawlet, Vermont, on the farm of Mr. Blakely. Vigorous, upright growth, regular bearer.

Fruit, large, regularly oblate, slightly conic; skin, yellow, with a sunny cheek, thinly sprinkled with reddish dots; stem, small and short, inserted in a broad cavity of moderate depth; calyx, nearly closed; basin, small and shallow; flesh, tender, juicy, with a very pleasant, mild, sub-acid flavor. January and March. (Downing.)

BLEDSOE.

Bledsoe Pippin.

"From Kentucky. Resembles White Pippin. Fruit, large, conical, flattened at base, greenish yellow, light bronze at base, brownish specks, skin, smooth; stem, short; cavity, deep; calyx, small, closed; basin, shallow; core, open; seeds, large, light brown; flesh, white, tender, juicy; 'very good.' March and April. Claimed as a seedling—new." (A. H. Ernst, Ms.)

BLOOD.

From Central Ohio. Fruit, medium, roundish, occasionally angular, dull red, marbled and striped with shades of purplish red, occasional rough gray dots; stem, varying; cavity, funnel shaped; calyx, half open; broad segments; basin, furrowed; core, small, compact; seeds, oblong ovate, dark red; flesh, yellowish, tinged with red near the surface, breaking mild, almost sweet; "very good." December to March.

BLUE PEARMAIN.

Tree, hardy; shoots stout, dark color; buds, large, unsuited to exposed situations, the fruit being large and heavy is easily blown off. Fruit, very large, roundish, slightly conical, striped and blotched with purplish red over a dull ground—white bloom; stem, short; calyx, small; basin, deep; core, medium; flesh, yellowish, mild sub-acid; "very good." Early Winter.

BOALSBURG.

A seedling of Centre County, Pennsylvania. Large, oblong, inclining to conical, delicately mottled, and striped with red on a yellow ground; stem, short, thick; deep, acuminate, russeted cavity; basin, deep, moderately wide; flesh, yellowish, juicy, sprightly, and refreshing; "very good." (W. D. B.)

BOAS.

American: From Berks Co., Pa. Fruit, medium, roundish oblate, crimson red stripes or greenish yellow, whitish yellow blotches; stem,

short, stout; calyx, in a plaited basin; flesh, yellowish white, crisp, pleasant; "very good;" core, small. February to June.

BONUM.

Magnum Bonum.

From North Carolina. Tree, hardy and vigorous, an early and abundant bearer.

Fruit, large, oblate; color, light to dark red; basin and cavity, shallow; flesh, yellow, sub-acid, rich, delicious. (Downing.)

BOWLING'S SWEET.

Raised by Louis Bowling, Spottsylvania County, Virginia. A very vigorous grower, and very productive.

Fruit, medium, roundish; color, dull red, on a yellow ground; flesh, rich, juicy, sweet, and entirely free from acid. October to January. (H. R. Roby, Ms.)

BOWKEA.

From Western New York. Fruit, medium, roundish, flattened, angular, pale yellow, with crimson in sun, small, brown gray dots; stem, slender; cavity, medium; calyx, closed; flesh, whitish tender, mild sub-acid; "good." October.

BOURASSA.

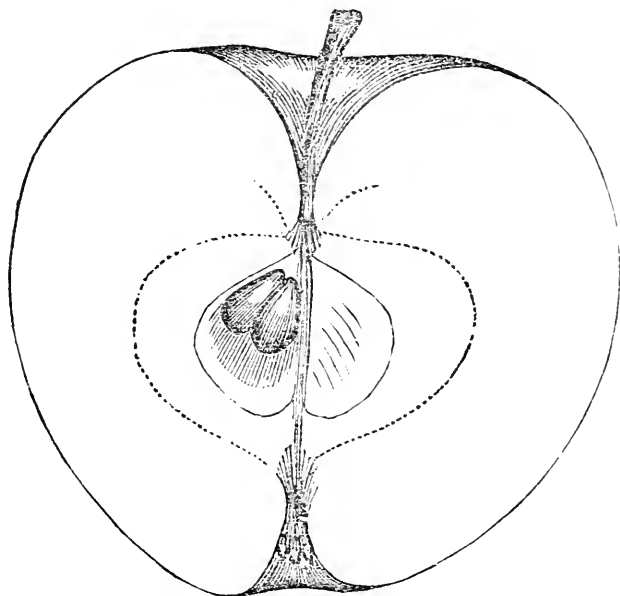

Foreign. Succeeds finely in Canada and northern sections, Vermont, North Michigan, on poor soil, etc. Fruit, medium, ovate conical, slightly ribbed, occasionally irregular; color, rich, orange russet on yellow, reddish brown in sun; stem, long, slender; cavity, small, irregular; calyx, with long segments; basin, narrow; core, rather large; seeds, few; flesh, white, fine grained, sub-acid. October to January.

BRABANT BELLFLOWER.

Brabant Belle-fleur, | Iron Apple.

Foreign. Tree, strong, irregular growth, making, however, a good head. Valuable for cooking. Fruit, above medium, roundish oblong, flattened at ends; pale yellow, mostly covered with red, striped and splashed; calyx, large; basin, wide; flesh, firm, crisp, sharp sub-acid. November to January.

BRENNAMAN.

Origin, Lancaster County, Pennsylvania. Fruit, above medium, yellowish, mostly covered with stripes of red; stem, short; calyx, closed; basin, deep; flesh, white, tender, juicy, sub-acid—good for cooking. August.

BRIGGS' AUBURN.

Origin, Auburn, Maine. Fruit, large, oblate, very much depressed; skin, light yellow, with a slight blush on the sunny side; stem, rather long, in a very large cavity; basin, broad and shallow; flesh, fine, white, with a very pleasant sub-acid flavor. Tree, hardy and productive. September to October. (Me. P. S. Report.)

BRITTLE SWEET.

Origin unknown—good grower, and very productive.

Fruit, above medium, roundish, approaching conic, sometimes elongated, angular; skin, greenish yellow, shaded and splashed with crimson, sprinkled with gray dots; stem, short, inserted in a broad, shallow cavity; calyx, closed, set in a small corrugated basin; flesh, yellowish, crisp, tender, juicy, sweet, and excellent. September, October. (Downing.)

BROOKE'S PIPPIN.

A native of Virginia. Large, roundish, inclining to conical, obscurely ribbed, greenish yellow, with a faint blush; stem, short, rather stout, deep, irregular, russeted cavity; basin, small, shallow, waved, sometimes furrowed; seeds, long, slender, acuminate; flesh, crisp, juicy, of fine texture, with a pleasant aroma; "best." Winter; bearing abundantly every year in localities where the Newtown Pippin, to which it bears some resemblance, does not succeed.

BUCK'S COUNTY.

Buck's County Pippin.

A Pennsylvania Seedling. Large, roundish oblate, inclining to conical; greenish yellow, with sometimes a faint brown cheek; stem, short, not stout, inserted in a deep, open cavity; basin, wide, deep, slightly plaited; seeds, small, short; flesh, tender; texture, fine; flavor, excellent; "very good." (W. D. B.)

BUFF.

Granny Buff.

Origin, uncertain. Tree, vigorous, erect. Fruit, very large, irregular, roundish flattened, and slightly angular; skin, thick, yellow, striped, and shaded with red, very dark next the sun, marked with a few greenish russet spots; stem, three-fourths of an inch long, in a medium cavity; calyx, in a large, irregular basin; flesh, white, and when well ripened, tender and excellent, sometimes indifferent. November to March. (White's Gard.)

BUFFINGTON'S EARLY.

A moderate bearer—origin unknown. Fruit, below medium, flattened, little ribbed, yellowish white, with faint blush; cavity deep; basin, shallow, furrowed; flesh, tender, delicate sub-acid; "best." Last of July.

BURR'S WINTER SWEET.

Native of Higham, Massachusetts. Tree, good grower, spreading. Early and abundant bearer. Fruit, large, roundish oblate, flattened at base, full at crown—smooth, greenish yellow, striped and splashed with vermilion, russet at stem—small gray specks; stem, short, slender; cavity, broad, open; eye, medium, closed; segments, short; basin, open, ribbed; core, small; seeds, medium; flesh yellowish, tender, sweet, slight aromatic perfume. December to March. (Hov. Mag.)

BUSH.

Native of Boalsburg, Pa. Size, medium, oblate conical; greenish yellow, russet dots near the crown; calyx, small; basin, deep plaited; flesh, "very good." (W. D. B.)

BUTTER APPLE.

American—probably from Pennsylvania. Fruit, below medium, regular roundish, red marbling and overspreading yellow, few yellow russet dots, russet near and in cavity of stem: stem, long, slender; cavity, narrow, deep; calyx, half closed; basin, abrupt, ribbed; core, medium; seeds, roundish ovate: flesh, yellowish white, tender, sweet; "very good." November to February.

BLOCKLEY.

Probably from Pennsylvania. Growth upright; fruit, large, round flattened, occasionally a little uneven, pale yellow, with occasional patches of light thin russet; stem, short; cavity, narrow, deep; calyx, with short segments; basin, broad, deep; flesh, yellowish white, crisp, tender, sub-acid; core, large; capsules, open. October to January.

BUCHANAN'S PIPPIN.**Buchanan's Seedling.**

Raised by Robert Buchanan, of Cincinnati, O. Tree, vigorous, and very productive.

Fruit, medium, oblate, very much flattened, slightly angular; skin, yellowish, somewhat waxy, deeply shaded with maroon, sometimes very obscurely striped and thickly covered with light conspicuous dots; stalk, very short and small, surrounded by thin, scaly russet, inserted in a large cavity; calyx, partially closed, set in a round, abrupt basin, slightly ribbed; flesh, greenish, very solid, crisp, and juicy, with a fine, refreshing, sub-acid flavor. March, April.

BUCKINGHAM.

Fruit, large, round conical, angular, greenish yellow, shaded with crimson and whitish gray dots; stem, short; cavity, broad, deep; calyx, closed; basin, deep; flesh, yellow, juicy, tender, mild sub-acid; "very good;" core, medium. December.

BUCK MEADOW.

From Norwalk, Conn. Tree, drooping habit; productive. Fruit, above medium, roundish conical, angular, yellow, marbled and streaked with red;

stem, short; cavity, deep, abrupt, thin russet; calyx, closed; basin, open, flesh, yellowish, tender, juicy, pleasant, vinous; "very good." November to March.

BUEL'S FAVORITE.

Spotted Pippin, | Gray Pippin.

Fruit, medium, roundish, greenish yellow; stem, slender; cavity, deep, russeted; calyx, medium; flesh, a little tough. November.

BURNHAP GREENING.

From Vermont. Tree, a good grower and regular bearer. Fruit, medium, roundish conical, flat at base, greenish yellow; stem, medium; cavity, deep, abrupt; calyx, closed; basin, open; flesh, juicy, crisp, firm, sub-acid; "good;" core, large, open. January, February.

CALLASAGA.

American: from Macon, N. C. Fruit, above medium, roundish, dull brown on greenish yellow russet; calyx, large; wide furrowed basin. October, November. Valued highly South.

CAMACK'S SWEET.

Camack's Winter Sweet, | Grape Vine.

Southern. Fruit, below medium, roundish conical, whitish green, clouded with green russet; calyx, large, closed; flesh, firm, slightly sweet, juicy; "very good." December to March. Will prove valuable throughout the Southwest.

CAMPFIELD.

Newark Sweeting.

American. Tree, vigorous, nearly upright, spreading. Fruit, medium, roundish flattened, greenish yellow, with dull red in sun; flesh, white, dry, sweet. Valued for stock and cider.

CANN.

American. Fruit, medium, nearly conical, dull green, little red in sun and near the stem; flesh, white, sweet; "very good." October to December. Tree, thrifty, spreading.

CANNON PEARMAIN.

American. Tree, good grower, branches diverging. Fruit, small, roundish, yellow, with dull red and large yellow specks; stem, short; cavity, shallow, russety; calyx, small, closed; basin, furrowed; flesh, yellow, crisp, slightly. December to March.

CAPRON'S PLEASANT.

Fruit, medium or above, roundish oblate; skin, greenish yellow, with a brownish tinge; stem, rather stout, inserted in an open cavity; calyx, large in a medium basin; flesh, yellow, juicy, tender, mild sub-acid, and very agreeable. September to October. (Downing.)

CARNAHAN.

Cannah's Favorite.

Native of Southern Ohio. Tree, vigorous, spreading. Fruit, large, roundish, tapering to the eye, yellow, with stripes of red, greenish russet;

dots; stem, medium; cavity, deep, open; calyx, large; long segments, basin, ribbed; core, compact; seeds, brown; flesh, yellowish white, juicy; "very good." December to February.

CAROLINE.

Origin, premises of A. G. Baldwin, Hanover, New Jersey. Tree, vigorous and productive.

Fruit, medium, oblate angular; skin, yellowish, mostly shaded with maroon, obscurely striped, and thickly covered with light dots; stalk, three-quarters of an inch long, inserted in a cavity surrounded by green russet with rays; calyx, closed, set in a shallow, uneven basin; flesh, greenish, tender, juicy, with a mild, pleasant, sub-acid flavor. January to April. (Downing.)

CARPENTER.

American. New, originated with Charles Carpenter, of Kelly Island. Tree, strong, healthy grower—an annual, abundant bearer.

Fruit, above medium, roundish flattened, oblique; skin, rather rough, rich lemon yellow, deepening in sun, often with a rich red cheek, thickly dotted with small gray dots, apparently raised upon the surface; stem, varying, sometimes thick, short, and stout; again, medium in length and size; cavity, open, deep, regular; calyx, large, open; segments five, distinct, long, reflexed; basin, deep, round, regular, slightly furrowed; flesh, yellowish white, crisp, breaking juicy, sharp sub-acid; core, medium or small, compact; seeds, long, ovate pointed. February to May. Valuable for cooking from November to May.

CARTER.

Royal Pippin.

Southern. Fruit, above medium, roundish, yellow and red; flesh, tender, mild, pleasant; almost "very good." October to January.

CAT FACE.

From Kentucky. Fruit, large, conical, flattened at ends, greenish yellow, streaked with light and dark red; stem, long, slender; cavity, deep, wide; calyx, prominent; basin, deep; core, small; seeds, light brown; flesh, white, tender, brisk, sub-acid. April and May. (A. H. Ernst, Ms.)

CATOOGA.

Large to very large, irregular, broadest at the base, yellow mottled, with black dots, and sprinkled with flecks of green; stalk, of medium length, slender; cavity, deep; calyx, open, in a deep basin; flesh, yellowish, with a mild, pleasant, sub-acid flavor.

CAT PIPPIN.

West's Spitzenberg,		Honemaker Pippin,
Haymaker,		Hommacher Apfel.

Western Pennsylvania. Tree, vigorous, productive. Fruit, medium to large, greenish; flesh, greenish, juicy, sub-acid. December to April.

CAYUGA RED STREAK.

Twenty Ounce,		Twenty Ounce Pippin, <i>erroneously</i> ,		Colman,
Eighteen Ounce,		Gov. Seward,		Dunlap's Aurora.
Twenty Ounce Apple,				

From Western New York. We adopt the name "Cayuga Red Streak," to prevent continued confusion with "Twenty ounce Pippin." Fruit, large,

roundish conical, dull yellowish green, striped and marbled with yellowish red; stem, short; calyx, closed; core, large; flesh, yellowish white, coarse, crisp, sub-acid. November, December. Esteemed for cooking.

CAYWOOD.

Origin, Ulster Co. N. Y., valuable only for its late keeping.

Fruit, medium, oblate; skin, bright yellow, with a tinge of red on the sunny side; stalk, rather long, in a broad shallow cavity; calyx, small, closed; basin, broad and wrinkled; flesh, yellowish, rather firm, pleasant, but not juicy or rich. Keeps until July or September.

CHAMPLAIN.

Tree, moderately vigorous, productive. Fruit, large, roundish conic; skin, greenish, with a fine blush; stem, long; cavity, deep; calyx, closed; basin, narrow; flesh, white, tender, juicy, pleasant, sub-acid. September. (Downing.)

CHESTER.

Origin, Chester Co., Pa. Fruit, medium, oblate; skin, whitish yellow, sometimes with a sunny cheek, and sprinkled with carmine dots; stalk, short, inserted in a broad shallow cavity; calyx, closed, set in broad open basin; flesh, crisp, tender, juicy, with a pleasant sub-acid flavor. November, December.

CHRISTIANA.

Origin, on the premises of John R. Brinckle, near Wilmington, Delaware. Size, medium, roundish, inclining to conical; skin, beautifully striped, and mottled with carmine on a yellowish ground; stem, half an inch long, inserted in a deep, rather narrow cavity; calyx, partially closed, set in a deep, moderately wide, plaited basin; flesh, yellowish white, fine texture, juicy; flavor, pleasant, delicate, sprightly, vinous, quality "very good." November. (Int. Rep.)

CHURCHILL GREENING.

Origin, uncertain. Tree, vigorous and productive. Fruit, large, oblate, somewhat conic, ribbed, angular; skin, yellowish green, shaded with dull red, and thickly sprinkled with green dots; stem, rather long, slender; cavity, broad; calyx, closed; basin, deep, somewhat furrowed; flesh, yellow, tender, granular, with a brisk, vinous, almost saccharine flavor. December to February.

CLARKE'S PEARMAIN.

Gloucester Pearmain, | Golden Pearmain.

American. From Virginia. Fruit, medium, roundish; yellow, mostly covered with bright red, and sprinkled with large whitish dots; stem, medium; cavity, narrow; calyx, closed; basin, shallow, furrowed; flesh, yellowish, crisp, sub-acid; "good," or "very good." December.

CLYDE BEAUTY.

Mackie's Clyde Beauty.

From Clyde, N. Y. Productive. Fruit, large, roundish conical, slightly ribbed; pale greenish yellow, striped and mottled with light red, deep crimson in the sun; stem, short, slender; cavity, deep; calyx, closed; basin, furrowed; flesh, white, fine-grained, juicy, sub-acid. October to December.

COLE.

Scarlet Perfume.

Foreign. Tree, slender growth, irregular, diverging or spreading, hardy, an early bearer of a pleasant sprightly fruit. Fruit, medium, roundish, little conical, bright red; stem, long, slender; calyx, medium, partly closed; flesh, white, juicy; "very good." August.

CONNETT'S SWEET.

Tree, strong, upright grower, early and abundant bearer. Fruit, large, roundish flattened; rich yellow ground, mostly covered with dark red; stem, slender; cavity, wide, deep; calyx, closed; basin, broad; flesh, yellow, fine-grained, tender, sweet, excellent; promises great value. December to March.

CONWAY.

American. Fruit medium, roundish flattened; color, greenish yellow, few brown dots; stem, short; cavity, broad, shallow; calyx, closed; basin, furrowed; flesh, crisp, juicy, vinous, aromatic sprightly flavor. January to February.

CHIEF GOOD.

Summum Bonum.

From Kentucky, near Louisville. Fruit, medium to large, roundish, flattened at base, light yellow, streaked and mottled with red, few splashes of green; stem, short, slender; cavity, open; calyx, small, partly closed; basin, shallow; flesh, white, tender, juicy, sub-acid, aromatic; core, open; seeds, large, light brown. September and October. (A. H. Ernst, Ms.)

COCKLIN'S FAVORITE.

Small, roundish, truncated apple, native of Allen Township, Cumberland Co.; quality, "very good." (W. D. B.)

COOPER'S MARKET.

Cooper's Redling.

Tree, vigorous, upright, with long slender branches. Productive, and a late keeper.

Fruit, medium, oblong conic; skin, yellowish, shaded with red, and striped with crimson; stem, short; cavity, deep, narrow; calyx, closed; basin, small; flesh, white, tender, with a brisk, sub-acid flavor. December to May. (Downing.)

CORNELL'S FANCY.

Cornell's Favorite.

From Pennsylvania. Tree, vigorous and productive. Fruit, medium, oblong conical; skin, waxen yellow, shaded and splashed with crimson, stalk, of medium length; cavity, rather large; calyx, closed, abrupt, corrugated; flesh, white, tender, crisp, juicy, with a pleasant, sub-acid flavor. September. (Downing.)

COURT-PENDU PLAT

Court-pendu,
Garnon's Apple,
Cour Pendu, Rond Gros,
" " Musqué,

Coriandra Rose,
Wollaton Pippin,
Capendu,
Cour pendu Extra,

Cour pendu, Ronge Musqué,
Pomme de Berlin,
Russian,
Princesse Noble Zoete.

Foreign. Tree, slender, early and prolific bearer. Fruit, medium regular, flat; pale greenish yellow, crimson in sun; stem, short; cavity

deep; calyx, large; basin, wide, shallow; flesh, yellow, crisp, sprightly, little acid. "Very good." November to February.

COURT OF WICK.

Barlow,
Coart de Wick,
Fry's Pippin,
Wood's Huntingdon,

Philip's Reinette,
Week's Pippin,
Court of Wick Pippin,
Rival Golden Pippin,

Golden Drop,
Transparent Pippin,
Knightwick Pippin,
Yellow.

Foreign. For those who like a firm, spicy, sprightly fruit for dessert, this may be esteemed. Tree, very hardy—suited to the North. Fruit, small, regular, roundish ovate, flattened, greenish yellow in shade, little red and dotted with russet specks in sun; stem, long, slender; calyx, with long, wide-spread segments; basin, shallow; core, large; seeds, ovate; flesh, yellow, sharp sub-acid, crisp, juicy. October to February.

CRACKING.

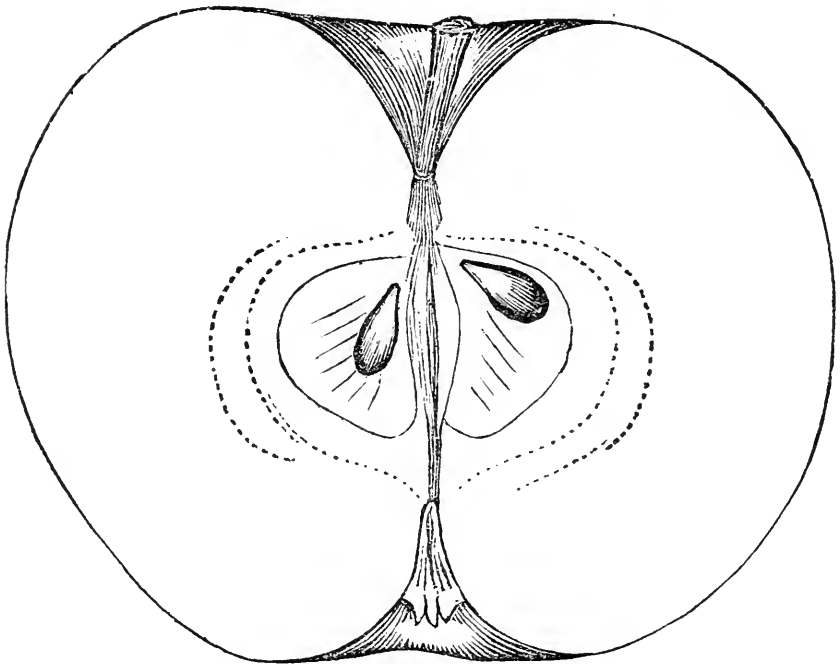

From Harrison County, Ohio. Tree, strong grower; requires little pruning. Fruit, large, roundish, yellowish white, slight tinge of red in sun, and large green dots; stem, short; cavity, deep; calyx, closed; basin, furrowed; flesh, tender, juicy, crisp, sprightly, sub-acid. October to January New; highly esteemed where known.

CRANBERRY.

American. Fruit, medium, roundish conical, red, striped with carmine, gray russet dots; stem, in a narrow, russeted cavity; calyx, small, closed.

CULP.

A native of Jefferson Co., Ohio. Tree, a fine, upright grower. Fruit, medium to large, conical, irregular; skin, yellow, with dull blush, dotted

with russet specks; calyx, closed; basin, uneven; flesh, firm, crisp, very hard until ripe, juicy, with an agreeable sub-acid flavor and light perfume. January to March.

CUMBERLAND.

Cumberland Seedling.

From Cumberland County, Pa. Tree, fine grower. Fruit, esteemed, valuable for market, large, roundish flattened; flesh, white, sub-acid; "good," new.

CUMBERLAND SPICE.

The Blenheim Pippin has been received at the West as this variety. In absence of fruit to examine, we copy Thomas's description:

"Rather large, varying from roundish conical to long conical, the tapering sides being nearly straight and not rounded; color, waxen yellow, with a slight vermilion tinge near the base, and with black specks on the surface; stalk, half to three-fourths of an inch long; cavity, wide, slightly russeted; calyx, open; basin, even; flesh, yellowish white, breaking, rather light; core, hollow; flavor, mild sub-acid, with a peculiar and agreeable spiciness; of good second-rate quality."

CURTIS SWEET.

Origin, unknown. Fruit, large, oval, ribbed, yellow, sprinkled and marbled with crimson, whitish gray dots; calyx, small; basin, shallow; flesh, white, tender, juicy, esteemed; core, large. August to October.

DAPPER.

American. Fruit, small, roundish, yellow, clouded with dull green, and speckled with crimson in sun; calyx, small, closed.

DAVIS.

From Wayne Co., Mich. Fruit, below medium, ovate regular, flattened at base and crown; color, yellowish, shaded with red-gray dots; calyx, closed; basin, small; flesh, whitish, firm, sub-acid; great bearer and keeper. March to April.

DARLINGTON.

Darlington Russet.

Native of Northern Ohio. Fruit, medium, roundish, clear, smooth russet; stem, medium; cavity, deep; calyx, half closed; basin, deep; flesh, white; hardly "very good" January to June.

DERRY NONSUCH.

Dinsmore, | Londonderry.

Origin, unknown; from Keene, N. H., and held in estimation there. Tree, thrifty and productive; a late keeper. Fruit, above medium, oblong or conic angular; skin, yellow, sprinkled, shaded, and splashed with crimson; stem, short, in a moderate cavity; calyx, large, closed; basin, shallow, uneven; flesh, yellowish, juicy, tender, slightly aromatic, agreeably sub-acid. January to April. (Downing.)

DICKSON'S EMPEROR.

From Scotland. New. Fruit, large, irregular, slightly ribbed, yellow, with dashes of carmine red and minute specks of straw color, dull red cheek in sun; stem, short; calyx, large; basin, deep, irregular; core, small; flesh, yellowish white, juicy; "very good." November to January.

DELIGHT.

From R. Buchanan, Esq., Southern Ohio. Fruit, medium, roundish flattened, slightly angular, yellow russet at stem, irregular russet spots, vermilion red cheek in sun; stem, very short; cavity, deep; calyx, large, short segments; basin, round, slightly furrowed; core, compact; seeds,

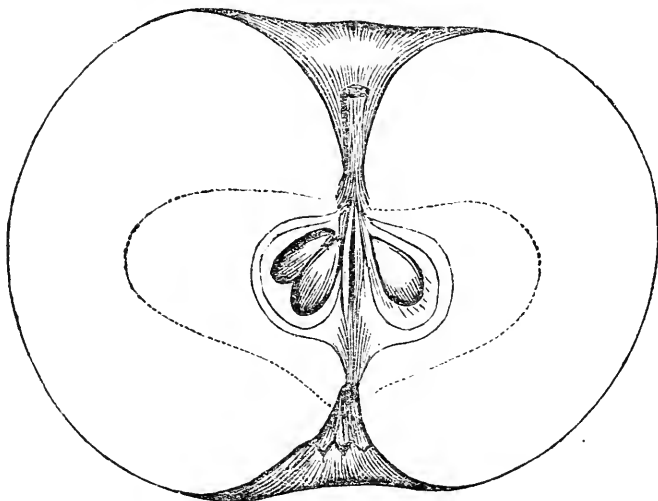

ovate angular; flesh, yellowish, firm, mild sub-acid, almost sweet; "very good." New. December to March.

DETROIT.

Red Detroit,		Jacksonia,
Black Detroit,		Crimson Pippin.

Foreign. Introduced to Detroit, Michigan, by early French settlers. Fruit, medium to large, roundish flattened, dark, blackish crimson, dotted and marbled with fawn specks in sun; cavity, deep; calyx, closed; basin, plaited; core, large, hollow; flesh, white, often stained with red to the core, crisp, juicy, sub-acid. October to February. This is sometimes grown as the Black Apple.

DILLINGHAM.

From D. C. Richmond, Esq., Sandusky, Ohio. Native. Fruit, medium, round regular, whitish yellow, dots of red in sun; cavity, deep, russeted; calyx, closed; basin, medium; core, small; seeds, plump; flesh, white, fine grained, juicy, sweet; "very good;" great bearer. October and November.

DOCTOR.

Red Doctor,		De Witt.
-------------	--	----------

Native of Pennsylvania. Much grown in Southern Ohio and Indiana, producing abundantly of second-rate fruit. Fruit, medium to large, flat, yellow striped and washed with several shades of red and occasional spots of russet; calyx, closed; basin, open; cavity, deep; core, small; seeds, oblong pyriform; flesh, tender, juicy. October to January.

DUCKET.

Southern. Fruit, medium, roundish flattened, light waxen yellow, often

a red cheek, grayish dots; stem, slender; calyx, small; basin, deep; flesh, white, crisp, juicy, tender, vinous; core, small; "very good." October to November.

EARLY LONG STEM?

Early Spice.

Origin unknown. Specimens received from Henry Avery, Burlington, Iowa.

Fruit, small, oblong conical, slightly ribbed; skin, greenish yellow; stem, long, slender, in a large cavity, slightly russeted; calyx, closed; basin, shallow, corrugated; flesh, white, tender, juicy, slightly aromatic, sub-acid. August. (Downing.)

EARLY PENNOCK.

Shakers' Yellow,		August Apple,		Warren Pennock,
Indian Queen?		New Jersey Red Streak?		Harmony.

This is probably an old Eastern variety, so changed by our Western soils as not to be recognized. It was distributed West from Harrison or Belmont counties, Ohio. Trees, thrifty, hardy, early, prolific bearers of fruit, rather below second-rate quality. Fruit, large, roundish, tapering to the eye, greenish yellow, blotched and streaked with lively red; stem, long; cavity, deep, irregular; flesh, yellowish white, juicy, sub-acid. August. Resembles, but is distinct from, Summer Queen.

EARLY RED MARGARET.

Early June, } of South,		Red Juneating,		Eve Apple, of the Irish,
Red June, } of some in Ohio,		Striped Juneating,		Margaretha Apfel, of Germans.
June, of some in Ohio,		Early Red Juneating,		

This should not be confounded with Early Strawberry—oftener grown as Red Juneating. Tree, a regular, moderate bearer, upright, downy shoots. Fruit, medium or below, roundish oblong conical; green in shade, dark crimson red in sun; stem, short, thick; cavity, medium; calyx, half closed; basin, shallow; flesh, white, fine grained, tender; "very good." July.

EARLY SWEET.

American. Originated with W. C. Hampton, Ohio. Tree, productive, growth, upright. Fruit, medium, roundish oblique, clear lemon yellow, light blush red in sun, a few small russet dots, and consecutive russet lines about the calyx, suffused white spots on the blush side; stem, medium to long, slender; cavity, deep, regular; calyx, half closed, with long, partially reflexed segments; basin, deep, regular; flesh, white, very tender, juicy, sweet and delicious as an eating apple. July, August.

ENFIELD PEARMAN.

American. Fruit, medium, globular; color, deep red, with many small dots; stem, long, slender; cavity, large, thinly russeted; calyx, partially closed; basin, broad, shallow; flesh, tender, juicy, pleasant, rich flavor. November to January.

ENGLISH GOLDEN RUSSET.

Golden Russet, of New York."

Foreign. Growth, irregular; fruit, medium, roundish, russet on yellow; stem, slender; flesh, fine grained, crisp; nearly "best." December to March.

ENGLISH SWEETING.

Ramsdell's Sweeting, Ramsdell's Sweet,		Ramsdell's Red Pumpkin Sweet, Red Pumpkin Sweet,		Avery Sweeting.
---	--	---	--	-----------------

Foreign. Tree, vigorous, upright, early, prolific bearer. Fruit, medium to large, oblong, tapering to the eye, green and rough in shade, dark red dotted with fawn specks, and with a blue bloom in sun; stem, short; cavity, narrow, angular, often a fleshy knob; calyx, with short stiff segments; basin, round, regular; core, long, ovate; seeds, imperfect; flesh, yellowish white, sweet; "very good." October to February.

ERNST'S PIPPIN.

Ohio Pippin.

American. Originated with A. H. Ernst, Esq., of Cincinnati, Ohio. Tree, strong, vigorous grower, productive and hardy. Fruit, large, roundish flattened, sometimes slightly oblong; color, light greenish yellow, faint blush when exposed to sun, small dark green specks, surrounded with light green, suffused beneath the skin; stem, short; cavity, narrow, deep; calyx, large; basin, deep; flesh, yellowish white, crisp, tender, juicy, sprightly, sub-acid; core, small, laying nearest the stem end; seeds, dark. December to February. The general appearance of this apple closely resembles the Canada Reinette, from a seed of which it probably originated.

ESTEN.

From Rhode Island. Tree, vigorous, productive. Fruit, large, oblong ovate, slightly ribbed; yellow, faint blush in sun, large green dots; stem, slender; cavity, deep; basin, shallow; flesh, white, sub-acid. October.

EUSTIS.

Ben.

Native, Mass. Fruit, medium to large, roundish, slightly flattened; red and yellow striped or splashed; stem, slender, inclined to one side; cavity, deep, open; calyx, closed; basin, open; core small; seeds, ovate angular; flesh, yellowish, crisp, tender, aromatic, sub-acid. December to January.

EVENING PARTY.

From Berks Co., Pa. Fruit, medium, roundish flattened, greenish yellow, shaded with red; stem, short; cavity, deep; calyx, closed; basin, open; flesh, juicy, tender, crisp, fine dessert fruit; core, medium. December to March. Young shoots, reddish; old wood, gray. A new variety that promises valuable for small gardens.

EWALT.

Origin, farm of John Ewalt. Size, full medium; form, truncated, somewhat angular; color, greenish yellow, with a bright red cheek, and many greenish russet spots, especially about the base; stem, very short, rather stout, inserted in a narrow, not very deep, cavity; calyx, closed, set in a narrow, moderately deep, slightly plaited basin; flesh, fine texture, tender; flavor, sprightly and pleasant, with an exceedingly fragrant odor; quality, very good. April. (W. D. Brinckle.)

EXCEL.

From Sharon, Conn. Tree, strong grower, productive. Fruit, medium, roundish flattened, marbled and splashed with red, light gray dots; cavity

deep; calyx, closed; flesh, yellow, tender, juicy, sub-acid; "very good;" core, large. December, February.

EXQUISITE.

Named and introduced by C. R. Overman, of Canton, Ill. Tree, moderate, upright grower, productive, hardy. Fruit, medium, roundish flattened; yellow striped and marbled with red; stem, short, russet at base; cavity, broad, deep; calyx, small, partly closed; basin, small; flesh, white, juicy, melting, fine grained, tender, rich, vinous, almost sweet; promises to be valuable. September, November.

FAIRBANKS.

Origin, Winthrop, Maine. Fruit, medium, oblate conic, light yellow, striped with red and patched with russet; stem, long; cavity, broad and shallow; flesh, yellowish, juicy, with a rich vinous flavor. September to October. (Me. P. S. R.)

FALL HARVEY.

Native of Mass. Not productive. Fruit, large, roundish flattened, greenish yellow, with scattered brown dots; stem, slender; cavity, deep; flesh, white, mild sub-acid, juicy; "very good." October and November.

FALL JENNETTING.

Fall Gennetting.

Probably American. Fruit, large, roundish flattened, ribbed at base, narrowing to the eye, pale greenish yellow, blush in sun, russety specks; stem, short; cavity, deep; calyx, closed; basin, round; core, small; seeds, angular; flesh, yellowish white, tender, juicy; "very good." October and November. There is another Gennetting grown in Ohio, maturing from July to September, which is sour and unworthy.

FALL PEARMAN.

A variety considerably grown in Connecticut. Trees, moderate bearers; healthy. Fruit, medium size, roundish conical; color, yellow ground, mostly overspread with red in stripes, patches, &c., and many grayish green dots; stem, medium; cavity deep, slightly russeted; calyx, partly closed; basin, deep, slightly furrowed; flesh, white, tender, juicy, sub-acid, rich aromatic flavor. September and October. So far as we have met with this, at the West and Southwest, it proves successful.

FALL SEEK-NO-FURTHER.

Winter Seek-no-Further.

Tree, thrifty and productive. Origin, unknown; grown in Connecticut, and much prized there.

Fruit, very large, oblate; skin, yellow, mostly shaded with red, striped with darker red and covered with numerous grayish dots; stalk, rather long, inserted in a broad, deep, russeted cavity; calyx, closed, in a very broad, uneven basin; flesh, whitish, tender, moderately juicy, with a pleasant, sub-acid flavor. October, January. (Downing.)

FARLEY'S RED.

From Kentucky. Tree, hardy and productive. Fruit, roundish conical angular; color, yellowish, shaded and striped with bright, rich red, dotted

with light dots; stem, short; cavity, deep, irregular, thinly russeted; calyx, open; basin, shallow, uneven; flesh, firm, crisp, juicy, pleasant. January to April.

FATHER ABRAHAM.

From Virginia; considerably grown in Kentucky. We copy Coxe's description: "Small, flat, red, little yellow, spots and blotches of darker red; texture, thin, tender; flesh, white, tinged with red next the sun, juicy, agreeable. Early Winter. Keeps till April."

FAVORITE.

From Kentucky. Fruit, small, roundish, tapering to the eye, pale yellow, striped and splashed with red, and small rough dots; stem, short; cavity, deep; calyx, small; basin, medium, regular; core, medium; seeds, long, ovate; flesh, yellow, juicy, mild sub-acid; not quite "very good." November to January.

FAY'S RUSSET.

From Vermont. Tree, moderate grower, productive. Fruit, small, conical, light yellow russet, faintly striped with red; stem, short; calyx, with long segments; basin, furrowed; flesh, white, tender, sub-acid. March to April.

FERDINAND.

Native South Carolina. Tree, moderately vigorous, upright. Fruit, large, oblate irregular, pale greenish yellow; stem, thick; calyx, open; basin, shallow; flesh, yellowish, tender. November to March. New. (Wm. Sumner in Hort.)

FERRIS.

Westchester Seek-no-Farther.

Fruit, medium, roundish flattened, yellow shades and stripes of red; stem, slender; cavity, broad, deep; calyx, closed; basin, shallow; flesh, yellow, crisp, tender, mild sub-acid; "very good;" core, small. November, December.

FISK'S SEEDLING.

Origin, Keene, New Hampshire. Tree, vigorous and productive; highly esteemed in its locality.

Fruit, medium, oblate oblique; skin, deep red on the sunny side, indistinctly striped with darker red and yellow, and sprinkled with yellow dots, stalk, medium length, in a round, deep, russeted cavity; calyx, large, segments reflexed, in a broad basin of moderate depth: flesh, greenish white, tender, melting, with a rich vinous, saccharine flavor. October, November. (Robert Wilson's MS.; Downing.)

FLEINER.

Foreign. Tree, great bearer, growth upright. Fruit, medium, oblong, lemon yellow, red cheek; flesh, white, tender, sub-acid; "good." September and October. Productiveness its chief merit.

FORD APPLE.

Origin, farm of David Ford, Canaan, Columbia Co., N. Y. Fruit, large, roundish, slightly conical: color, rich yellow; stem, long; cavity, shallow; basin, small, plaited; flesh, yellowish white, solid, moderately tender, with a high, rich, rather acid flavor. October, January. (Cult)

FLUSHING SPITZENBERG.

American. Tree, vigorous, strong brown shoots. Fruit, medium, roundish, slightly conical, greenish yellow, mostly covered with warm yellowish red, russet dots, with suffused fawn shade surrounding; stem, slender;

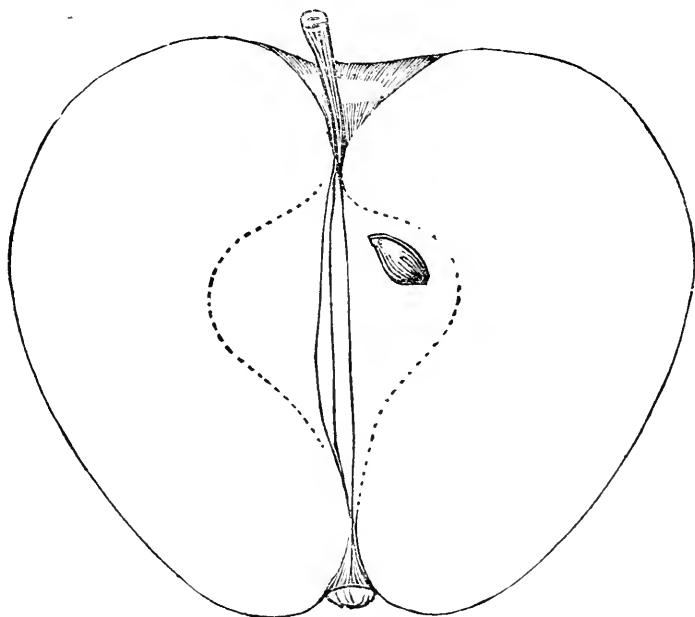

cavity, narrow; calyx, small; basin, shallow; core, rather large; flesh, white, tinged yellow, juicy, mild, crisp, nearly sweet; "very good." November to February.

FOCHT.

A seedling of Lebanon Co., Pa. Tree, a low open head; productive. Fruit, large, oblate, slightly conic angular; skin, pale yellow, sometimes with a blush; stem, short; cavity, broad, deep, russeted; calyx, almost closed; cavity, broad and shallow; flesh, white, crisp, tender, juicy, with a good sub-acid flavor. October, December. Excellent for culinary purposes. (Downing.)

FOUNDLING.

Funtling, | Shirley, | Groton.

Native of Mass. Fruit, large, roundish flattened, narrowing to the eye, yellowish green, with broken stripes, pale red, greenish specks; stem, short, slender; cavity, deep; calyx, closed; basin, furrowed; core, medium; seeds, small; flesh, yellowish, crisp, tender, sprightly, sub-acid. August and September.

FRANKLIN GOLDEN PIPPIN.

Sudlow's Fall Pippin.

American. Tree, upright, vigorous, early annual bearer. Fruit, medium, roundish ovate conical, pale light greenish yellow, interlined with fine whitish net-work, few russet dots; stem, slender; cavity, deep; calyx, small, closed; basin, narrow, slightly plaited; flesh, crisp, juicy; "very good." October.

FRENCH'S SWEET.

The seedling trees are still standing in Braintree, Mass. Large, round ovate, green, inclining to a yellow when fully ripe, great bearer, highly perfumed; flesh, firm. Ripe, October and November, and will keep till January or February. Richest baking I know. (B. V. French, Ms.)

FRONCLIN.

Native of Lancaster Co., Pa. Tree, rapid grower, great bearer. Fruit, medium, regular, round, bright red; flesh, yellowish, acid, vinous. New. (Pom. Trans.)

GABRIEL.

Ladies' Blush, *erroneously*.

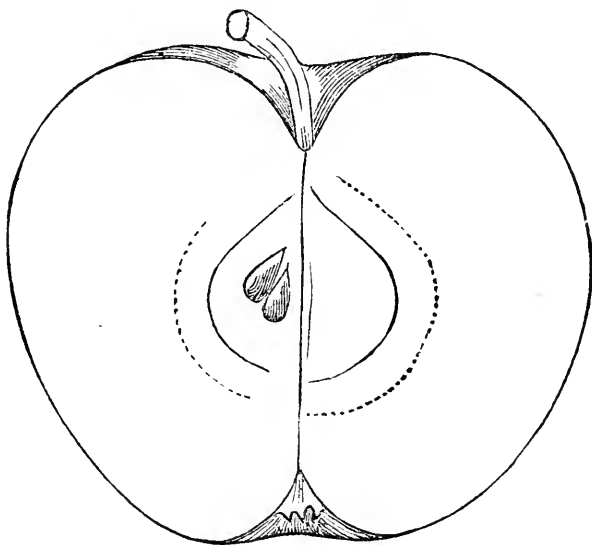

The origin of this variety is uncertain. It will most likely yet prove identical with some variety heretofore described. Our engraving is under medium size of the apple. Trees, moderate growth, good bearers; fruit, medium or below, roundish conical, yellowish, striped, and splashed with pale red; stem, slender; cavity, medium; calyx, small; basin, shallow; core medium; seeds, long ovate, pointed; flesh, yellowish, juicy, sub-acid; "best." October and November.

GARRETSON'S EARLY.

John Garretson's Early.

Native probably of New Jersey. Tree, vigorous growth, early, abundant bearer; fruit, medium, roundish flattened; pale green, becoming yellowish, dotted with whitish specks; stem, short; cavity, shallow; calyx closed; basin, ribbed; core, large; seeds, plump; flesh, white, crisp, tender, sub-acid; "very good." August.

GEORGE.

From Muskingum Co., Ohio. Tree, spreading, free bearer. Fruit, medium, roundish flattened; pale yellow, with russet blotches and specks,

oft quite russety ; calyx, large, open ; basin, shallow ; flesh, whitish, firm, juicy, mild acid. July.

GILES

From Wallingford, Conn. Fruit, medium, conical, dark red ; flesh, tender, juicy ; " very good." October to November.

GILPIN.

Carthouse, | Romanite, of the West.

From Virginia. Its keeping and bearing qualities will always render it more or less popular. Fruit, below medium, roundish, flattened at apex, deep red and yellow ; stem, varying ; cavity, deep ; calyx, closed ; basin, sometimes furrowed ; core, medium ; seeds, ovate ; flesh, yellow, firm, juicy ; will keep a year.

GLOUCESTER WHITE.

American ; medium, roundish oblong, bright yellow, black patches ; flesh, breaking, dry. October and November.

GOBLE RUSSET.

Sweet Seek-no-further.

Medium to large, oblong flattened, yellow russet, marbled with red ; flesh whitish yellow, dry, sweet. October and December.

GOLDEN GOSS.

Fruit, roundish flattened, angular, yellow ; stem, slender ; calyx, nearly closed ; flesh, whitish, juicy, brisk ; " very good ;" core, medium.

GRANDFATHER.

American. Fruit, large, roundish flattened ; color, yellowish white, striped, splashed, and shaded with rich red ; stem, short ; cavity, deep, russeted ; calyx, small, closed ; basin, deep, abrupt, with prominent angles ; flesh, white, tender, juicy, sub-acid. October.

GRANNIWINKLE.

Tree, slow grower, compact head, first described by Coxe ; esteemed only for cider. Fruit, medium, roundish oblong, dark red ; flesh, yellowish, sweet. October and November.

GRANNY EARLE.

Fruit, small, roundish oval, green, striped and splashed with red ; flesh, white, crisp, tender. November to January. (Hov. Mag.)

GREEN'S CHOICE.

Origin, Chester Co., Pa. Tree, vigorous and productive. Fruit, medium, roundish conical ; skin, yellow, striped with red ; flesh, tender, juicy, very mild sub-acid or almost sweet ; ripe, last of August and first of September.

GREEN CHEESE.

Winter Cheese, | Turner's Green.

Origin, Tennessee. Tree, of rather slow growth, an early and abundant bearer. Fruit, medium, oblate, obliquely depressed ; skin, greenish yellow, covered with brown dots ; stalk, very short, in a broad, deep cavity, surrounded by russet ; calyx, partially closed, in a broad, shallow, uneven basin ; flesh, rather fine, juicy, with a brisk sub-acid flavor. November to April. (Downing.)

GREEN MOUNTAIN PIPPIN.

From Georgia, and much grown there as a market fruit. Fruit, medium, oblate, inclining to oblong, flattened at base and crown; skin, greenish yellow; stalk, medium, curved, in a rather broad, deep cavity, surrounded with russet; calyx, open, in a broad, shallow basin; flesh, white, crisp, juicy, tender, with a pleasant vinous flavor. November and February.

GREENSKIN.

Southern Tree, vigorous, productive. Fruit, medium, roundish flattened, greenish yellow, oily; stem, short; cavity, deep; calyx, small, closed; basin, broad, open; flesh, juicy, core, sweet, vinous, very good dessert apple; core, small. October to January.

GRIMES' GOLDEN PIPPIN.

From Brooke Co., Va. Fruit, medium, oblong flattened, golden yellow; flesh, yellowish white, sub-acid; "very good." December to March.

GULLY.

From Lancaster Co., Pa. Fruit, small to medium; white, with blush cheek; flesh, white, juicy. New. (Pom. Trans.)

HAGLOE.

Summer Hagloe.

Tree, medium bearer, dark colored strong shoots; valued for cooking, often fine for dessert. Fruit, medium, roundish flattened, bright red on yellow; flesh, tender. July. Distinct from Hagloe Crab, a small, ovate, cider fruit.

HAIN.

Origin, Berks Co., Pa. A vigorous grower and profuse bearer. Fruit, large, globular, inclining to oblong; skin, yellow, striped, marbled and mottled with red; stalk, rather long, slender, set in a deep, abrupt cavity; calyx, nearly closed; basin, open, slightly corrugated; flesh, white, juicy, tender, rich, sweet and slightly aromatic. November, March. (Downing.)

HALL.

Hall's Red, | Jenny's Seedling.

From North Carolina. Fruit small, roundish flattened, mostly red, with many dots; stem, slender; cavity, open; basin, small; flesh, yellowish, fine-grained, juicy, rich, vinous aromatic; "best." January. This variety should be introduced Southwest as a dessert apple. The trees are very hardy.

HAMPHILL.

From North Carolina. Tree, erect, vigorous grower; very productive; young wood, reddish gray. Fruit, medium, roundish, straw color marbled and washed with red; stem, long; basin and cavity, small; flesh, firm, sub-acid, juicy; "very good." November to May.

HARRIS.

Originated with Mr. Harris, Rockingham Co., N. C. Tree, vigorous, erect, productive, popular in its native locality. Fruit, large, oblate; skin, bright straw color, occasionally with a pink blush; stem, very short and stout; cavity, broad and shallow; basin, large and deep; flesh, coarse,

pleasant, sub-acid. Last of August and continues a long time: valuable for culinary purposes. (G. W. Johnson.)

HARRISON.

Generally grown for cider, but, in absence of better fruit, and kept until March, it becomes "very good" for dessert. Tree, thrifty, hardy, very productive. Fruit, medium or small, roundish ovate; yellow, with black specks, light-suffused shade around; stem, one inch; cavity, wide; calyx, closed; basin, shallow, furrowed; flesh, yellow, firm, spicy, sub-acid; core, large; seeds, long, ovate. November to March. It is from this variety, mixed with a small proportion of Campfield, that the celebrated Newark cider is made.

HARNISH.

Fruit, medium, oblong oval, slightly angular; skin, mostly shaded with dark red, and sprinkled with grayish dots; flesh, compact, tender, not juicy, almost sweet, pleasant. September to October. From Pennsylvania, said to have originated in Lancaster County. (Downing.)

HARTFORD SWEETING.

Spencer Sweeting, | Champ Sweeting.

Native of Hartford, Conn. Growth, slow, hardy, productive. Fruit, large, roundish flattened, red striped on greenish yellow; stem, slender; cavity, shallow; calyx, large; basin, shallow; flesh, whitish, juicy, tender; "very good." December to March.

HASKELL SWEET.

Sassafras Sweet.

Tree, vigorous, moderately prolific, deserves more general culture. Fruit, large, nearly flat, greenish, with dull brown cheek in sun; stem and cavity, medium; flesh, tinged with orange yellow, tender, sweet; almost "best." October.

HAWTHORNDEN.

White Hawthornden, | Mountaineer.

Foreign. Above medium, roundish flattened, pale yellow, blush in sun; flesh, white, acid. October, November. Not equal to Maiden's Blush.

HEART'S PIPPIN.

Fruit, medium, roundish, flattened at ends, oblique; color, pale yellow, with suffused shades of whitish yellow, and faint blush cheek in sun; stem, medium; cavity, regular, even, moderately deep, russeted; calyx, with five distinct, erect, open segments; basin, regular, medium depth; flesh, white, very tender, acid, juicy, fine for sauce; core, medium; seeds, roundish oval. November.

HECTOR.

From Chester County, Pa. Large, oblong conical, striped and mottled with red on a yellow ground; stem, slender; deep, open russeted cavity; basin, narrow, deep, furrowed; flesh, crisp; texture, fine; "very good." (W. D. B.)

HELEN'S FAVORITE.

From Troy, Ohio. Fruit, medium, roundish, dark red shades, light spots, stem, short, slender; cavity, deep; calyx, small; core, compact; seeds,

small; flesh, white, streaked with red, tender, juicy; "very good." January and February. (A. H. Ernst, Ms.)

HENRY.

From Vermont. Tree, vigorous, productive; fruit, large, conical; color, yellow, bronzed red in sun, small gray dots; stem, short; calyx, closed; basin, small; flesh, yellow; "good." October, December.

HERMAN.

From Cumberland County, Pa. Tree, productive; fruit, medium, oblong, red striped on greenish yellow; flesh, greenish, tender, juicy; "very good." December to April. (Pom. Trans.)

HESS.

American. From Lancaster County, Pa. Fruit, medium, roundish conical; shades of red; stem, short, stout; cavity, narrow; basin, deep, narrow; flesh, greenish white, tender, aromatic. December to March. "Good to very good."

HIGBY'S SWEET.

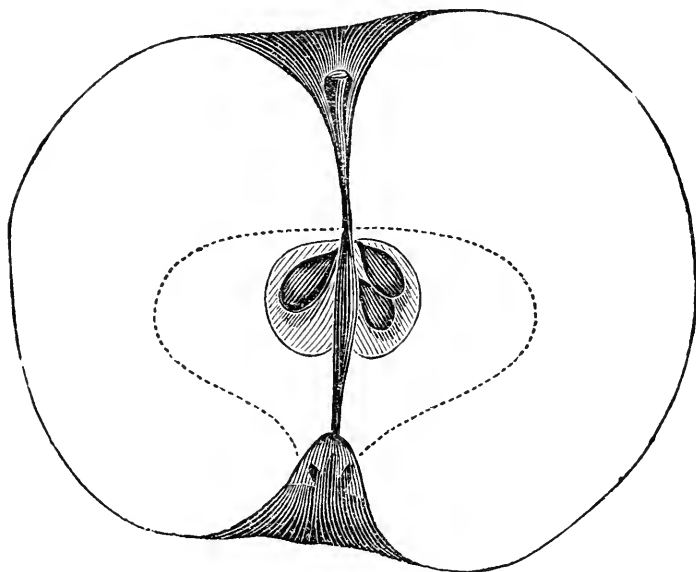

According to present information, this variety originated in Trumbull County, Ohio. It is a good and regular bearer, and extremely valuable as a table fruit. Fruit, medium, occasionally large; form, roundish flattened, often one side enlarged or oblique; color, pale, clear yellow, with faint tinge of red is seen small obscure dots, and mostly apparently underneath the skin; stem, short, slender; cavity, regular, moderate depth, russeted regular; calyx, small, nearly closed; basin, deep, pretty regular, slightly furrowed; flesh, white, very tender, pleasantly sweet, juicy and well flavored; core, small; seeds, plump, round ovate. October to March.

HIGHLANDER.

Origin, Sudbury, Vermont. Tree, a good grower, very productive; fruit, medium, oblate, approaching conic; skin, greenish, mottled and striped with red; stalk, short, rather slender, inserted in a rather deep cavity; calyx, small and closed; basin, small; flesh, white, juicy, tender, with a pleasant vinous flavor. September, October. (Downing.)

HILTON.

Origin, Columbia County, N. Y. Tree, vigorous and productive; apples making the finest tarts and pies. It is not equal to the Fall Pippin for eating. Fruit, very large, roundish, a little more square in outline than the Fall Pippin, and not so much flattened, though a good deal like it; a little narrowed next the eye; stalk half an inch long, thick, deeply sunk; calyx, small, closed, moderately sunk in a slight plaited basin; skin, greenish yellow or pale green, becoming pale yellow when fully ripe, washed on one side with a little dull red or pale brown, with a few scattered, large greenish dots. (Downing.)

HILL'S FAVORITE.

From Mass. Tree, thrifty, productive. Fruit, above medium, roundish conical, yellow shaded and striped with red, whitish dots, thin bloom, stem, short; cavity, uneven; calyx, closed; basin, shallow; flesh, yellow, firm, tender, juicy, aromatic; core, medium; "very good." September, October.

HIXON'S FAVORITE.

American. The fruit resembles Houghton Seedling in size and quality. The plant is of dwarf habit; upright growth, hardy and productive.

HOCKING.

Western. Fruit, medium to large; red and yellow striped, sometimes slightly russeted; stem, medium length; cavity, open, broad; basin, shallow, slightly ribbed; flesh, fine grained, tender, mild sub-acid; core, small. August. Tree, upright, vigorous grower, hardy and productive. Origin, uncertain; may prove identical with some Eastern sort—as yet only known West.

HOLLADY'S SEEDLING.

Raised by John Hollady, Spottsylvania County, Va. A very thrifty, upright grower, a good bearer. Fruit, medium, oblate; color, yellow, with a faint blush, and sprinkled with gray dots; flesh, yellowish, compact, tender, rich, aromatic. November to March. (H. R. Roby.)

HOOKER.

Origin, Windsor, Conn. Growth upright, vigorous, productive. Fruit, medium, conic, slightly oblique; skin, greenish yellow, shaded with dull crimson, striped with red, and sprinkled with large russet dots; stalk, short, inserted in a very shallow cavity; calyx, small, partially closed, in a small, abrupt basin; flesh, greenish, tender, juicy, with a pleasant sub-acid flavor. November to January.

HOOVER.

Raised by Mr. Hoover, of Edisto, South Carolina. Fruit, large and beautiful, nearly globular, inclining to conic; color, rich, dark crimson,

peculiarly marked with round, white spots, of about an eighth of an inch in size; stem, half an inch long, fleshy; calyx, open, in a smooth, greenish yellow basin; flesh, white; flavor, brisk acid. November to February

HOLLAND PIPPIN.

Reinette d'Holland,
Summer Pippin,

Pie Apple,
French Pippin, *of some.*

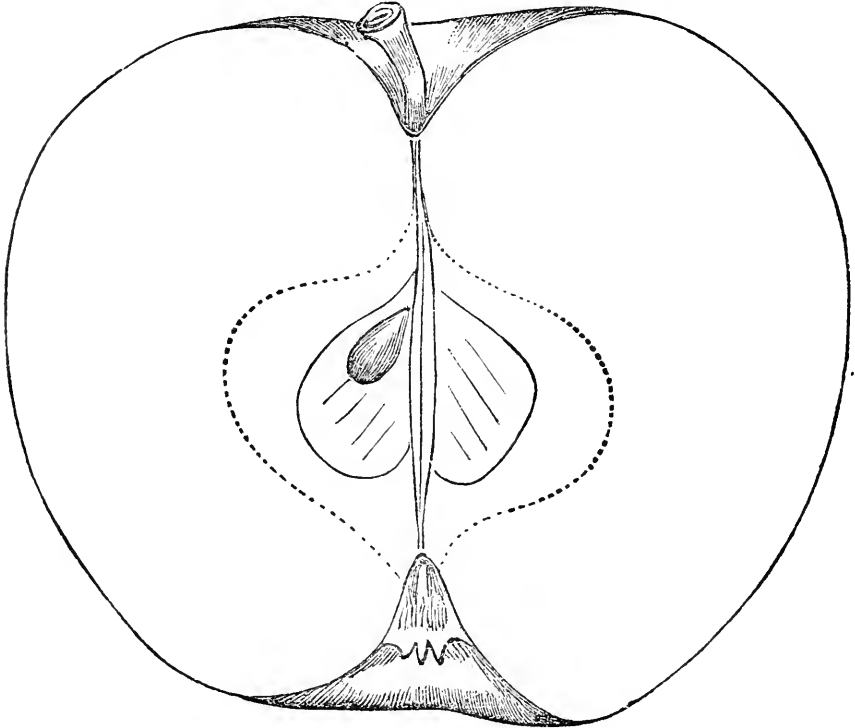

Tree, resembles Fall Pippin, with which it is often confounded, but from which it is distinct. It is esteemed for cooking, for which it is fitted in August. but we think surpassed by Gravenstein. We refer for description to Fall Pippin, with this difference, more regular round, stem shorter, cavity not as deep, more broad and open; calyx smaller, and basin not as wide.

HOUSUM'S RED.

From Berks County, Pa. Large, oblong, compressed at the sides; skin, red, in stripes, yellow at base; stem, short, thick; cavity, narrow, not deep, slightly russeted; basin, moderately deep, plaited; flesh, fine texture, tender, with delightful aroma; "very good," at least. October to February. (W. D. B.)

HOWE'S RUSSET.

Origin, Shrewsbury, Mass. Very much resembles Roxbury Russet, and may be seedling of it. Fruit, large, oblate, often conic, angular; skin, greenish yellow, mostly covered with russet, and generally with a bronzed cheek; stalk, short, inserted in a broad cavity; calyx, partially closed; basin, abrupt, uneven; flesh, yellowish, compact, brisk vinous flavor January to May. (Downing.)

HUGHES.

Origin, Berks Co., Pa. From Thomas Hughes, said to be an abundant bearer; large, roundish. Skin, greenish yellow, with a blush, and numerous gray dots; stem, variable in length, slender, inserted in a moderately deep, open cavity; calyx, large, open, set in a wide, deep, sometimes plaited basin; flesh, fine texture, tender, juicy; flavor, very agreeable, saccharine without being sweet, with a delicate and delicious aroma; quality, "very good," if not "best." March, April. (Ad. Int. Rep.)

HUNTER.

From Delaware Co., Pa. Fruit, medium, roundish conical, striped and splashed bright red on yellow; stem, slender; cavity, narrow; calyx, small; basin, deep; flesh, white, tinged with pink, tender, crisp, juicy October.

HUNT'S RUSSET.

Origin, Mr. Hunt's Farm, Concord, Mass. Growth, rather slow, bears annually and abundantly.

Fruit, small, conic; skin, russet, shaded with dull red, on a greenish yellow ground; stalk, short, slender; cavity, deep and broad; calyx, closed; segments, long, recurved in a round open basin; flesh, juicy, fine grained, rather rich, sprightly, sub-acid flavor. December to April. Little known at the West.

HURLBUT.

Hurlbut Stripe.

Origin, farm of Gen. Hurlbut, Winchester, Conn. Tree, very vigorous, and great bearer. Fruit, medium, oblate, slightly conic angular; skin, yellow, shaded with red stripes, and splashed with darker red, and thinly sprinkled with light dots; stalk, short, rather slender, inserted in a broad, deep cavity, surrounded by russet; calyx, closed, basin rather shallow; flesh, white, crisp, tender, juicy, with a mild sprightly sub-acid flavor. November, December. (Downing.)

INDIANA FAVORITE.

From Fayette Co., Ind. Tree, spreading head, good bearer. Fruit, medium to large, round, flattened at ends, tapering to calyx, angular; yellow, mostly covered, splashed and striped with two shades of red, many russet specks; stem, slender; cavity, deep, regular; calyx, irregular, short segments; flesh, white, tender, juicy, slightly sub-acid, almost sweet, pleasant; "very good;" core, compact; seeds, pointed, light brown. January to April.

IOLA.

Southern origin. Fruit, large, oblate angular, compressed horizontally; skin, yellow, mottled, marbled, striped and shaded with crimson; stem, short, in rather large cavity; calyx, large, partially closed, in an abrupt furrowed basin; flesh, white, fine grained, tender, juicy, vinous, rich and agreeable. A very delightful apple; core, small. December to February.

JABEZ SWEET.

From Middletown, Conn. Fruit, medium, nearly round, pale green, dull red in sun, sweet. October to April. (Hov. Mag.)

JACKSON.

From Bucks Co., Pa. Fruit, medium, roundish; color, greenish yellow, with dark blotches and gray dots in sun, faint stripes and mottlings of red; stem, in a deep narrow cavity; calyx, closed; basin, slightly furrowed; flesh, greenish, tender, juicy, aromatic flavor. October, December.

JEFFERSON COUNTY.

From Jefferson Co., N. Y. Tree, vigorous, productive. Fruit, medium, globular; color, greenish yellow, with marblings and shades of red russet in sun; stem, in a deep cavity; calyx, small; basin, deep; flesh, crisp, juicy, mild sub-acid. October, December.

JENKINS.

Native of Montgomery Co., Pennsylvania. Fruit, small, roundish ovate; red, interspersed with numerous large white dots, on a yellowish ground; stem, slender; cavity, deep, rather wide, sometimes russeted; calyx, closed; basin, deep, open, furrowed; core, above medium; seeds, grayish brown, acute-ovate; flesh, white, tender, fine texture, juicy; flavor, agreeably saccharine, exceedingly pleasant and aromatic; "very good," if not "best." The Jenkins is one of those delicious little apples peculiarly fitted for the table at evening entertainments. (W. D. B.)

JEWETT'S RED.

Jewett's Fine Red, | Nodhead.

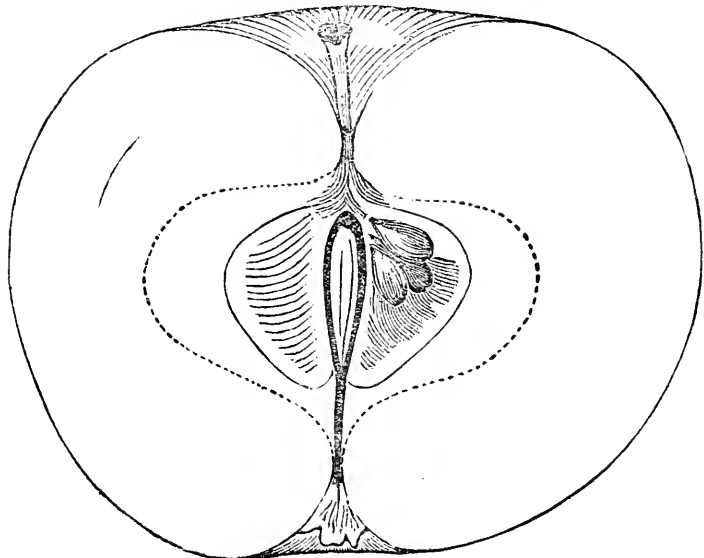

Tree, slow, rather slender, diverging growth; fruit, unfair while young; best adapted to strong clay soils North, where it is hardy, and said to succeed well. Fruit, medium to large, roundish flattened, tapering to the eye, sometimes angular; greenish yellow, mostly overspread or striped with red, numerous white dots; stem, varying; cavity, narrow; calyx, small, partially closed; basin, shallow, wrinkled; core, medium; seeds, ovate rounded; flesh, yellowish white, fine-grained, tender, mild aromatic sub-acid. November to February.

JERSEY PIPPIN.

Foreign. Fruit, medium, round oblong conical, flattened, pale yellowish green, faint stripes red; stem, short, stout; cavity, deep, open; calyx, rather large; basin, shallow; core, small; seeds, imperfect; flesh, greenish yellow, juicy, vinous, sub-acid; "very good." November to February. New.

JOHNSON.

From Brookfield, Conn. Fruit, above medium, roundish; smooth, striped red on yellow, dark red in sun; flesh, tender, crisp, juicy; very fine. August, September.

JOHN'S SWEET.

Origin, Lyndsboro, New Hampshire. A good grower, somewhat straggling; a prolific bearer.

Fruit, medium, oblong or conic; skin, whitish yellow, sprinkled, striped, and splashed with red; stem, short, inserted in a narrow cavity, surrounded by russet; calyx, closed, set in an abrupt basin; flesh, juicy, tender, with a sweet peculiar flavor. January to May. (Downing.)

JUNALIESKA.

Raised in Cherokee Co., North Carolina, by J. Whittaker. Fruit, large, globular, inclining to conic; skin, fine yellow color, speckled with dark brown russet; stem, short and fleshy; cavity, narrow; basin, very small; flesh, yellow, with a sprightly sub-acid flavor. November to March. (J. Van Beuren.) (Downing.)

KEIM.

Fruit, below medium, roundish conical, pale waxen yellow; stem, long, slender; cavity, medium; calyx, small, closed; basin, shallow, plaited; core, medium; flesh, white, tender, mild, pleasant; "very good." January to March.

KEISER.

Red Seek-no-further.

An old variety much grown in Jefferson Co., Ohio, and highly prized, growth of tree like Rambo.

Fruit, medium, roundish oblate, slightly oblique, angular; skin, pale yellow, shaded with red, indistinctly striped and thickly sprinkled with large grayish dots; stalk, short, inserted in a large cavity; calyx, small, closed in a broad, shallow, corrugated basin; flesh, yellowish, not very juicy, but mild sub-acid. November to February.

There is another Red Seek-no-further, grown near Lebanon, Pa., distinct, and a universal favorite there. December to April.

KELSEY.

Origin, Berks County, Pa., on the premises of John Kelsey. Size, medium, roundish oblate, sometimes inclining to conical; skin, greenish yellow, with occasionally a faint blush and numerous gray dots; stem, short, inserted in a deep, moderately open cavity; calyx, closed, set in a very shallow, plaited basin; flesh, tender, fine texture, greenish white; flavor, mild, and exceedingly pleasant, fragrant aroma; quality, very good. March. (W. D. Brinckle.)

KAIGHN'S SPITZENBERG.

Red Spitzenberg,
Red Pearmain,
Red Winter Pearmain,
Long Pearmain,

Lady Finger,
Scarlet Pearmain, } *erroneously*,
Long John,
Red Pippin,

Red Phœnix,
Sheepnose, of some,
Russam.

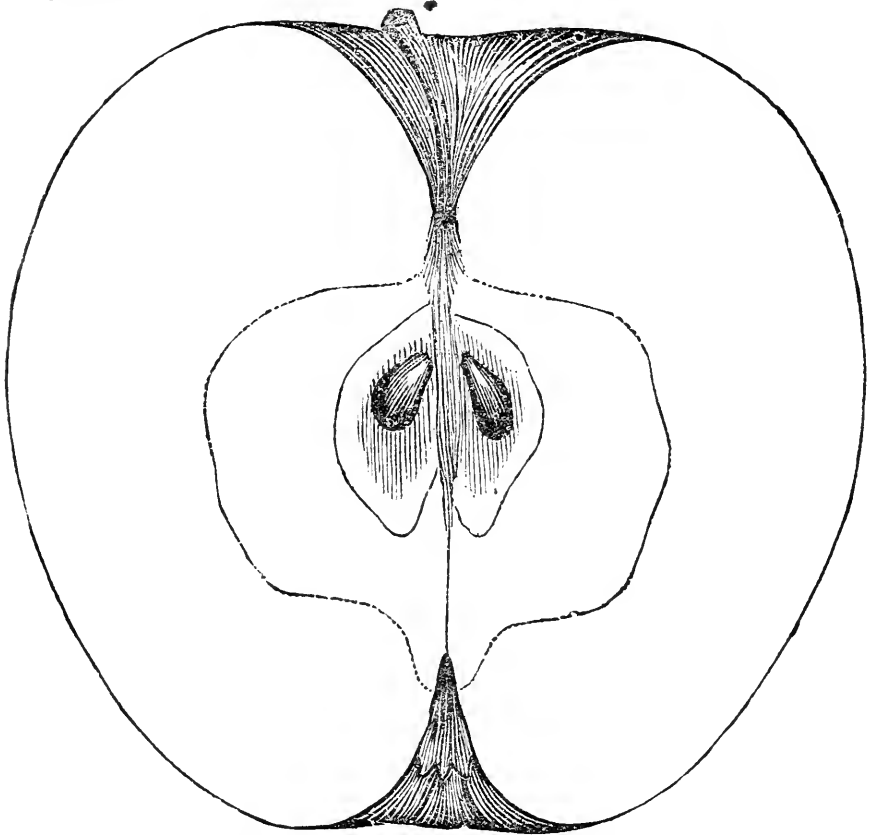

This variety is showy, annually productive, and that is all of its good qualities. We present the drawing to aid the unacquainted to detect it, as the name often aids in its sale. Dr. Warder, at the late Ohio Pom. Meeting, stated that it came originally from Kaighn's Point, and the name, *Spitzenberg*, was derived from a mountain "berg." Fruit, large, oblong rounded; yellow, mostly overspread with bright clear red; stem, about even with surrounding surface; cavity, deep, regular; calyx, small; basin, slightly furrowed; core, small; seeds, irregular in form; flesh, yellowish, coarse, dry; "good." November and December. Often grown in Michigan as Red Belleflower.

KETCHUM'S FAVORITE.

Origin, farm of Mr. Ketchum, Sudbury, Vt. Tree, vigorous and productive. Fruit, medium, irregularly oval, inclining to conic; skin, light waxen yellow, slightly shaded with rosy blush, irregularly sprinkled with carmine dots; stalk of medium length, inserted in a narrow cavity, surrounded by russet; calyx, closed; basin, deep and narrow; flesh, white, with a very mild, rich, and excellent flavor. September to January. (Downing.)

KING APPLE.

From Mason Co., Ky. Fruit yellow, clouded, and mostly obscured with dull red, small specks, and large patches of mould or fungus peculiar to the Southern grown fruits; oblong, flattened at base; calyx, small; basin, shallow; stem, short, slender; cavity, narrow; core, small; seeds, medium; flesh, white, tender, juicy, sub-acid. January to February.

KIRKBRIDGE WHITE.

Medium in size or rather large, oval, ribbed, tapering equally to each end, and blunt at the ends; skin, smooth, pale yellow; stem, short; cavity and basin both very narrow; flesh, very tender, sub-acid, fine-grained; "good." Latter part of Summer.

KLAPROTH.

From Lancaster Co., Pa. Tree, vigorous, prolific. Fruit, medium, roundish flattened, greenish yellow, streaked and stained with red, light specks and russet spots; stem, short; cavity, smooth, deep; calyx, small, closed; segments, reflexed; basin, broad; flesh, white, crisp, juicy, sub-acid; "very good." August to October. Valuable for market.

KOHLE.

From Germany. Tree, thrifty, good grower; new. Fruit, small, roundish; crisp, juicy; good keeper. December, May.

KROWSER.

Origin, Berks Co., Pa., where it is exceedingly popular. Tree, a handsome grower and abundant bearer. Fruit, medium, roundish conic; color, whitish yellow, striped and splashed with carmine; stalk, rather short, inserted in a medium cavity; calyx, closed; basin, small and corrugated; flesh, white, tender, mild sub-acid flavor. December, March.

LANCASTER.

Lancaster Greening.

From Lancaster Co., Pa. Tree, hardy, vigorous, productive. Fruit, medium, roundish conical, greenish yellow, with brown dots and blotches; stem, short; cavity, deep; calyx, small; flesh, greenish white, juicy, sub-acid; valued for keeping till April.

LONDON.

From Vermont. Fruit, medium, roundish, yellow ground, mottled with two shades of red, minute dots with grayish suffused skin surrounding; stem, medium; cavity, regular, with a tinge of greenish russet; calyx, with broad segments nearly closed; basin, shallow, furrowed; flesh, yellowish, crisp, firm, tender, juicy, aromatic; "very good," or "best;" core, medium; seeds, abundant. January to March. A new variety that promises high value.

LANDRUM.

American. Fruit, medium, conical, deep crimson sprinkled with large white dots; stem, slender; cavity, deep, russeted; calyx, small, closed; basin, furrowed; flesh, yellowish, rather coarse, crisp, tender, juicy, vinous; "very good;" core, small. October, November.

LANE'S RED STREAK.

Origin, orchard of Mr. Lane, Edgar Co., Illinois. Tree, of moderate growth. Fruit, large, round conical, regular; color, yellow, with very fine short stripes, and specks of bright red, beautiful; flesh, white, fine, tender, pleasant sub-acid, of fair quality. October. (McWhorter.)

LAKE.

Grown by D. C. Richmond, Sandusky, Ohio. Tree, abundant bearer, fruit hangs well. Fruit, below medium, round ovate conical, yellow, mostly overspread and striped with deep lake red, many dots; cavity, deep; calyx, closed; basin, open; core, medium; seeds, plump; flesh, yellow, tender, juicy, sub-acid; "very good." October.

LATE QUEEN.

Brown's Late Queen.

American. Native of Ohio. Fruit, large, roundish conical, pale red on yellow, bluish tinge at stem end, and many large russet dots; calyx, closed; basin, deep, round, slightly furrowed; stem, medium; cavity, deep; flesh, yellowish, crisp, tender, sub-acid; "very good." September and October.

LECKER.

Laquier, | Lacker.

From Lancaster, Pa. Described by Thomas as Laquier. Medium, roundish oblate; skin, striped with crimson on a pale red, with numerous large dots; stem, short and slender, sometimes stout; cavity, russeted, narrow, rather deep; basin, wide, deep, plaited; core, small; seed, dark cinnamon, short, plump; flesh, whitish, fine texture, tender, juicy, "good," at least. December to March. (W. D. B.)

LEDGE SWEET.

From Portsmouth, N. H. Tree, productive, regular bearer. Fruit, large, roundish flattened; yellowish green tinged with blush in sun, reddish russet specks; stem, short, stout; cavity, open, deep; calyx, partially closed; basin, shallow; core, open; seeds, light brown; flesh, yellowish white, fine, juicy, crisp, sweet. January to June. (Hov. Mag.)

LELAND SPICE.

Leland Pippin, | New York Spice.

From Mass. Fruit, large, roundish, slightly conical, and ribbed; greenish yellow, mottled with crimson stripes, dark crimson in sun; stem, half-inch; cavity and basin, ribbed; flesh, yellowish white, spicy, sub-acid; "best." October to December. Deserves more attention than yet received.

LEICESTER SWEET.

Potter Sweet.

Rather large, flattish, greenish yellow and dull red; tender, rich, excellent, fine for dessert or baking. Winter. Tree, vigorous, not very productive. Origin, Leicester, Mass. (Cole.)

LEWIS.

Origin, Putnam Co., Indiana. A good grower, and productive. Fruit, medium, oblate conic; skin, yellowish, striped with crimson, and partially covered with thin cinnamon russet, and sprinkled with gray and brown

dots; stalk, short, inserted in a deep cavity; calyx, closed, or nearly so, in a moderate basin; flesh, yellow, compact, with a rich sub-acid flavor; not very juicy. November, February. (Downing.)

LIBERTY

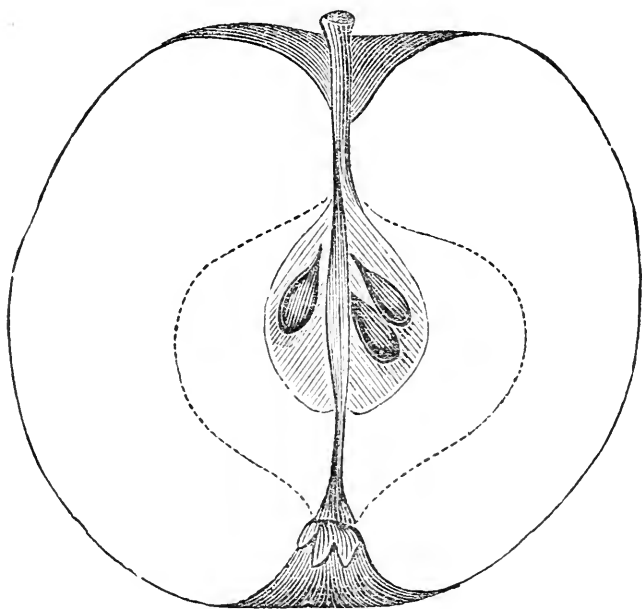

The Liberty Apple, as exhibited at the Ohio State Fruit Conventions, is claimed to be a seedling of Delaware county, in that state. Its claim for introduction to the West, we think, rests upon its character as a long keeper, even when grown on rich prairie lands.

Fruit, medium to large; form, oblong oblique conical; color, yellowish, striped and splashed with shades of red—often the red is most prominent at first glance, and it appears as though there was a shade of rich yellow marbled underneath, small, irregular, russet dots, and occasionally a large oblong rounded russet patch; stem, usually medium height; cavity, narrow, of medium depth, regular; calyx, large; segments, half open, slightly recurved. basin, open, broad, acute; flesh, yellow, firm, a little tough, juicy, rich, mild sub-acid; skin, thick, tough; core, medium, central, compact; seeds, light brown, ovate long, pointed. February to June.

Locy.

Globular, sometimes inclining to oblate, and sometimes oblong or conic; skin, greenish, shaded and striped with dull red; stalk, short, inserted in a small, acute cavity; calyx, closed, in an open, furrowed basin; flesh, greenish, crisp, tender, juicy, with a very pleasant, brisk, vinous flavor. November, February. (Downing.)

LIMBER TWIG.

James River.

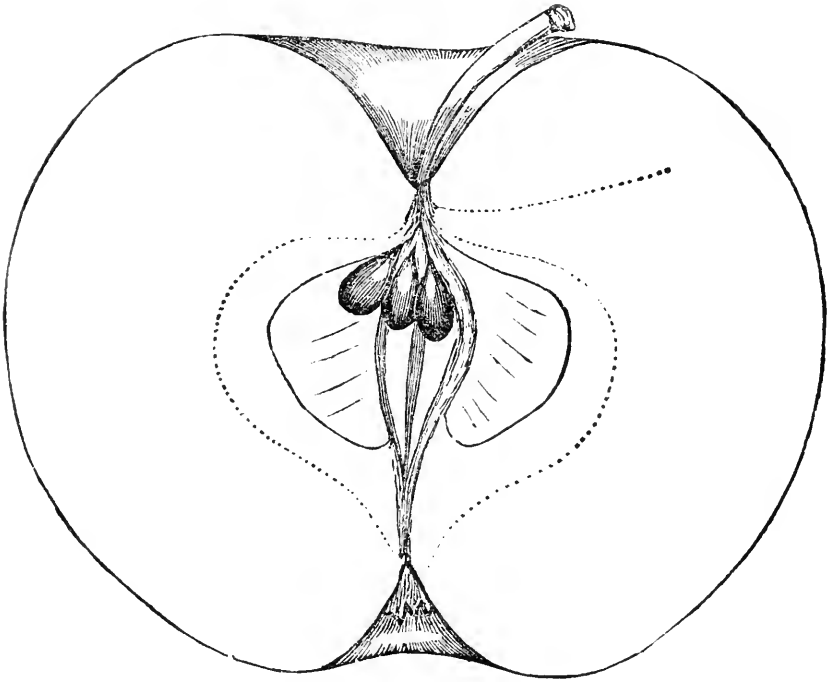

A valuable fruit in Southern Ohio, Kentucky, and Indiana. Tree, hardy, productive. Fruit, large, roundish, tapering a little to the eye; light yellow, striped and splashed with red in sun, rough russet specks, and occasional patch of russet; stem, long, slender; cavity, open, funnel shape, russeted; calyx, rather small; basin, irregular, round; core, large, hollow; seeds, plump, pyriform; flesh, whitish, tender, sub-acid; "very good." Keeps to May. For varieties of this, see Willow Twig, &c.

LONG STEM.

From Berks Co., Pa. Below medium, roundish oblong, sometimes angular; skin, red, in faint stripes, with a number of gray russet dots; stem, long; cavity, medium, acuminate; basin, small, shallow, plaited; flesh, greenish white, tender, agreeably sub-acid flavor, with Spitzenberg aroma; quality, "very good." This is distinct from the "Long Stem" of Cole, which is large, roundish, pale yellow, brown in sun; calyx, large; basin, broad, shallow; flesh, white, juicy, aromatic. September and October. A native of Mass. And also distinct from the "Long Stem" of Count.

LORING SWEET.

Native of Mass. Fruit, medium, oblate; greenish yellow, tinged with pale red in sun, brownish specks; stem, short; cavity, deep, open; calyx, medium, closed; basin, shallow; core, small; seeds, plump; flesh, yellowish white, crisp, juicy, tender, sweet "very good." Nov. to Jan.

LOUDON PIPPIN.

Tree, productive ; most grown in Northern Virginia. Fruit, large, roundish conical ; greenish yellow ; stem, short ; calyx, large ; flesh, greenish white, sub-acid ; valued only for its size, where people know what apples should be.

LOWRE QUEEN.

Loure Queen.

Trees, upright, early bearers, extensively grown in Central Ohio ; somewhat resembles the Vandervere. Fruit, medium, roundish flattened, oft angular ; yellow, striped and splashed with dull red, rough irregular dots, or specks of dull russet, russet at stem ; stem, slender ; cavity, regular, deep ; calyx, with long pointed segments ; basin, abrupt, broad, slightly furrowed ; core, small ; seeds, ovate ; flesh, yellowish white, tender, juicy ; "very good." November to February.

LYSCOM.

Matthew's Stripe, | Osgood's Favorite.

From Mass. Fruit, large, round ; greenish yellow, broken stripes, and splashes of red ; stem, short ; cavity, deep ; calyx, small ; basin plaited ; flesh, fine-grained, mild sub-acid. September to November.

MACOMBER.

Origin, Guilford, Maine. Fruit, full medium, oblate angular ; skin, yellowish, shaded and striped with red ; stalk, short ; cavity, large ; calyx, closed ; basin, large and regular ; flesh, white, fine-grained, tender ; flavor sub-acid. December to January. (Downing.)

MAGNOLIA.

Origin, Bolton, Mass. Growth moderate, productive. Fruit, medium, oblate conic ; skin, yellow, beautifully striped and mottled with crimson ; stalk, short, in a broad, uneven cavity ; calyx, closed ; basin, small ; flesh, white, tender, juicy, with a brisk, aromatic flavor. October. (Downing.)

MAIDEN'S FAVORITE.

Maiden's Apple.

From Stuyvesant, N. Y. Tree, a slow grower, productive. Fruit, below medium, oblong rounded, pale yellow, shaded with blush, sometimes mottled carmine, and few minute dots ; stem, short ; cavity, deep, thin, russeted ; calyx, closed ; segments persistent ; basin, regular ; flesh, whitish, crisp, very delicate, vinous ; "very good ;" a dessert apple. December to February.

MANSFIELD RUSSET.

American. Tree, good grower, productive. Fruit, small, oblong conical ; cinnamon russet ; stem, long, slender ; calyx, with long segments ; flesh, white, aromatic "very good ;" core, small.

MANOMET SWEET.

Horseblock.

From Plymouth, Mass. Tree, vigorous, good bearer. Fruit, medium, roundish ; lemon yellow, bright red in sun, dotted with russet specks, and trace of russet at stem ; stem, short, slender ; cavity, shallow ; calyx, large, closed ; long segments ; basin, shallow ; core, compact ; seeds, medium ;

flesh, yellowish, juicy, tender, sugary sweet; "very good." August and September.

MALE CARLE.

Mela Carla,	Pomme de Charles, Charles Apple.
Mela de Carlo,	

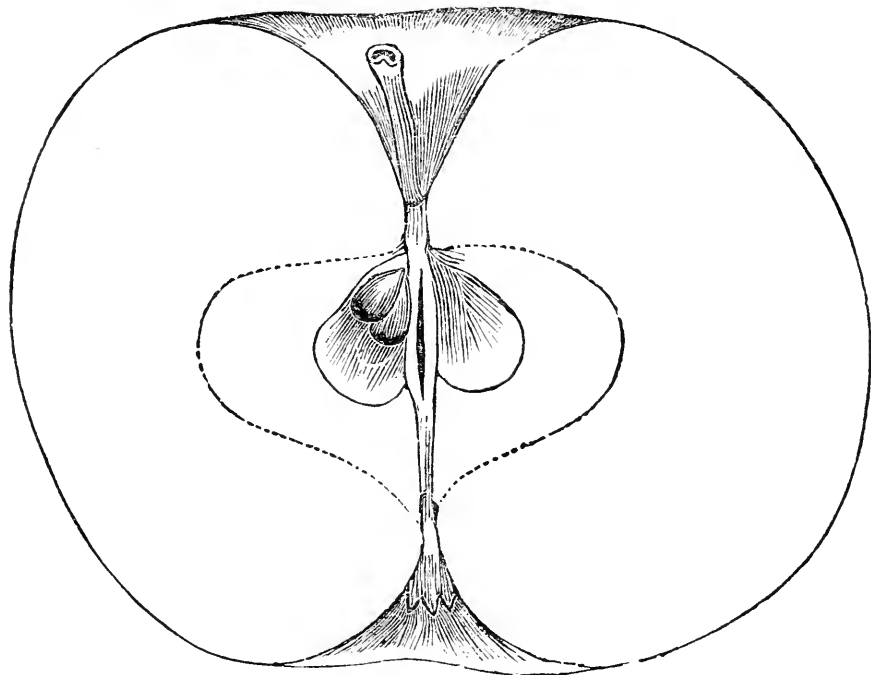

Foreign. In our Southern and Southwestern sections, where the soil is rich and summers long, this is one of the very finest apples, and should always have a place. North, it does not answer. Fruit, medium, globular, slightly tapering to the eye; pale waxy lemon yellow, with distinct brilliant crimson cheek in sun, irregular russet dots, and oft marred by patches of mold or fungus when grown on the alluvial bottoms; stem, slender; cavity, narrow, deep, regular; calyx, small; basin deep; core, small; seeds, round, ovate pointed; flesh, white, tender, delicate rose perfume; "best." October to January.

MARIA BUSH.

Origin, Lancaster Co., Pennsylvania. A healthy grower and good bearer. Fruit, large, roundish oblate; skin, yellow shaded, striped and splashed with red, and thinly sprinkled with russet dots; stem, slender; cavity, large basin, abrupt and open; flesh, white, very tender, juicy, sub-acid. October and November.

MARKS.

Origin, Berks Co., Pennsylvania, on the lands of Mr. Klinger. Tree vigorous, upright, productive. Fruit, medium size, roundish, tapering slightly to the crown, somewhat angular; skin, yellowish white, with a few russet dots, and nearly covered with a faint orange blush; stem, half an inch long, rather stout; cavity, narrow, deep, acuminate; calyx, small,

closed; basin, narrow, rather deep, slightly russeted; flesh, whitish, tender, fine texture, delicately perfumed; quality, "very good," if not "best." January to March. (Ad. Int. Rep.)

MARKS.

From Berks Co., Pennsylvania. Size, medium, roundish, tapering slightly to the crown, somewhat angular; yellowish white, with few russet dots, nearly covered with a faint orange blush; stem, half inch long; cavity, narrow, deep, slightly russeted; seed, yellowish gray; flesh, whitish, tender, fine texture; flavor, delicately perfumed; quality, "very good," if not "best." (W. D. B.)

MARSTON'S RED WINTER.

From New Hampshire. Tree, vigorous, productive. Fruit, large, roundish oval; yellow in shade, red in sun, russet at stem; stem, short, slender; cavity, deep; calyx, partly open; basin, abrupt; core, compact; seeds, dark brown; flesh, yellowish, tender, juicy; "very good." January to April.

MAJOR.

Native of Pennsylvania, Northumberland Co. Size, large, roundish; red, sometimes blended with yellow on the shaded side; stem, variable in length, of medium thickness; cavity, rather wide, moderately deep; basin, uneven, shallow; flesh, yellowish, crisp; flavor, pleasant, agreeably saccharine, and resembles, in some measure, that of the Carthouse, to which, however, it is superior; quality, "very good." (W. D. B.)

MAY.

Medium sized, roundish conical, flattened; greenish yellow, with dull red streaks; flesh, tender, juicy, sub-acid; valued only for its earliness, which, in the South, is the latter end of May.

MCAFEE'S NONSUCH.

From Kentucky; somewhat grown Southwest. Fruit medium, roundish flattened, oblique angular; yellowish, mostly overspread with two shades red, bluish tinge, and grayish dots apparently raised on surface; stem, short, slender; cavity, open, little russeted, broad, deep; calyx, medium; segments, short, stiff, half open, erect, reflexed; basin, deep; flesh, yellowish, firm, crisp, juicy, sub-acid, aromatic; core, medium, compact; seeds, short, ovate; "very good." December to February.

McHENRY.

Origin, Hamilton Co., Ohio. Growth upright and free, moderately productive; color, and quality similar to American Summer Pearmain. September to December. (Jackson.)

MEACH.

From Vermont. Fruit, large, roundish, slightly conic; skin, greenish yellow, striped and mottled with light red, and sprinkled with brown dots; stalk, long, rather slender, set in a pretty large cavity; calyx, closed in a corrugated basin; flesh, yellowish, rather fine, juicy, rich, mild sub-acid, aromatic. October and November.

MEIGS.

Fruit, large, regular oblong, narrowing to the eye, sometimes slightly ribbed; skin, yellow, but mostly concealed with a marbling of red, and

sprinkled with prominent yellow dots; calyx, small and closed, set in a narrow basin; stem, very short, thick, in a narrow, deep cavity; flesh, yellowish white, tender, juicy, with a rich, slightly sub-acid flavor. Autumn. (White's Gard.)

MEISTER.

From Berks Co., Pa. Size, below medium; roundish conical; skin, greenish yellow, striped with red, with numerous white spots, and russet dots; stem, nearly half an inch long, inserted in a wide, moderately deep cavity; calyx, small, closed, set in a narrow, shallow basin; flesh, tender; flavor sprightly and pleasant; quality, "very good." October. (Int. Rep.)

MELVIN SWEET.

From Concord, Mass. Fruit, medium, roundish, yellowish green, striped with pale red; flesh, juicy, sweet. November to February. (Hov. Mag.)

MELT IN THE MOUTH.

Melting Mouth, | Melting.

Fruit, medium, roundish flattened, slightly conical; deep red on a green ground, small white dots; stem, long, slender, curved; cavity, broad, deep; calyx, small, closed; flesh, white, tender, juicy, rich, mild sub-acid; very good. October and November.

MIFFLIN KING.

From Mifflin Co., Pa. Fruit, small, oblong, red on yellow; flesh, tender, juicy, sub-acid; "best." October to December. (Pom. Trans.)

MILAM.

Harrigan, | Winter Pearmain, *of some*.

American. Small to medium, roundish, greenish yellow, striped dull red; flesh, greenish, insipid. December and March. This variety continues to have its friends South and West. It should be superseded, for it is unworthy.

MILLER APPLE.

Supposed to be a seedling, and brought to notice by James O. Miller, Montgomery, Orange Co., N. Y. Tree, vigorous and productive. Fruit, rather large, oval or conical; skin, yellow, striped with red; stalk, short, inserted in a deep, large cavity; calyx open, in a broad, uneven basin; flesh, yellow, tender, juicy, with a rather mild, rich, pleasant flavor. September and October. (Downing.)

MONARCH.

A fruit considerably grown, West; will yet probably prove identical with some variety already described. Fruit, medium, roundish conical; rich dark red over a lighter shade, with many specks; stem, long, slender; cavity, deep, open; calyx, small; basin, narrow, furrowed; core, medium; seeds, ovate pointed; flesh, white, slightly tinged with red, tender, perfumed; "good." October.

MONK'S FAVORITE.

From Randolph Co., Indiana. Tree very thrifty, rapid growth, annual bearer. Fruit, large, roundish flattened, slightly angular; yellow, mottled, striped and splashed with dark red, gray russet dots; stem, short; cavity, open, regular; calyx, small; basin, broad, obscure furrows; flesh, yellowish white; sub-acid, tender; "very good." December to June.

MORRISON'S RED.

From Medfield, Mass. Tree, good grower, productive. Fruit, above medium, conical, angular: whitish yellow, shaded and striped with deep red; stem, short, stout; cavity, narrow; calyx, closed; basin, small; flesh, tender, crisp, mild, pleasant; core, large, open. January.

MOUNTAIN SPROUT.

American. Fruit, medium, oblong truncate, red striped, numerous white dots.

MOUSE.

Moose.

From Ulster Co., N. Y. Fruit, large, roundish conical; pale greenish yellow, brownish blush in sun, russet dots; stem, slender; calyx, closed; flesh, white, sprightly, faintly perfumed; not more than "very good." December to March.

MURRAY.

Southern. Fruit, medium, oblong conical, rich yellow; stem, short, cavity, deep; basin, deep; flesh, whitish, brisk sub-acid. January to March. South.

MUSK SPICE.

Fruit, small, roundish flattened, yellowish, bright, clear red cheek; stem, long; cavity, shallow; calyx, closed; segments, reflexed; basin, furrowed; flesh, yellowish white, juicy, tender, sub-acid; "very good." October.

MUNSON SWEETING.

Orange Sweet, | Ray Apple, | Meachum's Sweet.

From Massachusetts. Tree, strong, upright grower, dark-colored; short-jointed shoots, good bearer. Fruit, medium or above, roundish flattened; pale yellow, blush in sun; flesh, yellowish white, tender, rather dry, sweet; "very good." October to December.

NANTEHALEE.

Maiden's Bosom.

Origin, Alabama; introduced by Dr. W. O. Baldwin, of Montgomery.

In size large, in shape quite conical, and deeply ribbed; in color a beautiful pale waxen yellow; stem, three-fourths of an inch long, in a narrow, deep cavity; calyx, rather large, basin deep, very much ribbed; flesh, white, juicy, and pleasant. Middle of July to first of August. (J. Van Beuren, MS.)

NE PLUS ULTRA.

Southern. Fruit very large, roundish flattened, angular; shades of crimson with large brightish dots; stem, short; cavity, deep, broad, surrounded by russet; calyx, open; basin, large, deep, furrowed, downy; flesh, white, fine-grained, tender, juicy, vinous; core, small; "very good" or "best." October.

NEQUASSA.

Origin, Franklin, Macon Co., North Carolina.

Fruit, large, oblate; color, yellow, striped with red; stem, of moderate length, inserted in a large, open cavity; basin, smooth and open; flesh, white, and very sweet. November to January. (J. Van Beuren's MS. in Downing.)

NEVERSICK.

From Berks Co., Pennsylvania. Fruit, large, roundish; exterior of an exceedingly beautiful waxen orange yellow color, with a few russet dots, and a delicately striped and richly mottled carmine cheek; stem, short and rather stout; cavity, narrow, acuminate, shallow; calyx, large; basin, deep, rather wide, furrowed; seeds, grayish yellow, acute ovate; flesh, yellowish, somewhat tough, owing probably to the fruit being much shriveled; flavor, approaching that of the Pine Apple; quality, "very good." (W. D. B.)

NEWARK KING.

Hinchman.

An old variety from Newark, New Jersey; originally described by Coxe. It is sometimes shown as "King" of New Jersey, and it is for this we have taken it from our list of unworthy sorts. It is unworthy attention along side of "Tompkins County King." Tree strong, spreading grower, productive. Fruit medium, roundish conical; striped and shaded with two shades red on a yellow ground, grayish dots; stem, varying; cavity, medium; calyx, closed; basin, furrowed; flesh, white, firm, pleasant; core small; "good." October to February.

NEWARK PIPPIN.

French Pippin, | Yellow Pippin.

Tree, crooked, irregular growth. Fruit, large, roundish, oblong; greenish to clear yellow, small black dots; cavity and basin, deep; flesh, yellow, tender, sub-acid; "very good." November to February.

NICKEJACK.

Summerour.

American. From North Carolina. Fruit, large, oblate, red striped and mottled on greenish yellow; cavity, deep, russeted; calyx, large, partially open; core, small; seed, light brown; flesh, tender, juicy, delicate; "best." Well adapted to the Southern and Southwestern States. November to April.

NORTHERN SWEET.

Northern Golden Sweet.

From Vermont. Tree, moderate grower, hardy, early abundant bearer. Fruit, medium, roundish flattened, occasionally ribbed and angular; rich yellow, often carmine red cheek; calyx, nearly closed; basin, slightly furrowed; stem, rather stout, swollen at base; cavity, shallow; flesh, white, tender, sweet; nearly "best." November.

OCONEE GREENING.

Origin, banks of the Oconee river, a little below Athens, Ga. Fruit very large, roundish flattened; skin, yellow, a little brownish in the sun, russet about the stem, with a few scattered russet dots; calyx, open, in a shallow, slightly-furrowed basin; stalk, very short, in a rather regular, deep cavity; flesh, yellowish, fine-grained, crisp, abounding in a delightful aromatic, lively, sub-acid juice; quality, "best."—(Ad. Int. Rept., Ga. H. Sc.)

OHIO RED STREAK,

Originated with James Mansfield, Jefferson Co., Ohio. Growth, vigorous, upright. Fruit medium, oblate; skin, yellow, shaded, splashed, and striped

with red ; stalk, short ; cavity, large, russeted ; calyx, large, closed ; basin, shallow, uneven ; flesh, rather compact, juicy, rich, sub-acid. January to April. (Downing.)

OLD TOWN CRAB.

Spice Apple, *of Va.*

Growth, strong, compact ; fruit, small ; greenish yellow, brown specks ; flesh, crisp, fragrant, juicy, sweet. December to April. (Thomas.)

ORANGE.

Holden,		Holden Pippin,		Red Cheek.
Hog Pen,		Jones' Pippin,		

From Connecticut. Tree, with dark colored stout shoots ; early and productive bearer. Fruit, large, roundish ovate ; greenish to yellow ; stem, short ; cavity, deep ; calyx, closed ; basin, slightly plaited ; core, small ; flesh, greenish white, perfumed, tender, sub-acid ; best when fresh from tree. October to December.

ORNDORF.

From Putnam, Ohio. Fruit, medium, roundish, slightly angular ; lemon yellow, rich red blush in sun, and few stripes and blotches of red ; stem, slender ; cavity and basin, deep ; calyx, open ; core, small ; seeds, ovate ; flesh, yellowish, juicy, crisp, tender, sub-acid ; nearly "best." October and November.

ORNE'S EARLY.

Foreign. Fruit, large, somewhat ribbed ; pale yellow, sprinkled with thin russet, dull red cheek towards the sun ; flesh, white, tender, juicy. September. (Thomas.)

OSBORN'S SWEET.

Osborn's Fall Sweet.

Fruit, large, roundish ; lemon yellow, with specks ; flesh, yellow, crisp, tender, sweet. October.

OVERMAN'S SWEET.

From Fulton Co., Ill. Fruit, medium, conical ; pale yellow, striped with red ; cavity, narrow, deep ; calyx, closed ; basin, obscure ; flesh, white, firm, crisp, juicy, sweet ; "very good ;" baking. October and November.

OSCEOLA.

From Indiana. Fruit, above medium, flat ; yellow, striped with red, dotted with dark spots ; stem, long ; cavity, deep ; flesh, yellowish, juicy, sub-acid ; keeps till May. Resembles the Newtown Spitzenberg.

PARAGON.

Downing's Paragon.

Origin, Canton, Ill. Fruit, above medium, round ovate, flattened at ends ; pale yellow, faint blush ; stem, short, slender ; cavity, deep ; calyx, half open ; basin, deep, slightly ribbed ; core, medium ; capsules, open ; seeds, ovate pointed ; flesh, yellow, crisp, brisk, juicy, slightly sweet ; nearly "best." September to November. Good regular bearer.

PAWPAW.

Originated Little Bain, Ronde, Mich. Size, medium ; color, red, obscurely striped ; flesh, yellowish, juicy, mild sub-acid ; sprightly.

PFEIFFER.

From Berks County, Pennsylvania. Size, below medium, roundish; sparsely streaked with red on a yellowish green ground, (on the shaded parts, the streaks being more numerous,) and on a fawn colored ground, on the side exposed to the sun; stem, slender; narrow cavity; calyx, rather large; basin, wide, moderately deep, plaited. July.

PHILLIPS' SWEET.

American; native of Ohio. Growth, vigorous, upright, wants strong heavy soil.

Fruit, medium to large; form, roundish conical, slightly flattened; color, yellow ground, mostly overspread and mottled with red; flesh, yellowish, tender, juicy, crisp. December and January.

PHILLIPPI.

From Berks Co., Pa. Fruit, large, oblate conical; skin, greenish-yellow, with numerous blotches and gray dots, and a blush on the exposed side; stem, short and slender, inserted in a wide, moderately deep cavity; calyx, small, closed, set in a narrow superficial basin; flesh, tender, fine texture, juicy, fragrant; flavor delicate and fine quality; "very good" or "best." January. (W. D. Brinckle.)

PICKMAN.

Pickman Pippin.

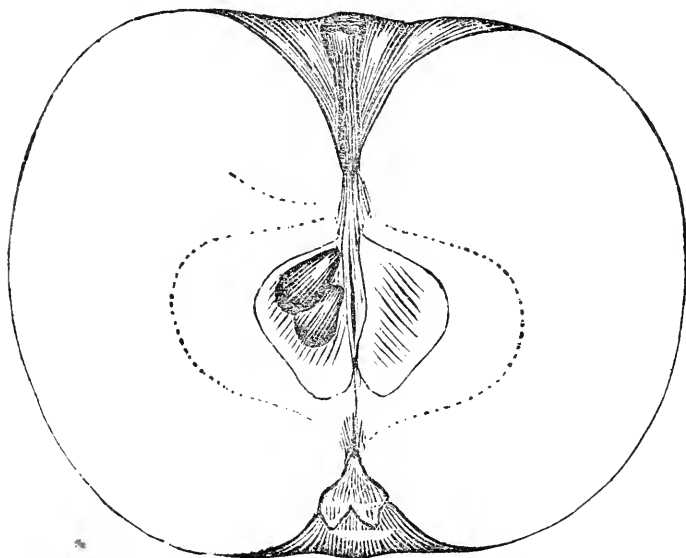

From Massachusetts. Fruit, medium, roundish; yellow, with scattered shades of russet and small russet specks; stem, short; cavity, acuminate; calyx, large, half closed; core, medium, centre somewhat hollow; seeds, light brown; flesh, yellowish white, crisp, sharp acid; valued for cooking. January to April.

PINK SWEETING.

Originated Cumberland Co., Pa. Tree vigorous, spreading, producing enormous crops. Fruit, small, greenish, nearly covered with bright red,

perfect in form ; rich, pleasant, sweet flavor, and a general favorite where known, but think it too small for general use. September and October.

PINE APPLE RUSSET.

Hardingham's Russet.

Foreign. Fruit above medium ; roundish ovate, greenish yellow, overspread with thin russet ; stem, long ; calyx, small ; basin, shallow, plaited ; flesh, yellowish white, juicy, crisp, spicy, sub-acid. October to November.

PITTSBURG PIPPIN.

Flat Pippin,		Swiss Apple,		William Tell.
Father Apple,		Switzer Apple,		

Supposed origin, Pittsburgh, Pa. Tree, irregular grower, moderate bearer. Fruit, large, roundish flattened ; pale yellow, with brown dots ; stem, short ; cavity, deep, slightly russeted ; calyx, nearly closed, segments long ; flesh, whitish, sprightly sub-acid ; core, medium. December to January.

POWNAI SPITZENBERG.

From Pownal, Vermont. Worthy more attention. Fruit, above medium, roundish oblong ; yellow, striped and overspread with red in sun, large russet specks ; flesh, yellowish, crisp, a little coarse ; "good." December to February.

PRESS EWING.

Origin, Kentucky. Tree, hardy, vigorous, and productive. Fruit, medium, roundish, flattened at base and crown, angular, slightly oblique ; skin, yellow, shaded and striped with crimson, and thickly covered with dots, having a dark centre ; stalk, medium, inserted in a very deep, narrow cavity ; calyx, closed, set in an uneven, abrupt, peculiar basin ; flesh, yellowish, firm, juicy, crisp, tender, with a very agreeable sub-acid flavor, aromatic. February till April. (Downing.)

PROGRESS.

Esquire, | Miller's Best Sort.

From Connecticut. Tree, vigorous, productive. Fruit, large, yellow, specked with greenish russet, blush in sun, conical ; flesh, tender. Keeps till Spring.

PUMPKIN RUSSET.

Sweet Russet, | York Russet, | Flint Russet.

Fruit, large, roundish, yellowish green, thinly russeted ; stem, long ; cavity, wide, shallow ; basin, small ; flesh, dry, sweet ; "good." September to December.

PUTNAM HARVEY.

American. Origin, uncertain ; first received by me from A. H. Ernst, Esq., Cincinnati. Fruit, of size medium or above, roundish flattened, pale green, with suffused white specks, patches of russet about the stem ; stem, long and slender, with a strong knob at end where joined to the tree ; cavity, narrow, rather deep ; calyx, closed ; segments long, connecting, reflexed ; basin, varying, sometimes moderately deep and regular, sometimes slightly furrowed ; flesh, white, crisp, very tender, juicy, sub-acid, agreeable ; core, medium, centre capsule open, seed capsules closed ; seeds, ovate pointed. August and September.

QUINCE.

Cole's Quince.

From New York. Originally described by Coxe. Great bearer: should be better known. Fruit, medium, roundish ovate, with ridges, pale yellow, occasional faint blush, little russet from the stem, distinct line or ridge from stem to calyx; stem, short; cavity, open; calyx, with long segments; basin, shallow, much ribbed; core, small, surrounded by broad concentric lines; seeds, short ovate, dark brown; flesh, yellowish white, tender, juicy, aromatic perfume, sub-acid; "very good." December to March.

RAGAN.

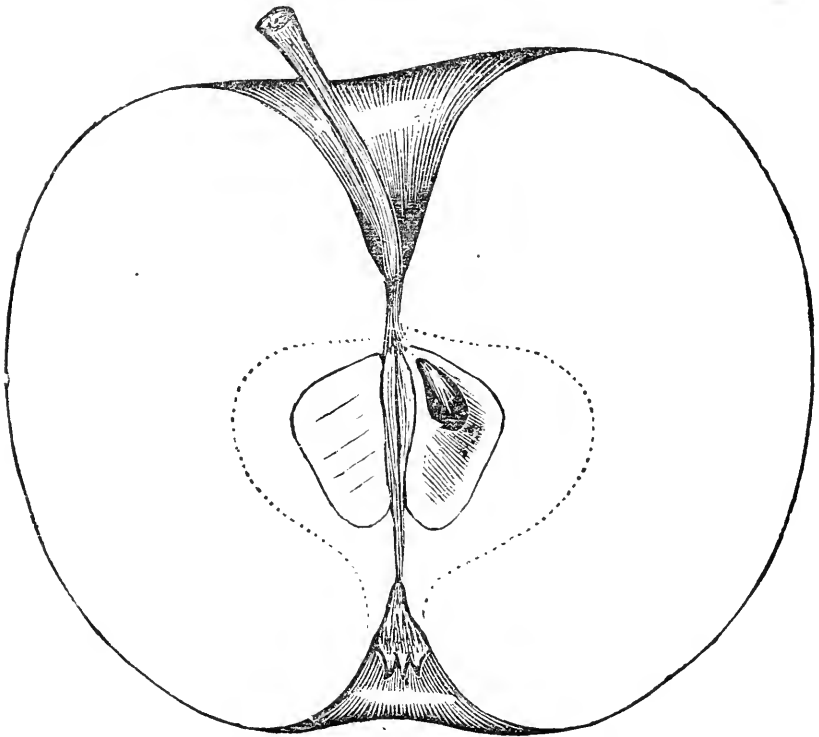

Origin, Putnam Co., Ind. Fruit, large, roundish, pale yellow, over-spread, striped, and marbled with light red; an occasional russet patch; stem, long, rather stout, curved; cavity, deep; calyx, small, nearly closed; basin, open, deep, slightly plaited; core, small; seeds, abundant; flesh, white, crisp, little coarse, sharp sub-acid. Promises valuable as an early Winter market variety.

RANDEL'S BEST.

Randel Bert.

Fruit, medium, globular, slightly flattened, greenish yellow, mostly striped and overspread with dark red; stem, short; calyx, small; basin, shallow; core, compact; seeds, brown; flesh, white, tender, smooth-grained, sweet. November to February. (A. H. Ernst, MS.)

RARITAN SWEET.

From New Jersey. Tree, productive; valued for baking and stock. Fruit, medium, roundish ovate, dull yellow, tinged with red in sun, irregularly scattered brownish red spots; stem, short; cavity, deep, little russeted; calyx, with bold, stiff segments; basin, deep, irregular, slightly wrinkled; core, medium; seeds, ovate pointed; flesh, white, tender, sweet October, November.

REBECCA.

From Delaware. Fruit, above medium, roundish flattened, whitish yellow, red cheek in sun; stem, short; cavity, deep; calyx, open; basin, deep; flesh, white, tender, juicy, sub-acid; "very good." September.

RED CATHEAD.

Southern. Fruit, medium, roundish, yellow, shaded with red, whitish dots; stem, short; cavity, deep; calyx, half open; flesh, yellowish, tender, juicy, pleasant; "very good." October, November.

REPUBLICAN PIPPIN.

Red Republican.

From Lycoming Co., Pa. Considerably distributed South and West. A poor bearer, on deep, rich limestone soils. Tree, strong grower, spreading habit. Fruit, large, roundish flattened, greenish yellow, mottled and striped with red, few large gray dots; stem, slender; cavity, narrow; calyx, small, nearly closed; core, small; seeds, brown; flesh, yellowish white, tender, sub-acid. September to October.

RED QUARRENDEN.

Devonshire Quarrenden, | Sack Apple.

Foreign. Fruit, medium, roundish flattened, clear, deep red, with specks of russet green; stem, short; cavity, deep, russeted at base; calyx, large, half closed; basin, shallow, slightly ribbed; flesh, white, tender, sub-acid; "very good." August.

RED SWEET.

Grown by D. C. Richmond, Sandusky, O. Tree, good bearer. Fruit, uniformly fair, regular, heavy specific weight, valuable for dessert or cooking. Fruit, medium, round flattened, yellow, overspread and striped with lively red; stem short; basin, deep; calyx, with stiff closed segments; core and seeds, small; flesh, yellowish white, crisp, juicy, tender, sweet. November to February.

RICHARD'S GRAFT.

Derrick's Graft, | Wine Strawberry,
Red Spitzenberg.

An old fruit, supposed from Ulster County, N. Y., but as yet little known. Tree, a free, upright grower, good bearer of an apple, fine for the dessert. Fruit, above medium, roundish flattened; yellow, striped with red; stem, inch long; cavity, deep, broad; calyx, closed; segments reflexed; basin, deep; flesh, fine grained, tender, juicy, vinous. September to October.

RITTER.

American. From Berks County, Pa. Fruit, medium, roundish oblong, shades of red striped, white dots; stem, short; cavity, deep, narrow; seed, short, plump; flesh, tender; "very good." October, November.

RIDGE PIPPIN.

Fruit, rather large, roundish conical, very much ribbed; skin, yellow, very slightly shaded, sprinkled with russet and crimson dots; stalk, rather short, inserted generally in a large cavity; calyx, closed, set in an abrupt, uneven basin; flesh, yellowish, juicy, crisp, with a mild, almost saccharine, slightly aromatic flavor. March, April. (Downing.)

RIEST.

From Simon S. Riest, Lancaster, Pa. Size, large, roundish, ribbed at apex; skin, fair yellow; stem of medium length, in a narrow, moderately deep cavity, with some stellate russet rays; calyx, small, closed, set in a narrow, contracted, ribbed basin; flesh, fine, flavor pleasant; "very good." August. (W. D. Brinckle.)

RIVER.

Origin, Mass. Tree of slow growth, but productive. Fruit, medium to large, oblong oval, slightly conic, ribbed; skin, yellow, striped and shaded with dark red, with a slight bloom; stalk, medium, deeply planted; calyx, small, closed, set in a basin of moderate depth; flesh, coarse, juicy, tender, pleasant sub-acid. August, September. (Downing.)

ROCK SWEET.

From Newbury, Mass. Tree hardy, strong grower, regular bearer. Fruit, medium, roundish conical, splashed and shaded with red, large whitish dots; stem, short; cavity, russeted; calyx, closed; basin, shallow; flesh, white, tender, juicy, sweet; "good." September.

ROCK APPLE.

From New Hampshire. Fruit, large, roundish; red on yellow; flesh, white, tender, juicy, sub-acid. September.

ROCKPORT SWEET.

Originated with H. R. Spencer, Rockport, O. Tree, a moderate healthy grower. Fruit, medium, roundish conical, flat at base; waxy yellowish green, with brown russet or occasionally a dull red cheek; stem, slender; cavity, russeted; calyx, nearly closed; basin, regular, open; flesh, white, juicy, pleasantly sweet; core, open; seeds, ovate pointed; "very good;" January to April. There is also a Rockport Sweet, originated in Mass., with a short, thick stem, set in a ribbed cavity.

ROADSTOWN PIPPIN.

From Roadstown, N. Jersey. Tree, strong, erect grower, good bearer; market sort. Fruit, large, roundish flattened, angular; greenish yellow, with green dots; stem, short, stout; cavity, deep; calyx, small, closed; basin, deep; flesh, white, tender, sub-acid; "good." August, September.

RUM APPLE.

Bromley's Rum.

American. Tree, vigorous, upright, hardy, shoots slender, productive. Fruit, medium, oblate, yellow, slight crimson shades; stem, short; cavity, deep; calyx, half closed; basin, open; flesh, whitish, juicy, sub-acid. November to March.

SAILLY AUTUMN.

Origin, Plattsburgh, N. Y. Tree, upright, vigorous and productive. Fruit, medium, oblate conic; skin, greenish yellow, the exposed side frequently deep red; stalk, short, in a medium cavity; calyx, small, closed; basin, small, narrow; flesh, very tender, rich, high flavored, with a peculiar aroma. September.

SEEVER.

Seever's Red Streak.

From Coshocton County, O. Fruit, medium, globular; lemon yellow, striped with bright clear red; stem, short, slender; calyx, with long segments; basin, deep, open; core, small; seeds, roundish ovate; flesh, yellowish, juicy, sub-acid; "best." October to November.

SELMA.

From Clark County, O. Fruit, medium to large, roundish flattened yellow, with pale russet patches, especially around stem, dull, faint red in sun; stem, long; cavity, narrow, deep; calyx, small, closed; basin, deep, abrupt; core, medium; capsules, small; seeds, ovate; flesh, yellowish white, breaking, mild sub-acid; "very good." November to December.

SCOLLOP GILLFLOWER.

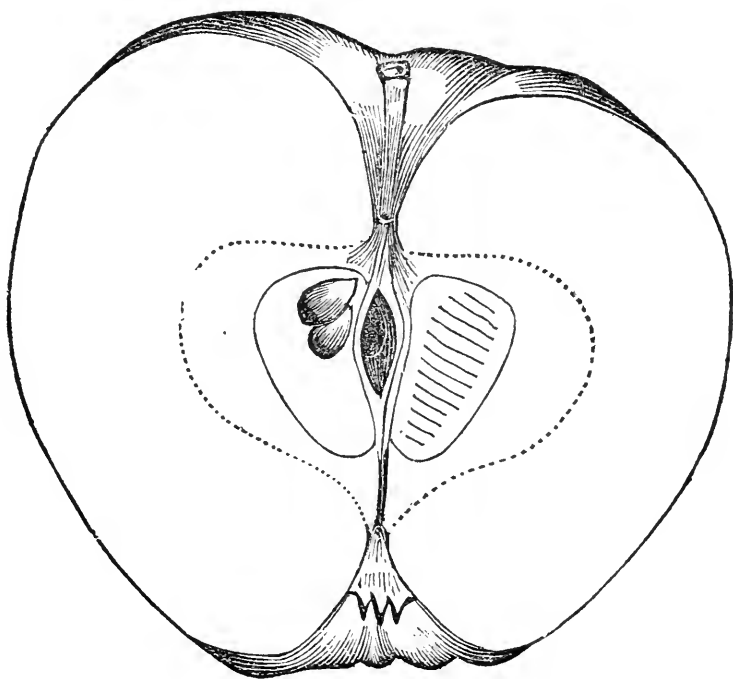

This is entirely distinct from Red Gillflower, with which it has been confounded. It requires rich, strong soil; is largely grown, and much esteemed in Central Southern Ohio. Fruit, medium to large, roundish conical, flattened at base, tapering towards the eye, sometimes angular, always much ribbed or scolloped; light yellow, striped and splashed with

shades of light and dark red ; stem, short, slender ; cavity, deep, russeted, irregular ; calyx, with long segments ; basin, abrupt, deep, ribbed ; core, large, hollow ; seeds, ovate rounded ; flesh, yellowish, firm, crisp, tender, juicy, slight tinge of sweet. November to February.

SCARLET PEARMAIN.

Bell's Scarlet Pearmain, | Oxford Peach.

Foreign. A good bearer, valued on poor, light soils. Fruit, medium, conical, red on yellow ; stem, slender ; calyx, open ; flesh, white, crisp, juicy, sub-acid ; "good." September to October.

SCHOONMAKER.

Schoolmocker.

Probably Foreign. Grown in Detroit, in 1804. Fruit, large, roundish flattened, sometimes angular ; greenish yellow, bronzed blush in sun ; skin, little rough ; stem, short, stout ; cavity, deep ; calyx, small, closed, basin, open ; core, small, compact ; flesh, yellowish white, crisp, brisk sub-acid ; "very good." January to March.

SEPTEMBER.

Pride of September.

Origin, Canton County, Pa. Tree, hardy and vigorous, a good and regular bearer. Fruit, large, globular, somewhat depressed, very slightly conic angular ; skin, yellow, slightly shaded, and thinly sprinkled with brown dots ; stalk, short, inserted in a deep, abrupt cavity, surrounded by thin russet ; calyx, partially closed, set in an open basin ; flesh, yellowish, tender, juicy, with a very agreeable sub-acid flavor. October. (Downing.)

SHEPPARD'S SWEET.

Origin, Windham County, Conn. Tree, thrifty, upright, and a great bearer. Fruit, medium, angular oblong, approaching conic ; skin, yellow, striped with red ; stalk, long, slender, inserted in an acute cavity ; calyx, firmly closed, set in a small basin ; flesh, white, tender, sweet, and pleasant. October, November.

SIBERIAN CRAB.

The *Pyrus baccata* of botanists. There are a number of varieties, as Red, Large Red, Yellow, Purple, Striped, Transparent, Oblong, Double White, Fragrant, Cherry, Showy, Astrachan, Currant, all used only for preserving, or grown for ornament. All Crabs, if left on the tree, will naturally dry and preserve themselves.

SINCLAIR'S YELLOW.

Fruit, small to medium, flat or roundish ; skin, smooth, of a fine orange color, darkened in the sun ; flesh, pale yellow, with a rich, sub-acid flavor ; a good bearer, and excellent for both the table and kitchen. June and July.

SINE-QUA-NON.

From Long Island. Slow, poor grower, and an indifferent bearer. Fruit, medium, roundish, greenish yellow ; stem, slender ; calyx, closed ; flesh, greenish white, tender, juicy, mild sub-acid. August.

SLINGERLAND PIPPIN.

From Albany Co., N. Y. Fruit, medium to large, oblate angular, inclining to conic, or distinctly conic; skin, yellow, shaded with red, and sprinkled with minute dots; stalk, short and stout, inserted in a broad, deep cavity, surrounded with very thin russet; calyx, small, partially closed, set in a fine angled basin of variable size; flesh, white, tender, juicy, with a very brisk, rather rich, sub-acid flavor. December, February. (Downing.)

SMALLEY.

Spice.

From Kensington, Conn., where it was much esteemed. Medium size, oblate conic; skin, yellow, with a slight blush; stalk, short and large; cavity, russeted; calyx, closed; basin, uneven, shallow; flesh, tender, juicy, brisk, with a pleasant aromatic flavor. September, October.

SOPS OF WINE.

Sops in Wine, | Sapsion, | Bennington.

Foreign. Tree, vigorous early bearer; esteemed for its peculiar pink flesh, as a curiosity for dessert. Fruit, medium or small, roundish; light red, nearly covered with bright purplish red, in streaks, yellowish in shade with yellow specks, whitish bloom; stem, short, slender; calyx, with broad segments; basin, shallow, slightly furrowed; core and seeds, medium; flesh, yellowish, stained with pink, juicy, mild, sub-acid; "very good." August to September.

SPICE SWEETING.

Moderate bearer, large, roundish, yellowish; flesh, firm, sweet. August and September.

SPICE RUSSET.

Sweet Russet, *of some erroneously*

Fruit, below medium, roundish flattened; light yellow russet, numerous small fine dots; exposed to sun, carmine and yellow bronzed; stem, slender; cavity, narrow; calyx, closed; basin, shallow; core, large, somewhat hollow; seeds, ovate; flesh, white, slightly tinged with yellow, fine-grained, juicy, slightly sweet, aromatic; "very good." December to March.

SPONGE.

Fruit, large, round, flattened at base; yellowish green, with blotches and stripes of red; stem, short; calyx, closed; basin, open; core, large open; flesh, white, tender, juicy, sub-acid; "very good." October.

SPRING PIPPIN

Springport Pippin.

Tree, unproductive, upright, thrifty. Fruit, above medium, roundish, yellowish green, with few scattered minute dots; calyx, closed; stem, short; flesh, crisp, sprightly sub-acid. December to May.

STANARD.

Stanard's Seedling.

From Erie Co., N. Y. Tree, productive. Fruit, large, roundish, yellow, overspread with red; stem, short; cavity, open; calyx, closed; basin

ribbed ; core, small ; seeds, ovate pointed ; flesh, yellowish, coarse, juicy, acid ; not quite "very good." November to February.

STEHLY.

Origin, Berks Co., Pa. Tree, vigorous. Fruit, large, oblate conic, angular ; skin, yellow, striped and shaded with red, and covered with large brown dots ; stem, very short, inserted in a deep cavity ; calyx, partially closed, set in a small, uneven basin ; flesh, whitish, juicy, tender, pleasant, mild sub-acid. January to April.

STILLMAN'S EARLY.

Origin, Clinton, Oneida Co., N. Y. Tree of moderate, upright growth, productive.

Fruit, small, roundish conic ; skin, yellow, sometimes a slight blush, and a few brown dots ; stalk, long, stout ; cavity, shallow ; calyx, closed ; basin, very shallow, plaited, flesh, yellow, tender, pleasant sub-acid. Last of July and first of August.

ST. LAWRENCE.

Montreal.

From Canada. Fruit, large, roundish flattened, pale yellow, striped and splashed with red and deep crimson ; stem, short ; cavity, open, deep ; calyx, closed ; basin, slightly furrowed ; core, large ; seeds, small ; flesh, white, fine-grained, tender, juicy, sharp, sub-acid ; "very good." September to October.

STRAUDT.

From Berks Co., Pa. Size, large, roundish, inclining to conical ; skin, deep crimson, with stripes of paler red, and numerous light dots ; stem, short, in a wide, deep, russeted cavity ; calyx, small, closed, set in a narrow, shallow, furrowed basin ; flesh, fine-grained, tender, white ; flavor, sub-acid and pleasant ; "very good." November. (W. D. Brinckle.)

STURMER PIPPIN.

Foreign. Tree, healthy, good bearer. Fruit, rather small, roundish conical, yellowish green, with brown dull red in sun ; flesh, firm, crisp, juicy, acid ; keeps well. January to June.

STROAT.

Stratt.

The Dutch name for Street, where the original tree is said to have grown. Fruit, above medium, roundish conical ; yellowish green ; stem, short ; cavity, shallow ; basin, small ; flesh, tender, brisk sub-acid. September to November.

STRIPED PEARMAIN.

Large Striped Pearmain. |

Snorter.

Grown in Ky., from whence we have received fruit. We copy description from Mr. Ernst's manuscript. Fruit, medium to large, globular, slightly flattened, yellow, striped and blended with two shades of red ; calyx, small closed ; basin, shallow ; stem, short, slender ; core, open ; seeds, large ; flesh, yellow, tender, juicy, sub-acid. December to February.

SUGAR SWEET.

This apple I received from Hingham. Size, medium, ovate; dull yellowish, inclining to a russet; abundant bearer; ripe, September, October; a very rich baking apple; flesh, breaking and juicy. (B. V. French.)

SUMMER SWEET PARADISE.

From Columbia Co., Pa. Tree, abundant, early bearer, spreading shoots. Fruit, large, roundish oblong, flattened at ends; pale green, yellow in sun, dark russet marblings and gray dots; stem, short; cavity, deep, oft russeted; calyx, with coarse segments partially closed; basin, deep; core, small; seeds, ovate pointed; flesh, yellowish white, crisp, juicy, sweet; "very good." September.

SUMMER QUEEN.

Sharpe's Early, | Lancaster Queen, | Homony.

Popular and profitable in some sections of the Southwest. Fruit, medium to large, roundish conical, tapering to the eye, yellow, striped and splashed with purplish red; stem, medium; cavity, narrow; calyx, large, open; basin, furrowed; flesh, yellowish, sometimes a pink tinge, juicy, aromatic, sub-acid; "very good." August to September.

SUMMER BELLFLOWER.

Summer Belle-fleur.

From Dutchess Co., N. Y. Tree, strong, upright growth, spreading head, early regular bearer. Fruit, above medium, roundish oblong, slightly conical, two or three obscure ribs; clear yellow, few greenish dots, faint orange blush; stem, long, stout at base; cavity, shallow; calyx, closed, small reflexed segments; basin, five-sided; core, medium, hollow; small seeds; flesh, white, fine-grained, tender, sub-acid; "best." New. Aug. to Sept. (Hort.) There is a Summer Bellflower grown in Ohio, which we have only once seen, which is an inferior fruit, distinct from above.

There is also a

SUMMER BELLFLOWER

which is distinct from the above, and very much resembles Yellow Bellflower in shape and color, but has a very wide and deep cavity, and closed calyx. Flesh, yellowish white, firm and fine texture, not very juicy, with a brisk, agreeable, very pleasant flavor, and decidedly the best of its season. Last of August and first of September.

SUMMER PIPPIN.

Sour Bough.

American. Tree, vigorous, profitable market sort; valuable for cooking. Fruit, medium to large, oblong oval, irregular, waxy yellow; shaded with crimson blush, green and grayish dots; stem, varying; cavity, deep, abrupt; calyx, closed; basin, deep, furrowed; flesh, white, tender, pleasant, sub-acid; core, large. August, September.

SUPERB SWEET.

Raised by Jacob Dean, Mansfield, Mass. Tree, vigorous, productive. Fruit, rather large, roundish, pale yellow, much red in the sun; stalk, long, inserted in a deep cavity; calyx, large, open; basin, broad; flesh, white,

very tender, juicy, sweet, rich, high-flavored. September and October. (Cole.)

SUPERB.

Origin, Franklin Co., North Carolina. Tree, tolerably vigorous, and a prodigious bearer. Fruit, medium or above, roundish oblate, regular; skin, green, rarely with a blush; stalk, of medium length, in a shallow cavity; calyx, large and open; flesh, yellow, solid, slightly coarse-grained, rich, and particularly high-flavored. November to March.

SUTTON BEAUTY.

Beauty.

Originated in Sutton, Mass. Tree, upright, thrifty grower, good bearer; fruit, very handsome, fair and regular in form. Fruit, medium, roundish conical; yellow, shaded and striped with fine crimson, slightly sprinkled with whitish dots; stem, medium; cavity, with a slight greenish russet; calyx, closed; basin, open, round; flesh, whitish, crisp, tender, juicy, sub-acid; "very good;" core, small. November to February.

SWEET BELLFLOWER.

Butter, of some.

There are two apples cultivated in Southern Ohio under this name. We append Mr. Ernst's descriptions. Fruit, large, globular, flattened at base, slightly ribbed; lemon yellow, slight blush in sun, numerous light and dark specks; calyx, closed; basin, ribbed; stem, long, slender; cavity, deep; core, open; seeds, small; flesh, whitish yellow, breaking, juicy, slightly sub-acid. October, November.

SWEET BELLFLOWER OF WYANDOTT COUNTY.

Fruit, large, globular, slightly conical; light yellow, dark cloudy flakes and reddish specks; stem, short; calyx, large, partly closed; basin, shallow; core, small, compact; seeds, small; flesh, white, tender, sweet. November, December. There is also a Sweet Gilliflower, which closely resembles this, and may prove identical.

SWEET FALL PIPPIN.

From Westchester Co., N. Y. Tree, vigorous, productive. Fruit, large, oblate; skin, greenish yellow, slightly sprinkled with brown dots; stalk, short, in a large cavity; calyx, closed, in a very shallow basin; flesh, juicy, sweet, and rich. October, November.

SWEET PIPPIN.

Moore's Sweeting, | Red Sweet Pippin, of *Indiana*, | Pound Sweet, of some, *West*.

Fruit, medium to large, round, flattened; yellow striped and mostly covered with red, white bloom; stem, short; cavity, deep; calyx, closed; basin, broad; core, small; flesh, firm, rather dry, sweet, good baking. December to February. There is also a Sweet Pippin grown in South Ohio, which is globular, pale green, tender, juicy, open texture, sweet. Early Winter.

SWEET VANDERVERE.

Sweet Redstreak, | Sweet Harvey.

Origin, unknown. Tree, of crooked growth; a profuse bearer. Fruit, medium size, oblong, slightly conic, obscurely angular, sometimes nearly

cylindric; skin, greenish yellow, shaded and striped with dull red; stalk, short, rather slender, inserted in a large, irregular cavity; calyx, partially closed, set in a broad, open basin; flesh, tender, juicy, almost melting, with an exceedingly saccharine, aromatic flavor. November, March. (Downing.)

SWEET WINESAP.

From Clark County, Ohio. Fruit, large, roundish flattened, rough skin, greenish yellow, with blotches of dark green; calyx, medium; basin, open; stem, short; core and seeds, small; flesh, yellowish white, tender, mild sub-acid, almost sweet. November, December.

SWEET WINESAP.

From Pennsylvania. Tree of moderate, upright growth, productive. Fruit, medium, oblate, slightly approaching conic; color, red, splashed with deep crimson; stalk, long and slender, inserted in a deep cavity, surrounded with russet; calyx, large, open, set in a rather deep, open basin; flesh, tender, juicy, almost melting, with a very sweet, rich, peculiar flavor. November, December. (Downing.)

SWEET ROMANITE.

Sweet Nonsuch, | Orange Sweet, *erroneously*.

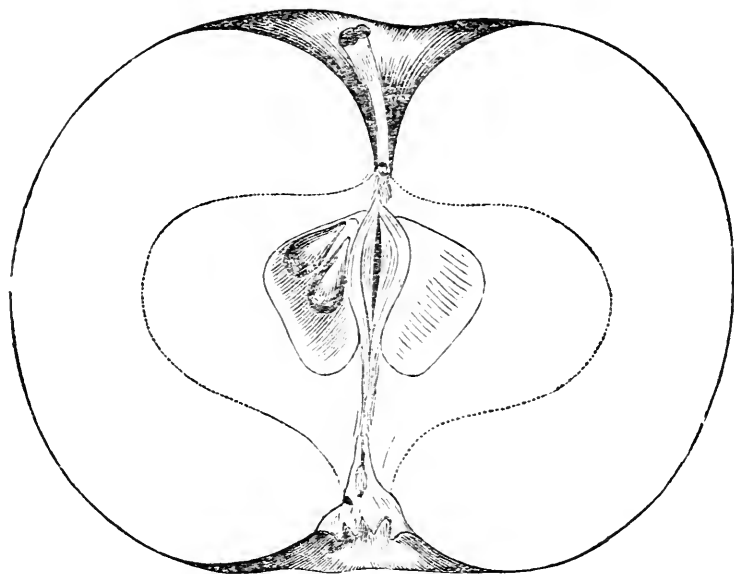

This is a variety introduced to the Ohio Pomological Society by W. B. Lipsey, of Morrow County, Ohio. We have not been able to identify it with any variety heretofore described. The flesh being fine-grained and firm—somewhat like the Gilpin or *Romanite*—probably induced the name. It is grown in Illinois, under the name of “Sweet Nonsuch,” and introduced there under the erroneous name of “Orange Sweet.” Tree, hardy, moderate but regular bearer.

Size, medium; form, roundish flattened, very regular; color, greenish yellow ground, mostly striped and overspread with bright red, and covered

with a fine bloom ; stem, short ; cavity, open, regular, with little russet, calyx, large, segments in divisions, short, half erect ; basin, broad, shallow, furrowed ; flesh, greenish yellow, firm, crisp, juicy, sweet—superior to Ramsdell's or Danvers' Sweeting ; core, medium, or rather small, compact—centre, slightly hollow ; seeds, ovate, oblong pyriform. November to March.

There is another Sweet Romanite grown in the Western States, which is oblong ; stem, long and slender ; core, light yellow, striped with red ; flesh, more yellow and dry—an inferior or unworthy variety.

There is also a Sweet Nonsuch grown, which is flat, with slender stem, cavity, deep, light red on pale yellow ; flesh, white, sweet, dry, and tough : inferior.

SWERT PIPPIN.

Hog Island.

American. Tree, good grower, productive. Fruit, large, roundish conical or angular ; yellow, shaded and striped with red ; stem, short ; calyx, closed ; basin, small, furrowed ; flesh, yellowish, tender, crisp, juicy, sub-acid ; "very good ;" core, large. November to March.

SWERT RAMBO.

From Berks Co., Pa. Fruit, medium, roundish oblate ; yellow with shades of red, large gray dots ; stem, slender ; cavity, deep, russeted ; calyx, closed ; basin, deep, open ; core, small ; flesh, yellowish, rich, sugary ; "very good." November, January.

SYLVESTER.

Originated at Lyons, N. Y. Growth, upright, vigorous, productive. Fruit, medium size, roundish ; color, yellowish white, red cheek in sun, occasionally net work of russet ; flesh, white, crisp, tender, fine-grained, sub-acid, negative but pleasant flavor. October.

TETOFSKY.

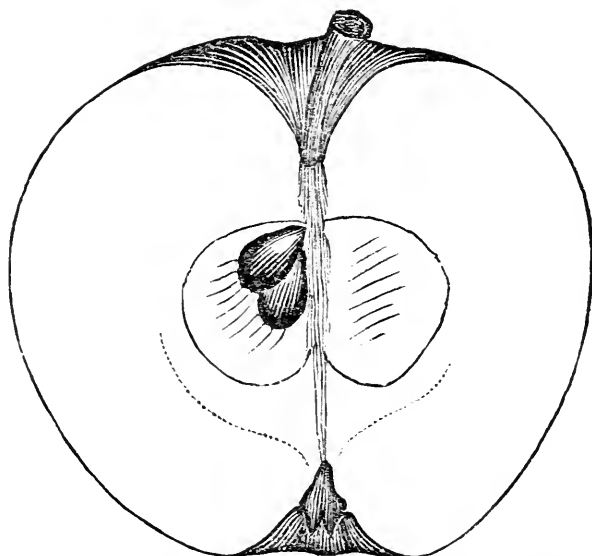

A Russian variety. Trees, very stout and upright growth ; leaves large

broad, light green, peculiar; regular annual bearer; in quality about with Red Astrachan, but maturing some ten days or two weeks earlier; very valuable for cooking or marketing; a gross feeder, requiring good soil; needs little pruning. Our figure does not well represent it, being far too small for an average.

Fruit, medium; form, roundish, slightly conical; color, light yellow ground, striped and splashed with red, and a beautiful white bloom; stem, short, stout; cavity, deep, furrowed; calyx, rather large, long segments; basin, abrupt, deep, irregular, furrowed; flesh, white, tender, sprightly, juicy, slightly acid or sharp sub-acid, with a peculiar aromatic taste; core, small, fleshy; seeds, plump, light brown. Last of July.

TEWKSBURY BLUSH.

Tewksbury Winter Blush.

From New Jersey. Tree, rapid, rather upright growth, very productive, always fair, great keeper. Fruit, small, round ovate flattened, yellowish green, with minute russet dots and occasionally a red cheek; stem, slender; calyx, small; basin, shallow; core, medium; seeds, light brown; flesh, yellowish white, juicy, firm, tender, sub-acid. January to August. Fink's Seedling so closely resembles this, as to be by many thought identical.

TINMOUTH.

Origin, Tinmouth, Vt. Tree, a good grower and productive. Fruit, above medium, oblate; skin, whitish yellow, considerably shaded with carmine, and sprinkled with a few brown dots; stem, short, inserted in a deep cavity; calyx, partially closed, set in a rather large basin; flesh, whitish, juicy, tender, pleasant, mild sub-acid. November to February.

TOCOCA.

Muskmelon.

Originated Toccoa Falls, Habersham Co., Georgia. Fruit, rather large, conical irregular; skin, yellow, striped with red; stem, short, in an irregular cavity; calyx, closed in a small, irregular basin; flesh, yellow, with a brisk, rich, Spitzenburgh flavor, moderately juicy. First of August. (White's Gard.)

TOWNSEND.

From Pennsylvania. Tree, moderately spreading growth, abundant early bearer. Fruit, medium, roundish, pale yellow, overspread and streaked with red in sun, marblings of russet at stem, grayish white dots, rough, blue bloom; stem, slender; cavity, deep; calyx, closed; segments, narrow, in divisions; basin, abrupt, medium; core, medium; seeds, ovate; flesh, yellowish white, breaking rather dry, sub-acid; "very good." September. This may prove same as Hocking.

TRENTON EARLY ?

History unknown. We think it an old English apple belonging to the class of codlins. Our warm suns and rich soils have so improved it that it is often a right good table fruit, and always valuable for cooking.

Fruit, medium or above, roundish conical, slightly ribbed; color, yellowish, with suffused patches of green; skin, smooth, oily; basin, often furrowed; flesh, white, tender, pleasant, sub-acid. July and August.

TRUMBULL SWEETING.

Fenton Sweeting.

From Trumbull Co., Ohio. Fruit, above medium, roundish flattened, pale yellow, slight blush and red spots; stem, short; cavity, deep; calyx, large; basin, deep; flesh, white, tender, juicy, sweet; "very good." September to November.

TWITCHELL'S SWEET.

From New Hampshire. Fruit, medium, conical, red, with small gray dots; flesh, white, veined with red, sweet. November, December.

VANDYNE.

Fruit, large, roundish, slightly conic; skin, yellowish, with a tinge of red, and slightly sprinkled with brown and reddish dots; stalk, rather slender, in a large cavity; calyx, closed, in a deep, uneven basin; flesh, white, tender, juicy, sub-acid, agreeable. October.

VAUGHAN'S WINTER.

Origin, Kentucky. Tree, hardy, vigorous and productive. Fruit, medium, oblate oblique angular; skin, whitish waxen yellow, shaded with crimson and lilac, and sometimes obscurely striped and thickly covered with conspicuous light dots; stalk, small and short, inserted in a deep, uneven cavity, surrounded by very thin green russet; calyx, open, or partially closed; basin, deep, abrupt, open, slightly corrugated; flesh, yellowish, tender, juicy, with a brisk, very agreeable vinous flavor. January to March.

VIRGINIA GREENING.

Fruit, large, roundish oval, flattened at ends, slightly angular, dull greenish yellow, brownish in sun, scattered brown specks with whitish green circle suffused around them; stem, medium; cavity, acuminate; calyx, large, short segments; core, small; seeds, long ovate; flesh, yellowish white, mild sub-acid; not quite "very good." December to March. Esteemed at the South as a keeper.

WADDEL'S HALL.

Shockley.

Southern. Fruit, medium, roundish conical, yellow, clouded and striped with red, little russet; stem, long, slender; cavity, deep, narrow; calyx, closed; basin, shallow; flesh, firm, juicy, saccharine; "very good." October to March.

WALKER'S YELLOW.

This apple is a native of Pulaski Co., Georgia. Fruit, large, conic, fine golden yellow, with a faint blush on the sunny side; stalk, of moderate length, in a deep, acute cavity; basin, small; flesh, white, juicy, rather too acid for a dessert fruit. November to April. (White's Gard.)

WALPOLE.

From Massachusetts. Fruit, large, roundish, tapering to the eye, yellow, with bright red stripes, deepest in sun, and yellowish specks; stem, short; cavity, open; calyx, closed; basin, slightly ridged; core, large, open; seeds, large; flesh, yellowish, tinged with pink, tender, juicy, brisk sub-acid. August and September. (Hov. Mag.) The following description of the Sparhawk is from B. V. French, Esq. We suspect the two

identical: "The Sparhawk originated in Walpole, N. H., and is known in the family of Mr. Sparhawk, on whose farm it was found, as the 'Gall' Apple. It was introduced to our Society by A. de Copen, of Dorchester, and the Society gave it the name of Sparhawk. It is a large apple, oblate; skin, smooth and glossy; color, yellowish ground, striped with red; abundant bearer; the size, color, and gloss, serve to give it a desirable appearance; flesh, firm, with a sprightly acid. Highly desirable for cooking, and is ripe September, October, but will keep longer. It will class well with the Twenty ounce Pippin."

WALWORTH.

Vermont, | Large Golden Pippin.

From New Jersey. Fruit, large, roundish conical, clear yellow, bright red in sun, dotted with greenish russet specks; stem, short, slender; calyx, small, closed; basin, furrowed; core, large, open; seeds, plump; flesh, yellowish white, tender, juicy, sub-acid. October. (Hov. Mag.) We suspect this is an old variety under a new name.

WASHINGTON ROYAL.

Origin, farm of Joseph P. Hayward, Sterling, Mass. Fruit, above medium size, flattish round, yellowish green, with numerous small gray dots, and a clear red in the skin; calyx, in a broad basin; stem, slender, half an inch long; flesh, crisp juicy, and fine flavor, keeping till July. (N. E. Farm.)

WAXEN.

American. Fruit, above medium, oblate, pale yellow, oily skin, sprinkled with a few dots; stem, slender; cavity, narrow, deep; calyx, closed; basin, shallow; flesh, whitish yellow, crisp, tender juicy, mild sub-acid; core, small; "good," or "very good." November, December. Formerly much grown and esteemed in Virginia. This must not be confounded with "Belmont," which is sometimes grown under the erroneous name of Waxen.

WELLFORD'S YELLOW.

Origin, Essex Co., Virginia. A rapid grower and a great bearer. Fruit, rather small, roundish flattened; skin, pale yellow, with faint red streaks on one side; flesh, yellow, fine-grained, very juicy, with a rich aromatic flavor. Keeps well until June, retaining its flavor.

WELL'S SWEETING.

From Newburgh, N. Y. Tree, strong, upright growth. Fruit, medium, roundish, dull light green, brownish red cheek; stem, slender; calyx, small; basin, shallow; flesh, white, tender, juicy, sweet; "very good." November to January.

WESTERN SPY.

From Southern Ohio. Tree, vigorous, slender, spreading. Fruit, large, roundish flattened, pale yellow, with red, becoming brilliant on sunny side, small white specks; stem, short; cavity, narrow; calyx, large; basin, deep; flesh, yellowish, tender, juicy, sharp sub-acid; "very good." December to March.

WESTON.

Origin, Lincoln, Mass. Fruit, medium, roundish conical; skin, yellow, striped and marbled with red; flesh, white, tender, pleasant. September, October.

WHEELER'S SWEET.

American. Introduced by W. C. Hampton, O. Fruit, large, conical, flattened at ends; color, rich lemon yellow, with reddish cheek in sun and russet marblings at blossom end; surface, uneven or ribbed; stem, short; cavity, deep, russeted at bottom; calyx, nearly closed; basin, deep, uneven, slightly corrugated; flesh, yellowish white, crisp, tender, sweet, pleasant. October.

WHITE.

Medium to large, regular, slightly conical; calyx, in a hollow basin; color, lemon yellow, with spots and splashes made darker by minute black specks on a greenish ground; flesh, crisp, tender, juicy. Keeps until January. Rather acid for the table, but fine for cooking.

WHITE BEAUTY.

Ashtabula Co., O. Medium, globular, smooth, even surface, dull greenish, grayish specks; stem, medium; cavity, shallow; calyx, in a broad, open basin; flesh very white, tender, juicy, sprightly, sub-acid; negative character. September to December. Good grower; wood, reddish, with gray specks.

WHITE DOCTOR.

Origin, Pennsylvania. Tree, vigorous and productive. Fruit, large, roundish oblate; skin, greenish yellow; stem, short, set in an acute cavity; calyx, closed; basin, shallow and furrowed; flesh, white, tender, acid, sprightly but not rich. September, October.

WHITE JUNEATING.

Juneating, Caroline,		Owens' Golden Beauty, Early May,		Carolina, of some.
-------------------------	--	-------------------------------------	--	--------------------

Foreign. Its early maturity its chief merit. Tree, fair upright growth, moderately productive. Fruit, small; pale green, marbled slightly with a darker shade, small russet dots; stem, medium; cavity, shallow; calyx, closed; broad basin; seeds, dark brown; flesh, white, tender, juicy, sub-acid. Last of June, early July.

WHITE SPANISH REINETTE.

Reinette Blanche d'Espagne, De Ratteau,		D'Espagne, Concombre Ancien.
--	--	---------------------------------

Foreign. Probably the parent of Fall Pippin. Fruit, large, roundish oblong, sometimes ribbed; calyx, large, open; basin, deep, irregular; stem, half inch long; cavity, even; color, yellowish green; flesh, yellowish white crisp, sharp sub-acid; valued for cooking. November to February.

WHITE WINTER.

Origin, farm of Mr. Cacklin, Cumberland County, Pennsylvania. Tree, moderately vigorous, very productive. Fruit, small, nearly globular; skin, light yellow, with a dull crimson cheek; stem, medium, in an acute cavity; calyx, firmly closed, a little sunk, in a very small basin; flesh, whitish, juicy, almost buttery, with a mild, sub-acid, but not a rich flavor. January to May.

WHITE RAMBO.

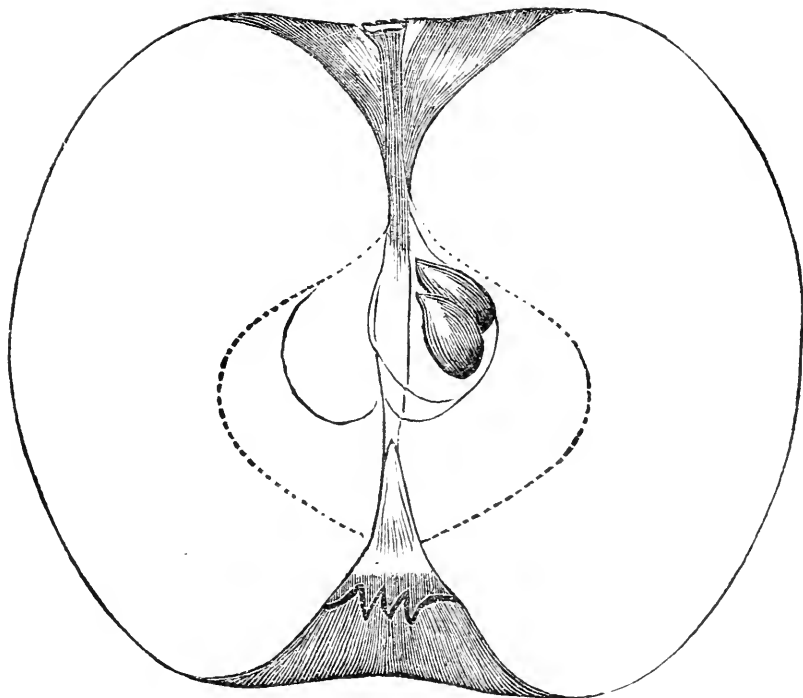

Considerably grown and esteemed in Central Southern Ohio. Fruit, large, roundish, flattened at ends; skin, rough, yellow, russet dots and spots, which, in sun, are of a reddish tinge; stem, stout; cavity, broad, open; calyx, large; segments, in divisions; basin, large, open, deep; core, small; seeds, round ovate, plump; flesh, yellowish, rather coarse, breaking, mild sub-acid; "very good." November to February.

WHITE SWEETING.

Wetherill's White Sweeting.

From New Jersey. Tree, vigorous; productive on light soils. Fruit, large, roundish oblong, pale yellow; stem, short; flesh, white, sweet; valued for baking and for stock. September.

WHITEWATER SWEET.

From Southern Ohio. Fruit, medium, round, bright yellow, with dark spots; stem, short; calyx, slightly sunk; flesh, yellowish, firm, juicy, sweet; keeps till May. (Hov. Mag.)

WHITNEY'S RUSSET.

From Canada. Medium, oblate, almost wholly covered with thick yellow russet; flesh, white, with a very smooth, pear-like texture, and rich brisk, spicy flavor; keeps well till March; tree, is a good bearer, but must be stock-worked the same as Rambo, when planted in Western orchards.

WILLIAM PENN.

A native of Columbia, Pennsylvania. Rather large, roundish oblate, slightly conical; color, grayish, delicately mottled, and striped with red on a greenish yellow ground, with numerous white specks, in the centre of which is a minute russet dot; stem, short, not very stout, sometimes fleshy, inserted in an open, rather deep, russeted cavity; basin, sometimes wide and shallow, usually narrow, rather deep and furrowed; flesh, greenish yellow, juicy, with a delicious Spitzenberg aroma; quality, "very good," if not "best;" represented as being an abundant bearer. (W. D. B.)

WINSLOW.

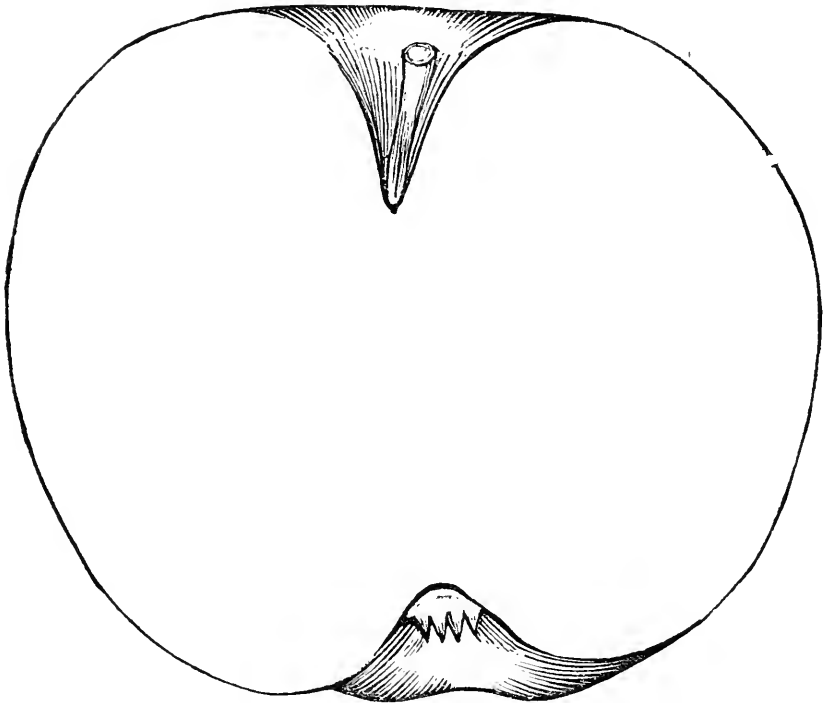

From Virginia. Fruit, large, globular, flattened at base, rounded towards calyx; dark and light red, somewhat streaked, little russet near calyx, light brown specks, and dark flakes; calyx, open, segments, short; basin, expanded; stem, short, slender; cavity, narrow, rather deep; core, small, compact; seeds, plump, dark brown; flesh, yellowish white, tender, juicy, sub-acid. Fall and early Winter. (A. H. Ernst's MS.)

WINN'S RUSSET.

Origin, Sweden, Maine. Tree, of slow growth, hardy and productive. Fruit, large; cavity, deep; basin, broad and shallow; color, dark russet, with obscure stripes of red, covered with whitish spots; flesh, fine grained, sub-acid; keeps till May. (Me. P. S. Rept.)

WING SWEETING.

Fruit, small, round flattened; light and dark red indistinctly striped on light yellow; calyx, small, closed; basin, broad, deep; stem, long; cavity, narrow; core, small; seeds, ovate; flesh, reddish yellow, dry, sweet; productive. Winter.

WINTER PIPPIN OF VERMONT.

Origin unknown, much cultivated in Vermont; a fair grower, and productive. Fruit, large, to very large, nearly globular, inclining to conic, obscurely angular; skin, greenish yellow, sprinkled with star-like crimson dots, cheek shaded with dull crimson; stem, short, inserted in a deep compressed cavity; calyx, small, nearly closed; segments, long, in a rather deep, uneven basin; flesh, white, tender, and agreeable. November to March. (Downing.)

WINTER PIPPIN OF GENEVA.

The appearance of the tree and fruit is strikingly like that of the Fall Pippin, but is a very late keeper, continuing in perfection until May.

Fruit, large, oblate, slightly angular; skin, fine yellow with a crimson cheek, sparsely covered with gray dots; stalk, short and small, inserted in a narrow cavity; calyx, open; segments, long; basin, open; flesh, yellow, tender, juicy, vinous, excellent. January to May. (Downing.) A variety of Northern origin; will not keep South later than January.

WINTER HARVEY.

Fruit, large, conical, slightly ribbed; pale yellow; stem, short; flesh, yellowish, tender, firm, juicy.

WINTER PEARMAIN.

This is distinct from, and far inferior to the Herefordshire Pearmain. Fruit, medium, oblong ovate; dull red on greenish yellow; stem, slender; cavity, narrow; basin, small; flesh, greenish yellow, not juicy, tender, sub-acid; not quite "very good." December to March.

WINTHROP GREENING.

Lincoln Pippin, | Howe Apple.

Origin, Winthrop, Maine. Fruit, large, golden yellow, with slight rus set tinge of red in the sun; flesh, tender, crisp, very juicy, with a sprightly rich flavor. September. (Cole.)

WINTHROP PEARMAIN.

Origin, Winthrop, Maine. Size, large, roundish ovate; skin, yellow, striped with red, and deep red in the sun; stem, in a large cavity; basin, shallow; flesh, white, juicy; flavor, spicy and pleasant. September to January. (Me. P. S. R.)

WONDER.

A Southern variety. Size, large: mostly covered with red on yellow ground; flesh, white, tender, juicy, well-flavored. August.

WRIGHT APPLE.

Origin, Hubbardton, Vermont. Tree, vigorous and productive. Fruit, medium, roundish oblate; skin, fine lemon yellow; stalk, short, inserted in a deep cavity; calyx, closed; basin, rather large and corrugated; flesh, white, very tender, juicy, vinous, almost sweet, aromatic. Middle of September to middle of October.

YACHT.

Origin, Montgomery County, Pa. Tree of moderate growth, a regular bearer. Fruit, large, roundish, striped with red, with various hues on yellowish ground; stalk, short, inserted in a small cavity; calyx, open, set in a large, shallow basin; flesh, yellowish, tender, with a pleasant, sub-acid flavor. November to March.

YACHT.

Medium, roundish, striped with red of various hues on yellowish ground; stem, half an inch long; cavity, open, obtuse; basin, very shallow, plaited; flesh, fine texture, tender, pleasant flavor; "very good." (W. D. B.)

YELLOW CRANK.

Medium size, flat, greenish yellow; high flavor. January to March.

YELLOW MEADOW.

A Southern fruit. Fruit, large, oblate; skin, greenish yellow; stem, rather slender, in a deep, irregular cavity; calyx, large and open, in a shallow basin; flesh, yellow, compact; flavor, vinous, rich and excellent. November.

YELLOW PEARMAIN.

Golden Pearmain.

Origin uncertain; probably a Southern fruit, moderate in growth and productiveness. Fruit, medium, obliquely conic, inclining to oblong; skin, yellowish, slightly shaded with dull red; stem, short, inserted by a lip in a very narrow cavity; calyx, small and closed; basin, deep, round and open; flesh, yellowish, tender, with a pleasant, rich, vinous flavor, slightly aromatic. January to March.

YOPP'S FAVORITE.

Fruit, large, roundish, slightly conic; skin, smooth, oily, greenish yellow, with a blush in the sun, sprinkled sparingly with russet dots, and a little russet about the stem; calyx, open, in a deep basin; stalk, short; cavity, deep; flesh, white, fine grained, tender, juicy, almost melting, of a most grateful, sub-acid flavor. From Thomas Co., Georgia. (Robert Nelson.)

YORK IMPERIAL.

Johnson's Fine Winter.

From York County, Pennsylvania. Size, rather below medium; truncated oval, angular; the unexposed side is mottled and striped, so as to present a grayish red aspect on a greenish yellow ground, and, on the sunny side, the color is a dull crimson; stem, short and moderately stout; cavity, wide, and rather deep; calyx, small, closed, and set in a deep, wide, plaited basin; flesh, greenish white, tender, crisp, juicy; flavor, pleasant and agreeably saccharine; quality, at least "good"—to many tastes, "very good." (W. D. B.)

YOST.

Rather large; roundish oblate, beautifully striped and delicately mottled with crimson on a yellow ground; stem, short; wide, deep, cavity; flesh, yellowish, tender, juicy, pleasant flavor; "very good" quality. (W. D. B.)

CLASS III. *Superseded by better sorts.*

ALFRISTON.

Foreign. Large, oblong, pale green, orange in sun; flesh, crisp, acid. October, December.

AMERICAN PIPPIN.

Grindstone, | Green Everlasting.

Medium, roundish flattened, dull green, patches of dull red; flesh, white, firm, acid. January to June.

ANGLE.

Medium, roundish yellow, nearly covered with stripes and splashes of light and dark red, with white dots; flesh, yellow, tender, sweet. September.

AUGUSTINE.

American. Large, conical, red striped on yellow; flesh, sweet, dry. August.

AUTUMN ROMANITE.

American. Medium, round, red; flesh, yellow. September.

BARETT.

American. Rather large, conic; skin, yellow, striped and splashed with crimson; flesh, yellow, juicy, tender. January.

BARR.

Bars.

American. Medium, roundish oblong, red striped on greenish yellow; flesh, greenish white, poor.

BARNHILT.

American. Small, conical, yellow striped with red; flesh, white, tough, dry. October, November.

BEAUTY OF AMERICA.

Large, roundish flattened, yellow with blush cheek; flesh, yellowish, tender; poor bearer. November to January.

BEAUTY OF THE WEST.

Large, round, red striped on greenish yellow; flesh, coarse, sweet. October, November.

BEAUTY OF KENT.

Foreign. Large, roundish, greenish yellow, striped with purpled red; flesh, tender, inferior. October, November.

BEDFORDSHIRE FOUNDLING.

Foreign. Large, roundish, green; flesh, yellowish, acid. November, December.

BLACK ANNETTE.

American. Small, roundish, dark red. November.

BLACK LADY APPLE.

Api Noir.

Foreign. Small, roundish, blackish red; flesh, white stained. November to March.

BLACK GILLIFLOWER.

Large, oblong conical, dull reddish purple; flesh, greenish white, dry, sub-acid, poor. November to March.

BLACK OXFORD.

Fruit small, roundish, yellowish, nearly covered with red, light dots; stem, long, slender; calyx, half open; basin, slightly russeted; flesh, whitish, compact, not juicy, sub-acid. March to May.

BLENHEIM PIPPIN.

Blenheim Orange, | Woodstock Pippin.

Foreign. Large, roundish, yellow and dull red; flesh, yellowish, sweet, dry. October, November.

BORSBORFFER.

Borsdorff, King George the Third, | Queens.

Foreign. Medium, roundish oval, pale yellow, with red cheek; flesh, yellowish white, crisp, sub-acid. November, December.

BOXFORD.

Fruit, medium, oblate; skin, whitish striped with red; flesh, compact, not very juicy, nor high flavor. September, October.

BREWER.

From Mass. Fruit very large, roundish, yellow, with a slight blush; flesh, yellowish, tender, pleasant, mild sub-acid. October, November.

BURNIAP GREENING.

Origin, Vergennes, Vt. Medium, nearly globular, inclining to conic; skin, greenish yellow; flesh, solid, juicy, crisp, with a pleasant, sub-acid flavor. January and February.

BOROVITSKY.

Foreign. Medium, roundish, pale green striped red; flesh, white, sub-acid. August, September.

BULLET.

Bartlett, | Priestly, *of some*.

American. Medium, oblong, bright red on yellow; flesh, light yellow, inferior; January to June.

CAKE APPLE.

From Connecticut. Medium, oblate, much depressed; skin, yellowish, with a blush; flesh, juicy, tender, pleasant. January to March.

CHANDLER.

Winter Chandler.

American. Large, roundish, imperfect, dull red on yellow; flesh, greenish white, sub-acid. November, February.

CAROLINE.

Foreign. Medium, round, yellow, streaked with red; flesh, firm, acid. November, February.

CATHEAD.

Cathead Greening, | Round Catshead.

Large, roundish, yellowish green; flesh, white, coarse, sharp acid. October, November. There is another one of this name, equally worthless, same shape, but striped yellow and red.

CATLINE.

Gregson, | Winter Grixon.

Medium, roundish, greenish yellow, red in sun; flesh, pale yellow, nearly sweet, for cider. October, December.

CASH SWEET.

American. Medium, round conical, light red; flesh, white, coarse, sweet, dry. October, November.

CHEESEBOROUGH RUSSET.

Howard Russet, | York Russet, *of some*,
Kingsbury Russet, | Forever Pippin, *of some*, *West*.

American. Large, conical, thin russet on greenish yellow; flesh, greenish white, coarse, dry, sub-acid. October, November.

COS, OR CAAS.

American. Large, roundish, greenish yellow, red streaks; flesh, white, tender, sub-acid. December to March.

CORNISH GILLIFLOWER.

Cornish July Flower, | Pomme Regelans, | Egg Top, *of some*.

Foreign. Medium, oblong ovate, pale yellowish green, brown cheek; flesh, yellowish, acid. November to February.

CONNECTICUT SUMMER SWEET.

American. Medium, roundish, yellow and red striped; flesh, yellowish, sweet, tough. August.

CRANBERRY PIPPIN.

American. Above medium, roundish, clear yellow, red cheek; flesh, white, juicy, sub-acid. November, December.

DONNELAN'S SEEDLING.

American. Medium, roundish, greenish yellow, dull red stripes; flesh, yellowish, dry, sub-acid. September.

DOWNTON PIPPIN.

Downton Golden Pippin, | Knight's Golden Pippin, | Elton Pippin.

Foreign. Small, roundish, yellow; flesh, yellowish, sharp acid. October, November.

DUMELOW'S SEEDLING.

Dumelow's Crab, | Wellington Apple.

Foreign. Medium, round, yellow with blush red, brown spots; flesh, yellow, acid. November to March.

DUMPLING.

Crooked Limb Pippin, | French Pippin, of *Indiana*, | Watson's Dumpling.

Large, roundish oblong, light yellow, blush in sun; flesh, white, indifferent. October December.

DUTCH CODLIN.

Chalmer's Large.

Foreign. Large, roundish oblong, pale yellow, orange in sun; flesh, white, sub-acid. October, December.

EASTER PIPPIN.

Young's Long Keeper, | Ironstone Pippin,
Claremont Pippin, | French Crab.

Foreign. Medium, roundish, deep green, brownish blush; flesh, greenish, inferior. November to June.

EGG TOP.

Eve, | Round Top,
Sheep Nose, of *some*, | Wine, of *some*, *West*.

Foreign. Medium, oblong ovate, pale yellow, striped with red; flesh, yellowish white, tender, inferior. November to February.

ELLIS.

From Conn. Small, roundish, greenish yellow, brown cheek; flesh, firm, juicy, pleasant; a long keeper. April, May.

EPSY.

From Vermont. Handsome, productive, small, elongated conic, deep red, almost crimson; flesh, whitish, sweet. December, January.

FALL CHEESE.

Gloucester Cheese, | Summer Cheese.

American. Medium to large, roundish, greenish yellow, flush of red in sun; flesh, crisp, often mealy. September to November.

FAMA GUSTA.

Foreign. Large, conical, pale green; flesh, white, acid. October.

FERRIS.

American. Medium, roundish, red, sub-acid; new, but surpassed by many others. November to February.

FENNOUILLET ROUGE.

Black Tom, | Bardin.

Foreign. Small, roundish, dark red; flesh, firm. November to January.

FENNOUILLET GRIS.

Pomme d'Anis, | Caraway Russet.

Foreign. Small, roundish, russet on yellow; flesh, firm, acid.

FLOWER OF KENT.

Foreign. Large, roundish, flattened, dull yellow and red; flesh, greenish yellow, coarse, sub-acid. October, January,

GAULT'S BELLFLOWER.

American. Large, roundish, pale yellow; flesh, white coarse. October, December.

GIANT.

American. Large, roundish, dull red striped; flesh, greenish white, tender; "good."

GOLDEN APPLE.

American. Large, oblate; skin, golden yellow, slightly sprinkled with brown dots; flesh, yellow, coarse, juicy, sub-acid flavor. October to December.

GOLDEN.

American. Medium, roundish, ribbed, light yellow; flesh, yellowish, acid. July.

GOLDEN REINETTE.

Aurore,		Kirke's Golden Reinette,
Yellow German Reinette,		Wyker Pippin, &c., &c.

Foreign. Small, roundish, greenish yellow, a little red; flesh, yellow, crisp, mild sub-acid. October, January.

GOLDEN HARVEY.

Brandy Apple.

Foreign. Small, roundish, russet on yellow, reddish cheek, sub-acid. November to March.

GOLDEN PEARMAIN.

Buckman's Pearmain,		Dutch Pearmain,		Red Russet.
---------------------	--	-----------------	--	-------------

Medium, roundish flattened, red, russet; flesh, yellowish, dry, sub-acid. November, December.

GOODYEAR.

Goodyear's Seedling.

American. New, medium, roundish, red; flesh, juicy; only valuable as a keeper.

GOVERNOR.

American. Large, yellowish, tinged with red, juicy, acid, cooking. October, January.

GOLDEN PIPPIN.

English Golden Pippin,		Old Golden Pippin, &c.		Eleven other names.
------------------------	--	------------------------	--	---------------------

Foreign. Small, round; yellow, with irregular russet marblings; stem, long, slender; basin, shallow; flesh, yellow, fine-grained, sub-acid, sprightly. December to March. There is an "English Golden Pippin" grown at the West, which is large, oval, basin deep, entirely distinct from above.

GRAND SACHEM.

Large, roundish, ribbed, dull red; flesh, white, dry. September.

GREEN DOMINE.

Medium, oblate, greenish yellow, washed or obscurely striped with dull red; flesh, whitish, firm, with a pleasant, peculiar flavor. December, February.

GREYHOUSE.

Medium, oblate, nearly globular, dull red, with faint stripes; flesh, firm and dry; said to be fine for cider. Winter.

HANNAH.

American. Medium, conical, pale yellow and dull red; flesh, white, dry. October, November.

HARVEST RED STREAK.

From Michigan. A local name; probably an old variety; small or medium, oblate angular; skin, whitish, striped and splashed.

HEPPER.

Hepler, *of some*.

American. Small, roundish, yellow; flesh, dry.

HEWITT'S SWEET.

Large, oblate, yellow, splashed with red; flesh, whitish, sweet, tender, and pleasant. October, November.

HETERICH.

American. Medium, round, yellow; flesh, whitish, acid. November, January.

HOLLAND SWEET.

Fruit, medium, conic, green, with stripes of dull red; flesh, firm, sweet. January to May.

HOLLANDBURGH.

Hollandbury.

Medium, roundish flattened, red on yellow; flesh, white, sour. December, February.

HOARY MORNING.

Dainty Apple, | Downy, | Sam Rawling's.

Foreign. Large, roundish, red striped on yellow; flesh, pinkish. October, December.

HUNGE.

Hunger.

Origin, uncertain. Popular, and long cultivated in North Carolina. Fruit, large, roundish; skin, green, with a blush; flesh, soft, sub-acid, pleasant. September, October.

IRISH PEACH APPLE.

Early Crofton.

Foreign. Medium, roundish conical, yellowish, streaked with red; flesh, whitish, watery. September, October.

KANE.

Cane, | Cain.

American. Medium, roundish, striped crimson; flesh, yellowish; beautiful to look at. Autumn.

KERRY PIPPIN.

Edmonton's Aromatic.

Foreign. Medium, roundish oval, yellow, streaked with red; flesh, firm, crisp. September, October.

KENTISH FILL BASKET.

Potter's Large Grey Seedling, | Lady de Grey's.

Foreign. Large, roundish, ribbed, yellowish, brownish blush; flesh, tender. October, January.

KENRICK'S AUTUMN.

American. Large, roundish, yellowish green, striped red; flesh, white, acid. September.

KILHAM HILL.

American. Large, roundish, ribbed, pale yellow and red; flesh, dry. September.

KING OF THE PIPPINS.

Hampshire Yellow.

Often grown West as Gravenstein. Medium, roundish oblate, yellow and red splashed; flesh, white, slightly sweet, not agreeable. October, November.

KIRKE'S LORD NELSON.

Foreign. Large, roundish, red on pale yellow; flesh, firm, juicy, acid. October, December.

LADIES' BLUSH.

American. Medium, yellow, with red blush; flesh, dry.

LADY FINGER.

Sheep Nose.

Medium, oblong, pale yellow, faint blush; flesh, firm, watery. November, December.

LANE SWEET.

Small, roundish flattened, yellow with red; flesh, yellowish, dry. November.

LEMON PIPPIN.

Kirke's Lemon Pippin.

Foreign. Medium, oval, pale greenish yellow; flesh, firm, sub-acid. October, January.

LONG ISLAND RUSSET.

Medium, roundish oblong, dull yellowish russet; flesh, greenish, dry. December, March.

LOAN'S ENGLISH PEARMAIN.

Small, roundish conical, dull red and russet; flesh, firm; almost worthy culture. September, October.

LONGVILLE'S KERNEL.

Sam's Crab.

Foreign. Below medium, oval flattened, brownish red on yellow; flesh, firm, sub-acid. August, September.

LONG JOHN.

American. Large, conical, greenish yellow; flesh, yellowish white dry; great keeper.

LUCOMBE'S SEEDLING.

Foreign. Large, roundish conical, yellow, spotted with red in sun; flesh, whitish, firm cooking. October, December.

LUCE'S EARLY JOE.

American. Small, round, bright red on yellow; flesh, crisp, inferior. September.

LOVETT'S SWEET.

American. Fruit, medium, roundish conic; skin, yellow; flesh, yellow, moderately juicy sweet. October to February.

MERRITT'S SWEET.

Fruit, medium, oblate, yellow, sometimes with a blush; flesh, compact, very sweet. Last of August.

METHODIST.

From Connecticut. Medium size, oblong oval; skin, greenish, marbled and striped with red; flesh, white, tender, mild sub-acid, not rich. November.

MANE'S CODLIN.

Irish Pitcher, | Frith Pitcher.

Foreign. Medium, roundish oblong, pale yellow, red cheek in sun; cooking only. August.

MARGIL.

White Margil.

Foreign. Small, roundish, dull yellow, streaked with red; flesh, white, tender. Early Winter.

MARBLE SWEETING.

Virginia Sweet, | McIntire's Sweeting.

American. Medium to large, roundish ovate, marbled, dull red and yellow; flesh, sweet, dry. November, February.

MAY SEEK NO-FURTHER.

Pilliken, | May Apple, | Lop-sided Pearmain.

Outwardly like Pryor's Red; flesh, dry, coarse; only valued as a keeper; skin, thick.

MAUCK.

Large, greenish yellow, blush in sun, conical; flesh, "good."

MENAGERE.

Menagerie.

Foreign. Large, flat, pale yellow. September to January.

MONSTROUS PIPPIN.

Gloria Mundi, | New York Gloria Mundi, | Baltimore Pippin.
 American Mammoth, | Ox Apple,

Very large, greenish yellow, roundish; flesh, white, acid. October, December.

MOTHER DAVIES.

Medium, round oblong, greenish yellow, little red; flesh, crisp; "good." October, November.

MOLASSES.

Priest's Sweet, | Butter, | Blue Sweet.

American. Small, roundish, red, dry, sweet. October.

MURPHY.

Murphy's Red, | Jack Murphy.

American. Large, roundish oblong, pale, and dark red streaked; flesh, greenish white; "good." November, February.

NORFOLK BEAUFIN.

Read's Baker, | Catshead Beaufin.

Foreign. Large, flat, dull red on greenish; flesh, sub-acid, good drying. November to May.

NONSUCH.

English Nonsuch.

Foreign. Medium, flat, greenish yellow, with dull brick red; flesh, white. October, November.

OLD FIELD.

Origin, Connecticut. Fruit, medium, oblate conic; skin, yellow, with a slight blush; flesh, yellowish, tender, mild sub-acid. January to April.

OLD ENGLISH CODLIN.

English Codlin.

Large, oblong conical, lemon yellow; flesh, white, tender, cooking. July to November.

OLD ROYAL RUSSET.

Leather Coat Russet.

Foreign. Medium, roundish, gray russet on green; flesh, greenish white, sharp sub-acid. November, February.

OLD NONPAREIL.

Non Pareille.

Foreign. Medium, flat, yellowish reddish brown; flesh, firm, crisp; poor bearer. December, January.

OSLIN.

Arbroath Pippin.

Foreign. Small, roundish, pale yellowish; flesh, firm, crisp, acid. August.

PARSON'S EARLY.

American. Medium or above, roundish, pale yellow; flesh, yellowish white, sharp sub-acid. August, September.

PUTNEYITE.

American. Medium, roundish, light yellow, coarse, dry, acid. December, January.

PRESS.

Origin, Buck's Co., Pa. Rather large, oblate; skin, whitish yellow, striped and splashed with red; flesh, juicy, tender, mild sub-acid. March.

PROLIFIC SWEET.

From Connecticut. Roundish conic; skin, greenish; flesh, whitish, tender, sweet. November to February.

PENNOCK.

Pomme Roye, <i>of some, West,</i>		Large Romanite,		Penick,
Big Romanite,		Red Pennock,		Neisley's Winter.
Pennock's Red Winter,		Prolific Beauty,		

American. Large, roundish conical, angular, dull red, little yellow; flesh, coarse, dry rot. November to March. This is largely grown through the Southwest, but intelligent persons do not now plant it.

POLLY BRIGHT.

Resembles Maiden's Blush. Sharp acid. September, October.

POUND.

Large, roundish oblong, yellowish green, coarse, poor. October, January.

POMME DE ROSE.

Large, roundish flattened, red on yellow, small dots; flesh, white, coarse, acid. December February.

PRIESTLEY.

Priestley's American, | Red Cathed.

Large, roundish oblong, dull red, streaks of yellowish green; flesh, greenish white, inferior. December to March.

QUAKER PIPPIN.

American. Medium, greenish yellow, very acid. October.

RED AND GREEN SWEET.

Prince's Red and Green Sweet, | Large Red Sweeting, | Red Bough.

American. Very large, oblong conical, green and red striped; flesh, sweet, poor. August, September.

RED INGESTRIE.

Foreign. Small, oblong ovate, yellow, marbled with red; flesh, firm, sprightly. September, October.

RED GILLIFLOWER.

Red Seek-no-Further, | Harkness' New Favorite.

American. Medium, oblong conical, fine red; flesh, white, mild sub-acid. November to January.

RED CALVILLE.

Red Winter Calville, | Calville Rouge,
Calville Rouge d'Illiver, | Spice, *of some, West.*

Foreign. Above medium, roundish oblong, pale red, dark red in sun; flesh, tender, poor. November, February.

RED BELLFLOWER.

Red Belle Fleur, | Belle Fleur,
Belle Fleur Rouge, | Striped Belle Fleur, *of some.*

Foreign. Large, oblong conical, greenish yellow, covered and striped with red; flesh, white, dry. November, January.

RED STREAK.

Herefordshire Red Streak, | Scudamus Crab.

Foreign. Medium, roundish, red, yellow streaks; flesh, yellow, dry, cider only. October, December.

RYMER.

Foreign. Above medium, roundish flattened, clear red, glossy; flesh, white, sharp acid. October, December.

ROSEAU D'AUTOMNE.

Roseau, *incorrectly, of some.*

Foreign. Medium, roundish ovate, flat at base, yellow, bluish red cheek; flesh, yellowish, crisp, acid. November to January.

ROSEAU.

Foreign. Large, dark red, irregular in size and form; unprofitable.

RULE'S SUMMER SWEETING.

American. Medium, oblong, yellow, poor. August.

SCARLET NONPAREIL.

New Scarlet Nonpareil.

Foreign. Medium, roundish, deep red on yellowish green; flesh, firm, acid. November to February.

SHIPPEN'S RUSSET.

Large, roundish, flattened, russet on greenish yellow; flesh, white, spongy, acid. January to March.

SHIPLEY GREEN.

American. Medium, oblong, rusty red, acid; cooking only. All Winter.

SKUNK.

Polecat.

American. Large, flat, dull dark red on yellow; flesh, yellowish, dry. December, January.

SPRAGUE.

Size, small, oblong oval, slightly conic; skin, yellow; flesh, yellow, juicy, tender, sprightly, sub-acid. October.

STEEL'S SWEET.

Origin, Kensington, Conn. Fruit, medium, globular angular, yellowish, slight blush; flesh, white, compact, juicy, with a peculiar saccharine flavor. December to March.

SPRING GROVE CODLIN.

Foreign. Medium, oblong rounded, greenish yellow; flesh, greenish, sub-acid; cooking. August, November.

SPRINGER'S SEEDLING.

American. Small, oblong oval, dull yellowish green, stripes of red; flesh, firm, negative January to May.

STRIPED MOHAWK.

Above medium, round, red striped on yellow; flesh, dry, poor. Late Autumn.

SUGAR LOAF PIPPIN.

Sugar Loaf Greening.

Foreign. Large, oblong conical, dull greenish yellow, brownish in sun; flesh, "good." August, September.

SUMMER GOLDEN PIPPIN.

Foreign. Small, roundish oblong, yellow; flesh, whitish, firm, sweet. August, September.

SUMMER RAMBOUR.

Summer Rambo, | Rambour Franc, | Rambour d'Ete.

Foreign. Above medium, greenish yellow, streaked with red, roundish flattened, apt to be mealy. August.

SUMMER RUSSET.

American. Small, roundish conical, yellow, partly russeted, sweet, dry. September.

SWEET AND SOUR.

Medium, roundish flattened, greenish; only valued as a curiosity. From a diseased propagation.

SURPRISE.

Foreign. Small, round, whitish yellow; flesh, stained with red. November, December.

SWEET BALDWIN.

American. Medium, roundish, deep red, striped on yellow; flesh, sweet, dry. September, October. There are, we think, two apples grown under this name, as Thomas describes one as "nearly first-rate," and ripening "early Winter."

TART BOUGH.

Resembles Early Harvest, but trees more rapid in growth, and ripens ten days later; more acid.

TURKEY GREENING.

From Connecticut. Fruit, fair, and very productive, large, oblate, slightly conic; skin, green, with a dull blush, and many light dots; flesh, greenish, tender, juicy, sub-acid, not rich. January, February.

TITUS PIPPIN.

Tree, vigorous and productive. Fruit, large, oblong conic; skin, light yellow; flesh, tender, juicy, not high flavored. November, December.

TRANSPARENT DE ZURICH.

Small or medium, beauty its only merit, waxen white, clear, translucent. September.

THEMS RED STREAK.

American. Medium, round, pale green, red stripes; flesh, sour. Winter. (Hov. Mag.)

TWENTY OUNCE PIPPIN.

Large, roundish conical, brown red, very distinct from Twenty Ounce, or Cayuga Red Streak.

VICTUALS AND DRINK.

Big Sweet, | Pompey.

American. Large, oblong, rough, dull yellow, russet blush, sweet, dry. October, January.

VICTORIEUSE REINETTE.

Reinette Triomphante.

Foreign. Large, roundish oblong, pale yellow, rough dots; flesh, firm, sub-acid. December, January.

WHITE DOCTOR.

Small, pyramidal, greenish white, sweet, dry. September, October.

WHITE CALVILLE.

White Winter Calville, | American White Winter Calville,
Calville Blanche d'Hiver, | Nigr.

Foreign. Above medium, roundish flattened, whitish or greenish yellow; flesh, white, negative. November, February.

WHITE ASTRACHAN.

Transparent de Moscovic, | Glace de Zelande.

Foreign. Medium, roundish conical, white, faint streak of red; flesh, white, dry, poor. August.

WINTER CHEESE.

American. Medium, greenish, with stripes of dull brownish red in sun, mealy, poor. December, January.

WILLIS SWEET?

Large, roundish oblong conical, yellow, marbled with dull red; flesh, white, sweet, cooking. October, November.

WORMSLEY PIPPIN.

Knight's Codlin.

Foreign. Medium, roundish, greenish yellow, acid. October, November.

WINTER QUEEN.

Winter Queening.

American. Medium, conical, crimson and pale red; flesh, yellowish, sub-acid. December.

YELLOW INGESTRIE.

Foreign. Small, clear yellow, crisp, spicy, not valued. October.

YORKSHIRE GREENING.

Foreign. Large, roundish flattened, dull dark green, striped with dull red; flesh, greenish white, acid. Winter.

ZANE.

Zane Greening.

American. Large, roundish, dull greenish yellow, poor. February to June.

ZIEBER.

American. Small, roundish, yellow, striped red cheek; flesh, dry; "good."

THE BLACKBERRY.

Rubus Villosus.

A WELL known bramble, indigenous to this country. The fruit is so easily procured in its wild state, as not to have received due attention from cultivators.

Ripening, as it does, just as Raspberries are gone, when there is a dearth of the smaller fruits, it is surprising that more exertions have not been made to grow improved varieties from seed. Plants selected from the wild state, placed in the garden, and well cultivated, have produced fruit of double the usual size and improved in flavor.

In 1845, Colonel Coit, of Cleveland, exhibited at one of the Cleveland Horticultural Society's meetings, a plate of Blackberries grown from plants he had carefully selected from the woods. Many of the berries measured five inches in circumference. He stated that he had selected the plants when in fruit, transferred them to his garden in the Fall, and those on exhibition were a sample of the produce, having been increased in size fully one half, and much improved in flavor.

Our fields throughout the Middle States contain many plants worthy cultivation. The "New Rochelle," or Lawton, the "Newman," Crystal White, and others, are instances of what has been done by the use of a little attention to the subject.

As a crop for profit, there is no question but that it will prove more valuable than any Raspberry yet known.

Cultivation of the Blackberry. Prepare ground by digging or plowing very deep; if not naturally rich, add plentifully of well rotted manures or leaf mold. Set the rows six feet apart, running north and south, and place one plant every four feet distant in these rows.

When planting, cut the plant back to a stem of not more than ten inches long. After having finished planting, run the plow north and south, throwing earth up to the plants and leaving the centre with an open furrow, that perfect drainage may ensue.

The first season, permit but one shoot to grow from the parent; this course will cause the shoot to be very strong and healthy.

The second season, early in Spring, cut back the shoot of the previous year's growth one half; permit but one other shoot to spring from the ground until after the fruit crop is ripened. After the fruit is gathered, any number of shoots may be permitted to grow, pro-

vided extra plants are wanted for forming new beds ; but if plants are not wanted for re-setting other beds, then more than two shoots should never be permitted to grow from one stool at a time. Keep the ground well stirred with plow or hoe from time to time, or better, cover the entire surface with three to four inches deep of leaves or chopped straw.

Seedlings may be grown in the same way as Raspberries.

There are, in its wild state, many varieties, but all answering the same botanical description. They are known under the common names of High Blackberry, Bush Blackberry, Low or Trailing Blackberry, etc. ; the stems being tall and more or less branching. The fruit ripens from 20th July to 10th August, and is highly esteemed for making syrup, which is regarded valuable as a preventive as well as a curative of diarrhœa, dysentery, etc. As a dessert fruit, and for cooking, when well grown and ripened, it is esteemed, and often advised by physicians, on account of its healthful character.

There is a variety known as the White Blackberry, differing not in habit, but with shoots and fruit of a greenish-white.

Of the varieties named and offered for sale by dealers, we select the following as most esteemed.

CRYSTAL WHITE.

Originated from seed, in Albion, Ill. This is a new variety, and entirely distinct from the old white blackberry, being free from spines. The canes are a bright, clear, light green ; vigorous, strong growers ; hardy and very productive. *Fruit*, very large, oval roundish ; when fully ripe, a clear, rich white, juicy, tender, sweet, and high flavor. Ripens last July to middle of August.

DORCHESTER.

Introduced to notice by the late Capt. Lovett, of Beverly, Mass. ; nearly equal in size to New Rochelle, of a more elongated form, grains rather smaller, somewhat sweeter, and producing large crops of high-flavored fruit ; a vigorous grower. *Fruit*, large, oblong conic, sometimes measuring an inch and a quarter in length, of a deep shining black. The berries should be fully matured before they are gathered ; it bears carriage well. Ripens about the first of August.

HIGH BLACKBERRY.

Bush Blackberry, | *Rubus Villosus*.

This is an erect growing blackberry, the stems tall, and more or less branching. The fruit is small, round, reddish-black, and good ; seldom juicy or high-flavored. There is a variety cultivated with greenish *white* fruit, that is unworthy. *Not the Crystal White*.

NEW ROCHELLE.

Seacor's Mammoth, | Lawton.

This variety was found by Lewis A. Seacor, by the road-side in the town of New Rochelle, Westchester Co., N. Y. It is of very vigorous growth, with strong spines which belong to the bramble ; is hardy and exceedingly

productive. *Fruit*, very large, oval, and when fully ripe, intensely black; when mature, the fruit is very juicy, rather soft and tender with a sweet excellent flavor; when gathered too early it is acid and insipid. The granules are larger, consequently the fruit is less seedy than any other variety. Ripens about the first of August, and continues in use five or six weeks.

NEWMAN'S THORNLESS.

A new variety discovered by Jonas Newman, Ulster Co., N. Y. Promises to be valuable; growth not so vigorous as New Rochelle and Dorchester, but produces abundantly of good-sized oval berries of excellent flavor; the canes have but few spines or thorns in comparison to the others, which is an important consideration. We have too little personal knowledge of it to speak decidedly of its merits. Ripens about the first of August.

THE CHERRY.

Cerasus Sylvestris, and *C. vulgaris*, Arb. Brit. *Rosaceæ* of Botanists.

THE Cherry, in its wild state, is a native of most parts of the United States, and also of Britain; but the cultivated variety is recorded as having been brought from *Cerasus* (whence the name), a city of Pontus, in Asia Minor, and planted in the gardens of Italy by the Roman General, Lucullus, after he had vanquished Mithridates, in the year 69, B. C.

In 1824, Rev. Dr. Robert Walsh made communication to the London Horticultural Society, stating the Cherry to be now growing in the land of its origin, whence it was brought near 2,000 years ago.

He describes two varieties. "The first of these varieties is a Cherry of enormous size which grows along the northern coast of Asia Minor, from whence the original Cherry was brought to England. It is cultivated in gardens always as a standard, and by a graft. The second variety is an amber-colored transparent Cherry of a delicious flavor. It grows in the woods, in the interior of Asia Minor, particularly on the banks of the Sakari, the ancient Sangarius. The trees attain gigantic size—the trunk of one measured in circumference five feet; height to where the first branch issued, forty feet; summit of highest branch, ninety feet—and this immense tree loaded with fruit."

From Italy it was introduced into England as early as the forty-second year B. C., although some authorities date its introduction as late as fifty-five years after the Christian Era—that is, in the early part of the reign of Nero. The former date appears to be confirmed

by Pliny, who says: "Italy was so well stocked, that in less than twenty-six years after, other lands had Cherries, even as far as Britain, beyond the Ocean." The poet Lydgate, who wrote in or about 1415, says that Cherries were then exposed for sale in the streets of London, much as they are at the present day; and in a curious poem, entitled Lickpenny, is found the following allusion to them:

" Hot pescodes one began to cry,
Straberys rype and Cherreys in the ryse."

From England and Holland both seeds and trees were introduced into this country, early after its first settlement.

"Pliny mentions eight kinds of Cherries as being cultivated in Italy when he wrote his Natural History, which was about 71, A. D.;" and from this date up to the present time, the varieties have been gradually increasing, until we have now described, in various works, upwards of one hundred and fifty.

The disposition of Americans to combine the useful with the ornamental, has induced the planting (where the Cherry succeeds) of many as ornamental or shade trees; while examples of reward pecuniary, from sale of fruit on trees so planted, has probably been additional inducement. The symmetrical form and rapid growth of the Cherry fit it well for a street tree throughout the country, and we wish we could induce the following of example of our Connecticut forefathers in 1760, and recently renewed by Prof. J. P. Kirtland, of Cleveland, Ohio, who has planted the Cherry as a street tree upon the entire front of his grounds. Mr. Loudon, in his Arboretum, gives an account of long avenues of the Cherry in Germany; and more recent travelers have written repeatedly of, and described them in such manner, that it is not a little strange our people, as a body, have not as yet seen and acted upon the plan, to the advantage of their pecuniary as well as social interests. Says Mr. Loudon: "These avenues in Germany are planted by the desire of the respective Governments, not only for shading the traveler, but in order that the poor pedestrian may obtain refreshment on his journey. All persons are allowed to partake of the Cherries, on condition of not injuring the trees; but the main crop, when ripe, is gathered by the respective proprietors of the land on which it grows."

In our view, this practice, if extensive in this country, would render less of one crime in the summing up of her annals—*i. e.*, the robbing of orchards; and possibly a law like that enacted in the territory of Erfurth in 1795, would be beneficial. It provided that, in case of the robber not being discovered, the district in which the offence was committed should be obliged to make compensation for the damage sustained. This made every individual interested in preventing depredations on his neighbor's property.

Propagation. The Cherry is propagated from seed—by budding—by grafting—and occasionally, by pieces of roots.

By Seed. The seed of the black Mazard is that generally used, and considered best for propagating the Heart and Duke varieties upon, while the Mahaleb is used only for the purpose of creating a dwarf habit. Seeds of the Graffion or Yellow Spanish will occasionally reproduce trees bearing fruit similar to the parent; while seeds of many of the cultivated kinds will not vegetate, there being no germ or seed bud within the stone. The seed should not be permitted to get dry, but immediately when gathered, rubbed and washed clean of pulp, and mixed half and half with sand, placed in boxes, of say four inches deep, having holes in the bottom for drainage, and then set in the open air, on the north side of a building, clear of direct sunlight. The ground should be well drained, and if possible fresh turf; and spaded or plowed in the Fall one foot deep. As soon as the frost is out in the Spring, rake down the ground level, mark out drills six inches wide and one inch deep, sow seed so that it will be about three inches apart, cover with the soil one inch, and add one inch of sand or leaf mold.

By Budding. This is done as described on page 20; but in the Cherry, and especially when the buds are a little unripe, it is best in cutting the bud from the scion to take liberally of the wood, thereby preventing its drying as soon as otherwise. The season for budding the Cherry is, when the tree on which you are going to operate is forming its terminal bud, and varies in seasons, as also in the age of the trees; trees of four or five years old, in sections south of Cincinnati, being ready by middle of June, while plants transplanted the past Spring will not be ready until early in July. North of this section line, the season will vary from two to four weeks later. Occasionally it will answer to bud in September, as it sometimes happens that a second growth is made about that time.

By Grafting. This should be performed in all sections south of Cincinnati early in February, and for those north, from the last week in February to middle of March. Saddle grafting is best where both stock and scion are equal in size; whip or tongue grafting is best where the stock is not over half to three fourths inch diameter; and cleft grafting, where large stocks are to be changed. This last is dangerous, inasmuch as it gives too great a check to the tree; it is better to graft the small limbs and branches. Side grafting is the mode most advisable for young beginners, and also where the work has been put off a little too late.

By Roots. The root of the Mazard Cherry, cut into pieces of about four to six inches long, and having the upper end set about one inch under ground early in Spring, will often throw up strong shoots, and where a person is unable to get seedlings, this is the next

best mode of obtaining stocks, as they are no more liable to sucker than if from seed.

Transplanting. When from the seed bed to the nursery row, it should be done in the Fall on dry soils, and early in Spring on soils not perfectly dry in Winter. They should be set in rows four feet apart, and one foot apart in the row, and the plants should have one half of last year's growth cut off, and all long, straggling, as well as the tap root, cut back to six inches. These, if the season is good will be suitable for budding the same Summer. Orchard trees, and also dwarfs for gardens, should have one half of the previous year's growth cut off, and the roots trimmed smoothly at ends with a sharp knife. The distance apart for standard trees in orchard, should be about twenty-five feet, while dwarfs may be planted at distances of eight feet each way.

Standard Trees. Are best for orcharding, and should, in no situation, have their heads formed more than four feet from ground, and throughout the West and South not more than two feet.

Dwarf Trees. Are produced by propagating the Sweet or Duke varieties on the Mahaleb, or Morello roots. They should in all cases be worked just at the crown of the root, as it is there a union is best formed; and also, by means of pruning (see page 28), they should be made to form heads branching immediately from the ground.

Soil and Situation. The soil best suited to most Cherries is that of a rich light loam on a gravelly sub-soil, but they will grow and produce fruit freely in all soil *not wet*. *The roots of the Mazard or Sweet Cherries are very impatient of water, and will only endure a few seasons in strong soils void of drainage, or where water stands most of the Winter. To this want of drainage, in great measure, is attributable the destruction of the Cherry in most of the prairie soils throughout Southern and Western States; and not until we manage to drain freely our rich alluvial deposits, can we succeed perfectly with the Sweet Cherries. The roots of the Dukes, Morellos, and Mahaleb, are less open and spongy in texture, and therefore less impatient of water. They, however, do not flourish vigorously for any length of time unless drainage is effected. To this point in the culture of the Cherry we beg especially to call attention of our Western and Southern readers, assuring them, that whatever of theory may have been advanced referable to climate, they will find drainage, or the want thereof rather, to be the primary cause of destruction.* Situated at a point where the Cherry probably does as well as at any place in the United States, we have had occasion to notice the result of trees situated in what appeared suitable soil, but where, on examining, after having lost several trees, we found water to have stood a long time about the roots.

Naturally, most of the soil of Western and Southern States is rich in vegetable matter, giving vigorous, even rampant growth to the

Cherry tree ; which, added to the fact that most trees have their roots standing in stagnant cold water, induces tendency to disease from the first. If, then, when about to plant Cherry trees, perfect drainage is made, so that no water will stand for twenty-four hours together about the roots, an application, on prairie soils, of sulphur and finely broken or ground bones be made, the ground-work to success will be performed.

Situations sloping south will affect the producing of early bloom, rendering less chance of fruit from effect of late vernal frosts, and also render the tree more liable to second growth in the Fall, and thus unfit it for the severe changes of temperature throughout Winter. Northern exposures are recommended, but an eastern one we regard best. The forenoon sun may excite circulation, but not as rapidly as the mid-day, or from one to three o'clock, p. m. ; while there is, also, more or less of moisture in a morning atmosphere, and none in the afternoon ; the tree, also, has a chance to have its circulation gradually checked ere the cold of night, which it has not when planted on ground, sloping south, west, or north. When planting on either of the last exposures, or on level land, let your *tree* slope to the south-west, as the sun has less effect upon it in that position.

Cultivation. In nursery rows, the earth in Spring should be first turned away from the trees ; in about ten days it should again be stirred and left nearly level, and so kept throughout the growing season. In October it should be turned up toward the trees. The plants budded last season should be cut back to within six inches of the bud as soon as the same commences to swell strongly. The buds, after having grown six to eight inches, should be tied up to the stocks, and in June the stock should be cut with a slope downward close to the bud. The second year, they should be headed back to four feet, when some will throw out branches two feet from the ground ; others, where headed back. The third year, they should be transplanted. Throughout the West, on the rich prairie soils, it has been found impolitic to hoe, or otherwise use any mode of culture toward keeping the ground clean, after August ; it induces second growth, immature ripening of wood, and consequent injury in Winter. Orchard and garden trees should be lightly spaded around in July, and a quantity of mulch, or stones, laid over the roots.

Pruning and Training. The Heart Cherry, as a standard, needs little pruning except to cut away limbs liable to cross one another. This is best done in July, when the cut, if made smooth, and close to the body or large limb, will at once heal. If disposed to grow too rapidly, dig around a tree, of say four inches in diameter, a circular trench, three feet distant from the body of the tree, and two feet deep, cutting off with a sharp spade every root and fibre outside that space. And for every inch diameter, up to a tree twelve inches through, add four inches distance of trench from tree. Often the top of the tree

will also require pruning, so as to give it a round head, as of an acorn, based on the circle of the trench.

The Dukes and Morellos need somewhat more pruning than the Heart varieties, but all are impatient of the knife; yet if to be done, let it be in July, or when the terminal buds are forming.

Dwarfs are trained to please the fancy of growers, and mostly by the "pinching-in" process. And as they grow with extreme vigor on the Mahaleb, for three or four years, they require not only to have their tops pruned, but also to be root-pruned annually.

If possible to be avoided, large branches should never be cut from a Sweet Cherry tree. We have examined the results of many cases where large branches were lopped in Spring for the purpose of changing the tree to a different variety by grafting; the result has almost invariably been death after two summers. When necessary to be done, the wound should be covered with grafting composition or gum-shellac, to exclude the air, and the body wrapped in straw or matting. Encasing the body during the winter and spring months with straw, cloth, or moss, will often prevent injury; for the cause of bursting of bark is in winter, not summer months, although it does not always exhibit itself until July or August. The atmospheric blight, injuring young shoots, acts at once in Summer.

Insects and Diseases. The aphid, slug, caterpillar, and curculio, are more or less destructive to the Cherry, but as they are described in other chapters we must refer the reader thereto. The diseases, according to writers, are, in the West, numerous; but as they all centre in the bursting of bark and exudation of gum, we shall only note on that. Under the head of Soil, we have given what we term the primary cause of this disease, and if added to what we have said under heads of Cultivation and Pruning, we believe will have effect to check, in great measure, the evil. That it will render the tree entirely free of the disease we are not prepared to say; but if to it be added selections of buds from healthy trees, and growth in nursery on ground well drained and not over stimulated by barn-yard manures, we believe a change for the better will be the result.

Uses. The wood of the Wild or Virginia Cherry is used by cabinet makers, being susceptible of a fine polish. The fruit of the Sweet Cherries is universally esteemed for the dessert, and that of the tender-fleshed, like Belle de Choisy, is regarded as wholesome. The Sour Cherries, either dried or fresh from the tree, are much esteemed for culinary use, while the Mazard and Wild Virginian Cherries are used in flavoring liquors. "The celebrated German *Kirschwasser* is made by distilling the liquor of the common black Mazard (in which the stones are ground and broken and fermented with the pulp); and the delicious *Ratiffa* cordial of Grenoble is also made from this fruit. *Mareschino*, the most celebrated liquor of Italy, is distilled from a small Mazard, with which, in fermenting, honey and the leaves and

kernels of the fruit are mixed. The gum of the Cherry is nearly identical with gum-arabic, and there are some marvelous stories told of its nutritive properties."

As a substitute for raisins, the following method of preparing the Sour Cherries deserves especial attention. It is given us by Charles Carpenter, Esq., of Kelley's Island, Ohio, by whom it has been successfully practised:

"Take the ripe cherries and pit them. Put a quantity in a porcelain kettle and let them just scald, which will separate a part of their juice from the pulp. Skim out the cherries on platters to dry. Put more cherries in the hot juice and scald until all are scalded. Partially dry them (one or two good days is sufficient), and put them in jars, scattering a little sugar among them—say a quarter of a pound of sugar to a pound of the dried fruit. Thus prepared, they will keep for years, if protected from the moths. For all purposes of cooking they are as good, and by many preferred to raisins.

"To the juice which is separated from them by the scalding, add a small quantity of sugar, and boil down a little, and it is better than boiled cider for all purposes for which boiled cider is used."

Gathering the Fruit. The flavor and character of the Cherry is best obtained when gathered early in the morning; but if intended for distant market, they should always be gathered with the stem attached, and when dry.

Classification. In order the more readily to distinguish varieties of the Cherry, authors have entered into classification; but as those heretofore made have seemed rather to perpetuate error than induce correctness, we have ventured upon a partially new order. Lindley, in his Guide to the Orchard, makes two divisions: one embracing varieties the fruit of which is round, acid, or sub-acid; the other sweet, and heart-shaped. Downing, in his Fruits and Fruit Trees, makes four divisions or classes, viz.: Heart-shaped, Bigarreus, Dukes, and Morellos; and, in a measure, all other writers have adopted these classifications. The two last terms of Mr. Downing—Dukes and Morellos—we shall continue, as they are not inapplicable, and the trees are distinct in growth. But the word Bigarreau, being derived from *Bigarrée*, originally meaning and intended to convey the idea of a parti-colored, or yellow and red fruit, and *not* meaning (as it is generally used and understood by pomologists) *firm-fleshed*, we can see no just cause for continuing in use. Again: there are varieties which, although round in form, are yet sweet, and partially tender-fleshed, and however erroneous, would have (if the old classification were pursued) to come under the head of Heart-shaped. There are also varieties where the characters, both of tree and fruit, of those determined by the two distinctions—Heart and Bigarreau—are so closely commingled as to often perplex the amateur, and thus increase rather than lessen his troubles. We shall therefore desig-

nate in our text descriptive of each variety, the classes heretofore known as Hearts and Bigarreaus—being rapid growing, lofty, and spreading trees—as *Sweet*, of which the old Black Heart may be taken as the type. The Dukes are mainly distinguished by the trees having narrower leaves than those of the Sweet Cherry, being upright in growth while young, but forming a low, spreading head, with wood less strong and somewhat darker colored than the Sweet Cherries. Fruit, generally round, of one color, and when fully ripe, rich sub-acid.

The Morellos are less upright in growth than the Dukes. Branches, small, slender, drooping; foliage, narrow, dark green; fruit, acid.

Engravings. These have been made from medium sized specimens, taken direct from the tree, and placed in the engraver's hands. They represent the Cherry cut in half, and are intended to show the form of fruit in that way, and also exhibit the lines of tissue in the flesh, which are different in varieties, but uniform in numerous specimens of the same variety.

CLASS I. *Most generally esteemed.*

AMERICAN HEART.

Probably a native of this country; its origin is, however, uncertain. Tree, vigorous, spreading. *Fruit*, medium, heart shaped, four sides compressed, pale yellow and red; *flesh*, yellowish, watery towards the pit, juicy, sweet, second flavor; *pit*, medium; *stem*, long, moderately slender. Early in June. Productive.

ARCH DUKE.

Griotte de Portugal,		Late Arch Duke,
Portugal Duke,		Late Duke.

An English variety, first described by Lindley. The May Duke, or Late Duke, have almost always been sold as this variety. It is a more vigorous grower, and distinguished in its fruit by being more heart shape. *Fruit*, large, heart shape, compressed, dark shining red; *flesh*, light red, slightly adhering to the stone, tender, sub-acid; *stem*, long, slender. Early in July. Desirable South and West.

BELLE DE CHOISY.

Ambree de Choisy,
Cerise Doucette,

Cerise a Noyau Tendre,
Ambree a Gros Fruit,

Cerise de la Palembre,
Schone Von Choisy.

Raised in 1760, at Choisy, a village near Paris, France. The tree is of a Duke habit—thus far proving hardy in nearly all locations. It bears regularly every year, but only moderate quantity. Its delicacy and exquisite peculiar flavor, render it one of the most desirable for the table, but unsuited to market purpose.

Fruit, round, or slightly depressed; *skin*, thin, translucent, showing the netted texture of flesh beneath; of pale amber in the shade, mottled with red and yellow where more exposed, and grown fully in the sun, becoming a bright cornelian red; *flesh*, amber yellow, slightly tinged with pink radiating lines or tissues, in irregular long curves, very tender, delicate, juicy, subacid, nearly sweet, peculiar and agreeable flavor; *pit*, small, round, a little pointed at apex; *stalk*, often short, but varying. Last of June.

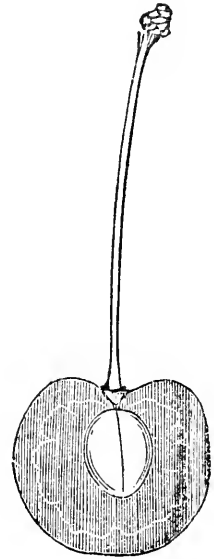

BELLE OF ORLEANS.

Belle de Orleans.

From France. Tree, vigorous grower, good bearer, valuable. *Fruit*, medium, roundish; light yellowish white, with clear pale red covering about one half the surface; *flesh*, tender, juicy, and delicious. Early in June. This proves one of the very best early Sweet Cherries.

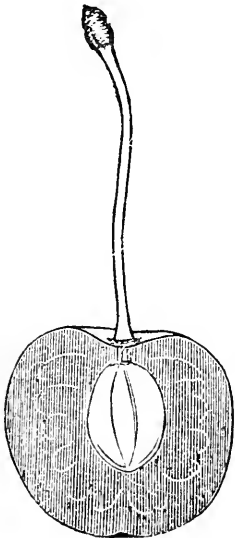

BLACK HAWK.

Raised by Prof. J. P. Kirtland, near Cleveland, in 1842. Commenced fruiting in 1846. The tree is of healthy, vigorous, spreading habit, with much of the general character of Yellow Spanish; flowers, above medium; soil of origin, a gravelly loam. As a table fruit, its high flavor will always commend it; while, as a market fruit, its size and productive habit of tree place it among the very best.

Fruit, large, heart shape, often obtuse, sides compressed, surface uneven; *color*, dark purplish black, glossy; *flesh*, dark purple, half tender, almost firm, radiating lines irregular, without form, juicy, rich, sweet, fine flavor; *pit*, medium size, uneven surface; *stalk*, varying, inserted in a broad cavity. From 20th June to 1st July. We regard this as the *best* Black Cherry known.

BLACK TARTARIAN.

Bishop's Large,
Frazer's Black Heart,
Ronald's Heart,
Circassian,

Superb Circassian,
Black Russian,
Ronald's Black Heart,
Frazer's Black Tartarian,

Tartarian,
Black Circassian,
Ronald's Large Black Heart,
Double Heart.

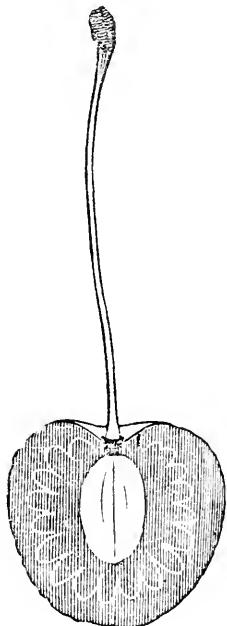

This variety is supposed to have originated in Spain, whence it was transmitted to Russia, and thence introduced into England, about 1794 or 1796, whence it found its way to this country, and in 1810 was cultivated in Middletown, Ct., as Bishop's Large, and 1813 as Ronald's Black Heart. The tree is of peculiar, upright growth, unlike any other variety, or most resembling the Black Mazard. Its vigorous habit, erect form, large foliage, and large sweet fruit, have rendered it perhaps the most popular variety in cultivation. The tree requires somewhat more pruning to thin it out than other varieties; otherwise, as the trees grow old, they become too thick, and the fruit attains only medium size.

Fruit, large, heart shape, often obtuse, irregular uneven surface, glossy, purplish black, slight suture half round; *flesh*, liver color, juicy, sweet, half tender, separating freely from pit, mild, pleasant, not high flavor; *pit*, below medium size; *stalk*, sunk in a regular cavity. Last of June.

BLACK EAGLE.

English; raised by the daughter of Mr. Knight. Tree, healthy, strong grower, unproductive while young. *Fruit*, above medium, borne in threes, obtuse heart shape, deep purple, almost black; *flesh*, reddish purple, half tender, with a rich, sweet, high flavor. Early in July.

BRANT.

Raised by Prof. Kirtland, on a gravelly loam. The tree is vigorous, with large foliage, and spreading, or rather round regular form; flowers, large, and open irregularly, so that often a portion may be injured by late frosts, and others escape.

Fruit, large, rounded, angular heart shape, sides slightly compressed; *color*, reddish black; *flesh*, dark purplish red, radiating lines whitish, partially indistinct, half tender, juicy, sweet, and rich; *pit*, nearly smooth, slight depressions, round oval; *stem*, medium, set in a cavity slightly angular. Early—say middle of June.

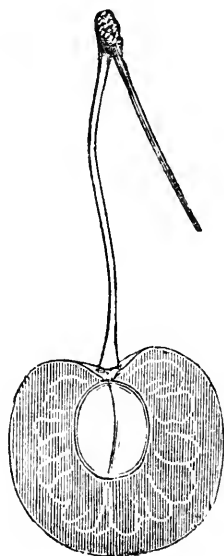

BELLE MAGNIFIQUE.

Belle et Magnifique.

First introduced into this country from France, by Gen. Dearborn. The tree is of Duke habit, hardy, healthy, and vigorous. It is a moderate bearer, the fruit, if permitted, hanging on the tree until August, although much of it suitable for cooking last of June. As a fruit for culinary purposes, it is very desirable.

Fruit, when trees are well cultivated, of the largest size, ovate rounded, often pointed, heart shape; *color*, clear rich red on pale yellow; when fully exposed to the sun, mostly red; *flesh*, yellowish, tender, sub-acid when fully ripe, sprightly, separates freely from the pit; *stem*, planted in a deep yet open cavity, or basin, and varying from $1\frac{1}{4}$ to $1\frac{3}{4}$ inch in length. Middle June to August.

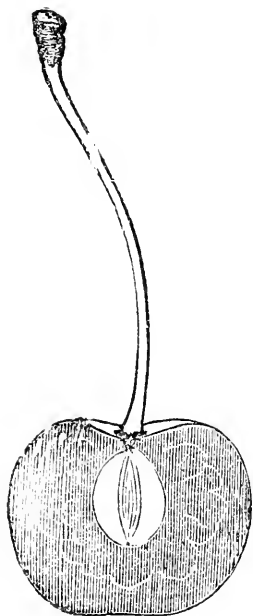

CAROLINE.

Raised by Prof. Kirtland. Tree, much resembles Belle de Choisy; in growth, healthy, hardy, vigorous, and productive; it promises to become valuable as a dessert Cherry.

Fruit, above medium, round oblong, one side compressed slightly; *color*, pale amber, mottled with clear light red, and when fully exposed to the sun becomes rich red; *flesh*, slightly tinged with pale red, or pink, translucent, very tender, juicy, sweet, and delicate; *pit*, medium, oblong oval. Last of June.

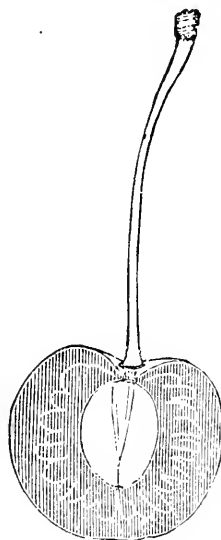

CARNATION.

Wax Cherry,
Crown,
Cerise de Portugal,

Cerise Nouvelle d'Angleterre,
Grosse Cerise Rouge Pale,

Grottier Rouge Pale,
Griotte de Villennes.

A variety of the Morello. that from its hardiness has been pretty largely disseminated through our Western and Southwestern States. *Fruit*, above medium, yellowish white, becoming, when fully ripe, a lively red, slightly marbled; *flesh*, tender, juicy, and, when fully ripe, less acid than most of this class; *stem*, stout. Middle to last of July, but will hang a long time. Tree, a good grower, with strong wood, and a profuse bearer. Valuable Southwest on the prairies.

CLEVELAND.

Cleveland Bigarreau.

Raised by Prof. Kirtland, in 1842, on a gravelly loam soil. The tree is thrifty, with stout shoots, and of a rounded, spreading habit; large leaves; flowers, above medium, profusely abundant, and, thus far, it has proved healthy wherever grown.

Fruit, large, round heart shape, flattened at apex, generally a regular uniform surface, occasional seasons it has a projection on one side, near the stem; *color*, bright clear red on amber yellow ground, and occasionally blotched with carmine red; *flesh*, pale yellowish white, almost firm, deepest in color next the pit, radiating lines indistinct, juicy, rich fine flavor; *pit*, medium size; *stem*, rather stout, medium length. About one week before Elton, or say 23rd to 25th June. Very productive.

COE'S TRANSPARENT.

Raised by Curtis Coe, Middletown, Ct. Tree, upright, somewhat spreading, vigorous, healthy habit. *Fruit*, medium size, occasionally large, regular rounded form, often slightly angular at junction of stem; *color*, pale light amber yellow, with a bright, clear red, indistinctly mottled on two-thirds the surface; *flesh*, with irregular radiating lines, yellowish, tender, juicy, rich, sweet, and excellent; *pit*, above medium; *stem*, rather short, a moderate depression. Middle to 25th June.

EARLY PURPLE GUIGNE.

German May Duke, | Early Purple Griotte.

The origin of this valuable variety we have been unable to decide. Eastern cultivators received it from England, where it was figured and described by Mr. Thompson, in the London Hort. Society's Transactions. Western cultivators received it through a party of emigrants from Germany, under the name of German May Duke, by which it is much grown in Ohio. The trees are poor growers in the nursery, of a straggling, loose, irregular, somewhat pendent habit, but of healthy, hardy character, only moderately productive while young, but as they grow older become more prolific. Its earliness and delicious character, must always render it popular where known.

Fruit, medium to large, roundish heart-shaped, with an indenture at the point or apex; *color*, when fully ripe, dark purplish black; *flesh*, dark purplish red, juicy, rich, sweet, and excellent; *pit*, medium; *size*, roundish oval; *stem*, long, slender, inserted in a shallow, narrow, basin. June.

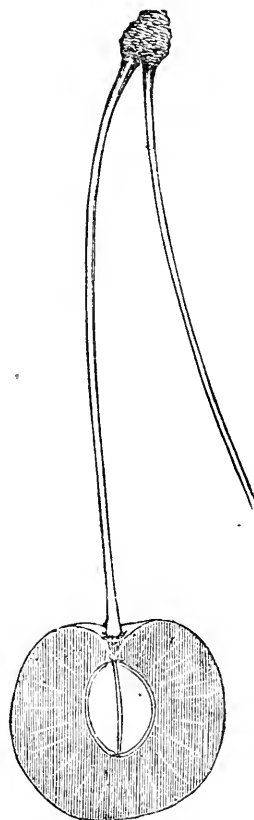

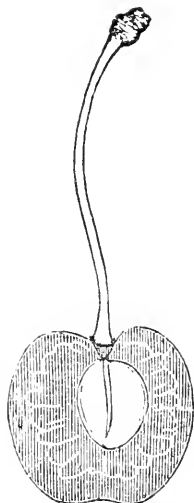

DOCTOR.

The Doctor.

Raised by Prof. Kirtland, in 1842. The tree is of healthy habit, not extremely vigorous, spreading, rounded in form, bearing even to excess of fruit, so much so, that unless well cultivated, the fruit becomes small. Original soil, gravelly loam.

Fruit, medium, roundish heart shape, with a suture extending all round; *color*, light yellow and red, the latter most prevailing; *flesh*, white, tinged with pale yellow, juicy, tender, sweet, with a delicious flavor; *pit*, small; *stem*, rather slender, in a round, regular basin. It ripens early in June, and will hang until July.

ELTON.

Bigarreau Couleur de chair,
Flesh Colored Bigarreau,
Gros Bigarreau Couleur du chair,
Gros Bigarreau Blanc,
Bigarreau a Gros Fruit Blanc,

Large Heart-Shaped Bigarreau, *erroneously*.
Bigarreau de Rocmont,
Cœur de Pigeon,
Bigarreau Belle de Rocmont,
Guigne Gros Blanche, *of some*.
Bigarreau Common,
Belle Audigeoise.

Raised in England, in 1806. Its superior qualities have made it a great traveller, and although often introduced to notice, under a new name, it is always worthy place.

The trees grow vigorously, with a spreading, rather drooping habit; leaves, with purplish foot stalks. First introduced to this country in 1823.

Fruit, large, long heart shape, pointed; *color*, beautiful light yellow ground, mottled and streaked with bright glossy red; *flesh*, yellowish, radiating lines not bold, half tender, when fully ripe, nearly tender, juicy, sweet, with an exceedingly rich, high flavor; *pit*, above medium, oval, rounded, with a sharp point; *stem*, long and slender, set in a rather deep basin; very productive. Last of June.

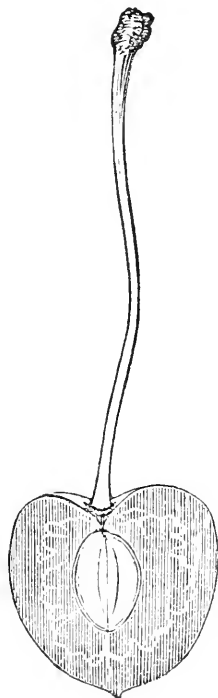

DOWNER'S LATE.

Downer, | Downer's Late Red.

Raised by Samuel Downer, Dorchester, Mass., 1808. The tree is vigorous, half spreading in habit, healthy, hardy, and abundant bearer. Should be in all collections.

Fruit, medium size, round heart shape, slightly compressed on one side; *color*, a bright, lively red, mottled with amber in the shade; *flesh*, amber color, stained slightly with red near the pit, radiating lines slight; tender, sweet, and delicious when fully ripe. It is often gathered before fully ripe, when it is a little bitter; *pit*, above medium size, oblong rounded; *stem*, medium, inserted in a narrow slight depression. From fourth to twelfth July. This variety suffers less than most varieties from warm wet weather.

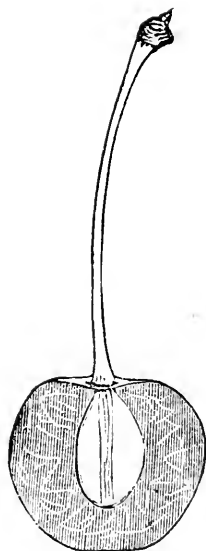

DELICATE.

Raised by Prof. Kirtland, in 1842, upon a gravelly loam. The tree is of thrifty, healthy habit, spreading so as to form a round head. It is productive, and as a dessert cherry, its delicate, translucent character, rich, juicy, sweet, high flavor, will always render it a favorite. When the Sweet Cherry can be grown it is far preferable to the Belle de Choisy.

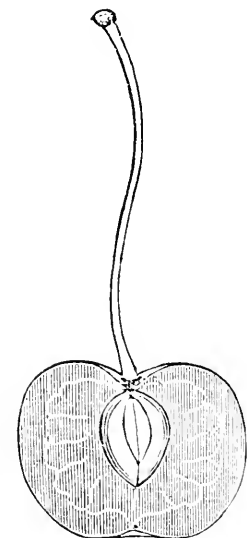

Fruit, medium to large; *form*, regular, roundish flattened, with a slight suture one side; *color*, rich amber yellow, overspread and mottled with light carmine red, while the flesh is so translucent that, held to the light, the tissue is distinctly traced, and red appears as though mingled throughout, when, on cutting it, the flesh is a whitish yellow, with distinct radiating lines; tender, juicy, sweet, delicious, high flavor; *pit*, small, roundish oval, with a broad ridge; *stem*, medium, set in a deep, round depression. About first July. The best of all for the amateur.

FLORENCE.

Knevett's Late Bigarreau.

From Florence, in Italy. The tree is of stocky strong growth, spreading, unproductive while young, becoming more productive as it grows old. *Fruit*, large, roundish heart shape, flattened at base, pale amber, mottled or mostly covered with bright red; *flesh*, amber color, firm, rich, sweet, fine flavor; *pit*, small, roundish oval; *stem*, inserted in a broad basin. Middle July.

EARLY RICHMOND.

Kentish,
Virginian May,
Common Red,

Sussex,
Pie Cherry,
Kentish Red,

Montmorency a longue queue,
Commune,
Muscat de Prague.

An old European sort, but extensively grown in this country, under the name we have adopted. It is probably the true Kentish; but under that name it becomes so often confounded with the common Sour Pie-Cherry, of our country, that we have preferred to continue it here, under the name it is best known in this country. The tree belongs to the Morello class; grows about twenty feet high, with a roundish spreading head; very productive, ripening its fruit in May, but, in dry seasons, holding it until July. It is indispensable to every garden; and for market, coming as it does so early, is very profitable. It is remarkable for the corolla remaining on the stalk, and for the tenacity with which the stone adheres thereto.

Fruit, of medium size, borne in pairs, round, bright red, becoming darker as it hangs on the tree a long time: *flesh*, of a reddish cast, juicy, very tender sprightly, rich acid flavor; *stem*, usually short, say one and a quarter inch, set in deep, round, basin

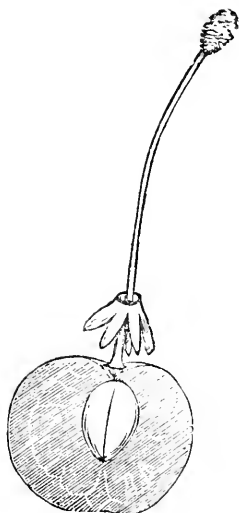

GOVERNOR WOOD.

Raised by Prof. Kirtland, 1842, and named in honor of Reuben Wood, late Governor of Ohio.

The tree is a vigorous, healthy grower, forming a rounded, regular head; very productive while young: flowers large.

Fruit, of the largest size, roundish heart shape; *color*, rich, light yellow, mottled or marbled with a beautiful carmine flush; grown fully exposed to the sun, it becomes a clear, rich red; *suture*, half round, followed on opposite side by a dark line; *flesh*, light, pale yellow, with radiating lines, transverse, acuminate, half tender, juicy, sweet, and fine, rich, high flavor; *pit*, roundish ovate, considerably ribbed; *stem*, varying in length and size. Middle of June.

In even small collections, this variety should always have a place.

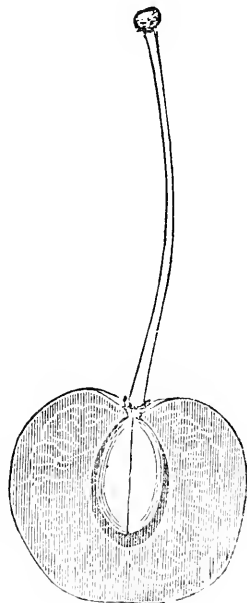

GREAT BIGARREAU.

Large Prool?

Foreign. Its direct origin in obscurity: first introduced to notice by that eminent writer, A. J. Downing, when editing the *Horticulturist*, in 1851.

Trees, extremely vigorous, with large and long foliage, and producing

abundantly. When first preparing this work, we made it a synonym of "Large heart-shaped;" we are now satisfied it is a distinct and a very desirable variety.

Fruit, very large, oblong heart shape; beautiful deep red, becoming nearly black at maturity; *stem*, rather short, and set in a deep cavity; *flesh*, similar to Black Tartarian. Early July.

GRAFFION.

Bigarreau,	White Bigarreau?	Bigarreau Royal,
Yellow Spanish,	Amber or Imperial,	Italian Heart,
Fellow's Seedling,	Turkey Bigarreau?	Bigarreau Gros?
West's White Heart,	Bigarreau Tardif,	Groote Princess,
Hollandische Grosse,	Prinzessin Kirsche,	Cerise Ambrée.

The Graffion, or Yellow Spanish, as it is generally known throughout the States, is truly one of the richest and best cherries, but its tendency to decay just as it is on the point of ripening, makes it unprofitable. The tree is of strong, spreading, healthy habit, and productive.

Fruit, large regular obtuse heart-shape; whitish yellow, mottled and mostly overspread in the sun with bright red; *flesh*, yellowish, firm, juicy, rich, sweet, delicious; *pit*, small, round, ovate; *stem*, stout, in an open basin. Early July.



Joc-o-sot.

Raised by Prof. Kirtland, in 1842, and named after a noble Sioux chief, who died at Cleveland, in 1844. Tree, thrifty, half spreading, or round-headed, and productive.

Fruit, large, very regular, uniform, heart-shape, slightly obtuse, and with a deep indentation at apex; *sides*, compressed; *suture*, broad, half round, followed with a dark line, and often a knob-like projection; *surface*, uneven; *color*, rich, glossy, dark liver-color, almost black; *flesh*, with indistinct radiating lines, dark liver-color, tender, juicy, with a rich, sweet flavor; *pit*, below medium size, regular smooth; *stem*, long, and of medium size. Near the last of June.

HILDESHEIM.

Hildesheim Bigarreau,	Bigarreau Marbre de Hildesheim,
Tardif de Hildesheim,	Bigarreau Blanc Tardif de Hildesheim,
Bigarreau Tardif de Hildesheim,	Bigarreau Noir Tardif.

From Germany. Tree, upright, strong grower, unproductive while young.

Fruit, medium, heart-shaped, yellow, mottled, marbled and splashed

with red; *stem*, long, slender; *basin*, shallow, broad; *suture*, broad, half round, with hollow depression at apex; *flesh*, pale yellow, firm, sweet; *pit*, medium, surface marbled with red. Last of July to twentieth August. The true variety is rarely sold, but when obtained, is truly valuable, as coming just before peaches, and when there are few fruits in market.

KIRTLAND'S MARY.

Raised by Prof. Kirtland, in 1842, described and named by ourself, in compliment to the daughter of Prof. K. The tree is a strong, healthy grower, upright, rounded in form, shoots strong, not rampant; *flowers*, large and open, very prolific. The fruit is one of the most beautiful of all cherries, quite firm-fleshed, but, withal possessing delicacy and high flavor, that renders it one of the most desirable varieties, either for dessert or market purposes.

Fruit, large, roundish heart-shaped, very regular; *color*, light and dark rich red, deeply marbled and mottled on a yellow ground, grown fully in the sun is mostly a rich, dark glossy red; *flesh*, with distinct irregular radiating lines, light yellow, quite firm, rich, juicy, sweet, and very high flavored; *pit*, medium, regular, rounded, with distinct prominent lines or ridges, flesh adheres slightly to it; *stem*, moderately stout, varying in length. Last of June and first of July.

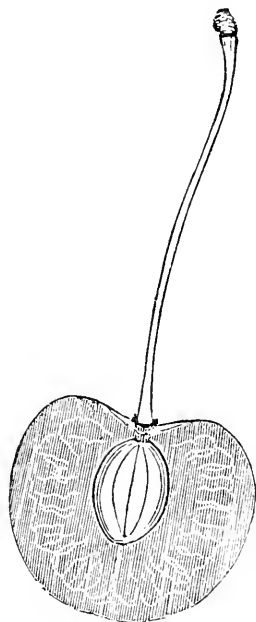

KIRTLAND'S MAMMOTH.

Raised by Prof. Kirtland, from a pit of the Yellow Spanish, grown on a tree remote from other varieties. Its name is given from the extreme large size of the fruit, being one-eighth greater than any other variety. The tree is of strong, vigorous growth, with very large leaves and large flowers. It is, however, only moderately productive. Soil of origin, gravelly loam.

Fruit, of the very largest size, often three and a half inches in circumference, obtuse, heart shape; *color*, light clear yellow, partially over-spread, and marbled with rich red; *flesh*, with distinct radiating lines, broad, ovate, reversed, almost tender, juicy, sweet, and with a very fine high flavor; *pit*, roundish oval, regular, surface indented; *stem*, generally short, moderately stout. Last of June.

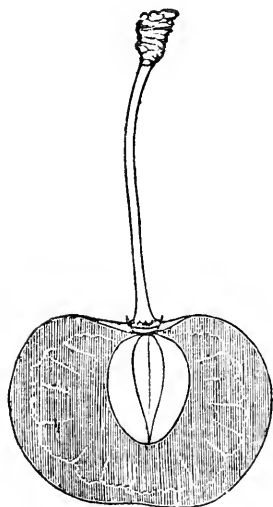

KNIGHT'S EARLY BLACK

English. Tree, moderate grower, requiring good culture and sheltered

situation to obtain good fruit. As it makes only a tree of second class in size, it is well suited to small gardens; moderately productive.

Fruit, medium or rather above, obtuse heart shape, broad, open suture, half round, with a knobby projection opposite; purplish red, becoming nearly black; *flesh*, parts freely from pit, tender, juicy, rich, sweet; *pit*, medium; *stem*, inserted in a deep, open basin. Last of June.

LARGE HEART-SHAPED.

Black Bigarreau of Savoy,
Bigarreau gros Couret,
Bigarreau de Lyon,
Guigne Noire luisante, *erroneously*,
New Large Black Bigarreau,

Bigarreau gros Monstreux,
Gros Couret,
Large Heart-Shaped Bigarreau,
Ward's Bigarreau.

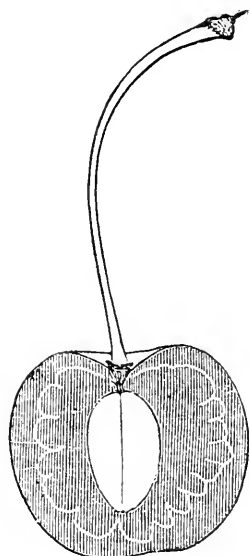

This variety, originally from France, we have received from different sources, and fruited under most of the synonyms given.

The tree is a strong, vigorous grower, with large foliage. Its productive habit, fine flesh, and large size of fruit, render it very desirable as a market variety; while its want of delicacy and flavor unfit it for grounds of those who grow only for private use.

Fruit, very large, roundish heart shape, occasionally obtuse, dark shining red, becoming, when fully ripe, dark purplish black; surface, very uneven; *flesh*, reddish purple, coarse tissue, with a distinct dark line one side next the pit, not very juicy and lacking in high flavor; *pit*, large, oval; *stem*, varying, inserted in a shallow depression. Fourth to tenth July.

LOGAN.

Raised by Prof. Kirtland, in 1842; soil a gravelly loam. Tree, hardy, healthy grower, somewhat spreading, moderately productive; flowers, large, opening late, little liable to injury from frost.

Fruit, medium or above, obtuse, sometimes regular heart shape, with a shallow indenture at apex; *color*, purplish black, when ripe; *flesh*, liver color, radiating lines, almost white, nearly firm, juicy, sweet, and rich flavor; *pit*, above medium, oval; *stem*, varying in length, in a deep cavity. Middle to last of June.

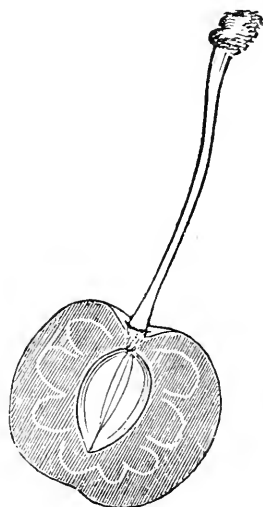

MANNING'S MOTTLED.

Mottled Bigarreau.

Raised by Mr. Manning, Salem, Mass. Tree, vigorous, spreading, very productive. *Fruit*, large, roundish heart shape; suture, half round, distinct line opposite; amber color, mottled and overspread with red; *flesh*, yellowish white, half tender, juicy, sweet, deficient in flavor; *pit* large, oval, lies in a hollow, separated on all sides but one from the flesh *stem*, in a broad hollow. Last of June.

MAY DUKE.

Early Duke,	Thompson's Duke,	Cerise Guigne,
Large May Duke,	Portugal Duke,	Conlarde,
Morris Duke,	Buchanan's Early Duke,	De Hollande,
Morris' Early Duke,	Millet's Late Heart Duke,	D'Espagne.
Benham's Fine Early Duke,	Royal Native,	

From France. Tree, hardy, upright growth. It produces freely, is one of the oldest sorts, succeeds admirably upon prairie soils and in the Southern States. With us it has proved a most unreliable sort, ripening very irregularly.

The Holman's Duke, Jeffrey's Duke, Late Duke of most gardens, are all so similar to May Duke, that one description will suit all. They are only sub-varieties, and the Late Duke probably obtained by propagating from late ripening branches of May Duke. *Fruit*, roundish obtuse heart shape, red at first, becoming, when fully ripe, a dark purplish red; *flesh*, reddish, tender, juicy, sub-acid. Last of May to last of June.

MONSTREAUX DE MEZEL.

Bigarreau Gaubalis.

From France. Tree, strong, vigorous grower, productive. *Fruit*, large, oval, flattened on sides, obtuse at base, irregular surface, reddish purple or reddish black; *flesh*, firm, rather coarse, purplish, melting, sweet; "very good;" *pit*, large, oval; *stem*, varying. Early July.

NAPOLEON.

Napoleon Bigarreau,	Spotted Bigarreau,	Armstrong's Bigarreau,
Bigarreau Lauermann,	Lauermann's Kirsche,	Turkey Bigarreau ?
Bigarreau d'Hollande,	Clarke's Bigarreau,	Holland Bigarreau.

From Holland. Tree, erect, vigorous grower, productive. The best sweet cherry for cooking purposes, and, on account of its showy appearance, always sells well in market. It is, however, liable to decay on the tree before fully ripe. *Fruit*, large, heart shape, inclining to oblong, bright delicate yellow, with shades of rich red marbled and spotted over nearly two-thirds surface; *flesh*, pale yellow, very firm, moderately juicy, and, unless perfectly ripe, a little bitter; *pit*, medium, oblong; *stem*, stout, set in a narrow basin. Last of June.

OHIO BEAUTY.

Raised by Prof. Kirtland, in 1842, and described by us in 1847, shortly after which the original tree was destroyed. We had, however, previously sent out buds and grafts, and have often heard of its success. *Fruit*, large, obtuse heart shape, dark rich red on pale red ground, somewhat marbled;

flesh, white, tender, delicate, juicy, with a fine flavor; *pit*, small, oval, *stalk*, long, set in a deep, open basin. Middle of June.

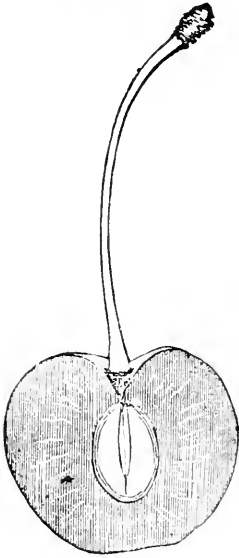

OSCEOLA.

Raised by Professor Kirtland, in 1842; soil, gravelly. Tree, round, spreading, regular form, hardy, healthy grower; flowers, medium, opening rather late and in succession; a good, not excessive bearer.

Fruit, medium to large, regular, heart shape, with a deep, broad suture, half round; *color*, dark purplish red, inclining to black; *flesh*, liver color, fine tissue, so much so, that the radiating lines are almost obliterated, juicy, rich, and sweet; *pit*, medium or small, ovate rounded; *stem*, moderately stout, in a deep, regular cavity. Last of June and early July. One of the best for all collections.

PONTIAC.

Raised by Professor Kirtland, in 1842; soil, gravelly. Tree, upright, rounded form, slightly spreading, vigorous, healthy habit; flowers, above medium size, opening in succession; regularly productive.

Fruit, large, obtuse heart shape, sides compressed; *suture*, half round, deep, distinct, followed by dark line; slight depression at apex; *color*, dark purplish red, approaching to black when fully ripe; *flesh*, purplish red, radiating lines irregular, half tender, juicy, sweet, and agreeable; *pit*, medium, smooth, parts freely from the flesh; *stem*, varying from long to short, inserted in a broad, open cavity. Last of June. A very desirable variety, and profitable for market.

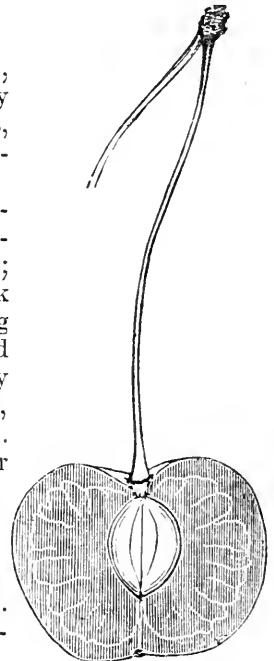

POWHATTAN.

Raised by Prof. Kirtland, in 1842; soil gravelly. Tree, vigorous, healthy, round-headed, productive.

Fruit, medium size, uniform, roundish, flattened or compressed on sides, surface irregular; *color*, liver-like, highly polished; *suture*, half round; *flesh*, rich purplish red, marbled, radiating lines obscure, half tender, juicy, sweet, pleasant, but not high flavor; *pit*, small, round, elongated; *stem*, medium. Late, 8th to 15th July.

For profitable market purposes, this is one of the very best, the fruit ripening late, and all being uniform and regular in size.

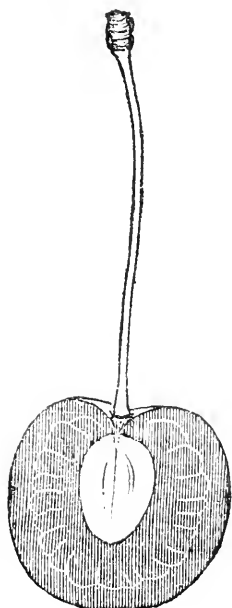

RED JACKET.

Raised by Prof. Kirtland, in 1842. The original tree has always stood in ground uncultivated; yet its fruit from lateness of ripening, size and quality, renders it most desirable, and especially for market culture, as it is very productive. The tree forms a head similar to the Black Mazard, not quite as erect.

Fruit, large, regular, long obtuse heart shape; *color*, fine, clear, light red, when grown in the sun, but of an amber color, overspread with pale red, and often a yellow russet patch, when grown in the shade; *flesh*, with radiating lines distinct, half tender, juicy, of good, not high flavor; gathered before ripe, it is a little bitter; *pit*, medium; *stem*, rather long and slender, set in an open, moderately deep basin. Middle of July.

REINE HORTENSE.

Lemercier of E. and B.,
Monstreuse de Bayay,

Belle de Bayay,
De 16 a la livre,

Belle de Petit Brie.

Introduced to this country from France, in 1842. The tree is of Duke habit, vigorous, healthy grower, forming a dense, upright, round head, and promises to be very hardy, and extremely desirable in rich, moist soils, where the Sweet Cherries do not succeed as well. It is moderately prolific, the fruit quite large, and ripening as it does, quite late in the season, combined with the habit of hanging long after ripe, and its rich, sprightly, sub-acid juice, must render it extremely popular, when it becomes fully known.

Fruit, quite large, round elongated, sides compressed, smooth, glossy, regular surface; *suture*, shallow, half round, followed by a marked line, terminating at base, in a knobby projection; *color*, bright lively red, marbled and mottled on amber; grown in the sun, it is mostly red; *flesh*, pinkish yellow, with radiating lines, distinct, but irregular in form, tender, and when fully ripe, separating freely from the stone, often even exhibiting a hollow, vacant space, between pit and flesh, high, sprightly, slightly acid flavor; *pit*, rather large, oblong rounded; *stalk*, two inches long, generally slender. Twelfth to twentieth July.

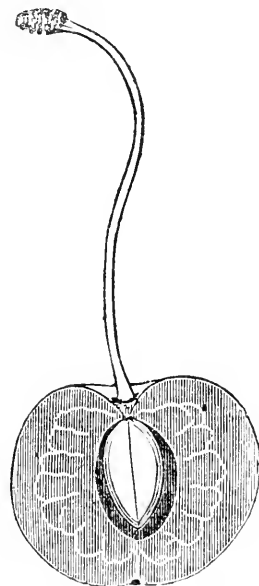

ROCKPORT.

Rockport Bigarreau.

Raised by Prof. Kirtland, in 1842; gravelly loam. Tree, strong, vigorous grower, forming a very upright habit, more resembling the Black Tartarian than any other variety we know. It is one of the first of Prof. Kirtland's seedlings that was described, and feeling interested in its success, in various parts of the States, we distributed it pretty liberally in shape of buds and grafts. It has now been fruited extensively, and every where proves among the largest and very best quality. The tree wants good culture, and its period of maturity is materially altered both by soil and culture, while its character appears unchanged. Valuable, either for private or market gardens.

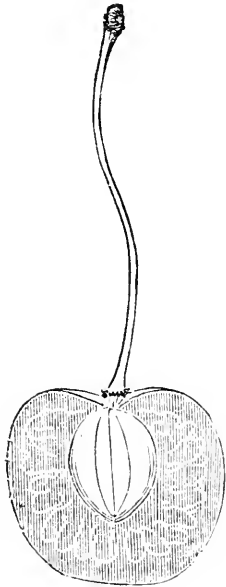

Fruit, large, round obtuse, heart shape, surface generally slightly uneven, and always with a knobby or swollen projection on one side; *color*, clear, brilliant, deep red, shaded and mottled on a pale amber yellow, with occasional carmine spots; *flesh*, yellowish white, radiating lines irregular, a yellow tinge around the pit, firm, juicy, sweet, with a rich, delicious flavor; *pit*, oval, regular and without ridges; *stem*, usually of medium length—one, to one and a half inches. 20th to the last of June.

SHANNON.

This is a Morello, raised by Prof. Kirtland, in 1829; first described in 1849. Named in respect to Wilson Shannon, once governor of Ohio. The tree is very hardy, having been tested in many locations.

Fruit, slightly above medium size, globular, flattened at junction with stem, dark purplish red, when ripe; *flesh*, tender, reddish purple, juicy, acid; *pit*, small; *stem*, long, slender, inserted in an open cavity. Middle of July.

TECUMSEH.

Raised by Prof. Kirtland, in 1842, on a soil of gravelly loam. The tree is moderately vigorous, spreading, hardy, producing its blossoms late in the season.

Fruit, medium to large, obtuse heart shape, compressed, with a broad, shallow suture; *color*, when fully ripe, a reddish purple, or dark liver-color, mottled somewhat with red; *flesh*, reddish purple, irregular, distinct radiating lines, half tender, very juicy, sweet, but not high flavor; *pit*, medium size, smooth, round, slightly elongated; *stem*, varying, set in an open, rather deep cavity. Middle to 20th July. Very valuable for a late market variety.

VAIL'S AUGUST DUKE.

Raised by Henry Vail, Troy, N. Y. Tree, hardy, healthy, moderate grower. *Fruit*, above medium, borne in pairs, obtuse heart shape; rich bright red in the shade, a lively cornelian in the sun; *flesh*, tender, sub-acid; *pit*, oval; *stem*, thick, where it joins the fruit, set in a deep, narrow cavity. Middle to last of August.

WENDELL'S MOTTLED.

• Wendell's Mottled Bigarreau.

Raised by Herman Wendell, M.D., Albany, N. Y. Tree, upright, thrifty growth, early and prolific bearer. This variety has proved highly valuable during the few years it has been before the public. *Fruit*, large, obtuse heart shape; dark, purplish red; *flesh*, firm, juicy, well flavored; *pit*, small; *stem*, set in a round, regular basin. First to middle of July.

CLASS II.—*Embraces varieties, of which many are new and untested, and others suited to large orchards, or certain localities.*

ADAM'S CROWN.

English; little known in this country. Fruit, medium, round heart shape; pale red; flesh, tender, juicy and agreeable. Middle of June.

AMBER GEAN.

Gean Amber.

Fruit, small, oval heart shape, pale yellow and red; flesh, white, juicy, sweet, often bitter or mazardy; stem, long, slender. Early July.

AMERICAN AMBER.

Bloodgood's Amber, | Bloodgood's Honey, | Bloodgood's New Honey.

American. Fruit, medium, roundish heart shape, amber and bright red; flesh, tender, juicy, variable; pit, large; stem, long, slender. Last June.

ANNE.

From A. V. Bedford, Paris, Ky. Fruit, below medium, bright red, tender, juicy, sweet, excellent—good for amateurs. Early in June.

BAUMAN'S MAY.

Bigarreau de Mai, | Wilder's Bigarreau de Mai.

From France. Fruit, small, dark red, oval heart shape; flesh, purplish, tender, sweet. Last of May or early in June.

BELLE AGATHE.

Foreign. New. Medium. roundish oval, two shades red; flesh, firm, sweet; very late, which is the only inducement to its culture.

BELLE DE SCEAUX.

Chatenay.

A Morello, from France. Fruit, round, deep red; flesh, yellowish, juicy, acid. June. Valuable only at the West.

BELLE VEZZOURIES.

Foreign. Fruit, medium to large, light red, somewhat translucent, roundish, sub-acid; "good." 10th to 20th July.

BLACK HEART.

Early Black, Black Russian,		Gaigne Grosse Noir, Ansell's Fine Black,		Spanish Black Heart, Guinier a fruit Noir.
--------------------------------	--	---	--	---

An old variety, hardy and productive, but at this day surpassed by many. Fruit, above medium, heart shaped, dark, nearly black color; flesh, almost tender, juicy, sweet. Last of June.

BRANDYWINE.

Originated with J. R. Brinckle, Wilmington, Del. Tree, vigorous grower. Fruit, above medium, broad heart shape, brilliant crimson mottled; flesh, tender, juicy, sweet, sprightly. Last of June.

BURR'S SEEDLING.

Originated in Western New York. Tree, vigorous, spreading, productive. Fruit, medium to large, heart shape, clear bright red on pale yellow, half tender, juicy, sweet; stem, slender. Middle to last of June.

BUTTNER'S BLACK HEART.

Buttner's Herz Kirsche, | Schwarze Neue Herz Kirsche.

From Germany. As a late variety, firm fleshed, for market, this promises well. Fruit, large, heart shape, purplish black, when fully ripe; flesh, reddish violet, firm, juicy, good, not high flavor. Middle to last of July. Tree, productive, a vigorous grower.

BUTTNER'S YELLOW.

Buttner's Wach's-Knorpel Kirsche, | Buttner's Gelbe Knorpel Kirsche.

From Germany. Tree, vigorous, spreading; only as a novelty is it desirable. Fruit, medium, regular heart shape, flattened at stem end, pale lemon yellow, with russet marblings; flesh, whitish yellow, firm, even, tough, without flavor, adheres to the pit; stem, medium length and size, in an open, round, regular cavity. Middle to last July.

CARMINE STRIPE.

Raised by Prof. Kirtland. Tree, vigorous, healthy, spreading, very productive. Fruit, above medium, heart shape, compressed on sides, often an uneven surface, with suture half round, followed by a line of carmine; color, amber yellow, shaded and mottled with bright, lively carmine; flesh, tender, juicy, sweet, sprightly, and agreeable; pit, small; stem, varies. Last of June.

CONESTOGA.

This variety originated in Conestoga Township, Lancaster County, Pennsylvania. Fruit, very large, obtuse heart-shaped, slightly indented at the apex, dark purple; stem, from an inch and three-quarters to two and a quarter long, slender, inserted in an open cavity; flesh, purplish, firm; flavor, sugary, and very pleasant; quality, "best." (W. D. B.)

CHRISTIANA.

Raised by B. B. Kirtland, Greenbush, N. Y., and resembling, in character of tree and fruit, the May Duke. Not having fruited it, we only note from the Horticulturist, where the fruit is said to be borne in clusters, of a bright, lively, red color, and sprightly sub-acid flavor.

CHAMPAGNE.

Raised by Chas. Downing, Newburgh, N. Y. For large orchards, we think it desirable as a bearer, but not of size to command price in market. Tree, vigorous, healthy, productive. Fruit, medium, roundish heart shape, slightly angular; color, shades of lively red; flesh, amber color, juicy, sprightly, rich flavor; stem, moderate length, in a shallow cavity. Middle of June, but hangs well into July.

CUMBERLAND.

Triomphe, of Cumberland, Monstrous May,		Brenneman's May, Steret's May,		Cumberland Seedling.
--	--	-----------------------------------	--	----------------------

This is claimed to be a seedling of Cumberland Co., Pa. Having fruited it from two sources, one proving identical with Yellow Spanish, and the other identical with Tradescant's Black, we have some doubts as to its being a seedling or new variety. In the *ad interim* report of the Pennsylvania Hort. Society, it is thus described: "Large, obtuse heart-shaped, sometimes roundish, compressed at the sides, deep crimson, almost purple when fully ripe; suture, indistinct; stem, rather long, slender, inserted in a broad, open cavity; apex, slightly depressed; stone, roundish oval, compressed; flesh, rather solid, red, slightly adherent to the stone; flavor, fine; quality, 'best.' About the middle of June."

CHINA BIGARREAU.

Chinese Heart.

Raised by Wm. Prince, Flushing. Tree, hardy, healthy, spreading. Fruit, medium, roundish heart shape; bright amber yellow, becoming mostly red when fully ripe; flesh, half tender, juicy, and rich, but, unless perfectly ripe, slightly bitter; stem, long and slender; very productive.

DAVENPORT.

Davenport's Early, | Davenport's Early Black.

Tree, tender. Fruit, medium, heart shape, dark purplish black; flesh, tender, juicy, sweet. Last of June.

D'ESPERIN.

Bigarreau D'Esperin.

From Belgium. Hovey says the tree has a compact, spreading habit, of moderate growth, a good bearer. Fruit, large, roundish heart shape, depressed at ends, flattened on sides; suture, all round; color, clear, soft amber in the shade, mottled with pale red in the sun; flesh, pale amber, tender, juicy, excellent; pit, medium, oval; stem, long, slender. Early in July.

DOWNING'S RED CHEEK.

Raised by Chas. Downing, Newburgh, N. Y. Tree, vigorous, half spreading. Fruit, medium to large, obtuse heart shape, yellowish white, with a rich dark crimson, covering more than one-half the fruit; flesh, yellowish, half tender, delicately sweet; stem, set in an even hollow of moderate depth. Middle to last June.

DONNA MARIA.

A Morello cherry, forming a small tree, but very prolific. Fruit, of medium size, dark red, tender, juicy, rich, acid; valuable for cooking. Middle July. Promises valuable South and West.

DOWNTON.

English : raised by T. A. Knight. Tree, healthy, regular round head ; moderately productive.

Fruit, medium, globular flattened, bright red on yellow ; flesh, yellowish, half tender, juicy, sweet, but not rich flavor ; pit, medium ; stem, set in a deep cavity. Early in July or last of June.

DUCHESS OF PALLUA.

A variety introduced from France, by Hon. M. P. Wilder, of Boston, and fruited for the first time in this country, in 1853.

Fruit, medium size, heart-shaped, purplish black, juicy, half tender, sub-acid ; stone, small, oblong ovate. 15th to 20th June. Promises to be a productive, valuable variety.

EARLY WHITE HEART.

Arden's Heart,		Dredge's Early White Heart,		Sweedish,
White Transparent,		Amber Heart,		Sweedish Red Heart.
Arden's Early White Heart,		Herefordshire White,		

An old variety, and generally known throughout the States. It is a variable and uncertain bearer, and does not ripen sufficiently early to compete with many new varieties. Fruit, medium, or a little below, heart shape, whitish yellow, often nearly covered with pale red : flesh, half tender, juicy, sweet. Middle of June. The Early Red and Yellow of Manning is very similar. "Manning's Early White Heart," "Bowyer's Early Heart," and "River's Early Amber," are sub-varieties, varying but little from the original.

EARLY MAY.

Cerise Indulle,		May Cherry,
Small May,		Precoce.

A Morello, with small fruit, round, slightly flattened, lively light red ; flesh, tender, juicy, acid. Much esteemed in many Southern and South-western sections because of its hardihood and productiveness. It should, however, give place to better sorts.

EARLY PROLIFIC.

Raised by Prof. Kirtland, in 1842. The original tree fruited three years, during which we carefully noted the fruit. It then was lost by being removed ; meantime, buds had been sent to Mr. Chas. Downing, and it is from the character shown under his hands that we make our description. Tree, healthy, vigorous, upright, slightly spreading. Fruit, medium to large, round obtuse heart shape, bright carmine red, mottled on light amber yellow ; and, on one side, a distinct line, edged with yellow ; stem, varying both in size and length ; flesh, half tender, almost firm, juicy, rich, sweet, and delicious flavor ; very productive. Middle of June.

ELKHORN.

Tradescant's Black Heart,		Bigarreau Noir Tardive,		Guigne Noir Tardive,
Large Black Bigarreau,		Bigarreau Gros Noir,		Grosse Schwarze Knoopel.

This is, probably, an old variety from Europe, but as it was first made known in this country, and distributed under the name of Elkhorn, we have preferred following that to copying from the London Hort. Society

Trees, very vigorous, with broad leaf and bark of peculiar gray color, producing fine large fruit while young, but as they grow older, unless very highly cultivated, the fruit diminishes to nearly the size of the old Black Heart. Its period of late ripening has heretofore kept it favorably before horticulturists, but we now think it must give way to later and better varieties. Fruit, large, heart shape, uneven surface, purplish black; flesh, firm, purple, moderately juicy; pit, large; stem, short. Middle of July.

ENGLISH AMBER.

This is, undoubtedly, an old variety, but we have as yet been unable to identify it with any described variety. The tree is of vigorous, strong growth, forming a rounded pyramidal head, and very productive.

Fruit, medium size, roundish heart shape, very regular, borne in threes; color, delicate amber, beautifully mottled with pale red; flesh, whitish yellow, half tender, delicate, juicy, and very sweet; pit, medium; stem, long. Middle to last of June.

ELIZABETH.

Raised by Caleb Atwater, of Portage County, O., in 1823. Original soil, clay. Tree, vigorous, upright, pyramidal rounded; very prolific.

Fruit, medium to large, heart shape, flattened on sides; color, rich dark red, when fully ripe; flesh, yellowish, slightly tinged with red, half tender, juicy, pleasantly sweet; pit, ovate rounded; stem, medium, set in a regular basin. Middle to last of June.

FAVORITE.

Elliott's Favorite.

Raised by Prof. Kirtland, in 1842; gravelly soil. Tree, vigorous, half spreading, productive.

Fruit, medium, round regular, slightly compressed; color, pale amber yellow, with a bright carmine red cheek, mottled and marbled; flesh, pale amber, translucent, delicate, juicy and sweet; pit, small; stem, medium, inserted in an even basin. Last of June.

This variety requires high cultivation, otherwise the fruit is small and the flavor only good; but, under high cultivation, its sprightly high flavor is unsurpassed.

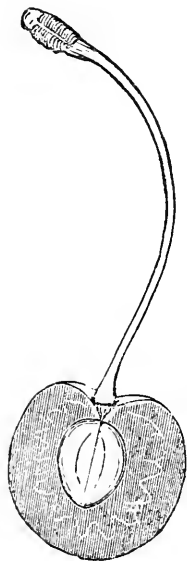

GUIGNE NOIR LUISANTE.

Black Spanish,

Or bright black red, is a cherry of the Duke or near Morello class. Tree, erect in habit, healthy, hardy, forming a pretty round head, regular, moderate bearer. In 1823, it was cultivated in New Jersey, as Black Spanish, and under that name brought to Ohio. Fruit, of medium size, heart shape, globular; glossy blackish red; flesh, reddish purple, tender, juicy, rich, acid; pit, round; stem, medium. Middle to last of July.

HOADLEY.

Raised by Prof. Kirtland in 1842, named by ourself, in compliment to one of our best pomologists, Geo. Hoadley, Esq., of Cleveland. Tree, of healthy, vigorous habit, forming a round, spreading head. Fruit, above medium, regular round heart shape; light clear carmine red, mottled and striped on pale yellow, with some tinges or blotches of russet bronzed yellow; flesh, yellowish, tender, almost translucent, juicy, rich, sweet and delicious; pit, medium, roundish oval; stem, medium, set in a shallow basin. Twentieth to last of June. This promises to become one of the most valuable as a dessert cherry; not quite as sweet as Coe's Transparent, but more delicate and sprightly, with a pit of less size.

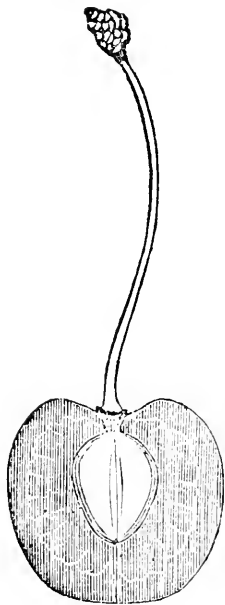

HOVEY.

Raised by C. M. Hovey, Esq., Boston. Tree, vigorous, forming a pyramidal head. Fruit, large, obtuse heart shape, depressed point at apex; rich amber color, mottled or nearly covered with brilliant red; stem, short; flesh, pale amber, rather firm, but tender, slightly adhering to stone; stone, small, oval. 15th to last July. (Hov. Mag.)

JAURIE DE PRUSSE.

Foreign. Fruit small, obtuse heart shape, yellowish white; stem, long, slender; flesh, tender, brisk, a little bitter before fully ripe. Middle July. May possibly be valuable West.

KENNICOTT.

Raised by Prof. Kirtland, and named by ourself after the most enthusiastic horticulturist in the West, J. A. Kennicott, M. D., of Northfield, Ill. Tree, vigorous, hardy, spreading, very productive. Fruit, large, oval heart shape, compressed; suture, shallow, half-round; color, amber yellow, mottled and much overspread with rich, bright, clear, glossy red. flesh, yellowish white, firm, juicy, rich and sweet; pit, below medium size, smooth and regular; stem, short in cavity, with bold surrounding projections. Eighth to Sixteenth July. As a market fruit, the time of ripening, size and beauty of this variety will make it popular when known.

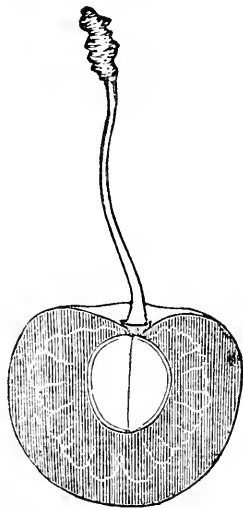

KEOKUK.

Raised by Prof. Kirtland. Tree, strong, vigorous grower, forming a large tree. Fruit, large, heart shape, dark purplish black; flesh, half tender, purple, rather coarse, deficient in flavor; its chief value, a market variety; pit, medium; stem, stout. Early July.

IMPERIAL.

Imperial Morello.

A variety of Morello, forming a small, low-headed tree; very productive. Very valuable throughout the Southwest. Fruit, rather above medium size, roundish heart shape, elongated, sides compressed; dark purplish red when fully ripe; flesh, tender, juicy, rich acid; if gathered unripe, quite bitter; pit, small, long, pointed. Very late, last of July to middle of August.

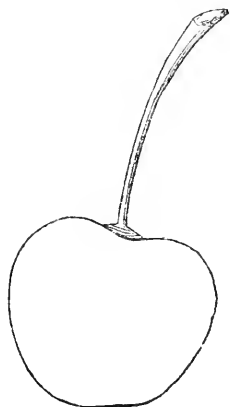

LADY OF THE LAKE.

Originated by Chas. Pease. Medium or above, globular heart shape, compressed on sides; no suture; stem, 1 to 1½ inch, in a very shallow cavity; pale, light clear yellow, overspread mostly, when grown in sun with rich, bright vermilion red, with few marblings of light yellow; flesh, pale yellow, concentric radiating lines; in sun, flesh lined with pink; nearly tender, very juicy and sweet.

LARGE MORELLO.

Kirtland's Large Morello.

Raised by Prof. Kirtland, promises valuable, very large and fine. Fruit, above medium, roundish, dark red, juicy, rich acid, good flavor; pit, small. Early July. One of the best for South and West.

LATE BIGARREAU.

Raised by Prof. Kirtland in 1842, on a gravelly soil. Tree, vigorous, shoots stout, not rampant, forms a round, regular head; flowers, open, abundant, very productive.

Fruit, large, obtuse heart shape, occasionally a little angular, and with a deep, broad indenture at the apex; color, a rich yellow ground, with a bright red cheek, frequently the red covers nearly the whole surface—occasionally, it is blotched or mottled; suture, shallow, half round, marked with a line on opposite side; flesh, with distinct radiating lines, yellowish, nearly firm, juicy, sweet, and of agreeable flavor; pit, small, round, regular; stalk, one and a half inch long, inserted in a broad, open depression. 4th to 12th July.

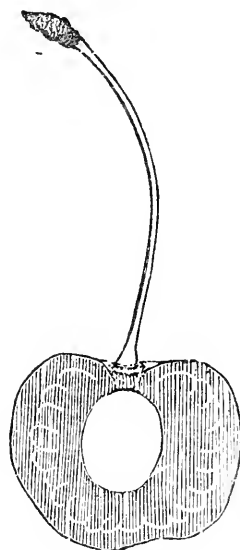

LINDLEY.

Raised by Prof. Kirtland from seeds given him by Mr. M. Lindley, of Euclid, O. Tree, vigorous, moderately prolific. Fruit, large, heart shape, surface uneven, dark purplish red; flesh, almost firm, tinged with red, juicy, but deficient in richness of flavor. First of July.

LEATHER STOCKING.

Raised by Prof. Kirtland, in 1842; gravelly soil. Tree, vigorous, hardy, moderately productive. Fruit, medium to large, heart shape, often obtuse color, faint dull red, becoming, when fully ripe, rich reddish black; flesh, very firm, tinged with red, sweet, good flavor; pit, medium; stem, in an open, but deep basin. Middle to last of July. As a variety to transport long distances to market, this will prove valuable.

LOUIS PHILLIP.

A variety of the Morello, from France. The tree makes a beautiful bush pyramid, bears profusely a medium-sized, roundish, dark red fruit; flesh, red, juicy, tender, quite acid. Middle July. Valuable South and West.

MADISON.

Madison Bigarreau.

Raised by Mr. Manning. Tree, healthy, moderate grower, tolerably productive. Fruit, medium; color, red, marbled on light yellow; flesh, half tender, juicy, sprightly, very agreeable; pit, small, oval; stem, slender. Last June.

MARY.

Raised by B. B. Kirtland, Greenbush, N. Y., and noted in the Horticulturist as similar to Christiana.

MERVEILLE DE SEPTEMBER.

Tardive de Mons.

The Marvel of September is a French cherry, marvelous only because it ripens the last of August or early in September. Tree, vigorous. Fruit, small, dark red, firm, dry, sweet.

MORELLO.

English Morello,		Large Morello,		Ronald's Large Morello.
Dutch Morello,		Late Morello.		

The true English Morello is rare in this country, nor do we see any reason for introducing it, as seedlings may be raised from the common Morello equaling, if not often surpassing, the one so favorably described by most writers. In growth, it varies from our common Morello only in the branches being more strong and upright, while the fruit is one third larger. Fruit, medium or above, round; dark red or purplish black; flesh, purplish red, tender, juicy, sub-acid. Middle to last July.

MOYER'S HONEY HEART.

Originated in Springfield, Bucks Co., Pa. Tree, strong grower, forming a round head; productive. Fruit, large, heart shape; suture, half round: color, rich red; stem, long; flesh, pale yellow, juicy, sweet, high flavor. Fifteenth to twentieth June, or just after Purple Guigne.

PIERCE'S LATE.

Originated with Amos Pierce, and introduced by Hyde & Son, Newton Center, Mass. Tree, forms an upright round head. Fruit, medium, obtuse heart shape, dark red mottled on amber; stem, rather short and slender; flesh, soft, tender, juicy, sweet, rich, "delicious;" pit, small. Last July.

PLUMSTONE MORELLO.

Fruit, large, roundish, deep red; flesh, tender, juicy, agreeable acid. Last July. Its very large pit renders it unworthy, as compared with Shannon.

PRESIDENT.

Raised by Prof. Kirtland, 1842. Tree, vigorous, spreading. Fruit, large, dark red, slightly mottled; suture, all round, deep, distinct; flesh, yellowish white, half tender, juicy, sweet; pit, medium; stem, short, slender. Middle to last of June.

PROUDFOOT.

Proudfoot's Seedling.

Raised by D. Proudfoot, Cleveland, O. Soil, sandy. Tree, vigorous, round, spreading head; moderately productive. This promises to become valuable on account of large size and lateness in ripening, often, even, on warm, sandy soil (and sheltered in a city garden), holding its fruit until the 20th July. Fruit, large, heart shape, flattened at base; color, when fully ripe, dark, purplish red; flesh, yellowish, firm, juicy, sweet; pit, large; stem, set in a shallow, open cavity. Fifteenth to last July.

RICHARDSON.

Large, heart shaped, rather short, and tapering to the point; dark red, inclining to black; stem, short, slender; flesh, deep red, half tender, juicy, saccharine, rich, luscious flavor. Last of June and first of July. It keeps well on or off the tree. Good grower and bearer, rather upright, hardy in tree, and fruit. Original tree, as far as known, in the garden of J. R. Richardson, Esq., Boston. (Cole.)

ROBERTS' RED HEART.

Raised by David Roberts, Salem, Mass. Tree, moderate, healthy grower, productive. Fruit, medium, roundish heart shape; pale amber ground, nearly overspread and mottled with red; suture, distinct; flesh, white, juicy, sweet, tender, and well flavored; pit, medium; stem, long, slender. Last of June.

SPARHAWK'S HONEY.

Sparhawk's Honey.

Fruit, below medium, roundish; yellow, mostly covered with red; flesh, tender, sweet, very productive. 10th to 15th July. A variety much esteemed by a few persons; but we think superseded by other and better sorts.

TOWNSEND.

From W. P. Townsend, Lockport, N. Y. Fruit, large, obtuse heart shape, high shouldered, compressed; suture, distinct, apex, depressed; light amber mottled and shaded with carmine; stem, long, slender, set in a broad, deep, depression; flesh, almost tender, juicy, rich sprightly; pit, small. Last June.

WALSH'S SEEDLING.

A seedling much resembling "Large Heart Shaped." It has been classed by Am. Pom. Society, as among those that "promise well."

WATERLOO.

We have never been able to obtain this variety to meet the description given by Downing in his *Fruits and Fruit Trees*. At the last Pomological Congress, Hon. M. P. Wilder stated it to be synonymous with *Moustreuse de Mezel*. This, we conclude, must be error, either in the variety grown by Mr. Wilder, or in the description given by Mr. Downing. We copy the latter's description: "Fruit, large, obtuse heart shape; dark purplish, becoming black at maturity; stalk, long and slender; flesh, purplish red, juicy, tender, when fully ripe, with a rich, sweet flavor. Beginning of July."

WERDER'S EARLY BLACK.

Werdersche Fruhe Schwarze Herzklrsche.

Fruit, large, roundish heart shape; surface, slightly uneven; dark purplish red, becoming nearly black; flesh, purplish, tender, juicy, rich, sweet; pit, small; stem, medium. Middle of June.

WHITE BIGARREAU.

White Ox Heart, Ox Heart,		Large White Bigarreau, Harrison Heart,		Turkey Bigarreau.
------------------------------	--	---	--	-------------------

Fruit, large, heart-shaped, yellowish with red in the sun; flesh, almost firm, sweet, delicious; poor bearer. Last of June.

CLASS III. *Superseded by better sorts.*

BROWN'S SEEDLING.

American. Fruit, medium, yellow and red, sweet, half tender; wanting in flavor.

BLACK MAZARD.

Mazard, Wild English Cherry,		Common English, Black Honey, Bristol Cherry
---------------------------------	--	---

This is the wild species of Europe, from which many of our sweet cherries have sprung. It is now found in nearly every village, or cultivated region of the States, and is valuable mainly for its seed, for growing stocks on which to bud. There are numerous varieties, as all are grown from seed; some are red, some black, and some nearly white—all more or less bitter. Fruit small, oval heart shape; flesh, tender, juicy. Middle to last July.

BLACK BIGARREAU.

Bigarreau Noir.

Fruit, middle size, heart shape, nearly black; flesh, firm, sweet, dry. July.

BLEEDING HEART.

Gascoigne's Heart, Herefordshire Heart,		Red Heart, Guigne Rouge Hative.
--	--	------------------------------------

Fruit, medium, long, pointed heart shape, dark red mottled; flesh, half tender, sweetish. Last of June.

BUTTNER'S OCTOBER.

Buttner's October Morello, Du Nord,		Du Nord Nouvelle, De Prusse.
--	--	---------------------------------

A Morello, of medium size, dark red, roundish; of no value, except as hanging long on the tree.

BOREATTON.

Small, roundish heart shape, nearly black; flesh, half tender, sweet, poor flavor. Middle July.

CERISE DE XAVIER.

A Morello; medium, dark red, round, acid.

CORONE.

Couronne, Herefordshire Black,		Coroun, Black Orleans,		Large Wild Black.
-----------------------------------	--	---------------------------	--	-------------------

Fruit, small, roundish heart shape, dull black; flesh, tender, mazardy. Middle July.

COE'S LATE CARNATION.

Fruit, medium, roundish, red, acid; only for cooking.

CLUSTER.

Cerise a Boquet,		Chevreuse,		Boquet Amareile.
------------------	--	------------	--	------------------

Fruit, small, borne in clusters, round, lively red, acid. Last of June.

CHINESE DOUBLE FLOWERING.

Yung To,		Cerasus Serrulata,		Serrulated-leaved Cherry.
----------	--	--------------------	--	---------------------------

A tree of dwarf habit, valuable only as ornamental.

CORWIN.

A Morello. Medium size, roundish, red; flesh, tender, acid; pit, large. July.

CLARKE'S SUPERB.

Clarke's Bigarreau?

Fruit, medium, roundish heart shape, bright red, with a dark maroon-colored stripe half round; flesh, whitish, half tender, mingling of sweet and bitter. Early July.

DE SPA.

A Morello; medium size, dark red, acid.

DWARF DOUBLE FLOWERING.

Double Flowering Kentish,		Cerisier a Fleurs Doubles.
---------------------------	--	----------------------------

A variety of the Kentish, or Sour cherry, with semi-double flowers; a pretty ornamental shrub tree.

FLEMISH.

Montmorency, Cerise a Courte Queue,		Kentish, Montmorency a Gros Fruit,		Gros Gobet.
--	--	---------------------------------------	--	-------------

Fruit, large, round, flattened at both ends, bright lively red; flesh, yellowish white, juicy, sub-acid; stem, stout, short; fruit borne in pairs. Last of July.

GRIDLEY.

Apple Cherry,		Maccarty.
---------------	--	-----------

American. Fruit, small, roundish; color, almost black; flesh, firm, purplish, moderately juicy. Early July.

HONEY.

Large Honey, Late Honey,		Cream, Yellow Honey,		Meresier a Fruit Blanc.
-----------------------------	--	-------------------------	--	-------------------------

Little better than a Mazard; small, roundish oval, yellow and red; flesh, tender, sweet; pit large. Middle July. Sumner's Honey of Cole is very similar, and probably identical with this.

HYDE'S RED HEART.

Hyde's Seedling.

Fruit, medium, heart shape, red on yellow; flesh, whitish, sweet, mazardy. Early July.

HYDE'S LATE BLACK.

Fruit, medium, roundish obtuse heart shape, purplish black; flesh, half tender, juicy, sweet. Early July.

KENTISH.

Late Kentish, Pie Cherry,		Common Red, Common Sour Cherry,		Kentish Red.
------------------------------	--	------------------------------------	--	--------------

This is probably a seedling of this country, which is found everywhere that man has cleared the forest. Throughout the West, it appears as though it had been among the household goods brought by first settlers, and that, wherever planted, it has grown, and by suckers, increased "seventy fold." It is hardy, and fruits abundantly; and many think it indispensable, but not after having grown and fruited the Early Richmond. Fruit, medium size, round, lively red; tender, juicy, acid. Middle to last July.

KNIGHT'S LATE BLACK.

Medium to large, roundish heart shape; flesh, half tender, sweet, dry. Middle July.

LADY SOUTHAMPTON'S YELLOW.

Lady Southampton's Duke, Yellow or Golden,		Lady Southampton's Golden Drop, Spanish or Yellow.
---	--	---

Fruit, small, heart shape, yellow; flesh, firm, dry. Middle July.

LARGE DOUBLE FLOWERING.

A beautiful ornamental tree, with large, showy, double white flowers, like little roses, without fruit, and therefore placed here, as unworthy cultivation, on account of fruit. As an ornamental tree, it is beautiful when in flower.

LUNDIE GEAN.

Fruit, medium, roundish elongated, dark purplish black; flesh, tender, juicy, sub-acid, harsh July.

MANNING'S LATE BLACK.

Manning's Late Black Heart.

Fruit, medium size, heart shape, dark purplish black; flesh, purple, half tender, sweet; pit, large. Early July.

MANNING'S EARLY BLACK.

Fruit, medium, heart shape, purplish black; flesh, tender, sweet, good. Middle June.

OX HEART.

Lion's Heart,		Bullock's Heart,		Very Large Heart.
---------------	--	------------------	--	-------------------

Fruit, above medium to large, obtuse heart shape, dark red, nearly black; flesh, red, half tender, sweet. Early July.

OSTHEIM.

Ostheimer Weichsel.

A Morello. Fruit, below medium, round, dark red, tender, acid. Middle July.

PRINCE'S DUKE.

Like carnation, but poor bearer.

PINK HEART.

A small Mazard, of pinkish red, oval; stem, short. July.

RED BIGARREAU.

Large Red Bigarreau,		Gros Bigarreau Rouge,		Bigarreau a Gros Fruit Rouge.
----------------------	--	-----------------------	--	-------------------------------

Fruit, very large, oblong heart shape, irregular; color, yellow or red, becoming dark red in sun; flesh, yellowish, stained with red, firm, sweet. Early July. Poor bearer.

REMINGTON.

Remington White Heart,		Remington Heart.
------------------------	--	------------------

Fruit, small, heart shape, yellow; flesh, dry, bitter sweet. Middle of August.

RUMSEY'S LATE MORELLO.

This variety matures its fruit late; but we have been unable to find qualities in it worthy of extensive, or even moderate growing: the pit is too large, and the tree a miserable grower. Fruit, medium, roundish heart shape, lively red, juicy, acid. August.

SWEET MONTMORENCY.

Allen's Sweet Montmorency.

Fruit, medium or small, round, amber and light red, mottled; flesh, yellowish, tender, sweet. Middle to last July.

TOBACCO-LEAVED.

Four to the Pound.

Fruit, small, round, red; firm, dry flesh; large pit.

TRANSPARENT GUILNE.

Transparent Gean, | Transparent.

Fruit, small, oval heart shape, yellowish white, shaded with red; flesh, translucent, tender, melting sweet, a little bitter. Early July.

VIRGINIAN WILD CHERRY.

This native cherry is valuable as a beautiful shade tree, and its fruit for flavoring liquors, but is not worthy a place in garden or orchard. It is too well known to need description, being the *Cerasus serotina* of Torrey and Grey; while the Choke cherry, as it is commonly known, is the *Cerasus Virginiana*. There are two varieties of *C. serotina* in the West that produce fruit three to four weeks.

VIRGINIA MAY DUKE.

A variety of Mazard.

WHITE TARTARIAN.

Fraser's White Tartarian, | Fraser's White Transparent, | Amber a Petit Fruit.

Fruit, small, obtuse heart shape, reddish cream color; flesh, whitish yellow, half tender, sweet.

WEeping, OR ALL SAINTS.

Ever Flowering Cherry,		Cerise Tardive,
Cerisier Pleurant,		Cerise de St. Martin.

Fruit, of no value; as an ornamental tree, its peculiar weeping habit makes it very desirable.

WARREN'S TRANSPARENT.

Small, roundish heart shape, pale yellow and red, tender, sweet, Middle July. (Cole.)

WILKINSON.

Fruit, medium size, nearly black, half tender, juicy, sweet. Middle July.

WELLINGTON.

Fruit, medium size, obtuse heart shape, black; almost firm fleshed. Early July.

THE CURRANT.

Ribes rubrum, Lin. *Grossulariæ* of Botanists.

THE Currant of our gardens is from the north of Britain. The native varieties of our country are valueless. Of easy growth, producing abundance of fruit, even in the most neglected positions, it has found its way into every garden, and is the first fruit-shrub planted by all new settlers. Had attention, commensurate with its merits, ever been given to reproduction of varieties from seed, we have no doubt the size might ere this have been increased, equaling that of the Kentish cherry.

The Cherry currant, a variety of comparative new introduction, by cultivation in rich soil, comes nearest in size to what might be expected, and what we hope in few years to see realized. To the Dutch horticulturists belongs the credit of first reproducing from seed, and improving the currant; and not until the latter period of the life-time of Thomas Andrew Knight, Esq., did English horticulturists give it any attention. Mr. Knight originated several new kinds, varying, however, so slightly from the old Dutch Red as to be hardly worth retaining as distinct varieties.

Propagation. Where the intention is to produce new and improved varieties, seed should be selected from plants permitted to produce but little fruit, in order to perfect and increase the vigor of seed. When ripe, the fruit should be crushed sufficient to wash the seeds clean, when they may be wrapped in paper and laid aside until early in following Spring, when they should be sown in light, rich soil, and covered about half an inch deep; or, they may be at once sown in a cold frame or border with northern exposure, and on approach of Winter have two inches deep of tan bark or leaf mold scattered among the plants.

The continuance of varieties by means of cuttings is performed in similar manner, and at the same time as directed under head of Gooseberries.

Transplanting. This is best done in October, or *early* in Spring; but may be done at almost any season except July or August, as the currant is so tenacious of life that failures to grow rarely occur. The distance apart of plants should be not less than four feet each way.

Soil and Situation. The Currant will grow in almost any soil, producing fruit abundantly; but it is only when grown in rich, deep

soil, under high culture, that varieties exhibit their peculiar characters. We have grown the Cherry currant in a poor, gravelly soil, and on a rich loam, and could hardly recognize the fruit as the same; the first being only of medium size and indifferent character, while in the second they were large, as described, and possessing the sharp acid characteristic of the variety. The situation should be free from shade of trees, but if shaded by hedge or fence, so as to give the morning and evening and not the noonday sun, the fruit will ripen and hang on much later, serving, by means of a few plants so placed in each garden, to continue the currant season from July to September.

Culture. The soil should be well enriched with rotted barn-yard manure every Fall; this should be spaded or forked in lightly, and during the fruit season the ground should be kept clean of weeds.

Pruning. This should be pursued much as is described under head of Gooseberries, except that the suckers, or a portion of them, should be permitted to grow; while wood of three years old should be regularly cut out. Where new shoots springing from the root are not permitted to grow, but plants kept as miniature trees, it will be necessary to furnish plants every four or five years; and as the best and largest fruit is borne upon wood of the preceding year's growth, it is always best to retain as much of that as possible, compatible with form and habit of the plant; which should present, when fairly grown, or at three years from setting, a bush of pyramidal shape, three to five feet high, and about two to three in diameter.

The Currant, as well as Gooseberry, may both be trained as Espaliers, or otherwise, to suit the fancy or particular situations, producing freely of fruit in all positions, and of good quality when well supplied with food.

Insects. The *Currant Borer* (*Aegeria tipuliformis*) attacks the Currant, but is seldom met with in the West, or in gardens where the three years' old wood is regularly cut away, thereby giving vigor to the remainder of the plant. This insect is produced from a blue-black moth, appearing about the middle of June, and depositing its eggs near the lower buds; these hatch, and the young borer enters the stem to the pith, which it devours. The best remedy is to cut off and burn all branches affected.

The *Abraxas* (?) *Riberaria* is said to destroy the foliage of the Currant and Gooseberry, and prevent the perfection of fruit. We have not seen the insect at the West. It is fully described in the New York State Agricultural Transactions for 1847, pages 461 to 469, by Asa Fitch, M.D.

Uses. Familiar to every one are the uses of the Currant; green, it is made into pies, and bottled for similar use in Winter, by gathering when of full size, or just before they commence turning red; have

them dry, put them in glass bottles, cork and seal tight, and pack in sand in a cool cellar.

Currant jelly, made when the fruit is fully ripe, is considered by many persons an indispensable accompaniment to many dishes. Currant shrub and currant wine are also made from the ripe fruit, numerous recipes for which are in all the Horticultural journals. The fruit of the Black currant, made into a jelly, is regarded by many invaluable as a remedy for sore throat, quinsy, etc.; made into jam or dried, it is valuable for puddings, etc.

Varieties. Of the varieties there are but few truly worthy of cultivation. The *Ribes rubrum*, or Common Red currant, is distinct in leaf and habit from the *Ribes nigrum*, or Black currant. The *Ribes aureum* has ever been considered only as ornamental, and cultivated only for that purpose. Nor do we think the variety with prefix "large-fruited" any more deserving attention of fruit-growers. The *Ribes sanguineum*, with its clusters of crimson flowers, is a pretty, ornamental shrub, deserving place only in large grounds. The *Ribes floridum*, or American Black, may perhaps have qualities and habits rendering it desirable as a parent from which to produce new varieties.

CLASS I.—*Most generally esteemed.*

BLACK NAPLES.

Black Grape, | Ogden's Black Grape.

The largest fruited and most productive of the Black currant. Hardy in all sections of the States.

CHERRY.

From Italy. In rich, deep, strong soils, and high culture, it is an abundant bearer of large, very acid fruit. In poor, thin, light soils, it is not desirable.

KNIGHT'S SWEET RED.

Varying from Red Dutch only in the fruit, being less deeply colored and slightly less acid; resembling more the White Dutch in quality.

PRINCE ALBERT.

New. Plants, vigorous, large foliage, productive, ripens late, therefore valuable. *Fruit*, large, resembling Victoria.

RED DUTCH.

Long Bunched Red Dutch, | Large Red Dutch, | Morgan's Red.
New Red Dutch, | Red Grape, *incorrectly*, |

Distinct from the variety usually grown in most old gardens, in the fruit being somewhat larger, clusters longer, and acid less sharp. One of the best for general cultivation.

VICTORIA.

May's Victoria,		Goliath,
Raby Castle,		Houghton Castle.

Bunches very long. *Fruit*, red, somewhat larger than Red Dutch, and slightly more acid ; ripens later, and hangs a long time. *Plants*, vigorous, of a spreading habit. Its very large, long bunches make it the most desirable of all currants for market culture.

WHITE DUTCH.

New White Dutch,		White Leghorn,		Large White,
White Crystal,		Reeve's White,		White Clinton.
Morgan's White,				

Differing from the Red Dutch, in being of a yellowish white, and less acid, therefore preferred for table use.

WHITE GRAPE.

River's White Grape.

Slightly larger in fruit than the White Dutch, with branches more spreading. The two are not sufficiently distinct to be desirable in small gardens. Productive.

CLASS II. *Embraces varieties, of which many are new and untested, and others suited only to large Orchards, or certain localities.*

AMERICAN BLACK.

Unproductive.

ATTRACTOR.

New, from France. *Fruit*, very large, white ; vigorous and productive.

BLACK ENGLISH.

Common Black.

Bunches short, poor flavor, unproductive.

COMMON RED—COMMON WHITE.

Well known old sorts, not requisite to describe.

CHAMPAGNE.

Pale red, or flesh color, very acid.

FERTILE D'ANGERS.

France, new. Bunches, long, large ; fruit, red, said to be valuable.

GONDOUIN RED.

From France. Strong growth, large, matures late, should be further tested, but not largely planted. There is also a white variety.

GONDOUIN WHITE.

Fruit, large, whitish yellow, quite sweet, more so than any other sort ; branches, rather long, strong growth, productive.

KNIGHT'S EARLY RED.

Claimed to ripen ten days earlier than others, but does not sustain it.

KNIGHT'S LARGE RED.

Hardly to be distinguished from Red Dutch.

LA CAUCASSE.

A new variety ; vigorous, upright shoots ; bunches, very long, often seven inches, with berries two inches in circumference, sprightly, mild acid, promises valuable.

LA VERSAILLAISE.

New French currant, very large, with long bunches ; next in size to Cherry currant, deep red, very productive.

LA HATIVE.

A new early Red currant from France, not yet fruited here. Said to be excellent.

MISSOURI.

Missouri Fragrant, | Jefferson.

Valuable only as ornamental ; fruit, large, bluish black ; flavor, requiring a peculiar taste to admire it.

MISSOURI LARGE FRUITED.

Missouri Eatable.

Similar to the foregoing.

PALNAU.

Fertile Currant of Palnau.

From Tours, in France. It is considered of great excellence, flowering early, and producing abundance of fruit, less acid than others of the reds.

RED GRAPE.

Fruit, large ; bunches long, clear red, more acid than Red Dutch ; productive. Not upright in growth.

RED PROVENS.

Similar to, if not identical with, Red Dutch.

SHORT BUNCHED RED.

Very similar to Red Dutch, except bunches shorter, and fruit not as large.

STRIPED FRUITED.

Valuable only as a curiosity, in the fruit being striped slightly with white and red.

TRANSPARENT.

Blanc Transparent.

A new French currant. Fruit, very large, yellowish white, similar to White Dutch ; very productive.

WHITE PEARL.

A new variety we have not seen. Hovey says it is announced as having bunches four inches long, quarter inch in diameter, color of pearl; raised near Brussels.

WHITE ANTWERP.

Fruit, large, sweet; productive.

 THE GOOSEBERRY.

Ribes Grossularia—*Grossulaceæ* of Botanists.

THE Gooseberry is found wild in most of the northern and middle portions of our country, but with few exceptions its fruit is prickly and unworthy. On some of the islands of our upper Lakes, where the climate is moist and cool, there are varieties that produce abundantly of fruit, small in size, but of good flavor, smooth and free of prickles. Our garden varieties generally cultivated, have all been introduced from England, reproduction of new kinds from seed having been rarely attempted in this country, owing to the low price at which the best kinds can be purchased in England, and the almost certainty of success of importations made in the Autumn.

The moist, cool climate of Lancashire, England, joined to the enthusiasm for culture of this fruit by a class of people employed there as weavers, and possessing only very small yards or gardens, has been the origin of most of our approved varieties. Gooseberry Shows were held in England as early as 1743; and it has long been customary to issue annually a GOOSEBERRY BOOK, in which all new varieties are noticed and all previous varieties named, with accounts of size, &c. This list has now swollen to over twelve hundred kinds; yet a selection embracing those truly best and most profitable, and with distinctive marks, would not exceed forty kinds.

Throughout our Southern and inland States, except in sections bordering on large bodies of water, it requires great care to succeed well with this fruit. The deep, rich soil of our Western prairies suits the plant in its growth, but the heat and dry atmosphere, in sections distant from bodies of water, induce mildew, to the destruction of perfect fruit. Easily grown from seed, it is worth the attention of some one to make experiments, by raising from seed of our best varieties, sown in the rich soils of the West; the result of which, it might safely be expected, would be plants vigorous and comparatively free from disease as our natives.

Propagation. Seed should be sown in rich loam, covered half an inch deep, and shaded from all but morning sun. This course is only advisable where production of new varieties is the object. The most general mode of propagating is by cuttings. These should be made of the new wood of present year, say in August, or early in September, or as soon as the season's growth is completed and the wood ripened. The cutting should be about ten inches long, with all buds on the lower six inches cut out, and the lower end cut square and even, immediately underneath the bud. Plant perpendicularly in a soil two feet deep, composed of loam and sand, and exposed only to the morning sun; set the cuttings six inches deep, fill up two inches, and tread very firm and compact, the remaining four inches fill in loosely. Grafting on the stalk of the Yellow-flowering or Missouri currant, has been practiced, and is said to prevent mildew.

Transplanting. This is best done in early October, at which time the bushes transplanted (if it has not been previously done) should be pruned back to within three buds of this year's growth. The distance of plants, one from another, should not be less than three feet each way. Immediately after transplanting, cover the whole ground with three inches deep of tan bark, saw-dust, sea-weed, or new-mown grass. Fresh plantations should be made every five or six years, as young plants bear better and larger fruit than old ones.

Soil and Situation. The soil should be two feet deep, well enriched, and of a loamy, clayey texture; where your ground is sandy, haul on clay or turf loam. The situation should be open, airy, and away from under shade of trees; but where it can be done, shaded from the mid-day sun by a fence or hedge.

Culture. Where mulching is practiced, the ground dug up once early in Spring and liberally supplied with well rotted manure and soot from chimneys or stove-pipes, will be all required, save the pulling of the few weeds which struggle through the mulch in course of Summer.

Pruning. This, in training the Gooseberry, like the Dwarf Pear, consists much in the "pinching-in" process, *i. e.*, by means of thumb and finger, stopping back, in months of May and June, such branches as become straggling, irregular, or getting too much vigor for success of balance of plant; leaving the fruit on strong branches, and pulling most of that on weak ones. Late in August, or early September, the time best suited for cuttings, the plant may have such shoots cut out as have been neglected to be stopped in or rubbed off, and are tending to make the top so thick as to obstruct free circulation of air. All suckers should be destroyed. Some cultivators prune in February; we prefer the Fall. The following simple process of training or ripening is sometimes pursued, and with good success:—In a row, the first bush has the branches of the year's growth cut back one third; the second bush has every branch cut back to two, close to the

stem; the third, trimmed same as first; fourth, same as second, and so on alternately. The next year this course is reversed, and No. one takes place of No. two. This supplies fresh wood, and some think the increased vigor given to the plant in only fruiting every other year, has a tendency to prevent mildew.

Mildew. This is regarded as a parasitical plant or fungus, attaching itself to the fruit and covering its surface as with an appearance of scurf. It is induced by heat, want of moisture in the atmosphere and free circulation of air, and perhaps unhealthy state of the plant. The remedies are: mulching the ground three or four inches deep, with tan bark, sawdust, salt hay, or sea-weed, serving to keep the roots cool and moist, and adding vigor to the plant. The salt is, by some, regarded as effective in itself; we think it acts only in creating moisture. Sprinkling the bushes freely *early* in Spring, and after the fruit is set, twice a week, with strong soap-suds, or such as come from the weekly wash of families, is also a preventive.

Uses. In its green state, the Gooseberry is esteemed for pies, tarts, &c., and is often bottled for winter use. This is done by filling the bottles nearly full of berries, then turning in clear soft water, then placing the bottles a few moments in boiling water, corking and sealing, and burying them in a cool cellar with necks downward.

Half ripened, the fruit is capable of yielding a juice which, after fermentation and a little necessary compounding, forms a liquor resembling champagne.

The ripe fruit is agreeable to the palate, and coming immediately after cherries, when there is little variety, finds ready sale in market.

VARIETIES.

Varieties. As before remarked, the varieties of the Gooseberry are far too numerous for any practical uses, very many of them varying only in some slight shape of the fruit or shade of leaf. We have therefore selected the following, as kinds which have been well tested in this country.

BRIGHT VENUS. (Taylor's.)

Branches erect; fruit, whitish green, middle size, obovate, hairy; flavor, "best;" hangs a long time.

BUNKER HILL. (Capper's.)

Branches spreading; fruit, yellow, large, roundish, smooth; flavor very good.

CHAMPAGNE.

Branches erect ; fruit red, small, roundish oblong, hairy ; very good ; extremely productive.

CROWN BOB. (Melling's.)

Branches spreading ; fruit red, very large, oblong, hairy ; flavor, "best."

DUCKWING. (Buerdsill's.)

Branches erect ; fruit, yellow, large, obovate, smooth, flavor very good ; ripens late.

EARLY SULPHUR.

Branches erect ; fruit yellow, medium size, roundish, hairy ; flavor, "best ;" ripens very early.

GREEN WALNUT.

Branches spreading ; fruit, green, medium size, obovate, smooth ; flavor, "best."

GREEN GAGE. (Pitmaston's.)

Branches erect ; fruit, green, small, obovate, smooth ; flavor, "best ;" hangs late.

HEART OF OAK. (Massey's.)

Branches drooping ; fruit, green, very large, oblong, smooth ; flavor, "best."

HOUGHTON'S SEEDLING.

Branches erect, spreading, slender ; fruit, pale red, oval, medium size, flavor, "good ;" productive. This is claimed an American seedling, and thus far has proved entirely free from mildew. Especially fine for cooking.

IRONMONGER.

Branches spreading, fruit, red, small, roundish, hairy ; flavor, very good ; productive.

JOLLY ANGLER. (Collier's.)

Branches erect ; fruit, green, large, oblong ; flavor "best."

KEEN'S SEEDLING.

Branches drooping ; fruit, red, medium, oblong, hairy ; flavor, "best ;" early and productive.

LAUREL. (Parkinson's.)

Branches erect ; fruit, green, large, obovate ; flavor, "best."

PALE RED.

Branches erect, slender ; fruit, pale red, medium, oval, flavor very good ; very productive. We received this variety from England, in 1847, and have fruited it yearly since. We have grown it in good and poor soil,

with and without cultivation, and have never had it mildew ; while for productiveness we have not its equal, a single branch often producing two hundred fruit.

RED WARRINGTON.

Branches drooping ; fruit, red, large, roundish oblong, hairy ; flavor, "best."

ROARING LION.

Branches drooping ; fruit, red, large, oblong, smooth ; flavor, "best ;" hangs late.

SHEBA QUEEN. (Crompton's.)

Branches erect ; fruit, white, large, obovate, downy ; flavor, "best."

WHITESMITH. (Woodward's.)

Branches erect ; fruit, white, large, roundish oblong, downy ; flavor, "best."

WHITE HONEY.

Branches erect ; fruit, white, medium, roundish oblong, smooth ; flavor, "best."

THE AMERICAN GRAPE.

Vitis labrusca, L.—*Vitaceæ* of Botanists.

THROUGHOUT nearly every portion of the United States the Grape, in its wild state, is found growing. Of these, classes are divided, the *vitis labrusca*, being our common Fox grape, and from which we are yet to suppose the Diana, Catawba, and Isabella, are accidental seedlings; while the Frost grape (*vitis cordifolia*), may, perchance, have been the parent of the Elsinburgh, Clinton, &c. Hardy, and almost equaling in delicacy many of the varieties of foreign grape, they have become the companions of our advanced civilization, until almost every American can sit under his own vine and eat the fruit thereof. They have made our country already known as a wine-producing country, after repeated trials and failures with foreign varieties, and are destined to add millions to our wealth, and temperance to the character of our people. Records of immense vines are made, as growing on the rich soil of our valleys bordering on streams of waters; yet, when age is taken into consideration, we deem them all surpassed by a vine of Catawba grape which we saw last year growing on Kelley's Island, in Lake Erie. It had been planted out but two years, yet had reached at least three hundred feet in length, with a girth, near the ground, of main stem, five inches, and had produced that year over 200 lbs. of fruit.

The secret of this extraordinary growth rests in the soil abounding in lime, while the wash-water, soap-suds, &c., &c., of the house had its escape near the roots.

We may also remark that upon this island we have seen grapes, more perfectly grown and ripened, than in visiting any of the vineyards of the Ohio; and wine possessing all the bouquet and aroma so much esteemed by connoisseurs.

Vineyards. The vineyards of the Rhine and of the territory of France, have world-wide celebrity. The quantity produced by the latter country having been stated as high as 900,000,000 gallons, annually, for which nearly 5,000,000 acres of ground were required.

The Romans cultivated the vine at an early period of their history, and used wine in their libations at their sacrifices. Romulus, however, discouraged its use, which prevented the introduction of it as a beverage, until his edict was abolished. The general culture was then encouraged, and increased to such excess that it became necessary to restrict the use of wine by severe laws. At one time

women were prohibited from using wine in any case whatever, under the penalty of death, and men until they had attained the age of thirty years. Cato mentions that the custom among relations of kissing women when they met, was to ascertain by their breath if they had been drinking wine.

“Pliny gives an account of a renowned Roman who so improved his farm, near the city of Rome, that in one year the product of his vines sold for four hundred thousand sesterses.

“The vine was highly esteemed by the heathen nations, and the invention of wine was ascribed by the Egyptians to Osiris, by the Latins to Saturn; and the Greeks elevated Bacchus to the rank of a deity for having brought the vine from Arabia Felix.

“It is said by Pliny that Bacchus was the first who ever wore a crown, and as the god of vintage, his crown is formed of the vine and its twining branches, bedecked with clusters of fruit. The manufacture of wine was known to the people in the early part of the Christian era, as we are informed that our Saviour, at a wedding, changed the water into wine.

“At several periods of the history of the world, the cultivation of the vine was prohibited by severe laws, but since the twelfth century a new impulse has been given, which extended through all portions of Europe; and we now find the banks of the Rhine, the mountains of Hungary and Switzerland, and the plains of France and Italy cultivated with more than two hundred varieties of the grape. Those most highly esteemed in France for the manufacture of wine, are the Burgundy grapes, three varieties of which produce the champagne wine. The German and Swiss grapes are principally celebrated as wine grapes, and four or five varieties are highly esteemed for their prolific bearing, and regular crops.

“The Madeira grapes are all celebrated for wine. The table grapes of France are principally the Chasselas, the Frontignac, and other Muscat grapes.” Noah planted a vineyard and made wine; and among the blessings of the promised land are mentioned “wheat, barley, and vine.”

Although we have record of wine being made from a native grape in Florida, as early as 1564, no vineyards of note are spoken of in the United States until those established at Vevay and New Harmony, Ind., Lexington, Ky., &c, about 1812, the originals of which are now mostly destroyed.

Jefferson recorded his opinion, that “no nation is drunken where wine is cheap; and none sober where the dearness of wine substitutes ardent spirits as the common beverage.” A wish to sustain and exemplify this assertion, if not to exhibit the profitableness of the pursuit, would seem to have held sway in the mines of denizens of the “Rhine of America,” *i. e.*, the borders of the Ohio river, above and below Cincinnati, where now, it is probable, over ten thousand

acres are occupied with vines, mostly of the Catawba grape, the produce of which is made mostly into, what is there termed, "dry wine," much resembling the better class wines of the Rhine. The culture of the vine and manufacture of wines, is only now in its infancy; and ten years, we doubt not, will increase ten-fold the present amount. Large establishments for the manufacture are now existing at Cincinnati and St. Louis. At the latter place the manufacture of the "Still Catawba," into sparkling champagne, is conducted by the Missouri Wine Company, upon a large scale, and upon the most intelligent principles.

Medical men have looked upon this establishment of vineyards in our own country with favor, in a point of view as relating to health. Prof. Kirtland, in 1842, says: "During an extensive practice in the medical profession, for more than twenty-five years, I have frequently found it important to employ wine and other diffusive stimulants as medicines; and while I am disposed to go as far as any one in excluding strong drinks from the daily use of people in health, I must express my satisfaction at finding we can produce, in our own country, a pure, healthy wine, well adapted to medicinal purposes, and far superior to the poisonous foreign compounds, that often find their way to the bedsides of the sick, under the names of 'Lisbon,' 'Madeira,' &c., &c."

Most of the earlier planted vineyards in this country were of foreign vines, which, not succeeding, native varieties were adopted; and at this time only two, the Catawba and Schuylkill, are advised to be planted to any considerable extent.

Notwithstanding the borders of the Ohio and Missouri rivers have thus far taken the lead in production of wine and extent of vineyards, there is no good reason to suppose *that* the boundary where success may be had. On the contrary, abundant sites may be found throughout the entire West, where, by application of manures suited to the wants of the vine, and found deficient in the soil, equal success would be had. Georgia and North Carolina have lately produced large crops of the Catawba.

The whole extent of Western prairies, rich in all the constituents of the grape vine (if we except potash, and, possibly, in sections, the phosphates), are yet destined to be tenanted with immense vineyards, and at no greater outlay of expense for constituents toward successful culture, than the vineyards of the "Rhine of America," which have thus far been made dependent on the natural inhereents of the soil, and have already shown failure, *i. e.*, decay by rot, where food, in the form of potash and bone dust, has not been supplied.

North of latitude 42°, however, it may be doubted whether saccharine sufficient can be obtained from the most valuable wine grapes yet known, to make wines in competition with those grown farther South; but as this subject is one so extensive that, if thoroughly written on, would more than occupy the number of pages intended

for this entire book, we must forbear, and only devote our space to such instructions as will enable the inexperienced to make the first start correctly, premising that once interested and engaged in the subject, disposition will be found freely to avail himself of all works yet issued devoted to the subject.

Propagation. By Seed. This course is only pursued where intended to originate a new variety. At this time, large offers of premium are circulated in the journals of the day for the production of a hardy grape, surpassing the Catawba as a wine grape. Fertilizing some variety of the *vitis vinefera* with pollen of *vitis labrusca*, or *vice versa*, will be the course to pursue with any expectation of success; the seed so fertilized, gathered carefully and sown in rich vegetable mould. Cultivation of our wild grapes only increases the size without ameliorating their character.

By Cuttings. These are taken from the strongest vines of the last year's growth, cut to a length, embracing three or four buds, according as the joints are long or short of the variety; where possible, a little piece of the old wood left on the lower end is preferred. These being made in the Fall, when pruning the vines, are laid away in bundles in a cool cellar until Spring; when, as soon as the ground is ready, they should be soaked or swollen in a tub of water, for four or five days, or until the buds become fully swollen. They are then planted in rows, if in the nursery, by bending into nearly the form of a half circle, as represented by figure, which shows the cutting as it appears in about one month from planting. By this, it is seen that the upper bud is covered nearly an inch: in clayey soils, or those retentive of moisture, the upper bud should be just even with the soil. The rows, in nursery, should be three feet apart, and the plants one foot distant each in the row.

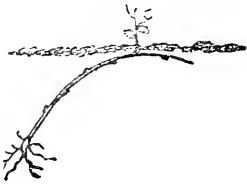

This is the best and most successful mode of growing the grape vine. The earth should be pressed firmly at the base of the cutting, and left light and loose at top.

By Grafting. The best season to perform this operation is when the leaves are about half grown. Earlier, the sap is very abundant, and at same time watery, and grafts do not succeed well. Whip grafting, as it is termed, is best; or, if stock and graft are near of size, saddle grafting. The graft should have been cut early in the season, before any flow of sap or swelling of buds, and have been kept in a cool, yet moist place. The point on the stock at which it is best done, is at or near the ground; and, after insertion, earth up a small mound around it, to protect from change of temperature, sun, &c. If the operation be performed further up on the stalk, wrapping the place of union with grafting clay will be requisite. Care must be taken that the *inner* bark of both graft and stock join each other

perfectly, otherwise success will be uncertain. The practice is only advised where a new variety is desired to be tested, as new vines are almost always better than the patching up of old, neglected plants, which have never been "cared for" either in branch or root.

Transplanting and distances. In taking up the vines at one year's growth from the cutting (which is best), care should be taken to mutilate as little as possible, and also to keep the roots from exposure to the sun, or drying air or winds. Cut back the growth of the past year to two buds. Have the ground mellow, rich, dug deep; the hole broad; spread the roots carefully and as naturally as they grew; after having pruned each end and bruised or broken root with a *sharp* knife, fill in the earth carefully and finely until only the two buds are visible, then *avoid treading* on it. The distance apart, if making a vineyard plantation, depends on the variety. That for the Catawba or Isabella, should be four by eight feet; the Schuylkill and Herbemont, five by seven feet; the Missouri and Clinton, three and a half by three feet. These two latter should be pruned low, while the former varieties may rise seven to eight feet. These extents are for vineyard culture. Our native grapes, however, all do better and produce most when permitted to make long growths upon high, extended trellises. Some vines trained in this way have produced nearly thirty bushels in a season.

Cost per acre of Vineyard. The estimated cost of trenching, furnishing cuttings, stakes, and planting an acre of vineyard, is not far from two hundred dollars; and at the expiration of three years it may be estimated to yield, annually, about 200 gallons of wine, at a cost, however, for dressing vines, pruning, gathering, &c., of about seventy-five dollars; leaving, therefore, about one hundred dollars a year (supposing the wine to sell at one dollar a gallon), as the net profit per acre. The quantity here estimated will, no doubt, be thought low by many, but while it will often exceed this quantity, seasons do occur when even less is the result; and we, therefore, stand on the safe side if we found our vineyard on this basis of expectation.

Position and Soil. R. Buchanan, Esq., who has written a capital treatise on the "Culture of the Grape," as well as practically trained the vine, has the following on this point:

"A hill side with southern aspect is preferred, although an eastern or a western exposure is nearly as good. Some have recommended the north, on account of safety from late Spring frosts, but it will scarcely afford sun enough to ripen the grapes in cold, wet seasons (if the declivity is steep), and may perhaps be more subject to the 'rot.' Any undulating surface, if dry, is preferable to a level one.

"*The Soil* best suited for a vineyard, is a dry calcareous loam, with a porous sub-soil, not retentive of moisture; if mixed with

some gravel or small stones, so much the better. Some prefer a sandy soil with a gravelly sub-stratum, as in this the grapes are less subject to rot; the juice, however, is not so rich—lacking in saccharine matter—and in dry seasons the vines will suffer from the drought, shedding their leaves prematurely, and preventing the grapes from ripening well. In warm, sandy soils, the fruit-buds on the vines, if swelled prematurely in Autumn, are sometimes killed by the frosts of a severe Winter.

“Any soil underlaid by a stiff, wet clay, is to be avoided, as also wet or spongy lands. No trees should be allowed to grow within one hundred feet of the vineyard.”

Preparing the Ground. “In Autumn, or early Winter, dig or trench the ground all over, two to two and a half feet deep, with the spade; this is far better than ploughing; turn the top soil under.

“Wet spots in the vineyard may be drained by small stone culverts, or by what is termed a French drain, a ditch, with some loose stones thrown into it edgewise, covered with flat ones, and filled up with the earth again. Surface draining may be obtained by *concave sodded* avenues of ten feet wide, and intersecting each other at 100 or 120 feet, thus throwing the vineyard into squares of that size. This will do for gentle declivities, but steep ones must be terraced or benched with sod or stone. These benches should be as broad as they can be made conveniently, and with a slight inclination to the hill, that they may be drained by stone or wooden gutters, running into the main trunks, to carry off the water without washing away the soil. This is important, and requires good judgment and skill.”

Cultivation of the ground. The first two years the grounds should be kept clean of weeds, by use of the German hoe, a two-pronged instrument. A light plow is sometimes used in the Spring, but the best vine dressers object to it. The third year, and afterwards, the earth should be kept clean until July, after which time it should not be stirred; this especially through the Western prairie country.

Pruning and Training. Tact and judgment are necessary to perform this portion of vineyard work, and none but general instructions can be given. Buchanan says: “In the Spring, cut the young vine down to a single eye, or bud, at first; if two are left for greater safety, take off one, afterward; drive a stake, six or seven feet long, firmly to each plant; locust or cedar is preferred, but oak or black walnut, charred at the end, driven into the earth, or coated with coal-tar, will, it is said, last nearly as long. Keep the young vine tied neatly to the stake with rye or wheat straw; pick off all suckers, and let but one stalk or cane grow.

“The *second Spring* after planting, cut down to two or three eyes, or joints, and the *third year* to four or five; pinching off laterals, tying up, and hoeing the vines as recommended above. Replant where failures have occurred. The third year the vines will produce

a few grapes. Train two canes to the stake this year, and take off laterals." We advise the cutting down or pruning to be done as

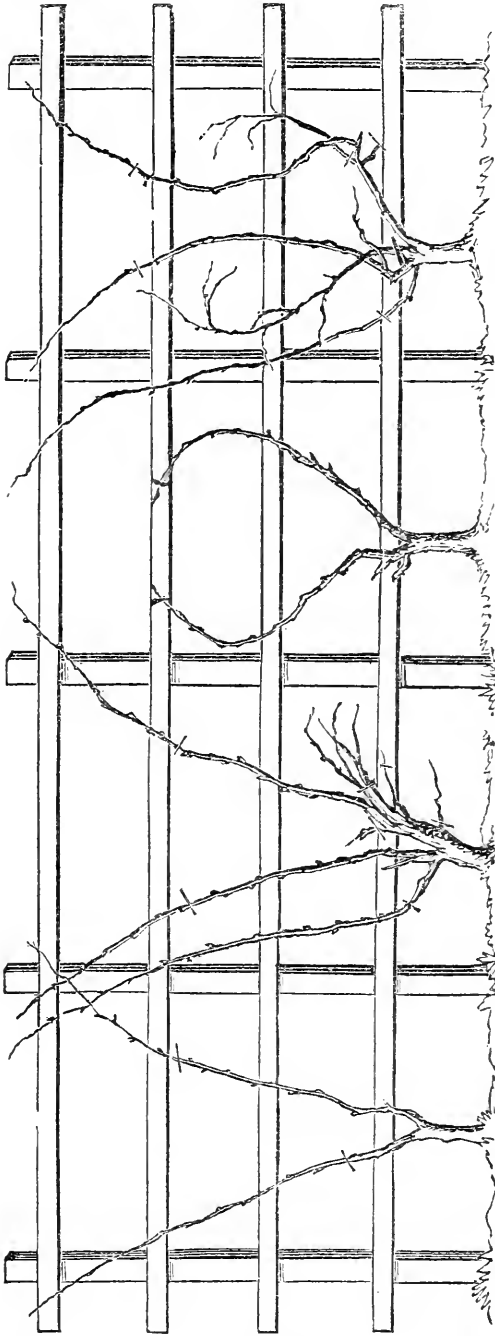

soon as the fall of the leaf in Autumn, but any time when the frost is not in the wood will answer. "Pruning the *fourth year* requires good judgment, as the standard stem or stalk has to be established." "Select the best shoot or cane of last year, and cut it down to six or eight joints, and fasten it to the adjoining stake in a horizontal position, or bend it over in the form of a hook or bow, and tie it to its own stake. The ties should be of willow. This is the bearing wood. The other cane, cut down to a spur of two or three eyes, to make bearing wood for the next season.

"Give the shoot the first tie on the stake, nine inches from the ground, and the second, nine inches above it; then bow it over to the neighboring stake in a horizontal position, and give it the third tie to the stake, at that top of the vine."

"In the succeeding, and all subsequent years, cut away the old bearing wood, and form the new bow, or arch, from the best branch of the new wood of the last year, leaving a spur as before, to produce bearing wood for the coming year,

thus keeping the old stalk of the vine down to within eighteen to

twenty-four inches from the ground. The vine is then always within reach and control."

The practice of many vine dressers in Missouri, is a medium course, between severe or close pruning, and long straggling culture. Mr. Geo. Husman, of Herman, has written a capital work on this subject, to which we invite all who desire to grow the Grape extensively. We give on previous page cuts descriptive of manner now regarded best for training.

Summer Pruning—"Consists in removing suckers, and pinching off all lateral shoots, leaving but two stalks or canes to be trained for bearing wood the ensuing year, and pinching off the ends of the bearing branches, about the time of blossoming, some two or three joints beyond, or above the last blossom bunch; pull no leaves off the bearing branches, and but very few from any other. As the vines grow, tie them neatly to the stakes, with rye straw (some use grass), and when they reach the top, train them from one stake to the other, until the fruit has nearly matured; the green ends may then be broken off. If this is done too early, there is danger of forcing out the fruit-bearing buds for the next year, and of injuring the grapes in ripening.

Some cultivators are averse to removing any lateral branches from the fruit-bearing wood, merely pinching off their ends. Others adopt close pruning, in Summer, and even taking off some of the leaves of the bearing branches. Both these extremes are wrong. The experience of the writer is in favor of removing such lateral shoots as appear unnecessary to the growth or ripening of the fruit—to pinch off the ends of the bearing branches two, three, or four joints beyond the upper bunch of grapes—according to the number it bears—to take off all laterals from the bearing wood intended for the ensuing year; and not to break off the ends of these branches at all (as has heretofore been done about the time the grapes began to color). The leaves are the lungs of the plant, and while it is necessary to remove suckers and laterals, to throw strength into the fruit and the bearing branches for next year, a liberal supply of leaves should be left for the maturity of both."

Grapes are often injured in the Summer by cutting off too much young wood. Shoots not intended to grow, should be stopped by pinching off the ends; but, if by neglect, they have been permitted to grow long, stop all, or nearly all, their ends, and let remain the part that has matured leaves.

It is well in the Winter pruning, to leave plenty of wood, and if too much fruit sets for the vine to mature, thin it out when small.

Trellises made by setting posts, well braced, at either end of the row, and running coarse wire through standards intermediate from post to post, we have seen much practiced elsewhere than at Cincinnati, and with great success. The vines are trained horizontally, as represented in the accompanying figure :

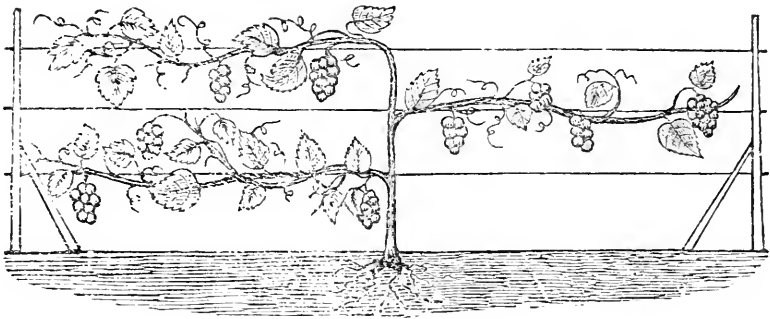

For private gardens where ground is scarce, the vine should be well supplied at its roots with liquids hereafter named, and permitted to run or ramble upon lofty trellises. Spur pruning, which consists in training the old, or main stem, and yearly cutting back the laterals to two or three good buds, must here be pursued; care should be taken, however, not to cut back, and preserve the same side branches or spurs from year to year, lest by so doing they soon become enfeebled, and the fruit ripens imperfectly; but new side shoots should be yearly selected of the strongest growth, and cut back to the two or three bearing buds, while that of last year's bearing is cut away.

Manures. The analysis made by Prof. Emmons, of the common wild grape vine is as follows:

	Wood.	Bark.
Potash.....	20.84	1.77
Soda.....	2.06	9.27
Chlorine.....	0.02	0.40
Sulphuric acid.....	0.23	trace
Phosphate of lime.....	15.40	5.04
Phosphate of peroxide of iron.....	1.20	5.04
Carbonic acid.....	34.83	32.22
Lime.....	17.33	39.32
Magnesia.....	4.40	0.80
Silex.....	2.80	14.00
Soluble silica.....	0.00	30.00
Coal and organic matter.....	2.20	1.70
	<hr/>	<hr/>
	100.21	100.86

From this, any one moderately conversant with the components of soils can readily see what is required for his vines. Burying the refuse cuttings and leaves, sprinkling on gypsum (plaster of Paris), and supplying freely the soap-suds, and wash-water of a family, with animal (or barn-yard) manures, and wood ashes, are most advisable, aside from the specific application of potash and bone dust.

Insects and Diseases. The *aphis* and *slug*, described fully in "Harris's Treatise," appear in the months of May and June. They are

easily destroyed by syringing with tobacco-water. The grape vine flea-beetle (*Haltica Chalybea*), a small, glossy, greenish-blue beetle, about three-twentieths of an inch long, sometimes preys upon the buds, causing them to appear as if bored. This insect was first (we believe) described by David Thomas, in Silliman's Journal of Science, and is also noticed in "Harris's Treatise." The eggs are deposited early, and soon change to a greenish, smooth worm, which preys upon the tender leaf and young bunches. It is destroyed in this state by syringing with tobacco-water, or sifting lime over the vines when wet with dew.

Ageria Polistiformis, or, *Grape-vine Borer*. The roots of cultivated grape vines, especially in the Southern States, are often so much injured by this borer, as to prevent the ripening of the fruit, and occasionally to cause death of the vine. "They are found about the vines and on the wing, from the middle of June to the middle of September, during which time they couple and lay their eggs, near the roots of the vines, and the whitish grubs hatched therefrom will be found boring into the bark and wood of the roots during Summer. The winged insects are dark brown, tinged with tawny orange, varying from six to nine-tenths of an inch long. When fully grown these grubs measure from one inch to one inch and three-quarters in length. They undergo their transformations in oblong oval pods, formed of a gummy kind of silk, covered with fragments of wood, bark, and dirt, which will be found within, or adjacent to the injured roots. The insects take the chrysalis form at various times during the Summer. The rings of the chrysalis are surrounded with minute teeth, which assist the insect in coming forth from its pod or cocoon when about to be changed to a moth."

Eight-spotted Sphinx, or *Alypia Octomaculata*. There are two insects, occasionally found on the grape vine, which, in their caterpillar state, closely resemble each other in form, size, color, and habits. One of these is the beautiful *Eudryas*; the other is the *Sphinx*, or *Alypia*, above named. This *Alypia*, though common, and occasionally so numerous as to be quite hurtful to the vine in some parts of the United States, is very rare in New England. These caterpillars are white, passing into blue, transversely banded with narrow black lines, with a broader orange-colored band, dotted with black, on the middle of each ring. The head and feet are also orange, dotted with black. The black dots on the body produce a few short whitish hairs. They are found eating the leaves of the vine in the latter part of June and beginning of July. Full grown specimens measured one inch and a quarter, or more, in length. Before the 16th of July they leave the vines, and conceal themselves in a loose web upon the surface of the ground, and soon take the chrysalis form. Some are transformed to moths in August; others remain in the chrysalis state through the Winter, and come forth winged in May and June. The winged in-

sects are black, with two large yellow spots on each of the fore wings, and two white ones on the hind wings. Their shanks are clothed with orange colored hairs. Their wings expand from one inch to one inch and a half.

The Rose-bug (*melolontha*) occasionally attacks the vines in great numbers, eating off the upper surface of the leaf, and causing the vinous fibres left to look like a sieve. They are best destroyed by spreading a cloth underneath, and shaking the vines in the cool of evening or near sun-set. They will fall, and may then be burned. A few dollars expended in this way, we have known to have saved the entire crop for the year, as well as prevent their presence to any extent another season. The curculio sometimes attacks the grape, but thus far we have never heard of any serious injury to the crop.

Mildew, or American Blight, is easily checked by free sprinkling of powdered sulphur over the vines and earth when wet with dew. Or, take one peck lime, one pound sulphur, pour hot water to slake the lime, mix, add three gallons water, when clear draw off. Syringe, when disease first appears, with half pint of above to three gallons of water. It is a fungus, attacking the plant when not in perfect health. The *rot*, so much deprecated by Vignerons, at Cincinnati, we regard as attributable to want of perfect and free drainage. Many soils in which all the elements of health to the vine are existent, are at the same time so saturated with water that chemical action is checked, and the soil being in a dormant condition, the plant must of necessity become diseased. Some, we notice, consider it attributable to too late and clean cultivation; and as late cultivation only tends to late growth, and formation of new leaves to exhaustion of what is required for perfection of those already formed, the theory is good, so far as it goes; and possibly in soils greatly deficient in the constituents to perfect the grape, it may in a measure be the cause; but in soils well supplied with the required food, late cultivation would only cause the bursting of new buds and continuance of growth.

Uses—Mode of Keeping. Universally esteemed when well ripened, as a dessert fruit, the Grape is also highly valued by many physicians, as in its free use tending to health and the prevention of rheumatic affections of the human system. For culinary use, and for making of preserves, they are sought for, both in a green and ripened state. Carefully gathered when ripe, laid in heaps for a few days on the floor of a cool, dry room, then spread out for one or two days, and packed in shallow boxes, with layers of cotton-batting at bottom and intermediate between layers of fruit, as well as between bunches, they may be placed in a cool room and kept fresh throughout most of the Winter. The following method has been practiced successfully by an extensive grape-grower, Charles Carpenter, Esq., of Kelley's Island:

• In putting down grapes for Winter use, several requisites are necessary for success, viz.: The fruit must be fully ripe, well supplied

with saccharine matter, very carefully handled, and a cool, dry room or cellar to keep them in. They should also either be sealed up so as entirely to exclude the air, or have just air or ventilation enough to prevent moulding. A little shriveling does not injure them so much as mould. But few varieties of grapes contain sufficient sugar to keep them through the Winter. The Catawba does when well matured, and is one of the best for the purpose.

“ They will keep good four or five months in either of the following ways, if the conditions previously stated are complied with :

“ In a dry day, take a broad basket into the vineyard, gather some of the dry fallen grape leaves, rubbing them in the hands to break them up some, and put a layer of them on the bottom of the basket. Then commence gathering the grapes, selecting the best ; examine each bunch, carefully cutting out the unripe, decayed, and broken berries, with a pair of grape scissors ; do not pick them off with the fingers, for by so doing you will start some good berries from the stem, causing them to rot and injure others. When trimmed, lay each cluster in the basket until one layer is complete, then a layer of broken leaves, alternately, until the basket is full, finishing with the leaves. More than ten or twelve inches in depth of fruit should never be packed, on account of the weight breaking those at the bottom. It is much better to put them into the basket at the time they are picked, to save another handling ; as every time they are handled, some are broken and injured.”

Last, though not least, is the making of wine. To do this successfully requires practice, and a knowledge that can not be taught by any description that can be written. Season and maturity of the fruit affect very materially the quality of the wine, even when made by those experienced therein. The following sketch of the details, with cuts illustrative of plan of a wine-house and press, we extract from the “ Western Horticultural Review : ”

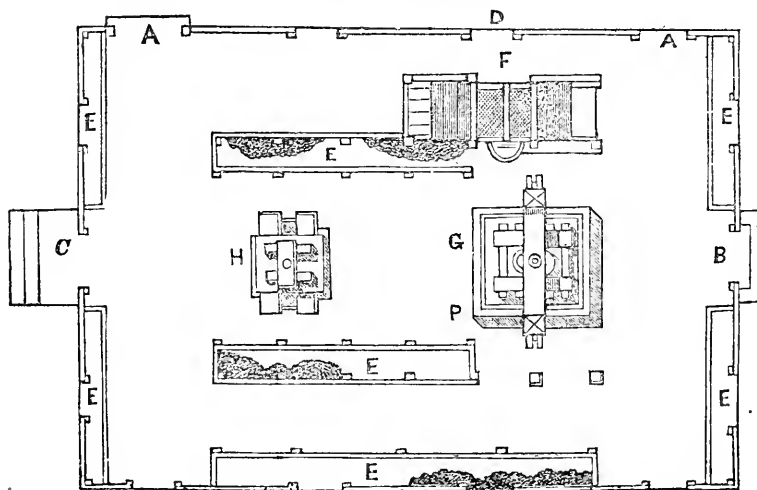

A.—Door opening to the vineyard, by which the grapes are brought into the wine-house.

B.—Back door of wine-house.

C.—Front door of wine-house.

D.—Opening, through which the stems are thrown from the machine.

E.—Tables for picking over and assorting the fruit previous to being stemmed.

F.—Stemming and crushing apparatus.

G.—Large press, capacity of one hundred bushels.

H.—Small press, capacity of forty bushels.

L.—Door opening into the basement.

Signs of Ripeness of Grapes. The stem of the grape should be of a brown color. The cuticle of the berry must be clear and transparent. The berries should separate easily from the stems. The seed must be of brown color. The juice must be sweet and sticky.

Do not cut the grapes early in the morning, with the dew on, nor during rainy weather, nor shortly after rain.

Gathering. The grapes, when fully ripe, are gathered in baskets containing about one bushel, as well as in a sort of "pannier" of wood, made very light and strong, and which is supported by straps, or thongs of willow, on the back of the gatherer.

Picking. This consists in removing by hand all green, shriveled or decayed grapes, which are thrown into tubs or barrels and pressed separately, to make a common wine or vinegar. The finest grapes are carried thence to the stemming apparatus, where they undergo another operation.

Stemming. Consists in separating the berries from the stem; it is done in *F* (of the ground plan), by means of the apparatus of which a cut is appended. This practice is now abandoned as useless and injurious to the wine.

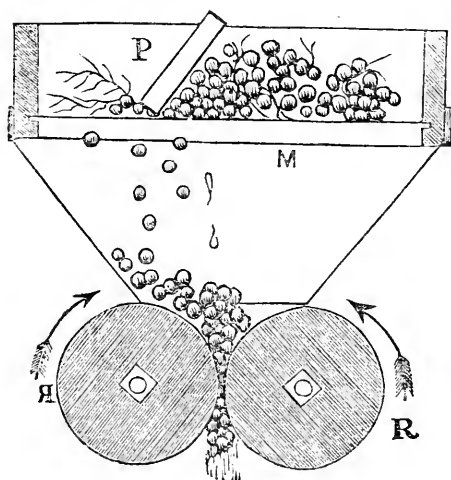

The grapes are thrown on the wire sieve *M*, which is open enough to allow the berries to pass, but retains the stems; a little plank, *P*, is held in an inclined position, to which a backward and forward movement is given, so as to force the berries through the sieve, and remove out of the way all the stems as they are stript.

Mashing. After passing through the stemming process, the grapes fall into a wooden mill, consisting of two rollers

ridged obliquely, to one of which is attached a set of screws, by which their distance from each other may be graduated to the proper degree; it being desirable that every grape should be crushed, but that the seed should not be broken. [Simple wooden rollers are equally good.—*Ed.*]

The rollers are turned by hand; the foregoing cut exhibits in R R a section of these rollers, and that which follows shows two men, one stemming, the other mashing the grapes. From the rollers, the

grape (being entirely separated from the stem, and thoroughly mashed) passes into the press, when the first operation of separating the juice is performed. The wine passes from the bed of the press by means of a conductor, into the basement, from whence it is conveyed into casks containing 260 gallons each; these, though by no means so large a size as used by some wine manufacturers, are of very convenient capacity for ordinary crops. The first fermentation takes

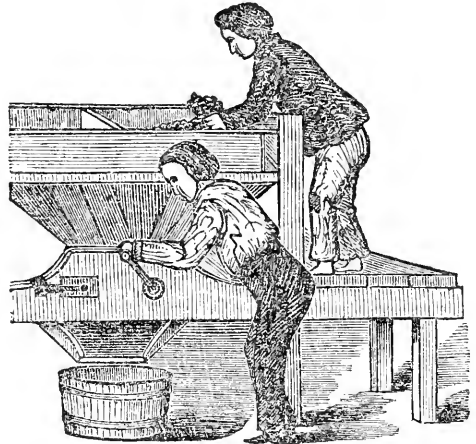
BURRIDGE *clur*

place immediately, and at the end of six or eight weeks the wine becomes perfectly clear, or what is technically termed “fine;” a second fermentation takes place in the Spring, about the period of the blooming of the grape. The wine should not be bottled until it is at least one year old, though it is frequently bottled for immediate use just previous to the second fermentation; this may be done with safety, if the bottles can be kept in a very cool place.

VARIETIES.

Over one hundred varieties of our native grapes have been noticed by Prince, in his “Treatise on Grapes;” but as few are worthy of cultivation, therefore of no practical benefit, we have confined our descriptions to those most known and meritorious.

CLASS I. *Varieties most generally esteemed.*

CATAWBA.

Red Muncy, Lebanon Seedling,		Catawba Tokay, Singleton,		Arkansas.
---------------------------------	--	------------------------------	--	-----------

Through Dr. S. Mosher, of Cincinnati, Dr. Solomon Beach is said to have found this variety in the Summer of 1821, growing wild in Buncombe

Co., North Carolina, on the border of the Catawba river. We have found this to ripen equally as well, and as far North, as the Isabella, when correctly pruned, and grown in dry or well-drained soil. It is esteemed both for dessert and wine use. In growth and foliage, it resembles Isabella, except that the wood is darker color, shorter jointed, and more round, and, at base of every leaf, there is a white downy spot.

Bunches, medium size, shouldered; *berries*, nearly round, large, pale red, becoming deeper when fully ripened in good soil, and covered with a lilac bloom; *flesh*, slightly pulpy, sweet, juicy, with a rich aromatic, musky flavor.

Too often gathered when only just turned in color, and then sour and unpalatable; hence the impression of many that they are not equal to Isabella.

DELAWARE.

Heath.

This variety was introduced to notice by A. Thompson, Esq., of Delaware, Ohio, in 1852. In our first edition of this work, we made it identical with Traminer, a foreign variety, which it closely resembles. At the time of its introduction, Mr. Thompson made the following statement respecting its origin:

“It was brought to our country from New Jersey about ten years ago by Mr. Jacob Moffard, who procured it from the garden of a French gentleman named Paul H. Provast, residing in Kingsmood Township, Hunterdon Co., N. J. Mr. P. came to this country about fifty years ago, and this variety, with others, was sent him, some twenty years since, by a brother residing in Italy.

“In our region it is perfectly hardy, free from mildew or rot, a prodigious bearer, never failing to perfectly ripen both fruit and wood, and comes to maturity two or three weeks earlier than the Isabella, and a month sooner than the Catawba.

“The berries are uniform in size and quality, it being almost impossible to find one that is imperfect, wholly free from pulp, and of rich and pleasant flavor.”

Another history of its introduction is, that in 1831 an old vintager fled from Italy to this country, and settled in New Jersey; that he brought with him roots and cuttings of grapes; that when he died, some few years since, he had two roots of this variety; that Heath and Wafford, two connections of his, dug up these two plants, and brought them to Delaware Co., Ohio. After a time, they bore fruit, which, when taken into the town of Delaware for sale, attracted attention, and soon created a demand for the vines.

It is also regarded by some as a seedling of this country; but, come from whence it may, it is certainly the most desirable hardy table grape now known.

Bunches, medium, compact; *berries*, small or medium, round clear pale red, delicate, thin skin, tender, juicy, sweet, delicious; very productive; not valuable for wine.

DIANA.

"This," says Mr. Downing, "is a seedling from the Catawba, grown by Mrs. Diana Crehore, near Boston, Mass." It is smaller size than its parent, but has the character of maturing its fruit two weeks earlier. It is yet but little known, and, although stated to have surpassed its parent, when grown at Mobile, at Cincinnati it has not equaled the Catawba.

Bunches, below medium size, compact; *berries*, round, delicate pale red; *flesh*, juicy, sweet, little pulp, rich, and slightly resembling Catawba in flavor. Valuable as a table grape.

ISABELLA.

This variety has, thus far, been stated to have originated in South Carolina, to have been taken thence to a garden in Brooklyn, N. Y., and there given to William Prince, who propagated, distributed, and named it after Mrs. Isabella Gibbs, who then (1816) owned the garden. On the authority of Lewis F. Allen, it was grown several years previous at Norwich, Connecticut, as the "Vernet Grape," and claimed to have been brought from one of the French West India Islands. Other authority places it as a common variety of Spain, and imported by a Mr. Laspeyre, who cultivated and sold it as "Laspeyre Grape," in 1810. Geo. Hoadley, Esq., states that in 1824 it was growing in Elizabethtown, N. J., where it was said to have been brought thirty years previous, from South Carolina or Georgia.

We incline to belief of its being a native, its hardihood, habit, and character all tending that way; but, come from whence it may, its vigorous habit and productiveness will ever render it a favorite.

As a wine grape, it is not esteemed. *Bunches*, large, rather loose, shouldered; *berries*, oval, large, dark purple, when fully ripe nearly black, covered with a blue black bloom; *flesh*, tender, with some pulp, which lessens as it ripens, juicy, sweet, rich, with slight musky aroma.

CLASS II. *Embraces varieties many of which are new and untested, and others suited only to certain localities.*

ADA.

Raised by Dr. Valk, Flushing, L. I. *Bunches*, large, compact, dark, almost black berries, sweet, vinous.

BLAND.

Bland's Virginia,	Powell,
Bland's Madeira,	Bland's Pale Red.

Found on the Eastern shore of Virginia by Col. Bland. It is not of value north of Philadelphia, on account of not often ripening, and is by many discarded, from its habit of only bearing moderately. As a table grape, in latitude where it will ripen, it is of the best, the objection to it being, that it drops its leaves before ripening.

Foliage, a light shade of green, smooth, propagated by layers; bunches, long, loose; berries, round, on long stalks or pedicles; skin, pale red, thin; flesh, slightly pulpy, slightly astringent, but of pleasant delicate flavor. Late in ripening, and valuable for packing away for Winter use.

BRINCKLE.

Raabe's No. 1.

First fruited in 1850. Bunch, large, rather compact, sometimes shouldered; berry, five-eighths of an inch in diameter, round, black; flesh, solid, not pulpy; flavor, rich, vinous, and saccharine; quality, "best." (Ad. Int. Rep.)

CANADIAN CHIEF.

From Canada, and claimed to be a native, but so strongly marked with foreign characteristics that we think it will not prove to be an acquisition for general cultivation.

Bunches, very large and shouldered, and the vine very productive, and will probably do better in Canada than in a warmer latitude. (Downing.)

CANBY'S AUGUST.

Raised by William Canby, of Wilmington, Delaware. Ripe eight or ten days before Isabella.

Bunch, four to five inches long, and over two inches broad, very compact; berry, medium size, roundish, inclining to oval, nearly black, thickly covered with bloom; flesh, tender, juicy, not pulpy, or but very little, sweet and pleasant.

CARTER.

Newly introduced; origin uncertain. Berries, round, large, deep reddish black; ripens before Isabella, and said to be superior.

CASSADY.

An accidental seedling white grape, with native leaf and dark purplish wood. Bunch, of medium size, tolerably compact, and sometimes shouldered; berry, below medium, five-eighths of an inch in diameter; form, round; color, greenish white, with occasionally a faint salmon tint, and thickly covered with white bloom; flesh, juicy, with but little pulp; flavor, pleasant; quality, "very good." (Ad. Int. Rept.)

CHILD'S SEEDLING.

A very large, fine grape, grown in Utica, N. Y., by Mr. Childs. It is doubtless of foreign origin, but has succeeded with him without glass, although latterly grown under it. We presume its foreign characteristics will not fit it for open culture. (Downing.)

CLARA.

Raabe's No. 4.

Bunch, medium, not compact; berry, medium, round, green, faintly tinged with salmon when exposed to the sun; flesh, tender, juicy; flavor, rich, sweet, and delicious; quality, "best." Fruited the present season for the first time. (Ad. Int. Rept.)

CLINTON.

Worthington.

This variety is claimed to have its origin in Western New York, but we have seen vines taken from the woods in Northern Ohio that so closely

resemble, in both leaf, wood, and fruit, that grown under this name, as to make us doubt its coming from the origin stated.

It is not a strong grower, although perfectly hardy, and suited to border planting three feet apart, and stake training not exceeding four feet high, in gardens. Its greatest recommendation is, that it ripens some ten days or two weeks earlier than Isabella, and, therefore, suited to higher or more Northern latitudes.

Foliage, small; wood, short jointed. Bunches, medium or small, not shouldered, compact; berries, nearly round, small, black, thin blue bloom, pulpy; juicy, with a harsh flavor; productive.

COLUMBIA.

This grape is said to have been found by Mr. Adlum on his farm at Georgetown, D. C. A vigorous grower, productive.

Bunch, small, compact; berry, small, black, with a thin bloom, with very little hardness or acidity in its pulp, not high flavored, but pleasant and vinous, scarcely, if at all, foxy. Ripe last of September.

CONCORD.

This fine, hardy native grape was raised from seed by E. W. Bull, Concord, Mass. It is of very healthy, vigorous habit, and exceedingly productive. Bunch, rather compact, large shouldered; berries, large, globular, almost black, thickly covered with bloom; skin, rather thick, with more of the native pungency and aroma than the Isabella, which it resembles, but does not quite equal in quality; flesh, moderately juicy, rather buttery, very sweet, with considerable toughness and acidity in its pulp. It is more hardy than the Isabella, and ripens about ten days earlier, consequently, it is a very valuable variety. Promises valuable for Ohio.

DEVEREUX.

Bunches, of medium size, compact; berries, rather small, purple, very juicy and sweet; good table grape, and makes a good wine; not liable to rot. Latter part of July. (Berekmans' Col.)

ELSINBURGH.

Elsinboro, | Elsinborough, | Smart's Elingburgh.

The spelling of this name is matter of some difference in opinion among horticulturists, but the manner we adopt, being that of all previous writers, we choose to continue it. The variety is said to have come from a village in Salem Co., N. J. It is a nice little grape, suited for the dessert, and for growing on trellises in gardens. A moderate, regular bearer, ripening a little before or with Isabella.

Wood, slender, long jointed; leaves five lobed. Bunches, medium, loose, shouldered; berries, small, round, thin skin, black, covered with blue bloom; flesh, without pulp, melting, sweet; "best."

EMILY.

Raabe's No. 2.

Bunch, large, not very compact, occasionally shouldered; berry, below medium, from three-eighths to one-half of an inch in diameter, round, pale red; flesh, very juicy, with little or no pulp; flavor, saccharine and delicious; quality, "best" for an out-door grape. Fruited in 1850 for the first time.

GARRIGUES.

Raised by Edward Garrigues, Kingsessing, Philadelphia. A vigorous grower, hardy and productive, very much resembles Isabella, and no doubt a seedling of it. Bunch, large, loose, shouldered; berries, large, oval, dark purple, covered with a thick bloom; flesh, with little toughness in its pulp, juicy, sweet, and rich. Ripe eight or ten days before Isabella.

GRAHAM.

An accidental seedling raised by Mr. Graham. It sprung up in 1845, and fruited in 1850 for the first time. Bunch, of medium size, shouldered, not compact; berry, half an inch in diameter, round, purple, thickly covered with a blue bloom, contains little or no pulp, and abounds in a saccharine juice of agreeable flavor; quality, "best." The leaf indicates its native parentage. It is probably a natural cross between the Bland and Elsinborough, both of which were in bearing in the garden where it originated. (Ad. Int. Rept.)

HALL'S GRAPE.

A seedling raised by David Hall, of Urbana. Berries, of medium size, dark color, larger and better flavor than Clinton, but not equal to Isabella. Said to be earlier and hardier than Catawba or Isabella.

HARTFORD PROLIFIC.

A variety of the Fox Grape, from West Hartford, Ct. For early maturity and escaping of frosts, it is valuable, as it always bears, but its foxy character is not agreeable, when the Delaware or Catawba can be had.

Bunches, medium, loose; berries, round; skin, black; sweet, with considerable pulp. Ripens ten days or two weeks before Isabella.

HERBEMONT.

Herbemont's Madeira, | Warren, | Warrenton.

The origin of this is yet in doubt, some claiming it same as Lenoir, and a native—others claiming it as a French variety. Its hardy character and resemblance in foliage to the River grapes, however, seems rather to favor its being a seedling of our States.

Only moderately vigorous. Wood, dark color; terminal leaves, red or brownish. Bunches, large, compact, shouldered; berries, small, round; skin, thin, purple, slight bloom; flesh, tender, without pulp, sweet, excellent, juicy, vinous, valued for dessert, and yields a wine like Spanish Manzanella.

HUDSON.

Originated in the gardens of Mr. Calkins, Hudson, N. Y. Growth similar to Isabella, and said to be two or three weeks earlier. Bunch and berry much the same, but less sprightly and not quite so rich.

IMITATION HAMBURG.

Union Village, | Shaker Grape.

A native variety. Fruit, large, dark purple, or as large, skin as thin, pulp as soft and juicy, but of inferior aroma and flavor, to the Black Hamburg. Origin, supposed among the Shakers, at Union Village, Ohio.

LENOIR.

Sumpter? | Clarence?

Subject, in clay soils, to mildew and rot. Bunches, large, compact, sometimes shouldered; berries, small, black, sweet, agreeable. Earlier than Herbemont, and by many considered superior.

LOGAN.

A new variety of a dark or black grape; hardy, and said very fine. We have not seen it.

LOUISA.

Origin, Lebanon Co., Pa. Vine, hardy, vigorous growth. Bunch, medium, rather compact, sometimes shouldered; berry, round, oval, blackish, with blue bloom; resembles Isabella, and said to ripen a few days earlier.

MARION.

A seedling raised at Bethlehem, Pa., many years since, but not until recently much noticed. It is said to resemble (we have never seen it) the Isabella in many respects, but is more uniform in ripening, and of a more delicate character. Vines, healthy; wood, firm, short jointed; good bearer. Bunches, large, regular, seldom shouldered; berries, above or medium, inclining to oval, dark purplish black, with blue bloom; juice, abundant; pulp, thin; promising to be one of the most valuable.

MISSOURI.

Missouri Seedling.

Said to be a native of Missouri; it is of slow growth, short jointed, and, like the Clinton, suited to border culture in gardens. From it a wine is made resembling Maderia.

Leaves, deeply cut, tri-lobed. Bunches, below medium, loose; berries, small, round; skin, thin, almost black, very little bloom; flesh, tender, little pulp, sweet, and pleasant; "very good."

NORTON'S VIRGINIA.

Norton's Seedling.

A native seedling produced by a cross between the Bland and Miller's Burgundy, by Dr. N. Norton, of Richmond, Virginia. It is a most productive grape in garden or vineyard, bearing very large crops (especially at the South, where many kinds rot), in all seasons. It has been confounded by some with Ohio grape, from which it is quite distinct, more pulpy, and less agreeable for the dessert, though a much better wine grape.

Bunches, long, sometimes eight or nine inches, occasionally shouldered, somewhat compact; berries, small, round; skin, thin, dark purple; flesh, pulpy, with a brisk, rather rough flavor. Shoots strong and hardy.

NORTHERN MUSCADINE.

Raised by the Shakers, at New Lebanon, Columbia County, N. Y. Bunches small, short, compact; berry, large, round, chocolate or brownish red; skin, thick, with a pungency and odor common to the wild fox grape, and is a very little, if any, improvement on it. The berries fall from the bunch as soon as ripe, which is about two weeks before Isabella. (Downing.)

OHIO.

Longworth's Ohio, | Segar Box.

The original of the vines now known under this name were some cuttings left in a segar box at the residence of N. Longworth, Esq., Cincinnati, during his absence from home. Its true origin is yet in doubt. North of Cincinnati it does not succeed, and wherever planted should have long range on a trellis. Only valued for table use.

Bunches, large, loose, shouldered; berries, small, round, nearly black, blue bloom; flesh, without pulp, sweet. Only suited to the amateur.

PAULINE.

The finest Southern native grape. Bunches, large, shouldered, compact; berries, medium, brownish crimson, very sweet; skin, thin; no pulp. (Berkman's Cat.)

RAABE.

Raabe's No. 3.

Bunch, small, compact, rarely shouldered; berry, below medium, round, dark red, thickly covered with bloom; flesh, very juicy, with scarcely any pulp; flavor, saccharine, with a good deal of the Catawba aroma; quality, "best." (Ad. Int. Rept.)

REBECCA.

Originated in the garden of E. M. Peake, Hudson, N. Y. The vines are hardy, and it promises to be one of the most valuable; leaves deeply lobed, coarsely and sharply serrated; upper surface light green, under surface with thin whitish down. Bunches, medium size, very compact, not shouldered; berries, medium, obovate, greenish white, becoming pale amber at maturity, and covered with a thin white bloom; flesh, melting, juicy, free from pulp, musky aroma; seeds, small, two to four in each berry.

SCUPPERNONG.

Fox Grape, of the South,
Bull or Bullet, "American Muscadine, of the South,
Roanoke, "

A distinct Southern species, *vitus vulpina*, too tender for the North, highly esteemed throughout the entire Southern States, where it is much grown as a wine grape in vineyards, and is found wild from Virginia to Florida.

Species, diœcious; leaves, small, roundish, coarsely serrated, glossy on both sides: young shoots slender, old wood smooth. The White and Black varieties differ only in the color of fruit, the White being light green, and the Black, dark red, with tendrils of vine corresponding with color of fruit.

Bunches, small, loose; berries, round, large; skin, thick; flesh, pulpy, juicy, sweet, with a strong musky scent.

SCHUYLKILL.

Schuylkill Muscadell,
Alexander,
Spring Mill Constantia,Maderia, of York, Pa.,
— Muscadine,
Cape Grape,Clifton's Constantia,
Tasker's Grape,
Winne.

From the banks of the Schuylkill, Pa. Its value is only as wine grape, and for that, not equal to Catawba. We have found it extensively distributed North and West as the Isabella. As the leaves are much more

downy, it is easily detected in foliage, and the bunches being not shouldered, while the Isabella is always shouldered.

Berries, often large, roundish oval, thick skin, quite black; flesh, firm pulp, juicy, musky, often harsh.

Minor's Seedling, Shurtleff's Seedling, Northern Muscadine, Charter Oak, Mammoth, and some others are cultivated in localities, but their *good* qualities seem destined to remain in circumscribed limits; not having yet been seen, when cultivated away from their first friends, inclines us to say they are simply varieties of the Fox Grape.

Hyde's Eliza, Troy Grape, Pennsylvania, Sherman, Chillicothe Seedling, and Lee's, are all sub-varieties, and not equal to the original Isabella.

Pond's Seedling, James' Seedling, Clermont, White Catawba, and Zane, are sub-varieties of the Catawba, but not equaling it. The "Mammoth Catawba" is also a sub-, which, under high culture, surpasses the original only in size.

TAFT.

Originated with W. P. Taft, Cleveland, O. Bunches, medium, short, compact, variety shouldered; berries, above medium, globular compressed, light green in shade, marblings of chocolate red in sun; flesh, slightly pulpy, juicy, sweet, a little musky; skin, tough, thick, with somewhat of the pungency belonging to the common Fox Grape; vines very hardy; fruit ripens two weeks before Isabella.

TO-KALON.

Raised by Dr. Spofford, of Lansingburgh, N. Y. This fine grape has been but little disseminated in consequence of the general supposition that it was very much like, if not identical with, the Catawba, from which it is entirely distinct in wood, foliage, and every characteristic of the fruit. It is a vigorous grower, foliage very large, abundant, and much less rough than Catawba or Isabella, and the *alæ* of the leaves overlap each other different from any other with which we are acquainted.

Bunches large and shouldered; berries varying in form from oval to oblate, very dark in color and profusely covered with bloom. Its fruit, when ripe, is very sweet, buttery, and luscious, without foxiness in its aroma, or any toughness or acidity in its pulp. It is perfectly hardy, and with good treatment in deep, rich, pervious soil, it is an early and abundant bearer; with indifferent treatment it is a poor bearer. It ripens a little earlier than Isabella. (Downing.)

YORK MADEIRA.

From York Co., Pa. Excellent when fully ripe; extremely productive, hardy; canes, rather slender, short jointed; resembles Miller's Burgundy in size of berry, shape, and compactness of bunch. Excellent when fully ripe; of a peculiar flavor. (Downing.)

THE FOREIGN GRAPE.

Vitis vinifera, L.—*Vitaceæ* of Botanists.

From the earliest record of foreign lands, the vine has ever been held in high esteem; its fruit valued for the dessert as well as for the making of wine, and itself held as symbolic of happiness and plenty. "The pages of Scripture abound with allusions to the fertility of the vine, as emblematical of prosperity." To trace its introduction and entire history up to this date, would occupy more room than the limits of our present work will admit: we shall therefore content ourself by saying that the original type of the *vitis vinifera* came from Persia; that it was probably cultivated in Britain not many years after the commencement of the Christian era; that the varieties native of Britain and America, are quite distinct; that those native of Britain are not edible, while those of our own land embrace a number of edible species. The success of the Foreign varieties, so far as tried north of 34° of latitude, has not been satisfactory, few or no varieties withstanding the extremes of our climate, without protection. Between 1760 and 1770, Lord Sterling imported large numbers of foreign grapes into New Jersey, with a view to wine. The experiment failed, as have those of Longworth, and others since.

Of the longevity of the vine, records are made, giving it existence from six hundred years down, with immense length of vine, and stems six feet around, or sufficient to afford the cutting out of planks fifteen inches broad.

Propagation. The same practices as noted under head of American Grapes are applicable here, but that most generally pursued in propagating esteemed varieties of the foreign grapes is by eyes, as represented in adjoining figure. This is done by selecting a strong bud and cutting it off from the remainder of the branch, at about two inches above and below, and planting it in a pot covered about half an inch deep with light loamy soil, then plunging the pot in a hot-bed. By this means every bud on a shoot can be formed into a plant.

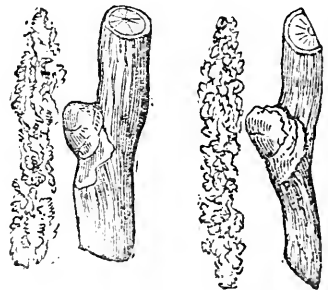

Out-door Culture. In sheltered locations, warm yards, in cities, &c., such varieties as the Black Prince, Traminer, and Royal Mus-

cadine, may be grown in the open air by bending down the vines in the month of November, and covering them with tan-bark, or other mulch, and raising them again to their position in April. Free supply of wood ashes and soap-suds will be found requisite to hasten their growth and maturity of fruit, as well as prevent mildew.*

Cold-Houses. By this term is meant an inclosed structure of wood or brick, with a sloping roof covered with glass. These structures, as made at the East, and by a few wealthy men at the West, and represented in the Horticultural journals of the day, are too expensive to make the growing of the better foreign grapes general at the West. But expensive structures are not necessary; many a man at the West has a south side of a building unoccupied; this may serve as the back of his cold-house, by setting up pieces of four-inch scantling against the building, nailing boards to it, and filling in between with tan-bark, saw-dust, or fine charcoal, he has the back; now, four inch square posts rising four feet from the ground, at a distance of say fourteen feet from the back, boarded on each side, and filled in same as the back, make the front wall; leaving, however, two spaces six feet from either end, of about two feet square, for hanging shutters. Now, the back wall being ten feet high, the ends are to be made in same way as the front, giving, of course, the slope from back to front, and leaving out at one end space for a door-way, and at the highest point of sides near the back at each end, a space for swinging shutters of say two feet square; these opened, will give ventilation, in connection with those in the front wall. This done, a joiner will be required to fit on a plate of two inch plank all around, and fit in rafters and sash; the sash should be the entire length of width of house; stiles four inch wide by one and a half thick, bars one inch wide beveled to half inch on the under side, the upper stile or head piece six inches wide, the lower one fourteen inches; the rafters should be placed so that sash cannot be over forty two inches wide, or sufficient for five lights wide of six-inch glass. When the location of such houses is not in a very cold climate, or where the thermometer rarely falls below zero, cotton cloth dipped in boiled oil and varnished will answer a very good purpose; but, perhaps in the end, not be as cheap, as its durability will only be about two years. Those who wish for more expensive houses, we advise to purchase "Allen's Treatise on the Grape."

Vine Borders. Upon the formation of vine borders for cold, as well as forcing-houses, more has been written and published than one person could read at the rate of ten hours a day, in one entire month. Some advise the formation of the border all outside, while

* Geo. Hoadley, Esq., says, that in 1820 to 1830 there was growing in the garden where he then resided, in New Haven, Conn., many white grapes, received from David Deforest, as White Sweet-Water, which never mildewed. This garden was sixty or seventy rods from the harbor (or salt water). The prevalent winds were from the harbor, in Summer, and in storms the shrubbery not unfrequently covered with spray.

others prefer inside. If sandy ground, no care will be required to form a drainage: but if on clayey, retentive soil, dig out all the earth three feet deep, form a drain in centre at bottom, leading away from the house, prepare fresh virgin earth or turf from old pastures or woods, and mix well rotted barn-yard manure in about equal quantities, or perhaps a little most of the soil, add to this one-tenth in quantity each of gypsum (plaster of Paris), and ground bones, and one-sixth of wood ashes; let it be well mixed before putting in the border. Parings of horses' hoofs, and cinders from a blacksmith's shop, street scrapings, leather parings, old rags, bones, &c., are all used and all good, but the above named materials, with liberal watering with soap-suds, and occasional sprinkling with sulphur (which will be necessary at times to check mildew) will give good growth of vine and fruit.

Planting and Training. The vines, being obtained from the nursery, generally come in crocks or pots; the earth should be well wet, and then by inserting the finger at the hole at the small end or bottom of the crock, the whole ball of roots entire is pushed out; now plant just outside the front wall, and so that you can run the stem immediately under, leaving the roots only outside; let each plant stand half way between each rafter, and as they grow train to a wire fastened at top each of front and back wall, so as to be six inches below the glass. Spur pruning is regarded best for cold houses, and is plainly described as follows: "In pruning in the Fall, after the first year's growth, each alternate eye is disbudded on each side of the cane, leaving those wanted for breaking next season about fifteen inches apart. The next season, when pruning for spurs, the side shoots are cut back to three eyes, or even four, according as the lower buds may be plump and well rounded. In breaking, each bud puts forth a shoot; the most promising one nearest the top, and the one at the base is allowed to remain, and the other is rubbed out. The top one is allowed to bear, and the fruit on the bottom one is pinched out. The fruit-bearing spur is stopped three or four joints above the fruit, and the other one next to the base is also stopped, when it has grown seven or eight leaves. They are now trained as shown in the following figure.

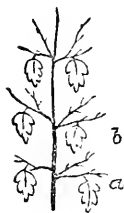

"*a* is the bearing shoot, and *b* the one not to be fruited till next year; at next pruning (or what is still better, two or three weeks previous), *a* is cut clean cut to the base of *b*, and, when the leaves fall, *b* is cut back to three eyes, as *a* was last season, and so on from year to year." Every Fall, at approach of cold weather, take down the vines, lay them on the border, inside, and cover with tan-bark four inches deep; cover the border outside same depth with barn-yard manure.

Routine of Culture. The following brief instructions, from A. J.

Downing, contain all that is essential for a cold-house: "In a vinery without heat this is comparatively simple. As soon as the vines commence swelling their buds in the Spring, they should be carefully washed with mild soap-suds, to free them from insects, soften the wood, and assist the buds to swell regularly. At least three or four times a week; they should be well syringed with water, which, when the weather is cool, should always be done in the morning; and every day the vine border should be duly supplied with water. During the time when the vines are in blossom, and while the fruit is setting, all sprinkling or syringing over the leaves must be suspended, and the house should be kept a little more closed and warm, than usual, and should any indications of mildew appear on any of the branches, it may at once be checked by dusting them with flour of sulphur. Air must be given liberally every day when the temperature rises in the house, beginning by sliding down the top sashes a little in the morning, more at mid-day, and then gradually closing them in the same manner. To guard against the sudden changes of temperature out of doors, and at the same time to keep up as moist and warm a state of atmosphere within the vinery as is consistent with pretty free admission of the air during sunshine, is the great object of culture in a vinery of this kind.

Insects. The *aphis* or "vine-fretter," is destroyed by fumigating, *i. e.*, burning tobacco in the house, and syringing the vines freely afterward. If red spiders are troublesome, syringe the vines at evening, and dust the leaves with flour of sulphur.

VARIETIES.

Feeling that a multiplicity of varieties would only mislead and confuse the practical man, and our own experience with foreign grapes not having been sufficient to enable us fully to decide on which to recommend, we adopt and describe few besides those voted worthy of general cultivation by the American Pomological Society.

BLACK HAMBURGH.

Warner's Black Hamburg, Red Hamburg, Dutch Hamburg, Hampton Court Vine,	Valentine's, Purple Hamburg, Brown Hamburg,	Salisbury Violet, Gibraltar, Frankendale.
--	---	---

This variety is one of the most esteemed for the vinery. In sheltered locations, out of doors in cities south as far as Cincinnati, it does well with protection in Winter. A good bearer.* *Bunches*, large, shouldered on both sides; *berries*, very large, roundish inclining to oval, brownish purple, becoming purplish black when fully ripe; of sugary rich flavor.

Wilmot's New Black Hamburg is similar. *Fruit*, larger, bloom very thick; *flesh*, firm, nearly or quite equal to the common Hamburg.

* A vine of this variety at Hampton Court Palace, planted in 1769, is stated to produce annually over one ton weight of fruit.

Allen's seedling Black Hamburg, is of less value. *Bunches*, not as large; *berries*, black, oval. Victoria, heretofore regarded as a synonym of the old Hamburg, is now regarded as a slightly-improved sub-variety.

BLACK PRINCE.

Alicant, Black Valentin, Boston, Pocock's Damascus,	Steward's Black Prince, Black Spanish, Black Portugal,	Sir A. Pytche's Black, Cambridge Botanic Garden, Black Lisbon.
--	--	--

This often succeeds well with Winter protection out doors, while in the house it is esteemed on account of hanging long after fully ripe. A profuse bearer. *Bunches*, long, often shouldered; *berries*, large, thinly set, oval; *skin*, rather thick, black, covered with blue bloom; *flavor*, sweet, excellent; "very good."

Black St. Peter's differs from this in having a thin skin.

BLACK FRONTIGNAN.

Muscat Noir, Muscat Noir Ordinaire, Black Frontignan,	Bourdales des Hautes Pyrenées, Sir Wm. Rowley's Black, Purple Frontignan,	Purple Constantia, Muscat Moir de Jura.
---	---	--

This is the variety from which the muscadine wine is made. A good bearer. *Bunches*, long; *berries*, medium size, round, black; *skin*, thin; *flavor*, musky rich.

BLACK CLUSTER.

Black Morillon, True Burgundy, Small Black Cluster,	Early Black, Pineau,	Black Burgundy, Black Orleans.
---	-------------------------	-----------------------------------

This variety is hardy, and succeeds out doors. It is valued in France for wine, but will never take high rank in this country. It has been pretty extensively disseminated throughout the West, which is our main reason for noting it. It has over forty synonyms, but those given are all which we have ever heard applied to it in this country. *Bunches*, small compact; *berries*, medium size, roundish oval, black, juicy, sweet; "good," distinguished from Miller's Burgundy, by absence of down on the leaf.

EARLY BLACK JULY.

July Grape, Madeleine Noir, Morillon Hatif,	Burgunder, Madeleine, Raisin Precoce,	De St. Jean, August Traube, Jacob's Straube.
---	---	--

The habit of ripening its fruit by the middle of August, or earlier, is its chief merit. *Foliage*, small light green; *bunches*, small, compact; *berries*, small, round, black, with a blue bloom, a little acid and of indifferent flavor; "good."

GRIZZLY FRONTIGNAN.

Grizzly Frontignac, Muscat Rouge, &c., &c., in all thirteen Synonyms.	Red Constantia, Muscat Gris,
---	---------------------------------

Adapted only to the house, where it ripens early, and being of "best" quality, is highly esteemed. *Bunches*, rather long, narrow, slight shoulders; *berries*, round, medium size, grayish red, thick bloom, juicy, rich, musky, high flavor.

ROYAL MUSCADINE.

Chasselas de Fontainebleau, Golden Chasselas, Chasselas Doré, D'Arbois,	Amiens, Chasselas, White Chasselas, Chasselas Blanc,	Raisin d'Champagne, Amber Muscadine, Early White Teneriffe.
--	---	---

This is highly esteemed ; is distinguished from White Sweet Water (often sold as this variety) by its larger berries and stronger growth. Grown out of doors, it requires not only Winter protection, but also to be well supplied with wood ashes, as otherwise it cracks and mildews.

Allen says, the Royal Muscadine and Chasselas of Fontainebleau are distinct, but only in size of bunch. The Early White Muscadine, he also says, only varies from this in ripening a few days earlier.

Bunches, large, long, shouldered ; *berries*, above medium, round, greenish white, becoming amber color when fully ripe, tender, rich delicious flavor Middle to last of September.

MUSCAT OF ALEXANDRIA.

White Muscat of Alexandria, Jerusalem Muscat, Malaga, White Muscat of Lunel,	Lunel, Frontniac of Alexandria, Muscat d'Alexandria, White Muscat,	Tottenham Park Muscat, Passe-longue Musque, Passe Musqué.
---	---	---

Adapted only to house culture, and, even then, benefitted by artificial heat. This is probably the "Malaga" Grape brought to this country in jars and sold by confectioners.

Bunches, very large, loose, irregular ; *berries*, large, oval, pale amber, thick skin, firm flesh, crisp, musky, rich perfumed flavor, often seedless. A strong grower.

The Cannon Hall Muscat, is esteemed a sub-variety not equalling its parent.

TRAMINER.

Red Traminer, Fromentin Rouge, Rother Traminer, Rother Klevner, Tokayer, Kleinbranner,	Rothclausen, Ranfoliga, Gris Rouge, Fromentean, Declmanner, Rothedel,	Rothfranken, St. Clausen, Marzimmer, Ran Folak, Rothe Reifer.
---	--	---

Hardy in the open air, being free from mildew or rot, a productive bearer, and never failing to perfectly ripen both fruit and wood. Allen says of it, "a much-esteemed wine Grape on the river Maine." It is described in the London Horticultural Society's Catalogue. It deserves a place in every garden.

Bunches, medium size, compact ; *berries*, roundish oval, middle size, uniform, pale reddish, tender, juicy, sweet, without pulp, rich and pleasant flavor. Ripens ten days before Isabella.

WHITE FRONTIGNAN.

White Frontniac, Nepeans Constantia, Raisin de Frontignan, Moschata Bianca,	Moscateel Commun, White Constantia, Muscat Blanc,	Muscat Blanc de Jura, Moscado Bianco, Muscateller.
--	---	--

An old productive variety suited only to the house. *Bunches*, middle size, rather long, rarely shouldered ; *berries*, middle size, round rather closely set ; *skin*, thin, dull white or greenish yellow, thin white bloom ; *flesh*, delicate, sugary, rich musky flavor

NECTARINES.

THE Nectarine is claimed to be only a sport in nature from the Peach, to which occasionally plants grown from seeds return; record is also made of the Nectarine tree producing both Peaches and Nectarines on the same tree. Of this we confess some little unwillingness of belief; certain, however, it is that the trees so closely resemble the Peach, as not to be detected except when in fruit.

Grown under glass, or South, where the heat is greater than at the North, the Nectarine is a really fine fruit; but here it is inferior to the Peach, possessing a flavor partaking of the peculiar flavor and taste of the pit. When we say the trees are undistinguishable from the peach, we speak the general view; closely examined, the wood may be found slightly more smooth, and possibly a trifle firmer or closer grained. The trees are usually propagated by budding, in same manner and time as the Peach, and their after culture is the same.

The fruit of the Nectarine being smooth skinned, is equally liable to attack from curculio as the Plum, and the same remedies are adopted for prevention; we, therefore, refer the reader to the article under head of Insects injurious to the Plum. The same marks distinguishing varieties in the leaf are found in the Nectarine, as in the Peach, and used accordingly.

CLASS I. *Most generally esteemed.*

BOSTON.

Lewis, | Perkins' Seedling.

American. Claimed to have originated from a peach-stone. It is probably one of the very best Nectarines, and well adapted to all sections of our country.

Flowers, small; *glands*, globose; *fruit*, large, sometimes eight inches round, roundish oval; *skin*, light yellow, with deep red cheek, shaded off by a mottling of red; *flesh*, yellow to the stone, sweet, with a pleasant, peculiar flavor; *stone*, small, pointed. Free-stone. First September.

DOWNTON.

Foreign. *Flowers*, small; *glands*, reniform; *fruit*, large, roundish oval; *skin*, pale green, with violet red cheek; *flesh*, pale green, melting, rich, high flavor. Free-stone. Last of August.

EARLY VIOLET.

Violet Hatif,	Hampton Court,	Brugnon Hatif,
Petite Violet Hatif,	Large Scarlet,	Violet Musk,
Early Brugnon,	New Scarlet,	Violet red at Stone,
Brugnon red at Stone,	Aromatic,	Lord Selsey's Elruge.

Foreign. Tree, very hardy, often confounded with Elruge, from which it is distinguished by its deep red flesh and dark colored stone.

Flowers, small; *glands*, reniform; *fruit*, large, roundish, narrowed at apex; *suture*, shallow; *skin*, yellowish green in shade, dark purplish red, mottled with pale brown dots, in sun; *flesh*, whitish, red at stone, melting, juicy, rich and high flavored; *stone*, roundish, reddish brown. Free-stone. Last of August.

ELRUGE.

Common Elruge, Claremont,	Anderson's, Temple,	Oatland's, Spring Grove.
------------------------------	------------------------	-----------------------------

Foreign. An old variety that has always maintained a first character wherever correctly grown.

Flowers, small; *glands*, reniform; *fruit*, medium, roundish oval; *suture*, distinct only at apex; *skin*, pale greenish shade, violet or blood red, dotted with brown specks in sun; *flesh*, greenish, slightly stained with pale red at stone, juicy, rich, high flavor; *stone*, oval, rough. Free-stone. Early September.

CLASS II. *Embraces varieties, many of which are new and untested, others suited only to certain localities.*

BARKER.

Foreign. "Flowers, small; glands, reniform; fruit, large obovate, dark red next sun, pale yellowish green, where shaded; flesh, fine, yellowish white, rayed with bright red at the stone; stone, large; kernel, bitter. Free-stone. August." New, not yet fruited in this country.

DUKE OF TELLIER'S.

Duc du Tellier's, Du Tilliers,	Du de Tello, Duke de Tilley,	Du Tilly's.
-----------------------------------	---------------------------------	-------------

Foreign. Flowers, small; glands, reniform; fruit, above medium, roundish oblong, pale green, purplish red cheek; flesh, greenish white, red at stone, second rate flavor. Free-stone. Last August.

EARLY NEWINGTON.

Early Black Newington, Lucombe's Black,	New Early Newington, Lucombe's Seedling,	Early Black.
--	---	--------------

Foreign. Flowers, large, glandless. Fruit, large, roundish ovate, point at apex, pale green, with shades of red marbled in sun; flesh, greenish white, red at stone. Cling-stone. Early September. Valued South.

FRENCH YELLOW.

Foreign. Fruit, medium, greenish yellow, dull red in sun; flesh, yellow, juicy, rich. Cling-stone. September. (W. R. P.)

HARDWICKE.

Hardwicke Seedling, | Hardwicke's Seedling.

Foreign. Flowers, small ; glands, reniform ; fruit, large, roundish oval, pale green, violet red cheek ; flesh, pale green, little marked with red at stone, juicy. Free-stone. Last August.

HUNT'S TAWNY.

Hunt's Large Tawny, | Hunt's Early Tawny.

Foreign. Flowers, small, glandless ; fruit, below medium, roundish ovate, point at apex, pale orange, red cheek, russety specks ; flesh, orange, juicy. Free-stone. Middle August.

LARGE EARLY VIOLET.

Violette Grosse.

Foreign. Similar to Early Violet, a trifle larger, and less high flavored.

NEATE'S WHITE.

New White,		Flanders,		Large White.
Cowdray White,		Emerton's New White,		

Foreign. Flowers, large ; glands, reniform ; fruit, above medium, round, white reddish cheek in the sun ; flesh, white, juicy. Free-stone. Early September.

OLDENBURG.

English. New ; not yet fruited in this country. It is described as of "medium size, ovate form, dark red on pale yellow ; flesh, separating freely from the stone, juicy, melting, sugary, vinous."

ORANGE.

Pitmaston's Orange, | William's Orange, | William's Seedling.

Foreign. Flowers, large ; glands, globose ; fruit, large, roundish ovate, acute point at apex, orange yellow, with dark brownish red cheek ; flesh, yellow, red at stone, juicy, sweet. Free-stone. Last August. Valued South.

RED ROMAN.

Old Roman,		Brugnon Violet Musquée,
Roman,		Brugnon Musquée.

Foreign. An old variety, which proves best adapted to our northern sections. Flowers, large ; glands, reniform ; fruit, above medium, roundish, greenish yellow, with dull red cheek, and russety specks ; flesh, firm, greenish yellow, deep red at stone, juicy, vinous. Cling-stone. Early September.

STANWICKE.

First fruited in this country by Caleb Cope, Esq., Phila. From its high praise in England, where it originated, and the fact of our clear, sunny climate adding to the richness and sugary character of both Peach and Nectarine, as compared with England, we are led to suppose this will prove the very best Nectarine extant.

It was grown from a stone brought from Syria, and is described in the journal of the London Horticultural Society as above medium size, round-

ish oval, slightly heart shape at base; pale greenish white, shaded into deep, rich violet in sun; flesh, white, tender, juicy, rich, sugary, and without the slightest trace of prussic acid flavor; stone, middle size, ovate, a prominent sharp edge, rugged, and of chocolate color; kernel, sweet.

CLASS III. *Superseded by better sorts.*

BROOMFIELD.

American. Glands, reniform; fruit, large, roundish; dull yellow, red cheek; flesh, yellow, pleasant; second rate. Cling-stone. Middle September.

FAIRCHILD'S.

Fairechild's Early.

Foreign. Glands, reniform; fruit, small, round; yellowish green, red cheek; flesh, yellow, dry, poor. Free-stone. Early August.

GOLDEN.

Orange, | Fine Gold Fleshed.

Foreign. Glands, reniform; fruit, medium, roundish ovate; light yellow, red in sun; flesh, orange yellow, firm, sweet; second rate. Cling-stone. Early September.

MURREY.

Murry, | Black Murry.

Foreign. Glands, reniform; fruit, medium, roundish ovate; pale green, red cheek; flesh greenish white, sweet, good flavor; poor bearer. Free-stone. Last August.

NEWINGTON.

Scarlet Newington,		Smith's Newington,		Rough Roman,
Scarlet,		French Newington,		Anderson's Round.
Old Newington,		Sion Hill,		

Foreign. Glandless; fruit, large, roundish; greenish yellow, red in sun; flesh, firm, juicy deep red at stone. Cling-stone. Middle September.

PRINCE'S GOLDEN.

American. Glands, reniform; about one-fourth larger, and a week later, otherwise, of second quality, and resembling the Golden.

PETERBOROUGH.

Late Green, | Vermash, | Genoa, or Genoese.

Foreign. Under the last synonym, it has, of late, been disseminated as *new*. Glands, reniform; fruit, small, roundish, green, with dull red in sun; flesh, greenish white. Free-stone. Early October.

SWEET YELLOW.

Janne Lisse, | Late Yellow.

Foreign. Glands, reniform; fruit, small, yellow, with dull red cheek in sun; flesh, yellow, dry. Free-stone. October.

THE PEACH.

Persica vulgaris, Dec.—*Rosaceæ* of Botanists.

FOUND wild on the Himalayan mountains, and not mentioned in Jewish history, it is doubtful whether the Peach is, as generally understood, a native of Persia and also of China. It was, however, introduced into Italy by the Romans, and, as early as 1550, was cultivated in Britain. About the year 1680 it was introduced into this country, and, with the exception of portions of the Northern New England States and Northern New York, it is now cultivated in every settled portion of our States. History clothes the Peach with deleterious qualities, and Pliny mentions that it was supposed the King of Persia had sent them into Egypt to poison the inhabitants, with whom he was then at war. In portions of China, Spain, Italy, and the South of France, as well as our own country, the peach is grown without aid of glass, or artificial heat, or by means of walls, etc.; we have, therefore, looked to receive some variety from abroad that would surpass our American Seedlings, but, as yet, none have been introduced.

The wood of the peach, being of a more open, coarse fibre than that of most fruits, we find it more susceptible to sudden and severe changes of temperature, and therefore less hardy, and of shorter duration. That this character is materially affected by soil, seems not to admit of a doubt; writers generally conceding that while in unfavorable soils the peach decays in four to ten years, in favorable ones it continues healthy and vigorous for forty or fifty years, and, with the addition of being annually correctly and freely pruned, may be made to produce regularly for near one hundred years. Of this we speak more at length under the head of SOIL.

Propagation. By Seed. The seed of the peach, if carefully planted in the Autumn, will often vegetate in the ensuing Spring, and, in good soil, make a growth, the first year, of three to four feet; but in order to succeed surely, it is best to gather the stones from late fruiting varieties, of hardy, healthy trees; spread them about four inches thick, on some light, sandy knoll, and cover with about four inches earth. In Spring, when the frost is fully out of the ground, leaving it fit for working, these stones will be found to have mostly cracked and the germ just started; they should then be carefully planted in rows, four feet apart, and one seed every foot in the row, covered about two inches deep. The stones that are not cracked

by the frost should be taken and carefully cracked, by placing on a wooden block and striking the *side edge* with a hammer; this will not injure the germ, as is often done when they are cracked by striking the *ends*. Separated from the stone, the kernels should be planted same as above, but in rows by themselves, as all are not sure to grow, and, even if they did, would not as soon as those already started, and, therefore, the rows in culture would often have trees unfitted for budding at same time; or frequently those coming from the last-named kinds would be entirely too small for budding the first year.

It is well to know that most of the yellow-fleshed peaches have a tendency to produce varieties similar to the parent; hence the innumerable new sorts that now swell the nursery-men's catalogues, and that are yearly being introduced to the public as "*highly superior*." If an orchard is desired to be produced of seedlings, by selecting seeds of the Yellow Rareripe, Crawford's Early, Bergen's Yellow, Lemon Cling, and Crawford's Late, it is very probable a collection would be obtained preserving, in a great measure, the characters, qualities, and times of ripening of these varieties. So, also, may the periods of ripening of each kind be, to a certain extent, hastened or retarded, by selecting pits of the first or last that ripen on each particular tree.

The grower should, however, recollect that while there is a strong tendency in these varieties to reproduce themselves, their capability so to do is often destroyed by the intermixture, while in flower, of some other variety which is perhaps adjoining them only a few feet; hence, in order to feel any degree of certainty toward the raising of kinds valuable, or resembling the parent, it is necessary that the tree from which the pits are taken should stand perfectly isolated, or certainly distant two hundred rods from any other peach tree.

Those who have not the dry sandy knoll wheron to place the pits, to prepare them for the ensuing Spring, may place them in a moist cellar until nearly the close of Winter; then take them out, soak them in water two or three days, spread them on the ground and cover two or three inches of sawdust or leaf mold over them; thus exposing them to action of frost until the season for planting.

By Budding. The seed sown as above will, early in the month of September, be found to have grown, in good soil, from three to four feet, when they should be budded as near the ground as possible; and in October one-half of the entire top should be cut back—not the limbs pruned off, leaving bare stems—but the growth of every limb, should be shortened or cut back one-half; this is to prevent injury from high winds or heavy snows, which frequently break the tree just at the insertion of the bud.

Some bud upon the Plum stock for the purpose of dwarfing the tree; and when so done the month of August is best. The exact

time cannot be stated, as seasons vary even in the same section of country, but the watchful eye will soon learn to detect the period when the young stock is about to form its terminal bud, and then is generally the best time. If the bud is inserted too early in the season, on the peach stock, it is liable to overgrow and "gum."

Budding the peach may also be performed in the month of June, on trees of two or more years old. It is done in same manner as that in common budding, except in selecting the buds, you select a young shoot, of about one to two inches grown, and, cutting it back to one or two leaves, you insert and tie as in the common mode.

By Grafting. This is rarely performed at the North, but may be made tolerably successful if performed very early on trees standing in warm, light soil. A strong, sharp knife or spade should first be used around, cutting off all the roots of the tree, at about one foot from the body of a tree four feet high—the tree headed back about one half, and the lower limbs cut in to about two buds each—the graft inserted in the manner termed tongue or whip-grafting, tied with soft bark, and covered with a ball of grafting-clay. When the graft has made one foot growth, the ligature should be loosed, and the lower limbs cut in smoothly to the body. Some cultivators in the Southern States graft into the crown of the root, and when the stocks are small it is a good way; but the cleft-grafting mode is then best.

Transplanting. In transplanting from the nursery to the orchard, the limbs, or branches, should be shortened back to the form of a pyramidal, rounded head, having the lower limbs within two feet of the ground, and not exceeding one foot long. The side roots should only have their ends smoothed with a sharp knife, all broken or bruised roots cut away, and the tap root cut off to within one foot of the crown.

Distances apart. On light, sandy soils, twelve feet apart each way is sufficient for the Peach; but on good strong soil, the trees require from eighteen to twenty-five feet, in order, when full-grown, to enable them to mature their fruit with full exposure to the sun.

Soil and Situation. The soil whereon to make plantations of the Peach is a matter of great import, as thereby hang the main chances of success or failure. The following analysis, made by B. Kirtland, Esq., of Poland, Ohio, from three esteemed varieties, viz.: Yellow Rareripe, Morris Red Rareripe, and Morrisania, will be found extremely useful to every planter, as it is easy to get an analysis made of soils, and from the two the planter will know at once which particular manure is required to perfect his fruit, and give vigor to his

trees. Equal quantities of limbs and twigs from the three kinds above-named, were taken, and after having been thoroughly dried (whereby they lost about 44 per cent of water), carefully burned with a moderate heat, yielded as follows :

Charcoal and Sand.....	3.180
Silica.....	1.480
Perphosphate of Iron.....	2.174
Potash.....	12.545
Soda.....	2.000
Sulphate of Lime.....	2.258
Lime.....	23.951
Phosphate of Lime.....	21.699
Magnesia.....	7.052
Peroxide of Manganese.....	.800
Chloride of Sodium.....	.699
Carbonic Acid.....	33.350
	<hr/>
	111.188
Loss in Analysis.....	3.812
	<hr/>
	115.000

These analyses show the wood of the Peach tree as next to the Pear in amount of phosphates, and also the erroneous impression so generally current, that the Peach requires a light, sandy soil. The most vigorous, healthy trees we have ever seen, are growing on the borders of the Ohio river, on what is termed limestone soil, and where perfect drainage is naturally formed by the hills. On the prairies the trees grow rapidly, but to us have the appearance of a forced, green-house plant, and unable to endure aught but genial air, while feeding thus upon one or two of the elements of growth, and at the same time devoid of others requisite to the perfection of healthy wood. Lime and bone-dust, we judge, will be found especially beneficial in perfecting truly healthy trees, capable of enduring the great changes of climate on our western prairies. If to this application be added the practice of shortening-in during the month of September, and perfect drainage of water from the roots, we believe the tree will be found to endure more successfully the extreme changes of climate.

The duration of the Peach tree we consider greatly dependent upon the soil being properly drained, and containing the proper proportions of food toward forming perfect wood. The doctrine of excretions of vegetables is one which we are yet inclined to support, having been unable to succeed, even with renewed preparation of the soil, in growing two successive crops of the same kind of tree upon the same plot.

A rank, luxuriant tree, with shoots spongy, sappy, plethoric, un-

ripened, and incapable of being matured, with the roots in an un-drained, cold, or wet soil, is too often regarded as thrifty, when in truth it is but the expression of a false stimulant, as in the human frame, exciting only to destroy.

The situation of a peach-orchard should, if possible, be upon high ground, as less subject to extreme and severe changes of temperature, and as tending to more perfect maturity of wood in Fall of year, and later period of blooming in Spring. If the trees are low-branched and well shortened-in, supplied with requisite inorganic elements in the soil, the lay of the land to the east, south, or north, will only affect the time of ripening the fruit; that to the south maturing about one week earlier than that toward the north. Elevated situations, surrounded by, or bordering on, bodies of water, will often furnish fruits when adjacent valleys fail; and this is especially true where the bodies of water do not entirely freeze over during Winter, the southern shores of several of our lakes rarely failing to produce peaches, when the entire crop is destroyed five or ten miles back in the interior. Even slight knolls often protect the crop, an instance of which we had in our own grounds, where trees were distant only thirty feet; in one night all of the buds upon the lower limbs, or more than half way up, being destroyed on the tree standing on what would be termed the level, while on the tree on the knoll not one was injured.

The destruction of buds by extreme cold in the Winter is of rare occurrence, except the tree has been excited by a season of warm weather, or has been grown in the manner called "thrifty," previously noted. Where trees are steadily and healthily grown, they are capable of withstanding 20° to 25° below zero without injury, unless immediately followed by clear, warm sun, or the tree being in an immature, unhealthy state.

Season to Transplant. Throughout the Northern and Western States it is best to transplant the Peach in the Spring. South or Southwest, Fall or mid-winter may be best; but from remarks of many writers, we incline to the belief, that early in March or the last of February is best, as they occasionally have some severe changes in January, very trying to newly planted trees. The ground should always be planted in the Fall.

Cultivation. The ground about peach trees should always be kept clean; if planted on light, sandy soil, running through an orchard with a cultivator so as not to break the roots; if upon rich prairie or limestone soils, the ground may be plowed and cropped without injury; but on the sandy, light soil, no crop except the white turnip should ever be grown, and that pays best to be turned under by a very shallow plowing, of say two inches deep. On rich, deep prairie soils, it is best not to stir the ground after mid-summer.

Pruning. The fruit being borne only on wood of the preceding year, one of the great objects in pruning is to keep all parts of the tree furnished with a regular and constant succession of annual bearing shoots. P. Barry, in his "Fruit Garden," has the following, so correctly descriptive of the mode, that we adopt it, together with a cut illustrative of buds, on which *C, D, E,* are fruit buds, *F, G, H,* leaf buds, *I,* double buds, *C,* triple buds: the two side buds being fruit buds, and the centre one a leaf bud. By referring to the branch, it will be seen that it is furnished with a certain number of wood buds and fruit buds. At the base, there are always one or more wood buds.

Now, if that shoot were not pruned, all the fruit buds on it would produce fruit, one, two, or three of the wood buds at the top would make new shoots; these would necessarily be very weak, in consequence of the number of fruit below them. At the end of the season there would be a long, vacant space, entirely destitute of a young shoot or a living bud. This is the way that the interior or lower parts of trees become so soon degar-nished.

But when that shoot is shortened, we will say one half, the sap is retained in its lower parts, one half of the fruit buds are removed, and the consequence is, that large and fine fruits are obtained from those remaining; young vigorous shoots are produced from the lower buds to bear next year, and take the place of those which have already borne. In this way regular uniform crops of large and fine fruit are obtained, and a constant succession of young shoots is kept up.

To form the head of a stand-ard Peach tree. We will suppose it the intention to form a standard tree, with a trunk two feet in height, and a round, open, and symmetrical head,

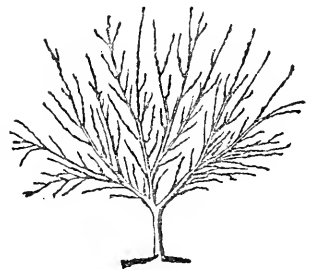

Form of a low standard peach tree, with a stem two feet high, and a round, open head.

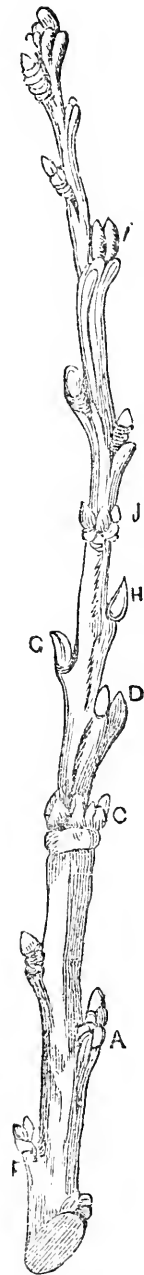

like figure. We take a yearling tree and cut it back to within two feet and a half of the ground in the Spring. Below this cut a certain number of shoots will be produced, from which three will be selected to form the main branches or frame-work of the head. All the others are rubbed off when two or three inches long or sooner. At the end of the season we have a tree with three branches.

The *second year* these three branches are cut back full one half their length, and from each we take a shoot to continue the branch, and one to form a secondary branch. The other shoots produced below these are pinched or checked to prevent them from interfering with the growth of the leading branches. In the Fall of the year we have a tree with six leading branches, and some bearing shoots below on the older wood.

The *third year* each of these six branches is shortened one-half, in order to obtain more secondary branches, and some fruit branches on the lower parts. All young shoots on the old wood, whether fruit branches or not, should be cut back one-half, or as far as may be necessary, to cause the wood buds at their base to push, and make shoots to bear next year.

The formation of the head goes on as described for two or three years more, when it is complete; for peach trees, properly pruned, do not assume such wide spreading forms as they do naturally. The main branches and secondary branches should be at equal distances throughout, and far enough apart to give the bearing wood on their sides the full benefit of the sun and air.

An equality of vigor should also be preserved amongst them by summer pinching. It is not uncommon to see a very vigorous shoot start up in a peach tree, and appropriate so much of the sap as to injure a whole branch; these should be checked the moment their character is observed, unless they may be wanted to fill a vacancy. Every part of the branches should be furnished with bearing shoots, and these should, every Spring, be shortened in one half or more, to produce others at their base, whilst those that have borne are cut out.

With the advice above, as well as of most writers, to shorten back or prune the Peach in the Spring, we do not fully agree; believing, rather, that if the operation be performed in September, it will enable the tree to more fully perfect the remaining buds, and fit it to endure changes of temperature during Winter.

Diseases and Insects injurious. The Curl of the Leaf. The first developed leaves, in the Spring, often become diseased with a spongy and malignant growth, exhibiting reddish blotches or swellings on the upper side, that, after two or three weeks, causes them to fall off. "This occurs at a period when the vigorous circulation of the sap requires a corresponding action in those important organs. A second growth is soon forced out, which ultimately restores the tree to its wonted force and vigor. It is, however, evident, that though the recuperative powers of nature may, for once, twice, or even thrice, restore a growth of leaves, the shock must at length impair the vitality, and induce an unhealthy condition." This curl of the leaf is produced by the punctures of a small plant-louse, the "*Aphis persica*," fully described by Dr. Harris in his work on Insects.

A mixture of tobacco water and strong soap-suds, applied with a syringe, early, or as soon as the leaves are one-third grown, will be found a good remedy. Barry regards the curl of the leaf induced by sudden change of weather, a number of warm days that cause the expansion of the young leaves, followed by a cold, rainy day; the more severe and protracted the cold, the more severe and fatal the curl. Soaping the limbs of the trees early in Spring, or washing them with a solution of sulphur and potash, it is said, will prevent the curl.

The Yellows. What is regarded as the Yellows is little known throughout the West; neither have we ever observed it, to any extent, in the New England States, except where trees were procured from, or grown on poor, sandy soils, enfeebled and imperfect from their first start. That it may be perpetuated by inoculation, or sowing seeds from trees diseased, we have no doubt; it therefore behooves every tree grower to be careful from whence he procures his pits for stocks. Prof. Kirtland says: "It is questionable whether any distinct disease occurs, to which this name applicable. Perhaps it is only a collection of symptoms arising from causes acting either individually or collectively. Facts seem to favor this view, though the insight of popular opinion is in favor of its being a specific and contagious disease." Depredations of the *Ægeria exitiosa*, *Aphis persica*, exhaustion of elements in the soil, and want of correct pruning appear to be the primary causes, and, in reference thereto, Prof. Kirtland further remarks: "In estimating the power and extent of these causes, it should be recollected that an injurious impression, acting constantly upon successive generations of either animal or vegetable species, may ultimately establish a hereditary entailment that may be propagated in the form of a predisposition to disease, or disease itself. The converse is equally true in producing health or physical development."

These several causes have been exerting their influence on the Peach tree for a long term of years, impairing the stamina and health of its fruit germs. These impressions have been propagated and re-propagated, in conjunction with the action of the primary causes of impairment, till at length we have only a sickly progeny.

The remedy is to cut down and destroy all diseased trees; the preventive is judicious cultivation.

Mildew. This is the name applied to a minute fungus which attacks the ends of the young branches of some particular varieties, termed serrated or glandless. It checks growth, and renders the tree unsightly. Application, by means of a syringe, of one ounce of nitre to one gallon of water, in proportion, will destroy it, and, at the same time, add to vigor and health of the tree. Dusting of sulphur is by some advised.

The *Peach-worm*, or *Borer* (*Ægeria exitiosa*), was known as early

as before the commencement of the present century, and has been repeatedly described. There are two sexes, and so remarkably different that some naturalists have almost hesitated in arranging them. "The insect, in its perfect state, is a slender, dark blue, four-winged moth, somewhat like a wasp. It commences depositing its

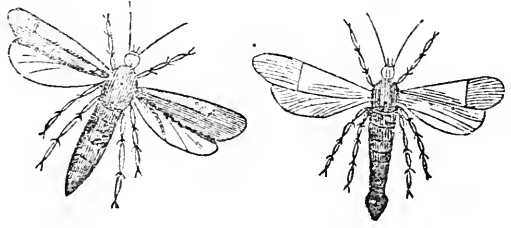

eggs in the soft and tender bark at the base of the trunk, usually about the last of June, but at different times from June to October. The egg hatches, and becomes a small white borer, or grub (fig. *a*), which eventually grows to three-fourths of an inch long, penetrates and devours the bark and sap-wood, and, after passing the Winter in the tree, it enfolds itself in a cocoon (fig. *b*), under, or upon the bark, and emerges again in a perfect or winged form, in June, and commences depositing its eggs for another generation."



Multiform have been the prescribed remedies for protection against this insect, but none have been found infallible; and the careful cultivator will find the use of a sharp knife, once in June, and again in September, applied to cutting out the worm, whose location is easily discovered by exudation, near the crown of the roots, of gummy matter—a far better preventive, and also really cheaper than heaping up of ashes, cinders, etc., etc.

Gathering. If for immediate use the Peach should not be gathered until fully ripe, but if intended for market, it is necessary often to gather while yet firm.

Characters and Classification. The general outward characters of many kinds are so nearly similar that it is necessary to resort to other means than exhibited in the fruit, in order to identify varieties. This, even with all the means at command, is often very difficult, owing to the numerous seedlings constantly being produced. The distinction of free-stones and cling-stones (melters and paves of the English) is the most natural and well understood; next, the distinction by means of what are termed *glands* on the leaves, as also the indentations, or irregular edge of the leaf termed *crenate*, *serrated*, and *coarsely serrated*; and, lastly, the distinction by means of the flowers, as large or small. This last is open only to examination a short period, and, therefore, is not used, except by the careful amateur pomologist, or correct nurseryman.

The accompanying figures are illustrative :

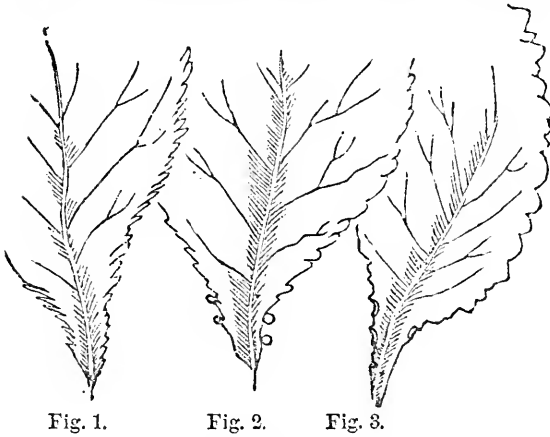

Figure 1, the serrated without glands ; figure 2, coarsely serrated, and with globose glands ; figure 3, crenate and with reniform or kidney-shaped glands. "The form of the glands," observes Lindley, "as well as their position, is perfectly distinct ; they are fully developed in the month of May, and continue to the last permanent in their character, and are not affected by cultivation. The globose glands are situated, one, two, or more, on the foot-stalks, and one, two, or more, on the tips or points of the serratures of the leaves. The reniform glands grow also on the foot-stalks of the leaves, but those on the leaves are placed within the serratures, connecting, as it were, the upper and lower teeth of the serratures together ; their leaves, when taken from a branch of vigorous growth, have more glands than the leaves of the globose varieties. It will, however, sometimes happen that glands are not discernible on some of the leaves, especially on those produced from weak branches ; in this case, other branches must be sought for which do produce them." Lindley, as well as most writers since, have rendered these classes, with sub-classes or divisions, founded mainly on the structure of the leaves, but we have preferred in this fruit, as well as others, to embody the distinction in the text descriptive of a variety, and confine ourself to the practical every-day wanted division of "best," "very good," and "good." The word "Melocoton," only meaning "peach," we have dropped, and only use it in connection with the synonyms.

Uses.—The various uses made of the peach are so well known as not to require a word, yet the profit to be obtained from drying or preserving fresh, the fruit, when distant from market, induces us to make the following descriptions. In most parts of the country where peaches are largely cultivated, the fruit is dried, and in this state sent to market in very large quantities. The drying is performed on a small scale, in spent ovens ; on a large scale, in a small drying house heated by a stove, and fitted up with ventilated drawers. These drawers, the bottoms of which are formed of laths, or narrow strips sufficiently open to allow the air to circulate through them, are filled with peaches in halves. They are cut in two without being peeled, the stone taken out, and the two halves placed in a single layer with

the skin downward. In a short time the heat of the drying house will complete the drying, and the drawers are then ready for a second filling. Farther south they are spread upon boards or frames, and dried in the sun merely; but usually, with the previous preparation, of dipping the peaches (in baskets) for a few minutes in boiling water before halving them.

Preserving the fresh fruit. Thomas describes the process as follows: "Prepare the canisters in the best manner, of good tin—about seven or eight inches in length, and four to four and a half in diameter. Whatever be the size, they should be uniform, that they may be heated alike. The fruit selected should be just ripe and no more, free from specks or bruises. When the canisters are filled, the tops are to be carefully soldered on, leaving a hole in them about the size of a small pin for the escape of the air. They are then to be set in a vessel of water, to be kept boiling moderately, until the temperature of the fruit is raised to that of the water. The way in which this is to be ascertained, is to put a drop of water on the pin hole, which will continue to bubble as long as the air escapes from the canister. When the internal temperature is equal to that of the water, no more air will escape. The water is then to be wiped off, and a drop of solder immediately put in its place. The boiling water should be raised as near to the tops of the canisters as possible, so as not cover them. If the operation has been properly conducted, the ends of the canisters will, shortly after the cooling has taken place, be depressed, in consequence of the external pressure of the atmosphere. The degree of heat to which the fruit is subjected does not cook it in the least. It is proper that the canisters should be set in a cool place. The vessel in which the water is to be kept boiling, must of course have a level bottom; and every one who is disposed to try the experiment can devise one for himself."

VARIETIES.

The varieties of the Peach have, within a few years been largely increased, but as the fruit is, when matured, quickly perishable, we have endeavored to select out only those that are really valuable, and that will furnish a perfect succession from earliest to latest. Many varieties are undoubtedly good in their immediate locality, and often perhaps equal the best, yet there seems no necessity for increasing the numbers unless some evident superiority is found either in fruit or tree.

The periods of ripening, which we have attached to each variety, mark its character on the southern shore of Lake Erie, in northern Ohio. At Cincinnati it will often be found two weeks earlier, while at Boston or Buffalo it will be eight or ten days later.

CLASS I. *Varieties most generally esteemed.*

ALBERGE.

Yellow Alberge, Alberge Juane, Purple Alberge, Red Alberge,	Golden Mignonne, French Rareripe, Peche Jaune, Gold-Fleshed,	Yellow Rareripe, <i>of some</i> , Hardy Galande, Golden Rareripe.
--	---	---

Foreign. *Flowers*, small; *glands*, globose; *fruit*, medium, roundish, yellow, purplish cheek; *flesh*, yellow, red at stone. Free-stone. Middle August. Valued highly for market purposes.

BERGEN'S YELLOW.

American. It much resembles yellow Rareripe, but ripens about ten days later; a moderate, regular bearer. *Flowers*, small; *glands*, reniform; *fruit*, large, globular; depressed, broad *suture*, distinct, rather more than half round; *skin*, deep orange, with a broad red cheek; *flesh*, yellow, melting, and of luscious flavor. Free-stone. Early September.

BREVOORT.

Brevoort's Morris, | Brevoort's Seedling Melter.

American. A moderate but regular bearer. *Flowers*, small; *glands*, reniform; *fruit*, medium to large, round; rather broad, distinct *suture*, deep at apex; *skin*, dingy white, with a bright red cheek; *flesh*, firm, slightly red at stone, sweet and highly-flavored. Free-stone. Early September.

CRAWFORD'S EARLY.

Crawford's Early Melocoton, | Early Crawford.

American. As a market fruit, one of the most deservingly popular of the yellow-fleshed varieties; productive. *Flowers*, small; *glands*, globose; *fruit*, large, oblong, oval sometimes roundish, point at apex prominent; *suture*, shallow; *skin*, yellow, with red cheek; *flesh*, yellow, juicy, and, when ripened in warm sunny weather, rich and sweet, at other times slightly sub-acid. Free-stone. Last of August to 10th of September.

CRAWFORD'S LATE.

Crawford's Late Melocoton, | Crawford's Superb Melocoton,
 Crawford's Superb Malacatune.

American. One of the most valuable yellow-fleshed late varieties, deserving place in all collections; productive. *Flowers*, small; *glands*, globose; *fruit*, large, roundish; *suture*, shallow; *skin*, yellow, with dark red cheek; *flesh*, yellow, red at the stone, juicy, vinous, and, like the foregoing, depends on warm sunny weather to make it sweet. Free-stone. Last of September and first of October.

COOLEGE'S FAVORITE.

Cooledge's Early Red Rareripe

American. Tree, very hardy and productive. *Flowers*, small; *glands*, globose; *fruit*, medium to large, roundish, largest on one side; *suture*, at apex only; *skin*, white, with a bright red cheek, often mottled; *flesh*, melting, juicy, rich, sweet delicious flavor. Free-stone. Twentieth to last of August.

COLUMBIA.

Indian Peach, | Mulatto, | Italian Peach.

American. Tree, moderate grower, hardy, young wood a purplish cast, moderate regular bearer. *Flowers*, small; *glands*, reniform; *fruit*, large, roundish, with a shallow suture half round; *skin*, singularly marked and striped with dark red; *flesh*, yellow, often exhibiting a red streak next the skin, rich, juicy, and excellent flavor. Free-stone. More grown than any variety at the South. Middle to last of September.

EARLY NEWINGTON.

Early Newington Freestone, | Newington, | Smith's Newington.

Foreign. This variety ripens directly after the forenamed. Tree, hardy, moderately productive. *Flowers*, small; *glands*, reniform; *fruit*, large, roundish, one half always largest; *suture*, distinct; *skin*, yellowish white, dotted and streaked with red, the cheek a rich red; *flesh*, white, red at the stone, to which many particles adhere (if not fully ripe, it has the habit of a cling), juicy, rich, vinous flavor. Twentieth to last of August.

EARLY TILLOTSON.

American. This variety requires a strong soil, otherwise it is liable to mildew. The trees are hardy, but not good bearers while young, nor are they rapid growers. Its period of maturity must, however, give it place for market purposes. For small gardens, where only three or four days are little consequence, it is not advisable to plant it. *Flowers*, small; *leaves*, glandless, serrated; *fruit*, medium, roundish; *skin*, nearly white, dotted with red, and becoming dark red in the sun; *flesh*, whitish, red at the stone, to which the flesh partially adheres, juicy, rich, high flavor. *Season*, variable, we having fruited it as early as 29th July, and, again, not until 10th of August, but always, however, a few days before Early York; and we only note this here in order to show that no certain dates will answer from year to year in any fruit.

EARLY YORK.

Serrate Early York, | True Early York.

Much confusion has arisen with growers respecting this peach, owing to the same name having been applied to seedlings in New Jersey. Tree, hardy, productive, and, from the period of ripening, one of the very best. *Flowers*, large; *leaves*, serrated, without glands; *fruit*, medium, roundish oval; *suture*, slight; *skin*, with pale red dotted on greenish white in the shade, and becoming dark red where exposed to the sun; *flesh*, greenish white, tender, melting, full of rich, sprightly juice. Free-stone. Middle of August.

GEORGE THE FOURTH.

American. Tree, vigorous, hardy, regular, good bearer. *Flowers*, small; *glands*, globose; *fruit*, above medium; *suture*, broad and deep, making one half larger than the other; *skin*, yellowish white, dotted with bright red, on one side a rich dark red cheek; *flesh*, pale red at the stone, melting, juicy, rich, luscious flavor. Free-stone. Last of August.

GROSSE MIGNONNE.

Royal Kensington,
Grimwood's Royal George,
" New Royal George,
Large French Mignonne,
French Mignonne,
Swiss Mignonne,
Purple Avant,
Early Purple Avant,

Early May,
Early Vineyard,
Vincuse,
Niel's Early Purple,
Johnson's Early Purple,
Superb Royal,
Royal Sovereign,

Ronald's Seedling Galande,
Pourprée Hative,
Belle Beauté.
Pourprée de Normandie,
Vincuse de Fromentin,
Mignonne,
Early Purple.

Foreign. The Grosse Mignonne, or Large Favorite, was a favorite peach in France in time of Louis XIV., and is everywhere esteemed, although in this country it is seldom that the true variety is cultivated. The true variety has *large* flowers, while that often grown has *small* flowers.

Flowers, large ; *glands*, globose ; *fruit*, large, roundish, apex depressed, with a deep, hollow suture ; *skin*, dull, greenish yellow, mottled with red, and with a purplish red cheek ; *flesh*, yellowish white, marked with red at the stone, juicy, melting, rich, high, vinous flavor ; *stone*, small, very rough. Free-stone. About 20th August to 1st September.

HEATH CLING-STONE.

White Heath, | Fine Heath, | Red Heath.

American. This variety is extremely valuable in the Middle and Southern and Western States. In the Northern States it does not always ripen well, but the fruit may be gathered, wrapped in paper same as oranges, and laid in a cool room and kept until Christmas. It often reproduces itself from the stone, and Bayne's New Heath partakes of no new qualities over many other of its seedlings. The trees are very hardy, often producing on our Western soils when all others fail. Esteemed all South and West.

Flowers, small ; *glands*, reniform ; *fruit*, large, oblong, narrowing to both ends, with a swollen point at apex ; *suture*, one side, distinct ; *skin*, downy, cream-colored white, a tinge of red in the sun ; *flesh*, greenish white, adhering closely to the stone, juicy, rich, luscious flavor. Cling-stone. October.

HYSLOP'S CLING-STONE.

American. This variety should take the place of Heath in all Northern localities, and, indeed, deserves a place in every garden, however small. From not finding it noticed in any work since Kenrick's issue, we had supposed it probably a synonym, but have been unable so to detect it. Trees are hardy, vigorous, and productive. *Flowers*, small ; *glands*, reniform ; *fruit*, large, oblong roundish ; *skin*, white, with a deep, rich red cheek ; *flesh*, very juicy, melting, rich, and luscious. Cling-stone. Early in October.

JAQUES RARERIPE.

Jaquish, | Jaques Rareripe.

American. A very desirable market variety, good flavor, and very certain bearer.

Flowers, small ; *glands*, reniform ; *fruit*, large, roundish, distinct suture ; *skin*, downy, dull yellow, with red cheek ; *flesh*, yellow, red at the stone, juicy, rich, slightly sub-acid. Free-stone. Middle of September.

LARGE EARLY YORK, OR NEW YORK RARERIPE.

Livingston's New York Rareripe, Honest John,		Haine's Early Red, Early York of New Jersey.
---	--	---

American. The synonyms which we attach to this variety, we are aware, are questioned by some good pomologists, but, after having grown and examined the trees under the several names, we confess ourselves unable to distinguish any material difference, certainly not sufficient to make distinct descriptions requisite. Trees, vigorous, healthy, moderate, but good bearers. *Flowers*, small; *glands*, globose; *fruit*, above medium, roundish; *skin*, whitish, with marblings and dots of red, with a clear, rich red cheek where exposed to the sun; *flesh*, almost white, fine-grained, very juicy, rich, mild, excellent flavor. Free-stone. Last of August.

LATE ADMIRABLE.

Royale, La Royale, Pêche Royale, Bourdine,		Boudin, Narbonne, Téton de Venus, French Bourdine,		Judd's Melting, Motteux's, Pourprée Tardive.
---	--	---	--	--

Foreign. An old variety, the trees of which have proved successful wherever grown. Moderate regular bearer. *Flowers*, small; *glands*, globose; *fruit*, large, roundish, inclining to oval; *suture*, bold, apparently making two halves of the fruit, a swollen point at apex; *skin*, yellowish green, with a cheek of two shades of red, mingled, or marbled; *flesh*, greenish white, juicy, melting, delicate, delicious flavor. Free-stone. About 20th September.

LEMON CLING-STONE.

Kennedy' Carolina, Kennedy's Lemon Cling-stone, Long Yellow Pine Apple,		Largest Lemon, Pine Apple Cling-stone, Yellow Pine Apple.
---	--	---

American. The flavor of this variety, except grown in warm climate and good soil, would not place it among the first class; but the uniform hardihood and productiveness of the tree, together with the fine appearance of the fruit, making it very desirable for marketing purposes, has induced us to retain it. *Flowers*, small; *glands*, reniform; *fruit*, large, oblong, with a projecting point at apex like unto a lemon; *skin*, fine yellow, with a dark brownish red cheek, becoming sometimes, in certain locations South, almost a crimson red; *flesh*, firm, yellow, tinged with red at stone, juicy, sprightly, vinous, sub-acid acid flavor. Cling-stone. Middle to last of September. The "Yellow Blanton Cling" is only a sub-variety, ripening a few days later.

MORRIS WHITE.

Morris White Rareripe, White Rareripe, Luscious White Rareripe,		Lady Ann Steward, White Malacaton, Cole's White Malacaton,		Free-stone Heath, Morris White Free-stone, Philadelphia Free-stone.
---	--	--	--	---

American. This variety is most suited to the Southern and Southwestern States, where it is a most delicious fruit; but grown at the North, it is one of the most valuable for preserving in brandy, and always commands a high price therefor. Tree, vigorous, moderate bearer. *Flowers*, small; *glands*, reniform, *fruit*, large, oval; *suture*, moderate, swollen point small; *skin*, downy, greenish white, becoming a creamy white when fully ripe, rarely a purplish tinged cheek; *flesh*, white to the stone, moderately firm, sweet and rich. Free-stone. Middle of September.

MALTA.

Pêche Malte, Malte de Normandie,	Italian, Belle de Paris.
-------------------------------------	-----------------------------

Foreign. The true Malta is less known than a spurious sort having globose glands, which is most generally known. The true Malta is a delicious fruit for the private garden, but not desirable for marketing. *Flowers*, large; *leaves*, serrated, without glands; *fruit*, above medium, roundish flattened, with a broad, shallow suture on one side; *skin*, pale, dull green, marked on the sunny side with broken spots and blotches of dull purple; *flesh*, greenish, with a little dark red at the stone, very juicy and melting rich, vinous, delicious flavor. Free-stone. Last of August.

MORRIS RED RARERIPE.

Red Rarripe, | Large Red Rarripe.

American. Has been confounded with George the Fourth, and also with Grosse Mignon, from both of which it is distinct. The large Early York of New Jersey most nearly resembles it, but is quite different. It is universally esteemed. Trees, vigorous and productive. *Flowers*, small; *glands*, globose; *fruit*, large, roundish, slightly depressed at apex; *suture*, well marked; *skin*, greenish white, with a lively red cheek; *flesh*, greenish white, red at the stone, melting, juicy, rich, sweet flavor. Free-stone. Last of August.

NIVETTE.

White Rarripe, Nivette Velouté,	Velouté Tardive, Dorsetshire.
------------------------------------	----------------------------------

Foreign. An old variety, which succeeds most admirably throughout all Northern sections, and, where known, equally well South. Trees, upright, healthy growth, regular bearers. *Flowers*, small; *glands*, globose; *fruit*, large, roundish, inclining to oval; *suture*, shallow, point of apex slightly depressed; *skin*, yellowish green, and, when exposed to sun, a bright, lively, red cheek; *flesh*, greenish white, tinged with reddish pink at the stone, juicy, melting, with a rich, delicious flavor. Free-stone. Early in September.

OLDMIXON CLING-STONE.

Baltimore Rose.

American. Of the Cling-stone peaches we think this and Hyslop's the best, and deserving place in every collection. *Flowers*, small; *glands*, globose; *fruit*, large, roundish oval; *suture*, well marked, and one side of fruit slightly larger than the other, without *mamelon* or swollen point; *skin*, yellowish white, with red more or less dotted, and becoming bright red cheek where exposed fully to sun; *flesh*, pale white, juicy, rich, high and excellent flavor. Cling-stone. Early in September.

OLDMIXON FREE-STONE.

Oldmixon Clear-stone.

American. Said to have been produced from seed of the Oldmixon, which we think somewhat doubtful. It is, however, a variety meriting place everywhere, as it always produces a crop, appearing to withstand late Spring frosts better than many others, and for market, its ripening just at a period when most other varieties are out, makes it extremely desirable. *Flowers*, small; *glands*, globose; *fruit*, large, roundish, slightly oval, one side swollen; *suture*, apparent only at apex; *skin*, a mingling of yellowish

white and pale green, more or less marbled with dull red, and having a deep red cheek in the sun; *flesh*, white, tinged with red at stone, rich, sweet, vinous, excellent flavor. Fifth to fifteenth September.

PRESIDENT.

American. Trees, healthy, productive, similar to the Rareripes; a valuable market fruit. *Flowers*, small; *glands*, globose; *fruit*, large, or above medium, roundish oval; *suture*, shallow; *skin*, downy, pale yellowish green, with a red cheek; *flesh*, white, red at the stone, juicy, sweet, rich, high flavor; *stone*, rough, and unless fully ripe the flesh adheres slightly to it. Free-stone. Middle of September.

PRINCE'S RED RARERIFE.

Late Red Rareripe.

American. Trees, vigorous, productive, and fruit of a grayish appearance, distinguishing it from all other varieties. *Flowers*, small; *glands*, globose; *fruit*, large, roundish oval, with a depressed suture and sunken point at apex; *skin*, downy, pale grayish yellow, mottled and marbled with red, and with a red cheek mottled with fawn-colored specks; *flesh*, white, deep red at stone, juicy, melting, rich, luscious flavor. Free-stone. Early in September.

RED CHEEK.

Red Cheek Melocoton,
Hogg's Melocoton,
Yellow Melocoton,

Malagatune,
Malacatune,

Lady Gallatin,
Yellow Malagatune.

American. *Flowers*, small; *glands*, globose. The parent of most of the recently-introduced yellow peaches. *Fruit*, large, roundish oval, swollen point at apex; yellow, deep red cheek; *flesh*, yellow, red at stone, juicy, a little sub-acid. Free-stone. Early September.

RED RARERIFE.

Large Red Rareripe,
Early Red Rareripe,

Douglas,
Burgess' Beauty.

American. *Flowers*, small; *leaves*, glandless; *fruit*, large, round; *suture*, broad; *skin*, white, mottled with red, becoming quite red in sun; *flesh*, whitish, red at stone, melting, juicy, sweet. Free-stone. Last August. Sometimes mildews. From this variety it is probable most of our rareripes have been produced.

ROSEBANK.

American. Originated with James Dougall, Esq., C. W. Trees, healthy, moderate, but regular bearers; leaf, serrated without glands. *Fruit*, above medium, round, compressed at the apex; *suture*, deep, extending somewhat more than half way round; *skin*, whitish yellow, with a red cheek, where fully exposed to the sun, the red becomes almost purple; *flesh*, thick, whitish yellow, very little red about the stone, juicy, rich, excellent flavor. Free-stone. Middle of September.

STURTEVANT.

Originated by E. T. Sturtevant, of Cleveland, O., in 1826. Although an old peach, its originator has never brought it forward, and hence it is as yet little known. It is unquestionably the *best* yellow-fleshed peach in existence. *Fruit*, medium size or above, roundish, compressed; shallow,

broad *suture*, half round, followed by a dark line; *skin*, very downy, rich yellow, mostly covered with dark rich red, very dark in sun; *stem*, set in a deep oval-shaped cavity; *flesh*, yellow, red at stone, and the lines of red running into its flesh nearly one-half its thickness; *stone*, very small, roundish compressed. Free-stone. Last August, first September.

VAN ZANDT'S SUPERB.

Waxen Rarripe.

American. A variety not suited to market purposes, but highly desirable in small gardens for dessert use. *Flowers*, small; *glands*, globose, obscure; *fruit*, medium, roundish, one side enlarged; *suture*, distinct, but not deep; *skin*, white, beautifully sprinkled and marbled with clear red, cheek red, dotted with carmine; *flesh*, whitish, tinged with red at the stone, juicy, sweet, very fine flavor. Early in September.

WALTER'S EARLY.

American. A popular orchard variety, adapted to light soils. Trees, healthy and productive. *Flowers*, small; *glands*, globose; *fruit*, above medium, globular flattened; *skin*, white, with a rich red cheek; *flesh*, whitish, tinged with red at the stone, juicy, sweet, fine flavor. Free-stone. Last of August.

WARD'S FREE-STONE.

Ward's Late Free, | Ward's Free.

American. We have examined this variety for several years, and were we to have but one late-ripening variety, should unhesitatingly select this. The Weld's Free-stone spoken of by Mr. Manning, in the second volume of the Horticulturist, we strongly suspect to be this variety. It is a variety highly successful among orchardists in Delaware, and so far as we have seen, equally valuable at the North. Trees, vigorous, healthy, not too rapid growth. *Flowers*, small; *glands*, ———; *fruit*, above medium, roundish; *skin*, yellowish white, with a red cheek, where exposed to the sun; *flesh*, nearly white, rarely tinged with red at the stone, juicy, vinous, and, for a late peach, sweet and delicious flavor; for late preserving, it is invaluable. Free-stone. Early October.

WASHINGTON.

Washington Rarripe, | Washington Red Free-stone.

American. *Flowers*, small; *glands*, globose; *fruit*, large, broad, depressed; *suture*, broad, deep, nearly round; *skin*, yellowish white, with crimson cheek; *flesh*, yellowish white, tender, juicy, sweet, rich. Free stone, but often adheres slightly. Middle September.

WELD'S FREE-STONE.

American. *Flowers*, small; *glands*, reniform; *fruit*, large, roundish oval; greenish white, with some red. First to Middle October. (Manning.) We are inclined to regard this as probably identical with Ward's Free-stone.

WHITE IMPERIAL.

American. A valuable variety for the northern parts of our country, being hardy and vigorous, and a regular moderate bearer. South, the trees

grow too rapid, while the fruit is insipid. It seems to do equally well in sandy or loamy soil, but in the former will probably sooner require some specific stimulant. *Flowers*, small; *glands*, globose; *fruit*, large or above medium, roundish, broad, depressed at apex; *suture*, not deep, but well marked, and the fruit often one side enlarged; *skin*, yellowish white, tinged or marbled with light purplish red towards the sun; *flesh*, nearly white, melting, juicy, sweet, delicate, delicious flavor. Free-stone. Last of August.

WHITE CLING-STONE.

Large White Cling-stone, Williamson's New York,		New York White Cling-stone, Selbey's Cling.
--	--	--

American. We think the Oldmixon preferable, and this variety suited to large orchards.

Flowers, small; *glands*, globose, *fruit*, large, round, small swollen point at apex; *suture*, shallow; *skin*, yellowish white, little covered or dotted with red, where exposed to sun; *flesh*, whitish, tender, melting, juicy, sweet, high flavor. Early September.

YELLOW RARERIPE.

Yellow Red Rareripec, Large Yellow Rareripec,		Marie Antoinette, French Rareripec.
--	--	--

American. As a market or garden variety, this has no equal among yellow-fleshed fruits. Cultivators should, however, be careful of the correctness of their trees, as an old sort, far inferior, and often known under name of Yellow Malacatune, is frequently grown for this variety. *Flowers*, small; *glands*, reniform; *fruit*, large, roundish; *suture*, shallow, extending rather more than half round, a small point at apex; *skin*, deep orange yellow, dotted somewhat with red, the cheek rich red, shaded off in streaks; *flesh*, deep yellow, red at the stone, juicy, melting, rich, vinous, nearly first-rate flavor. Free-stone. 20th to last August.

CLASS II. *Embraces many new varieties, and others suited only to certain localities or very large orchards.*

ALLEN.

American. Small, roundish; white, red cheek; juicy. Free-stone. Middle September. (Cole.)

ASTOR.

American. Glands, globose; fruit, above medium, yellowish white, red cheek, deficient in flavor. Last of August.

ATWATER.

American. Closely resembles President, and may prove identical.

AUSTIN'S LATE RED.

A large fruit; juicy and excellent. Its late maturity makes it a valuable variety for preserves. Latter part of October.

BACHELDER.

American. Large, round, white, with deep blush; flesh, white, juicy. Free-stone. Middle September. (Cole.)

BAGBY'S LARGE.

The tree has a peculiar, slender growth, with drooping branches. Fruit, oblong, white, juicy, and well flavored. Is one of the best peaches for drying. Middle of August.

BALDWIN'S LATE.

American. Fruit, large, oblong, with a distinct swollen point at top; skin, greenish white, slight red cheek; flesh, juicy, melting. Free-stone. Originated South, where it ripens last of October, and can be kept two or three weeks.

BARRINGTON.

Buckingham Mignonne, | Colonel Ausley's.

Foreign. Glands, globose; fruit, large, roundish, whitish yellow and red; flesh, tinged red at stone. Free-stone. September.

BARNARD.

Early Barnard, | Yellow Barnard.

American. Much resembles Alberge.

BAUGH.

American. Glands, globose; fruit, medium, roundish, terminated with a small point; skin, pale yellow, slight blush towards the sun; flesh, yellowish, melting, juicy, sweet, pleasant. Free-stone. Originated at the South, where it ripens first October.

BRIGGS.

American. Large, roundish; whitish, red cheek; flesh, white, red at stone; sweet. Free-stone. Early September. (Cole.)

BELLE DE BEAUCAIRE.

Beauty of Beauceaire.

Foreign. Glands, globose; flowers, small; fruit, medium, greenish yellow, red cheek; suture, well marked, juicy. Free-stone. August. Ripens in July at South, where it is esteemed.

BELLEGARDE.

Early Royal George,
Red Magdalen,
French Royal George,
Smooth-leaved Royal George,

Violette Hative,
Violette Hative Grosse,
Brentford Mignonne,

Ronald's Mignonne,
Large Violet,
Early Galande.

Foreign. Flowers, small; glands, globose; fruit, large, round, with a point; suture, shallow, yellowish green, red cheek; flesh, little red at stone, juicy. Free-stone. Early September.

BLANTON CLING.

American. Glands, reniform: fruit, large, resembles Lemon cling, except that it matures somewhat later, and is more juicy. August.

BLOOD CLING-STONE.

Claret Cling-stone, | Blood Cling.

American. Valuable only for pickling and preserving. Flowers, small; glands, reniform; fruit, often measuring twelve inches round; suture, distinct, skin, downy, dark, clouded, purplish red; flesh, deep red throughout, firm, juicy. Last September.

The old French Blood Cling-stone is a smaller fruit than the above, and also has large flowers. The Blood Free-stone is a variety of above, medium size, glandless leaves, and less valuable.

BORDEAUX CLING.

American. Fruit, large, oblong oval, one-sided; color, lemon yellow, red cheek; flesh, yellow, red at stone, juicy, melting, excellent. Early August.

CABLE'S LATE.

Cable's Late Melocoton.

American. A seedling of the old Red Cheek, and resembles Crawford Late, only ripening some six days earlier. Free-stone.

CAMBRIDGE BELLE.

Hovey's Cambridge Belle.

American. Large, roundish, white with a blush, red cheek, juicy; "good." Free-stone. Early September. (Hovey.)

CARMINE.

American. Glands, reniform; flowers, small; fruit, large, oblong, reddish; flesh, juicy, sweet. Free-stone. August.

CARPENTER'S WHITE.

Raised by Wm. S. Carpenter, upper part of New York City. Tree, vigorous and productive; leaves, very large, serrulate, with globose glands. Fruit, very large and round; skin, white, with a slight shade of green; flesh, white to the stone, juicy, melting, rich, and of excellent flavor; separates from the stone. Ripens about the middle of October, and promises to be a valuable late market variety.

CHINESE PEACH.

Flat Peach of China, | Java Peach, | Peen To.

Foreign. Glands, reniform: flowers, large; fruit, small, flattened, long, yellowish green, and pale red; skin, thin; pale yellow, red at stone, to which it adheres; juicy, delicate, vinous flavor; fitted only for the amateur's garden. September; July, at the South.

CHINESE CLING.

Reniform glands. Flowers, small: fruit, large, globular; sides, compressed; suture, quite shallow; skin, creamy white, shaded and marbled with fine red; flesh, white, red at the stone (which is adherent), very juicy, melting, with a rich, excellent vinous flavor. Ripens first to middle of September; at the South, from the middle of July to first of August. Tree, vigorous and productive. Imported from China. (Downing.)

CLARKE.

American. Large, roundish, yellow, red blush; flesh, yellow, red at stone, juicy, sugary, fine. Early September. (Cole.)

CLINTON.

American. Only suited for marketing. Flowers, large; glands, globose; fruit, large, roundish, yellowish white with red cheek, juicy. Free-stone. Last of August.

COLE'S EARLY RED.

American. Productive. Flowers, small; glands, globose; fruit, medium, roundish, pale yellow, mostly covered with red, often dry. Free-stone. Last August.

COLUMBUS JUNE.

American. Flowers, small; glands, reniform; fruit, medium to large, flattened; suture, shallow; skin, pale, yellowish white, rich red cheek; flesh, slightly red at stone, melting, juicy, high flavor. Free-stone. Originated South, where it ripens in June.

DONAHOO CLING.

From Mr. Donahoo, Clark county, Ga. Glands, reniform; fruit, very large, roundish; suture, quite deep on one side, and visible entirely around the fruit; apex, depressed; skin, creamy white, beautifully dotted and tinged with red in the sun; flesh, white to the stone, exceedingly juicy, excelling the Heath cling in tenderness of texture, and equally rich and luscious, and a most desirable variety. Ripens from 10th to 20th September. (Ga. Pom. S. Report.)

DOUBLE MONTAGNE.

Double Mountain, | Montagne, | Montauban.

Foreign. Almost worthy a place in first class. Flowers, large; leaves, glandless; fruit, medium, roundish, pale greenish white, with two shades of red, when exposed to the sun; flesh, white, delicate, juicy, fine. Free-stone. Last of August.

DRUID HILL.

American. Glands, globose; fruit, large, roundish, greenish white, red in the sun; flesh, greenish white, juicy, inferior to Ward's Free-stone. Free-stone. September.

EARLY CHELMSFORD.

Mammoth.

Leaves, glandless; fruit, large, roundish; suture, clear round, deep on one side; skin, white, with a bright red cheek; flesh, white, very melting and juicy; of a very delicious, slightly vinous flavor. Free-stone. Twentieth to last of August. Hardy, vigorous, and productive; one of the best, handsomest, and largest of early peaches. (Cole.) It also succeeds well at the South, and is one of their most profitable market varieties.

EASTBURN.

Eastburn's Choice.

American. Large, roundish; pale yellow, with red on the sunny-side; flesh, yellowish, red near the stem, juicy, sprightly. Free-stone. Last of September.

EDWARD'S LATE WHITE.

From Dr. Baldwin, Montgomery, Alabama. Fruit, large, roundish, depressed at the summit; suture, distinct; point at the apex, small, and

slightly sunken ; skin, moderately downy, white, with a beautiful waxen red cheek ; flesh, white, red at the stone, slightly adherent ; sweet, juicy, and of excellent flavor. Ripe first of October, and continues all the month. (Wm. N. White, MS.)

ELIZA.

American. Originated at Philadelphia. Glands, reniform ; fruit, large, round, terminating in a nipple ; skin, yellow, with mottled red cheek ; flesh, yellow, red at stone. Free-stone. Last of September. (W. D. B., in Pomologist.)

ELMIRA.

American. This variety originated in Mississippi, by M. W. Phillips, Esq. We have not seen it, nor a description, but it is spoken of as a Cling-stone, ripening a few days earlier than early Tillotson, and being very desirable in that section.

FAVORITE.

Favorite Red.

American. Glands, globose ; fruit, above medium, oval, white, with much red in sun ; flesh, firm, red at stone. September.

FLEWELLEN CLING.

Fruit, large, globular, depressed at the apex ; skin, downy, yellowish white, mostly overspread with shades of red ; dark, dull purplish red in the sun, the lighter tints of red somewhat in stripes ; flesh, yellowish white, red at the stone, to which it firmly adheres, very juicy, sweet, and high flavored ; a desirable early cling. First of August. (Wm. N. White, MS.)

FOX'S SEEDLING.

American. Glands, globose ; fruit, round, white, with red cheek. Free stone. September.

FULKERSON.

Fulkerson's Early.

American. Leaves, glandless ; specimens of the Fulkerson Peach were sent us 20th of August, 1851, by its originator, R. P. Fulkerson, Ashland, O., from which we made our description. Mr. Fulkerson states it hardy and productive when Yellow Rareripec, Tillotson, and other varieties fail. Fruit, medium, obtuse rounded, sides irregular, unequal ; suture, half round ; skin, whitish, rich, red cheek ; flesh, whitish yellow, tinged with red at the pit, juicy, rich sweet and high flavored ; stone, small, angular, flattened. Free-stone. 20th August.

GALARDE.

Hardy Galarde.

Foreign. Received from France by Messrs. Parsons & Co., Flushing, L. I., who describe it thus : Flowers, small ; glands, globose ; fruit, below medium ; suture, deep ; skin, downy, dark blood color on one side, on opposite, red and yellow marbled ; flesh, yellow, red at stone, juicy, rich, apricot flavor. Free-stone. Last August.

GORGAS.

American. Native of Philadelphia ; originated with Benjamin Gulliss, from a stone of Morris White. Leaves, serrate ; fruit, large, roundish, with

a slight prominence at the apex ; dull greenish white, clouded and blotched with red on the exposed side ; cavity, wide, rather deep ; stone, free ; flesh, whitish, slightly stained at the stone, juicy ; flavor, saccharine and exceedingly luscious ; quality, "best." Free-stone. Middle to end of September.

GREEN CATHERINE.

Doctor Cooper.

Probably foreign. Flowers, small ; glands, globose ; fruit, large, round, pale green, with red cheek ; flesh, bright red at stone, tender, juicy ; very fine South, inferior at the North. Free-stone. First to middle September.

GREEN RARERIPE.

American. Flowers, small ; glands, globose. We have not seen it. Manning says : medium size, productive, fine flavor. Free-stone. Middle September.

GRISWOLD.

Large, round, greenish white, slightly tinged with red ; very juicy and high flavored. Middle of September.

HALE.

Hale's Melocoton.

American. Above medium, oblong, flat at base ; suture, slight, yellow ; flesh, yellow, rich, sweet. Free-stone. Early September. (Cole.)

HARKER'S SEEDLING.

American. Glands, globose ; flowers, small ; fruit, large, roundish, reddish mostly ; flesh, yellowish, sweet, juicy. Free-stone. Early September.

HARTSHORN.

American. Large, roundish, oval, yellow, deep blush ; flesh, coarse ; keeps long. Cling-stone. Middle September. (Cole.)

HASTINGS.

American. Flowers, small ; glands, globose ; fruit, above medium, round, slightly flattened ; yellowish white, with a purplish red cheek, juicy, delicious. Free-stone. Early September. (Manning.)

HATCH.

American. Very large, roundish pointed ; suture, shallow ; deep yellow, blush in sun ; flesh, yellow, melting, sweet. Free-stone. Early September. (Cole.)

HATIVE DE FERRIERES.

New. Early French variety. Medium, round, a little one-sided, white, nearly covered with red, juicy, melting, rich vinous flavor. July.

HENRY CLAY.

American. Newly introduced by A. B. Lawrence, Woodville, Miss., by whom it is thus described : Glands, reniform ; fruit, very large, deep purple in sun, shading to bright pink and creamy white ; flesh, grayish white, tender, peculiar flavor, partaking of strawberry and pine-apple ; small stone, parting freely from the flesh. First August. September at the North.

HILL'S CHILI.

Fruit, medium, roundish elongated, yellow, with red cheek ; flesh, yellow, juicy, sweet, slight sub-acid ; productive.

HOFFNER.

Hoffner's Seedling.

American. Glands, globose ; fruit, medium or above, roundish, whitish, with red in sun ; flesh, yellowish white. Free-stone. August.

HONEY PEACH.

A new Seedling peach, originated by H. Lyons, Esq., of Columbia, S. C. Fruit, large, oblong, coming to a sharp recurved point ; the color of the skin is of a yellowish white ground, mottled with red and crimson ; flesh, very fine, tender, juicy, of a peculiar delicious honeyed sweetness, white, with a few red veins round the stone. The stone has the same peculiar sharp recurved point as the fruit. Tree, a thrifty grower, and productive ; the foliage is small, resembling a wild seedling. It is undoubtedly one of the finest peaches, and its earliness will make it the standard market variety. It commences ripening at the South about June 25, and lasts until July 15th. (Berekmans' Col.)

HORTON'S DELICIOUS.

Fruit, large, roundish, inclining to oval, depressed at apex, point very small, and within the depression ; suture, shallow ; skin, moderately downy, of a rich, creamy white, with a faint blush in the sun ; flesh, white to the stone, with the exact flavor of a Heath cling ; quality, "best." From first to middle of October. (Ga. Pom. S. Rept.)

HUBBARD'S EARLY.

Medium, white, with a little red ; flesh, juicy, very fair. July to August.

IMPERIAL—(Middleton's).

American. Flowers, small ; glands, globose ; fruit, large, roundish ; yellow, with red in sun ; flesh, yellowish, sweet. Free-stone. September fifteenth.

IMPERIAL—(Pettit's.)

American. Flowers, small ; glands, globose ; fruit, large, roundish oval, yellow, with red in sun ; flesh, yellowish, juicy, sweet, sub-acid. Free-stone. Middle September.

INCOMPARABLE.

Pavie Admirable, | Late Admirable Cling.

Foreign. Valuable only for market. Trees, healthy, productive ; flowers, small ; glands, reniform ; fruit, large, roundish, swelling a little on one side, yellowish white, with red cheek ; flesh, yellowish white, red at stone, juicy. Cling-stone. Late September.

JACKSON CLING.

Raised by Mrs. L. A. Franklin, Athens, Ga. Fruit, large, oblong, with a very large, swollen point ; skin, rich, dark yellow, covered with dark red in the sun ; flesh, rather firm, orange-yellow, and dark red at the stone ; juicy sprightly, rich, and delicious ; quality, "best." Last of August. (Ga. Pom. S. Rep.)

JONES' EARLY.

American. Glands, globose; fruit, medium, roundish, yellowish white, with pale red in sun; flesh, yellowish white, red at stone, juicy. Free-stone. Middle August. (Hovey.)

JONES' LARGE EARLY.

American. Glands, reniform; fruit, large, roundish flattened; suture, deep; greenish white with crimson cheek; flesh, white, melting, pink at stone. Free-stone. Middle August. (Hovey.)

JOSE SWEET.

American. Flowers, small; glands, globose; fruit, medium, roundish, broad; suture, deep; greenish white, dull red cheek, juicy, delicious flavor. Free-stone. Last September.

KENRICK'S HEATH.

Heath Free-stone, | Heath Free.

American. Flowers, small; glands, reniform; fruit, large, oblong, swollen point at apex; suture, slight; greenish white, purplish red cheek; flesh, greenish white, red at stone, coarse, juicy, sub-acid. September.

LA GRANGE.

American. Glands, reniform; fruit, large, oblong, greenish white, little red in sun; flesh, greenish white, juicy, not equal to many others at same time ripening. Free-stone. September.

LADY PARHAM.

Large, round, yellowish white, downy; flesh, pale red at the stone, resembles Baldwin's October. Of Southern origin.

LINCOLN.

American. Glands, globose; fruit, large, roundish; broad suture; downy, yellow, with purplish red; flesh, yellow, red at stone, juicy, sweet. Free-stone. Early September. (Cole.)

MADEIRA.

Hill's Madeira, | Madeira Free-stone.

American. A variety now little known, and, we think, never much out of Southern Ohio. Fruit, large, roundish; suture, well marked, not deep; yellow, with rich red cheek; flesh, yellowish, rather firm, rich, and, in warm seasons, sugary and delicious. Free-stone. Early September.

MADELEINE OF COURSON.

Madeleine de Courson, Red Magdalen,		True Red Magdalen, French Magdalen,		Madeleine Rouge, Rouge Paysanne.
--	--	--	--	-------------------------------------

Foreign. Glandless; fruit, medium, roundish, yellowish white, red cheek; flesh, white, red at stone. Last August.

MALDEN.

Early Malden.

American. Flowers, small; leaves, glandless. A variety originated by James Dougall, Esq., of C. W. Fruit, medium, roundish compressed, one side enlarged; suture, distinct; skin, white, with reddish blush cheek; flesh, white, juicy, sprightly. Free-stone. Last August.

MERRIAM.

American. Glands, globose; large, oval, light yellow, red cheek; flesh, yellow, red at stone, juicy, sweet. Free-stone. Last September. (Cole.)

MOORE'S FAVORITE.

American. Glands, globose; fruit, large, roundish, white, bright blush; flesh, white, juicy, vinous. Free-stone. Early September. (Cole.)

MOORE'S JUNE.

Below medium, globular; suture, shallow; cavity, deep; skin, yellowish, nearly covered in the shade with red dots and marblings, and deep red in the sun; flesh, white, marbled with red from the skin to the stone in the darker colored ones, but red only at the stone where grown in the shade, juicy, vinous, pleasantly flavored, and good; flowers, small; glands, reniform. Free-stone. Origin, Athens, Ga. Last of June and first of July. (William N. White, MS.)

MOLDEN'S WHITE.

Origin, Molden Mountain, on the Chesapeake; a fine white peach, valuable for its lateness.

Fruit, large, oblong; suture, on one side, distinct, one side usually a little larger than the other; skin, creamy white, rarely with a tinge of red; flesh, white to the stone, juicy, sweet, melting, and excellent. Separates from the stone. Ripe last of September, and first of October.

MONSTROUS CLINGSTONE.

Pavie de Pompone,
Monstrous Pompone,
Monstrous Pavie,

Pavie de Pomponne Grosse,
Pavie Monstreux,
Pavie Rouge de Pompone,

Pavie Camu
Gros Melocoton,
Gros Persique Rouge.

Foreign. A variety which succeeds finely in rich, deep soils, often of very fine flavor, but apt to be deficient. Its very large size makes it sell readily. Flowers, large; glands, reniform; fruit, very large, roundish oval, swollen point at apex, obtuse; suture, marked half round; skin, yellowish white, with red mostly overspreading it; flesh, firm, yellowish white, deep red at stone, juicy. Cling-stone. Last October.

MONTGOMERY'S LATE.

Glands, reniform; flowers, large; fruit, large, round, depressed at apex; suture, shallow, but distinct; skin, downy, yellowish white, dotted with red, and having a dull red cheek; flesh, pale white, red at the stone, very juicy, melting, and of very fine flavor. Separates from the stone. A hardy and desirable kind. Ripens the first of September, and continues nearly all the month. (Wm. N. White, MS.)

MORRISANIA.

Morrisania Pound, | Hoffman's Pound, | Morrison's Pound.

American. Glands, globose; fruit, large, round, greenish white, dull red cheek; flesh, yellowish white; poor bearer. September.

MRS. POINSETT.

American. Origin in South Carolina. Glands, globose; fruit, large, globular; suture, distinct, regular; skin, brownish yellow, veined with red; flesh, yellowish, juicy, partially cling-stone. First September.

NEWMAN.

American. Large, round, greenish white, with a blush ; flesh, white juicy, sweet. Free-stone. Middle September. (Cole.)

NOBLESSE.

Vanguard, | Mellishe's Favorite, | Lord Montague's Noblesse.

Foreign. The "Double Montague" is said by some to be identical with this old variety. We have fruited them two years, but the Double Montague under unfavorable circumstances, so that we are, as yet, unwilling to place them as identical, although their identity is not improbable. Flowers, large ; leaves, glandless ; fruit, above medium, roundish oblong, pale greenish white, with two shades of red where exposed to sun ; flesh, greenish white, melting, juicy. Free-stone. Last of August.

NONPAREIL.

Scott's Nonpareil.

American. Glands, globose ; fruit, large, roundish oblong, yellow, with red cheek, much like Crawford's Late. Free-stone. September.

OLD NEWINGTON.

Newington Cling, | Newington, | Large Newington

Foreign. Glandless ; fruit, large, roundish, yellowish white with red cheek ; flesh, pale yellowish white, red at stone, juicy. September.

ORANGE CLING-STONE.

American. Flowers, small, serrated, glandless ; fruit, large, round ; suture, well marked ; deep orange, occasionally dark red cheek ; flesh, yellow, firm, juicy, vinous. Cling-stone. Middle September.

ORCHARD QUEEN.

Reine des Vergers.

Foreign. Comes with high praise ; should be tested. Tree, vigorous ; new shoots, reddish ; glands, reniform ; fruit, large, oval, depressed at apex ; skin, yellow, purplish red in sun ; flesh, yellowish white, red at stone, melting, vinous. Free-stone. September.

OWEN.

Owen's Lemon, | Owen's Lemon Rareripe.

American. Glands, globose ; fruit, large, roundish ; suture, distinct ; yellow, purplish red in sun ; flesh, yellow, red at stone, juicy, sweet. Free-stone. Middle September.

PARAGON.

Prince's Paragon.

American. Flowers, large ; glands, globose ; fruit, large, roundish oval, yellowish green, with red cheek ; suture, shallow, terminating in a point at apex ; flesh white, red at stone, juicy, sweet, rich. Free-stone. Middle September.

POINSETT.

American : originated in South Carolina. Glandless ; fruit, large, roundish oval, ruddy yellow ; flesh, firm, juicy. Cling-stone. September.

POOLE'S YELLOW.

Poole's Large Yellow, † Poole's Late Yellow Free-stone.

American. Glands, reniform; fruit, large, roundish; suture, half round; deep yellow, dark red cheek; flesh, yellow, red at stone, rich, juicy. Free-stone. Last of September.

PRESIDENT CHURCH.

Raised by the Rev. A. Church, President of the Franklin College, Ga. Glands, reniform; fruit, large, roundish, inclining to oval; suture, shallow, often a mere line, with a small point at the apex, which is rarely depressed; skin, pale red in the shade, beautifully mottled and washed with dark red in the sun; flesh, white, pale red at the stone, very juicy, melting, and of delicious flavor. Middle September.

PRINCE'S CLIMAX.

Originated on the farm of George Mitchell, Flushing, Long Island; very productive. Fruit, large, oval; skin, yellow, with crimson cheek, and two-thirds mottled with crimson; flesh, yellow, very rich, aromatic, pine-apple flavor; adheres to the stone. Ripens the middle and end of September. (Wm. R. Prince's MS.)

PRINCE'S EXCELSIOR.

Originated with William R. Prince, Flushing, Long Island. Fruit, very large, round; suture, slight, a mere line, ending in a flattened depression at top, where there is a slight cavity, and a little abortive mamelon; skin, a most splendid pure bright orange color; flesh, golden yellow to the stone, very rich, luscious, aromatic, apricot, or exquisite orange flavor, sweet and rich; separates freely from the stone. Ripens middle of October; well suited to the South. (W. R. Prince's MS.) (Downing.)

PRINCE JOHN.

Large, oblong, orange yellow, very juicy and delicious; resembles the Crawford's. Ripens latter part of July.

REEVES' FAVORITE.

American. Distinct from "Favorite" of Coxe. Flowers, small; glands, globose; fruit, large, roundish; yellow, with red in sun; flesh, yellow, juicy, sometimes a little acid. Free-stone. Early September.

RODMAN'S RED.

American. Flowers, small; glands, reniform; fruit, large, oblong, mostly red in sun; flesh, whitish, firm, juicy. Cling-stone. Last of September.

SCOTT'S MAGNATE.

A noble variety of the Red Rareripe. Glands, reniform; fruit, very large, round, depressed; skin, pale yellow, with a dark red cheek; flesh, white, luscious, and well flavored. Ripens early in September. (Downing.)

SCOTT'S NECTAR.

Another very fine seedling from the Red Rareripe. Glands, globose fruit, large, round, somewhat depressed; color, red, shaded on pale yellow ground, and bright red next the sun; flesh, white, very sweet, and of the highest flavor. Ripens early in September. (Downing.)

STETSON'S SEEDLING.

American. Glands, globose ; flowers, small ; fruit, large, roundish ; suture, indistinct ; skin, greenish white, marbled, and shaded with crimson in the sun ; flesh, white, pink at the stone, very melting, juicy, brisk, rich, and luscious. Free-stone. Ripens from middle to last of September. (Hov. Mag.)

SHANGHAI.

From North of China. Flowers, large ; leaves, crenate ; glands, reniform ; fruit, large, roundish ; pale yellow in shade, crimson red in sun ; flesh, pale yellow, deep red at the stone, to which it partially adheres. (Jour. L. H. Society.)

SITES' OLD ZACK.

A variety esteemed at Columbus, Ohio, where it originated. Fruit, above medium ; yellow, with dull red cheek ; flesh, yellow, juicy, separating freely from the stone. 1st to 15th September.

SKINNER'S SUPERB.

A free-stone yellow peach, originated at the South, where it ripens early in August, and is regarded as "very good."

SMITH'S FAVORITE.

American. Glands, reniform ; fruit, large, roundish ; deep suture ; yellow, red in sun ; flesh, yellow, juicy, sweet. Free-stone. Middle September.

SMOCK FREE.

Smock, | Saint George.

American. Valuable market sort. Glands, reniform ; fruit, large, oval, compressed sides ; orange yellow, red in sun ; flesh, bright yellow, red at stone, juicy, rich. Free-stone. Last September.

SNOW.

American. Only suited to sunny exposures, and rich, deep, warm soil's. Flowers, small ; glands, reniform ; fruit, medium, round ; suture, slight ; skin, thin, clear white ; flesh, white, juicy. Free-stone. Early September. The blossoms of this variety are white, and the wood is a light green.

STEPHENSON CLING.

From Thomas Stephenson, Clark county, Ga. Fruit, large, roundish ; suture, distinct ; skin, very downy, of a creamy tint, shaded with flesh-color—the tint deepening in the sun to a dark, dull, purplish red, where fully exposed ; flesh, white, somewhat tinged with red, and deep red at the stone ; flesh, very tender, melting, juicy, delicious, vinous flavor. One of the best. September 12th. (Ga. Pom. S. Rep.)

STRAWBERRY.

Rose.

American. Glands, reniform ; fruit, below medium, surface mostly red ; flesh, whitish ; too small. Free-stone. August.

STUMP THE WORLD.

Fruit, very large, roundish, a little oblong; skin, creamy white, with a bright red cheek; suture, shallow, rather more than half round; flesh, white, juicy, and high flavored; very productive. A fine market variety.

SUSQUEHANNAH.

Griffith's Melocoton.

American. Glands, reniform; flowers, small; fruit, large, oblong roundish; yellowish red in sun; flesh, juicy, sweet, delicious. Free-stone. Middle September.

TARBELL.

American. Large, roundish, flattened at base; suture, nearly round; yellow, mostly covered with red; flesh, yellow, red at stone, juicy, sweet. Free-stone. Middle September. (Cole.)

TIPPECANOE.

American. Flowers, small; glands, reniform; fruit, large, roundish; yellow, red in sun; flesh, yellow, juicy, sprightly. Cling-stone. Middle to last of September.

There is also a Free-stone variety under this name, which originated in Ohio. It is, however, rarely grown, and we know of no description, nor have we seen the fruit.

TROTH'S EARLY RED.

American. Flowers, small; glands, globose; fruit, medium, roundish, bright red in sun; flesh, juicy, sweet. A new variety; very productive, and valued highly as an early market sort ripening about time of early Fillotron.

TUFT'S EARLY.

American. Glands, globose; large, roundish; yellowish white, red cheek; flesh, white, red at stone, juicy, sweet. Free-stone. Last of August.

TUFT'S RARERIFE.

American. Glands, globose; medium, roundish; red and yellow; flesh, yellow, sweet. Free-stone. Middle September. (Cole.)

WALBURTON.

Walburton Admirable.

Foreign. Leaves, glandless, serrated; fruit, above medium, roundish oblong; greenish white, with red cheek; flesh, greenish white, melting, and separating freely from the stone. Late September.

WASHINGTON CLING-STONE.

American. Requires a warm climate and good soil. Valuable South, not at the North. Flowers, small; glands, reniform; fruit, medium, roundish; yellowish green, with gray specks and a tinge of red in sun; juicy, tender, and rich, sweet flavor. Last September.

CLASS III. *Superseded by better sorts*

ACTON SCOTT.

Foreign. Glands, globose; fruit, medium, yellowish white, red cheek, flat, pale white, often bitter. August.

ANNE.

Early Anne, | Green Nutmeg.

Foreign. Glandless; fruit, small, greenish white, poor flavor. Early August.

ADMIRABLE.

Early Admirable, | L'Admirable, | Belle de Vitry.

Foreign. Glands, globose; fruit, medium, yellowish white, red cheek; flesh, red at stone. August.

ALMOND.

Foreign. Glandless; fruit, small, light yellow, red cheek; flesh, red at stone. September.

BELLE DE VITRY.

Admirable Tardive, | Bellis.

Foreign. Glandless; fruit, medium, yellowish white, red cheek; flesh, firm, red at stone. Last September.

BEAUTY OF SALISBURY.

Foreign. Trees mildew; fruit, large, roundish, yellowish white, red cheek, juicy. Free-stone. September.

BALTIMORE BEAUTY.

American. Glands, globose; fruit, medium, roundish, yellowish white, red cheek. Free-stone. August.

BULLARD'S CLINGSTONE.

American. Large, round, white, with red cheek, juicy, fine. September. (Kenrick.)

BULLARD'S SEEDLING.

American. Large, round, pale yellow and red. Free-stone. Middle of September. (Kenrick.)

BENNETT'S RARERIPE.

American. Glands, globose; fruit, large, whitish yellow and red, deficient in flavor. August.

BELLE CHEVREUSE.

Foreign. Glands, reniform; fruit, medium, oval, greenish white, with red cheek; flesh, white, red at stone. Free-stone. September.

BELZAR'S EARLY RARERIPE.

American. Glands, globose; fruit, medium, round, red in sun; flesh, streaked with red. August.

CHILIAN.

American. Glands, ———; fruit, medium, yellowish white, red cheek, deficient in flavor. Free-stone. September.

CANARY.

American. Fruit, medium, canary color; flesh, yellow, not colored at stone, to which it adheres closely. September.

CABLE'S MEDIUM MELOCOTON.

American. Glands, globose; fruit, large, yellow and red; flesh, yellow, sub-acid. September.

THE PEACH.

CABLE'S EARLY.

Cable's Early Melocoton.

American. Glands, globose ; fruit, large, yellow and red ; flesh, yellow, sub-acid. September.

CONGRESS.

Congress Cling.

American. Glands, reniform ; fruit, large, whitish with red, juicy ; poor bearer. September.

CHANCELLOR.

Chanceliere, Late Chancellor,		Noisette, Stewart's Late Galande,		Edgar's Late Melting.
----------------------------------	--	--------------------------------------	--	-----------------------

Foreign. Glands, reniform ; fruit, large, oval, yellowish white, crimson cheek ; flesh, red next stone. Free-stone. September.

CAREY'S MAMMOTH CLING.

American. Glands, globose ; fruit, little above medium, oval ; flesh, white. September.

CHARLOTTE.

Old Royal Charlotte Grinwood's Royal Charlotte,		New Royal Charlotte, Kew's Early Purple.
--	--	---

Foreign. Glandless ; fruit, above medium, ovate, greenish white, red cheek ; flesh, white red at stone. September.

CATHERINE CLING.

Foreign. Glands, reniform ; fruit, large, roundish oval, one side enlarged, yellowish green, red in sun ; flesh, firm, yellowish white, red at stone. September.

DOWN EASTER.

Hall's Down Easter.

American. Large, roundish, deep suture, yellow, broad red cheek, good, hardy, productive. 20th September. (Cole.)

EMPEROR OF RUSSIA.

Cut-leaved, Serrated,		New Cut-leaved, Unique.
--------------------------	--	----------------------------

American. Mildews badly ; glandless ; fruit, medium, roundish, yellowish white, red cheek ; flesh, firm, yellowish white. Free-stone. August.

EARLY ROBINSON CRUSOE.

American. Glands, globose ; fruit, large, round, whitish, with red in sun. September.

GEST'S SUPERB.

Gest's Large Free-stone.

American. Glands, globose ; fruit, large, roundish, yellowish white and red ; flesh, firm, sub-acid. September.

GOLDEN BALL.

American. Glands, globose ; fruit, large, roundish, orange yellow, with red cheek ; flesh, yellow, pink at stone, juicy, but not equal to Bergen's Yellow, with which it ripens. Early September. There is a Golden Ball cultivated at the South ; but whether it is this variety, or distinct, we do not know.

ISPAHAN.

Pecher d'Ispahan.

Foreign. Glandless ; fruit, small, round, whitish green ; flesh, greenish white, a little sub-acid. September.

LATE YELLOW ALBERGE.

October Yellow, | Algiers Yellow, | Algiers Winter.

Foreign. Glands, reniform ; fruit, medium, roundish oval, yellow when ripe ; flesh, firm, yellow, dry. October.

LA FAYETTE CLINGSTONE.

American. Fruit, large, oval, yellow, red cheek; flesh, yellow, poor. September.

LA FAYETTE.

American. Fruit, above medium, round, whitish, crimson in the sun; flesh, stained with red. September.

MELTING.

Large Melting.

American. Glands, globose; fruit, large, whitish, with red cheek; flesh, white, red at stone, poor bearer. Free-stone. September.

MAGISTRATE.

Majestrate.

American. Glands, reniform; fruit, large, greenish white, red cheek; flesh, juicy, not high flavor. Free-stone. September.

MONSTROUS FREE-STONE.

American. Glands, globose; fruit, large, round, pale yellow and red; flesh, yellowish white; poor bearer. September.

PHLEIGER.

American. Fruit, large, yellow, juicy, good flavor, poor bearer. Free-stone. September.

RED NUTMEG.

Brown Nutmeg,	Avant Rouge,
Early Red Nutmeg,	Red Avant.

Foreign. Glands, reniform; fruit, small, round, pale yellow, red cheek; flesh, yellowish, red at stone. Early August.

ROYAL GEORGE.

Early Royal George,	Lockyer's Mignonne,	Superb,
New Royal George,	Griffin's Mignonne,	Red Magdaline.
Millet's Mignonne,		

Foreign. Mildews badly; glandless; fruit, medium, roundish, pale white, red dots, and marbled red in sun; flesh, whitish, red at stone. Last of August.

ROSANNA.

Foreign. Glands, reniform; fruit, medium, yellow, and purplish red; flesh, yellow, red at stone. Free-stone. September.

SWALSH.

Double Swalsh,	Swalze.
----------------	---------

Foreign. Glands, reniform; fruit, medium, ovate, yellow, red cheek; flesh, white, red at stone; poor bearer. Free-stone. September.

SWEET WATER.

Early Sweet Water,	Large American Nutmeg.
--------------------	------------------------

There are two varieties under this name; one with globose glands, and one glandless; neither as valuable as Tillotson.

SCOTT'S EARLY RED.

American. Glands, globose; fruit, medium, roundish, much dashed with red; flesh, whitish, juicy. Free-stone. August.

SMITH'S NEWINGTON.

Early Newington,	Smith's Early Newington.
------------------	--------------------------

Foreign. Glandless; fruit, medium, oval, pale yellow, streaked with purplish red in sun; flesh, firm, pale yellow, red at stone. Cling-stone. August.

SMOCK CLINGSTONE.

American. Large, oblong, yellow and red; flesh, yellow, juicy, sub-acid. September.

THE PEACH.

SPRING GROVE.

Foreign. Glands, globose; fruit, medium, roundish, greenish yellow, red cheek; flesh, greenish yellow. Free-stone. September.

SULHAMSTEAD.

Foreign. Glandless, mildews; fruit, large, roundish, pale yellow, red in sun; flesh, yellowish white, sweet. September.

SLOCUM'S EARLY.

American. Glands, globose; fruit, large, yellow and red; flesh, yellow. August.

SIEBOLT.

American. Glands; fruit, above medium, greenish yellow, with red cheek; flesh, yellowish white. Free-stone. September.

TICE.

Tice's Red and Yellow.

American. Fruit, large, yellow, red in sun; flesh, yellow, juicy; poor bearer. Free-stone. September.

VANDERMARK.

American. Fruit, large, roundish; flesh, acid. A cling-stone. September.

WHITE NUTMEG.

Early White Nutmeg, | Avant Blanche, | White Avant.

Foreign. Glandless; fruit, small, oval, greenish white; flesh, white to the stone. Early August.

WHITE BLOSSOM.

White Blossomed Incomparable, | Willow Peach.

American. Glands, reniform; fruit, above medium, oval, white; flesh, white to stone. Free-stone. September.

WEEPING.

Reid's Weeping.

American. Glands, reniform; only ornamental as a tree, and does not deserve to be classed in fruits.

YATE'S EARLY.

American. Much resembles Early York, but far inferior.

YELLOW ADMIRABLE.

Orange, | Apricot Peach,
Abricotée, | Admirable Jaune.

Foreign. Glands, reniform; fruit, medium, roundish oval, yellow, little red in sun; flesh yellow, slightly red at stone, dry. Free-stone. September.

ZOAR BEAUTY.

American. Glands, globose; fruit, medium, roundish, mostly red where exposed to sun flesh, tinged with red. Free-stone. September.

THE PEAR.

Pyrus communis, L. *Rosaceæ* of Botanists.

NATIVE of Europe and Asia, the Pear has long been cultivated, but not until within the past three centuries has there been any considerable number of sorts esteemed valuable as dessert fruits, except they were cooked. Of Van Mons, Knight, and others, and their exertions in originating and improving fruit, have we before written, and to their skill and care do we owe many of our best imported varieties; while, in this country, we are not the less indebted to such men as H. A. S. Dearborn, David Thomas, M. P. Wilder, J. P. Kirtland, W. D. Brinckle, and many others, for the importation, origin, and dissemination of the best varieties throughout the States.

Our pioneer settlers all planted seeds of the Pear, as well as of the Apple; and while in nearly all the middle portions of the States there are immense trees, healthy and vigorous as the native forests, few of these chance seedlings prove in fruit more than about one remove from the wild state. To this fact, and the erroneous impression that "he who plants Pears, plants for his heirs," we attribute the neglect of fruit-growers, for years, to plant any considerable number of Pear trees. Gradually, however, as facilities of traveling have increased, giving opportunity of comparing impressions with practice and results, and information become freely disseminated through our agricultural and horticultural journals, have pear plantations increased, until at this time there are, probably, yearly planted in the States not less than one million of trees.

In almost every State there appear certain localities where the Pear succeeds most perfectly, continuing to increase in size, vigor, and productiveness, from year to year. The following may be selected from many: Danvers, in Mass.; Hartford, and East New Haven County, in Conn.; Vincennes, in Ia.; Detroit, in Mich.; and North-western or Central New-York. And, indeed, we may find it difficult to name a place where, with the appropriate care in culture we have pointed out, the Pear may not be grown healthy and productive.

Propagation—By Seed. The propagation of the Pear by seed is the same as that of the Apple, if we except the fact that, as the roots of the Pear the first year are generally confined to the one "tap-root," as it is termed, and a few fibres, it is necessary that the soil be at least two feet deep. Old pasture ground or meadow, trenched with the spade, is the best for the growing of pear seedlings.

The propagating by *grafting, budding, etc.*, is also the same in the Pear as in the Apple, and usually performed at same season. The remarks we made relative to root-grafting on pieces of roots are also equally applicable to the Pear as the Apple. Some practice the grafting on pieces of root, and plant deep to induce the rooting of the Pear from the graft; this is easily done, but we see no advantage; and our experience with trees, roots so formed, has not been favorable; we have found the roots thrown from the Pear small and insufficient to sustain the tree, while those of the old root, on taking up, were diseased, apparently from some want of action in the circulation of sap-vessels.

Hardihood. The comparative hardihood of American over foreign varieties has been much lauded, but as yet we do not think sustained by experiment. Propagation on healthy or unhealthy stocks we think has had more to do with it than aught else. Until within a few years past, most of the pears worked on pear stocks in this country were on suckers, and this we imagine the foundation of most said respecting the comparative hardihood of native over foreign varieties.

Stocks and Adaptation of Trees grown thereon. Healthy seedling pear stocks, usually two years old and about three-eighths to half an inch diameter at crown, are regarded best for grafting on, while the same left to grow until August, are usually suitable size for budding. The quince, apple, thorn, and mountain ash, are all more or less used for growing what are termed dwarf trees. Of these the quince is best, thorn next, and apple the least desirable. Of the quince, seedlings are not desirable to use for this purpose, as they do not run even in growth; but cuttings grown from what is generally known as the Angiers variety should be procured. The thorn and mountain-ash are used often with advantage on dry gravelly or sandy soils, where the quince roots do not appear as well suited.

While a very large number of varieties will take, and grow for a year or two finely, there are comparatively few that succeed for a series of years in continued vigor and productiveness, when grown on any stock but that of the pear; and while the cultivation is now very extensive on the quince root, we can not but fear that in eight-tenths it will prove unprofitable to the grower; and in the remaining two-tenths, require equally as much care in supplying nutrition and pruning, as a system of root pruning when grown on pear roots. There are, however, some sorts of the fruit that seem improved by being worked on quince, as Duchesse d'Angoulême, Easter Buerré, etc., and this is a strong item in favor of the quince stock; and therefore, while advising its use, we must not forget always to mention that without careful and high culture the grower will meet disappointment. About one hundred years may be taken as the natural duration of the Pear on pear roots, when grown in soil supplied with the elements

necessary to sustain it; and about thirty or forty years the natural duration when worked on the quince root, and regularly pruned and cultivated. Instances are of course recorded and known, where trees exist for longer periods, while hundreds decay and are gone in one half the time. The demand for pear trees on the quince has been so great for some years past that, too often, little regard has been paid to the stock; and we have now in our grounds rows of bearing trees on quince roots, all of one kind, received from France, from which, although receiving the same care and attention, there may be selected those that ere many years must of necessity decay, as the stock and tree are not adapted one to the other. Again, as before remarked, there are varieties that, while they grow apparently well for a few years, decay on fruiting the second year. The success of the Pear on quince roots trained en-pyramid in the old country has been confined to but few varieties, and these kept under a steady yet high state of cultivation. Orcharding with the pear on the quince, in the manner of most orcharding in this country, will never repay the first cost of the trees; but if trees are selected of varieties known to have been long successful, and a system of culture pursued which shall meet the requirements of the fibrous roots of the quince, then may the grower look for profit and pleasure in the result; but equally gratifying and profitable would be the result, if we except a few varieties of foreign origin, when grown on the pear, and annually root-pruned; added to which, if one half the trees were taken out after twenty years, the balance would form a fine permanent orchard, to be managed as our apple orchards. In small gardens, where the quince stock is advised by nearly all writers (and correctly so, if the right varieties are selected), success will not be had without an appreciation by the grower of the extent of roots formed by the quince, and the system of culture required to supply the food of the plant, as well as knowledge in how to prune, and also some little knowledge of the amount of fruit the young tree is capable of ripening and continue in health; the tendency being rather to over-production and exhaustion.

Transplanting, Selection of Trees, and Distances apart. The roots of the Pear have few laterals except grown on shallow, rich soil, and in transplanting, it is therefore requisite to secure as much of the large root as possible. If in taking up they are mostly destroyed, the branches will have to be shortened in and cut out. On the quince root, when well grown, there will need little attention, except to head back to a regular shape, and prune smooth the ends of each root, as often directed in this work; and in setting, taking care that the earth is even with the junction of the pear on the quince.

Trees on pear roots for the orchard or garden are best at about three years old, and five to seven feet high, well grown, and shaped as noted in the apple. Dwarf trees or those on quince roots, are

best at one year from the bud; for, as a general thing, the nurseryman has neither the time, nor will the price paid for trees as compared with that of labor in this country, warrant him in a system of careful and correct pruning in nursery row; neither can a tree be so evenly shaped as when transplanted to more open and exposed positions.

The distance apart of Pear on pear roots for large orcharding, should be from twenty five to thirty feet, while that of dwarfs for gardens should be ten to fifteen feet. Dwarfs are now much planted intermediate in large permanent orchards, but as a whole, the practice is not to be advised, unless the grower intends to cultivate such orchard with care and attention, superior to the ordinary method of plowing, planting potatoes, etc.

Soil and Manures. The pear roots thrive best in a soil where the subsoil is at once dry and moist; that is, where it is open and porous sufficient to admit of free drainage, and yet where the roots, extending deeply and freely in it, reach moisture in season of extreme drought. Cold clay is a bad subsoil, and where it exists in the ground of a prospective orchard, it should be deeply and thoroughly subsoiled, and well drained. The Pear on quince roots succeeds best in rich, deep, moist, loamy ground, even enduring considerable water better than dry sand. The following is the analysis of the ash of the Pear as made by Dr. Emmons:

	Sap-wood.	Bark.
Potash.....	22.25	6.20
Soda.....	1.84	—
Chlorine.....	0.31	1.70
Sulphuric Acid.....	0.50	1.80
Phosphate of Lime.....	27.22	6.50
Phosphate of peroxide of iron.....	0.31	—
Carbonic Acid.....	27.69	37.29
Lime.....	12.64	30.36
Magnesia.....	3.00	9.40
Silex.....	0.30	0.40
Coal.....	0.17	0.65
Organic Matter.....	4.02	4.20
	<hr/>	<hr/>
	100.25	98.30

From this it will be seen what is most wanted in the soil to produce healthy foliage and wood in the Pear. As a general thing, soils usually are or become deficient in lime and the phosphates, and the cheapest remedy is liberal dressing of wood ashes and bone dust; or in sections where bone dust is not easily attainable, dig in around the tree whole bones from the use of a family, or procured from a slaughter-house. Potash dissolved in water and applied to vegetable mould from the woods, and this dug in around the tree, is also a cheap and ready way of supplying food requisite. Iron filings, etc., from

smith-shops is also good, and hence the impression of some, that through it the *blight* was cured or prevented. The fact being only that a certain element requisite to health was exhausted in the soil.

Pruning. In connection with what we have recorded under this head on a previous page, we add the following, as directly applicable to the Pear. It is from the experience of Thomas Rivers, Esq., England, one of the most successful pyramidal pear tree growers in the world :

“If root-pruned pyramidal trees are planted, it will much assist them if about half the blossom buds are thinned out with sharp-pointed scissors, or a penknife, just before they open ; otherwise these root-pruned trees on the quince stock are so full of them, that the tree receives a check if they are all allowed to expand. About ten or fifteen fruit may be permitted to ripen the first season ; the following season two or three dozen will be as many as the tree ought to be allowed to bring to perfection, increasing the number as the tree increases in vigor, always remembering that a few full-sized and well-ripened pears are to be preferred to a greater number, inferior in size and quality.

“Summer pinching in the youth of the tree is the only remedy, if it is not well furnished below ; and a severe remedy it is, for *all* the young shoots on the upper tiers, including the leader, must be pinched closely in May and June till the lower ones have made young shoots of a sufficient length to give uniformity to the tree. This requires much attention and trouble ; it is better to be careful not to plant any tree for a pyramid that is not well furnished with buds and branches to its base. A tree of this description may soon be made to assume the shape of the foregoing figure, which is a perfect pyramidal pear tree, such as it ought to be in July, before its leading side shoots and perpendicular leaders

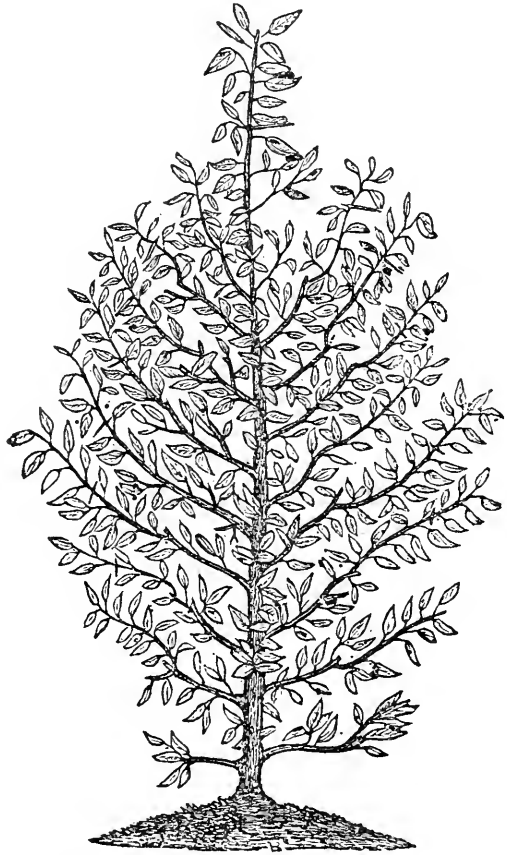

are shortened, which is best done towards the end of August; this shortening must be made at the marks —, and all the side shoots shortened in the same maneer; and also the leading shoot. Hooked pruning scissors will be found the best implement to prune with. The spurs are the bases of the shoots that have been pinched in June.”

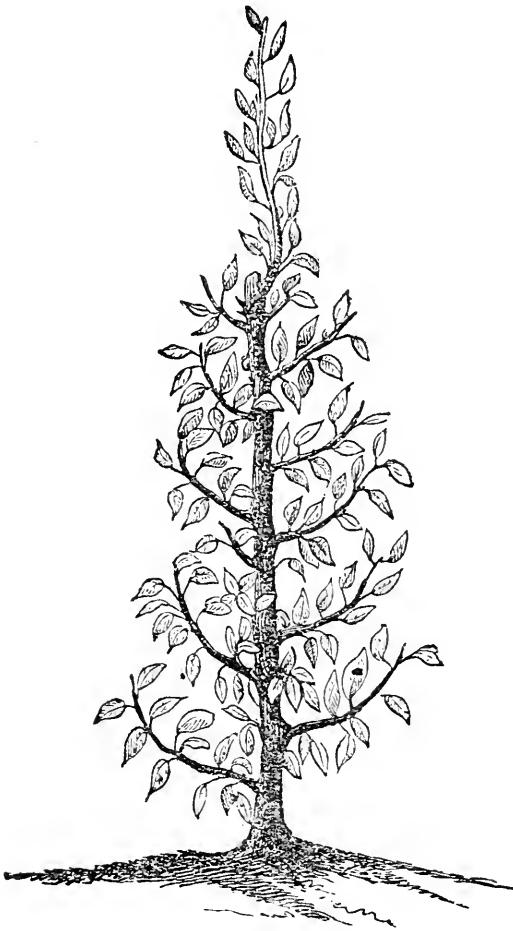

Planting and after management. As before mentioned, the autumnal and early winter months are to be preferred for planting; care should be taken in selecting trees that are furnished with buds and branches from bottom to top; but if a young gardener intends to plant, and wishes to train up his trees so that they will become quite perfect in shape, he should select plants one year old from the bud or graft; these will, of course, have good buds down to the junction of the graft with the stock. The first Spring, a tree of this description should be headed down so as leave the shoot about eighteen inches long; if the soil is rich, from five to six and seven shoots will be produced; one of these must be made the leader, and if not inclined to be quite perpendicular, this must be fastened to a stake.

As soon in Summer as the leading shoot is ten inches long, its end must be pinched off, and if it pushes forth two or more shoots, pinch all off but one to about two inches, leaving the topmost for a leader; the side shoots will in most cases assume a regular shape; if not, they may be this first season tied to slight stakes to make them grow in the proper direction. This is the best done by bringing down and fastening the end of each shoot to a slight stake, so that an open pyramid may be formed; for if it is too close and cypress-like, enough air is not admitted to the fruit; they may remain unpruned till the

end of August, when each shoot must be shortened to within eight buds of the stem ; * this will leave the tree like the preceding figure, and no pruning in Winter will be required.

The second season the trees will make vigorous growth ; the side shoots which were topped last August will each put forth three, four, or more shoots ; as soon as these are four inches long they must be pinched off to within three inches, *all but the leading shoot of each side branch* ; this must be left on, to exhaust the tree of its superabundant sap, till the end of August. The perpendicular leader must be topped once or twice ; in short, as soon as it has grown ten inches, pinch off its top, and if it breaks into two or three shoots, pinch them all but the leader, as directed for the first season ; in a few years, most symmetrical trees may be formed.

When they have attained the height of six or eight feet, and still continue to grow vigorously, it will be necessary to commence root-pruning to bring them into a fruitful state.

I have thus far given directions for those who are inclined to rear their own pyramids. Much time and attention are required ; but the interest attached to well-trained pyramids will amply repay the young cultivator.

I will now endeavor to give directions for the management of trees, adapted for the gardener of mature age, who feels somewhat impatient if his trees do not begin at once to be fruitful. A most valuable auxiliary to precocious fruitfulness in pears is the quince stock ; pears grafted on it may be safely recommended for all soils of moderate depth and fertility, and even for light and sandy soils I am induced to advise it, only in those circumstances the trees must have more care and higher cultivation. In soils of that nature I should recommend the surface of the soil round the tree to be covered, during June, July, and August, with short grass, moss, or manure, and to give them once a week, in dry weather, a drenching with guano water (about two pounds to six gallons), which must be well stirred before it is used ; each tree should have twelve gallons poured gradually into the soil : by this method the finest fruit may be produced ; and as it is very probable that, ere many years elapse, we shall have exhibitions of pears, this will be the mode to procure fine specimens to show for prizes.

Monsieur Cappe's method of pruning in the Garden of Plants (Jardin des Plantes), France, where all are on their own or pear roots, is thus described by the late A. J. Downing in the Horticulturist. These pyramidal pear trees, it is well known, are regarded as the most perfect of specimens.

"M. Cappe confines his pruning to three seasons of the year. In the month of March, or before the buds start, he shortens back with

* There are generally three or four abortive buds at the base of each shoot ; these must not be reckoned.

the knife all the leading shoots, fig. 1, *a, a*,—that is, the terminal shoots at the end of each side branch. Of course, this forces out not only a new leading shoot, at the end of the branch, but side shoots, *b, b*, at various places on the lower part of the shoot. The side shoots are left to grow till the *end of May*. They have then pushed out to about four or five inches in length. The ends of all these side shoots are then *pinched off*, leaving only about an inch and a half at the bottom of the shoot.

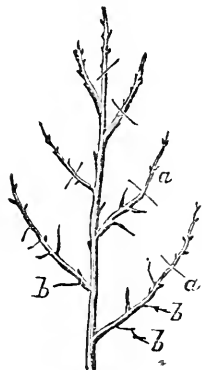

Fig. 1.

Notwithstanding this precaution, in luxuriant seasons the side shoots will frequently push out new shoots again, just below where they were pinched. This being the case, about the last of August M. Cappe shortens back these new side shoots to about an inch and a half. But this time he does not pinch them off. He *breaks* them, and leaves the broken end for several days attached and hanging down, so that the flow of sap is not so suddenly checked as when the branch is pinched or cut off, and the danger of new shoots being forced out a third time is thereby effectually guarded against.



Fig. 2.

shortened branches, by which means the remaining buds become fruit-buds instead of wood-buds. They also become spurs, distributed over the whole tree, which bear regularly year after year, sending out new side shoots, which are pinched back in the same manner every Summer.

“In order to keep the tree finely proportioned, the eye of the pruner must be a nice one, that he may, with a glance, regulate the pruning of the terminal branches or leaders, which, as we have just said, are shortened back in March—for then is the time to adjust any extravagances of growth which the tree may have run into, on either side; and in the summer pinching the balance of growth is adjusted by pinching the side shoots that start out nearest the ends of the branches, quite short, say an inch and a half, while those that start near the bottom of the branch (or the centre of the tree)

where they have less nourishment, are left from four to five inches long.

“Understanding this mode of pruning, nothing is easier than to form pyramidal pear trees of the most perfect symmetry and beauty of form. But in order to have the branches regularly produced from the ground to the summit, you must plant a tree which is only a couple of feet high, so that you can form the first tier of branches quite near the ground, by cutting back the leader at the very outset; for if the tree is once allowed to form a clean body or stem, of course it is impossible afterwards to give it the requisite shape and fullness of branches at the bottom.”

All this our readers will understand relates more especially to the art of pruning, as adapted to high or garden culture. Standard trees in the orchard require only the same or similar pruning to that pursued in the Apple; very few trees, in fact, requiring aught but a thinning out of branches, or rather a preventing, while young, of the branches becoming too thick.

Insects and Diseases. The *Scolytus pyri* is an insect described by Harris. This is by some counted as the cause of a species of blight. Its presence has, however, been rarely met with, and doubts arise among many cultivators whether it is as prevalent, and the *cause* of as much destruction, as reported.

The *Bupestis divaracata*, and perhaps some allied species, is found in the larvæ state under the bark, on the bodies of both the Pear and Apple; and what is often taken for sun-blight, is the effect of this insect. The bark appears blackened on the body of the tree, on the South or Southwest side. Cutting it away carefully, and destroying the larvæ in months of July to September, and washing the body first with lye-water, or strong soap-suds, and covering it with a coating of gum shellac, dissolved in alcohol, is the remedy.

The slug *Selandria cerasi* appears on the leaf of both Cherry and Pear in June, July, and August. It is about half an inch long, of a dull, greenish brown, slimy, shining, offensive appearance. It is easily destroyed, if taken in time, by scattering ashes or even dirt over the leaves early in morning, or while the dew is on, following up the application some four or five days. The frozen-sap blight, etc., often so destructive to trees in the West, we have remarked on in previous pages, and refer thereto.

Bark Lice, or *Scale insects*, are often found upon the Pear, as well as the Apple. See “Apple Insects,” for remedies.

“The *Psylla*, or jumping louse, is probably identical with the same species that infests the Pear tree in Europe. In some of its forms it

is found on pear trees from May to October; and probably two or more broods are produced every year. These little insects live by suction, and obtain their food by puncturing the bark of the young shoots, mostly in the vicinity of the buds. They defile the shoots with the fluid which they discharge in large quantities, and which soon forms a blackish crust on the bark. The best remedy that occurs to me is, a wash of strong soap-suds and sulphur, applied with a brush to the branches in the Spring, before the buds expand. A solution of whale-oil soap, thrown upon the trees, will kill the insects, but will have to be repeated at intervals through the Summer."

Selection of varieties known to be permanently successful on the Quince. As we have before remarked, while there are a great many varieties that at first take, and grow well on the quince stock, there are but few comparatively that are permanently successful. It therefore becomes the planter to select with care, and plant with a view to permanence, only those that are known to succeed. Of the error of planting indiscriminately, we have had practical experience, as in planting the grounds of our residence we looked to the testing of varieties, and therefore ordered and planted one tree only of a sort. On a double border so planted, containing over two hundred sorts, we in three years discarded one half, and feel confident that not more than one half of the remainder will answer to continue permanently. As yet, few of our American native Pears can be depended on when grown on the quince, and as all introduced are of the quality described when grown on pear roots, we advise most planters so to procure them. "Cultivated on the pear stock, the trees in general grow vigorously in a light, deep, alluvial soil, provided always that the subsoil is free from stagnant water. The form and quality of the fruits depend in a great measure on the conditions of the soil and subsoil, careful cultivation, proper management of the trees, and vigor of the stocks."

Gathering of the Fruit, and Uses. "Gather pears of the summer sorts rather before they are ripe, as, when thoroughly so, they eat mealy if kept above a day or two; even when gathered as they ought to be, in a week or less they begin to go at the core. They should not, however, be gathered when they require much force to pull them off. Autumn pears must also not be full ripe at the time of gathering, though they will keep longer than the Summer. Winter pears, on the contrary, should hang as long on the trees as they may, so as to escape frost, which would make them flat in flavor, and not keep well. Generally they may hang to the middle of October on full standards, a week longer on dwarfs, but not after they are ripe. The art of gathering is, to give them a lift, so as to press away the stalk, and if ripe, they readily part from the tree. Let them be quite dry when

pulled, and in handling, avoid pinching the fruit, or in any way bruising it; as gathered, lay them quietly in shallow baskets."

This process of gathering at the proper time, in connection with their after maturing in a fruit-room or house of equable temperature, has often very much to do in deciding the quality of a pear. Many varieties are entirely worthless as dessert pears, unless so ripened, when, with this care, they are really the most delicious. Others, again, as is the case with most varieties maturing late, require simply to be put away in barrels in the cellar, like apples, and a few days before wanted for use, brought out and placed in a warm room.

The old criterion of a good pear, viz.: one with a sugary aromatic juice, soft sub-liquid pulp, or melting, as in the White Doyenné, or fine crisp and "breaking," as in the Bergamottes; firm, juicy, yet austere for cooking, as in the Pound, is equally good at this day as when first written.

The common uses of the pear are for dessert, baking, stewing, drying, preserving, marmalades, and for perry. For the latter use, large orchards of the more common hardy sorts have heretofore been planted, and the result found more profitable than the same amount of ground appropriated to the apple for cider.

Varieties and Nomenclature. The number of varieties now known is something over twelve hundred, but of these it is more than probable over one thousand may be discarded, and then leave more than have qualities to sustain their continued culture when compared with the best. Throughout the West, the pear culture is only in its infancy, and we therefore place far less in our first class than probably may seem worthy that position by our Eastern pear amateurs; but we would rather our Western growers should plant varieties worthy their attention, than, as a whole, devote time to testing. We shall not pretend in this work to even note all varieties, but shall only speak of those most known in our own language, while we could wish (and probably may do so, as far as possible, at a future time) to transfer all names into the English language; we have at this time thought best in most cases to retain the foreign name, but in the first class giving the English meaning directly underneath, and in same size type.

Forms and Size comparative. Our forms illustrative of the terms used in description, are from the Transactions of the Massachusetts Horticultural Society. These are founded on the fundamental figure of a circle, and on this is drawn the form of the fruit; and where the circle forms not a part of the fruit form, it is shown by dots. It should always be recollected, that in the pear, *pyriform* is with the small end at the stem; while in the apple it is at the calyx.

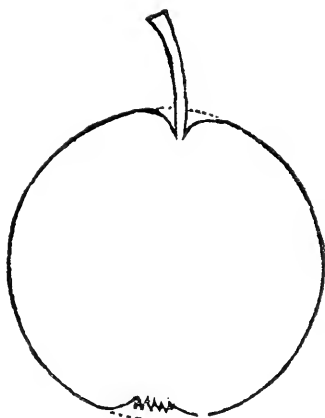

Globular.

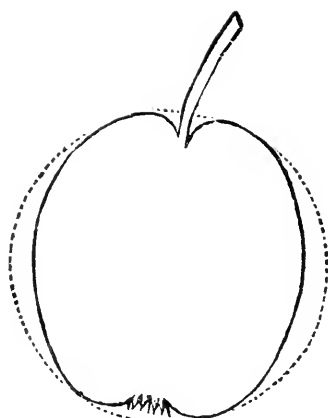

Ovate.

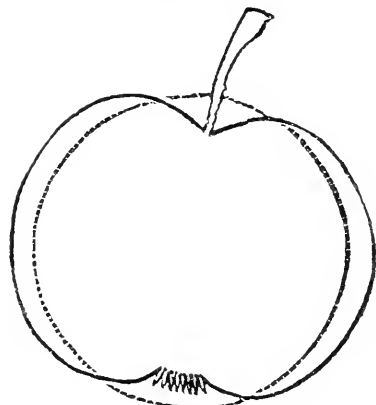

Obovate.

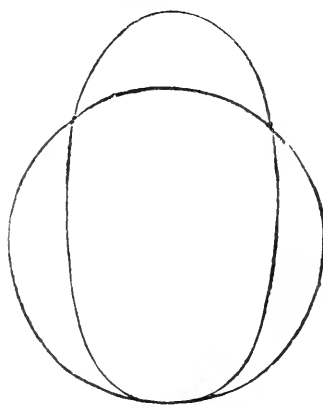

Oblong.

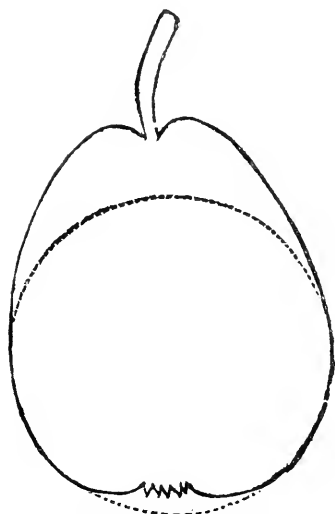

Globular; obtuse pyriform.

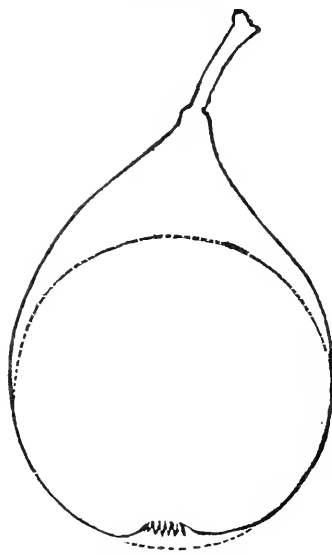

Globular; acute pyriform.

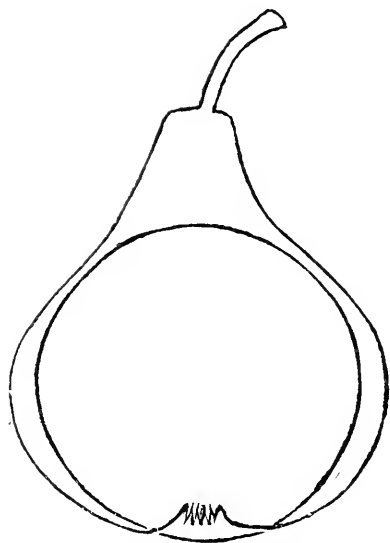

Obovate; acute pyriform.

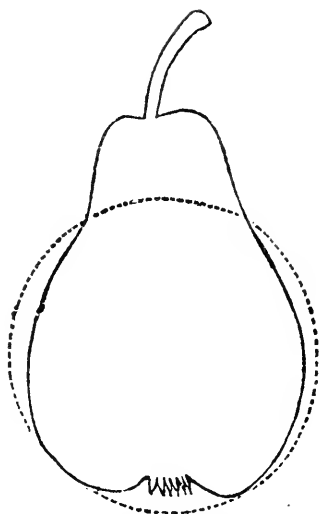

Ovate pyriform.

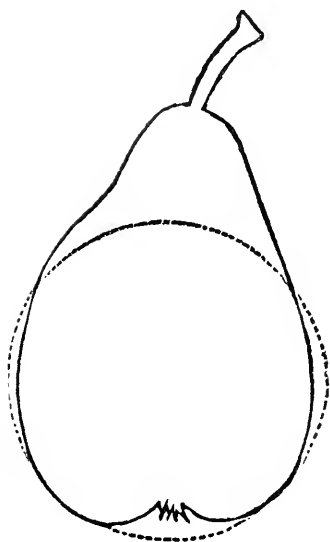

Oblong pyriform.

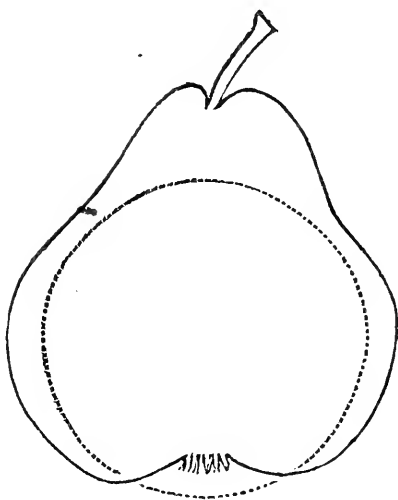

Obovate obtuse pyriform.

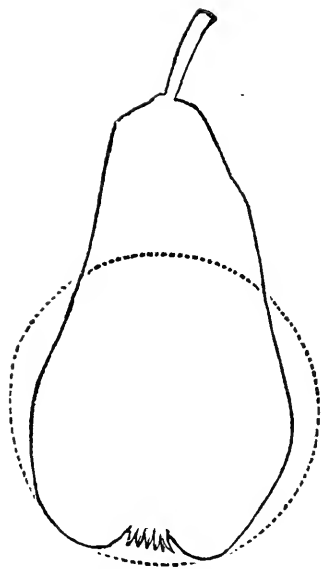

Oblong obovate pyriform.

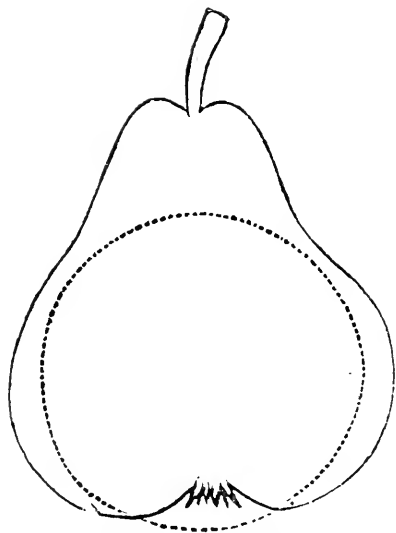

Oblong ovate pyriform.

Of size comparative, we take the Seckel as small; the White Doyenné, or Virgalieu, as medium; the Bartlett as large.

CLASS I. *Most generally esteemed.*

ANANAS D'ETE.

Ananas, of some, | Poire Ananas.

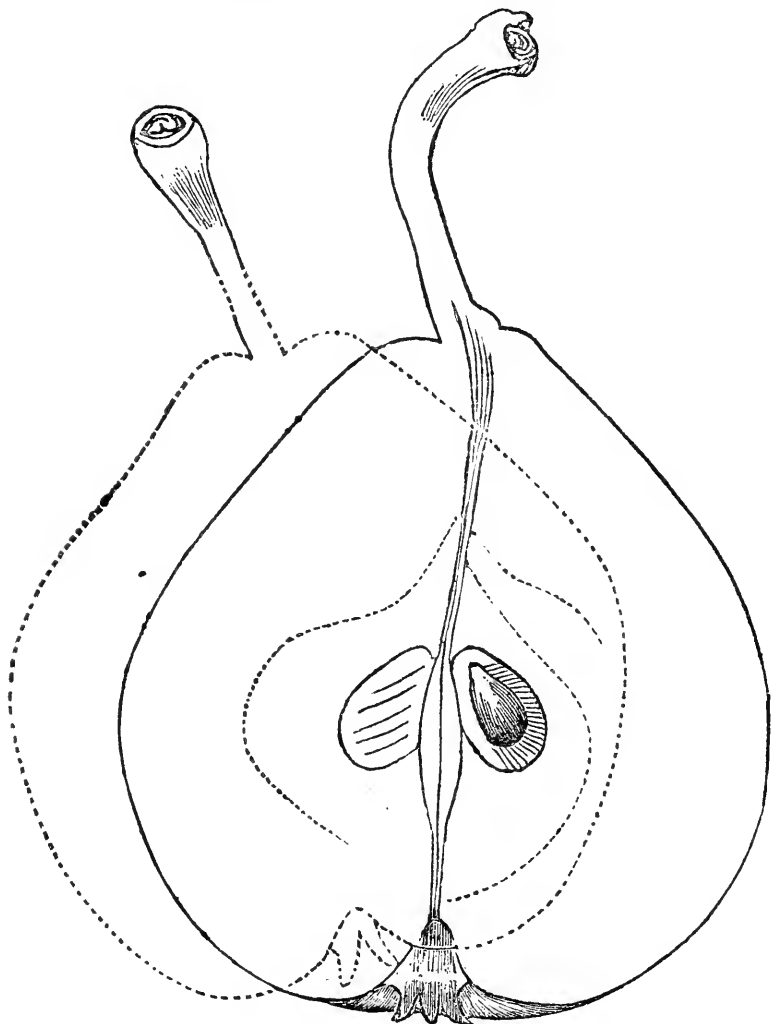

Foreign. A superior variety that deserves extensive planting. Tree, vigorous, light brown wood, with white oblong dots, early regular bearer, fruit always large and excellent.

Fruit, large, oblong, obovate pyriform, angular; *color*, dull yellowish green, with much rough brown russet marbling; *stem*, largest at base, or where it joins the fruit, and with a lip one side; *calyx*, open, short divisions; *basin*, shallow, open; *core*, compact, capsules small; *seeds*, long ovate; *flesh*, whitish, fine-grained, buttery, melting, sweet, perfumed

Last August and early September. This variety varies much in form. Our figures are from specimens from same tree.

BARTLETT.

William's Bon Chretien,
William's,

Poire Guillaume,
Delavault de Clement.

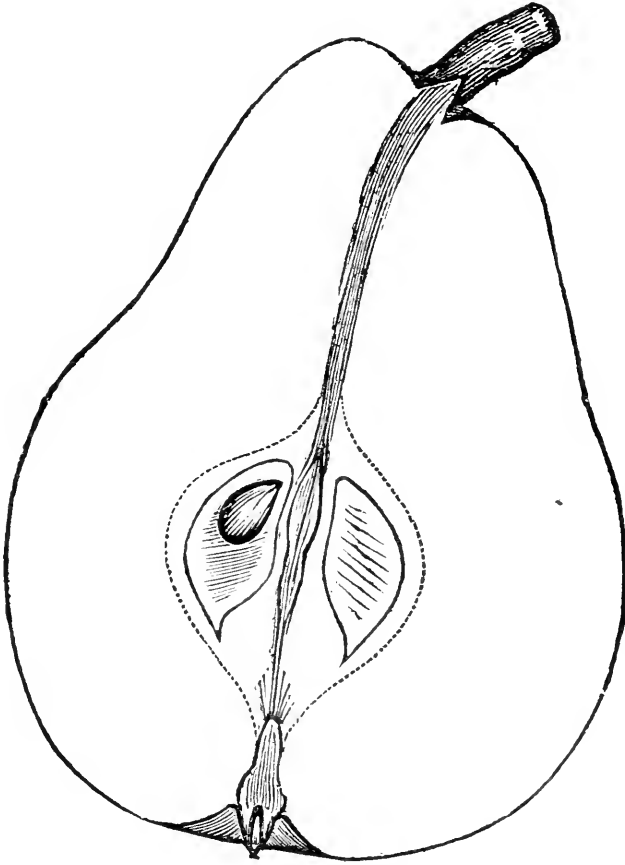

An English variety, originated about 1770. Now extensively grown, and too well known to really need description. The trees are vigorous, and early productive of fair, handsome fruit, either on Pear or Quince root.

Fruit, large, ovate, obtuse pyriform, surface somewhat uneven; *color*, clear light yellow, tinged with blush in sun when ripe, russet around the stem, and minute russet dots over whole; *stem*, short, thick; *calyx*, medium, partly open; *basin*, shallow, furrowed; *core*, medium; *seeds*, broad ovate; *flesh*, yellowish white, melting, juicy, vinous Middle August to middle September.

BELLE LUCRATIVE.

Fondante d'Automne, | Seigneur d'Esperin.

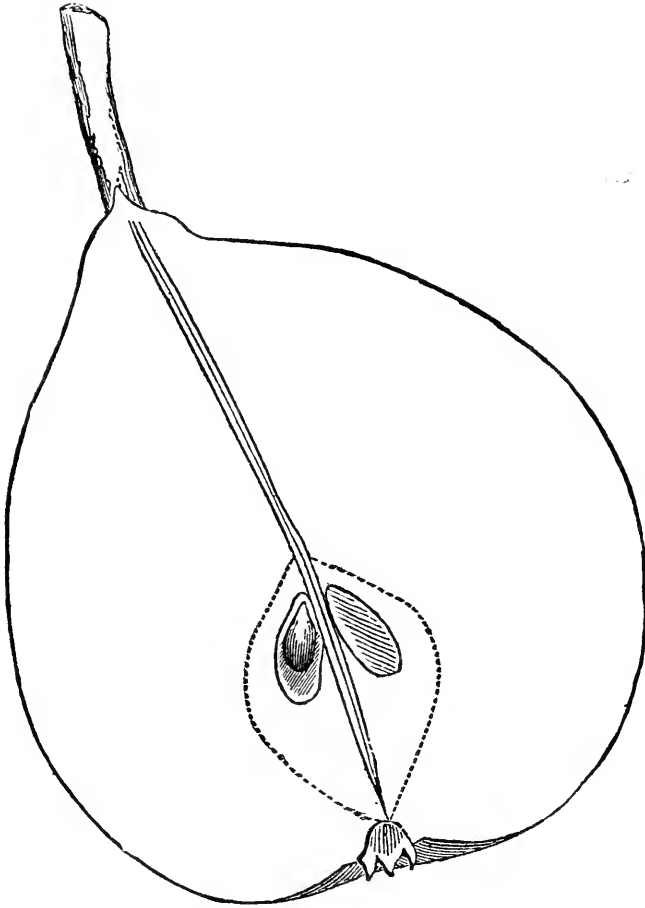

A Flemish variety. Tree, of moderate growth; productive bearer, young shoots long, yellowish gray. Thus far, does well on the Quince. If picked, and fruit ripened in house, one of the very best.

Fruit, medium, obovate pyriform; *color*, pale yellowish green, slightly russeted; *stem*, stout, often fleshy; *calyx*, short, open; *basin*, medium, *core*, medium; *seeds*, ovate; *flesh*, melting, juicy, aromatic, sweet. Last September.

BEURRE GIFFARD.

Beurré Gifford.

Foreign. Tree, moderate grower, long slender shoots, dark reddish, good bearer on Quince or Pear. *Fruit*, medium pyriform, yellowish green to pale yellow, red in sun, pale russet specks; *stem*, long, slender, curved; *calyx*, open; *core*, small; *flesh*, white, melting, juicy, vinous, "very good." Last of August.

BEURRE D'AREMBERG.

Duc d'Areberg,
Colmar Deschamps,
L'Orphelines,

Soldat Laboureur, *of some*,
Deschamps,
D'Areberg Parfait,

Beurré des Orphelines,
Orpheline d'Enghein.

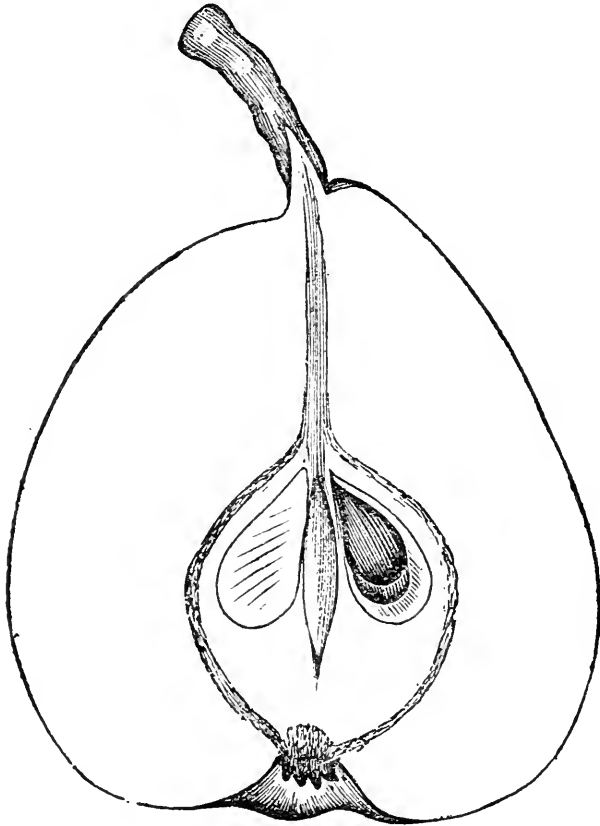

A foreign variety which has been often confounded with Glout Morceau and Soldat Laboureur, from both of which it is distinct. The wood is strong, long-jointed, yellowish brown, dotted with pale gray specks; leaves, narrow, deeply serrated; trees, very hardy, bear young on the pear root, annually and abundantly; the fruit hangs well, and may be gathered and ripened at will from December to February. A warm, rich soil suits it best.

Fruit, above medium, obovate, obtuse pyriform, tapering toward the stem, where it often terminates in a fleshy junction; *color*, dull pale green, at maturity light yellow, clouded with green, with traces and patches of light cinnamon russet; *stem*, short, stout, uneven, set obliquely, without depression; *calyx*, small, closed, segments short; *basin*, rather deep; *core*, medium; *seeds*, light brown, acutely pointed; *flesh*, white, juicy, melting, vinous. December to February.

BUERRE DIEL.

Diel,
Diel's Butterbirne,
Dorothee Royal,
Grosse Dorothee,

Buerré Royal,
Des Trois Tours,
De Melon,

Melon de Kops,
Buerré Magnifique,
Beurre Incomparable.

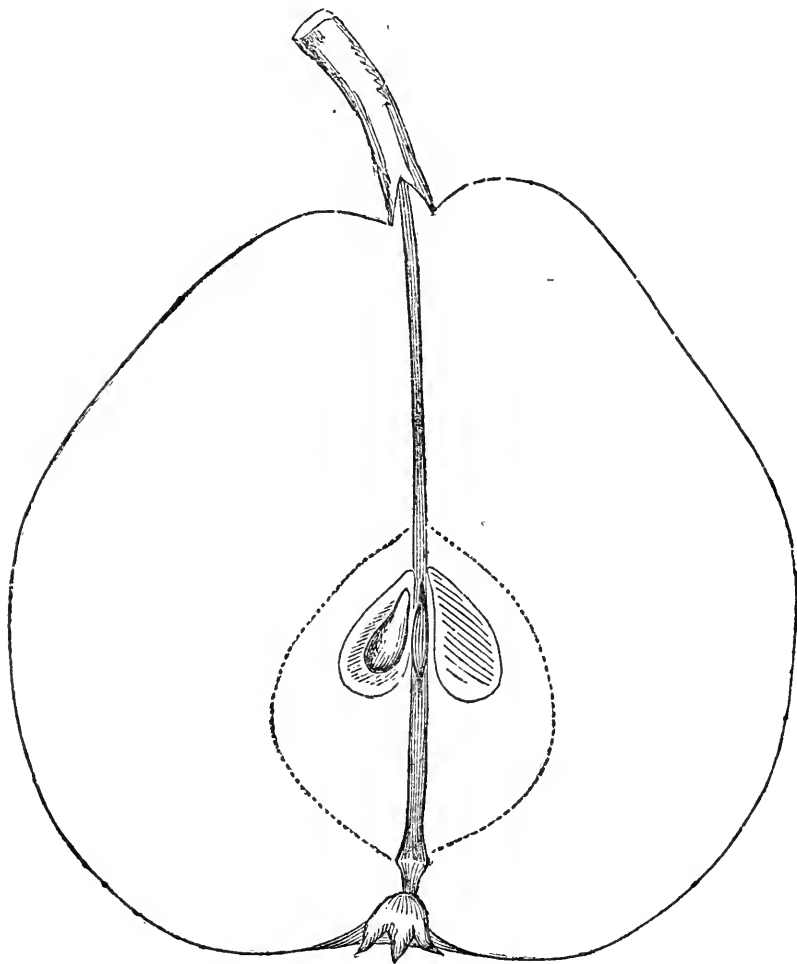

Foreign. Grows and fruits well on Pear or Quince, but is best on Quince. Tree vigorous, the foliage large; wood, olive brown, with grayish specks, very productive.

Fruit, large, obovate obtuse pyriform, surface rather uneven; *color*, dull green, bright yellow when mature, russet specks, and scattered russet and greenish brown patches; *stem*, stout, and slightly curved; *cavity*, narrow; *calyx*, medium, open, long segments; *basin*, abrupt; *core*, large; *seeds*, dark brown; *flesh*, yellowish white, rather coarse, especially near the core, juicy, melting, perfumed. October to last November.

BEURRE MOIRE.

Beurré Moire.

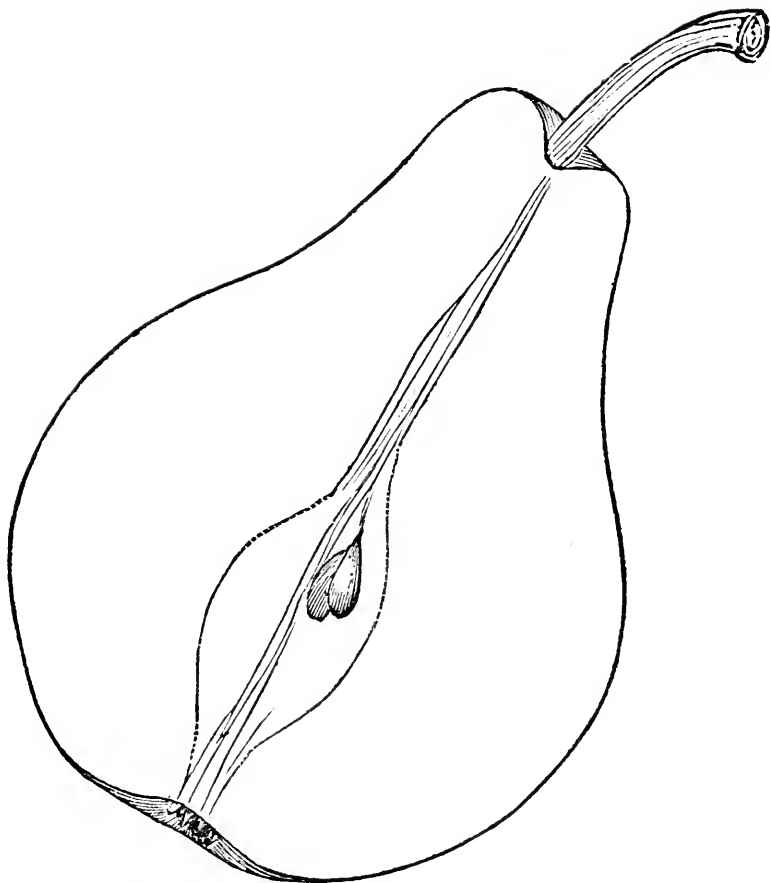

Foreign. Tree, vigorous, upright grower, early, productive bearer, often blossoms the second time in a season, and sets fruit, which, of course, does not mature; promises well. *Fruit*, large, obovate oblong pyriform, pale green, with dots of darker green, and occasionally a russet patch; *stem*, one inch, stout, slight lip on one side of depression; *calyx*, small, short, stiff segments; *core*, small; *seeds*, imperfect; *skin*, thick, harsh; *flesh*, white, juicy, vinous, half melting, sprightly; "very good." November and December.

BRANDYWINE.

American, from the banks of the Brandywine river. Tree, thrifty, rapid grower, long upright shoots, regular and abundant bearer. *Fruit*, medium, varying in form, generally obovate pyriform, running into the stem, which is fleshy, and rather obliquely set; *color*, dull yellowish green, reddish brown in sun, marked with russet dots and streaks, and much russeted about eye; *calyx*, open, segments few; *basin*, smooth, moderate depth;

core, small, compact; *seeds*, few, dark brown; *flesh*, white, rather coarse, melting, juicy, vinous. Last of August, first of September. Succeeds on Quince.

BEURRE BOSC.

Calcbasse Bosc, | Marianne Nouvelle, | Bosc's Flaschenbirne.

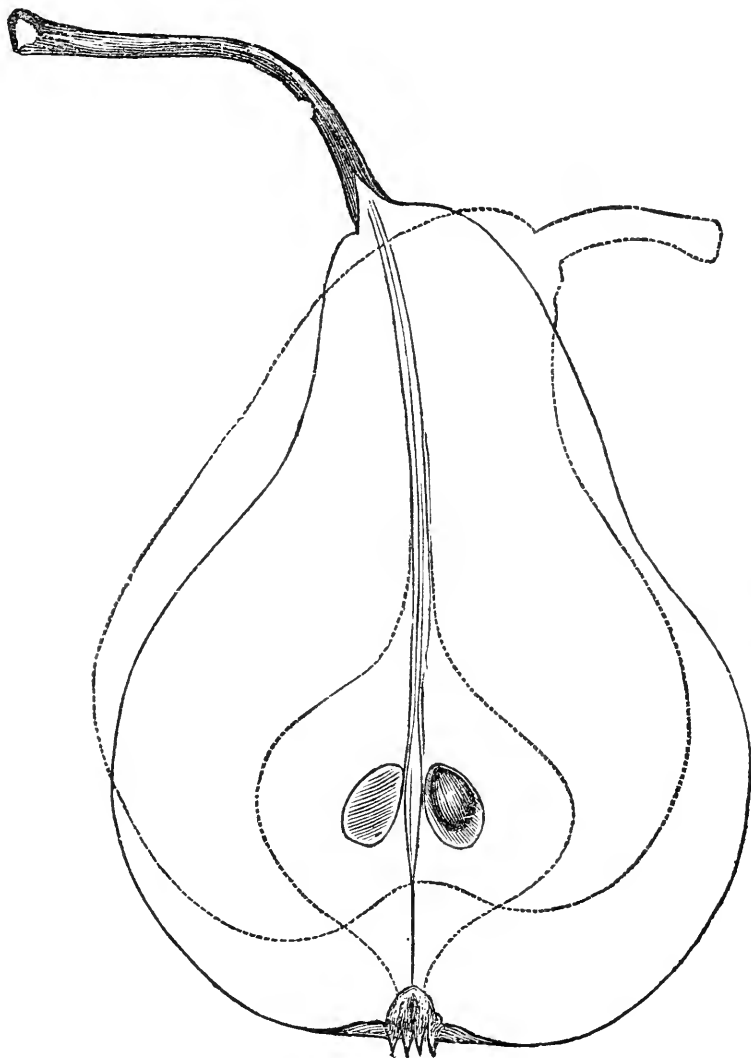

A foreign variety, raised in 1807, by Van Mons. It is an early, annual, and productive bearer on the pear roots, and should have a place in the smallest collection. Tree, vigorous, with long brownish olive shoots straggling or diverging. The fruit varies some in size and form, as see our checked outline in engraving, but it is always fair and smooth.

Fruit, large, obovate acute pyriform; *color*, dark yellow, nearly covered,

dotted and marbled with cinnamon russet, slight brownish red in sun ; *stem*, usually long, slender ; *calyx*, medium, segments partially erect ; *basin*, round, shallow, sometimes a little uneven ; *core*, small ; *seeds*, blackish ; *flesh*, white, melting, juicy, sweet, perfumed. October, or last of September.

BEURRE D'ANJOU.

Niell,
Beurré Niell,

Poire Niell,
Ne Plus Meuris, *of some catalogues,*

Colniac Bosc,
Fondante du Bois, *erroneously.*

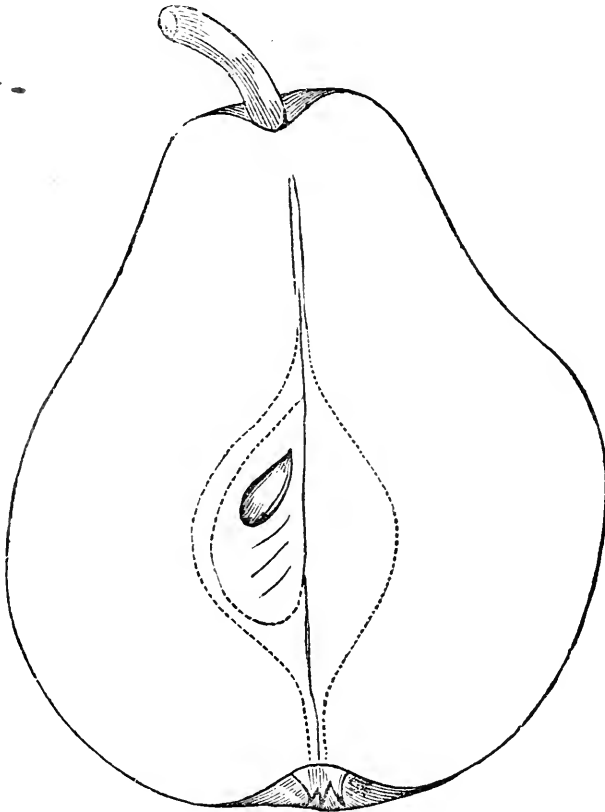

Foreign. An old pear in Loudon's select list of 1834, recently introduced under a new name, and grown on Quince. It is found of the highest excellence. It succeeds equally well on Pear or Quince, but largest on Quince.

Fruit, large, long, oblong obovate pyriform, obtuse at stem ; *color*, pale yellow, dull blush, and numerous small specks of faint russet ; *calyx*, open, segments thick, reflexed ; *basin*, round, not deep, russeted ; *stem*, short, curved, and obliquely inserted in a shallow cavity ; *core*, small ; *seeds*, long pointed ; *flesh*, yellowish white, melting, juicy, vinous, sprightly, delicious to the core. October and November.

BEURRE EASTER.

Doyenné d'Hiver,
Doyenné du Printemps,
Bergamotte de la Pentecote,
Beurré de la Pentecote,
Beurré d'Hiver de Bruxelles,

Beurré Roupé,
Du Patre,
Beurre de Paques,
Phillippe de Paques,
Bezi Chaumontelle très gros,

Chaumontel très gros,
Canning,
Seigneur d'Hiver,
Pater Noster.

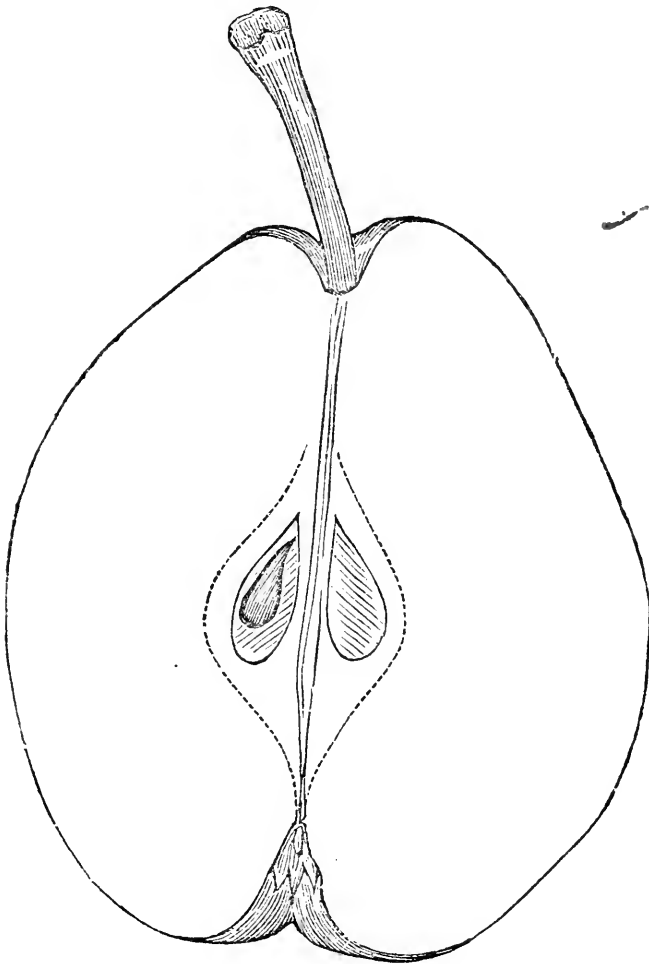

Foreign. Requires rich, warm soil, and some care in ripening, when it is one of the very finest of pears. It is best on Quince.

Fruit, large, globular obtuse pyriform; *color*, yellowish green, with russet spots, and occasional specimens grown in sun have a brownish russet check; *stem*, medium to short; *cavity*, rather deep; *calyx*, generally small; *basin*, narrow, rather deep; *core*, medium; *seeds*, long, ovate acute pyriform; *flesh*, white, buttery, juicy, sweet. January to May.

BEURRE ST. NICHOLAS.

St. Nicholas, | Duchess of Orleans.

Foreign. Tree, moderately vigorous, upright, olive-colored wood, leaves

dark blue green, narrow. Thus far productive and healthy on Quince; one little tree, two years planted, this season yielded forty-three beautiful specimens.

Fruit, large, oblong ovate pyriform, greenish, becoming greenish yellow, with stripes and patches of dull thin russet, sometimes red cheek in sun; *stem*, variable, fleshy at base; *calyx*, small, open, short segments; *flesh*, melting, juicy; "very good." October.

BEURRE COIT.

A new variety, raised by Col. Coit, of Euclid, O. We first ate of it in 1846, when we made our notes in its favor.

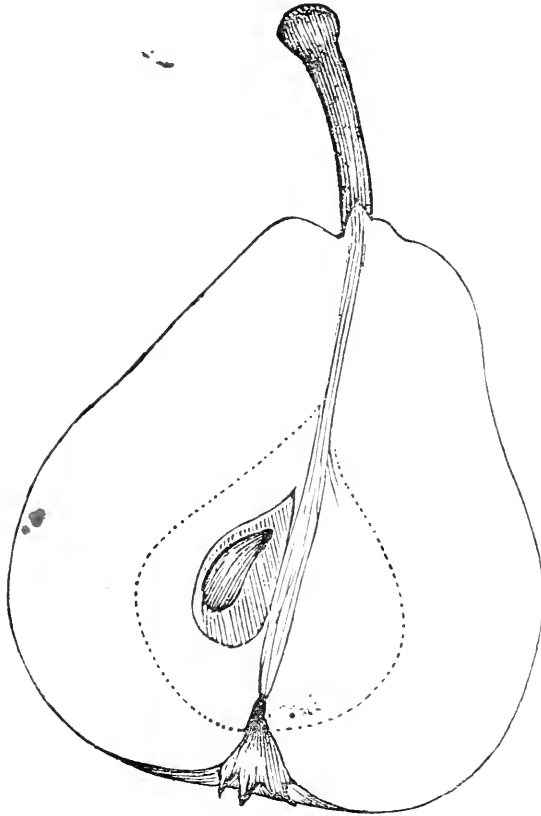

Since that we have seen it several times, and as we write this, September 25, 1853, have the fruit before us. It is worthy a place in all collections. The tree is hardy, vigorous, upright, spreading in form, dark brown shoots, and early good bearer on the pear root. Our drawing was made from a specimen pulled in August, and is below an average size.

Fruit, above medium, obtuse pyriform, slightly angular; *color*, rich brown russet, mostly overspreading a yellow ground, with a brownish red cheek in sun; *stem*, rather short; *cavity*, shallow, with unequal projections; *calyx*, with segments nearly erect, surrounded by depressed crescent-shaped furrows in a shallow basin; *core*, small; *seeds*, blackish; *flesh*, yellowish white, melting, buttery, juicy, sweet vinous. Last Sept. and Oct.

BEURRE LANGELIER.

A foreign pear, newly introduced; it has fruited but few times in this country, but may safely be placed as "best."

Fruit, large, obovate pyriform, contracted toward, and terminating obtusely at, stem; *color*, light green, becoming, at maturity, pale yellow, with a dull red cheek in sun, and numerous gray russet dots; *stem*, one inch, or more, long, angularly inserted, without depression; *calyx*, medium; *basin*, shallow, plaited; *core*, medium; *seeds*, long, ovate pyriform; *flesh*, yellowish white, melting, juicy, fine-grained, sub-acid, slight perfume. November to January.

BLACK WORCESTER.

Black Pear of Worcester, | Parkinson's Warden, | Iron Pear.

A valuable and profitable variety for marketing and cooking purposes ; shoots, dark olive, diverging ; tree, hardy vigorous.

Fruit, large, obovate oblong ; *color*, dull green, with numerous marblings and specks of dark iron russet ; *stem*, stout, in a slight depression ; *calyx*, rather small ; *flesh*, firm, coarse, austere. November to February.

BLOODGOOD.

American. From Flushing, L. I. The tree is a moderate grower, with reddish brown, short-jointed wood ; a regular bearer. We think it requires a rich, deep, warm soil to produce good-flavored fruit. *Fruit*, medium, or below, ovate obovate, yellow, with russet marblings and dots ; *calyx*, open ; *stem*, fleshy at base ; *core*, small ; *flesh*, yellowish white, melting ; "very good." Early August.

BON CHRETIEN FONDATE.

Foreign. Tree, vigorous, hardy, productive on Quince or Pear. *Fruit*, medium, roundish oblong oval, yellowish green, brownish red in sun, and much russet ; *stem*, medium, curved ; *calyx*, small, partly closed ; *basin*, furrowed ; *core*, large ; *flesh*, white, coarse, melting, juicy, a little gritty ; "very good." September, October.

BUFFUM.

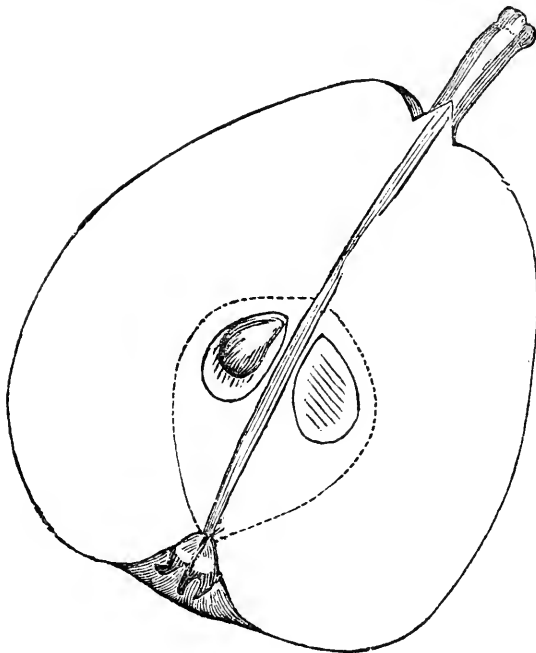

American. Native of Rhode Island. It is very successful wherever grown, admirably adapted to standard orcharding, an upright, strong grower, reddish brown shoots, always productive of fair, even-sized fruit ; not, however, of more than second-rate quality.

Fruit, medium, oblong obovate ; *color*, brownish green, becoming yellow, bright red, suffused in sun ; brown dots and a little russet ; *stem*, half to inch long, slight depression ; *calyx*, with short recurved segments ; *basin*, round ; *core*, rather small ; *seeds*, dark brown ; *flesh*, white, buttery, sweet. September.

DELICES D'HARDENPOINT.

Délices d'Ardenpont, | Délice d'Hardenpont of Angers.

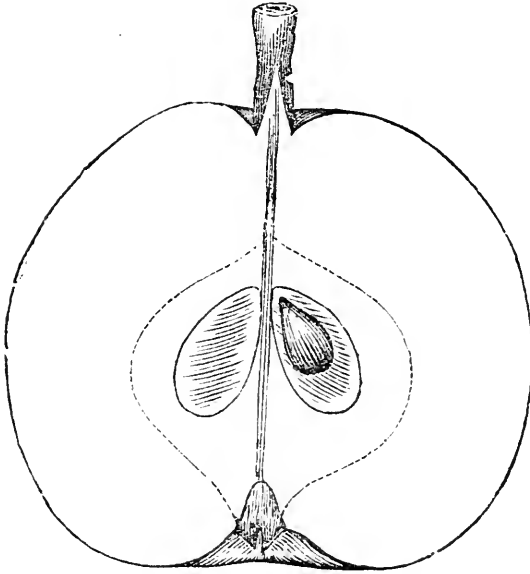

Foreign. Tree, hardy, moderate grower; shoots, upright, yellowish brown, good bearer; deserves more attention.

Fruit, medium, roundish, pale yellow, with many gray dots and russet in sun; *stem*, varying; *calyx*, small, closed; *basin*, round, slightly uneven; *core*, medium; *seeds*, broad, ovate; *flesh*, whitish, buttery, melting, juicy, almost "best." October.

DIX.

American. Origin, Boston, Mass. Tree, hardy, vigorous, young shoots, pale yellow, upright, slender, unproductive while young, well suited to extensive orcharding. *Fruit*, large, oblong pyriform; *skin*, little rough, yellow, with russet dots, and around the stem; *stem*, set obliquely, raised one side, short, stout, thickest at each end; *calyx*, small; *basin*, shallow; *core*, marked with a dark gritty circle, extending toward the stem; *flesh*, yellowish white, melting, a little harsh, juicy, sweet. October and November.

DOYENNE D'ETE.

Summer Virgalieu, | Summer Doyenné,
Duchess de Berry d'Eté of Bivort, | Doyenné de Juliet.

Foreign. Trees, moderately vigorous, dull brownish red wood, early and abundant bearers, unsuccessful on Quince.

Fruit, rather small, roundish obtuse pyriform; *color*, yellowish green, nearly yellow when fully mature, side exposed to sun with a bright marbled red cheek; *stem*, rather long, fleshy at base, inserted without depression; *calyx*, small, closed; *basin*, shallow; *core*, medium; *seeds*, small, dark brown; *flesh*, yellowish white, rather coarse, buttery, juicy, sugary, sprightly. Last of July.

DOYENNE BOUSSOUCK.

Doyenné Boussouck Nouvelle, | Plymouth, | Double Phillip's.
Providence, | Beurre de Mesode, |

Foreign. A variety, we believe, first introduced to this country in 1841, by William Kenrick. Tree, vigorous; wood, reddish brown, sprinkled with large round grayish specks; a good and regular bearer; a little variable in quality.

Fruit, large, globular, obtuse obovate pyriform; *color*, yellow, with tracings of russet, and large russet specks; *stem*, short, stout, fleshy at base; *cavity*, shallow; *calyx*, medium, open; *core*, medium; *seeds*, small, almost black, abortive; *flesh*, yellowish white, rather coarse, melting, juicy, vinous, sweet perfume. October.

DOYENNE GRIS D'HIVER NOUVEAU.

Doyenné Marbre,		St. Michael d'Hiver,
Doyenné d'Alençon,		Doyenné d'Hiver d'Alençon.

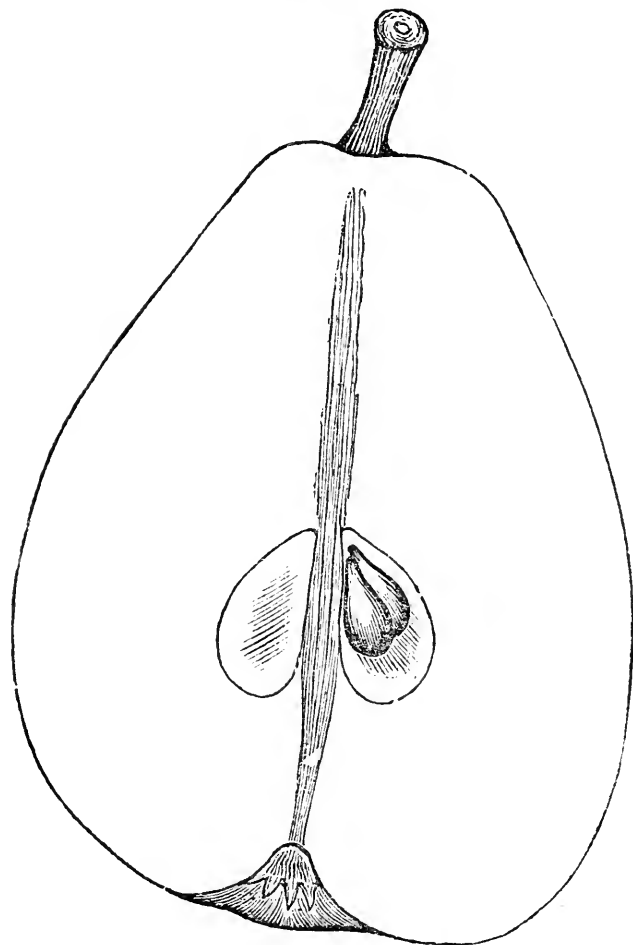

Foreign. Proves valuable on the Quince

Fruit, medium or above, obovate, obtuse pyriform, slightly angular, or one side longest; *color*, pale dull yellow, with many small brown russet specks; *stem*, short, stout; *calyx*, medium; *basin*, irregular, abrupt; *core*, medium; *seeds*, dark brown, long, pointed; *flesh*, whitish, rather coarse-grained, melting, juicy, vinous, a little astringent unless well ripened January to May.

DOYENNE GRAY.

Gray Butter Pear,		Doyenné d'Automne,		St. Michel Doré,
Gray Doyenné,		Gray Dean's,		Doyenné Galeux.
Doyenné Rouge,		Doyenné Gris,		
Doyenné Roux,		Red Doyenné,		

This has been confounded with "Boussouck," and with "Surpassé Virgalieu," but is distinct. It is a good bearer on Pear or Quince, a hardy tree, with upright, grayish brown shoots.

Fruit, medium, roundish, obovate or obtuse pyriform; *skin*, covered with smooth cinnamon russet; *stem*, curved; *cavity*, rather deep; *calyx*, small, closed; *basin*, shallow; *flesh*, white, fine-grained, buttery, melting. Oct

DEARBORN'S SEEDLING.

Done's, | Wheeler's New St. Michael.

Raised by General H. A. S. Dearborn, about 1819, at Roxbury, Mass. Tree, vigorous, erect, yet spreading; requires little pruning; productive on the pear root; quality variable.

Fruit, rather small, roundish, inclining to obovate, narrowing a little to the stem; *color*, pale yellow, little russet at base of stem, and surface dotted with small russet dots; *calyx*, with short thick segments; *stem*, long, slender, curved; *core*, medium; *seeds*, dark brown, long, pointed; *flesh*, yellowish white, fine-grained, melting, juicy, sweet, delicately perfumed. August.

DOYENNE WHITE.

White Dean
Virgalieu,
Butter Pear,
St. Michael,
Virgaloo,
Bergaloo,
Yellow Butter,

White Beurré,
White Autumn Beurré
Regnier,
Dean's,
Warwick Bergamotte,
Snow Pear,
Pine Pear,

St. Michael,
Doyenne,
Doyenné Blanc,
Beurré Blanc,
Reigner,
And twelve others of
French and Dutch.

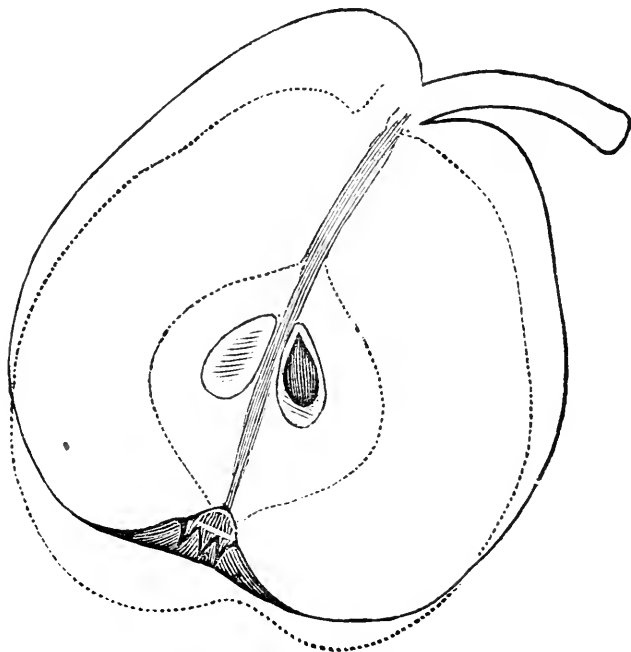

An old variety, everywhere esteemed when well grown. Trees, hardy, productive either on Pear on Quince.

Fruit, medium, obovate pyriform; *color*, clear pale yellow, regularly sprinkled with small dots, often a fine red cheek; *stem*, medium, brownish; *cavity*, small, round; *calyx*, small, closed; *basin*, shallow, slightly plaited; *flesh*, white, fine-grained, melting, juicy, buttery, delicious. September to November.

The DOYENNE PANACHEE is a sub-variety, differing from this in its more pyriform shape, and its color being yellow, green and red striped. It is juicy not high flavored. October.

FLEMISH BEAUTY.

Belle de Flanders,
Bosche Nouvelle,
Bosch,

Fondante du Bois, *erroneously*,
Bosc Sire,
Imperatrice de France,

Beaurré Spence, *of some*.
Poire Davy.

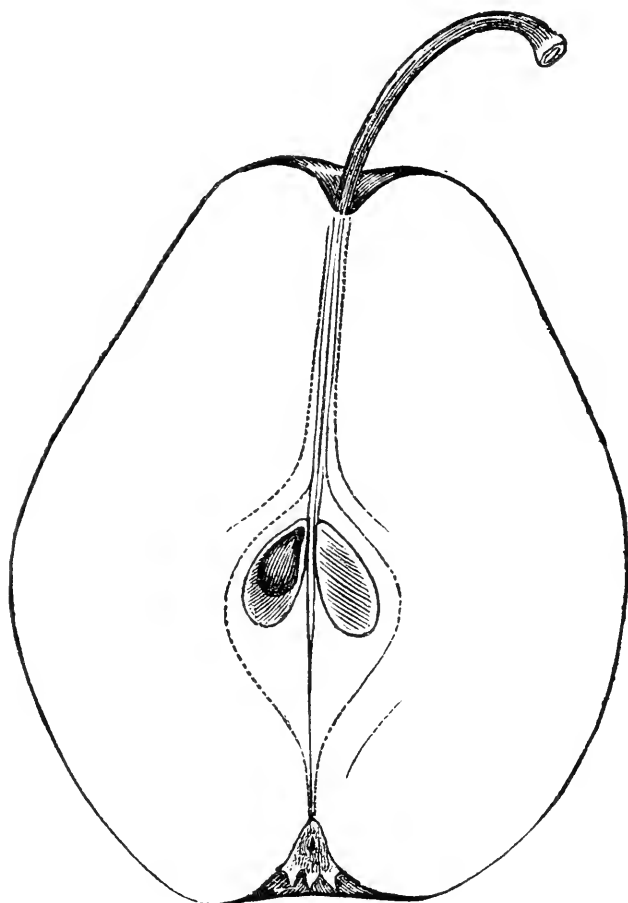

Foreign. This variety is deserving of far more general cultivation than it has yet received. It succeeds most admirably on the Quince, and on the rich soils of Illinois, we have seen it far surpass even the most highly nursed specimens of Boston amateur gardens. The tree is vigorous, with upright, dark brown shoots.

Fruit, large, oblong obtuse obovate; *color*, pale yellow, mostly covered with marblings and patches of light russet, and in sun, rich reddish brown: *stem*, one to one and a half inch long; *cavity*, narrow, deep; *calyx*, short, open; *basin*, round, small; *core*, medium, with oblong capsules; *seeds*, oblong pyriform; *flesh*, yellowish white, not very fine-grained, juicy, melting, sugary. Last of September. Does not keep long.

FULTON.

American. Native of Maine. Tree, very hardy, yearly and abundant bearer, well suited for standard orcharding at the West; young shoots, slender, reddish brown.

Fruit, small, obovate; *color*, at first gray russet, becoming dark cinnamon russet; *calyx*, open, segments nearly erect; *basin*, round, regular; *stem*, one to two inches long; *cavity*, narrow; *core*, encircled by a coarse line, but of itself small, compact; *seeds*, blackish; *flesh*, half buttery, moderately juicy, sprightly. October, November.

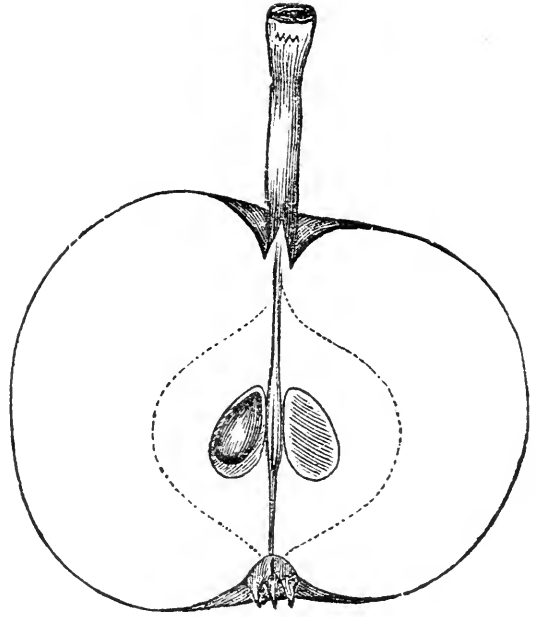

GOLDEN BEURRE OF BILBOA.

Hooper's Bilboa.

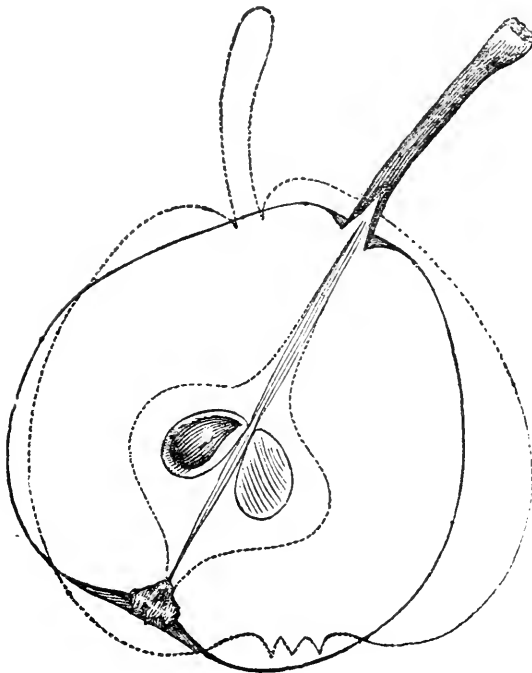

Foreign. From Spain. Tree, hardy, requires rich, strong, heavy soil, when it is an abundant bearer of fair, regular, medium-sized fruit of second-rate quality.

Fruit, medium, obovate; *color*, rich yellow, with russet around the stem, and many russet dots and patches over the entire surface; *stem*, slender; *cavity*, slight; *calyx*, small, mostly open, short stiff segments; *basin*, shallow; *flesh*, fine-grained, melting, juicy, sometimes a little acid and harsh. September.

GLOUT MORCEAU.

Goulu Morceau,
Gloux Morceau,
Beurré d'Hardenpont,
Hardenpont d'Hiver,

Colmar d'Hiver,
Beurré d'Hiver Nouvelles,
Linden d'Automne,

Roi de Wurtemberg,
And five more of German.
Beurré d'Areberg, *of the French.*

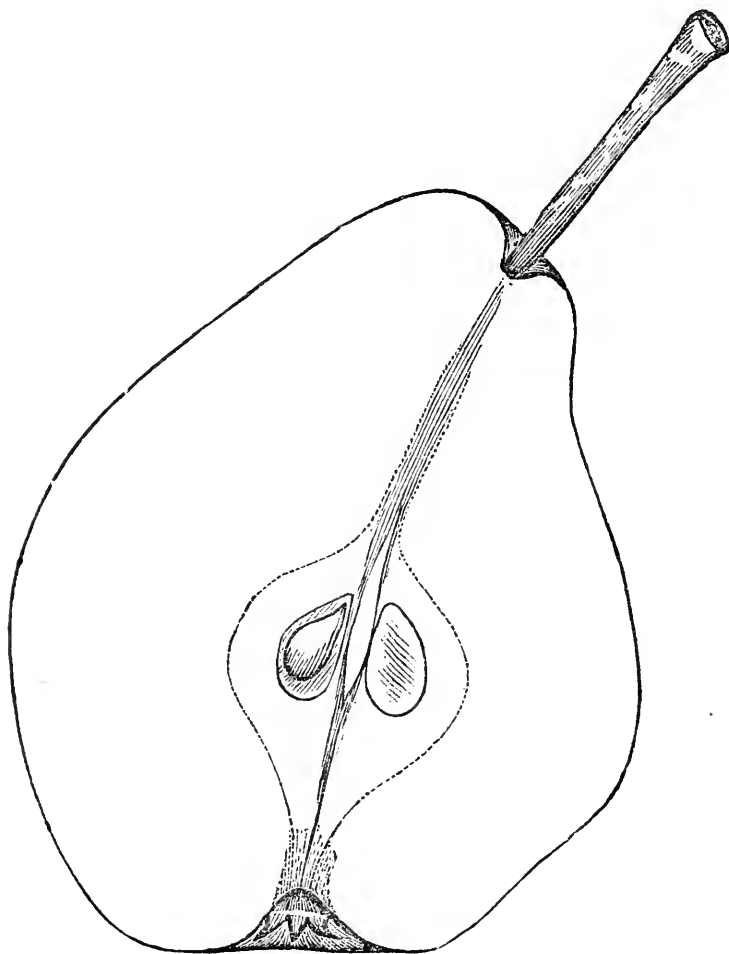

This variety is regarded as among the most delicious of Flemish pears. The rendering of its name to sugared or honeyed pear is only expressive of its quality, and equally so of many more; and as this cannot claim the title par excellence, we see not but it must retain its original, and those who grow it must speak the name as best they may.

It is an unproductive variety while young, either on Pear or Quince; trees on the latter stock even requiring ten years to bring them well into bearing; once at maturity, it is an abundant bearer. It is a beautiful grower, making a perfect pyramidal head with little pruning. It is also easily distinguished by its dark olive-green or blue-green wood and its wavy leaves.

Fruit, large, obovate obtuse pyriform, often angular, and surface rough;

color, pale greenish yellow, russeted around the stem, and traces of russet and greenish gray russet specks over the whole surface; *stem*, one to one and a half inch long, often without cavity, but flesh raised one side; *calyx*, medium, segments half reflexed; *basin*, rather deep, often furrowed or uneven, like the general surface of the fruit, which is frequently apparently scalloped; *core*, large; *seeds*, large, ovate, pointed; *flesh*, white, fine-grained, buttery, juicy, sugary, perfumed. December to February.

HOWELL.

American. Native of New Haven, Conn., recently introduced to notice. *Fruit*, large, obovate pyriform, pale yellow, small russet dots, faint red blush in sun; *stem*, often curved, without depression; *calyx*, open; *basin*, irregular; *flesh*, melting, juicy, slightly acidulous, delicate aroma. October.

JALOUSIE DE FONTENAY VENDEE.

Foreign. We have never fruited a pear that has given us more satisfaction. On the Quince it is a fine grower, and inclined to over-bear. It must not be confounded with the "Jalousie," a third-rate variety. Young shoots upright; brownish yellow.

Fruit, medium or above, ovate pyriform; *color*, dull yellow, with brownish red cheek, and patches and dots of russet, often the russet covering one half the surface; *stem*, varying, often obliquely set on, with a fleshy ridge at side; *calyx*, with segments, long, half open; *basin*, shallow; *core*, medium or small; *seeds*, long, ovate; *flesh*, white, buttery, melting, juicy, sweet, aromatic. Last September, early October.

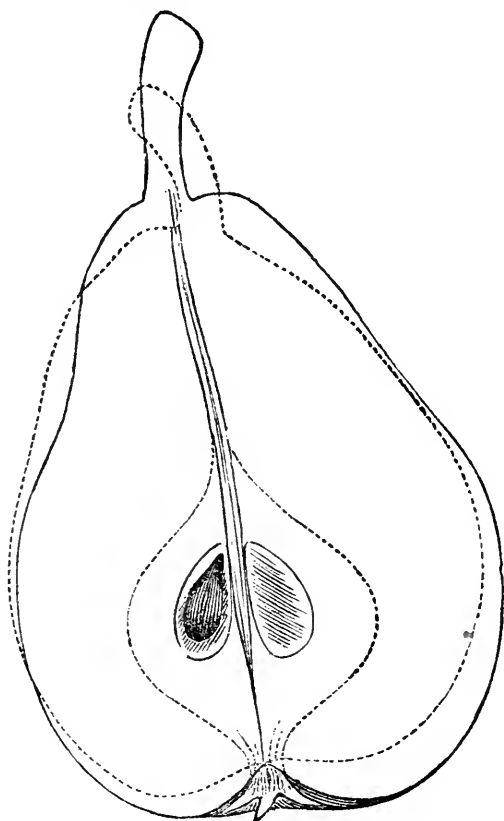

LAWRENCE.

Native of Flushing, L. I. An abundant bearer on pear roots, exceedingly desirable for Western orcharding. Tree, hardy, moderate growth; wood, light yellowish brown, rather thorny. S. B. Parsons says, "Succeeds very finely on Quince."

Fruit, above medium, long, obovate, obtuse at stem; *color*, pale red yellow.

low, marbled with dull green, small dark specks, and russet at each end; *calyx*, large, closed; *basin*, open, furrowed; *stem*, medium length, stout, swollen at junction with tree; *cavity*, round, deep; *core*, medium; *seeds*, small, dark brown; *flesh*, yellowish white, juicy, gritty at core, slightly sugary. November to February.

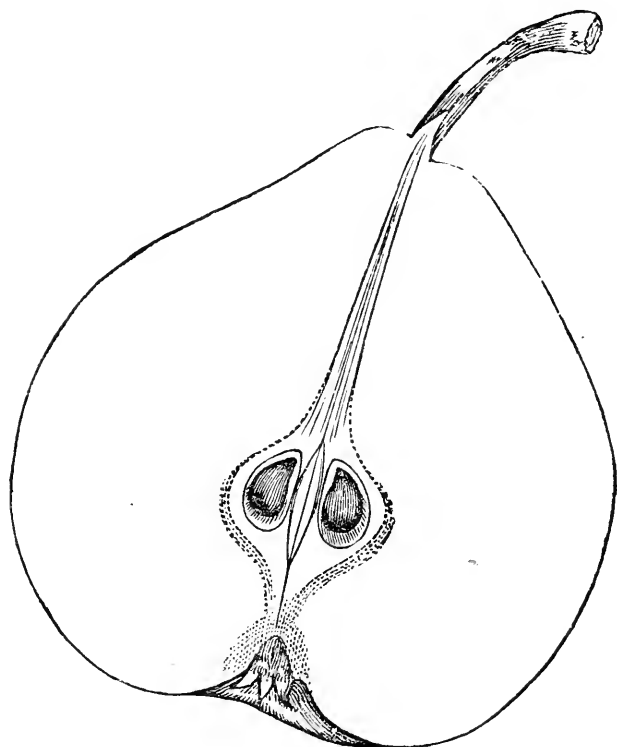

KIRTLAND.

Seedling Seckel,
Kirtland's Seedling,
Kirtland's Beurre.

Grown from seeds of the Seckel pear, by H. T. Kirtland, of Mahoning Co., Ohio. Tree, vigorous, hardy, early and very productive bearer on the pear root; shoots, yellowish brown, upright, stout; succeeds well on Quince.

Fruit, medium, often above obovate, obtuse pyriform; *color*, rich yellow, overspread with cinnamon russet; *stem*, usually stout, medium length, curved; *calyx*, short, reflexed, persistent;

basin, shallow; *core*, small; *seeds*, short, ovate, blackish; *flesh*, white, melting, juicy, sweet, aromatic. September.

LONG GREEN, of COXE.

Verte Longue de la Mayenne?
Verte Longue,

Mouth Water,
New Autumn,

Muscet Fleure,
Mouille Bouche.

This is an old foreign variety, always excellent, and an abundant bearer.

Fruit, medium, oblong, ovate pyriform; *color*, green with dark green specks; *stem*, medium length, slender; *calyx*, with long reflexed segments; *basin*, very shallow; *core*, above medium; *seeds*, dark brown; *flesh*, yellowish white, melting, juicy, delicious. October.

The *Striped Long Green*, *Verte Longue Panachée*, resembles the above, but is smaller, and of no great value, aside from its prettily striped appearance.

LEWIS.

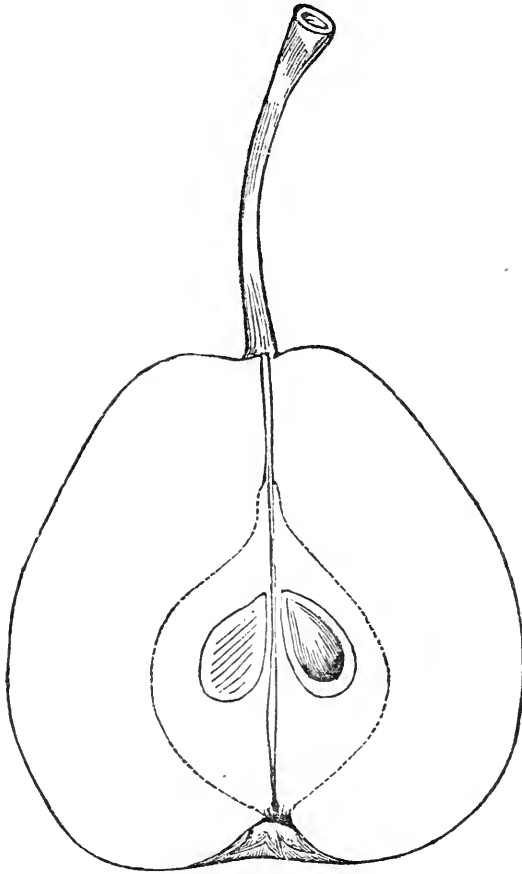

Native of Roxbury, Mass. It is a hardy tree, vigorous, spreading, rather drooping as it grows old, always bears, and fruit always regular and even in size. If well ripened, it is a fine, delicious fruit, otherwise not more than second quality. It is profitable as a standard orchard variety, but requires rich deep soil, or its immense crops exhaust too rapidly, causing the fruit to be quite small and insipid. *Fruit*, below medium, roundish obovate, obtuse at stem; *color*, dark, becoming pale green with many russet specks; *stem*, long, slender, shallow depression; *calyx*, large; *segments*, broad, in divisions; *basin*, almost obscure; *core*, above medium for size of fruit; *seeds*, large, ovate; *flesh*, yellowish white, rather coarse, melting, juicy. November to February.

ELIZABETH. (Manning's.)

Elizabeth Van Mons, | Van Mons No. 154.

Foreign. Received under number, and named by the elder Manning; young wood, reddish brown. *Fruit*, small, obovate rounded, lemon yellow; red in sun, slight traces of russet; *calyx*, small, open; *core*, large; *flesh*, yellowish white, melting, sugary, juicy; "very good." Last August.

LODGE.

Bordenave, | Smith's Bordenave.

American. From vicinity of Philadelphia. Requires rich, warm, sandy soil, when it is one of the best; on cold clay it is hardly "very good." *Fruit*, medium, or above, sometimes large, varying in form, (see our engraving); when fully mature, yellowish, with rich golden russet, and

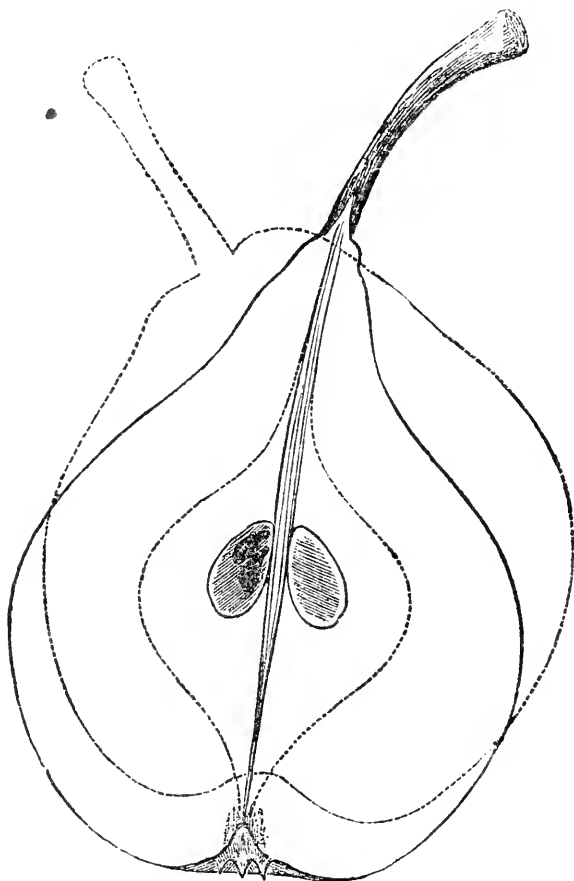

patches of dull russet; *calyx*, with short, half reflexed segments; *core*, medium; *seeds*, blackish; *flesh*, whitish, a little gritty at core, juicy, melting, "very good." September and October.

MADELEINE.

Citron des Carmes, | Magdalen.

Foreign. Tree, very vigorous, strong grower, a little liable to frozen sap-blight on the rich Western soils, until it has acquired the age of ten or more years; very productive on pear or quince root.

Fruit, below medium, obovate, oblong pyriform; *stem*, long, slender, at base one side of fruit a little enlarged; *color*, pale yellowish green, a little brownish blush, and russet specks on those exposed most to sun; *calyx*,

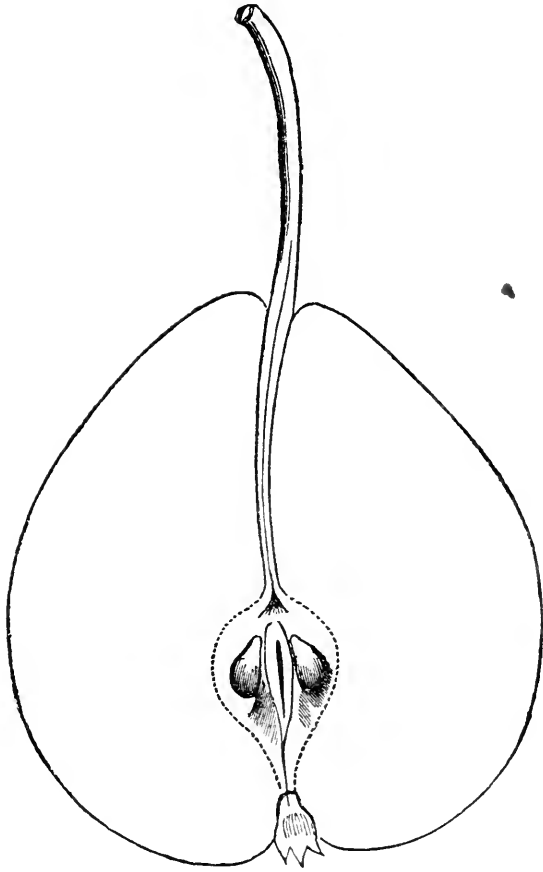

with long, persistent, irregularly placed segments; *basin*, obscure, slightly plaited; *core*, small; *seeds*, ovate; *flesh*, white, juicy, melting, sweet, slightly perfumed. Fifteenth to last July.

The *Striped Madeleine Citron des Carmes Panachée*, differs from the former in being striped with light yellow, flesh more sweet and less juicy. It is not as vigorous in growth, the wood shorter jointed, striped red and yellow, and said to be less liable to blight.

NOUVEAU POITEAU.

New Pear.

Foreign. Tree, upright, vigorous, an early bearer, and thus far successful on both pear and quince stock.

Fruit, above medium, obovate, obtuse pyriform, contracted or one-sided at neck; *color*, pale green, with many dark green dots, and a few russet stripes or blotches; *stem*, about one inch long, medium size, set on and not into the fruit; *calyx*, medium, with broad segments half reflexed; *basin*, irregularly contracted; *core*, medium, capsules long, ovate; *seeds*, obovate pyriform; *flesh*, white, fine grained, juicy, melting, rich aroma. November.

LOUISE BONNE DE JERSEY.

Louise Bonne d'Avranches,
Beurré or Bonne Louise d'Arandore,
William the Fourth.

The "Good Louise of Jersey," from the Isle of Jersey, proves one of the best pears grown on the quince stock in this country. Tree, hardy, very productive, shoots vigorous, upright.

Fruit, large, (our drawings were made ere the fruit had swollen its full size, and are not more than half size,) oblong pyriform; *skin*, glossy, smooth, green in shade, brownish red in sun, dotted with gray dots; *stem*, about one inch long, moderately stout, a little curved, fleshy enlargement at base; *calyx*, open, segments large, reflexed; *basin*, shallow; *core*, small; *seeds*, long, ovate pointed; *flesh*, white, juicy, melting, delicious. October.

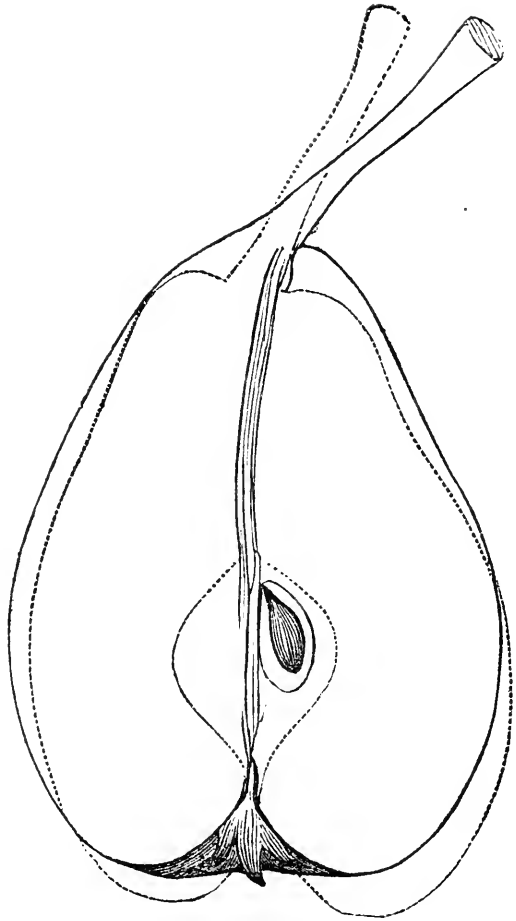

PARADISE D'AUTOMNE.

Calebasse Bosc.

Foreign. This is esteemed by many pomologists as superior even to the Beurré Bosc, which it much resembles. Tree, of very vigorous growth, shoots at first upright, afterwards straggling and pendulous; wood, reddish brown, with large whitish gray specks, very productive. *Fruit*, large, obovate acute pyriform, irregular and uneven surface; *color*, dull yellow, covered with bright russet, deepening on the sunny side; *calyx*, rather large, open; *segments*, reflexed; *basin*, furrowed; *stem*, about one and a half inch long, rather slender, obliquely attached to the fruit by a fleshy, and often times wrinkled base; *core*, small; *seeds*, long, pointed; *flesh*, yellowish white, rather coarse, buttery, melting, juicy, delicious. September and October.

POUND.

Duchess De'Berré, of some,
Winter Bell,
Bretagne le Cour,
Uvedale's St. Germain,
Uvedale's Warden,

Germain Baker,
Lent St. Germain,
Pickering Pear,
Du Tonneau,
Belle de Jersey,

Piper,
Union,
Chamber's Large,
Belle Angevine.

Foreign. Tree, strong, vigorous grower; very productive, very valuable for cooking, and profitable orchard sort.

Fruit, very large, oblong pyriform, yellowish green, with dull brown and brown russet patches; *stem*, long, stout, curved; *cavity*, deep oblique angular; *calyx*, large; *flesh*, white, firm, astringent. December to March

OTT.

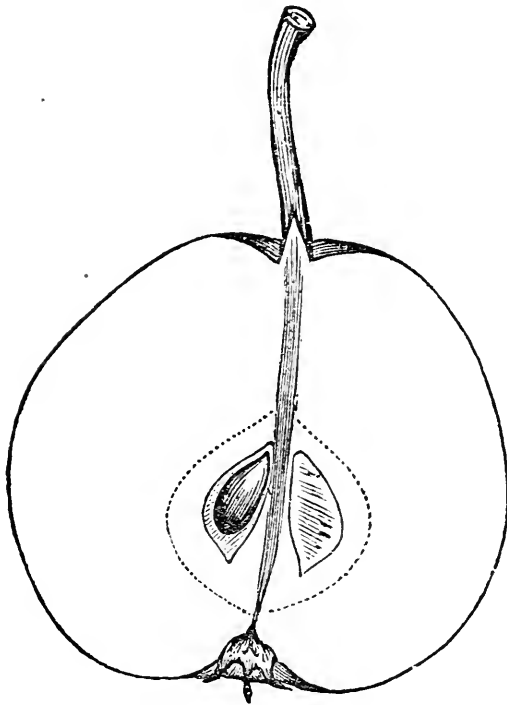

American. Native of Montgomery Co., Pa. This is by many Eastern pomologists classed as "best;" specimens we have had, have not merited more than to be classed "very good." *Fruit*, small, roundish, greenish yellow, with little russet, and rarely faint red cheek in sun; *stem*, medium, a little curved; *calyx*, rather large, open, reflexed; *core*, below medium; *seeds*, blackish; *flesh*, yellowish, melting, juicy, slightly aromatic. August. We believe this pear will prove valuable as a standard orchard sort at the Southwest.

ROSTIEZER.

Foreign. Tree, strong, upright grower, large foliage, dark olive-colored wood; an early, free, abundant bearer; succeeds on Quince.

Fruit, below medium, obovate pyriform; *color*, dull green, reddish brown cheek in sun; whitish specks, and traces of thin russet; *stem*, long, slender, without depression; *calyx*, medium, open; *basin*, very shallow; *core*, small; *seeds*, ovate pointed; *flesh*, juicy, melting, sweet, perfumed. Last of August.

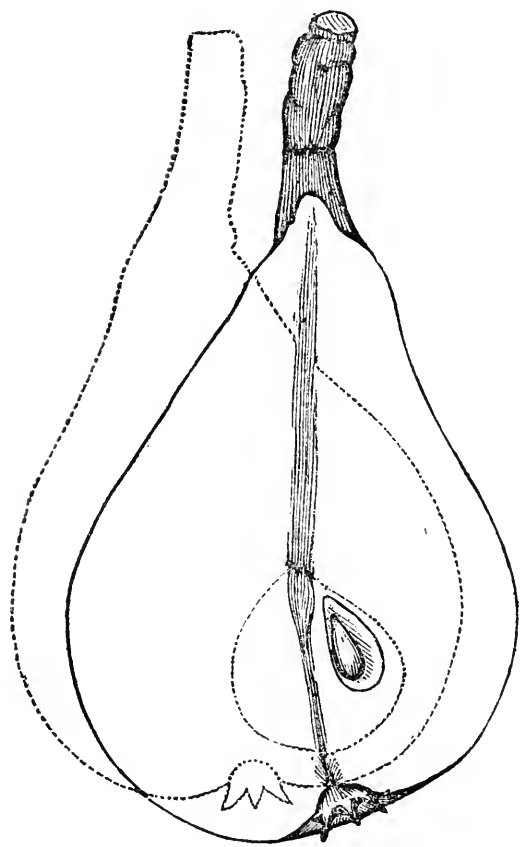

PAYENCY.

Paquency,
Poire de Payency.
Poire de Périgord,
Payenchi,
Payenchi de Périgord.

Foreign. Tree of vigorous growth, early bearer, and especially profitable on the Quince.

Fruit, medium, pyriform, extending into the stem, which is stout, uneven, dark brown; *color*, at first dull pale green, becoming brownish yellow at maturity, many russet dots and patches round stem and calyx, few in centre, occasionally a tinge of dull red in sun; *calyx*, open, segments half erect; *basin*, very shallow; *core*, small; *seeds*, oblong pointed, dark brown; *flesh*, white, rather coarse, melting, juicy, sugary, vinous. October.

SHELDON.

Penfield, | Wayne.

American. Native of western Central New York. Tree, vigorous, erect, hardy, good bearer on pear, young shoots short-jointed, light yellowish. *Fruit*, medium or above, roundish, a little angular, sometimes obovate, pale greenish russet, light red or bronzed in sun, little specked with dark russet; *stem*, short, rather stout, slightly curved; *calyx*, medium, open, broad short segments; *core*, rather large; *seeds*, dark brown; *flesh*, a little coarse, and gritty, at core, otherwise melting, juicy, sugary, sprightly, aromatic; nearly "best." October.

SECKEL.

Seckel, | New York Red Cheek, | Sycle.
Sickle, | Red-checked Seckel, |

The original tree of this variety, according to Dr. Brinckle, stands in Passyunk township, on the Delaware river, about three and a half miles from Philadelphia. No one variety has become so generally known in this country as the Seckel, and in our Southern and Middle States, no one

variety deserves so extended culture. North, it should, when possible, be planted in warm, rich, sandy loam, and sheltered situations. The tree is of slow growth; wood, short-jointed, stout, forming a round head, and of only medium size on the pear stock, and well suited to garden planting.

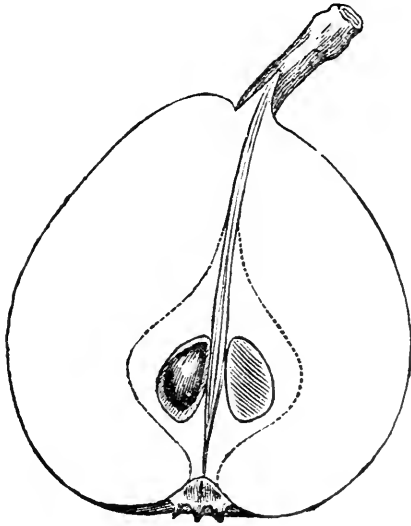

Fruit, small, (our drawing too small for a fair average), rounded, obtuse pyriform; *color*, brownish green at first, becoming yellowish brown, with a lively red russet cheek; *stem*, short, slightly curved, set in a very slight depression; *calyx*, small, open; *basin*, shallow; *core*, small; *seeds*, broad, ovate; *flesh*, yellowish white, juicy, buttery, spicy, aromatic, sweet. September and October.

PRINCE'S ST. GERMAIN.

New St. Germain, | Brown St. Germain.

Raised from the seed of the old St. Germain, nearly fifty years since, at the Prince Nurseries, Flushing, L. I. Tree, hardy, thrifty, very productive; the fruit keeps well, and requires no more care to ripen than apples; shoots, reddish brown.

Fruit, medium, oblong obovate pyriform; *color*, green and pale yellow marbled, and covered nearly with brownish russet specks; *stem*, long, slender, (our drawing shows only a portion of it); *cavity*, slight, narrow; *calyx*, with broad segments without divisions; *basin*, regular, even, not deep; *core*, small; *seeds*, oblong ovate; *flesh*, white, juicy, melting, sweet, vinous. December to March.

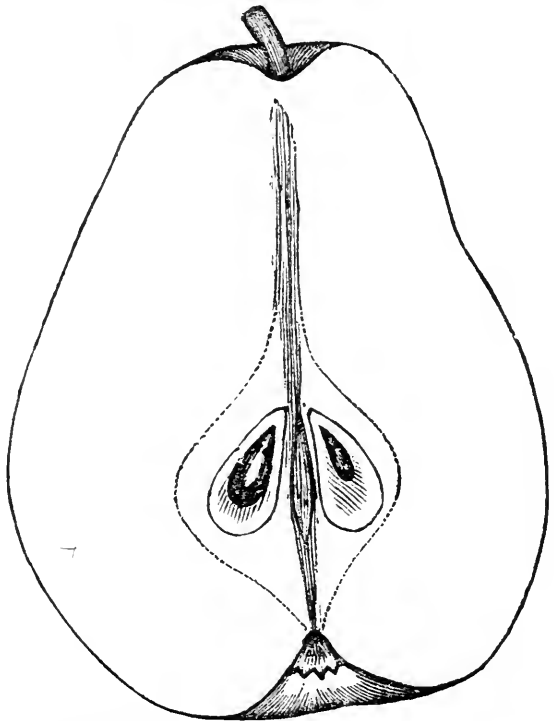

SOLDAT LABOUREUR D'ESPERIN.

Auguste Van Krans, | Beurré de Rhine.

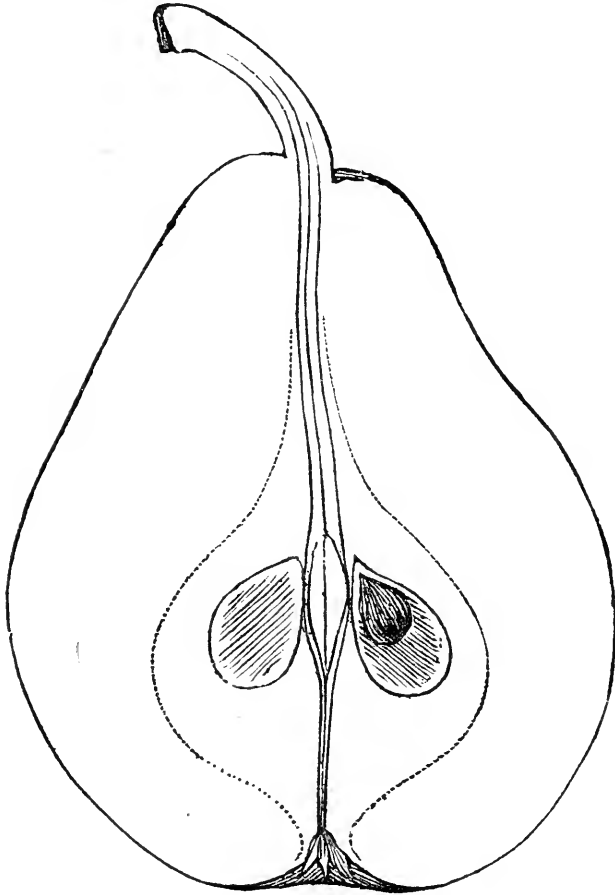

This variety is usually grown in this country under the name of Soldat Laboureur. It is entirely distinct from the "Soldat Laboureur" of the French, which is regarded as our Beurré d'Arenberg. It was grown by Major Esperin, of Malines; is of strong, vigorous, upright growth, yellowish brown wood, succeeding finely on the Quince, producing abundantly, and its fruit well disseminated over the tree, always large and fair, but of only second-rate quality.

Fruit, large, generally oblong obovate pyriform, sometimes obovate pyriform; *color*, greenish yellow, becoming yellow, with many patches, stripes and dots of russet; *stem*, short, stout, curved, in a slight round depression, or rather a raised lip one side; *calyx*, open, sometimes round, regular, and without divisions, others have stout persistent segments in divisions; *core*, compact, with outer concentric lines; *seeds*, obovate; *flesh*, rather coarse, juicy, melting, perfumed; "very good." December to February.

ST. ANDRE.

Poire St. Andre.

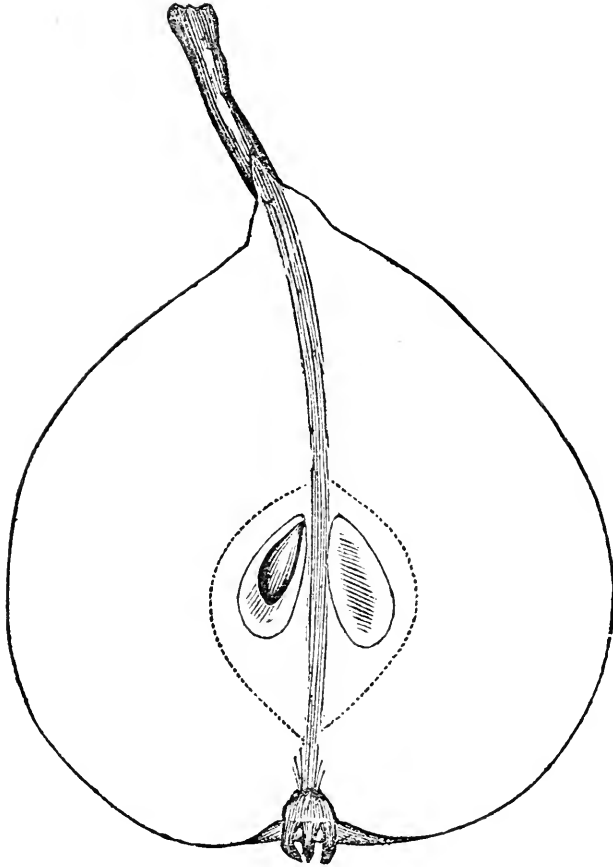

Foreign. Tree, vigorous, healthy grower, early bearer. *Fruit*, above medium, globular acute pyriform, sometimes obovate pyriform; *color*, yellowish green, with dark green specks, rarely a brownish red cheek in sun; *stem*, medium, swollen or fleshy where it joins the fruit; *calyx*, medium, open, segments varying; *basin*, very shallow, sometimes slightly furrowed; *core*, small, compact; *seeds*, oblong pointed, light brown; *flesh*, greenish white, fine-grained, buttery, juicy, sprightly, vinous, perfumed. September.

SKINLESS.

Sanspeau, | Poire Sans Peau, | Fleur de Guignes.

Foreign. An old variety, that on rich, deep, strong, clayey soils is productive, and often "best." *Fruit*, small, oblong pyriform, pale greenish yellow, light red specks in sun; *stem*, long, slender; *calyx*, closed; *flesh*, white, juicy. Early August.

STEVENS' GENESEE.

Louise de Prusse,

| Guernsey,

| Stephens' Genesee.

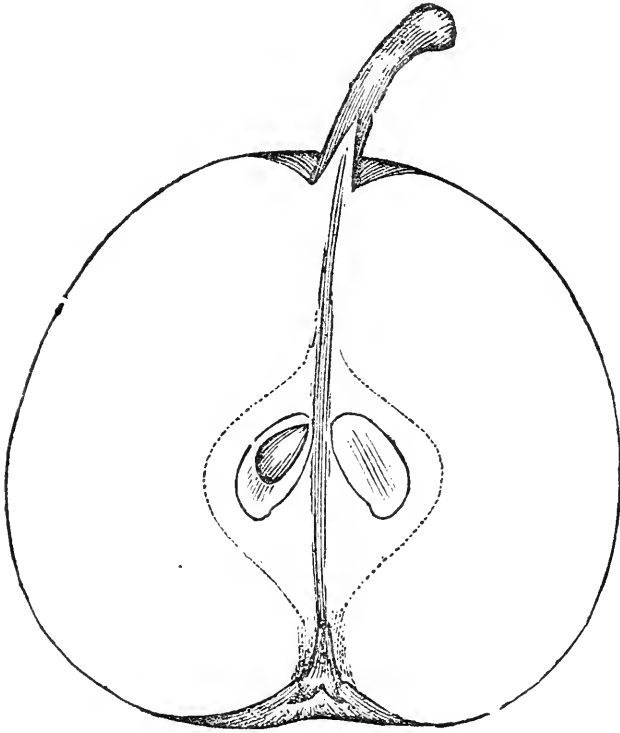

Native of Rochester, N. Y. It is one of the most desirable of pears for all collections, either on Pear or Quince; a fine grower, with diverging, dark gray shoots; productive.

Fruit, large, roundish obovate; *color*, greenish yellow, becoming yellow; *stem*, rather stout; *cavity*, narrow; *calyx* with short, stiff, connected segments, half reflexed; *basin*, medium, regular; *core*, medium; *seeds*, ovate pyriform, blackish; *flesh*, white, half buttery, juicy, sweet, aromatic. September. Even windfalls of this variety are extremely fine.

TYSON.

This fine variety was found in a hedge near Jenkintown, Pa., about 1792-4. The tree is of vigorous, upright growth, with reddish brown wood; a moderate, regular bearer.

Fruit, rather below medium, roundish pyriform, irregular; *color*, dull yellow, shaded with red in sun, little russeted, and with numerous black specks; *stem*, rather long, moderately stout, curved, and obliquely attached to the fruit by a fleshy junction, swollen on one side; *calyx*, open, with short segments; *basin*, round, shallow; *core* and *seeds*, small; *flesh*, white, fine-grained, melting, juicy, sugary, aromatic. Thus far succeeds on Quince. August.

SURPASSE VIRGALIEU.

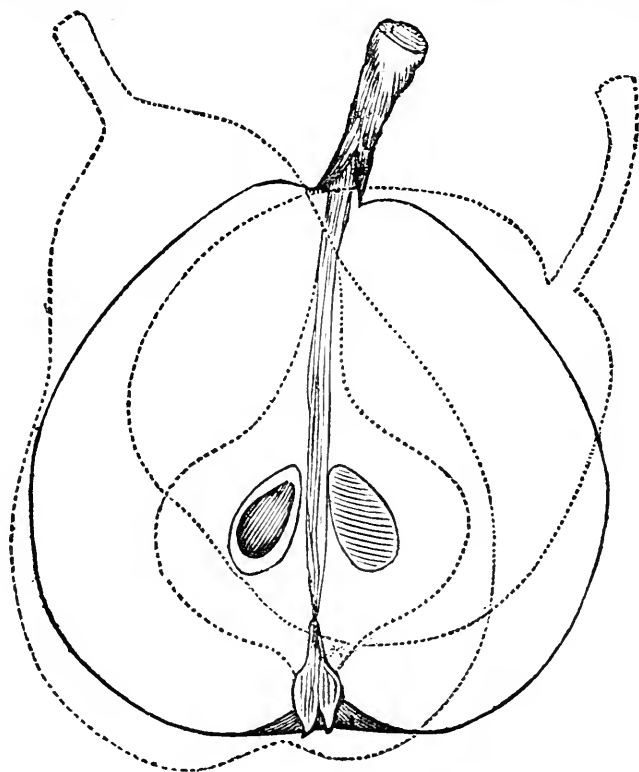
Beurre Van Mons, | Surpasse Vigilouse, | Colmar Van Mons, *of some*.

Origin uncertain, probably an American seedling, first disseminated by the late Andrew Parmentier, Brooklyn, N. Y. It is a regular abundant bearer on Pear or Quince, a vigorous, healthy tree, with yellowish brown wood, upright growth.

Fruit, medium, varying in form; (see our drawings, the specimens from which they were made all being pulled by ourself from the same branch;) *color*, yellowish, with brownish red in sun, minute dots, and often sprinklings of russet; *calyx*, generally small, erect, open; *basin*, slight; *stem*, varying; *core*, medium; *seeds*, broad, ovate; *flesh*, white, fine-grained, juicy, aromatic. October.

URBANISTE.

St. Marc, | Louise of Orleans, | Beurré Picquery.

Foreign. Moderately vigorous, healthy, hardy, well suited to rich soils West; young shoots, upright, short-jointed, grayish yellow; not an early bearer, but when in bearing produces regularly and abundant. Fine grower and bearer on Quince.

Fruit, medium, obovate pyriform; *color*, pale yellow, with gray dots, and a few russet streaks; *stem*, about an inch long, rather stout; *cavity*, shallow; *calyx*, small, generally closed; *basin*, narrow, abrupt; *core*, medium or small; *seeds*, obovate pointed; *flesh*, white, yellowish, buttery, melting, vinous. October and November.

THOMPSON'S.

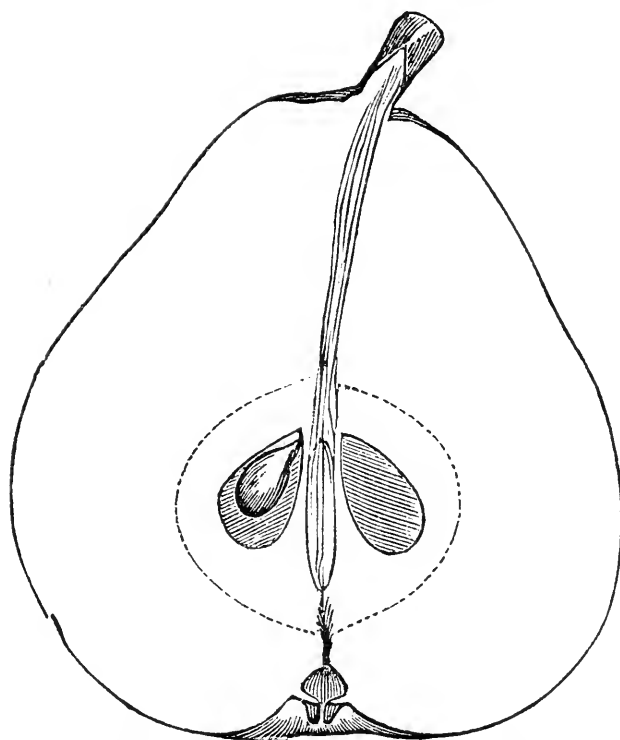

Foreign. Tree of vigorous, diverging habit; young wood, yellowish olive, with grayish specks; bears on the Pear about the sixth year.

Fruit, large, obovate obtuse pyriform, surface uneven; *color*, lemon yellow, with brownish red cheek in sun, some russet dots and marblings, and russet at the stem; *stem*, short, usually planted or set on angularly, with a fleshy rim one side; *calyx*, with connected half-closed segments, *basin*, round, narrow, abrupt; *core*, medium; *capsules* and *seeds*, formed like

the fruit; *flesh*, white, buttery, melting, sugary, slightly aromatic. October to November.

VAN ASSENE.

Van Assche, | Vanassé, | Van Asshe.

This is a new pear, first fruited at the West, in the grounds of A. H. Ernst, Cincinnati, who has disseminated it freely, and thus far it has proved "best." Leaves, light yellow green; young wood, yellowish red; tree, a vigorous, erect grower, an abundant and early bearer, succeeding well on the Quince. *Fruit*, medium, obovate obtuse, largest near the eye, flattened at both ends, occasionally slightly ribbed; *calyx*, small; *basin*, smooth, wide, rather shallow, ribbed; *stem*, one and a half inch long, rather slender, slightly sunk; *skin*, smooth and fair, light yellow in the shade, sprinkled with dark dots, light red on the sunny side, sprinkled with carmine dots; *flesh*, white, buttery, melting. September and early October; August at Cincinnati and South.

VICAR OF WINKFIELD.

Vicar of Wakefield, Le Curé,		Monsieur le Curé, Clion.
---------------------------------	--	-----------------------------

Foreign. First found growing wild in a wood by M. Clion, a French curate, hence the names, Clion, Le Curé, &c. ; afterwards it was grown in a garden at Winkfield, Berkshire, by Rev. Dr. Rham, and received the name of Vicar of Winkfield, concentrating the two associations in the one



name, and which, being of our own language, is to be preferred. It is a most profitable variety, grown on the quince stock, and, although only second quality, it is always fair and large. Tree, a vigorous grower, with large, roundish, glossy leaves ; shoots, diverging, dark olive color.

Fruit, large, oblong obovate pyriform ; *color*, dull pale green at first

becoming pale yellow, with sometimes a brownish cheek, marked with brown dots over the whole surface; *calyx*, with open reflexed segments; *stem*, an inch or more long, rather slender, obliquely inserted without depression; *core*, small; *seeds*, oblong ovate; *flesh*, greenish white, juicy, sprightly; 'very good.' November to January.

WINTER NELIS.

Nellis d'Hiver,
Bonne de Malines,

Beurré de Malines,
La Bonne Malinoise,

Milanaise Cuvelier,
Etourneau.

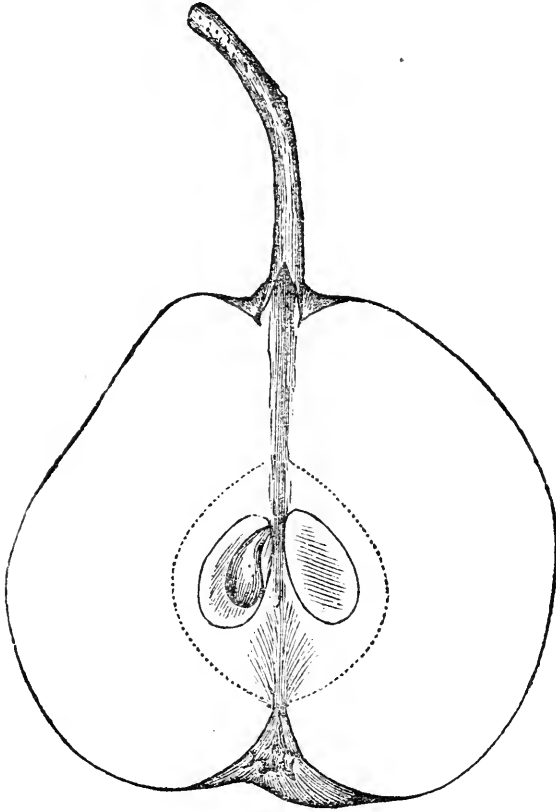

Foreign. As a standard Winter pear, if we were to select but the one, it would be this variety. The tree is vigorous, though with slender diverging shoots; very hardy; an early prolific bearer on Pear or Quince. It requires rich, strong soil to produce good-sized fruit, and is well suited to extensive planting on our Western lands.

Fruit, medium, roundish obovate, narrowing towards the stalk; *color*, yellowish green, much covered and dotted with gray russet; *stem*, rather long, a little curved; *cavity*, narrow; *calyx*, open, with short segments; *basin*, shallow; *core*, medium; *capsules*, ovate; *seeds*, oblong pyriform, curved; *flesh*, yellowish white, buttery, melting, sugary, aromatic. November to middle January.

WASHINGTON.

Robertson.

American : native of Delaware. Tree of healthy, moderate growth, with slender, diverging, reddish brown shoots : an annual bearer.

Fruit, medium, roundish ovate, or ovate pyriform ; *color*, lemon yellow, tinged in sun with red and reddish russet, and, near the stem, patches of clear russet ; *stem*, an inch long, inserted in a narrow cavity, sometimes almost obsolete, and then there is a fleshy lip one side of stem ; *calyx*, small, long pointed segments ; *basin*, round, regular ; *core*, rather small, lying near the apex ; *seeds*, obovate pyriform, blackish ; *flesh*, white, juicy, sweet. September.

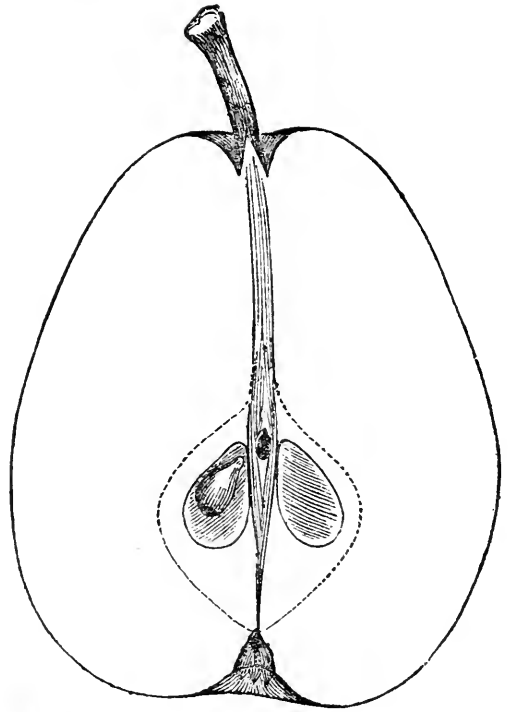

ZOAR BEAUTY.

Zoar Seedling.

American : native of Ohio Tree, vigorous grower ; dark brown shoots : early and abundant bearer.

Fruit, a little below medium, varying in form, usually as seen in our engraving ; *color*, light yellow, with greenish spots, red in the sun, with deep red spots ; *stem*, generally long, slender, curved, plaited, with slight depression one side ; *calyx*, large, for size of fruit ; *basin*, shallow ; *core*, medium ; *seeds*, obovate, or broad ovate ; *flesh*, yellowish white, a little coarse, juicy, sweet. Early August.

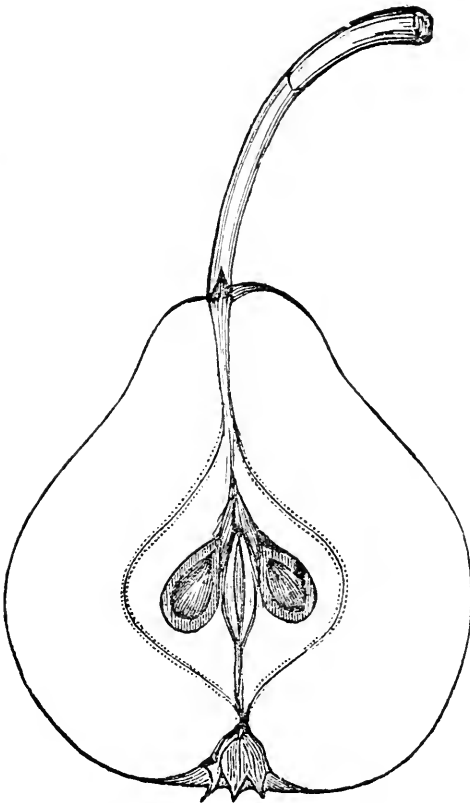

CLASS II. *Embraces varieties many of which are new and untested, and others suited only to certain localities.*

ABBE EDOUARD.

Foreign. Tree, a beautiful pyramid, very vigorous on Pear and Quince. Fruit, medium, turbinate; skin, bright green, becoming bright yellow at maturity; flesh, white, half fine, melting, half buttery, juice abundant, sugary, and agreeably perfumed, resembles Janimett. November.

ABBE MONGEIN.

Foreign. Fruit, of first quality, immensely large, weighing forty-two ounces, recommended by M. Tourres as a delicious fruit. Ripe March and April. (Hor. Mag.)

ABBOT.

From Providence, R. I. Wood, slender, dark reddish, productive. Fruit, medium, oblong obovate, dark green, reddish brown cheek; calyx, small; flesh, melting, sugary, sprightly; core, large. Middle to last September.

ADAMS.

American. Wood, short-jointed, moderate healthy grower. Fruit, medium, obtuse ovate pyriform; deep yellow, tinged with pale red in sun, dotted with russet specks; stem, short, wrinkled, fleshy, obliquely inserted; calyx, small, closed; short segments; flesh, white, melting, juicy, vinous, perfumed; core small; seeds, medium. September and October. New. Originated in Waltham, Mass. First fruited in 1847.

ADELE DE ST. DENIS.

Baronne de Mello, | Poire His.

Foreign. Grows fine and bears abundantly on Quince. Fruit, medium, obovate acute pyriform, yellowish russet; stem, short, stout, fleshy at base; flesh, greenish white, melting, juicy, sub-acid; "very good." Middle October.

ADELAIDE DE REVES.

Foreign. Tree, vigorous, and very fertile on Pear or Quince. Fruit, large enough, roundish, Bergamotte or turbinate; skin, bright green, becoming lemon yellow at the time of ripening; flesh, white, half fine, melting, juice very abundant, sugary, vinous, well perfumed, of first quality. Ripe last half of October. (An. Pom.)

ALEXANDER.

Originated in the town of Alexander, Genesee Co., N. Y. Young shoots yellowish, rather stout; leaves, narrow, acuminate, deep green; fruit, medium or below, obovate, slightly irregular and often one-sided; stem, one and a quarter inch, curved, fleshy at base, in a shallow cavity; calyx, small, partly closed; segments, short, irregular; basin, narrow, medium depth; skin, yellowish green, rather thick, often overspread with cinnamon russet; flesh, white, a little coarse, and gritty at core, melting, very juicy, with rich, sugary flavor; core, small; seeds, small, nearly black and pointed. September and October.

ALEXANDRE LAMBRE.

Foreign. Fruit, medium, roundish, compressed at ends, yellowish green, mottled with red in sun, russet at base of stem and calyx; stem, stout, calyx, in a flat basin; flesh, greenish white, melting, juicy, sweet; core, small; seeds, plump, acute pointed. November, December.

ALEXANDRINE DOUILLARD.

Foreign. Tree, vigorous. Fruit, above medium, pyriform ovate; yellowish; stem, long; flesh, white, juicy, sugary. November, December.

ANANAS DE COURTRAI.

Foreign. Tree, very vigorous and productive, takes readily any form; turbinate, pyriform; skin, citron-yellow at maturity, beautifully colored on the sunny side; flesh, white, firm, buttery, melting, sweet and juicy, pleasantly perfumed, but not musky. Ripens at the end of August. (An. Pom.)

ANDREWS.

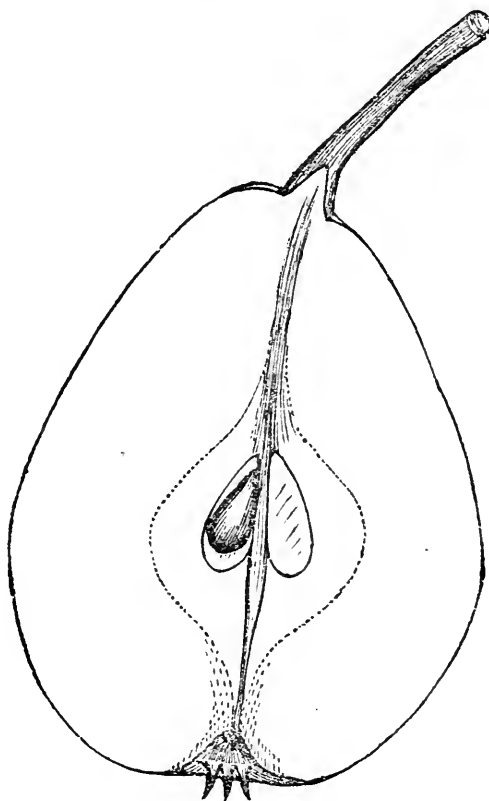

American. An early bearer, a little disposed to decay at core, otherwise highly desirable. Fruit, large (our drawing too small for an average), roundish, ovate pyriform, yellowish green, dull red cheek, scattered dots and russet patches; calyx, open; segments, long, half reflexed; basin, small; stem, one to one and a quarter inch, curved, often set without depression; flesh, greenish white, juicy, vinous, nearly "best." September.

ALPHA.

Foreign. Very productive. Fruit, medium, oblong obovate, pale yellowish green, with reddish dots, brown blush; flesh, white, fine-grained, buttery; "very good." October.

ALTHORPE CRASSANE.

Foreign. Quality, variable. Fruit medium, roundish obovate, rough, pale green, with dark green suffused dots, and spots of russet, tinge of brown; flesh, white, buttery, juicy, rather coarse; "very good." October and November.

AUGUSTE DE MARAISE.

Seedlings of Van Mons, of Belgium. Fruit, large, pyriform; skin, rough, dotted and patched with deep brown; stem, short; calyx, closed; basin, shallow; flesh, buttery, sweet, juicy, delicious flavor. October.

BANKERBINE.

Foreign. The specimens from which we describe were from Messrs. Ellwanger and Barry. Fruit, medium, obovate, greenish yellow, with small russet dots; stem, stout; calyx, open, broad segments; core, large; flesh, breaking, coarse. October.

BARRY.

Foreign. Fruit, medium size, sometimes, large, pyriform, irregularly shaped; skin, rough red, spotted on the sunny side, yellow greenish on the opposite; calyx, small, set in a narrow basin; stalk, obliquely inserted; flesh, white, coarse, tender at the centre, very juicy, sugared and perfumed. October.

BELLE CRAINESE.

Elize d'Heyst.

Foreign. Fruit, below medium, globular obovate, pale greenish yellow with dirty green or brown specks; stem, slender; calyx, open; flesh, white, coarse-grained, juicy; "good." February to March.

BELLE DE NOEL.

Fondante de Noel, | Belle apres Noel.

Foreign. Fruit, rather below medium, obovate obtuse pyriform, pale greenish yellow, with few russet spots, dark red cheek, with carmine dots; calyx medium; segments, half reflexed; basin, shallow, slightly furrowed; core, large; flesh, whitish, melting, juicy; "very good." December.

BELLE DE THOUARS.

Foreign. Fruit, medium, pyriform angular, rich brown russet; short stem; cavity, little plaited; calyx, half open; shallow basin, core, small; seeds, ovate; flesh, white, tender, juicy; "very good." October and November.

BELLE EXCELLENT.

Foreign. Resembles Louise Bonne of Jersey. Oblong pyriform, yellow, red blush, with raised specks on surface. October.

BELLE JULIE.

Foreign. Tree, upright grower. Fruit, medium, long ovate, yellowish green, cinnamon russet, bronzed red in sun; stem, short, stout; calyx, medium, reflexed; flesh, greenish white, juicy; "very good." October and November. (Hov. Mag.)

BELLE EPINE DUMAS.

Epine Dumas, | Du Mas, | Duc de Bordeaux.

Foreign. Heretofore considered as a synonym of Vicar of Winkfield. Fruit, large, oblong pyriform, dull yellow, with red cheek in sun; flesh, fine grained, juicy, sugary; "very good." November, December.

BERGAMOTTE HAMBOURG.

Belgium. Tree, vigorous, good bearer. Fruit, large, roundish, compressed at ends, greenish yellow, rough, dotted with brownish red in sun; flesh, white, fine-grained, sugary, perfumed. September and October.

BEURRE BEAULIEU.

Foreign. Fruit, above medium, obovate pyriform, yellow, with russet spots and blotches; short, stout stem; calyx, open; basin, shallow; flesh, white, juicy. October.

BEURRE BENOIST.

Beurré Auguste Benoit, | Benoits.

Foreign. Tree, not vigorous, but very productive. Fruit, medium, obovate; skin, bright green, spotted and shaded with brown russet; stalk, of moderate length, inserted in a cavity; calyx, open, in a regular basin; flesh, white, fine, melting, juice abundant, sugary, and well perfumed. Ripe, end of September.

BEURRE BROWN.

Beurré Gris,	Beurré Vert,	Beurré d'Ambleuse,
Beurré Rouge,	Badham's,	Beurré du Roi,
Beurré,	Beurré d'Or,	Poire d'Amboise,
Golden Beurré,	Beurré Dorée,	Isambert,
Gray Beurré,	Beurré d'Amboise,	Isambert le Bon.

An old variety; does finely in warm, rich soil, but a peculiar vinous taste, not admired by every person. Fruit, medium, oblong obovate, yellowish green, with thin russet, reddish brown in sun; flesh, greenish white, melting, juicy, vinous, sub-acid. September.

BEURRE CHARRON.

Foreign. Fruit, medium, roundish, greenish yellow; stem, long; calyx, small, closed; basin, deep; flesh, juicy, melting, buttery; "best." October. (T. S. H. & Co.)

BEURRE CRAPAUD.

Beurré Cadet.

Foreign. Vigorous and productive on Pear or Quince, fine for extreme northern sections, proving hardy. Fruit, medium, roundish obovate, deep yellow, red in sun, small russet dots; stem, stout, curved; calyx, partially closed; core, large; flesh, yellowish melting, sugary, juicy; "very good." October.

BEURRE DE BEAUMONT.

3eri Vaet.

Foreign. Fruit, medium, roundish obovate, yellowish green, brownish red in sun, covered with dark green or russet specks; stem, short; calyx, closed; flesh, white, buttery, juicy, sweet; "very good." Last September

BEURRE DE RANZ.

Beurré Rance,		Beurré de Flanders,		Buerré Noirchain.
Beurré Epine,		Hardenpont du Printemps,		

Foreign. Very variable, rarely "very good." Tree, a straggling, pendulous habit. Fruit, large, oblong obtuse pyriform, dark green, bronzed in sun, russet at crown, russet dots over surface; stem, long; calyx, open; core, small; flesh, greenish white, coarse, juicy. December to April.

BEURRE DE RHINE.

Foreign. Fruit, large, pyriform, irregular; stem, stout; calyx, open, basin, shallow, light yellow, rough spots; flesh, white, rather coarse; "good." Grows well on Quince. October and November.

BEURRE FOUGIERE.

A foreign pear, introduced by J. C. Lee. Fruit, of medium size, obovate; skin, greenish yellow, with patches and points of light russet, and some dark green spots; flesh, yellowish white, coarse-grained, a little gritty at the core, melting, juicy, sweet, and good. October. (Robert Manning.)

BEURRE KOSSUTH.

Foreign. Fruit, large, turbinate rounded, surface uneven; stem, curved, inserted upon a little projection; calyx, in divisions, dull yellowish green, traced and dotted with gray bronze, yellowish at crown, greenish at stem; flesh, fine, buttery, sugary, juice acidulated. (Hov. Mag.)

BEURRE LEON LE CLERC.

Foreign. Fruit, above medium, oval, approaching elongated pyriform, skin, yellowish green, thickly speckled with large russet dots; stalk, long, curved, inserted in a cavity by a lip; basin, abrupt, deep; calyx, partially closed; flesh, white, juicy, melting, sweet, but not high flavored. October.

BEURRE MOLLETT'S GUERNSEY.

Mollett's Guernsey Chaumontelle.

Foreign. Fruit, medium, ovate pyriform, yellowish green, with dark brown russet in sun; calyx, large; stem, stout; flesh, yellowish, melting, vinous; "very good." December.

BEURRE PREBLE.

American. Fruit, large, oblong obovate, greenish yellow, with russet and green spots; flesh, white, buttery; "very good." October and November.

BEURRE SUISSE

Foreign. Fruit, medium, obovate oblong, striped green, red and yellow Only desirable as a curiosity. October.

BEURRE WINTER.

Raised by Thomas Rivers, England. Tree, moderately vigorous, spreading, an early and abundant bearer. Fruit, medium, obovate elongated pyriform; skin, greenish, rough, spotted with russet; stalk, stout, curved, inclined at its insertion; calyx, firmly closed, set in a shallow irregular basin; flesh, yellowish fine grained, melting, buttery, vinous or sub-acid. January, February.

BEURRE BENNETT.

Foreign. A new, hardy, late, melting pear of small size from the collection of Van Mons. Ripe February. (Riv. Cat.)

BEURRE GENS.

Tree, vigorous, very productive. Fruit, medium, irregularly obovate, inclining to conic, truncate; skin, rough, greenish, slightly shaded on the sunny side and thickly covered with russet dots; stalk, short and thick, inserted in a cavity at an inclination; calyx, open, stiff, in a broad, rather deep, uneven basin; flesh, sugary, perfumed, excellent. September.

BEURRE D'ELBERG.

Foreign. Tree, moderately vigorous. Fruit, large, obtuse pyriform; skin, pale yellow, often with a blush, slightly speckled with russet; stalk, medium, stout, curved, inserted in an irregular cavity; calyx, small, open, set in a very small basin; flesh, whitish, somewhat coarse, juicy, buttery, melting, sweet, and perfumed. November.

BEURRE HAMECHER.

Foreign. Fruit medium, elongated-oval, inclining to pyriform, angular, and irregular; stalk, large, long, curved, inserted at an inclination by a lip; calyx, small, and closed, set in a shallow, irregular basin; flesh, melting, sugary, and excellent. October, November.

BEURRE DUHAUME.

Foreign. Tree, a moderate grower, productive, young wood yellowish brown. Fruit, medium, oblate turbinate, very much depressed, with a suture along one side; skin, rough, covered with thin russet, and thickly sprinkled with russet dots; stalk, short, thick and fleshy, inserted by a lip at an inclination; calyx, open, segments stiff; basin, irregular; flesh, coarse, buttery, juicy, melting, with a pleasant vinous flavor. November to February.

BEURRE MILLET OF ANGERS.

Foreign. Tree, vigorous, and very productive, young wood yellowish brown. Fruit, medium, angular, somewhat conic; skin, greenish, covered with russet, and thickly sprinkled with minute russet dots; stalk, medium, stout, curved, inserted in a rather abrupt cavity; calyx, closed, set in a deep, irregular basin; flesh, greenish, somewhat buttery, exceedingly juicy, melting, with a brisk vinous flavor, sometimes astringent. November to January. (Downing.)

BEURRE D'AMALIS.

Beurré d'Amanlis, | Beurré d'Amaulis.

Foreign. A free, vigorous grower on Pear or Quince; said to bear well; our experience has been the reverse. Fruit, large, ovate obovate, dull

yellowish green, with reddish brown cheek, brown dots, russet patches ; stem, long, obliquely set ; calyx, open ; basin, shallow ; flesh, yellowish, a little coarse, often austere : "very good." Early September.

There is also a striped *Beurré d'Analis*, differing not materially, except in being striped red, yellow, and green.

BEURRE BYMONT.

Bymont.

Above medium, obovate truncated, russety ; stem, rather long, curved, slight lip ; calyx, small ; basin, shallow ; flesh, juicy, sweet, perfumed ; "very good," perhaps "best." New ; foreign. October, December.

BEURRE NANTAIS.

Beurré de Nantes.

Foreign. Fruit, large, oblong pyriform, pale yellow, crimson cheek, russet dots ; flesh, white, melting, juicy, sugary ; "very good." September.

BEURRE SUPERFINE.

Foreign ; with some very fine, others unproductive. Fruit, large, pale green, traces, and patches of russet, dull brownish cheek ; flesh, juicy, melting, slight aroma ; "very good." Succeeds on Quince. Middle to last October.

BEURRE VAN MARJUM.

Grosse Calébasse of Langlier,		Triumph de Nord,
Triumph de Hasselt,		Boutielle.

Foreign. A very early and productive bearer on pear ; the fruit always fair. Fruit, large, oblong pyriform, dull greenish yellow ; stem, long ; calyx, large ; flesh, white, hardy ; "good ;" its bearing, its recommendation. October.

BEURRE BACHELIER.

Foreign. Fruit, very large, oblong, obovate pyriform, greenish yellow ; stem, stout ; cavity, deep ; flesh, firm, sugary. December. (*Hov. Mag.*)

BEURRE MILLET.

Madam Millet.

Foreign. Fruit, medium, roundish obtuse pyriform, pale yellow, with large pale russet specks ; stem, short, stout ; calyx, small, open ; core, small ; flesh, yellowish white, melting, juicy, vinous. Tree, healthy grower. November to January.

BEURRE BRÉTONNEAU.

Beurré Bretonneau.

Foreign. Does not succeed on the Quince ; very fine on Pear ; very hardy, thorny wood. Fruit, large, obovate obtuse pyriform, yellow, dotted with russet ; flesh, melting, juicy, sugary. February to April. (*Rivers, in Hort.*)

BEURRE D'ALBERT.

Poire d'Albert,		Poire Prince Albert.
-----------------	--	----------------------

Foreign. Tree, vigorous, dark wood, good bearer. Fruit, medium, pyramidal, angular, dark russet, bronzed in sun ; stem, stout, curved, swollen at base ; calyx, partly open ; core, small ; flesh, greenish white, coarse, melting, juicy. October.

BEURRE GRIS D'HIVER NOUVEAU.

Beurré Gris d'Hiver, Beurré de Luçon,		Beurré Gris Supérieure, St. Michael d'Hiver.
--	--	---

Foreign. Very similar to Brown Beurré, except in its time of ripening. Tree a poor, irregular grower, with dark reddish brown wood. Fruit, medium, obovate obtuse oblique, rough, dull, yellow, cinnamon russet, reddish, bronzed in sun, and dotted with dark specks; stem, short, stout, obliquely inserted; calyx, small, open; flesh, yellowish white, melting, juicy, vinous; core, large. December to February.

BEURRE COMICE DE TOULON.

Foreign. Tree, vigorous, productive. Fruit, large, oblong obovate, pale yellow, with red dots, highly colored in the sun; flesh, white, melting, juicy. November, December.

BEURRE PHILIPPE DELFOSSE.

Foreign. Tree, vigorous. Fruit, medium, roundish, yellowish brown, tinge of red in sun; flesh, white, juicy, sugary. December.

BEURRE DE WETTEREN.

Foreign. Tree, vigorous, thorny. Fruit, medium, turbinate, cinnamon russet; flesh, fine, yellowish white, buttery, sugary, perfumed; "very good."

BEURRE JUDES.

Longue de Monkowty,		Longue de Nakourto,
---------------------	--	---------------------

Foreign. Fruit, medium, pyriform, dull yellowish green, russet patches and dots; stem, long; calyx, open; basin, furrowed; flesh, melting, buttery, sweet; variable, core, medium; seeds, sharp pointed. October.

BEURRE DE KONINK.

, Beurre de Konig, of Downing.

Belgium. Fruit, medium, oblate, yellowish green, with russet and brown dots; stem, medium length, stout, inserted in shallow cavity; calyx, open basin, broad; flesh, white, melting, vinous. October.

BEURRE DE MONTGERON.

Beurre de Montigeron,		New Frederick, of Wurtemberg.
-----------------------	--	-------------------------------

Foreign. Tree, vigorous, productive. promises to succeed on Quince. Fruit, medium, obtuse pyriform, deep yellow, suffused with bright vermilion in sun, a few pale gray specks; stem, long, swollen at base; calyx, large, open, in a broad, open basin; segments, thick, broad; core, small; seeds, large, light colored; flesh, yellowish white, fine, juicy, melting, sugary, perfumed. October. (Hov. Mag.)

BEURRE BENOITS.

Beurre Auguste Benoits.

Foreign. Wood, reddish brown. Fruit, large, roundish, depressed, irregular, dull green, bronzed with red, dotted with russet specks; stem, short, fleshy at base; calyx, small, short segments; flesh, greenish white, coarse, vinous, sprightly, musky. core, large, gritty; seeds, obovate, brown. October.

BEURRE DUHAUME.

Foreign. Fruit, medium, obovate, brownish russet; flesh, melting, juicy; "good." November.

BEURRE KENNES.

Medium, oblate turbinate, angular or oblique, greenish, with thin russet and shade, dull crimson russet, and crimson dots; stem, varies, fleshy ring at base; calyx, large, open; flesh, whitish, buttery, juicy, sweet, perfumed; "good" or "very good." October.

BEURRE NAVER.

Foreign. Fruit, medium or above, turbinate; stem, medium, inserted without depression; calyx, closed; flesh, melting, juicy, vinous, pleasant; "very good." October.

BEURRE SOULANGE?

Foreign. Fruit, medium, acute pyriform, pale yellow, tracings of russet; stem, curved, fleshy at base; flesh, melting, juicy, sugary, pleasant. October, November.

BEURRE SPENCE?

Medium, globular, short pyriform, greenish, yellow at maturity, shaded crimson and russet, russet dots; stem, fleshy at insertion; calyx, closed; basin, abrupt; flesh, juicy, melting, vinous; core, small. September.

BEURRE RICHELIEU.

Large, obovate oblong, obtuse pyriform, truncate irregular, greenish yellow dots; stem, stout, slight lip; calyx, closed; basin, broad, shallow, furrowed; flesh, buttery, juicy, melting, sweet, aromatic; "good" to "very good." November.

BEURRE SIX.

Foreign. Tree, vigorous on pear stock. Fruit, large, pyriform, light green, dotted with brown, and a deeper shade of green; flesh, white buttery, melting, sugary, perfumed. November.

BEURRE DELFOSSE.

Foreign. Tree, vigorous. Fruit, medium, roundish, yellowish brown, tinge of red in sun; flesh, white, melting, juicy, sugary, perfumed. November, December.

BEURRE BERCKMANS.

Medium, turbinate or short pyriform; yellowish, rough russet; stem, at right angles, large; calyx, small, basin, shallow, furrowed; flesh, white, juicy, melting, highly perfumed; core, small; "very good." November.

BUERRE LEON LE CLERC.

Above medium, oval obovate elongated, yellowish green, with large russet dots; stem, curved, large, inserted with a lip; calyx, partly closed, basin, deep; flesh, white, juicy, melting, sweet; "good." October.

BEAU PRESENT D'ARTOIS.

Foreign. Fruit large, oblong obovate pyriform, gray and green spotted; stem, large, short; calyx, short, broad; flesh, white, with green lines, tender, juicy, sugary. September. (Hov. Mag.)

BERGAMOTTE D'ESPERIN.

Foreign. Fruit, medium, roundish, dull green, with dots and patches of russet; calyx, closed; basin, furrowed; flesh, buttery, melting, juicy, sweet; "very good;" very productive in clusters. December to February.

BERGAMOTTE GAUDRY.

Foreign. Fruit, medium, roundish, yellowish green, with russet dots; flesh, white, tender, juicy; "good." November.

BERGAMOTTE CADETTE.

Beurré Beauchamps, Ognonet,		Beauchamps, Poire de Cadet,		Bergamotte Buffo, Bergamotte Crapaud.
--------------------------------	--	--------------------------------	--	--

Foreign. Fruit, hardly medium, roundish obovate, pale green, rarely little red in sun; stem, long, stout; calyx, small, closed; flesh, buttery, juicy, sweet; requires care in ripening. October to December. Wood, light olive brown; productive on Pear or Quince.

BEURRE AUDESON.

Foreign. Fruit, medium, obovate, acute pyriform, yellowish green at maturity, dull red cheek in sun, and numerous russet dots; stem, short, stout; calyx, large, open; flesh, melting, tender, juicy; "very good." October. (Wilder, in Hort.)

BEURRE CLAIRGEAU.

Foreign. Tree, vigorous, light yellow wood. Fruit, large, oblong obovate pyriform; color, mostly russet, reddish in sun; stem, short, stout; calyx, small, open; flesh, yellowish, rather coarse, juicy, vinous; "very good." October, November. This will probably prove one of the most valuable, as a large-sized pear, and desirable as an orchard variety, on the pear root. Growing strong, and bearing very young; does not succeed on Quince.

BEURRE ESPERIN.

Foreign. Fruit, large, ovate pyriform, yellow, with patches, tracings and dots of russet; stem, short, swollen at base, obliquely inserted, slight lip; calyx, small, with segments united; core, medium; seeds, large; flesh, yellowish white, a little coarse, melting, juicy; "very good." October.

BEURRE STERCKMAN.

Beurré Hardy.

Foreign. Tree, vigorous, large strong shoots; succeeds on Quince or Pear. Fruit, medium, obtuse pyriform, dull greenish ground, nearly covered with russet; stem, short, stout; calyx, open; flesh, white, melting, juicy, sub-acid. October.

BEZI DE MONTIGNY.

Trouvé de Montigny, Louise Bose,		Doyenné Musque, Beurré Romain.
-------------------------------------	--	-----------------------------------

Foreign. Tree, vigorous, brownish olive wood. Fruit, medium, obovate, yellowish green, with russet specks and dots; stem, long, curved, rather stout; calyx, small, open, reflexed; core, large; flesh, white, fine, melting, juicy, sugary. October.

BEZI DE LA MOTTE.

Bein Armudi, | Beurre Blanc de Jersey.

Foreign. A vigorous, hardy sort, well suited to orcharding. Fruit, medium, obovate rounded, yellowish green, with many small russet dots; stem, short, rather stout, slightly curved; calyx, small, open, reflexed segments; core, medium; seeds, plump, ovate; flesh, yellowish white, rather coarse, sugary, juicy, melting; "very good." October.

BEZI DE NAPLES.

Foreign. Fruit, medium, ovate obovate, light yellowish green, with blotches and stripes of darker hue, occasional russet patches and dots; stem, stout; calyx, small; basin, furrowed; flesh, fine, buttery, juicy, sweet; "very good." Last September.

BEZI SANSPAREIL.

Foreign. Fruit, small, globular, obtuse pyriform, dull greenish yellow, much russet, and in sun, a little crimson; stem, long; cavity, deep; calyx, open; segments, long; core, medium; seeds, purplish black; flesh, yellowish white, melting, juicy, aromatic; "very good," if not "best." February to March.

BEZY D'ESPEREN.

Foreign. Tree, a moderate grower; good bearer. Fruit, large, elongated pyriform; skin, dull yellow, sprinkled, and patched with russet, and thickly covered with russet dots; stalk, rather long, stout, inserted by a ring or lip at an inclination, in a small, irregular cavity; calyx, small, open, set in a very deep, acute basin, surrounded by russet; flesh, juicy, with a sprightly, vinous flavor. October, November.

BEZY GARNIER.

Foreign. Fruit, pyriform, very beautiful; flesh, white, breaking, very juicy, sugary. April. (Pap. Cat)

BEZY QUESOY D'ETE.

Foreign. Tree, of good vigor, and of exceeding fertility. Fruit, moderate size, roundish oval, of almost equal diameters; skin, rough, thick, and altogether covered with gray russet, becoming russet fawn at maturity; flesh, yellowish white, fine, half melting, very juicy, sugary, and deliciously perfumed. This pear is very beautiful, and of first quality, with the exception of a little grit about the core. Ripe towards the middle of September. (An. Pom.)

BEADNELL.

Beadnell's Seedling.

Foreign. Tree vigorous, abundant bearer; shoots long, bright chestnut color; white dots; fruit, middle-sized, turbinate, stalk short; eye a little open; skin, pale yellowish green on the shaded side, red next the sun, much speckled with whitish gray dots; flesh melting, exceedingly juicy. Last September.

BENOIST NOUVEAU.

Foreign. The specimen from which we describe was received from Messrs. Ellwanger & Barry. Fruit, medium, roundish obovate, greenish yellow, brown cheek, dull russet marblings, and indistinct brown specks;

stem, stout; cavity, deep, narrow; calyx, open; core, small; seeds, long, ovate pointed; flesh, breaking, juicy, rather astringent, requires careful ripening. February to April.

BERGEN PEAR.

A chance seedling, found in a hedge on land formerly belonging to Simon Bergen, of New Utrecht, Long Island. Tree vigorous, and early bearer, productive. Fruit, large, turbinate; skin, very thin, smooth, clear yellow, with a beautiful red cheek on the sunny side; stalk, rather long, slightly curved, inserted at an inclination, in a very small depression; calyx, small; basin, very shallow; flesh, white, fine grained, buttery, juicy, melting, with a sweet, excellent flavor; core, small, with few seeds. Ripens last of September. (T. G. Bergen.)

BELLE FONDANTE.

Fruit, medium, pyramidal, turbinate; skin, pale yellow, clouded with green, irregularly patched with russet, especially around the eye; flesh, juicy, buttery, very fine grained and rich, with a perceptible astringency. October. (Rob. Manning.)

BERGAMOTTE HEIMBURG.

Foreign. Tree vigorous and very productive. Fruit, large, Bergamotte shaped; skin, rough, green, changing to lemon yellow when ripe, dotted with brown, and tinged with red next the sun; flesh, white, very fine, somewhat buttery, juice abundant, sugary, perfumed. Ripe early in October. (Gard. Chron.)

BERGAMOTTE LESEBLE.

Foreign. Tree vigorous and productive. Fruit, medium, oblate, or Bergamotte shaped; skin, yellow, with a sunny cheek, numerous small dots, and russeted patches; stalk, long, curved, inserted in a depression; calyx, large, open, broad; basin, irregular; flesh, juicy, buttery, melting, sweet and perfumed. October. (Hov. Mag.)

BERGAMOTTE DE MILLEPIEDS.

Foreign. Fruit of medium size, roundish, resembling Belle de Brussels; skin, greenish, rather dark, dotted; flesh, white, melting, juicy, first rate. Ripens September. (Leroy's Cat.)

BLEEKER'S MEADOW.

Spice Butter,		Heidelberg,
Large Seckel,		Feaster.

American. Tree, free grower, hardy and productive. Fruit, medium, roundish, yellowish; quality, "good." October, November.

BONNE DE EZEE.

Bon d'Ezee,		Bonne des Haies.
-------------	--	------------------

Foreign. Tree of short, stocky habit; wood, yellowish; fruit, large, obtuse pyriform, light yellow and pale red, and somewhat russeted; stem, rather short, uneven; calyx, partly closed; short segments; core, large, flesh, yellowish white, melting, juicy, sugary; "very good." September.

BONNE CHARLOTTE.

Foreign. Tree, vigorous and productive; fruit, moderate size, variable in form, generally resembling Doyenne; skin, smooth, lightly washed with purple on the side of the sun; flesh, moderately fine, more buttery than melting, sugary, and strongly perfumed. Should be gathered early. It is a long time in use. Ripe middle of August. (Al. Pom.)

BON GUSTAVE.

Foreign Tree, vigorous; fruit, medium, pyriform, light green, nearly covered with russet; flesh, white, sugary, perfumed. December, January. (Hov. Mag.)

BOUVIER BOURGERMESTRE.

Foreign. Growth moderate. Fruit, above medium, obtuse, pyriform, green, yellow at maturity, rarely red cheek in sun; stem, rather long; calyx, small; basin, narrow, deep; flesh, white, melting, juicy, pleasant sweet; "good." October, November.

BRANDES ST. GERMAIN.

Foreign. Considering its season, R. Manning, Esq., considers this a very desirable variety. Tree, moderate grower, succeeding finely on Quince, very productive. Fruit, medium, oblong oval, brownish yellow, with smooth russet; stem, short, stout; calyx, small; flesh, juicy, vinous; "very good." November, December.

BRINGEWOOD.

Foreign. Fruit, medium, pyriform, yellowish brown and russet; stem, long and slender; calyx, open, prominent; flesh, yellowish white, gritty at core, the rest buttery; "very good." November. (Hov. Mag.)

BRIELMONT.

Foreign. Fruit, medium, obovate oblong, angular, yellow, with greenish and russet specks; calyx, prominent; basin, open; flesh, white, melting; "good." October.

CAEN DU FRANCE.

Foreign. Fruit, medium, roundish obovate, mostly yellowish russet and reddish dots; stem, rather long; calyx, open; flesh, fine, juicy, sweet; "very good." December, January.

CAPIAUMONT.

Beurré Aurore, | Beurré Capiaumont, | Beurré Caloma.

Foreign. This is a profitable orchard and market variety, on Pear or Quince. A free grower; branches, grayish yellow. Fruit, medium, globular, acute pyriform, yellow, with cinnamon red cheek, and russet dots and streaks; stem, curved; calyx, large; flesh, buttery, sweet, a little astringent; "very good." September, October.

CALHOUN.

American. Native of New Haven, Conn. Fruit, medium, roundish, yellow, with much of russet traced and dotted; stem, short; calyx, small; core, medium; flesh, yellowish white, melting, juicy; "very good." October, November.

CAPSHEAF.

American. Native of Rhode Island. Tree, hardy, wood yellowish. Fruit, medium, roundish obovate, yellow, mostly covered with cinnamon russet; stem, short; calyx, closed; core, large; flesh, yellowish white, fine, melting, juicy, sweet; "very good." October.

CATINKA.

Foreign. Fruit, large, oblong pyriform, yellowish; flesh, fine, juicy, 'very good,' and will probably prove "best." We have only seen it once. November.

CANANDAIGUA.

Catherine.

American. From Central New York. Fruit, large, resembling Bartlett; flesh, white, fine, juicy; "good." Tree, vigorous, upright grower on Quince or Pear, productive. September.

CALEBASSE D'ETE.

Summer Calebasse.

Foreign. Tree, vigorous, hardy; foliage, light green. Fruit, above medium, oblong pyriform, irregular, dull green, little brown in sun, rich yellow at maturity, russet at stem and eye; stem, long; calyx, small; core, small; seeds, long; flesh, white, fine, buttery, juicy, sugary, perfumed. One of the best. Last August and early September.

CAMERLYN.

Foreign. Vigorous and productive. Fruit, medium, pyriform; skin, yellow, with numerous brown dots and a slightly marbled cheek; stalk, long, slightly inclined in a small cavity surrounded by russet; calyx, open; basin, small and shallow; flesh, juicy, melting, rich, sugary, with a very peculiar, aromatic flavor. September, October.

CANANDAIGUA.

Catherine.

Origin uncertain; supposed to have been brought from Connecticut to Canandaigua about the year 1806; vigorous and productive.

Fruit, rather large, irregular, obtuse pyriform, surface uneven, resembling Bartlett; skin, lemon yellow; stalk, medium or rather short, inclined; calyx, open; basin, small; flesh, whitish, not very fine, buttery, and melting, with a vinous somewhat sugary flavor. September.

CASSANTE DE MARS.

Foreign. Tree, vigorous. Fruit, which is borne in clusters, resembles Doyenne blanc; skin, smooth, bright green, becoming golden yellow at maturity, striped and shaded with fawn; flesh, when in full perfection is half melting, juicy, sugary, vinous, and well perfumed. December to April. (Al. Pom.)

CATHERINE GARDETTE.

Raised by Dr. W. D. Brinckle, of Philadelphia. Foliage much waved, young shoots short-jointed, yellow-olive on the shaded side, brownish-olive on the side exposed to the sun, with many minute white dots; buds, pointed. Size, above medium, roundish obovate; skin, fair, yellow, with numerous small carmine dots on the exposed side; stalk, one inch long,

curved, inserted by a fleshy termination into a slight depression; calyx, small, set in a rather deep, regular basin; flesh, fine texture, buttery; flavor, delicious, with a delicate aroma; quality, "best." Beginning of September. (Trans. A. P. S.)

CAMERLING.

Medium, yellow, brown dots, marbled cheek; stem, rather stout, curved, inserted by slight inclination in a small cavity; calyx, open; basin, shallow; core, small; flesh, juicy, melting, sweet, aromatic peculiar flavor; "very good." September to October.

CHAPTAL.

Beurré Chaptal.

Foreign. Fruit, medium or above, roundish, ovate obovate, greenish yellow; stem, curved; cavity, slight; calyx, large, open; basin, shallow; core, medium; seeds, oblong; flesh, white, breaking, juicy; "very good." December, January.

CHANCELLOR.

Green's Germantown, | Early St. Germain.

Probably a native of Pennsylvania. Tree, healthy, abundant bearer; young wood, slender, yellowish brown. Fruit, large, oblong obovate pyriform, green, with minute brown specks and some russet blotches, rarely a faint brown cheek; stem, one inch long, rather thick; cavity small, irregular; calyx, small; basin, contracted; core, medium; seeds, long, yellowish brown; flesh, melting; "very good." Last September.

CHARLES VAN MONS.

Foreign. Fruit, below medium, obovate obtuse pyriform, yellowish green, brownish red cheek, and russet dots; stem, slender, curved, depression one side; calyx, large, open; segments, broad, completely reflexed; basin, shallow; core, medium; seeds, obovate pyriform; flesh, whitish, melting, juicy, vinous; "very good," if not "best." January.

CHARLES VAN HOOGTEN.

Foreign. Fruit, above medium, obovate acute pyriform, dull pale yellow; stem, stout, enlarged at base; calyx, open; segments, short; flesh, yellowish white, melting, juicy; "very good." Promises valuable; good grower, productive. Early October.

CHRISTMAS.

Noel.

American. New: from Cincinnati, Ohio. Fruit, medium, ovate rounded, skin, rough, bronzed, russety; stem, stout, slight depression; calyx, small; basin, shallow; flesh, a little gritty, juicy, sweet; "very good." December, January. (Warder's Notes.)

CHOICE D' UN AMATEUR.

Foreign. New. Tree, upright, strong growth. Fruit, large, oblong ovate, smooth, pale green; core, small; flesh, melting, juicy, vinous, sugary. (Hov. Mag.)

CHARLOTTE DE BROWER.

Foreign. Very productive. Fruit, medium, roundish obovate, greenish golden russet, with spots of yellow in sun; stem, short; calyx, small; long segments; core, small; flesh, pinkish white, half melting, buttery, juicy, perfumed. November. (Hov. Mag.)

CHURCH.

From New Rochelle, N. Y. Medium, obovate acute pyriform, yellowish green, spotted and marbled with russet; stem, medium; calyx, closed; basin, medium; flesh, buttery, juicy, sweet, aromatic. July, August.

CHAUMONTEL.

Bezi de Chaumontelle,		Winter Beurré,
Beurré d'Hiver,		Oxford Chaumontel,

Foreign. Requires rich warm soil. Fruit, large, oblong obovate; skin, rough, yellowish, brownish red in sun, russet dots; stem, one inch, curved; calyx, medium; basin, deep; core, small; seeds, flattened; flesh, buttery, melting; "very good." November, January.

CITRON.

American. Native of New Haven, Conn. Fruit, medium, roundish obovate, dull green, sprinkled with small russety dots; flesh, a little coarse, greenish white, melting, juicy; "very good." Last August.

COOKE.

Origin, King George County, Virginia. Tree, a very strong, vigorous grower, and productive. Introduced by H. R. Roby, Fredericksburgh, Virginia. Fruit, rather large, irregularly pyramidal; color, pale yellow; flesh, juicy, buttery, melting, sweet, rich and vinous. (Roby.)

COLLINS.

Watertown.

American. From Watertown, Massachusetts; supposed a seedling of white Doyenné; a regular, abundant bearer. Fruit, large or above medium, roundish obovate, yellowish green, mottled with dull red in sun, some russet; stem, short, curved; calyx, large, open; core, large; flesh, white, vinous, juicy, sweet, melting. September.

COLMAR EPINE.

Foreign. Fruit, large, roundish obtuse oblong, dull green, with cloudings of darker hue; flesh, white, melting, vinous, juicy; "very good." September.

COLMAR D'ALOST.

Comtesse d'Alost,		Duchesse d'Alost,		Delies d'Alost.
-------------------	--	-------------------	--	-----------------

Foreign. Tree, vigorous and productive. Fruit, large, elongated pyriform, sometimes obovate; skin, greenish yellow, with a red cheek, sprinkled with many green or brown dots, often much russeted; stalk, large, rather long and curved, inserted in a slight depression; calyx, open; segments, long; basin, shallow and uneven; flesh, white, buttery, melting, juicy, slightly astringent. October, November.

COLUMBIA.

Columbian Virgalieu, | Columbian Virgalouse.

Native of Westchester county, N. Y. Without being of more than second quality, its hardihood of tree, productive habit, and fruit uniformly smooth and fair, make it a valuable as well as profitable variety. Tree, thrifty; young shoots, yellowish brown.

Fruit, large or above medium, oblong obovate pyriform; color, at first pale green, becoming, when ripe, fine golden yellow, dotted with small gray dots; stem, medium size, slightly curved; calyx, rather small, partially open, or half closed; basin, shallow; core, medium; seeds, oblong pyriform; flesh, white, moderately juicy, sweet; variable quality. December to January.

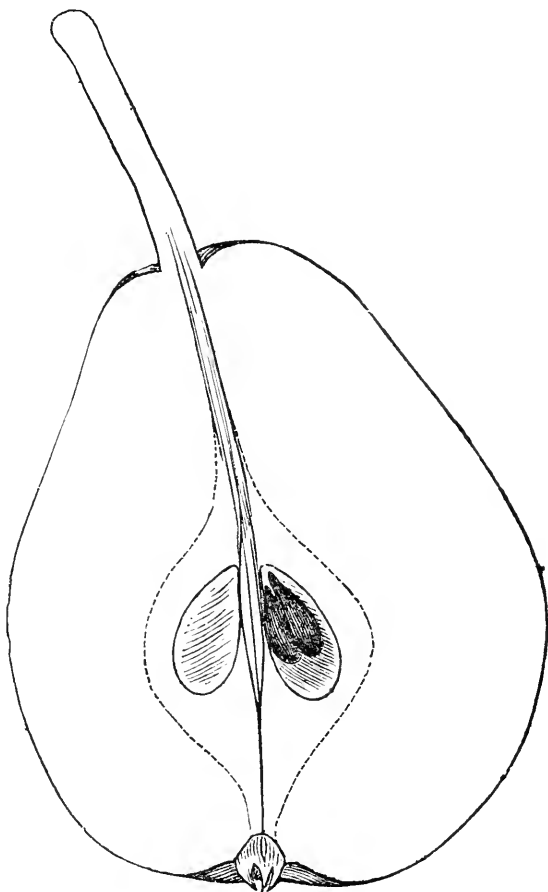

COLMAR NEILL.

Foreign. Fruit, large, obovate, pale yellow; flesh, white, buttery, melting; "good." October.

COMPTE DE LAMY.

Beurre Curté, | Marie Louise the Second,
Dingler, | Marie Louise Nova.

Foreign. Tree, upright. Fruit, medium, roundish obovate, yellow, brownish red cheek, small russet dots; stem, long; calyx, small; flesh, white, fine-grained, buttery; "good." Early October.

COMTE LELIEUR.

Foreign. Tree, vigorous, upright, moderately productive. Fruit, medium, turbinate; skin, yellowish green, with a brownish red cheek, speckled with gray and patched with russet; flesh, yellowish white, fine-grained, melting, juicy, sweet, and very high flavored. September. (Rob. Manning.)

COMTE DE FLANDRE.

Foreign. Tree, vigorous, prolific. Fruit, medium, obovate acute pyriform, yellowish, traced with russet, occasional red in sun; stem, stout, fleshy at base; flesh, melting, juicy, sweet sub-acid; very good. November, December. Promises to become valuable.

CONSEILLEUR RAMUEZ.

Conseilleur Ranwez.

Foreign. Fruit, medium, obovate obtuse pyriform, dull green, clouded and traced with russet; flesh, melting, tender; "good." October. Valuable as a market sort.

COUNTESS OF LUNAY.

Comtesse de Lunay.

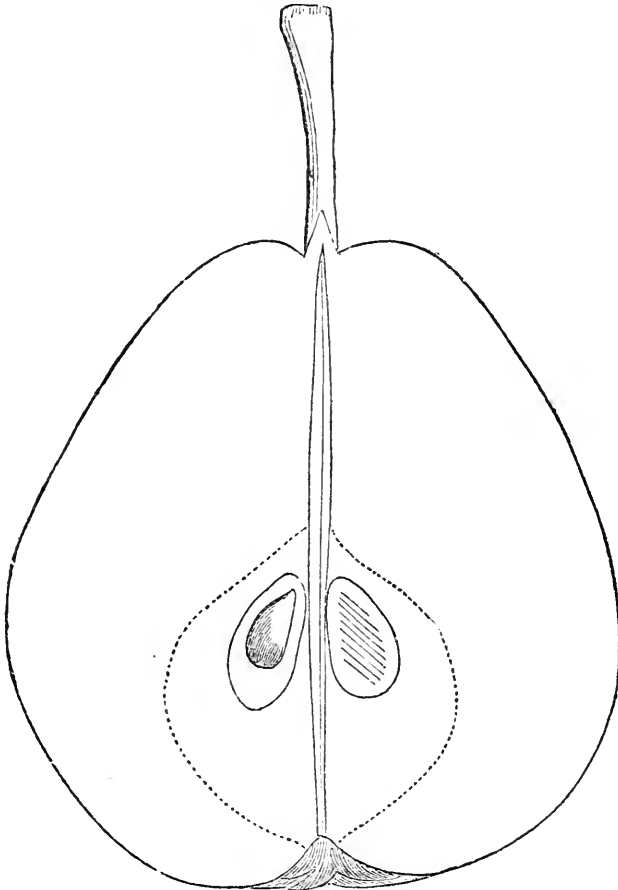

Foreign. Tree, vigorous: very productive on Quince; has been much disseminated as "Doyenné d'Été." Fruit, medium, roundish obovate; skin, smooth, pale yellow, often thinly sprinkled with red in sun, some russet specks, and russet at base of stem: stem, long, largest where it joins the tree; cavity, slight, often a little lip one side of stem; calyx, large, open, with long reflexed segments; core, medium; seeds, brown; flesh, white, rather coarse, melting, juicy; "very good." October.

COTER.

Foreign. Tree healthy; young wood, short-jointed, light yellow. Fruit, medium, regular obovate, pale green; flesh, fine-grained, tender, melting, juicy; "very good." November.

CROSS.

Winter Cross.

American. From Massachusetts. Tree, hardy, slender, grayish yellow wood. Fruit, medium, roundish obovate, deep yellow, with russet dots and patches; stem, stout; calyx, small; flesh, white, melting, juicy. "very good." November, January.

CUSHING.

American. Native of Hingham, Mass. Tree, hardy, of slender, diverging growth. Fruit, medium, ovate obovate, light greenish yellow, small gray dots, dull red cheek; calyx, small; stem, one inch long; flesh, white, fine-grained, melting, sweet; "very good." September.

DALLAS.

American. From New Haven, Conn. Fruit, medium, roundish obovate, dull yellow, mostly covered with red russet; stem, medium; calyx, large, open; core, rather small; flesh, yellowish white, melting, juicy, vinous; "very good." November.

DANA'S No. 19.

Raised by Francis Dana, of Roxbury, Mass. Fruit, large, obovate, swelling out at the base: stalk of moderate length, inserted in a rather slight depression; skin, yellow and thick; flesh, white, tender, juicy, half melting, with a pleasant perfumed flavor. November. (Hov. in Mag.)

DANA'S No. 16.

Raised by Francis Dana, of Roxbury, Mass. Fruit, under medium, obovate; skin, yellow russet, with dark russet specks; stem in a very slight depression; calyx, open, in a deep cavity; flesh, yellowish white, juicy, tender, sweet, high flavored. November. (Hov. in Mag.)

DE LOUVAIN.

Poire de Louvain.

Foreign. Fruit, large, obovate acute pyriform, dull greenish yellow, rough russet dots and patches; stem, long, medium size, curved; calyx, large; basin, shallow; core, medium; seeds, blackish; flesh, greenish white, crisp, juicy, astringent, valuable only for baking. January, March.

DESIREE CORNELIS.

Cornelis.

Foreign. Tree, vigorous, productive, thorny. Fruit, large, roundish ovate; skin, rough, pale green, yellowish, and tinged red in sun; calyx, open; flesh, white, buttery, melting, sugary. Early September. (Hov. Mag.)

DELICES D'HARDENPONT DU NORD AND BELGIUM.

Fondante Pariselle du Cornice Horticule, | Beurré Curtet, *of A. Leroy.*

Foreign. Fruit, large, pyriform, yellow, gray spotted; calyx, small; flesh, coarse, melting, sugary, "good." October. Promises to become valuable.

DES NONNES.

Poire des Nonnes, | Beurré de Brignais, | Des Nonnes.

Foreign. New. Fruit, medium, turbinate, clear light yellow, many small brown dots; stem, long, slender; calyx, small, closed; basin, shallow; flesh, whitish, melting, juicy, sweet, perfumed; "very good," perhaps "best." September.

DEUX SŒURS.

A fine tree, very productive. Fruit, large, elongated, pyriform; skin, green, spotted with dark brown; flesh, fine yellowish, green, buttery, very sugary, with a decided flavor of almonds. November. (Al. Pom.)

DE BAVAY.

Poire de Bavay.

Foreign. Succeeds and bears well on quince or pear stock. Fruit, medium, turbinate, dull yellow, dotted and traced with russet; calyx, large, open; flesh, juicy, agreeable sub-acid; "very good." October, November.

DELICES CHARLES VAN MONS.

Delices de Charles.

Foreign. Fruit, large, medium, pyriform; skin, fine, lemon yellow, thinly washed with russet, quite like the Golden Beurré, which it also resembles in size and shape; stalk, an inch and a quarter long, inserted without depression; calyx, small, open, and placed in a narrow and shallow basin; flesh, melting, vinous, juicy, and refreshing.

DELICES DE MONS.

Foreign. Fruit, medium, pyriform, uneven surface; stem, half-inch long; calyx, small; skin, yellowish green in shade, russet in sun, dotted and spotted with gray; flesh, yellowish, melting, juicy, perfumed; "very good." September, October.

DE SORLUS.

Foreign. Tree, vigorous; branches, straight, erect, compact; wood, yellowish, grayish white dots; free bearer. Fruit, large, turbinate; stem, one side, short, curved; calyx, small, closed; color, yellowish green, gray russet, marbled most at stem; flesh, white, melting, juicy. October, December.

DICKERMAN.

Dikeman, | Pardus, No. 2.

From New Haven, Conn. Good grower and bearer, medium, roundish oblate, yellowish, minute dots; stem, short, curved, fleshy at insertion; calyx, small; segments, persistent; basin, shallow, uneven; flesh, whitish, buttery, juicy, melting, vinous, perfumed; core, small; "very good." September, October.

DILLEN.

Deacon Dillen, | Dillon, | Doyenné Dillen.

Foreign. This has been heretofore considered a synonym of Beurré Diel; it, however, proves distinct. Tree, not vigorous, branches erect, diverging; grayish rough wood. Fruit, large, obovate obtuse pyriform, greenish yellow, russet at stem; stem, short; calyx, small; flesh, fine, melting, tender, juicy, vinous. October, November.

DILLER.

Probably a native of Pennsylvania. Tree, moderately vigorous; wood, short-jointed, reddish brown, a regular and abundant bearer. Fruit, medium, ovate obovate, angular, golden yellow, sprinkled, and, in sun, mostly covered with light cinnamon russet; calyx, open; basin, shallow; core, small; seeds, long, black, pointed; flesh, yellowish white, buttery, sugary; "very good," or "best." September. It must not be confounded with the Dillen, a foreign variety.

DOCTEUR BOUVIER.

Foreign. A vigorous tree, covered with long, sharp spines, forming a beautiful pyramid; very productive.

Fruit, large, elongated pyriform; skin, light green, taking a slight tint of yellow at maturity, and mottled with russet; flesh, white, fine, half buttery, half melting, sufficiently juicy, vinous, and of a perfume most agreeable. February, March. (Al. Pom.)

DOCTEUR CAPRON.

Foreign. A new pear of good promise. It has a thick skin of greenish yellow color, covered with blotches of russet, red in the sun, and russet specks; calyx, closed; flesh, yellowish white, melting, of a pleasant, rather spirited flavor. October, November. (Hov. Mag.)

DOCTEUR LENTIER.

Foreign. Tree, vigorous and productive. Fruit, medium, pyriform; skin, bright green, becoming slightly yellow at maturity; flesh, fine, melting, buttery, juice abundant, sugary, and deliciously perfumed. Mature at the end of October and November. (An. Pom.)

DOCTEUR TROUSSEAU.

Foreign. Fruit, large, pyriform; skin, green, spotted with red, and sprinkled with gray dots; stalk, strong and woody; flesh, firm, white, melting, buttery, with an abundance of perfumed sugary juice. November, December. (An. Pom.)

Dow.

Raised by Dr. Eli Ives, New Haven, Conn. Tree upright, vigorous, productive.

Fruit, rather above medium, obovate, acutely pyriform, sometimes turbinate; skin, rough, yellowish green, sprinkled with russet dots, and a few small patches of russet; stalk, long, inserted at an inclination in a very slight cavity; calyx, large, open, set in a very small basin; flesh, white, buttery, juicy, melting, with a good vinous flavor, sometimes slightly astringent. September, October. (Downing.)

DOYENNE DU COMICE.

Doyenné du Comice, of Angers.

Foreign. Tree, vigorous, productive. Fruit, large, obtuse pyriform, greenish yellow, russet specks, red around stem; stem, short; calyx, open; basin, deep; core, large; flesh, yellowish white, melting, juicy, sugary; "very good." October, November.

DOYENNE DEFAIS.

Beurré Defais, | Doyenné D'Affay.

Foreign. Fruit, large, roundish; skin, smooth, yellow, often with a fine red cheek; stalk, stout, about one inch long, inserted in a deep cavity; calyx, spreading, placed in a deep, narrow basin; flesh, fine, white-grained, very buttery, melting, juicy, rich, high-flavored, and delicious. Tree, robust, and a great bearer. "Promises well." October.

DOYENNE DOWNING.

Foreign. Raised and dedicated by M. Leroy (France) to the memory of A. J. Downing.

Fruit, medium, roundish, irregular; green yellowish, speckled with russet dots; stem, short, obliquely inserted; flesh, white, crisp, juicy, sugary, slightly acidulated. September.

DOYENNE GAUBALT.

Chapen.

Foreign. Promises a valuable variety for orcharding, on Pear roots. Fruit, medium to large, obovate acute pyriform; surface, uneven, dull pale yellow, with a few traces of russet; stem, short, thick flesh next the fruit; calyx, small; basin, deep; core, small; flesh, melting, juicy, sweet; "very good." November, December.

DOYENNE ROBIN.

Beurré Robin.

Foreign. Fruit, rather large, bergamot-shaped, greenish, covered with russet dots and spashes; stem, usually very long and thick; deep, narrow cavity; calyx, small, narrow; moderately deep basin; seed, large, black; flesh, melting, somewhat granular; flavor, pleasant; quality, "very good." Succeeds on Quince. September.

DOYENNE SIEULLE.

Beurré Sieulle, | Sieulle, | Bergamotte Sieulle.

Foreign. A variety requiring high culture; does best on Quince, under garden culture. Fruit, above medium, roundish oblong, dull yellowish green, with fine red cheek in sun, scattered russet specks; stem, stout; calyx, open; core, large; flesh, white, melting, sugary, vinous, juicy; "very good," sometimes "best." October, November.

DOYENNE SANTELLETE.

Sentilet.

Foreign. An old variety, little known. Tree, vigorous; wood, stout, yellowish. Fruit, above medium, roundish pyriform, dull yellowish green, traces, streaks, and dots of russet, red in sun; stem, long, slender; calyx, small, open; flesh, yellowish white, vinous, melting, juicy; "very good." October.

DOYENNE ROSE.

Foreign. Fruit, above medium, oblong, ovate pyriform, yellow, bluish red cheek, patches and dots of russet; stem, stout, set without depression; calyx, with short, stiff segments; core, small; flesh, white, coarse, juicy; "good." October.

DUCHESS D'ALOST.

Comtesse d'Alost, | Delices d'Alost.

Large, elongated pyriform, or oval, greenish yellow, red cheek, brownish dots and russet; stem, stout, long; calyx, open, segments long; basin, shallow, uneven; flesh, white, melting, juicy; core, small; "very good." October.

DUCHESS D'ANGOULEME.

Foreign. A valuable variety for market, on the Quince, and on the Quince only. It succeeds well at the Southwest. High culture of this variety produces very large and very good fruit, otherwise it is indifferent in size or character. Fruit, large, oblong obovate pyriform, dull greenish yellow, traced and dotted with russet; stem, rather long, stout; calyx, medium, partly open; basin, deep, uneven; core, below medium; seeds, oblong pyriform; flesh, white, buttery, juicy; "very good." An extremely variable fruit, unreliable. October. The striped Duchess d'Angoulême differs only in the fruit being striped yellow and green.

DUC DE BRABANT.

Miel de Waterloo,
Desirée Van Mons,
Beurré de Charneau,

Fondante des Charneuse,
Eccellentissima, *of some,*

Beurré de Waterloo,
Fondante du Comice.

Vigorous, productive, large, oval pyriform, angular, greenish shade, crimson in sun, greenish dots; stem, long, curved, flesh at base; calyx, large, open, segments persistent; basin, irregular, ribbed; flesh, whitish, granular, vinous; core, medium; "very good." October, November.

DUCHESS DE BERRI D'ETE.

Souverain d'Eté, | Duchess of Berry.

Foreign. This name has sometimes been applied to the Duchess of Angoulême, which is entirely distinct. Tree, moderately vigorous, spreading; shoots, reddish brown. Fruit, medium, roundish obovate, clear pale yellow, dotted with small russet specks; stem, short; calyx, small; seeds, large; flesh, yellowish white, rather coarse, melting, juicy, sugary. September and October. The Duchess de Berri is a synonym of "Pound."

DUCHESS DE MARS.

Captif de St. Helena.

Foreign. Fruit, below medium, oblong obovate, yellow, mostly covered with russet, ruddy in sun; stem, set without depression; calyx, small, closed; core and seeds, small; flesh, melting, juicy, perfumed; "very good," if not "best." This succeeds well, and this fruit is best grown on Quince. October and November.

DUC D'ORLEANS.

Foreign, new. Fruit, medium, obtuse pyriform, golden yellow, with reddish brown dark specks; stem, slender; flesh, white, juicy, melting, sugary, vinous. November, December.

DUNDAS.

Parmentier.

Foreign. Rather liable to drop before mature. Fruit, medium, obovate ovate, yellow, greenish black dots, deep red cheek in sun; stem, stout; calyx, small; flesh, yellowish, melting, perfumed; "very good." October and November.

DUNMORE.

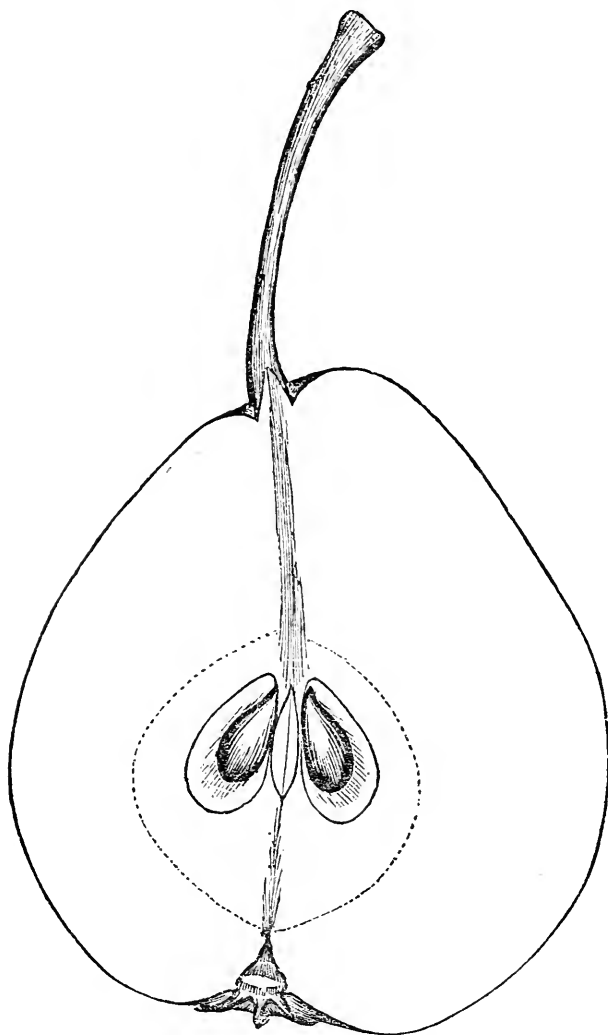

Foreign. A good grower and early bearer on pear roots; requires rich, high culture; shoots, slender, erect, brownish slate color. Fruit, large to very large (our drawing made from an unripe specimen); oblong obovate, greenish, dotted and speckled with brownish red russet, patches of rough russet near calyx; when not fully ripe, dark green specks underneath the skin; stem, rather long; fleshy at base; calyx, open; segments, much reflexed; core, rather large; flesh, yellowish white, buttery, melting; "very good." September and October.

DUPUY CHARLES.

Foreign. Tree, vigorous. Fruit, medium, pyriform; skin, rough, becomes yellow at maturity, and chiefly covered with fawn russet; flesh, whitish green, melting, juicy, very sugary. An excellent fruit, ripening the end of November. (Al. Poin.)

EARLY SUGAR.

Amiré Joannet, Joanette, St. John's Pear,	Archduc d'Eté, Sugar Pear,	Harvest Pear, St. Jean.
---	-------------------------------	----------------------------

Foreign. Only valued for ripening very early. Fruit, small, pyriform, light green to yellowish, faint blush; flesh, white, sugary; "good," if eaten just in perfection, otherwise mealy. July.

ELIZABETH. (Edwards.)

American. From New Haven, Ct. Fruit medium, roundish obtuse pyriform, angular, lemon yellow, russet specks and patches; stem, short; calyx, large, open; core, large; flesh, white, rather coarse, melting, juicy, vinous; "very good," often "best." October.

EARLY BUTTER OF CINCINNATI.

This is a variety which our Cincinnati Pomologists seem unable to recognize with any known description. We have been unable to examine the fruit in perfection, but some small specimens received, from which our drawing was made, induced a guess at Dearborn Seedling. The original tree at Cincinnati is said to have been probably brought from New Jersey. It is of upright growth, short-jointed, yellowish brown wood, forming a handsome symmetrical head. Fruit, small, oblong ovate, narrowing most to the stem, light greenish yellow, with dark green specks, rarely a bronzed red in sun; calyx, prominent; segments, bold, reflexed; core, compact; seeds, few, defective; flesh, white, juicy, buttery; "very good." Last July.

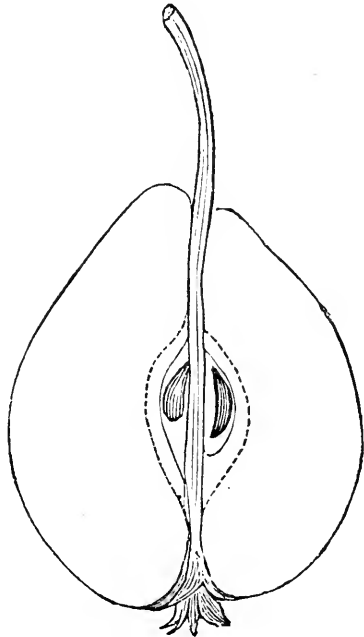

ECHASSERY.

Echasserie, Bezi d'Echassie,	Bezi de Chasserie, Jagdbirne.
---------------------------------	----------------------------------

Foreign. Poor grower. Fruit, medium, roundish oval, pale green, yellowish, dotted with gray when ripe; calyx, open; flesh, melting, buttery, sweet; "good." November and December.

EMILE D'HEYST.

This fruit is dedicated by Major Esperen to the son of his friend, L. E. Berckmans, of New Jersey.

A Belgian fruit. Tree of moderate vigor; a healthy and good grower, but straggling and not easily brought to a pyramidal form. It seems well suited to this climate and grows well on Quince. Young wood, fawn or light-brown, rather slender. Fruit, large, or above medium size, long calbasse form; color, light green, washed and waved with fawn and russet, becomes bright yellow at the time of maturity; stem, variable, but rather long, sometimes fleshy, inserted in an uneven cavity; calyx, small, set in a deep, narrow basin, surrounded by uneven protuberances; flesh, buttery, melting, very juicy, exceedingly fine, sugary and well perfumed. Ripening well through November. (L. E. Berckmans.)

EMILE BIVORT.

Dedicated by Bonvier, to the daughter of the distinguished Belgian Pomologist, A. Bivort.

Tree, of slow growth, but very hardy, with reddish or light brown, upright, stout, short shoots. Fruit, medium, oblate, inclining to conic, very much depressed; skin, deep orange-yellow, much covered with russet; stalk, short and fleshy, inserted in a rather deep cavity, surrounded by protuberances; calyx, small, inserted in a deep well formed basin; flesh, yellowish, buttery, melting, abounding in rich, sugary, vinous juice, with a peculiar flavor, somewhat resembling quince. Ripe October, November. (Berckmans.)

EYEWOOD.

Foreign. Tree, vigorous, branches very strong, stout, yellowish brown, with large white specks; fruit, below medium, obovate, pale greenish yellow, russet traces and specks; stem, long, slender; calyx, small, open; core, large; flesh, white, rather coarse, melting, juicy, sub-acid; "very good." October.

FIGUE OF NAPLES.

Figure de Naples,	}	Comtesse de Frenol,
Fig Pear of Naples,		De Vigne Pelone.

Foreign. Grown by some under name of Beurré Bronzé. Tree, vigorous, productive, shoots upright, brown; fruit, medium, oblong obovate, pale greenish yellow, dull red in sun, russety; calyx, small; stem, stout, fleshy knob at base; flesh, juicy, pleasant, breaking; "good." October.

FIG D'ALENCON.

Vert Longue de la Mayenne.

Medium, long, oval, curved, green, netted with russet; stem, short, thick at junction; calyx, open; basin, shallow; flesh, greenish, coarse; core, small; "good." October, November.

FIGUE.

Figure Vert.

Foreign. Tree, vigorous, hardy, productive on either Pear or Quince. Fruit, medium, oblong pyriform, green, much overspread with yellow and red russet; stem, stout, fleshily set upon the neck; calyx, open, without

divisions; core, rather large; flesh, white, juicy, melting, slightly perfumed; "very good." November.

FONDANTE SERRURIER DE MEILLOT.

Serrurier d'Automne.

Foreign. Fruit, medium, oblong obovate, yellow, with russet specks and blotches; stem, in a deep cavity; basin, shallow; flesh, melting, juicy, "good." October.

FONDANTE DES PRES.

Foreign. Fruit, medium, turbinate pyriform, greenish lemon yellow; stem, medium, fleshy at base; flesh, white, sweet, agreeable. October.

FONDANTE AGREEABLE.

Foreign. Fruit, medium, roundish obovate, yellowish green, slightly russeted; stem, planted angularly, fleshy at base; calyx, open; basin, shallow; flesh, tender, melting, juicy, delicately aromatic; very good, if not best; core, large; seeds, plump. August, September.

FONDANTE DE MALINES.

Fondante de Malines (Esperia.)

Foreign. Tree, vigorous, productive; fruit, medium, roundish obovate, pale yellow, traced and much covered with red russet and brownish red, occasional spot of vermilion in sun; stem, long; calyx, small; core, large; flesh, white, buttery, melting, sweet; "very good." October.

FONDANTE VAN MONS.

Foreign. Tree, good grower and productive. Fruit, medium, roundish obovate, greenish yellow, marbled with red and some russet specks; stem, stout, curved; calyx, large, open; core, large; flesh, yellowish white, coarse, melting, buttery, sweet; "very good." October.

FORELLE.

Trout Pear, | Poire Truite, | Forellenbirne.

Foreign. Deserves more attention than it has yet received. Tree, vigorous, productive on Quince or Pear; wood, violet red, young shoots, downy. Fruit, medium, oblong obovate, dull yellow in shade, vermilion in sun, grayish dots, margined with crimson; stem, slender; calyx, partly open; core, medium; flesh, white, fine-grained, buttery, melting, juicy, vinous; "very good" or "best." October, November.

FREDERICK OF WURTEMBERG.

Frederick de Wurtemberg.

Foreign. Well known and extensively grown in this country. Tree, very early and productive bearer; young wood, strong, yellowish brown; fruit decays rapidly at core, often worthless ere the grower thinks it ripe. Fruit, large, angular pyriform, uneven surface, dull yellow, crimson cheek; stem, stout, usually set on or thickening into the fruit; calyx, open; basin, shallow; flesh, white, juicy, melting; "good." September.

FLEUR DE NEIGE.

Snow Flower.

Foreign. Fruit, medium or above, tapering by a mamelon protuberance to its junction with the stem which meets it by a fleshy enlargement; calyx, small, partially closed, in a small, shallow basin; surface, very uneven; color, yellowish green, mottled with thin russet; flesh, somewhat granular and coarse, but sweet and high flavored. Ripens middle of October.

FLORIMONT PARENT.

Foreign. Tree, of moderate vigor and fertility. Fruit, very large, pyramidal, swelled towards its centre; skin, green, pointed and striped with brown russet, becomes deep yellow at maturity; flesh, coarse, melting, juicy, sugary, and agreeably perfumed. End of September. (Al. Pom.)

FRANKFORD.

Origin, on the premises of Eli Merkins, near Frankford, Philadelphia. A new fruit, and said to be an acquisition. Size, medium, roundish, sometimes inclining to pyriform, not unfrequently obovate; skin, yellow, containing many russet dots, especially towards the crown, and having occasionally a faint blush on the part exposed to the sun; stalk, rather short, thick, and fleshy at its termination, inserted in a small cavity; calyx, medium, open, set in a shallow, moderately wide basin; flesh, fine texture and buttery; flavor, exceedingly rich, with a delicious aroma; quality, "best." November. (Int. Rept.)

FRANKLIN.

Native of Georgia. Fruit, large, oblong turbinate, irregular, narrowing to the eye; green, clouded with shades of darker green, and dotted with dark green gray dots; basin, shallow, oblique; stem, medium, one side fleshy at base; flesh, melting, juicy, sweet. January. Valued South.

FREDERIKA BREMER.

Virgalieu, *erroneously, of some.*

American. From Oneida Co., N. Y. Fruit, above medium, roundish obovate, obtuse pyriform, greenish, becoming pale yellow with slight russet dots; stem, one to one and a half inch long, rarely a cavity; calyx, open, short, erect segments; basin, rather deep, slight furrows; core, medium; seeds, blackish; flesh, white, a little coarse, melting, juicy. Quality, variable; often only "good." October, November.

GANSEL'S BERGAMOT.

Broca's Bergamot,		Staunton,		Gurle's Buerré,
Ives' Bergamot,		Bonne Rouge,		Diamant.

Foreign. An old variety, with few superiors when well grown. It requires, a warm, rich soil; on cold clay it is almost tasteless. Tree, vigorous, spreading, succeeds well on Quince, productive. Fruit, large, roundish obovate, yellowish brown russet, red in sun, russet dots and patches; stem, short; cavity, deep; calyx, open; basin, deep; core, large; flesh, yellowish white, coarse, melting, juicy; "very good," or "best." October.

GANSEL'S LATE BERGAMOT.

Foreign. An new variety recently introduced, very much resembling the preceding, except its period of maturity being extended into December. It is also said to have less color in sun, and the flesh entirely free from granulations. Tree, vigorous, and productive on the pear root.

GANSELL'S SECKEL.

Medium, oblate, rough, uneven; yellow, with thin russet; stem, short, stout, inserted in a broad, shallow cavity; calyx, closed; basin, abrupt; flesh, coarse, aromatic; "very good." November.

GENERAL DE LOURMEL.

Foreign. Fruit, medium size, resembling Doyenné; skin, greenish, irregularly spotted and dotted with russet; flesh, delicate, juicy, melting, sugary. Ripening in November. (Leroy's Cat.)

GENERAL TAYLOR.

Native of Maryland. The tree supposed to be the original one grows near Baltimore, and is 25 or 30 years old.

Size, under medium; form, turbinate, obscurely pyriform, broad at the crown; color, cinnamon russet, becoming fawn on the exposed side; stem, inserted into a very small cavity; calyx, partially closed, set in a broad, not very deep, furrowed basin; core, medium; seeds, dark brown, ovate, no angle at the obtuse end; flesh, yellowish white, granular, becoming buttery and melting, but somewhat gritty at the core; flavor, as high as the Seckel, aroma, delicious; quality, "best." November. (Ad. Int. Rept.,

GERARDIN.

Fruit, medium, roundish, somewhat irregular; skin, yellow, with many spots and patches of rough russet, and a reddish tint towards the sun; flesh, coarse, buttery, astringent, granular, tolerably good. September.

GIDEON PARIDANTE.

Foreign. Fruited with us this year for the first time. Fruit, medium, obovate pyriform, yellowish green, with brown red cheek in sun, and marbled red russet over surface; stem, one and a half inch long, angularly planted, with a lip one side; calyx, open, narrow segments; basin, shallow; core, medium; flesh, white, melting, sugary; "very good," nearly "best." Last September and October.

GLORY OF COMBRONE.

This variety we have fruited several years upon the pear stock. It is a fine grower, healthy and hardy, and deserves extensive cultivation. Fruit, above medium, or nearly large, oblong pyriform, regular; skin, yellowish, mostly overspread, marbled and dotted with warm brownish yellow russet; stem, $\frac{3}{4}$ inch long, moderately stout, and planted in a slight cavity; calyx, medium size; segments, open, reflexed; basin, medium depth, regular; flesh, whitish yellow, granulated, almost buttery, melting, juicy, abounding in saccharine, high-flavored, delicious; core, small; seeds, nearly black oblong pyriform acuminate. Twentieth September to tenth October.

GRAND SOLEIL.

Foreign. Tree, vigorous, erect, well-formed, productive. Fruit, medium, roundish, orange yellow, with a russety red blush, few russet specks; stem, medium, swollen at base; calyx, small, closed; core, large; seeds, obovate; flesh, yellowish white, little coarse, buttery, melting, sugary, aromatic; "very good," nearly "best." November.

GRASLIN.

Large, oval pyriform, green, sprinkled with russet, stem, thick at junction; calyx, open; segments stiff; basin, abrupt, furrowed; flesh, whitish, granular, juicy, rich, vinous; core, large; "very good." October, November.

GREEN MOUNTAIN BOY.

American. Fruit, medium or above, roundish obovate, sometimes angular pyriform; stem, varying; calyx, open, reflexed segments; golden yellow or russety yellow, with numerous russety brown specks; core, rather large; seeds, long, flattened; flesh, yellowish, melting, juicy, sweet; "very good." October.

GROOM'S PRINCESS ROYAL.

Foreign. Fruit, of medium size, roundish; skin, greenish brown, with tinge of brownish red, and some russet tracings; stalk, short and thick, set in a very trifling depression; calyx, small, open, set in a shallow basin; flesh, buttery, melting, a little gritty near the core, but sweet and high-flavored. January and February.

GROSSE MARIE.

Foreign. Fruit, medium, oblate pyriform; skin, yellow, covered with cinnamon russet; stalk, inserted without depression; calyx, partially closed; flesh, juicy, tender, with a rich, perfumed flavor resembling Brown Beurré. October.

GROS ROUSSELET D'AOUT.

Foreign. Tree, vigorous, of pyramidal form, very productive. Fruit, medium pyriform; skin, green, becoming golden yellow at maturity, shaded with russet and spotted with fawn; flesh, whitish, fine, melting, very juicy, sugary, vinous, deliciously perfumed. Ripens in August. (Al. Pom.)

HACON'S INCOMPARABLE.

Downham Seedling.

Foreign. A hardy, productive variety; spreading, rather drooping branches; deserves more attention than yet received, young shoots slender, olive color, diverging; fruit, rather large, roundish obtuse pyriform, dull yellowish green and pale brown, with many russet streaks and dots; stem, rather long, straight; calyx, with small divisions; basin, shallow; flesh, white, buttery, melting, sugary, juicy, nearly if not quite "best." October, November.

HAGERMAN.

Hampton.

American. From Flushing, L. I. Fruit, small, roundish yellow, overspread with thin golden russet, red cheek in sun; stem, short, stout; calyx, open, segments, reflexed; basin, shallow; core, small; seeds, broad ovate; flesh, juicy, sprightly, pleasant; "very good." September.

HADDINGTON.

Smith's Haddington.

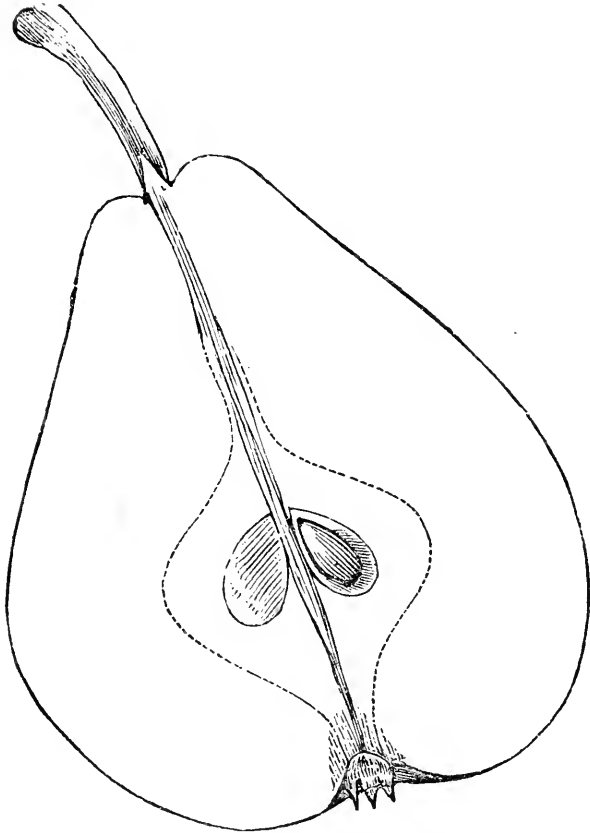

American. From seed of Pound Pear, grown by J. B. Smith, Esq., at Haddington, Pa. Tree, vigorous, productive. Fruit, above medium, oblong obovate pyriform, greenish yellow, brownish cheeks, and russet dots and patches; stem, medium; cavity, shallow; calyx, medium; segments, short, erect; core, medium; seeds, long, ovate; flesh, yellowish, juicy, aromatic; "very good." January to April.

HAMPTON.

Cluster Pear.

American. Originated with W. C. Hampton, Ohio. Very productive, fruit hanging in clusters. Fruit, small, roundish, slightly obovate flattened, in most specimens, a distinct suture half around like unto a plumb; color, light yellow ground, mostly overspread with reddish russet in sun, and russet marbling in shade, whitish gray dots on the sunny side; stem, $\frac{1}{2}$ to $\frac{3}{8}$ inch long, slightly curved, generally set without depression, and fleshy at base; calyx, open; segments, fine, disconnected, partially reflexed; basin shallow; flesh, white, juicy, buttery, melting, delicious flavor; core, medium; seeds, plump, brownish black. August.

HAMPTON VIRGALIEU.

Originated with W. C. Hampton, of Mount Victory, Hardin Co., O., from a seed of the White Doyenné. Tree, vigorous, hardy, very productive.

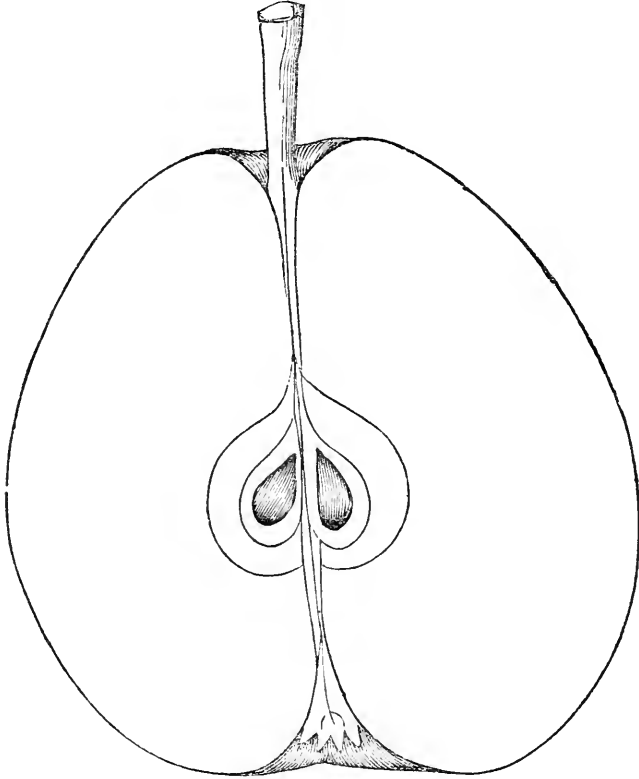

Fruit, medium size or above, globular, or slightly obtuse pyriform, yellowish green, with many russet dots and marblings of russet, the russet becoming reddish brown in sun; stem, short, stout, with little or no cavity; basin, moderately deep, regular; calyx, with five segments, nearly erect, open; flesh, white, buttery, juicy, rich, vinous, excellent; core, small, eatable even to the capsules; seeds, full, oblong pyriform. Oct and Nov.

HANNERS.

Hamus.

Origin, uncertain; has generally been considered a synonym of Cushing, but proves distinct; Mr. C. M. Hovey, first pointed out the error. Shoots, upright, brownish yellow. Fruit, medium, oblong, rounded at crown, obtuse at stem, yellowish green to pale yellow, with large pale russet patches and dots; stem, stout, swollen at base; calyx, small, open; core, large; flesh, white, melting, juicy, vinous; "very good." September.

HANOVER.

From Hanover furnace, New Jersey. In size it is usually rather small, round obovate, green, with dull green russet markings, and a brown cheek;

stem, one inch, shallow cavity, usually angular; calyx, open, plaited, sometimes furrowed, irregular basin; seeds, large, plump, acuminate; flesh, greenish yellow, melting, juicy, pleasant; "good." (W. D. B.)

HARVARD.

Boston Epargne, | Cambridge Sugar Pear.

American. Native of Cambridge, Mass. Tree, hardy, vigorous, upright, productive. Fruit, medium, oblong pyriform, russety olive yellow, reddish cheek; stem, rather stout, not sunk; calyx, small; basin, narrow; seeds, long, obovate; flesh, white, juicy; "very good;" liable to decay at core. September.

HAWE'S WINTER.

Origin, King and Queen counties, Va., on the farm of the Hawe's family. Tree, vigorous and productive. Fruit, large, roundish, slightly flattened; color, at maturity, dull yellow, with russet spots; flesh, a little coarse, very juicy, rich, sweet, vinous. November to January. (H. R. Roby.)

HEATHCOT.

Gore's Heathcot.

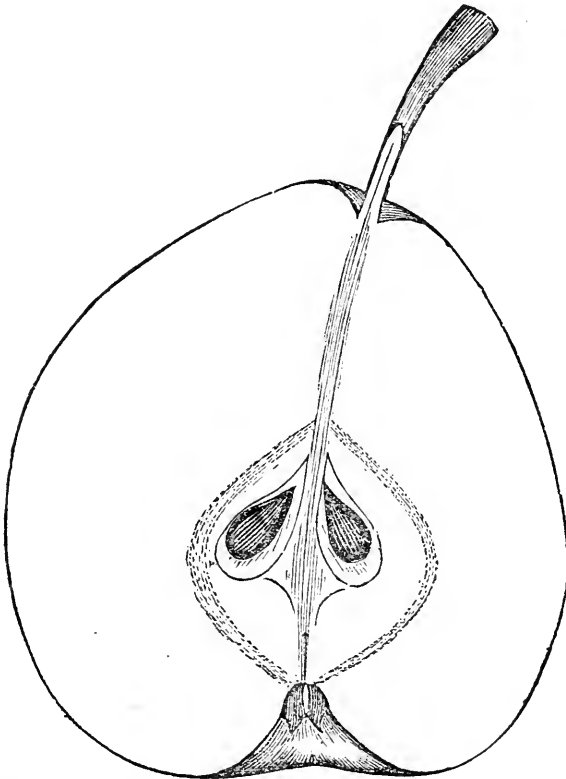

Native of Waltham, Mass. Tree, hardy, a moderate grower, branches slender, when grown makes a compact head unless well thinned out; young shoots reddish brown.

Fruit, medium or above, obovate rounded; skin, rough; color, greenish

yellow, yellow increasing at maturity, some russet around stem and eye, stem, medium; cavity shallow; calyx, partly closed; basin, narrow; core, above medium; seeds, dark brown, pointed; flesh, white, buttery, juicy, vinous and sprightly. October.

HENKEL.

Foreign. Tree, fine grower, young shoots, grayish brown; an early, very productive bearer on pear roots; valuable for orcharding. Fruit, large obovate, somewhat obtuse pyriform, dull yellow, patches of russet and green specks; stem, long, curved; calyx, open; segments, short; basin, uneven; core, medium; flesh, yellowish white, rather coarse, juicy, vinous, "very good." Early September.

HENRIETTA.

Edwards' Henrietta.

American. Native of New Haven, Conn. Tree, vigorous, hardy, productive. Fruit, medium, obovate obtuse pyriform, dull yellow crimson spots in sun, russet at base of stem; calyx, closed; basin, furrowed; core, large; flesh, white, rather coarse, melting, juicy; "good." Last August.

HENRIETTA.

Foreign. Fruit, small or medium, turbinate; skin, rough, almost entirely covered with russet; flesh, white, half fine, melting, abounding in juice, sugary, agreeably perfumed. A very good fruit, ripening in November. (Al. Pom.)

HENRI BIVORT.

Foreign. Tree, very vigorous. Fruit, large, obtuse pyriform; calyx, open; skin, smooth, pale green, with brownish specks; flesh, yellowish white, half buttery, juicy, melting, perfumed. September.

HENRY THE FOURTH.

Ananas,		Beurré Ananas,		Jaquin.
Poire Ananas,		Henri Quatre,		

Foreign. Tree, hardy, good bearer, young shoots diverging, yellowish brown. Fruit, small, roundish pyriform, greenish yellow, with small gray dots; stem, long, slender, swollen at base; calyx, small; flesh, whitish, rather coarse, juicy; "good." Early September.

HERICART DE THURY.

Foreign. A good grower, of peculiar habits and appearance, rather pyramidal, but with diverging, crooked limbs of a deep brown or purple hue. Not an early nor a very profuse bearer.

Fruit, pyramidal, turbinate; skin, rather rough, with a decided cinnamon color; stalk, long, and curved, inserted in a small abrupt cavity calyx, closed, deeply sunk; basin, uneven. Flesh, yellowish, compact, buttery, sufficiently juicy, with a peculiar rich flavor. January and February. (L. E. Berckmans.)

HERICART.

Foreign. Fruit, large, obtuse pyriform, light pale greenish yellow, russet dots and patches; stem, long, slender; calyx, small; segments, reflexed; core, small; seeds, long; flesh, rather coarse, breaking, juicy, very sweet; "very good." Early September. Some specimens we have had of this proved almost best; we think it improves with age of trees.

HONEY.

This is a delicious little pear, received some year since by Professor Kirkland, and which we have been unable to recognize with any description published, if we except a slight note in Prince's Pomological Manual. The tree is moderately vigorous; wood, yellowish brown, an early and productive bearer of fruit, uniform in size and regular shape. Our drawing is too small.

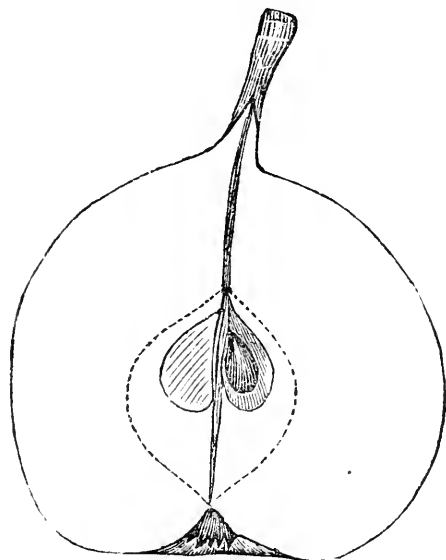

Fruit, below medium, roundish, tapering slightly to the stem; color, rich golden russet yellow, with faint blush, many small red russet dots, and occasional patches of brown russet; stem, rather stout, uneven, without depression; calyx, with open half reflexed segments; basin, shallow, little russeted; core, medium; seeds, ovate, blackish; flesh, yellowish white, juicy, buttery, a little coarse-grained, sweet, perfumed. Ripe a few days before Bartlett.

HOVEY.

Foreign. Fruit, medium size, pyriform, regular, resembles the Beurre Capiaumont; skin, fair, smooth, yellow, speckled and dotted around the eye; calyx, set outside; stem, obliquely inserted; flesh, yellow, melting, juicy, sugary, perfumed and vinous. September.

HOSEN-SCHENCK.

Schenck's Pear,
Smokehouse,

Schenck's August Watermelon,
Butter Pear.

American. From Pennsylvania. Fruit, large, obovate, yellow, melting not high flavor; quality, variable. Last of August.

HULL.

American. Native of Somerset, Mass. Tree, vigorous, upright; wood, reddish brown. Fruit, medium, obovate, yellowish green, dull red, and russet; stem, long; calyx, half open; core, large; flesh, white, rather coarse, gritty at core, juicy; "good." October.

HUNTINGTON.

From New Rochelle, N. Y. Below medium, ovate obovate, green with a slight crimson tinge near calyx; stem, long, slender; deep, broad, uneven cavity; calyx, closed; basin, abrupt, dotted with a few russet circles; flesh, melting, juicy, buttery, delicate. Tree an early bearer. September.

INCONNUE VAN MONS.

Foreign. Best on Quince. Fruit, medium, oblong pyriform, dull, pale green, traces and dots of russet; stem, long, slender; calyx, open; basin,

deep; flesh, melting, buttery, "very good." December to February. (Wilder, in Hort)

ISLAND.

From Gowanus, L. I. New. Said to be of medium size, pyramidal form, and, when ripe, a pale yellow, rich aromatic flavor, and very productive.

IVES' BERGAMOT.

Raised by Dr. Eli Ives, New Haven, Conn. Tree closely resembles the Seckel, and is very productive. Fruit, medium or small, Bergamot shape, protuberant at calyx; skin, greenish yellow, with slight traces of russet; stalk, short and thick, inserted by a ring or lip; flesh, rather coarse, buttery, melting, juicy, with a Gansel's Bergamot flavor. Ripens first of September. (Downing.)

IVES' PEAR.

Raised by Dr. Eli Ives, New Haven, Conn. Tree, vigorous and very productive. Fruit, small, irregularly turbinate, inclined; skin, greenish, with a brownish red cheek; stalk, long, inserted by a fleshy ring or lip; calyx, open; basin, very small; flesh, juicy, melting, sugary, and good. Ripens first of September.

IVES' SEEDLING.

Raised by Dr. Eli Ives, New Haven, Conn. Fruit, nearly medium, somewhat globular; skin, greenish yellow, shaded with crimson; stalk, short and thick; calyx, small, nearly closed; basin, shallow and irregular; flesh, whitish, coarse, and granular, juicy, melting, with a refreshing sugary flavor, well perfumed. Ripe about the first of September.

IVES' VIRGALIEU.

American. Below medium, pyriform, greenish, shades dull crimson, russet dots; stem, fleshy at base, or with a lip; calyx, small, open; basin, irregular; flesh, whitish, granular, juicy, sweet, vinous; "good," or "very good." October.

JACKSON.

Origin, New Hampshire. Tree, vigorous and productive. Fruit, medium, oblate, short pyriform, or turbinate; skin, greenish yellow, somewhat russeted; stalk, long and curved, fleshy at its junction, inserted in a slight cavity; calyx, small and open, set in a rather deep, abrupt basin; flesh, white and juicy; flavor, brisk and vinous. Ripens the last of September. (Downing.)

JACKSON'S SEEDLING.

Originated by S. S. Jackson, Cincinnati, from seed of the Seckel. Size, below medium, larger than Seckel; color, similar, but less russety; flavor, very good, not as spicy as the Seckel. Tree, moderately vigorous, and does well on Quince.

JAMINETTE.

Josephine,		Sabine,		Beurré D'Austrasie,
Colmar Jaminette,		D'Austrasie,		Wilhelmine.

Foreign. Tree, vigorous, not an early bearer. Fruit, above medium, obovate obtuse pyriform, green, with russety brown dots and patches; stem, stout; calyx, open; flesh, white, rather gritty at core, juicy, sweet; "good." November, December. This has proved with us, for two years past, a great bearer, and one of the best of Winter Pears.

JARGONELLE.

Epargne,
Grosse Cuisse Madame,
Beau Present,
Poire de Tables des Princes,

Saint Sampson,
Saint Lambert,
Sweet Summer,

Real Jargonelle,
Jargonelle of the English,
Belle Verge.

Foreign. An old variety, abundant bearer, now surpassed, for all except large collections by more recently originated sorts. Fruit, large, long, ovate pyriform, greenish yellow, little brown in sun; stem, long; calyx, open, prominent; flesh, yellowish, coarse, juicy; "good," often "very good." August.

JEAN DE WITTE.

Nos. 1,482, 1,082, and 1,602 of Van Mons.

Foreign. Tree, moderate growth, short-jointed wood, upright. Fruit, medium or above, obovate, narrowing to the stem, pale yellow, little russet; flesh, melting, juicy, vinous, slightly sub-acid; "very good." November to January.

JERSEY GRATIOLI.

Foreign. Tree, moderately vigorous, abundant bearer, succeeds on Quince; wood, stout, short-jointed. Fruit, large, roundish oblong obovate, slightly angular, greenish yellow, blush in sun, russet specks, and also at base of stem and crown; stem, stout, obliquely inserted; calyx, open, short segments; core, medium: flesh, yellowish white, little coarse, melting, juicy, vinous. September, October. (Hov. Mag.)

JOHONNOT.

Franklin.

American. Native of Salem, Mass. Tree, moderate, healthy grower, upright, spreading; wood, dark reddish brown; suited to orcharding in our Western rich soils; productive. Fruit, below medium, roundish obovate, angular, greenish yellow, dull russet; stem, stout, fleshy at base, calyx, large, open; core, large, seeds, small; flesh, white, rather coarse, melting, juicy, vinous; almost "best." September.

JONES.

Small, acute pyriform, cinnamon russet, reddish in sun, juicy, buttery, sweet; "very good." November.

JOSEPHINE DE MALINES.

Foreign; not an early bearer or a good grower; best on Pear. Fruit, medium, roundish obovate, yellow blush in sun, traces and specks of russet; calyx, open; core, large; flesh, yellowish white, melting, fine, juicy, vinous; "very good." December, January.

JULES BIVORT.

Foreign. Tree, moderate grower, productive. Fruit, large, obovate, dull greenish yellow dotted with brown, and red tinge in sun; flesh, yellowish white, melting, half buttery, sugary, vinous. November.

JULIENNE.

Origin uncertain. Tree, thrifty, upright, light yellowish brown shoots, productive, and in warm, rich, sandy soils often very fine; in cold clay it is inferior; best on Quince. Fruit, below medium, roundish oblong obo-

vate, clear bright yellow, with a little of fine russet marblings and patches, stem, rather stout; calyx, small, closed; core, compact; seeds, blackish; flesh, white, rather coarse, half buttery, sweet; "very good." August.

KING EDWARD'S.

Jackman's Melting.

Foreign. Tree, thrifty; shoots, upright, dark brown. Fruit, large, pyriform, yellow, with patches of dull russet, red cheek in sun; stem, short; calyx, small; flesh, yellowish, buttery, melting, variable; "good." October.

KINGSESSING.

Leech's Kingsessing.

American. Native of Kingsessing township, near Philadelphia. Tree, upright, vigorous, somewhat thorny; young shoots, yellowish green or brownish olive, gray dots. This, when better known, will, we think, take position in first class. It is, however, not a very early bearer, and on Quince, requires double working. Fruit, large, or above medium, obovate, sometimes obtuse pyriform, sea-green, with patches of dark green; stem, stout, fleshy at base; calyx, small; basin, shallow; flesh, buttery, delicate; "best." Last August.

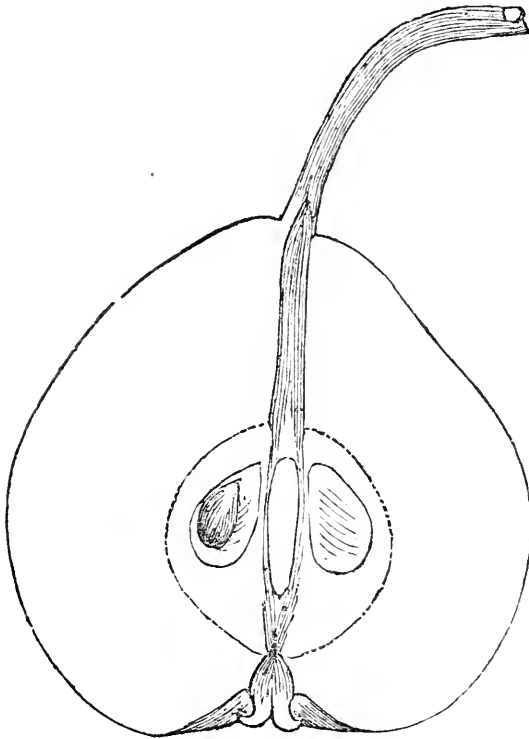

KNIGHT'S SEEDLING.

Knight's R. I. Seedling.

Native of Cranston, R. I. Tree, vigorous, hardy, and early productive; wood, smooth, yellowish.

Fruit, medium, obovate, tapering a little to the stem; color, yellowish green, with a brown red cheek in sun, brownish specks, and dull russet around the calyx; stem, medium or rather long, curved; calyx, medium; segments, broad, partially reflexed; core and seeds, medium; flesh, white, not fine-grained, melting, juicy, sugary. September.

KNIGHT'S MONARCH.

Foreign. A variety requiring very high culture; wood, light olive color. Fruit, large, obovate oblong, yellowish brown, tinged with red, dotted with gray; stem, short; calyx, open; flesh, yellowish white, melting, juicy. January.

LAS CANAS.

Foreign. Tree, upright, vigorous, early, good bearer. Fruit, medium or below pyriform, pale yellow, partly covered with thin russet, seeds, black; flesh, juicy, sweet, nearly "best." October.

LA JUIVE.

Foreign. Tree, vigorous; branches, upright. Fruit, above medium, pyriform, yellow, with gray specks; stem, short; flesh, yellowish, buttery, juicy. October.

LAMORICIERE.

General Lamoriciere.

Foreign. Fruit, medium, pyriform, gray, with green dots; stem, stout, calyx, large, closed; flesh, greenish white, melting, buttery, juicy. Last September.

LAHERARD.

Foreign. Fruit, above medium, obovate, obtuse pyriform, lemon yellow, brownish red cheek in sun; calyx, closed; stem, stout; flesh, white, melting, juicy, pleasant, sub-acid; "very good." October. Succeeds on Quince.

LAURE DE GLYMES.

Foreign. Tree, productive. Fruit, medium, oval turbinate, dull yellow, nearly covered with orange russet; stem, short; calyx, open; flesh, white, melting, juicy, pleasant; "good." October, November.

LENAWEE.

Origin, uncertain. Grown at Adrian, Michigan, and introduced by Dr. D. K. Underwood of that place, and description made by T. M. Cooley.

Fruit, medium to large, ovate pyriform, generally more or less one-sided, surface frequently irregular; skin, lemon yellow, with small russet specks, and a lively vermilion cheek in the sun; stalk, an inch long, curved, inserted without depression, sometimes below a fleshy protuberance; calyx, small, set in a shallow basin; flesh, yellowish white, tender, buttery, with a high and quite peculiar aromatic flavor. Ripens first to middle of August (Downing.)

LEOPOLD I.

Foreign. Tree of moderate vigor. Fruit, large, turbinate pyriform; skin, smooth, green, spotted with brown russet; flesh, whitish, melting, buttery, juicy, sweet, and strongly perfumed. Ripens middle of December and keeps till January. (Al. Pom.)

LEE'S SEEDLING.

American. Native of Salem, Mass. Fruit, medium, roundish oval, greenish russet, brown in sun; stem, short; calyx, open; core, large; flesh, white, coarse, juicy; "good." September.

LIBERALE.

Foreign. Fruit, rather large, elongated, truncate pyriform; skin, greenish yellow, sprinkled with brown or russet, and having patches of russet; stem, long, curved, inserted in a cavity at an inclination; calyx, large and open; basin, broad and shallow; flesh, juicy, melting, sweet, rich and peculiarly aromatic. October.

LIEUTANANT POIREVIN.

Foreign. Fruit, of large size, resembling in color *Glout Morceau*; skin, yellow, netted and spotted with russet; flesh, white, juicy, half melting. Ripe from February to April. (Leroy's Cat.)

LIMON.

No. 8 of Van Mons, | Beurré Haggenton.

Foreign. This promises to take a first-class rank. Tree, moderately vigorous; shoots, long, slender, reddish brown. Fruit, above medium, obovate roundish, yellow, with faint red cheek; stem, rather short; basin, shallow; flesh, white, melting, juicy, nearly "best." August.

LOCKE.

Locke's New Beurré.

American. From West Cambridge, Mass. Fruit, medium, roundish obovate, yellowish green, spotted with shades of darker green and russet; stem, medium; calyx, small, half closed; flesh, greenish white, juicy, vinous; "good." November and December.

LOUIS DUPONT.

Foreign. Tree, vigorous and beautiful, promises to be fertile. Fruit, sufficiently large, sometimes in the form of *Doyenné*, but ordinarily longer and more turbinate; skin, smooth, dull green, passing to yellow at maturity, strongly shaded with fawn russet, sometimes striped and marbled; flesh, white, half fine, melting, juicy, sweet, and perfumed. A fruit of first quality, ripening towards the end of October. (An. Pom.)

LYCURGUS.

A variety originated by Geo. Hoadley, Esq., of Cleveland, from seed of the *Winter Nelis*, collected from fruit grown on a *Winter Nelis* tree in close proximity to a tree of *Martin Sec*. The fruit has outward form, and russet yellow skin, closely resembling the *Martin Sec*, and its texture melting and juicy and sprightly, as the *Winter Nelis*, but with the sweet saccharine of the *Martin Sec*.

Fruit, below medium, generally oblong pyriform, occasionally oblong obovate pyriform; color, rich dull yellow, overspread with brownish yellow russet; stem, usually three-fourth inch long, slender, set without depression, and one side a slight lip; calyx, large in proportion to the size of fruit, open; segments, connected: basin, shallow; flesh, yellowish, hard, and of breaking texture, until fully ripe, when it becomes melting, juicy, and extremely sweet, with a spicy, sprightly, and slightly vinous character; core, compact; seeds, large; capsules, close. January.

MADAME ELIZA.

Foreign. Tree, vigorous, wood stout. Fruit, large, pyriform; skin, smooth, bright green, and becomes almost yellow at maturity; flesh, rosy, fine, buttery, melting, abounding with sweet juice, very agreeably perfumed. November. (Al. Pom.) Excellent in Belgium, promising well here. The tree is hardy, but has an awkward, rather crooked, and declining habit, and very narrow leaves. The young shoots are olive gray.

McLAUGHLIN.

Origin unknown; probably an American seedling. Tree, moderate, healthy grower, productive. Fruit, above medium, oblong obtuse pyriform, pale yellow, with brownish red in sun, stem, short, swollen at junction with tree; calyx, open; core, medium; flesh, yellowish white, a little coarse juicy; "very good." November and December.

McLAUGHLIN.

A native of Maine, first described in the *N. E. Farmer*. Tree, hardy and vigorous.

Fruit, large, elongated, obtuse pyriform; skin, rough, greenish, mostly covered with russet, which becomes yellowish at maturity, with a warm, sunny cheek; stalk, short, inserted at an inclination, with some appearance of a lip; calyx, open, set in a shallow, corrugated basin; flesh, whitish, not very fine, juicy, and melting; flavor, sweet rich, and perfumed. November to January.

MADAM DUCAR.

Foreign. Tree, pyramidal, vigorous, productive. Fruit, medium, oval, slightly depressed at base and crown; skin, smooth, bright green, becoming yellow at maturity; flesh, white, half fine, very juicy, sugary, and slightly perfumed. Ripens the middle of August. (Al. Pom.) Good in Belgium.

MALCONAITRE D'HASPIN.

Foreign. Fruit, large, roundish obovate, dull yellow, brownish red cheek, coarse dots, russet at calyx; stem, set in a slight depression; calyx, closed; basin, deep; flesh, juicy, tender, sub-acid, perfumed; core, medium; seeds, small. Tree, vigorous, hardy and productive. Promises to prove valuable.

MALCOMAITRE.

Foreign. We suppose this name to be only a synonym of the foregoing, but our tree, received of Ellwanger and Barry, produces a small, greenish yellow fruit, with a coarse, yellowish flesh, rotting at core, and ripening in August.

MARTHA ANN.

Dana's Seedling, No 1.

American. Fruit, above medium, obovate oblong, smooth, yellow, with russet specks; calyx, closed; flesh, white, juicy, tender, sub-acid, "good."

MARIANNE DE NANCY.

Foreign. Tree, moderate grower. Fruit, medium, greenish yellow, streaked and dotted with russet; flesh, white, juicy, melting, sugary, vinous. September and October.

MARIE PARENT.

Foreign. Tree, moderately vigorous. Fruit, large pyriform, surface uneven; stalk, short, inclined; calyx, in a large furrowed cavity; skin, golden yellow at maturity; flesh, white, very fine, melting, somewhat buttery, very juicy, sugary, and deliciously perfumed. October. (An Pom.)

MARIE LOUISE.

Forme de Marie Louise, Marie Chretienne,		Princes de Parme, Braddick's Field Marshal,		Marie.
---	--	--	--	--------

Foreign. Tree, vigorous, rather straggling, or diverging and drooping, with olive gray colored shoots; requires rich, warm, sandy soil, otherwise it is only a "good" pear. It is hardy and productive. Fruit, large, oblong pyriform, dull green, becoming pale yellow, with marblings, dots and patches of russet, and russet at crown and base of stem; stem, medium, obliquely set in a slight cavity, or with a raised lip on one side; calyx, open, irregularly formed; segments, connected; core, small; seeds, broad, ovate; flesh, white, buttery, melting, juicy, vinous; "very good." Last of September and October.

MARCH BERGAMOTTE.

Foreign. Fruit, medium, obovate, greenish yellow; flesh, buttery, gritty at core; "good." March.

MARTIN SEC.

Roussellet d'Hiver,

Foreign. Fruit, medium, or below, obovate angular, yellow, with small specks, bright red one side: stem, long, slender; calyx, in an abrupt furrowed basin; flesh, yellowish, half melting, juicy; "good." December.

MATHER.

Originated with John Mather, near Jenkinstown, Montgomery Co., Pa.

Fruit, below medium size, obovate; skin, red, with occasionally a mottled cheek, and russeted around the stem, which is obliquely inserted by fleshy rings without depression; calyx, medium; basin, very small; flesh, a little coarse, but buttery; flavor, delicate and pleasant. August. (Ad. Int. Rep.)

MAYNARD.

Origin unknown; grown in Lancaster Co., Pa. Fruit, medium, obovate pyriform; skin, yellow, with russet dots and a crimson cheek; stalk, obliquely inserted, fleshy at its junction; calyx, open, in a slight depression; flesh, white, juicy, and sugary. Ripe last of July. (Dr. Eshleman.)

MERRIAM.

American. From Roxbury, Mass. Tree, thrifty, productive, supposed a seedling from Gray Doyenné. Fruit, large, roundish, dull yellow, much covered with smooth pale russet; stem, short; calyx, small, closed; flesh, yellowish white, coarse, juicy, sugary: core, large: seeds, dark brown. Last of September. (Hov. Mag.)

MIGNONNE D'HIVER.

Foreign. Fruit, medium, obovate, inclining to pyriform; skin, very rough, russet; stalk, stout, inserted by a lip, often at a great inclination; calyx, partially closed, set in a small basin: flesh, yellowish, juicy, granular, nearly melting, brisk, sweet, and rich, slightly astringent. November.

MILLOT DE NANCY.

Foreign. A pyramidal tree, very fertile, producing at the same time at the extremity of its branches and its long spurs.

Fruit, small, or medium, regularly pyriform; skin, smooth, light green,

becoming yellow a long time before its maturity; flesh, whitish yellow, buttery, melting, not deficient in juice, sugary, and very agreeably perfumed. October, November. (A. Pom.)

MILLOT DE NANCY.

Foreign. Fruit, medium, obtuse pyriform, pale yellow, with patches and traces of russet; flesh, melting, juicy, sugary; "good." January. (Wilder, in Hort.)

MITCHELL'S RUSSET.

Origin Bellville, Illinois. Fruit, medium, or small, obovate, inclining to conic; skin, rough, dark russet, thickly covered with gray dots; stalk, long, inserted in a small cavity by a ring or lip; calyx, open; basin, uneven; flesh, juicy, melting, rich, highly perfumed. November. (Downing.)

MOCCAS.

Foreign. Tree, very vigorous, rapid growth, and productive. Fruit, medium, obovate roundish, greenish yellow, brown check in sun, and a few russet dots; stem, long, curved; calyx, partly open; flesh, yellowish, melting, juicy; "very good." December.

MONSEIGNEUR AFFRE.

Foreign. Fruit, medium, roundish, somewhat angular; skin, rough, greenish, considerably covered with thick russet, and thickly sprinkled with russet dots; stalk, long, curved, inserted in a moderate cavity; calyx, small, open, persistent; basin, broad; flesh, white, rather coarse, granular, rich, and perfumed. November.

MOYAMENSING.

Smith's Moyamensing.

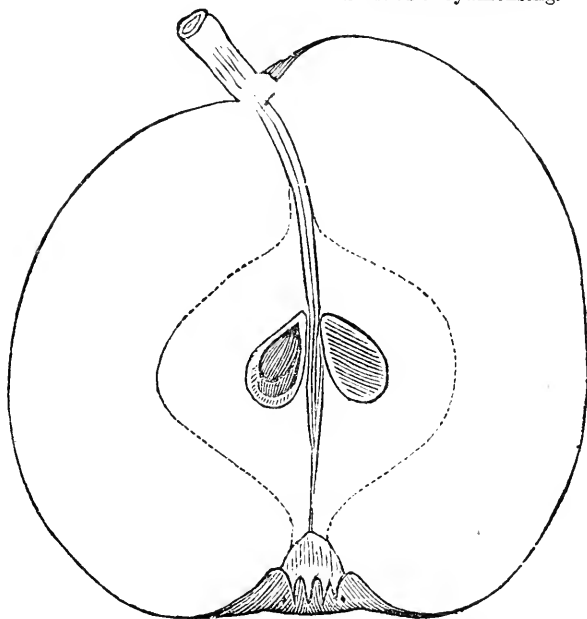

Native of Pennsylvania. Tree, vigorous, wood yellowish brown, with light dots, regular and abundant bearer.

Fruit, medium, roundish obovate; color, lemon yellow, with occasional blotches and lines of yellowish russet; stem, short, stout, often fleshy; calyx, large; basin, furrowed, broad, and rather deep; core, medium; seeds, ovate; flesh, white, buttery, melting, juicy, "best." August.

MUSCADINE.

American. From near Newburgh., N. Y. Fruit, medium, roundish, obovate, pale yellowish green, with brown dots; stem, an inch long;

calyx, with reflexed segments; basin, shallow; flesh, white, buttery, melting, musky; shoots, stout, dark gray brown. Last August, first September.

MUSKINGUM.

American. Supposed a native of Ohio. Fruit, medium, roundish obovate, greenish yellow, numerous russet specks; stem, long, slender; calyx, open; segments, short, connected; flesh, white, coarse; "good." Last August.

MARECHAL DE LA COUR.

Consieller de la Cour, | Duc d'Orleans.

Foreign. Tree, vigorous, branches long, thorny at ends, early bearer. Fruit, large, oblong pyriform, or ovate, yellowish green, vermilion in sun; stem, broken, inserted with a lip one side; calyx, large, open; flesh, white, fine, melting, juicy, vinous; "promises well."

NAPOLEON.

Médaille, | Roi de Rome.

Foreign. Tree, vigorous, upright grower, olive-colored shoots, fruit largest and finest on Quince, very productive. Fruit, large, obtuse to obovate, and rounded pyriform; greenish yellow, smooth; stem, varying, usually stout; calyx, medium, open; flesh, white, tender, juicy; "good." Valuable as a market sort on Quince. River says the Napoleon d'Hiver is not sufficiently distinct to be retained. October.

NE PLUS MEURIS.

Belgian. An unprepossessing looking, uneven, dull russet fruit, of very fine flavor. The tree grows upright, has short-jointed, olive-colored shoots and bears in thick bunches or clusters.

Fruit, medium, or rather small, roundish, usually very irregular, with swollen parts on the surface; skin, rough, dull yellowish brown, partially covered with iron-colored russet; stalk, quite short, set without depression, in a small cavity; flesh, yellowish white, buttery, melting, with a sugary and very agreeable flavor. January to March.

NONPAREIL.

American. A new variety from Western New York; too small for any but amateurs. Fruit, small, roundish flattened at apex, russet yellow, with red specks; stem, short; calyx, large; core, large; flesh, fine, melting, juicy, sugary, vinous; nearly "best." November.

OAKLEY PARK.

Oakley Park Bergamotte.

Foreign. Fruit, medium, roundish obovate, greenish yellow, with russet; calyx, partly open; stem, slender; flesh, buttery, melting; "good." October.

OMAR PASHA.

From France. New. Productive. Fruit, medium, turbinate, roundish, irregular, clear green, dotted and specked with russet about the stem; flesh, fine, tender, juicy, sugary, vinous. Early September.

ONONDAGA.

Swan's Orange, | Onondaga Seedling.

Probably a native of Farmington Ct. It takes its name from having been first brought to notice by cultivators in Onandaga Co. N. Y. Tree vigorous, with strong, upright, olive-colored shoots. In quality it is variable, not succeeding in all locations.

Fruit, large, ovate obovate; color, pale greenish yellow, becoming golden yellow at maturity, many gray russet dots, and occasionally a dull blush in

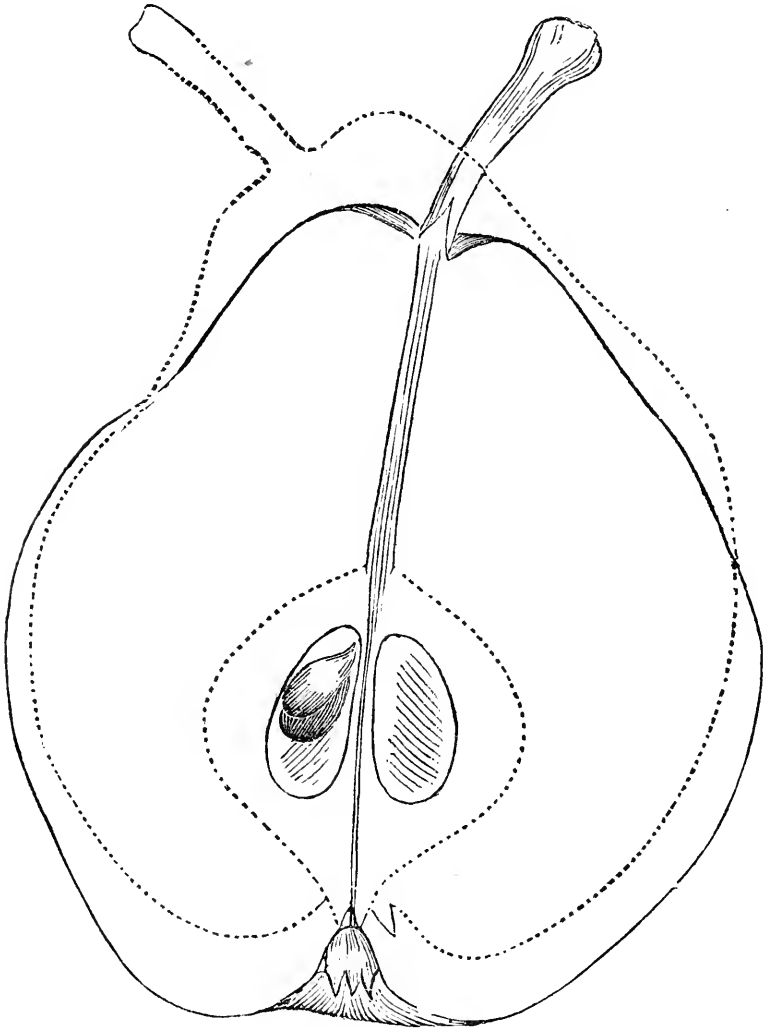

sun; stem, one to one and a half inch long, inserted without depression, but with lip of fruit folded unevenly around it; calyx, rather small, closed; basin, shallow, abrupt and marked with patches of cinnamon russet, core, compact; seeds, small; flesh, white, juicy, buttery. October and November.

ONTARIO.

Origin, Geneva, Ontario County, N. Y. Tree vigorous and productive, said to be a valuable market variety.

Fruit, medium, elongated obtuse pyriform, somewhat irregular, skin, pale yellow, thickly covered with gray or green dots; stalk, long, curved, inserted by a fleshy ring in a rather large depression; calyx, partially closed, or open in a shallow, irregular, corrugated basin; flesh, white, granular, juicy, almost melting, with a sweet pleasant flavor. Ripens last of September. (Downing)

ORANGE BERGAMOTTE.

Orange Pear.

Foreign. An old variety, great bearer, valuable only for cooking. Fruit, above medium, pyriform; yellow, russet in sun; flesh, yellowish, sprightly astringent. September and October.

ORPHELINE COLMAR.

Foreign. Tree vigorous, very fertile. Fruit, very large, pyriform; skin, bright green, becomes somewhat yellow at maturity, striped and dotted with gray, brown, and black, and shaded with russet fawn on the sunny side, and around the calyx and stem; flesh, whitish yellow, fine, melting, a little granular around the core, juicy, sweet, and perfumed. A beautiful and excellent fruit, ripening about the middle of October. (An. Pom.)

OSBAND'S SUMMER.

Osband's Favorite, | Summer Vergalieu, *of some.*

American. Native of Wayne Co., N. Y. Fruit, below medium, ovate obovate pyriform, clear yellow, small green dots, and rarely a slight red cheek in sun; skin, rather thick; stem, medium, inserted in a shallow, uneven cavity; calyx, with open, long, straggling segments; flesh, yellowish white, rather coarse grained, juicy; promises "valuable." Early September.

OSBORN.

American. From Economy, Ia., introduced first to notice by A. H. Ernst, Esq., of Cincinnati. Fruit, small, ovate pyriform, greenish yellow; stem, about one inch long, set with two or more fleshy ridges at base, flesh, white, tender, juicy, sweet, a little astringent; "good. Early August.

OSWEGO.

Oswego Beurré, | Reed's Seedling.

American. Native of Oswego, N. Y. Tree, vigorous, hardy, succeeds well thus far, and an early bearer on Quince or Pear roots; fruit, medium, ovate obovate, or obovate rounded, dull yellowish green, with marblings and patches of russet; stem, short, stout; cavity, rather deep; calyx, medium, closed; core, small; flesh, melting, juicy, sub-acid, sprightly "very good" October.

OUDINOT.

Beurré Oudinot.

Foreign. Fruit, large, pyriform, yellowish green, with brownish cheek; stem, curved; calyx, medium; basin, shallow; flesh, fine, juicy; "good." September.

PADDOCK

From C. Goodrich, Burlington, Vt. Small, ovate conical, light yellow; flesh, fine-grained, sweet; "good." August.

PARSONAGE.

Medium, obovate obtuse pyriform, yellow, rough, shades of dull crimson, netted russet, russet dots; stem, short, thick at junction; calyx, half open; short, stiff segments; basin, shallow, russeted; flesh, white, coarse, granular; core, small; "very good." September.

PASSANS DU PORTUGAL.

Poire Cheneille, | Miller's Early, | Bergamotte.

Foreign. Tree, upright growth; shoots, reddish brown, Fruit, below medium, roundish obovate, pale yellow, brownish red in sun; stem, one inch; calyx, erect; flesh, white, juicy, breaking; "very good." Last of August.

PASSE COLMAR.

Passé Colmar Epineaux,
Colmar Gris,
Passé Colmar Gris,
Beurré Colmar Gris, dit Prêcel,
Prêcel,
Fondante de Panisel,
Fondante de Mons,
Beurré d'Argenson,

Regintin,
Chapman's,
Colmar de Sille,
Colmar Hardenpont,
Présent de Malines,
Marrotte Sucree Jaune,
Souverain,

Colmar Souverain,
Gambier,
Cellite,
Colmar Preule,
Colmar Doree,
Colmar Van Mons,
Colmar d'Hiver.

Foreign. Tree, vigorous, with long, stragling, half drooping shoots of a lively brownish yellow; with high culture, severe thinning, and great care, it is a first-class sort; with common ordinary care it is worthless. Fruit, medium to large, oblong obovate, obtuse pyriform, yellowish green, dull yellow when fully mature, with some russet; stem, a little more than medium length, set with slight depression; calyx, partly open; basin, shallow; flesh, yellowish white, buttery, sweet, aromatic. November, January.

PATER NOSTER.

Foreign. Fruit, large, oblong, obtuse at ends, surface uneven; stem, fleshy; calyx, open; segments, short, thick; core, medium; flesh, yellowish, juicy, vinous, perfumed, acid. November, December. (Hov. Mag.)

PAUL THIELEN.

Foreign. Fruit, medium, roundish obovate, yellow, with dull red cheek; stem, long, obliquely set; calyx, open; segments, short, upright; flesh, rather coarse, juicy; "good." October.

PEACH PEAR.

Medium, turbinate pyriform, yellowish, dots of red russet; calyx, open, flesh, juicy; "good." August, September.

PENDLETON.

Pendleton's Early York Pear

American. From Connecticut. Young wood, dark olive. Fruit, rather large, obovate obtuse pyriform, pale greenish yellow, russet specks; stem, curved; calyx, open; flesh, white, tender, sweet; "good." Last July (Hov. Mag)

PENGETHLEY.

Foreign. Tree, vigorous. Fruit, medium, obovate, yellowish brown, russeted; stem, medium; calyx, small, partly open; flesh, yellowish, juicy; "good." February, March.

PENNSYLVANIA.

American. From Pennsylvania. Tree, vigorous, hardy, and moderately productive. Fruit, large, obovate pyriform, surface irregular, yellowish green, brownish russet, marbled; stem, stout; calyx, small, half closed; core, small; flesh, yellowish, rather coarse, breaking, juicy; "good." October.

PETRE.

American. Originated in the old Bartram Botanic Garden, near Philadelphia, Pa. Tree, moderate grower, with slender, yellowish brown shoots, abundant bearer. Fruit, medium to large, oblong obovate pyriform, pale yellow, with russet patches; stem, rather stout, largest at base; cavity, abrupt; calyx, medium; basin, narrow; flesh, whitish, fine, melting, buttery, perfumed, juicy, nearly "best." October. The "Bézi de la Motte" has been disseminated for this variety, somewhat, through the West.

PHILADELPHIA LATCH.

Large, oblate pyriform, yellow, greenish gray dots, netted russet; stem, stout; cavity, deep, abrupt; calyx, half closed; basin, open; flesh, coarse, sugary, juicy; core, small; rots at core; productive; "very good." September, October.

PHILIPPE GOES.

Foreign. Tree, sufficiently vigorous and very fertile. Fruit, medium, turbinate-pyriform, bossed, and often irregular; skin, rough, totally covered with gray russet; flesh, whitish-yellow, fine and melting, juice enough, sweet and finely perfumed; quite first quality. Ripens middle of November. (An. Pom.)

PINNEO.

Boston,		Summer Virgalieu,
Graves?		Hebron.

American. Originated in Tolland County, Conn., and first introduced to notice in transactions of the Hartford County Horticultural Society. Young wood, of a brownish red; tree vigorous and productive. Fruit, small to medium, oblong obovate pyriform, tapering toward the stem; color, pale yellow, tinge of red in the sun, obscure dots, and considerable russet near base of stem; stem, rather long; cavity, shallow; calyx, medium, open; basin, broad, shallow, slightly ribbed or furrowed; flesh, yellowish white, melting, juicy, sugary, rich delicious flavor; core, medium or small; seeds, dark brownish black. Last of August.

PIUS IX.

Foreign. Large, obovate, irregular pyriform; yellow, slightly russeted; stem, short, curved, fleshy at junction; calyx, open; basin, shallow; flesh, coarse; "good." September, October.

PLATT'S SEEDLING.

Origin, on the farm of the late Thomas Tredwell, Beekmantown, Clinton County, N. Y. Tree, vigorous, hardy and productive. Fruit, rather large; skin, yellow; a fruit of good quality, and perhaps may be valuable for orchard culture, particularly at the North. October, November.

POCAHONTAS.

Origin, Quincy, Mass. Tree, moderately vigorous. Fruit, medium, form variable, obovate pyriform, often turbinate; calyx, small, closed; stem, short, inserted without depression; color, lemon yellow, with traces of russet, and occasionally a bright vermilion cheek; flesh, white, melting, juicy and buttery; flavor, sweet, rich and musky. Ripe first to the middle of October. (Wilder in Hort.)

POIRE D'ALBERT.

Foreign. Tree, vigorous, productive. Fruit, medium, pyramidal (elongated or obtuse-pyriform); skin, rough, clear dark cinnamon russet, bronzed on the sunny side; stem, of medium length, stout, curved, swollen and fleshy at the base, obliquely inserted in a slight cavity, on the lower side; eye, medium, partially open, and very slightly depressed, in a small, shallow basin; flesh, greenish white, coarse, buttery, melting and juicy; flavor, vinous, very rich, and deliciously perfumed. October. (Hov. Mag.)

POIRE DES DEUX SŒURS.

Foreign. Tree, vigorous, productive. Fruit, large, long pyriform, pale green, with brown and black dots; stem, short; calyx, small, closed; flesh, fine, yellowish green, juicy, sugary. November.

POIRE RAMEAN.

Begy de Vetrans.

Large, obtuse pyriform, light yellow, gray dots, patches of russet; calyx, half closed; basin, open; flesh, firm, tough, cooking; productive.

POIRE D'ABONDANCE.

D'Abondance.

Foreign. Fruit, above medium, oblong pyriform, pale yellow, with russet dots, red in sun; flesh, melting, juicy; "very good." October.

POIRE D'AVRIL.

Foreign. Fruit, medium, acute pyriform, yellowish green, rough, russeted, and reddish in sun; stem, fleshy at base; calyx, closed; flesh, greenish white, crisp, juicy, cooking; core, small; seeds, long, pointed. February to May.

POIRE DE TONGRES.

Foreign. Tree, strong grower. Fruit, large, obovate, bronzed, brownish yellow, streaks of red in sun; flesh, melting, juicy, sugary, agreeable. October.

PRATT.

American. Native of Rhode Island. Tree, vigorous, upright growth, productive on Pear. Fruit, above medium, obovate pyriform, greenish yellow, with gray and russet dots and specks; stem, slender; calyx, open; flesh, white, fine-grained, melting, juicy, sugary; "variable." September.

PREVOST.

Poire Prevost.

Foreign. Fruit of medium size; skin, thin, smooth, light green, passing to golden-yellow at maturity, deeply shaded with carmine in the sun;

flesh, white, half melting, half buttery, sweet, and strongly perfumed. Ripens in December, but may be kept until April. (Al. Pom.)

PRINCE ALBERT.

Foreign. Tree, vigorous, succeeds on Pear and Quince. Fruit, medium, pyriform; skin, very thick and smooth; color, yellowish, sometimes with a slightly sunny cheek; stalk, an inch long; eye, small, open, in a shallow even cavity; flesh, yellowish white, fine, melting, sugary and rich. February, March. (Gard. Ch.)

PRINCESS ROYAL.

Groom's Princess Royal.

Foreign. Tree, hardy and vigorous; not an early bearer. Fruit, medium, obovate, dull pale green, dotted with russet; stem, set in shallow cavity; calyx, open; segments, short; core, large; flesh, yellowish, rather coarse, melting, juicy; "good." January, February.

PULSIFER.

American. Native of Illinois. Tree, upright, vigorous; shoots, dark olive; early and productive bearer. Fruit, below medium, pyriform obtuse, dull yellow, with traces of russet; stem, short; calyx, small, open, flesh, white, melting, juicy, sweet; "very good." Early August.

QUEEN OF THE LOW COUNTRIES.

Reine des Pays Bas.

Foreign. We have often examined this sort, but have been unable as yet to fruit it in ten years that we have had the variety. We condense our description from Downing. Fruit, large, obovate acute pyriform, dull yellow, dotted and russeted, dark red in sun; stem, one and a half inch long, curved; calyx, small; basin, deep; flesh, white, buttery, melting, juicy, vinous, sub-acid. Early October.

RALLAY.

We received specimens (from which we take our description) of this pear from Messrs. Ellwanger and Barry. It is, we believe, an old variety, but we had never before seen it. Fruit, small to medium, globular acute pyriform; skin, rough, dull yellow, dull reddish cheek, over the whole spots of russet; stem, slender, obliquely set without depression; calyx, with crumpled segments; core, large; flesh, yellowish white, breaking, juicy, gritty at core; "good." November, December.

RAPALJE.

Rapalje Seedling.

American. Fruit, medium, brownish yellow or russet, oblong pyriform, stem, long; calyx, in a slight hollow; flesh, buttery; variable quality. Early September.

RAVENSWOOD.

Fruit, obtuse pyramidal, tending to obovate, small to medium in size, with a very short, thick stem; ripening from the middle of July to middle of August; rich aromatic flavor, and great abundance of vinous carbonated juice. It is a great bearer. It is a seedling found in the woods of Astoria, and planted on the grounds of Mr. Charles Ehrard.

READING.

Large or above medium, pyriform, greenish yellow with numerous dots, stem, medium, fleshy at base; calyx, open; segments, erect; basin, very shallow; core, medium; seed, dark brown; flesh, greenish white, juicy, sprightly, vinous; young shoots, slender, yellowish olive; "good." January to May.

RETOUR DE ROME.

Fruit, medium, oblate, very much depressed, obscurely pyriform, angular; skin, yellowish, blotched with russet and thickly sprinkled with russet dots; stalk, short, and stout at its insertion in a small inclined cavity; calyx, partially closed, in a round, narrow basin; flesh, whitish, coarse, granular, melting, juicy, with a rich vinous flavor, slightly astringent. September.

RICHARDS.

Origin, Wilmington, Delaware. Fruit, rather large, obovate oblate pyriform; skin, yellow, with numerous small russet dots; stalk, of medium length, curved, inserted by a fleshy ring in a slight depression; calyx, partially closed; basin, very small; flesh, buttery, juicy, melting, granulated, with a sweet, pleasant, vinous flavor. Ripens first of October.

RIDELLE'S.

Beurré Audusson, | Poire Ritelle.

Tree, of moderate vigor, reddish brown shoots; productive. Fruit, medium, oblate turbinate, remotely pyriform; skin, yellow, covered nearly all over with bright red; stalk, short, fleshy at its insertion by a lip; calyx, open, in a very shallow basin; flesh, not very fine, rather juicy, not melting or delicate in flavor. September.

ROE'S BERGAMOTTE.

Raised by William Roe, Newburgh, N. Y. Tree, moderately vigorous, very productive.

Fruit, medium, oblate or Bergamotte-shaped, somewhat angular and irregular; skin, smooth, yellow, with minute yellow dots in the shade, mottled and clouded with red on the sunny side; stalk, short, inserted in a narrow, abrupt cavity; calyx, small, with short, stiff segments, set in a narrow basin; flesh, rather coarse, melting, with a sweet, rich, brisk, well-perfumed flavor; core, large. The flavor of this excellent new pear is extremely like Gansel's Bergamotte, but much more sugary. September. (Downing.)

RONDELET.

Foreign. Tree, upright, thrifty, good bearer, suited to orcharding. Fruit, small, obovate, yellow, dotted with russet, red in sun; stem, slender; calyx, erect, long segments; core, medium; flesh, yellowish white, buttery, juicy, sugary, aromatic; nearly "best." October.

ROPES.

American. Its name from that of the gentleman in whose garden it originated at Salem, Mass. Fruit, small, oblong obovate, brownish russet, tinged with red in sun; stem, short, rather stout; calyx, small, open, core, small; flesh, yellowish, rather coarse, melting; "good." October.

ROSABIRNE.

Foreign. Fruit, medium, obovate acute pyriform, angular, surface, un- even, russet on dull greenish yellow; stem, fleshy at base; flesh, white, melting, juicy, brisk, sub-acid; "very good," may be "best." October. (Wilder, in Hort.)

ROSS.

Foreign. Tree, vigorous. Fruit, medium, obovate, yellowish green and russet; stem, short; calyx, open; flesh, yellowish, rather gritty, sweet, juicy; "good." January.

ROUSSELET D'ESPERIN.

Foreign. Fruit, above medium, obovate acute pyriform, dull greenish yellow, covered with cinnamon russet; stem, long, stout, fleshy at base; calyx, open; basin, deep, furrowed; flesh, white, melting, sprightly; "very good." October. Promises valuable.

ROUSSELET VANDERWECKEN.

A pyramidal tree, of medium vigor, but very productive. Fruit, small, varying in form from Doyenné to Bergamotte; skin, yellow at time of maturity; flesh, white, fine, melting; juice, abundant, sugary, and strongly aromatic, like that of the Rousselet; fruit, quite of first quality, and ripe first of November. (An. Pom.)

SALISBURY SEEDLING.

A native of Western New York. Tree, vigorous. Fruit, depressed pyriform; skin, rough, somewhat covered with russet, and thickly sprinkled with russet dots; stalk, short and thick, inserted by a fleshy ring; calyx, closed, in a deep, uneven basin; flesh, coarse, and of not much claim to excellence so far as proved. Ripe October.

SELLECK.

The origin uncertain. Tree, 30 years old. Mr. Selleck, Columbus, Vt. Tree, healthy, productive; leaves, small; a free, thrifty grower. Fruit, large, ovate obovate obtuse pyriform, angular ribbed, fine yellow, and crimson cheek, russet dots; stem, medium, curved, fleshy at insertion, where it is slightly russeted; calyx, nearly closed; basin, small, uneven; flesh, juicy, melting, aromatic; core, small; "very good;" promises valuable for market. October.

SHEPPARD.

Raised by James Sheppard of Dorchester, Mass. Tree, a free grower, and very productive.

Fruit, large, obovate pyriform, sometimes pyramidal (greatly varying in form); skin, rough, yellow, sometimes with a brownish red cheek, slightly sprinkled with russet dots, and with some patches of russet; stalk, short and stout, in a depression, often inclined, surrounded by russet; calyx, partially closed, set in a very shallow, furrowed basin; flesh, whitish, coarse, and granular, buttery, melting, very juicy, with a vinous, perfumed, banana flavor. Ripens last of September, and first of October. (Downing.)

SHURTLEFF.

Shurtleff's Seedling.

American. Native of Boston. Tree, vigorous, good bearer. Fruit, medium, roundish obovate, greenish yellow, russeted at stem, dotted with

russet specks, dark red cheek in sun; stem, rather long, swollen at base, calyx, large, open; core, large; flesh, white, coarse, melting, juicy, gritty at core. September.

SIGNORET.

Sagaret.

Foreign. Fruit, medium or below, roundish obovate, greenish yellow, russet specks; calyx, open; flesh, coarse, breaking, hardly "good." November.

SOVERAINE DE PRINTEMPS.

Poire de Printemps.

Fruit, medium, obscurely pyriform; yellow, sprinkled with russet; stalk, short, inserted in a depression; calyx, closed; basin, irregular; flesh, white, juicy, melting, coarse and granular, somewhat astringent. March.

ST. GHISLAIN.

St. Galen.

Foreign. Tree, upright, vigorous growth; young shoots, light brown; requires warm rich soil, otherwise a little insipid.

Fruit, below medium; generally pyriform, but varying; color, pale yellow, or yellowish green, with dots of green underneath, and marblings of russet on surface; stem, generally curved; calyx, open; basin, shallow; core, small; seeds, obovate pointed; flesh, white, buttery, juicy, and sprightly. September.

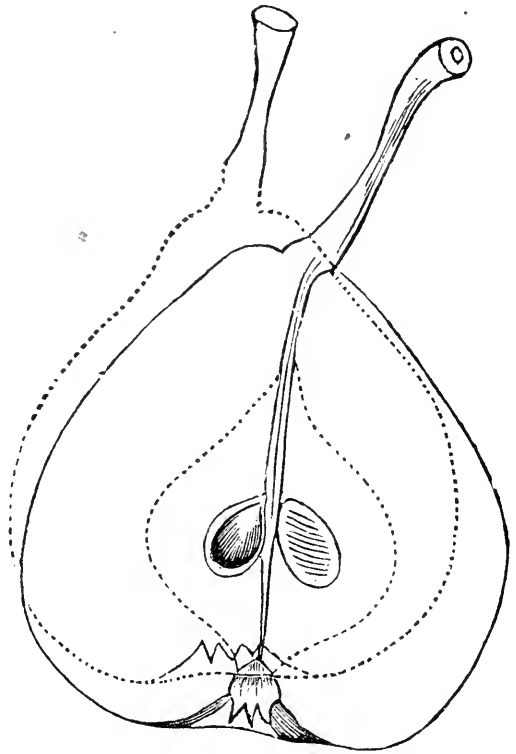

ST. DOROTHEE.

Royale, | Nouvelle.

Foreign. Tree, vigorous. Fruit, large, acute pyriform; skin, rough, dull green, faintly browned in the sun; stalk, long and curved, in a very shallow cavity; calyx, partially closed, moderately sunk in a rather contracted basin; flesh, white, fine, very melting and juicy; flavor, rich, saccharine and vinous, with an orange-like perfume. October. (Hov. Mag.)

ST. HERBLAIN D'HIVRE.

Foreign. New; poor grower. Fruit, below medium, smooth, green, sprinkled with small brown dots; stem, short; flesh, white, juicy, sugary. December to March.

ST. JEAN BAPTISTE.

Foreign. Tree, moderate grower, stout, short-jointed shoots. Fruit, medium, oblong obovate pyriform, pale greenish yellow, with dark specks; stem, short, curved, swollen at base; flesh, white, melting, buttery, vinous, calyx, half open. October and November.

ST. MENIN.

Poire St. Menin.

Foreign. Fruit, large, pyriform, greenish, nearly covered with pale russet; flesh, melting, sweet; "good." August.

ST. MESMIN.

Foreign. Fruit, large, oblong ovate, yellowish green; stem, without depression; calyx, half open; flesh, juicy; "good," perhaps may be "very good." October.

ST. MICHAEL ARCHANGE.

Plombgastel, Dusnas,		Plumbgartel, Plougastel,		Jergils?
-------------------------	--	-----------------------------	--	----------

Foreign. Tree, vigorous, upright, succeeds on Quince. Fruit, above medium to large, ovate pyriform, greenish yellow, red in sun, dull russet specks; stem, stout; calyx, large, open, segments reflexed; core, large; flesh, white, half-melting, juicy; "good," or perhaps "very good." September, October.

STERLING.

De Motte.

American. Native of Western New York. Tree, thrifty, upright growth, early bearer. Fruit, large, roundish obovate, pale yellow, shaded with red in sun, russet at base of stem; stem, long; calyx, open; core, large; flesh, white, coarse, half melting, juicy; "very good." Early September. Long known as De Motte in Michigan.

ST. VINCENT DE PAUL.

Foreign. Fruit, small, like Martin Lee; skin, russet; flesh, sugary, half melting, ripening in January. (Leroy's Cat.)

STYRE.

Origin unknown. Fruit, medium, roundish, green, becoming yellow, with russet dots and tracings; stem, varying; cavity, shallow; calyx, imperfect; basin, narrow, abrupt, deep; core, medium; flesh, yellowish white, a little gritty at core, buttery, juicy, perfumed; "best." September.

SUMMER FRANC REAL.

Franc Real d'Eté, Mouille Bouche,		Gros Micet d'Eté, Fondante.
--------------------------------------	--	--------------------------------

Foreign. Tree, thrifty, hardy, good bearer, rarely more than "good" on pear roots, sometimes nearly "best" on Quince. Fruit, medium, obovate obtuse pyriform, dull green, becoming yellowish green, with brownish

green dots; stem, short, thick; calyx, medium, long segments, furrowed basin, large core; flesh, white, not fine-grained, buttery, juicy, sweet. September.

SUPREME DE QUIMPER.

Foreign. Tree, strong, erect grower; wood, brownish-olive. Fruit, medium, roundish obovate, lemon yellow, red in sun, and russet specks; stem, short, stout; calyx, medium, partly open, segments, short; flesh, yellowish white, coarse, sugary, perfumed; core, medium; seeds, pale brown. August.

SUZETTE DE BAVAY.

Suzette de Bavay (Esperen).

Foreign. Tree, vigorous, shoots light greenish brown. Fruit, medium, obovate pyriform, dull yellow and russet; flesh, melting, juicy; "very good." February and March.

TAYLOR PEAR.

Merriweather.

Originated on the farm of Mr. Merriweather, near Charlottesville, Albemarle Co., Va. Tree, vigorous, young wood olive, productive.

Fruit, medium, roundish, oblate; skin, light green, mottled with dark green; stalk, rather long, fleshy at its termination, in a very slight depression; calyx, very small, set in a wide, superficial basin; flesh, fine texture, buttery; flavor, vinous, with a delicate vanilla aroma; quality, "very good." November to February. (Dr. W. D. B.)

TEA.

American. Native of New Haven Co., Conn. Fruit, below medium, roundish oval, clear rich yellow, blush in sun; calyx, with short open segments, even with surface; core, small; flesh, whitish, melting, juicy; "very good," nearly "best." Last September.

THEODORE VAN MONS.

Foreign. Fruit, medium, obovate pyriform, yellow, with russet spots; stem, long, little or no depression; calyx, large, open, broad segments; flesh, whitish, melting; "very good" on Quince. November.

THORP.

Prindle.

Above medium, obovate truncated, oblique, yellow, dull reddish cheek, brown dots; stem, medium, inserted in an abrupt, acute cavity; calyx, small, closed; basin, shallow, russeted; flesh, white, coarse; core, small; "good." November.

THUERLINCK.

A very large, showy fruit, whose quality does not equal its beauty, and whose great weight of fruit causes it to fall from the tree with so little wind, that it is not profitable for garden or orchard. (Al. Pom.)

TOTTEN'S SEEDLING.

Raised by Colonel Totten, of New Haven, Conn. Tree, vigorous. Fruit, medium or below, turbinate pyriform; skin, pale yellow, slightly sprinkled with russet, and shaded with dull crimson; stalk, long, and

fleshy at its insertion, by a lip : calyx, closed ; basin, shallow ; flesh, whitish, buttery, juicy, melting, with a rich, vinous, perfumed flavor. Ripens last of September, and first of October. (Downing.)

TRIOMPHE DE JODOIGNE.

Foreign. Tree, very strong, vigorous grower, not an early bearer. Fruit, large to very large, obovate, obtuse pyriform, greenish with traces and faint spots of russet ; flesh, melting, juicy, sub-acid ; "good." November. Unsuccessful on Quince.

TYLER.

Fruit, small, turbinate, remotely pyriform ; skin, yellow, covered with russet dots ; stalk, long and slender, in a moderate cavity, surrounded by russet ; calyx, open ; basin, shallow and uneven ; flesh, white, coarse, granular, buttery, melting, juicy, brisk and vinous. October.

UPPER CRUST.

American. Native of South Carolina. Tree, healthy, moderate grower ; branches, slender, forming a pyriform head. Fruit, size and shape of Dearborn Seedling, green, with distinct irregular russet blotches ; flesh, buttery, melting ; "very good," if not "best." July. (Wm. Sumner, in Hort.)

UWCHLAN.

Dowlin, | Round Top.

From Chester, Pa. Above medium, obovate, somewhat compressed ; skin, cinnamon russet, patches and dots of fair yellow ; stem, medium, slight depression at base ; calyx, above medium ; segments, half reflexed ; core, medium ; flesh, fine, buttery, saccharine. August, September. Young wood yellowish brown, old wood grayish.

VEZOUZIERE.

Foreign. Tree, vigorous, succeeds on Quince. Fruit, medium, roundish obovate, lemon yellow, dotted with red in sun ; stem, long ; cavity, open ; calyx, medium, open ; basin, shallow ; core, large ; flesh, yellowish white, rather coarse, juicy, sweet ; "very good." November.

VICOMTE DE SPOELBERCH.

Despoilberg, | Bezi de Spoelberch, | Vicomte de Spoelberg.

Foreign. Tree, moderately vigorous, branches upright, yellowish brown, with whitish gray specks. Fruit, large, obovate obtuse pyriform, pale yellow when mature, little red in sun, and russet patches and specks ; stem, long, stout, fleshy at base ; calyx, medium ; segments, short, erect ; core, medium ; flesh, white, fine-grained, buttery, melting, juicy, sugary ; "best." December.

WALKER.

Fruit, large, oblong pyriform, lemon yellow, marbled with light sea-green ; stem, curved, fleshy at base ; calyx, open ; long segments ; basin, shallow ; flesh, coarse, crisp, juicy ; "very good." September.

VAN MON'S LEON LE CLERC.

Poire de Boulogne, | Louise Bonne de Boulogne, | Celestin.

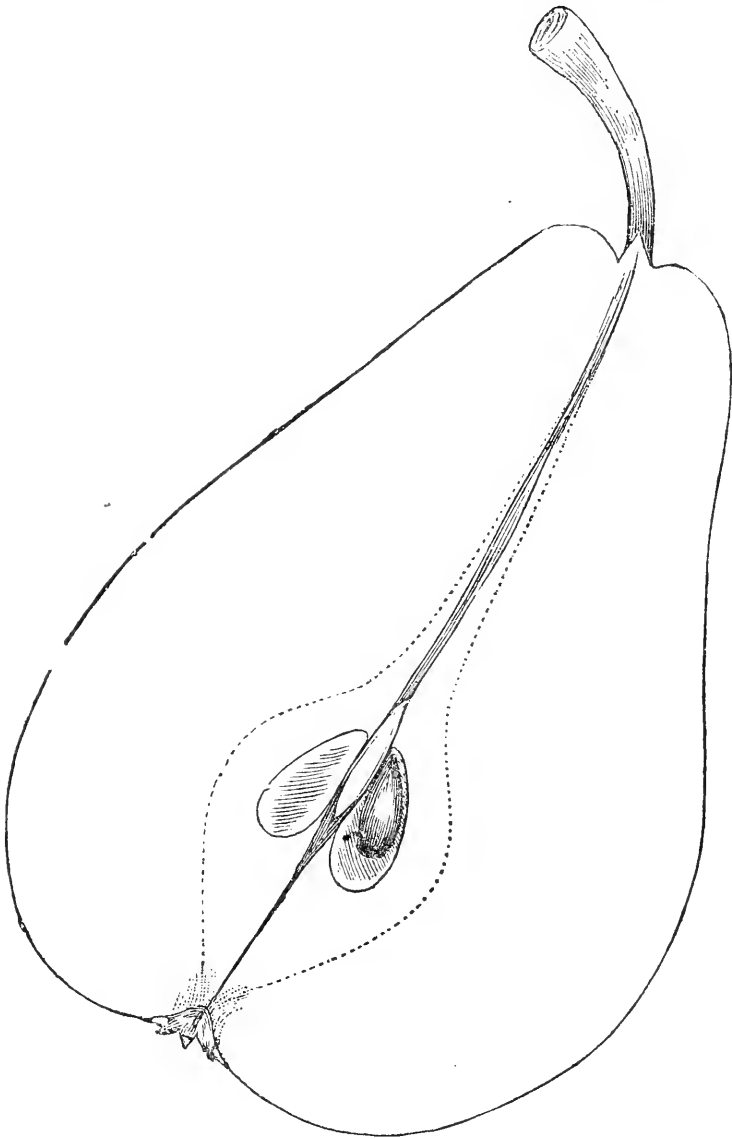

Foreign. Distinct from "Leon Le Clerc of Van Mons." A variety on the Quince, bearing early, but not surely. In growth the tree is moderately vigorous, nearly upright, yellowish olive wood with round grayish spots.

Fruit, very large, oblong obovate pyriform; color, pale yellow, golden at maturity, with brown in sun, russet specks and patches, some dark green dots, and russet at base of stem; stem, medium length and size, curved; calyx, large, open, broad, reflexed segments; basin, medium; core, medium

long ovate capsules; seeds, long, ovate, sometimes imperfect; flesh, yellowish white, fine, buttery, melting, juicy, sugary, vinous. October and November.

WHARTON'S EARLY.

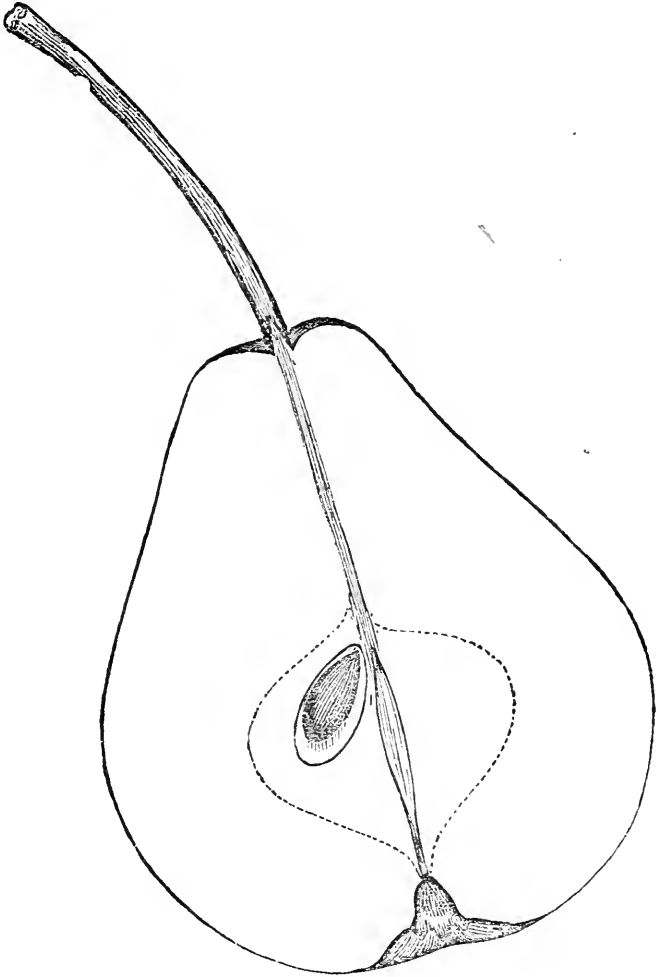

Originated from seed sown by Silas Wharton, a pioneer in fruit culture, in Ohio. First grafts were distributed by A. H. Ernst, Esq. Tree, a vigorous, strong grower; wood, yellowish brown; large foliage. Fruit, above medium, oblong obovate pyriform, yellowish green, with minute russet dots, suffused at base with a sea-green, occasionally a russet trace; stem, long, slender; cavity, slight; calyx, open; segments, short, rounded; core, medium; seeds, ovate; flesh, white, melting, juicy, sweet; "best." Middle to last August. It deserves extensive cultivation.

WENDELL.

A seedling of Van Mons, named in honor of Dr. H. Wendell, Albany, N. Y. Tree, vigorous, upright.

Fruit, of medium size, pale yellow, with tracings and sometimes large patches of russet, often with a bright red cheek next the sun; flesh, melting and juicy; "good," but not high flavored. Middle of August to middle of September. (Robert Manning.)

WESTCOTT.

American. Native of Cranston, R. I. Fruit, medium, roundish obovate, pale green to light orange yellow, dots and blotches of russet; stem, slender, fleshy at base; calyx, large, open; basin, plaited; flesh, white, juicy, coarse, melting, sugary; "good." September.

WIEDOW.

Wredow.

Foreign. Tree, moderately vigorous; wood, yellowish. Fruit, medium, oblong obovate, acute pyriform, greenish yellow; stem, medium, obliquely planted with lip one side; calyx, small; flesh, white, juicy, vinous, perfumed; "very good." October.

WILBUR.

American. Native of Somerset, Mass. Tree, a moderate grower, with reddish brown shoots, productive and hardy. Fruit, medium, oval obovate, dull yellowish green, much russet; stem, medium; calyx, open; core, large; flesh, whitish, rather coarse, a little variable, juicy; "good." September.

WILLIAM'S EARLY.

American. Native of Roxbury, Mass. Tree, moderate grower, reddish brown wood. Fruit, below medium, ovate obovate, light yellow, red cheek, little russet at base of stem, and a few greenish specks; stem, medium, a little fleshy at base; calyx, large, open; core, large; flesh, yellowish white, coarse, juicy, sweet; "very good." September.

WILLIAMSON.

American. From the South side of Long Island. Fruit, medium, obovate rounded, obtuse at stem, yellow, with russet dots and specks, and russet at stem and crown; stem, short, stout, narrow irregular cavity; calyx, none; basin, deep, narrow, russeted; seeds, small, flattened; flesh, yellowish white, fine grained, juicy, sugary, vinous; "very good," if not "best." October.

WILLERMOZ.

Foreign. Fruit, large, pyriform; stem, short; calyx, open; skin, smooth, pale green, yellowish, tinged with red in sun; flesh, white, melting, juicy, sugary, musky. October, November.

WILKINSON.

American. From Cumberland, R. I. Tree, thrifty, hardy, productive, "good" in its own locality, elsewhere poor. Fruit, medium, oval obovate, yellow, with brown dots and specks; stem, rather long and stout; calyx, small, open; flesh, white, juicy, sweet. October to December.

WILMINGTON.

A seedling of Passe Colmar, raised by Dr. Brinckle, of Philadelphia. Fruit, medium, obtuse pyriform, somewhat compressed at the sides, sometimes roundish obovate; skin, cinnamon russet, with patches of greenish yellow on the shaded side, and sometimes faint traces of carmine on the part exposed to the sun, with occasionally a number of black dots encircled by a carmine margin; stem, somewhat variable in length, obliquely inserted in a small cavity, sometimes without depression; calyx, medium, with short, erect, segments, set in a rather large, sometimes slightly furrowed basin; flesh, fine, melting and buttery; flavor, rich and saccharine, with the delicious aroma of the Passe Colmar; "best." September. (W. D. B.)

WINSHIP.

Winship's Seedling.

American. Native of Brighton, Mass. Tree, vigorous, wood yellowish, early and productive bearer. Fruit, medium, ovate pyriform, pale yellow, traces of russet, blush in sun; stem, long, slender, curved; calyx, closed; core, large; flesh, white, melting, juicy, sugary; "good." August.

WINTER SECKEL.

Origin, near Fredericksburg, Va. Introduced by H. R. Roby. Fruit, medium, regularly formed, obovate; skin, dull yellowish brown, somewhat russeted, with a red cheek; stalk, long, slender, curved; flesh, white, fine-grained, buttery, very juicy, melting, with a very rich, sweet, aromatic flavor. February.

WOODSTOCK.

Origin, Woodstock, Vt. Medium, irregularly ovate obovate; yellow, with brown dots; stem, long, straight, abrupt cavity; calyx, closed; basin, broad, open; flesh, white, juicy, sweet, perfumed; core, small; "good." September.

ZEPHERINE GREGOIRE.

Foreign. Fruit, globular, acute pyriform; stem, fleshy; color, dull green, thin covering of russet, brownish red cheek; flesh, very melting, tender, juicy; "very good." November.

ZEPHIRIN LOUIS GREGOIRE.

Foreign. Tree, of moderate growth; productive. Fruit, of medium size, turbinate; skin, yellow, with a crimson cheek, and slightly russeted about the stalk, which is short and thick, inserted in a small cavity; eye, small; basin, shallow; flesh, white, melting, very juicy, and delicately perfumed. December. (Al. Pom.)

CLASS III. *Superseded by better sorts.*

ADMIRAL.

Amiral, | Colmar Charnay.

Foreign. Large, roundish pyriform, greenish yellow; flesh, coarse, juicy. October.

AMANDE DOUBLE.

Amanda's Double.

Foreign. Medium, pyriform, yellow and red. September.

AMBRETTE.

Tilton, | Ambrette d'Hiver, | Trompe Valet.
Ambre Gris, | Belle Gabriel, |

Foreign. Small, roundish, long stem, green, russeted. November, January. This is classed by some as identical with Echassery; we think them different.

AMBROSIA.

Early Beurre.

Foreign. Medium, roundish obovate, greenish yellow, russeted. August.

ANGLETERRE.

English Beurré, | Beurre d'Angleterre.

Foreign. Medium, pyriform, green and russet; flesh, white. September.

ANGLETERRE NOISETTE.

Foreign. Large, roundish, dark green. September.

ASTON TOWN.

Foreign. Small, roundish, greenish yellow. October.

AUTUMN BERGAMOT.

English Bergamot, | York Bergamot, | English Autumn Bergamot.

Foreign. Small, roundish, green, gray specks. September. The French Autumn Bergamotte is pyriform, light yellowish green, equally valueless.

AUTUMN COLMAR.

Foreign. Medium, oblong pyriform, pale green. October.

BELMONT.

Foreign. Medium, roundish obovate, yellowish green. October.

BELLE ET BONNE.

Gracieuse.

Foreign. Large, roundish, greenish yellow. September.

BERGAMOT, EASTER.

Bergamot de Paques, | Bergamot de Toulouse, | Royal Tairling,
Bergamot d'Hiver, | Winter Bergamot, | Terling,
Bergamot de Bugi, | Paddington, | Robert's Keeping

Foreign. Medium or above, roundish obovate, greenish yellow. February, May.

BERGAMOT D'HOLLANDE.

Holland Bergamot, | Bergamot d'Alencon, | Amoselle,
Beurre d'Alencon, | Bergamotte de Fougere, | Lord Cheeney's.

Foreign. Large, roundish, yellowish green, with brown russet. For ever.

BERGAMOT PARTHENAY.

Foreign. Small, roundish, greenish yellow. December, January.

BERGAMOT BOUSSIERE.

Foreign. Small, turbinate, yellowish green. December, January.

BEURRE BRONZEE.

Foreign. Large, roundish, greenish, dull russet. November, December.

BEURRE DUVAL.

Foreign. Medium, obtuse pyriform, yellowish green. October, November.

BEURRE SEUTIN.

Foreign. Above medium, pyriform, yellow, red cheek. December.

BEURRE KNOX.

Foreign. Large, oblong obovate, pale green, little russet. September.

BEURRE COLMAR.

Beurre Colmar d'Automne.

Foreign. Medium, oval obovate, pale greenish yellow. October.

BEURRE ROMAIN.

Gros Romain.

Foreign. Medium, obovate, yellowish green. October.

BEURRE DE BOLLWILLER.

Foreign. Medium, turbinate, yellowish red in sun. Winter.

BEURRE KENEICK.

No. 1599 of Van Mons.

Foreign. Medium, pyriform, greenish yellow. September.

BELLE DE BRUXELLES.

Belle of Brussels, | Belle d'Aout.

Foreign. Variable. Fruit, large, obovate pyriform, deep yellow, greenish dots, tinge of red in sun; flesh, white, sweet. August.

BEZI D'HEEL.

Bezi Royal.

Foreign. Medium, roundish, greenish yellow. October.

BEZI BLANC.

Foreign. Large, oblong pyriform, yellowish. August.

BON CHRETIEN, SPANISH.

Bon Chretien d'Espagne, | Spina.

Foreign. Large, pyriform, yellow, red cheek. December.

BON CHRETIEN, FLEMISH.

Bon Chretien Ture.

Foreign. Medium, obovate, pale green, brown cheek. November, March.

BISHOP'S THUMB.

Beurre Adam.

Foreign. Large, oblong irregular pyriform, yellowish green and russet. October.

BURGOMASTER.

Burgermeister.

Foreign. Medium, long, pyriform, yellowish green. December.

BOUCQUIA.

Beurre Boucquia.

Foreign. Large, angular, oval pyriform, pale yellow, red cheek. October.

BURLINGAME.

Burlingame.

American. Medium, roundish obovate, greenish yellow. September.

BURNETT.

American. Large, obtuse pyriform, pale yellow, russet. October.

BROOME PARK.

Foreign. Medium, roundish, brown. December.

BROUGHAM.

Foreign. Fruit, below medium, obovate, yellowish russet; stem, short; calyx, open; flesh yellowish white, a little gritty, buttery, sugary; "very good." November.

CABOT.

American. Medium, oval roundish, russet yellow, red in sun. September.

CALEBASSE.

Calebasse Double Extra, | Calebasse d'Hollande.

Foreign. Medium, oblong, dull yellow, russet. September.

CALEBASSE GROSSE.

Monstrous Calabash.

Foreign. Large, pyriform, yellowish, dull green. October.

CALEBASSE DELVINGE.

Foreign. Above medium, obovate pyriform, pale yellow. October, November.

CAPUCIN.

Foreign. Large, oval obtuse, greenish yellow. October.

CATILLAC.

Cadillac, | Grand Monarque, | Groote Mogul.

Foreign. Large, turbinate, yellow and brown. November to March.

CHAPMAN.

American. Above medium, ovate pyriform, yellow. October.

CHARLES OF AUSTRIA.

Charles d'Autriche.

Foreign. Large, roundish, greenish yellow, russeted. October.

CITRON OF BOHEMIA.

Great Citron of Bohemia.

Foreign. Large, oblong, yellow, red cheek. October.

CLINTON.

No. 1233, Van Mons.

Foreign. Large, obovate, light yellow. November.

CLARA.

Claire.

Foreign. Medium, oval pyriform, yellow, with red. October.

CHELMSFORD.

Stone.

American. Large, pyriform, yellow, red check. September.

COLMAR.

Colmar Dore,		D'Auch,
Incomparable,		De Maune.

Foreign. Large, obtuse pyriform, yellowish. December.

COLMAR D'AREMBERG.

Foreign. Large, obovate pyriform, yellow, with russet. October, November.

COLMAR DE MEESTER.

Foreign. Large, pyriform, greenish yellow. October.

COMPRETTE.

Foreign. Medium, obtuse pyriform, yellowish green. October, November.

COMMODORE.

Van Mons, No. 1218.

Foreign. Medium, obovate, yellow with red. October, November.

COMSTOCK.

Comstock Wilding.

American. Medium, obovate, yellow, crimson check. November, January.

COPEA.

American. Large, obovate acute pyriform, yellow. September, October.

CRASANNE.

Bergamot Crasanne, | Cresane, | Beurré Plat.

Foreign. Large, roundish, greenish yellow, thin russet. October.

CRAWFORD.

Foreign. Medium, obovate, yellow, tinged with brown. August.

CROFT CASTLE.

Foreign. Medium, oval obovate, greenish yellow. October.

CUVELIER.

Foreign. Medium, obovate pyriform, yellow. October, November.

CUMBERLAND.

American. Large, obovate, orange yellow, red check. September, October.

D'AMOUR.

Ah! Mon Dieu, | Mon Dieu.

Foreign. Small, obovate, pale yellow and red. October, November.

DEARBORN.

Foreign. Large, pyriform, russeted. November, December.

DE DEUX FOIX LANE.

Foreign. Medium, roundish obovate, dull yellow. Last August.

DOYENNE D'HIVER.

Coffin's Virgalieu.

Foreign. Medium, roundish obovate, yellow, faint blush. November.

DOWNTON.

Foreign. Medium, pyriform, yellowish brown. December, January.

DORR.

American. Large, obtuse pyriform, pale yellow, red cheek. August.

DUMORTIER.

Foreign. Small, obovate, yellow russet. October.

DUQUESNE D'ETE.

Foreign. Medium, obtuse pyriform, greenish. September.

EARLY BERGAMOT.

Foreign. Medium, roundish flattened, yellowish green. August.

EARLY CATHERINE.

Roussellet Hatif,		Poire de Chypre,		Kattern,
Early Roussellet,		Perdrue,		Green Catherine.
Cyprus Pear,				

Foreign. Small, pyriform, yellow, red cheek. July.

EARLY DENZELONIA.

American. Fruit, small, roundish flattened, yellow russet. August. Much resembles Fulton outwardly.

EMERALD.

Foreign. Medium, obovate, green and brown. December.

ENFANT PRODIGE.

Foreign. Medium, obovate acute pyriform, dull yellow. October.

FAMENGA.

Foreign. Medium, obovate, greenish yellow. September.

FINE GOLD OF SUMMER.

Fin Or d'Ete/

Foreign. Medium, roundish, yellow, red cheek. August.

FORTUNEE.

Episcopal,		La Fortunee de Paris,
La Fortunee de Parmentier,		Beurré Fortunee.

Foreign. Small, roundish, grayish yellow. December, February.

FORME DE DELICES.

Foreign. Medium, obovate, yellowish, with russet. October.

FOSTER'S ST. MICHAEL.

Foreign. Medium, roundish obovate, dull yellow. September, October.

FRANC REAL D'HIVER.

Franc Real,		Fin Or d'Hiver.
-------------	--	-----------------

Foreign. Medium, roundish, yellow, brownish cheek. December, February.

FRENCH JARGONELLE.

Chaumontel d'Eté,		Vermilion d'Eté,		Summer Beauty,
Bellissime d'Eté,		Poire des Princes,		English Red Cheek.
Supreme,		Red Muscadel,		Red Cheek,
Bellissime Supreme,		Sabine d'Eté,		Ridal.
Bellissime Jargonelle,				

Foreign. Medium, roundish obovate, yellow, with red cheek. July, August.

GENDESHEIM.

Foreign. Large, obtuse pyriform, greenish yellow. October, November.

GILOGIL.

Gile-o-gile, Poire à Gobert,		Garde d'Ecosse, Jilogil.
---------------------------------	--	-----------------------------

Foreign. Large, roundish, reddish russet. November, February.

GREEN CHISEL.

Sugar.

Foreign. Small, roundish, green, with brown cheek. August.

GREEN PEAR OF YAIR.

Green Yair.

Foreign. Medium, obovate, green. September.

GREEN SUGAR.

Prince's Green Sugar.

American. Medium, roundish obovate, yellowish green. August, September.

GRISE BONNE.

Small, pyriform, green. Middle August.

HAMPDEN'S BERGAMOT.

Bergamot d'Angleterre, Fingals,		Ellanrioch, Summer Bergamot,		Bergamot d'Ete.
------------------------------------	--	---------------------------------	--	-----------------

Foreign. Large, roundish obovate, yellow. September. There is also a Summer Bergamot, small, roundish, yellowish green; and a *large* Summer Bergamot, all equally worthless. Ripens 1st of August.

HARRISON'S FALL.

Rushmore Bon Chretien.

Large, obtuse pyriform, greenish yellow. October.

HESEL.

Hazel.

Foreign. Small, obovate, yellowish green. September.

HUGUENOT.

American. Medium, roundish, pale yellow, spots of red.

JALOUSIE.

Foreign. Large, obovate pyriform, russet, reddish in sun. September.

LEON LE CLERC.

Leon Le Clerc de Laval.

Foreign. Large, obovate, yellow, few russet spots. December, February.

LITTLE MUSCAT.

Little Musk, Primitive,		Petit Muscat, Muscat Petit.
----------------------------	--	--------------------------------

Foreign. Small, turbinate, yellow, dull red cheek. July.

LOUISE BONNE.

Louise Bonne Real,		St. Germain Blanc.
--------------------	--	--------------------

Foreign. Large, pyriform, pale green. December.

MARULIS.

Marcellis.

Foreign. Small, roundish, greenish yellow. September.

MADOTTE.

Amadotte.

Foreign. Large, pyriform, yellow. October.

MESSIRE JEAN.

Monsieur Jean,		Messire Jean Blanc,		Mr. John,
Messire Jean Gris,		Messire Jean Dore,		John.

Foreign. Medium, turbinate, yellow, brown russet. November, December.

MARIE LOUISE NOVA.

Foreign. Large, pyriform, yellow, with red cheek. September.

MICHAX.

Compte de Michaux.

Foreign. Medium, roundish, yellowish green. September, October.

MOOR FOWL EGG.

Little Swan's Egg,		Knevet's New Swan's Egg.
--------------------	--	--------------------------

Foreign. Below medium, roundish, dull green. October.

MUSCAT ROBERT.

Poire a la Reine,		St. Jean Musquee Gros,		Early Queen,
D'Ambre,		Musk Robine,		Queen's Pear.

Foreign. Small, roundish pyriform, greenish yellow. July.

NAUMKEAG.

American. Medium, roundish, yellow russet. October.

OLIVER'S RUSSET.

American. Small, obovate roundish, yellow, red russet. October.

OWEN.

American. Medium, roundish oval, dark green. November. (Cole.)

PAILLEAU.

Foreign. Medium, pyriform, greenish yellow. September.

PITT'S PROLIFIC.

Pitt's Marie Louise,		Pitt's Surpasse Marie.
----------------------	--	------------------------

Foreign. Medium, oblong pyriform, yellow, and brownish red. September.

POPE'S QUAKER.

American. Medium, oblong pyriform, yellowish russet. October.

POPE'S SCARLET MAJOR.

American. Large, obovate, yellow, red cheek. August.

PRINCESS OF ORANGE.

Princesse d'Orange,		Princesse Couquette.
---------------------	--	----------------------

Foreign. Medium, roundish, reddish russet. October, November.

QUEEN CAROLINE.

Reine Caroline.

Foreign. Medium, oblong pyriform, greenish yellow. November.

QUEEN OF PEARS.

Reine des Paires.

Foreign. Large, obtuse pyriform, greenish yellow. September, October.

QUITTELETTE.

Foreign. Below medium, roundish, greenish, dull russet. November.

RAYMOND.

American. Medium, obovate yellow, red in sun. October.

ROUSSELET.

Large Rousselet, | Gros Rousselet,
Foreign. Medium, obtuse pyriform, greenish, russety. August.

ROUSSELET DE MEESTER.

Ferdinand de Meester.

Foreign. Medium, roundish, yellow, pale red in sun. October.

ROUSSELET OF RHEIMS.

Rousselet, | Spice, or Musk Pear,
Petit Rousselet, | Late Catherine.

Foreign. Small, ovate pyriform, yellowish green, brown red. September.

STYRIAN.

Foreign. Large, pyriform, yellow, red check. October.

SUGAR TOP.

July Pear, | Prince's Sugar Top, | Harvest.
Small, roundish ovate, yellow. July.

SUCREE DE HOYERSWERDA.

Sugar of Hoyerswerda.

Foreign. Medium, oblong obovate, yellowish green. August.

SUMMER BON CHRETIEN.

Bon Chretien d'Eté, | Richard's Beurré,
Summer Good Christian, | Musk Summer Bon Chretien.

Foreign. Large, uneven pyriform, yellow, faint blush. August, September.

SUMMER ROSE.

Epine Rose, | Caillot Rosat, | Epine d'Eté Couleur Rosa,
Poire de Rose, | Caillot Rosat d'Eté, | Thorny Rose.

Foreign. Below medium, round obovate, yellow, red russet. August.

SUMMER THORN.

Epine d'Eté, | Fondante Musquée, | Satin Vest.

Foreign. Medium, pyriform, greenish yellow. September.

SUMMER ST. GERMAIN.

Short's St. Germain, | St. Germain de Martin, | St. Germain d'Eté.

Foreign. Medium, obovate, pale green. August, September.

SULLIVAN.

Foreign. Medium, oblong pyriform, greenish yellow. September.

SWAN'S EGG.

New Swan's Egg.

Fruit, below medium, oval obovate, pale green, dull brown. October.

SWISS BERGAMOT.

Bergamot Suisse.

Foreign. Medium, roundish, striped pale green, yellow and red. October.

SYLVANGE.

Bergamot Sylvange, | Green Sylvange.

Foreign. Medium, roundish obovate, dull pale green. October.

TARQUIN.

Foreign. Medium, oblong pyriform, dull yellow. December, February

VAN BUREN.

American. Large, obovate, yellow, red in sun. October.

VALLEE FRANCHE.

De Vallee, | De Keingheim.

Foreign. Medium, obtuse pyriform, pale yellowish green. August.

VIRGOULEUSE.

Poire Glace, | Chambrette, | Bujaleuf.

Foreign. Large, oval obovate, yellowish green, gray dots. November, January.

WHITFIELD.

Medium, obovate, yellowish brown. October.

WILLIAM. (Edwards'.)

American. Medium, obtuse pyriform, yellow, dotted with red. September.

WINDSOR.

Summer Belle, | Konge.

Foreign. Large, pyriform, dull yellowish green. August, September.

WINTER ORANGE.

Orange d'Hiver.

Foreign. Medium, roundish, yellowish green. November, January.

WURZUR.

Wurzur d'Automn.

Foreign. Medium, pyriform, yellowish, russeted. November.

YAT.

Yutte.

Foreign. Small, pyriform, brownish russet. September.

ZOAR FLAT.

American. Small, obovate, green. September, October.

THE PLUM.

Prunus domestica, L. *Rosaceæ* of Botanists.

THE Plum is found in a wild state throughout the middle sections of this country, but the original parent of the cultivated varieties is supposed to have come from Asia Minor. The fact of production in our States of many varieties esteemed among the best, attests the adaptedness of both soil and climate.

Propagation.—By Seed. The gathering, preserving, and planting of the plum is the same as we have described under head of peaches, to which, therefore, we refer the reader. Of the best varieties for producing stocks on which to bud, any free-growing sorts may be taken; avoiding, except when wanted for forming dwarf trees, those of slow habit, and in all cases avoiding the damsons. The wild red or yellow (*P. Americana*) is much used by many nurserymen, but it should always be worked just at or rather below the collar. Seedlings from it often answer to work the same season, and we have seen them used with advantage as stocks for the peach. The Chickasaw (*P. Chicasa*) is used at the South, where it is a native. New varieties have thus far been produced from chance seedlings; no person, to our knowledge, in this country, having exerted themselves to the production of varieties with any special view to the preserving of separate or combined characters.

By Budding. The plum is generally and best propagated in its varieties by budding. This should be performed in the month of July. Strong stocks of free-growing sorts should be especially selected for inserting buds of such varieties as Green Gage, Purple Favorite, &c., &c.

By Grafting. Where budding can be done, we should prefer never to graft. But it not unfrequently happens among nurserymen, that owing to some causes buds fail, and this, too, when the stocks, if left to another budding season, would become too large. They may therefore be grafted with success and profit, by cutting them off just at the collar, and grafting early in the month of March, drawing the earth up around the graft, and leaving only one bud out. Tan, bark, saw-dust, or other mulch should be placed on the ground, and free-growing sorts, as Imperial Gage, Lombard, &c., should only be used. Grafting on pieces of roots is sometimes practiced, and as successfully, if free-growing kinds only are used, as in the apple; it is also done in same way we cannot recommend it.

Transplanting and Distance Apart. The plum tree is perfectly hardy, and we prefer in all cases to transplant in the Fall, say October. The shoots of the year should be cut back to form a round regular head, and all small or slender-grown shoots cut out. The roots, with exception of tap-roots, should only have the ends trimmed smooth, the tap-root should be cut out. The distance apart depends very much on the variety; such sorts as Green Gage, Cloth of Gold, &c., requiring only to be about fifteen feet apart, while the Imperial Gage, Washington, &c., would be better at twenty feet.

Soil and Situation. The soil generally recommended for successful growth and fruiting of the plum is denominated heavy clay; this, by some, is construed to mean a soil so devoid of sand as to bake and crack open after periods of heavy rain; we have been unable to perceive any special difference in the success of growers in varied soils, relative to the growth, hardihood, or bearing habit of trees. That certain elements are requisite in the soil, wherever a tree is planted, to supply suitable food for the growth and perfecting of both fruit and wood, we do not doubt; but as yet, we are to learn that a cultivator who plants on clay soil will be any more successful either in health of trees or procuring a crop of perfect fruit, than he who plants on what is termed usually a light or sandy soil, and supplies that soil, if deficient, with the elements requisite for the plant to support health. Analysis of the plum tree and fruit has not, to our knowledge, as yet been made. The trees appear to grow, both in nursery and orchard, equally well on sandy as on clay soil: the insect curculio, and the leaf-blight or defoliation of the trees in July and August, black warts, &c., &c., are equally injurious in one as the other location. Native wild trees are found growing in all soils, and in our rambles we have met with trees equally healthy and productive, equally attacked in fruit by curculio, and rot or decay, in leaf-blight and black knots, in all soils from strong clay, through all intermediates, to sandy soils. We therefore say, plant the plum in any good soil which is well drained. The situation suited to the plum is that where the soil is well drained, and where the most convenient.

Pruning. The plum grown as a standard tree, with head formed four to six feet high, requires little pruning, except to shorten back, each Summer or Spring, such shoots as are becoming too vigorous and likely to destroy the regular form of the tree, or to cut out weakly-growing and unripened shoots. A round-headed tree, with branches formed at two feet from the ground, we consider best. In order to have this, trees one year old from the bud are best to begin with; the stem cut off so as to let two buds start at about two feet from ground, then shortened back one-half the next year. After which,

if the tree is of the slow or slender-growing varieties, it will need no farther pruning than the above-named standard. If it is of the strong, rampant-growing kind, it will require both root-pruning, (*i. e.*, passing round the root of the tree in a circle distant from the body two feet for a tree of ten feet high, and with a long, sharp spade, cut off all the roots), and at the same time shorten back the year's growth one-half. This is best done in August. This mode is especially calculated for the Western prairies and the warm Southern States.

Cultivation. Like all other fruit trees, the plum does best when the ground is often dug or hoed around. Many growers are also of impression that frequent stirring the soil prevents attacks of curculio. Trees planted where swine have run among them are generally healthy and fruitful; but whether it is owing to the stirring of ground by their rooting, or food supplied the plants in their excrements, is yet a question undecided.

Manures. The plum requires abundant food in the soil, and this is generally best supplied by animal manure; and where abundant supply of animal manure has been given, salt will be found highly beneficial: the proportion should be controlled somewhat by the quantity of animal matter contained in the soil; but a dressing of half an inch deep over the whole ground, if applied in the Spring, may be regarded as a medium. The benefit to the tree of this application will be in its tendency to an equable state of moisture in the soil. Ashes, in soils devoid of lime and the phosphates, will be found beneficial: two bushels to a tree twelve feet high, and in bearing state, will be a guide; larger trees requiring more, and smaller ones less. Brewer's grains are also valuable as a manure, when they can be obtained at prices corresponding with the value of animal manures.

Diseases. *The Black Warts, Knots, or Black Gum,* is a disease affecting many plum trees at the North. In the Southern States it is not yet much known. Its cause is variously attributed—by some to insects (*membracis bubalis*), (see Harris's Treatise on Insects); by some to inherent cause from its parent; by some to temperature and atmospheric change on the health and vigor of the tree; and by others to a diseased state of sap. After noting that it first appears in a neighborhood on trees grown from suckers, or propagated on suckers or unhealthy stocks, we are inclined to a support of the last-named cause. Trees in a judicious, rather high state of cultivation, and grown or worked on good, healthy seedlings, are rarely subject to it. And a tree diseased by inoculation may be recovered by appliance of abundant food at the roots, cutting away the apparent

knots, and washing the wounds either with salt or copperas-water. The latter is best. And if, also, the whole tree be watered with a solution of one ounce of copperas to two gallons of water, the *knots* will disappear.

Defoliation of both seedling stocks and bearing trees, in the months of July and August, we believe is caused by want of some specific ingredient in the soil. We have cured it by dressing with ashes, and by watering with copperas-water as above named. When animal manures and salt have been used, we have never seen the foliage drop.

Rot or Decay of Fruit is often a very serious drawback to the sanguine expectations of the fruit-grower. We have supposed it to arise from atmospheric influence, and to pervade the fruit in like manner as fever and ague does the human frame, but have been compelled to relinquish this theory. Latterly we are inclined to the belief that it has its origin in too great exhaustion of the supplies of the tree, by reason of excess of quantity; as trees that have come under our notice, on which only a moderate quantity of fruit was permitted to mature have apparently been free, while those overloaded, and only moderately, or not additionally, supplied with food, have decayed.

Our friend, Professor Kirtland, with some friends of science, have, however, lately pronounced it a species of fungus.

Insects Injurious. The *Ægeria*, which is noted under head of peaches, sometimes, but rarely, attacks the plum. We refer to that head for its remedy. The Curculio, or Plum Weevil (*Rhynchænus Nenuphar*), is an insect so destructive as in some sections to have caused orchardists to cut down their plum trees and replant with different fruit. Again, there are sections where the insect, although known, appears not to increase, or injure fruit, materially to affect the crop. It was unknown in the Western States until within a few years past, but now pervades all sections, even to destruction oftentimes of the wild plum. It has been thoroughly described in "Harris's Treatise on Insects;" and so much is written yearly relative thereto, that one entire book of four hundred pages would not contain it. Our accompanying figure represents the insect in its natural size, *i. e.*, about one quarter of an inch long, of a grayish brown color, the wing-covers forming two little humps, giving a rounded appearance to it, resembling a ripe hempseed. The head has a long rostrum, beak, or snout, projecting, with which it punctures the fruit, as represented by the crescent-shaped mark on the fruit in our engraving. Early in the month of June, the curculio commences his task of propagation, and his mark will



then be found near the apex of the fruit, at this time not much larger than a pea; as the fruit increases in size, the marks newly made will be found gradually approaching the stem, until in July, near the close of his labors, they will be found very near the stem. These last marks in July are not often found, as they are produced only from a few insects which have escaped late from the larva state, or, as some say, have, owing to shallow imbedding in the earth and great heat, been transformed from eggs deposited the same season.



The eggs, one of which is deposited in each crescent mark, soon hatches into a small white larva, which enters the body of the fruit, and feeds upon it, causing, usually, its premature fall to the ground.

The period at which the young fruit falls, after being punctured, varies with its age at the time of the injury. The earlier portions drop in about two weeks; but if the stone is hard when the egg is laid, the fruit remains till near the usual period of ripening, sometimes presenting a fair and smooth exterior, but spoiled by the worm within.

The insect, soon after the fall of the fruit, makes its way into the earth, where it is supposed to remain till the following Spring, when it is transformed into the perfect insect or beetle, to lay its eggs and perpetuate its race.

The curculio travels by flying, but only during quite warm weather, or at the heat of the day, at which time a person lying upon his back under a tree, and perfectly still, can observe their movements. If the least motion or noise is made, they remain inactive. The insects mostly confine themselves to certain trees, or to the same orchard. But the fact that newly bearing and isolated orchards are soon attacked, clearly shows that in occasional instances they must travel considerable distances. Indeed, they have been known to be wafted on the wind for a mile or more, the windward side of orchards being most infested, immediately after strong winds from a thickly planted plum neighborhood. In the cool of the morning they are nearly torpid, and can scarcely fly, and crawl but slowly; hence, at this time of the day they are most easily destroyed.

The plum alone is, however, not the only fruit subject to attack from this insect, but the peach, apricot, nectarine and cherry, all suffer; and, when a scarcity of fruit, then the tender branches of the oak, wild plum, and other trees, receive the egg, and dropping the same, after a period, to the ground, its regular transformations are continued, and the succeeding season the natural instinct of the insect leads it to the fruit again.

The preventives to injury from the natural instinct and course of the curculio are recorded in number more than we care to recount. Suffice it that, as yet, no certain agent or preventive has been found;

trees, to our knowledge, this year producing abundant crops, when no specific disinfecting agent has been applied, while trees forty rods distant have all their fruit destroyed. Salt, sulphur, lime-water, etc., etc., as variously recommended, is not a certain specific; and he who uses is just as liable to lose his crop of fruit as he who uses not. Hanging iron hoops in the trees, etc., etc., is a little like the old Salem practice of nailing horse-shoes over the door; and the one as valuable as the other. The natural instinct of the insect teaching it to seek such place of deposit for its egg as will insure successful production, avoids all trees where the soil is daily stirred underneath, or where causes are that the fruit shall drop ere required by the larvæ of the insect; hence the value of plantations made where swine are to run, or the planting of single trees where daily passing subjects them to chance loss of fruit. So also that of paving, and of trees standing on sites where water becomes the recipient of falling fruit. Heavy soils are just as much subject to destruction of plum from curculio as light soils. Soils termed wet are less subject; but here the tree does not flourish as well. In large orchards, where there is much fruit to save, a man constantly employed with a pole of about ten feet long, having a small cup or basin fastened at one end, passing from tree to tree, and scattering dirt freely, will well repay the cost, in the amount of fruit saved; while, for small gardens, the plan first introduced, more than twenty years since, by one of the most estimable horticulturists of the States, David Thomas, of New York, is the best. It is, in first preparing a short pole, having at one end a cushion made of several thicknesses of cloth or India rubber; place this cushion against the body of the tree early in the morning, (having first spread a sheet or large cloth on the ground, the diameter of the branches;) then strike the end with a heavy mallet: the jar causes the insect to drop on the cloth, when it may easily be gathered and destroyed.

Uses. The best varieties are by many esteemed delicious for the dessert. Others, and even the unripe fruit, are used in pies, tarts, conserves, and sweetmeats. Our own taste compels us to place the plum in the lowest state of cultivated fruits, and mainly from the fact that, unless perfectly ripe and fresh from the tree, if eaten in a raw state, they tend to flatulence and disease. Dried or cooked, they are regarded valuable, and are an article of considerable commerce as imported to this country under name of French prunes or dried plums. By a selection of the richest varieties, there is no doubt that prunes superior to those of foreign preparation might be easily obtained. The following description of an oven purposely built for prunes, and doubtless, with some modifications, well adapted to the drying of other fruits, is given in Liegel's Treatise (German), as quoted in the Horticulturist. The amount of heat obtained by a

small quantity of fuel, commends it to the particular attention of those engaged in drying fruit :

“Prunes,” says Liegel, “have become an important article of commerce. In order to have them fair and glossy, they must be *suddenly cooled*, when drawn from the oven.

“The country people in this part of Germany prepare their prunes by putting them into their bread ovens. I have put up, for my own use, a very conveniently arranged drying apparatus, which, after the experience of many years, I am induced to recommend ;

and for the construction of which I give the annexed drawing and explanatory description :

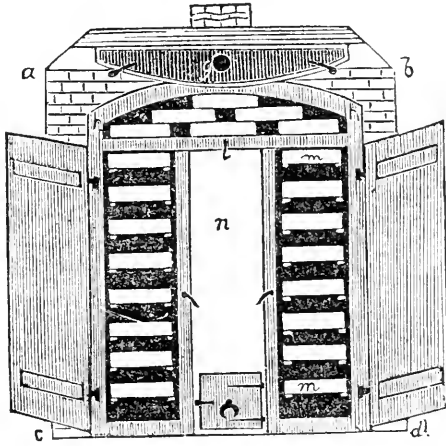

Fig. 1.

m m, for containing the prunes, rest upon shelves fixed upon two bearers. It would be better if they rested upon *rollers*, so as to admit of their being pushed in and drawn out with greater ease.

These lines of trays are placed at a distance of six inches from the furnace, so as to keep the fruit from too great a heat ; they may be made entirely of wood, but it will be better if the bottoms are of open work, like shelves. Their weight is such that they may be easily managed by a woman ; but in preparing prunes on a large scale, let them be made of greater length and breadth, so as to just come within the strength of a more robust person.

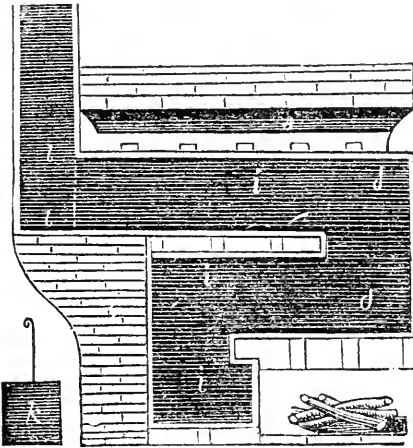

Fig. 2.

“The wooden frame, *h h*, is that on which the two doors are hung. The door, *g*, which covers the arch (and which is represented in the cut as open and fastened up), shuts up the front of the upper part

of the oven. In the middle of this upper door or flap is a round vent-hole, for the escape of the moist vapor. *k* is an iron damper or slide, to be placed in the flue at *ll*, in order to regulate the heat.

“A thousand fully ripe quetsches (prune plums) make about ten pounds of dried prunes.

“Plums of different kinds may be dried, either whole or deprived of their skins and stones. In the latter case, they are styled *prunelles*.”

Characters and Classification. The characters of the plums are represented by the texture of the flesh as combined with its juiciness and flavor; and what are termed gages (a word really of no meaning as applied to the fruit) represent fruits of round form, very delicate, and of a rich, sugary, juicy high flavor. The prunes are known as those fruits that are dry in the texture of their flesh. The character of size is one of which Washington may be taken as *large*, Green Gage as *medium*, and Mirabelle as *small*; while the wood being *smooth* or *downy*, needs no explanation, and the depressed line on one side, called a *suture*, is the same as in cherries or peaches, and often serves as a guide in detecting varieties. The classification by most writers of divisions of green, white, or yellow, and of blue, or red, or purple, we adopt only in our text descriptive of each distinct variety; preferring as a practical matter, here as elsewhere in our work, to follow that of, in short, best, very good, and good.

VARIETIES.

These are far too numerous for any practical use; and while we may have possibly reduced too much, we yet feel that the uses and wants of the community will be best supplied in this fruit by a few really valuable, and for the particular purposes pointed out in our text descriptive.

CLASS I. *Most generally esteemed.*

AUTUMN GAGE.

Roe's Autumn Gage.

American. Productive; branches, smooth. *Fruit*, medium, oval, broadest at base, pale yellow, whitish bloom; *flesh*, greenish yellow, juicy, sweet, separates freely from stone, long, compressed, and pointed at both ends; *stalk*, three-fourths inch long. September 15th.

BLEECKER'S GAGE.

German Gage.

Raised at Albany, N. Y., about forty years since, by Mrs. Bleecker. The tree is of healthy, hardy habit, and a regular, sure bearer. *Branches*, downy; *leaves*, dark green. *Fruit*, medium size, roundish oval, very regular; *suture*, slight; *skin*, yellow, with numerous imbedded white specks,

and a thin white bloom; *flesh*, yellow, rich, sweet and luscious flavor, separating freely from the stone, which is pointed; *stalk*, an inch or more long, downy, inserted in a slight cavity. Last of August here; in Georgia, first of July. Distinguished from Prince's Yellow Gage by its larger stalk and later maturity.

BLUE IMPÉRATRICE.

Impératrice, Veritable Impératrice,		Impératrice Violette, Violette.
--	--	------------------------------------

Foreign. A fine variety. The *true* Blue Impératrice must not be confounded with Semiana or Blue Impératrice of some Eastern growers. (See Semiana) *Branches*, smooth, long, slender. *Fruit*, medium, obovate, tapering to the stalk, deep purple, bloom blue, thick; *flesh*, greenish yellow, rich, sugary, hangs long on the tree, adheres to the stone. Last September.

BRADSHAW.

Large Black Imperial.

Branches, nearly smooth; strong grower. *Fruit*, large, roundish oval, dark violet red, juicy; "very good;" productive; may prove one of most valuable. August.

COE'S GOLDEN DROP.

Bury Seedling, Coe's Imperial,		New Golden Drop, Fair's Golden Drop,		Golden Gage, Waterloo, of some.
-----------------------------------	--	---	--	------------------------------------

This is an English variety. Tree, only moderately productive; and although we should always plant, yet it does not always mature perfectly north of 40° latitude. *Branches*, smooth. *Fruit*, large, oval; *suture*, well marked, one side enlarged; *skin*, light yellow, much dotted or mottled with red on side exposed to sun; *flesh*, adhering to the stone, yellowish, firm, rather coarse-grained, but rich and sweet; *stalk*, three-fourths to an inch long, rather stiff. Last of September. The Yellow Egg is often grown under this name at the West.

DENNISTON'S SUPRE.

A variety originated in the famous garden of Mr. Denniston, Albany, N. Y. Its great productiveness, together with its period of ripening, more than its quality, makes it desirable. *Branches*, downy. *Fruit*, medium, or rather above, roundish, slightly flattened; *suture*, distinct; *skin*, pale yellowish, overspread with a thin bloom, and mottled or clouded with purple; *flesh*, thick, not juicy, but with rich vinous flavor; *stone*, small, roundish, from which the flesh parts freely; *stalk*, three-fourths inch long, set in a cavity of moderate depth. 15th to 20th August.

DRAP D'OR.

Mirabelle Double,		Mirabelle Grosse,		Yellow Perdrigon.
-------------------	--	-------------------	--	-------------------

Foreign. Productive. *Branches*, slightly downy. *Fruit*, below medium, round; *suture*, indistinct; *skin*, bright yellow, crimson specks in sun; *flesh*, yellow, sugary, rich, adheres slightly to the stone. Early August.

DUANE'S PURPLE.

Duane's Purple French,		English Pond's Seedling.
------------------------	--	--------------------------

Foreign. *Branches* downy. *Fruit*, large, oblong oval, one side enlarged, reddish purple in sun, pale red in shade, dotted with yellow specks, lilac bloom; *flesh*, amber color, juicy, slightly acid, adhering to the stone; *stalk*, three-fourths inch long, slender, narrow cavity. Early August.

EARLY ORLEANS.

Wilmot's Early Orleans, New Early Orleans,		New Orleans, Grimwood's Early Orleans,		Hampton Court, Monsieur Hatif.
---	--	---	--	-----------------------------------

An English variety, which on accounts of its quality and early maturity must always make it popular as an orchard fruit. *Branches*, downy. *Fruit*, medium, round oval; *suture*, shallow; *skin*, dark reddish purple; *flesh*, yellowish green, of rich, brisk flavor, and separating freely from the stone; *stem*, usually about half-inch long, but varying. First August.

FELLENBERG.

Italian Prune,		Prune Suisse.
----------------	--	---------------

Foreign. *Branches*, grayish, smooth; moderate grower; very productive. *Fruit*, ovate rounded, dark purplish, not juicy; free-stone; large; "very good." Valuable for drying. Last September.

GREEN GAGE.

Ida Green Gage, Waterloo, King of Plums, Wilmot's Late Green Gage, Schuyler Gage.		Rensselaer Gage, Isleworth Green Gage, Wilmot's Green Gage. ————— New Green Gage, Brugnon Gage,		Bruyn Gage, Bradford Gage, Reine Claude, Grosse Reine Claude, Grosse Reine.
---	--	---	--	---

"During the last century, an English family by the name of *Gage*, obtained a number of fruit trees from the monks of Chartreuse, near Paris. Among them was a tree of this plum, which, having lost its name, was called by the gardener the Green Gage." There are very few trees in bearing of the true variety at the West, the Imperial Gage having been often sold as Green Gage. The true variety is readily known by its short jointed, slow-growing, spreading, and dwarfish habit. It also requires a rich, warm soil to insure fruit in perfection in locations north of 42 deg. *Branches*, smooth; *buds*, with large shoulders. *Fruit*, medium, round; *suture*, slight; *skin*, yellowish green, marbled and dotted on the sunny side with red; *flesh*, separates freely from the stone, pale green, exceedingly melting, rich, sprightly, high flavor; *stalk*, slender, slightly inserted. Middle to last August.

IMPERIAL GAGE.

Prince's Imperial Gage, Flushing Gage,		White Gage, Jenkinson's Imperial,		Superior Green Gage.
---	--	--------------------------------------	--	----------------------

This is an American variety, originating at the old nursery of William Prince, Flushing, N. Y. In heavy, strong soils it is sometimes deficient in flavor, probably from a deficiency of some particular element in the soil, as it produces abundantly, grows vigorously, and trees apparently healthy. In light, loamy, or even dry, poor soils, it is a hardy, productive variety, and the flavor often almost equaling a true Green Gage. As a market variety, it is far superior to Green Gage, and hardly surpassed by any other plum. *Branches*, slightly downy, dark-colored, upright, vigorous. *Fruit*, above medium, oval; *suture*, distinct; *skin*, at first pale green, with a white bloom, becoming yellowish green, marbled with dark green stripes; *flesh*, greenish, juicy, rich, sprightly flavor; *stone*, oval, with flesh occasionally adhering—in good seasons and soils, it separates freely from the stone; *stalk*, long, hairy, stout, inserted in an even cavity. First September; at the South, July first.

IMPERIAL OTTOMAN.

A foreign variety, but from whence is uncertain. We have fruited it several years, and, as an early variety, have not met its superior. The

trees are hardy, regular, not rampant growers, and regular, abundant bearers. *Branches*, slightly downy. *Fruit*, medium, roundish oval, regularly formed; *skin*, greenish yellow, marbled with darker shades in stripes underneath; if permitted to hang, it becomes mostly pale yellow, bloom thin; *suture*, only half way down on one side; *flesh*, yellowish, juicy, rich, sweet, delicious, and, when fully ripe, parts freely from the stone; *stem*, downy, three-fourths inch long, inserted in a cavity of moderate depth. Last July.

JEFFERSON.

An American variety, originated by Judge Buel, at Albany, N. Y., probably from a seed of Coe's Golden Drop, which in growth, wood, &c., it closely resembles. It has been pretty extensively tested, both in this country and in Europe, and fully sustains the high character given it by the late A. J. Downing. The Bingham Cling-stone plum has occasionally been disseminated for this variety. In rich, high flavor it does not equal the Green Gage, but its large size, great beauty, productiveness, freedom from decay, and habit of hanging long on the tree after ripe, render it valuable for all collections. *Branches*, nearly smooth. *Fruit*, large, oval, slightly narrowed one side toward the stalk; *skin*, at first greenish yellow, becoming golden yellow when fully ripe, and with a rich reddened cheek in the sun; *bloom*, thin, white; *suture*, slight; *flesh*, separating nearly free from the long pointed stone, yellow, almost orange yellow, juicy, with rich flavor; *stalk*, an inch long, inserted without depression. Last of August; at the South, last of July.

LAWRENCE'S FAVORITE.

Lawrence's Gage.

An American plum, raised from seed of the Green Gage, by Mr. L. U. Lawrence, Hudson, N. Y. It forms a tree of upright, thrifty growth, and bears young and abundantly of fruit much resembling outwardly the Green Gage, except being larger. *Branches*, downy, short-jointed. *Fruit*, large, roundish; *skin*, dull yellowish green, clouded with streaks of a darker shade beneath, and in sun, around the stem a mottling or dotting of brownish red; *bloom*, light bluish green; *flesh*, greenish, juicy, rich, excellent, only surpassed by Green Gage, when fully ripe, separates freely from the stone; *stalk*, half-inch long, slender, inserted in a narrow cavity. Middle August.

LOMBARD.

Bleecker's Scarlet, | Beekman's Scarlet, | Montgomery Prune ?

An American variety, which, as a tree, is thrifty, healthy, hardy, and productive, while the fruit appears less attractive than most others to the curculio. It is, therefore, very desirable. *Branches*, smooth, bright purple, very thrifty; *leaves*, much crumpled. *Fruit*, medium, roundish oval, slightly flattened at ends; *suture*, slight; *skin*, violet red, dusted thinly with bloom; *flesh*, yellow, juicy, not rich, but pleasant flavor; *stalk*, slender, three-fourths inch long, set in a broad, open cavity; adheres to the stone. Middle to last of August.

MADISON.

An accidental seedling in the Denniston Garden, Albany, N. Y., and, according to Dr. Herman Wendell, a hybrid from Bleecker's Gage and Blue Gage. Its flavor, late period of maturity, and hardihood, commend it.

Branches, slender, smooth; *leaves*, light green, slightly downy. *Fruit*, medium, roundish oval; *suture*, slight; *skin*, light orange, with a cast of greenish yellow, in sun, mottled and spotted with lake carmine; *bloom*, thin, delicate; *flesh*, yellow, firm, juicy, rich and sweet, agreeable flavor, separates freely from the stone, which is small, oval, pointed; *stalk*, three-fourths inch long, inserted in a regular, not deep basin. First to fifteenth October.

McLAUGHLIN.

An American variety, raised by James McLaughlin, Bangor, Maine. The tree is very thrifty, making stout, vigorous shoots of four to six feet in a season, but forming a round, regular head. Originating so far North, it will unquestionably prove a most valuable variety for Northern culture. The fruit, in character of quality, resembles the variety just previously described. *Branches*, smooth; *leaves*, broad, glossy. *Fruit*, above medium, roundish, flattened at ends; *suture*, obscure; *skin*, thin, tender, russet yellow, sprinkled with a red tinge, which deepens to a purplish hue around the stalk; *flesh*, adhering to the stone, dull yellow, firm, juicy, excellent; *stone*, roundish; *stalk*, three-fourths inch long, inserted without depression. Middle to last of August.

MOROCCO.

Early Morocco,		Early Black Morocco,		Black Damask.
Black Morocco,		Early Damask,		

Foreign. Moderate bearer. *Branches* downy. *Fruit*, medium, roundish, shallow suture; *skin*, dark purple; *bloom*, thin; *flesh*, greenish yellow, slightly adhering to the stone, juicy, rich and sweet; *stalk*, half inch long. Early August.

PURPLE FAVORITE.

This variety the late A. J. Downing states to have been planted and grown by his father. Although of dwarfish, slender habit, the trees are very hardy, and bear when young. For large market orchards it is not as valuable as some other varieties, but in private gardens it should always have a place. *Branches*, smooth, short-jointed. *Fruit*, medium, or rather above, roundish obovate; *skin*, brownish purple, dotted with golden specks; *bloom*, light blue; *flesh*, pale greenish, juicy, sweet and excellent, and separating freely from the stone, which is small; *stalk*, three-fourths inch long, depression slight. Last of August.

PURPLE GAGE.

Reine Claude Violette, | Violet Queen Claude, | Die Violette Koning Claudie.

A foreign variety, moderate bearer, but high flavor. *Branches*, smooth, short-jointed. *Fruit*, medium, roundish, a little flattened; *suture*, shallow; *skin*, violet, dotted with pale yellow; *bloom*, light blue; *flesh*, greenish yellow, firm, sugary, high flavor; *stone*, oval, compressed, from which the flesh separates freely; *stalk*, an inch long, set in a narrow basin. About 10th September, but will hang a fortnight, shriveling slightly.

PRINCE'S YELLOW GAGE.

American Yellow Gage, | White Gage, | Harvest Gage.

A variety produced in 1783, by the elder Mr. Prince, of Flushing, N. Y. The trees are abundant bearers, and the fruit carries well to market, and always sells readily. As a table fruit it is often too dry, and does not

deserve to be planted in small gardens where market sales are not contemplated. *Branches*, smooth, short-jointed; *leaves*, glossy. *Fruit*, slightly above medium size, oval, broadest near the stalk; *suture*, a mere line; *skin*, golden yellow, little clouded; *bloom*, white, abundant; *flesh*, yellow, sugary, rich, sometimes rather dry, parts freely from the stone; *stalk*, an inch long, set in a round cavity. Early in August; at the South, middle of June. It is stated, also, at the South, to ripen gradually, to be juicy, and of the best.

RED GAGE.

An American plum, raised from seed of the Green Gage, by the elder Wm. Prince, in 1790. The tree is of hardy, yet vigorous habit, wood dark reddish color, and producing abundantly a fruit rather small, yet of the best flavor. *Branches*, smooth; *leaves*, crimped. *Fruit*, hardly medium size, oval, rounded; *skin*, brownish red; *bloom*, slight; *flesh*, parting freely from the stone, greenish amber, juicy, sweet, delicious; *stalk*, slender; *cavity*, narrow. Middle August.

REINE CLAUDE DE BAVAY.

Foreign. *Branches*, smooth. *Fruit*, medium, roundish, oval, greenish yellow, spotted with red; *flesh*, firm, juicy, sweet, rich, adhering slightly to the stone; *stem*, short. Last September.

SAINT MARTIN'S.

St. Martin's Quetsche.

A German fruit. The word quetsche or prune not applying to this fruit, we prefer to drop it. It is a juicy, not a dry prune plum. The trees are good bearers and the time of ripening makes it profitable for market or preserving. *Branches*, smooth. *Fruit*, medium, or rather above, ovate, broadest at base; *skin*, bright yellow, dotted a little with brownish red in the sun; *bloom*, white; *flesh*, yellowish, juicy, rich, excellent. First October, but will hang two weeks.

SMITH'S ORLEANS.

La Delicieuse.

American. Originated by a Mr. Smith, on Long Island, and first described by Prince. As a market plum this is a fine variety, but for dessert it is deficient in richness and flavor on moist, strong soils. *Branches*, stout, nearly smooth. *Fruit*, large, oval oblong, largest at base; *suture*, half round; *skin*, deep purplish red, with small golden specks and deep blue bloom; *flesh*, yellow, tender, juicy, adhering closely to a large ovate stone; *stalk*, short, inserted in a deep round cavity. Last August.

WASHINGTON.

Bolmar,		New Washington,		Parker's Mammoth,
Bolmar's Washington,		Franklin,		Irving's Bolmar.

The original tree of this variety grew on what, in 1818, was known as Delancey's Farm, and now constitutes a portion of New York city, known as the Bowery. It was introduced to notice, grown and distributed by Michael Floy, Esq., American Editor of Lindley's Guide to the Orchard. Without possessing high flavor, the uniform hardihood of the tree, with its productive habit, large size of fruit, and often freedom from attack of *curculio*, renders it a most popular variety, and for market deservedly so

at the North. In Georgia, and other sections South, it is said to be entirely flavorless and dry. *Branches*, downy. *Fruit*, large, roundish oval; *suture*, obscure, except near the stalk; *skin*, dull yellow, with faint marblings of green, and on the sunny side some little red, often dotted; *flesh*, yellow, firm, sweet, and separating freely from a pointed stone; *stalk*, nearly three-fourths inch long, downy, planted in a wide, shallow basin. Last of August.

CLASS II.—*Embraces varieties, many of which are new and untested, and others suited only to certain localities, or very large orchards.*

ABRICOTE SAGERET.

A seedling of Sageret. Tree, very vigorous; branches, smooth. Fruit, rather below medium size, globular; suture, medium, extending nearly all around; skin, green, dotted, and slightly flaked with yellow; stem, three-fourths of an inch long, set in a very slight cavity, apex, slightly dimpled; flesh, green, juicy, very sugary, with a rich, delicious flavor. Separates from the stone. Ripens the first half of September. (Downing.)

ALBANY BEAUTY.

Deniston's Albany Beauty.

American. Branches slightly downy. Fruit, below medium, roundish oval; skin, whitish green, with purple dots, bloom thin; flesh, yellow, rich, sweet, not juicy, separates freely from a small, pointed stone; stalk slender, one inch long. Last August.

ANGELINA BURDETT.

English. Round, medium size, nearly black, spotted thickly with brown spots, very rich, juicy, and excellent; skin, thick. Free-stone. Middle of September. (Riv. Cat.)

APPLE PLUM.

From the garden of D. U. Pratt, Chelsea, Mass. Fruit, medium, roundish flattened, a little swollen on one side; suture, medium; skin, reddish purple, with a blue bloom and light dots; stalk, short and stout, inserted in a broad, deep cavity; flesh, greenish yellow, a little coarse, sweet, sprightly, with considerable austerity at the skin. Adheres partially to the stone. Ripens first of September. (Downing.)

AUTUMN COMPOTE.

Foreign. Tree, vigorous; branches smooth. Fruit, large, oval rounded, reddish purple; "good." October.

BELGIAN PURPLE.

Tree, vigorous; branches, smooth; buds, prominent. Fruit, medium, roundish; suture, slight, one side a little swollen; skin, purple, with a bloom; stalk, rather long and slender, inserted in a cavity; flesh, greenish, a little coarse, very juicy, sweet, luscious. Adheres slightly to the stone. Ripens first of September. (Downing.)

BELLE DE SEPTEMBRE.

Tree, large, vigorous and very productive. Fruit, very large, oval, reddish brown, an excellent kitchen fruit. Middle of October. (Riv. Cat.)

BLUE PLUM.

Tree, productive; branches, smooth; leaves, rather small. Fruit, medium, roundish, scarcely oval; suture, obscure, dark blue; light blue bloom; flesh, yellowish green, juicy, sweet, adheres to the stone; stalk, three-eighths inch long, inserted in a shallow cavity. Middle July in Georgia; middle August here. Propagated by suckers. Description by W. N. White, Athens, Ga.

BINGHAM.

American. Productive; branches, downy. Fruit, above medium, oval, deep rich yellow, dotted with red in the sun; flesh, yellow, juicy, rich, delicious, adheres to the stone; stalk, three-fourths inch long, slightly sunk. Last August.

BRICETTA.

Fruit, medium, roundish oval; color, yellow, with spots of red in sun; stalk, medium; cavity, small; flesh, yellow, firm, juicy, sugary, adheres to the stone. September.

BUEL'S FAVORITE.

American. Branches, smooth. Fruit, large, ovate; suture, half round, pale green, little red next the stalk; flesh, greenish yellow, firm, juicy, adhering to a long pointed stone; stalk, three-fourths inch long. Last August.

BURGUNDY PRUNE.

Prune de Burgoyne.

Foreign. Fruit, medium, egg-shape, with neck; color, reddish black blue bloom, and many small dots; stem, long; cavity, small; flesh, fine, juicy, pleasant, separates from the stone. September.

BURETTES.

Foreign. Fruit, large, long, oval; color, dull yellow; flesh, melting, juicy, sweet, high flavor. September.

CHAPIN'S EARLY.

Received of Mr. E. Chapin, of York, Pa. Origin unknown. Tree, healthy, but not vigorous.

Branches downy. Fruit, small, roundish globular, slightly protuberant on one side; suture, indistinct; skin, pale red, covered with a light bloom; stalk, half an inch long, inserted slightly in a ring; flesh, yellow, rather coarse, sweet, juicy, and refreshing, adheres slightly to the stone. Ripens the middle of August. (Downing.)

CHERRY.

Early Scarlet,		Der Virginia,		Prunus Cerasifera,
Myrobolan,		D'Amerique Rouge,		Miser Plum,
Virginian Cherry,		Prunus Myrobolana,		Golden Cherry,

A variety of which many sub-varieties have been and are constantly being produced from seed. Its chief merit is in the tree being ornamental, and the fruit maturing early. Being very pretty for the dessert, commands

ready sale. It requires root-pruning every two years, in order to make it productive. Branches, smooth. Fruit, small, round, yellow, and red, shaded and mottled; flesh, greenish, juicy, pleasant, adhering closely to an oval stone; stalk, short; cavity, narrow. Middle of July. The Chickasaw Plum (*Prunus Chicasi*) is very similar to this.

COLUMBIA.

Columbian Gage.

American. Valuable market sort, productive, succeeds well South; branches downy. Fruit, large, globular, one side enlarged; skin, brownish purplish, with fawn-colored specks, blue bloom; flesh, orange, rather coarse, dry but sugary, separates freely from stone, which is small, compressed; stalk, an inch long; cavity, small, narrow. Last August.

COOPER.

Cooper's Red, | Cooper's Large Red, | Cooper's Large American.

American. Described by Coxe, in 1817, as grown from a stone of Orleans. Some writers state it to be identical with "Smith's Orleans;" but we do not so consider it. Fruit, large, deep purple, with a bloom; suture, shallow and broad; stem, three-quarters inch long; flesh, coarse, yellow; "good." Last August.

CRUGER'S SCARLET.

Cruger's, | Cruger's Seedling, | Cruger's Scarlet Gage.

American. Productive, and comparatively free from attacks of curculio, branches, downy. Fruit, little above medium, roundish oval; skin, lilac red, with thin bluish bloom and yellow dots, in dark shade one side, pale fawn color; flesh, orange, rather dry, rich, separates free from stone; stalk, half-inch long; basin, shallow. Last August.

DANA'S YELLOW GAGE.

American. Branches, downy. Fruit, medium, oval, pale yellow; flesh, yellowish. Cling-stone. September.

DE DELICE.

Foreign. New; branches, smooth. Fruit, medium, roundish oval, slight neck, little swollen one side; suture, nearly indistinct; skin, green, marbled and shaded with violet, and covered with thin bloom; stalk, medium length and size; flesh, orange yellow, juicy, melting, sugary, rich flavor, adheres slightly to the stone. September.

DE MONTFORT.

Foreign. Branches, downy. Fruit, above medium, roundish, light purple, spotted with brownish yellow, and with blue bloom; flesh, light yellow, rich; when fully ripe parts freely from stone; stalk, half-inch long. Middle August.

DENISTON'S RED.

American. Branches, smooth. Fruit, medium, roundish oval; suture, half round; skin, light red, with fawn-colored dots, bloom, thin; flesh, amber color, separates freely from a small, oval, compressed stone; stalk, long, slender. Last August.

DOMINE DULL.

German Prune, | Dutch Prune, | Dutch Quetzen.

American. From seed of the Dutch Prune; productive and valuable for drying; branches, smooth. Fruit, medium size, long oval; skin, dark purple, nearly black, with blue bloom; flesh, yellow, juicy at first, if allowed to hang on the tree becomes dry, rich, and sweet, adheres to stone; stalk, an inch long. September.

DOWNING'S EARLY.

American. Branches, short-jointed, slightly downy. Fruit, medium, yellow, roundish oval, sweet, juicy. Early in August.

DOWNTON IMPERATICE.

Foreign. Branches, smooth, valued for preserving. Fruit, medium, oval, narrowing to the stalk, pale yellow; flesh, yellow, melting; unless fully ripe, acid, then sweet, adheres to the stone; stalk, three-fourths inch long. Last of September. Sometimes grown as Yellow Egg.

DRAP D'OR D'ESPERIN.

Cloth of Gold d'Esperin.

Foreign. Branches, smooth, slender; buds, pointed, projecting. Fruit, medium, ovate, yellow; very productive. August.

DUNMORE.

Foreign. Fruit, small, egg-shaped; skin, thick, and green, becomes golden yellow at maturity; flesh, yellow, fine, very juicy, sweet, very aromatic; separates from the stone. Ripens the first of October. (Al. Pom.)

EARLY CROSS.

Originated with Mr. Cross, Salem, Mass. Tree, moderately vigorous, productive. Fruit, small to medium, roundish; skin, reddish purple, covered with a thick bloom; stalk, half an inch long; flesh, greenish yellow, juicy, sweet and good; adheres to the stone. Ripens the second week in August. (Downing.)

EARLY ROYAL, OF NIKITA.

Tree, moderately vigorous: branches, smooth, gray. Fruit, small, roundish; skin, reddish purple, with a bloom; stalk, medium, curved; flesh, yellow, sweet, juicy, of pretty high flavor, adheres partially to the stone. Ripens middle of August.

EARLY PURPLE.

Sea.

Foreign. Fruit, small, roundish, brownish purple, with a scanty light-colored bloom; flesh, greenish yellow, highly perfumed, sweet, juicy, parts freely from stone. Early June at South, July here. (W. N. White, in Horticulturist.)

EARLY YELLOW PRUNE.

Tree, vigorous and very productive; branches, downy. Fruit, rather large, oval; skin, yellow, with a very slight bloom, and dotted with red in the sun; stalk, of medium length, inserted in a small cavity; flesh, yellow, sweet, juicy, with somewhat of a melon flavor, separates from the stone. Ripens middle of August. (Downing.)

ELFREY.

Elfrey's Prune.

American. Very productive, always valuable for drying, often very fine for the dessert, succeeds admirably at the South; branches, smooth. Fruit, rather below medium size, oval, blue; flesh, greenish, sweet, parts freely from stone. Middle August; South, first July.

EMERALD DROP.

American. Productive; branches, smooth. Fruit, medium, long oval, one side enlarged, yellowish green; flesh, greenish yellow, juicy, adheres to the stone; stalk, three-fourths inch long. Last August.

ENGLISH WHEAT.

Fruit, medium, roundish oval; suture, moderate; skin, reddish purple, with a blue bloom, covered with numerous white dots; stalk, half an inch long, rather strong; set in a rather deep cavity; flesh, yellow, a little coarse, juicy, sweet, with a rich flavor, adheres to the stone. Ripens the last of August.

FROST GAGE.

American. Does not answer well in soils of only moderate richness; requires rich, moist, clayey soil. Branches, slender, upright habit. Fruit, below medium, roundish oval; suture, half round, deep purple, bloom thin; flesh, greenish yellow, sweet, adhering to stone; stalk, three-fourths inch long. First October.

FULTON.

Fruit, medium, yellow, roundish ovate, juicy, sweet; hangs well. November.

GALBRAITH.

An early plum, said to have originated with the late Mr. Galbraith, near Boalsburg, Pa; and is represented as being a straggling grower, but the best early plum cultivated in that vicinity. An inch and a half long, by one and five-sixteenths broad, oval, purple; stem, five-eighths of an inch, by one-fourteenth; flesh, tender, juicy, adherent to the stone; flavor, luscious; quality, "very good," if not "best." (W. D. B.)

GENERAL HAND.

Montgomery.

American. Branches, nearly smooth. Fruit, large, roundish oval, yellow marbled; flesh, pale yellow. Free-stone. September.

GERMAN PRUNE.

Quetsche,		Turkish Quetsche,		Damask.
Common Quetsche,		Leipzig,		Quetsche Grosse,
True German Prune,		Sweet Prune,		Prune d'Allemagen.

A variety with numerous sub-varieties, the best of which is "Manning's Prune," previously described. Branches, smooth. Fruit, long oval, purple; flesh, greenish. Free-stone. September.

GUNDAKER PLUM.

Same origin as the Prune, of a purple color on one side, and the other a light color, heart-shaped, resembling a plum called Golden Drop, but larger in size, and a great bearer. (Gundaker in Hort.)

GUNDAKER PRUNE.

Groundaere.

Raised by Samuel E. Gundaker, of Lancaster, Pa. The Gundaker is of a yellowish white color, nearly as large as the Blue Prune, and of the same oval shape, very high-flavored, and a good bearer.

GUTHRIE'S LATE GREEN.

Foreign. Branches, smooth. Fruit, medium, globular, swollen on one side; skin, yellow, with splashes of green, thin bloom; stalk, three-fourths of an inch long, inserted in a small cavity; flesh, light yellow, firm, rather dry, but sweet and rich, adheres slightly to the stone. Middle of September.

GUTHRIE'S TAY BANK.

Foreign. Branches, smooth; short jointed. Fruit, large, green, oval roundish, juicy; "very good." September.

GUTHRIE'S TOPAZ.

Foreign. Tree, productive, moderate grower; branches, brownish, smooth. Fruit, medium, oval, with slight neck; stem, inch long, slender; suture, slight, one side enlarged, golden yellow, thin bloom; flesh, yellow, juicy, rich, sweet, adheres to the stone. September.

HARTWISS' YELLOW PRUNE.

A new German variety. Tree, vigorous. Fruit, medium, oval, with a neck narrowed at the crown; suture, moderate; skin, waxen yellow, with occasional red dots; stalk, long; flesh, light yellow, fine, rich, sub-acid flavor, moderately juicy. Last of September. (Downing.)

HIGHLANDER.

Tree, vigorous and very productive. Branches, gray, smooth. Fruit, large, irregularly ovate, somewhat swelled on one side; suture, moderate, half round; skin, deep blue, inclining to reddish brown, covered with a thin bloom, and thickly sprinkled with brown dots; stalk, very short, inserted in a slight cavity; flesh, yellow, juicy, sugary, rich, vinous, refreshing, and excellent; adheres slightly to the stone. Last of September. (Downing.)

HENRY CLAY.

American. Fruit, large, bright yellow, with a carmine^d cheek; stem, long, white bloom; skin, tough; flesh, yellow, sugary; "very good;" half cling-stone. September. Originated at Albany; yet new.

HOWARD'S FAVORITE.

American. A profuse bearer and hangs well. Fruit, large, roundish obovate, slight neck; stem, one inch; color, orange yellow, shaded with red, and reddish spots; flesh, yellow, juicy, sub-acid; "very good." Sept.

HOWELL'S EARLY.

American. Branches, slender, gray, downy. Fruit, below medium, oval angular; suture, indistinct; light brown, greenish yellow in the shade, thin blue bloom; flesh, amber color, juicy, sweet, separates freely from a small oval stone; stalk, three-fourths inch long, slender. Last July.

HOW'S AMBER.

American. Branches, slightly downy. Fruit, medium, roundish; skin, amber color, dotted and mottled with rose; flesh, yellow, a little coarse, adhering to the stone, rich, fine flavor. Last August. (Hov. Mag.)

HUDSON GAGE.

American. Somewhat like Imperial Gage, but earlier. Branches, downy. Fruit, medium, oval, enlarged one side; suture, obscure; skin, yellow, clouded as if underneath with stripes of green; bloom, white; flesh, greenish, juicy, sprightly, and mostly parts from the stone, which is small; stalk, half inch long. Early August.

HULING'S SUPERB.

This variety we have little doubt will eventually command a place in the first class: at present it has been little grown; Duane's Purple being almost invariably the variety distributed under this name. Leaves, broad, large; branches, stout, downy, with a swollen knob behind each bud. Fruit, very large, roundish oval, shallow suture; skin, dull greenish yellow, covered with pale bloom; flesh, greenish yellow, little coarse grain, rich, brisk, sprightly flavor, adheres partially to the stone; stalk, an inch long, swollen at its junction with the tree, and set in a round, small cavity. Middle August.

ICKWORTH IMPERATRICE.

Knight's No. 6.

Foreign. North this does not ripen well; in the Middle and Southern States it promises yet to become a first-class plum, on account mainly of its period of ripening. Branches, smooth. Fruit, above medium, obovate, purple, with irregular tracings of fawn yellow; flesh, greenish yellow, sweet, juicy, and mostly adhering to a small stone; stalk, half inch long, thick. Early October. If gathered by hand, wrapped in paper, and laid in a dry place, will keep a month.

IMPERIAL OF MILAN.

Imperiale de Milan.

Foreign. Fruit, large, oval, deep purple, juicy, sugary. October. (T. Rivers, in Hort.)

ISABELLA.

Foreign. Branches downy. Fruit, above medium, oval, dull red, mottled; flesh, yellow, rich, juicy parting freely from the stone when fully ripe; stalk, three-fourths inch long. Last August.

ITALIAN DAMASK.

Damas d'Italie.

Foreign. Productive; succeeds finely South. Branches, smooth. Fruit, medium, roundish, flattened at the base; suture, half round; skin violet, becoming brown; flesh, yellowish green, firm, sweet, separating from a thick oval stone; stalk, half inch long, slender; cavity, small. Last August. Bears well in all soils.

IVES' WASHINGTON.

Ives' Seedling.

American. Originated by J. M. Ives, Salem, Mass. Branches, smooth; buds, prominent; good grower and productive, not as yet much known;

promises valuable. Fruit, medium, yellowish, blush in sun, much resembles Jefferson.

JAUNE HATIVE.

Catalonian,
White Primordian,
Amber Primordian,

Jaune de Catalogue,
Prune de St. Barnabée,

D'Avoine,
Picket's July.

Foreign. Branches, downy. Fruit, small, oval, pale yellow; flesh, yellow. Free-stone. July.

KIRKE'S.

Foreign. Branches, smooth. Fruit, medium, round, dark purple, thick blue bloom; flesh, greenish yellow, firm, rich, separating freely from a broad, flat stone; stalk, three-fourths inch long. Last August.

LADY PLUM.

Raised by Isaac Denniston, Albany, N. Y. Tree of slender growth, productive. It is quite a pretty fruit, esteemed highly for preserving, this being its chief quality. It is a rampant grower, an abundant bearer. Fruit, quite small, oval; stalk, short and stout; color, light yellow, spotted with red; stone, free and small; flavor, acid. First of September. (E. Dorr in Cult.)

LANGDON'S SEEDLING.

Raised by Reuben Langdon, of Hartford, Conn. Tree, vigorous and productive; branches, smooth. Fruit, rather large, roundish oval, with a moderate suture; skin, reddish purple, covered with a thick bloom; stalk, three-fourths of an inch long, inserted in a rather deep cavity; flesh, greenish yellow, juicy, sprightly, sub-acid, and adheres mostly to the stone. Last of August. (Downing.)

LONG SCARLET.

Scarlet Gage.

American. Branches downy; fruit, medium, oblong obovate, one side enlarged, tapers towards the stalk, bright red in shade; bloom, lilac; flesh, yellow, rich, juicy, adheres to stone; stalk, three-fourths of an inch long in a narrow cavity. Last of August. A good market sort, valued for making jelly.

MAMELONNE.

Mamelonne Segerat.

Foreign. Fruit, medium, round, with a knob-like protuberance where joined to the stalk, occasional specimens with unequal surface; skin, greenish, spotted with red; flesh, yellow, juicy, rich, and parts freely from the stone. Early August.

MANNING'S PRUNE.

Manning's Long Blue Prune, | Large Long Blue, | Manning's Long Blue.

American. A sub-variety of the German prune, and superior thereto. Branches, smooth. Fruit, large, long oval, a little one-sided; skin, dark purple, thick blue bloom; flesh, greenish yellow, firm, rather juicy, sweet, pleasant, separates readily from a long, pointed stone; stalk, long, slender. September.

MARTIN'S SEEDLING.

American. Tree, vigorous; branches, grayish, smooth. Fruit, very large, oblong irregular, yellow, with green stripes; suture, one side, deep, a little sunk at apex; flesh, yellow, rather coarse, sweet, juicy; "very good;" adheres to the stone. September.

MEDITERRANEAN.

Fruit, obovate necked, irregular; suture, shallow, light crimson; stem, downy; flesh, yellow, sweet, sprightly, not high-flavored. September.

MEIGS.

Fruit, large, roundish oval; suture, indistinct; skin, dull reddish purple, with numerous gray dots; stalk, long, curved, slender, set in a small cavity; flesh, greenish-yellow, juicy, rich, sugary and excellent, adheres to the stone. Last of September. (Downing.)

MIRABELLE.

Mirabelle Petite, | Mirabelle Jaune.

Foreign. Branches, downy. Fruit, small, obovate; suture, distinct; skin, yellow, spotted with red; bloom, white; flesh, orange, sweet, sprightly, separates from stone; stalk, half inch long. Early August.

MIRABELLE D'OCTOBER.

Mirabelle Tardive.

Foreign. Branches, downy, slender. Fruit, small, roundish, yellow, juicy; very productive. Free-stone. October.

MONROE.

Monroe Egg.

American. Originated with Miss Denham, Penfield, N. Y. Tree, vigorous; branches, smooth. Fruit, above medium, oval, greenish yellow, rarely a blush in sun; stalk, long, slender; flesh, greenish yellow, with a rich, sugary flavor. Last of August.

MULBERRY.

American. Branches, stout, smooth. Fruit, large, oval, narrowing to the stalk, pale yellow, with dots of red in sun; flesh, greenish yellow, coarse-grained, adheres to an oblong pointed stone; stalk, an inch long, slender. First September.

NOTA BENE.

Corse's Nota Bene, | Dictator?

Canadian. Branches smooth. Fruit, large, round, pale lilac or brownish, dull green on the shaded side, bloom light blue; flesh, greenish, rather firm, juicy, sweet, separating freely from the stone; stalk, half an inch long, in a round basin. First September.

OCTOBER GREEN GAGE.

Reine Claude Tardive, | Reine Claude d'Octobre.

Foreign. Branches, slightly downy. Fruit, small, round, yellowish green, marbled and dotted slightly with red in the sun; flesh, yellowish, juicy, melting rich, separating freely from the stone; stalk, slender. First to 15th October.

ORANGE.

Orange Gage.

American. Branches, smooth. Fruit, very large, oval, flattened at both ends, bronze yellow, clouded with purplish red near the stalk; flesh, yellow, coarse-grained, adhering slightly to the stone; stalk, three-fourths inch long, in a narrow, round cavity. Last of August.

ORLEANS.

Monsieur, Monsieur Ordinaire,		Old Orleans, Red Damask,		Italian Damask, <i>of some</i> .
----------------------------------	--	-----------------------------	--	----------------------------------

Foreign. Branches, downy. Fruit, medium, round, reddish purple; flesh, yellowish. Free-stone. August.

PARSONAGE.

American. Originated in Dutchess Co., N. Y. Comparatively new. Branches, smooth. Fruit, medium to large, oval, pale yellow, with splashes of green; stalk, medium, depression slight; flesh, yellow, juicy, rich, sugary flavor, separating freely from the stone. Last of August.

PEACH PLUM.

Prune Peche.

Foreign. Long cultivated at Schenectady, N. Y., as the French plum, it having been received from France. and lost its name on the voyage: was only recognised of late as the old Prune Peche of French authors. It is tender at the North, and an indifferent bearer. Branches, smooth. Fruit, very large, shaped much like a peach, one side enlarged, wider than deep, light brownish red, with small yellow dots, flesh, pale yellow, coarse-grained, slightly sub-acid, separates freely from the stone, which is round and much furrowed; stalk, short. Last July, first August.

PETER'S YELLOW GAGE.

American. Resembles Cloth of Gold. Tree, rather longer jointed, and fruit separates freely from the stone. August.

PENOBSCOT.

Raised by James McLaughlin. Bangor, Maine. Tree, vigorous, hardy, productive; branches, smooth. Fruit, large, oval, suture distinct; stalk, three-fourths of an inch long, set in a small cavity; skin, yellow, tinged with green, and a faint red cheek; flesh, yellow, sweet and pleasant, adheres to the stone. Ripens the first of September. (Hort.)

POND'S SEEDLING.

Plum de l'Inde.

English origin. Tree, vigorous; branches, smooth, grayish. Fruit, very large, nearly egg-shaped, a little tapering towards the stem; skin, thick, reddish violet, with numerous brown dots, and covered with a beautiful bloom; flesh, yellow, a little coarse, abounding in juice, very sugary, not rich. Ripens middle of September. (Al. Pom.)

POND'S SEEDLING.

Pond's Purple.

American. Branches, downy. Fruit, medium, roundish, purple; flesh, yellowish. Free-stone. Promises well. August.

PRECOCE DE BERGTHOLD.

Foreign. New. Branches, downy; slender, rapid grower. Fruit, large oval rounded, yellowish green, juicy, sweet. Last of July.

PRINCE ENGELBERT.

A new Belgian sort. Branches, downy. Fruit, large, oblong oval, deep bluish purple, with a dense bloom; stem, slender, with a distinct ring at base; cavity, narrow and deep; suture, distinct; flesh, juicy, melting, moderately rich; stone, medium, separates freely from the flesh. August.

PRINCE OF WALES.

Chapman's Prince of Wales.

Foreign. Branches, smooth. Fruit, medium, oval, bright purplish pink; bloom, abundant; flesh, pale yellow, sweet, separates from stone. Last August.

PRINCE'S ORANGE EGG.

Originated by William Princee, Flushing, L. I. Tree, vigorous and productive. Fruit, large, oval; color, yellow, covered with thin bloom; stem, rather stout, set in a small cavity; flesh, yellow, coarse, juicy, subacid, sprightly, adhering to the stone. September.

PRUNE DE LOUVAIN.

Plum of Louvain.

Tree, vigorous, fertile. Origin, nursery of Van Mons. Fruit, large, egg-shaped, with a neck; deep purple, shaded with violet; suture, deep, half round; flesh, rather coarse, melting, pleasant. Free-stone. Ripens end of August. (Al. Pom.)

PRUNE OF AGEN.

Agen Date, Prune d'Agen, D'Agen,	Prune d'Ast, St. Maurin,	Robe de Sergrut, Prune de Brignole ?
--	-----------------------------	---

Foreign. Valuable only for drying. Branches, smooth. Fruit, medium, obovate flattened, purple, with a blue bloom; flesh, greenish yellow, sweet; stalk, short. October.

QUACKENBOSS.

Origin uncertain. Tree, a strong, upright grower; foliage, dark and glossy. Fruit, large, oblong oval; skin, deep purple, profusely covered with a bluish bloom; stalk, short, thin, crooked, and set in a slightly depressed cavity; flesh, greenish yellow, sprightly, juicy, a little coarse-grained, sweet, and excellent, adheres slightly to the stone. Ripens the last of October. For market, it is unsurpassed.

REAGLE'S ANCIENT CITY.

American. New; probably from seed of Washington. Fruit, large, roundish oval, clouded orange, red in sun; suture, distinct; flesh, yellow, juicy, sweet, delicious, parts readily from stone. Last August.

REAGLE'S GAGE.

American. New. Fruit, medium, round; suture, distinct; color, light green, marbled with deep green; stalk, slender; flesh, greenish, juicy, sweet; separates from stone. Last of August.

REAGLE'S UNION PURPLE.

American. Originated with C. Reagles, Schenectady. Fruit, of the largest size, roundish oval; skin, reddish purple, covered with a thin bloom;

suture, only perceptible near the stalk and apex ; stalk, short and thick, set on a nearly even surface ; flesh, greenish, a little coarse ; vinous, but when fully matured, sweet and rich ; adheres to the stone on one side. September.

RED DIAPER.

Diaprée Rouge, Mimms,		Roche Corbon, Imperial Diadem.
--------------------------	--	-----------------------------------

Foreign. Slow grower ; branches, nearly smooth. Fruit, above medium, obovate, brownish red and purple, light blue bloom ; stalk, slender, slightly hairy ; flesh, pale green, juicy, melting ; very good ; parts free from stone. Last August.

RED EGG.

Red Magnum Bonum, Askew's Purple Egg,		Purple Egg, Red Imperial, of some,		Purple Magnum Bonum, Florence.
--	--	---------------------------------------	--	-----------------------------------

Branches, smooth. Long and extensively grown. It is far surpassed by many others ripening at same time. Fruit, large, oval, deep red, with gray dots ; flesh, greenish, coarse. Free-stone. September.

RED SAINT MARTIN.

Saint Martin Rouge, Saint Martin,		Prunier de St. Martin, Coe's Fine Late Red,		Coe's Late Red.
--------------------------------------	--	--	--	-----------------

Foreign. Branches, downy. Fruit, medium size, roundish ; suture, half round, well marked ; skin, light purplish red, thin blue bloom ; flesh, yellowish, juicy, vinous, separating freely from the stone ; stalk, three-fourths inch long, stout. October. In Northern locations it does not always mature its fruit.

REINE CLAUDE DIAPHANE.

Raised by M. Laffay, of Paris. Tree, of medium vigor ; branches, gray. Fruit, medium, roundish flattened ; skin, smooth, transparent green, shaded with red ; flesh, juicy, very sweet and aromatic. Ripens the middle of September. (Al. Pom.)

REINE CLAUDE D'OCTOBER.

Tree, very vigorous ; young wood, smooth, stout, and short-jointed. Fruit, small, roundish ; suture, moderate ; apex, dimpled ; skin, greenish yellow ; stalk, stout, rather long ; flesh, green, juicy, sugary and rich ; separates from the stone. Ripens the first of October.

REINE CLAUDE ROUGE OF SEPTEMBER.

Reina Nova.

Tree, vigorous. Fruit, very large, roundish oval ; skin, smooth, reddish, shaded with purple on the sunny side, finely pointed with russet ; stalk, slender, set in a slight cavity ; flesh, firm, juicy, sugary, slightly acid, somewhat aromatic ; very agreeable. Ripe, middle of September, and continues a month. (Al. Pom.)

REIZENSTEIN'S YELLOW PRUNE.

An Italian fruit. Tree, very vigorous and productive. Fruit, medium, oval, slightly necked ; suture, slight ; skin, yellow, occasionally a sunny check ; flesh, yellow, juicy, aromatic and pleasant ; adheres to the stone. Ripens the last of September. (Downing)

RIVERS' FAVORITE.

Rivers' Early No. 1.

Foreign. Branches, downy. Fruit, medium, roundish oval, purple; flesh, melting, rich, sweet. Early August.

RIVERS' PROLIFIC.

Rivers Early No. 2.

Foreign. Branches, smooth. Fruit, little above medium, roundish oval, purple; flesh, yellowish, rich, sweet, excellent flavor. Early August.

ROYALE.

La Royale.

Foreign. Branches, very downy. Fruit, medium or slightly above, roundish, reddish purple, with light brown specks, thick, pale bloom; flesh, dull yellow, rather firm, juicy, vinous, parts freely from a small, roundish stone; stalk, three-fourths inch; cavity, narrow. Last August, and hangs to middle September.

ROYAL DE TOURS.

Royal Tours.

Foreign. Branches, downy. Fruit, large, roundish; suture, deep, giving appearance of one side enlarged, lively red in shade, violet in sun, minute golden dots, blue bloom; stalk, stout; cavity narrow; flesh, greenish, firm, with abundant juice; adheres closely to large, oval flattened stone. Early August.

ROYAL HATIVE.

Mirian.

Foreign. Slow grower, and tender tree far North; branches, downy. Fruit, medium, roundish, light purple, dotted little with dull yellow; flesh, amber color, rich, parts from stone; stalk, half-inch long, stout; stone, small. Last July.

ST. CATHERINE.

Foreign. Branches, smooth; valued in France for drying, surpassed here by varieties of later origin. Fruit, medium, obovate, pale yellow, little red in sun; flesh, yellow. Cling-stone. September.

SCHENECTADY.

Schenectady Catherine.

An American Plum, originated at Schenectady, N. Y., and first introduced to notice and described by Dr. Herman Wendell. Tree, thrifty, hardy, and prolific. Branches, smooth, rather slender; fruit, above medium, roundish oval, broadest and slightly depressed at stem end; suture, shallow; skin, rich, deep purple, slightly netted on the sunny side; flesh, greenish yellow, fine-grained, melting, juicy, rich, sweet, delicious flavor; stone, small, thick, ovate, parts readily from the flesh; stalk, three-fourths inch long, rather slender, inserted in a deep, narrow cavity. Last August.

SCHUYLER GAGE.

American. Origin, Albany, N. Y. Tree, upright grower; branches, gray, smooth. Fruit, medium, oval; suture, indistinct; yellow, with small green splashes, dots and shades of red in sun, thin bloom; stalk, long, curved; flesh, yellow, juicy, sweet, rich, high flavor, separates freely from the stone. September.

SHARP'S EMPEROR.

Denyer's Victoria, | Queer Victoria.

Foreign. Branches, downy. Fruit, large, roundish oval, lively red in sun, paler in shade; flesh, yellow, separates from stone, pleasant flavor. Middle September.

THOMAS.

American. Hovey, in Mag. of Hort., says this is a seedling of Mr. Thomas, Boston, Mass. We take from his description. Branches, stout, slightly downy. Fruit, large, oblong, flattened at apex, shallow suture, dark amber color, mottled and shaded with red, sprinkled with white dots and whitish bloom; flesh, deep yellow, sweet, separating from a large, roundish ovate stone; stalk, half-inch, stout, deeply inserted. September.

TROUVEE DE VOUCHE.

Foreign. Tree, moderately vigorous and very fertile. Fruit, medium or small, is regularly oval; skin, thick, reddish violet, with a shady side, and a violet bloom on the sunny side; flesh, juicy, sweet, and "very good." Ripens the end of August. (Al. Pom.)

WAX PLUM.

American. Fruit, large, oval rounded; stem, long, downy; color, yellow, mostly covered with carmine; lilac bloom; flesh, greenish yellow, juicy, brightly; "good." Free-stone. October. (Hov. Mag.)

WHITE DAMSON.

Late Yellow Damson, | Shailer's White Damson,
White Prune Damson, | White Damascene.

Foreign. Branches, smooth. Fruit, small, oval, pale yellow, few red spots; flesh, yellow. Cling-stone. September.

WILKINSON.

Tree, vigorous. Branches, smooth, rather slender. Fruit, medium, oval, slightly necked; skin, reddish purple, covered with a thick bloom; stalk, medium, set in a small cavity; flesh, dark yellow, rather firm, sweet, not rich or high flavored; adheres partially to the stone. Ripens the last of September. (Downing.)

WOOLSTON'S BLACK GAGE.

Foreign. Fruit, round, below medium size, black, very juicy, rich and sugary; a free grower and great bearer. This, and Angeline Burdett, are much alike in their fruit, but differ in the habit of the trees. Both have thick skins, which induces them to shrivel on the trees and become luscious sweetmeats. Beginning of September. (Riv. Cat.)

YELLOW EGG.

Yellow Magnum Bonum,		Askew's Golden Egg,		Dame Ambert,
White Magnum Bonum,		Col. Young's Seedling,		" " Jaune,
White Egg,		White Imperial,		" " Blanche,
Egg Plum,		White Holland,		Grosse Luisante.
White Mogul,		Wentworth,		

Foreign. Numerous seedlings are produced from this variety, differing little from the parent. "Long's Yellow" is one considerably distributed

West. It is a variety only esteemed for cooking purposes. Branches, smooth. Fruit, large, oval, narrowing at ends, suture distinct; skin, yellow, white dots, and thin white bloom; flesh, yellow, adhering mostly to the stone; stalk, long, surrounded at insertion by fleshy ring. Middle to last August.

CLASS III. *Superseded by better sorts.*

ADMIRAL.

Corse's Admiral.

Canadian. Branches, downy. Fruit, medium, oval, light purple; flesh, greenish yellow
Cling-stone. September.

AMERICAN WHEAT.

American. Branches, smooth. Fruit, small, round, blue; flesh, greenish. Cling-stone.
August.

APRICOT.

Apricot Plum of Tours,		Abricotée,		Red Apricot.
Abricotée de Tours,		Yellow Apricot,		

Foreign. Branches, downy; fruit, medium, roundish, yellow, with red; flesh, yellow, bitter. Free-stone. August.

BLUE GAGE.

Azure Native,		Black Perdrigon,		Little Blue Gage.
---------------	--	------------------	--	-------------------

Foreign. Branches, downy. Fruit, small, round, blue; flesh, greenish. Free-stone.
August.

BREVOORT'S PURPLE.

New York Purple,		Brevoort's Purple Bolmar,		Brevoort's Purple Washington.
------------------	--	---------------------------	--	-------------------------------

American. Branches, smooth. Fruit, large, oval, reddish purple; flesh, yellowish. Cling-stone. September.

BEACH PLUM.

Native of the sea-coast. Fruit, small, reddish, astringent.

BLUE PERDRIGON.

Violet Perdrigon,		Brignole Violette,
Perdrigon Violette,		Battle Monument.

Foreign. Branches, downy. Fruit, medium, oval, reddish purple; flesh, greenish yellow.
Cling-stone. August.

BYFIELD.

American. Branches, smooth. Fruit, small, round, light yellow; flesh, yellow. Cling-stone. August.

CHESTON.

Cheston Matchless,		Matchless,		Violet Diaper.
--------------------	--	------------	--	----------------

Foreign. Branches, downy. Fruit, small, oval, purple; flesh, yellow. Free-stone. August.

COPPER.

French Copper.

Foreign. Branches, smooth. Fruit, medium, oval, bluish copper; flesh, greenish. Free-stone. September.

CROFT'S EARLY.

A small, reddish blue fruit, with yellow flesh, dry, and devoid of flavor. August.

DAMSON.

Common Damson,		Purple Damson,		Early Damson.
----------------	--	----------------	--	---------------

A variety common in all gardens, increased by seeds and suckers; many sub-varieties, under names of Winter Damson, Prune Damson, Sweet Damson, &c. Branches, downy. Fruit small, oval, purplish blue; flesh, greenish, partially free. September to November.

DIAMOND.

Foreign. Branches, downy. Fruit, large, oval, purplish black; flesh, yellow, dry. Free-stone. September.

DICTATOR.

Raised by Henry Corse, of Montreal. Tree, vigorous and hardy. Fruit, very large, brownish purple, covered with a bloom; flesh, juicy, rich, and high-flavored.

FIELD MARSHAL.

Corse's Field Marshal.

Canadian. Fruit, medium, oval; flesh, greenish yellow. Cling-stone. August.

FOTHERINGHAM.

Sheen, | Grove House Purple.

Foreign. Branches, smooth. Fruit, medium, obovate, reddish purple; flesh, greenish yellow. Free-stone. August.

GHISTON'S EARLY.

American. Branches, smooth. Fruit, large, oval, yellow; flesh, yellow. Free-stone. August.

GIFFORD'S LA FAYETTE.

American. Fruit, medium, long, oval, purplish blue; flesh, yellowish. September.

GOLIATH.

Caledonian, | Steer's Emperor,
Saint Cloud, | Wilmot's Late Orleans.

Foreign. Branches, downy. Fruit, large, roundish oblong, purplish red; flesh, yellow. Cling-stone. August.

GUTHRIE'S APRICOT.

Guthrie's Apricot Plum.

Foreign. Branches, downy. Fruit, medium, oval, yellow, with crimson dots; flesh, yellow. Cling-stone. August.

GWALSH.

American. Branches, smooth. Fruit, large, obovate, dark purple; flesh, yellow, acid. Cling-stone. August.

HOLLAND.

Blue Holland, | Holland Prune.

Foreign. Branches, downy. Fruit, medium, round, reddish purple; flesh, yellowish. Free-stone. September.

HORSE PLUM.

Large Early Damson, | Sweet Damson.

American. Seedlings make good stocks for budding. Branches, downy. Fruit, medium, oval, reddish purple; flesh, greenish yellow. Free-stone. August.

JUDSON.

American. Fruit, small, roundish oval, reddish pink, mottled; flesh, yellowish; stone, large, free. August.

LARGE GREEN DRYING.

Knight's Large Green Drying.

Foreign. Branches, smooth. Fruit, large, round, greenish yellow; flesh, yellowish. Cling-stone, insipid. September.

LATE BOLMER.

Fruit, medium, roundish. Skin, yellow, mottled with red next the sun. Flesh, yellow, rather firm, sweet, but not rich. Free-stone. September.

LEWISTON EGG.

Origin, Lewiston, N. Y. Tree, vigorous and productive. Branches, downy. Fruit, medium size, oval; skin, pale yellow, with a bloom; flesh, yellow, adhering closely to the stone, not very sweet, and only second-rate flavor. August.

LITTLE QUEEN CLAUDE.

Yellow Gage (of the English), Petite Reine Claude,		Reine Claude Blanche, Small Green Gage,		Gonne's Geen Gage, White Gage.
---	--	--	--	-----------------------------------

Foreign. Branches, smooth. Fruit, small, round, yellowish green, with red spots; flesh, pale yellow. Free-stone. August.

LUCOMBE'S NONSUCH.

Foreign. Branches, smooth. Fruit, medium, roundish, yellowish green; flesh, greenish. Cling-stone. August.

MUSCLE.

Foreign. Only grown for stocks. Fruit, oblong, dark red, large stone.

NECTARINE.

Caledonia? | Howell's Large.

Foreign. Branches, smooth. Fruit, large, roundish, purple; flesh, greenish yellow, partially cling-stone. August.

PEOLY'S EARLY BLUE.

American. Branches, downy. Fruit, medium, oblong, dark blue; flesh, yellow, partly free August.

PRINCE'S ORANGE GAGE.

Fruit, medium, roundish oval; suture, moderate; skin, yellow; stalk, long, set in an open cavity; flesh, light yellow, coarse, juicy, pleasant, but not rich, adheres to the stone. September.

QUEEN MOTHER.

Red Queen Mother, | Pigeon's Heart, | Damas Violet.

Foreign. Branches, smooth. Fruit, small, round, purplish red in sun, amber in shade flesh, yellow. Free-stone. September.

RED IMPERIAL.

Imperial Rouge, | Early Forcing.

Foreign. Branches, slightly downy. Fruit, large, oval, reddish violet; flesh, greenish yellow. Free-stone. September.

RED PERDRIGON.

Perdrigon Rouge.

Foreign. Branches, downy. Fruit, medium, roundish oval, deep red, lilac bloom; flesh, yellow. Free-stone. August.

RHINEBECK YELLOW GAGE.

Origin, Rhinebeck, N. Y. Tree, very strong and vigorous.

Fruit, large, oval; suture, deep; skin, yellow; stalk, rather long, inserted by a fleshy ring, without depression; flesh, coarse, adheres to the stone. September.

SEMIANA OF BOSTON.

This has been thought to be the Impératrice Violette of old Duhamel. We are not prepared to say, and as it is condemned by all growers, do not think it worth looking after. Branches, smooth. Fruit, medium, oval, dark blue; flesh, harsh, acid. Cling-stone. September.

SIAMESE.

American. Branches, smooth. Fruit, grows in pairs, which is its only merit, pale yellow, flesh, yellow. Cling-stone. September.

ST. JOHN'S.

Prune de St. Jean.

Foreign. Branches, downy. Fruit, medium, purplish blue; flesh, greenish yellow. August.

STABLER'S SEEDLING.

American. Branches, downy. Fruit, medium, oval, greenish yellow, with white specks; flesh, yellowish. Cling-stone. August.

SUISSE.

Simiana,		Swiss Plum,		Prune d'Altesse.
Prune Suisse,		Monsieur Tardif,		

Foreign. Branches, smooth. Fruit, above medium, round, violet red; flesh, greenish yellow, acid. Cling-stone. September.

VIRGIN.

Virginal.

Foreign. Branches, smooth. Fruit, medium, roundish, purple; flesh, yellow. Free-stone. September.

WHITE APRICOT.

Fruit, medium, roundish, yellow; flesh, rather firm, not sweet, but pleasant. Cling-stone. Middle of August.

WHITE IMPERATRICE.

White Empress,		Impératrice Blanche.
----------------	--	----------------------

Foreign. Branches, smooth. Fruit, medium, obovate, bright yellow, few red spots; flesh, yellow. Free-stone. September.

WHITE PERDRIGON.

Perdrigon Blanc,		Maitre Claude,		Brignole.
------------------	--	----------------	--	-----------

Foreign. Branches, downy. Fruit, medium, oval, greenish yellow, red spots in sun; flesh pale yellow. Cling-stone. August.

WILDE'S.

American. Fruit, large, oval oblong, greenish yellow; flesh, yellowish green. Cling-stone. July.

THE QUINCE.

Cydonia vulgaris, Dec. *Rosaceæ* of Botanists.

THE Quince is a tree of crooked, tortuous, rambling branches, and in the usual neglected state in which it is cultivated, seldom reaches a height of over fifteen feet. In rich, deep soils, however, it will acquire a height of twenty-five to thirty feet. While young and in the nursery, it is of rather rapid growth; but after the trees commence fruiting, the growth is less rapid, and is more spreading than upright. The botanical name, *Cydonia*, is said to be from its first attracting notice in the city of Cydon, Candia. The largest tree on record is growing in the neighborhood of Geneva, New York, and is, according to the "Horticulturist," thirty feet high, with a trunk girthing six feet, and branches extending over a circle seventy-five feet in circumference. In the Journal of the London Horticultural Society, a variety is spoken of as existing in Persia, of which the fruit acquires the weight of fifty to sixty ounces, and ripened, loses all its austerity, so that it is eaten at the dessert like a soft, ripe pear. No such variety has, however, yet found its way to our shores, and it is somewhat doubtful if it exists. The large, pale pink blossoms of the quince make it rather ornamental; and appearing, as they do, after other fruit trees have done blooming, it is almost certain to escape late frosts, and annually produce fruit. We have often wondered at the taste that cultivates carefully a bush of privet or snowberry, while the quince is neglected in some secluded shaded corner.

Propagation.—By Seed. The seed should be saved by cutting out the cores and seeds, and laying them in a heap for a few days, or until they become soft, when, rubbing in water and passing the pulpy part through a sieve, leaves the seeds clear. They should then be mixed with damp sand in shallow boxes, and placed in a cool cellar or out-house until Spring—care being taken that they do not get dry, nor yet wet enough to decay. In Spring, sow thinly, in drills, good, rich, deep soil, and cover about two inches deep.

By Cuttings. These are usually taken off in Spring, early, from wood of last year's growth, and are about one foot long each. The buds should all be cut out, except the two upper ones, and the cutting set erect, ten inches deep, in rich, moist, sandy soil. If ground is available where moisture can be insured in Summer, without overplus in Winter, the month of September is best for making and put-

ting in the cuttings. Small beds may be made, well shaded from noonday sun, and watered during the Summer season.

By Layers. These are usually made in Spring, by bending down and pegging, as described in a previous part of this work. They usually form roots the first season, and will answer the following Spring to be cut from the parent plant and transplanted into nursery rows.

By Roots. Small pieces of the roots, from four to six inches long each, taken off in Spring, and planted with the upper end about two inches under ground, will throw up fine shoots during the season. For propagating *Cydonia Japonica*, or Japan Quince, this is decidedly the best way.

By Budding and Grafting. The Portugal and Orange Quince, being the most valuable, are often propagated by budding and grafting; and when quince stocks for the purpose are not on hand, the common white thorn answers a very good purpose—often doing even better than the quince, in poor soils, or in the hands of those who neglect cultivation. It is rendered more thrifty, when worked on pear stocks—more hardy on thorn.

Soil. The soil, for successful growth, should be rich, deep—say two feet—and regularly cultivated, or, in other words, free of grass or weeds. Barn-yard manure, with salt in abundance, mixed, and allowed to lie six months before being applied, and spaded-in around the trees, will often render trees deemed unproductive, and of poor quality, productive, and of the best. New plantations, if to be made in old worn-out soils, should first have a liberal dressing of virgin earth or leaf mould from woods. Free use of liquid manures, applied during Winter and Spring, have to our knowledge kept a plantation of the quince in fine health and bearing for upwards of thirty years. Bog-earth, or salt-marsh mud, is frequently used in the States bordering on the ocean or salt water.

Situation. A shaded situation, and moist, has been almost universally advised; neither of which is at all essential. Shade, on the contrary, is objectionable; while, in soils well supplied with manures and salt, moisture sufficient will always be found.

Transplanting, Pruning, and Distance apart. The Quince is hardy, and the Fall is best for transplanting; but, when not convenient, its roots strike so readily that no one should be deterred, even if left until late in Spring. Newly planted trees should be pruned back very closely, or say two-thirds of the last year's growth cut away, and all branches for a distance of eighteen inches from the crown cut away, thus leaving the tree with a stem or body of eighteen inches—just sufficient to enable one to dig and cultivate around it underneath the branches. The distance apart for trees destined for an orchard, should be about twelve feet each way. The object of pruning orchard trees should be, to keep the head open and

regular—cutting away all crossing limbs and suckers. “The bearing branches, or spurs of the quince, are small twiggy shoots, produced on wood at least two years old. These bear two, three, or more fruit-buds. These produce shoots two or three inches long, on the point of which the fruit is borne singly. These spurs have always wood-buds, as well as fruit-buds, and therefore should be shortened back the Spring after they have borne, in order to produce new spurs at the same point.”

Insects, etc. “The borer sometimes proves a formidable enemy. It is the larva of an insect which attacks the wood of the trunk, near the surface of the ground, and works inwards, usually upwards, but sometimes downwards, to a distance of several inches into the wood, during the summer season.

“As the borer frequently destroys the tree, various means of prevention have been resorted to. The remedies described for the apple-borer are found useful. When the insect has once obtained possession, the best method appears to be direct attack. Scrape the soil from the trunk, and cut with a knife, lengthwise, and not across the bark and wood, till the insects are found. Repeat the operation once a week for several times, as a part escape the first examination. Then cover the wounded parts with a mixture of warm tar and ochre or brickdust. It is a great saving of labor to arrest early their progress; hence, trees should be examined frequently. They may sometimes be extracted by a flexible barbed wire, when cutting out would too much mutilate the tree.”

In Spring or early summer months the ends of the branches often turn black and die. By some, this is declared to be caused by an insect (*scolytus*), and the remedy said to lie in the cutting off and burning the branches. We do not so regard it, but believe it rather caused by atmospheric change; as a bright, clear, hot sun immediately opening at about midday, after a warm, softening rain, will often exhibit the result of blacking ends of young, tender shoots, in a very few hours.

Uses. The Quince is never eaten in a raw state, but has, from the days of Columella, been highly esteemed for making of marmalade, preserving, stewing, to give additional flavor to tarts of apple and of pastry, etc. In medicine, the expressed juice, repeatedly taken in small quantities, is regarded as cooling, astringent, and stomachic. Dried quinces are said to be excellent. Gathered carefully by hand, the quince may be wrapped in paper, and, placed in a cool room, kept until near midwinter.

VARIETIES.

Of these there are very few really worthy of description, and, of these, three only worthy of cultivation to any extent. The Chinese Quince (*Cydonia Sinensis*) is cultivated only as ornamental. Its fruit

is egg-shaped, dull green, with hard, dry flesh; its flowers rosy red, very pretty. The Japan Quince (*Cydonia Japonica*) is also only cultivated as an ornamental shrub. There are three varieties, bearing flowers bluish white, scarlet or crimson; and of the latter, with flowers nearly double. The fruit is dark green, hard, with a pleasant odor; not eatable.

ANGERS.

This variety is mostly grown for the purpose of engrafting the pear upon. The fruit is, however, equal to the Pear-shaped, and much resembles it, only that it is larger, somewhat more rounded, and a lighter, brighter yellow. The principal value, however, is for stocks on which to work the Pear.

NEW UPRIGHT.

Paris de Fontenay.

A variety first introduced to notice by Messrs. Ellwanger and Barry, of Rochester, N. Y. It grows upright, strikes readily from cuttings, but after the first year's growth, seems to lose vigor and afterwards grows very tardily.

ORANGE QUINCE.

Apple Quince,

| Apple-shaped Quince,

| *Cydonia v. Malformis.*

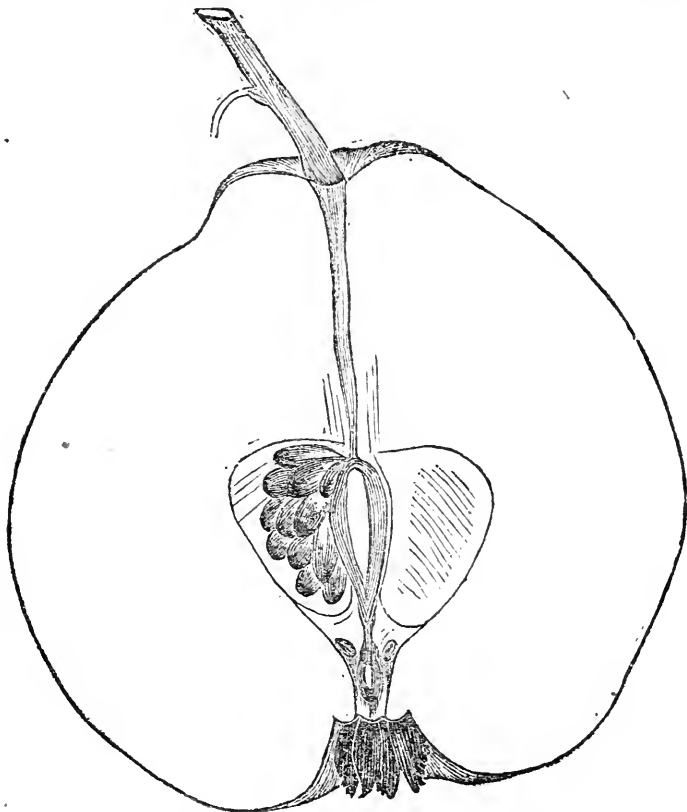

This is the variety most generally grown, and most esteemed. When fully ripe, its rich golden yellow resembles more the color of an orange

than its shape corresponds to the general form of apples; therefore we prefer the name orange to apple-shaped. It is not rare to find it grown from seed, and the seedlings sold as the Orange Quincee, when, in truth, as many of the seedlings are likely to produce the pear-shaped or even far inferior fruit, as seedlings from a good pear or good apple, when the parent was grown by itself. It is often gathered before ripe, which is not until from the middle to the last of October. If gathered too early they do not cook tender. Leaf, ovate pointed. *Fruit*, large, ovate, obtuse pyriform, varying to obovate conical; *stem*, usually in a slight depression; when well-grown and cared for, the *skin* is smooth, of a rich golden yellow; without care, it becomes small, knotty, and woolly; *core*, large, and placed nearest the blossom or calyx end; *seeds*, reddish brown.

PORTUGAL QUINCE.

Cydonia Lusitanica.

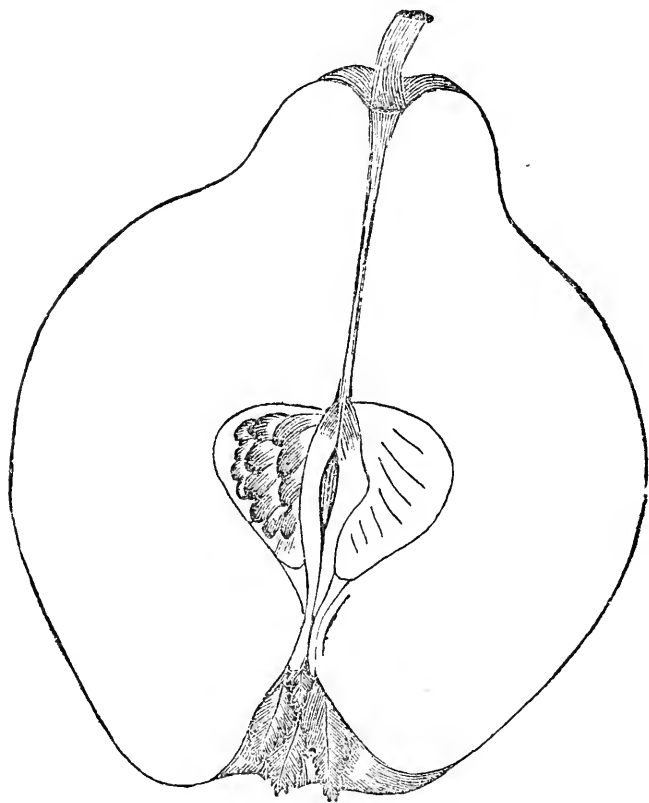

This variety is readily distinguished in the tree, by its leaf being round, or as wide as long, and very downy underneath. The true variety is yet scarce in the West. It has the reputation of being a shy bearer, but trees in our grounds have produced equally as abundant as the Orange Quince. *Fruit*, medium to large, regular oblong pyriform, smooth, of a paler yellow than the Orange variety; *core*, medium, and placed near the centre; *seeds*, light brown, *flesh*, mild, less astringent than other varieties; cooks tender,

and turns a fine purple or deep crimson, hence highly esteemed. It ripens about ten days earlier than Orange Quince; requires very rich, deep soil.

PEAR QUINCE.

Pear-shaped Quince, Oblong Quince,		Pyriform Quince, Cytosia Sub. v. Pyriform,
---------------------------------------	--	---

This takes its name from the fruit being shaped much like many varieties of the Pear. It is of medium size, roundish oblong or pyriform, tapering to the stalk. *Skin*, dull yellow; *flesh*, firm, tough, dry, but of high flavor. When stewed or cooked, it is less tender, and the flesh less lively in color than the Orange Quince. Leaves, oblong ovate. Last of October

REA'S SEEDLING.

Van Slyke.

New. Originated by Joseph Rea, Coxsackie, Green Co., N. Y. Tree, healthy, thrifty grower, productive; said to be very valuable. *Fruit*, one-third larger than the Orange variety; of same form and color, fair, handsome and equally good.

THE RASPBERRY.

Rubus idaeus. Rosaceæ of Botanists.

A LOW deciduous shrub, found wild in the woods, both of this country and Europe. The roots being permanent, and the stems biennial, they throw up a number of shoots, which produce fruit the second year and die. Our present cultivated varieties have been produced by high cultivation of seedlings from a variety no better than is to be found common in the fence corners of our slovenly farmers.

Propagation and Transplanting. New varieties are produced from seed; the seedlings having a tendency to depart materially from the character of the parent, as in the instance of the "Orange," produced from seed of a crimson berry.

Seedlings are easily grown by planting the berry when fully ripe, about one inch deep, in light loamy soil, where it is a little shaded. They will fruit the second or third year. Varieties are usually increased by transplanting the suckers or offsets. They can be propagated by cuttings, which is done much in the manner of managing cuttings of the rose; the care and attention requisite, making it only desirable in case of rare or new kinds. A few varieties, as the American Black and English Red, sometimes propagate by their branches bending over until the ends touch, and become covered in the ground.

In transplanting, the root should be protected from drying winds or hot suns, and the cane should be cut back one-fourth its previous season's growth.

The rows should be north and south, and three to four feet apart, according to the vigor of the sort, and the plants placed one every two feet. Some plant three in a hill, the hills four feet apart. We think they become matted too soon in this way.

Soil. All cultivators agree that, while the raspberry may be made to grow on gravelly loam, stony soil, or stiff cold clay, it can be relied on for a crop only when planted in a rich deep loam, where there is moisture, but such drainage that water will not stand. For those whose gardens are upon soils naturally unfavorable, deep trenching, placing coarse barn-yard manure at the bottom of the trench, and covering the surface with two inches of leaf-mould from the woods, will often render the plants productive, especially in wet seasons.

Situation. The situation should be open, fully exposed to light and air; to this end the advice to form rows north and south.

Culture and Training. In large plantations, weeds are kept down mostly with the plough and cultivator, hoeing where the cultivator does not reach. Where the variety is hardy, a single pruning in the Spring is all that is necessary. This should be done early in March or April, according to the season or section of the country where located; and consists in cutting away the canes of last year's bearing, leaving four to six of the strongest of last year's growth for the coming crop; these to be cut back one-fourth, cutting away all shoots of slender growth, and also all suckers, unless wanted for future planting. Varieties requiring winter protection should have the old fruiting canes cut away in September. Where increase of plants is wanted, they should not be dug or hoed around early in Spring.

An English gardener, in our immediate neighborhood, has practised the following modes of training, ever since our residence in the north of Ohio:

Figure 1 represents the canes prepared for fruiting, in April.

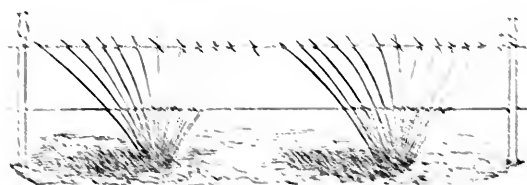

Fig. 1.

To the horizontal wires, the canes are tied by strips of bass bark, such as is used in budding.

The uprights are posts made of cedar or locust, four inches square at the bottom, and two inches at top. The horizontal lines may be of tarred rope, or annealed iron wire, coated with coal tar.

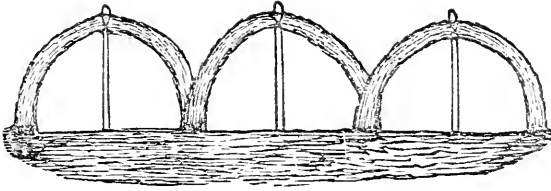

Fig. 2.

the plants in the Fall; the upright canes being those of the season's growth, while the arched ones are those which have produced fruit, and must be cut away.

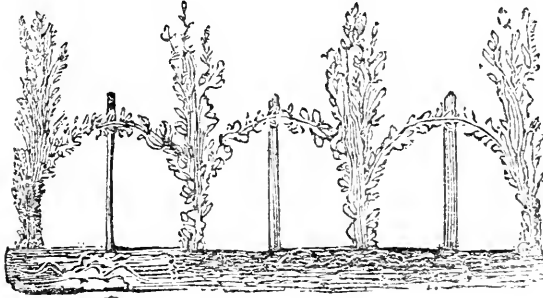

Fig. 3.

In figure 2, the arched portion tied to the stake in the centre, represents the canes of last year's growth prepared for fruiting the coming season.

Figure 3 represents the plants in the Fall; the upright canes being those of the season's growth, while the arched ones are those which have produced fruit, and must be cut away.

Insects. The raspberry is generally free from destructive insects. Dr. Munson, of New Haven, Conn., in a paper to the American Pomological Society, speaks as follows

of one. We have not seen it West. "It is a fungus of a bright orange color, and infests the under side of the foliage of the common red raspberry, *Rubus idæus*, in Connecticut; and the exhaustion occasioned by this fungus causes the plant to put up a multitude of spindling stalks, and renders it wholly unproductive. This affection disseminates itself, and I know of no remedy."

Protection. Many of the best varieties, like Red Antwerp, require protection in Winter, north of Philadelphia, in order to insure a full crop. This is best and easiest done by two men passing along the rows, one bending down the canes to the ground, while the other, with a shovel, throws two inches of earth upon them.

Gathering Fruit. This should be done in the cool of the morning, when they are higher flavored than at midday.

Uses. "The raspberry is held in general estimation, not only as one of the most refreshing and agreeable sub-acid fruits for the dessert, but it is employed by almost every family in making preserves, jams, ices, sauces, tarts, and jellies; and on a larger scale by confectioners, for making syrups; by distillers, for making raspberry brandy, vinegar, etc. Raspberry wine, made in the same way as that of currant, is considered the most fragrant and delicious of all home-made wines." (*Downing.*) Its fruit, immediately succeeding the strawberry, and not liable to undergo acetous fermentation in the stomach, is regarded, and prescribed by many physicians, as a promoter of health.

Profits. Seldom failing to produce a crop, when grown on situa-

able soil ; requiring comparatively little labor to prune and keep the plant in order ; always meeting ready sale, at fair prices, it is surprising that more attention has not been given the culture of the raspberry by orchardists and farmers. The "Red Antwerp," which is mostly grown for the New York market by cultivators on the Hudson river, is stated to have produced 3,300 baskets, of one pint each, from three-fourths of an acre ; and \$1,500 has been realized, in a single season, from sale of product of three acres. A plantation of raspberries will be in perfection the third year, and continue profitable five or six years, when it is best to form a new one on a fresh piece of ground.

Autumn Fruiting. Any variety may be caused to mature its fruit in the Autumn, by cutting away all shoots in Spring, and stopping in the young shoots about midsummer. It is, however, an unprofitable course, as the plant is unfitted for another season's fruiting, except in the same way, and the yield is only about one-half.

Classification and Varieties. We have made but two classes of the raspberry, from the great difficulty of selecting those only for a first class, which would bear the mark of worthy general culture. Heretofore, the Red and Yellow Antwerps have always been regarded as finest for the dessert ; but, since the introduction of the Fastolf and the Orange, they have by very many been regarded as surpassed in delicacy.

CLASS I. *Most generally esteemed.*

AMERICAN BLACK.

Thimbleberry, | Common Black Cup, | Black Raspberry.

This is to be found common around old stumps and in fence-corners in the country. Cultivated in deep, loamy soil, in the garden, it increases in size nearly one-fourth ; and ripening very late, will always be profitable for market. For making jam, flavoring puddings, etc., it is preferred to the more delicate kinds. Shoots, long, rambling, recurved. *Berries*, dark purple, nearly black, round flattened.

AMERICAN RED.

Common Red, | English Red, *of some.*

Well known. Shoots, upright, light brown. *Fruit*, medium, roundish, light red, sub-acid. Early.

BELLE DE FONTENAY.

A dwarf-growing variety, with large and deep green leaves ; bears large fruit all the Autumn, of good flavor, but requires warm soil and exposure. Hort.)

CATAWISSA.

American. From Columbia Co., Pa. *Fruit*, medium, dark reddish purple, producing abundantly on the young wood, and commencing to ripen

early in August. This character will probably make it valuable when raspberry canes are liable to be destroyed by the colds in Winter.

ANTWERP.

New Red Antwerp. | True Red Antwerp.

Although universally desired, it is rare that the *true* Red Antwerp raspberry is found West of the State of New York. It is a Dutch sort, originally from Antwerp city. An examination of the Red Antwerp as imported from several sources, all of which prove incorrect, leads us to doubt whether it is better known in the old country than here. The common Red Antwerp is easily detected in its fruit being smaller and round, while that of the *true* is large, regularly long conical, dull red, with a rich, sweet flavor. Canes, moderately strong, yellowish green, becoming pale brown or mouse color, early in Autumn, covered below with dark brown spines, but the upper portions, especially of the bearing wood, nearly smooth. Ripens from first to tenth July. The canes need protection in Winter throughout Northern sections, in order to secure a full crop.

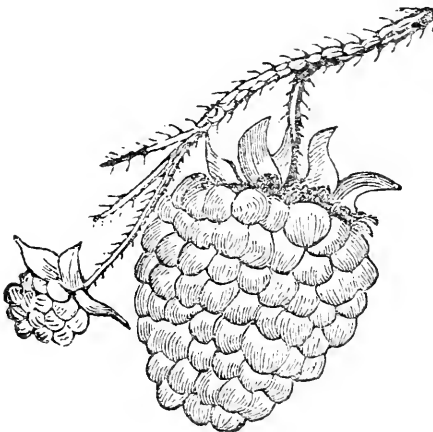

COLONEL WILDER.

Another seedling of Dr. Brinckle's. Shoots, strong, light-colored. *Fruit*, above medium, roundish conical, light cream color, firm, with a sprightly, fine flavor; moderately productive, ripening its fruit in succession, from early until quite late in the season. Raised from seed of the *Fastolf*, and named in honor of one of the best pomologists in America.

COPE.

A seedling of Dr. Brinckle's; promises well. Foliage, light green. *Fruit*, large, conical, crimson; *spines*, red.

CUSHING.

This fine raspberry was raised from seed of the Double-bearing, by Dr. Brinckle, of Philadelphia, in 1844. It promises well; should receive attention of amateurs. Shoots, strong, vigorous; prickles, brown; leaf, plaited, regular form. *Fruit*, large, roundish conical, crimson, and of fine flavor. Matures early.

EMILY.

A seedling from the Colonel Wilder; little disseminated; vigorous growth, with white spines. *Fruit*, large, round, occasionally shouldered; light yellow.

ENGLISH RED CANE.

Allen? | False Red Antwerp.

A variety much grown and highly valued by market gardeners. The canes are pretty strong, tall, of a bluish red color, whitish gray bloom, very hardy and productive. *Fruit*, medium or above, globular, slightly conical; dull red, large grains, and moderately firm, bearing carriage well; *flesh*, juicy, pleasant, not high flavor.

FASTOLF.

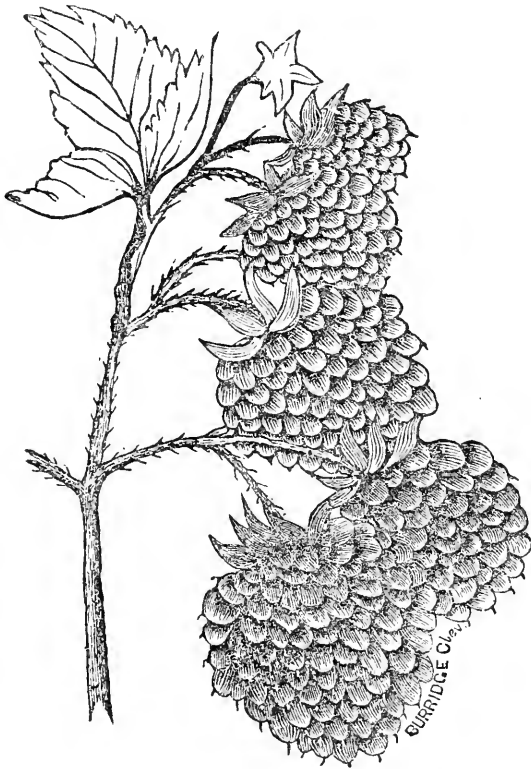

An English variety, introduced with high praise, which it has fully sustained in this country. It is probably a chance seedling of the Red Antwerp, which it much resembles. Its name is from an old pile, called *Fastolf Castle*, near Yarmouth, Eng. Throughout most of North and Western States it will need protection in Winter, as its canes are not quite hardy. For small gardens, we prefer it to Red Antwerp; but for market culture, the latter is best, on account of being more firm. Shoots, strong, are much inclined to branch, light yellowish brown. *Fruit*, large, roundish, obtuse conical, bright purplish red, soft, rich, high-flavored, productive; ripening its fruit in long-continued succession.

FRANCONIA.

Introduced to this country from France, under this name; but not to be found in any foreign catalogue to which we have had access. Its canes are nearly hardy; maturing good crops, without protection, four years out of five. Shoots, strong, branching, yellowish brown, with scattered, rather stout bristles; leaves, rather narrow. *Fruit*, large, obtuse conical, dark rich red, rich, rather acid flavor; more firm than Fastolf, and not as much so as Red Antwerp. A few days later than the latter in ripening. It is said that in New Hampshire there is a wild variety similar if not identical.

FRENCH.

Vice-President French.

This is a seedling of Fastolf crossed with Yellow Antwerp; originated with Dr. Brinckle. *Fruit*, large, round, crimson, matures late; *spines*, red. It is one of the best of the Brinckle seedlings, and deserves extensive culture.

FULTON.

From seed of French. *Fruit*, large, round, crimson; productive, and a vigorous grower; *spines*, red. One of Dr. Brinckle's origin.

GENERAL PATTERSON.

Seedling of the Colonel Wilder; vigorous grower. *Spines*, red. *Fruit*, large, round, crimson.

KNEVETT'S GIANT.



Imported from England by Col. Wilder, in 1843. This raspberry has proved more hardy than any other foreign variety, requiring no protection, and producing uniformly large crops of fruit. Its texture being firm, it will be found profitable to grow for market. Canes, strong, upright, disposed to branch. *Fruit*, large, obtuse conical or roundish, deep red and of excellent flavor. It is recommended for general cultivation by the American Pomological Society.

MAGNUM BONUM.

A white or yellowish fruit of large size, rather firm flesh, and finely flavored, similar to the old Yellow Antwerp. Very productive and vigorous.

MERVEILLE DE QUATRE SAISONS.

Large, bright red, and is, of all the Autumnal raspberries, the most abundant bearer; its spikes of fruit are often twelve or eighteen inches long, and produced till the end of October. (Hort.)

MERVEILLE DE QUATRE SAISONS.

Yellow fruit, new variety, raised from the above. It bears abundantly in the Autumn, and its fruit is sweet and well flavored. (Hort.)

MONTHLY.

Large-fruited Monthly, | Rivers' Large-fruited Monthly.

Shoots, long, slender, purplish in the sun, thickly covered with dark purple spines. *Fruit*, hardly above medium, red, fine flavor.

MRS. WILDER.

Seedling of Col. Wilder, which it so nearly resembles as not to require distinct description.

NORTHUMBERLAND FILLBASKET.

A new foreign variety. A strong, vigorous grower, with numerous rather strong, crimson-colored spines. *Fruit*, somewhat globular or obtuse conical, deep red, with a good, pleasant, slightly acid flavor. Productive.

OHIO EVER-BEARING.

Ohio Raspberry.

Native of Ohio, and differing from the American Black only in producing two crops in a year. By many esteemed very desirable.

ORANGE.

This variety was grown by Dr. Brinckle from seed in 1844. On account of being more hardy, it will probably supersede the Yellow Antwerp, while its late period of ripening will render it highly valuable for marketing. Shoots, vigorous, with white spines; leaf, irregular. *Fruit*, large, ovate, beautiful bright orange color, and of excellent flavor. Productive. By many this is regarded as the best of all the varieties originated by Dr. Brinckle.

THUNDERER.

A new variety lately introduced from England, and which very much resembles Franconia. It promises equally valuable.

YELLOW ANTWERP.

White Antwerp, | Double-bearing Yellow.

This variety is only suited to small gardens, and even there, we presume, will soon give place to the Col. Wilder and Orange. It sometimes throws up a succession of shoots, maturing fruit for a long time, whence its synonym of Double-bearing. Shoots, strong, light yellow, with greenish spines. *Fruit*, large, conical, pale yellow, sweet, and excellent. Requires protection in Winter. In our Southern States, the Antwerp varieties are said to fail.

WALKER.

Seedling grown by Dr. Brinckle, which promises to be valuable as a market variety. It is yet little known out of Philadelphia. *Fruit*, large, round, deep crimson, solid, adheres firmly to the stem, keeps long in perfection on the plant, and bears carriage well; *spines*, red.

WOODWARD.

Raised by Dr. Brinckle. This is one of the smallest varieties, though larger than the ordinary wild raspberry. *Fruit*, round, sometimes roundish ovate, crimson; red *spines*. Has ripened as early as the tenth of June. (Wilder in Hort.)

CLASS III. *Superseded varieties.*AMERICAN WHITE.
White Thimbleberry.

Varying from above, only in color.

BARNET.

Cornwall's Prolific,		Cornwall's Red,		Lord Exmouth's.
Cornwall's Seedling,		Large Red,		

English. Shoots, long, yellowish green, branching. Fruit, large, soft, roundish conical, purplish red, agreeable.

BRENTFORD CANE.

English. Shoots, strong, branching. Fruit, medium, oval conical, dull red. Inferior.

COX'S HONEY.

English. Fruit, medium, yellowish white, borne in clusters along the stems.

CRETAN RED.

From the Mediterranean. Shoots, upright, hardy. Fruit, medium, round, deep red, acid. Late.

DOUBLE-BEARING.

Perpetual Bearing,		Late Cane,
Siberian,		Red Double-Bearing.

Variety of the Antwerp. Large, dull red, hardy. Ripens late.

NOTTINGHAM SCARLET.

English. Fruit, medium, obtuse conical, red.

RED ANTWERP.

Old Red Antwerp,		Howland's Red Antwerp,		Burley.
Knevelt's Antwerp,		Framboisier à Gros Fruit,		

This is the common Red Antwerp of England and this country, and is quite distinct from the North River variety, which is shorter in growth, and has a conical fruit. Canes, strong and tall; spines, light red, rather numerous, and pretty strong. Fruit, large, nearly globular, or obtuse conical; color, dark red, with large grains, and covered with a thick bloom; flesh, juicy, with a brisk vinous flavor.

VICTORIA.

English. Medium, roundish conical, red.

WOODWARD'S RED GLOBE.

English. Large, red, roundish conical.

WILMOT'S EARLY RED.

English. Small, roundish, red. Early.

THE STRAWBERRY.

Fragaria, (of species,) L.—*Rosaceæ* of Botanists.

DURING the past ten years, or since the advent of Hovey's Seedling to the varieties of the Strawberry, there has arisen a furor for the production of new varieties, until nearly every village in the United States has its "rare and unsurpassed seedling," cultivated and extolled with praise and poetry equaling that of olden bard; while savans, wise on Strawberry culture and the structure of plants botanically, have occupied page after page of our Horticultural Journals, much to the amusement, if not instruction, of practical men.

A native of the temperate latitudes of both hemispheres, the varieties of the Strawberry are universally esteemed among the most delicious, as well as most wholesome, of the smaller fruits. And although it is regarded as properly a habitant of cold climates, it is successfully cultivated in the most southern latitude of this country.

As a fruit embracing delicious and healthful qualities, with full and satisfactory pecuniary returns, it has found a place in every garden, farm, and plantation, from the size of a bed four feet square to the field of five times that many acres; yet withal, there is not sufficient quantity grown to meet the demand. Olden records have been made of cures effected in the human frame from use of Strawberries. We consider the fact, that during strawberry season there is less of sickness in cities well supplied with that fruit, a most agreeable testimonial to its healthful and invaluable qualities at the present day. The distinctive name, *Fragaria*, is highly expressive of the fragrant scent emitted by the fruit.

Raising from Seed. When the fruit is perfectly ripe, it should be gathered and cut into small pieces, or with great care each seed separated. Select ground of light sandy soil, where only the morning sun will shine; or, better, perhaps, have ready a cold-frame with the lights sloping to the North. Sow the seed at distances of about one inch, and cover lightly, by sifting fine sand, or, what is preferable, vegetable mould from the woods. This done in June, the plants will need care until about October, at which time, if not grown in a frame, they should have tan-bark or decayed leaves strewed among them to the depth of two inches. Early in April following, transplant into deeply trenched ground, well manured with vegetable compost.

Propagation from Runners and Divisions. All varieties of the Strawberry, except the Wood and Alpine, propagate rapidly by means of runners. These, when a new variety is procured, should be carefully watched, and as fast as they make joints, should be pegged down, and have fine soil or sharp sand scattered over them, to induce them more readily to make roots. In this way, from fifty to one hundred new plants can be obtained from a single one in a season.

To secure a bed of those most prolific in old grounds, select while in fruit, and set stakes by side of those from which you wish to renew; after fruiting, destroy all around, thus giving them light and room to form abundance of new plants. The Wood and Alpine varieties are propagated easily from seed with but little variation. They are also propagated by dividing the roots or cluster of roots early in the Spring.

Fertile and Barren Plants. It is an old saying that "every person enjoys some hobby on which to ride." Mr. N. Longworth, of Cincinnati, has received the credit of starting the hobby of (in common phrase) male and female strawberry blossoms; and so vigorously has the hobby been ridden, that, with locomotive power and speed, it has found its way into every journal in the country, whether horticultural or otherwise; and so generally is the distinction of staminate (male) and pistillate (female) flowers understood, that we do not deem it necessary here to re-describe.

"The European Wood and Alpine Strawberries always maintain a natural character of the blossom, no matter how cultivated, and therefore every blossom gives a perfect fruit."

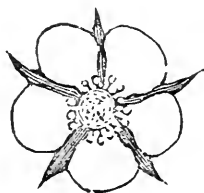

Fig. 1.
Sterile Staminate Blossom.



Fig. 2.
Sterile Pistillate Blossom.

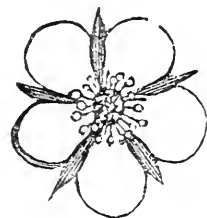

Fig. 3.
Natural State

The "Scarlets," and "Pines," as they are classed, when grown from seed in highly cultivated grounds, have a tendency to become imperfect in either stamens or pistils, as the case may be, and hence arises the necessity as well as apparent reality of the terms, male and female.

In the production of new varieties, even in our wildlings, the seedling plants, by means of highly enriched and stimulating soils, in exhibiting the full and even enlarged development of one organ, the

other remaining imperfect, has given rise to the theory of strictly barren (staminate) and fertile (pistillate) plants, which, when once formed, it is well known, seldom change. We coincide with Mr. Downing, "that the organs are always present, though imperfectly developed," and that when "deficient in pistils, (see Fig. 1,) they are called male plants; if deficient in stamens, (see Fig. 2,) female plants, the terms are incorrect;" yet these terms have become so commonly accepted, that we have, for the better understanding, continued their use.

This deficiency in the one or other organ arising from the original state of cultivation, cannot be changed by placing the plant in different soil and preserving an even temperature. The runners will, when grown in open air and usual cultivation, in nine hundred and ninety-five instances out of every thousand, continue to maintain the habit of the parent plant. A change from imperfect or perfect construction in the flower of the Strawberry cannot be depended on from a plant whose habit is once established, by means simply of varied cultivation, although very high and exciting cultivation from enriching of animal manures, will often produce over-luxuriance of foliage, with corresponding decrease of fruit-stems; hence, the necessity of forming beds or plantations of the two distinct fully developed plants, and also the care requisite to prevent the staminate or male plants from occupying too much ground, their supply of food derived from the root, being given to creation of new plants by means of runners instead of fruit, as in the pistillate or female variety.

With this understanding, therefore, that varieties are continually being produced, in which one organ is most prominently developed, and measurably to the destruction of the whole as a fruit-bearing flower, it has become a requisite in planting, to secure such proportion of fruit-bearing or pistillate plants with the fructifying or staminate varieties as to return the desired yield of fruit. The pistillates, being regarded as the female, are counted valuable in newly formed beds as of ten to one of staminates or males.

Varieties, however, exist, like the Large Early Scarlet, Burr's Old Seedling, and Longworth's Prolific, which have generally been classed as staminate or male plants, and yet produce abundance of fruit. These varieties possess both organs perfect, in proportion of about three out of five flowers, and we have therefore classed them as hermaphrodite.

Varieties and their Classification. The varieties of this fruit have within ten years past become so numerous as to be burdensome to the author who describes, as well as the amateur or nurseryman who grows, while for all practical and useful purposes, but very few are retained as desirable to cultivate, where quantity of produce and character, or rather flavor in fruit is expected.

The character exhibited in varieties often marks their parentage, yet, as it is known that a plant can be fertilized by two or more varie-

ties, it is sometimes difficult to select the distinct class, and writers are often not a little confused in endeavoring to place them.

Authors have classed the Strawberry as *Scarlets*, the original type being our wild Strawberry; *Pines*, originating from Pine or Surinam Strawberry; *Woods* and *Alpines*, from the common wood Strawberry of Europe; *Hautbois*, or *High wood*, from Bohemia; *Chili*, from South America.

The *Scarlets* are designated in their character by small flowers; long, thin, light green, sharply serrate leaves; acid or sub-acid fruit, of bright scarlet color, with seeds deeply imbedded.

The *Pines* are designated by large flowers; broad, dark green leaves; fruit of pine-apple flavor, and generally soft in texture; seeds slightly imbedded.

The *Alpines* and *Woods* have small flowers, perfect in their organs; small, thin, light green leaves; fruit, small, sweet, and separating freely from the calyx.

The *Hautbois* have large, pale green leaves, on tall foot-stalks, the fruit-stalk tall and erect, the fruit of a dull red or purplish color.

The *Chili*, designated by hairy, thick, obtusely serrate leaves, fruit pale red and insipid.

The *Green* Strawberries have light green foliage, plaited fruit, solid flesh, so unworthy cultivation as rarely to be found in this country.

We have dropped the arrangement into classes, as many of the new varieties combine two of the above classes, and it is therefore impossible to classify distinctly.

Soil and Situation. Rich, deep, loamy, inclining to clayey soils, are generally found to produce the largest berries, as well as most in quantity; but a sharp sandy soil, well manured with compost of animal manure, bones, decayed weeds, old mortar, brick-dust or rubbish, has, to our knowledge, produced some crops equal to any recorded in the public journals. Deep, the soil must be, say twenty inches, to insure the perfection of an entire crop. If only a moderately deep soil of six to eight inches, the first berries will fill and perfect, while the heat and drought, so usual throughout the West and South-west in Strawberry season, will cause too rapid exhaustion, and prevent the filling and perfecting of the remainder.

Trenches, three feet wide and two feet deep, with one foot of straw or leaves laid in the bottom, then filled up with good soil, well repay the labor, in the extra crop produced.

Where beds have been long established and rendered rich by digging in, liberally, of barn-yard manure, it frequently happens that too much growth of foliage ensues, to the destruction of flowers or fruit-stems. Where such is the case, application of one quart of gypsum (plaster of Paris), to every four feet square of ground, with two inches over the surface of leaf or vegetable mould from the woods

or old pastures, will again bring in fruit. It also often occurs, that the staminate have become too numerous. These are easily detected, as they flower some eight or ten days earlier than the pistillates, and may then be drawn out.

The situation of a bed or plantation affects only the earlier or later maturity of a variety. A side-hill sloping south-east, with springs of water gushing from several points near its summit, has enabled an acquaintance of ours to send to market the "Early Scarlet" strawberry, some ten days or two weeks in advance of others, who have the same variety on warm soils and upon level exposures. Situations so selected that water can be supplied liberally throughout the fruiting season, will increase the product nearly one-third. Wet ground, where water stands after rains, or springy, cold soils, should never be selected.

Season for Transplanting and Preparation of Plants. South of Philadelphia, the best season for forming new plantations is either the last of September, first of October, or in March. In latitudes north of this range it will generally be found best to transplant in April or early in May. July or August planting in either section will be found unprofitable, owing to the clear drying heat of our sun; while September or later planting in the northern range will require additional care, heavy mulching with tan-bark, saw-dust or the like; and even then, many of the plants will be drawn out by frosts of Winter.

The plants, when set, should be trimmed of all but two leaves, the roots immersed in muddy water, and if possible a damp or rainy time selected for the work; and in order to have the bed profitable, one hermaphrodite should be planted to every eight pistillate plants.

Time of Ripening. This varies according to latitude. In the latitude of Cincinnati, the season usually commences about the 25th May, continuing until the first of July, and for every degree of latitude a difference of ten days may be counted on, either earlier or later, as you go north or south.

The fruiting season may also be controlled at pleasure by means of cutting foliage and flowers, and liberal or restrained watering. If, for instance, a bed of Jenney's Seedling be taken, of eight feet square, the first two feet square shall be permitted to bloom and fruit at its usual time; the next two feet shall have only its first fruit-stems plucked when just about to bloom; the third shall have its entire foliage and fruit-stems cut close to the ground, and when the second fruit-stems appear, they are also to be picked as in the second plat; the fourth shall be treated as the third, but receive no moisture after the first cutting for a space of ten days or two weeks. The result will be a succession of fruit in order.

Modes of Culture. Different varieties require measurably different modes of culture in order to insure full and perfect fruit. That of

cultivation in hills of about two feet apart, one plant to a hill, the runners regularly destroyed, is most successful with the Wood and Alpine varieties, and is the only successful mode of growing any of the English varieties; it also returns the largest and most perfect berries with nearly all the Scarlets and Pines; but at the price of labor in this country, it is regarded as too expensive to compare favorably with the following modes in rows or strips, which have been successfully and largely practiced in this country, and are thus described by A. J. Downing:

Culture in Rows. The rows should be two feet apart, and the plants of the large growing kinds two feet from each other in the rows; of the smaller growing kinds, from one foot to eighteen inches is sufficient. The runners must be kept down by cutting them off at least three times a year, and the ground maintained in good order by constant dressing. During the first year, a row of any small vegetables may be sown in the spaces between the rows. Every Autumn, if the plants are not luxuriant, a light coat of manure should be dug in between the rows; but if they are very thrifty, it must be omitted, as it would cause them to run too much to leaf.

"A light top-dressing of leaves, or any good compost, applied late in the Fall, greatly promotes the vigor of the plants, and secures the more tender kinds against the effects of an unusually cold Winter. Before the fruit ripens, the ground between the rows should be covered with straw or new-mown grass to keep it clean. A plantation in rows is generally in full perfection the third year, and must always be renewed after the fourth year."

Culture in Alternate Strips. "Strike out the rows three feet apart with a line. Plant along each line, about a foot apart in the row. The plants will soon send out runners, and these runners should be allowed to take possession of every alternate strip of three feet, the other strip being kept bare by continually destroying all runners upon it, the whole patch being kept free of all weeds. The occupied strip, or bed of runners, will now give a heavy crop of strawberries, and the open strip of three will serve as an alley from which to gather fruit. After the crop is over, dig and prepare this alley or strip for the occupancy of the new runners for the next season's crop. The runners from the old strip will now speedily cover the new space allotted to them, and will perhaps require a partial thinning out to have them evenly distributed. As soon as this is the case—say about the middle of August—dig under the whole of the old plants with a light coat of manure. The surface may be then sown with turnips or spinach, which will come off before the next season of fruits.

"In this way, the strips or beds occupied by the plants are reversed every season, and the same plot of ground may thus be continued in a productive state for many years."

Specific Nutrition. R. G. Pardee, of Palmyra, N. Y., says: "I fertilize the plants, on opening of Spring, with a liberal sprinkling of a solution of one-fourth of a pound each of sulphate of potassium, Glauber salts, and sal soda, and one ounce of muriate ammonia, to eight gallons of water; continue this once a week, or ten days, until they blossom; then pure cold water until they ripen."

An old recipe, published in the "Friends' Review," Philadelphia, says that "a bed 30 feet by 40 should have applied, about once a week, for three times, commencing when the green leaves first begin to start, and making the last application just before the plants are in full bloom, the following preparation: "Of nitre, of potash, of Glauber's salt, and sal soda, each one pound; of nitrate of ammonia, one-quarter of a pound, dissolved in thirty gallons of rain or river water, one-third applied at a time, and the application made at evening." If dry weather, free application of clear soft water should be made between the times of using the preparation. Throughout most of the Western soils there is, as yet, no necessity for specific application of food to the strawberry, except it may be in old gardens. For field, or market culture, new clover-lye will be found better than specific manures on old grounds. The applying specific nutrition in solution to all fruit-bearing plants, undoubtedly increases their susceptibility, while it increases the vigor, and foliage, and size of fruit; yet we doubt the success of such increased action in the soils of the Western States, as combined with the great changes of climate. On the other hand, we advise such course as will rather check than enhance vigor. We append analysis of the Strawberry plant, made by Mr. Bilius Kirtland, for guidance of those whose grounds have become exhausted, and who prefer this method:

GARDEN STRAWBERRY.

In one hundred and sixteen grains of the ashes:

	Grains.
Silica	6.117
Charcoal and Sand.....	3.103
Perphosphate of Iron.....	1.515
Lime	26 539
Magnesia.....	8.908
Sulphuric Acid.....	1.469
Phosphoric Acid.....	6.970
Chlorine708
Potash	33.154
Soda.....	2.790
Carbonic Acid.....	23.008
	<hr/>
	114.281
Organic matter and loss.....	1.739
	<hr/>
	116.020

CLASS I. *Most generally esteemed.*

BOSTON PINE.

American. Staminate; requires high cultivation; vines, vigorous. *Fruit*, large, roundish, slightly conical; *seeds*, yellow, slightly imbedded. *color*, deep, rich, shining red; *flesh*, pale scarlet, firm, juicy, sweet, with a sprightly, agreeable flavor. C. M. Hovey is the originator of this variety. Its earliness and great productiveness make it highly valuable.

BURR'S NEW PINE.

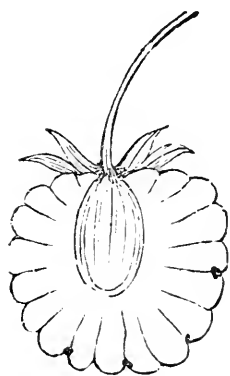

Originated at Columbus, Ohio, in 1846, on a clayey soil. Flowers, pistillate, large for the sex; vines, hardy, vigorous, very productive.

Fruit, large, obovate, or rounded, light pale red; *seeds*, slightly imbedded; *flesh*, whitish pink, delicate aromatic flavor, sweet, and delicious; *core*, firm, long rounded, too tender for a market fruit, highly desirable in gardens. Ripens among the very earliest.

GENESEE.

American. Hermaphrodite; vines, luxuriant; fruit-stalks, stout, supporting the fruit well. *Fruit*, large, roundish, dark crimson, very productive. Ripens late. Originated with Ellwanger and Barry.

HOOKER.

Originated with H. E. Hooker, Rochester, N. Y. Esteemed. Hermaphrodite; vines, vigorous, large broad foliage, hardy, productive, long time in bearing; fruit-stalks, long; truss, large. *Fruit*, large, obtuse conical, generally regular, but sometimes cock's comb, dark crimson, purplish red, surface soft, polished; *seeds*, not deeply imbedded; *flesh*, fine, sweet, rich, and excellent.

HOVEY'S SEEDLING.

American. Pistillate. Flowers, small; vines, vigorous; leaves, broad, roundish, distinct from all other varieties; leaf and fruit-stalks, short and stout. *Fruit*, very large, roundish ovate, slightly conical, with a short neck; *color*, when fully exposed to the sun, dark, rich, shining red; *seeds*, dark; *flesh*, scarlet, firm, bears carriage well, but is deficient in richness of flavor. In rich, deep, loamy soils, and supplied with a good impregnator, this variety will give immense crops of large fine fruit. In common or sandy soils it perfects only a few large berries. The "Methven Scarlet" has been largely disseminated in Illinois and farther west States as Hovey's Seedling. Newly planted beds require a covering of litter in Winter.

HUDSON.

Hudson's Bay, Old Hudson,	Late Scarlet, American Scarlet,
------------------------------	------------------------------------

Pistillate. More extensively cultivated than any other variety, its hardihood and late period of maturity, together with its fine, rich, acid flavor, so valuable for preserving, will continue for years to bring it abundantly to the markets of our large cities. In the rich clay lands around Cincinnati it grows to such size as frequently to have been mistaken for Hovey's. It must, however, gradually give place to such varieties as Longworth's Prolific, Western Queen, &c. *Fruit*, above medium, ovate, often with a neck; *seeds*, deeply imbedded; *color*, rich dark glossy red; *flesh*, firm, of a high, brisk acid flavor. Should be permitted to hang until fully matured. Season, rather late.

JENNEY'S SEEDLING.

Valuable for ripening late—say one week after "Longworth's Prolific," or about same time as "Dundee"—and for its firm texture, and desirable qualities as a variety for preserving. Flowers, pistillate; vines, very hardy; leaf and fruit-stems, both long, stiff, and upright; calyx, very large, distinctive. *Fruit*, large very regular, roundish conical; *color*, rich, glossy dark red; *seeds*, deeply imbedded; *flesh*, white, tinged with pink at the core, while the red of surface is shaded in one-sixteenth of distance, firm, rich, sub-acid, delicious; *core*, long conical, open texture, sometimes, hollow. Season, late. Very productive, 3,200 quarts having been gathered from less than three-quarters of an acre.

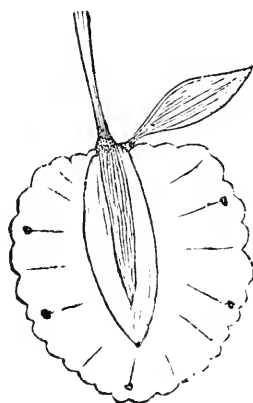

LONGWORTH'S PROLIFIC.

Schneike's Seedling.

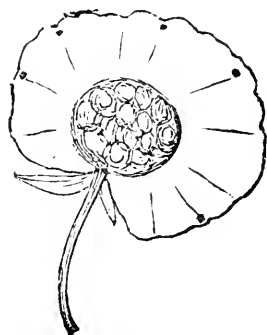

Originated at Cincinnati at the same time as McAvoy's Superior, and on similar ground; both on the land of Mr. Longworth known as the "Garden of Eden." For market culture we regard it of more value than McAvoy's Superior. Flowers, hermaphrodite; vines, hardy; foot-stalks, long, stout; leaf, broad, round, bold, upright, with a curve; trusses, large, full, stand up well from the ground; productive, regular, and sure bearer. *Fruit*, above medium to large, generally regular, roundish or obovate, sometimes slightly conical or cocomb; *color*, rich, dark

crimson; *seeds*, small, deeply imbedded; *flesh*, firm, bright red, with veins of white, and a white rim surrounding the core, which is obovate rounded, sub-acid, rich, high, not delicate flavor; *calyx*, around stem, is large, long acuminate, and the stem set deeply into the fruit. Ripens medium season, or with "Hudson."

LARGE EARLY SCARLET.

Early Virginia.

American. Hermaphrodite. With some this is regarded as the best early berry. Its chief value may be found as an impregnator of pistillate kinds. *Fruit*, medium, roundish ovate, bright scarlet; *seeds*, deeply imbedded; *flesh*, tender, rich, slightly acid flavor. Season, very early. We think "Jenny Lind" will prove superior to this, and take its place.

McAVOY'S SUPERIOR.

McAvoy's No. 12.

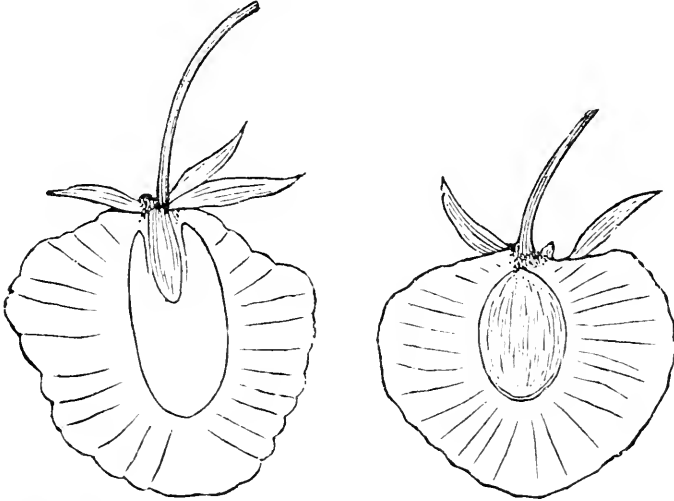

Originated at Cincinnati, in 1848, on loamy clay soil underlaid with limestone. Received the prize of \$100 from the Cincinnati Horticultural Society, 1851. Flowers, pistillate; vines, hardy; foliage, broad, dark, wavy, and sharply serrated; foot-stalks, long; trusses, full, and well-formed. *Fruit*, very large, exceeding by one-eighth that of any other variety; *form*, varied, as shown in our drawings, generally roundish, irregular conical, and occasionally slightly necked; *color*, rich, dark, glossy crimson; *seeds*, large, slightly imbedded; *flesh*, red crimson, lighted and veined with white, the white most apparent at the apex, tender, juicy, rich, with an exquisitely fine, high flavor; *core*, round oblong, rather open and coarse in texture. Too tender to endure carriage long distances; desirable for private gardens. Ripens at medium season.

MONROE SCARLET.

American. Pistillate. Plants, vigorous, prolific. *Fruit*, large, roundish, short neck, fair flavor; *flesh*, firm. Valuable market sort.

WALKER'S SEEDLING.

American. Staminate. *Fruit*, medium size, roundish conical, very dark crimson; *seed*, moderately sunk; *flesh*, not quite solid, deeply stained with red, sprightly rich flavor, of quality "best;" prolific for a staminate.

PROLIFIC HAUTOBOIS.

Conical Hautbois,
Musk Hautbois,

Double Bearing,
Caperon Royal,

Lafayette, of some,
La Grange, of some.

Of all the Hautbois or *high-wood* class of strawberries, this we regard as the only one worth cultivating; and even this is only adapted to private gardens of those who relish its peculiar musky flavor. One pint of these berries, mixed with a dish of two quarts of any of the Scarlet or Pine varieties, imparts a richness and character that few can avoid liking, after once tasting. Plants of both sexes require to be carefully selected in order to give product. Foot-stalks, long, bearing the fruit above the foliage; vines, hardy, and very productive. *Fruit*, medium, sometimes large, rounded conical, dark purplish red; *seeds*, light crimson, prominent; *flesh*, firm, musky, very rich, sweet and delicious; *core*, ovate conical, partially hollow. Ripens with "Western Queen;" and sometimes, when the season is rainy, gives a partial second crop. John Saul, Washington, D. C., says the Fertilized Hautbois of Myatt is a larger fruit and bearer than above.

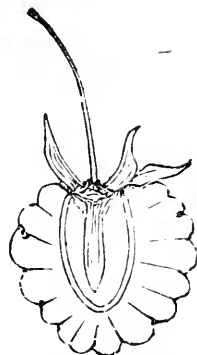

WESTERN QUEEN.

Originated at Cleveland, by Prof. J. P. Kirtland, in 1849, on gravelly loam. Flowers, pistillate; vines, very hardy; foot-stalks, long; foliage, dark, acuminate; truss, well spread, very productive. *Fruit*, medium to large, regular rounded conical, very little inclination to form a neck; *color*, rich dark glossy red; *seeds*, dark; *flesh*, yellowish stained, firm, juicy, sub-acid, sprightly and agreeable flavor; *core*, long, conical. This variety bears carriage well, and being less acid as well as larger than Hudson or Willey, should supersede them.

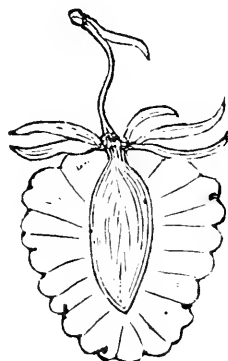

WILLEY.

Wiley.

American. Pistillate. Undoubtedly a seedling from Hudson, as plants taken from the bed of Mrs. Willey, originally Hudson, (from whence its name,) have some been recognized as Hudson, while others bear the character allied to, but yet varied. *Fruit*, medium to large, ovate conical rounded, rarely inclining to neck, rich, dark, glossy red; *flesh*, firm, juicy, high acid flavor. Hangs long, and should be permitted so to do; *vines*, very hardy, vigorous, require severe thinning, or the fruit is materially lessened in size.

WILSON'S ALBANY.

Raised by the late James Wilson, Albany, N. Y. Flowers, pistillate; vines, hardy, vigorous, and very productive. *Fruit*, large, broadly conical, pointed; *color*, deep crimson; *flesh*, crimson, tender, with a brisk acid flavor; a promising variety. The introduction of this, as well as most other Northern varieties, at the Southwest, should be done cautiously, as it is doubtful whether they will bear the heat of Southern summers.

CLASS II. *New and untested varieties, or adapted to certain localities.*

ADMIRAL DUNDAS.

English. New. Foliage, small. Fruit, large, irregular, conical flattened, pale scarlet, yellowish, seeds slightly imbedded; flesh, pale red, hollow, juicy; "good." (Hov. Mag.)

AJAX.

English. Staminate. Fruit, globular, sometimes cock's comb, dark crimson, fine flavor. New.

ALICE MAUDE.

Princess Alice Maude.

English. Hermaphrodite. Large flowers, conical, dark crimson, glossy, flavor sprightly, abundant bearer; grown largely in some sections of Virginia.

BICTON PINE.

English. Staminate. Fruit, large, long oval, flattened, bluish white. For amateurs only.

BISHOP'S ORANGE.

Orange Hudson's Bay, | Bishop's New.

Pistillate. Medium, light orange scarlet, conical; fruits in clusters, moderately prolific. Desirable in warm, deep, sandy soils.

BLACK PRINCE.

Black Imperial.

English. Pistillate. Large, rounded, deep purplish red, glossy; seeds, slightly imbedded, very showy; flesh, rich, red, sweet; in some localities—as at Newburgh, N. Y., and on the Canada shore opposite Detroit—proves of the very highest flavor; wants a rich, loamy clay; core, full, firm, surrounded by a light pink line. There is another variety of Black Prince, which is long, conical, somewhat acid.

BREWER'S EMPEROR.

English. Staminate. Large, ovate, dark red, hardy, and said to be productive. Although introduced to this country some eight years, it has not as yet been much disseminated.

BRIGHTON PINE.

Raised by Mr. Scott, of Brighton, Mass. An early and prolific variety, much lauded by Mr. Hovey, from whose magazine we extract description: Vines, vigorous, hardy. Fruit, large, roundish conical, dark red; flesh, tinged with scarlet, sprightly, high flavor. Ripens among the very earliest.

BRILLIANT.

American. Hermaphrodite. Flowers, large. Fruit, large, conical, deep crimson; flavor, excellent. Productive; plants vigorous. (W. R. P., in Hort.)

BRITISH QUEEN.

Myatt's British Queen.

English. Staminate. Large, roundish, scarlet, rich ; poor bearer.

BURR'S SEEDLING.

Burr's Staminate Seedling, | Burr's Old Seedling.

American. Hermaphrodite. Foliage, light green ; vines, strong, vigorous and hardy. Fruit, above medium, roundish oval, often conical ; seed, light-colored ; color, light pale red ; flesh, tender, mild, and pleasant flavor, does not bear carriage well, and is of too pale color to sell well in market. Productive, and, as a fertilizer for pistillate varieties, valuable.

CALEB COPE.

American. Pistillate. Large, pointed, scarlet ; flesh, white ; flavor, good. Prolific.

CAPTAIN COOK.

English. New. Vines, said to be strong and haray ; great bearer. Fruit, large, firm, bright scarlet.

CHARLOTTE.

American. Pistillate. Flowers, medium ; foliage, broad. Fruit, large, obovate ; color, dark scarlet. flesh, sweet, sprightly flavor. Productive. (W. R. P., in Hort.)

CLEVELAND.

American. Hermaphrodite. Leaf, large, ovate rounded, dark green. Fruit, large, varying from cock's comb to conical shape, irregular ; color, dark purplish red on sunny side, opposite a rich clear vermilion ; seeds, ovate pointed, prominent ; flesh, firm, of pine-apple flavor, rich, and delicious. A variety raised from seed in 1849, by Mrs. D. H. Lamb, of Cleveland, Ohio.

CLIMAX.

Climax Scarlet.

American. Pistillate. Fruit, medium, conical, slightly necked, light scarlet, rather acid. Very productive. (E. and B.)

CORNUCOPIA.

American. Pistillate. Fruit, large, conical, scarlet. Productive. (W. R. P., in Hort.)

CRESCENT SEEDLING.

A variety originated at New Orleans, said to be perpetual bearer. We have been unable to examine it. It requires further testing.

CRIMSON CONE.

Dutch Berry, | Scotch Pineapple.

Pistillate. Flowers, medium. Fruit, large, conical, good flavor, slightly acid. Vines, vigorous, requiring space ; productive. An old market sort. Superseded.

CUSHING.

American. Hermaphrodite. Fruit, large; color, light scarlet; form, obtuse conical; flesh, fine; flavor, sprightly, agreeable. Productive. Originated by Dr. W. D. Brinckle, of Philadelphia.

DUCHESS DE TREVISE.

A variety which as yet we do not know of having been fruited in this country. Mr. R. Thompson, of the London Horticultural Society, thus describes it: "Presented to the Society by M. Jamin, Bourg-la-Reine, near Paris, September 6th, 1851. Fruit, middle-sized, ovate, deep red; seeds, small, rather deeply imbedded; flesh, pale red, juicy, with a brisk, rich flavor; leaves, large, roundish, widely and rather obtusely serrated; leaf-stalks, moderately tall, very hairy, the hairs on these spreading horizontally, but those on the scapes and runners are depressed. Appears to be a good bearer."

DUNCAN'S SEEDLING.

English. New. Fruit, large, dark rich red, fine flavor, productive. Lately introduced.

DUNDEE.

Scotch. Pistillate; leaves, light green; foot and fruit-stalks, long, supporting the clusters of fruit clear of the ground. Fruit, medium to large, roundish oval, very uniform, light pale clear scarlet; flesh, firm, rich acid, high flavor very productive; extremely valuable as market berry, its period of ripening being from five to ten days after Wiley or Hudson. Vines, very hardy.

DUKE OF KENT.

Duke of Kent's Scarlet, | Austrian Scarlet, | Early Prolific Scarlet.

English. Staminate. Fruit, small, roundish conical, bright scarlet, sharp, rather acid flavor; valuable only on account of its early period of ripening. Vines, hardy.

FILLBASKET.

English. New. Vines, strong. Fruit, large, round, bright scarlet, firm; great bearer.

GERMANTOWN.

Young's Seedling.

From Germantown, Pa. Vines, vigorous, hardy, productive, long time in bearing. Fruit, large, roundish, slightly conical, regular, rich, dark crimson, firm, sweet, high flavor; promises valuable for market purposes.

GREEN STRAWBERRY.

Green Pine, | Green Wood, | Green Alpine.

Cultivated only by the curious. Small, roundish, whitish green.

HAUTOIS SEEDLING.

Peabody Seedling.

American. New. Origin, C. A. Peabody, Columbus, Geo. Hermaphrodite. Hardy, vigorous plant, withstanding both cold and heat without injury. Fruit, borne upon tall stalks, and attached to the calyx by a coral-

like neck, without seeds; size, large; form, irregular, conical ovate, compressed; color, rich, dark crimson; flesh, firm, melting, juicy, exquisite, pine flavor; prolific, and bears carriage well.

HOOPER'S SEEDLING.

English. Staminate. Fruit, medium, conical, dark rich red, good flavor; productive. Late.

IOWA MALE.

Washington.

American. Staminate. Fruit, medium, round conical; seeds, deeply imbedded; color, pale red; core, ovate conical, marked with a greenish line; flesh, yellow; flavor, delicate; moderate bearer.

JENNY LIND.

Staminate. Size, rather large; form, conical, perfect, generally with short neck; seeds, moderately sunk in oval cavities; color, bright light scarlet; flesh, white, nearly solid, heavy, tender, and juicy; flavor, pleasant sub-acid, and, under favorable circumstances, highly perfumed; quality, "very good." Early, ripening with the Early Virginia, but more prolific.

MAGNIFIQUE.

American. Pistillate. Very large, rounded, orange scarlet, pleasant flavor; productive. (W. R. P. in Hort.)

McAVOY'S NO. 1.

McAvoy's Extra Red.

American. Pistillate. Two varieties originated at same time and place as "McAvoy's Superior." They are yet comparatively untested, but, with exception of quality, the same description will answer for both; large, roundish, scarlet; seed, deeply imbedded; flesh, stained with red; flavor, agreeable; the extra red, sub-acid.

METHVEN SCARLET.

Methven Castle, Methven,		Southampton Scarlet, Keen's Seedling, <i>of some</i> , West,		Hovey's Seedling, <i>of some</i> , West, Stoddart's do. "
-----------------------------	--	---	--	--

Scotch. Pistillate. Strong grower. Fruit, large, roundish or cock's-comb shaped; seed, slightly imbedded; color, dull scarlet; flesh, coarse, open texture; core, large and hollow; flavor, very indifferent. It sometimes produces large crops, ripening some four or five days after the height of strawberry season.

MONTEVIDEO PINE.

American. Hermaphrodite. Foliage, large and vigorous; flowers, very large. Fruit, large, conical, of a pine-apple flavor, ripening late. (W. R. P. in Hort.)

MOYAMENSING.

American. Pistillate. Foliage, large, crenate serratures. Fruit, large, roundish conical, deep crimson; seed, crimson, set in rather deep depressions, with rounded intervals; flesh, red; flavor, fine. Valuable market sort in Pennsylvania and New Jersey.

NECKED PINE.

Unique Prairie, | Pine Apple.

American. Pistilla e. Fruit, medium, conical, always necked, light scarlet; flesh, white, delicate, a little acid, pleasant when fully ripe; little grown, except in private gardens at Cincinnati.

OMAR PACHA.

English. Vines, vigorous; a seedling from British Queen. Fruit, large, roundish, cock's-comb form; bright red, with many small, yellow seeds; flesh, white, juicy, sweet. New.

ORANGE PROLIFIC.

American. Hermaphrodite. Fruit, large, orange scarlet, acid; productive, late. (E. & B.)

PENNSYLVANIA.

American. Pistillate. Leaf, large, deep green. Fruit, large, broadly conical, dark crimson; seeds, crimson, when shaded, yellow; slightly imbedded; flesh, red; flavor, fine. (Trans. Penn. Hort. So.)

PRINCE OF WALES.

English. New. Said to be very early. Fruit, medium, deep scarlet, fine flavor; productive.

PRIMATE.

American. Hermaphrodite. Fruit, large, conical, deep scarlet; productive, fine for market. (W. R. P. in Hort.)

PRIMORDIAN.

American. Pistillate. Flowers, small. Fruit, large, conical, deep scarlet; productive. (W. R. P. in Hort.)

PROLIFIC HUDSON.

American. Pistillate. Fruit, medium, short cone, crimson, good flavor; ripens gradually. (W. R. P. in Hort.)

PROLIFIC SWAINSTONE.

American. Hermaphrodite. Fruit, large, ovate, scarlet; flavor, fine, productive. (W. R. P. in Hort.)

RED ALPINE.

Stafford's Washington Alpine, | Newland's Mammoth.

Flowers, perfect. Fruit, small, conical, bright scarlet, delicate, peculiar flavor. Its principal value in our climate is the ripening gradually a long time. An autumnal crop may be procured by destroying the early blossoms. The "White Alpine" varies only in the color of its fruit.

RED WOOD.

English Red Wood.

The wild strawberry of Europe, easy of cultivation, bears freely and of long continuance; small, red, roundish ovate, sweet and delicate. The White Wood varies only in color.

REFULGENT.

American. Pistillate. Medium, ovate with a neck, scarlet, fine flavor; productive. (W. R. P. in Hort.)

RICHARDSON'S LATE.

American. Hermaphrodite. Fruit, large, roundish, short neck, light scarlet, rich sub-acid, sprightly flavor; moderately productive. Ripens in succession, until about middle of July. (M. P. W., in Hort.)

RIVAL HUDSON.

Burr's Rival Hudson.

American. Pistillate. Fruit, large, bright scarlet; flesh, red, firm, sub acid; very productive. Originated same time as "Burr's New Pine," and is much like "Hudson," its parent.

ROSS PHENIX.

American. Staminate. Fruit, large, roundish, compressed, dark red; flesh, firm, good flavor; generally a poor bearer.

RUBY.

English. Fruit, medium, oval, ruby red, fine flavor, prolific. (Hov. Mag.)

SALTER'S VERSAILLAISE.

English. We copy description of Mr. R. Thompson, of London Hort. Society:

Presented to the Society by Mr. John Salter, Nurseryman, Hammer-smith, Oct. 24, 1851. Fruit, large, ovate, sometimes flattened or cock's comb-shaped, dark red; seeds, rather deeply imbedded; flesh, pale, juicy, and rich; leaves, middle-sized, roundish oval, widely serrated; leaf-stalks, scapes, and runners, hairy, the hairs spreading almost horizontally. A good bearer.

SCARLET NONPAREIL.

English. New. Vines, vigorous. Fruit, large, regular roundish, conical, glossy red; delicate perfumed flesh.

SCOTT'S SEEDLING.

From Brighton, Mass. Staminate. Vines, dwarfish, hardy; light yellowish green foliage. Fruit, medium, conical, crimson scarlet, hollow at core; flesh, pale red, wanting in flavor.

SIR C. NAPIER.

English. Vines, vigorous; foilage, medium. Fruit, large, roundish cock's comb, glossy scarlet; seeds, yellowish; flesh, pinkish, juicy, slightly musky.

SIR HARRY.

English. Vines, vigorous, productive. Fruit, large, cock's-comb form; flesh, red, solid, delicious, perfumed; fruit-stems, stout. New. (Hov. Mag.)

SOUTHBOROUGH.

Southborough Seedling, | Marshall's Seedling.

English. Pistillate. Fruit, medium, ovate conical, sometimes pointed, rich deep scarlet; seeds, small, deeply imbedded, mild rich flavor; firm

flesh, bearing carriage well. We have fruited this several years in connection with "Large Early Scarlet" (to which it is a good mate), and found it more productive, and ripening equally early in season. Vines, hardy; fruit and foot-stalks, short.

SWAINSTONE SEEDLING.

English. Staminate. Fruit, large, ovate, light crimson, firm fleshed, rich, delicious flavor. Ripens a long time, but is an uncertain bearer.

UNIQUE SCARLET.

American. Hermaphrodite. Large, light scarlet, sweet, rich, delicious flavor. Moderate bearer.

VICTORIA.

Trollope's Victoria.

English. Hermaphrodite, sometimes pistillate. Fruit, medium to large, round, conical, rich scarlet: flesh, firm, rich, high, slightly acid flavor. Season, with Hudson and Willey. Some six years since we received this variety, but have never been able to find it described, or to recognize it as any variety under different name. The vines are hardy; promise well.

WHITE ALPINE.

Varies from Red Alpine only in the color of its fruit.

WHITE BUSH ALPINE.

This and Red Bush Alpine differ from the Alpine previously described, only in not forming runners, but, growing in neat, compact bunches, are used by many persons for edging beds in kitchen gardens. Bearing throughout the entire season, renders it desirable. They are propagated by dividing the roots early in Spring. Andrew Parmentier, of Brooklyn, N. Y., first introduced the Bush Alpines to this country.

CLASS III. *Superseded by better sorts.*

ABERDEEN BEE HIVE.

English. Staminate; below medium, scarlet.

BAIN'S EXTRA EARLY.

Medium to small, round conical; flesh, tinged with red, sweet and pleasant.

BOSTOCK.

Rostock.

English. Roundish; poor bearer.

BUIST'S PRIZE.

American. Hermaphrodite; large, firm; moderately productive.

COLE'S LATE SCARLET.

English. Medium, deep color; moderate bearer.

COLE'S PROLIFIC.

English. Large, conical, good flavor.

COX'S SEEDLING.

English. Large, light red, irregular shape, acid.

COLUMBUS.

American. Pistillate; large, dark red, sweet, too tender.

CRIMSON PINE.

Hermaphrodite; resembles Hudson.

DEPTFORD PINE.

Myatt's Deptford Pine.

English. Staminate; large, long conical, rich, scarlet; poor bearer; partially hardy.

DOWNTON.

Knight's Seedling.

English. Staminate; large, irregular form, purplish scarlet; unproductive.

EBERLEIN'S SEEDLING.

American. Hermaphrodite; vines, vigorous; flowers, medium; fruit, medium, conical compressed; seeds, light colored, prominent; color, dark scarlet; good, slightly acid flavor.

ELTON.

Elton Pine.

English. Staminate; large, light red, ovate, acid, tender; unproductive.

GIANT ALPINE.

Medium, globular, tasteless.

GLOBE HAUTOBOIS.

English. Small, globular; unproductive.

GOLIAH.

German. Medium to large, scarlet, irregular, acid, vinous; there is also an English variety.

GROVE END SCARLET.

Atkinson's Scarlet.

English. Hermaphrodite; medium to small, globular, light vermilion, acid; early; productive.

HUNTSMAN'S.

American. Pistillate; large, productive, flavorless. Huntsman's Staminate: Medium, dark scarlet, good flavor; poor bearer.

KEENE'S SEEDLING.

English. Staminate; large, round cock's comb, purplish crimson, firm, rich, high flavor, tender; unproductive. There is also a pistillate Keene's Seedling, received by N. Longworth, of Cincinnati, equally unproductive.

LA LIEGOISE.

French. Staminate; medium, bright scarlet; unproductive.

LATE PROLIFIC.

American. Pistillate; medium, light pale scarlet.

LIZZIE RANDOLPH.

American. Pistillate; medium, scarlet; indifferent grower.

MYATT'S ELIZA.

English. Staminate; large, irregular cock's comb, tender flesh, hollow core, high flavor; poor bearer.

MOTTIER'S SEEDLING.

American. Pistillate; resembles its parent "Hudson."

MELON.

Scotch. Medium, roundish, dark color; dwarf.

MYATT'S ELEANOR.

English. Staminate; large, long conical, crimson scarlet, acid.

MYATT'S GLOBE.

English. Large, roundish, fine flavor, tender.

MYATT'S MAMMOTH.

English. Staminate; large, irregular roundish, dark crimson, flavorless, poor bearer.

MYATT'S PRINCE ALBERT.

English. Medium, conical, purplish crimson.

MYATT'S PINE.

English. Large, bright scarlet, fine flavor; poor bearer.

MYATT'S PROLIFIC.

English. Staminate; medium, conical, light scarlet, good flavor; *not* prolific.

OHIO MAMMOTH.

American. Staminate; large, light pale red, conical, hollow core, deficient in flavor; poor bearer.

OLD PINE, OR CAROLINE.

Bath Scarlet, | Old Scarlet Pine, | Pineapple.

American. Staminate; medium, conical, with a neck, bright scarlet, rich flavor, ripens when there are many better varieties.

PROFUSE SCARLET.

American. Pistillate; from seed of Large Early Scarlet, which it resembles.

PROFUSION.

American. Pistillate; small, rich, sweet, productive.

PRINCE OF ORLEANS.

Staminate; medium, delicate flavor.

ROSEBERRY.

English. Staminate; medium, conical, good flavor; poor bearer.

RICHARDSON'S EARLY.

American. Pistillate; medium, dark crimson, acid.

SCIOTO.

American. Pistillate; large, light pale scarlet.

SCARLET MELTING.

American. Pistillate; ovate conical, necked, light pale red; flesh, tender, juicy, good.

TAYLOR'S SEEDLING.

American. Pistillate; medium, long oval, neck distinct, light scarlet, sweet and agreeable, hollow core; unproductive.

TRUE CHILL.

Patagonian, | Greenwell's New Giant, | Greenwell's French.

This, with the two following, are little valued, and rarely grown. Fruit, large, conical, dull red, firm, hollow core.

WILMOT'S SUPERB.

English. Large, round, cock's comb, scarlet; poor bearer.

WILMOT'S NEW SCARLET.

English. Large, oval, bright scarlet; poor bearer.

WILLIAM HENRY HARRISON.

American. Staminate; large, cock's comb pointed, dark red; flesh, reddish.

YELLOW CHILL.

Fruit, large, irregular, yellow, firm.

SELECT LIST OF FRUITS.

We have prepared the following list of Fruits, as most desirable for growing in the several sections of country we have designated. It is not presumed to be a perfect list, or to embrace all the valuable varieties, but it is believed to embrace those most known, proved and esteemed, and comprisable within the bounds of our numbers. Our list embraces, of

Apples.....	40 varieties.
Peaches.....	12 market do.
Peaches.....	12 garden do.
Pears.....	30 varieties.
Pears on Quinee.....	20 do.
Sweet Cherries.....	12 do.
Duke Cherries.....	6 do.
Morello Cherries.....	6 do.
Plums.....	15 do.
Nectarines.....	3 do.
Quinces.....	3 do.
Apricots.....	4 do.
Currants.....	6 do.
Hardy Grapes.....	4 do.
Strawberries.....	6 market sorts.
Strawberries.....	6 garden sorts.
Raspberries.....	6 varieties.
Gooseberries.....	6 do.

We have divided the territory as follows:

SEC. 1. Embracing Northern Iowa, Wisconsin, Michigan, Northern Ohio, New York, most of Pennsylvania, and the States east.

SEC. 2. Embraces Southern Pennsylvania, Southern and Central Ohio, Indiana, Illinois, Southern Iowa, Northern Kentucky, Maryland, Tennessee, and Northern Missouri.

SEC. 3. Includes all territory south of what is noted in the two preceding sections.

These sections we use only with the Apple and Pear. With Cherries, and other fruits, we give selections of the best. Perfect drainage, and trees with branches near the ground, is essential to successful culture of the Cherry at the South and South-west. Propagated on Morello stocks, they are more hardy, and succeed better than on Mazzard or Mahaleb.

We have also endeavored to give the use for which the variety is most adapted, and also its time of ripening. In our illustrations necessary to this end, T stands to designate that it is used for the table, or dessert; M, that it is profitable as a market variety; C, that it is among the best for cooking purposes; b, for baking of sweet apples.

APPLES FOR SECTION 1.			<i>Name of Variety.</i>	<i>Uses.</i>	<i>Time of Ripening.</i>
<i>Name of Variety.</i>	<i>Uses.</i>	<i>Time of Ripening.</i>			
Amer. Summer Pear- main.....	T.	Aug., Sept.	Jeffries.....	T. M.	Sept., Oct.
Early Harvest.....	T. M. C.	July.	Fameuse.....	T. M.	Oct., Nov.
Red Astrachan.....	M. C.	July, Aug.	Baldwin.....	T. M.	Dec., Feb.
Sweet Bough.....	T. b.	Aug.	King of Tompkins' Co.	T. M.	Dec., Mar.
Primate.....	T.	Aug., Sept.	Belmont.....	T. M.	Dec., Feb.
Gravenstein.....	T. C. M.	Aug., Oct.	Bellflower.....	T. M. C.	Dec., Feb.
Fall Pippin.....	T. M.	Oct., Dec.	Bullock's Pippin.....	T.	Jan., Mar.
Lowell.....	T. M.	Sept., Oct.	Melon.....	T. M.	Dec., Feb.
Garden Royal.....	T.	Sept., Oct.	Rambo.....	T. M.	Nov., Jan.
Autumn Bough.....	T. M.	Sept., Oct.	Esopus Spitzenberg.....	T. M.	Jan., Mar.
Mother.....	T. M.	Oct., Jan.	Westfield Seek-no- further.....	T. M.	Dec., Feb.
Myer's Nonpareil.....	T. M.	Sept., Nov.	Domine.....	T. M.	Jan., Mar.
Jersey Sweet.....	T. b.	Sept.	Hubbardstown Non- such.....	T. M.	Dec., Feb.

Name of Variety.	Uses.	Time of Ripening.	Name of Variety.	Uses.	Time of Ripening.
Jonathan.....	T. M.	Jan., Mar.	Maiden's Blush.....	C.	July, Aug.
Lady Apple.....	T. M.	Dec., Mar.	Garden Royal.....	T.	July, Aug.
Newtown Pippin...	T. M.	Feb., May.	Autumn Pearmain....	T. M.	Aug., Sept.
Paradise Winter Sweet	T. M. b.	Dec., Feb.	Carnation.....	T. M.	Aug.
Peck's Pleasant.....	T. M.	Dec., Feb.	Fall Queen.....	M. C.	July, Aug.
Rhode Island Greening	T. M. C.	Nov., Mar.	Bohannon.....	M. C.	Aug., Sept.
Swarr.....	T. M.	Jan., Mar.	Fall Wine.....	T.	Aug., Sept.
Red Canada.....	T. M.	Jan., Mar.	Fall Pippin.....	T. M.	Aug.
Richmond.....	T. M. b.	Oct., Dec.	Dutch Mignonne.....	T. M.	Sept., Oct.
London Sweet.....	T. M. b.	Dec., Mar.	Mala Carle.....	T. M.	Aug., Sept.
Cogswell.....	T. M.	Jan., Apr.	White Spanish Reinette	T. M.	Oct., Nov.
Winesap.....	T. M. C.	Dec., Feb.	Ne Plus Ultra.....	T. M.	Oct.
Newtown Spitzenberg	} T. M.	Dec., Mar.	Waddell's Hall.....	T. M.	Oct., Jan.
Vandervere of Downing			T. M.	Dec., Mar.	Mangum.....
Ladies' Sweet.....	T. M. b.	Dec., Apr.	Bentley's Sweet.....	T. M. b.	Dec., Feb.
			Nickejack.....	T. M.	Dec., July.
			Carolina Winter Queen	T. M.	Nov., Jan.
			Ben Davis.....	T. M.	Jan., Mar.
			Hall.....	T. M.	Jan.
			Disharoon.....	T. M.	Oct., Nov.
			Green Skin.....	T. M.	Jan., Mar.
			Camaks' Sweet.....	T. M.	Dec., Mar.
			Maverack Sweet.....	T. M. b.	Jan., Feb.
			Duckett.....	T. M.	Oct., Feb.
			Berry.....	T. M.	Nov., Feb.
			Bachelor.....	T. M.	Oct., Dec.
			White.....	C.	Nov., Jan.
			Hamphill.....	T. M.	Nov., May.
			Callasaga.....	T. M.	Oct., Jan.
			Raule's Janet.....	T. M.	Nov., Jan.
			Jonathan.....	T. M.	Oct., Dec.
			Limber Twig.....	T. M.	Jan., Mar.
			Carter.....	T. M.	Oct., Jan.

APPLES FOR SECTION 2.

Amer. Summer Pearmain.....	T.	Aug.
Early Harvest.....	T. M. C.	July.
Red Astrachan.....	M. C.	July.
Sweet Bough.....	T. b.	July, Aug.
Primate.....	T.	Aug.
High Top Sweet.....	b.	July, Aug.
Red June.....	M.	July.
Fall Pippin.....	T. M.	Sept., Oct.
Garden Royal.....	T.	Aug., Sept.
Graevenstein.....	T. C. M.	Aug., Sept.
Mother.....	T. M.	Sept., Dec.
Porter.....	T. M.	Sept., Oct.
Fall Wine.....	T.	Sept., Oct.
Rambo.....	T. M.	Oct., Jan.
Smith's Cider.....	T. M.	Nov., Feb.
Smokehouse.....	T. M.	Nov., Feb.
Jeffries.....	T. M.	Aug., Sept.
Paradise Winter Sweet	T. M.	Nov., Jan.
Willow Twig.....	M.	Jan., Mar.
Newton Spitzenberg...	T. M.	Dec., Mar.
Vandervere.....	T. M.	Nov., Jan.
Winesap.....	T. M. C.	Nov., Feb.
Domine.....	T. M. C.	Dec., Mar.
Bullock's Pippin.....	T. M.	Nov., Jan.
Talman's Sweet.....	M. b.	Nov., Feb.
Ponghkeepsie Russet..	T. M.	Dec., Feb.
Myer's Nonpareil.....	T. M.	Sept., Oct.
Ortley.....	T. M.	Jan., Mar.
Bellflower.....	T. M.	Dec., Jan.
Esopus Spitzenberg...	T. M.	Dec., Feb.
Jonathan.....	T. M.	Dec., Feb.
Lady Apple.....	T. M.	Nov., Jan.
Newtown Pippin.....	T. M.	Jan., Mar.
Swaar.....	T. M.	Nov., Jan.
Maiden's Blush.....	M. C.	Sept., Oct.
Keswick Codlin.....	M. C.	Aug., Sept.
Prior's Red.....	M. T.	Jan., Mar.
White Pippin.....	T. M.	Jan., Mar.
Raule's Janet.....	T. M.	Feb., Apr.
White Winter Pearmain	} T. M.	Jan., Feb.

APPLES FOR SECTION 3.

Early Harvest.....	T. M. C.	May.
Red June.....	T. M.	June.
Julian.....	T. M.	July.
Red Astrachan.....	M. C.	June, July.
Toocoa.....	T. M.	July.
Sweet Bough.....	T. M.	June.
Amer. Summer Pearmain	T.	July, Aug.

PEARS FOR SECTION 1.

In this we have one column to designate the Stock upon which the variety succeeds best. P, stands for Pear Stock, and Q, for Quince Stock.

	Stocks.	Uses.	Maturity.
Ananas d'Eté....	P.	T. M.	Aug., Sept.
Bartlett.....	P.	T. M.	Aug., Sept.
Belle Lucrative..	P. Q.	T. M.	Sept., Oct.
Buffum.....	P.	T. M.	Sept., Oct.
Beurre Langlier..	P. Q.	T. M.	Nov., Jan.
Beurre Moire....	P. Q.	T. M.	Nov.
Brandywine.....	P.	T. M.	Aug., Sept.
Beurre Bosc....	P.	T.	Sept., Oct.
Beurre Coit.....	P.	T. M.	Oct., Nov.
Beurre d'Anjou..	P. Q.	T. M.	Oct., Nov.
Black Worcester..	P.	Cooking.	Nov., Feb.
Bloodgood.....	P.	T.	Aug.
Bon Chretien } Fondante.... }	Q.	T. M.	Sept., Oct.
Dearborn s } Seedling.... }	P.	T.	Aug.
Doyenne White..	Q.	T. M.	Oct., Nov.
Flemish Beauty..	P. Q.	T. M.	Sept., Oct.
Glout Moreau...	Q.	T. M.	Dec., Feb.
Jalousie de Fon- teenay Vendée }	Q.	T. M.	Oct.
Kirtland.....	P.	T. M.	Sept., Oct.
Lawrence.....	P.	T. M.	Nov., Jan.
Louise Bonne de } Jersey..... }	Q.	T. M.	Oct.
Long Green of } Coxe..... }	P. Q.	T. M.	Oct.
Nouveau Poiteau..	P. Q.	T. M.	Nov.
Doyenne d'Ete..	P.	T.	July, Aug.
Madelaine.....	P. Q.	T. M.	Aug.
Pound.....	P.	Cooking.	Dec., Mar.

<i>Stocks.</i>	<i>Uses.</i>	<i>Maturity.</i>
Soldat Labourneur d'Esperin.....	Q. T. M.	Dec., Jan.
Stevens' Genesee.....	P. Q. T. M.	Sept.
Tyson.....	P. Q. T. M.	Aug.
Winter Nelis.....	P. T. M.	Nov., Feb.
Jamiette.....	P. T. M. C.	Dec., Mar.
Washington.....	P. T. M.	Sept.
Urbaniste.....	Q. T. M.	Oct., Nov.
Vicar of Winkfield.....	Q. M. C.	Nov., Jan.
Doyenne d'Alencon.....	Q. T. M.	Nov., Jan.
Beurre St. Nicholas.....	Q. T. M.	Nov.
Beurre d'Aremberg.....	P. T. M.	Dec., Feb.
Zoar Beauty.....	P. T. M.	Aug.
Payency.....	Q. T. M.	Oct.
Skinless.....	P. T.	Aug.
Rostiezer.....	P. T.	Last Aug.

PEARS FOR SECTION 2.

Ananas d'Eté.....	P. T. M.	Aug.
Bartlett.....	P. T. M.	Aug.
Belle Lucrative.....	P. Q. T. M.	Sept.
Beurre Langlier.....	P. Q. T. M.	Oct., Nov.
Beurre Moire.....	Q. T. M.	Oct.
Beurre Bosc.....	P. T.	Sept., Oct.
Beurre d'Anjou.....	P. Q. T. M.	Oct.
Beurre Easter.....	Q. T. M.	Jan., Mar.
Buffum.....	P. T. M.	Sept.
Black Worcester.....	P. Cooking.	Nov., Jan.
Bloodgood.....	P. T. M.	July.
Bon Chret'n Fondante.....	Q. T. M.	Sept.
Dearborn Seedling.....	P. T.	July.
Doyenne White.....	P. Q. T. M.	Sept., Oct.
Fulton.....	P. T. M.	Oct.
Flemish Beauty.....	P. Q. T. M.	Sept.
Glout Morceau.....	Q. T. M.	Nov., Jan.
Jalousie de Fontenay Vendee.....	Q. T. M.	Sept.
Louise Bonne de Jersey.....	Q. T. M.	Sept.
Lawrence.....	P. T. M.	Nov.
Long Green of Coxé.....	P. T. M.	Sept., Oct.
Lewis.....	P. T. M.	Oct., Jan.
Nouveau Poiteau.....	P. Q. T. M.	Oct., Nov.
Beurre Giffart.....	P. Q. T.	July.
Beurre St. Nicholas.....	Q. T. M.	Oct., Nov.
Pound.....	P. Cooking.	Nov., Dec.
Soldat Labourneur d'Esperin.....	Q. T. M.	Nov., Dec.
Urbaniste.....	Q. T. M.	Sept., Oct.
Vicar of Winkfield.....	Q. M. C.	Oct., Dec.
Seckel.....	P. T. M.	Sept., Oct.
Stevens' Genesee.....	P. Q. T. M.	Sept.
Tyson.....	P. Q. T. M.	Aug.
St. Ghislain.....	P. Q. T. M.	Sept.
Winter Nelis.....	P. T. M.	Nov., Jan.
Jamiette.....	P. T. M.	Nov., Feb.
Duchess d'Angouleme.....	Q. T. M.	Aug., Sept.
Washington.....	P. T. M.	Aug., Sept.
Madeleine.....	P. Q. T. M.	July, Aug.
Beurre d'Aremberg.....	P. T. M.	Nov. Jan.
Skinless.....	P. T.	July Aug.
Bostiezer.....	P. T. M.	Aug.

PEARS FOR SECTION 3.

<i>Stocks.</i>	<i>Uses.</i>	<i>Maturity.</i>
Ananas d'Eté.....	P. T. M.	July, Aug.
Bartlett.....	P. T. M.	Early Aug.
Belle Lucrative.....	P. Q. T. M.	Aug., Sept.
Beurre Langlier.....	P. Q. T. M.	Oct.
Beurre Moire.....	P. Q. T. M.	Sept.
Brandywine.....	P. T. M.	July.
Beurre Bosc.....	P. T. M.	Sept.
Beurre d'Anjou.....	P. Q. T. M.	Sept.
Beurre d'Aremberg.....	P. T. M.	Nov., Dec.
Beurre Easter.....	Q. T. M.	Dec., Mar.
Buffum.....	P. T. M.	Aug., Sept.
Black Worcester.....	P. Cooking.	Oct., Jan.
Bloodgood.....	P. T.	Last June.
Bon Chret'n Fondante.....	Q. T. M.	Aug., Sept.
Doyenne White.....	P. Q. T. M.	Aug., Sept.
Duchess d'Angouleme.....	Q. T. M.	Aug., Sept.
Doyenne d'Alencon.....	Q. T. M.	Oct.
Beurre St. Nicholas.....	Q. T. M.	Sept.
Doyenne d'Eté.....	P. T.	June.
Franklin.....	P. T. M.	Jan.
Fulton.....	P. T. M.	Sept.
Glout Morceau.....	Q. T. M.	Nov., Jan.
Forelle.....	Q. T. M.	Sept.
Jamiette.....	P. T. M.	Nov., Dec.
Jalousie de Fontenay Vendee.....	Q. T. M.	Sept.
Louise Bonne de Jersey.....	Q. T. M.	Aug., Sept.
Lawrence.....	P. T. M.	Oct., Nov.
Long Green of Coxé.....	P. Q. T. M.	Sept.
Nouveau Poiteau.....	P. Q. T. M.	Sept.
Martin Sec.....	Q. T. M.	Oct.
Pound.....	P. Cooking.	Oct., Dec.
Rostiezer.....	P. T. M.	July.
Skinless.....	P. T.	June.
Seckel.....	P. T. M.	Aug., Sept.
Stevens' Genesee.....	P. Q. T. M.	Aug., Sept.
Soldat Labourneur d'Esperin.....	Q. T. M.	Oct., Nov.
St. Ghislain.....	P. Q. T. M.	July.
Payency.....	Q. T. M.	Sept.
Urbaniste.....	Q. T. M.	Sept.
Winter Nelis.....	P. T. M.	Oct., Nov.
Washington.....	P. T. M.	Aug.

THE TWELVE BEST SWEET CHERRIES.

All Cherries ripen, at the South, about one month earlier than the date we have fixed. These are all good market varieties, with the exception of "Delicate," and "Early Purple Guigne."

	<i>Uses.</i>	<i>Maturity.</i>
Belle of Orleans.....	Table ..	Early June.
Brant.....	" ..	Mid. June.
Black Tartarian.....	" ..	Last June.
Black Hawk.....	" ..	Last June.
Coe's Transparent, or Caroline.....	" ..	Last June.
Delicate.....	" ..	First July.
Downer's Late.....	" ..	Mid. July.
Early Purple Guigne.....	" ..	First June.
Elton.....	" ..	Last June.
Governor Wood.....	" ..	Mid. June.
Kirtland's Mary.....	" ..	Last June.
Rockport.....	" ..	Mid. June.

THE SIX BEST DUKE CHERRIES.

	Uses.	Maturity.
Arch Duke.....	Table & Cooking.	Early July.
Belle de Choisy	Table.	Last June.
Belle Magnifique	Cooking.	July & Aug.
May Duke.....	Table.	Mid. July.
Reine Hortense.	Table.	June.
Vail's August Duke.....	Table & Cooking.	Aug.

THE SIX BEST MORELLO CHERRIES.

	Uses.	Maturity.
Carnation (for South) and West.....	Table & Cooking.	July.
Early Richmond	Cooking.	June.
Shannon.....	Table & cooking.	Mid. July.
Donna Maria....	Cooking.	Mid. July.
Imperial.....	"	Aug.
Louis Philippe	"	Mid. July.

The "Large Morello," originated by Professor Kirtland, will probably supersede Carnation, but it is not yet sufficiently tested.

THE FIFTEEN BEST PLUMS.

Maturity at South. At North.

Bleecker's Gage.....	First July.	Last Aug.
Coe's Golden Drop..	Early Aug.	Last Sept.
Early Purple, for South.....	Early June.	
Early Orleans.....	Last June.	First Aug.
Green Gage.....	Early July.	Mid. Aug.
Imperial Gage.....	First July.	First Sept.
Jefferson.....	Last July.	Last Aug.
McLoughlin.....	Last July.	Last Aug.
Imperial Ottoman....	Mid. June.	Last July.
Purple Favorite.....	Mid. July.	Last Aug.
Purple Gage.....	Mid. Aug.	Mid. Sept.
Prince's Yellow Gage	Mid. June.	Early Aug.
Red Gage.....	July.	Mid. Aug.
Saint Martins.....	Last Aug.	First Oct.
Washington.....	July.	Last Aug.
Smith's Orleans.....	July.	Last Aug.

THE TWELVE BEST PEACHES FOR GARDENS.

Sturtevant.....	Early July.	Early Sept.
Coolidge's Favorite..	Early July.	Last Aug.
Early York.....	Mid. June.	Mid. Aug.
Grosse Mignonne....	Early July.	Mid. Aug.
Heath's Cling-stone (for the South)....	Mid. Sept.	
Hyslop Cling-stone..	First Sept.	First Oct.
Large Early York....	Mid. July.	Last Aug.
Morris's White, for preserving.....	Mid. July.	Mid. Sept.
Old Mixon Cling-stone	Last July.	Early Sept.
Old Mixon Free-stone	Mid. July.	Early Sept.
Ward's Free-stone....	Mid. Aug.	Last Sept.
Yellow Rareripe....	Early July.	Last Aug.
Ven Zandt's Superb..	Early July.	Early Sept.

THE TWELVE BEST MARKET PEACHES.

Maturity at South. At North.

Sturtevant.....	Early July.	Mid. Aug.
Crawford's Early....	Mid. July.	Early Sept.
Crawford's Late.....	Early Aug.	Last Sept.
Columbia.....	Early Aug.	Early Sept.
Heath Cling-stone, (for South).....	Sep.	
Lemon Cling-stone..	Early Aug.	Sept.
Large Early York....	Mid. July.	Last Aug.
President.....	Mid. Aug.	Mid. Sept.
Ward's Free-stone..	Early Sept.	Early Oct.
Yellow Rareripe....	Early July.	Last Aug.
Walter's Early.....	Early July.	Last Aug.
Troth's Early Red....	Mid. June.	Last July.
Hyslop's Cling-stone	Last Aug.	Early Oct.

THE SIX BEST STRAWBERRIES, FOR PRIVATE GARDENS.

Hovey's Seedling,	Hooker, or Wilson's Albany.
Burr's New Pine,	McAvoy's Superior,
Boston Pine,	Jenney's Seedling.

THE SIX BEST STRAWBERRIES, FOR MARKET GARDENS.

Hovey's Seedling,	Hooker, or Wilson's Albany,
Large Early Scarlet,	Genesee,
Longworth's Prolific,	Western Queen.

In the Southern States, "Moyamensing," and "Bishop's Orange," are to be preferred to "Longworth's Prolific," and "Genesee."

THE SIX BEST RASPBERRIES.

Fastolf,	Knevett's Giant,
Red Antwerp,	Franconia,
Vice-Presid't French,	Orange.

THE THREE BEST QUINCES.

Orange,	Portugal,	Rea's Seedling.
---------	-----------	-----------------

THE FOUR BEST APRICOTS.

Breda, Moorpark, Large Early,	Hemskirke,
-------------------------------	------------

THE THREE BEST NECTARINES.

Boston, Early Violet,	Elrige.
-----------------------	---------

THE SIX BEST CURRANTS.

Cherry,	White Dutch,
Victoria,	Red Dutch,
Knight's Sweet Red,	Black Naples.

THE SIX BEST GOOSEBERRIES.

Champagne.	Green Red,
Houghton's Seedling,	Pale Gage,
Crown Bob,	Whitesmith.

THE FOUR BEST HARDY GRAPES.

Delaware, Rebecca, Catawba, Isabella

INDEX TO THE DIFFERENT FRUITS.

[The standard names are in *Italic* letters. The synonymous names in Roman.]

ALMONDS.					PAGE
Amande Commune	43	D'Alexandrie	46		46
Amande Pistache	43	De Hollande	43		45
Amande Sultane	43	De Nancy	43		46
Amandier a coque tendre	43	De Nancy	43		43
Amandier a gros fruit	43	De St. Jean	43		46
Amandier a gros fruit doux	43	De St. Jean Rouge	43		46
Amandier a petit fruit	43	Dubois' Early Golden	43		47
Amandier des Dames	43	Dubois' Early Golden Apricot	43		47
Amandier Pecher	43	Dunmore	43		46
<i>Bitter Almond</i>	43	Dunmore's Breda	43		46
<i>Common Almond</i>	43	Du Pape	43		47
Common Sweet	43	<i>Early Golden</i>	43		47
Doux a coque tendre	43	Early Orange	43		49
Great-fruited Sweet	43	Early Masculine	43		49
Great Soft-Shell	43	Early White Masculine	43		49
Ladies' Thin-Shell	43	Germine	43		46
<i>Languedoc</i>	43	Gros d'Alexandrie	43		46
Large Persian	43	Gros Fruhe	43		46
<i>Long Hard-Shell</i>	43	Gros Musch	43		46
Long Hard-Shell Almond	43	Gros Precoce	43		46
Ou Amande Princesse	43	Gros Germine	43		46
<i>Peach Almond</i>	43	Hasselnassmandel	43		45
Pecher	43	<i>Hemskirke</i>	43		45
<i>Pistachia Sweet</i>	43	Hunt's Moorpark	43		46
<i>Soft-Shell Sweet</i>	43	<i>Kaisha</i>	43		47
Soft-Shell Sweet Almond	43	<i>Lafayette</i>	43		47
Sultan	43	<i>Large Early</i>	43		46
Sultan a coque tendre	43	<i>Large Red</i>	43		47
<i>Sultana Sweet Almond</i>	43	Large Turkey	43		48
APRICOTS.					
Abricot Commun	46	<i>Moorpark</i>	43		46
Abricotier	49	<i>Musch</i>	43		46
Abricotier blanc	49	Musch-musch	43		46
Abricotier Hatif	49	<i>Newhall's Early</i>	43		43
Abricot Peche	46	Noir	49		47
Abricot Precoce	49	Oldaker's Moorpark	49		46
Abricot Royal	43	<i>Orange</i>	49		49
<i>Alberge</i>	43	Peach	49		46
Albergier	43	Peche	49		46
Amande Aveline	45	Peche Grosse	49		46
Ananas	45	Persian	43		46
Angoumois	47	Persique	43		45
Anson's	46	Purple	43		47
Anson's Imperial	46	<i>Red Masculine</i>	43		47
<i>Blick</i>	47	<i>Ringold</i>	43		49
Blenheim	43	<i>Roman</i>	43		48
<i>Blotched Leaved Turkey</i>	43	<i>Royal</i>	43		46
<i>Breda</i>	45	Royal George	43		48
<i>Brown's Early</i>	47	Royal Orange	43		46
Brown Masculine	49	Royal Peach	43		46
<i>Brussels</i>	48	Royal Persian	43		49
<i>Burlington</i>	47	<i>Shaker Para</i>	43		43
		<i>Shipley's</i>	43		43
		Shipley's Large	43		48
		Sudlow's Moorpark	43		46
		<i>Temples</i>	43		46

	PAGE		PAGE
<i>Texas</i>	48	Bartlet	185
Transparent	46	Barlow	183
<i>Turkey</i>	48	<i>Burnhill</i>	184
Violet	47	<i>Batchelor</i>	64
Walton Moorpark	46	Bay Apple	72
White Algiers	49	<i>Beef Steak</i>	124
White Apricot	49	<i>Bean Sweet</i>	124
<i>White Masculine</i>	49	<i>Beauty of America</i>	184
Wurtemberg	46	Beauty	173
		Beauty Red	71
APPLES.		<i>Beauty of Kent</i>	184
<i>Abbott</i>	121	<i>Beauty of the West</i>	184
Abbot Seedling	121	Bear? Burden	73
<i>Adams</i>	121	<i>Bedfordshire Foundling</i>	184
<i>Adams Pearmain</i>	121	<i>Belden Sweet</i>	124
<i>Agnes</i>	121	<i>Belmont</i>	65
<i>Ailes</i>	121	<i>Bellflower</i>	66
<i>Albemarle Pippin</i>	121	Belle-Fleur	191
<i>Alexander</i>	121	Belle-Fleur Rouge	191
<i>Allen's Choice</i>	121	Belle et Bonne	81
<i>Allum</i>	121	Bell's Scarlet Pearmain	169
<i>Alpriston</i>	184	Belpre Russet	109
American Golden Russet	68	<i>Belzer</i>	124
American Golden Pippin	81	Ben	187
American Mammoth	190	<i>Ben Davis</i>	124
<i>American Beauty</i>	122	<i>Bentley's Sweet</i>	65
American Newtown Pippin	93	Bennington	170
<i>American Pippin</i>	184	<i>Benoni</i>	64
American Red Juneating	74	<i>Berry</i>	66
<i>American Summer Pearmain</i>	61	<i>Bethlehemite</i>	67
American White Winter Calville	193	<i>Better than Good</i>	124
<i>Angle</i>	184	Betsey's Fancy	82
<i>Anglo American</i>	122	<i>Betsey's Fancy</i>	124
Api	87	<i>Bevan</i>	124
Api noir	184	Bevan Favorite	124
Arbroath Pippin	190	Big Hill	101
<i>Aromatic Carolina</i>	122	Big Romanite	191
<i>Ashland</i>	122	Big Sweet	193
<i>Ashmore</i>	122	<i>Black Annette</i>	184
August Apple	186	<i>Black Coal</i>	125
<i>Augustine</i>	184	Black Detroit	185
<i>Aunt's Apple</i>	122	<i>Black Gillyflower</i>	184
<i>Aunt Hannah</i>	122	<i>Black Lady Apple</i>	184
Aurore	187	<i>Black Oxford</i>	184
<i>Autumn Bough</i>	62	Black Tom	186
<i>Autumn Pearmain</i>	63	<i>Blakely</i>	125
<i>Autumn Pippin</i>	123	<i>Bledsoe</i>	125
<i>Autumn Roman</i>	184	Bledsoe Pippin	125
<i>Autumn Seek-no-farther</i>	62	Blenheim Orange	184
<i>Autumn Strawberry</i>	62	<i>Blenheim Pippin</i>	184
Autumn Sweet Bough	62	<i>Blood</i>	125
Autumn Swaar	62	<i>Blockley</i>	128
<i>Autumnal Swaar</i>	62	<i>Blue Pearmain</i>	125
<i>Autumnal Sweet Swaar</i>	62	Blue Sweet	190
<i>Averill</i>	123	Blush June	105
Avery Sweeting	187	<i>Boalsburg</i>	125
<i>Baer</i>	123	<i>Boas</i>	125
<i>Baker's Sweet</i>	123	<i>Bohanon</i>	67
<i>Bailey Golden</i>	123	Bonne du Mai	72
<i>Bailey Sweet</i>	123	<i>Bonum</i>	126
<i>Bailey Spice</i>	123	Borsdorff	185
Baldwin	63	<i>Borsdorffer</i>	185
Baltimore Pippin	64, 190	<i>Borovitsky</i>	185
<i>Baltimore</i>	64	Bough	111
Baltimore	113	Boston Russet	109
<i>Barbour</i>	123	<i>Bourassa</i>	126
Bard Apple	73	<i>Bowkea</i>	126
Bardin	186	<i>Bowling's Sweet</i>	126
Bars	184	<i>Boxford</i>	185
<i>Barr</i>	184	<i>Brabant Bellflower</i>	127
<i>Barrett</i>	184	Brabant Belle Fleur	127
		Bracken	58

	PAGE		PAGE
Bracy's Seek-no-farther	116	Catshead Beaufin	190
Brandy Apple	157	Cattail Apple	92
Bread and Cheese Apple	102	<i>Cayuga Red Streak</i>	130
<i>Breunnamau</i>	127	<i>Caywood</i>	131
<i>Brewer</i>	185	Champ Sweeting	144
<i>Brigg's Auburn</i>	127	<i>Champlain</i>	131
<i>Broadwell</i>	67	<i>Challenge</i>	70
Broadwell Sweet	67	<i>Chandler</i>	185
<i>Brittle Sweet</i>	127	Chalmer's Large	186
Bromley's Rum	167	Charles Apple	157
<i>Brooke's Pippin</i>	127	<i>Cheeseborough Russet</i>	155
Brown's Golden Sweet	112	<i>Chester</i>	131
Brown's Late Queen	153	<i>Chief Good</i>	132
<i>Buel's Favorite</i>	129	<i>Christiana</i>	131
<i>Buchanan's Pippin</i>	123	Claremont Pippin	186
Buchanan Seedling	128	<i>Churchill Greening</i>	131
<i>Buff</i>	127	<i>Clyde Beauty</i>	131
<i>Buffington's Early</i>	123	<i>Clarke's Pearmain</i>	131
<i>Buckingham</i>	128	Coate's Greening	115
Buckman's Pearmain	187	<i>Cocklin's Favorite</i>	132
<i>Buck's County</i>	127	<i>Cogswell</i>	70
Buck's County Pippin	127	Cogswell Peirmain	70
<i>Buck Meadow</i>	123	<i>Cole</i>	132
<i>Bullock's Pippin</i>	63	Cole's Quince	165
Bullripe	73	Colman	130
<i>Bullet</i>	185	Concombue Ancien	179
Burbacker	75	Connecticut Seek-no-further	114
Burlington Spitzenberg	94	Connecticut Apple	81
Burlington Greening	106	<i>Connecticut Summer Sweet</i>	185
<i>Burn's Winter Sweet</i>	128	<i>Connett's Sweet</i>	132
<i>Burnap Greening</i>	185, 129	<i>Conway</i>	132
Butter	173, 190	<i>Cooper's Early White</i>	71
<i>Butter Apple</i>	128	<i>Cooper</i>	71
<i>Bush</i>	123	<i>Cooper's Market</i>	132
Cable's Gilliflower	64	Cooper's Redling	132
Cain	188	<i>Cornish Aromatic</i>	71
<i>Cake Apple</i>	185	<i>Cornell's Fancy</i>	132
<i>Callusaga</i>	129	<i>Cornish Gilliflower</i>	155
Calville Blanch de Hiver	193	Cornell's Favorite	132
Calville Rouge	191	Cornish July-flower	185
Calville Rouge de Hiver	191	Coriandra Rose	132
<i>Camack's Sweet</i>	129	<i>Cos or Caas</i>	185
Camack's White Sweet	129	<i>Cour Pendu Plat</i>	132
<i>Campfield</i>	129	Cour Pendu Extra	132
<i>Canada Reinette</i>	69	Cour Pendu	132
Canadian Reinette	69	Cour Pendu Rouge Musque	132
Cane	188	Cour Pendu Rond Gros	132
<i>Cann</i>	129	Cour Pendu Musque	132
Cannahan's Favorite	129	<i>Court of Wick</i>	133
<i>Cannon Pearmain</i>	129	Court of Wick Pippin	133
<i>Carpenter</i>	130	Court de Wick	133
Capendu	132	<i>Cracking</i>	133
<i>Capron's Pleasant</i>	129	Crane's Pippin	96
<i>Carnahan</i>	129	<i>Cranberry</i>	133
<i>Carnation</i>	69	<i>Cranberry Pippin</i>	186
Caraway Russet	186	Crimson Pippin	135
Carolina	179	Crooked Limb Pippin	186
Carolina Red June	105	<i>Culp</i>	133
Carolina June	105	<i>Cumberland</i>	134
<i>Carolina Winter Queen</i>	70	Cumberland Seedling	134
<i>Caroline</i>	135, 130	<i>Cumberland Spice</i>	134
Caroline	179	<i>Curtis Sweet</i>	134
<i>Carter</i>	130	Dainty Apple	133
Carthouse	142	<i>Danver's Winter Sweet</i>	72
<i>Cash Sweet</i>	185	<i>Dapper</i>	134
<i>Cat Face</i>	130	<i>Darlington</i>	134
Cat Head Greening	185	<i>Davis</i>	134
<i>Cat Head</i>	189	Darlington Russet	134
Catshead Beaufin	190	Davis	96
<i>Catooga</i>	130	De Bretagne	69
<i>Catline</i>	185	D'Espagne	179
<i>Cat Pippin</i>	130	<i>Delight</i>	135

	PAGE		PAGE
<i>Derry Nonsuch</i>	134	<i>Eustis</i>	137
De Ratteau	179	<i>Exquisite</i>	138
<i>Detroit</i>	135	<i>Esten</i>	137
Det. oit	96	<i>Excel</i>	137
Devonshire Quarrenden	166	<i>Esopus Spitzenburgh</i>	75
Derrick's Graft	166	<i>Ewalt</i>	137
De Witt	135	<i>Eve</i>	136
<i>Dickson's Emperor</i>	134	<i>Evening Party</i>	137
Dinsmore	134	<i>Eve Apple</i>	136
<i>Dillingham</i>	135	<i>Faldwulder</i>	75
<i>Disharon</i>	73	Fallwater	75
<i>Doctor</i>	135	<i>Fairbanks</i>	138
<i>Domine</i>	73	Fall Beauty	77
<i>Donnetans Seedling</i>	136	Fall Bough	62
Downing's Paragon	162	<i>Full Cheese</i>	136
<i>Downton Pippin</i>	136	Fall Genneting	133
Downton Golden Pippin	136	<i>Full Harvey</i>	133
Downy	138	<i>Full Jenetting</i>	138
Dow's	82	<i>Full Pearmain</i>	133
Douse	82	<i>Full Queen</i>	77
<i>Drap d'Or</i>	72	<i>Full Queen of Kentucky</i>	77
<i>Ducket</i>	135	<i>Full Pippin</i>	76
Dumelow's Crab	136	Fall Wine	122
<i>Dumelow's Seedling</i>	136	<i>Full Wine</i>	73
<i>Dumping</i>	136	Fall Wine Sap	68
Dunlap's Aurora	130	<i>Full Seek-no-further</i>	133
Duches of Oldenburg	73	Fall Vandervere	113
<i>Dutch Codlin</i>	136	<i>Fuma Gusta</i>	136
Dutch Codlin	75	<i>Fumouse</i>	78
Dutch Mignonne	73	<i>Futher Abraham</i>	139
Dutch Pearmain	137	<i>Furley's Red</i>	133
<i>Dyer</i>	73	<i>Favorite</i>	139
Early Crofton	133	<i>Fuy's Russet</i>	139
<i>Early Joe</i>	74	<i>Fenouillet Gris</i>	136
Early June	83, 136	<i>Fenouillet Rouge</i>	136
Early May	119	Fenton Sweeting	177
<i>Early Pennock</i>	136	<i>Ferdinand</i>	139
Early French Reinette	83	<i>Ferris</i>	139
<i>Early Long Stem</i>	136	Ferris	136
<i>Early Harvest</i>	83	Fisk's Seedling	139
Early Red Juncating	136	Flat Pippin	164
<i>Early Red Margaret</i>	136	<i>Fleiner</i>	139
Early Spice	136	Father Apple	164
<i>Early Strawberry</i>	74	Flint Russet	164
Early Summer Pearmain	61	<i>Flower of Kent</i>	137
Early Summer Pippin	72	<i>Flushing Spitzenburgh</i>	140
<i>Early Sweet</i>	136	Flushing Seek-no-further	116
Early Sweet Bough	111	<i>Ford Apple</i>	139
<i>Easter Pippin</i>	136	Forever Pippin	135
Edgerly Sweet	123	<i>Fort Miami</i>	79
Edmonton's Aromatic	133	<i>Focht</i>	140
<i>Egg Top</i>	136	Formosa Pippin	107
Egg Top	135	<i>Foundling</i>	140
Eighteen Ounce Apple	130	Fulton	79
<i>Ellis</i>	136	Funtling	140
Elton Pippin	136	<i>Franklin Golden Pippin</i>	140
Emperor Alexander	121	French Crab	136
<i>Enfield Pearmain</i>	136	French Pippin	161, 136, 107, 147
English Nonsuch	190	<i>French's Sweet</i>	141
English Vandevere	109	French's Sweet	102
English Summer Pearmain	63	Frith Pitcher	139
<i>English Sweeting</i>	137	<i>Fronclin</i>	141
<i>English Golden Russet</i>	136	Fry's Pippin	133
English Russet	100	<i>Gabriel</i>	141
English Golden Pippin	137	Garden Apple	124
English Winter	73	<i>Garden Royal</i>	80
Esquire	164	<i>Garretson's Early</i>	141
English Codlin	190	Garnon's Apple	132
<i>Epsy</i>	136	Gate	65
Epsis Sweet	72	<i>Gault's Bellflower</i>	137
<i>Equintely</i>	74	<i>George</i>	141
<i>Ernst's Pippin</i>	137	German Green	69

	PAGE		PAGE
<i>Giant</i>	187	Hall's Red	143
Gibbon's Smathouse	109	<i>Hamphill</i>	143
Gibbon's Smokehouse	142	Hampshire Greening	106
<i>Giles</i>	142	Hampshire Yellow	183
<i>Gilpin</i>	103	<i>Hannah</i>	187
Gillet's Seedling	193	Hardingham's Russet	164
Glace de Zelande	186	Harkness' New Favorite	191
Gloucester Cheese	131	Harmony	136
Gloucester Pearmain	142	<i>Harnish</i>	144
<i>Gloucester White</i>	190	<i>Harrison</i>	144
Gloria Mundi	107	<i>Harris</i>	143
Glory of York	142	Harrigan	159
<i>Golden Russet</i>	187	<i>Hartford Sweeting</i>	144
<i>Golden</i>	187	<i>Harvest Red Streak</i>	187
<i>Golden Apple</i>	81	<i>Haskell's Sweet</i>	144
<i>Golden Ball</i>	193	<i>Hawley</i>	82
Golden Drop	142	<i>Hawthornden</i>	144
<i>Golden Goss</i>	187	Hay Maker	130
<i>Golden Harvey</i>	100	Hay's Winter	116
Golden Pippin of Michigan	65, 96	Hay's Winter Wine	116
Golden Pippin	81, 187	<i>Heart's Pippin</i>	144
Golden Pearmain	131, 183	<i>Hector</i>	144
<i>Golden Pearmain</i>	187	Heicke's Winter Sweet	88
<i>Golden Reinette</i>	187	<i>Helen's Favorite</i>	144
Golden Russet	68	Henrick Sweet	111
Golden Russet of New York	136	Henry Sweet	111
Golden Spice	73	<i>Henry</i>	145
<i>Golden Sweet</i>	80	<i>Herman</i>	145
<i>Goodyear</i>	187	Hepler	187
Goodyear's Seedling	187	<i>Hepper</i>	187
<i>Governor</i>	130	Herefordshire Red Streak	191
Governor Seward	142	<i>Herefordshire Pearmain</i>	84
<i>Grandfather</i>	127	<i>Hess</i>	145
Granny Bull	142	<i>Heterich</i>	188
<i>Grannwinkle</i>	142	<i>Hewitt's Sweet</i>	188
<i>Granny Earl</i>	187	<i>Higby's Sweet</i>	145
<i>Grand Sachem</i>	129	<i>Highlander</i>	146
Grape Vine	81	<i>High Top Sweet</i>	85
<i>Gravenstein</i>	81	<i>Hill's Favorite</i>	146
Grave Slije	99	<i>Hilton</i>	146
Gray Apple	129	Hinchman	161
Gray Pippin	82	<i>Hiram's Favorite</i>	146
<i>Gray Vandevere</i>	80, 96	<i>Hocking</i>	146
Greasy Pippin	96	Hogan	73
Green Bellflower	142	<i>Hoary Morning</i>	188
<i>Green Cheese</i>	142	Hog Island	175
<i>Green's Choice</i>	187	Hog Pen	162
<i>Green Domine</i>	184	Holden Pippin	162
<i>Green Everlasting Synonym</i>	143	Holden	162
<i>Greenskin</i>	75	<i>Holland Pippin</i>	147
<i>Green Mountain Pippin</i>	93	<i>Holland's Sweet</i>	188
Green Mountain Pippin	82	<i>Holladay's Seedling</i>	146
<i>Green Sweet</i>	116	Hollandsberry	188
Green Seek-no-further	93	<i>Hollandburgh</i>	188
Green Winter Pippin	82	Hollow Brown Pearmain	116
Green Vandevere	185	Hollow Core Pippin	96
Gregson	187	Homony	172
<i>Greyhouse</i>	143	Hommacher Apfel	190
<i>Grime's Golden Pippin</i>	184	Hornemaker Pippin	180
Grindstone	99	Horse Apple	77
Grise	64	Horse Apple	157
Gross	87	Horse Block	156
Gros Api Rouge	69	Honey Greening	82
Grosse Reinette d'Angleterre	140	Honey Sweet	97
Groton	143	<i>Hooker</i>	146
<i>Gully</i>	143	<i>Housom's Red</i>	147
<i>Hain</i>	143	<i>Hoover</i>	146
<i>Hagloe</i>	143	Howe Apple	182
Hallum	121	Howard Russet	185
<i>Hall</i>	143	Howard's Sweet	123
		<i>Howe's Russet</i>	147
		<i>Hubbardston Nonsuch</i>	84

	PAGE		PAGE
Hubbardton Pippin	84	<i>King of Tompkin's County</i>	87
<i>Hughes</i>	148	<i>Kingsley</i>	87
<i>Hunge</i>	188	Kingsbury Russet	185
Hunger	188	Kirk's Golden Reinette	187
<i>Hunter</i>	148	Kirk's Lemon Pippin	189
Hunt's Russet	68	<i>Kirkbridge White</i>	152
<i>Hunt's Russet</i>	148	<i>Kirke's Lord Nelson</i>	188
<i>Hurlbut</i>	148	<i>Klaproth</i>	152
Hurlbut Stripe	148	Knight's Codlin	194
Hyde's Sweet	117	Knight's Golden Pippin	186
Imperial Vandervere	118	Knightwick Pippin	188
Indian Apple	82	Kountz	94
Indian Queen	136	<i>Kohl</i>	152
Indiana Jannetting	103	<i>Krouser</i>	152
<i>Indiana Favorite</i>	148	Lacker	158
Inman	96	<i>Ladies' Blush</i>	188
<i>Iola</i>	148	Ladies' Blush	141
<i>Irish Peach Apple</i>	188	Ladies' Sweet	70, 111
Irish Pitcher	189	<i>Ladies' Sweeting</i>	88
Iron Apple	127	Ladies' Favorite of Tenn.	77
Iron Stone Pippin	186	<i>Lady Apple</i>	87
<i>Jabez Sweet</i>	148	<i>Lady Finger</i>	188
<i>Jackson</i>	149	Lady Finger	151
Jacksonia	135	Lady de Grey's	188
Jack Murphy	190	Lady Washington	66, 71
James River	155	<i>Luke</i>	153
Januarea	69	<i>Lane's Red Streak</i>	153
Jenny's Seedling	142	<i>Lancaster</i>	152
<i>Jenkins</i>	149	Lancaster Greening	152
Jennette	103	Lancaster Queen	172
Jeniton	103	<i>Landon</i>	152
<i>Jefferson</i>	85	<i>Lane Sweet</i>	189
<i>Jefferson County</i>	149	<i>Landrum</i>	152
<i>Jeffries</i>	86	Laquier	153
Jersey Greening	96, 106	Large Golden Pippin	178
<i>Jersey Pippin</i>	150	Large Red Sweeting	191
<i>Jersey Sweeting</i>	85	Large Romanite	191
<i>Jewett's Red</i>	149	Large Striped Pearmain	171
Jewett's fine Red	149	Large White Juneating	88
<i>Jewett's Best</i>	86	Large Yellow Bough	111
Joe Berry	94	Late Baldwin	63
<i>John's Sweet</i>	150	Late Bough	62
<i>Johnson</i>	150	<i>Late Queen</i>	153
Johnson's Fine Winter	188	Late Golden Sweet	123
<i>Jonathan</i>	86	Late Golden Strawberry	62
Jones' Pippin	162	Leather Coat Russet	190
John Garretson's Early	141	<i>Lecker</i>	153
Jucy Bite	124	<i>Ledge Sweet</i>	153
Juneating	179	<i>Leicester Sweet</i>	153
June	136	Leland Pippin	153
<i>Julin</i>	87	<i>Leland Spice</i>	153
Juling	87	<i>Lemon Pippin</i>	189
July Pippin	88	<i>Lewis</i>	153
<i>Junatleska</i>	150	<i>Liberty</i>	154
<i>Kaighn's Spitzenburg</i>	151	<i>Limber Twig</i>	155
<i>Kane</i>	188	Lincoln Pippin	182
<i>Keiser</i>	150	Little Pearmain	68
<i>Keim</i>	150	Lippincot	109
Kelley White	65	<i>Loan's English Pearmain</i>	189
<i>Kelsey</i>	150	<i>Loey</i>	154
<i>Kenrick's Autumn</i>	188	Londonderry	134
<i>Kentish Fillbasket</i>	188	<i>London Sweet</i>	88
<i>Kerry Pippin</i>	188	London Winter Sweet	88
<i>Ketchum's Favorite</i>	151	<i>Long Island Russet</i>	189
<i>Keswick Codlin</i>	87	<i>Long John</i>	159
<i>Kilham Hill</i>	188	Long John	151
King	64, 87	Long Pearmain	151
<i>King Apple</i>	152	<i>Longvill's Kernel</i>	189
King George the Third	185	<i>Long Stem</i>	155
King Philip	86	Long Stem Sweet	123
<i>King of the Pippins</i>	188	Lop-sided Pearmain	189
King of Pippins	81	<i>Loring Sweet</i>	155

	PAGE		PAGE
<i>Loudon Pippin</i>	156	<i>Monmouth Pippin</i>	92
<i>Loure Queen</i>	159	<i>Monstrous Pippin</i>	190
<i>Lovett's Sweet</i>	186	Montreal	171
<i>Lovre Queen</i>	156	Moore's Sweeting	173
<i>Lowell</i>	89	Moose	160
<i>Luce's Early Joe</i>	189	<i>Morrison's Red</i>	160
<i>Lucombe's Seedling</i>	189	<i>Mother</i>	91
<i>Lyman's Pumpkin Sweet</i>	102	<i>Mother Dives</i>	190
<i>Lyscom</i>	156	Mountaineer	144
<i>Macomber</i>	156	Mountain Pippin	75
<i>Mackie's Clyde Beauty</i>	181	<i>Mountain Sprout</i>	160
<i>Magnum Bonum</i>	126	<i>Mouse</i>	160
<i>Magnolia</i>	156	<i>Munson Sweeting</i>	160
<i>Maiden's Apple</i>	156	<i>Murphy</i>	190
<i>Maiden's Blush</i>	89	Murphy's Red	190
<i>Maiden's Bosom</i>	161	<i>Murray</i>	160
<i>Maiden's Favorite</i>	156	Musk Melon	176
<i>Major</i>	158	<i>Musk Spice</i>	160
<i>Male Carl</i>	157	<i>Myer's Nonpareil</i>	92
<i>Mamma Beam</i>	65	Mygatt's Bergamot	73
<i>Mungum</i>	90	<i>Nimitchalee</i>	160
<i>Munk's Codling</i>	189	Neisley's Winter	191
<i>Manomet Sweet</i>	156	<i>Ne Plus Ultra</i>	160
<i>Mansfield Russet</i>	156	<i>Negussa</i>	160
<i>Marble Sweeting</i>	189	Neverfail	103
Margaretha Apfel	136	<i>Never sink</i>	161
<i>Margil</i>	189	<i>Newark Pippin</i>	161
Marietta Russet	109	<i>Newark King</i>	161
<i>Marston's Red Winter</i>	158	Newark Sweeting	129
<i>Marks</i>	158	New Jersey Red Streak	136
<i>Marks</i>	157	New Scarlet Nonpareil	192
<i>Maria Bush</i>	157	<i>Newton Spitzenberg</i>	94
Martin	90	Newtown Greening	81
<i>Maverack's Sweet</i>	90	<i>Newtown Pippin</i>	93
Matchless	94	<i>Newton Pippin of Sanders</i>	120
Matthew's Stripe	156	New York Gloria Mundi	190
<i>Mauck</i>	189	New York Greening	81
Maxfield	91	New York Spice	153
<i>May</i>	158	Niac Pippin	111
May Apple	189	<i>Nicke Jack</i>	161
<i>May Seek-no-further</i>	189	Niger	193
<i>McAfer's Nonsuch</i>	158	Nix's Green	70
McEntire's Sweeting	189	Nodhead	149
<i>McHenry</i>	158	Noll's No. 1	121
<i>McLellan</i>	90	Nonpareille	190
Meachum's Sweet	160	<i>Nonsuch</i>	190
<i>Meach</i>	158	<i>Norfolk Beaupin</i>	190
<i>Meigs</i>	158	<i>Northern Sweet</i>	161
Mela Carla	157	Northern Golden Sweet	161
Mela di Carlo	157	<i>Northern Spy</i>	95
<i>Meister</i>	159	Norton's Melon	90
Melon	90	Nyack Pippin	111
Melting	159	<i>Ocoee Greening</i>	161
<i>Melt-in-the-mouth</i>	159	Ohio Favorite	96
Melting-mouth	159	Ohio Nonpareil	70, 92
Melting Pippin	96	Ohio Pippin	137
<i>Melvin Sweet</i>	159	Ohio Wine	78
<i>Menagere</i>	189	<i>Ohio Red Streak</i>	161
Menagerie	189	<i>Old English Codlin</i>	190
<i>Merritt's Sweet</i>	189	<i>Oldfield</i>	190
<i>Methodist</i>	189	Oldfield	77
<i>Michael Henry Pippin</i>	91	Old Golden Pippin	87
<i>Mifflin King</i>	159	Old Pearmain	84
Millcreek	109	<i>Old Nonpareil</i>	190
Miller's Best Sort	164	Old Nonsuch	105
<i>Miller Apple</i>	159	<i>Old Royal Russet</i>	190
Millcreek Vanderveve	109	<i>Old Town Crab</i>	162
<i>Milum</i>	159	Onstine	115
<i>Minister</i>	91	Orange	89
<i>Molasses</i>	190	<i>Orange</i>	162
<i>Monarch</i>	159	Orange Sweet	80, 160, 174
<i>Monk's Favorite</i>	159	<i>Oregon Spitzenberg</i>	110

	PAGE		PAGE
<i>Orne's Early</i>	162	<i>Pound</i>	191
<i>Orndorf</i>	162	<i>Pound</i>	66, 75
<i>Ortley</i>	96	<i>Pound Royal</i>	89, 116
<i>Ortley Pippin</i>	96	<i>Pound Sweet</i>	102
<i>Osborn's Sweet</i>	162	<i>Pownal Spitzenburgh</i>	164
<i>Osborn's Fall Sweet</i>	162	<i>Press</i>	190
<i>Osceola</i>	162	<i>Press Ezcing</i>	164
<i>O-good's Favorite</i>	156	<i>Pride of September</i>	169
<i>Oslin</i>	190	<i>Priestley</i>	191
<i>Ox-rim-in's Sweet</i>	162	<i>Priestley</i>	185
<i>Ow-n's Golden Beauty</i>	179	<i>Priestley's American</i>	179
<i>Ox Apple</i>	190	<i>Priest's Sweet</i>	190
<i>Ox Eye</i>	94	<i>Primate</i>	101
<i>Oxford Peach</i>	160	<i>Prince's Harvest</i>	83
<i>Paradise Winter Sweet</i>	97	<i>Prince's Red and Green Sweet</i>	191
<i>Paragon</i>	162	<i>Princesse Noble Zoete</i>	132
<i>Parmain d'Ete</i>	63	<i>Prior's Red</i>	101
<i>Parmain Royal</i>	84	<i>Progress</i>	164
<i>Parson's Early</i>	190	<i>Prolific Beauty</i>	191
<i>Patterson Sweet</i>	123	<i>Prolific Sweet</i>	190
<i>Pawpaw</i>	162	<i>Pryo's Red</i>	101
<i>Peach Pond Sweet</i>	98	<i>Pumpkin Russet</i>	164
<i>Pecker</i>	63	<i>Pumpkin Sweet</i>	102
<i>Peck's Pleasant</i>	97	<i>Putnam Russet</i>	109
<i>Penick</i>	191	<i>Putnam Harvey</i>	164
<i>Pennock</i>	191	<i>Putneyite</i>	190
<i>Pennock's Red Winter</i>	191	<i>Quaker Pippin</i>	191
<i>Pennsylvania Vandervere</i>	113	<i>Queen's</i>	185
<i>People's Choice</i>	99	<i>Queen Anne</i>	89, 91
<i>Petersburg Pippin</i>	93	<i>Quince</i>	165
<i>Petit Api</i>	87	<i>Ragan</i>	165
<i>Petit Api Rouge</i>	87	<i>Rambour d'Ete</i>	192
<i>Pfeifer</i>	163	<i>Rambour Franc</i>	192
<i>Philadelphia Pippin</i>	76	<i>Ramdell's Sweet</i>	137
<i>Philadelphia Sweet</i>	62	<i>Ramsdell's Sweeting</i>	137
<i>Phillip's Reinette</i>	133	<i>Ramsdell's Red Pumpkin—Sweet</i>	137
<i>Philip Rick</i>	86	<i>Randel Bert</i>	165
<i>Philip's Sweet</i>	163	<i>Randel's Best</i>	165
<i>Philippi</i>	163	<i>Raritan Sweet</i>	166
<i>Pickman</i>	163	<i>Raul's Gnetting</i>	103
<i>Pickman Pippin</i>	163	<i>Raul's Janet</i>	103
<i>Pie Apple</i>	147	<i>Raul's Janette</i>	103
<i>Pillikin</i>	189	<i>Raul's Janet</i>	103
<i>Pim's Beauty of the West</i>	75	<i>Rawle's Jennette</i>	103
<i>Pink Sweeting</i>	163	<i>Ray Apple</i>	160
<i>Pine Apple Russet</i>	164	<i>Read's Baker</i>	190
<i>Pittsburgh Pippin</i>	164	<i>Rebecca</i>	166
<i>Pitzer Hill</i>	161	<i>Red Ashmore</i>	122
<i>Pole Cat</i>	192	<i>Red Astrican</i>	104
<i>Polly Bright</i>	191	<i>Red Belle Fleur</i>	191
<i>Pomme d'Anis</i>	186	<i>Red Bellflower</i>	191
<i>Pomme de Berlin</i>	182	<i>Red Bough</i>	191
<i>Pomme de Charles</i>	157	<i>Red Canada</i>	105
<i>Pomme de Caen</i>	69	<i>Red Culville</i>	191
<i>Pomme d'Api Rouge</i>	87	<i>Red Cathead</i>	191
<i>Pomme d'Api</i>	87	<i>Red Cathead</i>	165
<i>Pomme de Ne'ge</i>	78	<i>Red Cheek</i>	92, 162
<i>Pomme de Rose</i>	191	<i>Red Check Pippin</i>	92
<i>Pomme Grise</i>	99	<i>Red Detroit</i>	134
<i>Pomme Finale</i>	157	<i>Red Doctor</i>	185
<i>Pomme Regelans</i>	185	<i>Red Gilliflower</i>	191
<i>Pomme Royal</i>	73, 116	<i>Red Gloria Mundi</i>	77
<i>Pomme Rose</i>	87	<i>Red Hazel</i>	66
<i>Pomme Roye</i>	191	<i>Red Ingestrie</i>	191
<i>Pomme Water</i>	73	<i>Red June</i>	136
<i>Pompey</i>	193	<i>Red June</i>	105
<i>Porter</i>	100	<i>Red Juneating</i>	74, 136
<i>Portugal</i>	69	<i>Red Pearmain</i>	151
<i>Potter's Sweet</i>	153	<i>Red Pennock</i>	191
<i>Potter's Large Grey Seedling</i>	188	<i>Red Phœnix</i>	151
<i>Poughkeepsie Russet</i>	100	<i>Red Pippin</i>	151
<i>Pound Sweet, of some West</i>	173	<i>Red Pumpkin Sweet</i>	137

	PAGE		PAGE
<i>Red Quarrenden</i>	166	<i>Scarlet Nonpareil</i>	192
Red Republican	166	Schockley	177
<i>Red Russet</i>	106	<i>Schoonmacker</i>	169
Red Russet	187	Schoolmocker	169
Red Seek-no-further	150, 191	<i>Scollop Gilliflower</i>	168
Red Streak	73	Scudamus Crab	191
<i>Red Streak</i>	191	Seago	90
<i>Red Sweet</i>	166	Seek-no-further	71, 102, 114
Red Sweet Pippin of Indiana	173	Seek-no-farther of Coxé	116
Red Spitzenberg	151, 166	<i>Seever</i>	165
Red Winter Pearmain	114, 151	Seever's Red Streak	168
Red Winter Calville	191	<i>Selma</i>	168
<i>Red and Green Sweet</i>	191	<i>September</i>	169
Red Vandervere	113	Shaker's Yellow	136
Reinette blanche d'Espagne	179	Sharp's Spice	78
Reinette du Canada	69	Sharpe's Early	172
Reinette du Canada Blanche	69	Sheep Nose	183, 68, 151, 186
Reinette du Canada a Cortes	69	<i>Sheppard's Sweet</i>	169
Reinette Grosse du Canada	69	<i>Shipley Green</i>	192
Reinette d'Holland	147	<i>Shippen's Russet</i>	192
Reinette Triomphante	193	Shirley	140
<i>Republican Pippin</i>	166	<i>Siberian Crab</i>	169
<i>Rhode Island Greening</i>	106	Sigler's Reel	63
Ribbed Pippin	81	<i>Sinclair's Yellow</i>	169
<i>Ribstone Pippin</i>	107	<i>Sine-quanon</i>	169
Richfield Nonesuch	105	<i>Skunk</i>	192
<i>Richard's Graft</i>	166	<i>Slingerland Pippin</i>	170
Richmond	107	<i>Smalley</i>	170
<i>Ridge Pippin</i>	167	Smathouse	109
<i>Riost</i>	167	<i>Smith's Cider</i>	110
<i>Ritter</i>	166	Smithfield Spice	73
Rival Golden Pippin	133	Smith's Superb	110
<i>River</i>	167	<i>Snokehouse</i>	109
<i>Roadstown Pippin</i>	167	Snorter	171
<i>Rockingham Red</i>	121	Snow	75
Rock Remain	103	Sol Carter	74
Rock Rimmon	103	Sops in Wine	170
<i>Rock Apple</i>	167	<i>Sops of Wine</i>	170
<i>Rockport Sweet</i>	167	Sour Bough	172
<i>Rock Sweet</i>	167	Spencer Sweeting	144
<i>Rome Beauty</i>	103	Spice	170, 191
Roman Beauty	103	Spice Apple of Va.	162
Romanite	102	Spiced Oxeye	94
Romanite of the West	142	<i>Spice Sweeting</i>	170
<i>Roman Stem</i>	107	<i>Spice Russet</i>	170
<i>Roseau</i>	192	<i>Sponge</i>	170
Roseau	191	Spotted Pippin	129
<i>Roseau d'Automne</i>	191	<i>Sprague</i>	192
<i>Ross Nonpareil</i>	103	<i>Spring Grove Codlin</i>	192
Rough and Ready	101	<i>Spring Pippin</i>	170
Round Catshead	185	Springport Pippin	170
Round Top	186	<i>Springer's Seedling</i>	192
<i>Roxbury Russet</i>	109	Staalclubs	113
Royale d'Angleterre	84	<i>Stanard</i>	170
Royal Pearmain	63, 84	Standard's Seedling	170
Royal Pippin	64, 130	<i>Steel's Sweet</i>	192
<i>Rule's Summer Sweeting</i>	192	<i>Stehly</i>	171
<i>Rum Apple</i>	167	<i>St. Lawrence</i>	171
<i>Rumbo</i>	102	Sterling Beauty	122
Russian	132, 151	Steele's Red Winter	63
<i>Rymer</i>	191	Steele's Red Winter of Michigan	105
Sack Apple	166	Straat	171
<i>Sailly Autumn</i>	168	<i>Stillman's Early</i>	171
Sam's Crab	189	<i>Straudt</i>	171
Sam Rawlings	188	<i>Stroat</i>	171
Sanguineus	78	Strawberry	62
Sapson	170	Striped Ashmore	122
Sassafras Sweet	144	Striped Belle Fleur	191
Scandiana Mala	79	Striped June	124
Scarlet Perfume	132	Striped Juneating	136
Scarlet Pearmain	151	<i>Striped Mohawk</i>	192
<i>Scarlet Pearmain</i>	169	<i>Striped Pearmain</i>	171

	PAGE		PAGE
Striped Rhode Island Greening	78	<i>Tinmouth</i>	176
Striped Vandervere	118	<i>Titus Pippin</i>	193
<i>Sturmer Pippin</i>	171	<i>Toccoa</i>	176
Sudlow's Fall Pippin	140	Tolman's Sweeting	112
Sugar Loaf Greening	192	Tompkins	73
<i>Sugar Loaf Pippin</i>	192	Tom Woodward Pippin	96
<i>Sugar Sweet</i>	172	<i>Townsend</i>	176
Summer Bellefleur	172	Transparent Pippin	133
Summer Bellflower	62	Transparent de Moscovie	193
<i>Summer Bellflower</i>	172	<i>Transparent de Zurich</i>	193
Summer Cheese	186	Travers	107
<i>Summer Golden Pippin</i>	192	<i>Trenton Early</i>	176
Summer Hagloe	143	<i>Trumbull Sweeting</i>	177
Summer Horse	77	Turner's Green	142
Summer Pearmain	63	<i>Turkey Greening</i>	193
Summer Pippin	101, 147	Tulpahocken	75
<i>Summer Pippin</i>	172	Twenty Ounce	130
<i>Summer Queen</i>	172	Twenty Ounce Apple	130
<i>Summer Rambo Synonym</i>	192	<i>Twenty Ounce Pippin</i>	193
<i>Summer Rambour</i>	192	Twenty Ounce Pippin	130
<i>Summer Russet</i>	192	<i>Twitcheil's Sweet</i>	177
<i>Summer Rose</i>	109	Uncle Sam's Best	78
Summer Sweet of Ohio	85	<i>Fandevere</i>	113
Summerou	161	Vandervere	94
<i>Summer Sweet Paradise</i>	172	Vandervere Pippin	82, 113
<i>Summer Bellflower</i>	172	<i>Vandyne</i>	177
Summum Bonum	132	Vandyne	96
<i>Superb Sweet</i>	172	<i>Vaughan's Winter</i>	177
<i>Superb</i>	173	Vermont	178
<i>Surprise</i>	193	<i>Victorieuse Reinette</i>	193
<i>Sutton Beauty</i>	173	<i>Victuals and Drink</i>	193
<i>Sunar</i>	110	<i>Virginia Greening</i>	177
<i>Sweet Baldwin</i>	193	Virginia Sweet	189
<i>Sweet Bellflower of Wyandot County</i>	173	Vrai Drap d'Or	72
<i>Sweet Bellflower</i>	173	<i>Waddel's Hall</i>	177
<i>Sweet Bough</i>	111	<i>Wagener</i>	114
Sweet Golden Pippin	62	Wahr Reinette	69
Sweet Harvest	111	Waldower	82
<i>Sweet Fall Pippin</i>	173	<i>Walpole</i>	177
Sweet Harvey	173	Waldener	75
Sweet June of Illinois	85	<i>Walworth</i>	178
Sweet Nonsuch	174	Waltz Apple	97
<i>Sweet Pearmain</i>	111	<i>Walker's Yellow</i>	177
<i>Sweet Pippin</i>	175	Warren Pennock	186
<i>Sweet Pippin</i>	173	<i>Warren Pippin Synonym</i>	96
<i>Sweet Romanite</i>	174	Washington	111
Sweet Red Streak	173	<i>Washington Royal</i>	178
Sweet Russet	164, 170	Watermelon	90
<i>Sweet Rambo</i>	175	Watkin's Early	61
<i>Sweet and Sour</i>	192	Watson's Vandervere	113
Sweet Seek-no-further	142	Watson's Dumpling	186
<i>Sweet Wine Sap</i>	174	Waxen	65
Sweet Swaar	62	<i>Wææn</i>	178
Sweet Wine	78	Weeks' Pippin	133
<i>Sweet Wine Sap</i>	174	Welcome	125
<i>Sweet Vandevere</i>	173	Well Apple	73
Swiss Apple	164	Wells	73
Switzer Apple	164	<i>Wellford's Yellow</i>	178
Sylvan Russet	109	<i>Well's Sweeting</i>	178
<i>Sylvester</i>	175	Wellington Apple	186
<i>Talman's Sweeting</i>	112	<i>Westfield Seek-no-further</i>	114
Tallman's Sweeting	112	Westchester Seek-no-further	139
Tallow Apple	89	<i>Western Spy</i>	178
Tallow Pippin	89	Weston	178
<i>Tart Bough</i>	193	West's Spitzenberg	130
Terry's Red Streak	102	Wetherell's White Sweeting	180
<i>Tetopsky</i>	175	<i>Wheeler's Sweet</i>	179
<i>Tewksbury Blush</i>	176	White Apple	65
Tewksbury Winter Blush	176	<i>White</i>	179
<i>The Apple</i>	68	<i>White Astrachan</i>	193
<i>Them's Red Streak</i>	193	<i>White Beauty</i>	179
<i>Tift's Sweet</i>	113	White Bellflower	96

	PAGE		PAGE
White Bellefleur	96	Woolman's Harvest	109
<i>White Calville</i>	193	Woolman's Long	96
White Detroit	96	<i>Wood's Greening</i>	115
<i>White Doctor</i>	193	Wood's Huntingdon	133
<i>White Doctor</i>	179	<i>Wood's Sweet</i>	117
White Golden Sweet	123	Woodpecker	63
White Hawthornden	144	Woodstock Pippin	184
<i>White Junecating</i>	179	Woodward's Pippin	96
White Margil	189	<i>Wormsley Pippin</i>	194
White Pippin	96	<i>Wright Apple</i>	182
<i>White Pippin</i>	118	Wyker Pippin	187
<i>White Rambo</i>	180	<i>Yacht</i>	183
White Seek-no-further	96	Yankee Apple	102
<i>White Seek-no-farther</i>	116	Yellow	133
<i>White Spanish Reinelle</i>	179	Yellow Bellefleur	66
White Spice	73	Yellow Bellflower	66
<i>White Sweeting</i>	180	<i>Yellow Crank</i>	183
White Vandervere	82	<i>Yellow Germain Reinelle</i>	187
White Wine	113	Yellow Harvest	83
White Winter Calville	193	Yellow Horse	77
<i>White Winter</i>	179	<i>Yellow Ingestrie</i>	194
<i>White Winter Pearmain</i>	118	Yellow Janette	103
<i>Whitewater Sweet</i>	180	Yellow Junecating	83
<i>Whitney's Russet</i>	180	<i>Yellow Meadow</i>	183
William's Early	119	Yellow Newtown Pippin	69
William's Early Red	119	<i>Yellow Newtown Pippin</i>	119
<i>William's Favorite</i>	119	Yellow Pippin	96, 161
William's Favorite Red	119	<i>Yellow Pearmain</i>	183
William's Red	119	Yellow Vandervere	113
<i>William Penn</i>	181	<i>Yopp's Favorite</i>	183
William Tell	164	<i>York Imperial</i>	183
<i>Willis' Sweet</i>	194	York Russett	164, 185
Willow	118	<i>Yorkshire Greening</i>	194
Willow Leap	118	Young's Long Keeper	186
<i>Willow Twig</i>	118	<i>Yost</i>	183
Willow Leaf Pippin	96	<i>Zane</i>	194
Wine	186	Zane Greening	194
<i>Wine</i>	116	<i>Zieber</i>	194
Wine Apple	116		
Wine of Cole	78		
Wine Sap	86		
<i>Wine Sap</i>	117		
Wine Sop	117		
Wine Strawberry	166		
Windower	82		
<i>Wing Sweeting</i>	182		
<i>Winn's Russet</i>	181		
<i>Winslow</i>	181		
Winter Chandler	185		
Winter Cheese	142		
<i>Winter Cheese</i>	194		
Winter Genneting	103		
Winter Grixon	185		
<i>Winter Harvey</i>	182		
Winter King	87		
Winter Pearmain	84, 159		
<i>Winter Pearmain</i>	182		
<i>Winter Pippin of Vermont</i>	182		
<i>Winter Pippin of Geneva</i>	182		
Winter Queen	194		
Winter Queen	77		
Winter Queening	194		
Winter Russet	100		
Winter Seek-no-further	138		
Winter Sweet	88		
Winter Wine	116		
<i>Winthrop Greening</i>	182		
<i>Winthrop Pearmain</i>	182		
Wolf's Den	123		
Wollatin Pippin	132		
Wolman's Harvest	109		
<i>Wonder</i>	182		
		BLACKBERRIES.	
		Bush Blackberry	196
		<i>Crystal White</i>	196
		<i>Dorchester</i>	196
		<i>High Blackberry</i>	196
		Lawton	196
		<i>Newman's Thornless</i>	197
		<i>New Rochelle</i>	196
		<i>Rubus Villosus</i>	196
		<i>Rubus Villosus</i>	196
		Seacor's Mammoth	196
		CHERRIES.	
		<i>Adam's Crown</i>	219
		Allen's Sweet Montmorency	231
		<i>American Amber</i>	219
		<i>American Heart</i>	204
		<i>Amber Gean</i>	219
		Amber Heart	222
		Amber or Imperial	212
		Amber a petit fruit	231
		Ambree de Choisy	205
		Ambree a gros fruit	205
		<i>Anne</i>	219
		Adsell's Fine Black	220
		Apple Cherry	229
		<i>Arch Duke</i>	204
		Arden's Early White Heart	222
		Arden's Heart	222

	PAGE		PAGE
Armstrong's Bigarreau	215	<i>Butner's Yellow</i>	220
<i>Bauman's May</i>	219	<i>Carmine Stripe</i>	220
<i>Belle Agathe</i>	219	<i>Carnation</i>	207
Belle Audigeoise	209	<i>Caroline</i>	207
Belle de Bayay	217	Cerasus Serrulata	229
<i>Belle de Choisy</i>	205	Cerise Ambree	212
<i>Belle Magnifique</i>	207	Cerise a Boquet	229
Belle et Magnifique	207	Cerise a Courte Queen	229
Belle de Orleans	205	Cerise Doucette	205
<i>Belle of Orleans</i>	205	Cerise Guigne	215
Belle de Petit Brie	217	Cerise Indulge	222
<i>Belle de Sceaux</i>	219	Cerise Nouvelle d'Angleterre	207
<i>Belle Vezouries</i>	219	Cerise a Noyau Tendre	205
Benham's Fine Early Duke	215	Cerise de la Palembre	205
Bigarreau	212	Cerise de Portugal	207
Bigarreau Belle de Rocmont	209	Cerise de St. Martin	231
Bigarreau Belle d'Esperin	221	Cerise Tardive	231
Bigarreau Blanc Tardif de Hildesheim	212	<i>Cerise de Xavier</i>	229
Bigarreau Couleur de Chair	209	Cerisier a fleurs doubles	229
Bigarreau Common	209	Cerisier Pleurant	231
Bigarreau Gaubabis	215	<i>Champagne</i>	221
Bigarreau Gros	212	Chatenay	219
Bigarreau a Gros fruit Blanc	209	Chevereuse	229
Bigarreau Gros Couret	214	<i>China Bigarreau</i>	221
Bigarreau Gros Montreux	214	<i>Chinese Double Flowering</i>	229
Bigarreau a Gros fruit Rouge	230	Chinese Heart	221
Bigarreau Gros Noir	222	<i>Christiana</i>	220
Bigarreau d'Holland	215	Circassian	206
Bigarreau Lauermann	215	Clarke's Bigarreau	215, 229
Bigarreau de Lyon	214	<i>Clarke's Superb</i>	229
Bigarreau de Mai	219	<i>Cleveland</i>	208
Bigarreau Marbree de Hildesheim	212	Cleveland Bigarreau	208
Bigarreau Noir	228	<i>Cluster</i>	229
Bigarreau Noir Tardif	212	<i>Coe's Late Carnation</i>	229
Bigarreau Noir Tardive	222	<i>Coe's Transparent</i>	203
Bigarreau de Rocmont	209	Cœur de Pigeon	209
Bigarreau Royal	212	Common English	228
Bigarreau Tardif	212	Common Red	211, 230
Bigarreau Tardif de Hildesheim	212	Common Sour Cherry	230
Bishop's Large	206	Commune	211
<i>Black Bigarreau</i>	228	<i>Conestoga</i>	220
Black Bigarreau of Savoy	214	<i>Corone</i>	229
Black Circassian	206	Coroun	229
<i>Black Eagle</i>	206	<i>Corwin</i>	229
<i>Black Hawk</i>	205	Coularde	215
<i>Black Heart</i>	220	Couronne	229
Black Honey	228	Cream	229
<i>Black Mazard</i>	228	Crown	207
Black Orleans	229	<i>Cumberland</i>	221
Black Russian	206, 220	Cumberland Seedling	221
Black Spanish	223	<i>Davenport</i>	221
<i>Black Tartarian</i>	206	Davenport's Early	221
<i>Bleeding Heart</i>	228	Davenport's Early Black	221
Bloodgood's Amber	219	De Hollande	215
Bloodgood's Honey	219	<i>Delicate</i>	210
Bloodgood's New Honey	219	D'Espagne	215
<i>Borealon</i>	229	<i>D'Esperin</i>	221
Boquet Amurelle	229	De Prusse	228
<i>Brandy Wine</i>	220	<i>De Spa</i>	229
<i>Brant</i>	206	De 16 a-la-livre	217
Bristol Cherry	228	<i>Doctor</i>	209
Brenneman's May	221	<i>Donna Maria</i>	221
<i>Brown's Seedling</i>	228	Double Heart	206
Buchanan's Early Duke	215	Double Flowering Kentish	229
Bullock's Heart	230	Downer	210
<i>Burr's Seedling</i>	220	<i>Downer's Late</i>	210
<i>Butner's Black Heart</i>	220	Downer's Late Red	210
Butner's Gelbe-Knorpel Kirsche	220	<i>Downing's Red Cheek</i>	221
Butner's Wachs-Knorpel Kirsche	220	<i>Downton</i>	222
Butner's Herr Kirsche	220	Dredge's Early White Heart	222
<i>Butner's October</i>	228	<i>Duchess of Pallua</i>	222
Butner's October Morello	228	Dutch Morello	226

	PAGE		PAGE
Du Nord	228	<i>Joc-osot</i>	212
Du Nord Nouvelle	228	<i>Kennicott</i>	224
<i>Dwarf Double Flowering</i>	229	Kentish	211, 229
Early Black	220	<i>Kentish</i>	230
Early Duke	215	Kentish Red	211, 230
<i>Early May</i>	222	<i>Keokuk</i>	224
<i>Early Richmond</i>	211	Kirtland's Large Morello	225
<i>Early Prolific</i>	222	<i>Kirtland's Mammoth</i>	213
<i>Early Purple Griotte</i>	208	<i>Kirtland's Mary</i>	213
<i>Early Purple Guigne</i>	208	Kneve'tt's Late Bigarreau	210
<i>Early White Heart</i>	222	<i>Knight's Early Black</i>	213
Elizabeth	223	<i>Knight's Late Black</i>	230
Elliott's Favorite	223	<i>Lady of the Lake</i>	225
Elkhorn	222	Lady Southampton's Duke	230
Elton	209	Lady Southampton's Golden Drop	230
<i>English Amber</i>	223	<i>Lady Southampton's Yellow</i>	230
English Morello	226	Large Black Bigarreau	223
Everflowing Cherry	231	<i>Large Double Flowering</i>	250
<i>Favorite</i>	223	<i>Large Heart-Shaped</i>	214
Fellow's Seedling	212	Large Heart-Shaped Bigarreau	209, 214
<i>Flemish</i>	229	Large Honey	229
Flesh Colored Bigarreau	269	Large May Duke	215
<i>Florence</i>	210	<i>Large Morello</i>	225
Four to the Pound	231	Large Morello	226
Frazer's Black Heart	206	Large Prool	211
Frazer's Black Tartarian	206	Large Red Bigarreau	230
Frazer's White Tartarian	231	Large White Bigarreau	228
Frazer's White Transparent	231	Large Wild Black	229
Gascoigne's Heart	228	Late Arch Duke	204
Geau Amber	219	<i>Late Bigarreau</i>	225
German May Duke	208	Late Duke	204
<i>Governor Wood</i>	211	Late Honey	229
<i>Grafton</i>	212	Late Kentish	230
<i>Great Bigarreau</i>	211	Late Morello	226
<i>Grädley</i>	229	Lauermann's Kirsche	215
Griotte de Portugal	204	<i>Leather Stocking</i>	226
Griotte de Villennes	207	Lemercier of E and B	217
Groote Princesse	212	<i>Lindley</i>	225
Gros Bigarreau Blanc	209	Lion's Heart	230
Gros Bigarreau Rouge	230	<i>Logan</i>	214
Gros Courbet	214	<i>Louis Phillip</i>	226
Gros Goubet	229	<i>Lundie Geau</i>	230
Grosse Bigarreau Couleur-du-Chair	209	Maccarty	229
Grottier Rouge Pale	207	<i>Madison</i>	226
Grosse Cerise Rouge Pale	207	Madison Bigarreau	226
Grosses Schwarze Knoorpel	222	<i>Manning's Early Black</i>	230
Guigne Gros Blanc	209	<i>Manning's Late Black</i>	230
Guigne Grosse Noir	220	Manning's Late Black Heart	230
Guigne Noir Luizante	214	<i>Manning's Mottled</i>	215
<i>Guigne Noir Luizante</i>	223	<i>Mary</i>	226
Guigne Noir Tardive	222	May Cherry	222
Guigne Rouge Hative	228	<i>May Duke</i>	215
Guinier a fruit Noir	220	Mazzard	223
Harrison Heart	228	Merisier a fruit Blanc	229
Herefordshire Black	229	<i>Merveille de September</i>	226
Herefordshire Heart	228	Millett's Late Heart Duke	215
Herefordshire White	222	Monstrouse de Bevy	217
<i>Hildesheim</i>	212	<i>Monstrouse de Mezel</i>	215
Hildesheim Bigarreau	212	Monstrous May	221
<i>Hadley</i>	224	Montmorency	229
Holland Bigarreau	215	Montmorency a gros fruit	229
Hollandische Grosse	212	Montmorency a longue queue	211
<i>Honey</i>	229	<i>Morello</i>	226
<i>Hevey</i>	224	Morris' Duke	215
<i>Hyle's Red Heart</i>	229	Morris' Early Duke	215
<i>Hyle's Late Black</i>	229	Mottled Bigarreau	215
Hyde's Seedling	229	<i>Moyer's Honey Heart</i>	226
<i>Hyde's Jaurie de Prusse</i>	224	Muscate of Prague	211
<i>Imperial</i>	225	<i>Napoleon</i>	215
Imperial Morello	225	Napoleon Bigarreau	215
Italian Heart	212	New Large Black Bigarreau	214
<i>Jamie de Prusse</i>	224	<i>Ohio Beauty</i>	215

	PAGE		PAGE
<i>Oscocla</i>	216	<i>Warren's Transparent</i>	231
<i>Ostheim</i>	230	<i>Waterloo</i>	228
Ortheimer Weichsel	230	Wax Cherry	207
<i>Ox Heart</i>	230	<i>Weeping or All Saints</i>	231
Ox Heart	228	<i>Wellington</i>	231
Pie Cherry	211, 230	<i>Wendell's Mottled</i>	219
<i>Pierce's Late</i>	227	Wendell's Mottled Bigarreau	219
<i>Pink Heart</i>	230	<i>Werder's Early Black</i>	228
<i>Plumstone Morello</i>	227	Werdersche Frue schwarze Herz Kirsche	228
<i>Pontiac</i>	216	West's White Heart	212
Portugal Duke	204, 215	White Bigarreau	212
<i>Powhattan</i>	216	<i>White Bigarreau</i>	228
Precoce	222	White Ox Heart	228
<i>President</i>	227	<i>White Tartarian</i>	231
<i>Prince's Duke</i>	230	White Transparent	222
Prinzessin Kirsche	212	Wild English Cherry	228
<i>Proudfoot</i>	227	Wilder's Bigarreau de Mai	219
Proudfoot's Seedling	227	<i>Wilkinson</i>	231
<i>Red Bigarreau</i>	230	Yellow or Golden	230
Red Heart	228	Yellow Honey	229
<i>Red Jacket</i>	217	Yellow Spanish	212
<i>Reine Hortense</i>	217	Yung To	229
<i>Remington</i>	230		
Remington Heart	230		
Remington White Heart	230		
<i>Richardson</i>	227		
<i>Robert's Red Heart</i>	227		
<i>Rockport</i>	218		
Rockport Bigarreau	218		
Ronald's Black Heart	206		
Ronald's Heart	206		
Ronald's Large Black Heart	206		
Ronald's Large Morello	226		
Royal Hative	215		
<i>Rumsey's Late Morello</i>	230		
Schone von Choisy	205		
Schwarze Neue Herz Kirsche	220		
Serrulated-leaved Cherry	229		
<i>Shannon</i>	218		
Small May	222		
Spanish Black Heart	220		
Spanish or Yellow	230		
<i>Sparhawk's Honey</i>	227		
Sparhawk's Honey	227		
Spotted Bigarreau	215		
Steret's May	221		
Superb Circassian	206		
Sussex	211		
Swedish	222		
Swedish Red Heart	222		
<i>Sweet Montmorency</i>	231		
Tardif de Hildesheim	212		
Tardive de Mons	226		
Tartarian	206		
<i>Tecumseh</i>	218		
The Doctor	209		
Thompson's Duke	215		
<i>Tobacco Leaved</i>	231		
<i>Townsend</i>	227		
Tradescant's Black Heart	222		
Transparent	231		
Transparent Gean	231		
<i>Transparent Guigne</i>	231		
Triomphe, of Cumberland	231		
Turkey Bigarreau	212, 215, 228		
<i>Tail's August Duke</i>	218		
Very Large Heart	230		
<i>Virginia May Duke</i>	231		
Virginian May	211		
<i>Virginian Wild Cherry</i>	231		
<i>Walsh's Seedling</i>	227		
Ward's Bigarreau	214		
		CURRENTS.	
		<i>American Black</i>	235
		<i>Attractor</i>	235
		<i>Black English</i>	235
		Black Grape	234
		<i>Black Naples</i>	234
		Black Transparent	236
		<i>Champagne</i>	235
		<i>Cherry</i>	234
		Common Black	235
		<i>Common Red</i>	235
		<i>Common White</i>	235
		Fertile Currant of Palnau	236
		<i>Fertile d'Angers</i>	235
		Goliath	235
		<i>Gondouin White</i>	235
		<i>Gondouin Red</i>	235
		Houghton Castle	235
		Jefferson	236
		<i>Knight's Early Red</i>	236
		<i>Knight's Large Red</i>	236
		<i>Knight's Sweet Red</i>	234
		<i>La Caucasie</i>	236
		<i>La Haytve</i>	236
		Large Red Dutch	234
		<i>La Versailles</i>	236
		Large White	235
		Long Bunched Red Dutch	234
		May's Victoria	235
		<i>Missouri</i>	236
		Missouri Eatable	236
		Missouri Fragrant	236
		<i>Missouri Large-fruited</i>	236
		Morgan's Red	234
		Morgan's White	235
		New Red Dutch	234
		New White Dutch	235
		Ogden's Black Grape	234
		<i>Palnau</i>	236
		<i>Prince Albert</i>	234
		Raby Castle	235
		<i>Red Dutch</i>	234
		<i>Red Grape</i>	236
		Red Grape	234
		<i>Red Provens</i>	236
		Reeve's White	235
		Rivers' White Grape	235
		<i>Short Bunched Red</i>	236

	PAGE		PAGE
<i>Striped Fruited</i>	236	Catawba Tokay	255
<i>Transparent</i>	236	<i>Cassady</i>	258
<i>Victoria</i>	235	<i>Charter Oak</i>	263
White Clinton	235	Chasselas	269
White Crystal	235	Chasselas Blanc	269
<i>White Dutch</i>	235	Chasselas Dore	269
<i>White Grape</i>	235	Chasselas de Fontainebleau	269
White Leghorn	235	<i>Chilicothe Seedling</i>	263
<i>White Pearl</i>	237	<i>Child's Seedling</i>	258
<i>White Antwerp</i>	237	<i>Clara</i>	258
GOOSEBERRIES.			
<i>Buerdill's Duckwing</i>	240	Clarence	261
<i>Capper's Bunker's Hill</i>	239	<i>Clermont</i>	263
<i>Champagne</i>	240	Clifton's Constantina	262
<i>Collier's Jolly Angler</i>	240	<i>Clinton</i>	258
<i>Crompton Sheba Queen</i>	241	<i>Columbia</i>	259
<i>Early Sulphur</i>	240	<i>Concord</i>	259
<i>Green Walnut</i>	240	D'Arbois	269
<i>Houghton's Seedling</i>	240	Decimanner	269
<i>Ironmonger</i>	240	<i>Delaware</i>	256
<i>Keen's Seedling</i>	240	De St. Jean	268
<i>Massey's Heart of Oak</i>	240	<i>Derereaux</i>	259
<i>Melling's Crown Bob</i>	240	<i>Diana</i>	257
<i>Pale Red</i>	240	Dutch Hamburg	267
<i>Parkinson's Laurel</i>	240	Early Black	268
<i>Pitmaston Green Gage</i>	240	<i>Early Black July</i>	268
<i>Red Warrington</i>	241	Early White Teneriffe	269
<i>Roaring Lion</i>	241	Elsenborough	259
<i>Taylor's Bright Venus</i>	239	Elsinboro'	259
<i>White Honey</i>	241	<i>Elsingburgh</i>	259
<i>Woodward's White Smith</i>	241	<i>Emily</i>	259
GRAPES.			
<i>Ada</i>	257	Fox Grape	262
Alexander	262	Frankendale	267
Alicant	268	Fromentean	269
Amber Muscadine	269	Fromentin Rouge	269
American Muscadine	262	Frontniac of Alexandria	269
Amiens	269	<i>Garrigues</i>	260
Arkansas	255	Gibraltar	267
August Traube	268	Golden Chasselas	269
Black Burgundy	268	<i>Graham</i>	260
<i>Black Cluster</i>	268	Gris Rouge	269
Black Frontignac	268	Grizzly Frontignac	268
<i>Black Frontignan</i>	268	<i>Grizzly Frontignan</i>	268
<i>Black Hamburg</i>	267	<i>Hall's Grape</i>	260
Black Lisbon	268	Hampton Court Vine	267
Black Morillon	268	<i>Hartford Prolific</i>	260
Black Orleans	268	Heath	256
Black Portugal	268	<i>Herbemont</i>	260
<i>Black Prince</i>	268	Herbemout Madeira	260
Black Spanish	268	<i>Hudson</i>	260
Black Valentia	268	<i>Hyde's Eliza</i>	263
<i>Bland</i>	257	<i>Imitative Hamburg</i>	260
Bland's Madeira	257	<i>Isabella</i>	257
Bland's Pale Red	257	Jacob's Traube	268
Bland's Virginia	257	<i>James' Seedling</i>	263
Boston	268	Jerusalem Muscat	269
Bourdales des Hautes Pyrenees	268	July Grape	268
<i>Brinckle</i>	258	Kleibrunner	269
Brown Hamburg	267	Lebanon Seedling	255
Ball or Bullet	262	<i>Lec's</i>	263
Burgunder	268	<i>Lenoir</i>	261
<i>Camby's August</i>	258	<i>Logan</i>	261
Cambridge Botanic Garden	268	Longworth's Ohio	262
<i>Canadian Chief</i>	258	<i>Louisa</i>	261
Cape Grape	262	Lynel	269
<i>Carter</i>	258	Madeira	262
<i>Catawba</i>	255	Madeline	268
		Madeline Noir	263
		Malaga	269
		<i>Mammoth</i>	263
		<i>Mammoth Catawba</i>	263
		<i>Marion</i>	261
		Marzhammer	269

	PAGE		PAGE
<i>Minor's Seedling</i>	263	St. Clauser	269
<i>Missouri</i>	261	Stewart's Black Prince	263
Missouri Seedling	261	Stumpter	261
Morellon Hatif	263	<i>Taft</i>	263
Moscado Bianco	269	Tasker's Grape	262
Moscatal Common	269	<i>To Kalon</i>	263
Moschata Bianca	269	Tokayer	269
Muscadine	262	Tottenham Park Muscat	269
<i>Muscat of Alexandria</i>	269	<i>Traminer</i>	269
Muscat d'Alexandria	269	<i>Troy Grape</i>	263
Muscat Blanc	269	True Burgundy	268
Muscat Blanc de Jura	269	Union Village	260
Muscat Gris	268	Valentine's	267
Muscat Noir	268	Warren	260
Muscat Noir de Jura	268	Warren's Black Hamburg	267
Muscat Noir Ordinaire	268	Warrentown	260
Muscat Rouge	268	<i>White Catawba</i>	263
Muscatteler	269	White Chasselas	269
Nepean's Constantia	269	White Constantia	269
<i>Northern Muscadine</i>	263	White Frontinac	269
<i>Northern Muscadine</i>	261	<i>White Frontignan</i>	269
Norton's Seedling	261	White Muscat	269
<i>Norton's Virginia</i>	261	White Muscat of Alexandria	269
<i>Ohio</i>	262	White Muscat of Lunel	269
Passe longue Musque	269	Wiame	262
Passe Musque	269	Worthington	268
<i>Pauline</i>	262	<i>York Madeira</i>	263
<i>Pennsylvania</i>	263	<i>Zane</i>	263
Pineau	268		
Pocock's Damascus	268		
<i>Pond's Seedling</i>	263		
Powell	257	NECTARINES.	
Purple Constantia	268	Anderson's	271
Purple Frontignan	268	Anderson's Round	273
Purple Hamburg	267	Aromatic	271
<i>Raabe</i>	262	<i>Barker</i>	271
Raabe's No. 1	258	Black Merry	273
No. 2	259	<i>Boston</i>	270
No. 3	262	<i>Broomfield</i>	273
No. 4	258	Brunon Hatif	271
Raisin de Champagne	269	Brunon Red at the Stone	271
Raisin de Frontignan	269	Brunon Musque	272
Raisin Precoce	268	Brunon Violette Musque	272
Ranfolak	269	Clairmont	271
Ranfoliga	269	Common Elbruge	271
<i>Rebecca</i>	262	Cowdry White	272
Red Constantia	268	<i>Downton</i>	270
Red Hamburg	267	Duc Du Telliers	271
Red Muncy	255	Duc de Tello	271
Red Traminer	269	Duc de Tilly	271
Roanoke	262	<i>Duke of Telliers</i>	271
Rothclausen	269	Du Tilly's	271
Rothedel	269	Du Tilliers	271
Rothfranken	269	Early Brunon	271
Roth Reifler	269	Early Black	271
Rother Klevner	269	Early Black Newington	271
Rother Traminer	269	<i>Early Newington</i>	271
<i>Royal Muscadine</i>	269	<i>Early Violet</i>	271
Salisbury Violet	267	<i>Ebruce</i>	271
<i>Schuykill</i>	262	Emerton's New White	272
Schuykill Muscadell	262	<i>Fairchild</i>	273
<i>Scuppernon</i>	262	<i>Fairchild's Early</i>	273
Segar Box	262	Fine Gold-Floshed	273
Shaker Grape	240	Flanders	272
<i>Sherman</i>	263	French Newington	273
<i>Shuttle's Seedling</i>	263	<i>French Yellow</i>	271
Singleton	255	Genoa or Genoese	273
Sir A. Pytche's Black	268	<i>Gidea</i>	273
Sir William Rowley's Black	268	Hampton Court	271
Small Black Cluster	268	<i>Hardwicke</i>	272
Smart's Elsinburg	259	Hardwicke's Seedling	272
Spring Mill Constantia	262	Hunt's Early Tawny	272

	PAGE		PAGE
Hunt's Large Tawny	272	Baltimore Beauty	305
Hunt's Tawny	272	Baltimore Rose	289
Jaune Lisse	273	Barnard	293
Large Early Violet	272	Barrington	293
Large Scarlet	271	Baugh	293
Large White	272	Beauty of Beaucaire	293
Late Green	273	Beauty of Salisbury	305
Late Yellow	273	Belle Beaute	287
Lewis	270	Belle de Beaucaire	293
Lord Selsey's Elruge	271	Belle Chevreuse	305
Lucombe's Black	271	Belle de Paris	289
Lucombe's Seedling	271	Belle de Vitry	305
Murrey	273	Belle de Vitry	305
Murry	273	Bellegarde	293
Neal's White	272	Bellis	305
Newington	273	Belzar's Early Rareripe	305
New Early Newington	271	Bennett's Rareripe	305
New Scarlet	271	Bergen's Yellow	285
New White	272	Blanton Cling	293
Oatland's	271	Blood Cling	294
Old Newington	273	Blood Clingstone	294
Old Roman	272	Bordeaux Cling	294
Oldenburg	272	Boudin	288
Orange	272	Bourdine	288
Orange	273	Brentford Mignonne	293
Perkin's Seedling	270	Brevoort	285
Peterborough	273	Brevoort's Morris	285
Petite Violet Hativé	271	Brevoort's Seedling Melter	285
Pitmaston's Orange	272	Briggs	293
Prince's Golden	273	Brown Nutmeg	307
Red Roman	272	Buckingham Mignonne	293
Roman	272	Bullard's Clingstone	305
Rough Roman	273	Bullard's Seedling	305
Scarlet	273	Burgess Beauty	290
Scarlet Newington	273	Cable's Early	306
Sion Hill	273	Cable's Early Melocoton	306
Smith's Newington	273	Cable's Late	294
Spring Grove	271	Cable's Late Melocoton	294
Stanwicke	272	Cable's Medium Melocoton	305
Sweet Yellow	273	Cambridge Belle	294
Temple's	271	Canary	305
Vermash (of some)	273	Carmine	294
Violet Grosse	272	Carpenter's White	294
Violet red at the Stone	271	Carey's Mammoth Cling	306
Violet Musk	271	Catharine Cling	306
Violette Hativé	271	Chancellor	306
William's Orange	272	Chancelliere	306
Williams' Seedling	272	Charlotte	306
		Chilian	305
		Chinese Cling	294
		Chinese Peach	294
		Claret Clingstone	294
		Clarke	294
		Clinton	295
		Cole's Early Red	295
		Cole's White Malacaton	288
		Colonel Ausley's	293
		Columbia	286
		Columbus June	295
		Congress	306
		Congress Cling	306
		Coolidge's Early Red Rareripe	285
		Coolidge's Favorite	285
		Crawford's Early	285
		Crawford's Early Melocoton	285
		Crawford's Late	285
		Crawford's Late Melocoton	285
		Crawford's Superb Melocoton	285
		Crawford's Superb Malacatune	285
		Cuttleaved	306
		Doctor Cooper	297
		Doonahoo Cling	295
PEACHES.			
Abricotée	308		
Acton Scott	305		
Admirable	305		
Admirable Jaune	308		
Admirable Tardive	305		
Alberge	285		
Alberge Juane	285		
Algiers Winter	306		
Algiers Yellow	306		
Almond	305		
Allen	292		
Anne	305		
Apricot Peach	302		
Astor	292		
Awater	298		
Austin's Late Red	292		
Avant Blanche	308		
Avant Rouge	307		
Bachelor	293		
Bagby's Large	293		
Baldwin's Late	293		

	PAGE		PAGE
Dorsetshire	289	Haine's Early Red	288
Double Swaish	307	<i>Hale</i>	297
Double Mountain	295	Hale's Melocoton	297
<i>Double Montagne</i>	295	Hall's Down Easter	306
Douglas	290	Hardy's Galande	285, 296
<i>Down Easter</i>	306	<i>Harker's Seedling</i>	297
<i>Druid Hill</i>	295	<i>Hartshorn</i>	297
Early Admirable	305	<i>Hastings</i>	297
Early Anne	305	<i>Hatch</i>	297
Early Barnard	293	<i>Hative de Ferrieres</i>	297
Early Crawford	285	Heath Free	299
<i>Early Chelmsford</i>	295	<i>Heath Clingstone</i>	287
Early Galande	293	Heath Freestone	299
Early Malden	299	<i>Henry Clay</i>	297
Early May	287	Hill's Madeira	299
Early Newington	307	<i>Hill's Chili</i>	298
<i>Early Newington</i>	286	Hoffman's Pound	300
Early Newington Freestone	286	<i>Hoffner</i>	298
Early Purple	287	Hoffner's Seedling	298
Early Purple Avant	287	Hogg's Melocoton	290
Early Red Rareripe	290	Honest John	288
Early Red Nutmeg	307	<i>Honey Peach</i>	298
<i>Early Robinson Crusoe</i>	306	<i>Horton's Delicious</i>	298
Early Royal George	293, 307	<i>Horey's Cambridge Belle</i> —Synonym	294
Early Sweet Water	307	<i>Hoblard's Early</i>	298
<i>Early Tillotson</i>	286	<i>Hystop's Clingstone</i>	287
Early Vineyard	287	<i>Imperial (Middleton's)</i>	298
Early White Nutmeg	308	<i>Imperial (Petit's)</i>	298
<i>Early York</i>	286	<i>Incomparable</i>	298
Early York of New Jersey	288	Indian Peach	286
<i>Eastburn</i>	295	<i>Isahan</i>	306
Eastburn's Choice	295	Italian Peach	286
Edgar's Late Melting	306	Italian	289
<i>Edward's Late White</i>	295	<i>Jackson Cling</i>	298
<i>Eliza</i>	296	Jaques' Rareripe	287
<i>Elmira</i>	296	<i>Jaques' Rareripe</i>	287
<i>Emperor of Russia</i>	306	Jaquish	287
<i>Favorite</i>	296	Java Peach	294
Favorite Red	296	Johnson's Early Purple	287
Fine Heath	287	<i>Jones' Early</i>	299
Flat Peach of China	294	<i>Jones' Large Early</i>	299
<i>Flewellen Cling</i>	296	<i>Jose Sweet</i>	299
<i>Fox's Seedling</i>	296	Judd's Melting	288
Freestone Heath	288	Kennedy's Carolina	288
French Bourdine	288	Kennedy's Lemon Clingstone	288
French Magdalen	299	<i>Kenrick's Heath</i>	299
French Mignonne	287	Kew's Early Purple	306
French Rareripe	285, 292	L'Admirable	305
French Royal George	293	Lady Anne Stewart	288
<i>Fulkerson</i>	296	Lady Gallatin	290
Fulkerson's Early	296	<i>Lady Parham</i>	299
<i>Galade</i>	296	<i>Lafayette</i>	307
<i>George the Fourth</i>	286	<i>Lafayette Clingstone</i>	307
<i>Gest's Superb</i>	306	<i>La Grange</i>	299
Gest's Large Freestone	306	La Royale	288
Gold Fleshed	285	Large American Nutmeg	307
<i>Golden Ball</i>	306	<i>Large Early York</i>	288
Golden Mignonne	285	Large French Mignonne	287
Golden Rareripe	285	Large Melting	307
<i>Gorgas</i>	296	Large Newington	301
<i>Green Catharine</i>	297	Large Red Rareripe	289, 290
Green Nutmeg	305	Large Violet	293
<i>Green Rareripe</i>	297	Large White Clingstone	292
Griffin's Mignonne	307	Large Yellow Rareripe	292
Griffith's Melocoton	304	Largest Lemon	288
Grimwood's Royal George	287	<i>Late Admirable</i>	288
Grimwood's New Royal George	287	Late Admirable Cling	298
Grimwood's Royal Charlotte	306	Late Chancellor	306
<i>Griswold</i>	297	Late Red Rareripe	290
Gros Melocoton	300	<i>Late Yellow Alberge</i>	306
<i>Grosse Mignonne</i>	287	<i>Lemon Clingstone</i>	288
Grosse Perrique Rouge	300	<i>Lincoln</i>	299

	PAGE		PAGE
Livingstone's N. Y. Rareripec	288	Pavie Admirable	298
Lockyer's Mignonne	307	Pavie Cium	300
Long Yellow Pine Apple	288	Pavie Monstreux	300
Lord Montague's Noblesse	301	Pavie de Pomponne	300
Luscious White Rareripec	288	Pavie de Pomponne Gross	300
<i>Madeira</i>	299	Pavie Rouge de Pomponne	300
Madeira Freestone	299	Peche Jaune	285
Madelaine de Courson	299	Peche Malte	289
<i>Madeline of Courson</i>	299	Peche Royale	288
Madeline Reuge	299	Pecher d'ispanhan	306
<i>Magistrate</i>	307	Peen-To	294
Majestrate	307	<i>Phleiger</i>	307
Malacatune	290	Philadelphia Freestone	288
Malagatune	290	Pine Apple Clingstone	288
<i>Malden</i>	299	<i>Poinsett</i>	301
<i>Malta</i>	289	Poole's Large Yellow	302
Malte de Normandie	289	Poole's Late Yellow Freestone	302
Mammoth	295	<i>Poole's Yellow</i>	302
Maria Antoinette	292	Pourpree Hative	287
Mellishe's Favorite	301	Pourpree de Normandie	287
<i>Melting</i>	307	Pourpree Tardive	288
<i>Merriam</i>	300	<i>President</i>	290
Mignonne	287	<i>President Church</i>	302
Millet's Mignonne	307	<i>Prince John</i>	302
<i>Molden's White</i>	300	<i>Prince's Climax</i>	302
<i>Monstrous Clingstone</i>	300	<i>Prince's Excelsior</i>	302
<i>Monstrous Freestone</i>	307	Prince's Paragon	301
Monstrous Pavie	300	<i>Prince's Red Rareripec</i>	290
Monstrous Pomponne	300	Purple Alberge	285
Montague	295	Purple Avant	287
Montauban	299	Red Alberge	285
<i>Montgomery's Late</i>	300	Red Avant	307
<i>Moore's Favorite</i>	300	<i>Red Cheek</i>	290
<i>Moore's June</i>	300	Red Cheek Melocoton	290
<i>Morrisania</i>	300	Red Heath	287
Morrisania Pound	300	Red Magdalen	293, 299
<i>Morris Red Rareripec</i>	289	Red Magdaline	307
<i>Morris White</i>	288	<i>Red Nutmeg</i>	307
Morris White Freestone	288	Red Rareripec	289
Morris White Rareripec	288	<i>Red Rareripec</i>	290
Morrison's Pound	300	<i>Reeve's Favorite</i>	302
Motteux's	288	Reil's Weeping	308
<i>Mrs. Painsell</i>	300	Reine des Vergers	301
Mulatto	286	<i>Redman's Red</i>	302
Narbonne	288	Ronald's Mignonne	293
Neill's Early Purple	287	Ronald's Seedling Galande	287
New Cut Leaved	306	<i>Rosanna</i>	307
Newington	286, 301	Rose	303
Newington Cling	301	<i>Rosebank</i>	290
<i>Newman</i>	301	Rouge Paysanne	299
New Royal Charlotte	306	Royal	288
New Royal George	307	<i>Royal George</i>	307
<i>New York Rareripec</i>	288	Royal Sovereign	287
New York White Clingstone	292	Royal Kensington	287
<i>Nivette</i>	289	<i>Scott's Magnate</i>	302
Nivette Velvete	289	<i>Scott's Nectar</i>	302
<i>Noblesse</i>	301	<i>Scott's Early Red</i>	307
Noisette	306	Scott's Nonpareil	301
<i>Nonpareil</i>	301	Selby's Cling	292
October Yellow	306	Serrate Early York	286
Oldmixon Clearstone	289	Serrated	306
<i>Oldmixon Clingstone</i>	289	<i>Sibbott</i>	308
<i>Oldmixon Freestone</i>	289	<i>Site's Old Zack</i>	303
<i>Old Newington</i>	301	<i>Shanghai</i>	303
Old Royal Charlotte	306	<i>Skinner's Superb</i>	303
Orange	308	<i>Stocum's Early</i>	308
<i>Orange Clingstone</i>	301	<i>Smith's Favorite</i>	303
<i>Orchard Queen</i>	301	Smith's Newington	286
<i>Owen</i>	301	<i>Smith's Newington</i>	307
Owen's Lemon	301	Smith's Early Newington	307
Owen's Lemon Rareripec	301	Smock	303
<i>Paragon</i>	301	<i>Smock Free</i>	303

	PAGE	PEARS.	PAGE
<i>Smock Clingstone</i>	307		357
Smooth-leaved Royal George	293		357
<i>Snow</i>	303	<i>Albe Edouard</i>	357
<i>Spring Grove</i>	308	<i>Albe Mongein</i>	357
St. George	303	<i>Abbot</i>	357
<i>Stetson's Seedling</i>	303	<i>Adams</i>	357
Stewart's Late Galande	306	<i>Adle de St. Denis</i>	357
<i>Strawberry</i>	303	<i>Adelaide de Reves</i>	357
<i>Sturtevant</i>	290	<i>Admiral</i>	417
<i>Sulhamstead</i>	308	Ah ! Mon Dieu	420
Superb	307	<i>Alexander</i>	357
Superb Royal	287	<i>Alexandrine Douillard</i>	358
Swalze	307	<i>Alexander Lamire</i>	358
<i>Swalsh</i>	307	<i>Alpha</i>	359
<i>Sweetwater</i>	307	<i>Althorpe Crasanne</i>	359
Swiss Mignonne	287	Amanda's Pouble	417
<i>Stephenson Cling</i>	303	<i>Amande Double</i>	417
<i>Stump the World</i>	304	Amadottee	423
<i>Susquehannah</i>	304	<i>Ambrette</i>	417
<i>Tarbell</i>	304	<i>Ambrette d'Hiver</i>	417
Teton de Venus	288	<i>Ambre Gris</i>	417
<i>Tice</i>	308	<i>Ambrosia</i>	417
Tice's Red and Yellow	298	Amiral	417
<i>Tippecanoe</i>	304	Amire Joannet	381
<i>Troth's Early Red</i>	304	Amoselle	417
True Early York	286	<i>Ananas de Courtrai</i>	358
True Red Magdalen	299	Ananas	323, 399
<i>Tuft's Early</i>	304	<i>Ananas d'Ete</i>	323
<i>Tuft's Rareripe</i>	304	<i>Andrews</i>	358
Unique	306	<i>Anglo'erre</i>	417
<i>Vandermark</i>	308	<i>Anglo'erre Noisette</i>	417
Vanguard	301	Archduc d'Ete	381
<i>Van Zanl's Superb</i>	291	<i>Astora Town</i>	417
Veloutee Tardive	289	<i>Auguste de Maroise</i>	359
Vineuse	287	<i>Autumn Bergamot</i>	417
Vineuse de Fromentin	287	<i>Autumn Colmar</i>	417
Violette Hative	293	Auguste Van Krans	349
Violette Hative Grosse	293	Baham's	360
<i>Walberton</i>	304	<i>Bankerline</i>	359
Walberton Admirable	304	Baronne de Mello	357
<i>Walter's Early</i>	291	<i>Barry</i>	359
Ward's Free	291	<i>Barflett</i>	324
<i>Ward's Freestone</i>	291	<i>Beadwell</i>	367
Ward's Late Free	291	Beadwell's Seedling	367
<i>Washington</i>	291	Bauchamp's	366
<i>Washington Clingstone</i>	304	Beau Present	393
Washington Rareripe	291	<i>Beau Present d'Artois</i>	365
Washington Red Freestone	291	Begy de Vetrans	405
Waxen Rareripe	291	B-in Armudi	367
<i>Weeping</i>	303	Belle Angevine	346
<i>Weld's Freestone</i>	241	Belle Apres Noel	359
White Avant	303	Belle d'Aout	418
<i>White Blossom</i>	303	<i>Belle de Bruxelles</i>	418
White Blossomed Incomparable	303	Belle of Brussels	418
<i>White Clingstone</i>	292	<i>Belle et Bonne</i>	417
White Heath	287	<i>Belle Crainese</i>	359
<i>White Imperial</i>	241	<i>Belle Epine Dumas</i>	380
White Malacaton	288	<i>Belle Excellent</i>	359
<i>White Nutmeg</i>	308	Belle de Flanders	337
White Rareripe	283, 289	<i>Belle Fondante</i>	368
Williamson's New York	292	Belle Gabriel	417
Willow Peach	308	Belle de Jersey	346
<i>Yate's Early</i>	308	<i>Belle Julie</i>	360
<i>Yellow Admirable</i>	308	<i>Belle de Noel</i>	359
Yellow Alberge	285	<i>Belle de Thourcs</i>	359
Yellow Barnard	293	<i>Belle Lurative</i>	325
Yellow Malagatane	290	Belle Vergo	393
Yellow Melocoton	230	Bellissime d'Ete	421
Yellow Pine Apple	288	Bellissime Jargonelle	421
Yellow Rareripe	285	Bellissime Supreme	421
<i>Yellow Rareripe</i>	285	<i>Belmont</i>	417
Yellow Red Rareripe	292	Benoits	360
<i>Zoar Beauty</i>	308	<i>Benoist Nouveau</i>	367

	PAGE		PAGE
Bergaloo	336	Beurre Capiaumont	369
Bergamot d'Angleterre	422	Beurre Chaptal	371
Bergamot d'Alencon	417	Beurre de Chameau	379
<i>Bergamot Bousiere</i>	418	<i>Beurre Charron</i>	360
Bergamot de Bugi	417	<i>Beurre Clairgeau</i>	366
Bergamot Crasanne	420	<i>Beurre Coit</i>	332
Bergamot d'Été	422	<i>Beurre Colmar</i>	418
Bergamot d'Hiver	417	Beurre Colmar d'Automne	418
<i>Bergamot d'Holland</i>	417	Beurre Colmar Gris dit Preccel	403
Bergamot de Paques	417	<i>Beurre Conice de Toulon</i>	364
<i>Bergamot Parthenay</i>	417	<i>Beurre Crapaud</i>	360
<i>Bergamot Easter</i>	417	Beurre Curte	373
Bergamot Suisse	424	Beurre Curtet	376
Bergamot Sylvange	425	<i>Beurre Delphos</i>	365
<i>Bergamot de Toulouse</i> —synonym	417	<i>Beurre Diel</i>	327
Bergamotte	403	Beurre Doree	560
Bergamotte Buffo	366	<i>Beurre Dukaurne</i>	362
<i>Bergamotte Cadette</i>	366	<i>Beurre Duhaume</i>	365
Bergamotte Crapaud	366	<i>Beurre Duval</i>	418
<i>Bergamotte d'Esperin</i>	366	<i>Beurre Easter</i>	331
Bergamotte de Fougere	417	<i>Beurre d'Elberg</i>	362
<i>Bergamotte Gaudry</i>	366	Beurre Epine	361
<i>Bergamotte de Hambourg</i>	360	<i>Beurre Esperin</i>	368
<i>Bergamotte Heimbürg</i>	368	Beurre de Flanders	361
<i>Bergamotte Lesclé</i>	368	Beurre Defais	378
<i>Bergamotte de Millepieds</i>	368	Beurre Fortunce	421
Bergamotte de la Pentecote	331	<i>Beurre Fougere</i> de la Pentecote	361
Bergamotte Sieulle	378	<i>Beurre Gens</i>	362
<i>Bergen Pear</i>	368	Beurre Gifford	325
Beri Vaet	361	<i>Beurre Gifford</i>	325
Beurre	360	Beurre Gris d'Hiver	364
Beurre A'am	418	Beurre Gris	360
Beurre Ananas	390	<i>Beurre Gris d'Hiver Nouveau</i>	364
<i>Beurre d'Albert</i>	363	Beurre Gris Supérieure	364
Beurre d'Alencon	417	Beurre Haggenton	396
Beurre Aurore	369	<i>Beurre Hamecher</i>	362
Beurre d'Amanlis	362	Beurre d'Hardenpont	339
<i>Beurre d'Amalis</i>	362	Beurre Hardy	366
Beurre d'Ambleuse	360	Beurre d'Hiver	372
Beurre d'Ambois	360	Beurre d'Hiver de Bruxelles	331
Beurre d'Angleterre	417	Beurre d'Hiver Nouvelle	339
<i>Beurre d'Anjou</i>	330	Beurre Incomparable	327
<i>Beurre d'Aremberg</i>	326	<i>Beurre Jules</i>	364
Beurre d'Aremberg	339	<i>Beurre Kenrick</i>	418
Beurre Andusson	407	Beurre de Konig of Downing	364
Beurre d'Argenson	403	<i>Beurre Knox</i>	418
Beurre Auguste Benoits	364	<i>Beurre de Konink</i>	364
<i>Beurre Audosson</i>	366	<i>Beurre Kennes</i>	365
Beurre Auguste Benoit	260	<i>Beurre Kossuth</i>	361
Beurre d'Austrasie	392	Beurre de Lucon	364
<i>Beurre Bachelier</i>	363	<i>Beurre Leon le Clerc</i>	365
<i>Beurre Berckmans</i>	365	<i>Beurre Leon le Clerc</i>	361
Beurre Beauchamps	366	<i>Beurre Langelier</i>	332
<i>Beurre Beaulieu</i>	360	Beurre Magnifique	327
<i>Beurre de Beaumont</i>	361	<i>Beurre de Montgeron</i>	364
Beurre Blanc	336	Beurre de Malines	355
<i>Beurre Blanc de Jersey</i>	367	Beurre de Mesode	334
<i>Beurre Benest</i>	362	<i>Beurre Millet</i>	363
<i>Beurre de Beuiller</i>	418	<i>Beurre Millet of Angers</i>	362
Beurre de Brignais	376	Beurre Moire	323
Beurre, or Bonne Louise d'Araudore	345	<i>Beurre Moire</i>	328
<i>Beurre Benoits</i>	364	<i>Beurre Mollet's Guernsey</i>	361
<i>Beurre Benoit</i>	360	Beurre de Montigeron	364
<i>Beurre Bose</i>	329	<i>Beurre Nantais</i>	362
Beurre Boucquia	419	Beurre de Nantes	363
Beurre Bretonneau	363	Beurre Neille	330
<i>Beurre Bretonneau</i>	363	Beurre Noirchain	361
<i>Beurre Brown</i>	360	<i>Beurre Naver</i>	365
<i>Beurre Bronze</i>	418	Beurre d'Or	360
<i>Beurre Bymont</i>	363	Beurre Oudinot	400
Beurre Cadet	360	Beurre des Orphelins	326
<i>Beurre Caloma</i>	369	<i>Beurre de Paques</i>	331

	PAGE		PAGE
Beurre de la Pentacote	331	Boston	404
<i>Beurre Philippe del Fosse</i>	364	Boston Epargne	389
Beurre Piquery	352	<i>Bouquia</i>	419
Beurre Plat	420	Boutelle	363
<i>Beurre Preble</i>	361	<i>Bouvier Bourgermestre</i>	369
Beurre Rance	361	Braddick's Field Marshal	398
<i>Beurre de Ranz</i>	361	<i>Brande's St. Germain</i>	369
Beurre de Rhine	349	<i>Brandywine</i>	328
<i>Beurre de Rhine</i>	361	Bretagne Cour	346
Beurre du Roi	360	<i>Brielmont</i>	369
<i>Beurre Richelieu</i>	365	<i>Bringewood</i>	369
Beurre Romain	366	Broca's Bergamot	384
<i>Beurre Romain</i>	418	<i>Broom Park</i>	419
Beurre Robin	378	<i>Brougham</i>	419
Beurre Rouge	360	Brown St. Germain	348
Beurre Roupe	331	<i>Buffum</i>	333
Beurre Royal	327	Bujaleuf	425
<i>Beurre Scutin</i>	418	Burgermeister	418
<i>Beurre Sic</i>	365	<i>Burgomaster</i>	418
Beurre Siculle	378	Burlingame	419
<i>Beurre Soulange</i>	365	<i>Burlinghame</i>	419
Beurre Spence	327	<i>Burnett</i>	419
<i>Beurre Spence</i>	365	Butter Pear	336, 391
<i>Beurre Steikman</i>	366	Bymont	363
<i>Beurre St. Nicolas</i>	331	<i>Cabot</i>	419
<i>Beurre Suisse</i>	361	Cadillac	419
<i>Beurre Superfine</i>	363	<i>Cuen du France</i>	369
<i>Beurre Van Marum</i>	363	Caillot Rosat	424
Beurre Van Mons	352	Caillot Rosat d'Ete	424
Beurre Vert	360	Calabasse Bosc	329, 345
<i>Beurre de Wetteren</i>	364	<i>Calabasse</i>	419
Beurre de Waterloo	379	<i>Calabasse Delringe</i>	419
<i>Beurre Winter</i>	362	Calabasse Double Extra	419
<i>Bezi Blanc</i>	418	<i>Calabasse d'Ete</i>	370
Bezi Chaumontelle tres gros	331	<i>Calabasse Grosse</i>	419
Bezi de Chaumontelle	372	Calabasse d'Holland	419
Bezi de Chausserie	381	<i>Calhoun</i>	369
Bezi d'Eclassey	381	Cambridge Sugar Pear	389
Bezi d'Esperin	136	<i>Camerling</i>	371
<i>Bezi Heri</i>	418	<i>Camerlyn</i>	370
<i>Bezi de Montigny</i>	366	<i>Canandaigua</i>	370
<i>Bezi de la Motte</i>	367	Canning	331
<i>Bezi de Naples</i>	367	<i>Capitawmont</i>	369
B zi Royal	418	<i>Capshaf</i>	370
<i>Bezi Sanspareil</i>	367	Captif de St. Helena	379
Bezi de Spoelberch	412	<i>Capucin</i>	419
<i>Bezy d'Esperin</i>	367	<i>Cassante de Mars</i>	370
<i>Bezy Garnier</i>	367	Catherine	370
<i>Bezy Quessoy d'Ete</i>	367	<i>Catherine Gardette</i>	370
<i>Bishop's Thumb</i>	418	<i>Catillac</i>	419
Black Pear of Worcester	323	<i>Catinka</i>	370
<i>Black Worcester</i>	323	Celestin	413
<i>Blocker's Meadow</i>	368	Cellite	403
<i>Bloodgood</i>	333	Chambers' Large	346
Bon Chretien d'Espagne	418	Chambrette	425
Bon Chretien Tarc	418	<i>Chancellor</i>	371
Bon Chretien d'Ete	424	Chapin	378
<i>Bon Chretien Flemish</i>	418	<i>Chapman</i>	419
<i>Bon Chretien Fondante</i>	333	Chapman's	403
<i>Bon Chretien Spanish</i>	418	<i>Chaptal</i>	371
<i>Bon Gustave</i>	369	<i>Charlotte de Brover</i>	372
Bon d'Ezee	368	<i>Charles of Austria</i>	419
<i>Bonne d'Ezee</i>	368	Charles d'Autriche	419
Bonne des Haies	368	<i>Charles Van Hoogten</i>	371
<i>Bonne Charlotte</i>	369	<i>Charles Van Mons</i>	371
Bonne de Malines	355	<i>Chaumontel</i>	372
Bonne Rouge	384	Chaumontel d'Ete	421
Bordenave	343	Chaumontel tres gros	331
Bosc Sire	327	<i>Chelmsford</i>	420
Bosc's Flaschenbirne	329	<i>Choice d'un Amateur</i>	371
Bosch	337	<i>Christmas</i>	371
<i>Bosche Nouvelle</i>	337	<i>Church</i>	372

	PAGE		PAGE
<i>Citron</i>	372	<i>Dearborn's Seedling</i>	336
<i>Citron of Bohemia</i>	419	<i>De Baway</i>	376
<i>Citron des Carmes</i>	343	<i>De Deux foix Lane</i>	420
<i>Clara</i>	419	<i>De Kcingheim</i>	425
<i>Claire</i>	419	<i>Delavoult de Clement</i>	324
<i>Clinton</i>	419	<i>Delice d'Hardimpont of Angers</i>	334
<i>Clion</i>	354	<i>Delices d'Ardenpont</i>	334
<i>Cluster Pear</i>	387	<i>Delices de Charles</i>	376
<i>Coffin's Virgalieu</i>	420	<i>Delices Charles Van Mons</i>	376
<i>Collins</i>	372	<i>Delices d'Hardenpont</i>	334
<i>Colmar</i>	420	<i>Delices d'Hardenpont du Nord and Bel-</i>	
<i>Colmar d'Alost</i>	372	<i>gum</i>	376
<i>Colmar d'Arenberg</i>	420	<i>Delies d'Alost</i>	372
<i>Colmar des Champs</i>	326	<i>Delices d'Alost</i>	379
<i>Colmar Charnay</i>	417	<i>Delices de Mons</i>	376
<i>Colmar Dore</i>	403, 420	<i>De Louvain</i>	375
<i>Colmar Epine</i>	372	<i>De Maune</i>	420
<i>Colmar Gris</i>	403	<i>De Melon</i>	327
<i>Colmar Hardenpoint</i>	403	<i>De Mott</i>	410
<i>Colmar d'Hiyer</i>	339, 403	<i>De Sorlus</i>	376
<i>Colmar Jaminette</i>	392	<i>De Vallee</i>	425
<i>Colmar de Meester</i>	420	<i>De Vigne Pelone</i>	382
<i>Colmar Neill</i>	373	<i>Deschamps</i>	325
<i>Colmar Preule</i>	403	<i>Despoelberg</i>	412
<i>Colmar de Sille</i>	403	<i>Desiree Van Mons</i>	379
<i>Colmar Souveraine</i>	403	<i>Des Nonnes</i>	376
<i>Colmar Van Mons</i>	352, 403	<i>Des Nonnes</i>	376
<i>Colniac Bose</i>	330	<i>Des Trois Tours</i>	327
<i>Columbia</i>	373	<i>Desiree Cornelis</i>	375
<i>Columbian Virgalieu</i>	373	<i>Deux Sœurs</i>	376
<i>Columbian Virgalouse</i>	373	<i>Diamant</i>	384
<i>Commodore</i>	420	<i>Dickerman</i>	376
<i>Comprette</i>	420	<i>Diel</i>	327
<i>Compte de Flandre</i>	374	<i>Diel's Butterbirne</i>	327
<i>Compte de Lamy</i>	373	<i>Dikeman</i>	376
<i>Compte de Michaux</i>	423	<i>Dillen</i>	377
<i>Comte Lelieur</i>	373	<i>Diller</i>	377
<i>Comtesse d'Alost</i>	372, 379	<i>Dillon</i>	377
<i>Comtesse de Lunay</i>	374	<i>Dingler</i>	373
<i>Comtesse de Frenol</i>	382	<i>Dir</i>	334
<i>Comstock</i>	420	<i>Docteur Trouseau</i>	377
<i>Comstock Wibling</i>	420	<i>Docteur Bourrier</i>	377
<i>Conseilleur Ranwez</i>	374	<i>Docteur Capron</i>	377
<i>Conseilleur Ramuez</i>	374	<i>Docteur Letiern</i>	377
<i>Conseiller de la Cour</i>	400	<i>Done's</i>	336
<i>Cooke</i>	372	<i>Dorathy Royal</i>	327
<i>Copea</i>	420	<i>Dorr</i>	421
<i>Cornelis</i>	375	<i>Double Phillippe</i>	334
<i>Coter</i>	375	<i>Dow</i>	377
<i>Countess of Lunay</i>	374	<i>Dowlin</i>	412
<i>Crasanne</i>	420	<i>Downham Seedling</i>	386
<i>Crauford</i>	420	<i>Downton</i>	420
<i>Cresane</i>	420	<i>Doyenne</i>	326
<i>Craft Castle</i>	420	<i>Doyenne D'Alfay</i>	378
<i>Cross</i>	375	<i>Doyenne d'Alencon</i>	335
<i>Cumberland</i>	420	<i>Doyenne d'Automne</i>	335
<i>Cushing</i>	375	<i>Doyenne Blanc</i>	336
<i>Cuvelier</i>	420	<i>Doyenne Boussouck</i>	334
<i>Cyprus Pear</i>	421	<i>Doyenne Boussouck Nouvelle</i>	334
<i>Dallas</i>	375	<i>Doyenne du Comice</i>	378
<i>D'Abondance</i>	405	<i>Doyenne du Comice of Anger</i>	378
<i>D'Ambre</i>	423	<i>Doyenne Dillon</i>	377
<i>Dana's No. 16</i>	375	<i>Doyenne Downing</i>	378
<i>Dana's No. 19</i>	375	<i>Doyenne d'Ete</i>	334
<i>Dana's Seedling No. 1</i>	397	<i>Doyenne de Fuis</i>	378
<i>D'Amour</i>	420	<i>Doyenne Galleux</i>	335
<i>D'Arenberg Parfait</i>	326	<i>Doyenne Gauball</i>	378
<i>D'Auch</i>	420	<i>Doyenne Gray</i>	335
<i>D'Austrasie</i>	392	<i>Doyenne Gris</i>	335
<i>Deau's</i>	336	<i>Doyenne Gris d'Hiver-Nouveau</i>	335
<i>Deacon Dillen</i>	377	<i>Doyenne d'Hiver</i>	331
<i>Dearborn</i>	420	<i>Doyenne d'Hiver D'Alencon</i>	335

	PAGE		PAGE
Doyenne de Juliet	334	<i>Figue</i>	332
Doyenne Musque	366	Figue de Naples	382
Doyenne Marbre	335	<i>Figue of Naples</i>	382
<i>Doyenne d'Hiver</i>	420	Figue Vert	382
Doyenne du Printemps	231	Fig Pear of Naples	382
<i>Doyenne Robin</i>	378	<i>Fig d'Alencon</i>	382
<i>Doyenne Rose</i>	379	<i>Fine Gold of Summer</i>	421
Doyenne Rouge	335	Fingais	422
Doyenne Roux	335	Fin Or d'Ete	421
<i>Doyenne Santellette</i>	378	Fin Or d'Hiver	421
<i>Doyenne Sieulle</i>	378	<i>Flemish Beauty</i>	337
<i>Doyenne White</i>	336	Fleur de Guines	350
Duc d'Aremberg	326	<i>Fleur de Neige</i>	354
Duc de Bordeaux	360	<i>Florimont l'arcut</i>	334
<i>Duc de Brabant</i>	379	Fondante	410
Duc d'Orleans	400	Fondante d'Automne	325
<i>Duchess D'Alot</i>	379	<i>Fondante Agreeable</i>	383
Duchess of Berri	379	Fondante du Bois	350, 337
Duchess de Berri	346	Fondante du Cornice	379
Duchess de Berry d'Ete of Bivort	334	Fondante des Charneuse	379
<i>Duchesse d'Angouleme</i>	379	<i>Fondante de Malines</i>	383
<i>Duchess de Berri d'Ete</i>	379	Fondante de Malines (Esperin)	383
<i>Duchess de Mars</i>	379	Fondante de Mons	403
Duchess d'Alot	372	Fondante Musquee	424
Duchesse of Orleans	331	Fondante de Noel	359
<i>Duc d'Orleans</i>	379	Fondante de Panisee	403
Dumas	360	Fondante Pariselle du Cornice Horticulte	376
<i>D. mortier</i>	421	<i>Fondante Serurier de Midlot</i>	383
Dundas	380	<i>Fondante des Pres</i>	383
Dunmore	380	<i>Fondante Van Mons</i>	383
Du Patre	331	<i>Forelle</i>	383
Dupuy Charles	381	Forellin-birne	383
<i>Duquesne d'Ete</i>	421	<i>Forme de Delices</i>	421
Dusnas	410	Forme de Marie Louise	393
Du Tonneau	346	<i>Fortunee</i>	421
<i>Early Bergamot</i>	421	<i>Foster's St. Michael</i>	421
Early Beurre	417	Franc Real	421
<i>Early Butter of Cin</i>	381	Franc Real d'Ete	410
<i>Early Catherine</i>	421	<i>Franc Real d'Hiver</i>	421
<i>Early Denseloma</i>	421	Frankford	384
Early Queen	423	<i>Franklin</i>	384
Early Roussellet	421	Franklin	393
Early St. Germain	371	Frederic de Wertenburg	383
<i>Early Sugar</i>	381	<i>Frederic of Wertenburg</i>	388
Echasserie	381	<i>Frederika Bremer</i>	384
<i>Echassery</i>	381	<i>French Jargonelle</i>	421
<i>Edward's Elizabeth</i>	381	<i>Fulton</i>	333
Edward's Henrietta	390	Gambier	403
Eliza d'Heyst	359	<i>Gansel's Bergamot</i>	384
Elizabeth Van Mons	342	<i>Gansel's Late Bergamot</i>	385
<i>Elizabeth Mannings</i>	342	<i>Gansel's Seckel</i>	385
Ellanroch	422	Garde d'Ecosse	422
<i>Emerald</i>	421	<i>Genösesheim</i>	421
<i>Emile d'Hejst</i>	382	General Lamoricere	395
<i>Emile Bivort</i>	382	<i>General de Lourmel</i>	385
<i>Enfante Prodige</i>	421	<i>General Taylor</i>	385
English Autumn Bergamot	417	<i>Gerardin</i>	385
English Bergamot	417	Germain Baker	346
English Beurre	417	<i>Gideon Paridante</i>	385
English Red Cheek	421	<i>Gil-o-gil</i>	422
Epargne	393	Gile-o-gile	422
Epine Damas	360	<i>Glory of Combrone</i>	385
Epine d'Ete	424	<i>Glut Morceau</i>	339
Epine d'Ete Couleur Rose	424	Gloux Morceaux	339
Epine Rose	424	Golden Beurre	360
Episcopal	421	<i>Golden Beurre of Bilbao</i>	338
Etouneau	355	Gre's Heathcot	339
<i>Escarol</i>	382	Gold Morceau	339
Eschschina	379	Grainseuse	417
<i>Fumenja</i>	421	<i>Grain</i>	386
Feaster	368	Grand Monarque	419
Ferlinaud de Meester	424	<i>Grand Solal</i>	386

	PAGE		PAGE
<i>Grays</i>	404	<i>Island</i>	392
<i>Gray Beurre</i>	360	<i>Ives' Bergamot</i>	384
<i>Gray Butter Pear</i>	335	<i>Ives' Bergamot</i>	392
<i>Gray Deans</i>	335	<i>Ives' Pear</i>	392
<i>Gray Doyenne</i>	335	<i>Ives' Seedling</i>	392
<i>Great Citron of Bohemia</i>	419	<i>Ives' Virgatiou</i>	392
<i>Green Catherine</i>	421	<i>Jackman's Melting</i>	394
<i>Green Chisel</i>	422	<i>Jackson</i>	392
<i>Green Moutain Boy</i>	386	<i>Jackson Seedling</i>	392
<i>Green Pear of Yair</i>	422	<i>Jaquin</i>	390
<i>Green Sugar</i>	422	<i>Jagdbirae</i>	381
<i>Green Sylvange</i>	425	<i>Jalousie</i>	422
<i>Green Yair</i>	422	<i>Jalousie de Fontenay Vendee</i>	340
<i>Green's Germantown</i>	371	<i>Jaminette</i>	392
<i>Grise Bonke</i>	422	<i>Jargonelle</i>	393
<i>Groom's Princess Royal</i>	386	<i>Jargonelle (of the English)</i>	383
<i>Groom's Princess Royal</i>	406	<i>Jean de Wille</i>	393
<i>Groote Mogul</i>	419	<i>Jergil's</i>	410
<i>Grosse Calebasse of Langlier</i>	393	<i>Jersey Gratioli</i>	393
<i>Grosse Cuisse Madame</i>	393	<i>Jilogil</i>	422
<i>Grosse Dorothee</i>	327	<i>Joanette</i>	331
<i>Grosse Marie</i>	386	<i>John</i>	423
<i>Gros Micet d'Ete</i>	410	<i>Johannot</i>	393
<i>Gros Romain</i>	418	<i>Jones</i>	393
<i>Gros Rousselet</i>	424	<i>Josephine</i>	392
<i>Gros Rousselet d'Aout</i>	386	<i>Josephine de Malines</i>	393
<i>Guernsey</i>	351	<i>Julienne</i>	393
<i>Gurle's Beurre</i>	384	<i>Jules Bivort</i>	393
<i>Hacon's Incomparable</i>	386	<i>July Pear</i>	424
<i>Haddington</i>	387	<i>Kattern</i>	421
<i>Hagerman</i>	386	<i>King Edward's</i>	394
<i>Hampden's Bergamot</i>	422	<i>Kingsessing</i>	394
<i>Hampton</i>	386	<i>Kirtland</i>	341
<i>Hampton</i>	387	<i>Kirtland's Beurre</i>	341
<i>Hampton Virgatieu</i>	388	<i>Kirtland's Seedling</i>	341
<i>Hamus</i>	388	<i>Knevett's New Swan's Egg</i>	423
<i>Hanners</i>	388	<i>Knight's March</i>	394
<i>Hansrer</i>	388	<i>Knight's Seedling</i>	394
<i>Hardenpont d'Hiver</i>	339	<i>Knight's R. I. Seedling</i>	394
<i>Hardenpont du Printemps</i>	361	<i>Keng</i>	425
<i>Harvest</i>	424	<i>La Bonne Malinoise</i>	395
<i>Harvest Pear</i>	381	<i>La Fortunee de Paris</i>	421
<i>Harrison's Fall</i>	422	<i>La Fortunee de Parmentier</i>	421
<i>Harvard</i>	389	<i>Lalvard</i>	395
<i>Hawe's Winter</i>	389	<i>La Juive</i>	395
<i>Hazel</i>	422	<i>Lamorcieres</i>	395
<i>Heathcot</i>	389	<i>Large Rousselet</i>	424
<i>Hebron</i>	404	<i>Large Seckel</i>	363
<i>Heidelberg</i>	363	<i>Lus Canas</i>	395
<i>Henkel</i>	390	<i>Lute Catherine</i>	424
<i>Henrietta</i>	390	<i>Laure de Glymes</i>	395
<i>Henri Quatre</i>	390	<i>Lawrence</i>	340
<i>Henri Bivort</i>	390	<i>Le Care</i>	354
<i>Henry the Fourth</i>	390	<i>Leech's Kingsessing</i>	394
<i>Hericart</i>	390	<i>Lee's Seedling</i>	395
<i>Hericart de Thury</i>	390	<i>Leon le Clerc</i>	422
<i>Hessel</i>	422	<i>Leon le Clerc de Laval</i>	422
<i>Holland Bergamot</i>	417	<i>Leopold I.</i>	395
<i>Honey</i>	391	<i>Lenawee</i>	395
<i>Hooper's Bilboa</i>	388	<i>Lent St. Germain</i>	346
<i>Hosen Schenck</i>	391	<i>Lewis</i>	342
<i>Hovey</i>	391	<i>Liberale</i>	395
<i>Howell</i>	340	<i>Lieutenant Poiterin</i>	396
<i>Huquenot</i>	422	<i>Limou</i>	396
<i>Hull</i>	391	<i>Linden d'Automne</i>	399
<i>Huntington</i>	391	<i>Little Muscat</i>	422
<i>Imperatrice de France</i>	387	<i>Little Musk</i>	422
<i>Incomparable</i>	420	<i>Little Swan's Egg</i>	423
<i>Inconnue Van Mens</i>	391	<i>Locke</i>	396
<i>Iron Pear</i>	323	<i>Locke's New Beurre</i>	396
<i>Isambert</i>	369	<i>Lodje</i>	342
<i>Isambert le Bon</i>	360	<i>Longue de Monkowty</i>	364

	PAGE		PAGE
Longue de Nakourto	364	<i>Muskingum</i>	400
<i>Long Green of Coze</i>	341	Musk Robin	423
Lord Cheeny's	417	Mush Summer Bon Chretien	424
L'Orphelines	326	<i>Napoleon</i>	400
<i>Louis Dupont</i>	396	<i>Naumkeag</i>	423
Louise Bosc	366	Neill	330
<i>Louise Bonne</i>	422	Nellis d'Hiver	355
Louise Bonne d'Avranches	345	Ne Plus Meuris	330
Louise Bonne de Boulogne	413	<i>Ne Plus Meuris</i>	400
<i>Louise Bonne de Jersey</i>	345	New Autumn	341
Louise Bonne Real	422	New Pear	344
Louise of Orleans	352	New St. Germain	348
Louise de Prusse	351	New Swan's Egg	424
<i>Lycurgus</i>	396	New York Red Cheek	347
<i>Madeleine</i>	343	New Frederick of Wurtemberg	364
<i>Madam Ducar</i>	397	Noel	371
<i>Madame Eliza</i>	395	<i>Nonparcil</i>	400
Madam Millet	363	Nouvelle	409
<i>Madotte</i>	423	<i>Nouveau Poceau</i>	344
Magdalen	343	No. 8 of Van Mons	396
<i>Malcoultre d'Haspin</i>	397	No. 1602 of Van Mons	393
<i>Matcomaire</i>	397	No. 1238 of Van Mons	419
Marcellis	422	No. 1482 of Van Mons	393
<i>March Bergamotte</i>	398	No. 1599 of Van Mons	418
<i>Marchal de la Cour</i>	400	No. 1682 of Van Mons	393
Maria	398	<i>Oakley Park</i>	400
Marianne Nouvelle	329	Oakley Park Bergamot	400
<i>Marianne de Nancy</i>	397	Ognonet	366
Marie Chretienne	398	<i>Oliver's Russet</i>	423
<i>Marie Parent</i>	397	<i>Omer Pasha</i>	400
<i>Marie Louise</i>	398	<i>Onondaga</i>	401
Marie Louise Nova	373	Onondaga Seedling	401
<i>Marie Louise Nova</i>	423	<i>Ontario</i>	402
Marie Louise the Second	373	<i>Orange Bergamot</i>	402
<i>Martha Ann</i>	397	Orange d'Hiver	425
<i>Martin Sec</i>	398	Orange Pear	402
Marotte Sucre Jaune	403	Orpheline d'Enghein	326
<i>Marulis</i>	422	<i>Orpheline Colmar</i>	402
<i>Mather</i>	398	Osband's Favorite	402
<i>Maynard</i>	398	<i>Osband's Summer</i>	402
<i>McLaughlin</i>	397	<i>Osborn</i>	402
Medaille	400	<i>Oswego</i>	402
Melon de Kops	327	Oswego Beurre	402
Merriwether	411	<i>Oil</i>	346
<i>Merriam</i>	398	<i>Oudinot</i>	402
<i>Messire Jean</i>	423	<i>Owen</i>	423
Messire Jean Blanc	423	Oxford Chaumontel	372
Messire Jean Doree	423	<i>Paddock</i>	403
Messire Jean Gris	423	Paddington	417
Miel de Waterloo	379	<i>Pailleau</i>	423
<i>Mignonne d'Hiver</i>	398	Paquency	347
<i>Michaux</i>	423	<i>Parsonage</i>	403
Milanaise Cuyelier	355	Pardus, No. 2	376
Miller's Early	403	<i>Paradise d'Autumne</i>	345
<i>Millot de Nancy</i>	398, 399	Parkinson's Warden	333
<i>Mitchell's Russet</i>	399	Parmentier	380
<i>Moccas</i>	399	<i>Passans du Portugal</i>	403
Mollett's Guernsey Chaumontelle	361	<i>Passe Colmar</i>	403
Mon Dieu	420	Passe Colmar Epineaux	403
Monsieur Jean	423	Passe Colmar Gris	403
Monsieur le Cure	354	Pater Noster	331
<i>Monsieur Affre</i>	399	<i>Pater Noster</i>	403
Monstrous Calabash	419	<i>Paul Thiden</i>	493
<i>Moore-Fowl Egg</i>	423	<i>Payency</i>	347
Mouth Water	341	Payenchi de Perigord	347
<i>Moyamensing</i>	399	Payenchi	347
Mnoille Bouche	311, 410	<i>Pendleton</i>	403
Mr. John	423	<i>Peach Pear</i>	403
Muscot Fleure	341	Pendleton's Early York Pear	403
<i>Muscot Robert</i>	423	Penfield	347
Muscot Petit	422	<i>Pengethley</i>	403
<i>Muscadine</i>	399	<i>Pennsylvania</i>	404

	PAGE		PAGE
Perdrue	421	<i>Prince's St. Germain</i>	348
Petit Muscat	422	Prince's Green Sugar	422
Petit Rousselet	424	Prince's Sugar Top	424
<i>Petre</i>	404	Providence	334
<i>Philadelphia Latch</i>	404	<i>Pulsiper</i>	406
Phillippe de Paques	331	<i>Queen Caroline</i>	423
<i>Phillippe Goes</i>	404	<i>Queen of the Low Countries</i>	406
Pickering Pear	346	<i>Queen of Pears</i>	423
Pine Pear	336	Queen's Pear	423
<i>Pinneo</i>	404	<i>Quitlletle</i>	423
Piper	346	<i>Ralley</i>	406
Pitt's Marie Louise	423	<i>Rapalje</i>	406
<i>Pitt's Prolific</i>	423	Rapalje Seedling	406
Pitt's Surpasse Mario	423	<i>Ravenswood</i>	406
<i>Pius LX</i>	404	<i>Raymond</i>	424
<i>Platt's Seedling</i>	404	<i>Reading</i>	407
Plombgastel	410	Real Jargonelle	393
Plougastel	410	Red Cheek	421
Plumbgartel	410	Red Cheeked Seckel	347
Plymouth	334	Red Doyenne	335
<i>Pocahontas</i>	405	Red Muscadel	421
<i>Poire d'Abondance</i>	405	Reed's Seedling	402
Poire d'Albert	363	Regintin	403
<i>Poire d'Albert</i>	405	Regnier	336
Poire d'Ambois	360	Reigner	336
<i>Poire d'Avrille</i>	405	Reine Caroline	423
Poire Ananas	323, 390	Reine des Pays Bas	406
Poire de Bavay	376	Reine des Poires	423
Poire de Boulogne	413	<i>Rebour de Rome</i>	407
Poire de Cadet	366	<i>Richards</i>	407
Poire Chenielle	403	Richard's Beurree	424
Poire de Chypre	421	Ridal	421
Poire Davy	337	<i>Riddle's</i>	407
Poire Glace	425	Robertson	256
Poire Ritelle	407	Robert's Keeping	417
Poire Gillaume	324	Roi de Rome	400
Poire His	357	Roi de Wurtemberg	339
Poire de Louvain	375	<i>Rondolet</i>	407
Poire des Nonnes	376	<i>Ropes</i>	407
Poire Neill	330	<i>Rosabirne</i>	408
Poire Prince Albert	363	<i>Ross</i>	408
Poire de Payency	347	<i>Rose Bergamotte</i>	407
Poire Prevost	405	<i>Rostiezer</i>	346
Poire de Perigorel	347	Round Top	412
<i>Poire Rameau</i>	405	<i>Rousselet</i>	424
Poire a la Reine	423	Rousselet	424
<i>Poire des Deux Soeurs</i>	405	Roussellet Hatif	421
Poire de Roso	424	<i>Rousselet d'Esperin</i>	408
<i>Poire de Tongres</i>	405	<i>Rousselet de Meester</i>	424
Poire Sans Peau	350	<i>Rousselet de Rheims</i>	424
Poire de Printemps	409	<i>Rousselet Vanderwocken</i>	408
Poire St. Andre	350	Rousselet d'Hiver	398
Poire St. Menin	410	Royale	409
Poire de Tables des Prit ces	393	Royal Tairling	417
Poire des Princes	421	Rushmore Bon Chretien	422
Poire Truite	383	Sabine	392
Poire a Gobert	422	Sabine d'Ete	421
<i>Pope's Quaker</i>	423	Sagaret	409
<i>Pope's Scarlet Major</i>	423	<i>Salisbury Seedling</i>	408
<i>Pound</i>	346	Sanspeau	350
<i>Pratt</i>	405	Satin Vest	424
Preceel	403	Schenck's August Watermelon	391
<i>Prevost</i>	405	Schenck's Pear	391
Present de Malines	403	<i>Seckel</i>	347
Primitive	422	Seckel	347
Princesse Coquette	423	Seedling Seckel	341
Princesse d'Orange	423	Seigneur d'Esperin	325
Princesse de Parme	398	Seigneur d'Hiver	331
<i>Princess of Orange</i>	423	<i>Selleck</i>	408
Prindle	411	Scintilet	378
<i>Prince Albert</i>	406	Serrurier d'Automne	382
<i>Princess Royal</i>	406	<i>Sheppard</i>	408

	AGE		PAGE
<i>Sheldon</i>	347	<i>Surpasse Virgalieu</i>	352
<i>Short's St. Germain</i>	424	<i>Surpasse Vigilouse</i>	352
<i>Shurtleff</i>	408	<i>Suzette de Bevay</i>	411
<i>Shurtleff's Seedling</i>	408	<i>Suzette de Bevay Esperin</i>	411
<i>Sickle</i>	347	<i>Swan's Egg</i>	424
<i>Sioule</i>	378	<i>Swan's Orange</i>	401
<i>Sigaret</i>	409	<i>Sweet Summer</i>	393
<i>Skinless</i>	350	<i>Swiss Bergamot</i>	424
<i>Smith's Bordenave</i>	343	<i>Sycle</i>	347
<i>Smith's Haddington</i>	387	<i>Sylvange</i>	425
<i>Smith's Moyamensing</i>	399	<i>Tarquin</i>	425
<i>Smokehouse</i>	391	<i>Taylor Pear</i>	411
<i>Snow Flower</i>	384	<i>Tea</i>	411
<i>Snow Pear</i>	336	<i>Terling</i>	417
<i>Soldat Labourer of some</i>	326	<i>Theodore Van Mons</i>	411
<i>Soldat Labourer d'Esperin</i>	349	<i>Thompson's</i>	353
<i>Souveraine d'Ete</i>	379	<i>Thorny Rose</i>	424
<i>Souveraine</i>	403	<i>Thorp</i>	411
<i>Souveraine de Printemps</i>	409	<i>Thverlinck</i>	411
<i>Spice Butter</i>	368	<i>Tilton</i>	417
<i>Spice or Musk Pear</i>	424	<i>Totten's Seedling</i>	411
<i>Spina</i>	418	<i>Triumph de Nord</i>	363
<i>St. Andre</i>	350	<i>Triumph de Hasselt</i>	363
<i>St. Dorckhee</i>	409	<i>Triomphe de Jodoigne</i>	412
<i>St. Galen</i>	409	<i>Trompe Valet</i>	417
<i>St. Herlloin d'Hiver</i>	410	<i>Trout Pear</i>	383
<i>St. Germain de Martin</i>	424	<i>Trouve de Montigny</i>	366
<i>St. Germain Blanc</i>	422	<i>Tyler</i>	412
<i>St. Germain d'Ete</i>	424	<i>Tyson</i>	351
<i>St. Ghislain</i>	409	<i>Union</i>	346
<i>St. Vincent de Paul</i>	419	<i>Upper Crust</i>	412
<i>St. Jean</i>	381	<i>Ulaniste</i>	352
<i>St. Jean Baptiste</i>	410	<i>Uvedale's St. Germain</i>	346
<i>St. Jean Musquee Gros</i>	423	<i>Uvedale's Warden</i>	346
<i>St. John's Pear</i>	381	<i>Uwchlan</i>	412
<i>St. Lambert</i>	393	<i>Vallee Franche</i>	425
<i>St. Marc</i>	352	<i>Vanasse</i>	353
<i>St. Menin</i>	410	<i>Van Asshe</i>	353
<i>St. Mesmin</i>	410	<i>Van Assche</i>	353
<i>St. Michael</i>	336	<i>Van Assenz</i>	353
<i>St. Michael d'Hiver</i>	335, 364	<i>Van Duren</i>	425
<i>St. Michael Archange</i>	410	<i>Van Mons Leon le Clerc</i>	413
<i>St. Michael Dore</i>	335	<i>Van Mons, No. 154</i>	342
<i>St. Nicolas</i>	331	<i>Van Mons, No. 1,218</i>	420
<i>St. Sampson</i>	293	<i>Vermilion d'Ete</i>	421
<i>Staunton</i>	384	<i>Verte Longui</i>	341
<i>Stephen's Genessee</i>	351	<i>Verte Longui de la Mayenne</i>	341, 382
<i>Stevens's Genessee</i>	351	<i>Vezeuziere</i>	412
<i>Sterling</i>	410	<i>Vicar of Wakefield</i>	354
<i>Stone</i>	420	<i>Vicar of Winkfield</i>	354
<i>Styre</i>	410	<i>Vicomte de Spoelberch</i>	412
<i>Styrion</i>	424	<i>Vicomte de Spoelberg</i>	412
<i>Sucre de Hoyerswerda</i>	424	<i>Virgalieu</i>	336, 384
<i>Sugar</i>	422	<i>Virgaloo</i>	336
<i>Sugar of Hoyerswerda</i>	424	<i>Virgouleuse</i>	425
<i>Sugar Pear</i>	381	<i>Walker</i>	412
<i>Sugar Top</i>	424	<i>Warwick Bergamot</i>	336
<i>Sullivan</i>	424	<i>Washington</i>	356
<i>Summer Beauty</i>	421	<i>Watertown</i>	372
<i>Summer Belle</i>	425	<i>Wayne</i>	347
<i>Summer Bergamot</i>	422	<i>Wendell</i>	414
<i>Summer Bon Chretien</i>	424	<i>Westcott</i>	415
<i>Summer Calabasse</i>	370	<i>Whelan's Early</i>	414
<i>Summer Boyenne</i>	334	<i>Wheeler's New St. Michael</i>	336
<i>Summer Franc Real</i>	410	<i>White Autumn Bourne</i>	336
<i>Summer Good Christian</i>	424	<i>White Bourne</i>	336
<i>Summer Rose</i>	424	<i>White Pear</i>	336
<i>Summer St. Germain</i>	424	<i>Whitfield</i>	425
<i>Summer Thorn</i>	424	<i>Wiedow</i>	415
<i>Summer Virgalieu</i>	334, 402, 404	<i>Wilbur</i>	415
<i>Supreme</i>	421	<i>Wilhelmine</i>	392
<i>Supreme de Quimper</i>	411	<i>Wilkinson</i>	415

	PAGE		PAGE
<i>Willermoz</i>	415	Brevoort's Purple Bolmar	453
<i>William</i> (Edward's)	425	Brevoort's Purple Washington	453
<i>William's</i>	324	<i>Bradshaw</i>	424
<i>William's Bon Chretien</i>	324	<i>Bricetta</i>	440
<i>William's Early</i>	415	<i>Brignole</i>	456
<i>Williamson</i>	415	<i>Brignole Violette</i>	453
<i>William the Fourth</i>	345	<i>Brunnon's Gage</i>	425
<i>Wilmington</i>	416	<i>Brynn Gage</i>	425
<i>Windsor</i>	425	<i>Buel's Favorite</i>	440
<i>Winship</i>	416	<i>Burgundy Prune</i>	430
<i>Winship's Seedling</i>	416	<i>Bury Seedling</i>	424
<i>Winter Bell</i>	346	<i>Burrette's</i>	440
<i>Winter Bergamot</i>	417	<i>Byfield</i>	453
<i>Winter Beurree</i>	372	<i>Catalonian</i>	446
<i>Winter Cross</i>	375	<i>Caledonian</i>	454
<i>Winter Nelis</i>	355	<i>Chapin's Early</i>	440
<i>Winter Orange</i>	425	<i>Chapman's Prince of Wales</i>	449
<i>Winter Seckel</i>	416	<i>Cherry</i>	440
<i>Woodstock</i>	416	<i>Cheston</i>	453
<i>Wredow</i>	415	<i>Cheston Matchless</i>	453
<i>Wurzur</i>	425	<i>Cloth of Gold d'Esperin</i>	442
<i>Wurzur d'Autonne</i>	425	<i>Coe's Fine Late Red</i>	459
<i>Yal</i>	425	<i>Coe's Late Red</i>	450
<i>Yellow Butter</i>	326	<i>Coe's Golden Drop</i>	434
<i>York Bergamot</i>	417	<i>Coe's Imperial</i>	434
<i>Yutte</i>	425	<i>Columbia</i>	441
<i>Zepherine Gregoire</i>	416	<i>Columbian Gage</i>	441
<i>Zepherine Louis Gregoire</i>	416	<i>Col. Young's Seedling</i>	452
<i>Zoar Beauty</i>	356	<i>Common Damson</i>	453
<i>Zoar Flat</i>	425	<i>Common Quetsche</i>	443
<i>Zoar Seedling</i>	356	<i>Cooper's</i>	441
		<i>Cooper's Large American</i>	441
		<i>Cooper's Large Red</i>	441
		<i>Cooper's Red</i>	441
		<i>Copper</i>	453
		<i>Corse's Admiral</i>	453
		<i>Corse's Field Marshal</i>	454
		<i>Corse's Nota Bene</i>	447
		<i>Craft's Early</i>	453
		<i>Cruger's</i>	441
		<i>Cruger's Scarlet</i>	441
		<i>Cruger's Scarlet Gage</i>	441
		<i>Cruger's Seedling</i>	441
		<i>D'Agen</i>	449
		<i>D'Amerique Rouge</i>	440
		<i>D'Avoine</i>	446
		<i>Damask</i>	443
		<i>Damas d'Italie</i>	445
		<i>Damas Violet</i>	455
		<i>Dame Aubert</i>	452
		<i>Dame Ambert Blanche</i>	452
		<i>Dame Ambert Jaune</i>	452
		<i>Damson</i>	453
		<i>Dana's Yellow Gage</i>	441
		<i>De Delice</i>	441
		<i>De Monfort</i>	441
		<i>Denniston's Albany Beauty</i>	449
		<i>Denniston Red</i>	441
		<i>Denniston's Superb</i>	434
		<i>Deuyer's Victoria</i>	452
		<i>Der Virginia</i>	440
		<i>Diamond</i>	454
		<i>Diapree Rouge</i>	459
		<i>Dictator</i>	447
		<i>Dictator</i>	454
		<i>Die Violette Koning Claudie</i>	437
		<i>Domine Dull</i>	452
		<i>Downing's Early</i>	452
		<i>Downton Imperatrice</i>	442
		<i>Drap d'Or</i>	434
		<i>Drap d'Or d'Esperin</i>	442
		<i>Duane's Purple</i>	454
PLUMS.			
<i>Abricotee</i>	453		
<i>Abricotee de Tours</i>	453		
<i>Abricotee Sageret</i>	439		
<i>Admiral</i>	453		
<i>Agen Batte</i>	449		
<i>Albany Beauty</i>	439		
<i>Amber Primordian</i>	446		
<i>American Wheat</i>	453		
<i>American Yellow Gage</i>	437		
<i>Angelina Burdette</i>	439		
<i>Apricot</i>	453		
<i>Apricot Plum of Tours</i>	453		
<i>Apple Plum</i>	439		
<i>Askew's Golden Egg</i>	452		
<i>Askew's Purple Egg</i>	450		
<i>Autumn Compote</i>	439		
<i>Autumn Gage</i>	433		
<i>Azure Native</i>	453		
<i>Battle Monument</i>	453		
<i>Beach Plum</i>	453		
<i>Beckman's Scarlet</i>	433		
<i>Belgian Purple</i>	439		
<i>Belle de Septembre</i>	440		
<i>Bingham</i>	440		
<i>Black Damas</i>	437		
<i>Black Morocco</i>	437		
<i>Black Perdrigon</i>	453		
<i>Bleeker's Gage</i>	433		
<i>Bleeker's Scarlet</i>	436		
<i>Blue Gage</i>	453		
<i>Blue Holland</i>	454		
<i>Blue Imperatrice</i>	431		
<i>Blue Perdrigon</i>	453		
<i>Blue Plum</i>	440		
<i>Bolmar</i>	433		
<i>Bolmar's Washington</i>	433		
<i>Bradford Gage</i>	455		
<i>Brevoort's Purple</i>	453		

	PAGE		PAGE
Duane's Purple French	434	Ida Green Gage	435
<i>Dunmore</i>	442	Imperatrice	434
Dutch Quetzen	442	Imperatrice Blanche	456
Dutch Prune	442	Imperatrice Violette	434
Early Black Morocco	437	Imperial Diadem	450
<i>Early Cross</i>	442	<i>Imperial Gage</i>	435
Early Damask	437	Imperial de Milan	445
Early Damson	453	<i>Imperial of Milan</i>	445
Early Forcing	455	<i>Imperial Ottoman</i>	435
Early Morocco	437	Imperial Rouge	455
<i>Early Orleans</i>	435	Irving's Bolmar	438
<i>Early Purple</i>	442	<i>Isabella</i>	445
<i>Early Royal of Niketa</i>	442	Isleworth Green Gage	435
Early Scarlet	440	Italian Damask	448
<i>Early Yellow Prune</i>	442	<i>Italian Damask</i>	445
Egg Plum	452	Italian Prune	435
<i>Elfrey</i>	443	Ives' Seedling	445
Elfrey's Prune	443	<i>Ives' Washington</i>	445
<i>Emerald Drop</i>	443	Jaune de Catalogne	446
<i>English Wheat</i>	443	<i>Jaune Hatice</i>	446
English Pond's Seedling	434	<i>Jefferson</i>	436
Fair's Golden Drop	434	Jenkinson Imperial	435
<i>Fellenberg</i>	435	<i>Judson</i>	454
<i>Field Marshal</i>	454	King of Plums	435
Florence	450	<i>Kirke's</i>	446
Flushing Gage	435	Knight's Large Green Drying	454
<i>Fotheringham</i>	454	Knight's No. 6	445
Franklin	438	<i>Lady Plum</i>	446
French Copper	453	La Delicieuse	438
<i>Frost Gage</i>	443	La Royale	451
<i>Fulton</i>	443	<i>Langdon's Seedling</i>	446
<i>Galbraith</i>	443	Large Early Damson	454
<i>General Hand</i>	443	<i>Large Green Drying</i>	454
German Gage	433	Large Black Imperial	434
German Prune	442	Large Long Blue	446
<i>German Prune</i>	443	<i>Late Bohner</i>	454
<i>Ghaston's Early</i>	454	Late Yellow Damson	452
<i>Gifford's Lafayette</i>	454	<i>Lawrence's Favorite</i>	436
Golden Cherry	440	Lawrence's Gage	436
Golden Gage	434	Leipzig	443
<i>Goliath</i>	454	<i>Lewiston Egg</i>	454
Gonne's Green Gage	455	Little Blue Gage	453
<i>Green Gage</i>	435	<i>Little Queen Claude</i>	455
Gundaker Plum	443	<i>Lombard</i>	436
<i>Gundaker Prune</i>	444	<i>Long Scarlet</i>	446
<i>Guthrie's Late Green</i>	444	<i>Lucomb's Nonesuch</i>	455
<i>Guthrie's Topaz</i>	444	<i>Madison</i>	436
<i>Guthrie's Toy Bank</i>	444	Maitre Claude	456
<i>Guthrie's Apricot</i>	454	<i>Mamelonne</i>	446
Guthrie's Apricot Plum	454	Mamelonne Segerat	446
Grimwood's Early Orleans	435	Manning's Long Blue	446
Groundacre	444	Manning's Long Blue Prune	446
Grosse Luisante	452	<i>Manning's Prune</i>	446
Grosse Reine	435	<i>Martin's Seedling</i>	446
Grosse Reine Claude	435	Matchless	453
Grove House Purple	454	<i>McLaughlin</i>	437
<i>Gwalsh</i>	454	<i>Mediterranean</i>	447
Hampton Court	435	<i>Neigs</i>	447
Harvest Gage	437	Mium's	450
<i>Hartwiss Yellow Prune</i>	444	<i>Mirabelle</i>	447
<i>Henry Clay</i>	444	Mirabelle Double	454
<i>Highlander</i>	444	Mirabelle Tardive	447
<i>Holland</i>	454	Mirabelle Grosse	434
Holland Prune	454	Mirabelle Jaune	447
<i>Horse Plum</i>	454	Mirabelle Petite	447
<i>Howard's Favorite</i>	444	<i>Mirabelle D'October</i>	447
<i>Howel's Early</i>	444	Miriam	451
Howel's Large	455	Miser Plum	440
<i>How's Amber</i>	445	Montgomery	443
<i>Hudson Gage</i>	445	Monsieur	448
<i>Huling's Superb</i>	445	Monsieur Hatif	455
<i>Isleworth Imperatrice</i>	445	Monsieur Ordinaire	448

	PAGE		PAGE
Monsieur Tardif	456	Red Apricot	453
Montgomery Prune	436	Red Damask	448
<i>Mowoe</i>	447	<i>Red Diaper</i>	450
Monroe Egg	447	<i>Red Egg</i>	450
<i>Morocco</i>	437	<i>Red Gage</i>	438
<i>Mulberry</i>	447	Red Imperial	450
<i>Muscle</i>	455	<i>Red Imperial</i>	455
Myrobolan	440	Red Magnum Bonum	450
<i>Nectarine</i>	455	<i>Red Perdrigon</i>	455
New Green Gage	435	Red Queen Mother	455
New Golden Drop	434	<i>Red Saint Martin</i>	450
New Early Orleans	435	Reina Nova	450
New Orleans	435	Reine Claude	435
New Washington	438	<i>Reine Claude Diaphane</i>	450
New York Purple	453	<i>Reine Claude de Bayay</i>	438
<i>Nota Bene</i>	447	Reine Claude Blanche	455
<i>October Green Gage</i>	447	<i>Reine Claude Rouge of September</i>	450
Old Orleans	448	Reine Claude d'Octobre	447
<i>Orange</i>	447	<i>Reine Claude d'October</i>	450
Orange Gage	447	<i>Reine Claude Tardive</i>	447
<i>Orleans</i>	448	Reine Claude Violet	437
Parker's Mammoth	438	<i>Rhinebeck Yellow Gage</i>	455
<i>Parsonage</i>	448	Rennselaer Gage	435
<i>Peach Plum</i>	448	<i>River's Favorite</i>	451
<i>Penobscot</i>	448	River's Early, No. 1	451
<i>Peoly's Early Blue</i>	455	River's Early, No. 2,	451
Perdrigon Blanc	456	Robe de Sergut	449
Perdrigon Rouge	455	Roche Corbon	450
Perdrigon Violet	453	<i>River's Prolific</i>	451
<i>Peter's Yellow Gage</i>	448	Roe's Autumn Gage	433
Petite Reine Claude	455	<i>Reizenstein's Yellow Prune</i>	450
Picket's July	446	<i>Royale</i>	451
Pigeon's Heart	455	<i>Royale de Tours</i>	451
Plum de l'Inde	448	Royale Tours	451
Plum de Louvain	449	<i>Royal Hatve</i>	451
Pond's Purple	448	<i>Saint Catherine</i>	451
<i>Pond's Seedling</i>	448	Saint Cloud	454
<i>Precoce de Bergthold</i>	448	Saint Martin	450
<i>Prince of Wales</i>	449	Saint Martin Rouge	450
<i>Prince Enjlebert</i>	449	<i>Saint Martin's</i>	438
<i>Prince's Yellow Gage</i>	437	Saint Martin's Quetsche	438
<i>Prince's Orange Gage</i>	455	Scarlet Gage	446
Prince's Imperial Gage	435	<i>Schenectady</i>	451
<i>Prince's Orange Egg</i>	449	Schenectady Catherine	451
Prune d'Agen	449	Schuyler's Gage	435
Prune d'Allemagen	443	<i>Schuyler's Gage</i>	451
<i>Prune of Agen</i>	449	Sea	442
Prune d'Altesse	456	<i>Semiana of Boston</i>	455
Prune de Brignole	449	Shailer's White Damson	452
Prune d'Ast	449	<i>Sharp's Emperor</i>	452
Prune de Burgoyne	440	Sheen	454
Prune Peche	448	<i>Siamese</i>	455
Prune de St. Barnabe	446	Simiana	456
Prune de St. Jean	455	Small Green Gage	455
<i>Prune de Louvain</i>	449	<i>Smith's Orleans</i>	438
Prune Suisse	435, 456	Stabeler's Seedling	456
Prunier de St. Martin	450	Steer's Emperor	454
Prunus Cerasifera	440	<i>St. John's</i>	455
Prunus Myrobolana	440	St. Maurin	449
Purple Egg	450	<i>Suisse</i>	456
<i>Purple Favorite</i>	437	Superior Green Gage	435
<i>Purple Gage</i>	437	Sweet Damson	454
Purple Damson	453	Sweet Prune	443
Purple Magnum Bonum	450	Swiss Plum	456
<i>Quackenboss</i>	449	<i>Thomas</i>	452
<i>Queen Mother</i>	455	<i>Trowee de Fouclae</i>	452
Queen Victoria	452	True German Prune	443
Quetsche	443	Turkish Quetsche	443
Quetsche Grosse	443	Veritable Imperatrice	434
<i>Reagle's Ancient City</i>	449	Violet Diaper	453
<i>Reagle's Gage</i>	449	Violet Perdrigon	453
<i>Reagle's Union Purple</i>	449	Violet Queen Claude	457

	PAGE		PAGE
Violette	434	Cornwall's Red	470
Virgin	456	Cornwall's Seedling	470
Virginale	456	Cox's Honey	470
Virginian Cherry	440	Cretan Red	470
Waterloo	434, 455	Cushing	466
Wax Plum	452	Double Bearing	470
Washington	433	Double Bearing Yellow	469
Wentworth	452	Emily	467
White Damascene	452	English Red Cone	467
White Apricot	456	English Red, of some	465
White Damson	452	False Red Antwerp	467
White Egg	452	Festolf	467
White Empress	456	Framboisier a Gros Fruit	470
White Gage	455, 435, 457	Franconia	467
White Holland	452	French	463
White Imperatrice	456	Fulton	463
White Imperial	452	General Patterson	463
White Magnum Bonum	452	Howland's Red Antwerp	470
White Mogul	452	Knevett's Antwerp	470
White Perdrigon	456	Knevett's Giant	463
White Primordian	446	Large Fruited Monthly	463
White Prune Damson	452	Large Red	470
Wilde's	456	Late Cane	470
Wilkinson	452	Lord Exmouth's	470
Wilmot's Early Orleans	435	Magnum Bonum	463
Wilmot's Green Gage	435	Monthly	463
Wilmot's Late Green Gage	435	Merveille de Quatre Saisons	463
Wilmot's Late Orleans	454	Mrs. Wilder	469
Woolston's Black Gage	452	New Red Antwerp	466
Yellow Apricot	455	Northumberland Fillasket	469
Yellow Egg	452	Nottingham Scarlet	470
Yellow Magnum Bonum	452	Ohio Raspberry	469
Yellow Perdrigon	434	Ohio Ever-bearing	469
Yellow Gage	455	Old Red Antwerp	470
		Orange	469
QUINCES.		Perpetual Bearing	470
Angers	460	Red Antwerp	470
Apple Quince	460	Red Double Bearing	470
Apple-Shaped Quince	460	River's Large Fruited Monthly	463
Cydonia Lusitanica	461	Siberian	470
Cydonia v. Malformis	460	Thimble Berry	465
Cydonia Sub. v. Pyriform	462	Thunderer	469
New Upright	460	True Red Antwerp	466
Oblong Quince	462	Vice President French	463
Orange Quince	460	Victoria	470
Paris de Fontenay	460	Walker	469
Pear Shaped Quince	462	White Antwerp	469
Pear Quince	462	White Thimbleberry	470
Portugal Quince	461	Wilmot's Early Red	470
Pyriform Quince	462	Woodward's Red Globe	470
Red's Seedling	462	Woodward	469
Van Slyke	462	Yellow Antwerp	469
		STRAWBERRIES.	
RASPBERRIES.		Aberdeen Bee-Hive	433
Allen	467	Admiral Dundas	432
American Black	465	Ajax	432
American Red	465	Alice Maude	432
American White	470	American Scarlet	479
Antwerp	466	Atkinson's Scarlet	439
Barnet	470	Austrian Scarlet	434
Belle de Fontenay	465	Bain's Extra Early	433
Black Raspberry	465	Bath Scarlet	490
Brenford Cane	470	Bicton Pine	432
Barley	470	Bishop's New	432
Catawissa	465	Bishop's Orange	432
Colonel Wilder	466	Black Imperial	432
Common Black Cup	465	Black Prince	432
Common Red	465	Bostock	433
Cope	466	Boston Pine	473
Cornwall's Prolific	470	Brewer's Emperor	432

	PAGE		PAGE
<i>Brighton Pine</i>	482	<i>Late Prolific</i>	489
<i>Brilliant</i>	482	<i>Late Scarlet</i>	479
<i>British Queen</i>	483	<i>Lizzie Randolph</i>	489
<i>Bust's Prize</i>	488	<i>Longworth's Prolific</i>	479
<i>Burr's New Pine</i>	478	<i>Magnifique</i>	485
<i>Burr's Old Seedling</i>	483	<i>Marshall's Seedling</i>	487
<i>Burr's Seedling</i>	483	<i>McAvoy's Extra Red</i>	485
<i>Burr's Rival Hudson</i>	487	<i>McAvoy's Superior</i>	480
<i>Burr's Stamenate Seedling</i>	483	<i>McAvoy's No. 1</i>	485
<i>Caleb Cope</i>	483	<i>McAvoy's No. 12—Synonym</i>	486
<i>Caperon Royal</i>	481	<i>Melon</i>	489
<i>Captain Cook</i>	483	<i>Metlven Castle</i>	485
<i>Charlotte</i>	483	<i>Metlven Scarlet</i>	485
<i>Cleveland</i>	483	<i>Metlven—Synonym</i>	485
<i>Climax</i>	483	<i>Monroe Scarlet</i>	480
<i>Climax Scarlet</i>	483	<i>Monbeideo Pine</i>	485
<i>Cole's Late Scarlet</i>	488	<i>Mottier's Seedling</i>	489
<i>Cole's Prolific</i>	488	<i>Mojamensing</i>	485
<i>Conical Hautbois</i>	481	<i>Musk Hautbois</i>	481
<i>Columbus</i>	489	<i>Myatt's British Queen</i>	483
<i>Cornucopia</i>	483	<i>Myatt's Deptford Pine</i>	489
<i>Cox's Seedling</i>	489	<i>Myatt's Eleanor</i>	490
<i>Crescent Seedling</i>	483	<i>Myatt's Eliza</i>	489
<i>Crimson Cone</i>	483	<i>Myatt's Globe</i>	490
<i>Crimson Pine</i>	489	<i>Myatt's Mammoth</i>	490
<i>Cushing</i>	484	<i>Myatt's Pine</i>	490
<i>Deptford Pine</i>	489	<i>Myatt's Prince Albert</i>	490
<i>Double Bearing</i>	481	<i>Myatt's Prolific</i>	490
<i>Downton</i>	489	<i>Necked Pine</i>	486
<i>Duchess de Trevisse</i>	484	<i>Newland's Mammoth</i>	486
<i>Duke of Kent</i>	484	<i>Ohio Mammoth</i>	490
<i>Duke of Kent's Scarlet</i>	484	<i>Old Hudson</i>	479
<i>Duncan's Seedling</i>	484	<i>Old Pine, or Caroline</i>	490
<i>Dundee</i>	484	<i>Old Scarlet Pine</i>	490
<i>Dutch Berry</i>	483	<i>Omar Pacha</i>	486
<i>Early Prolific Scarlet</i>	484	<i>Orange Hudson's Bay</i>	482
<i>Early Virginia</i>	480	<i>Orange Prolific</i>	486
<i>Eberleine's Seedling</i>	489	<i>Patagonia</i>	490
<i>Elton</i>	489	<i>Peabody Seedling</i>	484
<i>Elton Pine</i>	489	<i>Pennsylvania</i>	486
<i>English Red Wood</i>	486	<i>Pine Apple</i>	486, 490
<i>Filbasket</i>	484	<i>Primate</i>	486
<i>Genesee</i>	478	<i>Primordian</i>	486
<i>Germantown</i>	484	<i>Prince of Orleans</i>	490
<i>Giant Alpine</i>	489	<i>Prince of Wales</i>	486
<i>Globe Hautbois</i>	489	<i>Princess' Alice Maud</i>	482
<i>Goliath</i>	489	<i>Profuse Scarlet</i>	490
<i>Green Alpine</i>	484	<i>Profusion</i>	490
<i>Green Pine</i>	484	<i>Prolific Hautbois</i>	481
<i>Green Strawberry</i>	484	<i>Prolific Hudson</i>	486
<i>Green Wood</i>	484	<i>Prolific Swainstone</i>	486
<i>Greenwell's New Giant</i>	490	<i>Red Alpine</i>	486
<i>Greenwell's French</i>	490	<i>Red Wood</i>	486
<i>Groce End Scarlet</i>	489	<i>Refulgent</i>	487
<i>Hooker</i>	478	<i>Richardson's Early</i>	490
<i>Hooper's Seedling</i>	485	<i>Richardson's Late</i>	487
<i>Hovey's Seedling</i>	478	<i>Rival Hudson</i>	487
<i>Hovey's Seedling</i>	485	<i>Roseberry</i>	490
<i>Hudson</i>	479	<i>Ross Phœnix</i>	487
<i>Hudson's Bay</i>	479	<i>Rostock</i>	488
<i>Hautbois Seedling</i>	484	<i>Ruby</i>	487
<i>Huntsman's</i>	489	<i>Saller's Versailles</i>	487
<i>Iowa Male</i>	485	<i>Scarlet Melting</i>	490
<i>Jenny Lind</i>	485	<i>Scarlet Nonpareil</i>	487
<i>Jenny's Seedling</i>	479	<i>Schmeike's Seedling</i>	479
<i>Keen's Seedling</i>	485	<i>Scoto</i>	490
<i>Keene's Seedling</i>	489	<i>Scotch Pine Apple</i>	483
<i>Knight's Seedling</i>	489	<i>Scott's Seedling</i>	487
<i>Lafayette (of some)</i>	481	<i>Sir C. Napier</i>	487
<i>La Grange</i>	481	<i>Sir Harry</i>	487
<i>La Liepaise</i>	489	<i>Southborough</i>	487
<i>Large Early Scarlet</i>	480	<i>Southborough Seedling</i>	487

	PAGE		PAGE
Southampton Scarlet	485	<i>Western Queen</i>	481
Stafford's Washington Alpine	486	<i>White Alpine</i>	488
Stoddard's Seedling	485	<i>White Bush Alpine</i>	488
<i>Swainstone Seedling</i>	488	<i>Wiley</i>	481
<i>Taylor's Seedling</i>	490	<i>Willey</i>	481
Trollope's Victoria	488	<i>William Henry Harrison</i>	490
<i>True Chili</i>	490	<i>Wilmot's New Scarlet</i>	490
Unique Prairie	486	<i>Wilmot's Superb</i>	490
<i>Unique Scarlet</i>	488	<i>Wilson's Albany</i>	481
<i>Victoria</i>	488	<i>Yellow Chili</i>	490
<i>Walker's Seedling</i>	480	<i>Young's Seedling</i>	484
Washington	485		







