

WILD BIRD GUESTS

HOW TO ENTERTAIN THEM

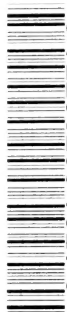

3 1761 06706771 0



ERNEST HAROLD BAYNES

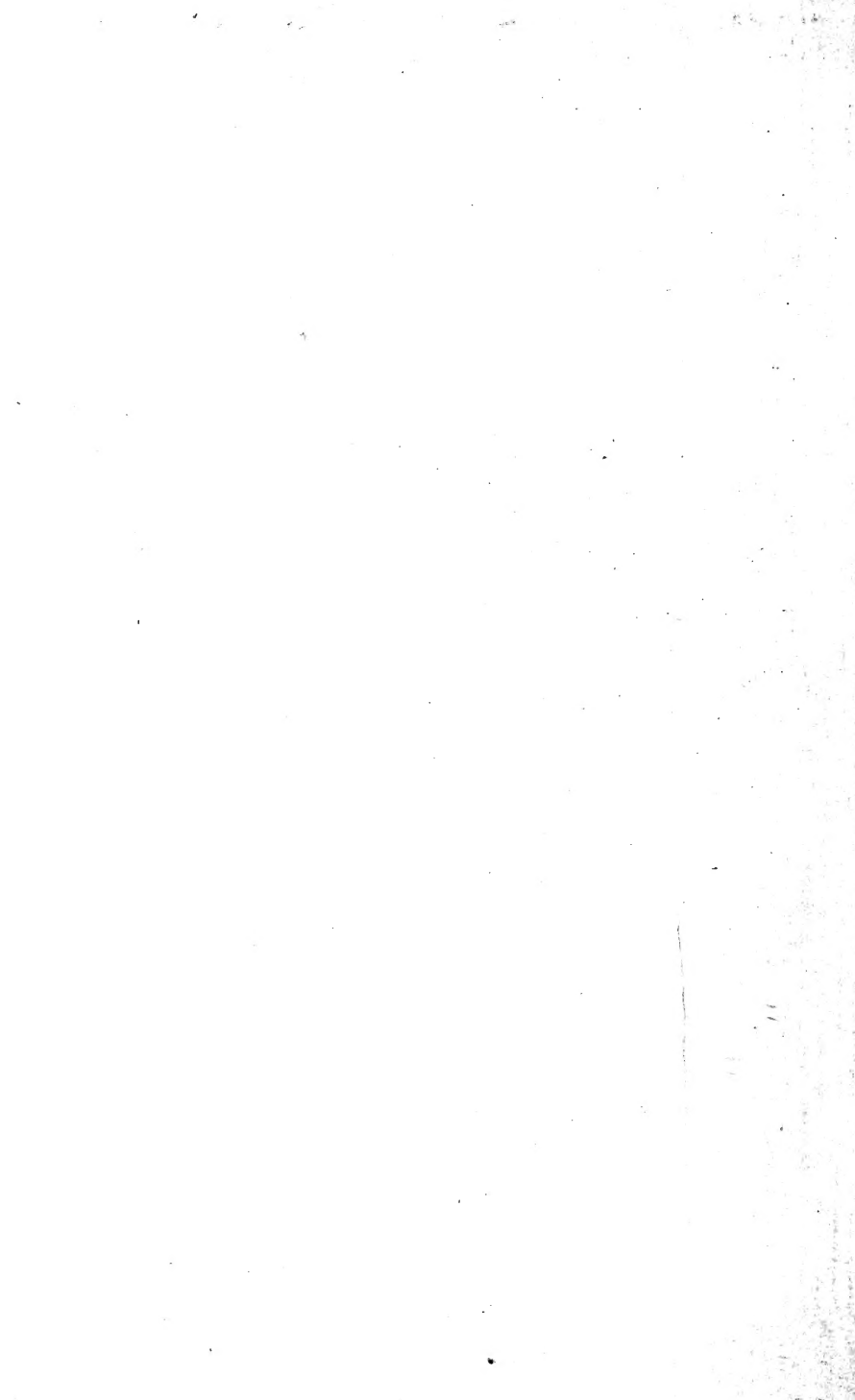

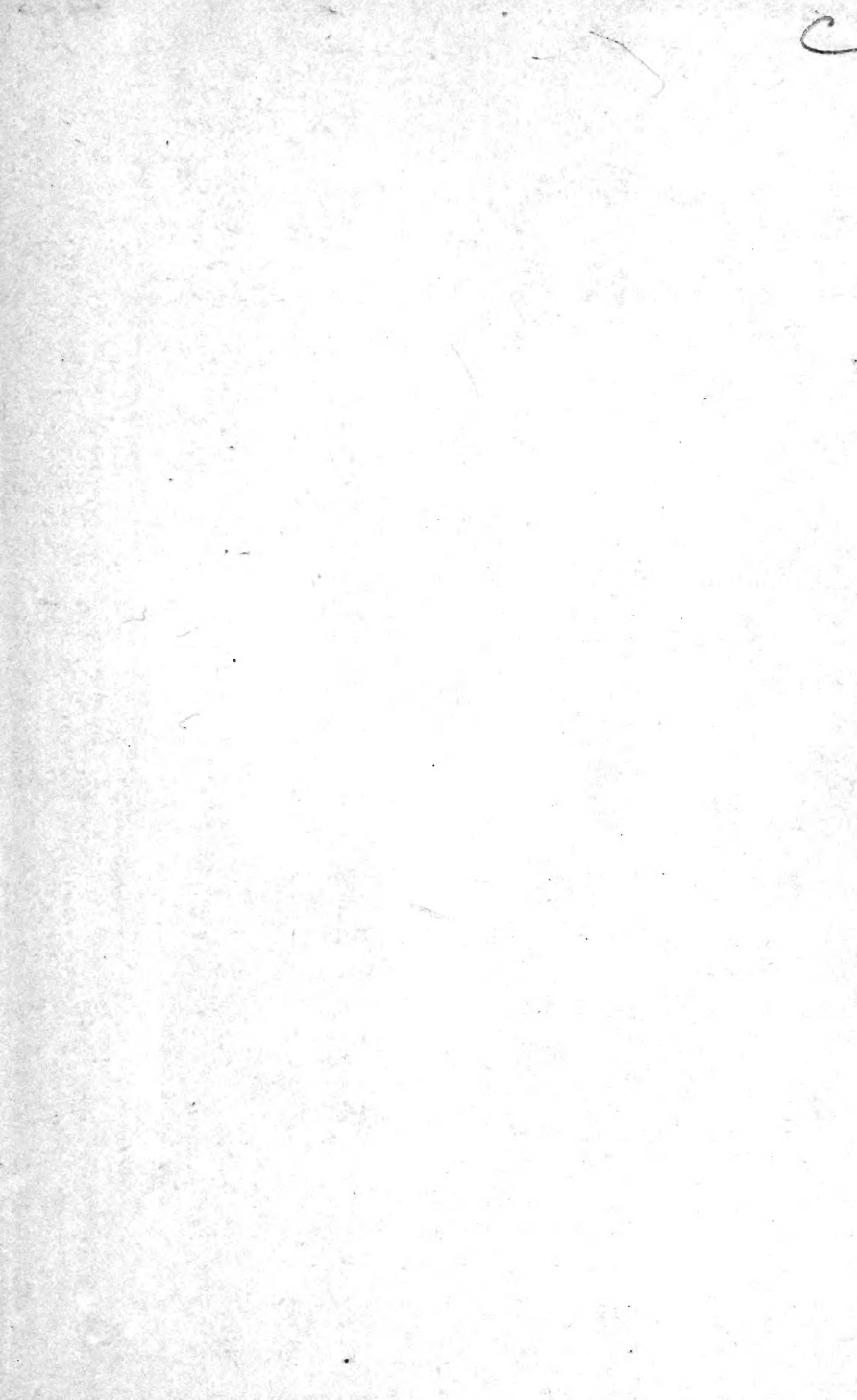

WILD BIRD GUESTS



Digitized by the Internet Archive
in 2007 with funding from
Microsoft Corporation

Copyright, 1915
BY
E. P. DUTTON & COMPANY

The Knickerbocker Press, New York

To

MY WIFE

A STANCH FRIEND OF THE BIRDS

AND ALWAYS MY BEST ASSISTANT

THIS BOOK IS AFFECTIONATELY DEDICATED



PREFACE

MR. BAYNES has written not only a very interesting book but one that is really of capital importance. We Americans have recklessly wasted our national assets in the past. But now there has come a change. We are trying to preserve our forests and utilize our water supply and care for the soil instead of merely exhausting it. One of the pleasantest features of the new movement is the constantly growing interest in wild life, and especially in bird life. The Meriden Bird Club has furnished a model for all similar experiments in preserving bird life, and Mr. Baynes writes in advocacy of a cause which by practical achievement he has shown to be entitled to the support of every sensible man, woman, and child in the country. I say "child" advisedly, for boys and girls have a peculiar part to play in the crusade for the better protection of our birds. There is sound economic reason for protecting the birds; and in addition there is ample reason for protecting them simply because they add immeasurably to the joy of life,

and of all those fit really to enjoy life outside of our great cities or even in the parks and suburbs of our great cities. I speak as one who has in his own person benefited by the result of Mr. Baynes's missionary work, for in consequence of this work we who live on Long Island have now organized a Bird Club for the Island. Our endeavor is to do for Long Island some small part of what has been done by the Meriden Bird Club and kindred organizations in New Hampshire and elsewhere.

THEODORE ROOSEVELT.

FOREWORD

“Kind hearts need no compulsion to be kind.”

MACKAYE.

FOR a long time it has been the writer's belief that the final solution of the problem of wild bird conservation lay, not in the enacting of more or better laws, necessary as those laws are, but in the creation of such an interest in, and love for birds, that a very large majority of people will have not only no desire to destroy them, but will actually fight to prevent their destruction; and that the birds themselves will become as safe as valuable private property. This, it seems, would be a fundamental solution. Most bird protection laws are in the nature of artificial restraints upon people who desire to kill. Restraints are often necessary but seldom popular. People do not like to be told not to do things which they very much desire to do; consequently such laws are often hard to obtain and harder to enforce. Now, if we could create the interest and love referred to, we might ac-

comply a double purpose; viz., first, a great reduction in the number of people who desire to destroy the birds for any purpose, and thus, second, make it much easier to enforce existing laws in the case of those who still persist in the desire to destroy. In other words, every person in whom we succeed in implanting this interest and love would be a recruit for the army of bird defenders directly from the ranks of either the bird destroyers or the indifferent, who are often quite as dangerous as the destroyers themselves. The result would be the strengthening of the defenders and a corresponding weakening of the destroyers, and the tendency would ever be to facilitate the passage of such laws as might still be necessary, and to make difficult the successful defiance of them.

Now comes the question as to how this interest and the love which the interest begets, can most readily be implanted in the heart of the average man, woman, and child. The writer believes that the answer to this question lies in doing active work directly for the birds. There are few laws more sacred than those of hospitality. It is not possible for us to be indifferent to the welfare of our invited guests. The moment a person—be it man or bird—has accepted our hospitality, has broken bread with

us, has eaten our salt, our relations toward that person have changed. We have been looked upon with the eyes of friendship—we have been trusted, and if we are even half decent we cannot betray our trust. Through the primitive man which is in most of us, we may kill a bird which we see in the wilderness, a stranger and on his guard; but the bird which comes to our garden, to our home, onto our hand perhaps, at our express invitation, we must protect with all the manliness, with all the womanliness in our make-up. I shall never forget the first time a chickadee alighted upon me, and I felt his wiry little hands close around my finger, while he cocked his head on one side and looked up at me from under his little black cap, as much as to say, "Is it all right? Honest?"

It surely was all right! I was a champion of the chickadee from that moment, and to-day I can think of no surer way for a man to effect an instant quarrel with me than by injuring a bird of this species. And a love for one bird tends to beget a love for other birds.

For the past few years I have been watching the results of studied kindness and hospitality to the birds, and the results have been good. I have seen the attitude of a whole town change from one of utter indifference to birds, to one of

enthusiastic interest in them, and I have seen this not once but many times.

I have organized many bird clubs—clubs which have for their chief object not so much the study of birds as the extension of hospitality to them, and in every case the result has been a better understanding between the members and their feathered neighbors, the creation of a strong local sentiment in favor of birds, and an amount of rational enjoyment and moral uplift out of all proportion to the labor and expense involved.

The writer makes no claim to originality, except in the idea that bird clubs may be made a most powerful factor in the work of bird conservation, and incidentally in the social life of the people in the towns and villages where they are organized. Judging from his own experience it should be possible in a few years' time to spread a network of such clubs over the United States. Any wide-awake, enthusiastic bird lover with a reasonable knowledge of methods of attracting and protecting birds can organize a bird club almost anywhere. In order to do so it is not necessary to be an ornithologist; one need not know a scarlet tanager from a great blue heron, if only he has enthusiasm—that is absolutely essential.

Because of the enormous value of birds—

economic, æsthetic, and moral—the writer believes that it is the duty of every civilized community to take its part in a great world-wide campaign for the conservation of bird life, and he knows of no more practical way to do this than by the organization of a bird club whose principal object is the care of the local birds. If this little book helps to inspire its readers to organize such bird clubs in their respective towns and assists them in their efforts to do something for the birds, whether they succeed in organizing a bird club or not, it will have accomplished the object for which it was written.

E. H. B.

MERIDEN, N. H.,

May 1, 1915.

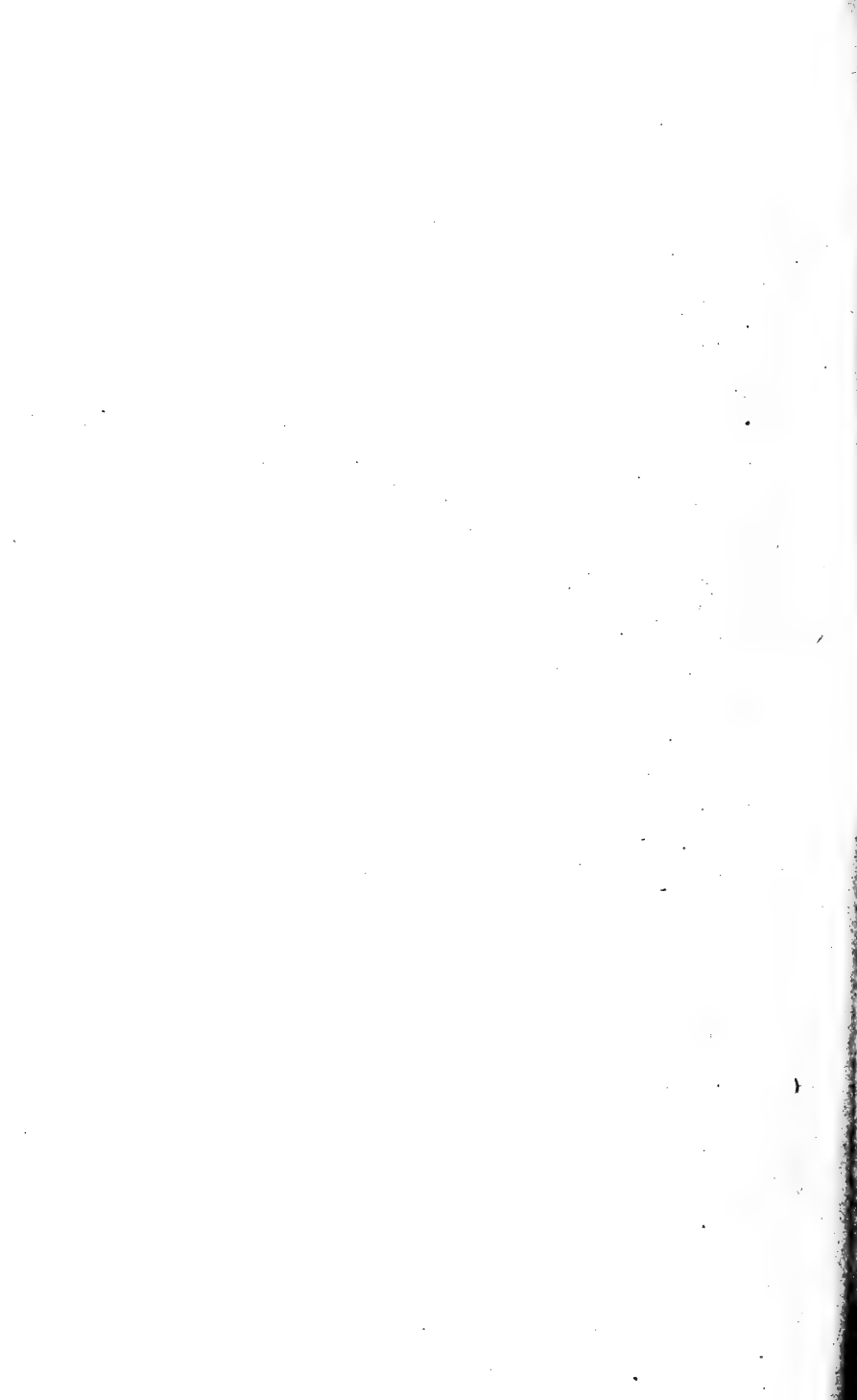

CONTENTS

	PAGE
FOREWORD	iii

PART I

WHY BIRDS NEED PROTECTION

CHAPTER

I. AN INTRODUCTION TO SOME WINTER GUESTS	I
II. THE DESTRUCTION OF BIRDS BY THE ELEMENTS AND BY DISEASE	10
III. THE DESTRUCTION OF BIRDS BY THEIR NATURAL ENEMIES	20
IV. THE DESTRUCTION OF BIRDS BY MAN AND BY CERTAIN ANIMALS FOR WHOSE PRESENCE MAN IS RESPONSIBLE	39

PART II

WHY IT IS WORTH WHILE TO GIVE BIRDS PROTECTION

V. THE MONEY VALUE OF BIRDS	81
VI. THE ÆSTHETIC AND MORAL VALUES OF BIRDS	115

PART III

HOW WE CAN ALL HELP TO PROTECT THE BIRDS

CHAPTER	PAGE
VII. THE ENTERTAINMENT OF WILD BIRDS IN WINTER	127
VIII. HOSPITALITY ALL THE YEAR 'ROUND WITH A LIST OF THE TREES, SHRUBS, AND CREEPERS MOST ATTRACTIVE TO BIRDS	163
IX. THE BIRD LOVER AS A LANDLORD. A CHAPTER CONCERNING NEST BOXES, NEST SHELVES, ETC.	192
X. BIRD BATHS AND DRINKING POOLS	219
XI. SOME OF THE PROBLEMS WHICH CONFRONT BEGINNERS	233
XII. BIRD CLUBS, HOW TO ORGANIZE THEM, WHAT THEY CAN DO TO BE USEFUL	269
APPENDIX.—CONSTITUTIONS OF CERTAIN BIRD CLUBS	299
ACKNOWLEDGMENTS	310
INDEX	317

ILLUSTRATIONS

	FACING PAGE
FLICKER FEEDING ITS YOUNG IN A BERLEPSCH NEST BOX*	Frontispiece
THE AUTHOR AND A FRIENDLY CHICKADEE	4
From a photograph by Louise Birt Baynes	
I WONDER WHAT HE'S GOT IN THAT	8
A CHICKADEE GUEST	8
From photographs by Louise Birt Baynes	
LAPLAND LONGSPURS AFTER A STORM	16
From a photograph by Dr. Thomas S. Roberts	
QUAIL DEAD FROM STARVATION	16
From a photograph by Wilbur Smith	
A RED SQUIRREL USURPING FEED BOX AND BATH*	22
RED FOXES DESTROY BIRDS BOTH OLD AND YOUNG*	22
TRACKS OF A MINK*	28
THE SKUNK WILL EAT YOUNG WILD BIRDS AS WELL AS HENS*	34
"ADVANCING DEATH." THE WHITE WEASEL, OR ERMINE*	34
THE SNOWY OWL IS PARTIAL TO WATERFOWL*	40
THE RACCOON DINES ON BIRDS WHEN HE CAN*	50

	FACING PAGE
THE OPOSSUM WILL DESTROY BIRDS AND EGGS*	58
AMERICAN SONG BIRDS KILLED BY ITALIANS	66
From a photograph by Wilbur Smith	
A SNAPPING TURTLE DESTROYED FIFTEEN YOUNG WOOD DUCKS	74
From a photograph by E. A. Quarles	
THIS BULL FROG COULD SWALLOW A YOUNG WATERFOWL*	74
MONUMENT TO THE SEA GULLS IN SALT LAKE CITY	84
Designed by Mahonri Young	
THE GREAT HORNED OWL DESTROYS MANY BIRD ENEMIES*	92
SCREECH OWL AND ITS HOME-MADE BIRD HOUSE*	100
STOMACH CONTENTS OF A MEADOW LARK: FOUR- TEEN CUTWORMS, THIRTY-SIX BEETLES	108
From a photograph by Harold C. Bryant	
A BARN OWL'S SCRAP HEAP: BONES OF MICE, BUT NO FEATHERS	108
From a photograph by Thomas H. Jackson	
ONE HUNDRED AND THIRTY-THREE REDPOLLS AND PINE SISKINS AS GUESTS*	116
MARTIN HOUSE IN A MERIDEN GARDEN*	116
GROUSE BURROW IN THE SNOW*	122
A FEEDING STATION WHERE THE "BIRD MASQUE" WAS STAGED*	130
QUAIL SAVED FROM STARVATION BY HIGH-SCHOOL BOYS	130
From a photograph by John Tresilian	

Illustrations

xvii

FACING
PAGE

A "WEATHERCOCK" FOOD HOUSE*	140
A WINDOW BOX IN THE AUTHOR'S STUDY From a photograph by Louise Birt Baynes	148
AN AUDUBON FOOD HOUSE IN WINTER*	154
AN "AUTOMATIC" FOOD HOUSE HOLDS A BUSHEL OF SEED*	154
BARRED OWL, USUALLY A BENEFICIAL BIRD*	160
A DECORATIVE BIRD BATH*	168
YOUNG BALTIMORE ORIOLE BEFORE THE BATH*	178
AFTER THE BATH*	178
SONG SPARROWS ENJOYING A BATH*	190
BIRD BATH IN THE AUTHOR'S GARDEN. From a photograph by Louise Birt Baynes	190
CHICKADEE FEEDING UNDER A BERLEPSCH "FOOD BELL"*	202
CHICKADEE AT A BERLEPSCH NEST BOX*	202
A BIRD BATH MEMORIAL TO EDWARD EVERETT HALE*	212
A BIRD BATH IN NEWTON CENTRE, MASS. From a photograph by Marr	226
BRONZE BIRD BATH COMMEMORATING THE "BIRD MASQUE" Designed by Mrs. Louis Saint-Gaudens	230
DUCKS DYING OF STARVATION ON LONG ISLAND From a photograph by Wilbur Smith	240
A SWAN THAT WAS CARRIED OVER THE FALLS From a photograph by James Savage	240

	FACING PAGE
ST. CATHERINE'S LIGHT-HOUSE, ISLE OF WIGHT, SHOWING BIRD-RESTS	256
<i>Courtesy of Our Dumb Animals</i>	
SOME JUNIOR MEMBERS OF THE CORN-FIELD BIRD CLUB OF CORNISH	270
"RAISING THE MARTIN HOUSE" FOR THE CHARLES- TOWN BIRD CLUB	270
From a photograph by Walter Buswell	
TRAMPLING SNOW TO MAKE A FEEDING STATION* .	280
CITIZENS OF MERIDEN GIVING THE BIRDS A DAY'S WORK*	280
THE RIGHT KIND OF FEATHERS FOR A HAT* .	290

*From a photograph by the author

WILD BIRD GUESTS



Wild Bird Guests

CHAPTER I

AN INTRODUCTION TO SOME WINTER GUESTS

IF on some winter day you were to alight from "Ike" Bonner's stage and approach one of the neat-looking cottages on the main street of Meriden, New Hampshire, it is more than likely that you would be greeted by the alighting of a wild bird upon your shoulder. And probably you would think that the bird had simply made a mistake, until another one alighted on your hat and peeped at you over the brim. Then, if you asked the meaning of this familiarity, you would be told that you were in "The Bird Village" where birds are treated as honored guests from one year's end to another; where they are provided with food and lodging and where they are protected from their enemies. And you would hear of all sorts of interesting and delight-

ful experiences which some of the people have had with birds which have become so fearless that they will sometimes permit one to pick them up. And if you were to express doubt that such experiences would ever come to you, you would learn that there is no mystery about it; that it is simply a matter of being very quiet and gentle with your feathered guests; of being patient with them, and of using a little thought and ingenuity for their comfort and welfare. Meriden people have done these things and they have been rewarded by having seven species of our winter birds come to their hands for food. Pine grosbeaks, white-winged crossbills, redpolls, pine siskins, white-breasted nuthatches, red-breasted nuthatches and chickadees have thus shown their appreciation of what the people of this little New England village have done for them. Perhaps no other place of equal size in this country has thus been honored. Every year for several years our people have had some memorable experience with birds.

For example, one severe winter when the pine grosbeaks came down from the north in great numbers, we fed hundreds of them in the gardens of Meriden, and not only the writer but several other bird-lovers fed them as they sat on hand or shoulder. They were so tame that one could sit

down in the middle of a flock, and the birds would come into one's lap to feed. They would alight upon the heads of children watching them, and sometimes they allowed us to pick them up one in each hand.

Another winter the crossbills visited us. A few, six or eight, had been coming most of the summer to the garden path. Two or three were American and the rest white-winged crossbills. They crept about, quiet as mice, eating something, but just what it was I could not tell until they had been here for some time. Then one day after watching them at work for several minutes, I took a magnifying glass and went down on my knees to see what there might be there to attract them. I found that they had been working on a patch of clay, the surface of which they had carved in every direction with their sharp bills. As there were no "chips" I knew that these must have been eaten, so I tasted the clay to see why they had eaten it. It was very salty, the result of scattering salt on the path to kill the weeds. A few days later our friend, Frederic H. Kennard, came to see us, and observing the crossbills, ran into the house for some salt, of which he had often observed their fondness. The flock continued to grow until midwinter, when it numbered about a

hundred and twenty-five. We went out to play with them for a while almost every day, and by and by they seemed to look for our coming. We would sit on the well-trampled snow we had prepared for their feeding ground, and from the trees about us they would come down in a musical shower, to alight upon our heads and shoulders and to feed from our hands. It was such fun that sometimes even when the thermometer registered from ten to fifteen degrees below zero we would sit there feeding them, photographing them, or often simply watching them, until we were almost too numb to get up.

Sometimes in winter the redpolls come to Meriden in flocks aggregating many hundreds, and there are usually a number of pine siskins among them. At such times the streets of the village are alive with birds, and their cheerful twitterings make it seem as though spring had come back several weeks in advance. These little birds alight in the dooryards and swarm over the piazzas like flies on a sugar bowl, and they will feed from the hands of anyone who has the patience to stand still in the snow for a little while. I have sat down among them, and had both species not only take food from my hand but treat me very much as they would a bush or a stump.



THE AUTHOR AND A FRIENDLY CHICKADEE



Neither of the nuthatches has ever condescended to alight upon me, but a red-breasted nuthatch once allowed me to stroke him with a forefinger as he was feeding on suet, and neighbors of ours entertained one which used to come to their hands almost every day for months. I have almost touched a downy woodpecker, but not quite. He was feeding on a food tree at Meriden, and showed no fear when I walked up until my face was within eight inches of him. My enemies say that this marks the limit of courage in any wild bird, and that that woodpecker should have been awarded a medal for bravery.

But as a rule the chickadees are the tamest of all; there seems to be no limit to the confidence which these little fellows will have in you if you give them a little encouragement. At my home they know us so well that if they don't see what they want they practically ask us for it. Sometimes before we are up in the morning they will sit in a row on the bedroom window-sill and hammer on the glass with their bills. We open the window and in they come. Like as not they will find some broken nuts on the dressing-table; if so, they may eat them there or they may fly out into the garden with them. One morning we invited them to breakfast. We set the

breakfast table close to an open window and sprinkled broken nuts upon the cloth. In came the chickadees, picked up the nuts, and flew out into the garden with them. To teach them better manners we swept up the small pieces of nut and stitched each large piece to the tablecloth; after that the chickadees stayed right on the table and took breakfast with us.

One day, when we were living at Stoneham, Massachusetts, I saw a flock of these little birds in a tree, and I thought I would see how tame I could make them. I held out a handful of broken nuts and gave an imitation of the "phœbe" note of the chickadee. One little fellow flew down to my hand, picked up a piece of nut, and flew away. I called to Mrs. Baynes to bring a camera, and when I saw another bird coming, instead of holding the loose nuts in the palm of my hand as before, I held a single piece tight between my thumb and forefinger. Down came the chickadee, and finding that he could not fly away with the nut, he sat there for several minutes and ate it. That seemed pretty good for a first attempt, but I thought I would test him further. I placed a piece of nut between my lips and held up my forefinger as a perch for him. He needed no second invitation, but alighted on the finger and helped himself. It didn't seem

possible that a bird could show much more confidence than that, but I thought I'd put him to still another test. Leaving the nut just where it was, I calmly folded my hands behind my back leaving him no perch at all. It didn't feaze him one bit, for the next moment he alighted on my lip and helped himself to the nut as though he had been used to feeding in this way all his life.

When we came to New Hampshire we found the chickadees just as friendly. A flock made our house its headquarters and the first time that Mrs. Baynes went out to feed them she succeeded in getting five of them to alight upon her at once. She used English walnuts and a little patience.

On one occasion I was in the garden with a rifle practising at a mark, when a chickadee alighted on the front sight, tipped over and deliberately looked down the barrel, as much as to say, "I wonder what there is in that." Sometimes when I am in the woods, far from the house, the chickadees will come to me. I remember one bitter winter day I was sitting in the snow having my lunch, and the chickadees swarmed about me, alighting on my cap, my shoulders, and my snowshoes, which I had taken off and stuck in the snow. I pulled a sandwich from my pocket and as I put it to my lips, a chickadee came down out of a tree overhead,

alighted on the other end of the sandwich and helped me to eat it. When we go out in winter, the chickadees often come down like so many little highwaymen and literally "hold us up" for nuts and other things we are likely to have in our pockets for them. I once had a chickadee sit on my hand eating nuts until he simply couldn't hold any more. He looked absolutely comfortable and I half expected to hear a sigh of contentment. I cupped my other hand and put it over him, until his head alone was visible in the circle of my thumb and forefinger, and perhaps made drowsy by the warmth, he closed his eyes and tucked his head beneath his wing.

And it is not only in winter that the chickadees are with us; they nest about the place, and come to our hands, though not as frequently, in the spring, summer, and fall. Not long ago a pair of chickadees nested in our orchard, and gave their nestlings an occasional meal of suet from a stump near the house. If we were photographing nearby, the parent birds would come to our hands or alight upon the camera or tripod. When the young ones left the nest they were quite fearless and allowed us to approach and stroke them, and when Mrs. Baynes placed a youngster on her outstretched hand, one of the parents came, and poising, humming-bird fash-



"I WONDER WHAT HE'S GOT IN THAT?"



"A CHICKADEE GUEST"

ion in the air beside it, passed insects into its mouth.

One day last spring I was delighted on returning from a lecture tour of several months duration, to be met in the lane, half a mile from my home, by a band of chickadees and escorted to the house by my little friends, first one and then another of whom would fly to my hands or shoulders.

CHAPTER II

THE DESTRUCTION OF BIRDS BY THE ELEMENTS AND BY DISEASE

BIRDS seldom tell us of their troubles. To be sure, when their homes are in danger, or when their little ones are killed or carried off, some parent birds let us know by their frantic cries, how real and bitter is their grief. And of course hungry nestlings often clamor for food. But usually, full-grown birds, like thoroughbred people, take their troubles, their dangers, and even death itself, with quiet courage and without any fuss. If they didn't I'm afraid their sympathetic human neighbors would get little rest, for they are beset by so many dangers and face death in so many forms that I sometimes wonder how any of them manage to escape. Of these dangers, the elements are among the worst and least controlable. Storms often kill thousands of birds in a few hours. The small birds, which during migration, cross large bodies of open water, are perhaps the ones most likely to perish

in great numbers from this cause. Flocks of warblers winging their way across the Gulf of Mexico or one of the Great Lakes, are sometimes overtaken by heavy storms which result in their wholesale destruction. Plucky as they are, their tiny muscles are no match for the mighty winds which sweep the water, and they are beaten backward and downward, with no spot on which to rest even for a moment. Even in such dark hours, their courage asserts itself; they do not give up, but battle still with their giant foe, which hurls them far from their course. Then perhaps comes a cold and driving rain, which soaks their plumage and increases the burden already too great for the weary muscles. Down they go toward the roaring water beneath them, until they are met by the leaping waves, which lick them into the deep, where the last spark of their dauntless courage is quenched in death. Next morning their tiny, bright-colored bodies may be found strewn for miles along the coast, among the shells and pebbles of the beach.

The cold storms of late spring, which come after many of the migrants have arrived, sometimes kill nearly all the birds of certain species over a wide area of country. Insect-eating birds suffer most as a rule from these storms, because the insects are driven to cover and are hard

to get in sufficient numbers to maintain life. Every now and then there comes a spring so cold and stormy that bluebirds perish in great numbers and a great scarcity of these birds is observed the following year. More rarely the destruction is so widespread that several years pass before bluebirds are seen again in their usual numbers. In *The Auk* for October, 1907, Dr. Thomas S. Roberts of the Minnesota Natural History Survey, tells of a snowstorm which occurred in Minnesota and Iowa, in March, 1904, when not far from a million and a half Lapland longspurs perished in a single night. But the birds which suffer most frequently, and as a rule most severely from these untimely storms, are those which capture their insect prey almost entirely on the wing—such birds as swifts and swallows. The snow or cold rain having swept the air practically clear of insect life, such birds quickly starve to death. Purple martins, perhaps because they are larger than the other swallows and hence require more food, often suffer very severely. For example, so many purple martins were destroyed by storms in the springs of 1903 and 1904 that there were hardly any of these beautiful birds to be found in Massachusetts and they were scarce all over New England.

Even birds as hardy and omnivorous as the robin have a hard time in the late snowstorms. Here in New Hampshire, robins are often driven to eat the decayed apples which have hung frozen to the trees all winter, and in some cases they eat so much of this fermenting fruit that they become intoxicated.

Bad storms occurring in the nesting season cause great havoc among young birds. The wind breaks down branches and sometimes whole trees containing the nests, and often the nests themselves are blown to the ground. Continuous heavy rain chills and kills the nestlings in spite of the best efforts of the parents to shield their little ones. One pouring wet June day I found a phœbe's nest on the side of a cliff in Massachusetts. The cold water from the rock above was dripping into it and the five young birds were already dead. Only last spring a pair of chipping sparrows had a nest in a little bush close to my front door and all the young ones were killed by a cold wet storm. The brave little mother did her very best to shelter them, and long after they were dead she continued to sit on the nest to cover them with her wet and bedraggled wings.

Floods occurring during the nesting season are sometimes very destructive to birds which nest

on the ground. Some years ago at Stamford, Connecticut, I had under observation several nests of song sparrows and other birds in a low-lying meadow. I went down there one morning after several days of heavy rain, and found the meadow, nests and all, under water. Some of the nests had contained newly hatched young and the parents were still flitting about among the bushes nearby, calling incessantly.

More dramatic, if much less serious, is the destruction wrought by the great waterfalls which every year take their toll of aquatic birds. Every spring many birds, chiefly ducks, geese, and swans go over the Horse-Shoe Falls at Niagara. Some of these are killed outright, but many of them are only stunned and might easily be saved. In 1912 one hundred and forty whistling swans went over the falls in this way, and were fished out by boys and men, knocked on the head and sold for food to people in Niagara Falls. Most of the birds were secured by a young man employed at the *Maid of the Mist* landing, who, living in a little house close to the water, was always on the watch. With Mr. James Savage of Buffalo I went to see this young man the following spring and he told us that the birds almost always came over at night. Far above the falls the water is smooth and here the birds

alight. Apparently they are carried down into the swift water when asleep and then it is evidently impossible for them to save themselves. The young man told us that once he captured a swan that was only stunned and that he tied a fishing line to its leg and kept it in a little pond made by an eddy of the river. The bird became very tame and would take food from his hand, but one day took alarm at a company of soldiers, flew into the air, and snapping the fishing line as though it had been a thread, flew away down the river.

Mr. Savage with some friends once saved a flock of swans by chasing them in a power boat and making them fly away just before nightfall. It was a daring thing for these men to do, for if by any chance the engine had become disabled nothing could have prevented their going over the falls.

Severe winters destroy great numbers of birds, which perish chiefly for lack of food. It seems that most birds can stand cold weather if only they can get food enough. A bird's body may be likened to a little furnace in which food takes the place of coal or wood. As long as there is plenty of fuel in the furnace it remains warm no matter how cold the weather may be; but when there is no fuel to be had the fire dies out and

the bird with it. I once kept a turkey vulture in my garden in Massachusetts and though he is naturally a bird of a warmer clime, he remained in perfect health through the very severe winter of 1903-1904, simply because I kept him well supplied with food. That same winter the hardy native birds died in great numbers because they could not get food—could not get the fuel to keep the little furnaces going. According to the State Ornithologist, Edward Howe Forbush, between ninety and ninety-five out of every one hundred quail in Massachusetts died of starvation that winter. Similar tragedies occur every severe winter, and if we do a little thinking we find that there is no mystery about it. When the trees and bushes are sheathed in ice it must be very difficult and at times impossible for the insect-eating birds such as woodpeckers, nuthatches, chickadees and creepers, to get at the insects and larvæ which lurk in and below the bark and in the axils of the twigs. And when the ground is covered under a foot or more of snow, how can such birds as sparrows and finches and quail and other seed-eaters dig down under it to get at their food? Of course some birds find weed-stalks sticking out above the snow and others perhaps switch off onto a diet of berries, but there are many others who



LAPLAND LONGSPURS AFTER A STORM



QUAIL DEAD FROM STARVATION



fail to find enough to support life and these of course starve to death.

We cannot control the elements, but we can at times, by offerings of food and shelter help the birds in their battle against the cold and the storms, and this matter will be taken up in detail in a later chapter.

THE DESTRUCTION OF BIRDS BY DISEASE

That wild birds sometimes become ill is a fact not very generally thought of perhaps, and comparatively few of us have ever seen a sick bird in its native haunts. Yet birds are sometimes attacked by epidemics which work as much destruction among them as cholera or the bubonic plague works among human beings. Such an epidemic has recently been playing havoc with the waterfowl and marsh birds of Utah. In a letter to the writer, Mr. Fred. W. Chambers, State Commissioner of Fish and Game, says:

“Since 1910 we have had an epidemic among the marsh birds of Utah, especially the ducks, though the snipe family has suffered considerably. We collected and buried in quicklime over a million birds in the year 1910, and each year thereafter until the present time, not in-

cluding 1914, we have buried in the neighborhood of five hundred thousand birds, making a total of two and a half millions of birds that have been destroyed by this epidemic. We have worked constantly to find out the real cause of the epidemic, but as yet have not been able to say just what it is."

A considerable number of wild birds as well as domesticated ones are troubled with a parasite known by the formidable name of Coccidiosis, and which in some species causes a dangerous disease of the intestines. Professor Philip B. Hadley of the Biological Laboratory at Kingston, Rhode Island, who has been studying this parasite, has found it in European sparrows, field sparrows, white-throated sparrows, juncos, robins, and hermit thrushes. He also found that seemingly the parasite can be transmitted from European sparrows to domestic poultry. Professor Hadley considers that the spreading of this disease from one part of the country to another by means of these birds and especially by the European sparrow is not only a menace to domestic poultry, but may result in the infection and destruction of wild game birds. This would seem to be another reason why we should unite in an effort to reduce the number of European sparrows.

Destruction by Elements and Disease 19

Grouse, quail, and others are known to suffer severely from disease at times, and this fact presents perhaps the most serious difficulty met by those who attempt to rear these birds in captivity.

CHAPTER III

THE DESTRUCTION OF BIRDS BY THEIR NATURAL ENEMIES

By the *natural* enemies of birds is here meant those wild creatures which naturally prey more or less upon birds. These include wild cats, wolves, foxes, bears, raccoons, weasels, mink, skunks, wolverines, squirrels, rats, and opossums among our mammals; shrikes, grackles, crows, jays, certain owls and hawks, and occasionally other species, among the birds; snapping turtles and many snakes among the reptiles; bullfrogs among the batrachians, and pike and possibly other voracious species among the fishes. There are others but these are the principal ones in this country. Animals like cats, dogs, and pigs, which have been domesticated by man, and European starlings and sparrows, which have been imported by him, are not, strictly speaking *natural* enemies of our wild birds and will be treated of elsewhere.

Some of the bird enemies mentioned above do

a great deal of damage, others only a little, and some so offset their own evil deeds by keeping other bird enemies in check that it is hard to decide whether we should class them as friends or foes.

Probably all our wild cats, including mountain lions, kill some birds if good opportunity offers, and when wild turkeys and grouse were abundant they probably took their share. Audubon once saw a bob cat capture a wild turkey and on another occasion watched one pounce upon a partridge in a covey which it had been carefully stalking. He also states that grouse and other birds form part of the food of the Canada lynx. But these powerful cats prey upon so many four-footed creatures, such as squirrels, rabbits, and even deer and mountain sheep, that it is doubtful if they would be a serious menace to bird life even if they were much more numerous than they are.

The damage done to birds by wolves is probably slight, owing to the fact that wolves prey chiefly upon other creatures. But we may be sure that no bird or nest of birds discovered by a wolf is permitted to escape if he can help it. Both timber wolves and coyotes have been known to kill domestic poultry. A tame coyote I once had at my home used to kill wounded

birds whenever he saw them and once killed and partly ate a turkey gobbler weighing nearly twenty-five pounds.

There is plenty of evidence to show that foxes are often destructive to bird life. It is easiest to get such evidence in the spring, when there are large families of hungry young foxes to be fed. At the mouth of a fox den at this season one may often see feathers, bones, and other remains of grouse, quail, and poultry. I once saw a fox shot just as she was about to enter her den with a grouse in her mouth. Foxes are wonderfully alert, sharp of ear, keen of sight and scent, quick on their feet, and very intelligent. If they were good climbers, they would be perhaps the worst enemies the birds could have. Even as it is they capture wild birds in many different ways. Sometimes they stalk them, and spring upon them as a cat might do, and a fox has been seen to take a quick run and a tremendous leap and catch a small bird on the wing. They will attack game birds on the nest, and their habit of capturing grouse which have been spending the night under the snow, has long been known. I once saw a fox barely miss capturing a grouse as it left its snowy shelter. Another method not so widely known, but which is apparently adopted by a good many foxes and possibly other animals,



RED FOXES DESTROY BIRDS BOTH OLD AND YOUNG

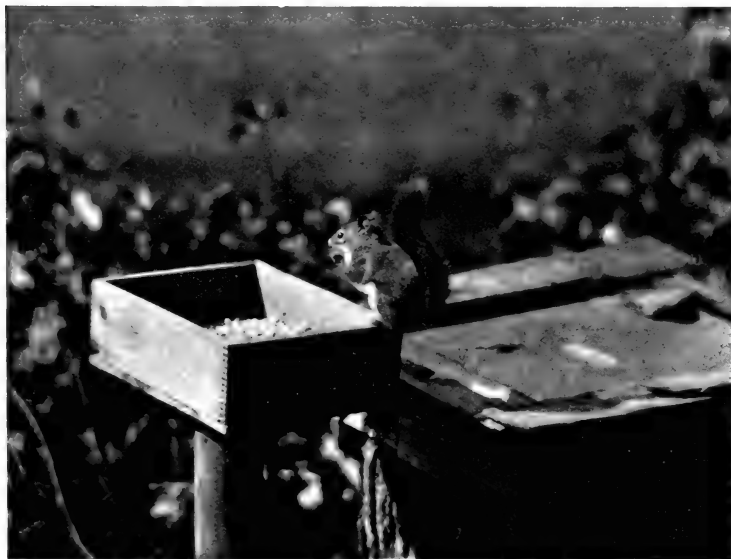

A RED SQUIRREL USURPING FEED-BOX AND BATH

consists in following the trail of persons who ramble in the woods and fields, apparently in the hope that they will lead to something desirable. Foxes are naturally curious, and have long been known to follow people seemingly to satisfy their curiosity. Now and then a fox comes upon the track of someone who has been visiting a bird's nest, and following it, finds that it leads to a meal of eggs or nestlings. Ever afterwards probably that fox will follow the trails of other human beings who cross his path, in the hope of similar pleasing results. So closely will foxes follow up clues of this kind that in some parts of the country to visit the nest of a ground-building bird is said to doom it to destruction. Personally I try to avoid going close to such a nest except when really necessary, for I greatly dislike to add to the many dangers which already surround the little home.

But foxes have many good points, which we sometimes overlook when speaking of their evil deeds. They eat great numbers of wild mice, so destructive to the crops and young trees, and possibly to birds as well. I have watched them for hours when they did nothing but catch grasshoppers, and it is well known that at certain times and places the much-hated woodchuck forms a considerable part of the fox's diet. Not

long ago I surprised a fox as he was eating a very large woodchuck. When he saw me he ran off with his prey, but I shouted at him and he dropped it. He had probably killed it the day before, eaten a part of it, and buried the rest, for it was rigid and had evidently just been taken from the ground.

Bears in the United States probably harm the birds very little; they are usually too slow of movement to capture anything that can fly, and the damage they do in this direction is probably limited to the devouring of eggs in nests which they happen to stumble upon. That at certain times and places bears may menace a colony of birds is pointed out by Dr. Charles H. Townsend who has kindly called my attention to Captain Cartwright's Journal of June 18, 1777, where it is recorded that polar bears were killed and their stomachs found to be filled with the eggs of eider ducks.

Raccoons eat a wide variety of food, of which in most places young birds and birds' eggs probably constitute only a small part. I doubt if they often capture full-grown wild birds. Waterfowl sitting on their nests may suffer in certain localities, and perhaps raccoons occasionally capture birds on their roosts at night. Comparatively slow-moving creatures, fond of fruit,

ripe corn, insects, crawfish, frogs, wild mice, and domestic poultry, they would as a rule be likely to destroy wild birds' nests only when they happened accidentally to find them. I once had two raccoons in a large pen in which I had placed a tree for them to climb. One morning, having a live crow and no special place for him, I put him in the pen with the raccoons. He flew about, made himself at home, and his hosts seemed barely interested in him. Ten minutes after dark I went to see if everything was all right and found nothing left of the crow but his feathers. A raccoon had probably climbed the tree after the bird had gone to roost, and either captured him where he slept or caused him to blunder to the ground in the dark.

Practically all members of the weasel tribe, including skunks and mink, are enemies of birds; most of them will eat the young and sometimes the eggs. Weasels are probably very destructive to birds, since they are extremely active and fearless, wonderful climbers and in the wild state almost wholly carnivorous. Moreover, they seem to kill for the love of killing, whether they are hungry or not, a fact testified to by many a farmer whose poultry yard has been visited by these blood-thirsty creatures. Weasels hunt by scent like hounds, and cover

great distances in a day, as anyone can prove for himself if he will try to follow the trail of one through the snow. To a certain extent, however, they are the friends of wild birds since they often kill other creatures, such as mice, rats, and squirrels which are also enemies of birds. A lady in Cornish, New Hampshire, tells me that she once saw a weasel chase and capture a chipmunk in an oak tree near her house and then leap some ten feet to the ground with the victim in its mouth.

A year or two ago the old farmhouse in which we are living had become infested with rats, when one autumn morning a white weasel or ermine appeared in the woodshed. For a day or two after that there was a terrible commotion in the walls and ceilings, as the weasel chased his squeaking prey from one stronghold to another to finally kill them after a last desperate scuffle. Then, when all the rats had been killed or driven away, the weasel came into the house and made himself at home. Mrs. Baynes was kind to him and he soon became tame, taking food from her hand and coming up into her lap to drink milk from a saucer. He stayed until spring, when he left the house never to return. In spite of the good services they perform, however, I should not consider weasels desirable neighbors for one

who was trying to attract birds to the home grounds.

Mink and skunks are probably much less destructive to bird life. In the first place neither of them climbs to any extent and their diet is more varied. The mink operates chiefly along streams and feeds very largely on fish, frogs, and other aquatic creatures. Nevertheless, Audubon states that in his day the mink in the salt marshes of the south lived chiefly on marsh hens and sharp-tailed finches, which they captured by springing upon them as a cat would do. It is also known that they kill young wild ducks, and Mr. William Brewster reports the destruction of a colony of bank swallows by mink.

Skunks are much slower in their movements than their cousins the weasels, and probably do much less harm to the birds. They seldom attempt to climb and on the ground they are neither clever enough to stalk a bird nor quick enough to run out and catch one. What damage they do is chiefly confined to the eggs and young of birds which nest on the ground. Even so, I should not regard the skunk as a desirable tenant in a bird preserve.

Wolverines, like bears, probably destroy such nests as they accidentally find, but these animals

are not numerous enough to constitute a serious danger to bird life.

Red squirrels are persistent robbers of the nests of small birds, in spite of the fact that this is disputed by certain well-known authorities. That some red squirrels do not have the nest-robbing habit is quite possible if not probable, but the fact remains that as devourers of eggs and young, red squirrels have few if any equals. The first time I ever saw a red squirrel interfere with a bird's nest was many years ago. I was attracted by the frantic cries of a pair of scarlet tanagers which had a nest in a pine tree in the garden. I rushed out to see what the matter was and discovered a red squirrel calmly seated on the edge of the tanager's nest and eating one of the eggs. He held it in his paws as he would a nut and he was losing some of the white which trickled from his jaws. I drove him away but he soon returned and I felt obliged to shoot him—the first creature of any kind which I had shot in fifteen years. Since then I have known so many nests to be destroyed by red squirrels that I will not allow one of these animals in my garden or in any other place where I am trying to attract birds. My friend Frederic H. Kennard, a trained ornithologist and a careful observer, has many times seen red squirrels destroy the

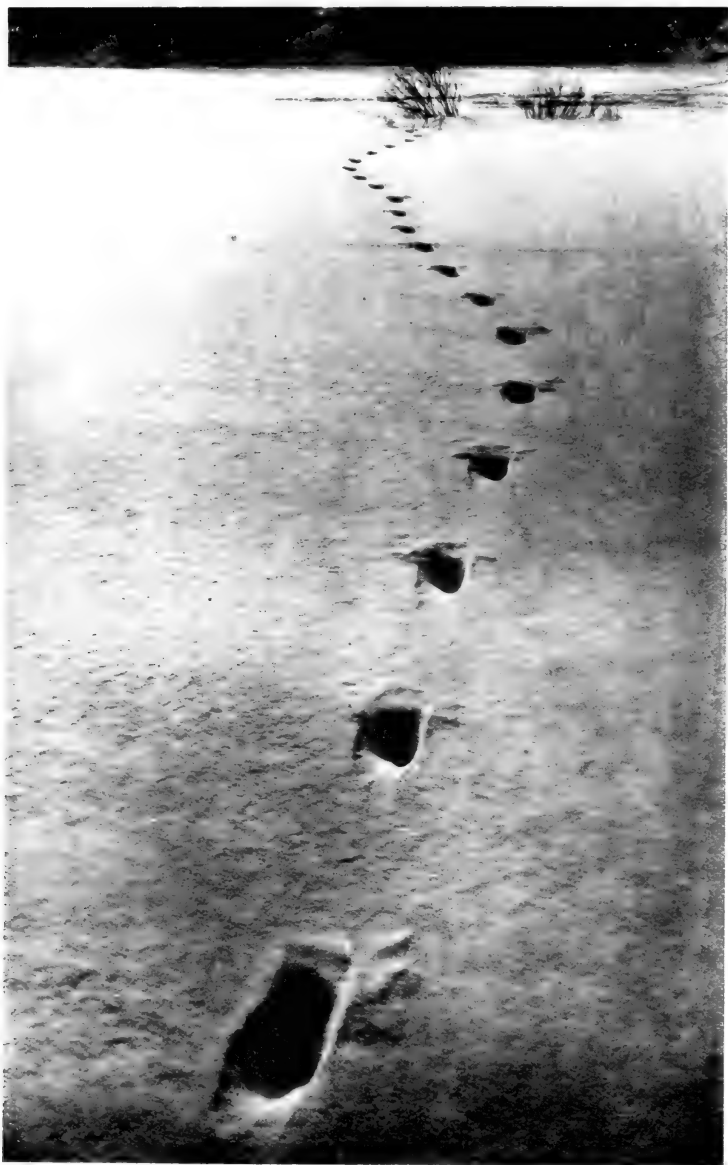

TRACKS OF A MINK



homes of birds. Such destruction has been seen by many other naturalists, some of whom have seen red squirrels bite off the heads of young birds and eat out the brains as they would eat the meat out of a nut.

Gray squirrels as a rule are not so destructive, but there is positive proof that some of them at least destroy birds' nests, and when they become numerous in a particular locality and when other food becomes scarce, probably they do not hesitate to eat either eggs or nestlings.

Chipmunks often destroy the nests of birds which build on or near the ground or in artificial arbors, and have been seen carrying off young birds in their mouths. Usually they do not climb enough to disturb birds which make their homes in trees.

Flying squirrels are gentle little creatures which probably seldom if ever destroy eggs or young birds, though they often make their homes in deserted birds' nests, in hollow trees, and even in nest boxes.

Muskrats are said to eat the eggs of birds nesting near water and in the marshes, but though I have lived where muskrats were plentiful, I have never seen any evidence of it.

That common rats are often very destructive to the eggs and young of domestic poultry is

well known, and there seems to be no good reason to believe that they would spare any young wild birds which they found unprotected. They are excellent climbers, our native black rat being almost the equal of a squirrel in this respect.

Whether our wild mice and shrews are destructive to bird life or not is a question on which we have little information. They are all more or less carnivorous, and white-footed mice at least are wonderful climbers, using their tails as well as their clever little feet. The dormouse of Europe is known to be destructive to birds, and it would be rather strange if creatures so similar in other habits were entirely guiltless of nest robbing.

Much of what has been said about raccoons may be said with equal truth about opossums. While not among the principal enemies of birds, it is safe to say that they destroy practically all nests which they discover in their daily search for food.

Many birds prey more or less upon other birds, but comparatively few seriously reduce the bird population.

Shrikes, especially northern shrikes in winter are sometimes very destructive to small birds. Some observers state that shrikes make a specialty of killing European sparrows, and to whatever extent they do this they are friends of

our native birds. But that they do not confine themselves to sparrows there is plenty of evidence. In the village of Meriden, New Hampshire, where we make special efforts to attract birds by feeding them in winter, shrikes cause us a lot of trouble. One winter we fed great numbers of pine grosbeaks. They are naturally fearless birds and became very tame under kindly treatment. The shrikes were so bold that they would attack the grosbeaks under our very noses. A neighbor, Mr. Lewis Stickney, who fed a large flock of birds, saw a shrike kill two in his garden. One of these was feeding on the window-sill under the roof of the piazza. Though the shrike was possibly an inch and a half the longer of the two, it could hardly have been so heavy as the plump, well-fed grosbeak, yet the butcher bird actually carried off its victim. After carrying it for a few feet he dropped it in the snow, picked it up, dropped it again, and then perhaps getting a firmer grip, carried it for fully four hundred feet before disappearing. I have been obliged to shoot several shrikes in my own garden where they come for the chickadees and other small birds which we always have in numbers. I once saw a shrike pursue a chickadee from point to point in the bushes until the little titmouse lost his head and flew

out over the open country. The shrike was after him instantly and quickly overtook him and bore him to the earth. And it is very apparent that the small birds know their enemy and fear him. As soon as he is seen, the pine grosbeaks fly up in alarm and scatter to the four winds; but when some chickadee gives the frightened squawk which in winter usually means a shrike, nearly all the other chickadees "freeze" wherever they happen to be—in a food house, the window box, or in the shrubbery. And they often remain rigid for as much as five minutes or more, allowing us to go close up and photograph them with the camera only a few inches away.

Grackles are well known to be persistent robbers of nests. Where there are large colonies of these strange-faced, yellow-eyed birds it is probable that many nestling songsters are taken to feed the young grackles.

That blue jays are even more destructive is the belief of many observers. One famous ornithologist told me recently that it was his private opinion that every individual blue jay was a nest robber, and if he is even nearly correct, the loss of bird life from this one cause alone must be considerable, for in the greater part of eastern North America the blue jay is a common bird.

Crows, useful as they are at most seasons, often get the nest-robbing habit, and when they do they become a source of great distress and disaster to the small birds. A few of these, like the kingbird and red-winged blackbird, seemingly by the great vigor of their attacks, are able to drive the crows away, but many others fail to do this and their nests are pillaged with impunity. Many a time in the breeding season have I seen a crow sneaking through the trees and bushes where he had no legitimate business, evidently hunting for birds' nests, but with no positive evidence against him until the frantic cries of parent birds called attention to the thief flying off with the nestlings in his bill. Not long ago a crow came into a garden on the main street of Meriden, and was seen flying off with his bill filled to overflowing with young robins. He had carried off the whole brood at once. Not all crows perhaps have the nest-robbing habit, but those which do are not only destructive themselves but may possibly spread the habit among their brethren.

Some of the owls also are destructive to smaller birds, but usually their vices are not unmixed with virtues. For instance, the great horned owl, while he sometimes kills crows and grouse and other useful birds, is a notorious

destroyer of skunks, and probably weasels, and other bird enemies. The screech owl undoubtedly kills many small birds, some no doubt while they are asleep on their roosts; others are probably dragged from their nests. From the wing and tail feathers often found in the nests of screech owls it would seem that they capture a good many flickers.

But of the birds of prey in this country, Cooper's hawk and the sharp-shinned hawk are perhaps, all things considered, the very worst. Not only does each individual kill and devour a great number of small birds, but these hawks are common over a wide range and thus constitute a serious check upon the increase of other birds. There are several other kinds of hawks, the duck hawk, for example, which are just as savage and individually just as destructive, but they are uncommon and therefore have but slight effect on the bird population of the country.

The sharp-shin is a small, silent, fast-flying hawk that suddenly appears seemingly from nowhere, descends like a flash of lightning upon some small bird in the grass, or dashes into the foliage of a tree or bush to emerge a moment later with a limp song sparrow, thrush, or other little songster in his talons. In a field close to my house I saw a sharp-shinned hawk catch and



A SKUNK WILL EAT YOUNG WILD BIRDS AS WELL AS HENS



"ADVANCING DEATH." THE WHITE WEASEL, OR ERMINE



kill a blue jay almost as large as itself and several times I have shot one of these birds as he was pursuing bird guests in my garden. Dr. A. K. Fisher, the great authority on American birds of prey, reports that he has examined the stomachs of 159 sharp-shinned hawks. Fifty-two of them happened to be empty but of the one hundred and seven which contained any food, there were poultry or game birds in six and other birds in ninety-nine. It is true that six of these hawks had also eaten mice and that five had eaten insects, but this does not alter the fact that the principal food of practically all those hawks consisted of birds.

The habits of Cooper's hawk are much the same as those of the sharp-shin, and he is worse simply because he is larger, more destructive to poultry, and needs more birds to satisfy his appetite. I once examined the stomachs of five Cooper's hawks—a female and her four young—in one day, and every one of them contained parts of small birds. Most of our hawks are very useful but many of them suffer severely for the sins of these two.

Snapping turtles, which often grow to a large size, are said to be destructive to waterfowl on ponds and rivers. I have been told by poultry keepers that these powerful reptiles will seize

ducks by the legs and drag them under the water. Mr. E. A. Quarles, an officer of the American Game Protective and Propagation Association, told me of a snapping turtle which he knew had killed fifteen young wood ducks, and Mr. C. H. Pease of Canaan, Connecticut, showed me a photograph of a full-grown duck which he and his wife had seen mangled and killed by a snapping turtle. The duck was feeding with its head under the water, and the reptile seized the head in its powerful jaws and crushed it.

Snakes are notorious devourers of young birds. They are splendid climbers and thus are able to rob nests built in trees and bushes as well as those on the ground. The skulls of snakes are loosely put together and the muscular tissue which binds them is very elastic. This permits them to be stretched to an almost unbelievable extent and is the secret of a snake's ability to swallow creatures much larger than his own head. I once caught a milk snake at a catbird's nest with a fully fledged young catbird just disappearing down its throat. Needless to say the meal was interrupted. The snake, which I afterwards measured, was twenty-seven inches long. The common black snake, perhaps because of its large size, is one of the most destructive. Some years ago I was approaching a

clearing in the woods when I heard two parent song sparrows uttering frantic cries, and as I came up I saw a large black snake make off and disappear under a pile of brush. Close to the point where I had first seen it, lay a fledgling song sparrow, which the snake had just prepared for swallowing. Its body seemed to have been squeezed out until it was long and narrow and it was wet with the slimy saliva with which some snakes cover their prey before swallowing it.

Large bullfrogs have been known to swallow young birds, but I do not believe that they are anywhere a serious menace to bird life.

Pike and certain other large fish sometimes capture waterfowl and at certain times and places may be very destructive. Edward Howe Forbush once saw a pied-billed grebe which was watching a hawk, spring out of the water to escape a pickerel which had tried to seize it by the feet.

One might think that with so many natural enemies, and with the wholesale destruction of bird life by the elements, there would soon be no birds left. Yet it is a fact that all the storms that sweep the earth and all the natural enemies, including savage people, would seldom make any lasting impression on the normal bird population, if it were not for civilized man and his works.

To be sure some kinds of birds become very much reduced in numbers owing to severe storms, but these very disastrous storms do not occur every year and in the meantime the natural increase makes up the losses. And among the birds and their natural enemies, nature preserves so nice a balance, that as a rule no one species gets very much ahead of another until civilized man steps in. Civilized man has many needs and many desires and displays great ingenuity in supplying the needs and gratifying the desires. When these needs or desires involve the destruction of animal life, the fine balance which would otherwise be preserved by nature is apt to be destroyed, and the next chapter will tell some of the ways by which civilized man becomes directly and indirectly, perhaps the most dangerous of all bird enemies.

CHAPTER IV

DESTRUCTION OF BIRDS BY MAN

SAVAGE tribes not influenced by civilization seldom cause a serious decrease in the numbers of birds about them. They usually kill only what they need for their own immediate use—as food and clothing and to a smaller extent ornament, and even though they may not be restrained by feelings of humanity or a desire to be provident, their weapons are usually so crude that they cannot inflict wholesale destruction upon any species. Sometimes, as in the case of the Esquimaux, they gather large quantities of the eggs of certain kinds of birds, but usually these birds are present in such vast numbers, the Esquimau population is so small, and the other bird enemies so few, that no noticeable impression is made upon the colonies of little auks and other birds whose eggs are taken.

But when civilized man creates a market for the flesh or plumage of the birds hunted by the savage, the latter is often urged to help to

supply that market. Then he may become a very dangerous enemy of the birds. When he has supplied his own needs, his work is not done; it is never done; he has those big markets to supply, and the more birds he kills the more he will be paid for, so it is to his advantage to kill all he can. And he goes on killing until there are no more birds to kill, or, until for some reason there is no more demand for them and therefore it no longer pays him to kill them. The head-hunting natives of Borneo and other islands of the same group have hunted and killed the wonderful birds of paradise to supply feathers for women's hats until some species are extinct and all others in danger of extinction.

But as destroyers of bird life civilized men are infinitely more dangerous than savages. Their most peaceful activities mean serious interference with the birds. They begin to clear the land of the forests growing upon it and the homes of millions of birds go down before the axe. They drain the marshes and vast numbers of other birds are not only driven out of their homes, but are deprived of their favorite feeding grounds. They erect lighthouses which every year lure thousands of birds to their destruction. The light on the Statue of Liberty in New York Harbor has been responsible for great loss of bird



THE SNOWY OWL IS PARTIAL TO WATER FOWL

life. It is said that on one morning soon after its erection, there were picked up at its base one thousand four hundred birds which had been killed the night before.

The thousands of miles of telegraph, telephone, electric light, and trolley wires, stretched in every direction across civilized countries, kill many birds which accidentally fly against them. More than once I have picked up dead snipe immediately below telegraph wires, and a neighbor recently picked up a badly wounded woodcock beneath the telephone wire in his garden. Tall wire fences are another cause of destruction. Close to a small inclosure one hundred feet square and surrounded by wire netting six feet high, I picked up in one summer five dead or wounded birds. The eight-and-a-half-foot wire fence surrounding the Corbin Game Preserve in New Hampshire probably accounts for the lives of many birds every year. I walked around it one day and in the twenty-seven miles I flushed a number of ruffed grouse. Five of them dashed right into the fence, some of them with such force as to leave tufts of feathers clinging to the wires. None of these birds happened to kill itself, but employees of the Corbins tell me that they have many times picked up dead grouse along the fence. A few days ago a boy working

on the road near the Park brought me a dying hermit thrush which he thought had been injured in this way.

Then civilized man is chiefly responsible, either directly or indirectly, for the terrible forest fires, which not only destroy the homes and food supply of millions of birds, but at times, as in the nesting season, must cause the immediate destruction of all young birds within the burning area and probably many of the old ones as well. Perhaps even greater destruction is wrought by the great autumn fires, which lure hosts of migrants to their doom. They become bewildered and fall into the flames. Not long ago, Mr. Nathan C. Schaeffer, Superintendent of Public Instruction, made an earnest appeal to the school children of Pennsylvania for help in the prevention of forest fires. He pointed out many of the evils of such fires and among them the fact that they destroy "all the birds' nests and their eggs and the young birds."

Of course much of this destruction is not to be avoided. We must clear the land in order that we may have farms and cities; we must drain the marshes for the same reason and as a matter of public health, and the lighthouses, telegraph wires, and fences follow as a matter of

course. Fires are unnecessary and often avoidable, but even these are generally the result of accident and are comparatively seldom set with any intention to injure the birds.

Nor are men to blame for killing such birds as they actually need for food. The early settlers were obliged to hunt in order to live, and waterfowl and what are commonly known as game birds played an important part in saving our ancestors from starvation. In those early days wild ducks and geese, wild turkeys, wild pigeons, grouse, and quail were here in countless numbers, and as the number of people in the country was for a long time comparatively small, the birds they took for food were never missed from the numberless flocks and coveys which dotted the waters and swarmed in the forests. In fact for many years the settlers might have been counted among the friends of the birds, because they also killed off mountain lions, wild cats, wolves, foxes, raccoons, opossums, and other natural enemies that would doubtless have destroyed more birds than were taken by the hunters. But gradually, very gradually at first, the tide changed against the birds. As more and more people thronged to our shores, more and more food was needed to sustain them. Birds were easy to get and cheap to buy and they were

killed and sold. Hundreds of towns and cities grew up, great markets were established, and more and more gunners took the field every year in order to supply those markets. Professional game dealers came into existence and professional market gunners took up their trade and saw to it that they were well supplied with birds. At first the game dealers would not buy more than could be used within a few days, that is before it spoiled, but presently the system of cold storage was invented and there seemed to be no limit to the quantity which would be bought and stored away. Another class of men, the sportsmen, also began to kill the birds, not because they actually needed them for food but because they found pleasure and recreation in hunting them. Nor were the game birds the only ones to suffer. With the coming of certain fashions in dress came a demand for bird plumage for women's hats and another class of bird killers, known as plume-hunters, sprang into existence. These men made a practice of shooting any kind of bird for which the milliners had a market. At one time it was grebes, at another gulls and terns, snowy herons, or bright-colored song birds like orioles and scarlet tanagers.

To supply this ever-increasing army of shooters great gun factories were established and the

ingenuity of many inventors was applied to the making of more effective guns—weapons with which men could kill more birds. The old flint-lock was replaced with a more reliable gun discharged by means of a cap. The muzzle-loading gun gave way to a breech-loading gun, which could be fired three times as fast. Then came the double-barrelled breech-loader, nearly twice as deadly as the single-barrelled, and this was followed by the “pump” gun and automatic shot guns said to be about ten times as effective as the old muzzle-loader.

Before these weapons in the hands of thousands of men, the wild fowl disappeared like snow before a summer wind, some of them never to return. The great auk, a flightless sea-bird inhabiting the coasts and islands of the North Atlantic, was the first to become extinct. From early times it had been the victim of attacks by voyagers and fishermen who killed it for its flesh, feathers, and oil. The fact that it nested in large colonies and that it could not fly resulted in its being destroyed in great numbers. It held its own fairly well, however, until its plumage came into demand for feather beds when it disappeared. No living specimen has been seen since 1842.

The Labrador duck was the next to go, but in

this case the cause of extinction is not known. Probably it was never a very numerous species. The gunners may have had something to do with its disappearance, for about the middle of last century it was often seen in the markets. It was not, however, considered very desirable for food, and it is hardly likely that there was sufficient demand for it to endanger its existence. Possibly it was wiped out by some disease such as the epidemic which has recently played such havoc among the wild ducks and other marsh birds in Utah and which we shall speak of elsewhere. But whatever the cause, no living Labrador duck has been seen since 1871.

The extermination of the passenger pigeon, however, was wholly due to the selfish greed of man. It is said that in the early part of last century this was probably the most numerous bird on the North American continent. In order to get a faint idea of the numbers of the passenger pigeon in the time of Alexander Wilson, the ornithologist, let us imagine, if we can, just one such flock as he observed near Frankfort, Kentucky, about 1808. The birds moved in a column, whose front was more than a mile in width, and, flying at the rate of a mile a minute, they took four long hours to pass. Wilson, who was an accurate observer, after a careful calcu-

lation, estimated that this one flock contained at least two billion, two hundred and thirty million, two hundred and seventy-two thousand pigeons.

Audubon also gives a grand account of the armies of the passenger pigeon as observed by him. In 1813, while riding from Henderson to Louisville, he noticed the pigeons flying over in even greater numbers than usual, and dismounted that he might attempt to count the number of detached flocks which passed him in an hour. In twenty-one minutes he gave up the task as impracticable. He says, "I travelled on, and still the air was literally filled with pigeons; the light of the noonday sun was obscured as if by an eclipse, and the continual buzz of the wings had a tendency to lull my senses to repose." It would seem that nothing man could do would greatly diminish such countless multitudes as these, especially when Audubon assures us that they at least doubled their number and not infrequently quadrupled them yearly. But alas, the pigeons were easy to get, they had a market value, and it was not against the law to kill them, and this combination would have insured their extermination had there been a hundred times as many. The fact that they roosted and nested in vast densely-packed colonies greatly simplified

matters for the destroyers, and though the birds were killed wherever they were seen, the great slaughters occurred at the roosts and at the nesting grounds.

In the time of Wilson and Audubon, one single colony of pigeons would sometimes occupy a forest forty miles long and perhaps three to four wide, every available tree of which would be laden to the breaking point with the nests. Wilson counted upwards of ninety nests in a single tree, and some trees contained more than a hundred. Each nest soon contained one or two fat squabs. Every morning the parent birds started for their feeding grounds, vast forests of beech or oak trees perhaps, possibly two or three hundred miles away; and from noon until late in the afternoon they came pouring in with well-laden crops. Then the pigeon harvest was ripe, and armies of people, men, women, and children from the surrounding country, came in to gather it. Some brought tents, that they might camp upon the scene, and others came with sacks, baskets, and barrels, in which to collect the spoils, and horses and wagons with which to remove them. Then began a fearful massacre, in which no one thought of anything save how he could secure the greatest number of pigeons in the shortest space of time. Some used guns, others clubs or long

poles with which to beat down the frantic pigeons, and still others suffocated the birds with pots of burning sulphur. The fat squabs in the nests were considered even more desirable prizes than the old birds, and scores of men spent their entire time in throwing to the ground, by means of long poles, all the nests within reach. Others, for whom this method was too slow, attacked the trees with axes, bringing down a hundred nests at once.

Eye-witnesses testify that the spectacle was an awful one. Savage Indians, and still more savage white men, with many women and children, all engaged in killing birds. With hands and faces smeared with blood, and with feathers sticking in their clothing, many of them looked scarce human in the uncertain light, as they ran back and forth over the slippery ground, shouting at the tops of their voices in order to make themselves heard above the thundering roar created by the wings of millions of pigeons. All night long this awful slaughter continued, and at dawn the woods were seen to be carpeted with dead and dying birds. Sneaking away through the shadows of the woods could be seen the dim forms of mountain lions, foxes, wild cats, skunks, and other night prowlers, and then in the air would appear eagles and

hawks and vultures coming for their share of the feast.

The slaughtered pigeons were gathered up and piled in heaps until everyone had all he could cart away, and then droves of hogs, sometimes driven from long distances, were turned into the woods to fatten on the remainder.

Year after year the massacres were repeated, the unfortunate pigeons being followed from one breeding ground to another, and that they were not exterminated years ago, is due solely to the fact that the remaining few became so scattered that it no longer paid anyone to pursue them.

In addition to those destroyed at the breeding grounds, hundreds of thousands of old birds were trapped in "clap nets," upwards of three hundred sometimes being taken in a single haul, and one man being able to catch perhaps six thousand in a day. Many were sent by schoonerloads to New York, where they were sold at one time for one cent apiece, and they were so cheap in some places that the hogs were fed on them.

They have gone, and America has nothing to show for her loss unless it be additional proof of the fact that no bird, no matter how numerous or how prolific, can long hold its own if it is repeatedly attacked on its breeding grounds.



THE RACCOON DINES ON BIRDS WHEN HE CAN

Several attempts were made to save the passenger pigeons by rearing flocks of them in confinement, but these attempts served only to postpone for a few years the absolute extinction of the bird. A flock was established at Woods Hole, Massachusetts, for a time by Professor C. O. Whitman of Chicago University, and another occupied a large cage in the Cincinnati Zoölogical Park, where I have several times visited what is believed to have been the last survivor of its race. This bird, a female, was in captivity for more than a quarter of a century and died only recently.

The Esquimau curlew is now believed to be extinct or nearly so, and again the selfishness of man is to blame. This curlew was, as its other common name, dough bird, implies, a delicious table fowl, and its demand for the market was the chief cause of its extermination.

Though its actual numbers were probably never so large as those of the passenger pigeon, they must have been very great. Dense flocks of these birds said to contain millions were often reported at points along the Atlantic coast during the earlier half of last century, and an immense flight in Labrador in 1833 actually reminded Audubon of the passenger pigeon itself.

The Esquimau curlews nested from Alaska to Labrador, the favorite breeding place being the Barren Grounds of Northwestern Canada. They wintered in Argentina and Patagonia, and every fall the birds appeared in almost unbelievable flocks in Labrador and Newfoundland and the Magdalen Islands, where the fishermen killed great numbers and salted them down in barrels. The curlews then proceeded to Nova Scotia where they left the land and headed for South America by way of the West Indies. On the Magdalen Islands and perhaps elsewhere they roosted in dense masses on the high beach, and men armed with sticks and carrying lanterns to dazzle the birds slaughtered them by wholesale. Nor did they receive any better treatment on the New England coast, where after buffeting a cold northeast storm until they were exhausted, they alighted in misplaced confidence to rest. Their arrival was the signal for men and boys to chase and beat them down with clubs, or for the market-hunters and other gunners to shoot them as long as one remained on shore. In 1872 they were killed in such numbers on Cape Cod that the boys sold them as low as six cents apiece. Even at such prices some of the market-hunters sold hundreds of dollars worth. It is little wonder that the curlews at last learned to shun

the New England coast as a deadly region, to be visited only at night and then only when they were too exhausted to continue their flight.

After spending the winter in South America, the dough birds went back to their northern homes by a different route, by way of the Gulf States, and in the spring months were seen in great numbers on the western prairies and in the Mississippi Valley. But they fared no better in the west than they did in New England and were massacred wherever they went. If one was wounded and cried out, many of its companions would at once come and hover over it, and this habit must have helped in its destruction by cowboys and others.

The Esquimau curlew was doomed. Its numbers began to diminish rather slowly at first, but rapidly later on. The great flights became less and less frequent and smaller and smaller in size until at last they ceased and the bird is now believed to be practically extinct. Specimens are still shot occasionally; an individual was taken as late as September 5, 1913, at East Orleans, Massachusetts.

Besides these birds which have gone forever, there are a number more which have been persecuted until they have disappeared from the greater part of their former range and in some

cases are so reduced in numbers that they will probably soon be extinct. Among these are the trumpeter swan, the whooping crane, and the Carolina parakeet. The last named is believed by some authorities to be extinct already, but Frederic H. Kennard, in a recent visit to Florida, satisfied himself that there are a very few left in that State. He did not see the birds, but by carefully sifting the evidence of a number of residents, he learned of the existence of at least seven individuals. According to Frank M. Chapman, the extermination of the parakeet was due chiefly to four causes. He says, "first, it was destructive to fruit orchards, and for this reason was killed by agriculturists; second, it was trapped and bagged in enormous numbers by professional bird-catchers; third, it has been killed in myriads for its plumage; and fourth, it has been wantonly slaughtered by so-called sportsmen. In short, in the present century, the parakeet has always disappeared soon after its haunts were invaded by civilized man."

There are many other birds which have been reduced in numbers to the danger point, but I will mention but two more—the great white heron and the snowy egret, both of which were once distributed over a wide range extending from Northern South America to New England,

and which were numerous in many places such as Florida and the Mississippi Valley. They have been extirpated over a very large part of this range and that they are not extinct is due to the passing of rigid laws for their protection, to the setting aside as bird refuges by executive order, certain suitable tracts of lands where the birds might live and nest in peace, and by the patriotic efforts of a few private individuals who have established sanctuaries for the herons.

The curse of these birds was the beautiful plumes or "aigrettes" which they wore only in the nesting season and which for this reason have often been called the "bridal" plumes. The story of the destruction of these herons for their plumage is perhaps the most disheartening and certainly the saddest of any connected with the killing of wild birds in this country. The herons nested in large colonies and the men employed by the feather dealers to obtain the plumes, would visit these colonies when the nesting season was at its height and when the mother love of the parent birds was so strong that no amount of shooting would make them leave the place. Here, usually with small noiseless rifles, the herons were shot down as they came in from the feeding ground with food for their young, as they sat upon their nests, or some-

times as they came in attracted by a wounded comrade tied to a stake in the swamp as a decoy. The plumes were then stripped from their backs and the bodies left to rot. Sad as this is, it is by no means the saddest part of the story. The young birds which occupied most of the nests at this season, and which were of course entirely dependent on their parents for food, were left to starve to death after pitifully calling, sometimes for days, for their parents who lay in the swamp beneath with their backs torn out, that women might wear the looted plumes in their hats.

If anything could be more outrageous than this, surely it is the recent massacre of birds on the Island of Laysan. In order to give an intelligent idea of this affair, it is necessary to say a few words about the island itself.

To most of us the word "Laysan" means little if anything more than a tiny dot on the map, indicating the position of a wee coral island in the Pacific about eight hundred miles northwest by west from Honolulu; but to the men who have been there, the mere mention of it brings to the mind a hundred pictures representing the joys and sorrows, the festivals and the tragedies in the lives of myriad birds which comprise perhaps the most unique community of feathered beings on the face of the earth. It is one of many tiny

islets, rocks, and reefs, which like so many truant children, straggle off from the main Hawaiian group in the direction of Japan; specks of land insignificant enough perhaps when judged by human standards, but great residential centers and nurseries for the unnumbered sea-fowl which call them "home." The great white albatross, King of the Pacific, whom we see on tireless wing, levying tribute on the very borders of his domains, carries in his brain a chart of these islands, and he has his capital at Laysan. How long this islet has been inhabited by its feathered population no man can tell, but doubtless for ages. Small as it is, barely three miles long, it was a few years ago the home of millions of birds, including five species found nowhere else in the world. Practically every square yard was occupied, and thousands of late comers were obliged to go away because there was no room for them. In fact there are so many bird homes on Laysan, that the tenants are obliged to live in tenement fashion, some underground in burrows, others on the surface, and others still in the bushes above. And quite unlike other bird homes, these are used all the year round; not by the same tenants to be sure, for at the very moment when the families of one species are ready to move out, those of another species are

waiting to move in. There is no "quiet" season in Laysan; it is the scene of strange and ceaseless activity from year's end to year's end, forever.

This, in a general way, is the impression I got from a story told me by Mr. Walter K. Fisher, the ornithologist who formed one of the party aboard the U. S. Fish Commission Steamer *Albatross*, which from March to August, 1902, was engaged in deep-sea explorations among the Hawaiian Islands.

Standing on a pile of phosphate rock not far from a little pond, one could overlook the largest colony of white albatrosses on the island and probably the largest in the world. At certain times of the day this whole section was literally white with the snowy plumage of these great sea-birds, actually numbering more than a million individuals. Overhead one might see and hear tens of thousands of terns, apparently all screaming at once and creating such a volume of bewildering noise that one was obliged to shout in order to make oneself heard. In another part of the island there were colonies of the black-footed albatross, which while not so numerous, would have been considered remarkable almost anywhere else but in Laysan. Birds' eggs were everywhere, and it was practically impossible to move about without de-



THE OPOSSUM WILL DESTROY BIRDS AND EGGS



stroying some. They were in the grass and the bushes, on the ground by hundreds of thousands, and in many places it was difficult to walk on account of the burrows of petrels and shearwaters into which one would sink to the knees at almost every step. There were birds overhead, birds under foot, peering from every bush and from behind every tussock of grass, scuttling about over the ground after food or with flopping wings attempting to lead the stranger from the vicinity of their homes. Red-tailed tropic birds, boobies, man-o'-war birds, rails, teal, bristle-thighed curlews, golden plovers, trunstones, honey-eaters, finches, and miller-birds, each species busy with its own affairs, which not infrequently involved interference with the affairs of others.

And more remarkable perhaps even than the great numbers of the birds was their tameness. The great albatrosses would literally meet a visitor half-way and gather about him, gently examining the texture of his clothing with their bills and in other ways seeming to take as much interest in his affairs as he did in theirs.

Mr. Fisher's experience with the Laysan rail will give some idea of how trustful of man birds may be if they never have cause to regard him as an enemy. This tiny brown bird is flightless; its wings are not used at all except when the rail

is hopping to a perch or hurrying very fast, at which times they are spread somewhat as a domestic fowl's wings are spread under similar circumstances. On one occasion Mr. Fisher was about to photograph the nest and eggs of one of these birds and for this purpose had parted and propped back the juncus stems which hid it from view. As he was about to make the exposure, and with the camera only two feet away, the little rail hopped back into the nest and in a business-like way began to cover herself up with the soft lining. Mr. Fisher photographed her several times, but then desiring to get the picture of the nest and eggs, he lifted her off, but at once she slipped back and defeated his purpose. Then with the black cloth he chased her away into the tall grass a short distance, and hastened back to the camera, but the little rail, as though determined that he should not get that picture if she could help it, came skipping back and was into the nest again before the exposure could be made.

It would seem that here at least was a colony of birds that need not fear the destructive hand of man. They had sought a refuge hundreds of miles from civilization, and by their presence and their activities had made an insignificant little island into one of the wonder spots of the world.

Beautiful, trustful, and defenseless, these inoffensive creatures make a direct appeal to every decent instinct, but as far as the plume-hunters were concerned, the appeal was made in vain. In the spring of 1909 a party of twenty-three of these cold-blooded men landed on Laysan, and began a work of slaughter which for heartless cruelty has perhaps never been equalled by anyone else engaged in this cruel business. Apparently it was their intention to kill all the birds on the island and they actually succeeded in butchering three hundred thousand of these innocent creatures before the United States Government, in prompt response to a telegram from Professor William A. Bryan of Honolulu, sent the revenue cutter *Thetis* and stopped the killing. Sad and almost unbelievable sights greeted Captain Jacobs and the men of the *Thetis*. Several acres which had been the site of teeming colonies of industrious happy birds, were strewn with bones and dead bodies. Car loads of feathers, skins, and wings were ready for shipping, and thousands of other wings were piled in a shed, and it is the bitter truth that many of these wings had been cut from the bodies of living birds which had then been allowed to run away to bleed to death. But the wretches who did this thing—I cannot bring myself to call them men—

went farther than this. They put hundreds of sea-birds in a dry cistern and allowed them to slowly starve to death, because in starving they would use up the fatty tissue stored next to the skin, leaving the skin free from grease and therefore much easier to prepare. These birds were tortured to supply the millinery trade which some people still dare to uphold; and the millinery trade required them because thoughtless women insisted on wearing these badges of cruelty in their hats.

When I see women wearing the plumage of wild birds, I wonder if they have normal brains, or indeed whether they have any brains at all. It seems impossible that they should, in this day, still be ignorant of the misery they are causing, and it seems equally impossible that if they do know it they can be so heartless as to uphold and prolong the cruel fashion.

Fortunately many good laws have recently been passed in this country to protect the wild birds formerly used for millinery purposes, and when the other civilized governments are ready to coöperate with our own we can have an international law which will practically put a stop to this traffic in wild-bird plumage. But it cannot be flattering to the women who persist in wearing plumage, to realize that it is necessary

for men to make laws to force them to give up a cruel practice.

But it is not the plume-hunter alone who is causing our remaining wild birds to disappear; there are many other kinds of hunters. Of these one of the worst is the so-called sportsman. I use the word "so-called" to distinguish him from the real sportsman who is one of the best protectors of birds we have. The real sportsman is the man who is fond of the woods and fields, and streams, and lakes, and who, when game and fish are plentiful likes to get a little for himself or a friend, but who, when game shows signs of decreasing, does his best in every way to protect it and insure its increase. The "so-called" sportsman often seems to forget that anyone else has an interest in the game; he sometimes acts as though he owned it all, and proceeds to take it all or as nearly all of it as he can get. It never seems to occur to him that there is a limit to the number of birds which it is fair for him to shoot, even when they are plentiful, or that he should refrain entirely from shooting when they are scarce. He fights to prevent the passage of any good law which may be framed with a view to saving the sorely harassed birds, if it in any way interferes with his own pleasure. He shoots all the birds the law permits him to,

even when he knows that the law is unfair to the birds and that they cannot hold their own against it. If there is no law to stop him he kills all the birds he can, and resorts to the use of automatic and pump guns and other unfair weapons because it is not "sport," but birds, that he is trying to get. With such weapons as these in a place where birds are plentiful, a man can kill from two hundred to four hundred wild ducks or wild geese in a day. The damage which can be inflicted on game birds and waterfowl by this class of gunner has been greatly increased by the invention of the automobile and the power boat, both of which enable him to hunt over a vastly wider field in a given time than was possible before.

As a destroyer of game birds the market-hunter is perhaps the worst of all. Most other gunners go hunting occasionally or for a few days at a time, but the market-man makes a business of hunting and if the law permits goes out every day as long as there are any birds left to shoot. Of course he uses the automatic and pump shot guns, because with them he can get more birds and more birds to him mean more money.

The farmers are to a large extent responsible for the great decrease among our birds of prey. They are not the only ones to blame for there are

many gunners who cannot resist the temptation to shoot at large, conspicuous birds of any kind. But the farmers, more than any others perhaps, kill hawks and owls more or less systematically, because they believe these birds, one and all, to be destroyers of poultry. In one way it is quite natural that they should believe this. It is easy to notice a hawk come down into one's poultry yard and fly away with a hen or even a chicken which one knows by sight. And it is easy to appreciate the loss because it is immediate and definite, the value of the chicken being known. But it is much less easy to keep in sight that same hawk or another, as day after day he picks up mice in the distant fields. And though the gain to the farm through the destruction of the mice may be many times greater than the loss sustained by the killing of the chicken, the exact amount of it is not known to the farmer and moreover he does not get it at once. The one thing that is really clear to him is that a hawk has caused him a loss, and without looking any farther he decides to prevent losses of that kind by killing every hawk he sees. When laws are passed to prevent the killing of birds, he sees to it that the hawks are not included in the list of birds protected by it, and sometimes he goes farther than this and demands that a reward or

bounty be paid by the state for every hawk killed.

The foreigners who come to our shores from countries where people are not taught to respect the rights of birds, are another great menace to our feathered neighbors, especially to the song birds. The lower classes of Italians are among the worst of these offenders, and it will help us to understand the problem if we glance at conditions in their own country. In Italy not even song birds are protected. In addition to what we call game birds, thrushes, skylarks, goldfinches, redstarts, siskins, crossbills, woodpeckers, nuthatches, titmice, warblers, and scores of others, are regarded as "game" and are sold for food in every market in Italy. As shown in the case of birds hunted for their plumage, wherever there is a market to be supplied, there will be people willing to supply it, and throughout Italy there are thousands of men who do nothing else but catch and kill song birds to be eaten by their fellow-countrymen. Thousands and tens of thousands are offered at from two cents to five cents apiece threaded on strings and sold in bunches as we sell beets or onions. Most of these birds are brought in by professional bird-catchers. Some of them are shot, some taken with snares or bird lime, but probably by far the



AMERICAN SONG BIRDS KILLED BY ITALIANS



greater number are captured in nets of various kinds. Many of these nets are used in connections with what are known as roccolos, permanent bird traps established in carefully chosen spots, often situated on hillsides, in valleys, along some natural migration route. Roccoles vary in size, and some are more elaborate than others, but the essentials are a clump or grove of trees to invite the attention of passing birds, a few little songsters to call and make the place appear homelike, a net of fine threads to entangle the victims of this treachery, and the fowler, who kills the captured birds and sells them to be eaten. The fowler or keeper of the roccolo lives close by in a little building which sometimes takes the form of a tower from which he can watch the nets, and in which he deposits his catch in a pile on the floor.

Hidden from view by the screen of trees, hang a number of small cages containing little birds whose eyes have been burned out with red-hot wires, because blind birds call more often than those which can see. These wretched little prisoners by their calls, and by their song, for they sing too at times, all unknowingly lure the wild birds to their death. If birds come near, but hesitate on the outside trees, the fowler, by means of a sort of raquet thrown through the air,

makes a sound like the whistling of a hawk's wings, and down plunge the frightened song birds to their doom. As they struggle in the net, the fowler comes forth from his hiding place, seizes them roughly, kills them by thrusting a sharpened stick through their heads, and tosses their pathetic little bodies on top of the growing heap on the floor of his dwelling. And there are hundreds of such roccolos, each of them destroying thousands—many of them tens of thousands of birds during a single migration. Is it any wonder that the Italians have no song birds of their own? This terrible trade can be carried on now only because many of the migratory birds from other parts of Europe come down through Italy in order to shorten their flight across the Mediterranean. Is it any wonder that ignorant Italian laborers, fresh from a country where this sort of thing is not only permitted but encouraged, should, on landing here, make themselves a set of snares and a wad of bird lime, buy cheap guns, and set out to catch and kill anything and everything that wears feathers? They are not necessarily either bad or lawless. Many of them land in this country which they have been taught is the freest in the world, probably never doubting that they have at least as much right to kill things here as they

had in Italy. They cannot read our books and papers and when they meet a game warden they do not know who he is nor what he is saying; they only understand in a general way that he is trying to stop them from doing what they think they have a perfect right to do. They are naturally hot-tempered and quick to resent what they believe to be an injustice, and serious trouble for the game warden is often the result. I remember a few years ago, watching a surgeon removing shot from the face of a policeman who had been shot by an Italian poacher in the Middlesex Fells Reservation, near Boston. He had chased the man, who deliberately turned around and let him have both barrels. I am not defending the Italian shooter of song birds. He is doing wrong and we must absolutely stop him, but we shall be able to do this in a wiser, surer way if we understand the kind of man we have to deal with, and realize that he is not entirely to blame for his attitude toward our wild life. In another chapter I shall give some suggestions for dealing with this problem.

The negroes and poor-white folks of our southern states are even worse than the ignorant foreigners, for they slaughter our song birds, not by scores but by hundreds and sometimes by thousands. Sad to say, robins and other songsters

are still ruthlessly destroyed in many of our southern states. They are killed for food and the negroes and poor whites supply the markets. When the holly berries are ripe, the robins gather by tens of thousands to feed upon them and their coming is the signal for every negro who can afford a three-dollar gun to get out and shoot them. The robins are also very fond of cedar berries, and during the winter months where these are plentiful, they gather in immense flocks. The fact that they roost in the cedars at night, makes possible another form of slaughter. Men and boys with torches each climb a tree while companions with poles and clubs disturb the robins and cause them to fly about. Dazzled by the torches, the sleepy robins fly to the torch-bearer who kills them by either pinching their necks or pulling their heads off, and drops their bodies into a bag. Three or four hundred birds represent a fair night's work for a man, and sometimes there are a hundred or more men engaged. The contribution of a single southern village in a year will sometimes amount to hundreds of thousands of birds and there are many villages. It is hardly to be wondered at if we fail to see large numbers of robins on our lawns in the spring.

The ignorant southern negroes are a problem

in themselves. In the nesting season or out of it, it makes no difference to them. In gangs, large and small, armed with cheap guns and followed by mongrel "bird" dogs, they rake the country, killing everything that flies or runs. Worst of all, perhaps, they burn over large tracts of land, destroying the natural cover for the birds, making it easy to pot the few which might otherwise have found shelter at the time, and preventing the area from being used as a breeding ground or as a refuge for years to come. Nevertheless, thanks to improved laws, to campaigns of education, and to a firmer stand taken by the cultivated people of the South, matters are much better than they were a few years ago, and the outlook for the future is hopeful.

Lumber camps and mining camps are often responsible for the local extermination of certain birds. When, as often happens, such camps are at a considerable distance from a large town, it is difficult and expensive to supply the men with fresh beef, mutton, or pork, and if there are game birds or waterfowl in the vicinity, they are sure to suffer. Such birds are killed in large numbers not only to supply immediate needs but for future use, so that when an opportunity presents itself, the men kill all they can get.

A great deal of damage has been done, and is

still done at certain times and places, by the small boy who has not been taught a proper regard for bird life. With air gun, sling shot, trap, and snare, he can quickly become a terror to the birds within walking distance of his home, and if he adds to these methods of destruction the offense of taking birds' eggs, he can increase the destruction many fold. Usually, I think, it is not the boy's fault. To a quite natural curiosity to see at close range or to possess, certain beautiful things which have attracted his attention, is added the joy of proving his quickness in discovery, his cleverness in outwitting, or his skill in capturing or killing the object of his desire. His curiosity has not been led into safer channels; he has not been shown more useful ways in which to prove his cleverness and skill.

The scientific collector of birds is one against whom popular indignation is often directed (or perhaps I should say misdirected), because he is occasionally seen shooting birds which other people are not allowed to shoot. I do not collect birds myself, and I do not believe in permitting people to collect birds simply because they would like to have collections. But there are in every state certain scientific men who are giving a great deal of time to the study of birds with a view to adding to our knowledge of ornithology

and it is my belief that these men should be permitted to collect. They should, I think, be allowed to take such birds as are needed and few of them will take more than this. I am acquainted with many collectors and most of them are not only conscientious gentlemen, but loyal supporters of the cause of bird protection. Some of them do not shoot more than a bird or two a year, after a reasonable working collection has been made. I know one, an enthusiast, too, who has shot only one bird in two years. One market-hunter will kill more birds than all the scientific men in his state, put together.

BIRD ENEMIES FOR WHICH MAN IS CHIEFLY RESPONSIBLE

In addition to the losses which man inflicts on birds directly, he does further damage indirectly through the activities of certain animals for whose present status he is to a greater or less extent responsible. Of these, far and away the most destructive is the house cat. She belongs to a family of highly carnivorous animals, and as compared with the dog is only about half domesticated. Her wonderful body is specially designed for capturing and overpowering creatures weaker than herself, and song birds seem

to be her favorite prey. When they nest in the trees or shrubs, or on arbors in the garden, her wonderful ability as a climber enables her to invade their nests. When they come to the ground for food or water, she lies in wait and springs upon them. She hunts by day and by night, and when she is abroad there are few places where birds are safe.

Mr. Chapman, America's best-known ornithologist and a most careful and accurate writer, says: "In our own opinion there are not less than twenty-five million cats in the United States, and there may be twice that number. A house cat has been known to kill fifty birds in a season and a naturalist, than whom none is better qualified to judge, believes that five hundred thousand birds are annually killed by cats in New England alone! Apply these figures to the cats and the country at large, and the result is appalling!"

Mabel Osgood Wright, president of the Connecticut Audubon Society, and author of *Bird Craft*, *Citizen Bird*, and other works, who has had a wide experience with both birds and cats, assures us that "the evidence of men and women whose words are incontestable would verify my most radical statement, but one fact is beyond dispute—if the people of the country insist on keeping cats in the same numbers as at pres-



A SNAPPING TURTLE DESTROYED 15 YOUNG WOOD DUCKS



THIS BULL FROG COULD SWALLOW A WATER FOWL

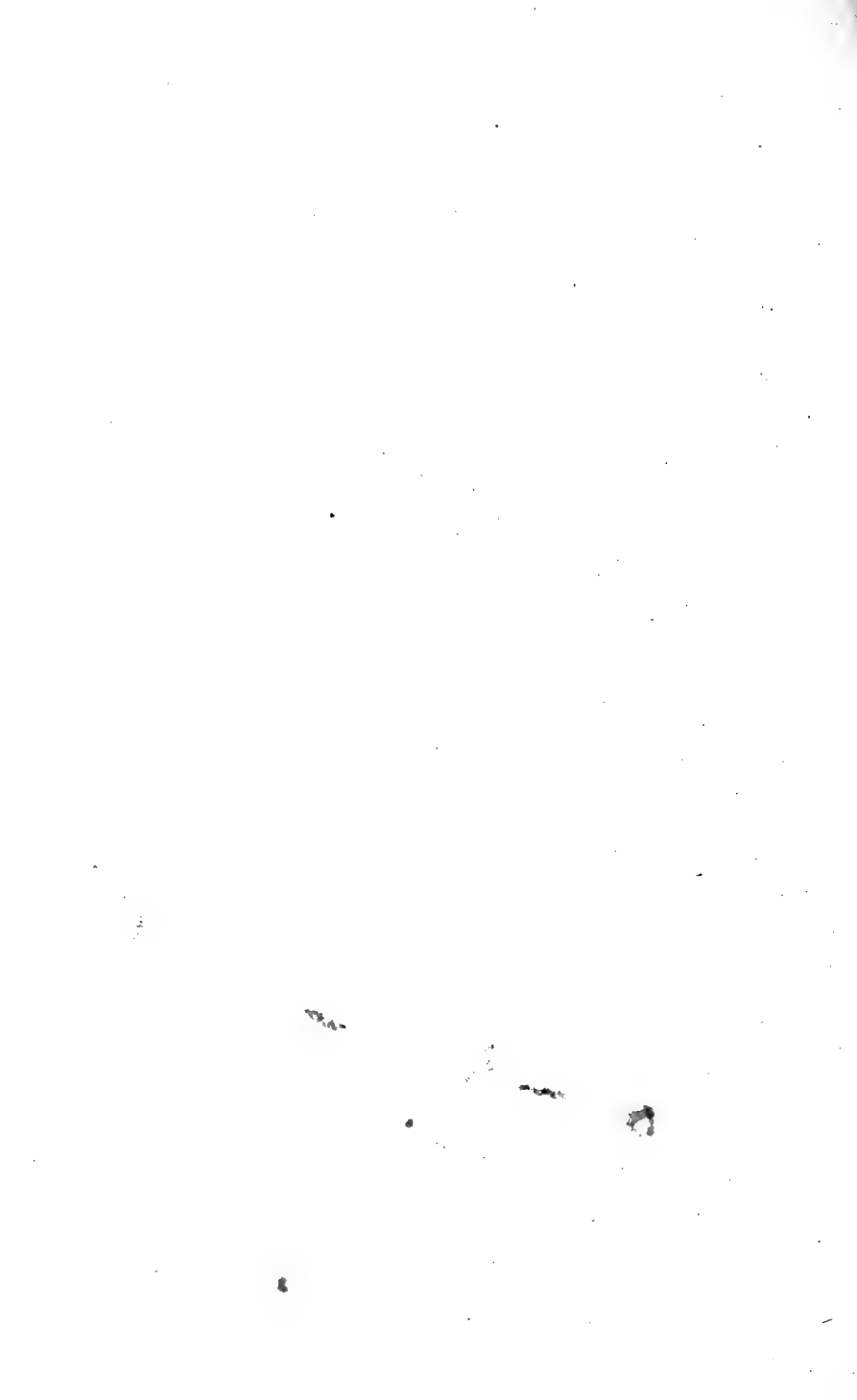

ent, all the splendid work of Federal and State legislation, all the labors of game and song bird protective associations, all the loving care of individuals in watching and feeding, will not be able to save our native birds in many localities."

Edward Howe Forbush, State Ornithologist of Massachusetts, a careful writer who is always sure of his ground, tells us of the situation in his own state. "Nearly a hundred correspondents scattered through all the counties of the state report the cat as one of the greatest enemies of the birds. The reports that have come in of the torturing and killing of birds by cats are absolutely sickening. The number of birds killed by them in this state is appalling. It is quite true, however, that some cats do not kill many birds, and that some intelligent or high-bred cats may be taught not to kill any. Some cat-lovers believe that each cat kills on the average not more than ten birds a year; but I have learned of two instances where more than that number were killed in a single day, and another where seven were killed. If we assume, however, that the average cat on the farm kills but ten birds in a year, and that there is one cat on each farm in Massachusetts, we have in round numbers, 70,000 cats killing 700,000 birds annually."

With the material at hand it would be a simple

matter for the writer to fill a book with the testimony of conservative people—naturalists, game wardens, owners of bird sanctuaries, yes, and avowed cat-lovers, too—all pointing to the fact that cats, despite their wonderful beauty of form and movement, and their many charming ways, are among the most cruel and destructive of all bird enemies. The writer himself has seen not a little of this destructive work on the part of cats—his own and others. He was a cat-lover once, owned seven attractive cats, and knows all their lovable attributes from amiability to wistfulness. But they were seen devouring young birds in their nests before the eyes of their grief-frantic parents; they were seen torturing terror-stricken adult birds for which they had lain in wait, and when their owner made up his mind that this sort of thing would go on as long as they lived, death, swift and painless, removed them from their feather-strewn path.

The most destructive cats, as a rule, are those which either have no owners or whose owners so neglect them that they are obliged to forage for themselves. And these constitute a very large proportion of our cat population. Among them are the so-called “tramp” cats and “stray” cats, with which many parts of our country are overrun. In the city of New York alone the Society

for the Prevention of Cruelty to Animals destroys over fifty thousand homeless cats a year, and it is a disgrace to that wonderful city that the conditions which make such destruction necessary, are permitted to exist. In a later chapter will be given some suggestions looking to the possible solution of this very serious problem.

Badly trained dogs also, at certain times and places, are destructive to birds. This is sometimes true of dogs belonging to people living on islands or on the coast, and allowed to range over the breeding grounds of sea-birds. When not under proper control such dogs are apt to get the habit of chasing the birds and of driving them off their nests and sometimes they will eat the eggs or young. Dr. Charles H. Townsend tells me that the Esquimau dogs of Labrador, which in summer are turned loose to forage for themselves, are often destructive to bird life and probably eat the eggs and young of all species which they find nesting on the ground.

Pigs, if not actually born with a taste for eggs and nestlings, soon acquire one, and it is safe to say that they never fail to devour such delicacies when an opportunity presents itself. If given free access to a colony of birds which nest on the ground, pigs will gobble up the contents of every

nest. It is said that pigs were the chief cause of the extinction of the dodo, a large flightless bird which inhabited the Island of Mauritius.

Man is also responsible for the presence, in this country, at least, of the European sparrow and the European starling. The first is, and has been for many years, a well-known pest, and a serious enemy of our native song birds. Unfortunately its bad character and offensive habits are too well known to require description in detail. Hardy and pugnacious and present in numbers that would baffle a census-taker, sparrows often attack and kill our smaller native birds. They can make their bulky nests almost anywhere, but seem to prefer nest boxes when these are to be had. In many localities by reason of their great numbers, they will occupy all the nest boxes with entrance holes large enough to admit them, to the exclusion of bluebirds, tree swallows, and other more desirable tenants. So the latter are often forced to leave the little homes which we have put up on purpose for them—leave their favorite haunts in our gardens and orchards, and take their chances of finding nesting sites away off in the wilderness perhaps.

In the summer, when we put out bird baths for our thirsty song birds, down come the sparrows and nothing else in feathers can get near the

water. In the winter when we attempt to feed our native birds, the sparrows come in hordes to the exclusion of practically all other species. The end of it is that thousands of people who are anxious to do something to help our native birds, become discouraged when they find that the chief result of their efforts is an increase in the size of the local flock of sparrows.

If the European sparrows were very useful birds or fine songsters, or if they had unusually beautiful plumage, there would be some compensation for the dearth of native birds which they create. But sad to say, usually they are neither useful nor ornamental. On the contrary they are often very destructive. As Mr. Ned Dearborn points out in his *Farmers' Bulletin*, "The English Sparrow as a Pest": "It destroys fruit, as cherries, grapes, pears, and peaches. It also destroys buds and flowers of cultivated trees, shrubs, and vines. In the garden it eats seeds as they ripen, and nips off tender young vegetables, especially peas and lettuce as they appear above the ground. It damages wheat and other grains, whether newly sown, ripening, or in shocks. As a flock of fifty sparrows requires daily the equivalent of a quart of wheat, the annual loss caused by these birds throughout the country is very great."

A thorough investigation of the subject by the Department of Agriculture shows that while European Sparrows do a certain amount of good by the destruction of insects in summer and of weed seeds in the fall and winter, they do such a vast amount of damage that there is comparatively little to be said in their favor.

The European starling threatens to create another problem for the American bird lover. Less than twenty years ago the range of the starling in this country did not extend beyond the boundaries of New York City. Now the bird has overrun or rather overflowed all the surrounding states, and may be seen in large flocks at all seasons. Its economic status has not been fully determined yet, but from what I can learn it seems to be a more useful bird than the European sparrow. It is certainly more pleasing to look at, it has a more pleasant voice and it is comparatively clean and dainty in its habits. Being partial to nest boxes, no doubt it would crowd out our native birds were it not for the fact that many of them, having smaller bodies, can use entrance holes through which the foreign bird cannot pass. So let us cheer up; the worst is already here.

CHAPTER V

ECONOMIC REASONS FOR PROTECTING THE BIRDS

IF the farmers once realize what powerful friends they have in the wild birds, they will be the best bird protectors on earth. They will band together and see to it that no one is allowed to cut down their incomes by destroying the most valuable allies they have in their fight against their enemies the weeds, the harmful insects, and the harmful rodents. The Department of Agriculture at Washington, after a careful study of the question, tells us that the annual loss to the farmers of this country from the attacks of insect and rodent pests alone, is about a billion dollars. This means a loss of about a dollar a month for every man, woman, and child in the United States. The loss occasioned by the enormous amount of labor required to battle with even partial success against the weeds which everywhere threaten the crops, is also very great. But the farmer's loss is by no means his alone; we must all share it, whether

we wish to or not, for we all eat what the farmer grows, and whatever loss he sustains by having a part of his crops destroyed, whether it be by drought or insects, by floods or wild mice, by storm or choking weeds, we must share by paying higher prices for what is left. So we should all be very much interested when the Department of Agriculture goes on to tell us that *birds* constitute the principal check upon the weeds and insects and rodents which cause this tremendous loss every year. And we may accept the statements of the Department of Agriculture on this subject with absolute confidence, because they are not the result of guesswork or of prejudice, but the result of careful investigation on the part of scientific men who are giving their lives, not to prove that birds are either beneficial or the reverse, but to learn the truth about birds, whatever that may be. For example, if Dr. A. K. Fisher tells us that at least seventy-five per cent. of the food of the short-eared owl consists of mice, we can be as sure of it as that seventy-five per cent. of a dollar is seventy-five cents. You may be certain that Dr. Fisher has taken nothing for granted. He has examined hundreds of owl pellets and the stomachs of hundreds of owls, from all parts of the country and at all seasons of the year, and has reserved

his opinion until he is sure that no further evidence will cause it to be reversed.

When Mr. F. E. L. Beal states that fifty-three per cent. of the rusty blackbird's food consists of animal food, chiefly noxious insects, he is not guessing either. He shows you a table which he has prepared after the careful examination of the stomachs of many blackbirds. There you can see at a glance what kinds of food and the proportions of each, which the birds eat during every season of the year. And you can see also that bad deeds are recorded as carefully as good ones, and that when practically nothing but grain is eaten, the table shows it.

And when Dr. Sylvester D. Judd expresses an opinion on the food of sparrows, he has based that opinion on the contents of the stomachs of between four thousand and five thousand sparrows; and so if he tells us, as he does, that during the colder half of the year, the seeds of smart weed, bird weed, pigeon grass, pig weed, lamb's quarters, ragweed, crab grass, and other seeds, form four-fifths of the food of song sparrows, we may accept the statement as a fact.

Of course I am aware that the subject of the economic value of birds, when taken up in detail, is very complex, and that the questions involved are not always easy to answer. Some birds, like

the yellow-bellied sapsucker, which is said to damage the trees to the extent of \$2,250,000 annually, and the sharp-shinned and Cooper's hawks, which live almost exclusively on poultry and useful wild birds, are easy to place in the destructive class. Others, like our cuckoos, which feed on destructive hairy caterpillars and other noxious creatures; and tree sparrows, which devote themselves chiefly to the gathering of weed seeds, are as easy to place in the beneficial class. But in between we have many birds not so easy to place. For example, the bobolink, which is beneficial in the north, where it feeds mainly on insects, is very destructive in the south, where it works havoc in the rice fields. The great horned owl is very useful in the west, where agriculture is the chief occupation and where the bird destroys vast numbers of gophers, ground squirrels, and other pests; but in the east where the population is denser and where there is more poultry raising, this owl sometimes gets himself very much disliked by killing hens and turkeys. Sometimes birds whose value may not be very apparent under normal conditions, come to the front at the time of a plague of insects or rodents, and perform invaluable service. For instance, when the Mormons first settled Utah, they were threatened with ruin by the millions



MONUMENT TO THE SEA GULLS IN SALT LAKE CITY

of black crickets which came down upon their grain fields and swept them as clean as though they had been burned with fire. The first year's crop was thus destroyed. With characteristic courage next year the Mormons sowed their seed again, but no sooner did the crops give promise of a bountiful yield, when again came the black crickets, bringing dismay to the settlers. But just at this juncture a wonderful thing happened. Suddenly, and seemingly from nowhere in particular, came a great avenging army. Hundreds and thousands of Franklin gulls poured themselves into the grain fields and annihilated those black crickets until there wasn't so much as a chirp left. It looked like a miracle from Heaven and the settlers thought it was. And the grateful Mormons did not forget. The gulls have been protected ever since, both by law and sentiment, and recently a suitable monument was erected in Salt Lake City in recognition of their services.

Certain otherwise beneficial birds complicate matters by devouring predacious beetles, ichneumon flies, and others which are themselves useful because they destroy harmful insects. But then again these predacious insects destroy some useful insects, complicating the matter still further, and making it extremely difficult to

determine the exact economic value of the birds. However, where pains have been taken to work out the interrelations of birds and predacious insects the evidence obtained seems to be chiefly in favor of the birds, and at least until a more exhaustive study of these interrelations results in definitely establishing their economic status, we should give such birds the benefit of the doubt.

As this book is not primarily a work on the value of birds, that subject cannot be dealt with exhaustively here. But I will try to present to the reader just enough evidence to leave in his mind no doubt that birds as a class are not only useful, but very useful, and that it is well worth our while, even from a selfish standpoint to protect them and to insist upon their protection by others.

We are often surprised to find that birds which we had regarded simply as beautiful or poetic are very useful as well. As we have seen in the case of the plague of crickets which threatened to ruin the Mormons, gulls can do more than add to the beauty of a landscape. Given the protection they deserve they become valuable allies of the farmers, coming with terns and other birds to be a scourge to the locusts and other insects which lessen the profits of farming. Eighty-four locusts have been found in the

stomach of a single tern. Sea-gulls also act as scavengers, cleansing the waters of our harbors and river mouths of offal and other refuse which threaten to pollute them. And they are not the least of the many agencies which make fertile and habitable what would otherwise be rocky or sandy, barren, and uninhabitable islands. Their rotting nests make soil; they fertilize it with their guano, and plant in it seeds which they have carried from afar and which have passed unharmed through their digestive tracts. Doubtless many a shipwrecked sailor owes his life to the unconscious work of sea-birds. And as Forbush points out they often save the mariner from shipwreck, especially in foggy summer weather. At such times the presence or the clamorous voices of sea-birds in great numbers often give warning of the presence of the rocks or islands where they make their homes, and off-shore fishermen receive similar warning from the unerring flight of homeward-bound gulls and terns. Chapman goes so far as to say that Columbus, facing a discouraged and mutinous crew, might never have discovered America had not the fall flight of land birds passing from the Bermudas to the Bahamas and Antilles, been observed by the mariners, who were given new courage by the unwearied and joyous songsters

which alighted in the rigging. The course of the vessel was changed, the flying birds were made the pilots, and the voyage was thus shortened by two hundred miles and land discovered.

Few of us, I think, would look to the great dignified, slow-moving, fish-eating white pelicans to help us much in solving our insect problem, yet at times they devour great numbers of locusts.

The ducks, geese, and swans are of value to us not so much for what they do as for what they are, most of them are excellent for food, and if we gave them reasonable protection instead of permitting them to be slaughtered wastefully, they would make a wonderful and perpetual addition to our national food supply. Under present conditions a comparatively few people get most of them, and they are growing fewer and fewer in numbers.

Spoonbills, ibises, storks, herons, and cranes are all more or less useful as destroyers of insects, and at times, such as when insect plagues threaten the crops in certain regions, the services of such birds may prove the salvation of the farmers. An example of such service was given some years ago in Australia when the sheep industry near Ballarat was seriously threatened by a swarm of locusts which was devouring the

pasture. Just as the sheep owners began to feel that they would be obliged to sell all their sheep to save them from starvation, down came flocks of spoonbills and cranes which with the assistance of a flock of starlings, soon completed the destruction of the locusts and saved the day.

Hérons, of course, when conditions are favorable for them, destroy a good many fish; but these birds are so picturesque that, save in very exceptional cases, it will do us good to make some sacrifice to have them with us. A stately heron, fishing on the edge of a lonely pool, is a pleasant memory to be cherished through life; a dead one upholstered and set up in a living-room is a perpetual reproach.

Many of the sandpipers and curlews are famous as destroyers of insects, and the smaller ones, at least, should be spared on this account. Professor Samuel Aughey, whose extensive and painstaking investigations have done so much to make us appreciate the value of Nebraska birds, once took from the stomachs of six spotted sandpipers 233 insects, ninety-one of which were locusts. The farmer lost a valuable friend when the Esquimau curlew disappeared and he will lose another if the upland plover passes, as it will unless given powerful protection by law and sentiment. This bird is used for food, but is

infinitely more valuable alive than dead. It lives very largely on locusts, and when these are numerous they are eaten almost exclusively.

Quail and grouse are valuable both as food and as destroyers of insects and weed seeds. The former, at least, are more valuable alive than dead. They are wonderful destroyers of potato bugs, and if encouraged to nest in the fields and fence corners, no Paris green need be used on the potato crops. On locusts they work just as well. Professor Aughey found in the stomachs of twenty-one quail, 539 of these insects, an average of twenty-five apiece, and that only a part of one day's work. These birds also eat large numbers of chinch bugs, cotton worms, cotton-boll weevils, cucumber beetles, May beetles, leaf beetles, clover-leaf beetles, corn-hill bugs, wire worms, cutworms, ants, flies, and many other insect pests. And being birds of good size they require large quantities of such food. As destroyers of weed seed they stand as high if not higher. Forbush states that they eat the seeds of over sixty different kinds of weeds, those of ragweed seeming to be the favorite. The same authority tells us that "as many as two to three hundred seeds of smartweed, five hundred of the red sorrel, seven hundred of the three-seeded mercury, and one thousand of the ragweed have

been eaten at a meal." Dr. Judd gives even stronger testimony in favor of these birds when he tells us that five thousand seeds of green foxtail and ten thousand of pigweed have been found in a single bird. He estimates that from June 1st to August 1st in the two states of Virginia and North Carolina alone, bobwhites eat 1341 tons of weed seed and 340 tons of insects. When to all this is added the æsthetic value of this gentle bird, whose cheery voice thrills all to whom it is familiar, we see that to kill a quail and serve it on toast is to realize but a very small part of what it is really worth.

The mourning dove which we see everywhere through the Middle West and which all day long rises in little flocks as our train passes through the fields, rivals even the bobwhite as a destroyer of weed seeds. Professor King, in Wisconsin, took from the stomach of a single dove 4016 seeds of pigeon grass, and from the stomach of another were taken 7500 seeds of oxalis.

I confess that I have little patience with the man who tries to tell the farmer that all hawks and owls are his friends, and that he should not shoot one under any circumstances. He should know better than this and the farmer does know better. Such sweeping statements not only fail to convince the intelligent farmer, but they tend

to make him discredit the truth concerning the birds of prey.

Dr. A. K. Fisher, America's greatest authority on our hawks and owls, divides them into four classes, as follows:

(1) Species *wholly* beneficial.

Rough-legged hawk, ferruginous rough-leg or squirrel hawk, and the four kites—the white-tailed kite, Mississippi kite, swallow-tailed kite, and everglade kite.

(2) Species *chiefly* beneficial.

Most of our hawks and owls, including: marsh hawk, Harris hawk, red-tailed hawk, red-shouldered hawk, short-tailed hawk, white-tailed hawk, Swainson hawk, short-winged hawk, broad-winged hawk, Mexican black hawk, Mexican goshawk, sparrow hawk, Audubon caracara, barn owl, long-eared owl, short-eared owl, great gray owl, barred owl, western owl, Richardson owl, Acadian owl, screech owl, flammulated screech owl, snowy owl, hawk owl, burrowing owl, pigmy owl, ferruginous pigmy owl, and elf owl.

(3) Species in which beneficial and harmful qualities about balance:

Golden eagle, bald eagle, pigeon hawk, Richardson hawk, aplomado falcon, prairie falcon, and great horned owl.



THE GREAT HORNED OWL DESTROYS MANY BIRD ENEMIES



(4) Species which are harmful:

The gyrfalcons, duck hawk, sharp-shinned hawk, Cooper hawk, and goshawk.

To the average farmer the most surprising thing about the above lists will be the very small number of species which are positively harmful. And for the farmer in the United States this list grows beautifully smaller when we take from it the gyrfalcons, which are northern species which seldom enter this country; when we remember that the duck hawk is uncommon except in the vicinity of large bodies of water and that his operations are conducted chiefly against waterfowl, and that even the goshawk, one of the most destructive of birds, is rare south of the Canadian border except in the fall and winter. This leaves us with two harmful hawks, Cooper's and the sharp-shinned hawk, and as I have already, in the chapter on the natural enemies of birds, spoken of the misdeeds of these two, it will not be necessary to say any more about them.

Naturally it is not possible here to go into details concerning the feeding habits of a large number of birds of prey, but I will try, by giving a few examples, to show why these birds, as a class, are beneficial, and why, therefore, most of them should be protected.

First in order come the vultures, which are

almost wholly beneficial. The turkey buzzard and the black vulture of our southern states render valuable service as scavengers. Flying at great heights and endowed with wonderful powers of vision, they quickly find and devour carcasses and other decaying animal matter, and thus prevent it from becoming a menace to health.

The hawks come next and I will begin with the red-tailed hawk, whose appearance in any locality is almost sure to attract the attention of the farmer, and which is among the birds most frequently shot for a "chicken hawk." As the range of this bird covers the whole United States, if chickens constituted any large proportion of its food, it would surely be a great enemy of the poultry keeper. Fortunately, however, its principal food consists of mice, with a fair proportion of shrews, rats, squirrels, gophers, rabbits, grasshoppers, beetles, frogs, snakes, and crayfish. Poultry is occasionally taken, and a few birds are on the list, but the great good which this hawk does by destroying rodent pests, pays many times over for the occasional chicken or song bird taken when perhaps the mouse-hunting is poor. How far the good deeds of this hawk outweigh its bad ones, may be seen when we learn from Dr. Fisher that out of 562 stomachs ex-

amined, 54 contained poultry or game birds; 51, other birds; 278, mice; 131, other rodents; 37, frogs, toads, and snakes; 47, insects; 8, crayfish; 1, centipede; 13, offal, and 89 were empty.

The red-shouldered hawk, another large species, which is a bird of eastern North America only, is even more beneficial in proportion to the size of its range. Though it is continually persecuted as a poultry thief, as a matter of fact it hardly ever touches poultry and most of the very few wild birds which it kills are possibly sick or decrepit ones. On the other hand this splendid bird wages an unceasing warfare on mice and many kinds of injurious insects, and the balance of its food consists chiefly of frogs, toads, and snakes. Though I have on several occasions closely observed red-shouldered hawks from the time their eggs were hatched until the young flew away, I have never seen one carry a chicken or in fact a bird of any kind to its young. I once reared two of these hawks in a poultry yard, actually confining them with the poultry for two months, and though they were not overfed, they never in a single instance even showed an inclination to molest the poultry.

Perhaps the most beneficial of all is the marsh hawk, because it is not only a useful bird, but also has a very wide range, being found in

practically all parts of the United States and Canada. As its name would imply, it is a bird of the open country and it makes its nest on the ground in the marshes. Flying low, and with slow-beating wings, this large bird tacks tirelessly back and forth over the country, sweeping the ground with its keen eyes for the mice and other small rodents which form the principal part of its food. Dr. Fisher tells us that of 124 stomachs examined, 7 contained poultry or game birds, 34, other birds, 57, mice; 22, other rodents; 7, reptiles; 2, frogs; 14, insects; 1, indeterminate matter, and 8 were empty. In some of these stomachs there were as many as four, five, and even eight meadow mice, and when we consider the extreme rapidity with which birds digest their food, we realize that these stomach contents do not begin to represent the entire work of the day on which they were shot. And again when we consider that marsh hawks rear from four to six young, and that these remain in the nest for several weeks, that young hawks are proverbially ravenous, and that during the latter part of their stay in the nest they eat even more than adult birds, we begin to get some faint idea of the number of mice and insects which their parents must destroy each day in order to provide food for the entire family.

As eight meadow mice have been found in the stomach of a single marsh hawk, and as this probably represented but a part of the day's food supply, it would not be unreasonable to suppose that each marsh hawk destroyed at least eight mice or their equivalent in other harmful creatures every day to supply its own needs. But in order to be well within bounds let us cut this number in two, and suppose that each hawk kills but four meadow mice each day—a number probably quite insufficient to keep such a large, active bird in good condition. This would mean that a pair of these hawks would destroy eight mice in a day, or 2920 mice in a year. It has been estimated that each meadow mouse on a farm causes an annual loss to the farmer of at least two cents, by destroying grass roots, tubers, grain, and young fruit trees—a very conservative estimate it would seem. The destruction of 2920 mice then, would save the farmer \$58.40. In other words it puts into his pocket \$58.40, which but for the hawks would have been eaten up by mice. Now, it is an exceptionally good cow which gives an annual return as large as that, and a farmer owning such a cow would be very careful not to shoot her by mistake for some harmful animal; yet that same farmer will, without a moment's hesitation,

shoot these valuable hawks, because hawks of an entirely different species have at some time carried off his chickens.

Owls, as a class, are even more beneficial than the hawks. They constitute what might be termed "the night shift" of the pest-killing forces, coming on about dusk, and continuing their work until dawn, when the hawks again take up the good work. Having very acute hearing, and also wonderful powers of vision, which are, in most species, keenest in the dusk, they are able to capture many nocturnal animals which are passed over by the hawks. Mice and rats, moles and shrews, rabbits, squirrels, gophers, and prairie dogs, besides many kinds of injurious insects, constitute the principal food of our owls. As Dr. Fisher has pointed out there are some owls which are not wholly beneficial. Certain species, when opportunity offers, are destructive to poultry. There is this to be said, however, that if poultry is properly housed at night there is little to fear from owls.

The barn owl, chiefly a southern species, is one of the most useful of all birds. It lives almost exclusively on small mammals, principally destructive ones. Fisher says that in the South Atlantic and Gulf States it feeds extensively on the cotton rat, and that the common rat also

is greedily devoured. He once examined two hundred pellets taken from the nesting site of a pair of these owls in one of the towers of the Smithsonian Institution. In these pellets he found 454 skulls, of which 225 were those of meadow mice, 2 of pine mice, 179 of house mice, 20 of rats, 6 of jumping mice, 20 of shrews, 1 of a star-nosed mole, and 1 of a vesper sparrow. In the retreat of another pair of these birds were found more than three thousand skulls, 97 per cent. of which were those of mammals, chiefly field mice, house mice, and common rats. And all this splendid work was done without the cost of one penny to anyone.

Best known perhaps of all our nocturnal birds of prey, is the little screech owl, a bird whose range covers the whole of the United States and the southern portions of Canada. The farmer who kills this useful little bird, or permits anyone else on his farm to kill it, is woefully negligent of his own interests. During the day there is no sign of its presence, but at dusk it suddenly appears in the entrance of its hiding place—a hollow apple tree, or a hole in some outbuilding perhaps—and without the slightest sound it passes into the air. Silent as a puff of smoke, it drifts through the orchard, over the barnyard, and around the corn ricks, with bright eyes wide

open, and sharp talons ready to snuff out the lives of the thieving mice or rats. This little fellow may often be induced to take up his residence on a given farm, if a suitable nest box is put up for him in the orchard. There are several such nest boxes in this village and I know of at least two which are occupied by screech owls. One of them is on an apple tree in my own orchard, and when I found the owl, I found in the box beside him, half a very large black rat, and several pellets containing the bones and fur of meadow mice.

If space permitted, we might go on through the whole long list and continue to prove by indisputable evidence that most hawks and owls are of great value to the men to whom the presence of rats and mice and gophers and other rodents means a money loss. But even from the above facts, I think it will be seen that in most birds of prey the farmer has powerful allies who should be encouraged in every way possible and made to feel that they are never so safe as when they are on the farm.

The cuckoos of which we have two species, the black-billed and the yellow-billed, are among our most valuable destroyers of insects. They make a specialty of hairy caterpillars and are among the best checks upon the destructive



SCREECH OWL AND ITS HOME-MADE BIRD HOUSE

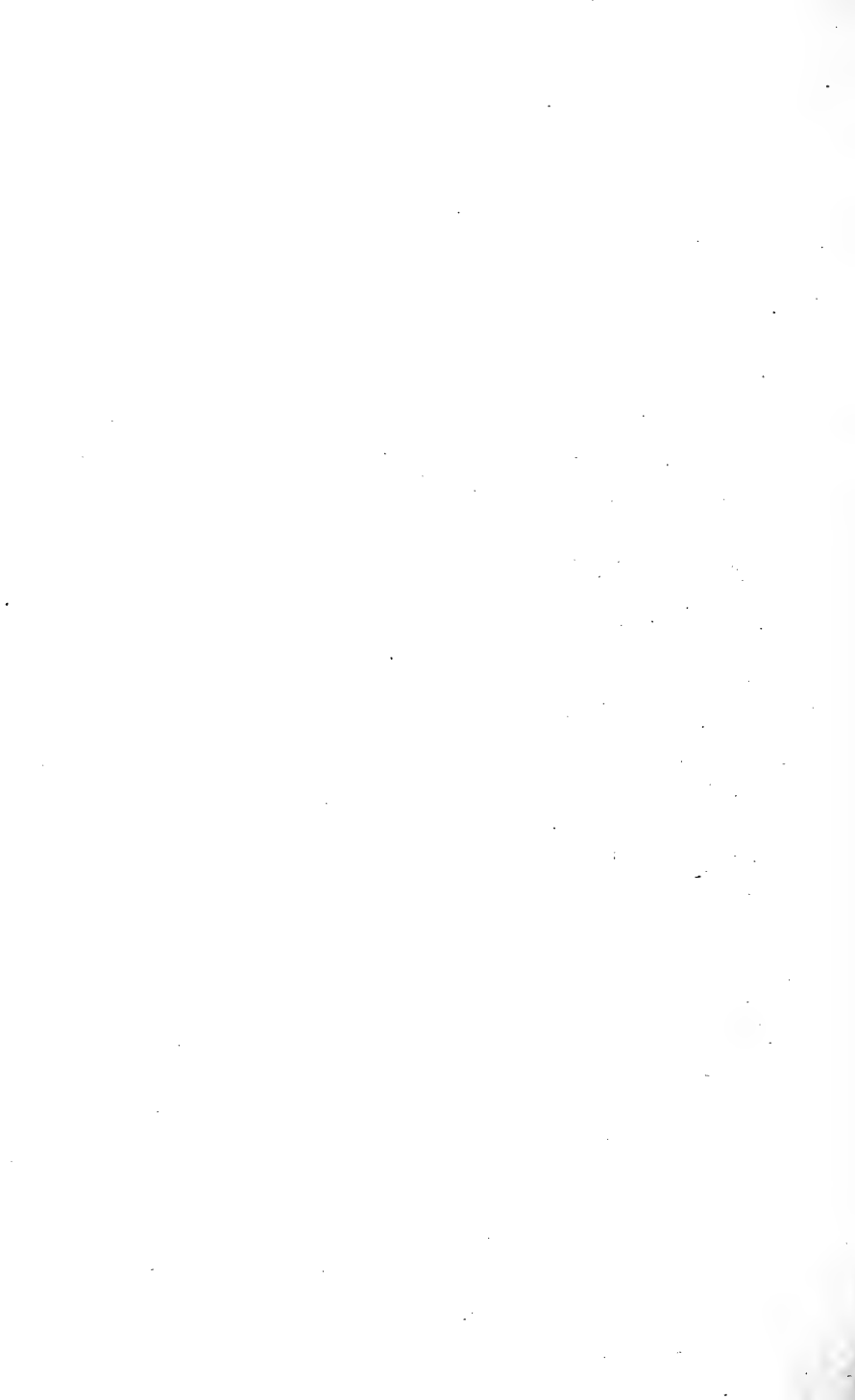

tent-caterpillar. Weed and Dearborn point out that they are unique in that they have a taste for stink bugs, hairy caterpillars, and poisonous spiny larvæ which most other birds reject. They are among the most persistent enemies of the caterpillars of the brown-tail and gypsy moths, and are said to kill many more than they can eat. Professor Beal states that from the stomachs of 121 cuckoos, were taken 2771 caterpillars, and Doctor Otto Luger found several hundred small ones in the stomach of a single bird. A cuckoo shot in Washington some years ago was found to have eaten 250 half-grown web-worms, one large cerambycid beetle and its eggs, one large plant bug, and a snail.

Most woodpeckers are highly beneficial, spending their lives chiefly in the destruction of insects which, if they were not kept in check would quickly kill the trees which they infest. Some species, like the ivory-billed and pileated woodpeckers, spend most of their time in the deep solitary woods; others like the hairy and downy, divide their time between the woodland, the shade trees, and the orchards; while one, the flicker, lives much of his life in the open, and gets a large part of his food on the ground. Wild fruits and berries are eaten more or less by most woodpeckers, but their principal food is insects.

Here again we must confine ourselves to a few examples. The downy woodpecker, which has a wide range and which is known to all of us, is one of the most useful members of this useful family. We need only watch him for a while as he works in our fruit and shade trees, to realize this, but as some of us haven't the time to prove it for ourselves, it is well to know that specialists have already proved it for us. From the contents of 140 stomachs examined by the U. S. Department of Agriculture, it is shown that three-fourths of the downy's food consists of insects. Seventeen specimens examined in Wisconsin were found to have eaten 40 insect larvæ, including 20 wood-boring grubs, 3 caterpillars, 7 ants, 4 beetles, 1 chrysalid, 110 small bugs, and a spider; also a few acorns and small seeds, and a little woody fiber which had probably been taken in accidentally with the food. Fanny Hardy Eckstorm, in her charming little book, *The Woodpeckers*, says of him: "Downy works at his self-appointed task in our orchards, summer and winter, as regular as a policeman on his beat. But he is much better than a policeman, for he acts as judge, jury, jailer, and jail. All the evidence he asks against an insect is to find him loafing about the premises." The hairy woodpecker is simply a larger edition of the downy,

and his feeding habits are similar. Most of his food consists of insects, and four specimens examined by Professor Aughey in Nebraska contained 157 grasshoppers.

Night hawks and whippoorwills are policemen of the air, and are especially useful in that they are working in the dusk and at night, when most other birds are off duty. The amount of good work they do is almost unbelievable. An Arkansas night hawk whose stomach was examined, had captured six hundred insects. Gnats, beetles, flies, and grasshoppers are also eaten by night hawks, and seven Nebraska specimens were found to have gathered in 348 Rocky Mountain locusts.

Swifts also capture most of their insect food while on the wing, and they are apt to be found on duty at any hour of the day or night. They should be encouraged to nest in the chimneys wherever they will.

Flycatchers, too, catch most of their prey on the wing, but unlike the swifts and night hawks, they do not go far afield to hunt for it. Upon some dead tree top, a telegraph pole, the gable of a barn, or similar vantage point, they stand, quiet but very watchful, until some luckless insect comes within range of their vision. A swift dive out into space, the click of a bill, and

the sentinel returns to his post with the insect inside. Perhaps no flycatcher is better known or better loved than our common phœbe, whose return in the spring is a pretty sure sign of mild weather or at least the approach of it. Ninety-three per cent. of this bird's food consists of insects, and the remainder of wild fruit. It rears two broods of young each year and as there are often five birds to each brood, the amount of food consumed is very great. There is always a nest under the roof of our piazza, and we should miss the birds in more ways than one if they did not come. In the first place we should miss their cheery companionship. We should also miss our customary freedom from annoyance by flies and mosquitoes, for which we are indebted to the phœbes and a few other birds. And it should be remembered that birds which destroy house flies probably destroy the typhoid germs they may be carrying, and that birds which destroy mosquitoes may be freeing us from the dangers of malaria. I am inclined to think that birds have not yet received the credit due them as preventers of disease. The kingbird has still another claim upon us. This handsome flycatcher is one of the best of all guardians of the poultry yard. If a pair of kingbirds make their nest on some pear or apple tree in the orchard or

chicken-yard, woe to the hawk or crow that attempts to steal the chickens. Long before he gets near, the kingbirds will fly out and attack him, and like as not will make the feathers fly from his back before he can escape. Besides, ninety per cent. of the kingbird's food consists of insects. He has been accused of eating honey bees, but that he does so to any great extent has not been proven. In 241 stomachs examined, there were found forty drones, four workers, and six whose sex could not be determined. The killing of the drones was beneficial, and the small loss entailed by the killing of four workers was more than made up for by the destruction of nineteen robber flies which were also found in these stomachs.

Crows and blue jays seem to be "on the fence." They both do great good at certain times and in certain places and great damage at other times and places. Both of them stand rather high as destroyers of insects and both have bad reputations as robbers of birds' nests. In his government bulletin on *The Common Crow of the United States*, Professor Walter B. Barrows sums up his subject's case as follows:

"(1) Crows seriously damage the corn crop, and injure other grain crops, usually to a less extent.
(2) They damage other farm crops to some extent,

frequently doing much mischief. (3) They are very destructive to the eggs and young of domesticated fowls. (4) They do incalculable damage to the eggs and young of native birds. (5) They do much harm by the distribution of the seeds of poison-ivy, poison-sumach, and perhaps other noxious plants. (6) They do much harm by the destruction of beneficial insects. On the other hand, (1) They do much good by the destruction of injurious insects. (2) They are largely beneficial through their destruction of mice and other rodents. (3) They are valuable occasionally as scavengers." In conclusion he says: "It seems probable that in most places the crow is neither so harmful nor so valuable as to render special laws necessary for its destruction or protection."

These last remarks probably apply equally well to the blue jay, who though a notorious robber of nests, is useful as a destroyer of the larvæ of brown-tail and gypsy moths, the eggs of the tent-caterpillar moth, besides beetles and grasshoppers. Neither crows nor blue jays should be exterminated but they should be watched, and where they become too numerous or too bold, and seriously interfere with other wild birds or with poultry, measures should be taken to thin them out.

Birds belonging to what we might call "the blackbird family," which includes the bobolinks, meadow larks, orioles, blackbirds, grackles, and cowbirds, are nearly all more beneficial than harmful. But there is a great difference in the amount of good done by the different members of this family. The meadow lark is one of the most useful. In the eastern states it does very little harm even in the spring when the corn is sprouting; in summer, it feeds almost exclusively on insects, chiefly noxious ones, and in the fall it is useful as a destroyer of weed seeds. Professor Harold Child Bryant of the University of California, in his splendid work on *The Economic Status of the Western Meadow Lark* shows how valuable the bird is to the California farmer, in spite of the fact that it does some damage by pulling grain during two weeks in the spring, a damage which might be prevented, he suggests, by planting the grain somewhat deeper or by a little overplanting. Professor Bryant gives ten good reasons why the meadow lark should be protected, and among them is the fact that it is probably unequaled as a destroyer of cutworms, caterpillars, and grasshoppers, three of the worst insect plagues in the state of California.

Taking the other extreme, the bobolink probably does much more harm than good, if we

judge him solely from an economic standpoint. It is hard for people of the north, where the bird is so well-beloved for æsthetic reasons, to hear him condemned, but the fact remains that his depredations in the rice fields of the south are often very serious. In the fall the bobolinks gather in flocks of millions, which move like armies upon the rice crops, which they would destroy in two or three days if they were not continually being driven off by "bird-minders" who patrol the fields, and slaughter the birds by shooting them.

Sparrows and finches base their chief claim to usefulness upon the fact that they are, as a family, the greatest destroyers of the seeds of noxious weeds. They help to keep down perhaps fifty or sixty kinds of injurious plants, and the amount of good they accomplish in the course of a year is hard to believe. Many of them, like the juncos, tree sparrows, and snow buntings, work in flocks, and before them such seeds as ragweed, pigweed, smartweed, and crab grass fairly melt away from the ground. It is not an uncommon thing to find from 300 to 500 seeds in the stomach of a single sparrow, and these represent but a part of the day's work. Prof. F. E. L. Beal some time ago made a very careful and conservative estimate of the number of tree sparrows which



STOMACH CONTENTS OF A MEADOW LARK: 14 CUTWORMS, 36 BEETLES



A BARN OWL'S SCRAP HEAP; NO FEATHERS

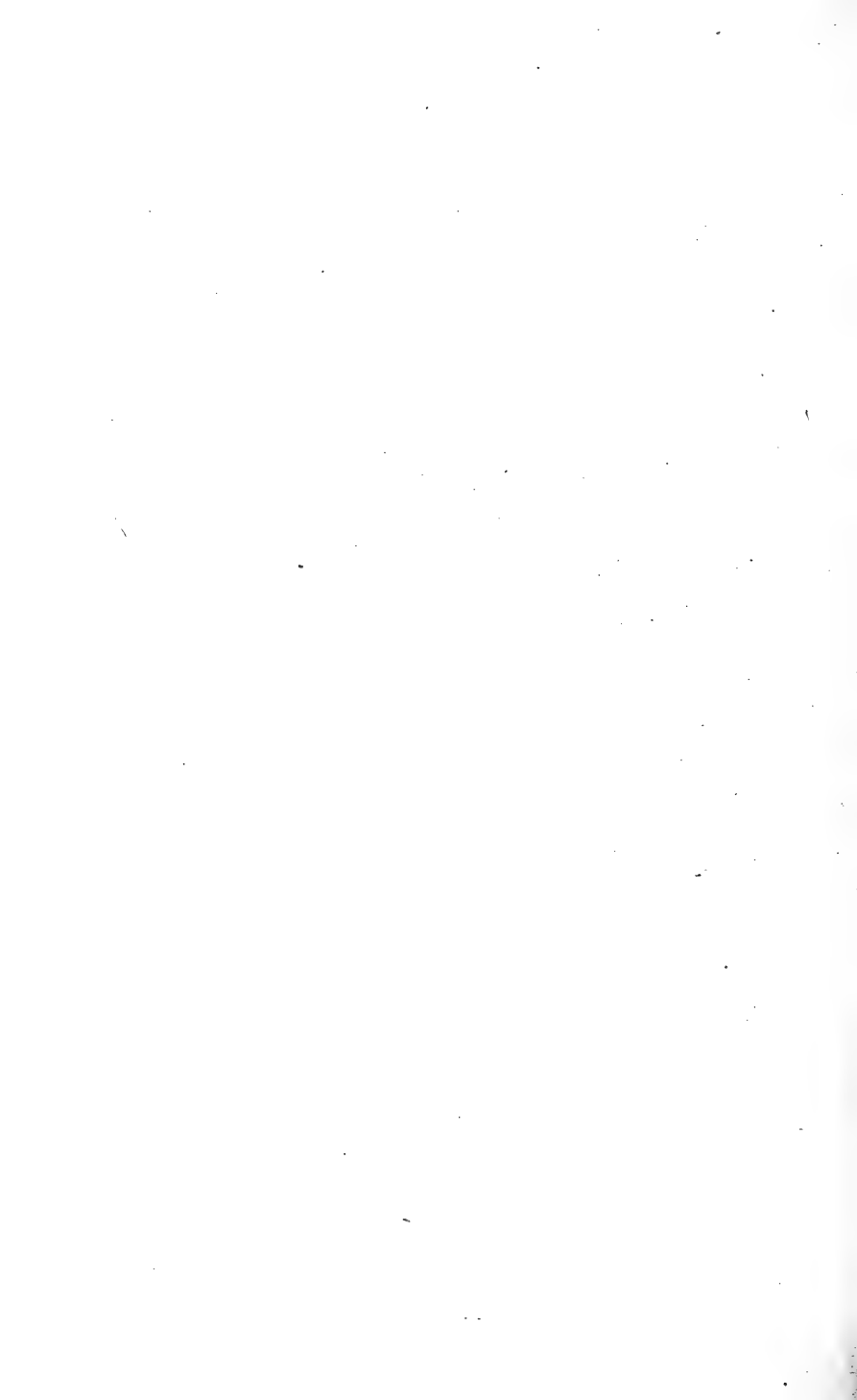

spent the winter in the state of Iowa. Judging from the stomach contents of many tree sparrows examined by him, he allowed a quarter of an ounce of weed seed a day for each bird, and on this basis calculated that in that one state, the tree sparrows destroy 1,750,000 pounds, or about 875 tons of weed seed during each winter. Supposing that those seeds had been left on the ground and that one in a hundred had germinated, I wonder what it would have cost the farmer to grub them out.

Our seven species of swallows may be counted among the birds which are almost wholly beneficial. They do no harm in any way beyond eating a few useful parasitic insects, and combing the air from morning to night they destroy an almost unbelievable number of noxious flying things, including house flies, mosquitoes, gnats, and horse flies. As most of them are quick to accept the hospitality of man, they are among the most useful birds we can have around our homes and barns. But they are valuable in fields as well, since they gather in locusts, leaf hoppers, ants, wasps, and bugs. The purple martin, the largest of the family, is very fond of squash beetles. The stomachs of ten purple martins, shot in Nebraska, were found to contain 265 locusts and 161 other insects.

When we see shrikes attacking our favorite chickadees and other little friends in winter, it is hard for us to regard them as useful birds. Yet Dr. Judd, who has closely studied their feeding habits, tells us that in the main these habits are good. It appears that one-fourth of their food consists of mice, one-fourth of grasshoppers, one-fourth of English sparrows and noxious insects, and only one-fourth of small native birds, useful beetles, and spiders.

Quite different is the important service rendered by a host of small birds whose duty it seems to be to protect the trees and shrubs among which they spend the greater part of their lives. Here we have the vireos, warblers, wrens, nut-hatches, titmice, and kinglets, all energetic and persistent hunters of small game, which if allowed to increase unchecked would quickly destroy our forests and set at naught the best work of the fruit grower. The vireos, many of the warblers, some of the wrens, and the titmice, work chiefly among the small twigs, the leaves, and blossoms of the trees, and they are well-hidden insects, insect eggs, or cocoons which escape the sharp little eyes made on purpose to spy them, and the sharper beaks so well fitted for probing the crannies where they lurk. Who can help admiring the work of a chickadee when

he undertakes to inspect a particular twig. He goes at it as if he knew his business and took a pride in doing it right. He studies his subject from every point of view—from above, from both sides, and from below, thinking nothing of swinging upside down if this position affords him a better view of any particular spot. And woe to the pests which may be hiding from him. Canker-worm eggs here, a small caterpillar there, and a bark beetle behind that twig, and the chickadee goes back and forth, up and down, and round and round, meanwhile chatting gaily to a dozen fellows, all working on different twigs, until that little job is finished and he passes on to the next one. Prof. E. D. Sanderson, who has carefully studied the chickadee in Michigan, estimates that this bird destroys every year in that one state about eight thousand million insects.

Certain warblers, the nuthatches, and brown creepers, devote themselves chiefly to the insects which infest the bark of the trees, and gather in many which the woodpeckers have passed by.

Mocking birds, thrashers, catbirds, thrushes, robins, and bluebirds should not be required to give evidence of their material usefulness in order to insure our protection. Almost all of them are world famous as musicians and their

cheerful presence alone has won for them the love of every American capable of the finer feelings. Nevertheless many of them are very useful as well. The bluebird, universal favorite, has a splendid record as a destroyer of injurious insects. Professor Forbes, in summing up his evidence for this bird, remarks: "One hundred bluebirds at thirty insects a day, would eat in eight months about 670,000 insects. If this number of birds were destroyed, the result would be the preservation, on the area supervised by them, of about seventy thousand moths and caterpillars (many of them cutworms), twenty thousand leaf hoppers, ten thousand curculios, and sixty-five thousand crickets, locusts, and grasshoppers. How this frightful horde of marauders would busy itself if left undisturbed, no one can doubt. It would eat grass and clover, and corn and cabbage, inflicting an immense injury itself, and leaving a progeny which would multiply that injury indefinitely."

The robin is charged with eating ripe fruit and there is no doubt whatever that in many cases the charge is true. At times owners of small fruit farms suffer severe losses from the attacks of this bird, though the investigations of Professor Beal tend to show that where wild fruit is abundant it is preferred to the cultivated

varieties. In any case the good work accomplished by the robin, in destroying insects, especially when there are hungry nestlings to be fed, much more than offsets the damage done in individual cases.

The catbird must also plead guilty to the charge of fruit eating, for he is notoriously fond of the smaller kinds, but as a check upon insect pests, he more than pays his bills. As he feeds his young almost exclusively on insects, and as he rears two and often three broods in a season, the service rendered is considerable. The stomachs of three nestling catbirds examined by Dr. Clarence Moores Weed, contained ninety-five per cent. of insect food. Sixty-two per cent. of this food was composed of cutworms.

Practically all the thrushes eat a good deal of fruit, but most of it is wild fruit that has little or no value to man. On the other hand, nearly two-thirds of their food consists of insects, chiefly injurious ones.

So making all allowances for a number of birds whose good deeds are offset by bad ones, and for a few which are positively harmful, we shall see that we have working for us a great army of feathered workmen—workmen, many of whom work for us three hundred and sixty-five days in the year, without wages, and without

even the necessity for supervision. And when we think that these workmen never loaf, never ask for a vacation, and never go on strike, it would seem that there should be, among all intelligent people, the keenest competition for their services. In later chapters I shall show some of the ways in which these workmen may be induced to spend at least a part of the year in our fields and orchards and gardens, where they will surely lay the foundations of a permanent friendship which shall be at once a source of pleasure and profit to us and of protection to themselves.

CHAPTER VI

ÆSTHETIC AND MORAL REASONS FOR PROTECTING THE BIRDS

WE have seen how valuable the birds are to us as guardians of our trees and crops, and we realize that we should protect them for our own interests, because they insure us heavier yields and more money. To do this will show our wisdom and far-sightedness; it will show our *interest* in birds. But it will not necessarily show our *love* for them, for "love does not traffic in a market-place, nor use a huckster's scales." Valuable as birds are as checks upon our enemies the weeds, the insects, and the rodents, there are higher reasons for protecting them. Looking at the matter from an æsthetic point of view, there are tens of thousands of people, and I number the reader and myself among them, who would find the world a much harder place to live in if it were not for the birds. Our happiness is made up largely of pleasant sights and sounds and thoughts, and there would

be far less of all of these if there were no birds. We should be deprived of the sight of their wonderful forms and colors and movements. How much a flock of sea-gulls, wheeling and turning and flashing sunlight from their silver pinions, above the deep blue water of a bay or harbor mouth, adds to the beauty of the scene. What an air of cheerfulness a flock of pine grosbeaks, or juncos, or a brave band of friendly chickadees gives to a leaden winter landscape. How much of spring there is on the back of a bluebird, that fluttering fragment dropped from the blue vault of Heaven. No woods are dreary if the jays or crows are calling; no field but is full of joy if the bobolinks are sprinkling it with their song; and he is not quite human whose heart does not beat faster when at night and far above him he hears the cry of the wild gander as he leads his flying squadrons northward, homeward, through the pathways of the skies. To a lover of nature it seems there is no time or place that the presence of living native birds does not add to one's happiness. In camp on a New England mountain top in the cool daybreak of a summer morning, the wonders of the coming sunrise are heralded by the voices of the hermit thrushes rising in chorus from the dawn-lighted spruce spires below. The loneliness of the marsh at



133 REDPOLLS AND PINE SISKINS AS GUESTS



MARTIN HOUSE IN A MERIDEN GARDEN



noonday vanishes as a stately heron flaps across the stagnant water and silently joins our vigil. In the afternoon among the flower-beds the soft purr of a humming-bird's motor causes us to smile as we realize that we are not alone in the garden. In the dusk of evening the call of the soft-voiced, invisible whippoorwill adds charming mystery to the gathering shadows of the roadside; and the glories of a winter night in the big woods are not complete without the deep-toned hooting of an owl to speak of the majesty of solitude. By the wonderful and delightful feeling of companionship which they create, birds lure us into the open—away from the cities, into the woods and fields and beside the rivers and the ocean beach, where the air and sunlight are pure and full of health and life. And perhaps, after all, this is just as important as keeping the beetles out of the potato patch.

So it would seem that all but particularly stupid or particularly thoughtless persons must be interested in birds entirely apart from their economic value, and to many they are the source of the greatest joy in life. Even primitive peoples have been deeply impressed by the remarkable forms and colors of birds; by their tranquil songs, their thrilling cries, and their

weird calls; and by their seemingly mysterious gatherings and disappearances and reappearances. It is hardly strange that these wonderful creatures, so different from all other forms of life, yet so human in many of their attributes, which had mastered the air and which came and went at will through paths where none could follow, should exert a powerful influence on the minds of peoples seeking to solve, without the aid of science, the mysteries of nature. So birds came to be invested with supernatural powers, some for good and some for evil; they became the subjects of story and legend and in this way interwoven with ancient folklore and symbolism. In Percy Mackaye's famous bird masque, *Sanctuary*, Ornis, the Spirit of All Birds, in her appeal to Stark, the Plume-hunter, says:

“ Do you not know me ? I am she
Whom first beneath the dark ancestral tree,
You rose upon your feet to hearken to.
By me you grew
To song and freedom. Round your olden feasts
You watched my circling flights, whereby your
priests
Proclaimed their omens and their oracles;
My cranes announced your victories, my storks
Fed your hearth fires, my silver-throated gulls
And golden hawks
Saved many your sea towns from sore pestilence;

And my sweet night bird tuned your poets' shells
 To lull sad lovers in languorous asphodels;
 Yet all my influence
 Shone dimmer than my beauty: my bright plumes
 Lured you to squander them, till, in the fumes
 Of greed, your heart forgot to cherish me,
 And sold me unto death and slavery."

And much of this symbolism and not a little of the superstition with it, has been handed down to us and is part of our every-day life and conversation. For example, the dove is the emblem of gentleness and peace; the eagle of war and aggressive power; the nightingale of song; the owl of wisdom; the vulture of greed, and the raven of darkness and disaster. Nor are we entirely dependent on the ancients for such symbols; we are beginning to adopt new ones. Our chickadee has become the symbol of friendliness, our robin of cheerfulness, and our bluebird of happiness. And it will pay us to learn, as many have already learned, that the happiness which comes with the bluebird in the spring, may be made to last through the rest of the year by sympathetic association with the other birds in their season.

In decorative art, especially in Oriental decorative art, birds have a very important place. For example, the artists of Japan seem never to

tire of using birds in their schemes of decoration. All kinds of birds are used and nearly always with beautiful effect. Sometimes it is a song bird, sitting with swelled throat and parted bill, among the delicately tinted blossoms of cherry or wild plum; again it is a heron standing on one leg beside a conventional stream, or a crow perched on a leafless branch amid the winter whiteness; and still again it is a flock of swallows or wild geese flung out across the sky and telling their story as well as if the picture had been labelled "Spring."

It can hardly be doubted that in the origin of music the songs of birds were among the first suggestions supplied to primitive musicians by external nature. Later instrumental composers have found in the imitation of Nature's voices a distinct phase of musical expression, and in this the calls and songs of birds hold a conspicuous place. The call of the cuckoo was a favorite motive among early instrumental composers, and was used by Beethoven in the *Scene by a Brook*, in the Pastoral Symphony, together with the songs of the nightingale and the call of the quail. Another very notable example of the employment of bird notes by great composers, is found in Wagner's *Siegfried*. Siegfried listens to the songs of birds, made plain to

him by a taste of the dragon's blood. A bird sings to him of Brünhilde, the flame-encircled warrior maiden. The bird wings its flight through the forest and Siegfried follows joyously.

In Haydn's *The Creation* a soprano sings:—

“On mighty pens uplifted soars
 The eagle aloft and cleaves the air
 In swiftest flight to the blazing sun.
 His welcome bids to morn the merry lark,
 And cooing calls the tender dove his mate.
 From every bush and grove resound
 The nightingale's delightful notes;
 No grief affected yet her breast,
 Nor to a mournful tale were turned
 Her soft enchanting lays.”

Grieg's beautiful *Spring* song fairly twitters with the joyous notes of birds, and this, with Schubert's "Hark, hark, the lark," from *Cymbeline* and Abt's *When the Swallows Homeward Fly* are among the many familiar examples which might be cited of the contribution which birds, directly and indirectly, have made to music.

And birds have affected literature even more. Thousands of books have been written either wholly or partly on birds. Many of these are English, but all civilized peoples have their books on this subject. One of the most beauti-

ful and poetic is *The Bird*, by the great French historian, Jules Michelet. As for the poets, few of them have been able to resist the power of the birds, and indeed it would seem that a poet could hardly remain unaffected by the charm of beings so essentially poetic. Some of the very earliest English poems, in some cases anonymous, had birds for their themes. Chaucer was a bird lover and continually shows it. King James the First of Scotland, in the early part of the fifteenth century wrote *Spring Song of the Birds*. Edmund Spenser wrote of feathered folk; Shakespeare alludes to them again and again, and William Blake never more tersely showed his sympathy for them than when he wrote:

" A robin redbreast in a cage
Puts all heaven in a rage."

Nearly all the later English poets, Milton, Pope, Cowper, Burns, Wordsworth, Hogg, Scott, Coleridge, Byron, Shelley, Keats, Hood, Tennyson, Browning, Rossetti, Wilde, and many others have received inspiration from the birds. The skylark alone has inspired many of them, and perhaps none of the poems of Hogg or Shelley are better known than their odes to this famous songster.

A few years ago the writer had reason to visit



GROUSE BURROW IN THE SNOW

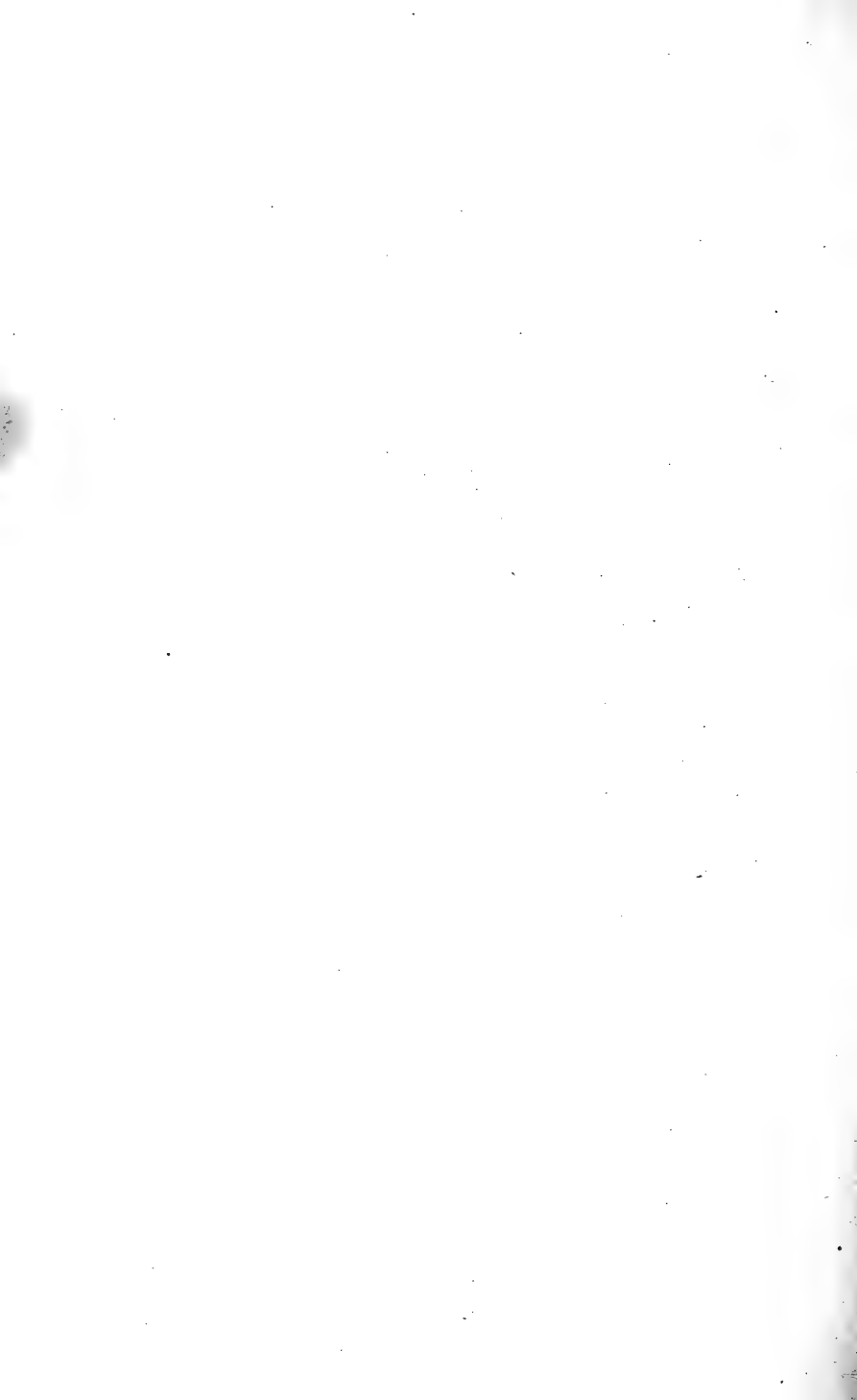

a New York department store, and there he made the acquaintance of the "chanticleer" bow, at that moment, the "latest thing" in women's neck wear. It was made of fluted satin ribbon, and would have been commonplace enough but for the fact that in the center of it was the head of an English skylark. And it was but one of scores of similar bows exposed to the indifferent gaze of thousands, some of whom stopped to buy for money what no money on earth should be permitted to buy. The writer is not a poet, but a boyhood spent in England made him an ardent lover of the skylark, and perhaps the reader can guess what feelings possessed him when he saw the mummied head of that modest little bard on a tawdry bow in a department store. Perhaps what he felt most keenly was the degradation of the bird, and it filled him with such indignation that he sought the manager of the store and registered a vigorous protest. This was followed by a written one to the proprietors and by a letter which was printed in the *New York Times*. But the National Association of Audubon Societies, under the direction of William Dutcher was already at work on the case, and it was but a short time before the sale of chanticleer bows was stopped—let us hope forever.

And American poets have held their own in

showing appreciation of wild birds; Bryant, Drake, Emerson, Whittier, Longfellow, Poe, Holmes, Van Dyke, and Mackaye are among the many who have tuned their lyres to the songs of birds. Of all Poe's poems the best known is *The Raven*; of Bryant's, few are better known than *To a Waterfowl*. How birds can awaken poetry in the heart of a child is shown by *The Hermit Thrush*, written by Percy Mackaye's little daughter Arvia at the age of nine. In short, as John Burroughs indicates in his book *Birds and Poets*, these bards are inseparable, and Tennyson must have felt this when he wrote *The Poet's Song*:

“ And he sat him down in a lonely place,
And chanted a melody loud and sweet,
That made the wild swan pause in her cloud,
And the lark drop down at his feet.
The swallow stopt as he hunted the bee,
The snake slipt under a spray,
The wild hawk stood with the down on his beak,
And stared, with his foot on the prey,
And the nightingale thought, ‘ I have sung many songs,
But never a one so gay,
For he sings of what the world will be,
When the years have died away.’ ”

And perhaps our own Van Dyke felt it even more deeply when at the close of his lovely poem on *The Veery* he sings:

“ And when my light of life is low,
And heart and flesh are weary,
I fain would hear before I go
The wood note of the veery.”

And I have noticed that the work of providing for the needs of wild birds has a wonderfully good effect upon the people engaged in it. In the first place it awakens or stimulates an interest in an important and fascinating subject, and provides for the mental and physical activities an outlet which can lead only to good. Through it the coming generation will get practical experience in the conservation of our natural resources, and thus by taking part in a great national movement they will at an early age begin to feel the joy of being useful. Most work of a public nature is impractical for children, but here is a work in which young people can be almost as useful as older ones and at the same time provide for themselves one of the sweetest and most satisfying hobbies known to man. Work for the birds tends to thoughtfulness and consideration; inasmuch as it is inspired by the work the birds do for us, it encourages appreciation and gratitude, and a sense of justice and fair play; as it brings to the worker a sense of the helplessness of his feathered friends at certain times, it begets feelings of humanity, kindness, sympathy,

and compassion and stimulates warmth of heart; and if some personal sacrifice is required in order to do this work, the worker gets practice in unselfishness. And it is the opinion of the author that if children once learn these things, they will have made a very fair start towards good citizenship if they are not taught anything else.

CHAPTER VII

THE ENTERTAINMENT OF WILD BIRDS IN WINTER

IF we are lovers of birds (and who would like to admit that he is not one) that fact alone should be sufficient to insure our feeding them in winter; for it is not conceivable that we would allow those whom we love to run the risk of starving to death, if by any reasonable effort we could prevent it. In spite of all we can do, many birds will die of starvation almost every winter, but the more of us there are who will give even a little thought, go to even a little trouble for their welfare, the fewer deaths there will be.

Looking at the matter merely from the standpoint of our own pleasure we shall soon learn that by feeding the birds regularly we shall make a lot of new friends, and that with a little patience and a little ingenuity sometimes, we may soon be on terms of the most delightful intimacy with them. At our home we are continually having unique and interesting experiences with the birds which accept our hospitality. We had one

only this morning, September 19, 1914. A little band of chickadees came into our lilac bushes, and thence flew down to a bird bath made from a huge shell and took their baths. Mrs. Baynes went out and called them, and two of them alighted upon her at once. One was dingy in color and somewhat dishevelled, and looked as though it might have just finished a very tedious nesting season. The other looked very clean and fresh and by its voice alone we knew it to be a young one. On the left leg of the dingy one was a tiny aluminum band, and as the bird preened its feathers we could read on this band the number. Instantly we knew her for an old friend of ours. Year before last she nested in a Berlepsch nest box in our garden, and was so tame, doubtless because we had fed her the winter before, that she came straight from the nest to Mrs. Baynes' hand for nutmeat. On one occasion I went up a ladder to the nest box, and this bird alighted at the entrance hole. She was so fearless that I put my hand gently over her, and placed the little band upon her leg. That was over two years ago and here she was back again, fearless as ever, and with a young one, very likely one of her own.

Some of us feed the birds all the year round, because we like to see them about. Moreover,

they are more likely to nest in or near the garden if they are in the habit of coming there for food every day, and we believe that if it does cost us a few pennies for seed and suet, it pays in more ways than one. As a rule, no matter how much food is put out the birds seem to regard it simply as a reserve supply and continue to get nine-tenths of their living in the usual way. Purple finches are notable exceptions to this rule; it has been my experience that they absolutely refuse to work as long as they are well supplied with seed. But then, the male purple finch is a splendid singer and has a long period of song, and perhaps he should be excused from further work on the ground that he is an artist.

But the birds actually need food only when for some reason their natural supply is not to be had. This is often the case in winter, especially after heavy snowstorms. At such times let us pay no attention to the wiseacres who tell us that we are pauperizing the birds; they might just as well argue against supplying food to starving men. Let us save the lives of a few thousand birds and then if anyone finds that we have made a mistake in doing this, we'll stand the consequences.

Perhaps no branch of bird-feeding work is more in need of consideration at this time than that which provides for the great army of game

birds and others which struggle along as best they can in the woods and fields. It would seem to be the duty of the people in every town where deep snows prevail in winter, to see that their own birds are provided for and not allowed to starve; and it has been my experience that nice people of all classes are of just one mind on this subject. The only question which should be raised at such a time is, "How shall we do it?" If there is a really live, efficient bird club in the town, it will answer this question promptly, and if there are Boy Scouts in the neighborhood, of course they will cooperate with enthusiasm. If there is no such club, then one should be organized as soon as possible, and in the meantime I will suggest a plan which has proved successful in several different towns, and which may help until a better one is thought out.

First of all, two or three enthusiasts call a meeting of all those interested in the welfare of the wild birds. This is done through the local paper, if there is one, or through the school-children, or both, or in any other way which may be convenient. A special effort is made to have this meeting attended by the superintendent of schools, and as many principals, teachers, and ministers as possible; this tends to impress the school-children and others with the dignity and



QUAIL SAVED FROM STARVATION BY HIGH-SCHOOL BOYS



A FEEDING STATION. WHERE THE "BIRD MASQUE" WAS STAGED

importance of the work, and has a good general effect. The necessity for feeding the birds in winter is explained very carefully, and then a few committees are appointed to arrange details. One committee devotes itself to obtaining bird-food and money to buy food, and sometimes calls to its assistance such available outsiders as may be able to help. There are very few people in any American town who will refuse to help such work along in one way or another, if the matter is brought directly to their attention in a proper way. It is usually possible to approach many people personally; but, in any case, the school-children can be urged to explain the matter to their parents, and local papers are usually very willing to make known the needs of the committee. Local grocers, butchers, and grain-dealers I have found to be among the most generous contributors, and often, after they have given all they can afford, they will sell to the bird-feeders a considerable amount of food at cost.

In the meantime another committee is busy getting the names of volunteers to distribute the food in the woods and fields. Here let me say that this work is not, as a rule, suitable for small children, girls, or women; it should be done by strong, healthy boys, and by such men as can af-

ford or will make the time. It has been my experience that no better workers can be found than the boys from the high schools and the upper grades of the grammar schools; this is especially true if they belong to the Boy Scouts. As a rule their work should be superintended by some older person in whom they have confidence. But, whoever the workers are, they should have the support of the entire community; they are engaged in a public work of great value.

The coming of the first real snowstorm is considered the signal for the beginning of operations. The volunteers meet at some convenient building, as the high school or the town hall, where the bird-food has previously been stored, and if they are wise, they come dressed for work in the snow. The country in and about the town is divided into sections, and a squad varying in size with the number of volunteers and the amount of territory to be covered, is sent to each section. Usually a squad consists of two, three, or four boys, who may or may not have an older person as leader. Each squad should be provided with snow-shovels to remove the snow, or better, snowshoes to trample it down hard. They should also have a bag or basket to carry a mixture of grain and birdseed, a quantity of fat meat or suet, and plenty of string

with which to tie it to the trunks and branches of trees. The suet or other fat, which is, of course, intended chiefly for the insectivorous birds, is displayed in conspicuous places on the branches of trees, and the string is wound round and round so as to form a sort of net which prevents the food from falling to the ground even after it has grown beautifully smaller under the attacks of hungry birds. This network of string also prevents a crow or a blue jay from carrying off the whole lump at once. It has been found wise to use three or four separate pieces of string, so that if a squirrel comes along and cuts one of them, the suet, being held by the others will not fall to the ground. Another way to prevent troubles of this kind is to flatten out a large lump of suet against a tree trunk and fasten over it with staples a square foot of half-inch wire netting. If the upper edge is fastened rather lightly, this netting may be made to form a pocket which may be opened and stuffed with more suet as occasion requires. Here any hungry bird can get a meal on the spot, but no selfish one can leave his fellows in distress by carrying home the whole feast.

As a rule, the best places to distribute grain, seed, etc., are in the middle of wide-open fields and pastures, which can be seen for a consider-

able distance by birds flying over. On reaching such a spot the members of the squad fall to with their shovels or snowshoes and clear or trample a space from ten to twenty feet square. If the food were thrown on untrodden snow, it would be likely to sink in at the first thaw, and then it would be quite out of the reach of most of the hungry ones. After scattering a quantity of grain, the squad moves on perhaps half a mile, and repeats the operation, establishing as many feeding stations as possible in its own section during the time at its disposal.

Of course it may be somewhat disheartening to find that seed scattered during the afternoon is covered up by snow next morning, as sometimes happens; but boys with the right stuff in them will not be discouraged, but will stand up to their work until it is finished. The high-school boys of Stoneham, Massachusetts, were among the first to show that no amount of snow could discourage bird-feeders who had the proper spirit, and in the unusually severe winter of 1903-1904, they got out with their snow-shovels and grain and suet after every storm, and established and maintained a chain of seventy-five feeding stations around their town; so that no intelligent bird could get either in or out without taking

a meal, if he wanted one. These boys fed thousands of hungry birds that winter, and made their school famous. By their splendid work they saved a few of the very few flocks of Massachusetts quail which survived that winter. If all the high schools in the state had been organized for this work, the death of unnumbered bobwhites would have been prevented.

Every farmer should make a point of keeping the birds in his fields and woodland supplied with food during bad weather, for, as we have seen, he is amongst those most greatly benefited by the presence of birds. Besides, he generally has on hand plenty of food in the shape of wheat, oats, etc., which can be offered whole to the large birds and ground to the small ones.

Country doctors, rural postmen, and others who have to take long drives through the country in winter, can perform valuable service by distributing food at likely spots or by reporting to the regular bird-feeders coveys of quail, or signs of coveys, seen or heard of at points along the route.

Snowshoeing, skiing, sleighing parties, and others out for pleasure during the winter may well assist in this work by establishing a feeding station here and there, and if they are thoughtful people, the thought that they have done a kindly

and useful act will tend to increase their pleasure, and will greatly add to their store of pleasant memories.

By working together in this way, the people of each town and village and hamlet can take care of its own birds, and the result will be a marked increase in their numbers without very much trouble or expense to any one person.

But it is the feeding of the birds in the home grounds, in the gardens, and orchards that appeals to the greatest number of people. Here is a work in which almost everyone, little children and elderly people included, can take an active part. And here, as a rule, will begin those strong friendships for birds which will make the staunch bird-protectors of the future. Here will come many of those delightful experiences with birds which will be among the purest delights of childhood, which will surely be looked forward to and repeated with pleasure and satisfaction as the years go by, and which we can never grow too old to enjoy.

Unless we are among the few who feed the birds all the year round, we should begin to prepare rather early for the winter work. Even before the first frosts begin to suggest the coming of colder weather we may order from the butcher a few pounds of suet or fat fresh pork, and find

out the best place to buy birdseed. By buying seed at wholesale, say one hundred pounds at a time, it may be had at a very low price. For example, the Meriden Bird Club buys its hemp seed at four cents a pound, when the retail price per pound is ten cents. We buy other seeds at equally low rates. Many people do not care to buy so much seed at once, but if there is a bird club in town, the club can buy it in large quantities and sell it to members at cost. Or, if there is no club, a few neighbors can club together, order a hundred pounds or more sent to one address, and then divide it afterwards.

Hemp seed and Japanese millet are among the best seeds to offer the birds in winter; most of the seed-eating birds will eat one or both of these, and chickadees and nuthatches chiefly insectivorous, are very fond of hemp. Sunflower and canary seed are both eaten by a number of birds, as are squash and pumpkin seeds, corn, oats, wheat, bread crumbs, doughnut crumbs, dog-biscuit crumbs and the seeds to be found in barn-floor sweepings. Nuts are a favorite food of chickadees, nuthatches, and some other birds, but of course those with hard shells must be cracked before being served.

As a substitute for insect food there is nothing better than suet, unless it be the mixture known

as "food-stone," the receipt for which I shall give farther on. Suet is easy to get and easy to handle, many birds like it and eat it freely, it is warmth-producing and nourishing, it keeps fresh for a long time and when it becomes rancid the birds seem to like it just as well. As I look out of my window at this moment, I can see a downy woodpecker feeding on suet which was put up about a year ago.

I give below a list, by no means exhaustive, of foods in general use for the winter feeding of wild birds; with each kind of food will be found the names of at least some of the birds which have been seen eating it.

SUET. Screech owl, hairy woodpecker, downy woodpecker, red-bellied woodpecker, flicker, blue jay, crow, Clark's nutcracker, starling, tree sparrow, junco, rose-breasted grosbeak, myrtle warbler, brown creeper, white-breasted nuthatch, red-breasted nuthatch, chickadee, Hudsonian chickadee, hermit thrush.

FAT PORK. Hairy woodpecker, downy woodpecker, blue jay, crow, white-breasted nuthatch, tufted titmouse, chickadee.

RAW MEAT. Screech owl, hairy woodpecker, downy woodpecker, blue jay, white-breasted nuthatch, chickadee.

HEMP SEED. Pine grosbeak, purple finch,

redpoll, goldfinch, pine siskin, vesper sparrow, white-crowned sparrow, white-throated sparrow, junco, song sparrow, white-breasted nuthatch, chickadee.

MILLET SEED. Purple finch, redpoll, goldfinch, pine siskin, vesper sparrow, white-throated sparrow, tree sparrow, chipping sparrow, junco, song sparrow, fox sparrow.

CRACKED CORN. Shore lark, blue jay, crow, snow bunting, Lapland longspur, tree sparrow, junco, cardinal grosbeak, white-breasted nuthatch.

BREAD CRUMBS. Blue jay, crow, tree sparrow, white-crowned sparrow, junco, cardinal grosbeak, mocking bird, brown creeper, chickadee.

BROKEN NUTS. Blue jay, white-crowned sparrow, junco, cardinal grosbeak, white-breasted nuthatch, red-breasted nuthatch, tufted titmouse, chickadee.

DOG BISCUIT CRUMBS. Blue jay, snow bunting, tree sparrow, junco, white-breasted nuthatch, chickadee.

SUNFLOWER SEEDS. Blue jay, purple finch, goldfinch, white-breasted nuthatch, chickadee.

CHAFF. Quail, shore lark, Lapland longspur, snow bunting, tree sparrow.

OATS. Quail, ruffed grouse, yellow-headed blackbird, snow bunting, chickadee.

WHOLE CORN. Blue jay, crow, white-breasted nuthatch, chickadee.

CANARY SEED. Goldfinch, vesper sparrow, junco, song sparrow.

DOUGHNUT CRUMBS. Blue jay, crow, white-breasted nuthatch, chickadee.

WHEAT. Quail, ruffed grouse.

KAFFIR CORN. White-throated sparrow, song sparrow.

BROKEN SQUASH SEED. White-breasted nuthatch, chickadee.

SALT, SALT WATER, AND MUD IMPREGNATED WITH SALT. White-winged crossbill, American crossbill.

The author is very well aware that the above lists are not complete, either with regard to the kinds of food which the winter birds will eat, or with regard to the kinds of birds which will eat the foods which are mentioned. These lists can be made complete only as a result of the careful experiments of many observers working for a considerable period over a wide territory. At present they are as complete as can be made from other records compiled by Gilbert H. Trafton, by the author himself, and by other members of the Meriden Bird Club. They will enable the reader to make a fair start and he can



A "WEATHERCOCK" FOOD HOUSE

then experiment for himself as much as time and inclination will permit.

In addition to food, many birds will appreciate a little grit which is often hard to get in winter. Sand is best, perhaps, but coal ashes will do and a flock of crossbills which made us a long visit a year or two ago, spent hours every day picking up particles of mortar which we obtained from some old bricks and pounded up with a hammer. We might never have guessed how fond they were of this particular kind of grit, had we not seen them swarming over a ruined building, and discovered with the aid of a field-glass that apparently they were nibbling the mortar which held the bricks together. We got some of this mortar, pounded it up, and scattered it on well-trampled snow in the garden and down came the crossbills, not only that day but every day for weeks. The flock usually arrived between half-past seven and eight o'clock in the morning, and were engaged in eating mortar until between one and two in the afternoon, when the greater part of them disappeared in the evergreen forest nearby, not to be seen again until the following morning. They became very fearless, coming to windows, allowing us to walk about among them when they were feeding, alighting freely on our hands and heads, and even permitting us to pick them

up, one in each hand. When sometimes I lay on the ground among them, they would poke their heads into my sleeves and if my ulster was not tightly buttoned, some of them would creep inside. While they were in the garden they kept up an incessant musical twittering, which added greatly to the pleasure they gavé us.

But to return to our work. There are certain appliances such as food houses, window boxes, food trolleys, etc., which it is very pleasant to have and which may be made at home or by local carpenters, or which may be bought ready-made. But if we cannot afford either the time to make them or the money to buy these things, we can get along pretty well without them. Let us get out our food early. The birds may not eat much of it at first, but they will have a chance to find out where it is, and be able to go directly to it when they really need it. We might begin by putting out some suet. I believe in having rather large pieces, weighing say about a pound apiece, at a few principal points and a number of smaller pieces scattered more widely, in order to attract the attention of as many birds as possible and guide them to the larger lumps. If our final object is to attract the birds to points near the house, let us first select the side of the house to which we wish to bring them. If we

try to attract them to all sides, we can probably do it, but shall not have as many in any one place. Usually people like to have them come to points where they can be seen from the principal living-room. Suppose then that we decide on this plan. Let us look out of the window and see if we can find a tree say seventy-five or a hundred feet away to which we can tie one of our lumps of suet. Let us suppose that we see such a tree, and that there is a well-exposed branch from eight to twelve feet from the ground. We fix that branch in our minds, and suet in hand we go out to the tree. Perhaps we can easily climb to the branch; but if not, we can get a ladder. We should have three or four pieces of soft string of convenient length, and with one of these tie the suet at just the place and in just the position we want it. It is well to have it either on top of the branch or on the side of it; if it is fastened underneath, certain birds which like suet would find it hard to get at. If it is fastened on the side of the branch, of course it should be on the side nearer the house where it can be seen. The other pieces of string should now be crisscrossed back and forth, and should bite into the suet a little at each turn, so that it may be left snug and tight. The loose ends of the string may now be cut off and the deed is done.

Next let us go to a tree say from ten to twenty feet from the window, and there we will tie a second piece of suet at about the height of the window itself. A third piece we will tie either to the window-sill or to a stick or a board which may be fastened to the window-sill. Those three we will call our main suet stations. Smaller pieces of suet we will tie in trees and shrubs out in all directions from the house and further away from it. These distant ones will probably be visited first, and as the birds gain confidence they should come nearer and nearer until they come to the window itself.

To encourage those who may think it a difficult matter to gain the confidence of our feathered neighbors, I give the following list of twenty-two kinds of birds which have come to feed at windows in the village of Meriden, New Hampshire, where we have been feeding for the past four years. Those marked with a star have visited our own window:

* Hairy woodpecker, * downy woodpecker, *ruby-throated humming bird, *blue jay, *pine grosbeak, *purple finch, *white-winged crossbill, *redpoll, *pine siskin, vesper sparrow, white-crowned sparrow, white-throated sparrow, tree sparrow, chipping sparrow, junco, song sparrow, *myrtle warbler, *winter wren, *white-breasted

nuthatch, red-breasted nuthatch, *chickadee, *Hudsonian chickadee. This is probably the largest list for any one town or village.

The red-bellied woodpecker, snow bunting, fox sparrow, brown creeper, and hermit thrush, have also been known to feed at the windows of houses, but they have never done so in Meriden, though we have them all here with the exception of the woodpecker.

If it becomes necessary to put out more suet during the intensely cold weather, we shall find it a good plan to bring some short branches into the house, and tie on the suet there in comfort. Then, if we drive a couple of wire nails part way through each branch, we can carry it out and quickly nail to any tree we like.

If we wish to go to just a little more expense, we can make the suet-pockets of half-inch wire netting and staple them to the trunks of trees instead of tying the suet itself to the branches.

The simplest way to feed the seed-eating birds is to scatter the food on the ground. If there is soft, deep snow, the food should not be thrown upon it. Seed and most other foods quickly sink into soft snow, and besides most birds do not like to flounder about in the snowdrifts in order to get a bite to eat. The snow may be swept or shovelled away, but personally, I much prefer

to trample it down. It is not easy, even with a snow-shovel, to thoroughly clear a generous space where there is long grass or weeds; cleared spaces are apt to become wet or muddy and are usually unsightly. The trampling process is quicker, much quicker if we have snowshoes, it makes no unsightly patches, and moreover the well-trodden snow forms the most pleasing background against which to see our feathered guests.

It is best to put out a day's supply of fresh food each morning; the birds learn to connect our appearance with the coming of good things for them, and gradually lose their fear of us. Moreover, by putting out comparatively small quantities of food we avoid the danger of unnecessary waste when snowstorms come and cover up whatever is on the ground. If there is danger from cats we should select for our feeding station a space well out in the open; if there are shrubs or other tall plants about, the cats will be able to creep up within leaping distance before the birds are aware of their presence.

This much we can do without any appliances, and at no expense beyond the cost of the food. But some of us will wish to make rather more elaborate preparations, so I shall now describe

some of the feeding devices which I have tried and found satisfactory for attracting birds to the home grounds.

The Food Tray

One of the simplest devices is a food tray or lunch counter which anyone can make, if it can be said to need making. It may be a shallow cigar box, though this is rather small. A better one could be made from a piece of board say a foot or eighteen inches wide, and two or three feet long with laths or similar strips of wood nailed around to form a rim, so that the seeds will not roll off. A good-sized hole should be bored in each corner, and over each, on the under side of the tray, should be tacked a piece of wire netting. This will prevent the tray from becoming full of water when it rains. Such a tray, with a stick below to brace it, may be fastened to a tree, to the window sill, or both, and if a supply of food is kept in it all the time, the birds are sure to find it. If a roof is arranged over it, it becomes a "food shelter," and will not require sweeping off after every snowstorm. Besides putting seed and other food in the tray itself we sometimes fasten to the tray an upright branch or small log and to this attach a piece of suet. This is for the convenience of any

woodpeckers which may come, though it is not really necessary even for them.

The Window Box

Few devices have given more satisfaction to members of our household than the window box, which was made from a sketch kindly sent to me by William Dutcher, President of the National Association of Audubon Societies. It is made to fit the open window, the sash coming down snug into a groove in the woodwork at the top. It projects into the room about a foot. The top, back, and sides are of glass, which helps to give the room a cheerful sunny appearance. The floor of the box is of wood and in the form of a tray projects into the garden ten or twelve inches. At the top, and inside the room, of course, is a hinged lid through which we put the food, and which can be used to ventilate the room when necessary. This window box has proved a great success, and at different times I have seen it filled with blue jays, pine grosbeaks, redpolls, crossbills, and chickadees, while many other birds have come in smaller numbers. At first we helped the birds to find it by erecting in the garden, about ten feet from the window, an old stump to which we tied big lumps of suet. Birds

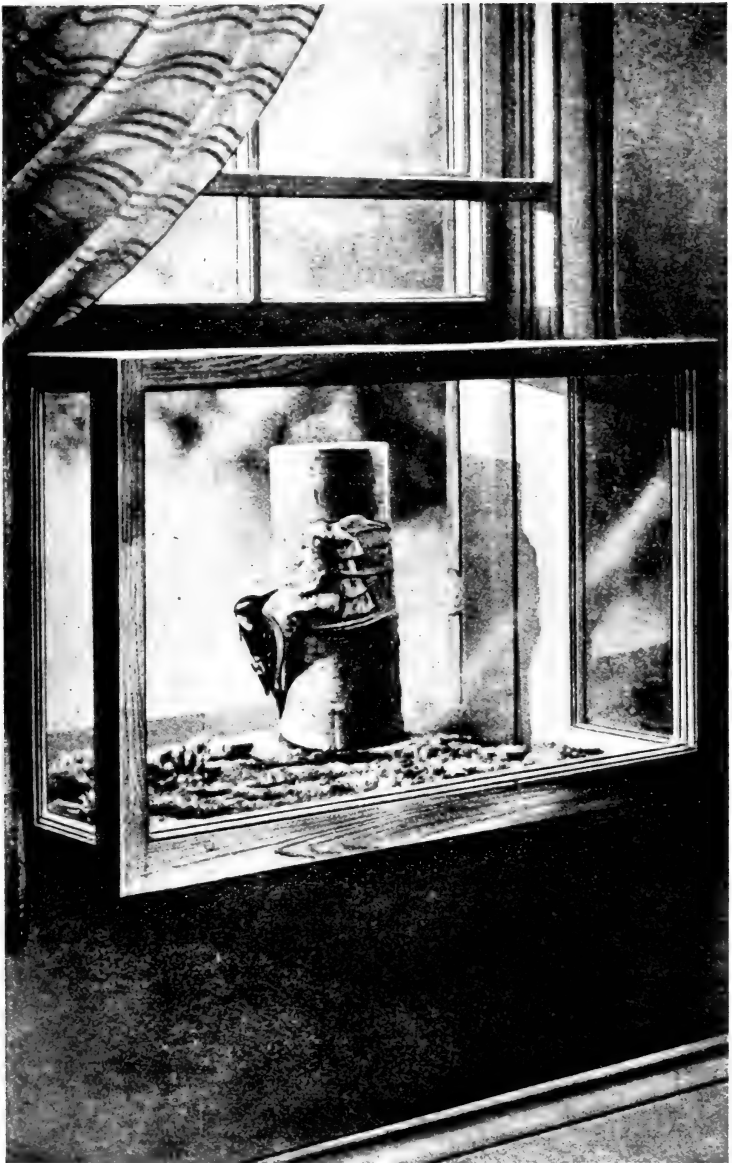

A WINDOW BOX IN THE AUTHOR'S STUDY

began to come to the stump and from there they would come to the feast arranged for them in the window box. The stump was then removed but the birds continued to come to the window in ever increasing numbers. Some people prefer to have their window boxes fastened to the window sill but entirely outside the window. This is almost as good but you can't have the birds quite so near, and it is not quite so easy to put in the food. On the other hand, almost anyone can make an outside window box, while one required to fit the sash of an open window well enough to keep out the draught, must, as a rule, be made by a carpenter.

The Weathercock Food House

Another device suggested to me by Mr. Dutcher, which has proved equally successful, is what I have named the "Weathercock" food house, because, like a weathercock it moves with the wind. It is little more than a well-made food shelter, set on a pole, and pivoted so that it can revolve horizontally. Two paddle-shaped arms or wings extend one on either side to catch the wind, which thus turns the open side of the house away from the storms at all times. The back is a single sheet of glass and sometimes the sides are

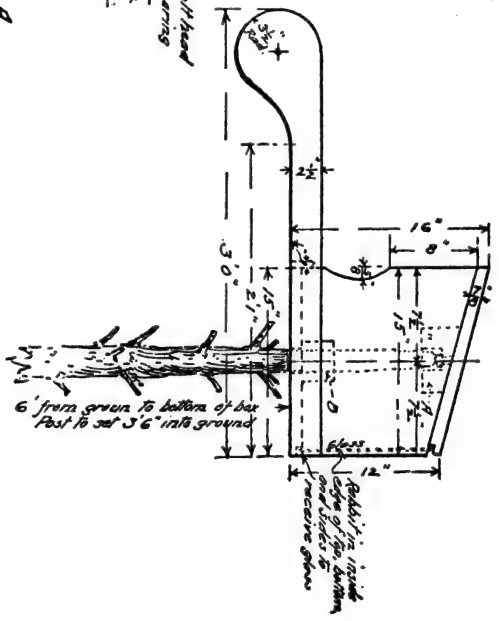
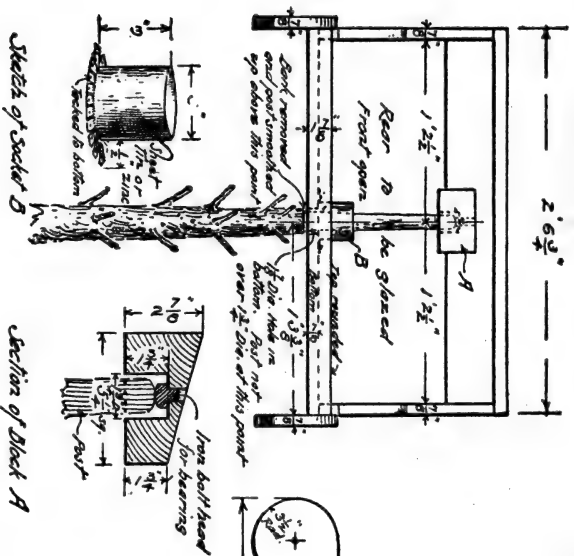

FRONT ELEVATION

Working plan for a "Weathercock" food house.

SIDE ELEVATION

also of glass. All kinds of winter birds and a number of summer birds, too, come to this house, and they don't mind the motion of it any more than we mind the motion of an express train, when we're sitting in the dining-car.

After we have been attracting the birds for a little while, every corner of the garden will have some interesting association connected with the work, every device or appliance we have used will recall some delightful or amusing incident. The mere mention of our "Weathercock" reminds me of a joke it once helped me to play. Mrs. Baynes had for some time been busy coloring a set of artificial birds made of cardboard which she intended to present to a school. She had begun work on the blue jay, and asked me if I could find for her a good picture of the bird from which she could sketch the markings of the wings. I found several but they would not do, chiefly because they showed the wings folded, whereas the bird she was making had the wings extended. At last I said, jokingly, "Well, I see there is nothing for me to do but go out into the garden and catch you a live one." With that I walked from her room into my study, and looking out of the window saw a flock of blue jays feeding in the "Weathercock." At that moment something startled them and out they

flew,—all but one, and he flew into the glass at the back. Then he lost his head, and began fighting the glass, and I opened the front door, walked across the lawn, and caught him. Spreading out one of his wings, I went back into Mrs. Baynes's room, and without a trace of a smile, asked, "Will this do?" You can imagine her astonishment better than I can describe it. She made her notes on the marking of the wings, then we put an aluminum band on the bird's leg, and let him go. It was exactly a month before we saw him feeding with other jays in the window box.

The Audubon Food House

Then Mr. Frederic H. Kennard, the landscape architect, sent us a plan of a food house which he had designed and found successful on his own estate at Newton Centre, Massachusetts. It was an adaptation of a device invented by Baron Hans von Berlepsch, the great German bird lover, of whose interesting experiments I shall speak again later on. As may be seen in the illustrations, it consists of two food trays, one above another, the upper and larger being protected from the snow and rain by a four-sided "hopper" roof, and from the wind by an "apron" of glass which falls from the roof, the

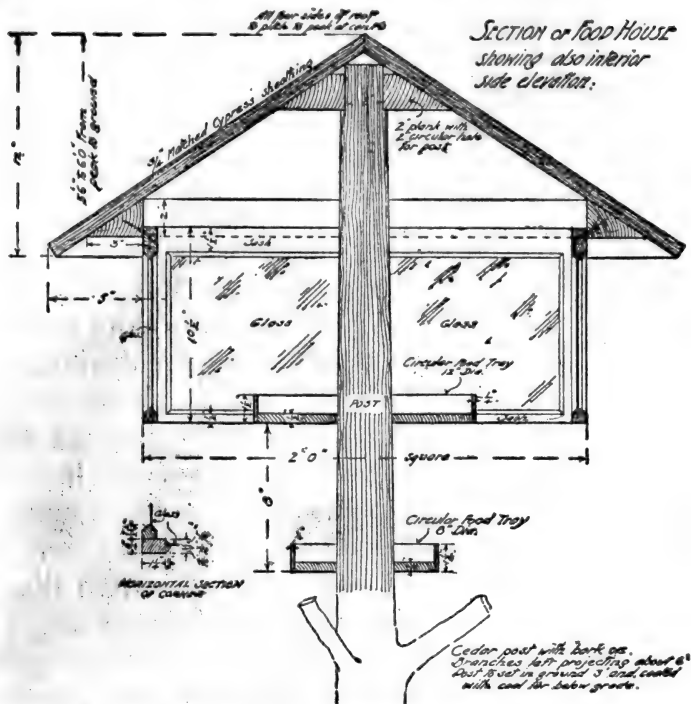

Plan for an "Audubon" food house.

whole supported by a single rustic pole running to the peak. We called this the "Audubon" food house, and it has been proved a success in half a dozen gardens in Meriden, and in hundreds of others in different parts of the country. This food house should be erected among or near shrubs or beneath the low-growing branches of a

tree—at least it is in such a place that it will be most quickly discovered by the birds. Until the latter become acquainted with it, food should be put in both trays. The lower and unprotected tray is the more conspicuous and will, of course, be seen first. When the food has gone from that, or sometimes before it has gone, some of the birds will find their way to the upper tray and the rest will soon follow. After that no more food need be put in the lower tray. In case the birds are a little slow in finding their way about, one or two crooked twigs arranged so that they connect the two trays, will usually show the little guests their way “upstairs.” These twigs may be removed a few days later. The glass apron, in addition to serving as a protection from the wind, admits light to enable the birds to see what they are doing, and also permits the host to see his guests at dinner. For several years now we have had an “Audubon” food house in our garden, and during the winter there is a continual stream of birds going to and from that house. Our neighbors report similar experiences. Birds feeding in either this house or the “Weathercock” would be in little danger from a cat even though the latter should climb the pole. The cat would have to climb around over the under side of the food tray and while the birds would of course

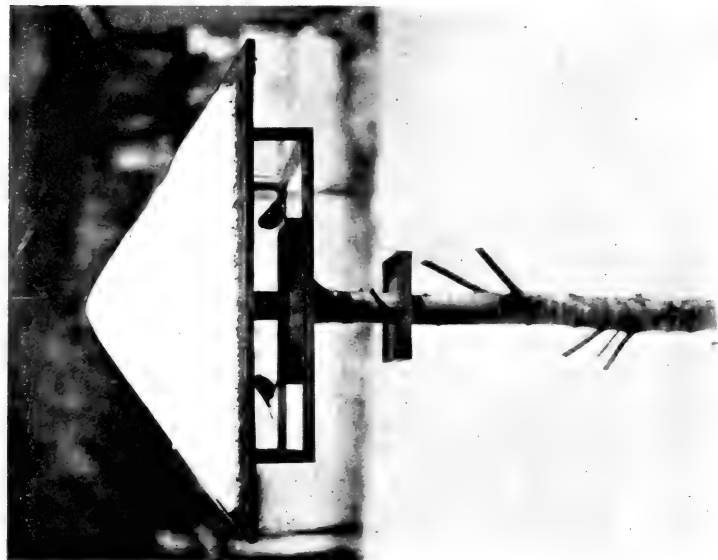

AN "AUDUBON" FOOD HOUSE IN WINTER

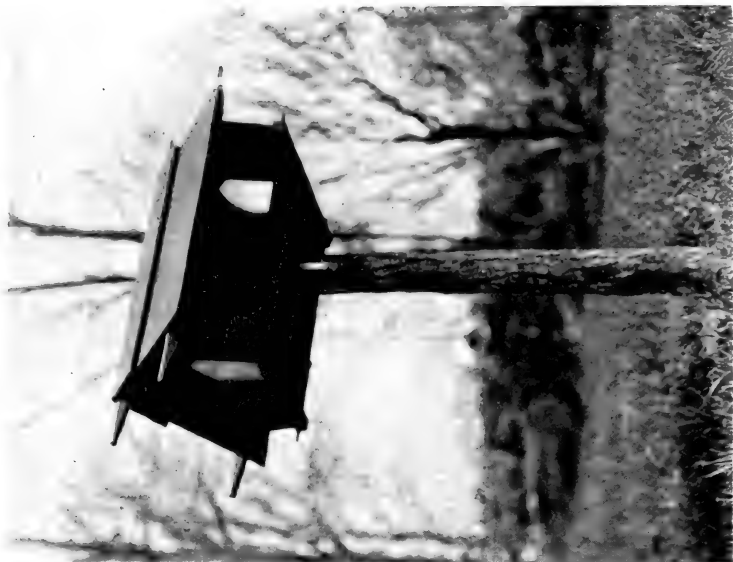

AN "AUTOMATIC" FOOD HOUSE HOLDS A BUSHEL OF SEED

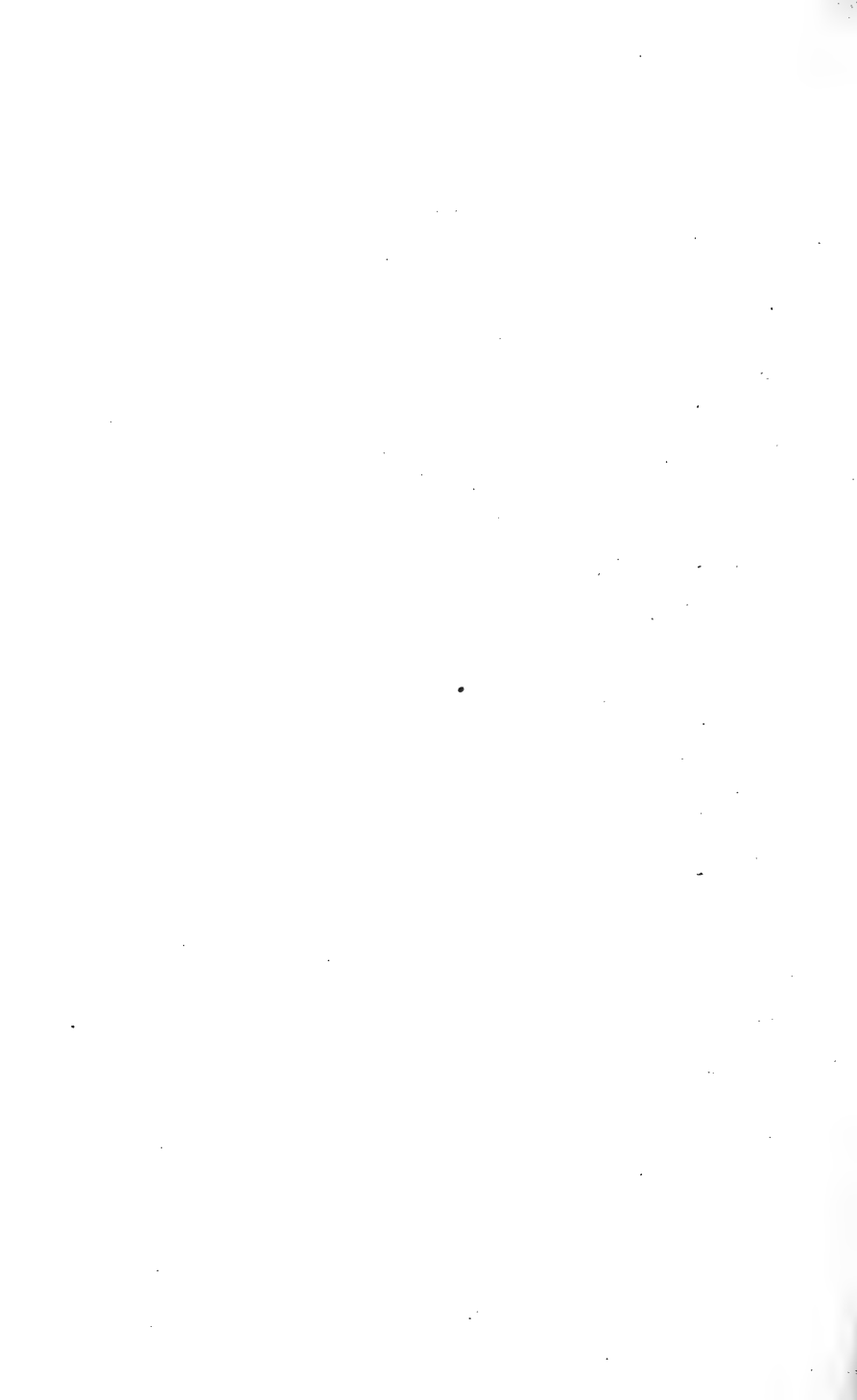

be frightened when her head came up over the rim, they would have plenty of time to escape before she would be in a position to spring upon them.

Several adaptations of the "Audubon" food house may be made or purchased, the most interesting, perhaps, being one which has a food hopper under the roof and connected with the upper tray to which it supplies seed as fast as the birds eat it. The top of the roof is removable and half a bushel or more of seed can be poured in at once. This is a very good style of house for people who cannot get out to replenish the food trays themselves, or who go to the city in the winter and wish to be sure that the birds are fed while they are away. But no matter what kind of feeding device is used by people who are away from their country homes during the winter, it is nearly always possible to arrange to have a country neighbor replenish the food as it is needed.

The Food Bell

The "food bell" is another device invented by von Berlepsch, and used especially for feeding titmice. It consists of a glass receptacle holding a quart or two of hemp seed, connected at the bottom with a tube down which the seed falls to

supply a tiny "food dish," which is protected from the weather by a metal "bell," a foot in diameter, from which it takes its name. It can be fastened to trees, piazza posts, or the sides of windows by means of iron rods which are screwed into the wood above and below. A piece of suet or a net bag of nut-meats will serve to guide the birds to the "food dish" in the first instance. We have given this device a long trial in Meriden, and find it very good for chickadees. They fly up under the bell, and carry off the hemp seed one at a time to some near perch. Each seed is held with the feet while the shell is cracked with the bill. A recent visitor to the bird sanctuary at Meriden was delighted to find that the chickadees came to the food bell quite unconcerned while she stood with her hand resting on the bell.

The Food Tree

The "food tree" is simply an evergreen, preferably a spruce, fir, or hemlock, covered with bird food. A discarded Christmas tree will answer the purpose very well. A growing tree should not be used as the following treatment will kill it. There is no limit as to size, though a rather small tree will be found more convenient in every way than a large one. I generally select one about

twelve feet high, cut off all branches within two or three feet of the butt before setting it in the ground, not too far from my window to get a good view of any bird visitors who may come. This much may be done in the fall, but beyond tying on a piece of suet, or scattering a little seed at the base, perhaps, it is best not to go any farther until the coming of settled cool weather. Then there should be poured over the twigs and branches bubbling hot bird food made from the following receipt, which is another contribution from Baron Hans von Berlepsch.

White bread (dried and ground)	4½ oz.
Meat (dried and ground)	3 “
Hemp	6 “
Crushed hemp	3 “
Maw	3 “
Poppy flour	2½ “
Millet (white)	3 “
Oats	1½ “
Dried elderberries	1½ “
Sunflower seeds	1½ “
Ants' eggs	1½ “

To the total quantity of this dry food, must be added about one and one-half times as much beef or mutton suet or fat of almost any kind. The

fat must be melted and the dry food stirred in thoroughly.

This mixture, bubbling hot, should be poured carefully over all the twigs and branches of the evergreen, care being taken to keep it well stirred up during the operation. It may be poured with a long-handled ladle held in one hand, and the drip can be caught in a frying pan or something similar, held in the other. The cold air will quickly "set" the fat with all the good things it contains, on the tree, where both insectivorous and seed-eating birds will find it, and each take what he likes best from the variety of food offered. If there is any of the mixture left after the tree is covered, it may be poured into molds and when hard served as "food-cake" or "food-stone" in the trays or food houses.

It is not necessary to stick very closely to the receipt. The ground dried beef, the hemp seed, and the bread crumbs should always be used, and of course the fat is essential. If certain of the other ingredients cannot readily be obtained, they may be left out, or other good foods, such as nuts and pumpkin seeds, ground or chopped, may be substituted for them. Now a suggestion about preparing the meat. The first time I made this food, I dried the raw beef and attempted to grind it afterwards; I found myself

in trouble at once. Next time I found it very much easier to grind the fresh raw beef very fine in a meat grinder, and then spread it out thin and dry it in a slow oven. When dried in this way it may be readily crumbled and mixed with the other ingredients. Probably every woman knows this, but the hint may be useful to men and children.

Another way to use up a small quantity of the mixture is to pour it over a single detached branch of an evergreen and then fasten that branch to any tree in the garden.

A style of food tree very popular with children is one on which the food is hung as presents are hung on a Christmas tree. In fact it is sometimes called a "Birds' Christmas Tree." This may be either a freshly cut tree stuck in the ground or almost any growing tree in the garden. To the branches may be hung net bags filled with nuts or suet, little chunks of bacon, doughnuts, and similar dainties, or cocoanuts, each with a good-sized hole in the side and stuffed with Berlepsch bird food, suet, or any other food that packs well. The stuffed cocanut was suggested to me by Dr. A. K. Fisher, who fills the cavity with fresh pork fat and black walnut kernels, and fastens the nut in a tree at his camp near Washington. Chickadees, tufted titmice, nut-

hatches, downy woodpeckers, and juncos are among the birds he has had visit him. Some of them go right inside the nut after they have eaten all the food which can be reached without doing so.

The Food Trolley

The food trolley is simply a food tray or lunch counter provided with grooved wheels by means of which it can be made to glide along beneath a wire or wires stretched between some point in the garden and a higher point,—say an upper window, at the house. Mr. Gilbert H. Trafton describes a moving food tray of this kind which he suspended from a single wire by means of two pulley wheels set in a frame. This he found, on the whole, the most satisfactory device he has tried.

The author's food trolley, which has been on duty in his garden for several years, embodies the same general idea. It consists of a food tray about eighteen inches square, slung below two wires eighteen inches apart, stretched taut at the same height between a second-story bedroom window sill and a wooden bar nailed to a branch of an apple tree at a point eight feet above the ground and about a hundred feet from the house. Four pulley wheels are used, one on each



BARRED OWL USUALLY A BENEFICIAL BIRD



corner of the tray, but the two nearer the house are screwed to short wooden pillars rising from the corresponding corners of the tray, so that although the wires are on a slant, the tray itself remains horizontal. By means of the pulley wheels, two on each wire, the tray glides easily back and forth. It is drawn up to the window by a string, and runs back down to the apple tree by its own weight. The chief use of the food trolley is to encourage shy birds to approach the house by easy stages. The plan is this. The tray is drawn up to the window, filled with bird food, and allowed to run back to the tree. Timid birds readily come to the tree and very soon learn to feed from the tray which they find there. As soon as they begin to come freely, the tray may be drawn up a few feet nearer the house. It is best to do this late in the evening after the birds have finished feeding for the day, and not having been frightened, when they return in the morning they will not hesitate to venture the extra few feet in order to get their breakfast. Every day or two the tray may be drawn a little nearer the house until the birds find themselves feeding at the window.

When used for this purpose, it is best to have no roof over the tray; very timid birds are afraid of any device which seems to shut them in. As

for the snow, it is easily brushed off when the tray is drawn up to the window. Later on, of course, if the trolley is to be used for feeding purposes only, it will be an easy matter to construct a simple roof for it.

No doubt the reader will soon think of other methods and invent other devices for feeding the birds in winter, but in the meantime those I have mentioned will serve all practical purposes.

Do not be discouraged if the birds do not accept your invitations at once. While sometimes they will come in almost immediately, in many cases they will not do so for weeks or even months. But keep food out all the time, so that when they do come they will find a good reason why they should come again, and bring their friends.

CHAPTER VIII

HOSPITALITY ALL THE YEAR 'ROUND

Most birds will appreciate hospitality at any season. To some of them at certain times, it is a matter of life and death. A few there are that we cannot assist even when they are in greatest need of assistance. For example, in a preceding chapter we have spoken of the vast number of birds which are sometimes killed by late spring storms. Some of these birds, which, like the purple martins, feed almost wholly on insects captured on the wing, we may find it impossible to help. But there are many other birds which naturally take their food on the ground or from the trees and bushes and these may in some cases at least be tided over for a few days until fine weather makes it possible for them to get their own living again. In Meriden, New Hampshire, for instance, a number of us make a practice of gathering, in the fall, the berries of mountain ash, wild cherry, and other food plants, and drying them on the stalks in some place where

the mice cannot get at them. Next spring, if a late snowstorm comes, we tie these berries to the branches of trees and shrubs in the gardens, where they are simply gobbled up by hungry robins, bluebirds, waxwings and others whose natural food supply has been cut off or curtailed by the storm. Meal worms are even more desirable as bird food at such times, but few people have a good stock of them on hand and they are very expensive when bought from cage-bird dealers. As it is quite a simple matter to raise these so-called "worms," almost any of us can be prepared to care for the insectivorous birds made temporarily destitute by the coming of late snowstorms. The writer, in anticipation of the perils of such storms, rears meal worms according to a simple method recommended by Professor Clifton F. Hodge, who in his valuable book, *Nature Study and Life*, has this to say about them:

"The best insect food for soft-billed birds is meal worms, and every child that wishes to help young birds (Professor Hodge here refers to birds which have fallen from the nest or which have been wounded) should learn how to rear them and keep a supply on hand. They are also excellent food for winter birds and for robins and bluebirds and many others that come early

in the spring. We do not always have the time to collect insects in sufficient quantity, but we can always have a supply of meal worms if we once learn how to feed them.

“The meal worm is the larva of a black beetle which can be found from May to October about granaries, mills, where feed is kept in stables, in the dust in haylofts, in pigeon lofts, and meal chests. The eggs are laid in these places and when hatched and fully grown the larvæ are smooth, yellow (*Tenebrio molitor*), or blackish (*T. obscurus*), ‘worms’ about an inch in length. While commonly looked upon as pests, for feeding birds they are well-nigh indispensable. The writer has paid twenty-five cents a dozen for them to feed mocking birds, and the market price by the wholesale is \$1.50 per thousand. If we know how to use them, the worms in a meal chest may thus be worth many times the value of the meal, chest and all.

“Directions in the bird books for raising meal worms are quite misleading and in order to go to work intelligently, we must learn the life from egg to egg. The first fact to learn is that the insect is single brooded, *i. e.*, it requires an entire season to complete its growth. The beetles may be found laying eggs from May until freezing weather in the fall. The early eggs will produce

larvæ which are full-grown by September or October of the same season, and larvæ from the late eggs do not attain their full growth until about midsummer of the next season. A female beetle lays from twenty to fifty eggs. While practically any farinaceous material—corn meal, ground feed, cracker crumbs, bread crusts—is suitable, feeding experiments have proved that wheat, in some form or other, is preferred and yields the best specimens.”

Professor Hodge suggests that the best way to rear a supply of meal worms is to take a good-sized tight box or earthen jar, half fill it with ground feed, corn meal, oatmeal, ground wheat, bread crusts—any or all of them—some scraps of leather, a raw potato or two to supply water, and last and most important, drop into it a few hundred larvæ or beetles. They should be covered with cloths—woolen ones are best, but cotton ones or burlap are almost as good, and over all there should be a lid of wire screening. The potatoes should be renewed as they are eaten; otherwise the insects should be left alone. If the original stock is started about April, you should have a fine lot of meal worms for use by the fall. After that it will be an easy matter to keep a supply on hand for feeding after cold spring storms and in other emergencies.

But it is not only at special times like those during or following severe weather that birds are attracted by food; they need it all the year round, and they are obliged to go somewhere to get it. And, just as men who go to business must live within convenient distance of their work, so birds must make their homes within easy reach of their food supply. Consequently, if we desire to entertain a great many different kinds of bird guests in spring and summer, our best plan will be to give them both food and nesting sites in our own gardens, woods, and pastures. In no other one way, perhaps, can this be so well done as by properly planting for the birds the kinds of trees, shrubs, and creepers which are attractive because they furnish food, shelter, and nesting sites. Of the latter I shall speak at greater length later on, but naturally many of the trees and shrubs which offer food and shelter will be used by the birds to build their nests in. A bit of convincing proof of the value of "cover" as an attraction for birds is to be seen at "The Pines," the estate of my friend Frederic H. Kennard, at Newton Centre, Massachusetts. Mr. Kennard, in an article published in the *National Geographic Magazine*, thus describes it:

"We have had for eight years under close observation about forty-four acres, comprising

three acres of lawn dotted with a few old apple trees, six acres of wet meadow, which are allowed to grow up with tussocks of grass, cedars, alders, wild roses, and the like, and the remaining thirty-five acres divided in two areas of about equal size. The first of these areas, that about the house, is covered with a growth of pines, hemlocks, cedars, birches, and various other deciduous trees, among which we have taken pains to cultivate suitable coppice and undergrowth, while the second area, covered with deciduous woods, is, on account of a fire that ran through it a number of years ago, almost devoid of the smaller evergreens or protecting coppice and undergrowth.

“In the first of these areas some thirty different species of birds breed nearly every year, while in the second area only from three to five different species build their nests.”

That the reader might have the very best information obtainable on this subject, the writer sought the advice of Mr. Kennard, who kindly consented to prepare a sub-chapter which follows.

TREES, SHRUBS, AND VINES ATTRACTIVE TO BIRDS

“It is probable that the fruits of nearly all our trees, shrubs, and vines are eaten sometimes by



A DECORATIVE BIRD BATH

some kinds of birds, provided they are hungry enough. The following is a list of those species native to the northeastern United States, whose fruits are known to be eaten by birds. This list, first published in *Bird-Lore*, July-August, 1912, has been revised, fruiting seasons added, and though still necessarily incomplete, brought as nearly up to date as possible.

“The fruits of those marked with three asterisks are known to have been eaten by thirty or more different species of birds, while those marked with two asterisks are known to have been eaten by at least ten species of birds, as indicated by stomach examinations.¹ Those marked with one asterisk are known, from general observation, to be very attractive to certain birds, and several of them might, except for present lack of accurate data, be given a second asterisk. Some of these more than make up, in the number of individual birds they attract, for the fact that they may not happen to prove attractive to a large number of species. It is known, for instance, that the fruits of the sour gum, gooseberries, currants, and snowberry, are each eaten by at least ten species of birds, and consequently each are marked with two asterisks; but it seems probable

¹ “Plants Useful to Attract Birds and Protect Fruit,” by W. L. McAtee from *Year Book of Department of Agriculture for 1909*.

that the mountain ash with its persistent fruit fed upon throughout the winter by flocks of robins, cedar birds, grosbeaks, purple finches, and others, may attract a greater number of individuals than many of those species marked with two asterisks; while the gray birch with the winter flocks of goldfinches, redpolls, siskins, juncos, etc., that feed upon its seeds, probably attracts a far greater number of birds than some of those species marked with three asterisks.

A LIST OF TREES, SHRUBS, AND VINES NATIVE TO NORTHEASTERN UNITED STATES, BEARING FRUIT ATTRACTIVE TO BIRDS

DECIDUOUS TREES	FRUITING SEASON
* <i>Acer Negundo</i> , ash-leaved maple	September— through winter
“ <i>saccharum</i> , sugar maple; and doubtless other maples, including <i>A. rubrum</i> , red maple and <i>A. saccharinum</i> , silver maple	September— October
<i>Alnus incana</i> , smooth alder	May—June
“ <i>rugosa</i> , speckled alder	September—March
* <i>Betula populifolia</i> , American gray birch	September— through winter
* <i>Betula lutea</i> , yellow birch; and doubtless other birches, in- cluding <i>Betula nigra</i> , black birch	October—through winter May—June

Hospitality the Year 'Round 171

DECIDUOUS TREES

FRUITING SEASON

<i>Carya sp.</i> , several kinds of hickory	September– November
** <i>Celtis occidentalis</i> , hackberry	September– through winter
<i>Cercis canadensis</i> , red-bud	September– January
*** <i>Cornus florida</i> , flowering dog-wood	August–December
** <i>Crataegus Arnoldiana</i> , white thorn	August–September
** <i>Crataegus Crus-galli</i> , cockspur thorn	Late August– March
** <i>Crataegus rotundifolia</i> , white thorn	September– November
** <i>Crataegus submollis</i> , white thorn; and others of this genus	September
<i>Diospyros virginiana</i> , Persimmon	October– November
<i>Fagus americana</i> , American beech	October– November
* <i>Fraxinus americana</i> , American white ash; and probably other species	September– January
** <i>Ilex opaca</i> , American holly	October–through winter
* <i>Larix americana</i> , larch	October–March
<i>Liquidambar Styraciflua</i> , sweet gum	October–March
<i>Liriodendron Tulipifera</i> , tulip tree	September– November

DECIDUOUS TREES	FRUITING SEASON
*** <i>Morus rubra</i> , native red mulberry	June-August
** <i>Nyssa sylvatica</i> , tupelo	August-October
<i>Ostrya virginiana</i> , hornbeam	August-October
<i>Platanus occidentalis</i> , sycamore	October-April
<i>Populus sp.</i> Various species of poplars are sometimes fed upon	May-June
*** <i>Prunus pennsylvanica</i> , bird cherry	June-October
*** <i>Prunus pumila</i> , sand cherry	June-August
*** " <i>serotina</i> , black cherry	July-November
*** " <i>virginiana</i> , choke cherry	July-August
* <i>Pyrus americana</i> , mountain ash	August-March
<i>Quercus sp.</i> Several species of oaks	September- November
<i>Sassafras variifolium</i> , sassafras	July-September
<i>Ulmus americana</i> , American elm; and doubtless other species	May

EVERGREEN TREES	FRUITING SEASON
** <i>Juniperus virginiana</i> , red cedar	Throughout the year
** " <i>communis</i> , common juniper	Throughout the year
* <i>Picea canadensis</i> , white spruce	September-winter
* " <i>rubra</i> , red spruce; and undoubtedly <i>P. nigra</i>	October-winter

Hospitality the Year 'Round 173

EVERGREEN TREES

FRUITING SEASON

- | | |
|--|-----------------------|
| * <i>Pinus rigida</i> , pitch pine; and
doubtless <i>P. resinosa</i> , Norway
pine | October–March |
| * <i>Pinus Strobus</i> , white-pine | September–
October |
| <i>Thuja occidentalis</i> , arbor vitæ | September–
October |
| * <i>Tsuga canadensis</i> , hemlock | October–March |

SHRUBS

FRUITING SEASON

- | | |
|---|------------------------------|
| ** <i>Amelanchier canadensis</i> , shad
bush; and other species | June–October |
| ** <i>Benzoin asitvale</i> , spice bush | August–November |
| * <i>Berberis vulgaris</i> , barberry (nat-
uralized) | August–May |
| <i>Clethra alnifolia</i> , sweet pepper-
bush | September–
through winter |
| <i>Corema Conradii</i> , broom crow-
berry | June–July |
| *** <i>Cornus alternifolia</i> , blue cornel | July–September |
| *** “ <i>amomum</i> , silky cornel | August–October |
| *** “ <i>paniculata</i> , gray cornel | August–October |
| *** “ <i>stolonifera</i> , red osier; and
probably other species | Late June–through
winter |
| <i>Corylus americana</i> , American
hazel | July–September |
| <i>Dirca palustris</i> , leatherwood | May–June |
| <i>Elæagnus argentea</i> , silver-berry | July–through
winter |
| <i>Empetrum nigrum</i> , crowberry | Throughout year |

SHRUBS	FRUITING SEASON
<i>Evonymus atropurpureus</i> , burn- ing bush	August-January
** <i>Gaylussacia baccata</i> , huckleberry	July-September
** <i>Gaylussacia frondosa</i> , dangle- berry	June-September
** <i>Ilex glabra</i> , inkberry	Throughout year
** " <i>verticillata</i> , black alder	July-through winter
** " <i>laevigata</i> , winterberry	August-through winter
* <i>Ligustrum vulgare</i> , common privet (naturalized)	Late July-through winter
<i>Lonicera canadensis</i> , fly honey- suckle	June-August
<i>Lonicera caerulea</i> , hairy fly honeysuckle; and doubtless other species	June-March
<i>Myrica asplenifolia</i> , sweet fern	September- October
** " <i>carolinensis</i> , bayberry	July-May
<i>Nemopanthis mucronata</i> , moun- tain holly	July-September
<i>Prunus maritima</i> , beach plum	August-October
* <i>Pyrus arbutifolia</i> , chokeberry	October-through winter
* " <i>melanocarpa</i> , dogberry	July-through winter
* <i>Rhamnus cathartica</i> , buckthorn (naturalized)	August-April
*** <i>Rhus canadensis</i> , fragrant sumach	July-September

SHRUBS	FRUITING SEASON
*** <i>Rhus copallina</i> , dwarf sumach	Throughout year
*** " <i>glabra</i> , smooth sumach	" "
*** " <i>Toxicodendron</i> , poison ivy	" "
*** " <i>typhina</i> , staghorn sumach	" "
*** " <i>Vernix</i> , poison sumach	August-through winter
** <i>Ribes Cynosbati</i> , prickly goose- berry	June-September
** <i>Ribes floridum</i> , black currant	August-September
** " <i>lacustre</i> , swamp black cur- rant	July-August
** <i>Ribes vulgare</i> , red currant (nat- uralized); and undoubtedly all other species of currants and gooseberries	June-August
** <i>Rosa humilis</i> , wild rose	August-through winter
** " <i>nitida</i> , wild rose	August-through winter
** " <i>virginiana</i> , wild rose; it is probable that the fruits of all the native wild roses, particu- larly the smaller fruited species, are eaten largely by birds	August-through winter
*** <i>Rubus allegheniensis</i> , wild blackberry	July-September
*** <i>Rubus canadensis</i> , thornless blackberry	July-September
*** <i>Rubus frondosus</i> , high-bush blackberry	July-August

SHRUBS	FRUITING SEASON
*** <i>Rubus idæus aculeatissimus</i> , wild red raspberry	July–October
*** <i>Rubus occidentalis</i> , thimbleberry	July–August
*** “ <i>triflorus</i> , dwarf raspberry	June–September
*** <i>Sambucus canadensis</i> , common elder	August–October
*** <i>Sambucus racemosa</i> , red-berried elder	June–August
<i>Shepherdia canadensis</i> , shep- herdia	June–September
** <i>Symphoricarpos racemosus</i> , snowberry	September– through winter
** <i>Symphoricarpos orbiculatus</i> , In- dian currant	October–April
*** <i>Vaccinium cæspitosum</i> , dwarf billberry	July–September
*** <i>Vaccinium corymbosum</i> , high- bush blueberry	June–September
*** <i>Vaccinium pennsylvanicum</i> , low bush blueberry; and doubtless other species	June–September
** <i>Viburnum acerifolium</i> , dock- mackie	August–March
** <i>Viburnum alnifolium</i> , hobble- bush	August–March
** <i>Viburnum cassinoides</i> , withe- rod	August–January
** <i>Viburnum dentatum</i> , arrow- wood	August–October
** <i>Viburnum Lentago</i> , sheepberry	August–March
** “ <i>nudum</i> , withe-rod	August–January

SHRUBS

FRUITING SEASON

- ***Viburnum Opulus*, high-bush
cranberry July-April
- ***Viburnum prunifolium*, black
haw; and doubtless other
species August-January

VINES

FRUITING SEASON

- Arctostaphylos Uva-ursi*, bear-
berry September-
through winter
- **Celastrus scandens*, false bitter-
sweet October-through
winter
- Chiogenes hispidula*, creeping
snowberry July-through
winter
- Menispermum canadense*, moon-
seed September-
through winter
- Mitchella repens*, partridge-
berry Throughout the
year
- ***Psedera quinquefolia*, Virginia
creeper September-
February
- ***Psedera vitacea*, Virginia creeper August-February
- Rubus Chamæmoris* cloudberry June-August
- **Smilax rotundifolia*, bull briar August-through
winter
- Vaccinium macrocarpon*, cran-
berry October-through
winter
- Vaccinium Oxycoccus*, dwarf
cranberry October-through
winter
- ***Vitis æstivalis*, summer grape Late August-
through winter

VINES	FRUITING SEASON
** <i>Vitis cordifolia</i> , frost grape	August–October
** “ <i>labrusca</i> , fox grape	August–October
** “ <i>vulpina</i> , frost grape	July–October

“There are a good many introduced species whose fruits are known to be eaten by our birds, and the following is a list of some of those that have proved to be particularly attractive.

INTRODUCED SPECIES

TREES	FRUITING SEASON
** <i>Crataegus Oxyacantha</i> , English hawthorn	August–through winter
** <i>Crataegus Phænopyrum</i> , Washington thorn	October–through winter
* <i>Larix decidua</i> , European larch	October–March
*** <i>Morus alba</i> , white mulberry	June–August
*** <i>Prunus pendula</i> , Japanese weeping cherry	June–October
*** <i>Prunus Sargentii</i> , Sargent’s cherry	June
* <i>Pyrus Aucuparia</i> , European mountain ash	August–through winter
* <i>Pyrus baccata</i> , Siberian crab-apple	September–May
* <i>Pyrus floribunda</i> , flowering crab-apple	September–May



YOUNG BALTIMORE ORIOLE BEFORE THE BATH



AFTER THE BATH

Hospitality the Year 'Round 179

EVERGREENS

FRUITING SEASON

* <i>Picea Abies</i> , Norway spruce	October—through winter
* <i>Pseudotsuga taxifolia</i> , Douglas spruce	September— through winter
* <i>Taxus cuspidata</i> , Japanese yew	August—September

SHRUBS

FRUITING SEASON

<i>Berberis Thunbergii</i> , Japanese barberry	August—May
* <i>Lonicera Morrowii</i> , bush honey- suckle	July—through winter
* <i>Lonicera tatarica</i> , bush honey- suckle	July—through winter
** <i>Rosa multiflora</i>	September— through winter

VINES

FRUITING SEASON

* <i>Celastrus orbiculatus</i> , false bittersweet	October—through winter
* <i>Psedera tricuspidata</i> , Boston ivy	September— through winter

“As the above lists are rather long, and for those who may contemplate doing any planting, perhaps difficult to choose from, the writer suggests the following species as among the best for providing birds with a continuous supply of food throughout the year. The deciduous

species are arranged according to season and the evergreens in a class by themselves.

“Various considerations have influenced their choice, beside their comparative attractiveness as food supply; such as beauty of flower, fruit, and form; time and duration of fruiting season; supply of nesting sites and cover; their ability to attract birds away from the cultivated fruits; and last, but not necessarily least, their attractiveness to those insectivorous birds that feed upon the insects that may inhabit them.

SUMMER

TREES

- *** *Morus alba*, white mulberry. (Introduced.)
- *** “ *rubra*, native red mulberry.
- *** *Prunus pennsylvanica*, bird cherry.

SHRUBS

- ** *Amelanchier canadensis*, shad bush.
- *** *Cornus alternifolia*, blue cornel.
- * *Lonicera tatarica*, Tartarian honeysuckle. (Introduced.)
- *** *Sambucus racemosa*, red-berried elder.

“Among the trees, the fruit of the white mulberry seems to be even more of a favorite than

that of our native species. Of the shrubs, the early blooming and fruiting shad bush is important, while the red-berried elder is perhaps the most popular fruit of all.

AUTUMN

TREES

- ****Cornus florida*, flowering dogwood.
- ***Cratægus Arnoldiana*, white thorn.
- ****Prunus serotina*, bird cherry.

SHRUBS

- ****Cornus Amomum*, silky cornel.
- *** " *paniculata*, gray cornel.
- ****Sambucus canadensis*, common elder.
- ***Viburnum cassinoides*, withe-rod.
- ** " *dentatum*, arrow-wood.

VINES

- ***Vitis vulpina*, frost grape.

"The flowering dogwood, with its beautiful spring blossoms and its attractive fruit, fed upon in the early autumn by a large number of individuals of numerous species, should be included in every garden. *Cratægus Arnoldiana* is one of those recently separated species of white thorn originally known as *C. coccinea*, which has

proved at the Arnold Arboretum to be one of the best and most attractive of the earlier ripening species.

“Of the cornels and viburnums there seems to be but little choice, they are all good. The common elder fruits a little later than the red-berried elder, and like it should be planted in every garden.

WINTER

TREES

- **Betula populifolia*, gray birch.
- ***Crataegus Crus-galli*, cockspur thorn.
- **Pyrus Aucuparia*, European mountain ash.
(Introduced.)
- **Pyrus baccata*, Siberian crab-apple. (Introduced.)

SHRUBS

- **Berberis vulgaris*, barberry.
- ***Ilex verticillata*, black alder.
- **Ligustrum vulgare*, common privet.
- **Rhamnus cathartica*, buckthorn.
- ***Viburnum Lentago*, sheepberry.
- ** “ *prunifolium*, black haw.

VINES

- ***Psedera quinquefolia*, Virginia creeper.
- ***Vitis æstivalis*, summer grape.

“Of the trees for winter food supply, the gray birch is one of the most attractive. In summer and autumn it is visited by many kinds of birds in search of the insects that it harbors, and in winter it seems a particular favorite with all the smaller finches and sparrows that flock about it. Of the mountain ashes, the European is the finer tree, and very attractive to robins, cedar birds, and the larger finches, and no garden should be without it. The Siberian crab-apple with its great quantities of persistent fruit has proved to be one of the very best.

“Of the shrubs, our common barberry should always be planted. The black alder with its persistent red berries, is one of our most beautiful winter shrubs. The common privet, the fruit of which seems only to be eaten when the supply of other fruits is exhausted, proves very acceptable late in the winter; while the buck-thorn is one of the greatest favorites, and is another of those shrubs that should be found in every plantation.

SPRING

TREES

***Cratægus Phænopyrum*, Washington thorn.
(Introduced.)

- **Larix americana*, American larch.
- * " *decidua*, European larch. (Introduced.)
- **Pyrus floribunda*, flowering crab-apple. (Introduced.)

SHRUBS

- Berberis Thunbergii*, Japanese barberry. (Introduced.)
- ***Rosa sp.*, wild roses.
- ***Rosa multiflora*. (Introduced.)
- ****Rhus sp.*, sumacs (non-poisonous).
- ***Viburnum Opulus*, high-bush cranberry.

VINES

- **Celastrus Orbiculatus*, false bittersweet. (Introduced.)
- **Celastrus scandens*, false bittersweet.
- **Psedera tricuspidata*, Boston ivy.

“The above species are listed as a spring food supply, not because their fruits ripen in the spring, but because ripening in the summer or autumn, they hang on or persist until spring, unless previously eaten by the birds. The Washington thorn is one of the handsomest of our native species, perfectly hardy, though not indigenous to the northeastern United States, and is, with its handsome fruit, a great favorite

with several species of birds. Of the larches, the European is the finer of the two, and both are favorites with crossbills, pine grosbeaks, and the smaller finches, and in the early spring are visited by many warblers and other birds in search of the insects that are to be found there.

“The Japanese barberry is included in this list of shrubs, not because its berries are eaten by many birds, for quail and partridge are the only species I know of that eat it habitually; but because it makes one of the very finest hedge plants, impenetrable alike to dog or cat, and, because of its compact method of growth, furnishes a favorite nesting site for many of our smaller birds.

“The fruits of many of our native wild roses persist throughout the winter; *R. humilis*, *R. nitida*, and *R. virginiana* are good, and may be planted along the walls and roadsides. *R. multiflora* grows either as a shrub or vine, and is, with its beautiful clusters of flowers and fruits, one of the finest of the introduced species. The fruits of all the sumachs persist throughout the year and are fed upon by numerous birds. Either of the large species, *R. glabra* or *R. typhina*, with its wonderful autumn foliage, is fine; while of the smaller species, *Rhus copal-*

lina is attractive. The high-bush cranberry is very attractive to the eye, both in flower and in fruit; and its conspicuous berries, persisting throughout the spring when other food is scarce, are eaten voraciously by numerous species of birds, and no garden should be without it.

“Of the vines listed above, the introduced false bittersweet bears its fruit a little more freely and retains it a little longer than the native species. All the vines listed for the various seasons are attractive and should be planted wherever possible. Boundary walls, old fences, or ugly out-buildings are appropriate places.

ATTRACTIVE EVERGREENS

- ** *Juniperus virginiana*, red cedar.
- * *Picea Abies*, Norway spruce. (Introduced.)
- * “ *canadensis*, white spruce.
- * “ *nigra*, black spruce.
- * “ *rubra*, red spruce.
- * *Pinus strobus*, white pine.
- * “ *resinosa*, Norway pine.
- * *Pseudotsuga taxifolia*, Douglas spruce. (Introduced.)
- * *Taxus cuspidata*, Japanese yew. (Introduced.)
- * *Tsuga canadensis*, hemlock.

“Evergreens, although the seeds of the various species may fall in the autumn, winter, or spring, are placed in a class by themselves because their usefulness throughout the entire year can hardly be overstated. The red cedar, whose fruit persists throughout the year, and is fed upon by at least twenty-five species of birds, is probably the most popular tree in the country for nesting sites, and is the hunting ground for countless warblers and other insectivorous birds. The spruces are almost as popular, as are also the pines and hemlocks, and all of them furnish protection in winter, as well as shade in summer. Of our native spruces, *P. canadensis* and *P. rubra* seem only to flourish in the higher altitudes or in the more northern States and are rather difficult to grow successfully elsewhere. In Eastern Massachusetts *P. canadensis* is perhaps the better tree, as *P. rubra* grows but slowly. *P. nigra*, which is better adapted for lower altitudes, and ordinarily drags out its weary, straggling existence in our swamps, will sometimes do well if planted in dryer soil.

“For those who do not live in a locality where our native spruces can be grown successfully, the old-fashioned Norway spruce, if free from the spruce louse (*Chermes abietis*), has always been a very attractive tree. During the winter

it is visited by grosbeaks, crossbills, finches of various sorts, nuthatches, chickadees, etc., and in the spring it is the favorite hunting ground of many of our migrants; while in the summer it offers tempting nesting sites to numerous residents. The Douglas spruce of the West is undoubtedly one of the finest of our introduced species. It seems perfectly hardy in many places where our native spruces do not flourish, and should be used in the future much more than it has been in the past.

“Of the hard pines the Norway is by far the best tree, and should be planted much oftener than it is. The white pine and the hemlock are perhaps the finest of our evergreens and too well known to need further description. The white pine is a particularly rapid grower, and both that and the hemlock flourish throughout practically the entire region, and should be planted whenever possible.

“The Japanese yew, although slow of growth, is one of the hardiest of the introduced species, and the mature plants, with their striking pink berries, make a wonderful addition to our gardens and evergreen plantations.

“The writer also believes in the planting of rhododendrons, either *R. maximum* or *R. catawbiense*, and laurel, *Kalmia latifolia*, when they

can be made to grow. They are perfectly hardy in many places where they are not supposed to flourish, and if properly planted, really do not require the care that many suppose. The writer does not know that their seeds are eaten by birds; but when planted in masses, in appropriate places in gardens or about the borders of woods, they are very beautiful all the year round, particularly when in bloom; and afford a cover much resorted to by birds, both winter and summer.

“On suburban places and in the country, the use of evergreens, large plantations wherever possible, is of prime importance as a source of perpetual food supply, and as a protection from the elements, as well as on account of the welcome nesting sites they offer. From an artistic standpoint also the use of evergreens is to be recommended. They warm up the landscape, and in these days when so many of us live in the country throughout the year, it behooves us to make our country places as attractive in winter as in summer.

“I am indebted to Messrs. William Brewster and Walter Deane of Cambridge, Massachusetts, and to Mr. C. E. Faxon of the Arnold Arboretum of Jamaica Plain, Massachusetts, for their many helpful suggestions in making up this list; and

my thanks are particularly due to Mr. Alfred Rehder of the Arnold Arboretum, to whose thorough knowledge and painstaking care I am indebted for the list of fruiting seasons. I am also indebted to the United States Department of Agriculture for information contained in the Bulletin entitled, *How to Attract Birds in North-eastern United States*, by W. L. McAtee."

In addition to the above there is a long list of herbaceous plants which are attractive to birds, but a few of the more important ones will suffice. In the open field of the Bird Sanctuary at Meriden, we plant Japanese millet, hemp, wheat, and sunflowers. Buckwheat is excellent, especially if there are wild doves in the vicinity. The hemp, millet, and sunflowers we leave standing, and the birds take the seed at will during the fall and winter. The wheat we cut, bind in sheaves, and tie, ears down, to the trunks of trees in the woodland, that grouse and other birds may find plenty of available food just above the snow.

In many of the village gardens are planted Japanese millet and sunflowers, and Mr. Kenard recommends that nightshade and pokeberry be planted along the stone walls.

Ruby-throated humming-birds are such universal favorites that many of us like to do a little planting especially for them. They are



SONG SPARROWS ENJOYING A BATH



BIRD BATH IN THE AUTHOR'S GARDEN

particularly fond of tall larkspur, salvia, columbine, bee-balm, gladiolus, and nasturtium. Then we often make for them artificial flowers of bright-colored cloth or paper, hiding in the heart of each a tiny bottle filled with honey and water or sugar and water. It is said that they will take the sweet stuff just as quickly if the bottle is not surrounded by a flower, but I am inclined to think that in the first instance, at least, the color and form of the flower will help them to find the bottle.

Where there is a possibility of attracting wild ducks, the planting of wild rice, wild celery, and pond weeds is recommended. For fuller information concerning the respective values of these foods, the best methods of planting them, and so forth, the reader is referred to Circular 81, issued by the United States Department of Agriculture and entitled, *Three Important Wild Duck Foods*, by W. L. McAtee. Further advice concerning the management of waterfowl and game birds may be had by application to the American Game Protective and Propagation Association, Woolworth Building, New York.

CHAPTER IX

THE BIRD LOVER AS A LANDLORD

I DOUBT if it ever occurs to the average person that birds are actually in *need* of nesting sites. Of course there are thousands of people who believe that it is a good thing to encourage bluebirds and tree swallows and wrens by putting up nesting boxes in the gardens and orchards, but most of them do it chiefly because it is interesting and delightful to have the birds about. A few go as far as to plant shrubbery in the hope that catbirds and songsparrows and a few others will make their homes in it. But they rarely do this because they think the birds need it. As they look out over the country side and see all the trees and bushes, it seems as if the birds had far more nesting sites than they could possibly use and the fact that so many of these trees and shrubs are not used by the birds, seems to confirm the opinion. The chances are, however, that many of these apparently good nesting sites are unused for the very simple reason that they are

not what the birds require, and that they would not even appear to be suitable if we knew a little more about the real tastes and preferences of birds. Perhaps no other man has given so much good thought to this subject as Baron Hans von Berlepsch, whose estate, "Seebach" near Essen, Germany, has become world-famous as a paradise for birds. As a result of the study he has given to the likes and dislikes of his feathered guests in the matter of nesting sites, he has a thousand birds nesting on the twelve or thirteen acres immediately surrounding his castle, every year, and thousands more in the woods beyond. And it has paid him to study the comfort of his guests, for they have become a power for good. When an insect plague swept over that section of the country some years ago, "Seebach" was the one green spot left on the face of the landscape; it stood out like an oasis in a desert. And all because a thousand birds, with perhaps two thousand hungry babies to feed, showed that insect destroyers of vegetation can be made to serve a very useful purpose.

The birds which suffer most perhaps from lack of nesting sites are those which naturally nest in holes in trees. We have brought about wholesale destruction of our forests, and even in our gardens, orchards, and farms we have made

BLUEBIRD HOUSE

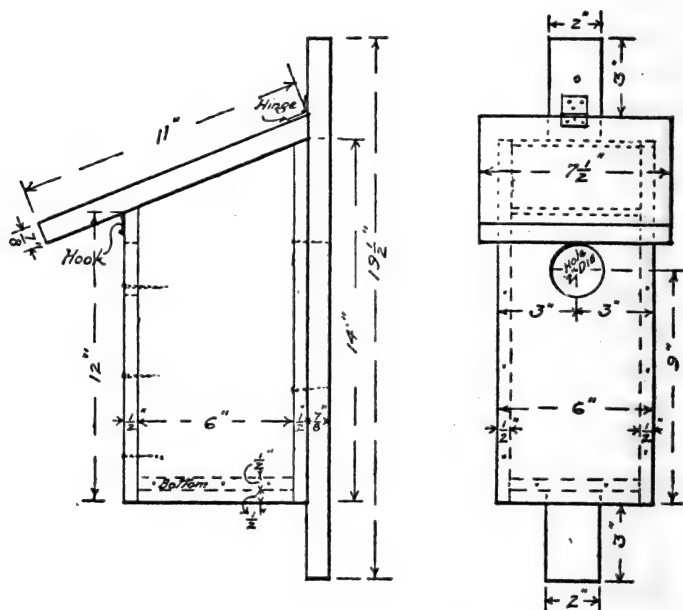

SIDE ELEVATION

FRONT ELEVATION

sure to remove the dead trees and stumps, which are the very ones usually selected by birds which nest in cavities. In short we have driven these birds farther and farther away from our homes and back into the wilderness, and if we wish them to return to their former haunts, we must substitute for the dead trees which they formerly occupied, suitable nest boxes of some kind.

Some birds, like house wrens, tree swallows, bluebirds, and starlings are so eager for new nesting sites, and so simple in their requirements, that they will accept almost any nest box offered to them—a common starch box, a flower pot, even an old tomato can with a hole cut in the end. But there is seldom any need to use such crude devices as these, since anyone who has access to a few boards, old or new, a saw, a hammer, and some nails, can for a few cents apiece make neat bird homes from such plans as are given here, or as may be found in *Farmers' Bulletin 609*, which may be obtained from the United States Department of Agriculture, Washington, D. C.

It is a matter of great importance that young people especially, be encouraged to make houses of this kind. It gives them an opportunity to do active work for the birds; work of which they will be likely to see the result, and thus be encouraged to continue. But they should study the requirements of the birds and not be led into making houses which are simply odd or pretty. There is no objection to having a pretty bird-house if the essential features—the dimensions of the room, the diameter of the entrance, etc., are correct. There is no use in making houses with more than one room, except for purple

martins, unless, of course, you wish to encourage starlings or European sparrows. The two-room houses for bluebirds, wrens, etc., which we see on the market are never really occupied by two families at the same time.

Sometimes we see houses made with a good deal of glass—in the form of windows perhaps; I do not remember having seen any house of this kind occupied by birds. And it is inadvisable to have more than one entrance to a room or to have rooms in the same house connected one with another. The extra doorways tend to make the house draughty. If in any case ventilation seems really necessary, holes should be made above the entrance.

But there are comparatively few of our birds which take kindly to bird houses made on any of these lines; most of the others refuse to occupy any ordinary hand-made nest box. Von Berlepsch discovered this, and after years of experiment decided that the only way to induce these more fastidious birds to become his tenants, was to give them nesting boxes practically like those which woodpeckers, tits, and others make for themselves by burrowing into the trunks and branches of trees. So he invented a machine which would hollow out a log in such a way that the cavity was an exact facsimile of a wood-

HOUSE FOR CHICKADEES,
NUTHATCHES OR HOUSE WRENS

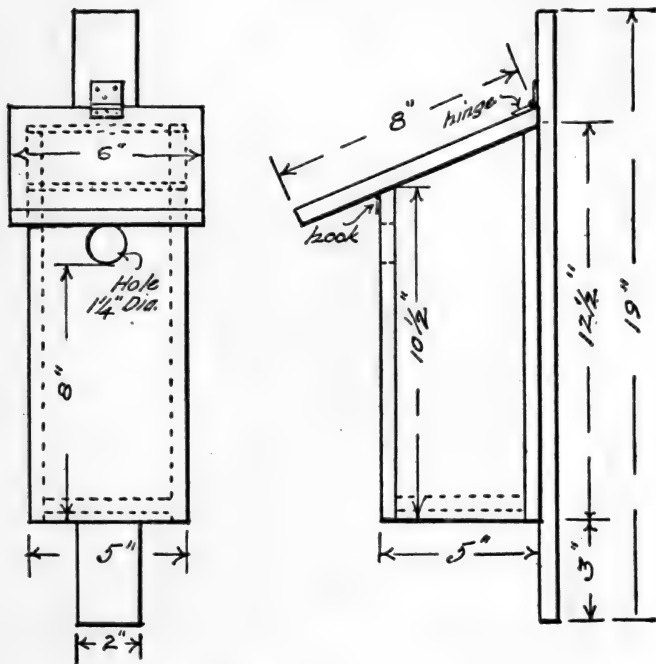

FRONT ELEVATION

SIDE ELEVATION

NOTE - All stock 3/4" thick

pecker's burrow or a titmouse's burrow,—not a straight bore, but flask-shaped with bulging sides and pointed at the bottom. He made a number of such boxes, in several different sizes to accommodate birds both large and small. For a little while the birds showed no marked preference for these boxes, but by and by he found that he got most interesting results. Birds which had never come to any of his other nest boxes came to these, and the birds which had always come to the other kinds liked the new ones at least as well. He once put up two thousand of these nest boxes, and seventeen hundred were occupied the first year. The following year they were all occupied and he knew that his experiment was an unqualified success. The German Government was so much impressed with the result of this and other experiments of the Baron's that it has established other bird sanctuaries in other parts of Germany. The Grand Duchy of Hess, not long ago, put up 40,000 of those nest boxes in the forests to protect the timber. And in many villages and towns, people who have no special love for birds, put up these nest boxes, realizing that it pays to encourage the birds which occupy them.

Some years ago the writer imported from Germany a hundred and fifty Berlepsch nest

boxes, and they were a great success. Later, at the request of Mr. William Dutcher, President of the National Association of Audubon Societies, he undertook to direct the manufacture of Berlepsch nest boxes in this country, and slightly modified to meet the special requirements of American birds, they are now made by the Audubon Bird House Company in Meriden, New Hampshire. Among American birds which the writer knows to have used these boxes, are: sparrow hawk, screech owl, hairy woodpecker, downy woodpecker, red-headed woodpecker, flicker, great-crested flycatcher, starling, tree swallow, house wren, white-breasted nuthatch, red-breasted nuthatch, chickadee, bluebird.

Some of these birds, hairy and downy woodpecker, and red-breasted nuthatch, for instance, have never been known to enter any other kind of nesting box; and others, the sparrow hawk and red-headed woodpecker, for examples, have rarely been known to do so. In fact less than one-half the birds mentioned in the above list regularly nest in carpenter-made nest boxes of any kind. Thus it will be seen that in spite of the fact that Berlepsch nest boxes are only just beginning to be known in this country, they already more than hold their own against all the other kinds put together. It is the

writer's belief that if Berlepsch nest boxes are made available for American birds they will eventually be occupied by practically all species which naturally nest in holes in trees. As von Berlepsch himself has proved by repeated experiment, when properly made these nest boxes are the best in the world. But he warns bird lovers to beware of unscrupulous dealers, who, ignorant of the real requirements of birds, make boxes which on the outside only, resemble the properly-made ones. These fail to attract the birds, of course, and the result is disappointment and discouragement to the bird lover.

A very common cause of failure with nest boxes is lack of knowledge of when, how, and where to hang them. The following rules are intended to enable the reader to avoid failure from this cause. They were written with special reference to Berlepsch nest boxes, but apply equally well to any other type of nest box with which it is hoped to attract American birds.

Time of Year

Nest boxes may be put up at any time of the year, and the sooner they are put up the better. Of course, if they are put up so late in the spring that the birds have already selected other sites

for their nests, one cannot expect great success that season; but some of the birds which, like the bluebird, rear two broods, may use the boxes for the second brood, and in any case the birds will become accustomed to the presence of the boxes and will be more likely to make use of them next year. To obtain the very best results in the spring, the boxes should be in place the autumn before. There are several reasons for this. In the first place, many of the birds which nest in holes, use holes to sleep in during the winter, and birds which become used to sleeping in the nest boxes will be very apt to use similar boxes as nesting sites in the following spring. In the second place, if they are hung before the leaves fall, one can see exactly what he is doing and avoid hanging the boxes in places which are too shady, whereas if the work is left until spring, they may be hung in places which seem open enough while the trees are bare but which will have too much shade when the leaves come out again. Then, if boxes are hung in the fall, they are sure to be out early enough in the spring. Otherwise the work is apt to be left until the birds begin to come back, which is too late for the very best results. Some birds seem to *select* their nesting holes very early, though they may not begin to build until later.

Condition of Nest Boxes

The statement often repeated, that birds prefer boxes whose appearance of newness has disappeared, may be true of the shyer species. From my own experience I am inclined to think that if bluebirds and tree swallows have any preference in this matter, it is for a clean new-looking box. I have repeatedly seen these birds enter and examine new boxes within ten minutes after they were put up, and then nest in them afterwards. I very much doubt, however, whether the age of the house has much to do with its chances of being occupied by such tenants, for I have known the same box to be used many years in succession when newer boxes were within sight.

General Situation

It should be continually borne in mind that nest boxes are for the accommodation of birds that naturally nest in holes in trees. Now, the trunks or branches in which such holes are situated, are usually dead or decayed and not, as a rule, heavily shaded. Therefore, to place a box in a perpetually shaded place like the heart of a leafy tree, would be to place it where birds would be unlikely to use it. As a rule it should



CHICKADEE AT A BERLEPSCH NEST BOX



CHICKADEE FEEDING UNDER A BERLEPSCH FOOD
BELL

be hung on a well-exposed trunk or branch, and though a little shade will do no harm and is even desirable, the box should get plenty of air and sunlight.

Position

If we examine the nests which birds make for themselves in the trunks and branches of trees, we shall find that sometimes these trunks and branches are perpendicular, and that sometimes they are leaning. And when they are leaning, we shall find that the entrance holes leading to the nests are usually on the *under* side. We can readily see good reasons for this. If they were on the upper side the rain water would run in, and moreover it would be less convenient for the birds to go in and out over an overhanging surface. So, as our object is to give the birds a home as nearly like a natural one as possible, we must hang our boxes either on upright trunks or branches, or on the *under* sides of leaning ones. They may also be erected on fence posts, and where the birds have become tame and fearless, on the sides of houses and barns. Of the occupied nest boxes on the writer's farm within the last year or two, some were on the house itself, others on the barn, on gate and fence posts, in

the trees of the garden and orchard, and in the woodland nearby.

Preparations for Hanging

If your boxes are of the Berlepsch type, the first thing to do is to drop into the bottom of each a small quantity of sawdust and dry earth mixed together, about half and half. This is to take the place of the peckings of decayed wood which woodpeckers always leave in the bottom of the cavities they make. Such birds do not as a rule carry in nesting material, and these peckings take the place of it. The quantity of dry earth and sawdust mixture differs with the size of the nest box. The following quantities are recommended by Baron von Berlepsch himself:

For sizes Nos. 1 and 2, one heaping tablespoonful.

For size No. 3, two heaping tablespoonfuls.

For sizes Nos. 4 and 5, ten heaping tablespoonfuls.

This mixture may be dropped through the entrance hole; it is not necessary to raise the lid. Any nest box intended for wood ducks should be left three-quarters full of dry leaves. This may be more leaves than necessary but the ducks will throw out what they do not need.

Other types of nest boxes are rarely occupied by woodpeckers other than flickers, but a little sawdust will do no harm in any nest box, and in case of driving rain may help the drainage. An inch or two is enough for bluebird or tree swallow boxes, but the deep boxes intended for flickers should be half filled, at least. If there is more than the flickers care for, they will quickly throw it out.

You are now ready to hang up the nest boxes and in most instances you will need a ladder for this. Where a number of boxes are to be put up, a wheelbarrow will be found a great convenience. Of course the work will progress much more rapidly if two persons are engaged—one to mount the ladder—the other to hand him the nest boxes and tell him when they hang true.

The Best Places to Hang Nest Boxes

Other things being equal the greatest success with nest boxes will be had by those who give heed to the preferences which different kinds of birds show in selecting sites for their homes. It would hardly be possible to give rules so complete as to cover all the preferences shown by birds likely to occupy nest boxes, but the following suggestions will be found useful by those who

have not had a wide experience in the field. And among these suggestions I will give what seem to be the best heights at which to hang nest boxes for different birds. I shall try to avoid extremes for good reasons. For instance, I have found flickers nesting within three feet of the ground; that is too low for safety. I have found them nesting forty or fifty feet above the ground; that is too high for convenience in hanging bird boxes. I suggest from eight to twenty-five feet; eight is usually safe and even twenty-five feet is usually convenient.

Bluebirds, as we all know, are usually found nesting in open apple orchards, along fence posts, and around the houses and farm buildings. Evidently then the best places to put up nest boxes for them are on the apple trees, fence posts, shade trees, arbors, pergolas, houses, and barns. Anywhere from eight to twelve feet will be found to be a good height.

Chickadees are fond of the open woods, especially rather swampy woods, and in such places usually nest rather close to the ground. I once found a chickadee's nest, the entrance to which was only one foot up the side of a poplar stump. From four to eight feet up would be all right for open woodland. But chickadees are also fond of orchards and here they usually nest somewhat

FLICKER HOUSE

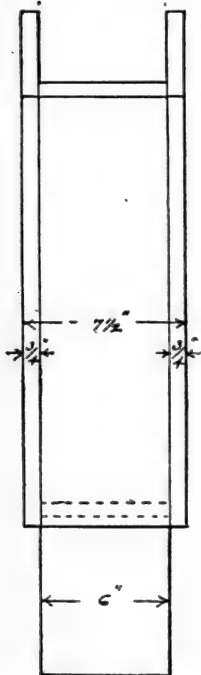
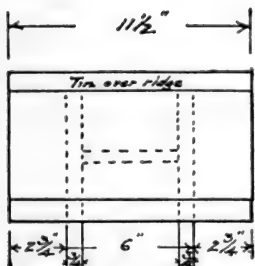

FRONT ELEVATION

NOTE - Roof lifted
away from house
to show construction

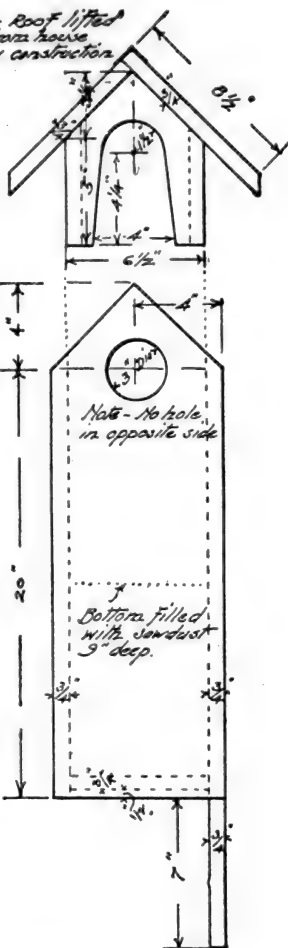

SIDE ELEVATION

higher. For chickadee boxes to be hung on apple trees and the sides of quiet buildings, I would suggest eight to twelve feet.

Red-breasted nuthatches usually nest in the open woods and seem partial to the borders of clearings. Nest boxes hung from fifteen to twenty-five feet above the ground are apt to suit their ideas as to proper height. A pair of these birds at Dover, Mass., nested in a Berlepsch nest box only seven feet from the ground.

White-breasted nuthatches sometimes like the open woods but at other times seem to prefer to nest in orchards or quiet gardens. For these birds nest boxes hung from eight to fifteen feet above the ground will be high enough.

The little house wrens will build almost anywhere, but seem to have a preference for quiet gardens and orchards. Nest boxes intended for them may be hung on trees, arbors, pergolas, porches, or the sides of buildings, and need not be hung more than from eight to twelve feet high.

Tree swallows are very easy to please and properly made nest boxes hung on the exposed trunks of shade trees, on tall stumps, on buildings or arbors, and eight to fifteen feet above the ground will be sure to please them. Nest boxes intended for these birds may also be

fastened to special posts and placed around open fields.

Purple martins seem to prefer to nest in many-roomed houses rather than in nest boxes which accommodate only one family. Such houses should be erected either on special poles, on telegraph or telephone poles, the trunks of trees, or on the tops of buildings. Martins like plenty of open space on at least one side, and they are especially fond of the banks of rivers whence they can swing out over the water. From fifteen to twenty-five feet is plenty high enough for martin houses, though they are often placed much higher.

Great-crested flycatchers usually seek their nesting sites in open woods or orchards. Anywhere from six to fifteen feet will be found a good height for the nest boxes.

Flickers are fond of nesting in old orchards where some of the trees are dead or dying, but they often nest in trees standing in the open, or in posts or even buildings at some distance from human habitation. As I have said, good heights for their nesting boxes may be found anywhere from eight to twenty-five feet above the ground.

Red-headed woodpeckers like open woods but seem to be quite willing to accept hospitality offered them in quiet gardens and orchards.

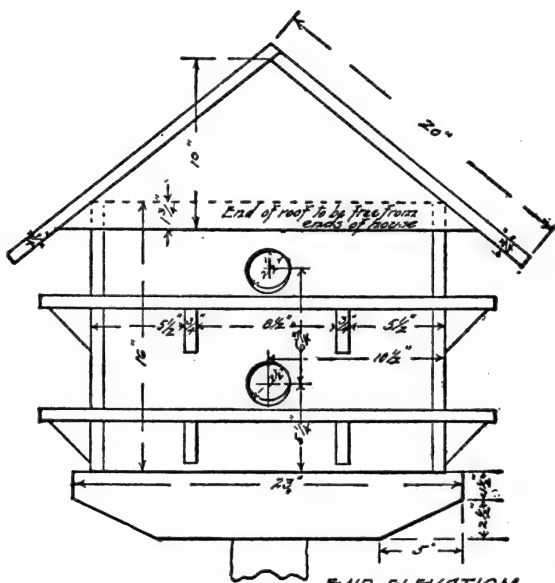

MARTIN
HOUSE

END ELEVATION

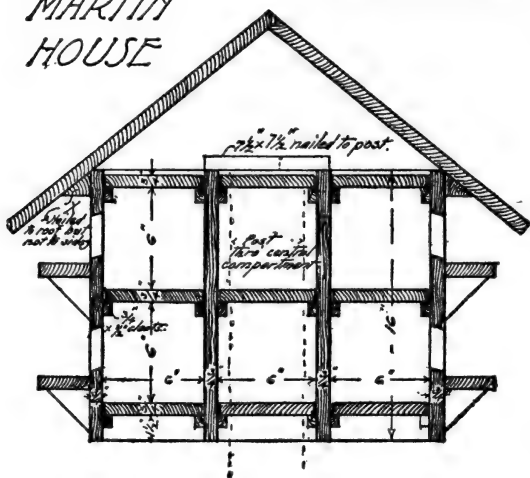

SECTION A-B (see plans)

Plans for a Martin house—Elevations

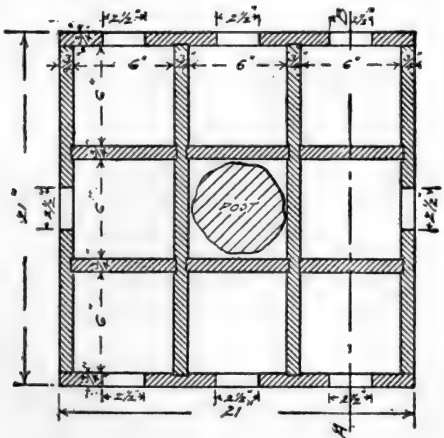
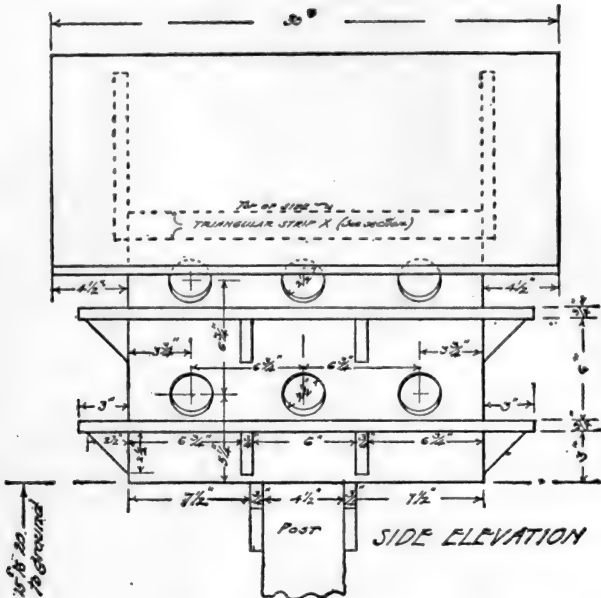

FLOOR PLAN
 Plans for a Martin house—Continued
 See also design on page 309

From twelve to twenty feet will suit them as to height.

Pileated woodpeckers, so far as I know, have never occupied artificial nesting boxes, but perhaps this is simply because no one has ever hung properly-made ones in suitable places. These woodpeckers are birds which usually prefer old forests, and it is here that nest boxes intended for them should be placed. Judging from their natural nesting sites, anywhere from fifteen to twenty-five feet would be a good height.

Yellow-bellied sapsuckers will nest in open woodland or in shade trees in gardens or along country roads and village streets. From fifteen to twenty feet would be a good height for nest boxes intended for their use. As sapsuckers are known to be destroyers of certain kinds of trees, especially of birches, which they girdle with holes in order to get the sap, some people may not wish to encourage them. But they should not be confused with other woodpeckers, most of which are very useful birds.

Saw whet or Acadian owls are often found nesting in old woodpeckers' holes or deserted squirrels' nests. Nest boxes intended for them may be hung in woodland or on the sides of isolated buildings, and anywhere from ten to twenty feet would be a good height.



A BIRD BATH MEMORIAL TO EDWARD EVERETT HALE

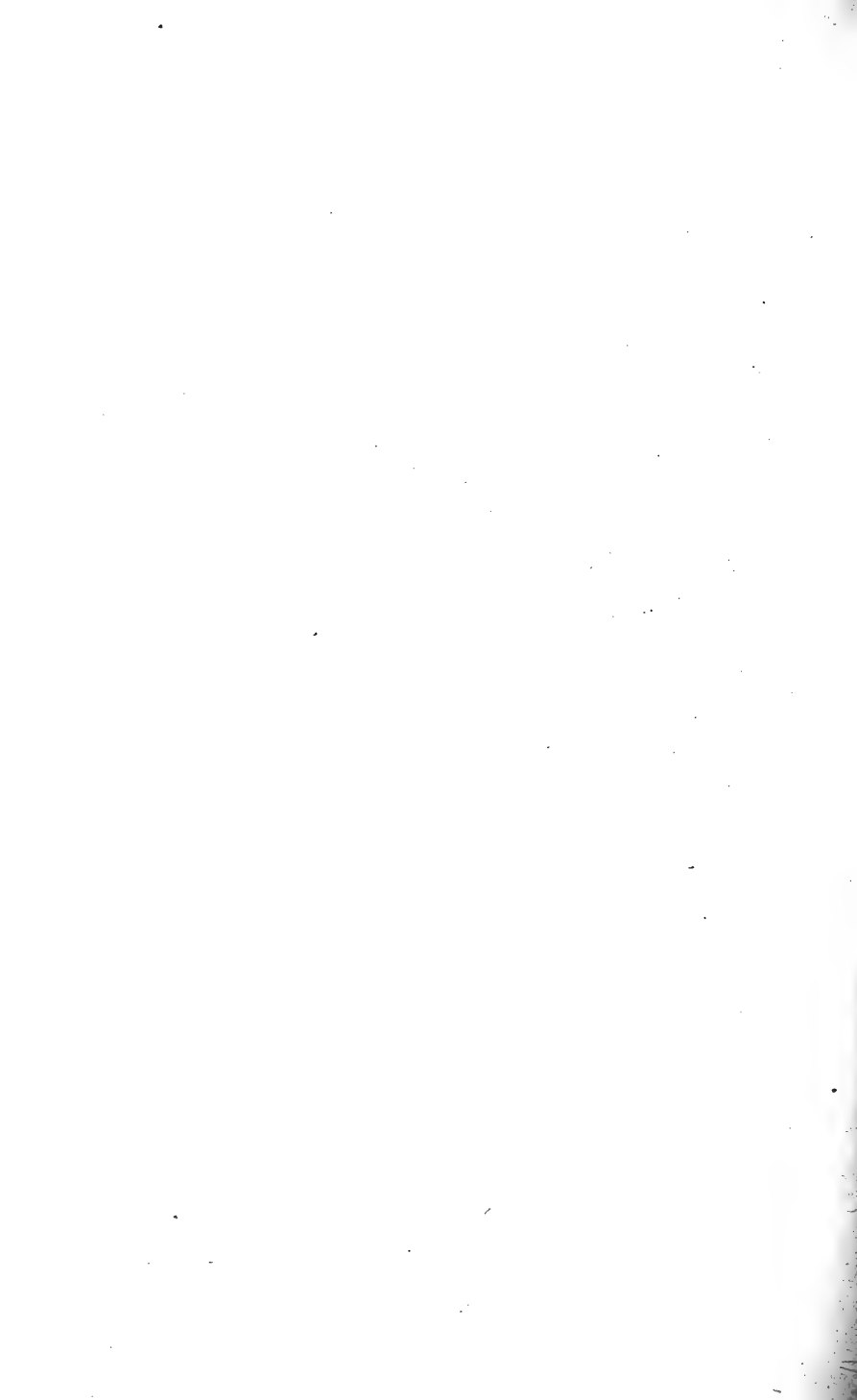

Sparrow hawks are usually birds of the open country and often nest in isolated trees. Nest boxes hung on such trees within the birds' breeding range, and from fifteen to twenty-five feet above the ground are apt to be occupied. Care should be taken that these beautiful and useful little hawks are not mistaken for sharp-shinned hawks, and killed.

Wood ducks and mallards both take kindly to artificial nesting sites, and golden eyes and American mergansers probably will do so eventually. Nesting boxes for wood ducks should be placed on trees within two or three hundred feet of some pond or stream, or if the ducks are tame, the boxes may be fastened a foot or so above the surface of the water upon posts driven into the mud at the bottom. In this case it is well to have a sort of gang-plank, made of a board with cleats nailed across it, leading from the entrance hole to a little float resting on the water. The ducks will climb out on the float and by means of the gang-plank reach the entrance to the nest box.

Three-toed woodpeckers usually inhabit living evergreen forests and nest boxes intended to attract them, may be placed from ten to twenty-five feet from the ground. These birds have not yet been known to use artificial nesting sites.

Downy woodpeckers are birds chiefly of the woods and orchards and should be attracted by suitable nest boxes hung from ten to twenty feet high. They have been known to occupy Berlepsch nest boxes only.

Hairy woodpeckers are fond of quiet woodland, especially swampy woodland or woodland near a stream; sometimes they nest quite close to houses. Nest boxes hung from fifteen to twenty-five feet above the ground will be at the proper height for them. They have been known to enter Berlepsch nest boxes only.

Screech owls seem to have little fear of man, and frequently nest in the orchards or in shade trees near the house or on the village streets. They will often occupy nest boxes hung on trees or the sides of barns from eight to twenty-five feet up.

While not essential in all cases, it is best to examine all nest boxes in the fall, and clean out those which have been occupied either by birds or by squirrels, mice, hornets, or moths. Some birds will go to the trouble of cleaning out a nest box, but many will refuse to use it unless it has been cleaned for them. Last spring a pair of bluebirds in Meriden, New Hampshire, refused to build in a nest box which they had used for years. Finally the owner of the box examined

it and found, in addition to the old nest, an addled egg left from the year before, which he decided was the cause of the trouble. He cleaned out the box and the bluebirds began building at once. On the other hand another pair of bluebirds in the same village built their nest in a Berlepsch box over the nest and eggs of a pair of tree swallows who, it would seem, had a better right to it. Ernest Thompson Seton adds the remark: "As a practical detail I have found it worth while to have each nest with a hinge door which would admit of easy inspection without disturbing the inside arrangements." The author's experience coincides with this, and all nest boxes made under his direction are fitted with hinged lids and simple fastenings to facilitate inspection, and cleaning when necessary.

Shelves for Phœbes and Robins

The author has had success in attracting phœbes to the house by putting up shelves for them under the piazza about four to six inches from the roof. At his own home a little shelf made of a bit of board four inches square, supported by a brace, has been occupied by a pair of phœbes for three successive years, two broods being reared each year.

Robins prefer a somewhat wider shelf, perhaps six inches, fastened a little farther away from the roof, to allow for the larger size of the birds when they stand on the rim of the nest to feed their young. Some people object to having birds nest in this way because they soil the piazza, but it requires so very little work to keep everything neat and clean, that it is hard to see how anyone can forego the delight of observing the home life of their little guests, to say nothing of the advantage of having countless troublesome insects destroyed. The pair of phœbes on our piazza, with two pairs of tree swallows which nest in boxes in the garden, and a pair of barn swallows in the barn, keep our house practically free from flies and mosquitoes all summer long.

A large proportion of the birds which will nest neither in nest boxes nor upon shelves are provided for in Mr. Kennard's splendid list of trees and shrubs and creepers given in Chapter VIII.

Baron Hans von Berlepsch goes a step farther and plants what he calls shelter woods, the trees and shrubs in which are systematically pruned in such a way that the new shoots form whorls and crotches of the kinds most attractive to birds which make their nests in such places. But this is an art in itself, and those who would learn it I must refer to Martin Hieseman's

How to Attract and Protect Wild Birds, an imported book for sale by the National Association of Audubon Societies, 1974 Broadway, New York City.

Nesting Material

It seems reasonable to suppose that birds are influenced more or less in their choice of nesting sites by the amount of suitable nesting material to be found comparatively close at hand. If barn swallows are to nest on a particular barn, there must be a supply of suitable mud within easy distance, or if a Baltimore oriole has selected a certain pendant branch on which to hang his nest, it is safe to assume that within a rather short radius may be found enough strings of some kind to make an oriole's nest. And the fact that birds so often avail themselves of the strings, rags, scraps of paper, and other materials accidentally dropped near our homes, suggests the possibility that if a generous supply of such nesting material were made available during the nesting season, more birds would be likely to nest on the premises. A great variety of nesting material is used by our common birds, and there is no telling to what extent this would be added to if new materials were available. Since the coming of the white man they have added string

of many kinds, woolen yarn, silk thread, horse hair, sheep's wool, feathers of domestic poultry, rags, cotton batting, wood shavings, paper, and probably other things. Any or all of these might be offered with a fair chance of their being used. Small dry twigs, and hay in convenient lengths, would doubtless be accepted by certain birds, and by a study of the nests in any locality, probably other materials could be added to the list.

A puddle with plenty of soft wet clay or sticky mud of some kind, or a tray of this material, in an exposed situation, would be likely to be visited by barn swallows and cliff swallows.

One objection to offering the birds such materials as rags, cotton batting, paper, and shavings, is that they are blown about by the wind and make a garden look untidy. Perhaps this objection might be overcome by putting the materials in net bags with a wide mesh or in shallow baskets or boxes with covers of netting and painted so that they are inconspicuous when placed on trees or in shrubbery.

CHAPTER X

BIRD BATHS AND DRINKING POOLS

IN hot weather, especially in time of drought, there is nothing more attractive to birds than water. They need it to drink and to bathe in, and when the natural pools and streams are dried up, they will come from far and near to visit a properly constructed bird bath. At the very time this chapter is being written the weather is very hot and dry and birds are coming to the artificial baths in the village, not one at a time, but by scores. Only this morning they gathered at a little cement bath just outside my study window, and gave it the appearance of an avian Manhattan Beach. I saw two bluebirds, a chewink, a white-throated sparrow, a song sparrow, a junco, a chipping sparrow, and a myrtle warbler, all bathing at once, and at least a score of other birds were hopping about in the grass or perched in the bushes nearby, awaiting their turn. There were similar scenes at nearly

all the bird baths in Meriden. One example will suffice. In the Bird Sanctuary there is a bath made from a granite boulder, or rather half a boulder, for it was split in two, ages ago, probably by the frost. It had broken in such a way that one-half had a gently sloping concave surface and we took this half, and turned the concave surface uppermost that when filled with water it might form a natural pool for the birds. As I approached this bath one evening after sundown, I saw the whole surface of the water dancing as though a shoal of little fish were sporting in it, and spray was flying in every direction. It was simply a flock of birds taking their evening bath. Perhaps because night was coming on they were too impatient to wait their turn, for all seemed to be trying to get in at once, and most of them were successful. Juncos seemed to be most numerous, but there were several bluebirds and myrtle warblers and some sparrows which in their wet plumage and in the uncertain light I could not identify. A little apart a phoebe sat on a twig above the pool, watching for chances to dip down into the water for an instant, after which she would return to the twig to preen her feathers.

Birds come to our bird baths every day in summer and fall in an almost continuous pro-

cession, but usually just a few are present at the same moment. They come in large flocks only at exceptional times, usually following severe drought.

Bird baths may be as simple or as elaborate as one likes. A rough earthenware saucer from six inches to twelve inches in diameter and with half an inch of fresh water in it, is a great deal better than nothing and may attract some of the most

BIRD BATH

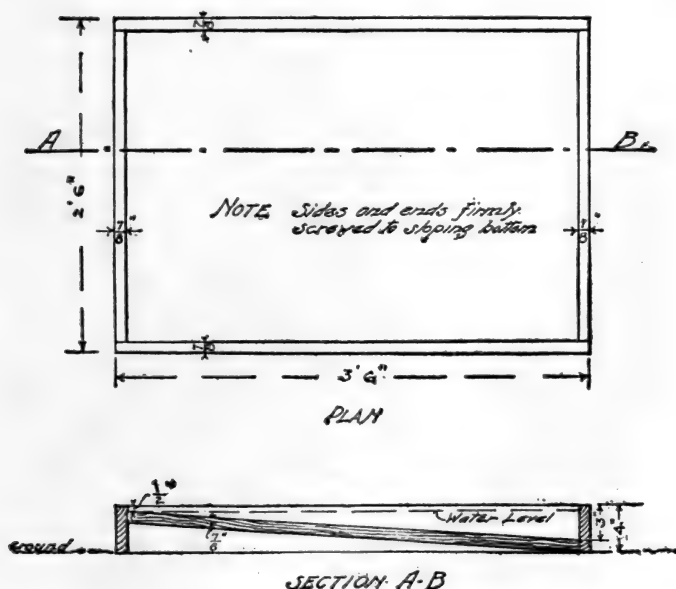

delightful birds. I have seen robins, catbirds, Baltimore orioles, rose-breasted grosbeaks, and many others bathe in an earthenware saucer. But the supplying of water is so very important that most of us will wish to do rather more than put out a saucer. Even from a selfish standpoint it is well to give birds all the water they want. If we do, they will be much less likely to destroy our small fruits, which they sometimes eat chiefly for the fluid they contain.

In making any bird bath the first thing to look out for is the depth of the water. Few of the birds which will come to bathe will use water of greater depth than two and a half inches, and even for grackles and blue jays five inches is about the limit. But most birds refuse to jump off into any such depth; if we had a pool with a uniform depth of even two and a half inches, birds would come and drink but few if any would bathe. So we must arrange for shallow places where the birds can enter the water; they will go in deeper presently, but they are very cautious. Half an inch is a good depth for the shallows and if the depth grades off to nothing at all, so much the better. A bath which the writer invented some time ago and which has proved very popular with the birds, is made on the principle of a flight of broad steps, each one of which is two

feet long and seven inches wide. There are five of these steps, each one-half inch lower than the last. So that when the water is half an inch deep on the top step, it is two and a half inches deep on the bottom one. The birds invariably enter the water at the top step. Their favorite steps are the second and third; they seldom go lower than that. The bottom is covered with clean sand and bright pebbles from a trout brook, and here and there among them are strewn beautifully-tinted shells.

Close beside it is a wooden tray of earth, on which are scattered every morning, bird-seed of several kinds, bits of bread, a little suet, ripe raspberries, and a piece of banana perhaps, as additional attractions for the feathered guests. Among the smaller visitors are the chipping sparrows, gentle, modest little fellows, who come to the food tray quietly as mice, crack a few seeds, and then take a bath on the top step where the water is shallow. Almost burly, in comparison, are the purple finches, which come, often two or three at a time, make a full meal in the food tray, and then souse themselves thoroughly in the deeper water, regardless of theories concerning the dangers of bathing too soon after dinner.

Perhaps the most amusing visitor is a catbird, who has a nest in the lilac bushes, from the top

of which, in the early morning, he sings his wonderful song which so surprises those who know him by his cat-call only. He comes boldly to the food tray, hops lightly about, jauntily flirting his long tail, swallows a ripe raspberry, takes a bite or two of banana, and then proceeds to inspect the bath as if he had never seen it before. He cocks his head first on one side and then on the other, hops into the shallow water, and begins to peck at the shells and pebbles at the bottom. Perhaps he will take one in his bill, and hold it for a moment before dropping it back. Then he goes out into deeper water, and with wings vibrating as though operated by an electric current, takes a thorough bath "all over." When he comes out, he is a sorry-looking object, dripping wet and with tail-feathers stuck together. But apparently he cares nothing for appearances, and proceeds with his toilet forthwith. He shakes himself vigorously, flips his tail from side to side to get rid of the bulk of the water, and then it is surprising how soon, with the aid of his deft bill and a warm sun, he makes himself into a clean fluffy catbird again.

Sometimes, toward evening, a bluebird visits the bath, and, after washing himself in a very business-like way, flies off to a dead tree to preen and dry his feathers.

Occasionally a phœbe comes, but apparently takes a bath more from a sense of duty than from any love of bathing. He seems to dislike cold water about as much as does the average small boy, for instead of getting right into it as most birds do, he flits through it, barely getting his feet wet. Perhaps this habit has been acquired by repeatedly darting after insects, and possibly is common to all flycatchers; at any rate I have seen a kingbird bathe by dashing through the water of a stream time and again, returning after each dip to a snag, from which he made a fresh dive after stopping a moment to preen his feathers, and perhaps to catch his breath.

But the song sparrows are perhaps the most numerous visitors to this bird bath; they come earlier and stay later than any of the other birds. They act as if they owned this particular sheet of water, three feet by two, and if any other bird ventures too near while a song sparrow is bathing the former is promptly driven away. These sparrows seem to fairly love the water, and not only splash in it, but squat right down in it until practically nothing but their heads are sticking out. Sometimes when it is almost dark, and the last red tinge of afterglow is reflected in the tiny pool, a couple of dark spots on the

shining surface tell just where two little song sparrows are cooling off for the night.

We have been altogether too busy to keep close watch on this bath but at different times we have observed the following birds using it: Flicker, phoebe, Baltimore oriole, purple finch, white-winged crossbill, American goldfinch, vesper sparrow, white-throated sparrow, chipping sparrow, junco, song sparrow, chewink, cedar waxwing, black-and-white warbler, Nashville warbler, myrtle warbler, chestnut-sided warbler, catbird, brown thrasher, hermit thrush, robin, and bluebird. Probably there have been many more which we have not observed. The arrangement of steps, while interesting, is by no means necessary, and a bath of the same size, say three feet long, two feet wide, and three inches deep, with a continuously sloping and roughened bottom, starting at one end half an inch from the top and ending at the other end at its lowest point, would probably answer the purpose just as well. And speaking of the roughened bottom, reminds me that almost if not quite as important as the depth of water in a bird bath, is the character of the footing on the bottom. This should never be slippery, for birds lose confidence when they find they cannot keep their feet. A layer of course sand or fine pebbles will usually give



A BIRD BATH IN NEWTON CENTRE, MASS.



the desired "footing" in a bird bath, and a slippery pan or dish can be rendered safe by placing in it a freshly-cut sod, having about half an inch of the grass submerged. This makes a wet spot such as many of the small birds are very fond of.

Concrete is very useful for the construction of pools for the comfort of birds; it may be used alone as in the case of a bird bath in my own garden, or in connection with natural rock cropping out above the earth, as seen in the photograph of Mr. Kennard's little pool, opposite. The former was made as follows: I scooped out in the lawn an elliptical hollow, four feet by three feet six inches, the sides sloping down in all directions toward the centre where the depth was four or five inches. I now took some Portland cement and some coarse sand and mixed in the proportion of one of cement to four of sand, adding just enough water to give it the consistency of common mortar. Then, with my hand, I plastered it all over the surface of the hollow, putting in enough to make the depth at the center about two and a half inches. I was careful not to make the sides too smooth, though the concrete itself gives an excellent foothold for the birds. We have no running water in this; about once a week we sweep the water out with a stiff

broom and put two pails of fresh water into it. It has been a complete success, and being within ten feet of the house we have had great pleasure in watching the birds from the windows and from the piazzas. We have seen six bluebirds—the parents and four young—bathing in it at once, and at other times there have been whole flocks of song sparrows, white-throated sparrows, and juncos, in addition to the many birds that come in smaller numbers. With a few shrubs and hardy flowers planted about it, such a bath can be made a beautiful little feature in any garden. And, of course, there is no reason in the world why it should not be made much larger if one has plenty of room and the time to make it.

Dr. Ernest L. Huse, President of the Meriden Bird Club, has a somewhat similar bath in his garden, but he has carried the idea a little farther. In the center he has sunk a tub, and from the rim which is perhaps two and a half inches below the surface of the ground, the concrete slants outward and upward in all directions, making shallows in which the birds will drink and bathe. In the tub pond lillies are planted, and spread their leaves and blossoms over the surface. Round about shrubs and tall grasses are planted and here and there among them one catches a

glimpse of a little food tray, filled with hemp and millet which tends to keep the birds about the spot even when the bath is over.

There is hardly a limit to what may be done with concrete in this way, especially if it is used in connection with beautiful stones, pebbles, sand, and shells. Small pools may be swept out often enough to prevent mosquitoes from breeding; in the larger ones a few small fish will quickly devour the larvæ of these insects.

Of course, in the case of bird baths which are not raised well above the ground, great care must be taken that the little bathers are not pounced upon by cats, which would otherwise have the little songsters at an unusual disadvantage. The birds become so engrossed with the joy of the bath that they are less wary than usual, and their feathers being wet they fly slowly and heavily, often close to the ground. If we cannot be sure about cats, we must either have our bath raised well above the ground on some object which a cat cannot climb, or else we must be content with a bath out in the open, without shrubs or grass about it, for behind such things a cat will crouch.

I have spoken of a bird bath made of a granite boulder; we have two of this kind in Meriden, New Hampshire, and they are among the most

satisfactory baths we have. One has the natural hollow which I have described.

It is set upon a well-made stone foundation, a hole has been drilled down through to admit a lead pipe which supplies running water, and a little bronze tablet bolted to the granite shows that the bath is placed there in memory of Dr. Edward Everett Hale, and gives the name of Miss Harriet E. Freeman of Boston who presented it to the Bird Club. I often think how much more appropriate as a memorial to a real man or woman, is a beautiful thing like this, made by Nature, carved by her mighty forces, and dedicated to the use and enjoyment of the loveliest of her children, than a shining, ugly, and utterly useless polished shaft, whose sole recommendation is that it costs from a hundred to a thousand times as much. In the case of the other boulder bird bath, which is on the campus of the local academy, a hollow was chiseled out by a mason at small expense.

When we decide to have such a bath our plan is to appoint a committee, each member of which has a good general idea of the kind of boulder required. When any member goes for a walk, he keeps his eyes open for likely boulders and when he finds one which he thinks will do, he takes the other members to see it. If it is

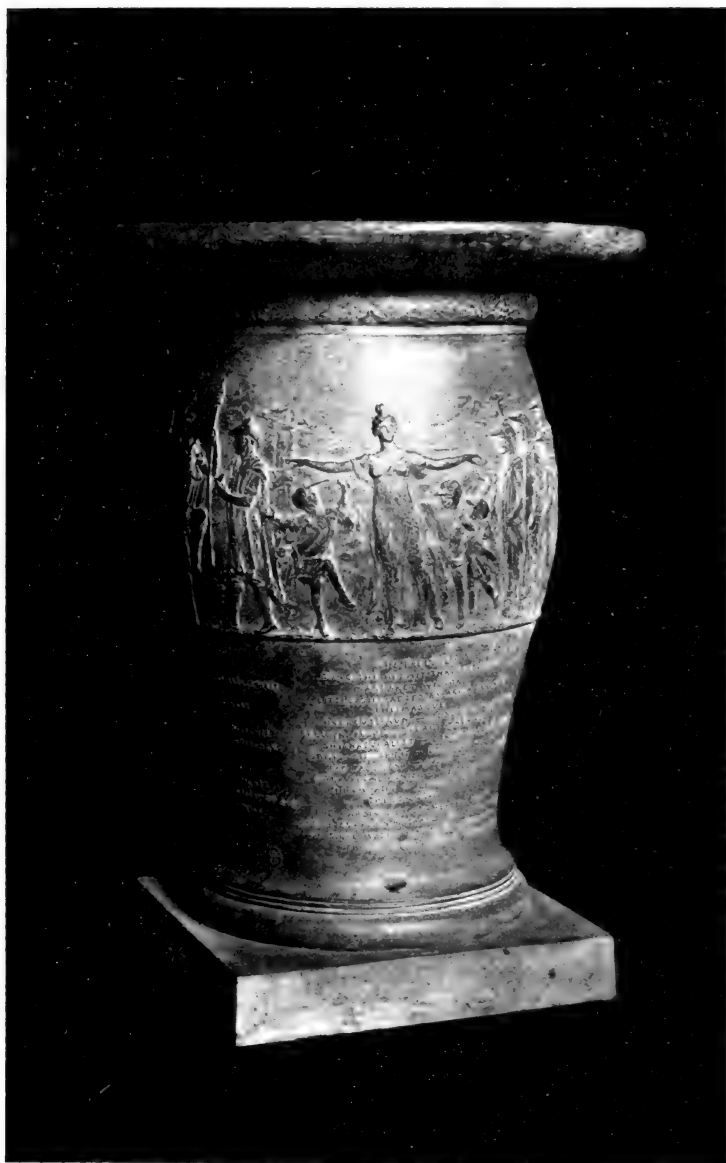

BRONZE BIRD BATH COMMEMORATING THE BIRD MASQUE



satisfactory as to size and form, the next step is to approach the owner of the land on which it lies, and secure his permission to remove it. He is usually glad to have it removed, and if he is the owner of oxen or heavy work horses he appreciates the contract to haul it at his convenience.

The lovely bronze fountain executed by Mrs. Louis Saint-Gaudens, and pictured here, is another of the charming features of the Bird Sanctuary at Meriden, and makes one realize that with the sculptor as an assistant there is no end to the artistic bird baths which may be designed. This particular bath was made in commemoration of the first presentation of Percy Mackaye's bird masque, *Sanctuary*, and was presented to the Meriden Bird Club by Helen Foster Barnett of New York who witnessed the play. It will be seen by the shallowness of the basin at the top that my remarks about the depth of the water apply just as much to a formal work of art as to a granite boulder or an earthenware saucer. The rule about surface also applies, and the sculptoress purposely left the surface of the inside of the basin slightly rough that the feet of the little bathers might not slip. Below the shallow bowl and in bas-relief may be seen in procession the principal characters who

took part in the masque. Below these are interesting inscriptions, some of them historical, others consisting of quotations from the masque itself. Of these the one that sends the reader away filled with determination to do something for the cause of bird conservation is the compact sworn to by the poet, the converted plume-hunter, and the naturalist:

“ A compact, then, we three, that when we go
Forth from these gracious trees
Into the world, we go as witnesses
Before the men who make our country's laws,
And by our witness show
In burning words
The meaning of these sylvan mysteries:
Freedom and sanctuary for the birds!”

CHAPTER XI

SOME OF THE PROBLEMS WHICH CONFRONT BEGINNERS

THE writer does not begin this chapter without realizing the magnitude of the task which would confront anyone who undertook to give in detail remedies for all the ills which birds are heir to. Even were he able to cope with such a task, it would be impossible in a book of anything like this size, to do so. But he knows from the letters of inquiry which he receives, that there are many people who seek just a few opinions—just a few suggestions from someone who has had even a little more experience than they have had, and whom they feel will be working along with them for the welfare of their mutual friends—the birds. It is principally for these and such as these that this chapter is written.

Storms

There seems to be little we can do to prevent birds from being killed as a direct result of storms.

We have already spoken of the planting of evergreens as shelter, and such local protection is valuable as far as it goes. We have also spoken of the feeding of birds in winter and after late spring storms.

Floods caused by heavy rains and which result in the destruction of nests upon the ground within the flooded area, might, it would seem, be prevented in many cases by a simple drain which would carry off the surplus water.

Waterfalls

Speaking of the swans which went over Niagara Falls in 1908, Mr. James Savage, in a report to the Buffalo Society of Natural Sciences, concludes: "While the killing of the wounded swans at the ice bridge . . . in a certain light might be regarded as an act of mercy inasmuch as without human interference most of the birds would probably have perished from their injuries or by starvation, yet it is greatly to be regretted that as many of the birds as possible were not taken alive and given an opportunity to recover. I believe that fully one-third of the 116 swans taken would have survived if given the proper care. But the impulse to kill was stronger than the spirit to save, and not even a pair of these

unfortunate birds was rescued from nature's doom and restored to nature's freedom."

The injured swan seen in our illustration was secured by Mr. Savage half an hour after it was picked up at Bass Rock eddy. It could not stand or use its wings, but nevertheless he took it to Buffalo and placed it under the care of the curator of the Zoo in Delaware Park. It quickly recovered and was soon floating gracefully on the waters of Park Lake.

The writer believes that the importance of saving as many as possible of the swans which are wounded by coming over Niagara is out of all proportion to the number of bird lives actually involved. The size and majesty of these kings of the waterfowl, together with the dramatic nature of the disaster which has overtaken them, insures a wide publicity, which may be made either to help or injure the cause of bird protection. Here are glorious, world-famous birds which are braving the dangers of a long journey to their Arctic home, and which have even survived a battle with one of the mightiest cataracts on earth. To permit these voyagers, while they are bruised and battered and still struggling bravely but hopelessly with the savage waters of the gorge, to be dragged out upon the ice and choked or bludgeoned to death

is highly demoralizing—as much to those who permit the barbarous practice as to the young men who murder the helpless birds for money. Would it not be a noble work for the Boy Scouts, with permission from the authorities, of course, to organize a “first-aid” corps to save the swans wounded by going over Niagara Falls? The Scouts could arrange to patrol the river bank at certain points during the brief period in March when the swans usually come over, take the birds from the water, and convey them to some suitable place where they would have every chance to recover, and later to continue their journey northward. Dead birds, instead of being plucked and eaten, might be sent to museums and to scientific collectors in the United States and Canada to become of permanent value as skins or mounted specimens. Such a corps would set a splendid example, and its work would become widely known.

Disease

Individual scientists here and there, though usually hampered by lack of sufficient funds, are doing splendid work in their investigation of the causes of disease in birds and in their search for methods of prevention and cure.

But a great epidemic like the one which has recently caused such havoc among the waterfowl of Utah, usually requires prompt and vigorous action by the Government. At the outbreak of any epidemic of disease among birds, the person discovering it should at once notify the Bureau of Animal Industry at Washington, District of Columbia, and await instructions from that Bureau. If, on investigation by the Bureau, the epidemic threatens to be serious, Congress will probably be asked to appropriate a fund with which to carry on the work of stamping out the disease.

Natural Enemies

On very large preserves devoted to the protection of birds and other wild life, a few natural enemies may be an advantage. Most of them eat a variety of food, and the birds which they get will often be the weaklings—those which are not quite healthy, or which in one way or another fail to come up to the standard. But on a small place, especially one which it is designed to make particularly attractive to birds, I should say the fewer enemies there are the better. On such a place, a fox, a pair of red squirrels, a house cat, or a sharp-shinned hawk, will be

likely to prevent a normal increase of the bird population.

Yet, to many of us the very hardest task we have to perform for our friends, the birds, is the killing of their enemies. It is always a sad thing to fire a gun at a sharp-shinned or Cooper's hawk, which but a moment before perhaps has been sailing far above the earth, a beautiful creature doing nothing more wicked than looking for his dinner, and bring him crashing down to his death. Neither does one enjoy killing a red squirrel, every line of whose muscular little body is beautiful, every motion graceful, and whose only sin is the eating of a few fresh birds' eggs for breakfast. If we are thoughtful, we shall probably ask ourselves some questions, such as, "Are sharp-shinned hawks, squirrels, cats, skunks, and other bird enemies to blame for what they do, when they simply act as nature intended that they should?"

But if we are reasonable and honest, we must try to answer such questions truthfully. Of course these animals are no more to blame for what they do than wolves are to blame for killing sheep, foxes for killing hens, or tigers for killing men. But we should hardly blame a shepherd for shooting a wolf if it threatened his sheepfold; we should think a farmer rather stupid if he

permitted foxes to destroy his hens year after year without making an attempt to stop them; and if a man were killed by a tiger which he had refused to have killed, I'm afraid that some of us would be rude enough to say, "Served him right."

Man's status upon this earth is based on the assumption that he has the right to regulate in so far as he is able, the status of every other animal with which he has relations. Unless we deny the right of this assumption and permit ourselves to be dominated by the wild animals, we must, to be consistent, protect the useful birds from their, to us, less useful enemies.

On large tracts devoted to the preservation of birds, one way to get rid of their natural enemies is to employ one or more men, part of whose duty it should be to shoot and trap. Another way is to give some local trapper the privilege of clearing the place of vermin. Where traps are used it should be stipulated that they be visited frequently. Such work should not be intrusted to boys or to any but reliable men.

On a small place one man with a gun, can, without devoting much time to the work, do a great deal toward keeping it free from bird enemies. For example, I know one New Hampshire man, who with a twenty-two calibre rifle, has for years kept his home farm of a hundred

acres, clear of red squirrels, house cats, and European sparrows; reduced the chipmunk population as much as seemed necessary, and who has shot several sharp-shinned and Cooper's hawks and two northern shrikes. The same man has shot practically all the red squirrels in the nearby village of Meriden, and with the help of one other man has cleared the village of European sparrows. Most of the latter were shot, but a few were caught in a sparrow trap. Both of these men lead very busy lives—one is a doctor, the other a writer—but by carrying their guns occasionally while going about their work, they have been able to free the local birds of nearly all their natural foes.

It has been the experience of men who have made determined effort to rid a given place of such bird enemies, that the task becomes increasingly easy. In Meriden, for example, about two hundred red squirrels were shot the first year, perhaps fifty the second, and now the shooting of half a dozen squirrels a year is all that is necessary, in spite of the fact that the village is full of trees and is surrounded by woodland.

European Sparrows

It was the same with the sparrow problem. At first Meriden was like any other sparrow-



A SWAN THAT WAS CARRIED OVER THE FALLS



DUCKS DYING OF STARVATION ON LONG ISLAND



infested village. The pests were everywhere, and nest boxes put up for native birds were at once appropriated by the intruders. A couple of guns began to speak, and spoke at intervals for perhaps three or four weeks. After that they spoke less and less frequently until at length they were silent. What European sparrows had not been shot had sought a milder climate. But there is a townful of them seven miles to the north and a villageful of them four miles to the south, and about once a year a flock of twenty or thirty drift into Meriden. At once guns are fired in honor of their arrival, and those which are able to leave generally do so without even stopping to say good-bye. Occasionally a few will stay about the village for a day or two but it is no use, they are simply not allowed to get a foothold.

And while I am on this subject let me say that the work of exterminating the European sparrow is not for children. It is hard work—unpleasant work—and should be done by real men who know the bird from all others and who are prepared to camp on its trail until there isn't a specimen left in the locality. Any other course is generally a waste of time; it may give temporary relief, but the work has to be done all over again and any cruelty which may be involved must be repeated

at the next trial. Clear the town thoroughly just once, and thereafter it will be comparatively easy to keep it cleared. Don't attempt to get rid of sparrows by tearing down the nests—an infant should realize the futility of this method. The birds will have another nest built before you're up next morning, and will play the game with you about once a day during the rest of their long nesting season. Kill the birds and your work is done once and for all. Dead sparrows make no nests.

The principal methods employed to destroy European sparrows, are trapping, shooting, and poisoning. Of these, trapping is the safest, and poisoning the most effective when large numbers of birds are to be disposed of. In *Farmers' Bulletin 493*, United States Department of Agriculture, written by Mr. Ned Dearborn, and entitled, "The English Sparrow as a Pest," there are some excellent suggestions for trapping, and detailed plans for making sparrow traps. And there are some fairly good traps on the market. In most of these traps the birds are caught uninjured and must be disposed of afterwards. This makes it possible to liberate any other birds which may be caught unintentionally. Almost any kind of small grain—wheat, oats, cracked corn, or birdseed will do to

bait a sparrow trap, and it should be kept baited all the time.

The following directions for poisoning sparrows are given by Professor Clifton F. Hodge, based on the results of his own careful and successful experiments, and are the best I know of:

“Dissolve one-eighth of an ounce of powdered strychnine sulphate in one half pint of boiling water. Pour this, while hot, over two quarts of wheat (or cracked corn), stir well, and continue stirring from time to time, until all the liquid is absorbed. Dry thoroughly, without scorching, and put away in some safe receptacle, labelled: ‘Poisoned Grain. Strychnine.’

“It requires but one kernel to kill a sparrow. A quart of wheat contains about twenty-three thousand kernels, and as a sparrow seldom takes more than two or three, you have enough to rid the neighborhood of about twenty thousand sparrows. Expose the grain where poultry and tame pigeons cannot get it, and by operating only during the winter there will be no danger of poisoning seed-eating wild birds, at least for all northern towns and cities. By taking advantage of the sparrows’ gregarious habits, and the fact that they drive off other birds from localities where they are numerous, much might be done even in the south.

“Sparrows are such suspicious and cunning birds, that, if the strychnine grain be exposed at first, they will probably roll each kernel in their bills, taste it, reject it, and possibly refuse to touch it again that winter. The best way is to select a safe place, where the wind is not likely to scatter it—a walk, driveway, or porch roof with a smooth surface so that the grain may be swept up after each trial. Accustom them to feeding there daily with grain exactly like that which is medicated (I often do this for a week or even a month, until all the sparrows in the neighborhood are wont to come regularly), study the times when they come for their meals, and then on a cold, dry morning after a heavy snowstorm, having swept up all the good grain the night before, wait until they have gathered and then put down enough strychnized grain to feed the entire flock. You have about ten minutes before any begin to drop, and those that have not partaken of the grain by this time will probably be frightened off; but by timing it properly I have repeatedly caught every sparrow in the flock. I have found the morning the best time as they all come then; and it is essential to success to select a dry day, since in wet weather they taste the strychnine too quickly; I have seen them actually throw it out of the crop.

“With this simple method at command, by concerted action a few friends of our native birds can rid any northern city of the sparrow pest in a single winter. This is no more than parents ought to be willing to do, if not for the sake of the native birds, at least to clear the way for the children to do effective work in their behalf.”

The shotgun, too, may sometimes be very useful in the war on sparrows. In sparsely settled districts it may generally be used without danger, and the other birds are only temporarily frightened by the noise. If the sparrows are accustomed to feeding in densely packed flocks around small heaps of grain, a great many may be killed at one discharge of the weapon. The gun is also very useful for gathering in here and there, single birds which have become too wary for trap or poison. When there is an opportunity to shoot only one of several birds, the gunner should select a female for obvious reasons. A preponderance of males is said to further the work of extermination.

Almost any town or city can be cleared of European sparrows and kept clear of them, if just a few men of resource and resolution will undertake the work. In almost any town there are a certain number of men who have made a great success in business, and I know and they

know that if the sparrows had stood between any one of them and the success he has made, there would not be a single sparrow in that town.

Crows

It would probably be unwise to exterminate the crows even where some individuals are addicted to nest-robbing. Such individuals should of course be shot, if possible, and even a general thinning out may be advisable. But crows are very intelligent and interesting birds, and the writer, for one, would miss them sadly if they were all gone. Nevertheless we must have consideration for the farmer and try to help him to prevent the pulling of his corn and other grain by the crows.

A single dead crow, hung up by the feet in a conspicuous place usually makes the best kind of a scare-crow and will protect a considerable area of ground.

One of the most effective methods of preventing the pulling of corn is to give the corn a thin coating of tar. There are several ways of doing this. One of the best is to soak the corn in water until it begins to germinate, and then stir in enough tar to give each kernel a thin coating. Some farmers simply moisten the corn with warm water before stirring in the tar. If the latter

is applied while the corn is dry, it is said to retard germination two or three days. After the grain has been coated it is usually rolled in plaster, wood ashes, or similar absorbent before planting. The only objection to this is that it prevents the use of the planting machine. A little experimenting would probably result in the discovery of a method to which there were no objections.

Cats

The house cat problem is one of the hardest with which the bird lover has to contend. The genuine affection which many people have for cats, the enormous numbers and wide distribution of the animals, and the fact that they have a certain value as destroyers of rats and mice, all tend to increase the difficulty of solving the problem. But the very difficulty should strengthen our determination to solve it, for its solution is of very great consequence.

Personally the writer has no faith in the idea of training cats. As Mr. Forbush says, there are some cats which may be trained not to kill birds but it is the writer's belief that they are few. Fewer still are the owners who possess the inclination, the time, and the very considerable knowledge necessary to train them. Neither has

the writer much faith in the belling of cats. Innocent young birds which are often the victims pay no attention to a bell, and though adult birds may often be saved by the warning tinkle, so will the rats and mice, to destroy which the cats are presumably kept. Confinement is certainly effective and cat owners should resort to this method to whatever extent is necessary to prevent their pets from killing birds. If the cat owner will think the matter over very calmly, he will realize that his neighbor has certain rights which should be respected; rights which his neighbor should, if necessary, insist on having respected—the right to do his duty by protecting our native birds, for instance. A cat owner who persists in balking a neighbor who is unselfishly striving to do his duty in this way, simply because it may be pleasant or convenient to keep cats, places himself in an absolutely untenable position. He has no more right to do it than he has to keep a savage dog at large and thus prevent his neighbor from voting. Personally I insist on my rights in this matter. My bird guests are and always will be assured of the fullest protection I can give them. Furthermore, cats are not allowed in the Bird Sanctuary which is under my management. It would be a crime to lure song birds to a supposed haven of

refuge and then permit them to be mangled by cats. When a cat crosses the boundary of our bird sanctuary he automatically signs his own death warrant. All the neighbors know this and take care of such cats as they consider worth keeping. Most of them realize the justice of the stand which is taken, and when a cat disappears no questions are asked.

Some people may argue, "Suppose cats do kill birds; haven't cats as much right to live as the birds?" Perhaps they have, but since many a cat destroys a hundred birds in the course of its life—sometimes in one year of its life, we must change the question a little and ask: "Has a cat a hundred times as much right to live?" I think even an ardent cat lover will hesitate before answering "yes" to this question. And if he does answer "yes," some people may find it very hard to agree with him.

No sensible person would advocate the extermination of cats, but I do believe that a serious effort should be made to get rid of unnecessary ones. There are many people owning a number of these animals who could get along perfectly well with one; and many other people, each of whom has one cat too dearly beloved to give up, who might without serious sacrifice resolve that when it died they would never replace it.

Entirely apart from their relation to our song birds, there is another vital reason for keeping the cat population of this country down to the minimum. The evidence against the domestic cat as a carrier of disease appears to be increased by every investigation of this subject by competent people. Any lengthy discussion of the matter would be quite out of place in a bird book, but the writer feels it his duty to say just enough to make intelligent owners of cats wish to know a little more concerning the cat as a factor in sanitary science. The fact that cats carry and transmit bubonic plague is well established. There is also positive proof that cats are subject to tuberculosis and diphtheria; that they are very susceptible to scabies and may transmit this disease to dogs, cows, horses, and men; that they are subject to pulmonary distomatosis, which is characterized by coughing and hemorrhage of the lungs, and that they are frequently infected with ringworm, blood flukes, and other unpleasant and dangerous diseases. The writer is inclined to believe that the fondling of cats by children may be the source of many of the seemingly mysterious cases of illness where the little patients "have not been exposed" to the diseases from which they suffer.

Anyone wishing to learn more about this sub-

ject, should first obtain from the Biological Department of Clark University a copy of *The Cat and the Transmission of Disease*, by Dr. C. A. Osborne. If they wish to go still farther, they will find in the back of Dr. Osborne's pamphlet, a list of thirty-two other books and pamphlets bearing more or less on this very important matter.

But after all, it would seem that the best and fairest solution of the cat problem lay in a reasonable tax, similar to that levied upon the owners of dogs. If there were a tax of say one dollar for each male cat and five dollars for each female, hundreds of thousands of birds would be saved, the sufferings of innumerable homeless cats would be prevented, and without injury to anyone. Granting that it is necessary for some people to keep one or more cats as a check upon the rats and mice, surely any real necessity is worth one dollar a year—the proposed tax on a male cat, which is said to be more than the equal of the female as a destroyer of rodents. The result of such a tax would be that every person who really needed a cat would be able to keep one for a nominal fee, but that when such a fee was required, few people would keep more cats than were necessary. It would undoubtedly result in a great reduction in the number of

female cats and consequently a reduction in the number of unnecessary cats brought into the world. As a result of a similar tax on dogs, there is just one female dog in our own village; there are scores of female cats.

The writer fails to see any legitimate objection which can be made to imposing such a tax. All humane persons, and especially cat lovers, should welcome such a measure, first because it would at once give the cat a legal status which it does not now enjoy, and at the same time prevent the misery now suffered by hundreds of thousands of unnecessary and sadly neglected cats, many of which get their revenge on thoughtless humanity, in the country by destroying useful birds, and in the city by preventing peaceful slumber. And surely all dealers in cats should be favorable to such taxation because the demand for the high-grade cats which they breed would be increased owing to the great reduction in the supply of common cats, and because there would be a tendency to own a cat worth paying a tax on. Then from the money derived from this tax there might be employed in each town an officer or officers whose duty it was to be informed of the number of cats owned by each family and to humanely destroy all cats not licensed according to law. It would

seem that intelligent people everywhere, cat lovers and bird lovers alike, should get together and discuss this question calmly and without prejudice or bitterness, and see if they cannot help one another out. Of course, no cat lover likes to have a favorite cat shot or trapped or poisoned, and no bird lover can be happy if a cat is permitted to mangle and torture the gentle feathered guests who come to the garden and orchard. It is unneighborly to kill one's neighbor's cat, but just as unneighborly to permit a cat to kill one's neighbor's birds. Let us be neighborly and work together to devise a reasonable plan whereby it may be possible to have what cats are necessary with the minimum danger to the birds. And let us begin at once, for as Frank M. Chapman sums up the situation, "The most important problem confronting bird protectors to-day is the devising of proper means for the disposition of the surplus cat population of this country."

Dogs

Dogs are seldom very destructive to birds. This is due partly to the fact that they do not climb, partly to the fact that their method of hunting is not, as a rule, well adapted to the

capturing of creatures endowed with flight, and partly to the fact that they are more directly under the control of their masters. Nevertheless, some dogs are notorious bird killers and when it is shown that they cannot be controlled, they should be given a painless death in the interest of the many birds whose lives would otherwise be taken.

Forestry and Bird Conservation

It goes without saying that every effort to save the forests is indirectly an effort to save the birds. The relation between birds and trees is such that each one tends to preserve the other. Forestry in one sense, then, means bird conservation, so bird lovers should always be willing to lend a hand in the work of saving the forests. The planting of trees and shrubs should be encouraged everywhere. The planting of hedges should also be encouraged; this form of fencing is beautiful, permanent, and very attractive to birds. Farmers can help the work by sparing the trees and shrubs which grow naturally by the sides of the roads and lanes. By cutting these down they may gain a few inches of unshaded land, but they mar the beauty of the countryside and drive away the birds, whose services

they need. And farmers should find time to do a little planting on purpose for the birds. There are on almost every farm waste places which could gradually be filled up with trees and shrubs and creepers which would insure the presence of many birds useful to the farmer. If properly selected, these would often save the cultivated fruits which certain birds are so fond of.

Forest Fires

The desire to protect birds should be another incentive to take every precaution to prevent forest fires, and to quickly check and extinguish those which have not been prevented. Owners and managers of bird preserves will do well to consult the best authorities on the subject of preventing and fighting forest fires. In one night a fire may undo the work of years. And fire wardens when asked for permission to burn over certain areas for any purpose, should always give due consideration to the probable effect upon the bird population, not only of the area in question, but of the town in which it is situated.

Lighthouses

In order to prevent the loss of bird life which occurs about our lighthouses every year, perhaps

we cannot do better than to follow the plan carried out by the Royal Society for the Protection of Birds at St. Catherine's, Isle of Wight, and at several other lighthouses on the English coast. It seems that the birds do not, as a rule, kill themselves by dashing against the lighthouse as was at first supposed, but by fluttering about it until they fall to the ground from sheer exhaustion. It has been found that if "bird-rests" or perches are arranged above and below the light as pictured here, the fluttering birds will find them, perch on them until morning, and then go on their way unharmed. The chief drawback seems to be the expense of installing the bird-rests, but with the vast number of friends which the birds now have in this country, this expense could hardly be prohibitive.

Market Gunning and Plume Hunting

As for market gunning and plume hunting, they are in many places already things of the past. Where they still exist, the writer believes that they should be done away with at once as professions detrimental to the best interests of the people. The men engaged in these pursuits often have valuable knowledge of the birds and their habits, and this knowledge may sometimes

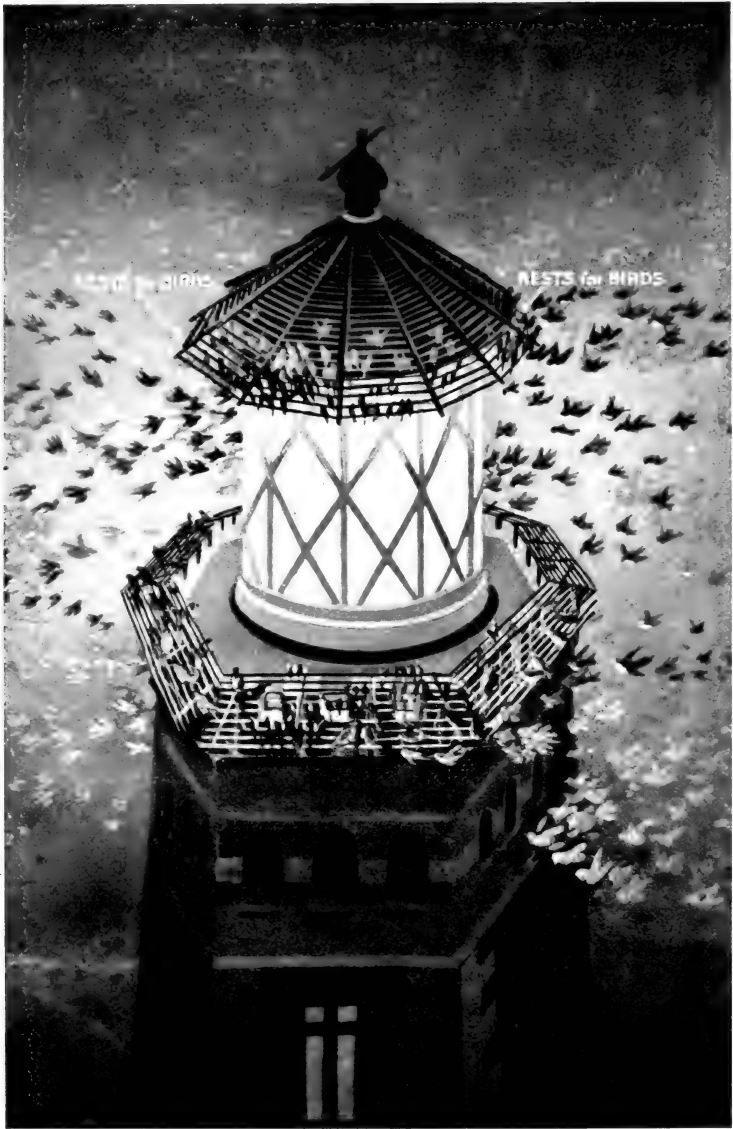

ST. CATHERINE'S LIGHTHOUSE, SHOWING BIRD-RESTS

be turned to good account. A reformed gunner, if honest, may make the best kind of a game warden.

Sportsmen

The term "sportsman" in its very best sense, is practically synonymous with "gentleman." Both stand for the spirit of fair play and decent conduct. With the true sportsman, therefore, we can find no fault; he takes no unfair advantage of the wild things whether the law permits him to or not; he prides himself on small bags rather than on large ones, and does not shoot at all when for any reason game is becoming scarce. He does his best to secure good game laws, and to see that they are enforced, and to encourage the establishment of game refuges and bird sanctuaries, public and private.

So-called Sportsmen

Unfortunately there is a large body of so-called sportsmen or perhaps we should say "self-styled" sportsmen, who constitute one of the most difficult problems with which the bird-protector has to contend. To be sure, some of them obey the letter of the law, but they lack the fine sensibilities of the gentleman, which

restrain the true sportsman when his reason and sense of justice tell him that a law is inadequate. They are often selfish and inconsiderate. How unfair it seems when we realize that if you and I own farms adjoining a third farm owned by one of these men, and if there are thirty quail on the three farms, he can take his gun and shoot, not only his ten, but your ten and my ten as well, in spite of our earnest protests. Surely we have as much right to our share of these birds alive as he has to his share dead, especially as the living quail are performing valuable service for the community, and are the ones from which future generations of quail would come. But we're not allowed to have them alive. If we want them at all, we must take a gun and kill them—and kill them soon—before our neighbor, the self-styled sportsman, can get them.

Looking at the matter from another standpoint, it is dishonest to cause our wild birds to diminish in numbers or to permit others to cause such diminution. In the wild birds, our ancestors have left us a valuable property, which, if we are honest, we shall pass on undiminished to the next generation. In the matter of game birds, we are perhaps entitled to the interest—that is, the increase, but not one bird more; we cannot

take more without literally stealing it from those who come after us—it is not ours to take. To concede that we have the right to take ever so small a percentage beyond the natural increase of any species, means the extermination of that species, and any schoolboy with a pencil and paper can prove it.

The passage of the famous federal migratory bird law is already bringing relief to many of the harassed birds, and its good effect will be greatly increased when we secure a treaty with Great Britain providing for the protection of all birds that migrate between the United States and Canada.

In addition, we should see to it that closed seasons are provided for all game birds in any given locality, that are not more than holding their own, and for other game birds open seasons short enough and bag limits small enough to absolutely prevent the decrease of those birds by shooting.

Ignorant Foreigners

In order to deal most effectively with the ignorant foreigners, we should first, by setting a good example, show them the love we have for our native birds. We must let them know by notices printed in their own languages, that we

have laws which protect our birds, and that there are penalties for the breaking of these laws. Then, usually, there is in every colony of foreigners, at least one man of some influence who has been here longer than the rest, who is better educated, speaks English, and who is looked up to as a counsellor and friend by his fellow-countrymen. It is often wise to ask the coöperation of this man, who should be glad to work with us to prevent his friends from getting themselves into serious trouble through the violation of our laws. The editors of papers which circulate among these people should always be willing to help, and all contractors employing foreigners, should, by the terms of their contracts or otherwise, be made responsible for the safety of the birds in the localities where their men are working. Illustrated lectures on the protection of birds, if really convincing, are apt to do a lot of good. Some time ago the writer tried the experiment of giving a lecture before the members of a colony of Italian workmen and their wives and children. The lecture was given in English, of which the audience knew little or nothing, but by a logical series of pictures, accompanied by gestures and changes in the tone of the voice, they were made to follow the speaker with intelligent interest, which was manifested by

their earnest and animated conversations during and after the lecture. The members of that audience had been especially active in the killing of birds, but their American instructors believe that the lecture has had a markedly good effect upon them. The worst offender in the audience came to his teacher next morning and volunteered the promise that he would never kill another bird.

Ignorant Whites and Negroes in the South

The problem of the ignorant whites and negroes of the south, is of course a serious one, but by no means unsolvable. The closing of the markets for the sale of birds will do much to discourage the slaughter which has characterized many of the southern states. A stiff gun license would save the birds from an army of tattered pot-hunters who now rake the fields and woods, and might be the means of making self-respecting citizens out of some of these shiftless, hand-to-mouth people. But after all, it will be the education of the rising generation which will have the most lasting effect. Teachers both white and colored can perform a valuable service to their country by fixing in the minds of their pupils the importance of protecting our birds. Mr. E. A. Quarles, an officer in the

American Game Protective and Propagation Association, himself a southerner, speaks most highly of the teachers in the southern schools, and especially of the colored teachers. And colored people should be encouraged to have their own bird clubs. Colored boys and girls can be taught to make nesting boxes and bird baths and to plant trees and shrubs, and after they become interested in this sort of work the desire to kill will occupy smaller and smaller space in their hearts.

And the churches, not only in the south, but all over the country, might fittingly take a part in this much needed work. I would suggest the observance of what might be called "Bird Sunday," on which the attention of every congregation in the country might be called to the beauty and usefulness of birds and the importance of protecting them. I know of no more beautiful or more fitting theme for a sermon. The ministers in my own village have already promised to preach on this subject and, if their example is widely followed, I believe that very great good will come of it.

Miners, Lumbermen, etc.

There seems to be no legitimate reason why the employees of mining and lumber camps

should be permitted to live on the wild birds about them, any more than they should be allowed to live on the crops and herds on the nearby farms if there are any. In the old days when there were no railroads and when game was very plentiful, it was of course perfectly right for pioneers of all kinds to live as best they could, and to take the food which nature provided. But now camps are too numerous to justify the men in living off the country; and the game is not sufficiently abundant to stand it. Moreover, there are now ample markets for the purchase of provisions of all kinds and in most places ample means of transporting these provisions. Save in very rare cases the feeding of the men is a problem to be solved by the men themselves or by their employer, and they should not be allowed to solve it by stripping the country of game, only a very small part of which may be said to belong to them.

How Farmers Can Help

And the farmers, who more than any other one class perhaps are directly benefited by the birds should help with the work of protecting them. They might begin by studying the birds, at least enough to enable them to know their friends from their enemies. For instance, every

farmer should be able to distinguish the two or three destructive hawks from all other hawks, and forbid the shooting of any but the destructive kinds. In their own interest they should oppose all legislation providing for a bounty on hawks and owls. In 1885 the Legislature of Pennsylvania passed what was known as "The Scalp Act," which was supposed to be in the interest of the farmers, and which provided for a bounty of fifty cents on each hawk, owl, weasel, and mink killed within the limits of the state. Dr. Clinton Hart Merriam, then Ornithologist and Mammalogist of the United States Department of Agriculture, in his report to the Department, estimated that to save a loss of possibly \$1875 a year through the destruction of poultry, the state of Pennsylvania had in a year and a half paid \$90,000. He further reported that this money had been paid for the destruction of 128,571 benefactors, worth at least \$3,857,130 to the agricultural interests of the state. In other words that the state had for a year and a half been throwing away \$2105 for every dollar saved.

The Small Boy

Somehow I can never become very much worried over the question of the small boy with

his air gun and sling shot. I know he does a lot of harm, but as a rule he isn't pigheaded, and as soon as someone he believes in will take the trouble to explain the situation to him, he'll turn right round and become a bird protector of a very useful kind. The harm he does is usually the fault of the people who have brought him up. He may or may not have been told not to kill birds. It's altogether too easy to tell boys not to do things; that's why so many people do it. It's much harder to give them good convincing reasons, and then offer a satisfactory substitute for the thing forbidden. A healthy, normal boy is active in mind and body, and he must have an outlet for both kinds of activity. He'd much sooner have a live bird perched on his hand than a dead one in his pocket, but unless his parents or guardians will take the trouble to teach him how to get the live bird, he'll probably take a gun and come back with a dead one. Get him an interesting bird book or two and let him learn something about the birds. Take him to an illustrated lecture on birds occasionally. When possible, arrange to have him meet the man who wrote the book and the man who gave the lecture; it will give him a feeling of confidence to know men who are interested in what he is doing or wants to do for

the birds. Both the writer and the lecturer may be far too busy to talk to a man, but if they're of the right kind, they'll seldom be too busy to say just a few words of encouragement to a boy or to answer one or two of his questions if they can. But there is nothing like active work for the birds to give the boy real enthusiasm. Encourage him to feed the birds, to give them water, and to put up nesting boxes for them, and when the birds have become sufficiently tame, let him photograph them, that he may be able to show the results of his good work and thus encourage others to do similar work. If there is a bird club in town, let him join it; if there isn't, organize one, or better still, help him to organize it.

I am proud to say that I have many friends among the boys, and most of them are loyal friends of the birds also. One of them, a Boston lad of thirteen, has organized two bird clubs, issues a monthly paper on birds and the care of them, and recently gave a talk which led to the establishment of a bird sanctuary. Let all grown-up bird lovers remember one of the best things Judge Ben Lindsey ever said: "Who stands in the presence of a boy whose confidence he has gained, stands in the presence of a great opportunity."

And there are few, if any, of these remarks concerning boys which do not apply equally well to girls.

A Word as to Scientists

As for scientific collectors, the writer believes that they should be allowed to go about their work unhampered by petty restrictions. Compared with other gunners they shoot few birds and these are generally made good use of. The complaint that scientific men do not do their share in the work of wild life conservation, is generally unfair. It is usually the cry of some conservationist who wishes he were scientific but is not, who wishes to attract attention to his own work by belittling that of others, or who does not appreciate the fact that the work he himself is doing is based largely on the work of the scientist. The latter during years of patient research has worked out convincing facts which the unscientific conservationist often dashes off in a few conventional sentences without half realizing the enormous amount of effort they represent. For example, one of the strongest arguments in favor of preserving birds, is that they have great economic value; the facts which support this argument have been ascertained, not by the men who shout them from the house-

tops but by quiet, modest ornithologists, who sit in their laboratories and whose names are seldom seen in the newspapers. Other men, "on the firing line," do wonderfully effective work for the cause of wild life conservation, but sometimes they do not seem to realize that this work is made possible, not so much by the noise of their own big guns, as by the ammunition supplied to them by the scientific men who work without making any noise at all. There are literally thousands of splendid men and women working for the protection of our wild birds and there will soon be many thousands more, and they should know that the backbone of this bird conservation movement is made up chiefly of the scientific members of the American Ornithologists' Union, some of whom founded the original Audubon Society, and who by patient, unselfish toil through many years have laid the foundation for the equally important but far more spectacular work being done by others who are oftener in the public eye.

CHAPTER XII

BIRD CLUBS AND HOW TO ORGANIZE THEM

AND now, "gentle reader," as the old-time ornithologists would have put it, if the foregoing chapters have convinced you that birds need protection, that it is worth our while to give it to them, and that there are ways in which all of us can help to give it to them, are you willing to do your share,—to do your duty in a great campaign in which the help of every man, woman, and child is needed? Perhaps you are already doing it along the lines which promise the maximum amount of good to be realized from your efforts. If so, I will simply say, "Go ahead, and good luck to you." But if not, let me suggest that I know of no way in which the average person can be so helpful to the cause of bird protection as through membership in an active local bird club. Whether it is desired to help in work for the benefit of the local birds, or in the passage of a great federal law for bird conservation, you will be in a stronger position

if you have a good club behind you than you would be alone.

It is the writer's belief that there should be a bird club in every village, town, and city in the country. In the larger cities, perhaps, there should be more than one, and these might unite in providing for our native birds in the public parks and gardens. Similar clubs should be started in colleges, private schools and academies, and where possible in the public school as well. Such a club was started a few years ago at Fay School, in Southborough, Massachusetts, and the result has been most interesting. The boys are reorganized at the beginning of each school year, and they do enthusiastic, faithful work for the birds not only while at school but during the vacations. The writer recently organized a similar club for the girls at Ferry Hall, Lake Forest, Illinois. If each school will do its small share, in ten years we shall have a race of men and women who will know their duty to our wild birds and how to perform it.

The organization of a school bird club is a very simple matter and may safely be left to any enthusiastic instructor. If the latter has had no experience, however, the rest of this chapter, devoted to the organization of clubs of



"RAISING THE MARTIN HOUSE." CHARLESTOWN BIRD CLUB



A PART OF THE CORN FIELD BIRD CLUB OF CORNISH

somewhat wider scope, may contain some helpful suggestions.

Some readers may ask, "Why is it necessary to organize a bird club? Why cannot each person help the birds as much as he or she likes without going to the trouble of calling and attending meetings, and to the expense of paying dues?" I would say that just as the United States is stronger and better than a lot of separate and independent states would be, so in a small way a bird club is stronger and better than a number of independent bird lovers. No matter how hard a particular person in a town may have worked for the birds, when he joins a bird club and compares notes with his fellow-members at a club meeting, he is sure to find that some of them have good ideas or suggestions which had not occurred to him and which he can make use of, while he, in turn, is sure to have had experiences which none of the other members have had and which they will be very glad to profit by. In this way each member, instead of having just his own ideas to help him, will have the ideas of everybody in the club. Then, there will be certain desirable things like the posting of land against gunners, the protecting of property against fire, the establishment of a public bird sanctuary, the passing of a law or

ordinance for the protection of the birds, or the starting of bird work among the school-children, which might be quite difficult for an individual to do, but which would be simple enough for a club.

Let there be no doubt in your mind about the desirability of organizing a bird club in your town if there is not one there already. It is the duty of every community to care for its own birds, and it will be difficult indeed to perform this duty unless the citizens organize for the purpose. Who should start the ball rolling? Why you, the reader, of course, and I'm going to tell you exactly how to do it. Don't let anyone dissuade you by telling you how hard it will be or that you can't do it. You can do it, and it's the people who can and will do things who really count in the world. The person who organizes a bird club in his or her own town or village is a public benefactor, and the neighbors will recognize that fact sooner or later. So start as soon as possible and make up your mind to succeed. This is the way to go about it:

Call on some of your friends who are fond of birds and tell them what you propose to do. The more intelligent your friends are the more likely they are to encourage and help you, so go to the most intelligent friends you have.

Tell them that you are about to organize a local bird club and ask their kind advice and assistance. Listen carefully to all advice given by older people or by those who have had more experience than you have had, but if there is no bird club in your town *let no one dissuade you from organizing one.* You have a great opportunity; don't let it pass.

With the assistance of your friends, few or many as the case may be, prepare to call a meeting for the purpose of organizing the club. Arrange to have the meeting held in some convenient place; if possible one likely to prove acceptable to almost everybody in the community. If you have a town hall, that may be the best place; the public library may have a suitable hall, or the Board of Education will probably be glad to allow you to use a school assembly room. A church makes a very satisfactory meeting place in a town where the people are broad-minded and where a large number will not refuse to attend simply because they don't belong to that church. It makes little difference where the meeting is held, provided only that the right spirit prevails. For example:

The Meriden (N. H.) Bird Club was organized in the chapel of the local Academy; the Alma (Michigan) Bird Club, in the High

School auditorium; the Hanover (N. H.) Bird Club, in one of the Dartmouth College buildings; the Brush Hill Bird Club of Milton, Massachusetts, in a private house; the Walpole (N. H.) Bird Club, in the Public Library; the Wyncote (Pa.) Bird Club, in a church; the Rhinebeck, (N. Y.) Bird Club in the Town Hall, and the Woodcrafters Bird Club of Culver, Indiana, was organized out of doors in the woods.

Having decided on the place of meeting, the next thing to do is to select a date that will be satisfactory to most of the people. Care should be taken not to conflict with regular prayer meetings or more than necessary with entertainments likely to draw heavily on the people who would otherwise probably attend your gathering. The date should be set far enough in advance to allow for advertising and to enable people with many engagements to arrange to come.

The next thing to do is to secure one or more speakers who can be depended upon to arouse enthusiasm in your cause. If possible arrange to have an illustrated lecture by some man who has had experience with bird clubs and who can show by means of lantern slides the success and pleasure that await the members of a club organized along the lines you will suggest.

That will win half your battle for you. Your state ornithologist may be just the man; if not, he may be able to suggest someone. If not, write to the Secretary of the Meriden Bird Club, at Meriden, New Hampshire, whose business it is to give information on such matters. In addition to the principal speaker you should have one or two good local men who are in sympathy with your plans and in whom the people of your town have confidence. A few words from them, backing you up, will have a very good effect, showing that you are not the only person in the town who desires to have a bird club.

Now for the advertising of your meeting, and this is very important. No matter how splendid a message you may have for the people, it counts for nothing if they don't hear it. A notice of the meeting and its purpose should be posted in several conspicuous places, and if there is a local paper you will find that the editor will be glad to help you by printing items about what you propose to do. Perhaps he will go as far as to print an editorial, setting his stamp of approval on your efforts. In these public notices be sure that the invitation is general. The birds belong to everybody, and everybody should have a hand in protecting them. Here is a ground where everybody in your town, good

and bad, rich and poor, Christian, Pagan, Gentile, and Jew may meet in a common cause, and if you can get them to do it, it will not only help to make your bird club a success, but it will make for friendly feeling throughout the town.

There will be a few busy people whom it will be especially desirable to have present—people who by reason of their standing can greatly help you if they will. Among these may be the Superintendent of Schools and the teachers, the ministers, the lawyers, the doctors, and other professional people, all of whom should gladly aid so great a cause. It is worth while to make a special effort to have those people present and if possible a special invitation should be sent to each one of them, asking them to kindly make a point of coming.

Before the day set for the meeting, consult the principal bird lovers and prepare a "slate" of the people whom it is desirable to have for officers of the proposed club; it is much easier to do this at your leisure beforehand than to wait until the meeting is on and then try to think of suitable officers in a hurry. All other things being equal, try to have both men and women represented on your slate. Be sure to select people who have, in addition to an interest in birds, the ability and enthusiasm necessary to

carry the work of the club along in spite of the little obstacles and discouragements which are sure to arise. The list should be presented at the proper time by some responsible person.

You will need a chairman. Perhaps you can take the chair yourself; if not, perhaps the lecturer will act at the close of his address. At any rate the chairman should be a business-like person who understands your plan and is thoroughly in sympathy with it. He will explain in a general way the purpose of the meeting, and then call upon the other speakers in turn. After that the audience should be given an opportunity to ask questions and discuss them briefly, and then it will be well to proceed to the election of officers. In addition to these there should be a committee on constitution. The members of this may be either elected by those present or appointed by the president. In any case it should be the duty of this committee to draw up a constitution to be presented at the next meeting of the club. At the end of this chapter will be found the constitutions of two successful bird clubs; from one or both of these your committee may at least get some suggestions. The first one given, modified to suit local conditions, is already being used by a great many bird clubs.

A word as to dues. You will see in the sample constitutions that the dues for active membership are made quite low. You will find it a good plan to have the dues for at least one form of membership made very low in order that no one may be barred from your club because he can't afford to belong to it. By having other forms of membership with comparatively larger dues, you give generous people with plenty of money an opportunity to befriend the club to almost any extent. Be sure to have a junior membership for the children.

It makes little difference what time of year a bird club is organized; there is always plenty of work to be done for the birds. In the spring there are bird houses to put up, bird baths to get ready, and the planting of crops and of trees and shrubs and creepers which are attractive to birds. In the summer, there are bird baths to put out and bird houses to make; in the fall, more bird houses to put out and preparations to be made for winter feeding; while in winter the work of feeding the birds alone will afford plenty of activity for the club and its members. The details of such work are given in other parts of this book. In addition to this active work for the birds, all sorts of things may be done to interest the members, to promote

the study of birds and advance the cause of bird protection.

Many of the boys and girls are sure to wish to make nest boxes and food houses, and in some cases the club will be able to follow the example of the Cornfield Bird Club of Cornish, N. H., and employ a manual training teacher. But unless this teacher has a first-hand knowledge of birds he should not be asked to furnish the designs for these appliances; he should be required merely to superintend the manufacture of them from plans obtained by some authority on the subject. This is very important, as improperly constructed nest boxes and food shelters are often worse than none, for they fail to attract the birds and thus disappoint and discourage people who might otherwise become bird protectors. The Charlestown (N. H.) Bird Club does not employ a teacher but distributes among its members cardboard patterns from which nest boxes may be made.

The Walpole Bird Club of Walpole, N. H., has had great success with what it calls "Bird Socials." These are generally held in the fall and winter months and the junior members are invited to meet in some suitable hall or large room under the leadership of older members. The entertainment takes various forms. Some-

times there is a contest to see who can identify the greatest number of birds from colored pictures held up one at a time. The young people are provided with pencils and paper and without consulting one another write down the names of the birds as they are shown. At other times the juniors are given instructions in tying suet to branches brought to the meeting on purpose, and then after experimenting indoors every member is provided with a generous lump of suet and some string and the whole party goes out doors to put into practice what they have learned.

The Brookline (Mass.) Bird Club has a paid instructor who helps the members to plan all sorts of activities and at different times escorts the children and adult members on bird walks and aids them in identifying birds with which they are not familiar. The Brush Hill Bird Club of Milton, Mass., distinguished itself some time ago by holding an exhibition of nest boxes, food houses, bird baths, and other similar appliances and the Arnold Arboretum coöperated by loaning a collection of shrubs, creepers, and other plants which are especially attractive to birds.

The Claremont (N. H.) Bird Club has been interested in outlining a graded course of bird



TRAMPLING SNOW TO MAKE A FEEDING STATION



CITIZENS OF MERIDEN GIVING THE BIRDS A DAY'S WORK

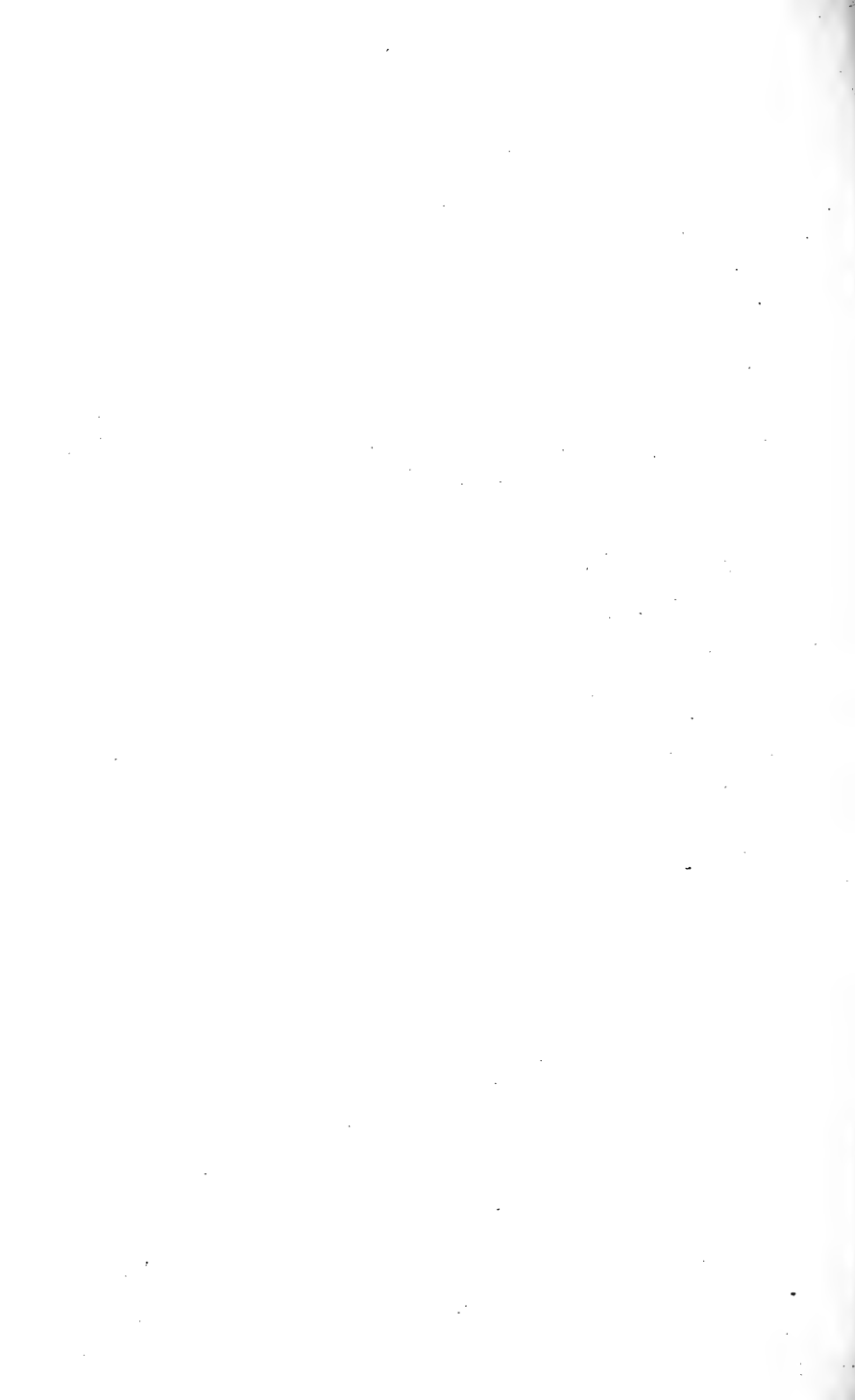

study which has been adopted by the local public schools.

The Meriden (N. H.) Bird Club, of which the author is General Manager, has many activities. First of all it is active in the organization of other bird clubs, and is responsible for the existence of scores of such clubs in different parts of the country. It has members scattered over about thirty different states and to each member is sent every year a beautifully illustrated report telling what the club has been doing, and giving instructions for the carrying on of similar work in other parts of the country. Then, the Meriden Bird Club has an old farm of thirty-two acres, the gift of Helen Woodruff Smith, which it has converted into a bird sanctuary. Here all native birds are provided with food in winter, with water in summer, and with many nesting boxes at all seasons. It was for the dedication of this preserve that Percy Mackaye wrote his famous *Bird Masque Sanctuary* which has since been played before many bird clubs, and which has already resulted in the establishment of several bird sanctuaries.

And speaking of bird sanctuaries, the writer believes that it is a matter of much importance that great numbers of these be established all

over the country. He thinks it might be well for practically every bird club to include among its objects, "the establishment of a bird sanctuary." It would not be necessary in every case to spend a lot of money for special devices to attract the birds; the main thing would be to secure a piece of property, large or small as the case might be, which should be set aside as a refuge; a place where birds would be safe from all their enemies, man included. Care should be taken, when possible, to select a piece of land attractive to a large variety of birds. An almost ideal place would contain some old forest with both evergreen and deciduous trees and plenty of undergrowth; some old pasture land overgrown with tangles of berry-bearing shrubs and creepers; a grassy meadow, an old orchard, a patch of swamp, a pond, and a good-sized stream. It would seldom be possible to get all these features on one place, but it would often be possible to get several of them. If nest boxes and other devices could be supplied later, so much the better, but the mere posting of it, and the freeing of it from bird enemies would be a fine thing for the local birds and would tend to give permanent value to the club. Then, of course, private individuals, whenever practicable, should make sanctuaries of their

own estates. This has already been done in many places. One of the most successful is that of Mr. Frederick C. Walcott, at Norfolk, Connecticut. Here is a four thousand-acre tract of typical New England country, with four ponds—two natural and two artificial ones—dedicated to the cause of bird protection only three years ago at this writing and now literally alive with birds at certain seasons. Not only the land birds but the waterfowl also have found it a haven of refuge. To use a bit of Mr. Walcott's own description:—"Between two and three thousand black ducks drop into the home pond each fall and remain until late December before going farther south; and each fall and spring, from forty to fifty wild Canada geese stay with our geese several days, for food." A further description of this and other more or less similar sanctuaries may be found in Mr. Walcott's chapter on "Private Game Preserves" in Dr. William T. Hornaday's book, *Wild Life Conservation in Theory and Practice*.

The following letter from John B. Burnham, President of the American Game Protective and Propagation Association, is very valuable as showing how a state legislature has set an example in making easy the establishment of bird sanctuaries.

“DEAR MR. BAYNES:

“Legislation has been enacted in the State of New York giving bird protectionists a splendid framework upon which to act for the creation of bird sanctuaries. It seems to me that the principles embodied in this legislation might well be copied in other states because there are altogether too few states in the country today where the plan has received legislative sanction.

“The new law permits the Conservation Commission to set aside any lands owned by the state, outside of the Adirondack and Catskill parks, as sanctuaries. It also empowers the Commission to purchase lands or the shooting and fishing rights for the purpose of creating sanctuaries and it puts such lands under the protection of the Conservation Commission.

“Another section of the Conservation Law, amended to its present form in 1913, provides for the creation of sanctuaries where private individuals desire to dedicate their lands for such a purpose and in this instance also the obligation to protect the land against trespass by law violators is placed upon the Conservation Commission.

“By the enactment of these laws it will be seen that provision is made for the establish-

ment of sanctuaries in a flexible and comprehensive way. The sanctuaries are intended for both game and game bird protection and also for the protection of song and insectivorous birds. In its practical application from the latter standpoint, splendid opportunities are open to individuals and bird clubs all over the state to secure the needed protection for their feathered friends. The state has many old farms as its property scattered in almost every county. A list of these is published by the State Comptroller in book form. These lands were acquired by tax sale, escheat, by foreclosure of mortgage, given by the United States Loan Commissioners, and in other ways.

“Suppose there was a bird club located in the town of Hillsdale, Columbia County. By consulting the Comptroller’s list, they would find that the state owned the old Dutcher farm of one hundred and twenty acres in that town, and running parallel into the town of Austerlitz. The club would appoint a committee to investigate the farm from the standpoint of its availability for a bird sanctuary. Armed with the facts they could send a concise description of the property to the Conservation Commission with the request that it be dedicated as a sanctuary under the provisions of Section 366 of

the Conservation Law. The Commission would then pass upon the petition and I have no doubt give it favorable attention and probably set it aside as a bird and game refuge and post it against all shooting and put it in charge of the nearest state game protector to see that there was no poaching or trespassing upon the property.

“It would then be up to the bird club to see that the tract was made a really effective sanctuary. From their funds they could provide for the proper care of the tract and I am sure that the Conservation Commission would be glad to give them the necessary privileges. Bird boxes could be erected for nesting places and feeding stations installed for the winter care of the birds and arrangements made for discouraging the attacks of cats or other predatory animals and birds.

“I see on reading over the section that no provision has been made for trapping vermin in this section. The law should be amended to give this privilege under proper regulations.

“While such tracts are available in many sections of the state, there are places, of course, having bird clubs, where state land is not available. Here two methods for securing sanctuaries are possible under the existing law. By one

of these the commission may be petitioned to buy a certain tract or to buy the shooting and fishing rights on the tract. This, of course, would require an appropriation by the legislature and it would be necessary for the bird club, first, to secure the approval of the Commission for the project and then from a practical standpoint to follow it up by appearing before the proper legislative committees.

“On the other hand, it is a very simple matter to find some landowner who is willing to dedicate his private land for the purpose of a sanctuary. To secure a legal dedication of this land it is necessary, under Section 153 of the Conservation Law, to procure from the Conservation Commission, two blanks which have been printed for this purpose. One of these, known as Form 36, is headed ‘Dedication of Land for Game and Bird Refuge.’ This is in the form of a petition to the town board of the town in which the land is located. It contains a simple description of the land, with the request that it be set aside by the Conservation Commission for a game and bird refuge for a period not exceeding ten years. Of course, the dedication can be renewed at the expiration of this period. The petition is signed by the owner of the land.

“The other form is Form 37, and is headed

'Resolution for Game and Bird Refuge.' This resolution is a request by a majority of the town board to set aside the land specified in the original petition as a game and bird refuge. It can either be passed at a meeting of the town board or signed by a majority of the board, which includes the supervisor, two justices of the peace, and the town clerk. There has never, so far as the writer's experience goes, been any difficulty in securing the signatures of a majority of the town board to such a petition and the method has the practical advantage of enlisting the town officers in the sanctuary project. After Form 37 is signed it is sent to the Conservation Commission for ratification and the petitioners may feel certain that it will be favorably acted upon.

"Under these various provisions of the New York Law there is not a town in the state of New York which cannot have its bird sanctuary. All that is necessary is a little educational work to arouse interest, the formation of a club to insure the proper care of the sanctuary and afterwards faithfully sustained work. The reward will be, to the workers, knowledge of work well done, and to the community a marked increase in the number of birds, with the result and effect of better crops on farms and in gardens, fewer diseased and dead trees in the

woodlands, and greater productiveness of apple orchards as well as the joy which comes from the beauty of color and form and song of the birds.

“Yours very truly,
“ (Signed) JOHN B. BURNHAM,
“ *President.*”

That the state of Minnesota is alive to the importance of this work is evidenced by the creation of the Minnetonka Game Refuge, where the birds are absolutely protected on a tract of over 55,000 acres adjacent to the city of Minneapolis.

Federal sanctuaries are also of the utmost importance and no one appreciated this fact more strongly than President Roosevelt, who during his administration, turned from other important matters long enough to create over fifty national refuges for wild birds.

But to return to New Hampshire. Other activities of the Meriden Bird Club consist in the placing of bird charts in the local schools, in the Academy, and in the summer hotel; in starting a library of bird books; in conducting a column of bird notes in the local paper; in offering prizes for the best essays on methods of attracting birds, and for photographs illustrating

the methods. This club also conducts debates on such subjects as, "Resolved, that the insect-eating birds are more beneficial than the seed-eating birds," and "Resolved, that the birds of prey are more beneficial than the insect-eating birds," and "Resolved, that the seed-eating birds are more beneficial than the birds of prey." The debating of these and similar subjects is of the greatest importance to the cause of bird protection.

I know of no better or stronger way to present the facts to the farmers, than to have these interesting and vital questions debated in the schools and academies where the farmers may come to hear. There are thousands of people who may not care to read a pile of government reports who will gladly sit for an hour and witness a live contest between young people whom they know, and who have the gist of those reports at their fingers' ends and can present it in a concise, interesting, and effective manner. It is the writer's opinion that the debating of these subjects should be encouraged in every grammar school, high school, academy, and private school in the country, and that if interscholastic debates could be brought about, so much the better. No end of material for such debates has been collected in recent years, and is



THE RIGHT KIND OF FEATHERS FOR A HAT

available in the form of bulletins issued by the federal and state departments of agriculture, respectively, leaflets published by the Audubon Societies and books written by specialists.

A very important piece of work recently suggested by Mr. H. W. Henshaw, Chief of the Bureau of Biological Survey at Washington, should also interest all bird clubs looking for new outlets for their enthusiasm. It consists of making bird censuses during the nesting season, in order to find out how many pairs of the different species of birds breed within definite areas. Mr. Henshaw suggests three different kinds of censuses. To make the first and most important, which we will call Census A, it is suggested that you select an area not less than forty acres and not more than eighty acres, representing fairly average farm conditions, including farm buildings, shade trees, orchards, plowed land, and pasture or meadow, but without woodland. The second census, which we will refer to as B, would be made on an isolated piece of woodland ten to twenty acres in extent, situated conveniently near the first tract, and the third census desired, which we will call C, is that of some definite area of woodland, forty acres perhaps, forming part of a much larger tract of timber, either deciduous

or evergreen. Each area should be selected with a view to making a yearly census of it and for that reason it would be best to select an area not likely to change very much for several years at least. Otherwise, when there were found to be changes in the bird population, it would be difficult to tell if these changes were due to an increase or decrease in the number of birds or simply to changed conditions in that particular neighborhood.

The height of the breeding season is the time to make these bird censuses, because the spring migration is over, the fall migration has not begun, so that the birds which you see in any locality are all likely to be birds which belong to that locality and which have their homes there. At Washington, D. C., latitude 39 degrees, the 30th of May is about the time to begin; farther south one should begin a little earlier, and farther north somewhat later of course. In the latitude of Boston, the 7th or 8th of June would be about right, while in Maine the middle of that month would be early enough.

The plan recommended by Mr. Henshaw and which has proved very successful for several years, is to begin at daylight and zig-zag back and forth across the whole area, counting the male birds, which at this hour and season should

be in full song and easily observed. After the birds have settled in their summer quarters, each adult male may safely be taken to represent a breeding pair. No bird should be counted unless he is actually within the boundaries of the area, no matter how near the boundary he may be. The census of the first day should not be taken as final. It should be checked by several days of further observation to make sure that each bird counted was actually nesting within the area, and also to make sure that no species has been overlooked. The census should be sent to the Chief of the Bureau of Biological Survey, Washington, D. C., about the 30th of June, and with it should go such a careful statement of the exact boundaries of the area selected that it would be possible twenty-five years hence to go right to the place, cover exactly the same ground, and repeat the census. The name and address of the owner of the property should also be given in every instance.

In the case of Census A, the observer should send, in addition, a careful description of the character of the land, tell whether the area is dry upland or swampy bottom land. He should give the number of acres in each of the principal crops,—in permanent meadow, pasture, orchard, swamp, and road and whether there are streams

or ponds on the place. He should also tell the kinds of fencing used, and whether there is much or little brush along the fences, roads, or streams, or in the permanent pasture.

In making Census B or C, the person making it should, in addition to giving the size and exact boundaries of the wooded tract, name the principal kinds of trees and state whether there is much or little undergrowth.

The making of one or more such censuses will not only be a very interesting and helpful bit of work for the person making it, but will furnish definite information concerning the bird life of the region, and give a basis for comparison when in future years the Government wishes to find out whether the laws made for the protection of birds are effective or not.

And before saying farewell to this subject, I must mention still another bird census which every bird club in the country should take part in. Several years ago Mr. Frank M. Chapman, editor of that splendid little magazine, *Bird Lore*, started a winter bird census to be taken on Christmas Day with a view to showing in a general way how the birds are distributed at this season. This is a very interesting and instructive census; it not only gives a very good idea of the comparative abundance of the permanent

residents and regular winter visitants in different parts of the country, but forms a record of those occasional flights of crossbills, redpolls, pine grosbeaks, and other birds which in many places are seen but once in several years. The plan adopted in taking this census is very simple. It consists of going out for a walk at any time on Christmas Day, and jotting down in a note-book the kinds of birds we have seen and the number of individuals of each kind. We should also jot down the time we started, the time we returned, whether the day was clear, cloudy, or snowy, the direction and strength of the wind, and the temperature. We should write the census very plainly and mail it that very night, if possible, to the Editor of *Bird Lore*, American Museum of Natural History, New York City. As there will be scores of other bird students sending in lists, it is necessary, in order not to overburden the busy editor, to make out our list exactly as he asks us to. Then it can be published in the next issue of *Bird Lore* just as we send it in. A census from my own village, for instance, should read about like this:

Meriden, N. H.

Time, 8.30 A.M. to 12.45 P.M. Clear; wind, northwest, very light; temperature, 15 degrees.

Screech owl, 1; hairy woodpecker, 2; downy woodpecker, 1; blue jay, 8; redpolls, 100; white-breasted nuthatch, 3; chickadee, 10; golden-crowned kinglet, 4. Total, 9 species, 134 individuals.

ERNEST L. HUSE.

No doubt many other lines of activity will occur to you and your fellow members from time to time, but perhaps I have given enough suggestions to show that there is plenty of interesting and much-needed work for every bird club that wishes to do its share in the world-wide campaign for the protection of birds.

As your interest grows you will wish to know what is being done by other organizations working along similar lines. Get in touch with the Meriden Bird Club at Meriden, N. H., which started the bird-club movement on the lines suggested above. It publishes a beautifully illustrated annual report giving the results of all sorts of interesting experiments in feeding birds and providing homes for them.

If you are especially interested in game-bird protection, write to the American Game Protective and Propagation Association, which has headquarters at 233 Broadway, New York.

If you have a State Audubon Society, look it

up and encourage it in any way you can. Make yourself familiar with the splendid work being done by the National Association of Audubon Societies whose office is at 1794 Broadway, New York. This organization, besides protecting the birds directly, is helping to educate the coming generation to a sense of its duty towards feathered creatures generally. The American Museum of Natural History and the New York Zoölogical Society, both of New York, are conducting equally noble campaigns of education, each along its own interesting and effective lines. These and many others are worthy of the best support which we can give them.

So many people ask where they may obtain current information concerning matters pertaining to bird protection, that it may not be out of place to mention the fact that the Bureau of Biological Survey, Washington, D. C., publishes each year a pamphlet called *Directory of Officials and Organizations Concerned with the Protection of Birds and Game*. This may be obtained free by writing to the Chief of the Bureau, and every bird club should have at least one copy for the use of its members. To keep in touch with the principal organizations listed here may be of mutual advantage. They can easily supply you with information which

might otherwise be hard for you to get, and you, in turn, can help them when they need support for good bills which they may be trying to have passed for the protection of birds. Law-makers will usually make laws if they are sure that enough people really want them, and if we want them we should let the law-makers know it.

In parting, the author hopes to be forgiven for his insistence if he urges the reader once more in the interest of American wild bird protection, to organize a bird club. ORGANIZE A BIRD CLUB!

“Gentles, if you have followed me,
Now is no need to say good-bye;
For we shall meet in revery
Wherever glad birds sing and fly—
Wherever sad birds bleed and dumbly die.”

MACKAYE.

APPENDIX

CONSTITUTION OF THE MERIDEN (N. H.) BIRD CLUB

ARTICLE I

NAME

The name of this organization shall be The Meriden Bird Club.

ARTICLE II

OBJECTS

The objects of this Club shall be the increase and protection of our local wild birds, the stimulation of interest in bird life, and the gradual establishment of a model bird sanctuary.

ARTICLE III

MEMBERSHIP

SEC. I. The membership of this Club shall consist of Associate Members, Active Members, Junior Members, Life Members, Patrons, and Benefactors.

SEC. 2. Any person in sympathy with the objects of this Club, whether a resident of the town or not, may become an Associate Member by paying the prescribed dues.

SEC. 3. Any resident of the town of Plainfield may become an Active Member of this Club on election by the Executive Committee and payment of the prescribed dues.

SEC. 4. Any child under fourteen years of age may become a Junior Member of this Club by payment of ten cents.

SEC. 5. Any person in sympathy with the objects of this Club may become a Life Member, Patron, or Benefactor upon payment of the prescribed fee and upon election by the Executive Committee.

SEC. 6. The dues of an Associate Member shall be one dollar, payable annually. The dues of an Active Member shall be fifty cents, payable annually. The fee of a Life Member shall be twenty-five dollars, payable at one time. The fee of a Patron shall be one hundred dollars payable at one time. The fee of a Benefactor shall be one thousand dollars.

SEC. 7. The voting power shall be limited to Active Members.

SEC. 8. A member may be expelled from the Club upon the written recommendation of any

officer, by the majority vote of the members of the Executive Committee present at any meeting, provided notice of such action with reasons therefor, be presented to the member and to the Executive Committee, at least one week before the meeting.

ARTICLE IV

GOVERNMENT

SEC. 1. The governing body of this Club shall consist of a Board of Directors of twelve persons, divided into two groups of six each. The tenure of office of the Directors shall be two years, but only six Directors' terms can expire by limitation in any one year. Therefore at each annual meeting of the Club six new members shall be elected by ballot of a majority of the members present, due notice having been given in advance to all members.

SEC. 2. The Board of Directors shall elect at its annual meeting, from its own members, by ballot and a majority vote, a President, four Vice-Presidents, a Secretary, a Treasurer and a General Manager.

SEC. 3. There shall also be an Executive Committee, to consist of the officers of the Club, as mentioned in Section 2, the President and

Secretary of the Senior Class of Kimball Union Academy, and ten persons to be chosen by the Board of Directors at its annual meeting.

SEC. 4. Vacancies occurring in the Board of Directors and Executive Committee may be filled by the President, or, in his absence, by the Executive Committee, to complete the year in which they occur.

SEC. 5. At the annual meeting a Nominating Committee, consisting of three members, shall be appointed by the presiding officer; its duty shall be to present a list of candidates to fill vacancies in the Board of Directors.

ARTICLE V

DUTIES OF OFFICERS

SEC. 1. The duties of officers shall be such as pertain to their respective offices in similar clubs. The President shall be ex-officio Chairman of the Board of Directors and of the Executive Committee.

SEC. 2. The Vice-Presidents shall perform the duties of the President in his absence, in the order of seniority of office.

SEC. 3. The Secretary shall record the proceedings of the Club, of its Board of Directors, and its Executive Committee, in books to be

kept for that purpose; shall have charge of the records of the Club and of its publications; shall conduct the correspondence of the Club, and keep a record thereof; shall inform members, Directors, and officers of their election, and shall give notice of all meetings, and inform Directors and officers of all matters requiring their attention.

SEC. 4. The Treasurer shall collect all bills and assessments due the Club; shall pay from the funds of the Club all bills duly approved by the President or the General Manager; shall send to the Secretary at least once a month, the names and addresses of all new members. He shall furnish, at the request of the Executive Committee, a statement of the financial condition of the Club.

SEC. 5. The General Manager shall have general oversight of all the activities planned by the Club for carrying on its work as indicated in Article 2.

ARTICLE VI

MEETINGS

SEC. 1. There shall be a regular meeting of the Club on the third Saturday of each month, and the third Saturday of September shall be the

date of the annual meeting. A printed notice of each regular meeting shall be posted in at least two conspicuous places in the village, seven days prior to each meeting.

SEC. 2. A notice of the annual meeting shall be mailed to each member not less than ten days prior to such meeting.

SEC. 3. A special meeting may be called at any time on three days' notice, by the President, by the General Manager, or on a written application signed by three members of the Executive Committee.

SEC. 4. Nine members shall constitute a quorum at any meeting of the Club.

SEC. 5. Meetings of the Executive Committee may be held at such times as may be appointed by the President, or in his absence, by the Secretary, and two days' notice of each meeting shall be given. Three members shall constitute a quorum.

SEC. 6. The order of business shall be as follows:

- Reading records of previous meeting.
- Reports of committees.
- Reading of communications.
- Election of members.
- Unfinished business.
- New business.

SEC. 7. Robert's manual shall be the authority for the decision of disputed questions of order and debate.

ARTICLE VII**AMENDMENTS**

Amendments or alterations of the Constitution may be made by a two-thirds vote of the members present at any meeting, provided written notice of the proposed change shall have been sent to every member of the Club not less than four days prior to said meeting

CONSTITUTION OF THE BRUSH HILL BIRD CLUB

ARTICLE I

NAME

This Club shall be known as the Brush Hill Bird Club.

ARTICLE II

PURPOSE

The purpose of this Club shall be to encourage protection of and interest in bird life in our community.

ARTICLE III

MEMBERSHIP

SECTION I. The membership in this Club shall consist of Active Membership, Active Family Membership, Associate Membership, Life Membership, Patrons, and Benefactors.

SECTION 2. Any resident of the Brush Hill-Blue Hill district of Milton may become an Active Member on payment of the prescribed dues.

SECTION 3. Any family residing in the Brush Hill-Blue Hill district of Milton may obtain a Family Membership on payment of the prescribed dues.

SECTION 4. Any non-resident in sympathy with the purpose of this Club may become an Associate Member on payment of the prescribed dues.

SECTION 5. Any person may become a Life Member on payment of the prescribed fee.

SECTION 6. Any person may become a Patron on payment of the prescribed fee.

SECTION 7. Any person may become a Benefactor on payment of the prescribed fee.

SECTION 8. The dues for Active Members shall be \$1, payable annually.

SECTION 9. The dues for Active Family Membership shall be \$5, payable annually.

SECTION 10. The dues for Associate Membership shall be \$1, payable annually.

SECTION 11. The fee for Life Membership shall be \$25.

SECTION 12. The fee for a Patron shall be \$100.

SECTION 13. The fee for a Benefactor shall be \$1000.

SECTION 14. The voting power shall be limited to active members.

ARTICLE IV

MEETINGS OF THE CLUB

Meetings shall be held at the discretion of the Executive Committee. The first meeting after September 1 shall be the business meeting at which the election of officers for the ensuing year shall be held.

ARTICLE V

GOVERNMENT

The officers of the Club shall consist of a President, Vice-President, Secretary, Treasurer, and General Manager. The officers of the Club shall constitute the Executive Committee, which Committee shall pass upon all business that is to be brought before the Club for action.

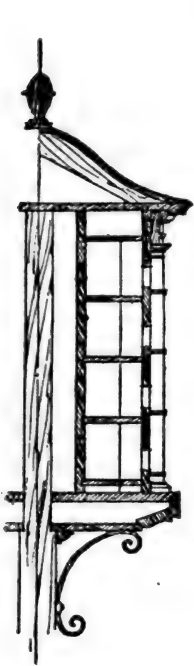

SECTION

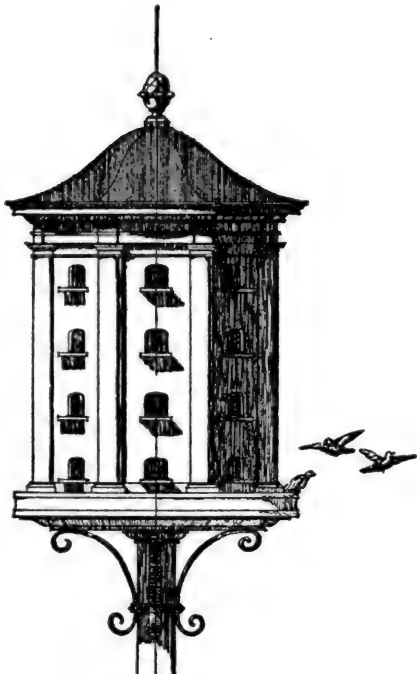

ELEVATION

SKETCH
for a
MARTIN HOUSE

Charles A. Platt
Architect

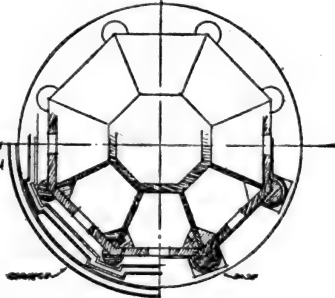

PLAN



ACKNOWLEDGMENTS

IN the preparation of this book the author has had much assistance—some direct from friends, some through the medium of books, pamphlets, and reports. To everyone who has given him any help, direct or indirect, he acknowledges his indebtedness and proffers his thanks, and to none more gratefully than to those scientific men in Washington and elsewhere, upon whose patient, accurate, but often unappreciated work, some of the strongest pleas for bird conservation are based.

By far the most important assistance which the writer received, was that given by his friend, Frederic H. Kennard, of Boston, landscape architect and ornithologist, whose peculiar combination of knowledge enabled him to contribute the sub-chapter on the trees, shrubs, and creepers which are attractive to birds (and in many cases to man, as well), quite the most unique and in many respects the most valuable part of the whole book.

Edward Howe Forbush, State Ornithologist for Massachusetts, has helped the author in many ways—by kindly advice on several occasions, by the contribution of photographs for illustrations, but most of all through his books—*Useful Birds and Their Protection* and *Game Birds, Wild Fowl, and Shore Birds*, two of the most useful bird books ever penned. When an unbiased history of American wild bird conservation is written, there will be few names which stand out with greater prominence than that of Edward Howe Forbush, who never pauses in his work to tell the world that it is he who is doing it.

The author is also indebted to Mr. E. A. Quarles, of Forest Hills, Long Island, for valuable suggestions and advice.

Others who have given direct assistance in one way or another are:

Mrs. Helen Foster Barnett, Mrs. E. H. Baynes, Professor S. A. Baldwin, William Brewster, Harold C. Bryant, John Burnham, Miss Millicent Bush, Walter M. Buswell, Hon. Fred. W. Chambers, André Champollion, Frank M. Chapman, Frank C. Clarke, Austin Corbin, Miss Annie H. Duncan, Miss Kate Percy Douglas, William Dutcher, George S. Edgell, George M. Fales, Waldo B. Fay, Dr. G. W. Field, Dr. A. K. Fisher,

Prof. P. B. Hadley, Ralph Hoffmann, Paul Howe, Dr. Ernest L. Huse, Dr. Frederick A. Lucas, Mrs. W. S. McCrea, S. R. Morse, Philip Orcutt, Edward L. Parker, Miss Marie Parker, C. H. Pease, Dr. Thomas S. Roberts, Hon. Theodore Roosevelt, James Savage, A. R. Shattuck, Mrs. Louis Saint-Gaudens, Miss Helen Woodruff Smith, Wilbur Smith, Miss Kate Stewart, Mrs. Ezra R. Thayer, Dr. Townsend W. Thorndike, Dr. Charles H. Townsend, Dr. Charles W. Townsend, William Lyman Underwood, Frederick C. Walcott, Mahonri Young.

PRINCIPAL BOOKS CONSULTED

Our Vanishing Wild Life. By DR. WILLIAM T. HORNADAY. A book which should be read by everyone interested in wild life conservation.

Methods of Attracting Wild Birds. By GILBERT H. TRAFTON.

How to Attract and Protect Wild Birds. By MARTIN HIESEMAN. An account of the wonderful and successful experiments of Baron Hans von Berlepsch.

Useful Birds and Their Protection. By EDWARD HOWE FORBUSH.

Game Birds, Wild Fowl, and Shore Birds. By EDWARD HOWE FORBUSH.

Nature Study and Life. By PROF. CLIFTON F. HODGE.

Birds in Their Relation to Man. By DR. CLARENCE M. WEED and DR. NED DEARBORN.

Wild Life Conservation in Theory and Practice. By DR. WILLIAM T. HORNADAY and FREDERICK C. WALCOTT.

Handbook of Birds of Eastern North America. By FRANK M. CHAPMAN. The best popular all-round bird book for the region it covers.

The Woodpeckers. By FANNY HARDY ECKSTORM.

Sanctuary. A Bird Masque. By PERCY MACKAYE. The first serious attempt to aid the cause of wild life conservation by means of the drama.

The Present Hour. By PERCY MACKAYE.

PRINCIPAL PAMPHLETS AND REPORTS CONSULTED

A Lapland Longspur Tragedy. By DR. THOMAS S. ROBERTS.

Report of the Buffalo Academy of Natural Sciences, 1908.

Coccidiosis in the English Sparrow. By PROF. PHILIP B. HADLEY.

The Cat—What Shall We Do with It? By M. S. and L. A. LACEY.

The Cat and the Transmission of Disease. By DR. C. A. OSBORNE.

- The English Sparrow as a Pest.* By NED DEARBORN.
- Birds of Laysan and the Leeward Islands.* By WALTER K. FISHER.
- Report of an Expedition to Laysan Island, 1911.*
By HOMER R. DILL and WILLIAM ALANSON BRYAN.
- Some Common Birds in Their Relation to Agriculture.* By F. E. L. BEAL.
- The Hawks and Owls of the United States.* By A. K. FISHER.
- Birds as Weed Destroyers.* By SYLVESTER D. JUDD.
- Food of Bobolinks, Blackbirds, and Grackles.* By F. E. L. BEAL.
- The Common Crow of the United States.* By WALTER B. BARROWS and E. A. SCHWARZ.
- A Determination of the Economic Status of the Western Meadow Lark (*Sturnella neglecta*) in California.* By HAROLD CHILD BRYANT.
- Birds in Relation to a Grasshopper Outbreak in California.* By HAROLD CHILD BRYANT.
- Bird Houses and How to Build Them.* By NED DEARBORN.

Parts of the book have appeared in *Bird Lore*, *The National Geographic Magazine*, *The Outlook*, *The American Museum Journal*, *Recrea-*

tion, Collier's Weekly, The Boston Evening Transcript, and The Boston Herald, and the author hereby expresses his appreciation of the courtesies extended to him by the editors of these publications.

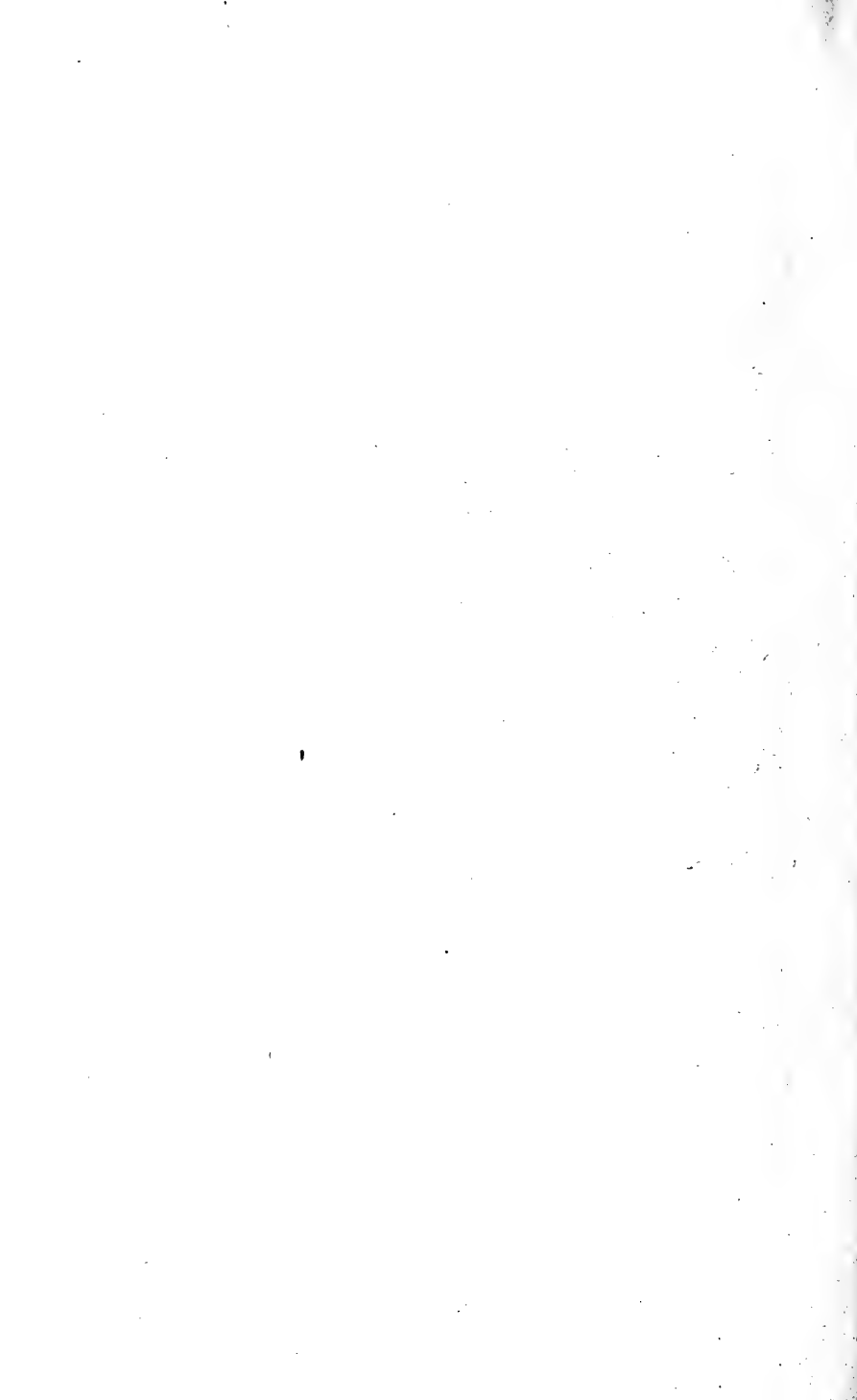

INDEX

A

Abt, Franz, 121
 Aigrettes, 55, 56
 Albatross, 57; black-footed, 58
 Alma (Michigan) Bird Club, 273
 American Game Protective and
 Propagation Association, 36,
 191, 283, 296
 American Museum of Natural
 History, 295
 Antilles, 87
 Arkansas, 103
 Arnold Arboretum, 182, 280
 Art, birds used in, 119, 120
 Audubon, 21, 27, 47
 Audubon Bird House Company,
 199
 Audubon Societies, National
 Association of, 123, 148, 199,
 217, 297
 Audubon Society, Connecticut,
 74
 Aughey, Professor Samuel, 89,
 90, 103
Auk, The, 12
 Auk, extinction of, 45
 Australia, Ballarat, 88

B

Bahamas, 87
 Ballarat, Australia, 88
 Barnett, Helen Foster, 231
 Barrows, Professor Walter B.,
 105
 Baths, bird, 128; construction of,
 221; dangers from cats, 229;
 depth of water, 222; descrip-
 tion of, 223; description of

one made by author, 227;
 footing, 227; list of birds
 making use of, 226; methods,
 230; necessity for, 219; plans,
 230
 Baynes, Mrs., 6, 7, 8, 128, 151
 Beal, Professor F. E. L., 83, 108,
 112
 Bears, harm done by, 24
 Beethoven, 120
 Beetles, predacious, destruction
 of, 85
 Berlepsch, Baron Hans von,
 152, 157, 193, 216; bird
 houses made by, 196, 198;
 nest box, 128
 Bermudas, 87
 Berries, winter food, 16
 Biological Laboratory at Kings-
 ton, Rhode Island, 18
Bird Craft, 74
 Bird-feeders, 134, 135
 Bird-feeding, danger from cats,
 146; in the home garden, 136;
 methods, 130, 142, 145; neces-
 sity, 131; plans, 130; seed-
 eating birds, 146; snowstorms,
 129; winter, 129, 131, 132,
 145, 146
 Bird-food, coal ashes, 141; de-
 scription of, 169; fruits, 169;
 general list for winter use,
 138-140; grit, 141; herbaceous
 plants, 190; hot, preparation
 of, 158, 159; mortar, 141;
 salt, 140; seeds, 90, 91, 137-
 140; suet, 138
Bird Lore, plan of census, 294
 Bird Masque, 281

- "Bird-minders," 108
 Bird-protectors, 136
 "Bird Socials," 279
 Birds, allies of farmers, 81; check upon weeds, 82; clothing, 39; destruction of, by fences, 41, 42; food, 39, 43; ornaments, 39; paradise for, 193; value of, 86
 Birds bathing, description of, 220
 "Birds' Christmas Tree," 159
 Birds of prey, American, 35; Cooper's hawk, 34; duck hawk, 34; feeding habits of, 93, 94; sharp-shinned hawk, 34
 Blackbirds, 70; family, 107; food of, 83; red-winged, 33; value of, 107; yellow-headed, 139
 Blake, William, 122
 Bluebirds, 116; destruction of, 12; homes for, 195; nesting box, 199; situation of nesting box, 206; value of, 111, 112; winter feeding of, 164
 Bobolinks, 116; economic value of, 84; harm done by, 107, 108; slaughter of, 108; value of, 107
 Bobwhite, food of, value of, 91
 Boobies, 59
 Borneo: birds of paradise, extinct species, head-hunting natives, 40
 Boxes, bird, kinds making use of, 199
 Boy Scouts, "first aid" corps, 236; work of, 130, 132
 Boys, small, bird clubs, 266; destruction by, 71, 72, 264; teaching of, 265
 Breakfast, birds invited to, table, nuts, 6
 Brewster, William, 27, 189
 Brookline (Mass.) Bird Club, 280
 Brush Hill Bird Club of Milton, Mass., 274
 Bryan, Professor William A., 61, 107
 Buffalo, 14; Society of Natural Sciences, 234
 Bunting, snow, 139, 145; value of, 108
 Bureau of Animal Industry, Washington, D. C., 237
 Bureau of Biological Survey, Washington, D. C., 291, 297
 Burnham, John B., letter from, 283
 Burroughs, John, 124
 Buzzard, turkey, scavengers, value of, 94
- C
- California, University of, 107
 Canaan, Connecticut, 36
 Cape Cod, Massachusetts, 52
 Captain Cartwright's Journal, 24
 Catbird, description of bath, 224; value of, 111, 113
 Catchers, bird, professional, 66
 Caterpillars, food for birds, 84; hairy, food for cuckoos, 100
 Cats, house, destruction by, methods, 74
 Cats, belling, 247; house, 74; restraining of, 247; tax on, 251; "Tramp," 76; unnecessary ones, 249
 Census, bird, description of, 291; sample, 295
 Chaff, 139
 Chambers, Fred. W., 17
 "Chanticleer" bow, 123
 Chapman, Frank M., 54, 74, 87, 253, 294
 Charlestown (N. H.) Bird Club, 279
 Chaucer, 122
 Chickadees, at breakfast, 6; attack on, 31, 110; band of, 9; boldness of, 8; cheerfulness of, 116; eating sandwich, 7; fearlessness of, 2; "food dish" for,

Chickadees—*Continued*

- 156; friendliness of, 128; Hudsonian, 138, 139, 140, 145; in New Hampshire, 7; insect-eating bird, 16; investigating rifle, 7; nesting box for, situation of, 199, 206; suet, 8; tameness of, 5; value of, 110; Washington, 159; window box, 148; winter food of, 137; work of, 111
- Chipmunks, 29
- Cincinnati Zoological Park, 51
- Citizen Bird*, 74
- Clap nets, 50
- Claremont (N. H.) Bird Club, 280
- Clark University, 251
- Clubs, bird, advertising of, 275; debates, 290; desirability of, 272; dues, 278; exhibitions, 280; growth of, 297; members, 276; Meriden, 137, 140, 228, 231, 273, 281; necessity for, 271; organizations interested in, 297; organization of, 269; place of meeting, 274; plea for, 298; work, 278
- Coccidiosis, disease of intestines, 18; sparrows as carriers of, 18
- Collectors, scientific, 72, 73
- Columbus, Christopher, value of birds to, 87
- Connecticut, Canaan, 36; Stamford, 14
- Conservation, bird, 254
- Corbin Game Preserve, 41
- Corn, cracked, Kaffir, whole, 139, 140
- Cornfield Bird Club of Cornish, N. H., 279
- Cornish, N. H., 26
- Courage, 10, 11
- "Cover," description of, 167; value of, 168
- Cowbirds, value of, 107
- Coyotes, enemies of birds, 21
- Crane, whooping, extinction of, 54
- Cranes, destroyers of insects, 88, 89

- Creation, The*, Haydn, 121
- Creepers, 16; brown, 138, 145; destroyers of insects, 111
- Crickets, black, destruction of, 85
- Crossbills, 66, 148; American, 3, 140; fearlessness of, 141; white-winged, 3, 140, 144
- Crows, 116, 133, 138, 246; economic value of, 105, 106; in raccoons' pen, 25; nest robbing by, 33
- Crumbs, bread, dog-biscuit, doughnut, 139, 140
- Cuckoos, black-billed, 100; classification of, 84; destroyers of insects, 101; yellow-billed, 100
- Curlews, bristle-thighed, 59; destroyers of insects, 89; Esquimau, 89; Esquimau, extinction of, 51, 53; nesting grounds, slaughter of, winter quarters of, 52

D

- Damage done by "so-called" sportsmen, 63, 64
- Deane, Walter, 189
- Dearborn, Ned, 79, 101, 242
- Department of Agriculture, Washington, D. C., 81, 82, 102, 190, 191, 195, 264
- Destroyers of bird life, civilized man, savages, 40
- Destroyers of insects, 88
- Destruction of birds, disease, 10, 17; elements, 10; foreigners, 66; forest fires, 42; light-houses, 40; lumber camps, 71; mining camps, 71; Statue of Liberty, New York Harbor, 40; wholesale, 39; wild birds, 17; wire fences, 41; wires, telephone, telegraph, electric light, trolley, 41
- Directory of Officials and Organizations Concerned with the Protection of Birds and Game*, 297

- Diseases, cholera, bubonic plague 17
- Dodo, extinction of, cause, 78
- Dogs, bird, 71; destroyers, 77; Esquimaux, 77
- Dormouse, 30
- Dough bird, extinction of, 51-53
- Dove, mourning, food of, 91; wild, 190
- Drinking pools, necessity for, 219
- Ducks, 14, 17; Labrador, extinction of, 45; mallard, nest boxes of, 213; value of, 88; wild, 191; wood, nest boxes, 213
- Dutcher, William, 123, 148, 199
- E
- Early settlers: friends of birds, destruction of bird enemies, 43
- Eckstorm, Fanny Hardy, 102
- Eggs, auks, 39; destruction of, 25; eider ducks', 24; Esquimaux, 39; as food, 39
- Egret, snowy, extinction of, 54
- Elements, help against, 17
- Enemies, savage people, civilized man, 37
- English Sparrow as a Pest*, 79
- Epidemics, 17; at Utah, 237
- Ermine, 26
- Esquimaux, 39
- European sparrows, extermination of, 241
- F
- Farmers' Bulletin*, 79
- Farmers, destroyers of birds of prey, 64; help given by, 263
- Faxon, C. E., 189
- Fay School, Southborough, Mass., 270
- Feathers, for women's hats, 40
- Federal Migratory Bird Law, 259
- Feeding devices, Audubon food house, 152-155; food bell, 155; "food dish," 156; food tray, 147; food tree, 156; food trolley, 160; stuffed cocoanuts, 159; weathercock food house, 149-151; window box, 148
- Feeding ground, 4
- Feeding stations, 134, 135, 146
- Ferry Hall, Lake Forest, Ill., 270
- Finches, 16, 59; purple, 129, 138, 144; sharp-tailed, 27; value of, 108
- Fisher, A. K., 35, 82, 92, 94, 98, 159
- Fisher, Walter K., 58
- Flickers, 34, 138; nesting box, 199; situation of, 209; value of, 101
- Flies, house, destruction of, 104; ichneumon, destruction of, 85
- Floods, effect of, on ground-nesting birds, 13, 14
- Flycatchers, great-crested, nesting box, 199, 209; method of feeding, 103
- Food bell 155
- "Food-cake," 158
- "Food-dish," 156
- Food houses, 142; Audubon, 152-155; weathercock, 149; description of, 151
- Food shelters, 147
- "Food stone," 138, 158
- Food tray, description of, 147
- Food tree, 5; description of, 156
- Food trolley, 142; description of, use, 160
- Forbes, Professor, 112
- Forbush, Edward Howe, 16, 37, 75, 87, 90, 247
- Foreigners, ignorant, damage done by, 259; trouble with, 260
- Forest fires, damage done by, 255; prevention and evils, 42
- Forestry, 254
- Foxes, enemies of birds, 22, 23; good points, 24
- Frankfort, Kentucky, 46

Freeman, Harriet E., 230
Fruits, food for birds, lists, 170-186

G

Game birds, 22
Game wardens, 69
Gander, wild, 116
Geese, 14; value of, 88
Germany, establishment of bird sanctuaries, 198
Goldfinches, 66, 139, 140
Gophers, 84
Goshawk, habitat, 93
Grackles, value of, 107; as robbers of nests, 32
Great Lakes, 11
Grebe, pied-billed, 37, 44
Grieg, Edouard, 121
Grit, 141
Grosbeak, cardinal, 138, 139; pine, 2, 31, 116, 138, 144, 148; rosebreasted, 138
Grouse, 19, 22, 190; ruffed, 139; value of, 90
Gulls, Franklin, economic value of, 85; scavengers, 87; sea, beauty of, 116; market for, 44

H

Hadley, Professor Philip B., 18
Hale, Edward Everett, 230
Hanover (N. H.) Bird Club, 274
Hawaiian Islands, 57; birds seen on, exploration of, 58
Hawks, classification of, 92; Cooper's, 35, 84, 238; destructiveness of, 84; duck, habitat, 93; goshawk, habitat, 93; marsh, habitat, food, method of hunting, value of, young, 95-97; night, food of, 103; red-shouldered, 95; red-tailed, range of, 94; sharp-shinned, 35, 84, 238; sparrow, nesting box, situation of, 199, 213; species, 92; value to farmers, 91, 94

Haydn, *The Creation*, 121
Henshaw, H. W., 291
Heron, great white, extinction of, 54
Herons, 89; destroyers of insects, 88; market for, 44
Hieseman, Martin, 216
Hodge, Professor Clifton F., 164, 243
Honey-eaters, 59
Hornaday, William T., 283
Hospitality, necessity for, 163
Houses, bird, description of, 195, 196
Humming-bird, 117; ruby-throated, 144, 190
Huse, Ernest L., 296; description of bird bath of, 228

I

Ibises, destroyers of insects, 88
Ice: insect-eating birds, 16
"Ike" Bonner's stage, 1
Information, current, 297
Insect-eating birds, 11
Insect life, scarcity of, 12
Inspiration of birds to poets, English, 122; American, 124
Isle of Wight, 256
Italy, 66, 69

J

Jacobs, Captain, 61
Japan, 57
Jay, blue, as a robber of nests, 32, 133, 144; æsthetic value of, 116; death of, 35; economic value of, 105; food for, 138, 139, 140; tameness of, 151; window box for, 148
Journal, Captain Cartwright's, 24
Judd, Dr. Sylvester D., 83, 91, 110
Juncos, 18, 144, 160; æsthetic value of, 116; economic value of, 108; food for, 138, 139, 140

K

- Kennard, Frederic H., 3, 28,
54, 152, 167, 190, 216
Kentucky, Frankfort, 46
Killing for market, 40
King, Professor, 91
King of the Pacific, 57
Kingbird, 33
Kingbird, flycatcher, food of, 104
Kinglets, value of, work of, 110

L

- Labrador, 52, 77; duck, extinc-
tion of, 45, 46
Landlord, bird lover as, 192
Lapland longspurs, 12, 139
Lark, shore, 139
Law, Federal Migratory Bird,
259
Laysan, 56, 57; slaughter on,
61, 62
Lighthouses, "bird rests," 256;
damage done by, 255
Lime, bird, 66
Locusts, destruction of, 86;
Rocky Mountain, 103
Longspur, Lapland, 12, 139
Lumbermen, damage done by,
263

M

- MacKaye, Percy, 118, 231, 281
Magdalen Islands, 52
Maid of the Mist, 14
Malaria, 104
Man-o'-war birds, 59
Market: cold storage, 44; game
dealers, 44; growth of, 44;
gunning, 256; gunners, pro-
fessional, 44; hunter, 64;
methods used, 64; milliners,
44; the passing of, 256;
plumage, 39, 40; plume hunt-
ing, 256
Marsh hens, 27
Martins, purple, 12, 109; situa-
tion of nest boxes, 209

- Massachusetts, 12, 13, 75; New-
ton Centre, 152, 167; Stone-
ham, 134; Woods Hole, 51
Mauritius, Island of, 78
McAtree, W. L., 191
Meadowlarks, 70; economic
status of, 107; value of, 107;
Western, 107
Mealworms, study of, 165
Meat, raw, 138
Meriden, N. H., 1, 2, 4, 5, 31,
33, 144, 145, 156, 163, 190,
199, 214, 220, 231; bird baths,
229; Bird Club, 137, 140, 228,
231, 273, 281, 289; destroying
bird enemies, 240
Merriam, Clinton Hart, 264
Mexico, Gulf of, 11
Mice, meadow, damage done
by, 30; destruction of, 97
Michelet, Jules, 122
Michigan, 111
Miller-birds, 59
Milliners' market, 44
Miners, damage done by, 262
Mink, 25
Minnesota, 289; Natural History
Survey, 12
Minnetonka Game Refuge, 289
Mocking birds, value of, 111
Mormons, 84
Music, origin of, 120
Muskrats as egg-eaters, 29

N

- Natural enemies of birds, 20
Nature, balance of, 38
Nebraska, 89, 103, 109
Negroes, teachers of, 262
Nest boxes, Berlepsch, 128, 200;
best places for, 205; cleaning
of, 214; condition of, 202;
general situation of, 202;
position of, 203; preparation
for hanging, 204; selection of,
201; sizes, 204; time, reasons
for, 201
Nesting material, 217

- Nesting sites, necessity for, 192
 New England, 12, 116
 Newfoundland, 52
 New Hampshire, 7, 41, 144;
 Cornish, 26; Meriden, 145,
 156, 163, 190, 199, 214, 220,
 231; Meriden Bird Club, 289
 Newton Centre, Mass., 152, 167
 New York City, 295
 New York Zoological Society,
 297
 Norfolk, Connecticut, 283
 North Carolina, 91
 Nutcracker, Clark's, 138
 Nuthatches, 5, 16, 66, 137, 159;
 red-breasted, 2, 138, 139, 140,
 145, 199, 208; situation of
 nest boxes, 199, 208; value of,
 110; white-breasted, 2, 138,
 139, 140, 145, 199, 208; work
 of, 110
 Nuts, 6; broken, 5, 139; nut-
 meat, 128
- O
- Oats, 139
 Opossums, destroyers of nests,
 30
 Origin of music, 120
 Orioles, market for, 44; value of,
 107
 Ornis, Spirit of all birds, 118
 Osborne, C. A., 251
 Owls, Arcadian, 212; barn, food
 of, value of, 98; classification
 of, 92; destructiveness of, 33;
 great horned, economic value
 of, 33, 34, 84; hooting of, 117;
 pellets of, 99; screech, 33, 34,
 138, nesting box of, 199;
 situation of nesting box of,
 214; range of, 99; value of,
 99; short-eared, food of, 82;
 species, 92; value to farmers,
 91
- P
- Paraquet, Carolina, extinction
 of, 54
- Pastoral Symphony, 120
 Pease, C. H., 36
 Pelicans, white, food of, 88
 Pennsylvania, 42; "The Scalp
 Act," 264
 Pests, destruction of, 81; lists of,
 90
 Petrels, 59
 Phoebe, habits of, 104; houses of,
 215; nests of, 13
 Pigs as destroyers of birds, 77
 Pigeon, passenger, armies of,
 47; extinction of, 46; flight
 formation of, 46; flocks raised
 in confinement, 51; harvest of,
 methods used, 48, 49, 50;
 markets for, 50; nests, 48;
 slaughter at roosts, 48; squabs,
 48
 Pike, an enemy of birds, 37
 Plover, golden, 59; upland, 89
 Plumage, demand for, 44, 54
 Plume-hunter, 118; "so-called"
 sportsman, 63
 Poachers, Italian, 69
 Polar bears, 24
 Policemen of the air, 103
 Pork, 138
 Potato bugs, 90
 Poultry, 22
 Problems for beginners, 233;
 cats, training of, 247; crows,
 246; disease, 236; dogs, 253;
 European sparrows, 240-242;
 floods, natural enemies, killing
 of, 238; preservation tracts,
 239; storms, 268; waterfalls,
 234
 Protection of birds, æsthetic
 reasons, 115; by law, 62;
 economic reasons, 81; moral
 reasons, 115, 125, 126
- Q
- Quail, 16, 19, 22, 139, 140;
 Massachusetts, saving of, 135;
 starvation of, in Massachu-
 setts, 16; value of, 90

Quarles, E. A., 261
 Quarles, F. A., 36
 Quicklime, birds buried in, 17

R

Raccoons, destructiveness of, 24, 30; food of, 25
 Rails, 59; photographing of, 60
 Raquet, description and use of, 67
 Rats as destroyers, 29, 30
 Redpolls, 2; flocks of, 4; food of, 139; friendliness of, 144; window box for, 148
 Redstarts, 65
 Rehder, Alfred, 190
 Resources, natural, conservation of, 125
 Rhinebeck, N. Y., Bird Club, 274
 Rhode Island, Biological Laboratory at Kingston, 18
 Roberts, Thomas S., 12
 Robins, 18; houses of, 216; legal killing of, 69; slaughter of, in Southern States, 70; value of, 111, 112; winter feeding of, 164; winter hardships of, 13; young, 33
 Roccolos, description and use of, 67
 Rodents, destruction of, 81
 Roosevelt, Theodore, 289
 Royal Society for the Protection of Birds at St. Catherine's, 256

S

Saint-Gaudens, Mrs. Louis, 231
 Salt, 3, 140
 Salt Lake City, Utah, 85
 Sanctuary, bird, 55, 190, 231; bath, 220; cats, 248; description of a successful one, 283; establishment of, 282; establishment of, in Germany, 198; *Sanctuary*, 118
 Sanderson, Professor E. D., 111

Sandpipers, destroyers of insects, 89
 Sapsucker, yellow-bellied, destructiveness of, 84; nest boxes of, 212
 Savage, James, 14, 15, 234
 Saw whet, nest boxes, 212
 Scalp Act, The, 264
 Scarecrow, 246
 Scavengers, 94; sea-gulls, 87
 Schaeffer, Nathan C., 42
 Schubert, *Cymbeline*, 121
 Scientists, value of, 267
 Scotland, King James I., 122
 "Seebach," 193
 Seeds, kinds used for food, 90, 91, 138, 139, 140; kinds used for winter food, 137; purchase of, 137
 Seton, Ernest Thompson, 215
 Shakespeare, 122
 Shearwaters, 59
 Shelter woods, 216
 Shelves, for Phoebe and Robins, 215
 Shrikes, destructive to small birds, 30; economic value of, 110
Siegfried, 120
 Siskins, 66; pine, 2, 4, 139, 144
 Skunks, 25; damage done by, 27
 Skylarks, 66
 Slaughter of birds by negroes, poor whites, 69, 70
 Smite, Helen Woodruff, 281
 Smithsonian Institute, 99
 Snakes, black, milk, 36
 Snipe family, 17
 Snow, seed-eating birds, 16
 Society for Prevention of Cruelty to Animals, 77
 Sparrows, 16; chipping, 13, 139, 140, 144; European, 18; enemy of song birds, 78; extermination of, 30, 241; field, 18; food of, 83; fox, 138, 139, 140, 145; poisoning of, 243; song, 14, 34; attacked by snake, 37; description of bath,

Sparrows—Continued

- 225; tree, 138, 139, 140; economic value of, 84; food found in, 109; value of, 108; vesper, 138, 139, 140, 144; white crowned, 138, 139, 140, 144; white-throated, 18, 138, 139, 140, 144; traps, 242
- Spenser, Edmund, 122
- Spirit of all birds, Ornis, 118
- Spoonbills, destroyers of insects, 88, 89
- Sportsmen, 44, "so-called," 54, 257; true, 257
- Squirrels, flying, 29; gray, 29; ground, 84; red, robbers of nests, 28, 29
- Stark, 118
- Starling, 138; European, 78, 80; insect-destroyers, 89; nesting boxes, 199
- Stickney, Mr. Lewis, 31
- Stoneham, Mass., 6, 134
- Storms, 11; a means of destruction, 10
- Storks, insect-destroyers, 88
- Suet, 133; as food, 5; pockets, description and use of, 145; suet stations, 144
- Survey, Minnesota Natural History, 12
- Swallows, bank, 27; beneficial species, 109; destruction of, 12; tree, homes for, 195; nesting boxes for, 199; situation of nesting boxes for, 208
- Swan, trumpeter, extinction of, 54
- Swans, 14; injured, 234; rescuing of, 235; saving, 15; value of, 88
- Swifts, destruction of, 12; method of feeding of, 103
- Symbolism of birds, 119

T

- Tameness of birds, 59
- Tanagers, scarlet, 28, 44

- Tar, the use of, 246
- Teal, 59
- Tenebrio molitor*, 165
- Tenebrio obscurus*, 165
- Terns, 58; economic value of, 86; market for, 44; value to sailors, 87
- Thrashers, value of, 111
- Thrush, 34, 66; hermit, 18, 138, 145; value of, 111, 113
- Titmice, 66; tufted, 138, 139, 159; value of, 110; work of, 110
- Townsend, Charles H., 24, 77
- Trafton, Gilbert H., 140, 160
- Traps, sparrow, 242
- Tropic birds, red-tailed, 59
- Trunstones, 59
- Turkey vultures, 16
- Turtles, snapping, 35, 36
- Typhoid, 104

U

- University of California, 107
- Utah, 84, 85; waterfowl, 17

V

- Village, The Bird, 1
- Vireos, value of, work of, 110
- Virginia, 91
- Vultures, black, value of, scavengers, 93, 94; turkey, 16

W

- Waco, Neb., Esquimau curlew shot at, 53
- Wagner, 120
- Walcott, Frederick C., 283
- Walnuts, English, 7
- Walpole, N. H., Bird Club, 274
- Warblers, 11, 66; myrtle, 138, 144; value of, 110; work of, 110
- Washington, 159
- Waterfalls, 14

- Waxwings, cedar, 70; winter feeding of, 164
 Weasel, method of hungry birds, 25; white, 26
 Weed, Clarence Moores, 101, 113
 Weeds, destruction of, 82
 West Indies, 52
 Wheat, 140
 Whippoorwills, 103, 117
 Whites, ignorant, 261
 Whitman, Professor C. O., 51
 Wild birds, entertainment in winter, 127; friendliness of, 127; providing for needs of, 125; winter feeding of, 127; winter foods of, 129
 Wild cats, enemies of birds, 21
 Wilson, Alexander, 46
 Window boxes, 142, 148
 Window-sill, 5
 Winter, lack of food, 15
 Wisconsin, 91, 102
 Wolverines, harm done by, 27
 Wolves, enemies of birds, 21
 Woodcrafters Bird Club of Culver, Ind., 274
 Woodpeckers, 16, 66; destroyers of insects, 101; downy, 5, 138, 144, 160; nesting box of, 199, 214; value of, 102; hairy, 138, 144; nesting box of, 199, 214; food of, 102; flicker, 138; pileated, 212; red-bellied, 138, 145; red-headed, 199, 209; species, 101; three-toed, 213; value of, 101
 Woods Hole, Mass., 51
 Worms, mealworms, raising of, 164, 165
 Wrens, homes for, 195, 199; value of, 110; winter, 144; work of, 110
 Wright, Mabel Osgood, 74
 Wyncote (Pa.) Bird Club, 274
- Y
- Young, destruction of, 25; robins, 33



Zool.
Aves
B

Baynes, Ernest Harold

168009

Wild bird guests, how to entertain them.

DATE.

NAME OF BORROWER.

University of Toronto
Library

DO NOT
REMOVE
THE
CARD
FROM
THIS
POCKET

Acme Library Card Pocket
Under Pat. "Ref. Index File"
Made by LIBRARY BUREAU

